

**LAVATORY FAUCET
K-454**

ADA

Features

- Brass construction
- Brass valve bodies
- Quarter-turn washerless ceramic disc valves
- Flexible connections for easy installation
- 2.2 gpm (8.3 lpm) flow rate
- Lower flow aerator options are available (refer to the Kohler Price Book)
- Pop-up drain with lift rod and tailpiece
- Cross or lever handles
- 5" (12.7 cm) spout

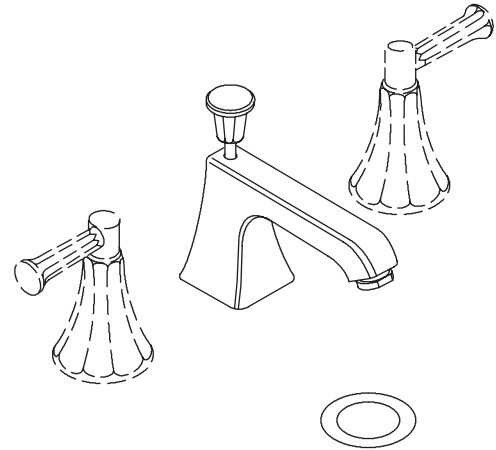

Codes/Standards Applicable





Specified model meets or exceeds the following:

- ASME A112.18.1/CSA B125.1
- IAPMO/UPC
- NSF 61
- Energy Policy Act of 1992 (EPACT)
- ADA

Colors/Finishes

- CP: Polished Chrome
- PB: Polished Brass
- Other: Refer to Price Book for additional colors/finishes

Specified Model

| Model | Description |  ADA | | |  ADA | | |
|----------|--|---|-----------------------------|-----------------------------------|---|-----------------------------|-----------------------------------|
| K-454-3C | Faucet with classic cross handles | <input type="checkbox"/> CP | <input type="checkbox"/> PB | <input type="checkbox"/> Other___ | | | |
| K-454-3S | Faucet with stately cross handles | | | | <input type="checkbox"/> CP | <input type="checkbox"/> PB | <input type="checkbox"/> Other___ |
| | |  ADA | | |  ADA | | |
| K-454-4C | Faucet with classic lever handle | <input type="checkbox"/> CP | <input type="checkbox"/> PB | <input type="checkbox"/> Other___ | | | |
| K-454-4S | Faucet with stately faceted lever handle | | | | <input type="checkbox"/> CP | <input type="checkbox"/> PB | <input type="checkbox"/> Other___ |
| | | | | |  ADA | | |
| K-454-4V | Faucet with stately Deco lever handle | | | | <input type="checkbox"/> CP | <input type="checkbox"/> PB | <input type="checkbox"/> Other___ |

Product Specification

Two-handle widespread lavatory faucet shall be of brass construction. Faucet shall feature brass valve bodies. Faucet shall feature quarter-turn washerless ceramic disc valves, assuring positive handle stop positioning. Faucet shall include flexible connections, 5" (12.7 cm) spout, pop-up drain with lift rod and tailpiece, and cross or lever handles. Faucet shall be rated at 2.2 gallons (8.3 L) per minute. Faucet shall have lower flow aerator options. Faucet shall be Kohler Model K-454-_____-_____.

MEMOIRS®

Installation Notes

Install this product according to the installation guide.

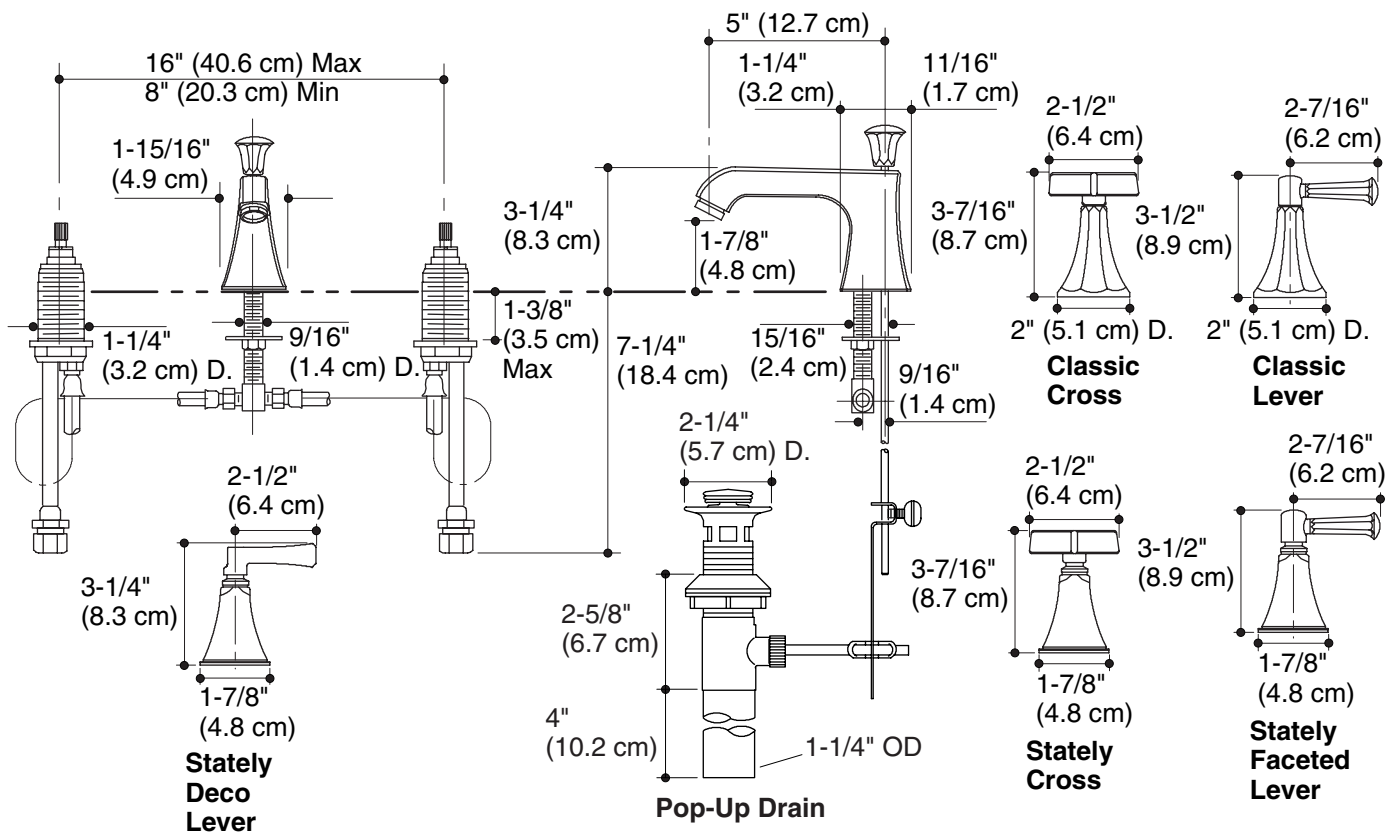

Product Diagram