

### Ordering Information

Applicable faucet:	
With cross handles	K-6813-3
With lever handles	K-6813-4
<b>ADA</b> Lever and cross handles are ADA compliant	

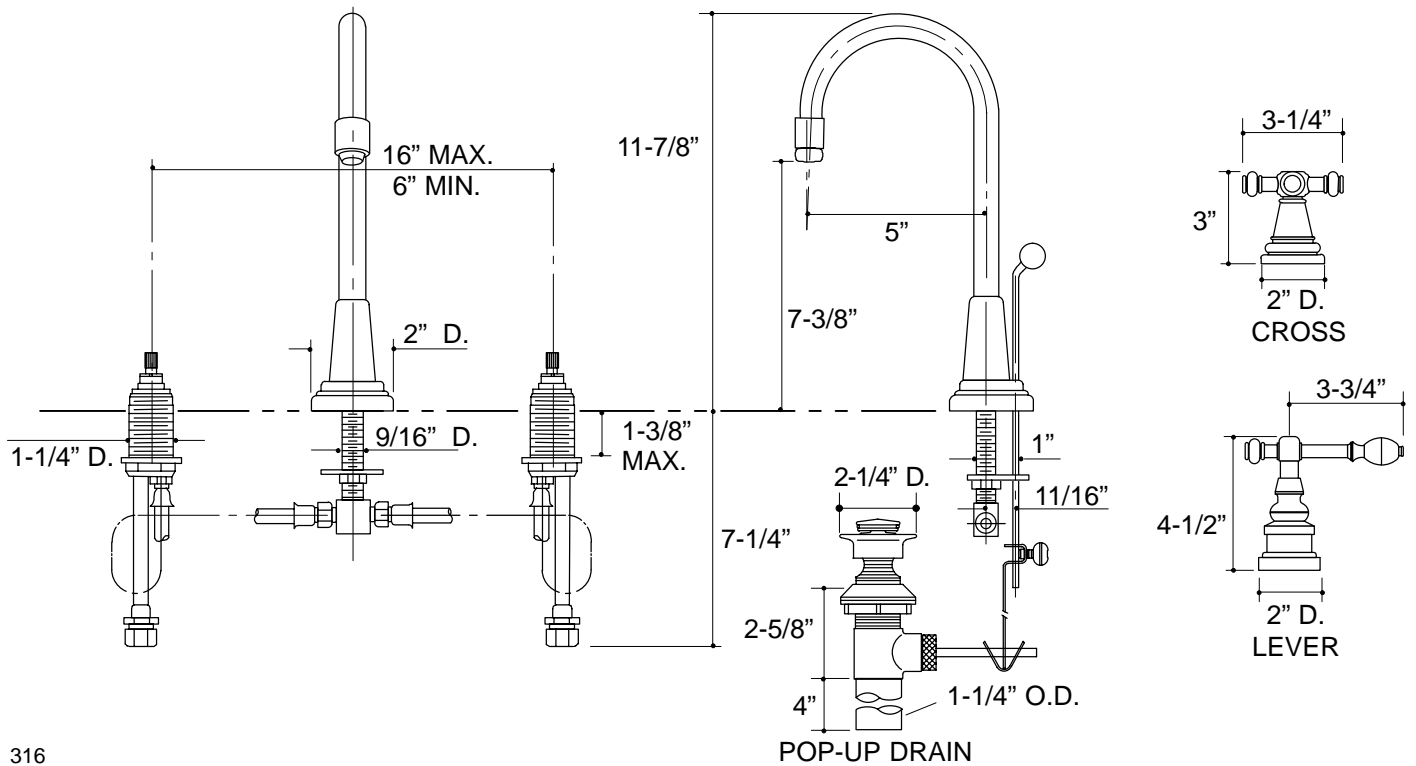

316

**K-6813** IV Georges Brass™ Lavatory Faucet  
110403-1-AA (9619)

**KOHLER®**

**NOTES:**