



Features:

- Ceramic disc valve cartridge
- Cast brass valve body with built-in check stops
- Adjustable hot limit safety stop
- Wax Thermostatic Unit permits shuttle valve to move between the hot and cold seats to maintain the preselected constant water temperature
- Available in 5 Handle Options

Pictured: 875/892 Thermostatic Mixing Valve with Straight Lever Handle

Maximum Temperature Limit: 112°

Kit Options	Handle Type	Product Number
3/4" Thermostatic Mixing Valve Set	Cross	875/780
3/4" Thermostatic Mixing Valve Set	Straight Lever	875/892
3/4" Thermostatic Mixing Valve Set	Curved Lever	875/893
3/4" Thermostatic Mixing Valve Set	Porcelain Lever	875/894
3/4" Thermostatic Mixing Valve Set	Crystal Lever	875/899

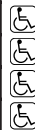

Rough & Trim Options	Handle Type	Product Number
Trim Only	Cross	875/771
Trim Only	Straight Lever	875/792
Trim Only	Curved Lever	875/793
Trim Only	Porcelain Lever	875/794
Trim Only	Crystal Lever	875/799
Rough Only		875/614/191

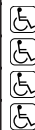

Available Finishes:	Finish Code
Polished Chrome	100
Old Bronze	105
UltraBrass	113
Brushed Nickel	144
Platinum Nickel	150
Diamond	167
Antique Nickel	444

Porcelain Finishes:	Finish Code
Brushed Nickel/White Porcelain	124
Polished Chrome/White Porcelain	128
Platinum Nickel/White Porcelain	152

ROUGH-IN DIAGRAM SHOWN ON REVERSE SIDE

Handle Options:

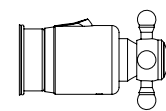
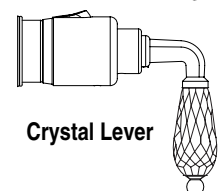
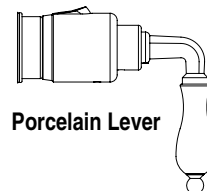
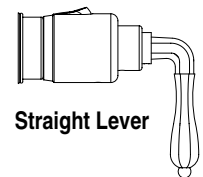
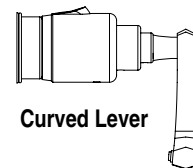

CODES & STANDARDS

These products meet and exceed the following codes and standards:

ASME A112.18.1

CSA B125

ASSE1016



Meets the American Disabilities Act Guidelines and **ANSI A117.1** Requirements for the physically challenged.

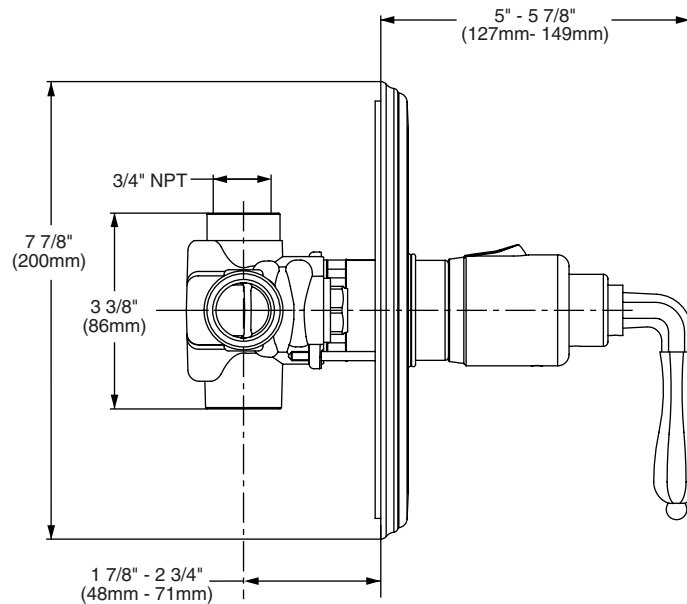
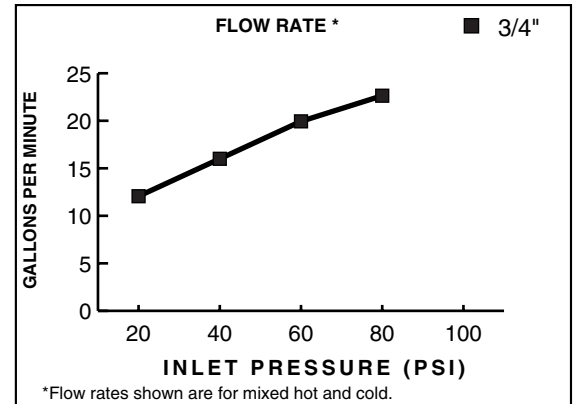

IMPORTANT: These measurements are subject to change or cancellation. No responsibility is assumed for use of superseded or voided pages.