

JADO

Classic/Victorian/Colonial Pressure Balance Shower Set



Features:

- Cast brass valves
- Ceramic disc valve cartridge
- Adjustable hot limit safety stop
- Pressure Balance cartridge maintains constant output temperature in response to changes in relative hot and cold supply pressures
- Multi-functional showerhead
- Available in 5 Handle Options

Pictured: 853/451 Shower Set with Straight Lever Handle

Showerhead Maximum Flow Rate: 2.5 GPM (9.5L/min)

Kit Options	Handle Type	Product Number
Shower Set	Cross	853/450
Shower Set	Straight Lever	853/451
Shower Set	Curved Lever	853/452
Shower Set	Porcelain Lever	853/453
Shower Set	Crystal Lever	853/454
PB Shower Valve Set	Cross	853/130
PB Shower Valve Set	Straight Lever	853/131
PB Shower Valve Set	Curved Lever	853/132
PB Shower Valve Set	Porcelain Lever	853/133
PB Shower Valve Set	Crystal Lever	853/134

Available Finishes:	Finish Code
Polished Chrome	100
Old Bronze	105
UltraBrass	113
Brushed Nickel	144
Platinum Nickel	150
Diamond	167
Antique Nickel	444

Porcelain Finishes:	Finish Code
Brushed Nickel/White Porcelain	124
Polished Chrome/White Porcelain	128
Platinum Nickel/White Porcelain	152

Rough & Trim Options	Handle Type	Product Number
Shower Set Trim Only*	Cross	853/485
Shower Set Trim Only*	Straight Lever	853/486
Shower Set Trim Only*	Curved Lever	853/487
Shower Set Trim Only*	Porcelain Lever	853/488
Shower Set Trim Only*	Crystal Lever	853/489
PB Shower Valve Set Trim Only**	Cross	853/535
PB Shower Valve Set Trim Only**	Straight Lever	853/536
PB Shower Valve Set Trim Only**	Curved Lever	853/537
PB Shower Valve Set Trim Only**	Porcelain Lever	853/538
PB Shower Valve Set Trim Only**	Crystal Lever	853/539
Shower Head Only		862/082
Rough Only		899/260/191

* Includes Pressure Balance Shower Valve Trim & Shower Head

**Pressure Balance Shower Valve Trim Only

Handle Options:

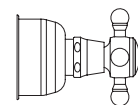
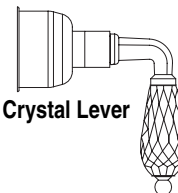
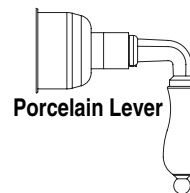
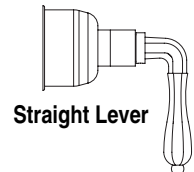
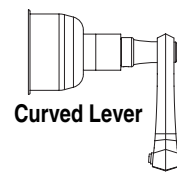

ROUGH-IN DIAGRAM SHOWN ON REVERSE SIDE

CODES & STANDARDS

These products meet and exceed the following codes and standards:

ASME A112.18.1

CSA B125

ASSE1016

 Meets the American Disabilities Act Guidelines and **ANSI A117.1** Requirements for the physically challenged.

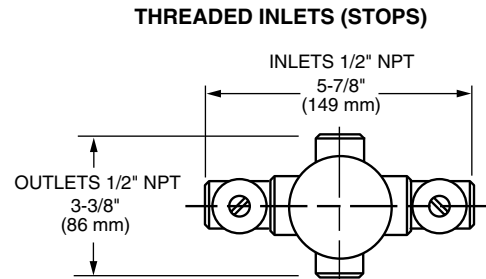
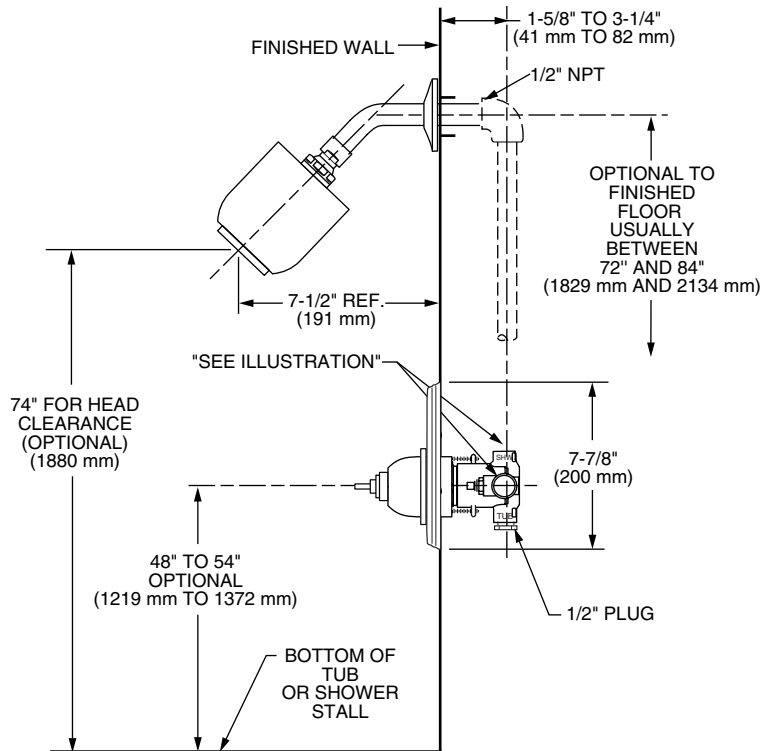
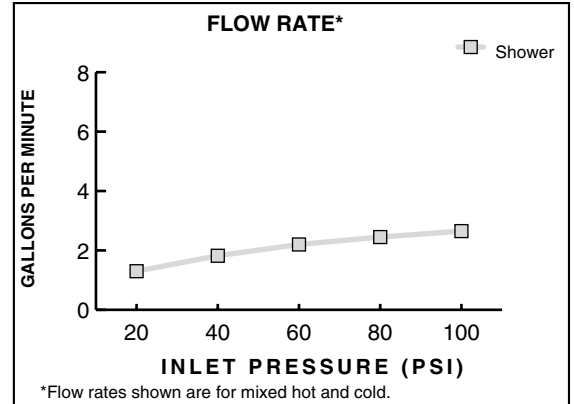

IMPORTANT: These measurements are subject to change or cancellation. No responsibility is assumed for use of superseded or voided pages.