



Shown without handles.
 Faucet comes complete with factory installed handles.

MODEL NUMBER:

- 5401.102H Centerset Lavatory Faucet**
 Brass Crown Handles. Metal pop-up drain. 
- 5401.142H Centerset Lavatory Faucet**
 Metal Lever Handles. Metal pop-up drain. 
- 5401.172H Centerset Lavatory Faucet**
 Brass Wrist Blade Handles. Metal pop-up drain. 

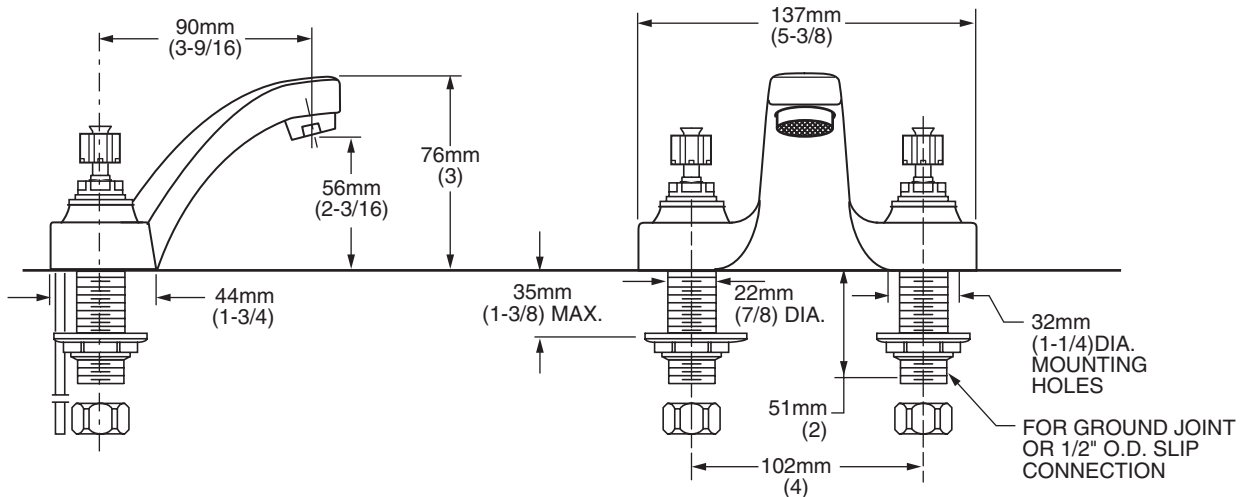

GENERAL DESCRIPTION:

Durable cast brass construction. Amarelis 1/4 turn washerless ceramic disc valve cartridges - reversible for use with either lever or round handles. One-half inch male inlet shanks with brass coupling nuts and shank nuts. All brass drain bodies with 1-1/4" (32mm) tailpieces. 2.2 gpm/8.3L/min. maximum flow rate.

PRODUCT FEATURES:

- Solid Brass Construction:** Durable - Excellent in high use applications. Ideal for prolonged contact with water.
- Ceramic Disc Valve Cartridges:** Assures a lifetime of drip-free performance.
- Low Lead:** Meets NSF Standard 61/Section 9 & Prop 65 lead requirements.
- Factory Installed Handles:** Simplifies installation.

SUGGESTED SPECIFICATION:



4" centerset lavatory faucet shall be cast brass construction with all brass shank nuts and coupling nuts. Shall also feature 1/4 turn washerless ceramic disc valve cartridges that are reversible for use with round or lever handles. Fitting shall be American Standard Model # 5401.____.002 .

CODES AND STANDARDS

These products meet or exceed the following codes and standards:

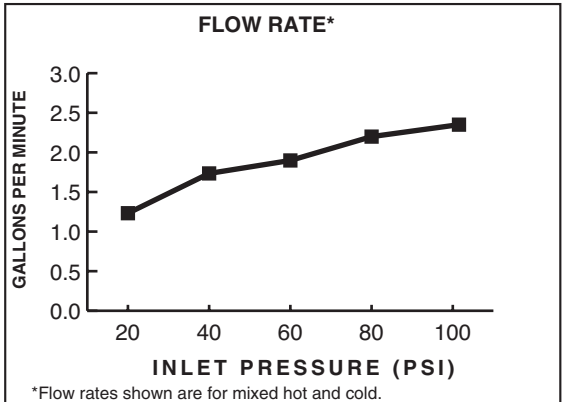
- ASME A112.18.1**
- CSA B 125**
- NSF 61/Section 9**



| | Product Number | Description | Finish |
|---|----------------|---|-----------------|
| | | | Polished Chrome |
| | | | 002 |
|  | 5401.102H | Centerset lavatory faucet. Brass Crown Handles. Metal pop-up drain. | |
|  | 5401.142H | Centerset lavatory faucet. Metal Lever Handles. Metal pop-up drain. | |
|  | 5401.172H | Centerset lavatory faucet. Brass Wrist Blade Handles. Metal pop-up drain. | |



 Meets the American Disabilities Act Guidelines and **ANSI A117.1** Requirements for the physically challenged.