

*American Standard*

## **INSTALLATION GUIDE FOR**

**TOWN SQUARE® 5' x 42" MODEL 2748**

**TOWN SQUARE® 6' x 42" MODEL 2742**

**ELLISSE OVAL MODEL 2709**

## **AIR MASSAGE SYSTEM**

### ***THANK YOU...***

for selecting an American Standard bath. Your new bath is shipped to you after careful inspection. The Air Massage System is completely assembled with air pump, motor, lights, and system piping. All you need to finish the installation are your selected fittings and electrical connections for an Air Massage System.

To insure maximum performance and pleasure from this product, please follow the instructions and cautions.

FOR AFTER-SALES SERVICE CALL 1 (800) 442-1902 WEEKDAYS.

© American Standard Inc. 2007  
All product names listed herein are trademarks  
of American Standard Inc. unless otherwise noted.

**TABLE OF CONTENTS:**

Cover.....Page 1

Table of Contents.....Page 2

Safety Instructions Notice.....Page 3

Roughing-in Reference.....Page 4

Installation and Framing Instructions.....Page 5 - 7

Supplied Drain Assembly and Installation Instructions.....Page 7 - 11







Post Installation Instructions.....Page 12

Remote Blower Location Option.....Page 13

Warranty.....Page 14

# IMPORTANT SAFETY INSTRUCTIONS

## READ AND FOLLOW ALL INSTRUCTIONS!

-  **WARNING: Risk of personal injury.** Do not permit children to use this bathtub without adult supervision.
-  **WARNING: Risk of electric shock.** Do not permit electrical appliances near any bathtub when bathtub contains water.
-  **WARNING: Risk of hyperthermia and possible drowning.** People using medications and/or having adverse medical history should consult a physician before using this product.
-  **WARNING: Risk of personal injury.** Do not overfill bathtub before entering. Entering tub when filled more than 2/3 can cause overflow and slippery conditions. Exercise caution when entering and exiting.
-  **WARNING: No Food or Alcoholic Beverages.** Use of your bathtub immediately after meals is not recommended. Avoid alcohol consumption before or during bathing. Alcoholic beverages can cause drowsiness or hyperthermia resulting in loss of consciousness or even drowning.
-  **WARNING: Pregnancy.** If you are or think you may be pregnant, consult your physician before using the bathtub.

Use this unit only for its intended use as described in this manual. Do not use any attachments not recommended by American Standard.

The unit must be connected only to a supply circuit that is properly protected by a ground-fault circuit-interrupter (GFCI). Such a GFCI should be provided by the installer and should be tested on a routine basis. To test the GFCI, push the test button. The GFCI should interrupt power. Push the reset button. Power should be restored. If the GFCI fails to operate in this manner, the GFCI is defective. If the GFCI interrupts power to the bathtub without the test button being pushed, a ground current is flowing, indicating the possibility of an electric shock. Do not use this air bath. Disconnect the air bath and have the problem corrected by a licensed electrician before using.

## SAVE THESE INSTRUCTIONS

# ROUGHING-IN REFERENCES

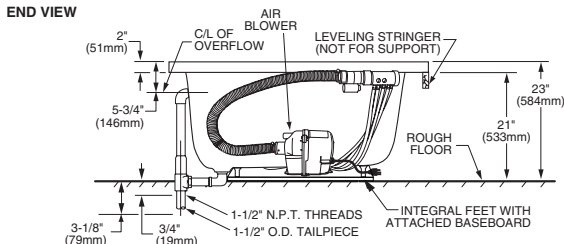
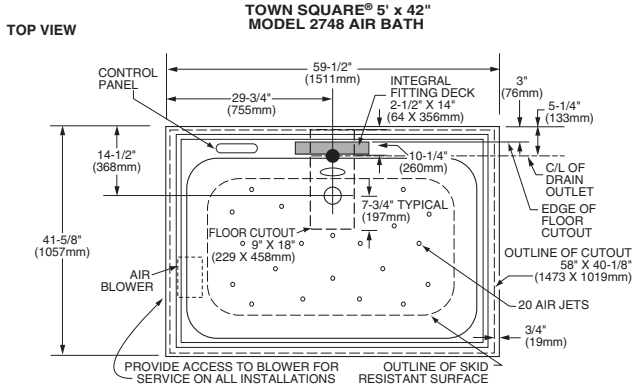

**HOLE DRILLING LOCATION FOR AMERICAN STANDARD "TOWN SQUARE" DECK MOUNT BATH FILLER WITH PERSONAL SHOWER, MODEL #2555.901 ONLY**

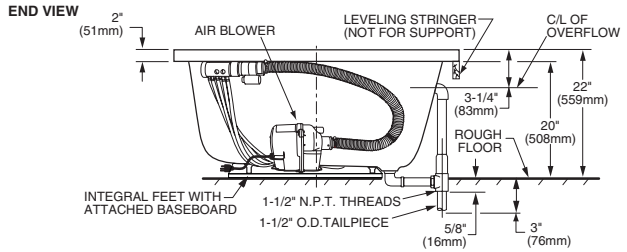
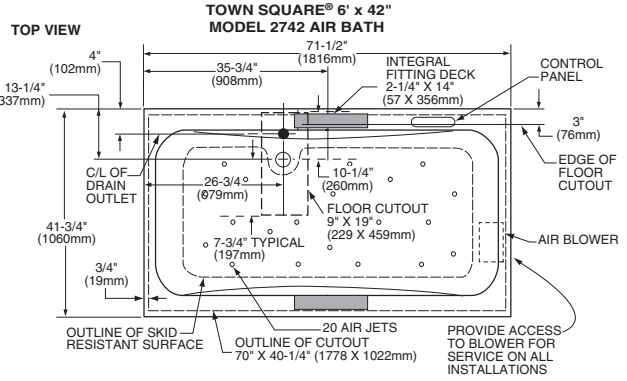
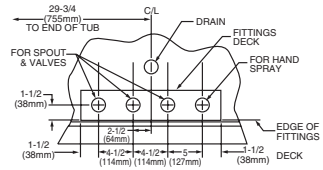

**HOLE DRILLING LOCATION FOR AMERICAN STANDARD "TOWN SQUARE" DECK MOUNT BATH FILLER WITH PERSONAL SHOWER, MODEL #2555.901 ONLY**

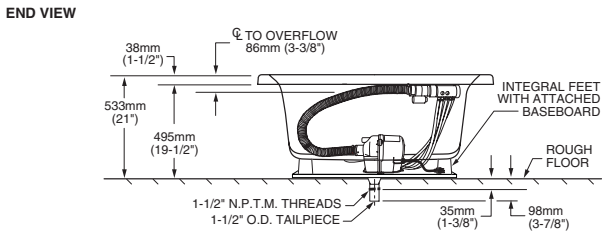
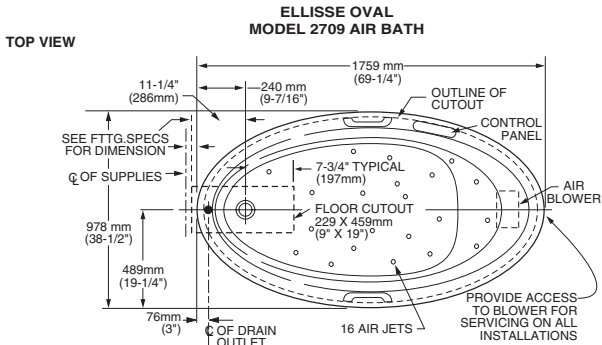
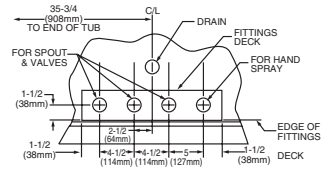

**GENERAL SPECIFICATIONS FOR 2748 AIR MASSAGE SYSTEM**

INSTALLED SIZE \_\_\_\_\_ 59-1/2 x 41-5/8 x 23 in. (1511 x 1057 x 584mm)  
WEIGHT \_\_\_\_\_ 110 Lbs. (50 Kg.)  
WEIGHT w/WATER \_\_\_\_\_ 611 Lbs. (278 Kg.)  
GAL. TO OVERFLOW \_\_\_\_\_ 60 Gal. (227 L)  
BATHING WELL AT SUMP \_\_\_\_\_ 34 x 24 in. (864 x 610mm)  
BATHING WELL AT RIM \_\_\_\_\_ 52 x 31 in. (1321 x 1321mm)  
WATER DEPTH TO OVERFLOW \_\_\_\_\_ 12-1/2 in. (318mm)  
FLOOR LOADING \_\_\_\_\_ 40 Lbs./Sq.Ft. (194 Kgs./Sq.m) (PROJECTED AREA)  
PTS. \_\_\_\_\_ 27.8  
CUBE (FT<sup>3</sup>) \_\_\_\_\_ 45.4

**ELECTRICAL SPECIFICATIONS**

BLOWER \_\_\_\_\_ 1.0 HP, 10 AMPS ,120V.

**GENERAL SPECIFICATIONS FOR 2742 AIR MASSAGE SYSTEM**

INSTALLED SIZE \_\_\_\_\_ 71-1/2 x 41-3/4 x 22 in. (1816 x 1060 x 559mm)  
WEIGHT \_\_\_\_\_ 115 Lbs. (52 Kg.)  
WEIGHT w/WATER \_\_\_\_\_ 690 Lbs. (313 Kg.)  
GAL. TO OVERFLOW \_\_\_\_\_ 69 Gal. (261 L)  
BATHING WELL AT SUMP \_\_\_\_\_ 41 x 21-1/2 in. (1041 x 546mm)  
BATHING WELL AT RIM \_\_\_\_\_ 62 x 31-1/2 in. (1574 x 800mm)  
WATER DEPTH TO OVERFLOW \_\_\_\_\_ 14-1/4 in. (362mm)  
FLOOR LOADING \_\_\_\_\_ 33 Lbs./Sq.Ft. (163 Kgs./Sq.m) (PROJECTED AREA)  
PTS. \_\_\_\_\_ 27.8  
CUBE (FT<sup>3</sup>) \_\_\_\_\_ 55.7

**ELECTRICAL SPECIFICATIONS**

BLOWER \_\_\_\_\_ 1.0 HP, 10 AMPS ,120V.

**GENERAL SPECIFICATIONS FOR 2709 AIR BATH**

INSTALLED SIZE \_\_\_\_\_ 69-1/4 x 38-1/2 x 19-3/4 in. (1759 x 978 x 502mm)  
WEIGHT \_\_\_\_\_ 107 Lbs. (49 Kg.)  
WEIGHT w/WATER \_\_\_\_\_ 640 Lbs. (291 Kg.)  
GAL. TO OVERFLOW \_\_\_\_\_ 64 Gal. (243 L)  
BATHING WELL AT SUMP \_\_\_\_\_ 45 x 23 in. (1143 x 584mm)  
BATHING WELL AT RIM \_\_\_\_\_ 63 x 32 in. (1600 x 813mm)  
WATER DEPTH TO OVERFLOW \_\_\_\_\_ 13 in. (330mm)  
FLOOR LOADING \_\_\_\_\_ 35 Lbs./Sq.Ft. (166 Kgs./Sq.m) (PROJECTED AREA)  
PTS. \_\_\_\_\_ 25.6  
CUBE (FT<sup>3</sup>) \_\_\_\_\_ 49.4

**ELECTRICAL SPECIFICATIONS**

BLOWER \_\_\_\_\_ 1.0 HP, 10 AMPS ,120V.

## INSTALLATION AND FRAMING INSTRUCTIONS FOR MODELS:

### TOWN SQUARE® 5' x 42" 2748, TOWN SQUARE® 6' x 42" 2742 and ELLISSE OVAL 2709 AIR MASSAGE SYSTEM

The variety of installations possible for this air massage system may require framing procedures other than those shown. Locate studs as required. Ensure roughing-in dimensions are proper, plumb and square. Provisions must be made in all installations for an access opening for servicing the air blower and controls. It is strongly recommended that an additional opening be provided for access to the drain components. The apron should not be used as the primary access opening.

1. Position the air massage system into the installation opening and level the deck in both directions, shimming the integral feet with attached baseboard as necessary. Refer to the Air Bath Installation Table for nominal installation dimensions. Mark the final position of the underside of the deck by tracing a line on to the studs (see Figure 1).
2. Remove the air massage system and attach a 1 x 4 stringer to the studs, with the top of the stringer touching the traced line.

**⚠** The rim of the bath **must not** support weight.

3. Install supplied cable drain components to the air massage system according to the enclosed drain installation instructions. Before replacing your air bath for final installation, be certain that an opening has been provided in the sub-floor for the drain. See the roughing-in drawing for suggested opening size (shaded) and location dimensions. The drain/overflow of the bath extends below the bottom of the bath. Note that this requires a cutout in the floor.
4. Replace air massage system and re-shim the integral support feet with attached baseboard, shimming the entire length of the baseboard as needed. Secure the shims using construction adhesive, silicone or equivalent materials.

**⚠** The rim of the bath **must not** support weight. Any finish material such as tile or wall board must be self-supporting if it contacts the deck of the bath.

**FIGURE 1**

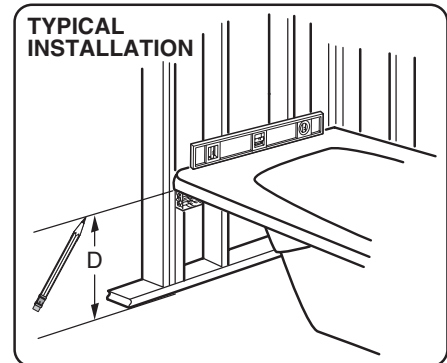

AIR BATH INSTALLATION TABLE							
DIM.	DESCRIPTION	AIR BATH MODEL					
		2748		2742		2709**	
A	Nominal tub length recess opening	59-3/4"	1518 mm				
B	Nominal tub apron support opening	39-3/4"	1511 mm				
C	Nominal tub width recess opening	41-3/4"	1060 mm				
D	Nominal tub height opening	21"	533 mm	20"	508 mm	19-1/2"	495 mm
E	Nominal tub length cutout	58"	1473 mm	70"	1778 mm	67"	1702 mm
F	Nominal tub width cutout	40-1/8"	1019 mm	40-1/4"	1022 mm	36-1/2"	927 mm

\*\* USE CUTOUT TEMPLATE PROVIDED FOR 2709 MODEL

**NOTICE:**

DO NOT BUILD THE SURROUNDING STRUCTURE BEFORE RECEIVING YOUR AIR BATH. STRUCTURE MEASUREMENTS SHOULD BE VERIFIED AGAINST THE ACTUAL AIR BATH RECEIVED TO ENSURE PROPER FIT.

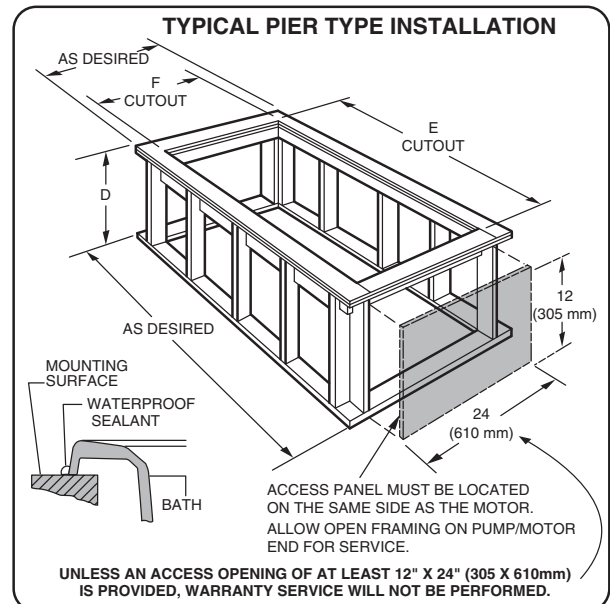
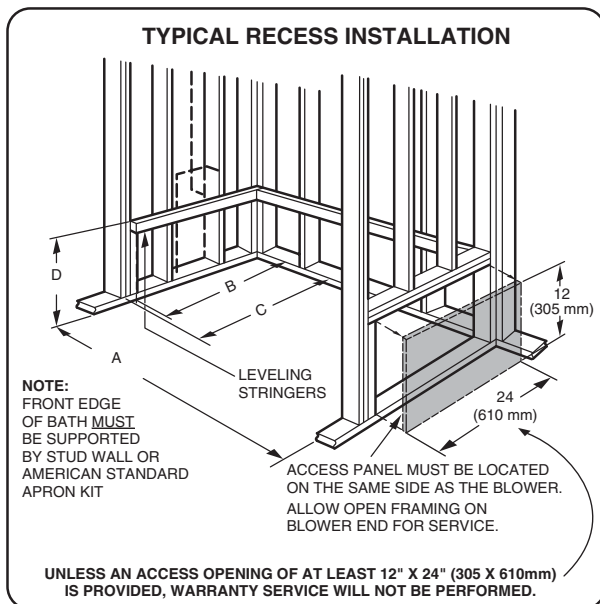
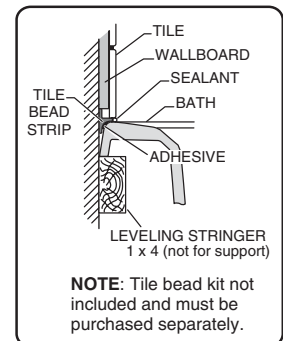

## AIR MASSAGE SYSTEM ELECTRICAL INSTALLATION INSTRUCTIONS

All wiring must be performed by a licensed electrician in accordance with the national electrical code and all other applicable codes.

**⚠ WARNING:** When using electrical products, basic precautions should always be observed, including the following:

1. **DANGER: RISK OF ELECTRIC SHOCK!** Connect only to a circuit protected by a ground-fault circuit interrupter.
2. Permit access for servicing blower as noted.
3. All building materials and wiring should be routed away from the air blower.

For **TOWN SQUARE® 5' x 42" MODEL 2748**, **TOWN SQUARE® 6' x 42" MODEL 2742**, and **ELLISSE OVAL MODEL 2709**

### AIR MASSAGE SYSTEM Model:

The air bath should be installed on a 120 vac, 15 or 20 amp dedicated circuit. The circuit should be hard-wired from the electrical power supply panel. The circuit must be a three (3) wire circuit from the electrical supply panel.

A grounded neutral wire and a third wire, earth ground, are essential.

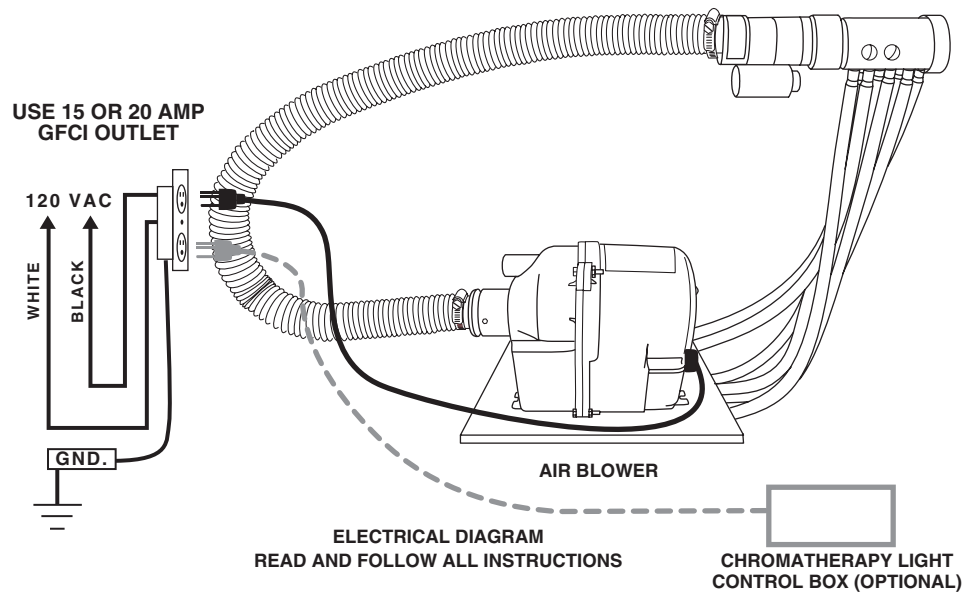

#### WIRE SELECTION GUIDE

**Motor  
Hi Performance  
Rating  
2.1 H.P.,  
1.4 H.P.,  
and 1.25 H.P.**

Maximum distance from fusebox to motor			
50'	100'	150'	200'
<b>115V Power Line</b>			
12	10	8	8

**The sizes shown on this chart are recommendations for copper conductors only. Always follow local and national electrical codes**

## UNDER DECK MOUNTING INSTRUCTIONS

Please note that care must be taken to protect the surface of the tub during all aspects of the installation. Do not drill or cut the bath deck with the tub directly beneath it as damage to the tub may result.

1. Install the tub per the installation instructions provided with the unit.
2. Prepare the bath deck support structure per the local codes. Note - the bath deck must be self supporting.
3. Cut bath deck to your specifications.
4. Place the bath deck in position and trace the opening on the tub with a soft pencil. Do not drill or cut the bath deck with the tub directly beneath it as damage to the tub may result.
5. Remove the bath deck and apply a generous bead of waterproof sealant on the outer edge of the traced line.
6. Replace the bath deck and secure it into place.
7. Apply additional sealant along the tub and bath deck interface as necessary to ensure a watertight seal.
8. Remove excess sealant per the manufacturer's instructions.

Finished bath deck surface material must be self-supporting and secured per local codes

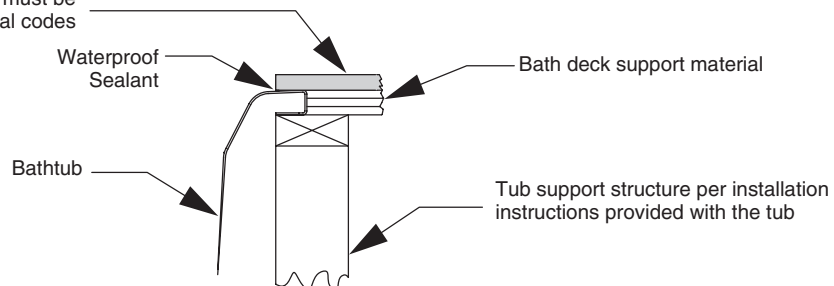

## DRAIN CONNECTION AND SYSTEM TEST (before installing bath into framed out structure)

With supplied cable drain assembled to bath, connect drain outlet to waste line in accordance with the drain assembly instructions. Tighten all drain joints securely. Check the couplings and make sure they are hand-tight. Clean the air bath and fill with water to a point 2" below the overflow. Recheck the couplings and make certain that they are not leaking. (Although the couplings are factory tightened and inspected, some loosening may have occurred during transit.) Make sure the air bath is connected to the electrical supply and turn the air bath on. Check for leaks around all piping connections while the air bath is running.

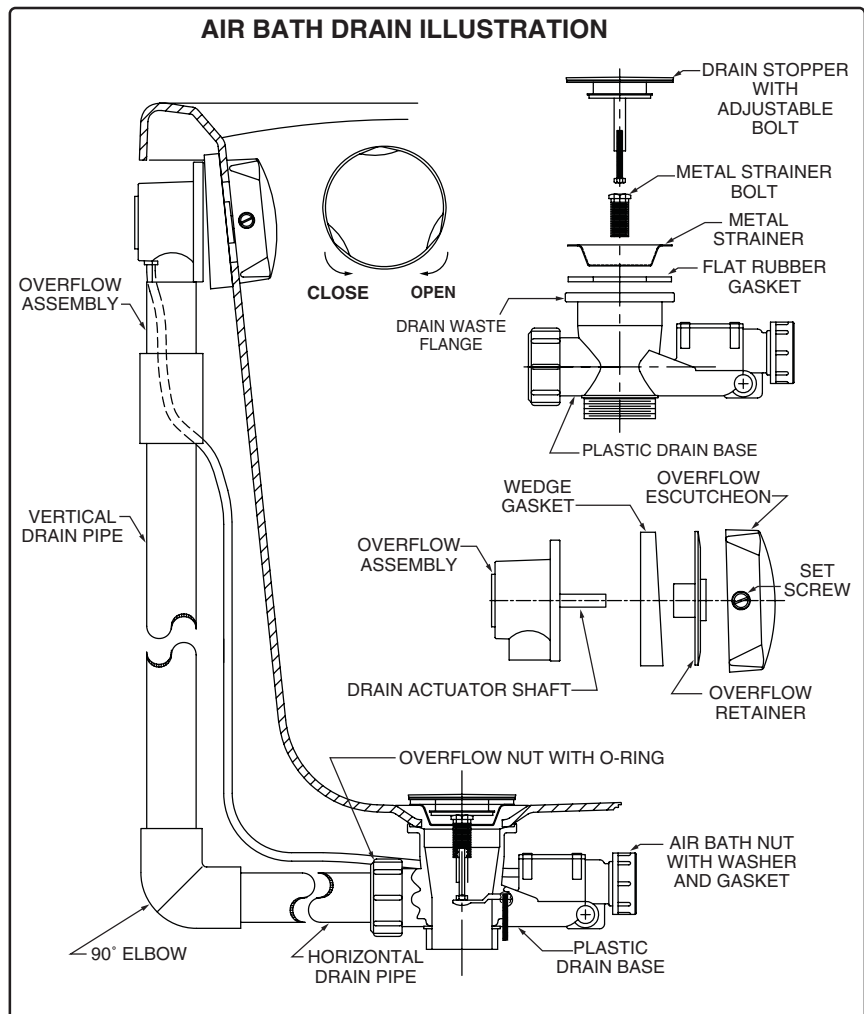

## DRAIN CONNECTION

1. Remove and identify all drain components as defined in air bath drain illustration.
2. Find 1" schedule 40 PVC pipe, see pipe chart, **HORIZONTAL DRAIN PIPE**. Mark as "horizontal pipe", drain to elbow section.
3. Find 1" schedule 40 PVC pipe, see pipe chart, **VERTICAL DRAIN PIPE**. Mark as "vertical pipe", drain to elbow section.
4. Install drain from below unit through opening as shown in photo **A**.

PIPE CHART
<b>VERTICAL DRAIN PIPE</b>
2748 is 10-3/4" long 2742 is 12" long 2709 is 11" long
<b>HORIZONTAL DRAIN PIPE</b>
2748 is 6-1/2" long 2742 is 6-1/2" long 2709 is 4-3/4" long



5. Apply 3 or 4 pea sized dabs of 100% silicone sealant to bottom waste drain flange and press flat rubber gasket into place as shown in photos **B** and **C**.



6. Apply 1/8" continuous bead of 100% silicone sealant to flat rubber gasket as shown in photo **D**. Set aside and be sure not to disturb silicone bead.



7. Apply 1/8" continuous bead of 100% silicone sealant to back side to metal strainer as shown in photo **E**. Press Strainer retaining bolt into metal strainer and insert into drain hole of acrylic bath.





## DRAIN CONNECTION *continued...*

8. Have assistant take drain assembly from step 6 and place over back surface of drain hole to engage the metal strainer bolt. Secure plastic drain base to metal strainer in drain opening using nut driver shaft. **DO NOT OVER TIGHTEN!** Carefully remove excess silicone from acrylic surface as directed by silicone sealant directions.
9. From unit back side, overflow nut should be in alignment with overflow opening, as shown in photo **F**.

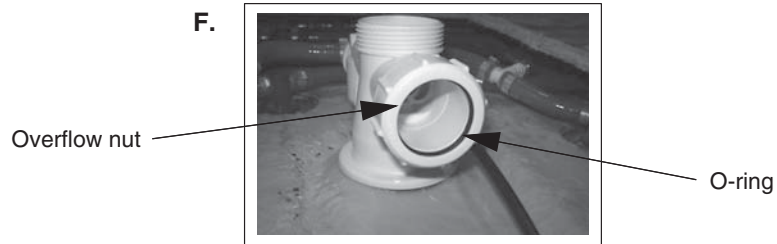

10. Slide air bath fitting nut, washer and gasket onto air bath fitting as shown in photos **G** and **H**.

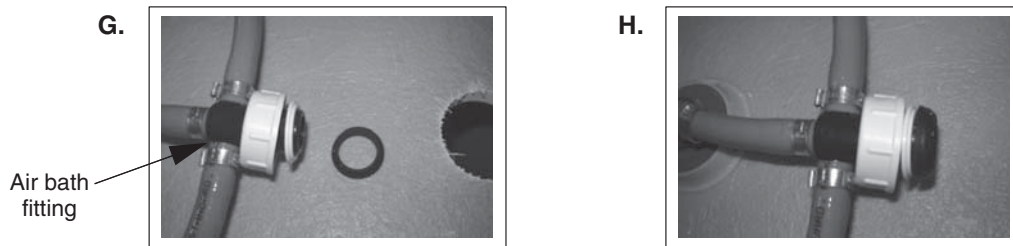

11. Assemble air bath fitting to plastic drain base as shown in photos **I**, **J**, **K** and **L**. Hand tighten nut to create watertight joint.

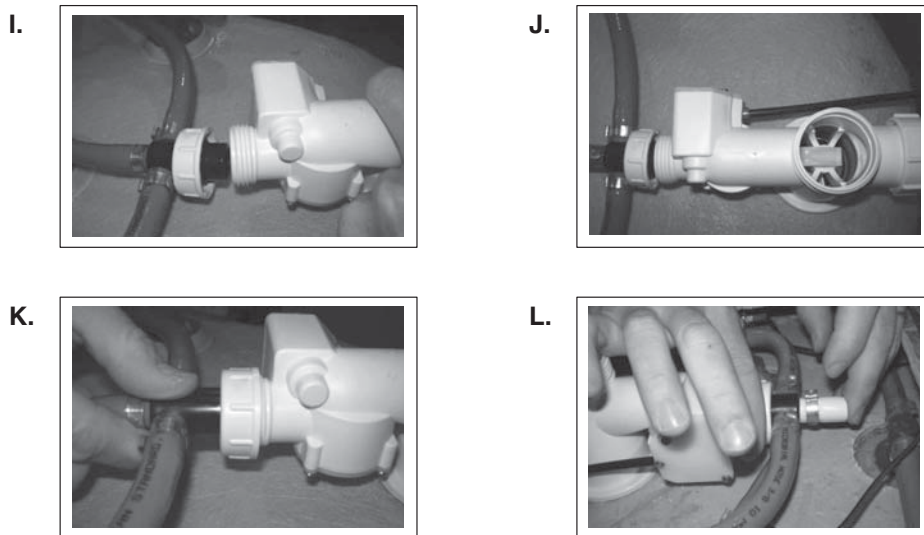

**DRAIN CONNECTION** *continued...*

12. Apply PVC cement to **Horizontal Drain Pipe** PVC and assemble to 90 degree elbow.

13. Dry fit **Vertical Drain Pipe** PVC into overflow assembly, then insert into elbow, WITHOUT PVC GLUE to align drain and overflow to bath. Mark overflow female coupling as shown in photo **M**.

**M.**



14. Test fit and trim pipe as required to get overflow drain into center of overflow hole BEFORE GLUING vertical pipe into 90 degree elbow, as shown in photos **N-1** and **N-2**.

**N-1.**

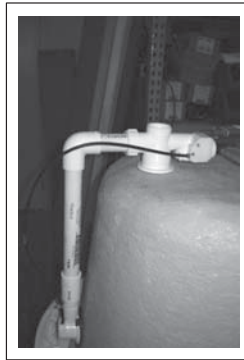

**N-2.**

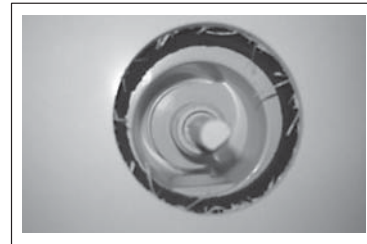

15. Apply PVC cement to **Vertical Drain Pipe** sub-assembly and assemble per re-aligned marks from step 13.

16. Disassemble overflow wedge gasket and chrome overflow retainer as shown in photo **O**.

**O.**

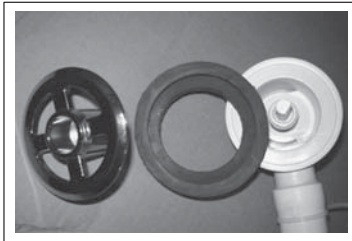

17. Place overflow wedge gasket onto plastic overflow pipe flange with round raised rib surface contacting flange as shown in photo **P**.

**P.**

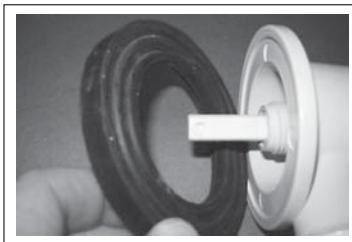

## DRAIN CONNECTION *continued...*

18. Tighten chrome overflow retainer onto drain overflow assembly pipe per photo **Q** below.

19. Align flat on drain actuator shaft with corresponding flat in chrome metal overflow escutcheon and tighten set screw to fix overflow escutcheon in place per photos **R** and **S**.

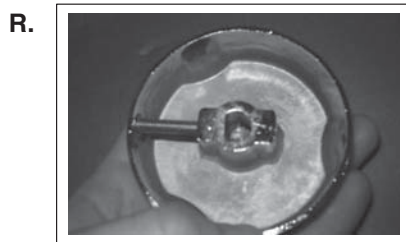

20. Rotate left and right lightly to feel stops in drain cable control. This opens and closes drain.

21. Place drain stopper into drain waste hole as shown in photo **T**.

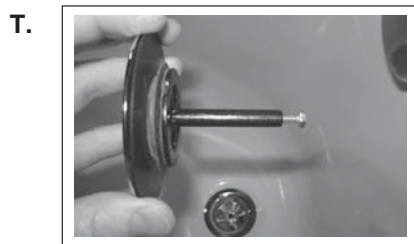

22. The drain stopper should prevent water from draining out of tub when the escutcheon is in the fully counterclockwise position as shown in photo **U**. Adjust the drainstopper bolt to obtain the best water seal in the tub.

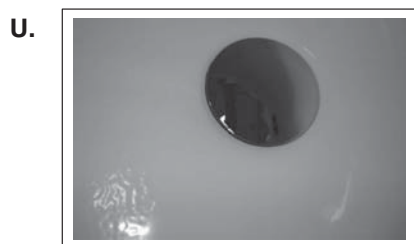

23. Rotate Drain Escutcheon to clockwise stop. This should open drain, between 1/8" and 1/4", to allow water to exit bath. If not adjust metal bolt in drain stopper to allow draining function, but not so high that drain will not seal when closed to hold water during use. See photo **V**.

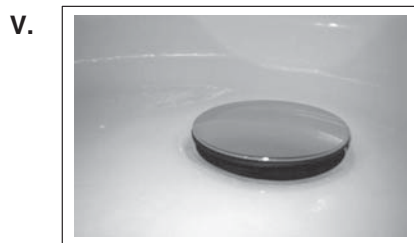

## **POST INSTALLATION CLEAN-UP**

Remove all construction debris from bath. Tile grout can be removed with a wooden popsicle stick or tongue depressor. Do not use wire brushes or any other metal implement on bath surface.

Post installation clean-up generally can be completed using warm water and liquid dishwashing detergent. Stubborn dirt or stains may be removed using granular Spic and Span® mixed with water.

Painter's naphtha can be used to remove excess adhesives and/or wet oil-base paint.

## **AFTERCARE and CLEANING**

- The high gloss surface is resistant to impact and chemicals and will retain its lasting luster with proper care and maintenance.
- Always fill the tub with temperate water. Excessively hot water may cause surface damage
- Clean after use with a mild liquid household detergent cleaner. Do not use Lestoil, Lysol Disinfectant (spray or concentrate), or Lysol Basin, Tub and Tile Cleaner, Windex, Mr. Clean, Dow Disinfectant Bathroom Cleaner, or cleaning products in aerosol cans.

## **HARSH CHEMICALS SHOULD NEVER BE USED ON ACRYLIC SURFACES.**

- Do not use wire brushes, knives or sharp objects to remove stains, cigarette tar deposits, or other surface blemishes.
- Abrasive cleaners or powders must not be used, since they will dull the surface. If the glossy surface loses its sheen, dulled areas can be restored by rubbing with a white "automotive type" polishing compound and waxing with a "liquid wax."
- **Do not wax areas where you walk or stand.**
- Do not allow nail polish remover, acetone, dry cleaning fluid, paint remover or other solvents to come into contact with the surface.
- Clean the surrounding surface immediately after using caustic drain cleaners.
- Burning cigarettes will damage the surface.
- Should damage to the fixture occur, repairs can be made quickly and easily. Your distributor or builder can provide details.
- Do not permit drain cleaner to enter the circulation system.

## REMOTE BLOWER LOCATION OPTION

**IMPORTANT!** It is not necessary that the blower motor be relocated. This option is provided for the case that a particular installation makes this effort practical.

**NOTE:** Relocating blower motor from factory installed location, see photo **W**, will require disassembly of air blower from mounting board. Keep all hardware for reattachment at new location. Additional hardware will be required depending upon final desired position of air blower. Follow all instructions listed below.

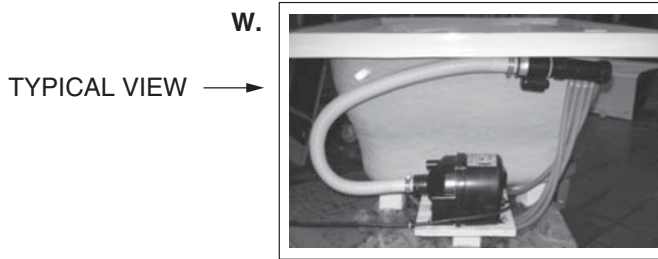

**NOTE:** Installing the blower in a remote location will reduce the system efficiency.

**NOTE:** Relocating a blower motor still requires a service access for the blower.

**NOTE:** All materials needed for the relocation must be supplied by the installer. This includes ordering a longer control panel cable (P/N 754069-201).

A separate circuit, which must be protected by the Ground Fault Circuit Interrupter (GFCI), is required in the remote location. Electrical connections should be performed by a licensed electrician.

Choose a space as close to the bath as possible so the system works as efficiently as possible. The space must be at least 30 cubic feet and the blower must be mounted at least 2 inches above the floor and 2 inches minimum away from any wall. The blower must NOT be installed in an attic area.

The blower motor must be located within 12 feet of rigid piping from the bath air manifold. This limitation is for the total pipe length and applies to any direction changes and elbows. There can be no more than six changes of direction. There should be as few direction changes as possible and the piping installation must meet all requirements of local plumbing and building codes.

Disconnect the blower from the flexible hose as shown in photo **X**. Do NOT remove the check valve manifold that this mounted to the underside of the air bath. The manifold MUST remain mounted above the tub overflow level as shown in **X**.

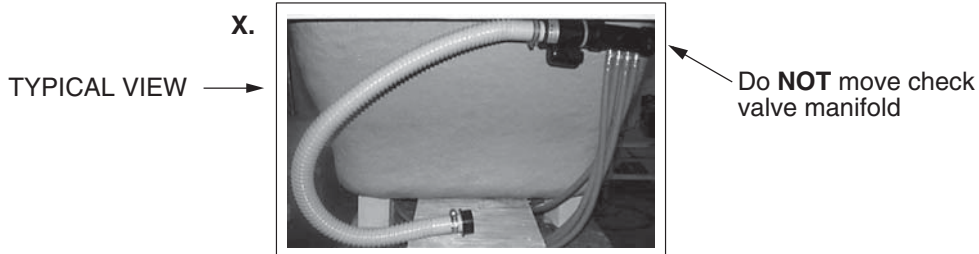

Use 1 1/2" PVC rigid piping and couplings to extend the blower motor location as shown in photos **Y** and **Z**. Detach the flexible hose section from the blower end and extend the air line by adding the appropriate length of PVC piping. Mount the blower in a horizontal direction using the mounting screws provided with the air bath system. Do NOT glue piping to either the manifold or blower. These couplings MUST be attached to the piping with screws as shown in photos **Y** and **Z**. Glue only the PVC piping and couplings needed to extend the air line. Let the glued couplings set overnight before attaching the blower and manifold couplings with screws.

**CAUTION:** It is imperative to let the glued piping set overnight as there may be fumes from the glue that could be ignited if not allowed to dissipate.

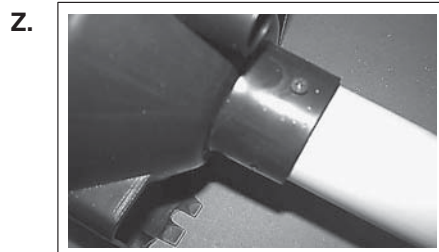
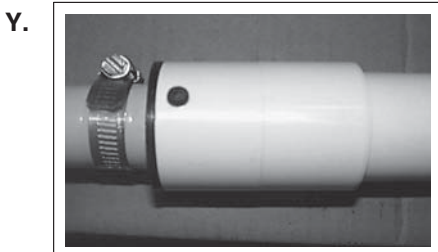

**American Standard Limited Lifetime Warranty for  
TOWN SQUARE® 5' x 42" MODEL 2748  
TOWN SQUARE® 6' x 42" MODEL 2742  
and ELLISSE OVAL MODEL 2709  
AIR MASSAGE SYSTEM**

American Standard warrants to the original consumer purchaser that it will, at its option, repair or replace this air massage system or any of its parts that are found by American Standard, in its sole judgment, to be defective under normal residential use and maintenance so long as it is owned by the original consumer purchaser.

This warranty shall only become effective upon receipt by American Standard of a completely filled out Warranty Registration Card evidencing proof of purchase.

THIS WARRANTY SHALL BE VOID IF THE ACCESS PANEL TO THE AIR MASSAGE SYSTEM IS COVERED IN ANY MANNER CONTRARY TO THE INSTALLATION INSTRUCTIONS. In no event will American Standard be liable for the cost of repair or replacement of any installation materials including but not limited to tiles, marble etc.

This limited warranty DOES NOT COVER the following:

1. Defects or damages arising from shipping, installation, alterations, accidents, abuse, misuse, lack of proper maintenance and cleaning as directed in the owner's manual and use of other than genuine American Standard replacement parts, in all cases whether caused by a plumbing contractor, service company, the owner or any other person.
2. Deterioration through normal wear and tear and the expense of normal maintenance.
3. Commercial application.
4. Options and accessories. American Standard's limited warranty on these items is one year for parts only and excludes labor. This one year limited warranty covers accessories manufactured by American Standard (e.g. aprons, drains, grab bars, heaters, trim kits) against defects of material or workmanship. Warranty coverage begins on the date the accessory was originally purchased by the owner.
5. Postage or shipping costs for returning products for repairs or replacement under this limited warranty and labor or other costs incurred in connection with product removal or installation under this limited warranty.
6. ANY LIABILITY FOR CONSEQUENTIAL OR INCIDENTAL DAMAGES, ALL OF WHICH ARE HEREBY EXPRESSLY DISCLAIMED, OR THE EXTENSION BEYOND THE DURATION OF THIS LIMITED WARRANTY OF ANY IMPLIED WARRANTIES, INCLUDING THOSE OF MERCHANTABILITY OR FITNESS FOR AN INTENDED PURPOSE. (Some jurisdictions do not allow limitations on how long an implied warranty lasts, or the exclusion or limitation of incidental or consequential damages, so these limitations and exclusions may not apply to you.)
7. Responsibility for compliance with local code requirements. (Since local code requirements vary greatly distributors, retailers, dealers, installation contractors and users of plumbing products should determine whether there are any code restrictions on the installation or use of a specific product.)

This warranty gives you specific legal rights. You may have other legal rights that vary from state to state. For service under this warranty, you should contact the following:

By Mail: American Standard Inc.  
P.O. Box 659  
West Caldwell, N.J. 07007  
Attention: Customer Care Center

By Telephone:  
**1-800-442-1902**