WAVEWORKS

Product Specifications	332
Configuration Options	334
Grommet Location Options	340
Guidelines/General Information	341
Drawer Specifications	341
Assembled	342
EZ Arrangements	342
Assembled Units	350

WAVEWORKS

PRODUCT SPECIFICATIONS

WORKSURFACE

- Worksurfaces are sized on 6" increments for easy planning
- Laminate surfaces are 1 $\frac{1}{8}$ " or 1 $\frac{1}{2}$ " HPL (high pressure laminate) or 1 $\frac{1}{2}$ " TFL (thermally fused laminate), and feature a 3mm PVC rim or 6 veneer rim options
- Veneer surfaces are 1 $\frac{3}{8}$ " or 1 $\frac{1}{2}$ " plain sliced slipmatched cherry (Amber, Autumn, Mocha, Truffle) or maple veneer (Brighton, Caramel, Honey, Natural), plain sliced bookmatched walnut veneer (Clear Walnut, Cordovan, Judicial), quarter cut walnut veneer (Almond, Portobello, Sable), or quarter cut oak veneer (Sonoma). All veneer surfaces feature a 3mm wood rim or knife rim profile
- When specifying Clear Walnut, a clear coat finish, the natural wood characteristics of walnut veneer are visible. These characteristics include, but are not limited to, color and woodgrain variation.
- Refer to page 334 for rim profiles and colors
- Grain direction runs left-to-right unless otherwise noted
- Size modifications available at no upcharge; many WaveWorks component worksurfaces can be cut down in $\frac{1}{8}$ " increments. See component sections for specific models

FINISH APPLICATION

- WaveWorks veneer tops finished using IntegraClear® UV technology. IntegraClear® is a water-based, high-performance wood finish that meets or exceeds indoor air quality standards. This proprietary finish is virtually VOC-free, has remarkable durability and allows the natural beauty of veneers to show through
- Vertical surfaces feature a semi-open pore matte finish

CHASSIS CONSTRUCTION

- All joints are securely fastened by screws, L-brackets, dowels, and concealed fasteners to ensure maximum strength
- Adjustable leveling glides are standard on all casegoods
- End panels and support panels are 1 $\frac{1}{8}$ " thick, modesty panels are $\frac{3}{4}$ " thick
- Laminate modesty panels have vertical grain direction unless otherwise noted
- Wood modesty panels have vertical grain direction unless otherwise noted
- Laminate with horizontal grain (example: Sable Horizontal 792H) will always have horizontal grain direction
- Back panels are fully finished unless otherwise noted

SHELVES

- Shelves on open bookcases will be veneer, when ordering a veneer bookcase
- Doors on bookcases and above worksurface units come standard with touch latch
- Shelves are $\frac{3}{4}$ " thick

PEDESTALS

- Full, lower height or mobile options available

DRAWERS

- Drawers feature 5-sided construction allowing for easy removal/replacement of drawer fronts
- Sides, back and front are $\frac{1}{2}$ " thick woodgrain vinyl wrapped
- Drawer fronts are 3-ply construction with matched woodgrain
- For interior drawer dimensions, reference page 341

DRAWER PULLS

- Available in 17 pull styles, refer to page 338 for pull styles and colors

DRAWER SUSPENSION

- Box and file drawers are equipped with black, full extension, progressive action slides
- Precision steel ball bearings combined with sequence slide movement ensures long lasting operation
- All suspensions have a lifetime warranty

FILING

- Drawers are equipped with black metal filing hardware that accommodates various filing requirements
- No-tool, easy installation allows for quick interchangeable filing capabilities
- Refer to page 341 for complete filing details

CORD MANAGEMENT

- Round grommets, racetrack grommets and wire managers are optional on worksurfaces
- Round grommets optional on component end panels
- Half-moon grommet optional on component modesty panels
- Extended radius grommet optional on end panels of component pedestals
- Wire manager worksurfaces have a flexible PVC trough that allows cords and cables to be routed along the back edge and sides of worksurfaces
- Refer to page 339 for available grommet/wire manager colors
- Refer to page 340 for complete grommet locations and details
- Undersurface wire managers are available for additional cable management requirements; see pages 673 and 741 for options

LOCKING

- Black and silver lock cores are available
- Key Random means lock cores/keys are randomly (1-5) picked and factory installed in unit
- Key Specific means you can pick any number (1-200) for black or silver lock core/key. Must specify the lock core model separately; not factory installed and will ship separately
- Specify a change key to remove and change lock cores
- To order key specific lock cores, change keys, and master keys, reference page 726

TABLE BASES

- Bases are formed metal with a powder coat finish
- Mobile bases have locking casters, glides are standard on fixed height legs
- Refer to pages 639-672 for recommended base applications

CONFERENCE TABLES, TRAINING TABLES AND PERIPHERAL ITEMS

- For matching conference tables, training tables and peripheral items, see the Tables Price List

EZ ARRANGEMENT MODEL NUMBERS

- Specify quickly and accurately with National's EZ Arrangement models. In each series, the most popular options have been pre-selected for a complete L or U configuration. Just choose the left or right model number, add a finish and you're done

HEIGHT ADJUSTABLE DESKS

- Wood, laminate/wood and laminate options
- Wood models are all wood; Laminate/Wood models are laminate tops with wood rim and wood chassis; laminate models are all laminate
- When in raised position, leg will be exposed
- Rim options are all Waveworks options
- Control pad can be moved to right-handed (RH) or left-handed (LH) by the customer
- Height adjustable customer range: 27 $\frac{3}{8}$ "-43 $\frac{3}{4}$ "
- Duty cycle: 2 minutes ON/18 minutes OFF
- Maximum load should not exceed 100 lbs. on the surface
- Power cord: Type A plug, max 10 A, 125 V; 78 $\frac{3}{4}$ " length
- Modesty panels are inset 1 $\frac{1}{8}$ " from edge of desk and 3 $\frac{3}{8}$ " from floor
- Modesty panel options full flush, full breakfront
- Overall dimensions of desk are undersized to allow for pinch points
- No pull or locking options

DIMENSION KEY

D	Depth
W	Width
H	Height
A	Overhang: Approach Side
KW	Kneespace Width

BUFFET CREDENZAS

- Models with trashcan will have 2 drawers and 2 sets of double doors. Trashcan will be housed behind one set of the double doors
- The side where trashcan is located determines the handed side (trashcan on left is a left model)
- One 7 gallon trashcan per model is included
- Models with space to house a refrigerator will have 2 sets of double doors (no drawers). Refrigerator will be housed behind one of the double door sets with ventilation
- The side where refrigerator is located determines the handed side (refrigerator on left is a left model)
- Refrigerator is not included
- Overall opening for refrigerator in a 36" high model is 22½" wide x 28⅞" tall x 25¼" deep. Max refrigerator size is 21½" wide x 27⅞" tall x 21¼" deep
- Overall opening for refrigerator in a 41" high model is 22½" wide x 28⅞" tall x 25¼" deep. Max refrigerator size is 21½" wide x 32⅞" tall x 21¼" deep
- Only locking cabinet is the side with an adjustable shelf
- Buffet credenza with refrigerator access will not be covered under standard warranty if unit is placed where vent will be blocked. Nor will the unit be covered under standard warranty for excess moisture because the unit has been designed to prevent this possibility

PULLOUT STORAGE

- Pull-out storage units are finished on all sides and top. A top is recommended for a finished aesthetic
- Available for left and right-hand applications
- Includes one full-depth shelf on top, one fixed and 2 adjustable shelves and one coat hook
- Simplex power unit is standard
- 2 depths of 24" and 30" with 2 height options of 41" and 53"

COMPONENTS

- Component models will ship bulk packed when applicable

LOCKERS

- Lockers available in laminate options only
- Available for left and right applications
- One door lockers feature 2 fixed shelves and 2 coat hooks
- Two and three door lockers feature 2 coat hooks behind each door
- Pulls will be installed vertically. All Waveworks pull options available with the exception of Horizon
- No pull units will have a touch latch closure
- If using 1 locker by itself it MUST be attached to a wall
- If using more than 1 locker side by side they MUST be ganged together
- If using more than 1 locker back to back, a cluster of 4 lockers MUST be ordered and ganged both side to side and front to back
- Electronic locks available (see electronic locks details below)

ELECTRONIC LOCKS

- Locks ship separately and require field installation
- Available in black or silver
- No pull option on electronic locker models
- Lock is always installed vertically
- Electronic locks feature motorized locking engagement with manual knob
- Battery Life—3 Months usage on Surface Mount
- Micro-B USB port (Android cable) for emergency power jump and battery charging
- Charging available with wired USB charger or mobile USB power pack
- Keypad locks out for 15 minutes after 5 invalid attempts
- 3 USER MODES
 - Resident employee mode—the passcode will not expire and can be re-used
 - Multi-user mode—in resident employee mode, additional users can be added with each user separately identified for higher security applications (e.g. drug, evidence lockers)
 - Shared use mode—suitable for day lockers/hotel safe
- 2 METHODS OF USE
 - Keypad operation
 - Wesko eLock App (must be downloaded to a smartphone)
- Admin passcodes can be managed by keypad commands (via program mode) or with the Wesko App in Admin mode
- MUST contact Customer Service for administrative passcodes

CONFIGURATION OPTIONS - WAVEWORKS

RIM PROFILE OPTIONS

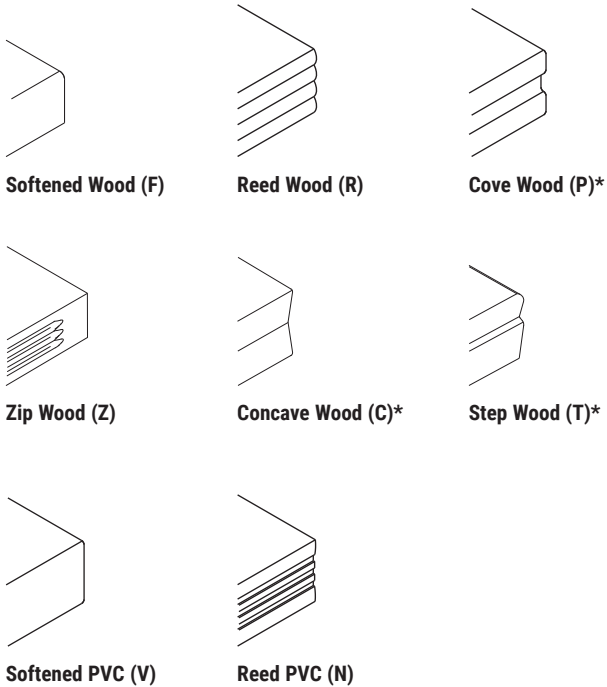

*Not recommended with EW Clear Walnut and SM Sonoma

PVC REED RIM

- AC2 Autumn 2
- CL Caramel
- CW Cordovan
- DW Judicial
- HN2 Honey 2
- MC Amber
- MH Mocha
- NM Natural
- TF Truffle

PVC SOFTENED RIM

- AC2 Autumn 2
- AD Almond
- CL Caramel
- CW Cordovan
- DW Judicial
- HN2 Honey 2
- IM Brighton
- MC Amber
- MH Mocha
- NM Natural
- PB Portobello
- PT Portico
- SK Skyline
- SM Sonoma
- TF Truffle
- 405 Designer White
- 419 Wallaby
- 425 Shadow
- 440 Cloud
- 461 Graphite
- 462 Cinder
- 478 Platinum Grey
- 488 Frosty White
- 491 Designer White Linear
- 492 Cinder Linear
- 792 Sable
- 793 Acorn

WOOD RIM

- AC Autumn
- AD Almond
- CL Caramel
- CW Cordovan
- DW Judicial
- EW Clear Walnut
- HN Honey
- IM Brighton
- MC Amber
- MH Mocha
- NM Natural
- PB Portobello
- SM Sonoma
- TF Truffle
- 792 Sable

GALLERY LAMINATE

- Grade 1 – 5% upcharge
- G1001 Citadel
- G1011 Pepperdust
- Grade 2 – 6% upcharge
- G1002 Planked Raw Oak
- G1003 Evening Notte
- G1004 Kirsche
- G1005 Midnight Run
- G1006 Sepia Walnut
- G1007 Serotina
- G1008 Timeless
- G1009 White Nebbia
- G1012 Phantom Ecru

See page 21 for Gallery program details and upcharges



Shaded model numbers are available on our "To You in 10 Days or Less" Quick Delivery program and will be delivered in 10 days or less.

WORKSURFACE WIRE MANAGER COLORS

403 Chamois	425 Shadow	462 Cinder
405 Designer White	440 Cloud	478 Platinum Grey
419 Wallaby	461 Graphite	485 Dark Chocolate

WIRE MANAGER FILLER CAP COLORS

403 Chamois	425 Shadow	462 Cinder
405 Designer White	440 Cloud	485 Dark Chocolate
419 Wallaby	461 Graphite	

NOTE: 478 not available. Recommended to use 440 Cloud for 478 Platinum Grey on filler caps.

WORKSURFACE FINISH/LAMINATE	WIRE MANAGER AND FILLER CAP COLOR RECOMMENDATIONS
WOODGRAINS	
AC2 Autumn 2	403 Chamois 419 Wallaby 485 Dark Chocolate
AD Almond	485 Dark Chocolate
CL Caramel	403 Chamois 419 Wallaby
CW Cordovan	485 Dark Chocolate
DW Judicial	485 Dark Chocolate
EW Clear Walnut	419 Wallaby 425 Shadow 485 Dark Chocolate
HN2 Honey 2	403 Chamois 419 Wallaby
IM Brighton	403 Chamois 405 Designer White 419 Wallaby
MC Amber	403 Chamois 419 Wallaby 485 Dark Chocolate
MH Mocha	485 Dark Chocolate
NM Natural	403 Chamois 419 Wallaby
PB Portobello	425 Shadow 461 Graphite
PT Portico	461 Graphite 478 Platinum Grey
SK Skyline	485 Dark Chocolate
SM Sonoma	403 Chamois 419 Wallaby
TF Truffle	403 Chamois 425 Shadow 485 Dark Chocolate
792 Sable	425 Shadow 485 Dark Chocolate
793 Acorn	419 Wallaby 425 Shadow 485 Dark Chocolate

WORKSURFACE FINISH/LAMINATE	WIRE MANAGER AND FILLER CAP COLOR RECOMMENDATIONS
SOLID LAMINATES	
405 Designer White	405 Designer White
419 Wallaby	419 Wallaby
425 Shadow	425 Shadow
440 Cloud	440 Cloud
461 Graphite	461 Graphite
462 Cinder	462 Cinder
478 Platinum Grey	478 Platinum Grey
488 Frosty White	405 Designer White
491 Designer White Linear	405 Designer White
492 Cinder Linear	462 Cinder

WORKSURFACE FINISH/LAMINATE	WIRE MANAGER AND FILLER CAP COLOR RECOMMENDATIONS
PATTERN LAMINATES	
814 White Tigris	440 Cloud 478 Platinum Grey
818 Crisp Linen	440 Cloud
819 Flax Gauze	403 Chamois 419 Wallaby
821 Elemental Concrete	440 Cloud 478 Platinum Grey
822 Smoke Quarstone	461 Graphite
874 Bronze Legacy	425 Shadow

WORKSURFACE LAMINATE	WIRE MANAGER AND FILLER CAP COLOR RECOMMENDATIONS
GALLERY LAMINATE	
G1001 Citadel	425 Shadow 461 Graphite 478 Platinum Grey
G1002 Planked Raw Oak	405 Designer White 419 Wallaby 440 Cloud
G1003 Evening Notte	425 Shadow 485 Dark Chocolate
G1004 Kirsche	403 Chamois 419 Wallaby 425 Shadow
G1005 Midnight Run	461 Graphite 462 Cinder
G1006 Sepia Walnut	485 Dark Chocolate
G1007 Serotina	425 Shadow
G1008 Timeless	485 Dark Chocolate 425 Shadow
G1009 White Nebbia	405 Designer White 440 Cloud
G1011 Pepperdust	425 Shadow 478 Platinum Grey
G1012 Phantom Ecrú	419 Wallaby 440 Cloud 425 Shadow

CONFIGURATION OPTIONS - WAVEWORKS

WOOD FINISHES

AC	Autumn
AD	Almond
CL	Caramel
CW	Cordovan
DW	Judicial
EW	Clear Walnut**
HN	Honey
IM	Brighton
MC	Amber
MH	Mocha
NM	Natural
PB	Portobello
SM	Sonoma
TF	Truffle
792	Sable

LAMINATE WORKSURFACES

WOODGRAIN LAMINATE

AC2	Autumn 2
AD	Almond
CL	Caramel
CW	Cordovan
DW	Judicial
HN2	Honey 2
IM	Brighton
MC	Amber
MH	Mocha
NM	Natural
PB	Portobello
PT	Portico*
SK	Skyline*
SM	Sonoma*
TF	Truffle
792	Sable
793	Acorn**

LAMINATE DRAWER/DOOR FRONTS & CHASSIS

WOODGRAIN LAMINATE

AC2	Autumn 2
AD	Almond
ADH	Almond Horizontal
CL	Caramel
CW	Cordovan
DW	Judicial
HN2	Honey 2
IM	Brighton
MC	Amber
MH	Mocha
NM	Natural
PB	Portobello
PBH	Portobello Horizontal
PT	Portico*
PTH	Portico Horizontal*
SK	Skyline*
SKH	Skyline Horizontal*
SM	Sonoma
SMH	Sonoma Horizontal
TF	Truffle
792	Sable
792H	Sable Horizontal
793	Acorn**

WORKSURFACE/MODESTY TYPE

M	Main
E	Extension
F	Filler

M = 0 Connecting Worksurface Flat Brackets
E = 2 Connecting Worksurface Flat Brackets
F = 4 Connecting Worksurface Flat Brackets

SOLID LAMINATE

405	Designer White
419	Wallaby
425	Shadow
440	Cloud
461	Graphite
462	Cinder
478	Platinum Grey
488	Frosty White
491	Designer White Linear
492	Cinder Linear

PATTERN LAMINATE

814	White Tigris
818	Crisp Linen
819	Flax Gauze
821	Elemental Concrete
822	Smoke Quarstone
874	Bronze Legacy

- Pattern laminates not available on TFL models
- CSL available; see page 21 for program details and upcharge
- CSL not available on TFL

SOLID LAMINATE

405	Designer White
419	Wallaby
425	Shadow
440	Cloud
461	Graphite
462	Cinder
478	Platinum Grey
488	Frosty White
491	Designer White Linear
491H	Designer White Linear Horizontal
492	Cinder Linear
492H	Cinder Linear Horizontal

GLASS DOOR ALUMINUM FRAME COLORS

462	Cinder
501	Platinum Metallic
503	Satin Nickel Metallic

*Not available on laminate/wood models
**Acorn is the laminate Complement to Clear Walnut finish

GALLERY LAMINATE

Grade 1 – 5% upcharge	
G1001	Citadel
G1011	Pepperdust
Grade 2 – 6% upcharge	
G1002	Planked Raw Oak
G1003	Evening Notte
G1004	Kirsche
G1005	Midnight Run
G1006	Sepia Walnut
G1007	Serotina
G1008	Timeless
G1009	White Nebbia
G1012	Phantom Ecu

GALLERY LAMINATE

Grade 1 – 5% upcharge	
G1001	Citadel
G1011	Pepperdust
Grade 2 – 6% upcharge	
G1002	Planked Raw Oak
G1003	Evening Notte
G1004	Kirsche
G1005	Midnight Run
G1006	Sepia Walnut
G1007	Serotina
G1008	Timeless
G1009	White Nebbia
G1012	Phantom Ecu

See page 21 for Gallery program details and upcharges

RESIN COLORS

- Grade 1
- 1677 Frosted
- Grade 2
- 2877 Ting Ting
- 2977 Scribble Cloud
- Grade 3
- 3377 Wisp Silver

SOLID SURFACE TOP OPTIONS

COLORS

- 7101 Bisque (Grade A)
- 7201 Glacier White (Grade A)
- 7202 Canyon (Grade B)
- 7203 Designer White (Grade B)
- 7204 Silt (Grade B)
- 7301 Concrete (Grade C)
- 7302 Deep Night Sky (Grade C)
- 7303 Deep Nocturne (Grade C)

LOCKING

KEY RANDOM

- KRB Black
- KRS Silver

KEY SPECIFIC

- KS1B Black, 1 lock per unit
- KS1S Silver, 1 lock per unit
- KS2B Black, 2 locks per unit
- KS2S Silver, 2 locks per unit
- KS3B Black, 3 locks per unit
- KS3S Silver, 3 locks per unit
- KS4B Black, 4 locks per unit
- KS4S Silver, 4 locks per unit

Unit list price will be reduced by \$18 per lock when selecting Key Specific option. Must order specific lock cores separately (\$18 list each). See page 726 for Key Specific model numbers.



Shaded model numbers are available on our "To You in 10 Days or Less" Quick Delivery program and will be delivered in 10 days or less.

WAVEWORKS - CONFIGURATION OPTIONS

PULL OPTIONS

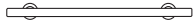

Nantucket (6)

- 6MB Cinder
- 6CC Concrete
- 6IR Iron
- 6PL Platinum Metallic
- 6SN Satin Nickel Metallic
(Boring Pattern 128mm)



Malibu (7)

- 7MB Cinder
- 7CC Concrete
- 7IR Iron
- 7PL Platinum Metallic
- 7SN Satin Nickel Metallic
(Boring Pattern 128mm)

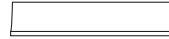

Laguna (76)

- 76MB Cinder
- 76CC Concrete
- 76IR Iron
- 76PL Platinum Metallic
- 76SN Satin Nickel Metallic
(Boring Pattern 128mm)



Summit (70)

- 70MB Cinder
- 70CC Concrete
- 70IR Iron
- 70PL Platinum Metallic
- 70SN Satin Nickel Metallic
(Boring Pattern 128mm)



Spiral (71)

- 71MB Cinder
- 71CC Concrete
- 71IR Iron
- 71PL Platinum Metallic
- 71SN Satin Nickel Metallic
(Boring Pattern 128mm)

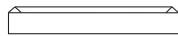

Balance (72)

- 72MB Cinder
- 72CC Concrete
- 72IR Iron
- 72PL Platinum Metallic
- 72SN Satin Nickel Metallic
(Boring Pattern 128mm)



Sweep (73)

- 73MB Cinder
- 73CC Concrete
- 73IR Iron
- 73PL Platinum Metallic
- 73SN Satin Nickel Metallic
(Boring Pattern 128mm)



Groove (74)

- 74MB Cinder
- 74CC Concrete
- 74IR Iron
- 74PL Platinum Metallic
- 74SN Satin Nickel Metallic
(Boring Pattern 128mm)



Beam (87)

- 87MB Cinder
- 87CC Concrete
- 87IR Iron
- 87PL Platinum Metallic
- 87SN Satin Nickel Metallic
(Boring Pattern 128mm)



Level (88)

- 88MB Cinder
- 88CC Concrete
- 88IR Iron
- 88PL Platinum Metallic
- 88SN Satin Nickel Metallic
(Boring Pattern 128mm)



Waterfall (89)

- 89MB Cinder
- 89CC Concrete
- 89IR Iron
- 89PL Platinum Metallic
- 89SN Satin Nickel Metallic
(Boring Pattern 96mm)



Horizon (91)

- 91MB Cinder
 - 91CC Concrete
 - 91IR Iron
 - 91PL Platinum Metallic
 - 91SN Satin Nickel Metallic
(Boring Pattern 96mm)
- Horizon pull is always flush to the top left of the door or drawer front



Bar (3)

- 3MB Cinder
- 3CC Concrete
- 3IR Iron
- 3PL Platinum Metallic
(Boring Pattern 32mm)



Curved (83)

- 83MB Black
- 83CC Concrete
- 83IR Iron
- 83PL Platinum Metallic
(Boring Pattern 128mm)

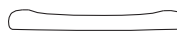

Elongated (84)

- 84MB Black
- 84CC Concrete
- 84IR Iron
- 84PL Platinum Metallic
(Boring Pattern 128mm)



Keen (77)

- 77SN Satin Nickel
(Boring Pattern 96mm)



Leather Pull (93)

- 93EB Ebony
 - 93CH Chestnut
 - 93CA Camel
- (Boring Pattern 128mm)
\$42 list upcharge per model



Shaded model numbers are available on our "To You in 10 Days or Less" Quick Delivery program and will be delivered in 10 days or less.

GROMMET OPTIONS

If no grommet is desired, specify an X (No Grommet)

Round Grommet, Nylon Plastic

\$25 list for each grommet

- G1L Left
- G1R Right
- G1LR Left & Right
- G1C Center
- G1LC Left & Center
- G1RC Right & Center
- G1A Left, Right & Center

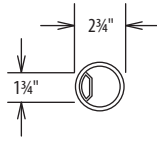

Racetrack Grommet, Satin Nickel Metallic

\$30 list for each grommet

- G11SNL Left
- G11SNR Right
- G11SNLR Left & Right
- G11SNC Center
- G11SNLC Left & Center
- G11SNRC Right & Center
- G11SNA Left, Right & Center

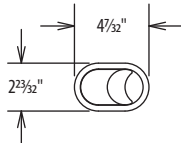

Racetrack Grommet, Platinum Metallic

\$30 list for each grommet

- G11PLL Left
- G11PLR Right
- G11PLLR Left & Right
- G11PLC Center
- G11PLLC Left & Center
- G11PLRC Right & Center
- G11PLA Left, Right & Center

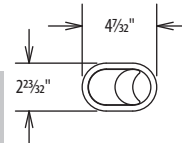

Racetrack Grommet, Cinder

\$30 list for each grommet

- G11MBL Left
- G11MBR Right
- G11MBLR Left & Right
- G11MBC Center
- G11MBLC Left & Center
- G11MBRC Right & Center
- G11MBA Left, Right & Center

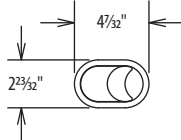

PEDESTAL GROMMET

If no grommet is desired, specify an X

- G22 Extended Radius (\$25 list)

MODESTY GROMMET

If no grommet is desired, specify an X

- G21 Half Moon (\$25 list)

WORKSURFACE WIRE MANAGER

If no wire manager is desired, specify an X (No Wire Manager)

Specify locations and color option
Comes attached to worksurface
\$40 list for each location

Locations:

- D1B Back \$40 list
- D1L Left \$40 list
- D1R Right \$40 list
- D1LR Left & Right \$80 list
- D1BL Back & Left \$80 list
- D1BR Back & Right \$80 list

Sample Option Selections:

- D1B425 Wire Manager on Back in Shadow, \$40 list
- D1BL403 Wire Manager on Back and Left in Chamois, \$80 list

END PANEL GROMMET

If no grommet is desired, specify an X

- G1EL Round, Black, Left (\$25 list)
- G1ER Round, Black, Right (\$25 list)

ADJUSTABLE HEIGHT LEG PAINT

- 462 Cinder
- 501 Platinum Metallic

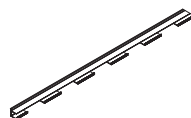

Colors:

- 403 Chamois
- 405 Designer White
- 419 Wallaby
- 425 Shadow
- 440 Cloud
- 461 Graphite
- 462 Cinder
- 478 Platinum Grey
- 485 Dark Chocolate

Cutout Option for 1 Touch Pivoting Power Grommet

\$25 list upcharge per cutout location

- CUT-G17L Left
- CUT-G17R Right
- CUT-G17LR Left & Right
- CUT-G17C Center
- CUT-G17LC Left & Center
- CUT-G17RC Right & Center
- CUT-G17A Left, Right & Center

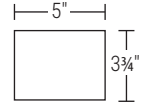

• Reference page 340 for cutout locations of CUT-G17

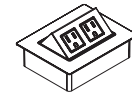

NACG17AELPGB, NACG17AELPGS, and NACG17AELPGW (Sold Separately)

• Reference page 733 for pricing and details

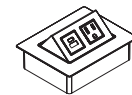

NACG17BELPGB, NACG17BELPGS, and NACG17BELPGW (Sold Separately)

• Reference page 733 for pricing and details

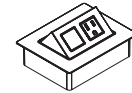

NACG17CELPGB, NACG17CELPGS, and NACG17CELPGW (Sold Separately)

• Reference page 733 for pricing and details

NOTE: Interlink IQ units are available in the Accessories section

PULLOUT STORAGE ELECTRICAL GROMMET

- G37PB Power Grommet \$85
- G37UB USB Grommet \$180

PULLOUT STORAGE SPACER SPACER CUTOUT

- CT1 Cutout, 1 Side \$25
- CT2 Cutout, 2 Sides \$25



Shaded model numbers are available on our "To You in 10 Days or Less" Quick Delivery program and will be delivered in 10 days or less.

WAVEWORKS

GROMMET LOCATION OPTIONS

Grommets are available for factory installation in worksurfaces in predetermined locations as shown below. Simply specify the desired grommet style and location in the model number sequence. Refer to page 339 for options.

Round grommets are also available for field installation; see page 731.

- If specifying a grommet in the center location of a component worksurface, be sure there is clearance under the grommet opening so as not to conflict with undersurface components

Worksurface grommet locations:

Excluding the J-Desk and the corner unit, distance to the center of the grommet is the same for the G1 round grommet, G11 racetrack grommet or the CUT-G17 option.

Excluding the J-Desk and the corner unit, the same locations are available for the round or racetrack grommet and the cutout option.

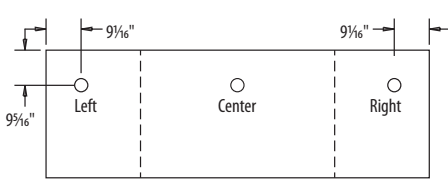

30" and 36" deep Worksurfaces

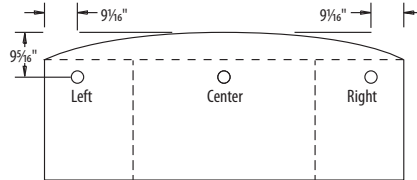

36" deep Arc Worksurfaces

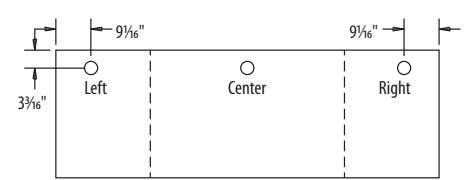

18" and 24" deep Worksurfaces

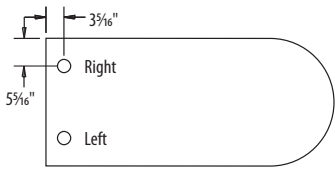

U-Shaped Desk

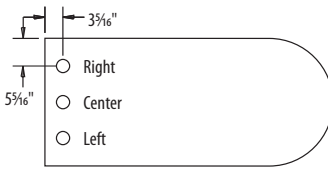

U-Shaped / P-Shaped Worksurface

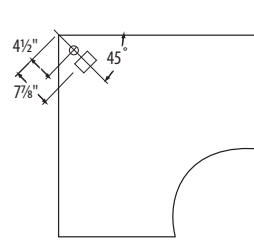

Corner Worksurface

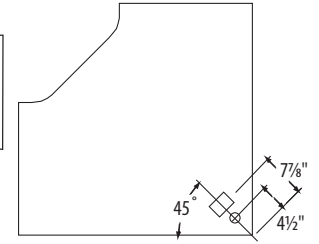

Corner Units

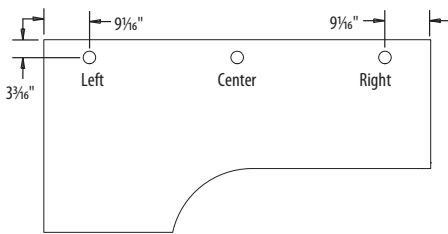

Extended Corner Worksurface (Right shown)

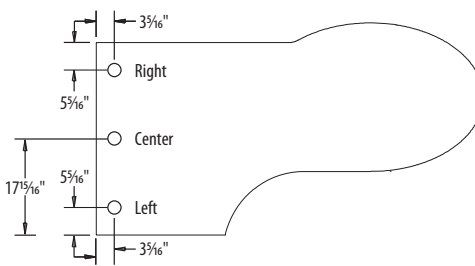

Extended P/U Shaped Worksurface (Right shown)

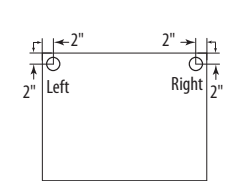

End Panel

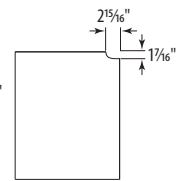

Pedestal

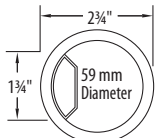

Round Grommet Plastic

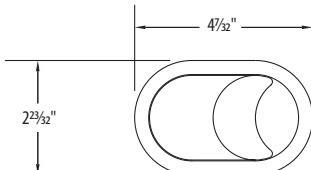

Racetrack Grommet Zinc

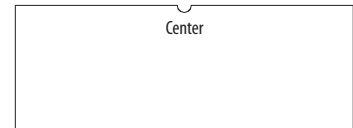

Modesty Panel

DRAWER SPECIFICATIONS

DESCRIPTION	INTERIOR DIMENSIONS			FILING CAPABILITIES	
	DRAWER	INSIDE WIDTH	INSIDE DEPTH		INSIDE HEIGHT
Desk—Recessed Modesty Panel 36 x 72	Box	14 ¹ / ₁₆ "	17"	2 ¹ / ₂ "	Letter, legal, and EDP side-to-side filing Legal filing front-to-back
	File	14 ¹ / ₁₆ "	17"	9 ³ / ₈ "	
Desk—Recessed Modesty Panel 30 x 66, 30 x 60	Box	11 ¹ / ₁₆ "	17"	2 ¹ / ₂ "	Letter filing front-to-back or side-to-side Legal and EDP filing side-to-side
	File	11 ¹ / ₁₆ "	17"	9 ³ / ₈ "	
Single Pedestal Desk 36 x 72	Box	14 ¹ / ₁₆ "	17"	2 ¹ / ₂ "	Letter, legal, and EDP side-to-side filing Legal filing front-to-back
	File	14 ¹ / ₁₆ "	17"	9 ³ / ₈ "	
Single Pedestal Desk 30 x 66	Box	11 ¹ / ₁₆ "	17"	2 ¹ / ₂ "	Letter filing front-to-back or side-to-side Legal and EDP filing side-to-side
	File	11 ¹ / ₁₆ "	17"	9 ³ / ₈ "	
Executive Return 24 x 60, 24 x 48, 24 x 42	Box	11 ¹ / ₁₆ "	17"	2 ¹ / ₂ "	Letter filing front-to-back or side-to-side Legal and EDP filing side-to-side
	File	11 ¹ / ₁₆ "	17"	9 ³ / ₈ "	
Credenzas 24 x 72	Box	14 ¹ / ₁₆ "	17"	2 ¹ / ₂ "	Letter, legal, and EDP side-to-side filing Legal filing front-to-back
	File	14 ¹ / ₁₆ "	17"	9 ³ / ₈ "	
Credenzas 24 x 66, 24 x 60	Box	11 ¹ / ₁₆ "	17"	2 ¹ / ₂ "	Letter filing front-to-back or side-to-side Legal and EDP filing side-to-side
	File	11 ¹ / ₁₆ "	17"	9 ³ / ₈ "	
Credenzas 24 x 72	Lateral File	32 ¹ / ₁₆ "	17"	9 ³ / ₈ "	Letter, legal and EDP filing front-to-back or side-to-side
Single Pedestal Credenzas 24 x 72	Box	14 ¹ / ₁₆ "	17"	2 ¹ / ₂ "	Letter, legal, and EDP side-to-side filing Legal filing front-to-back
	File	14 ¹ / ₁₆ "	17"	9 ³ / ₈ "	
Single Pedestal Credenzas 24 x 66, 24 x 60	Box	11 ¹ / ₁₆ "	17"	2 ¹ / ₂ "	Letter filing front-to-back or side-to-side Legal and EDP filing side-to-side
	File	11 ¹ / ₁₆ "	17"	9 ³ / ₈ "	
Single Pedestal Credenzas 24 x 72	Lateral File	32 ¹ / ₁₆ "	17"	9 ³ / ₈ "	Letter, legal and EDP filing front-to-back or side-to-side
Lateral File (23" depth) 36" width	Lateral File	32 ¹ / ₁₆ "	17"	9 ³ / ₈ "	Letter, legal and EDP filing front-to-back or side-to-side
Lateral File (17" depth) 36" width	Lateral File	32 ¹ / ₁₆ "	12 ¹ / ₃₂ "	9 ³ / ₈ "	Letter, legal and EDP filing front-to-back Letter filing side-to-side
Lateral File (23" depth) 30" width	Lateral File	26 ¹ / ₁₆ "	17"	9 ³ / ₈ "	Letter, legal and EDP filing front-to-back or side-to-side
Lateral File (17" depth) 30" width	Lateral File	26 ¹ / ₁₆ "	12 ¹ / ₃₂ "	9 ³ / ₈ "	Letter, legal and EDP filing front-to-back Letter filing side-to-side
Vertical Storage Cabinet 18 x 68	Box	14 ¹ / ₁₆ "	17"	2 ¹ / ₂ "	Letter, legal, and EDP side-to-side filing Legal filing front-to-back
	File	14 ¹ / ₁₆ "	17"	9 ³ / ₈ "	
Component Pedestals 23 x 18, 29 x 18	Box	14 ¹ / ₁₆ "	17"	2 ¹ / ₂ "	Letter, legal, and EDP side-to-side filing Legal filing front-to-back
	File	14 ¹ / ₁₆ "	17"	9 ³ / ₈ "	
Component Pedestal 17 x 18	Box	14 ¹ / ₁₆ "	12 ¹ / ₃₂ "	2 ¹ / ₂ "	Letter filing side-to-side Legal filing front-to-back
	File	14 ¹ / ₁₆ "	12 ¹ / ₃₂ "	9 ³ / ₈ "	
Component Pedestals 23 x 15, 29 x 15	Box	11 ¹ / ₁₆ "	17"	2 ¹ / ₂ "	Letter filing front-to-back or side-to-side Legal and EDP filing side-to-side
	File	11 ¹ / ₁₆ "	17"	9 ³ / ₈ "	
Component Pedestals 17 x 15	Box	11 ¹ / ₁₆ "	12 ¹ / ₃₂ "	2 ¹ / ₂ "	Letter filing front-to-back or side-to-side
	File	11 ¹ / ₁₆ "	12 ¹ / ₃₂ "	9 ³ / ₈ "	
Mobile Pedestals 23 x 15	Box	11 ¹ / ₁₆ "	17"	2 ¹ / ₂ "	Letter filing front-to-back or side-to-side EDP and legal filing side-to-side
	File	11 ¹ / ₁₆ "	17"	9 ³ / ₈ "	

- All file drawers will accommodate A4 and British fools cap filing
- Exterior dimension of legal width pedestal is 18". Letter width is 15"

WAVEWORKS ASSEMBLED L ARRANGEMENTS

Specify quickly and accurately with National's EZ Arrangement models. In each series, the most popular options have been pre-selected for a complete L or U configuration. Just choose the left or right model number, add a finish and you're done.

ARRANGEMENTS INCLUDE:

- Nantucket, Cinder pulls
- Softened Wood rim profile (wood models)
- Softened PVC, Cinder rim profile (laminated models)
- Random black lock cores
- Center grommet in return
- Must specify finish/laminate

L-CONFIGURATIONS	MODEL NO./DESCRIPTION	LIST PRICE
LEFT L-CONFIGURATION 1 3/16" WOOD	WW8572LLFW 84%D x 71 1/4"W	\$ 5435
	consists of	
	WW3672DRFW1 Right Pedestal Desk	3225
	WW2448RLEFW2 Left Pedestal Return	2210
	WW7972LLFW 78%D x 71 1/4"W	\$ 5350
	consists of	
	WW3672DRFW1 Right Pedestal Desk	3225
	WW2442RLEFW2 Left Pedestal Return	2125
	WW7966LLFW 78%D x 66W	\$ 5234
	consists of	
	WW3066DRFW1 Right Pedestal Desk	3024
	WW2448RLEFW2 Left Pedestal Return	2210
WW7366LLFW 72%D x 66W	\$ 5149	
consists of		
WW3066DRFW1 Right Pedestal Desk	3024	
WW2442RLEFW2 Left Pedestal Return	2125	

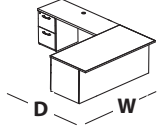

L-CONFIGURATIONS	MODEL NO./DESCRIPTION	LIST PRICE
RIGHT L-CONFIGURATION 1 3/16" WOOD	WW8572LRFW 84%D x 71 1/4"W	\$ 5435
	consists of	
	WW3672DLFW1 Left Pedestal Desk	3225
	WW2448RREFW2 Right Pedestal Return	2210
	WW7972LRFW 78%D x 71 1/4"W	\$ 5350
	consists of	
	WW3672DLFW1 Left Pedestal Desk	3225
	WW2442RREFW2 Right Pedestal Return	2125
	WW7966LRFW 78%D x 66W	\$ 5234
	consists of	
	WW3066DLFW1 Left Pedestal Desk	3024
	WW2448RREFW2 Right Pedestal Return	2210
WW7366LRFW 72%D x 66W	\$ 5149	
consists of		
WW3066DLFW1 Left Pedestal Desk	3024	
WW2442RREFW2 Right Pedestal Return	2125	

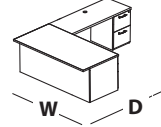

L-CONFIGURATIONS	MODEL NO./DESCRIPTION	LIST PRICE
LEFT L-CONFIGURATION 1 3/16" HPL TOP	WW8572LLFL 84%D x 71 1/4"W	\$ 3484
	consists of	
	WW3672DRFL1 Right Pedestal Desk	2126
	WW2448RLEFL2 Left Pedestal Return	1358
	WW7972LLFL 78%D x 71 1/4"W	\$ 3428
	consists of	
	WW3672DRFL1 Right Pedestal Desk	2126
	WW2442RLEFL2 Left Pedestal Return	1302
	WW7966LLFL 78%D x 66W	\$ 3393
	consists of	
	WW3066DRFL1 Right Pedestal Desk	2035
	WW2448RLEFL2 Left Pedestal Return	1358
WW7366LLFL 72%D x 66W	\$ 3337	
consists of		
WW3066DRFL1 Right Pedestal Desk	2035	
WW2442RLEFL2 Left Pedestal Return	1302	

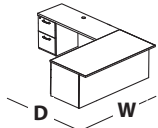

L-CONFIGURATIONS	MODEL NO./DESCRIPTION	LIST PRICE
RIGHT L-CONFIGURATION 1 3/16" HPL TOP	WW8572LRFL 84%D x 71 1/4"W	\$ 3484
	consists of	
	WW3672DLFL1 Left Pedestal Desk	2126
	WW2448RREFL2 Right Pedestal Return	1358
	WW7972LRFL 78%D x 71 1/4"W	\$ 3428
	consists of	
	WW3672DLFL1 Left Pedestal Desk	2126
	WW2442RREFL2 Right Pedestal Return	1302
	WW7966LRFL 78%D x 66W	\$ 3393
	consists of	
	WW3066DLFL1 Left Pedestal Desk	2035
	WW2448RREFL2 Right Pedestal Return	1358
WW7366LRFL 72%D x 66W	\$ 3337	
consists of		
WW3066DLFL1 Left Pedestal Desk	2035	
WW2442RREFL2 Right Pedestal Return	1302	

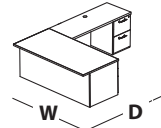

WAVEWORKS ASSEMBLED L ARRANGEMENTS

Specify quickly and accurately with National's EZ Arrangement models. In each series, the most popular options have been pre-selected for a complete L or U configuration. Just choose the left or right model number, add a finish and you're done.

ARRANGEMENTS INCLUDE:

- Nantucket, Cinder pulls
- Softened PVC, Cinder rim profile (laminated models)
- Random black lock cores
- Center grommet in return
- Must specify finish/laminate

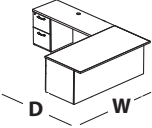
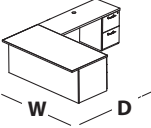
L-CONFIGURATIONS	MODEL NO./DESCRIPTION	LIST PRICE	L-CONFIGURATIONS	MODEL NO./DESCRIPTION	LIST PRICE		
LEFT L-CONFIGURATION 1½" TFL TOP 	WW8572LLFLL	84½D x 71½W	\$ 2791	RIGHT L-CONFIGURATION 1½" TFL TOP 	WW8572LRFLL	84½D x 71½W	\$ 2791
	consists of				consists of		
	WW3672DRFLL1	Right Pedestal Desk	1700		WW3672DLFLL1	Left Pedestal Desk	1700
	WW2448RLEFLL2	Left Pedestal Return	1091		WW2448RREFLL2	Right Pedestal Return	1091
	WW7972LLFLL	78½D x 71½W	\$ 2749		WW7972LRFLL	78½D x 71½W	\$ 2749
	consists of				consists of		
	WW3672DRFLL1	Right Pedestal Desk	1700		WW3672DLFLL1	Left Pedestal Desk	1700
	WW2442RLEFLL2	Left Pedestal Return	1049		WW2442RREFLL2	Right Pedestal Return	1049
	WW7966LLFLL	78½D x 66W	\$ 2720		WW7966LRFLL	78½D x 66W	\$ 2720
	consists of				consists of		
WW3066DRFLL1	Right Pedestal Desk	1629	WW3066DLFLL1	Left Pedestal Desk	1629		
WW2448RLEFLL2	Left Pedestal Return	1091	WW2448RREFLL2	Right Pedestal Return	1091		
WW7366LLFLL	72½D x 66W	\$ 2678	WW7366LRFLL	72½D x 66W	\$ 2678		
consists of			consists of				
WW3066DRFLL1	Right Pedestal Desk	1629	WW3066DLFLL1	Left Pedestal Desk	1629		
WW2442RLEFLL2	Left Pedestal Return	1049	WW2442RREFLL2	Right Pedestal Return	1049		

WAVEWORKS ASSEMBLED U ARRANGEMENTS

Specify quickly and accurately with National's EZ Arrangement models. In each series, the most popular options have been pre-selected for a complete L or U configuration. Just choose the left or right model number, add a finish and you're done.

ARRANGEMENTS INCLUDE:

- Nantucket, Cinder pulls
- Softened Wood rim profile (wood models)
- Softened PVC, Cinder rim profile (laminated models)
- Random black lock cores
- Center grommet in bridge
- Left and right grommets in credenza
- Must specify finish/laminate

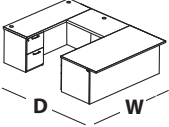
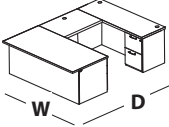
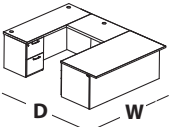
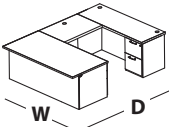
U-CONFIGURATIONS	MODEL NO./DESCRIPTION	LIST PRICE	U-CONFIGURATIONS	MODEL NO./DESCRIPTION	LIST PRICE		
LEFT U-CONFIGURATION 1 1/2" WOOD 	WW10972ULFW	108 1/2D x 71 1/8W	\$ 6825	RIGHT U-CONFIGURATION 1 1/2" WOOD 	WW10972URFW	108 1/2D x 71 1/8W	\$ 6825
	consists of				consists of		
	WW3672DRFW1	Right Pedestal Desk	3225		WW3672DLFW1	Left Pedestal Desk	3225
	WW2448BEFW	Bridge	943		WW2448BEFW	Bridge	943
	WW2472CLFW2	Left Pedestal Credenza	2657		WW2472CRFW2	Right Pedestal Credenza	2657
	WW10372ULFW	102 1/2D x 71 1/8W	\$ 6772		WW10372URFW	102 1/2D x 71 1/8W	\$ 6772
	consists of				consists of		
	WW3672DRFW1	Right Pedestal Desk	3225		WW3672DLFW1	Left Pedestal Desk	3225
	WW2442BEFW	Bridge	890		WW2442BEFW	Bridge	890
	WW2472CLFW2	Left Pedestal Credenza	2657		WW2472CRFW2	Right Pedestal Credenza	2657
	WW10366ULFW	102 1/2D x 66W	\$ 6582		WW10366URFW	102 1/2D x 66W	\$ 6582
	consists of				consists of		
WW3066DRFW1	Right Pedestal Desk	3024	WW3066DLFW1	Left Pedestal Desk	3024		
WW2448BEFW	Bridge	943	WW2448BEFW	Bridge	943		
WW2466CLFW2	Left Pedestal Credenza	2615	WW2466CRFW2	Right Pedestal Credenza	2615		
WW9766ULFW	96 1/2D x 66W	\$ 6529	WW9766URFW	96 1/2D x 66W	\$ 6529		
consists of			consists of				
WW3066DRFW1	Right Pedestal Desk	3024	WW3066DLFW1	Left Pedestal Desk	3024		
WW2442BEFW	Bridge	890	WW2442BEFW	Bridge	890		
WW2466CLFW2	Left Pedestal Credenza	2615	WW2466CRFW2	Right Pedestal Credenza	2615		
LEFT U-CONFIGURATION 1 1/2" HPL TOP 	WW10972ULFL	108 1/2D x 71 1/8W	\$ 4622	RIGHT U-CONFIGURATION 1 1/2" HPL TOP 	WW10972URFL	108 1/2D x 71 1/8W	\$ 4622
	consists of				consists of		
	WW3672DRFL1	Right Pedestal Desk	2126		WW3672DLFL1	Left Pedestal Desk	2126
	WW2448BEFL	Bridge	583		WW2448BEFL	Bridge	583
	WW2472CLFL2	Left Pedestal Credenza	1913		WW2472CRFL2	Right Pedestal Credenza	1913
	WW10372ULFL	102 1/2D x 71 1/8W	\$ 4568		WW10372URFL	102 1/2D x 71 1/8W	\$ 4568
	consists of				consists of		
	WW3672DRFL1	Right Pedestal Desk	2126		WW3672DLFL1	Left Pedestal Desk	2126
	WW2442BEFL	Bridge	529		WW2442BEFL	Bridge	529
	WW2472CLFL2	Left Pedestal Credenza	1913		WW2472CRFL2	Right Pedestal Credenza	1913
	WW10366ULFL	102 1/2D x 66W	\$ 4450		WW10366URFL	102 1/2D x 66W	\$ 4450
	consists of				consists of		
WW3066DRFL1	Right Pedestal Desk	2035	WW3066DLFL1	Left Pedestal Desk	2035		
WW2448BEFL	Bridge	583	WW2448BEFL	Bridge	583		
WW2466CLFL2	Left Pedestal Credenza	1832	WW2466CRFL2	Right Pedestal Credenza	1832		
WW9766ULFL	96 1/2D x 66W	\$ 4396	WW9766URFL	96 1/2D x 66W	\$ 4396		
consists of			consists of				
WW3066DRFL1	Right Pedestal Desk	2035	WW3066DLFL1	Left Pedestal Desk	2035		
WW2442BEFL	Bridge	529	WW2442BEFL	Bridge	529		
WW2466CLFL2	Left Pedestal Credenza	1832	WW2466CRFL2	Right Pedestal Credenza	1832		

WAVEWORKS ASSEMBLED U ARRANGEMENTS

Specify quickly and accurately with National's EZ Arrangement models. In each series, the most popular options have been pre-selected for a complete L or U configuration. Just choose the left or right model number, add a finish and you're done.

ARRANGEMENTS INCLUDE:

- Nantucket, Cinder pulls
- Softened PVC, Cinder rim profile (laminated models)
- Random black lock cores
- Center grommet in bridge
- Left and right grommets in credenza
- Must specify finish/laminate

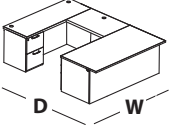
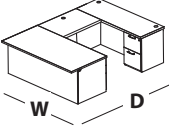
U-CONFIGURATIONS	MODEL NO./DESCRIPTION	LIST PRICE	U-CONFIGURATIONS	MODEL NO./DESCRIPTION	LIST PRICE	
LEFT U-CONFIGURATION 1 1/8" TFL TOP 	WW10972ULFLL 108 1/2D x 71 1/8W	\$ 3712	RIGHT U-CONFIGURATION 1 1/8" TFL TOP 	WW10972URFLL 108 1/2D x 71 1/8W	\$ 3712	
	consists of			consists of		
	WW3672DRFLL1 Right Pedestal Desk	1700		WW3672DLFLL1 Left Pedestal Desk	1700	
	WW2448BEFLL Bridge	472		WW2448BEFLL Bridge	472	
	WW2472CLFLL2 Left Pedestal Credenza	1540		WW2472CRFLL2 Right Pedestal Credenza	1540	
	WW10372ULFLL 102 1/2D x 71 1/8W	\$ 3669		WW10372URFLL 102 1/2D x 71 1/8W	\$ 3669	
	consists of			consists of		
	WW3672DRFLL1 Right Pedestal Desk	1700		WW3672DLFLL1 Left Pedestal Desk	1700	
	WW2442BEFLL Bridge	429		WW2442BEFLL Bridge	429	
	WW2472CLFLL2 Left Pedestal Credenza	1540		WW2472CRFLL2 Right Pedestal Credenza	1540	
	WW10366ULFLL 102 1/2D x 66W	\$ 3576		WW10366URFLL 102 1/2D x 66W	\$ 3576	
	consists of			consists of		
	WW3066DRFLL1 Right Pedestal Desk	1629		WW3066DLFLL1 Left Pedestal Desk	1629	
	WW2448BEFLL Bridge	472		WW2448BEFLL Bridge	472	
	WW2466CLFLL2 Left Pedestal Credenza	1475		WW2466CRFLL2 Right Pedestal Credenza	1475	
	WW9766ULFLL 96 1/2D x 66W	\$ 3533		WW9766URFLL 96 1/2D x 66W	\$ 3533	
consists of		consists of				
WW3066DRFLL1 Right Pedestal Desk	1629	WW3066DLFLL1 Left Pedestal Desk	1629			
WW2442BEFLL Bridge	429	WW2442BEFLL Bridge	429			
WW2466CLFLL2 Left Pedestal Credenza	1475	WW2466CRFLL2 Right Pedestal Credenza	1475			

WAVEWORKS METAL L ARRANGEMENTS

Specify quickly and accurately with National's EZ Arrangement models. In each series, the most popular options have been pre-selected for a complete L or U configuration. Just choose the left or right model number, add a finish and you're done.

ARRANGEMENTS INCLUDE:

- Integrated pulls
- Softened Wood rim profile (wood models)
- Softened PVC, Cinder rim profile (laminated models)
- Random black lock cores
- Center grommet in return
- Must specify finish/laminate and paint

L-CONFIGURATIONS	MODEL NO./DESCRIPTION	LIST PRICE
L-CONFIGURATION WOOD TOP/METAL CHASSIS (CAN BE CONFIGURED AS RIGHT OR LEFT HANDED)	WW8572LFWM 84% \times 71% \times W \$ 3591	
	consists of	
	WW3672WSSDW Worksurface 1071	
	WW2448WSSVDW Worksurface 727	
	WW3015PUBBFM B/B/F Pedestal 518	
	WW2315PUFFM F/F Pedestal 469	
	WW7227MPM Full Overlay Modesty 246	
	WW3027EPM End Panel 259	
	WW0827SRM Return Support Panel 89	
	WW4827MPM Full Overlay Modesty 212	
WW7972LFWM 78% \times 71% \times W \$ 3545		
consists of		
WW3672WSSDW Worksurface 1071		
WW2442WSSVDW Worksurface 696		
WW3015PUBBFM B/B/F Pedestal 518		
WW2315PUFFM F/F Pedestal 469		
WW7227MPM Full Overlay Modesty 246		
WW3027EPM End Panel 259		
WW0827SRM Return Support Panel 89		
WW4227MPM Full Overlay Modesty 197		

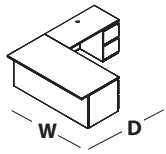

L-CONFIGURATIONS	MODEL NO./DESCRIPTION	LIST PRICE
L-CONFIGURATION WOOD TOP/METAL CHASSIS (CAN BE CONFIGURED AS RIGHT OR LEFT HANDED)	WW7966LFWM 78% \times 66W \$ 3357	
	consists of	
	WW3066WSSDW Worksurface 850	
	WW2448WSSVDW Worksurface 727	
	WW3015PUBBFM B/B/F Pedestal 518	
	WW2315PUFFM F/F Pedestal 469	
	WW6627MPM Full Overlay Modesty 233	
	WW3027EPM End Panel 259	
	WW0827SRM Return Support Panel 89	
	WW4827MPM Full Overlay Modesty 212	
WW7366LFWM 72% \times 66W \$ 3311		
consists of		
WW3066WSSDW Worksurface 850		
WW2442WSSVDW Worksurface 696		
WW3015PUBBFM B/B/F Pedestal 518		
WW2315PUFFM F/F Pedestal 469		
WW6627MPM Full Overlay Modesty 233		
WW3027EPM End Panel 259		
WW0827SRM Return Support Panel 89		
WW4227MPM Full Overlay Modesty 197		

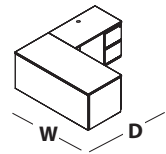

L-CONFIGURATION	MODEL NO./DESCRIPTION	LIST PRICE
HPL TOP/METAL CHASSIS (CAN BE CONFIGURED AS RIGHT OR LEFT HANDED)	WW8572LFLM 84% \times 71% \times W \$ 2864	
	consists of	
	WW3672WSSDL Worksurface 728	
	WW2448WSSVDL Worksurface 343	
	WW3015PUBBFM B/B/F Pedestal 518	
	WW2315PUFFM F/F Pedestal 469	
	WW7227MPM Full Overlay Modesty 246	
	WW3027EPM End Panel 259	
	WW0827SRM Return Support Panel 89	
	WW4827MPM Full Overlay Modesty 212	
WW7972LFLM 78% \times 71% \times W \$ 2817		
consists of		
WW3672WSSDL Worksurface 728		
WW2442WSSVDL Worksurface 311		
WW3015PUBBFM B/B/F Pedestal 518		
WW2315PUFFM F/F Pedestal 469		
WW7227MPM Full Overlay Modesty 246		
WW3027EPM End Panel 259		
WW0827SRM Return Support Panel 89		
WW4227MPM Full Overlay Modesty 197		

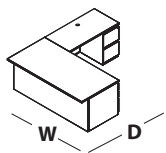

L-CONFIGURATION	MODEL NO./DESCRIPTION	LIST PRICE
HPL TOP/METAL CHASSIS (CAN BE CONFIGURED AS RIGHT OR LEFT HANDED)	WW7966LFLM 78% \times 66W \$ 2618	
	consists of	
	WW3066WSSDL Worksurface 495	
	WW2448WSSVDL Worksurface 343	
	WW3015PUBBFM B/B/F Pedestal 518	
	WW2315PUFFM F/F Pedestal 469	
	WW6627MPM Full Overlay Modesty 233	
	WW3027EPM End Panel 259	
	WW0827SRM Return Support Panel 89	
	WW4827MPM Full Overlay Modesty 212	
WW7366LFLM 72% \times 66W \$ 2571		
consists of		
WW3066WSSDL Worksurface 495		
WW2442WSSVDL Worksurface 311		
WW3015PUBBFM B/B/F Pedestal 518		
WW2315PUFFM F/F Pedestal 469		
WW6627MPM Full Overlay Modesty 233		
WW3027EPM End Panel 259		
WW0827SRM Return Support Panel 89		
WW4227MPM Full Overlay Modesty 197		

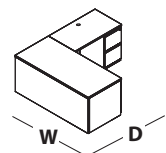

WAVEWORKS METAL L ARRANGEMENTS

Specify quickly and accurately with National's EZ Arrangement models. In each series, the most popular options have been pre-selected for a complete L or U configuration. Just choose the left or right model number, add a finish and you're done.

ARRANGEMENTS INCLUDE:

- Integrated pulls
- Softened PVC, Cinder rim profile
- Random black lock cores
- Center grommet in return
- Must specify paint
- Must specify laminate

L-CONFIGURATIONS	MODEL NO./DESCRIPTION		LIST PRICE
L-CONFIGURATION TFL TOP/ METAL CHASSIS (CAN BE CONFIGURED AS RIGHT OR LEFT HANDED)	WW8572LFLLM	84%D x 71 ¹ / ₆ W	\$ 2656
	consists of		
	WW3672WSSDLL	Worksurface	583
	WW2448WSSVDLL	Worksurface	280
	WW3015PUBBFM	B/B/F Pedestal	518
	WW2315PUFFM	F/F Pedestal	469
	WW7227MPM	Full Overlay Modesty	246
	WW3027EPM	End Panel	259
	WW0827SRM	Return Support Panel	89
	WW4827MPM	Full Overlay Modesty	212
WW7972LFLLM	78%D x 71 ¹ / ₆ W	\$ 2614	
consists of			
WW3672WSSDLL	Worksurface	583	
WW2442WSSVDLL	Worksurface	253	
WW3015PUBBFM	B/B/F Pedestal	518	
WW2315PUFFM	F/F Pedestal	469	
WW7227MPM	Full Overlay Modesty	246	
WW3027EPM	End Panel	259	
WW0827SRM	Return Support Panel	89	
WW4227MPM	Full Overlay Modesty	197	

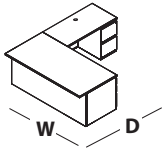

L-CONFIGURATIONS	MODEL NO./DESCRIPTION		LIST PRICE
L-CONFIGURATION TFL TOP/ METAL CHASSIS (CAN BE CONFIGURED AS RIGHT OR LEFT HANDED)	WW7966LFLLM	78%D x 66W	\$ 2456
	consists of		
	WW3066WSSDLL	Worksurface	396
	WW2448WSSVDLL	Worksurface	280
	WW3015PUBBFM	B/B/F Pedestal	518
	WW2315PUFFM	F/F Pedestal	469
	WW6627MPM	Full Overlay Modesty	233
	WW3027EPM	End Panel	259
	WW0827SRM	Return Support Panel	89
	WW4827MPM	Full Overlay Modesty	212
WW7366LFLLM	72%D x 66W	\$ 2414	
consists of			
WW3066WSSDLL	Worksurface	396	
WW2442WSSVDLL	Worksurface	253	
WW3015PUBBFM	B/B/F Pedestal	518	
WW2315PUFFM	F/F Pedestal	469	
WW6627MPM	Full Overlay Modesty	233	
WW3027EPM	End Panel	259	
WW0827SRM	Return Support Panel	89	
WW4227MPM	Full Overlay Modesty	197	

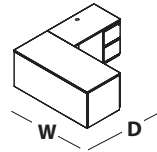

WAVEWORKS METAL U ARRANGEMENTS

Specify quickly and accurately with National's EZ Arrangement models. In each series, the most popular options have been pre-selected for a complete L or U configuration. Just choose the left or right model number, add a finish and you're done.

ARRANGEMENTS INCLUDE:

- Integrated pulls
- Softened Wood rim profile (wood models)
- Softened PVC, Cinder rim profile (laminated models)
- Random black lock cores
- Center grommet in bridge
- Left and right grommets in credenza
- Must specify finish/laminate and paint

U-CONFIGURATIONS	MODEL NO./DESCRIPTION	LIST PRICE
U-CONFIGURATION WOOD TOP/METAL CHASSIS (CAN BE CONFIGURED AS RIGHT OR LEFT HANDED)	WW10972UFWM 108½D x 71½W	\$ 4993
	consists of	
	WW3672WSSDW Worksurface	1071
	WW2448WSSVDW Worksurface	727
	WW2472WSSDW Worksurface	838
	WW3015PUBBFM B/B/F Pedestal	518
	WW2315PUFFM F/F Pedestal	469
	WW7227MPM Full Overlay Modesty	246
	WW7227MPM Full Overlay Modesty	246
	WW3027EPM End Panel	259
	WW0827SRM Return Support Panel	89
	WW0827SRM Return Support Panel	89
	WW2427EPM End Panel	229
	WW4827MPM Full Overlay Modesty	212

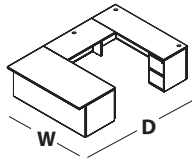

U-CONFIGURATIONS	MODEL NO./DESCRIPTION	LIST PRICE
U-CONFIGURATION WOOD TOP/METAL CHASSIS (CAN BE CONFIGURED AS RIGHT OR LEFT HANDED)	WW10366UFWM 102½D x 66W	\$ 4716
	consists of	
	WW3066WSSDW Worksurface	850
	WW2448WSSVDW Worksurface	727
	WW2466WSSDW Worksurface	808
	WW3015PUBBFM B/B/F Pedestal	518
	WW2315PUFFM F/F Pedestal	469
	WW6627MPM Full Overlay Modesty	233
	WW6627MPM Full Overlay Modesty	233
	WW3027EPM End Panel	259
	WW0827SRM Return Support Panel	89
	WW0827SRM Return Support Panel	89
	WW2427EPM End Panel	229
	WW4827MPM Full Overlay Modesty	212

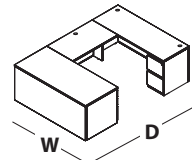

WW10372UFWM 102½D x 71½W	\$ 4947
consists of	
WW3672WSSDW Worksurface	1071
WW2442WSSVDW Worksurface	696
WW2472WSSDW Worksurface	838
WW3015PUBBFM B/B/F Pedestal	518
WW2315PUFFM F/F Pedestal	469
WW7227MPM Full Overlay Modesty	246
WW7227MPM Full Overlay Modesty	246
WW3027EPM End Panel	259
WW0827SRM Return Support Panel	89
WW0827SRM Return Support Panel	89
WW2427EPM End Panel	229
WW4227MPM Full Overlay Modesty	197

WW9766UFWM 96½D x 66W	\$ 4670
consists of	
WW3066WSSDW Worksurface	850
WW2442WSSVDW Worksurface	696
WW2466WSSDW Worksurface	808
WW3015PUBBFM B/B/F Pedestal	518
WW2315PUFFM F/F Pedestal	469
WW6627MPM Full Overlay Modesty	233
WW6627MPM Full Overlay Modesty	233
WW3027EPM End Panel	259
WW0827SRM Return Support Panel	89
WW0827SRM Return Support Panel	89
WW2427EPM End Panel	229
WW4227MPM Full Overlay Modesty	197

U-CONFIGURATION HPL TOP/METAL CHASSIS (CAN BE CONFIGURED AS RIGHT OR LEFT HANDED)	MODEL NO./DESCRIPTION	LIST PRICE
U-CONFIGURATION HPL TOP/METAL CHASSIS (CAN BE CONFIGURED AS RIGHT OR LEFT HANDED)	WW10972UFLM 108½D x 71½W	\$ 3929
	consists of	
	WW3672WSSDL Worksurface	728
	WW2448WSSVDL Worksurface	343
	WW2472WSSDL Worksurface	501
	WW3015PUBBFM B/B/F Pedestal	518
	WW2315PUFFM F/F Pedestal	469
	WW7227MPM Full Overlay Modesty	246
	WW7227MPM Full Overlay Modesty	246
	WW3027EPM End Panel	259
	WW0827SRM Return Support Panel	89
	WW0827SRM Return Support Panel	89
	WW2427EPM End Panel	229
	WW4827MPM Full Overlay Modesty	212

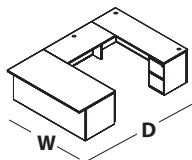

WW10366UFLM 102½D x 66W	\$ 3637
consists of	
WW3066WSSDL Worksurface	495
WW2448WSSVDL Worksurface	343
WW2466WSSDL Worksurface	468
WW3015PUBBFM B/B/F Pedestal	518
WW2315PUFFM F/F Pedestal	469
WW6627MPM Full Overlay Modesty	233
WW6627MPM Full Overlay Modesty	233
WW3027EPM End Panel	259
WW0827SRM Return Support Panel	89
WW0827SRM Return Support Panel	89
WW2427EPM End Panel	229
WW4827MPM Full Overlay Modesty	212

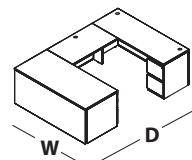

WW10372UFLM 102½D x 71½W	\$ 3882
consists of	
WW3672WSSDL Worksurface	728
WW2442WSSVDL Worksurface	311
WW2472WSSDL Worksurface	501
WW3015PUBBFM B/B/F Pedestal	518
WW2315PUFFM F/F Pedestal	469
WW7227MPM Full Overlay Modesty	246
WW7227MPM Full Overlay Modesty	246
WW3027EPM End Panel	259
WW0827SRM Return Support Panel	89
WW0827SRM Return Support Panel	89
WW2427EPM End Panel	229
WW4227MPM Full Overlay Modesty	197

WW9766UFLM 96½D x 66W	\$ 3590
consists of	
WW3066WSSDL Worksurface	495
WW2442WSSVDL Worksurface	311
WW2466WSSDL Worksurface	468
WW3015PUBBFM B/B/F Pedestal	518
WW2315PUFFM F/F Pedestal	469
WW6627MPM Full Overlay Modesty	233
WW6627MPM Full Overlay Modesty	233
WW3027EPM End Panel	259
WW0827SRM Return Support Panel	89
WW0827SRM Return Support Panel	89
WW2427EPM End Panel	229
WW4227MPM Full Overlay Modesty	197

WAVEWORKS METAL U ARRANGEMENTS

Specify quickly and accurately with National's EZ Arrangement models. In each series, the most popular options have been pre-selected for a complete L or U configuration. Just choose the left or right model number, add a finish and you're done.

ARRANGEMENTS INCLUDE:

- Integrated pulls
- Softened PVC, Cinder rim profile (laminated models)
- Random black lock cores
- Center grommet in bridge
- Left and right grommets in credenza
- Must specify laminate and paint

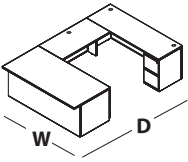
U-CONFIGURATIONS	MODEL NO./DESCRIPTION	LIST PRICE
U-CONFIGURATION TFL TOP/ METAL CHASSIS (CAN BE CONFIGURED AS RIGHT OR LEFT HANDED) 	WW10972UFLLM 108½D x 71⅞W	\$ 3631
	consists of	
	WW3672WSSDLL Worksurface	583
	WW2448WSSVDLL Worksurface	280
	WW2472WSSDLL Worksurface	411
	WW3015PUBBFM B/B/F Pedestal	518
	WW2315PUFFM F/F Pedestal	469
	WW7227MPM Full Overlay Modesty	246
	WW7227MPM Full Overlay Modesty	246
	WW3027EPM End Panel	259
	WW0827SRM Return Support Panel	89
	WW0827SRM Return Support Panel	89
	WW2427EPM End Panel	229
	WW4827MPM Full Overlay Modesty	212
	WW10372UFLLM 102½D x 71⅞W	\$ 3589
	consists of	
	WW3672WSSDLL Worksurface	583
WW2442WSSVDLL Worksurface	253	
WW2472WSSDLL Worksurface	411	
WW3015PUBBFM B/B/F Pedestal	518	
WW2315PUFFM F/F Pedestal	469	
WW7227MPM Full Overlay Modesty	246	
WW7227MPM Full Overlay Modesty	246	
WW3027EPM End Panel	259	
WW0827SRM Return Support Panel	89	
WW0827SRM Return Support Panel	89	
WW2427EPM End Panel	229	
WW4227MPM Full Overlay Modesty	197	

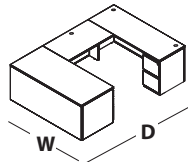
U-CONFIGURATIONS	MODEL NO./DESCRIPTION	LIST PRICE
U-CONFIGURATION TFL TOP/ METAL CHASSIS (CAN BE CONFIGURED AS RIGHT OR LEFT HANDED) 	WW10366UFLLM 102½D x 66W	\$ 3392
	consists of	
	WW3066WSSDLL Worksurface	396
	WW2448WSSVDLL Worksurface	280
	WW2466WSSDLL Worksurface	385
	WW3015PUBBFM B/B/F Pedestal	518
	WW2315PUFFM F/F Pedestal	469
	WW6627MPM Full Overlay Modesty	233
	WW6627MPM Full Overlay Modesty	233
	WW3027EPM End Panel	259
	WW0827SRM Return Support Panel	89
	WW0827SRM Return Support Panel	89
	WW2427EPM End Panel	229
	WW4827MPM Full Overlay Modesty	212
	WW9766UFLLM 96½D x 66W	\$ 3350
	consists of	
	WW3066WSSDLL Worksurface	396
WW2442WSSVDLL Worksurface	253	
WW2466WSSDLL Worksurface	385	
WW3015PUBBFM B/B/F Pedestal	518	
WW2315PUFFM F/F Pedestal	469	
WW6627MPM Full Overlay Modesty	233	
WW6627MPM Full Overlay Modesty	233	
WW3027EPM End Panel	259	
WW0827SRM Return Support Panel	89	
WW0827SRM Return Support Panel	89	
WW2427EPM End Panel	229	
WW4227MPM Full Overlay Modesty	197	

WAVEWORKS

WAVEWORKS

PRODUCT SPECIFICATIONS

- Wood and laminate tops and chassis available; refer to page 336 for options
- Refer to pages 717-760 for accessories
- Refer to page 341 for filing capabilities
- Assembled units and component units are interchangeable
- Refer to page 340 for grommet locations and page 339 for grommet options and upcharge
- If specifying wood, you must specify the same finish for all options
- Center grommet location not available on desks

TO ORDER, SPECIFY:

1. Model Number
2. Rim
3. PVC Rim Color (laminated models)
4. Pull
5. Grommet
6. Locking
7. Laminate Top Color (laminated/combo models)
8. Laminate Door/Drawer Color (laminated models)
9. Veneer Chassis Finish/Laminate Chassis Color

SAMPLE MODEL NUMBERS:

WW3672DDFAW8 F 1PL G1L KRS AC
 WW3672DDFAL8 VHN2 1PL G1L KRS HN2 461 HN2
 WW3672DDFALW8 F 1PL G1L KRS 461 HN

- See pages 334-339 for all options available in WaveWorks

DOUBLE PEDESTAL DESK ARC TOP

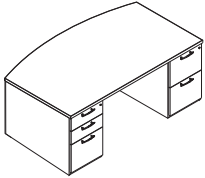

MODEL NO./DESCRIPTION	LIST PRICE	DIMENSIONS					CARTONED WEIGHT	CUBIC FEET
		D	W	H	A	KW		
1 1/8" TOP THICKNESS								
WWN3684DDFAW8 Wood	\$ 5513	36 1/16	83 1/16	29 3/8	6 3/16	47 3/16	347 lbs.	65.8
WWN3684DDFALW8 Laminate/Wood	5513	36 1/16	83 1/16	29 3/8	6 3/16	47 3/16	347 lbs.	65.8
WWN3684DDFAL8 Laminate	3626	36 1/16	83 1/16	29 3/8	6 3/16	47 3/16	347 lbs.	65.8
1 1/2" TOP THICKNESS								
WWN3672DDFAW8 Wood	\$ 4972	36 1/16	71 1/16	29 3/8	6 3/16	35 3/8	337 lbs.	52.3
WWN3672DDFALW8 Laminate/Wood	4972	36 1/16	71 1/16	29 3/8	6 3/16	35 3/8	337 lbs.	52.3
WWN3672DDFAL8 Laminate	3269	36 1/16	71 1/16	29 3/8	6 3/16	35 3/8	337 lbs.	52.3
1 3/8" TOP THICKNESS								
WW3684DDFAW8 Wood	\$ 5063	36 1/16	83 1/16	28 1/16	6 3/16	47 3/16	347 lbs.	65.8
WW3684DDFALW8 Laminate/Wood	5063	36 1/16	83 1/16	28 1/16	6 3/16	47 3/16	347 lbs.	65.8
WW3684DDFAL8 Laminate	3328	36 1/16	83 1/16	28 1/16	6 3/16	47 3/16	347 lbs.	65.8
WW3684DDFALL8 TFL	2662	36 1/16	83 1/16	28 3/8	6 3/16	47 3/16	347 lbs.	65.8
1 1/2" TOP THICKNESS								
WW3672DDFAW8 Wood	\$ 4520	36 1/16	71 1/16	28 1/16	6 3/16	35 3/8	317 lbs.	56.3
WW3672DDFALW8 Laminate/Wood	4520	36 1/16	71 1/16	28 1/16	6 3/16	35 3/8	317 lbs.	56.3
WW3672DDFAL8 Laminate	2971	36 1/16	71 1/16	28 1/16	6 3/16	35 3/8	317 lbs.	56.3
WW3672DDFALL8 TFL	2377	36 1/16	71 1/16	28 3/8	6 3/16	35 3/8	317 lbs.	56.3

- Arc top desk is 30" deep at ends
- Top overhangs 6" at center
- Random lock core (KRB, KRS) and specified lock core (KS2B, KS2S) available

ASSEMBLED

PRODUCT SPECIFICATIONS

- Wood and laminate tops and chassis available; refer to page 336 for options
- Refer to pages 717-760 for accessories
- Refer to page 341 for filing capabilities
- Assembled units and component units are interchangeable
- Refer to page 340 for grommet locations and page 339 for grommet options and upcharge
- If specifying wood, you must specify the same finish for all options
- Center grommet location not available on desks

TO ORDER, SPECIFY:

1. Model Number
2. Rim
3. PVC Rim Color (laminite models)
4. Pull
5. Grommet
6. Locking
7. Laminate Top Color (laminite/combo models)
8. Laminate Door/Drawer Color (laminite models)
9. Veneer Chassis Finish/Laminite Chassis Color

SAMPLE MODEL NUMBERS:

WWN3672DDFBAW8 F 1PL G1L KRS AC
 WWN3672DDFBAL8 VHN2 1PL G1L KRS HN2 461 HN2
 WWN3672DDFBALW8 F 1PL G1L KRS 461 HN

- See pages 334-339 for all options available in WaveWorks

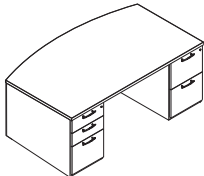
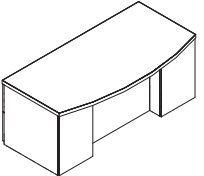
	MODEL NO./DESCRIPTION	LIST PRICE	DIMENSIONS				CARTONED WEIGHT	CUBIC FEET		
			D	W	H	A			KW	
DOUBLE PEDESTAL DESK ARC TOP BREAKFRONT MODESTY  	1 1/8" TOP THICKNESS									
	WWN3684DDFBAW8	Wood	\$ 5679	36 1/16	83 1/16	29 3/8	6 3/16	47 3/16	347 lbs.	65.8
	WWN3684DDFBALW8	Laminite/Wood	5679	36 1/16	83 1/16	29 3/8	6 3/16	47 3/16	347 lbs.	65.8
	WWN3684DDFBAL8	Laminite	3736	36 1/16	83 1/16	29 3/8	6 3/16	47 3/16	347 lbs.	65.8
	WWN3672DDFBAW8	Wood	\$ 5121	36 1/16	71 1/16	29 3/8	6 3/16	35 3/8	337 lbs.	52.3
	WWN3672DDFBALW8	Laminite/Wood	5121	36 1/16	71 1/16	29 3/8	6 3/16	35 3/8	337 lbs.	52.3
	WWN3672DDFBAL8	Laminite	3368	36 1/16	71 1/16	29 3/8	6 3/16	35 3/8	337 lbs.	52.3
	1 1/8" TOP THICKNESS									
	WW3684DDFBAW8	Wood	\$ 5215	36 1/16	83 1/16	28 1/16	6 3/16	47 3/16	347 lbs.	65.8
	WW3684DDFBALW8	Laminite/Wood	5215	36 1/16	83 1/16	28 1/16	6 3/16	47 3/16	347 lbs.	65.8
	WW3684DDFBAL8	Laminite	3428	36 1/16	83 1/16	28 1/16	6 3/16	47 3/16	347 lbs.	65.8
	WW3684DDFBALL8	TFL	2664	36 1/16	83 1/16	28 3/8	6 3/16	47 3/16	347 lbs.	65.8
WW3672DDFBAW8	Wood	\$ 4654	36 1/16	71 1/16	28 1/16	6 3/16	35 3/8	317 lbs.	56.3	
WW3672DDFBALW8	Laminite/Wood	4654	36 1/16	71 1/16	28 1/16	6 3/16	35 3/8	317 lbs.	56.3	
WW3672DDFBAL8	Laminite	3060	36 1/16	71 1/16	28 1/16	6 3/16	35 3/8	317 lbs.	56.3	
WW3672DDFBALL8	TFL	2376	36 1/16	71 1/16	28 3/8	6 3/16	35 3/8	317 lbs.	56.3	

- Arc top desk is 30" deep at ends
- Top overhangs 12" at center to the modesty panel
- Random lock core (KRB, KRS) and specified lock core (KS2B, KS2S) available

**DOUBLE PEDESTAL DESK
GLASS TOP**



WW3672DDFGW8	Wood	\$ 4930	36 1/16	71 1/16	29 3/8	35 3/8	—	275 lbs.	50.0
WW3672DDFGL8	Laminite	3242	36 1/16	71 1/16	29 3/8	35 3/8	—	275 lbs.	50.0

- Grommet option not available
- Clear 1/2" thick tempered glass top with pencil polished edge
- Some assembly required; top ships unattached
- Optional modesty panels in veneer or laminite and in full or 1/2 heights available, see page 524
- Random lock core (KRB, KRS) and specified lock core (KS2B, KS2S) available

WAVEWORKS

PRODUCT SPECIFICATIONS

- Wood and laminate tops and chassis available; refer to page 336 for options
- Refer to pages 717-760 for accessories
- Refer to page 341 for filing capabilities
- Assembled units and component units are interchangeable
- Refer to page 340 for grommet locations and page 339 for grommet options and upcharge
- If specifying wood, you must specify the same finish for all options
- Center grommet location not available on desks

TO ORDER, SPECIFY:

1. Model Number
2. Rim
3. PVC Rim Color (laminated models)
4. Pull
5. Grommet
6. Locking
7. Laminate Top Color (laminated/combo models)
8. Laminate Door/Drawer Color (laminated models)
9. Veneer Chassis Finish/
Laminate Chassis Color

SAMPLE MODEL NUMBERS:

WW3672DDFW8 F 1PL G1L KRS AC
 WW3672DDFL8 VHN2 1PL G1L KRS HN2 461 HN2
 WW3672DDFLW8 F 1PL G1L KRS 461 HN

• See pages 334-339 for all options available in WaveWorks

DOUBLE PEDESTAL DESK RECESSED MODESTY

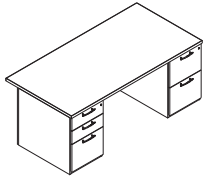

MODEL NO./DESCRIPTION	LIST PRICE	DIMENSIONS					CARTONED CUBIC	
		D	W	H	A	KW	WEIGHT	FEET
1 1/2" TOP THICKNESS								
WWN3684DDFW8 Wood	\$ 4594	36 1/16	83 1/16	29 3/8	6 3/16	47 3/16	347 lbs.	65.8
WWN3684DDFLW8 Laminate/Wood	4594	36 1/16	83 1/16	29 3/8	6 3/16	47 3/16	347 lbs.	65.8
WWN3684DDFL8 Laminate	2969	36 1/16	83 1/16	29 3/8	6 3/16	47 3/16	347 lbs.	65.8
<hr/>								
WWN3672DDFW8 Wood	\$ 4141	36 1/16	71 1/16	29 3/8	6 3/16	35 3/8	347 lbs.	52.3
WWN3672DDFLW8 Laminate/Wood	4141	36 1/16	71 1/16	29 3/8	6 3/16	35 3/8	347 lbs.	52.3
WWN3672DDFL8 Laminate	2677	36 1/16	71 1/16	29 3/8	6 3/16	35 3/8	347 lbs.	52.3
<hr/>								
WWN3066DDFW8 Wood	\$ 3974	30 1/16	66	29 3/8	6 3/16	35 3/8	277 lbs.	40.3
WWN3066DDFLW8 Laminate/Wood	3974	30 1/16	66	29 3/8	6 3/16	35 3/8	277 lbs.	40.3
WWN3066DDFL8 Laminate	2570	30 1/16	66	29 3/8	6 3/16	35 3/8	277 lbs.	40.3
<hr/>								
WWN3060DDFW8 Wood	\$ 3781	30 1/16	60	29 3/8	6 3/16	29 1/16	263 lbs.	36.7
WWN3060DDFLW8 Laminate/Wood	3781	30 1/16	60	29 3/8	6 3/16	29 1/16	263 lbs.	36.7
WWN3060DDFL8 Laminate	2476	30 1/16	60	29 3/8	6 3/16	29 1/16	263 lbs.	36.7
<hr/>								
1 1/2" TOP THICKNESS								
WW3684DDFW8 Wood	\$ 4218	36 1/16	83 1/16	28 1/16	6 3/16	47 3/16	374 lbs.	65.8
WW3684DDFLW8 Laminate/Wood	4218	36 1/16	83 1/16	28 1/16	6 3/16	47 3/16	374 lbs.	65.8
WW3684DDFL8 Laminate	2726	36 1/16	83 1/16	28 1/16	6 3/16	47 3/16	374 lbs.	65.8
WW3684DDFLL8 TFL	2182	36 1/16	83 1/16	28 3/8	6 3/16	47 3/16	374 lbs.	65.8
<hr/>								
WW3672DDFW8 Wood	\$ 3765	36 1/16	71 1/16	28 1/16	6 3/16	35 3/8	361 lbs.	56.3
WW3672DDFLW8 Laminate/Wood	3765	36 1/16	71 1/16	28 1/16	6 3/16	35 3/8	361 lbs.	56.3
WW3672DDFL8 Laminate	2435	36 1/16	71 1/16	28 1/16	6 3/16	35 3/8	361 lbs.	56.3
WW3672DDFLL8 TFL	1947	36 1/16	71 1/16	28 3/8	6 3/16	35 3/8	361 lbs.	56.3
<hr/>								
WW3066DDFW8 Wood	\$ 3613	30 1/16	66	28 1/16	6 3/16	35 3/8	285 lbs.	44.4
WW3066DDFLW8 Laminate/Wood	3613	30 1/16	66	28 1/16	6 3/16	35 3/8	285 lbs.	44.4
WW3066DDFL8 Laminate	2337	30 1/16	66	28 1/16	6 3/16	35 3/8	285 lbs.	44.4
WW3066DDFLL8 TFL	1870	30 1/16	66	28 3/8	6 3/16	35 3/8	285 lbs.	44.4
<hr/>								
WW3060DDFW8 Wood	\$ 3440	30 1/16	60	28 1/16	6 3/16	29 1/16	261 lbs.	40.7
WW3060DDFLW8 Laminate/Wood	3440	30 1/16	60	28 1/16	6 3/16	29 1/16	261 lbs.	40.7
WW3060DDFL8 Laminate	2251	30 1/16	60	28 1/16	6 3/16	29 1/16	261 lbs.	40.7
WW3060DDFLL8 TFL	1800	30 1/16	60	28 3/8	6 3/16	29 1/16	261 lbs.	40.7

- 3672 desk has 30" deep pedestals
- 3066 and 3060 desks have 24" deep pedestals
- Random lock core (KRB, KRS) and specified lock core (KS2B, KS2S) available

PRODUCT SPECIFICATIONS

- Wood and laminate tops and chassis available; refer to page 336 for options
- Refer to pages 717-760 for accessories
- Refer to page 341 for filing capabilities
- Assembled units and component units are interchangeable
- Refer to page 340 for grommet locations and page 339 for grommet options and upcharge
- If specifying wood, you must specify the same finish for all options
- Center grommet location not available on desks

TO ORDER, SPECIFY:

1. Model Number
2. Rim
3. PVC Rim Color (laminated models)
4. Pull
5. Grommet
6. Locking
7. Laminate Top Color (laminated/combo models)
8. Laminate Door/Drawer Color (laminated models)
9. Veneer Chassis Finish/ Laminate Chassis Color

SAMPLE MODEL NUMBERS:

WWN3672DDFBW8 F 1PL G1L KRS AC
 WWN3672DDFBL8 VHN2 1PL G1L KRS HN2 461 HN2
 WWN3672DDFBL8 F 1PL G1L KRS 461 HN

- See pages 334-339 for all options available in WaveWorks

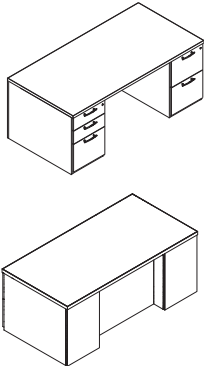
	MODEL NO./DESCRIPTION	LIST PRICE	DIMENSIONS					CARTONED WEIGHT	CUBIC FEET	
			D	W	H	A	KW			
<p>DOUBLE PEDESTAL DESK BREAKFRONT MODESTY</p> 	1 1/8" TOP THICKNESS									
	WWN3684DDFBW8	Wood	\$ 4730	36 1/16	83 1/16	29 3/8	6 3/16	47 3/16	374 lbs.	65.8
	WWN3684DDFBLW8	Laminate/Wood	4730	36 1/16	83 1/16	29 3/8	6 3/16	47 3/16	374 lbs.	65.8
	WWN3684DDFBL8	Laminate	3058	36 1/16	83 1/16	29 3/8	6 3/16	47 3/16	374 lbs.	65.8
	WWN3672DDFBW8	Wood	\$ 4265	36 1/16	71 1/16	29 3/8	6 3/16	35 3/8	347 lbs.	52.3
	WWN3672DDFBLW8	Laminate/Wood	4265	36 1/16	71 1/16	29 3/8	6 3/16	35 3/8	347 lbs.	52.3
	WWN3672DDFBL8	Laminate	2757	36 1/16	71 1/16	29 3/8	6 3/16	35 3/8	347 lbs.	52.3
	WWN3066DDFBW8	Wood	\$ 4092	30 1/16	66	29 3/8	6 3/16	35 3/8	277 lbs.	40.3
	WWN3066DDFBLW8	Laminate/Wood	4092	30 1/16	66	29 3/8	6 3/16	35 3/8	277 lbs.	40.3
	WWN3066DDFBL8	Laminate	2647	30 1/16	66	29 3/8	6 3/16	35 3/8	277 lbs.	40.3
	WWN3060DDFBW8	Wood	\$ 3895	30 1/16	60	29 3/8	6 3/16	29 1/16	263 lbs.	36.7
	WWN3060DDFBLW8	Laminate/Wood	3895	30 1/16	60	29 3/8	6 3/16	29 1/16	263 lbs.	36.7
	WWN3060DDFBL8	Laminate	2550	30 1/16	60	29 3/8	6 3/16	29 1/16	263 lbs.	36.7
	1 1/8" TOP THICKNESS									
	WW3684DDFBW8	Wood	\$ 4344	36 1/16	83 1/16	28 1/16	6 3/16	47 3/16	374 lbs.	65.8
	WW3684DDFBLW8	Laminate/Wood	4344	36 1/16	83 1/16	28 1/16	6 3/16	47 3/16	374 lbs.	65.8
	WW3684DDFBL8	Laminate	2808	36 1/16	83 1/16	28 1/16	6 3/16	47 3/16	374 lbs.	65.8
	WW3684DDFBLL8	TFL	2182	36 1/16	83 1/16	28 1/16	6 3/16	47 3/16	374 lbs.	65.8
WW3672DDFBW8	Wood	\$ 3877	36 1/16	71 1/16	28 1/16	6 3/16	35 3/8	361 lbs.	56.3	
WW3672DDFBLW8	Laminate/Wood	3877	36 1/16	71 1/16	28 1/16	6 3/16	35 3/8	361 lbs.	56.3	
WW3672DDFBL8	Laminate	2507	36 1/16	71 1/16	28 1/16	6 3/16	35 3/8	361 lbs.	56.3	
WW3672DDFBLL8	TFL	1946	36 1/16	71 1/16	28 1/16	6 3/16	35 3/8	361 lbs.	56.3	
WW3066DDFBW8	Wood	\$ 3720	30 1/16	66	28 1/16	6 3/16	35 3/8	285 lbs.	44.4	
WW3066DDFBLW8	Laminate/Wood	3720	30 1/16	66	28 1/16	6 3/16	35 3/8	285 lbs.	44.4	
WW3066DDFBL8	Laminate	2408	30 1/16	66	28 1/16	6 3/16	35 3/8	285 lbs.	44.4	
WW3066DDFBLL8	TFL	1869	30 1/16	66	28 1/16	6 3/16	35 3/8	285 lbs.	44.4	
WW3060DDFBW8	Wood	\$ 3542	30 1/16	60	28 1/16	6 3/16	29 1/16	261 lbs.	40.7	
WW3060DDFBLW8	Laminate/Wood	3542	30 1/16	60	28 1/16	6 3/16	29 1/16	261 lbs.	40.7	
WW3060DDFBL8	Laminate	2318	30 1/16	60	28 1/16	6 3/16	29 1/16	261 lbs.	40.7	
WW3060DDFBLL8	TFL	1800	30 1/16	60	28 1/16	6 3/16	29 1/16	261 lbs.	40.7	

- 3684 and 3672 desks have 35" deep pedestals
- 3066 and 3060 desks have 30" deep pedestals
- Random lock core (KRB, KRS) and specified lock core (KS2B, KS2S) available
- Modesty inset

WAVEWORKS

PRODUCT SPECIFICATIONS

- Wood and laminate tops and chassis available; refer to page 336 for options
- Refer to pages 717-760 for accessories
- Refer to page 341 for filing capabilities
- Assembled units and component units are interchangeable
- Refer to page 340 for grommet locations and page 339 for grommet options and upcharge
- If specifying wood, you must specify the same finish for all options
- Center grommet location not available on desks

TO ORDER, SPECIFY:

1. Model Number
2. Rim
3. PVC Rim Color (laminated models)
4. Pull
5. Grommet
6. Locking
7. Laminate Top Color (laminated/combo models)
8. Laminate Door/Drawer Color (laminated models)
9. Veneer Chassis Finish/Laminate Chassis Color

SAMPLE MODEL NUMBERS:

WW3672DRFAW1 F 1PL G1L KRS AC
 WW3672DRFAL1 VHN2 1PL G1L KRS HN2 461 HN2
 WW3672DRFALW1 F 1PL G1L KRS 461 HN

- See pages 334-339 for all options available in WaveWorks

MODEL NO./DESCRIPTION	LIST PRICE	DIMENSIONS				KW	CARTONED WEIGHT	CUBIC FEET
		D	W	H	A			
1 1/16" TOP THICKNESS								
LEFT PEDESTAL DESK								
RIGHT PEDESTAL DESK								
WWN3684DLFAW1	\$ 4820	36 1/16	83 1/16	29 3/8	6 3/16	64 1/16	374 lbs.	65.8
WWN3684DLFALW1	4820	36 1/16	83 1/16	29 3/8	6 3/16	64 1/16	374 lbs.	65.8
WWN3684DLFAL1	3253	36 1/16	83 1/16	29 3/8	6 3/16	64 1/16	374 lbs.	65.8
WWN3672DLFAW1	\$ 4348	36 1/16	71 1/16	29 3/8	6 3/16	52 1/16	277 lbs.	52.0
WWN3672DLFALW1	4348	36 1/16	71 1/16	29 3/8	6 3/16	52 1/16	277 lbs.	52.0
WWN3672DLFAL1	2932	36 1/16	71 1/16	29 3/8	6 3/16	52 1/16	277 lbs.	52.0
1 1/16" TOP THICKNESS								
LEFT PEDESTAL DESK								
RIGHT PEDESTAL DESK								
WW3684DLFAW1	\$ 4425	36 1/16	83 1/16	28 1/16	6 3/16	64 1/16	374 lbs.	65.8
WW3684DLFALW1	4425	36 1/16	83 1/16	28 1/16	6 3/16	64 1/16	374 lbs.	65.8
WW3684DLFAL1	2986	36 1/16	83 1/16	28 1/16	6 3/16	64 1/16	374 lbs.	65.8
WW3684DLFALL1	2388	36 1/16	83 1/16	28 3/8	6 3/16	64 1/16	374 lbs.	65.8
WW3672DLFAW1	\$ 3951	36 1/16	71 1/16	28 1/16	6 3/16	52 1/16	267 lbs.	56.3
WW3672DLFALW1	3951	36 1/16	71 1/16	28 1/16	6 3/16	52 1/16	267 lbs.	56.3
WW3672DLFAL1	2669	36 1/16	71 1/16	28 1/16	6 3/16	52 1/16	267 lbs.	56.3
WW3672DLFALL1	2134	36 1/16	71 1/16	28 3/8	6 3/16	52 1/16	267 lbs.	56.3

SINGLE PEDESTAL DESK ARC TOP

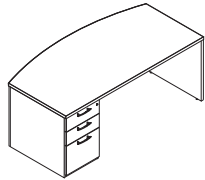

Left shown

- Arc top desk is 30" deep at ends
- Top overhangs 6" at center
- Random lock core (KRB, KRS) and specified lock core (KS1B, KS1S) available

PRODUCT SPECIFICATIONS

- Wood and laminate tops and chassis available; refer to page 336 for options
- Refer to pages 717-760 for accessories
- Refer to page 341 for filing capabilities
- Assembled units and component units are interchangeable
- Refer to page 340 for grommet locations and page 339 for grommet options and upcharge
- If specifying wood, you must specify the same finish for all options
- Center grommet location not available on desks

TO ORDER, SPECIFY:

1. Model Number
2. Rim
3. PVC Rim Color (laminated models)
4. Pull
5. Grommet
6. Locking
7. Laminate Top Color (laminated/combo models)
8. Laminate Door/Drawer Color (laminated models)
9. Veneer Chassis Finish/ Laminate Chassis Color

SAMPLE MODEL NUMBERS:

WWN3672DLFBAW1 F 1PL G1L KRS AC
 WWN3672DLFBAL1 VHN2 1PL G1L KRS HN2 461 HN2
 WWN3672DLFBALW1 F 1PL G1L KRS 461 HN

- See pages 334-339 for all options available in WaveWorks

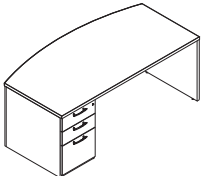
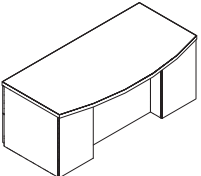
	MODEL NO./DESCRIPTION	LIST PRICE	DIMENSIONS				CARTONED WEIGHT	CUBIC FEET			
			D	W	H	A			KW		
<p>SINGLE PEDESTAL DESK ARC TOP BREAKFRONT MODESTY</p>  <p>Left shown</p>  <p>Left shown</p>	<p>1 1/2" TOP THICKNESS LEFT PEDESTAL DESK</p>	<p>RIGHT PEDESTAL DESK</p>									
	WWN3684DLFBAW1	WWN3684DRFBAW1	Wood	\$ 4965	36 1/16"	83 3/16"	29 3/8"	6 3/16"	64 1/16"	374 lbs.	65.8
	WWN3684DLFBALW1	WWN3684DRFBALW1	Lam/Wood	4965	36 1/16"	83 3/16"	29 3/8"	6 3/16"	64 1/16"	374 lbs.	65.8
	WWN3684DLFBAL1	WWN3684DRFBAL1	Laminate	3351	36 1/16"	83 3/16"	29 3/8"	6 3/16"	64 1/16"	374 lbs.	65.8
	WWN3672DLFBAW1	WWN3672DRFBAW1	Wood	\$ 4479	36 1/16"	71 1/16"	29 3/8"	6 3/16"	52 1/16"	277 lbs.	52.0
	WWN3672DLFBALW1	WWN3672DRFBALW1	Lam/Wood	4479	36 1/16"	71 1/16"	29 3/8"	6 3/16"	52 1/16"	277 lbs.	52.0
	WWN3672DLFBAL1	WWN3672DRFBAL1	Laminate	3020	36 1/16"	71 1/16"	29 3/8"	6 3/16"	52 1/16"	277 lbs.	52.0
		<p>1 1/2" TOP THICKNESS LEFT PEDESTAL DESK</p>	<p>RIGHT PEDESTAL DESK</p>								
	WW3684DLFBAW1	WW3684DRFBAW1	Wood	\$ 4558	36 1/16"	83 3/16"	28 1/16"	6 3/16"	64 1/16"	374 lbs.	65.8
	WW3684DLFBALW1	WW3684DRFBALW1	Lam/Wood	4558	36 1/16"	83 3/16"	28 1/16"	6 3/16"	64 1/16"	374 lbs.	65.8
	WW3684DLFBAL1	WW3684DRFBAL1	Laminate	3076	36 1/16"	83 3/16"	28 1/16"	6 3/16"	64 1/16"	374 lbs.	65.8
	WW3684DLFBALL1	WW3684DRFBALL1	TFL	2389	36 1/16"	83 3/16"	28 3/8"	6 3/16"	64 1/16"	374 lbs.	65.8
WW3672DLFBAW1	WW3672DRFBAW1	Wood	\$ 4072	36 1/16"	71 1/16"	28 1/16"	6 3/16"	52 1/16"	267 lbs.	56.3	
WW3672DLFBALW1	WW3672DRFBALW1	Lam/Wood	4072	36 1/16"	71 1/16"	28 1/16"	6 3/16"	52 1/16"	267 lbs.	56.3	
WW3672DLFBAL1	WW3672DRFBAL1	Laminate	2748	36 1/16"	71 1/16"	28 1/16"	6 3/16"	52 1/16"	267 lbs.	56.3	
WW3672DLFBALL1	WW3672DRFBALL1	TFL	2134	36 1/16"	71 1/16"	28 3/8"	6 3/16"	52 1/16"	267 lbs.	56.3	

- Arc top desk is 30" deep at ends
- Top overhangs 12" at center to the modesty panel
- Random lock core (KRB, KRS) and specified lock core (KS1B, KS1S) available
- Modesty inset

WAVEWORKS

PRODUCT SPECIFICATIONS

- Wood and laminate tops and chassis available; refer to page 336 for options
- Refer to pages 717-760 for accessories
- Refer to page 341 for filing capabilities
- Assembled units and component units are interchangeable
- Refer to page 340 for grommet locations and page 339 for grommet options and upcharge
- If specifying wood, you must specify the same finish for all options
- Center grommet location not available on desks

TO ORDER, SPECIFY:

1. Model Number
2. Rim
3. PVC Rim Color (laminated models)
4. Pull
5. Grommet
6. Locking
7. Laminate Top Color (laminated/combo models)
8. Laminate Door/Drawer Color (laminated models)
9. Veneer Chassis Finish/
Laminate Chassis Color

SAMPLE MODEL NUMBERS:

WW3672DRFW1 F 1PL G1L KRS AC
 WW3672DRFL1 VHN2 1PL G1L KRS HN2 461 HN2
 WW3672DRFLW1 F 1PL G1L KRS 461 HN

• See pages 334-339 for all options available in WaveWorks

SINGLE PEDESTAL DESK RECESSED MODESTY

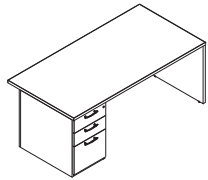

Left shown

MODEL NO./DESCRIPTION	LIST PRICE	DIMENSIONS				CARTONED CUBIC				
		D	W	H	A	KW	WEIGHT FEET			
1 1/8" TOP THICKNESS										
LEFT PEDESTAL DESK		RIGHT PEDESTAL DESK								
WWN3684DLFW1	WWN3684DRFW1	Wood	\$ 3932	36 1/16	83 1/16	29 3/8	6 3/16	64 1/16	374 lbs.	65.8
WWN3684DLFLW1	WWN3684DRFLW1	Lam/Wood	3932	36 1/16	83 1/16	29 3/8	6 3/16	64 1/16	374 lbs.	65.8
WWN3684DLFL1	WWN3684DRFL1	Laminate	2594	36 1/16	83 1/16	29 3/8	6 3/16	64 1/16	374 lbs.	65.8
1 3/16" TOP THICKNESS										
WWN3672DLFW1	WWN3672DRFW1	Wood	\$ 3547	36 1/16	71 1/16	29 3/8	6 3/16	52 1/16	287 lbs.	52.3
WWN3672DLFLW1	WWN3672DRFLW1	Lam/Wood	3547	36 1/16	71 1/16	29 3/8	6 3/16	52 1/16	287 lbs.	52.3
WWN3672DLFL1	WWN3672DRFL1	Laminate	2338	36 1/16	71 1/16	29 3/8	6 3/16	52 1/16	287 lbs.	52.3
WWN3066DLFW1	WWN3066DRFW1	Wood	\$ 3328	30 3/16	66	29 3/8	6 3/16	52 1/16	232 lbs.	40.3
WWN3066DLFLW1	WWN3066DRFLW1	Lam/Wood	3328	30 3/16	66	29 3/8	6 3/16	52 1/16	232 lbs.	40.3
WWN3066DLFL1	WWN3066DRFL1	Laminate	2239	30 3/16	66	29 3/8	6 3/16	52 1/16	232 lbs.	40.3
1 3/8" TOP THICKNESS										
LEFT PEDESTAL DESK		RIGHT PEDESTAL DESK								
WW3684DLFW1	WW3684DRFW1	Wood	\$ 3612	36 1/16	83 1/16	28 1/16	6 3/16	64 1/16	374 lbs.	65.8
WW3684DLFLW1	WW3684DRFLW1	Lam/Wood	3612	36 1/16	83 1/16	28 1/16	6 3/16	64 1/16	374 lbs.	65.8
WW3684DLFL1	WW3684DRFL1	Laminate	2381	36 1/16	83 1/16	28 1/16	6 3/16	64 1/16	374 lbs.	65.8
WW3684DLFLL1	WW3684DRFLL1	TFL	1904	36 1/16	83 1/16	28 3/8	6 3/16	64 1/16	374 lbs.	65.8
WW3672DLFW1	WW3672DRFW1	Wood	\$ 3225	36 1/16	71 1/16	28 1/16	6 3/16	52 1/16	311 lbs.	56.3
WW3672DLFLW1	WW3672DRFLW1	Lam/Wood	3225	36 1/16	71 1/16	28 1/16	6 3/16	52 1/16	311 lbs.	56.3
WW3672DLFL1	WW3672DRFL1	Laminate	2126	36 1/16	71 1/16	28 1/16	6 3/16	52 1/16	311 lbs.	56.3
WW3672DLFLL1	WW3672DRFLL1	TFL	1700	36 1/16	71 1/16	28 3/8	6 3/16	52 1/16	311 lbs.	56.3
WW3066DLFW1	WW3066DRFW1	Wood	\$ 3024	30 3/16	66	28 1/16	6 3/16	52 1/16	245 lbs.	44.4
WW3066DLFLW1	WW3066DRFLW1	Lam/Wood	3024	30 3/16	66	28 1/16	6 3/16	52 1/16	245 lbs.	44.4
WW3066DLFL1	WW3066DRFL1	Laminate	2035	30 3/16	66	28 1/16	6 3/16	52 1/16	245 lbs.	44.4
WW3066DLFLL1	WW3066DRFLL1	TFL	1629	30 3/16	66	28 3/8	6 3/16	52 1/16	245 lbs.	44.4

- 3684 and 3672 desks have 30" deep pedestal
- 3066 desk has 24" deep pedestal
- Random lock core (KRB, KRS) and specified lock core (KS1B, KS1S) available

PRODUCT SPECIFICATIONS

- Wood and laminate tops and chassis available; refer to page 336 for options
- Refer to pages 717-760 for accessories
- Refer to page 341 for filing capabilities
- Assembled units and component units are interchangeable
- Refer to page 340 for grommet locations and page 339 for grommet options and upcharge
- If specifying wood, you must specify the same finish for all options
- Center grommet location not available on desks

TO ORDER, SPECIFY:

1. Model Number
2. Rim
3. PVC Rim Color (laminate models)
4. Pull
5. Grommet
6. Locking
7. Laminate Top Color (laminate/combo models)
8. Laminate Door/Drawer Color (laminate models)
9. Veneer Chassis Finish/ Laminate Chassis Color

SAMPLE MODEL NUMBERS:

WWN3672DRFBW1	F	1PL	G1L	KRS	AC			
WWN3672DRFBL1	VHN2	1PL	G1L	KRS	HN2	461	HN2	
WWN3672DRFBLW1	F	1PL	G1L	KRS	461	HN		

• See pages 334-339 for all options available in WaveWorks

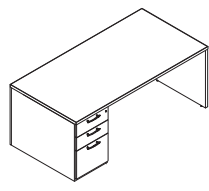
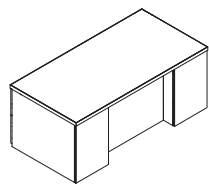
	MODEL NO./DESCRIPTION	LIST PRICE	DIMENSIONS					CARTONED WEIGHT	CUBIC FEET		
			D	W	H	A	KW				
<p>SINGLE PEDESTAL DESK BREAKFRONT MODESTY</p>  <p>Left shown</p>  <p>Left shown</p>	1 1/2" TOP THICKNESS										
		LEFT PEDESTAL DESK	RIGHT PEDESTAL DESK								
	WWN3684DLFBW1	WWN3684DRFBW1	Wood	\$ 4051	36 1/16	83 3/16	29 3/8	6 3/16	64 1/16	374 lbs.	65.8
	WWN3684DLFBLW1	WWN3684DRFBLW1	Lam/Wood	4051	36 1/16	83 3/16	29 3/8	6 3/16	64 1/16	374 lbs.	65.8
	WWN3684DLFBL1	WWN3684DRFBL1	Laminate	2672	36 1/16	83 3/16	29 3/8	6 3/16	64 1/16	374 lbs.	65.8
	WWN3672DLFBW1	WWN3672DRFBW1	Wood	\$ 3654	36 1/16	71 1/16	29 3/8	6 3/16	52 1/16	287 lbs.	52.3
	WWN3672DLFBLW1	WWN3672DRFBLW1	Lam/Wood	3654	36 1/16	71 1/16	29 3/8	6 3/16	52 1/16	287 lbs.	52.3
	WWN3672DLFBL1	WWN3672DRFBL1	Laminate	2410	36 1/16	71 1/16	29 3/8	6 3/16	52 1/16	287 lbs.	52.3
	WWN3066DLFBW1	WWN3066DRFBW1	Wood	\$ 3427	30 1/16	66	29 3/8	6 3/16	52 1/16	232 lbs.	40.3
	WWN3066DLFBLW1	WWN3066DRFBLW1	Lam/Wood	3427	30 1/16	66	29 3/8	6 3/16	52 1/16	232 lbs.	40.3
	WWN3066DLFBL1	WWN3066DRFBL1	Laminate	2305	30 1/16	66	29 3/8	6 3/16	52 1/16	232 lbs.	40.3
		1 3/8" TOP THICKNESS									
		LEFT PEDESTAL DESK	RIGHT PEDESTAL DESK								
WW3684DLFBW1		WW3684DRFBW1	Wood	\$ 3719	36 1/16	83 3/16	28 1/16	6 3/16	64 1/16	374 lbs.	65.8
WW3684DLFBLW1		WW3684DRFBLW1	Lam/Wood	3719	36 1/16	83 3/16	28 1/16	6 3/16	64 1/16	374 lbs.	65.8
WW3684DLFBL1		WW3684DRFBL1	Laminate	2453	36 1/16	83 3/16	28 1/16	6 3/16	64 1/16	374 lbs.	65.8
WW3684DLFBLL1		WW3684DRFBLL1	TFL	1904	36 1/16	83 3/16	28 3/8	6 3/16	64 1/16	374 lbs.	65.8
WW3672DLFBW1		WW3672DRFBW1	Wood	\$ 3321	36 1/16	71 1/16	28 1/16	6 3/16	52 1/16	311 lbs.	56.3
WW3672DLFBLW1		WW3672DRFBLW1	Lam/Wood	3321	36 1/16	71 1/16	28 1/16	6 3/16	52 1/16	311 lbs.	56.3
WW3672DLFBL1		WW3672DRFBL1	Laminate	2188	36 1/16	71 1/16	28 1/16	6 3/16	52 1/16	311 lbs.	56.3
WW3672DLFBLL1		WW3672DRFBLL1	TFL	1699	36 1/16	71 1/16	28 3/8	6 3/16	52 1/16	311 lbs.	56.3
WW3066DLFBW1		WW3066DRFBW1	Wood	\$ 3115	30 1/16	66	28 1/16	6 3/16	52 1/16	245 lbs.	44.4
WW3066DLFBLW1		WW3066DRFBLW1	Lam/Wood	3115	30 1/16	66	28 1/16	6 3/16	52 1/16	245 lbs.	44.4
WW3066DLFBL1		WW3066DRFBL1	Laminate	2097	30 1/16	66	28 1/16	6 3/16	52 1/16	245 lbs.	44.4
WW3066DLFBLL1		WW3066DRFBLL1	TFL	1629	30 1/16	66	28 3/8	6 3/16	52 1/16	245 lbs.	44.4

- 3684 and 3672 desks have 35" deep pedestal
- 3066 desk has 30" deep pedestal
- Random lock core (KRB, KRS) and specified lock core (KS1B, KS1S) available
- Modesty inset

WAVEWORKS

PRODUCT SPECIFICATIONS

- Wood and laminate tops and chassis available; refer to page 336 for options
- Refer to page 340 for grommet locations and page 339 for grommet options and upcharge
- If specifying wood, you must specify the same finish for all options
- Center grommet location not available on desks

TO ORDER, SPECIFY:

1. Model Number
2. Rim
3. PVC Rim Color (laminate models)
4. Grommet
5. Paint
6. Laminate Top Color (laminate models)
7. Laminate Chassis Color (laminate models)
8. Finish (wood models)

SAMPLE MODEL NUMBERS:

WWN3084DSFA1W F G1L 462 AD
 WWN3084DSFA1LW F G1R 462 440 MH
 WWN3084DSFA1L VPB X 462 PB PB

- See pages 334-339 for all options available in WaveWorks

ADJUSTABLE HEIGHT DESK SHELL FULL FLUSH MODESTY

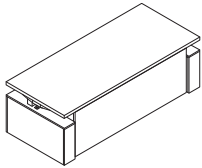

Approach view

MODEL NO./DESCRIPTION	LIST PRICE	DIMENSIONS					CARTONED WEIGHT	CUBIC FEET
		D	W	H	A	KW		
1 1/2" TOP THICKNESS 36" DEPTH								
WWN3684DSFA1W Wood	\$ 7240	36 1/16	83 1/16	27 1/16	-	-	lbs.	
WWN3684DSFA1LW Laminate/Wood	7240	36 1/16	83 1/16	27 1/16	-	-	lbs.	
WWN3684DSFA1L Laminate	6257	36 1/16	83 1/16	27 1/16	-	-	lbs.	
<hr/>								
WWN3678DSFA1W Wood	\$ 7048	36 1/16	77 1/16	27 1/16	-	-	lbs.	
WWN3678DSFA1LW Laminate/Wood	7048	36 1/16	77 1/16	27 1/16	-	-	lbs.	
WWN3678DSFA1L Laminate	6163	36 1/16	77 1/16	27 1/16	-	-	lbs.	
<hr/>								
WWN3672DSFA1W Wood	\$ 6856	36 1/16	71 1/16	27 1/16	-	-	lbs.	
WWN3672DSFA1LW Laminate/Wood	6856	36 1/16	71 1/16	27 1/16	-	-	lbs.	
WWN3672DSFA1L Laminate	6068	36 1/16	71 1/16	27 1/16	-	-	lbs.	
<hr/>								
30" DEPTH								
WWN3084DSFA1W Wood	\$ 6595	30 1/16	83 1/16	27 1/16	-	-	lbs.	
WWN3084DSFA1LW Laminate/Wood	6595	30 1/16	83 1/16	27 1/16	-	-	lbs.	
WWN3084DSFA1L Laminate	5309	30 1/16	83 1/16	27 1/16	-	-	lbs.	
<hr/>								
WWN3078DSFA1W Wood	\$ 6402	30 1/16	77 1/16	27 1/16	-	-	lbs.	
WWN3078DSFA1LW Laminate/Wood	6402	30 1/16	77 1/16	27 1/16	-	-	lbs.	
WWN3078DSFA1L Laminate	5216	30 1/16	77 1/16	27 1/16	-	-	lbs.	
<hr/>								
WWN3072DSFA1W Wood	\$ 6210	30 1/16	71 1/16	27 1/16	-	-	lbs.	
WWN3072DSFA1LW Laminate/Wood	6210	30 1/16	71 1/16	27 1/16	-	-	lbs.	
WWN3072DSFA1L Laminate	5121	30 1/16	71 1/16	27 1/16	-	-	lbs.	
<hr/>								
WWN3066DSFA1W Wood	\$ 6017	30 1/16	66	27 1/16	-	-	lbs.	
WWN3066DSFA1LW Laminate/Wood	6017	30 1/16	66	27 1/16	-	-	lbs.	
WWN3066DSFA1L Laminate	5027	30 1/16	66	27 1/16	-	-	lbs.	
<hr/>								
WWN3060DSFA1W Wood	\$ 5824	30 1/16	60	27 1/16	-	-	lbs.	
WWN3060DSFA1LW Laminate/Wood	5824	30 1/16	60	27 1/16	-	-	lbs.	
WWN3060DSFA1L Laminate	4933	30 1/16	60	27 1/16	-	-	lbs.	
<hr/>								
24" DEPTH								
WWN2454DSFA1W Wood	\$ 4657	24	54	27 1/16	-	-	lbs.	
WWN2454DSFA1LW Laminate/Wood	4657	24	54	27 1/16	-	-	lbs.	
WWN2454DSFA1L Laminate	4138	24	54	27 1/16	-	-	lbs.	
<hr/>								
WWN2448DSFA1W Wood	\$ 4573	24	48 1/16	27 1/16	-	-	lbs.	
WWN2448DSFA1LW Laminate/Wood	4573	24	48 1/16	27 1/16	-	-	lbs.	
WWN2448DSFA1L Laminate	4054	24	48 1/16	27 1/16	-	-	lbs.	

- Laminate/Wood combo units consist of a laminate worksurface and veneer shrouds and modesty
- Grain direction on shrouds is always vertical unless specifying a horizontal laminate
- Wire manager located on right side of desk; removeable panel allows for easy access
- Wire manager can be moved to opposite side in field if other side is preferred
- Any laminate modesty over 60" will be horizontal
- Control pad can be moved to RH or LH by the customer
- All models feature a 2 position memory
- Legs will be visible when the desk is in an upper position; specify paint color of Cinder or Platinum Metallic

PRODUCT SPECIFICATIONS

- Wood and laminate tops and chassis available; refer to page 336 for options
- Refer to page 340 for grommet locations and page 339 for grommet options and upcharge
- If specifying wood, you must specify the same finish for all options
- Center grommet location not available on desks

TO ORDER, SPECIFY:

1. Model Number
2. Rim
3. PVC Rim Color (laminated models)
4. Grommet
5. Paint
6. Laminate Top Color (laminated models)
7. Laminate Chassis Color (laminated models)
8. Finish (wood models)

SAMPLE MODEL NUMBERS:

WW3084DSFA1W F G1L 462 AD
 WW3084DSFA1LW F G1R 462 440 MH
 WW3084DSFA1L VPB X 462 PB PB

• See pages 334-339 for all options available in WaveWorks

**ADJUSTABLE HEIGHT
 DESK SHELL
 FULL FLUSH MODESTY
 (CONTINUED)**

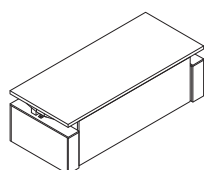

Approach view

MODEL NO./DESCRIPTION		LIST PRICE	DIMENSIONS				KW	CARTONED WEIGHT	CUBIC FEET
			D	W	H	A			
1 1/2" TOP THICKNESS 36" DEPTH									
WW3684DSFA1W	Wood	\$ 7132	36 1/16	83 1/16	26 1/16	—	—	lbs.	
WW3684DSFA1LW	Laminate/Wood	7132	36 1/16	83 1/16	26 1/16	—	—	lbs.	
WW3684DSFA1L	Laminate	6148	36 1/16	83 1/16	26 1/16	—	—	lbs.	
<hr/>									
WW3678DSFA1W	Wood	\$ 6940	36 1/16	77 1/16	26 1/16	—	—	lbs.	
WW3678DSFA1LW	Laminate/Wood	6940	36 1/16	77 1/16	26 1/16	—	—	lbs.	
WW3678DSFA1L	Laminate	6055	36 1/16	77 1/16	26 1/16	—	—	lbs.	
<hr/>									
WW3672DSFA1W	Wood	\$ 6748	36 1/16	71 1/16	26 1/16	—	—	lbs.	
WW3672DSFA1LW	Laminate/Wood	6748	36 1/16	71 1/16	26 1/16	—	—	lbs.	
WW3672DSFA1L	Laminate	5960	36 1/16	71 1/16	26 1/16	—	—	lbs.	
<hr/>									
30" DEPTH									
WW3084DSFA1W	Wood	\$ 6486	30 1/16	83 1/16	26 1/16	—	—	lbs.	
WW3084DSFA1LW	Laminate/Wood	6486	30 1/16	83 1/16	26 1/16	—	—	lbs.	
WW3084DSFA1L	Laminate	5201	30 1/16	83 1/16	26 1/16	—	—	lbs.	
<hr/>									
WW3078DSFA1W	Wood	\$ 6294	30 1/16	77 1/16	26 1/16	—	—	lbs.	
WW3078DSFA1LW	Laminate/Wood	6294	30 1/16	77 1/16	26 1/16	—	—	lbs.	
WW3078DSFA1L	Laminate	5107	30 1/16	77 1/16	26 1/16	—	—	lbs.	
<hr/>									
WW3072DSFA1W	Wood	\$ 6102	30 1/16	71 1/16	26 1/16	—	—	lbs.	
WW3072DSFA1LW	Laminate/Wood	6102	30 1/16	71 1/16	26 1/16	—	—	lbs.	
WW3072DSFA1L	Laminate	5013	30 1/16	71 1/16	26 1/16	—	—	lbs.	
<hr/>									
WW3066DSFA1W	Wood	\$ 5909	30 1/16	66	26 1/16	—	—	lbs.	
WW3066DSFA1LW	Laminate/Wood	5909	30 1/16	66	26 1/16	—	—	lbs.	
WW3066DSFA1L	Laminate	4919	30 1/16	66	26 1/16	—	—	lbs.	
<hr/>									
WW3060DSFA1W	Wood	\$ 5716	30 1/16	60	26 1/16	—	—	lbs.	
WW3060DSFA1LW	Laminate/Wood	5716	30 1/16	60	26 1/16	—	—	lbs.	
WW3060DSFA1L	Laminate	4825	30 1/16	60	26 1/16	—	—	lbs.	
<hr/>									
24" DEPTH									
WW2454DSFA1W	Wood	\$ 4248	24	54	26 1/16	—	—	lbs.	
WW2454DSFA1LW	Laminate/Wood	4248	24	54	26 1/16	—	—	lbs.	
WW2454DSFA1L	Laminate	3838	24	54	26 1/16	—	—	lbs.	
<hr/>									
WW2448DSFA1W	Wood	\$ 4164	24	48 1/16	26 1/16	—	—	lbs.	
WW2448DSFA1LW	Laminate/Wood	4164	24	48 1/16	26 1/16	—	—	lbs.	
WW2448DSFA1L	Laminate	3753	24	48 1/16	26 1/16	—	—	lbs.	

- Laminate/Wood combo units consist of a laminate worksurface and veneer shrouds and modesty
- Grain direction on shrouds is always vertical unless specifying a horizontal laminate
- Wire manager located on right side of desk; removable panel allows for easy access
- Wire manager can be moved to opposite side in field if other side is preferred
- Any laminate modesty over 60" will be horizontal
- Control pad can be moved to RH or LH by the customer
- All models feature a 2 position memory
- Legs will be visible when the desk is in an upper position; specify paint color of Cinder or Platinum Metallic
- SIN 33721

WAVEWORKS

PRODUCT SPECIFICATIONS

- Wood and laminate tops and chassis available; refer to page 336 for options
- Refer to page 340 for grommet locations and page 339 for grommet options and upcharge
- If specifying wood, you must specify the same finish for all options
- Center grommet location not available on desks

TO ORDER, SPECIFY:

1. Model Number
2. Rim
3. PVC Rim Color (laminate models)
4. Grommet
5. Paint
6. Laminate Top Color (laminate models)
7. Laminate Chassis Color (laminate models)
8. Finish (wood models)

SAMPLE MODEL NUMBERS:

WWN3084DSFBA1W F G1L 462 AD
 WWN3084DSFBA1LW F G1R 462 440 MH
 WWN3084DSFBA1L VPB X 462 PB PB

- See pages 334-339 for all options available in WaveWorks

ADJUSTABLE HEIGHT DESK SHELL BREAKFRONT FULL MODESTY

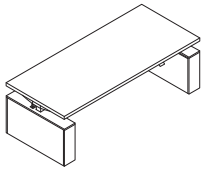

User side

MODEL NO./DESCRIPTION	LIST PRICE	DIMENSIONS				CARTONED WEIGHT	CUBIC FEET
		D	W	H	A		
1 1/2" TOP THICKNESS 36" DEPTH							
WWN3684DSFBA1W Wood	\$ 7349	36 1/16	83 1/16	27 1/16	—	—	lbs.
WWN3684DSFBA1LW Laminate/Wood	7349	36 1/16	83 1/16	27 1/16	—	—	lbs.
WWN3684DSFBA1L Laminate	6365	36 1/16	83 1/16	27 1/16	—	—	lbs.
30" DEPTH							
WWN3678DSFBA1W Wood	\$ 7156	36 1/16	77 1/16	27 1/16	—	—	lbs.
WWN3678DSFBA1LW Laminate/Wood	7156	36 1/16	77 1/16	27 1/16	—	—	lbs.
WWN3678DSFBA1L Laminate	6271	36 1/16	77 1/16	27 1/16	—	—	lbs.
WWN3672DSFBA1W Wood	\$ 6964	36 1/16	71 1/16	27 1/16	—	—	lbs.
WWN3672DSFBA1LW Laminate/Wood	6964	36 1/16	71 1/16	27 1/16	—	—	lbs.
WWN3672DSFBA1L Laminate	6177	36 1/16	71 1/16	27 1/16	—	—	lbs.
30" DEPTH							
WWN3084DSFBA1W Wood	\$ 6703	30 1/16	83 1/16	27 1/16	—	—	lbs.
WWN3084DSFBA1LW Laminate/Wood	6703	30 1/16	83 1/16	27 1/16	—	—	lbs.
WWN3084DSFBA1L Laminate	5417	30 1/16	83 1/16	27 1/16	—	—	lbs.
WWN3078DSFBA1W Wood	\$ 6510	30 1/16	77 1/16	27 1/16	—	—	lbs.
WWN3078DSFBA1LW Laminate/Wood	6510	30 1/16	77 1/16	27 1/16	—	—	lbs.
WWN3078DSFBA1L Laminate	5324	30 1/16	77 1/16	27 1/16	—	—	lbs.
WWN3072DSFBA1W Wood	\$ 6318	30 1/16	71 1/16	27 1/16	—	—	lbs.
WWN3072DSFBA1LW Laminate/Wood	6318	30 1/16	71 1/16	27 1/16	—	—	lbs.
WWN3072DSFBA1L Laminate	5229	30 1/16	71 1/16	27 1/16	—	—	lbs.
WWN3066DSFBA1W Wood	\$ 6126	30 1/16	66	27 1/16	—	—	lbs.
WWN3066DSFBA1LW Laminate/Wood	6126	30 1/16	66	27 1/16	—	—	lbs.
WWN3066DSFBA1L Laminate	5136	30 1/16	66	27 1/16	—	—	lbs.
WWN3060DSFBA1W Wood	\$ 5932	30 1/16	60	27 1/16	—	—	lbs.
WWN3060DSFBA1LW Laminate/Wood	5932	30 1/16	60	27 1/16	—	—	lbs.
WWN3060DSFBA1L Laminate	5041	30 1/16	60	27 1/16	—	—	lbs.

- Laminate/Wood combo units consist of a laminate worksurface and veneer shrouds and modesty
- Grain direction on shrouds is always vertical unless specifying a horizontal laminate
- Wire manager located on right side of desk; removeable panel allows for easy access
- Wire manager can be moved to opposite side in field if other side is preferred
- Any laminate modesty over 60" will be horizontal
- Control pad can be moved to RH or LH by the customer
- All models feature a 2 position memory
- Legs will be visible when the desk is in an upper position; specify paint color of Cinder or Platinum Metallic
- SIN 33721

PRODUCT SPECIFICATIONS

- Wood and laminate tops and chassis available; refer to page 336 for options
- Refer to page 340 for grommet locations and page 339 for grommet options and upcharge
- If specifying wood, you must specify the same finish for all options
- Center grommet location not available on desks

TO ORDER, SPECIFY:

1. Model Number
2. Rim
3. PVC Rim Color (laminated models)
4. Grommet
5. Paint
6. Laminate Top Color (laminated models)
7. Laminate Chassis Color (laminated models)
8. Finish (wood models)

SAMPLE MODEL NUMBERS:

WW3084DSFBA1W	F	G1L	462	AD
WW3084DSFBA1LW	F	G1R	462	MH
WW3084DSFBA1L	VPB	X	462	PB

• See pages 334-339 for all options available in WaveWorks

**ADJUSTABLE HEIGHT
DESK SHELL
BREAKFRONT FULL
MODESTY
(CONTINUED)**

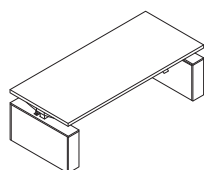

User side

MODEL NO./DESCRIPTION		LIST PRICE	DIMENSIONS				CARTONED CUBIC
			D	W	H	A	WEIGHT FEET
1 1/16" TOP THICKNESS 36" DEPTH							
WW3684DSFBA1W	Wood	\$ 7240	36 1/16	83 1/16	26 1/16	—	lbs.
WW3684DSFBA1LW	Laminate/Wood	7240	36 1/16	83 1/16	26 1/16	—	lbs.
WW3684DSFBA1L	Laminate	6257	36 1/16	83 1/16	26 1/16	—	lbs.
<hr/>							
WW3678DSFBA1W	Wood	\$ 7048	36 1/16	77 1/16	26 1/16	—	lbs.
WW3678DSFBA1LW	Laminate/Wood	7048	36 1/16	77 1/16	26 1/16	—	lbs.
WW3678DSFBA1L	Laminate	6163	36 1/16	77 1/16	26 1/16	—	lbs.
<hr/>							
WW3672DSFBA1W	Wood	\$ 6856	36 1/16	71 1/16	26 1/16	—	lbs.
WW3672DSFBA1LW	Laminate/Wood	6856	36 1/16	71 1/16	26 1/16	—	lbs.
WW3672DSFBA1L	Laminate	6068	36 1/16	71 1/16	26 1/16	—	lbs.
<hr/>							
30" DEPTH							
WW3084DSFBA1W	Wood	\$ 6595	30 1/16	83 1/16	26 1/16	—	lbs.
WW3084DSFBA1LW	Laminate/Wood	6595	30 1/16	83 1/16	26 1/16	—	lbs.
WW3084DSFBA1L	Laminate	5309	30 1/16	83 1/16	26 1/16	—	lbs.
<hr/>							
WW3078DSFBA1W	Wood	\$ 6402	30 1/16	77 1/16	26 1/16	—	lbs.
WW3078DSFBA1LW	Laminate/Wood	6402	30 1/16	77 1/16	26 1/16	—	lbs.
WW3078DSFBA1L	Laminate	5216	30 1/16	77 1/16	26 1/16	—	lbs.
<hr/>							
WW3072DSFBA1W	Wood	\$ 6210	30 1/16	71 1/16	26 1/16	—	lbs.
WW3072DSFBA1LW	Laminate/Wood	6210	30 1/16	71 1/16	26 1/16	—	lbs.
WW3072DSFBA1L	Laminate	5121	30 1/16	71 1/16	26 1/16	—	lbs.
<hr/>							
WW3066DSFBA1W	Wood	\$ 6017	30 1/16	66	26 1/16	—	lbs.
WW3066DSFBA1LW	Laminate/Wood	6017	30 1/16	66	26 1/16	—	lbs.
WW3066DSFBA1L	Laminate	5027	30 1/16	66	26 1/16	—	lbs.
<hr/>							
WW3060DSFBA1W	Wood	\$ 5824	30 1/16	60	26 1/16	—	lbs.
WW3060DSFBA1LW	Laminate/Wood	5824	30 1/16	60	26 1/16	—	lbs.
WW3060DSFBA1L	Laminate	4933	30 1/16	60	26 1/16	—	lbs.

- Laminate/Wood combo units consist of a laminate worksurface and veneer shrouds and modesty
- Grain direction on shrouds is always vertical unless specifying a horizontal laminate
- Wire manager located on right side of desk; removeable panel allows for easy access
- Wire manager can be moved to opposite side in field if other side is preferred
- Any laminate modesty over 60" will be horizontal
- Control pad can be moved to RH or LH by the customer
- All models feature a 2 position memory
- Legs will be visible when the desk is in an upper position; specify paint color of Cinder or Platinum Metallic
- SIN 33721

WAVEWORKS

WAVEWORKS

TO ORDER, SPECIFY:

1. Model Number

SAMPLE MODEL NUMBERS:

NAC05PCONB

- See pages 334-339 for all options available in WaveWorks

MODEL NO./DESCRIPTION	LIST PRICE	DIMENSIONS					CARTONED CUBIC	
		D	W	H	A	KW	WEIGHT	FEET
NAC05PCONB Black	\$ 186	2½	5½	1	—	—	3 lbs.	0.1

4 POSITION PROGRAMMABLE MEMORY CONTROL FOR ADJUSTABLE HEIGHT UNITS



- Will allow 4 position programmable option and digital readout.
- To be specified when needing a 4 position memory control on any WaveWorks Height Adjustable Desk Shell model, as these models have a 2 position memory controller as standard

ASSEMBLED

PRODUCT SPECIFICATIONS

- Wood and laminate tops and chassis available; refer to page 336 for options
- Refer to pages 717-760 for accessories
- Assembled units and component units are interchangeable
- Refer to page 340 for grommet locations and page 339 for grommet options and upcharge
- If specifying wood, you must specify the same finish for all options
- Center grommet location not available on desks

TO ORDER, SPECIFY:

1. Model Number
2. Rim
3. PVC Rim Color (laminite models)
4. Grommet
5. Laminate Top Color (laminite/combo models)
6. Laminate Door/Drawer Color (laminite models)
7. Veneer Chassis Finish/Laminite Chassis Color

SAMPLE MODEL NUMBERS:

WWN3072DUW R G1L NL AC
 WWN3072DUL VHN2 G1L AC2 AC2

- See pages 334-339 for all options available in WaveWorks

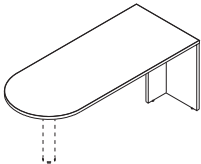
	MODEL NO./DESCRIPTION	LIST PRICE	DIMENSIONS					CARTONED WEIGHT	CUBIC FEET	
			D	W	H	A	KW			
U-SHAPED DESK 	1 1/8" TOP THICKNESS									
	WWN3672DUW	Wood	\$ 2179	36 1/2	71 1/2	29 3/8	—	—	145 lbs.	8.8
	WWN3672DULW	Laminite/Wood	2179	36 1/2	71 1/2	29 3/8	—	—	145 lbs.	8.8
	WWN3672DUL	Laminite	1292	36 1/2	71 1/2	29 3/8	—	—	145 lbs.	8.8
	WWN3072DUW	Wood	\$ 2059	30 1/2	71 1/2	29 3/8	—	—	130 lbs.	8.5
	WWN3072DULW	Laminite/Wood	2059	30 1/2	71 1/2	29 3/8	—	—	130 lbs.	8.5
	WWN3072DUL	Laminite	1091	30 1/2	71 1/2	29 3/8	—	—	130 lbs.	8.5
	WWN3066DUW	Wood	\$ 1941	30 1/2	66	29 3/8	—	—	100 lbs.	6.3
	WWN3066DULW	Laminite/Wood	1941	30 1/2	66	29 3/8	—	—	100 lbs.	6.3
	WWN3066DUL	Laminite	892	30 1/2	66	29 3/8	—	—	100 lbs.	6.3

- Not recommended as a freestanding unit
- Support base must be ordered separately; see pages 645-648 for support base options
- Some assembly required

WAVEWORKS

PRODUCT SPECIFICATIONS

- Wood and laminate tops and chassis available; refer to page 336 for options
- Refer to pages 717-760 for accessories
- Assembled units and component units are interchangeable
- Refer to page 340 for grommet locations and page 339 for grommet options and upcharge
- If specifying wood, you must specify the same finish for all options
- Center grommet location not available on desks

TO ORDER, SPECIFY:

1. Model Number
2. Rim
3. PVC Rim Color (laminate models)
4. Grommet
5. Laminate Top Color (laminate/combo models)
6. Laminate Door/Drawer Color (laminate models)
7. Veneer Chassis Finish/Laminate Chassis Color

SAMPLE MODEL NUMBERS:

WW3072DUW R G1L NL AC
 WW3072DUL VHN2 G1L AC2 AC2

- See pages 334-339 for all options available in WaveWorks

MODEL NO./DESCRIPTION	LIST PRICE	DIMENSIONS					CARTONED WEIGHT	CUBIC FEET
		D	W	H	A	KW		
U-SHAPED DESK (CONTINUED)								
1³/₁₆" TOP THICKNESS								
WW3672DUW Wood	\$ 1980	36 ³ / ₁₆	71 ¹ / ₁₆	28 ¹ / ₁₆	—	—	145 lbs.	8.8
WW3672DULW Laminate/Wood	1980	36 ³ / ₁₆	71 ¹ / ₁₆	28 ¹ / ₁₆	—	—	145 lbs.	8.8
WW3672DUL Laminate	1173	36 ³ / ₁₆	71 ¹ / ₁₆	28 ¹ / ₁₆	—	—	145 lbs.	8.8
WW3672DULL TFL	938	36 ³ / ₁₆	71 ¹ / ₁₆	28 ⁷ / ₁₆	—	—	145 lbs.	8.8
<hr/>								
WW3072DUW Wood	\$ 1872	30 ³ / ₁₆	71 ¹ / ₁₆	28 ¹ / ₁₆	—	—	130 lbs.	8.5
WW3072DULW Laminate/Wood	1872	30 ³ / ₁₆	71 ¹ / ₁₆	28 ¹ / ₁₆	—	—	130 lbs.	8.5
WW3072DUL Laminate	992	30 ³ / ₁₆	71 ¹ / ₁₆	28 ¹ / ₁₆	—	—	130 lbs.	8.5
WW3072DULL TFL	792	30 ³ / ₁₆	71 ¹ / ₁₆	28 ⁷ / ₁₆	—	—	130 lbs.	8.5
<hr/>								
WW3066DUW Wood	\$ 1765	30 ³ / ₁₆	66	28 ¹ / ₁₆	—	—	100 lbs.	6.3
WW3066DULW Laminate/Wood	1765	30 ³ / ₁₆	66	28 ¹ / ₁₆	—	—	100 lbs.	6.3
WW3066DUL Laminate	812	30 ³ / ₁₆	66	28 ¹ / ₁₆	—	—	100 lbs.	6.3
WW3066DULL TFL	649	30 ³ / ₁₆	66	28 ⁷ / ₁₆	—	—	100 lbs.	6.3

U-SHAPED DESK (CONTINUED)

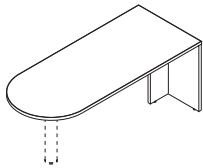

- Not recommended as a freestanding unit
- Support base must be ordered separately; see pages 645-648 for support base options
- Some assembly required

PRODUCT SPECIFICATIONS

- Wood and laminate tops and chassis available; refer to page 336 for options
- Refer to pages 717-760 for accessories
- Assembled units and component units are interchangeable
- Refer to page 340 for grommet locations and page 339 for grommet options and upcharge
- If specifying wood, you must specify the same finish for all options
- Center grommet location not available on desks

TO ORDER, SPECIFY:

1. Model Number
2. Rim
3. PVC Rim Color (laminite models)
4. Grommet
5. Laminate Top Color (laminite/combo models)
6. Laminate Door/Drawer Color (laminite models)
7. Veneer Chassis Finish/Laminite Chassis Color

SAMPLE MODEL NUMBERS:

- WWN3072DUFW R G1L NL AC
 WWN3072DUFL VHN2 G1L AC2 AC2
- See pages 334-339 for all options available in WaveWorks

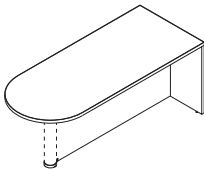
	MODEL NO./DESCRIPTION	LIST PRICE	DIMENSIONS				KW	CARTONED WEIGHT	CUBIC FEET	
			D	W	H	A				
U-SHAPED DESK WITH MODESTY PANEL 	1 1/8" TOP THICKNESS									
	WWN3672DUFW	Wood	\$ 2825	36 1/8	71 1/8	29 3/8	14 1/8	—	165 lbs.	8.9
	WWN3672DUFLW	Laminite/Wood	2825	36 1/8	71 1/8	29 3/8	14 1/8	—	165 lbs.	8.9
	WWN3672DUFL	Laminite	1687	36 1/8	71 1/8	29 3/8	14 1/8	—	165 lbs.	8.9
	WWN3072DUFW	Wood	\$ 2614	30 1/8	71 1/8	29 3/8	14 1/8	—	150 lbs.	8.6
	WWN3072DUFLW	Laminite/Wood	2614	30 1/8	71 1/8	29 3/8	14 1/8	—	150 lbs.	8.6
	WWN3072DUFL	Laminite	1489	30 1/8	71 1/8	29 3/8	14 1/8	—	150 lbs.	8.6
	WWN3066DUFW	Wood	\$ 2402	30 1/8	66	29 3/8	14 1/8	—	120 lbs.	6.5
	WWN3066DUFLW	Laminite/Wood	2402	30 1/8	66	29 3/8	14 1/8	—	120 lbs.	6.5
	WWN3066DUFL	Laminite	1291	30 1/8	66	29 3/8	14 1/8	—	120 lbs.	6.5

- Not recommended as a freestanding unit
- Support base must be ordered separately; see pages 645-648 for support base options
- Some assembly required

WAVEWORKS

PRODUCT SPECIFICATIONS

- Wood and laminate tops and chassis available; refer to page 336 for options
- Refer to pages 717-760 for accessories
- Assembled units and component units are interchangeable
- Refer to page 340 for grommet locations and page 339 for grommet options and upcharge
- If specifying wood, you must specify the same finish for all options
- Center grommet location not available on desks

TO ORDER, SPECIFY:

1. Model Number
2. Rim
3. PVC Rim Color (laminate models)
4. Grommet
5. Laminate Top Color (laminate/combo models)
6. Laminate Door/Drawer Color (laminate models)
7. Veneer Chassis Finish/Laminate Chassis Color

SAMPLE MODEL NUMBERS:

WW3072DUFW R G1L NL AC
 WW3072DUFL VHN2 G1L AC2 AC2

- See pages 334-339 for all options available in WaveWorks

MODEL NO./DESCRIPTION	LIST PRICE	DIMENSIONS					CARTONED WEIGHT	CUBIC FEET
		D	W	H	A	KW		
U-SHAPED DESK WITH MODESTY PANEL (CONTINUED)								
1³/₁₆" TOP THICKNESS								
WW3672DUFW Wood	\$ 2569	36 ³ / ₁₆	71 ¹ / ₁₆	28 ¹ / ₁₆	14 ¹ / ₁₆	—	165 lbs.	8.9
WW3672DUFLW Laminate/Wood	2569	36 ³ / ₁₆	71 ¹ / ₁₆	28 ¹ / ₁₆	14 ¹ / ₁₆	—	165 lbs.	8.9
WW3672DUFL Laminate	1534	36 ³ / ₁₆	71 ¹ / ₁₆	28 ¹ / ₁₆	14 ¹ / ₁₆	—	165 lbs.	8.9
WW3672DUFL TFL	1227	36 ³ / ₁₆	71 ¹ / ₁₆	28 ⁷ / ₁₆	14 ¹ / ₁₆	—	165 lbs.	8.9
<hr/>								
WW3072DUFW Wood	\$ 2376	30 ³ / ₁₆	71 ¹ / ₁₆	28 ¹ / ₁₆	14 ¹ / ₁₆	—	150 lbs.	8.6
WW3072DUFLW Laminate/Wood	2376	30 ³ / ₁₆	71 ¹ / ₁₆	28 ¹ / ₁₆	14 ¹ / ₁₆	—	150 lbs.	8.6
WW3072DUFL Laminate	1350	30 ³ / ₁₆	71 ¹ / ₁₆	28 ¹ / ₁₆	14 ¹ / ₁₆	—	150 lbs.	8.6
WW3072DUFL TFL	1081	30 ³ / ₁₆	71 ¹ / ₁₆	28 ⁷ / ₁₆	14 ¹ / ₁₆	—	150 lbs.	8.6
<hr/>								
WW3066DUFW Wood	\$ 2184	30 ³ / ₁₆	66	28 ¹ / ₁₆	14 ¹ / ₁₆	—	120 lbs.	6.5
WW3066DUFLW Laminate/Wood	2184	30 ³ / ₁₆	66	28 ¹ / ₁₆	14 ¹ / ₁₆	—	120 lbs.	6.5
WW3066DUFL Laminate	1172	30 ³ / ₁₆	66	28 ¹ / ₁₆	14 ¹ / ₁₆	—	120 lbs.	6.5
WW3066DUFL TFL	938	30 ³ / ₁₆	66	28 ⁷ / ₁₆	14 ¹ / ₁₆	—	120 lbs.	6.5

U-SHAPED DESK WITH MODESTY PANEL (CONTINUED)

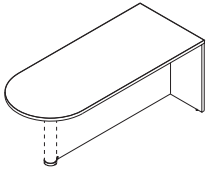

- Not recommended as a freestanding unit
- Support base must be ordered separately; see pages 645-648 for support base options
- Some assembly required

WAVEWORKS

ASSEMBLED

PRODUCT SPECIFICATIONS

- Wood and laminate tops and chassis available; refer to page 336 for options
- Refer to pages 717-760 for accessories
- Assembled units and component units are interchangeable
- Refer to page 340 for grommet locations and page 339 for grommet options and upcharge
- If specifying wood, you must specify the same finish for all options
- Center grommet location not available on P-shaped desks

TO ORDER, SPECIFY:

1. Model Number
2. Rim
3. PVC Rim Color (laminite models)
4. Laminate Top Color (laminite/combo models)
5. Laminate Door/Drawer Color (laminite models)
6. Veneer Chassis Finish/Laminite Chassis Color

SAMPLE MODEL NUMBERS:

- WW3072DPLW R AC
 WW3072DPLL VHN2 AC2 AC2
- See pages 334-339 for all options available in WaveWorks

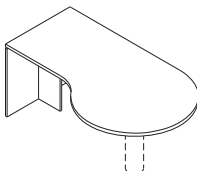
	MODEL NO./DESCRIPTION		LIST PRICE	DIMENSIONS				CARTONED CUBIC			
				D	W	H	A	KW	WEIGHT	FEET	
P-SHAPED DESK 	1 1/16" TOP THICKNESS										
	LEFT P	RIGHT P									
	WWN3072DPLW	WWN3072DPRW	Wood	\$ 2280	36 1/16	71 1/16	29 7/16	—	—	110 lbs.	6.9
	WWN3072DPLLW	WWN3072DPRLW	Laminite/Wood	2280	36 1/16	71 1/16	29 7/16	—	—	110 lbs.	6.9
	WWN3072DPLL	WWN3072DPRL	Laminite	1352	36 1/16	71 1/16	29 7/16	—	—	110 lbs.	6.9
	1 1/16" TOP THICKNESS										
	LEFT P	RIGHT P									
WW3072DPLW	WW3072DPRW	Wood	\$ 2073	36 1/16	71 1/16	29 7/16	—	—	110 lbs.	6.9	
WW3072DPLLW	WW3072DPRLW	Laminite/Wood	2073	36 1/16	71 1/16	29 7/16	—	—	110 lbs.	6.9	
WW3072DPLL	WW3072DPRL	Laminite	1229	36 1/16	71 1/16	29 7/16	—	—	110 lbs.	6.9	
WW3072DPLLL	WW3072DPRL	TFL	985	36 1/16	71 1/16	29	—	—	110 lbs.	6.9	

- Not recommended as a freestanding unit
- Support base must be ordered separately; see pages 645-648 for support base options; some assembly required

WAVEWORKS

PRODUCT SPECIFICATIONS

- Wood and laminate tops and chassis available; refer to page 336 for options
- Refer to pages 717-760 for accessories
- Assembled units and component units are interchangeable
- Refer to page 340 for grommet locations and page 339 for grommet options and upcharge
- If specifying wood, you must specify the same finish for all options
- Center grommet location not available on P-shaped desks

TO ORDER, SPECIFY:

1. Model Number
2. Rim
3. PVC Rim Color (laminate models)
4. Laminate Top Color (laminate/combo models)
5. Laminate Door/Drawer Color (laminate models)
6. Veneer Chassis Finish/Laminate Chassis Color

SAMPLE MODEL NUMBERS:

WW3072DPLFW R AC
 WW3072DPLFL VHN2 AC2 AC2

- See pages 334-339 for all options available in WaveWorks

MODEL NO./DESCRIPTION	LIST PRICE	DIMENSIONS					CARTONED CUBIC			
		D	W	H	A	KW	WEIGHT	FEET		
P-SHAPED DESK WITH MODESTY PANEL										
1 1/8" TOP THICKNESS WITH MODESTY										
LEFT P			RIGHT P							
WWN3072DPLFW	WWN3072DPRFW	Wood	\$ 2830	36 1/16	71 1/16	29 7/16	14 1/16	—	130 lbs.	8.8
WWN3072DPLFLW	WWN3072DPRFLW	Laminate/Wood	2830	36 1/16	71 1/16	29 7/16	14 1/16	—	130 lbs.	8.8
WWN3072DPLFL	WWN3072DPRFL	Laminate	1708	36 1/16	71 1/16	29 7/16	14 1/16	—	130 lbs.	8.8
1 3/16" TOP THICKNESS WITH MODESTY										
LEFT P			RIGHT P							
WW3072DPLFW	WW3072DPRFW	Wood	\$ 2571	36 1/16	71 1/16	29 7/16	14 1/16	—	130 lbs.	8.8
WW3072DPLFLW	WW3072DPRFLW	Laminate/Wood	2571	36 1/16	71 1/16	29 7/16	14 1/16	—	130 lbs.	8.8
WW3072DPLFL	WW3072DPRFL	Laminate	1553	36 1/16	71 1/16	29 7/16	14 1/16	—	130 lbs.	8.8
WW3072DPLFLL	WW3072DPRFLL	TFL	1242	36 1/16	71 1/16	29	14 1/16	—	130 lbs.	8.8

P-SHAPED DESK WITH MODESTY PANEL

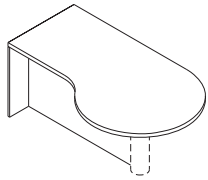

Left shown

- Not recommended as a freestanding unit
- Support base must be ordered separately; see pages 645-648 for support base options; some assembly required

PRODUCT SPECIFICATIONS

- Wood and laminate tops and chassis available; refer to page 336 for options
- Refer to pages 717-760 for accessories
- Assembled units and component units are interchangeable
- If specifying wood, you must specify the same finish for all options
- Only available grommet option on corner units is center location
- Refer to page 339 for grommet options and upcharge

TO ORDER, SPECIFY:

1. Model Number
2. Rim
3. PVC Rim Color (laminate models)
4. Grommet
5. Laminate Top Color (laminate/combo models)
6. Veneer Chassis Finish/Laminate Chassis Color

SAMPLE MODEL NUMBERS:

WW4242CFSW2	P	G11SNC	MC		
WW4242CFSL2	V	G11SNC	MC	440	MC
WW4242CFSLWL2	P	G11SNC	440	MC	440
WW4242CFSLW2	P	G11SNC	440	MC	

- See pages 334-339 for all options available in WaveWorks

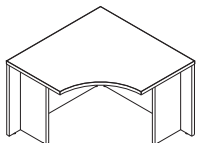
	MODEL NO./DESCRIPTION	LIST PRICE	DIMENSIONS					CARTONED WEIGHT	CUBIC FEET	
			D	W	H	A	KW			
CORNER UNIT  Grain direction runs diagonally	1 1/8" TOP THICKNESS									
	WWN4242CFSW2	Wood	\$ 2424	42 1/16	42 1/16	29 3/16	1/16	—	145 lbs.	50.4
	WWN4242CFSLW2	Laminate/Wood	2424	42 1/16	42 1/16	29 3/16	1/16	—	145 lbs.	50.4
	WWN4242CFSL2	Laminate	1472	42 1/16	42 1/16	29 3/16	1/16	—	145 lbs.	50.4
	WWN4242CFSWL2	Wood/Laminate	2062	42 1/16	42 1/16	29 3/16	1/16	—	145 lbs.	50.4
	WWN4242CFSLWL2	Laminate/Wood/Laminate	2062	42 1/16	42 1/16	29 3/16	1/16	—	145 lbs.	50.4
	1 1/8" TOP THICKNESS									
	WW4242CFSW2	Wood	\$ 2202	42 1/16	42 1/16	28 1/16	1/16	—	145 lbs.	50.4
	WW4242CFSLW2	Laminate/Wood	2202	42 1/16	42 1/16	28 1/16	1/16	—	145 lbs.	50.4
	WW4242CFSL2	Laminate	1340	42 1/16	42 1/16	28 1/16	1/16	—	145 lbs.	50.4
WW4242CFSL2	TFL	1072	42 1/16	42 1/16	28 1/16	1/16	—	145 lbs.	50.4	
WW4242CFSWL2	Wood/Laminate	1873	42 1/16	42 1/16	28 1/16	1/16	—	145 lbs.	50.4	
WW4242CFSLWL2	Laminate/Wood/Laminate	1873	42 1/16	42 1/16	28 1/16	1/16	—	145 lbs.	50.4	
<ul style="list-style-type: none"> • Must be connected to 24" deep worksurfaces • 42" corner unit has 25 1/2" on front edge 										
	1 1/8" TOP THICKNESS									
	WWN3636CFSW2	Wood	\$ 2269	36 1/16	36 1/16	29 3/16	1/16	—	125 lbs.	25.9
	WWN3636CFSLW2	Laminate/Wood	2269	36 1/16	36 1/16	29 3/16	1/16	—	125 lbs.	25.9
	WWN3636CFSL2	Laminate	1386	36 1/16	36 1/16	29 3/16	1/16	—	125 lbs.	25.9
	WWN3636CFSWL2	Wood/Laminate	1929	36 1/16	36 1/16	29 3/16	1/16	—	125 lbs.	25.9
	WWN3636CFSLWL2	Laminate/Wood/Laminate	1929	36 1/16	36 1/16	29 3/16	1/16	—	125 lbs.	25.9
	1 1/8" TOP THICKNESS									
	WW3636CFSW2	Wood	\$ 2062	36 1/16	36 1/16	28 1/16	1/16	—	125 lbs.	25.9
	WW3636CFSLW2	Laminate/Wood	2062	36 1/16	36 1/16	28 1/16	1/16	—	125 lbs.	25.9
	WW3636CFSL2	Laminate	1262	36 1/16	36 1/16	28 1/16	1/16	—	125 lbs.	25.9
WW3636CFSL2	TFL	1008	36 1/16	36 1/16	28 1/16	1/16	—	125 lbs.	25.9	
WW3636CFSWL2	Wood/Laminate	1754	36 1/16	36 1/16	28 1/16	1/16	—	125 lbs.	25.9	
WW3636CFSLWL2	Laminate/Wood/Laminate	1754	36 1/16	36 1/16	28 1/16	1/16	—	125 lbs.	25.9	
<ul style="list-style-type: none"> • Grain direction runs diagonally • Must be connected to 24" deep worksurfaces • 36" unit has 17" on front edge • Not intended to be used as freestanding unit 										

WAVEWORKS

PRODUCT SPECIFICATIONS

- Wood and laminate tops and chassis available; refer to page 336 for options
- Refer to pages 717-760 for accessories
- Assembled units and component units are interchangeable
- If specifying wood, you must specify the same finish for all options
- Only available grommet option on corner units is center location
- Refer to page 339 for grommet options and upcharge

TO ORDER, SPECIFY:

1. Model Number
2. Rim
3. PVC Rim Color (laminate models)
4. Grommet
5. Laminate Top Color (laminate/combo models)
6. Veneer Chassis Finish/Laminate Chassis Color

SAMPLE MODEL NUMBERS:

- | | | | | |
|----------------|---|--------|--------|-----|
| WWN4242CFSW3 | P | G11SNC | MC | |
| WWN4242CFSL3 | V | G11SNC | MC | 440 |
| WWN4242CFSLWL3 | P | G11SNC | 440 MC | 440 |
| WWN4242CFSLW3 | P | G11SNC | 440 MC | |
- See pages 334-339 for all options available in WaveWorks

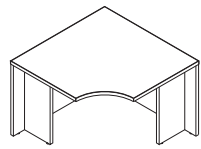
CORNER UNIT	MODEL NO./DESCRIPTION	LIST PRICE	DIMENSIONS					CARTONED CUBIC		
			D	W	H	A	KW	WEIGHT	FEET	
 <p>Grain direction runs diagonally</p>	1 1/8" TOP THICKNESS									
	WWN4242CFSW3	Wood	\$ 2666	42 1/16	42 1/16	29 3/8	1/16	—	145 lbs.	50.4
	WWN4242CFSLW3	Laminate/Wood	2666	42 1/16	42 1/16	29 3/8	1/16	—	145 lbs.	50.4
	WWN4242CFSL3	Laminate	1623	42 1/16	42 1/16	29 3/8	1/16	—	145 lbs.	50.4
	WWN4242CFSLW3	Wood/Laminate	2264	42 1/16	42 1/16	29 3/8	1/16	—	145 lbs.	50.4
	WWN4242CFSLWL3	Laminate/Wood/Laminate	2264	42 1/16	42 1/16	29 3/8	1/16	—	145 lbs.	50.4
	1 3/16" TOP THICKNESS									
	WW4242CFSW3	Wood	\$ 2423	42 1/16	42 1/16	28 13/16	1/16	—	145 lbs.	50.4
	WW4242CFSLW3	Laminate/Wood	2423	42 1/16	42 1/16	28 13/16	1/16	—	145 lbs.	50.4
	WW4242CFSL3	Laminate	1475	42 1/16	42 1/16	28 13/16	1/16	—	145 lbs.	50.4
WW4242CFSL3	TFL	1180	42 1/16	42 1/16	28 13/16	1/16	—	145 lbs.	50.4	
WW4242CFSLW3	Wood/Laminate	2058	42 1/16	42 1/16	28 13/16	1/16	—	145 lbs.	50.4	
WW4242CFSLWL3	Laminate/Wood/Laminate	2058	42 1/16	42 1/16	28 13/16	1/16	—	145 lbs.	50.4	

- Grain direction runs diagonally
- Must be connected to 30" deep worksurfaces
- 42" corner unit has 12 1/4" on front edge
- Not intended to be used as freestanding unit

TRANSACTION COUNTER

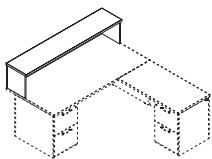

WW1572TCW	Wood	\$ 1059	15 3/16	71 13/16	15 13/16	—	—	90 lbs.	15.5
WW1572TCL	Laminate	576	15 3/16	71 13/16	15 13/16	—	—	90 lbs.	15.5
WW1572TCLL	TFL	460	15 3/16	71 13/16	15 13/16	—	—	90 lbs.	15.5
WW1566TCW	Wood	\$ 964	15 3/16	66	15 13/16	—	—	85 lbs.	14.5
WW1566TCL	Laminate	535	15 3/16	66	15 13/16	—	—	85 lbs.	14.5
WW1566TCLL	TFL	426	15 3/16	66	15 13/16	—	—	85 lbs.	14.5

- Some assembly required
- For tack board options, see pages 752-759

PRODUCT SPECIFICATIONS

- Wood and laminate tops and chassis available; refer to page 336 for options
- Refer to pages 717-760 for accessories
- Assembled units and component units are interchangeable
- If specifying wood, you must specify the same finish for all options
- Refer to page 339 for grommet options and upcharge
- See pages 379-383 for reception unit thought starters and examples
- Undersurface pedestals available; see pages 499-509
- Reception worksurfaces available in 1³/₈" only

TO ORDER, SPECIFY:

1. Model Number
2. Rim
3. PVC Rim Color (laminate models)
4. Grommet
5. Locking
6. Laminate Top Color (laminate/combo models)
7. Laminate Door/Drawer Color (laminate models)
8. Veneer Chassis Finish/ Laminate Chassis Color

SAMPLE MODEL NUMBER:

WW2572DSTF3W RX CW
 • See pages 334-339 for all options available in WaveWorks



Shaded model numbers are available on our "To You in 10 Days or Less" Quick Delivery program and will be delivered in 10 days or less.

**RECEPTION DESK
MAIN SHELL**

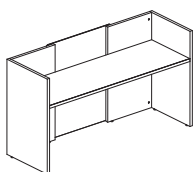

MODEL NO./DESCRIPTION	LIST PRICE	DIMENSIONS					CARTONED WEIGHT	CUBIC FEET
		D	W	H	A	KW		
WW2572DSTFW Wood	\$ 4565	25	71 ¹ / ₈	40 ³ / ₈	—	69 ¹ / ₂	230 lbs.	52.0
WW2572DSTFLW Laminate/Wood	4565	25	71 ¹ / ₈	40 ³ / ₈	—	69 ¹ / ₂	230 lbs.	52.0
WW2572DSTFL Laminate	3697	25	71 ¹ / ₈	40 ³ / ₈	—	69 ¹ / ₂	230 lbs.	52.0
WW2572DSTFLL TFL	2957	25	71 ¹ / ₈	40 ³ / ₈	—	69 ¹ / ₂	230 lbs.	52.0

- Frosted glass accent piece attached to approach side
- Do not specify pull option
- Center grommet location not available due to cords being visible through glass
- Unit is non-handed; can be used left or right to configure a U-station
- 23" deep undersurface pedestals can be ordered for storage; see pages 500-501
- Reception Counter Kits available; see pages 376-378 for additional information
- For tack board options, see pages 752-759
- When ordering a tack board, it is recommended to also order a reception counter kit for the best appearance

**RECEPTION DESK
MAIN SHELL**

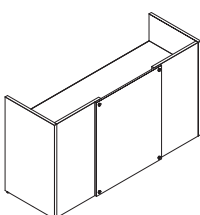

Approach view

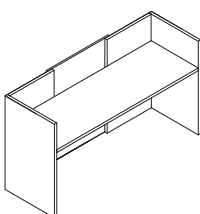

User view

MAIN SHELL		LIST PRICE	DIMENSIONS					CARTONED WEIGHT	CUBIC FEET
MODEL NO.	DESCRIPTION		D	W	H	A	KW		
QWW2572DSTF3W	Wood	\$ 3228	25	71 ¹ / ₈	40 ³ / ₈	—	69 ¹ / ₂	230 lbs.	52.0
WW2572DSTF3W	Wood	3228	25	71 ¹ / ₈	40 ³ / ₈	—	69 ¹ / ₂	230 lbs.	52.0
WW2572DSTF3L	Laminate	\$ 2347	25	71 ¹ / ₈	40 ³ / ₈	—	69 ¹ / ₂	230 lbs.	52.0
QWW2572DSTF3LL	TFL	1877	25	71 ¹ / ₈	40 ³ / ₈	—	69 ¹ / ₂	230 lbs.	52.0
WW2572DSTF3LL	TFL	1877	25	71 ¹ / ₈	40 ³ / ₈	—	69 ¹ / ₂	230 lbs.	52.0

- Wood worksurface/rim, wood front panel, wood chassis-no glass on unit
- Laminate worksurface/PVC rim, laminate front panel, laminate chassis-no glass on unit
- Do not specify pull option
- Unit is non-handed; can be used left or right to configure a U-station
- 23" deep undersurface pedestals can be ordered for storage; see pages 500-501
- Reception Counter Kits available; see pages 376-378 for additional information
- For tack board options, see pages 752-759
- When ordering a tack board, it is recommended to also order a reception counter kit for the best appearance

WAVEWORKS

WAVEWORKS

ASSEMBLED

PRODUCT SPECIFICATIONS

- Wood and laminate tops and chassis available; refer to page 336 for options
- Refer to pages 717-760 for accessories
- Assembled units and component units are interchangeable
- If specifying wood, you must specify the same finish for all options
- Refer to page 339 for grommet options and upcharge
- See pages 379-383 for reception unit thought starters and examples
- Undersurface pedestals available; see pages 499-509
- Reception worksurfaces available in 1 $\frac{1}{8}$ " only

TO ORDER, SPECIFY:

1. Model Number
2. Rim
3. PVC Rim Color (laminated models)
4. Pull
5. Grommet
6. Locking
7. Laminate Top Color (laminated/combo models)
8. Laminate Door/Drawer Color (laminated models)
9. Veneer Chassis Finish/Laminate Chassis Color

SAMPLE MODEL NUMBER:

WW2575DSTFLW F 72CC KRB AC

- See pages 334-339 for all options available in WaveWorks

QD Shaded model numbers are available on our "To You in 10 Days or Less" Quick Delivery program and will be delivered in 10 days or less.

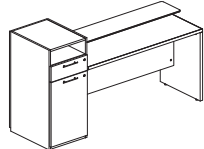
RECEPTION DESK ADA MAIN SHELL WITH VERTICAL TOWER	MODEL NO./DESCRIPTION		LIST PRICE	DIMENSIONS				CARTONED CUBIC		
	LEFT	RIGHT		D	W	H	A	KW	WEIGHT	FEET
	WW2575DSTFLW	WW2575DSTFRW	Wood \$ 4929	26 $\frac{1}{16}$ "	74 $\frac{1}{16}$ "	29 $\frac{3}{16}$ "	8"	54"	230 lbs.	52.0
	WW2575DSTFLLW	WW2575DSTFRLW	Lam/Wood 4929	26 $\frac{1}{16}$ "	74 $\frac{1}{16}$ "	29 $\frac{3}{16}$ "	8"	54"	230 lbs.	52.0
	WW2575DSTFLL	WW2575DSTFRL	Laminate 3980	26 $\frac{1}{16}$ "	74 $\frac{1}{16}$ "	29 $\frac{3}{16}$ "	8"	54"	230 lbs.	52.0
	WW2575DSTFLLL	WW2575DSTFRLL	TFL 3184	26 $\frac{1}{16}$ "	74 $\frac{1}{16}$ "	29 $\frac{3}{16}$ "	8"	54"	230 lbs.	52.0
	<ul style="list-style-type: none"> • Includes glass shelf on approach side • Grommet option not available • Kneespace depth is 15$\frac{1}{2}$" • Vertical tower has access door on approach side to access cords, 24" x 18" cornice tops available for tower; see page 462 • Random lock core (KRB, KRS) and specified lock core (KS2B, KS2S) available 									
	<ul style="list-style-type: none"> • In order to meet ADA standards from the approach side, specify an ADA compliant main shell and a reception return • Measurements of unit are compliant with the clearances outlined in the Americans with Disabilities Act guidelines for office furniture • In order to meet ADA standards from the user side, use the WW2866BSTF___, WW2866BSTF2___ or WW2563BSTF___ reception bridge 									

RECEPTION DESK ADA MAIN SHELL WITH VERTICAL TOWER

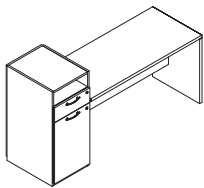

Left shown

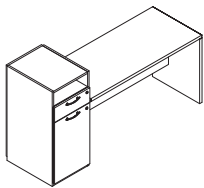
RECEPTION DESK ADA MAIN SHELL WITH VERTICAL TOWER	MODEL NO./DESCRIPTION		LIST PRICE	DIMENSIONS				CARTONED CUBIC		
	LEFT	RIGHT		D	W	H	A	KW	WEIGHT	FEET
	QWW2472DSTFLW	QWW2472DSTFRW	Wood \$ 3655	24"	72"	29 $\frac{3}{16}$ "	8"	54"	230 lbs.	52.0
	WW2472DSTFLW	WW2472DSTFRW	Wood 3655	24"	72"	29 $\frac{3}{16}$ "	8"	54"	230 lbs.	52.0
	WW2472DSTFLLW	WW2472DSTFRLW	Lam/Wood 3655	24"	72"	29 $\frac{3}{16}$ "	8"	54"	230 lbs.	52.0
	WW2472DSTFLL	WW2472DSTFRL	Laminate 2698	24"	72"	29 $\frac{3}{16}$ "	8"	54"	230 lbs.	52.0
	QWW2472DSTFLLL	QWW2472DSTFRLL	TFL 2157	24"	72"	29 $\frac{3}{16}$ "	8"	54"	230 lbs.	52.0
	WW2472DSTFLLL	WW2472DSTFRLL	TFL 2157	24"	72"	29 $\frac{3}{16}$ "	8"	54"	230 lbs.	52.0
	<ul style="list-style-type: none"> • No glass on unit • Reception Counter Kits available; see below • Grommet option not available • Kneespace depth is 15$\frac{1}{8}$" • Vertical tower has access door on approach side to access cords, 24" x 18" cornice tops available for tower; see page 462 • Random lock core (KRB, KRS) and specified lock core (KS2B, KS2S) available 									
	<ul style="list-style-type: none"> • Measurements of unit are compliant with the clearances outlined in the Americans with Disabilities Act guidelines for office furniture • In order to meet ADA standards from the approach side, specify an ADA compliant main shell and a reception return • In order to meet ADA standard from the user side, use the WW2866BSTF___, WW2866BSTF2___ or WW2563BSTF___ reception bridge 									

RECEPTION COUNTER KITS— ADA

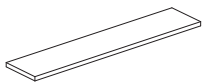

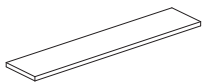
RECEPTION COUNTER KITS— ADA	MODEL NO./DESCRIPTION		LIST PRICE	DIMENSIONS				CARTONED CUBIC		
	LEFT	RIGHT		D	W	H	A	KW	WEIGHT	FEET
	QWW1154TSW	Wood	\$ 702	11"	54"	1 $\frac{1}{8}$ "	—	—	42 lbs.	1.8
	WW1154TSW	Wood	702	11"	54"	1 $\frac{1}{8}$ "	—	—	42 lbs.	1.8
	WW1154TSLW	Laminate/Wood	702	11"	54"	1 $\frac{1}{8}$ "	—	—	42 lbs.	1.8
	WW1154TSL	Laminate	682	11"	54"	1 $\frac{1}{8}$ "	—	—	42 lbs.	1.8
	QWW1154TSLL	TFL	546	11"	54"	1 $\frac{1}{8}$ "	—	—	42 lbs.	1.8
	WW1154TSLL	TFL	546	11"	54"	1 $\frac{1}{8}$ "	—	—	42 lbs.	1.8
	<ul style="list-style-type: none"> • For use with Reception Desk ADA Main Shell above • Unit includes stanchions to attach to the ADA Reception unit 									

PRODUCT SPECIFICATIONS

- Wood and laminate tops and chassis available; refer to page 336 for options
- Refer to pages 717-760 for accessories
- Assembled units and component units are interchangeable
- If specifying wood, you must specify the same finish for all options
- Refer to page 339 for grommet options and upcharge
- See pages 379-383 for reception unit thought starters and examples
- Undersurface pedestals available; see pages 499-509
- Reception worksurfaces available in 1 $\frac{1}{8}$ " only

TO ORDER, SPECIFY:

1. Model Number
2. Rim
3. PVC Rim Color (laminate models)
4. Grommet
5. Laminate Top Color (laminate/combo models)
6. Veneer Chassis Finish/Laminate Chassis Color

SAMPLE MODEL NUMBERS:

- WW2866BSTFW P G1C AC
 WW2866BSTFL NMH G1C MH
 WW2866BSTFLW F G1C 461 NH
- See pages 334-339 for all options available in WaveWorks

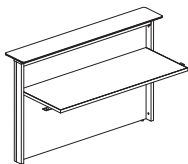
	MODEL NO./DESCRIPTION	LIST PRICE	DIMENSIONS				KW	CARTONED WEIGHT	CUBIC FEET
			D	W	H	A			
	WW2866BSTFW Wood	\$ 1076	28 $\frac{1}{16}$	66	42 $\frac{3}{4}$	—	66	260 lbs.	60.0
	WW2866BSTFLW Laminate/Wood	1076	28 $\frac{1}{16}$	66	42 $\frac{3}{4}$	—	66	260 lbs.	60.0
	WW2866BSTFL Laminate	742	28 $\frac{1}{16}$	66	42 $\frac{3}{4}$	—	66	260 lbs.	60.0
	WW2866BSTFLL TFL	594	28 $\frac{1}{16}$	66	42 $\frac{3}{4}$	—	66	260 lbs.	60.0
	WW2854BSTFW Wood	\$ 926	28 $\frac{1}{16}$	54	42 $\frac{3}{4}$	—	54	243 lbs.	51.0
	WW2854BSTFLW Laminate/Wood	926	28 $\frac{1}{16}$	54	42 $\frac{3}{4}$	—	54	243 lbs.	51.0
	WW2854BSTFL Laminate	565	28 $\frac{1}{16}$	54	42 $\frac{3}{4}$	—	54	243 lbs.	51.0
	WW2854BSTFLL TFL	452	28 $\frac{1}{16}$	54	42 $\frac{3}{4}$	—	54	243 lbs.	51.0

- Includes 11" deep clear glass reception counter and frosted glass accent piece attached to approach side
- Specify WW2866BSTF_ reception bridge for ADA compliant user side
- When WW2866BSTFL is ordered with woodgrain laminate, laminate will run left-to-right on modesty panel
- Do not specify pull option
- Woodgrain on worksurfaces runs front-to-back
- For tack board options, see pages 752-759

RECEPTION BRIDGE

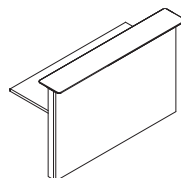

Approach view

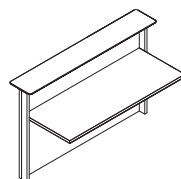

User view

WW2866BSTF2W Wood	\$ 1033	28 $\frac{1}{16}$	66	42 $\frac{3}{4}$	—	66	260 lbs.	60.0
WW2866BSTF2LW Laminate/Wood	1033	28 $\frac{1}{16}$	66	42 $\frac{3}{4}$	—	66	260 lbs.	60.0
WW2866BSTF2L Laminate	730	28 $\frac{1}{16}$	66	42 $\frac{3}{4}$	—	66	260 lbs.	60.0
WW2866BSTF2LL TFL	583	28 $\frac{1}{16}$	66	42 $\frac{3}{4}$	—	66	260 lbs.	60.0
WW2854BSTF2W Wood	\$ 904	28 $\frac{1}{16}$	54	42 $\frac{3}{4}$	—	66	243 lbs.	51.0
WW2854BSTF2LW Laminate/Wood	904	28 $\frac{1}{16}$	54	42 $\frac{3}{4}$	—	66	243 lbs.	51.0
WW2854BSTF2L Laminate	535	28 $\frac{1}{16}$	54	42 $\frac{3}{4}$	—	66	243 lbs.	51.0
WW2854BSTF2LL TFL	426	28 $\frac{1}{16}$	54	42 $\frac{3}{4}$	—	66	243 lbs.	51.0

- Includes 11" deep clear glass reception counter
- Specify WW2866BSTF_ or WW2866BSTF2_ reception bridge for ADA compliant user side
- When WW2866BSTF2L is ordered with woodgrain laminate, laminate will run left-to-right on modesty panel
- Do not specify pull option
- Grain direction runs front-to-back on worksurface
- For tack board options, see pages 752-759

WAVEWORKS

PRODUCT SPECIFICATIONS

- Wood and laminate tops and chassis available; refer to page 336 for options
- Refer to pages 717-760 for accessories
- Assembled units and component units are interchangeable
- If specifying wood, you must specify the same finish for all options
- Refer to page 339 for grommet options and upcharge
- See pages 379-383 for reception unit thought starters and examples
- Undersurface pedestals available; see pages 499-509
- Reception worksurfaces available in 1 $\frac{1}{8}$ " only

TO ORDER, SPECIFY:

1. Model Number
2. Rim
3. PVC Rim Color (laminated models)
4. Grommet
5. Laminate Top Color (laminated/combo models)
6. Veneer Chassis Finish/Laminated Chassis Color

SAMPLE MODEL NUMBERS:

WW2563BSTFW P G1C AC
 WW2563BSTFL NMH G1C MH
 WW2563BSTFLW F G1C 461 NH

- See pages 334-339 for all options available in WaveWorks

QD Shaded model numbers are available on our "To You in 10 Days or Less" Quick Delivery program and will be delivered in 10 days or less.

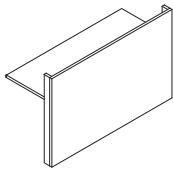
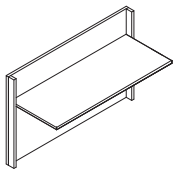
	MODEL NO./DESCRIPTION	LIST PRICE	DIMENSIONS					CARTONED CUBIC	
			D	W	H	A	KW	WEIGHT	FEET
RECEPTION BRIDGE  Approach view	QWW2563BSTFW Wood	\$ 996	25 $\frac{1}{2}$ "	62 $\frac{1}{16}$ "	40 $\frac{3}{8}$ "	—	66	260 lbs.	60.0
	WW2563BSTFW Wood	996	25 $\frac{1}{2}$ "	62 $\frac{1}{16}$ "	40 $\frac{3}{8}$ "	—	66	260 lbs.	60.0
	WW2563BSTFLW Laminate/Wood	996	25 $\frac{1}{2}$ "	62 $\frac{1}{16}$ "	40 $\frac{3}{8}$ "	—	66	260 lbs.	60.0
	WW2563BSTFL Laminate	693	25 $\frac{1}{2}$ "	62 $\frac{1}{16}$ "	40 $\frac{3}{8}$ "	—	66	260 lbs.	60.0
	QWW2563BSTFLL TFL	552	25 $\frac{1}{2}$ "	62 $\frac{1}{16}$ "	40 $\frac{3}{8}$ "	—	66	260 lbs.	60.0
	WW2563BSTFLL TFL	552	25 $\frac{1}{2}$ "	62 $\frac{1}{16}$ "	40 $\frac{3}{8}$ "	—	66	260 lbs.	60.0
 User view	QWW2550BSTFW Wood	\$ 865	25 $\frac{1}{2}$ "	50 $\frac{1}{16}$ "	40 $\frac{3}{8}$ "	—	66	243 lbs.	51.0
	WW2550BSTFW Wood	865	25 $\frac{1}{2}$ "	50 $\frac{1}{16}$ "	40 $\frac{3}{8}$ "	—	66	243 lbs.	51.0
	WW2550BSTFLW Laminate/Wood	865	25 $\frac{1}{2}$ "	50 $\frac{1}{16}$ "	40 $\frac{3}{8}$ "	—	66	243 lbs.	51.0
	WW2550BSTFL Laminate	495	25 $\frac{1}{2}$ "	50 $\frac{1}{16}$ "	40 $\frac{3}{8}$ "	—	66	243 lbs.	51.0
	QWW2550BSTFLL TFL	396	25 $\frac{1}{2}$ "	50 $\frac{1}{16}$ "	40 $\frac{3}{8}$ "	—	66	243 lbs.	51.0
	WW2550BSTFLL TFL	396	25 $\frac{1}{2}$ "	50 $\frac{1}{16}$ "	40 $\frac{3}{8}$ "	—	66	243 lbs.	51.0

- No glass on unit
- Reception Counter Kits available; see pages 376-378 for additional information
- Specify WW2563BSTF_ reception bridge for ADA compliant user side
- When WW2563BSTFL is ordered with woodgrain laminate, laminate will run left-to-right on modesty panel
- Grain direction runs front-to-back on worksurface
- For tack board options, see pages 752-759
- When ordering a tack board, it is recommended to also order a reception counter kit for the best appearance

RECEPTION RETURN

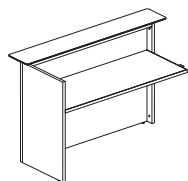

Left Shown

RECEPTION RETURN			LIST PRICE	DIMENSIONS					CARTONED CUBIC	
LEFT-SHELL	RIGHT-SHELL			D	W	H	A	KW	WEIGHT	FEET
WW2860RSTFLW	WW2860RSTFRW	Wood	\$ 1649	27 $\frac{3}{4}$ "	60	42 $\frac{3}{8}$ "	—	59 $\frac{1}{4}$ "	175 lbs.	47.0
WW2860RSTFLLW	WW2860RSTFRLW	Lam/Wood	1649	27 $\frac{3}{4}$ "	60	42 $\frac{3}{8}$ "	—	59 $\frac{1}{4}$ "	175 lbs.	47.0
WW2860RSTFLL	WW2860RSTFRL	Laminate	1539	27 $\frac{3}{4}$ "	60	42 $\frac{3}{8}$ "	—	59 $\frac{1}{4}$ "	175 lbs.	47.0
WW2860RSTFLLL	WW2860RSTFRLL	TFL	1232	27 $\frac{3}{4}$ "	60	42 $\frac{3}{8}$ "	—	59 $\frac{1}{4}$ "	175 lbs.	47.0

- Includes 11" deep clear glass reception counter and frosted glass accent piece attached to approach side
- Use with a main shell to make a reception L-station
- 23" deep undersurface pedestals can be ordered for storage; see pages 500-501
- Grain direction runs front-to-back on worksurface
- For tack board options, see pages 752-759

PRODUCT SPECIFICATIONS

- Wood and laminate tops and chassis available; refer to page 336 for options
- Refer to pages 717-760 for accessories
- Assembled units and component units are interchangeable
- If specifying wood, you must specify the same finish for all options
- Refer to page 339 for grommet options and upcharge
- See pages 379-383 for reception unit thought starters and examples
- Undersurface pedestals available; see pages 499-509
- Reception worksurfaces available in 1 $\frac{3}{8}$ " only
- Counter kits shipped with appropriate hardware to attach to reception units
- Rim on all 4 sides of laminate and wood counter kits
- Refer to pages 379-380 for examples of how the counter kits can be used

TO ORDER, SPECIFY:

1. Model Number
2. Rim
3. PVC Rim Color (laminate models)
4. Grommet
5. Laminate Top Color (laminate/combo models)
6. Veneer Chassis Finish/Laminate Chassis Color

SAMPLE MODEL NUMBERS:

WW2860RSTFL2W P G1C AC
 WW2860RSTFL2LW NMH G1C MH
 WW2860RSTFL2L F G1C 461 NH

- See pages 334-339 for all options available in WaveWorks

QD Shaded model numbers are available on our "To You in 10 Days or Less" Quick Delivery program and will be delivered in 10 days or less.

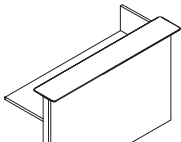
RECEPTION RETURN	MODEL NO./DESCRIPTION		LIST PRICE	DIMENSIONS				KW	CARTONED WEIGHT	CUBIC FEET
	LEFT-SHELL	RIGHT-SHELL		D	W	H	A			
	WW2860RSTFL2W	WW2860RSTFR2W Wood	\$ 1607	27 $\frac{3}{4}$	60	42 $\frac{3}{8}$	—	59 $\frac{1}{4}$	175 lbs.	47.0
	WW2860RSTFL2LW	WW2860RSTFR2LW Lam/Wood	1607	27 $\frac{3}{4}$	60	42 $\frac{3}{8}$	—	59 $\frac{1}{4}$	175 lbs.	47.0
	WW2860RSTFL2L	WW2860RSTFR2L Laminate	1509	27 $\frac{3}{4}$	60	42 $\frac{3}{8}$	—	59 $\frac{1}{4}$	175 lbs.	47.0
	WW2860RSTFL2LL	WW2860RSTFR2LL TFL	1208	27 $\frac{3}{4}$	60	42 $\frac{3}{8}$	—	59 $\frac{1}{4}$	175 lbs.	47.0

Approach view-left shown

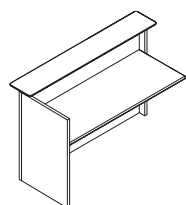

User view-left shown

- Includes 11" deep clear glass reception counter
- Use with a main shell to make a reception L-station
- 23" deep undersurface pedestals can be ordered for storage; see pages 500-501
- Grain direction runs front-to-back on worksurface
- For tack board options, see pages 752-759

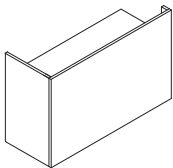
RECEPTION RETURN	LEFT-SHELL	RIGHT-SHELL	LIST PRICE	DIMENSIONS				KW	CARTONED WEIGHT	CUBIC FEET
				D	W	H	A			
	QWW2460RSTFLW	QWW2460RSTFRW Wood	\$ 1569	24 $\frac{1}{4}$	59 $\frac{1}{2}$	40 $\frac{3}{8}$	—	59 $\frac{1}{4}$	175 lbs.	47.0
	WW2460RSTFLW	WW2460RSTFRW Wood	1569	24 $\frac{1}{4}$	59 $\frac{1}{2}$	40 $\frac{3}{8}$	—	59 $\frac{1}{4}$	175 lbs.	47.0
	WW2460RSTFLLW	WW2460RSTFRLW Lam/Wood	1569	24 $\frac{1}{4}$	59 $\frac{1}{2}$	40 $\frac{3}{8}$	—	59 $\frac{1}{4}$	175 lbs.	47.0
	WW2460RSTFLL	WW2460RSTFRL Laminate	1470	24 $\frac{1}{4}$	59 $\frac{1}{2}$	40 $\frac{3}{8}$	—	59 $\frac{1}{4}$	175 lbs.	47.0
	QWW2460RSTFLLL	QWW2460RSTFRLL TFL	1177	24 $\frac{1}{4}$	59 $\frac{1}{2}$	40 $\frac{3}{8}$	—	59 $\frac{1}{4}$	175 lbs.	47.0
	WW2460RSTFLLL	WW2460RSTFRLL TFL	1177	24 $\frac{1}{4}$	59 $\frac{1}{2}$	40 $\frac{3}{8}$	—	59 $\frac{1}{4}$	175 lbs.	47.0

Approach view-right shown

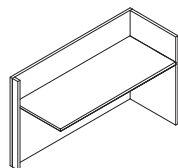

User view-right shown

- No glass on unit
- Reception Counter Kits available; see pages 376-378 for additional information
- Use with a main shell to make a reception L-station
- 23" deep undersurface pedestals can be ordered for storage; see pages 500-501
- Grain direction runs front-to-back on worksurface
- For tack board options, see pages 752-759
- When ordering a tack board, it is recommended to also order a reception counter kit for the best appearance

WAVEWORKS

PRODUCT SPECIFICATIONS

- Counter kits shipped with appropriate hardware to attach to reception units
- Rim on all 4 sides of laminate and wood counter kits
- Refer to pages 379-380 for examples of how the counter kits can be used

TO ORDER, SPECIFY:

1. Model Number
2. Rim
3. PVC Rim Color (laminated models)
4. Laminate Top Color/Veneer Top Finish
5. Veneer Rim Finish (laminated/wood models)

SAMPLE MODEL NUMBERS:

WWN15109TSW F MH
 WWN15109TSLW F 405 MH
 WWN15109TSL V405 MH

- See pages 334-339 for all options available in WaveWorks

MODEL NO./DESCRIPTION	LIST PRICE	DIMENSIONS					CARTONED WEIGHT	CUBIC FEET
		D	W	H	A	KW		
RECEPTION COUNTER KITS								
1 1/16" TOP THICKNESS								
WWN15109TSW Wood	\$ 1291	15 3/16	108 1/16	1 1/16	—	—	86 lbs.	3.5
WWN15109TSLW Laminate/Wood	1291	15 3/16	108 1/16	1 1/16	—	—	86 lbs.	3.5
WWN15109TSL Laminate	1254	15 3/16	108 1/16	1 1/16	—	—	86 lbs.	3.5
WWN1597TSW Wood	\$ 1051	15 3/16	96 1/16	1 1/16	—	—	76 lbs.	3.1
WWN1597TSLW Laminate/Wood	1051	15 3/16	96 1/16	1 1/16	—	—	76 lbs.	3.1
WWN1597TSL Laminate	1022	15 3/16	96 1/16	1 1/16	—	—	76 lbs.	3.1
WWN1584TSW Wood	\$ 854	15 3/16	83 1/16	1 1/16	—	—	66 lbs.	2.7
WWN1584TSLW Laminate/Wood	854	15 3/16	83 1/16	1 1/16	—	—	66 lbs.	2.7
WWN1584TSL Laminate	830	15 3/16	83 1/16	1 1/16	—	—	66 lbs.	2.7
WWN1578TSW Wood	\$ 818	15 3/16	77 1/16	1 1/16	—	—	62 lbs.	2.5
WWN1578TSLW Laminate/Wood	818	15 3/16	77 1/16	1 1/16	—	—	62 lbs.	2.5
WWN1578TSL Laminate	797	15 3/16	77 1/16	1 1/16	—	—	62 lbs.	2.5
WWN1572TSW Wood	\$ 784	15 3/16	71 1/16	1 1/16	—	—	56 lbs.	2.3
WWN1572TSLW Laminate/Wood	784	15 3/16	71 1/16	1 1/16	—	—	56 lbs.	2.3
WWN1572TSL Laminate	762	15 3/16	71 1/16	1 1/16	—	—	56 lbs.	2.3
WWN1566TSW Wood	\$ 755	15 3/16	65 1/16	1 1/16	—	—	52 lbs.	2.2
WWN1566TSLW Laminate/Wood	755	15 3/16	65 1/16	1 1/16	—	—	52 lbs.	2.2
WWN1566TSL Laminate	736	15 3/16	65 1/16	1 1/16	—	—	52 lbs.	2.2
WWN1560TSW Wood	\$ 729	15 3/16	59 1/16	1 1/16	—	—	48 lbs.	2.0
WWN1560TSLW Laminate/Wood	729	15 3/16	59 1/16	1 1/16	—	—	48 lbs.	2.0
WWN1560TSL Laminate	706	15 3/16	59 1/16	1 1/16	—	—	48 lbs.	2.0
WWN1554TSW Wood	\$ 702	15 3/16	53 1/16	1 1/16	—	—	44 lbs.	1.8
WWN1554TSLW Laminate/Wood	702	15 3/16	53 1/16	1 1/16	—	—	44 lbs.	1.8
WWN1554TSL Laminate	682	15 3/16	53 1/16	1 1/16	—	—	44 lbs.	1.8

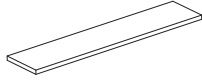

- Reference pages 379-380 for the multiple ways you can use Reception Counter Kits
- All hardware included to attach to reception units
- Reception Counter Kits can be used with Reception Mains, Reception Bridges and Reception Returns that do not have a Glass Reception Counters
- Reception Counter Kits can span the size of the unit or can extend beyond the unit and wrap around an entire L- or U-station to utilize counters on all sides

WAVEWORKS

ASSEMBLED

PRODUCT SPECIFICATIONS

- Counter kits shipped with appropriate hardware to attach to reception units
- Rim on all 4 sides of laminate and wood counter kits
- Refer to pages 379-380 for examples of how the counter kits can be used

TO ORDER, SPECIFY:

1. Model Number
2. Rim
3. PVC Rim Color (laminate models)
4. Laminate Top Color/Veneer Top Finish
5. Veneer Rim Finish (laminate/wood models)

SAMPLE MODEL NUMBERS:

WW15109TSW F MH
 WW15109TSLW F 405 MH
 WW15109TSL V405 MH

- See pages 334-339 for all options available in WaveWorks



Shaded model numbers are available on our "To You in 10 Days or Less" Quick Delivery program and will be delivered in 10 days or less.

MODEL NO./DESCRIPTION	LIST PRICE	DIMENSIONS					CARTONED WEIGHT	CUBIC FEET
		D	W	H	A	KW		
1 1/2" TOP THICKNESS								
QWW15109TSW Wood	\$ 1152	15 3/16	108 1/16	1 3/16	—	—	86 lbs.	3.5
WW15109TSW Wood	1152	15 3/16	108 1/16	1 3/16	—	—	86 lbs.	3.5
WW15109TSLW Laminate/Wood	1152	15 3/16	108 1/16	1 3/16	—	—	86 lbs.	3.5
WW15109TSL Laminate	1119	15 3/16	108 1/16	1 3/16	—	—	86 lbs.	3.5
QWW15109TSLL TFL	895	15 3/16	108 1/16	1 1/2	—	—	86 lbs.	3.5
WW15109TSLL TFL	895	15 3/16	108 1/16	1 1/2	—	—	86 lbs.	3.5
<hr/>								
QWW1597TSW Wood	\$ 912	15 3/16	96 1/16	1 3/16	—	—	76 lbs.	3.1
WW1597TSW Wood	912	15 3/16	96 1/16	1 3/16	—	—	76 lbs.	3.1
WW1597TSLW Laminate/Wood	912	15 3/16	96 1/16	1 3/16	—	—	76 lbs.	3.1
WW1597TSL Laminate	888	15 3/16	96 1/16	1 3/16	—	—	76 lbs.	3.1
QWW1597TSLL TFL	710	15 3/16	96 1/16	1 1/2	—	—	76 lbs.	3.1
WW1597TSLL TFL	710	15 3/16	96 1/16	1 1/2	—	—	76 lbs.	3.1
<hr/>								
QWW1584TSW Wood	\$ 714	15 3/16	83 1/16	1 3/16	—	—	66 lbs.	2.7
WW1584TSW Wood	714	15 3/16	83 1/16	1 3/16	—	—	66 lbs.	2.7
WW1584TSLW Laminate/Wood	714	15 3/16	83 1/16	1 3/16	—	—	66 lbs.	2.7
WW1584TSL Laminate	696	15 3/16	83 1/16	1 3/16	—	—	66 lbs.	2.7
QWW1584TSLL TFL	557	15 3/16	83 1/16	1 1/2	—	—	66 lbs.	2.7
WW1584TSLL TFL	557	15 3/16	83 1/16	1 1/2	—	—	66 lbs.	2.7
<hr/>								
QWW1578TSW Wood	\$ 680	15 3/16	77 1/16	1 3/16	—	—	62 lbs.	2.5
WW1578TSW Wood	680	15 3/16	77 1/16	1 3/16	—	—	62 lbs.	2.5
WW1578TSLW Laminate/Wood	680	15 3/16	77 1/16	1 3/16	—	—	62 lbs.	2.5
WW1578TSL Laminate	661	15 3/16	77 1/16	1 3/16	—	—	62 lbs.	2.5
QWW1578TSLL TFL	529	15 3/16	77 1/16	1 1/2	—	—	62 lbs.	2.5
WW1578TSLL TFL	529	15 3/16	77 1/16	1 1/2	—	—	62 lbs.	2.5

RECEPTION COUNTER KITS (CONTINUED)



- Reference pages 379-380 for the multiple ways you can use Reception Counter Kits
- All hardware included to attach to reception units
- Reception Counter Kits can be used with Reception Mains, Reception Bridges and Reception Returns that do not have a Glass Reception Counters
- Reception Counter Kits can span the size of the unit or can extend beyond the unit and wrap around an entire L- or U-station to utilize counters on all sides

WAVEWORKS

PRODUCT SPECIFICATIONS

- Counter kits shipped with appropriate hardware to attach to reception units
- Rim on all 4 sides of laminate and wood counter kits
- Refer to pages 379-380 for examples of how the counter kits can be used

TO ORDER, SPECIFY:

1. Model Number
2. Rim
3. PVC Rim Color (laminate models)
4. Laminate Top Color/Veneer Top Finish
5. Veneer Rim Finish (laminate/wood models)

SAMPLE MODEL NUMBERS:

WW1572TSW F MH
 WW1572TSLW F 405 MH
 WW1572TSL V405 MH

- See pages 334-339 for all options available in WaveWorks



Shaded model numbers are available on our "To You in 10 Days or Less" Quick Delivery program and will be delivered in 10 days or less.

MODEL NO./DESCRIPTION	LIST PRICE	DIMENSIONS					CARTONED WEIGHT	CUBIC FEET
		D	W	H	A	KW		
RECEPTION COUNTER KITS (CONTINUED)								
1 1/2" TOP THICKNESS (CONTINUED)								
QWW1572TSW Wood	\$ 646	15 3/16	71 3/16	1 3/16	—	—	56 lbs.	2.3
WW1572TSW Wood	646	15 3/16	71 3/16	1 3/16	—	—	56 lbs.	2.3
WW1572TSLW Laminate/Wood	646	15 3/16	71 3/16	1 3/16	—	—	56 lbs.	2.3
WW1572TSL Laminate	626	15 3/16	71 3/16	1 3/16	—	—	56 lbs.	2.3
QWW1572TSL TFL	502	15 3/16	71 3/16	1 1/2	—	—	56 lbs.	2.3
WW1572TSL TFL	502	15 3/16	71 3/16	1 1/2	—	—	56 lbs.	2.3
<hr/>								
QWW1566TSW Wood	\$ 618	15 3/16	65 1/16	1 3/16	—	—	52 lbs.	2.2
WW1566TSW Wood	618	15 3/16	65 1/16	1 3/16	—	—	52 lbs.	2.2
WW1566TSLW Laminate/Wood	618	15 3/16	65 1/16	1 3/16	—	—	52 lbs.	2.2
WW1566TSL Laminate	600	15 3/16	65 1/16	1 3/16	—	—	52 lbs.	2.2
QWW1566TSL TFL	497	15 3/16	65 1/16	1 1/2	—	—	52 lbs.	2.2
WW1566TSL TFL	497	15 3/16	65 1/16	1 1/2	—	—	52 lbs.	2.2
<hr/>								
QWW1560TSW Wood	\$ 589	15 3/16	59 1/16	1 3/16	—	—	48 lbs.	2.0
WW1560TSW Wood	589	15 3/16	59 1/16	1 3/16	—	—	48 lbs.	2.0
WW1560TSLW Laminate/Wood	589	15 3/16	59 1/16	1 3/16	—	—	48 lbs.	2.0
WW1560TSL Laminate	573	15 3/16	59 1/16	1 3/16	—	—	48 lbs.	2.0
QWW1560TSL TFL	459	15 3/16	59 1/16	1 1/2	—	—	48 lbs.	2.0
WW1560TSL TFL	459	15 3/16	59 1/16	1 1/2	—	—	48 lbs.	2.0
<hr/>								
QWW1554TSW Wood	\$ 563	15 3/16	53 1/16	1 3/16	—	—	44 lbs.	1.8
WW1554TSW Wood	563	15 3/16	53 1/16	1 3/16	—	—	44 lbs.	1.8
WW1554TSLW Laminate/Wood	563	15 3/16	53 1/16	1 3/16	—	—	44 lbs.	1.8
WW1554TSL Laminate	548	15 3/16	53 1/16	1 3/16	—	—	44 lbs.	1.8
QWW1554TSL TFL	438	15 3/16	53 1/16	1 1/2	—	—	44 lbs.	1.8
WW1554TSL TFL	438	15 3/16	53 1/16	1 1/2	—	—	44 lbs.	1.8

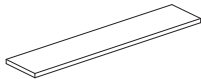

- Reference pages 379-380 for the multiple ways you can use Reception Counter Kits
- All hardware included to attach to reception units
- Reception Counter Kits can be used with Reception Mains, Reception Bridges and Reception Returns that do not have a Glass Reception Counters
- Reception Counter Kits can span the size of the unit or can extend beyond the unit and wrap around an entire L- or U-station to utilize counters on all sides

- National's reception units are offered without the glass reception counters allowing the customer to keep the space open or add the laminate or wood Reception Counter Kits
- Shown below are thought starters or ideas for how the Reception Counter Kits can be used on 1 side only or used to wrap an entire unit
- Model numbers are shown as examples of sizes used and fit of counter
- Reception Counter Kits will have an overhang on the approach side

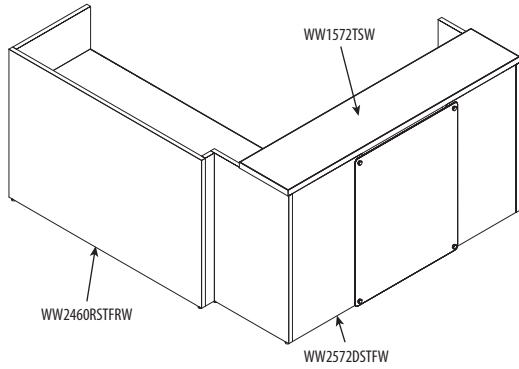

Fig. A - Main Shell with Reception Return
(Counter on main shell)

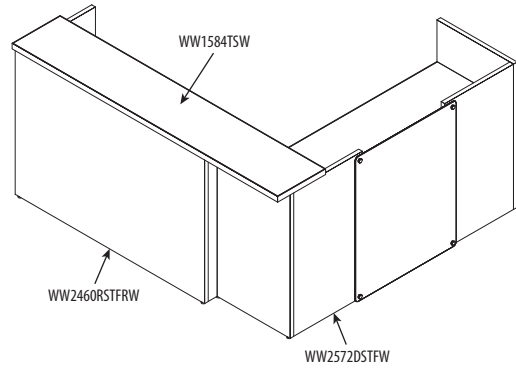

Fig. B - Main Shell with Reception Return
(Counter on reception return spanning main shell)

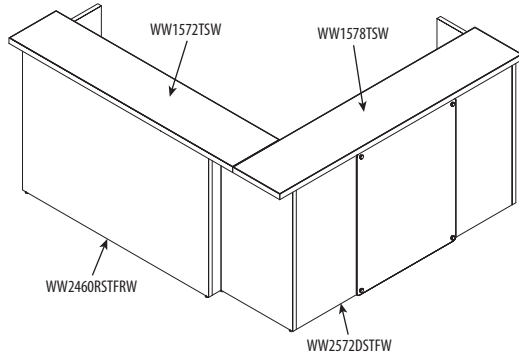

Fig. C - Main Shell with Reception Return
(Counters across entire unit)

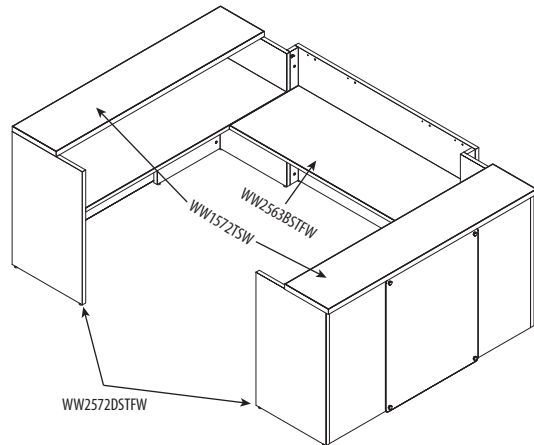

Fig. D - 2 Main Shells with Reception Bridge
(Counters on main shell)

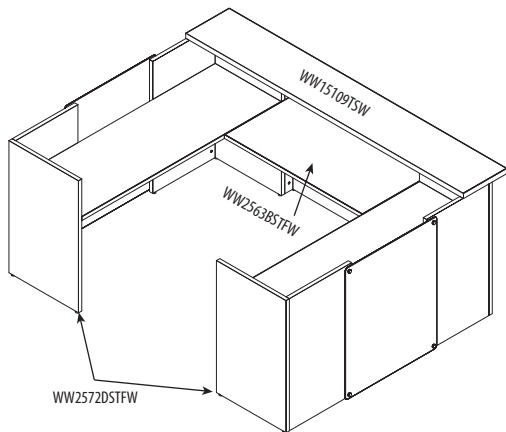

Fig. E - 2 Main Shells with Reception Bridge
(Counter on reception bridge spanning main shells)

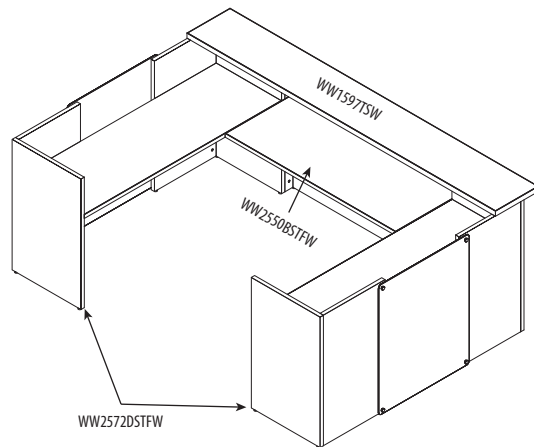

Fig. F - 2 Main Shells with Reception Bridge
(Counter on reception bridge spanning main shells)

THOUGHT STARTERS - WAVEWORKS RECEPTION

WAVEWORKS

ASSEMBLED

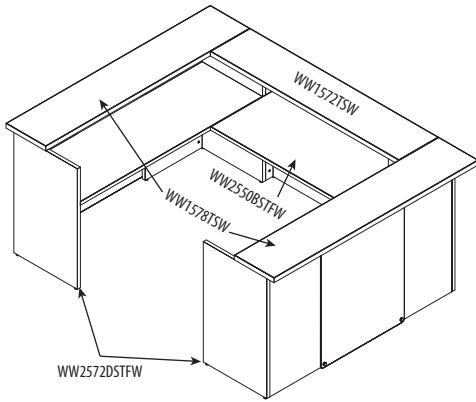

Fig. G – 2 Main Shells with Reception Bridge
(Counters across entire unit)

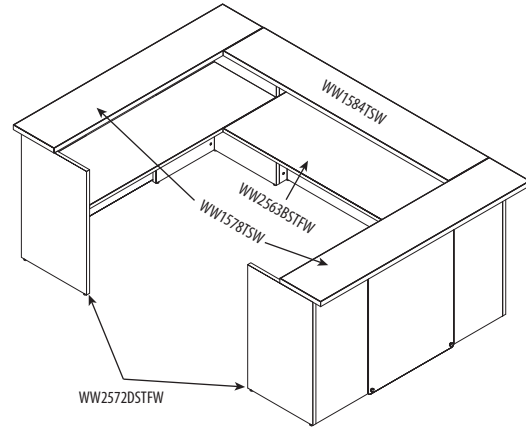

Fig. H – 2 Main Shells with Reception Bridge
(Counters across entire unit)

	CONFIGURATION		
	RECEPTION COUNTER KIT(S) COVER MAIN AND/OR ADA SHELL ONLY (SEE FIG. A OR D)	RECEPTION COUNTER KIT COVERS BRIDGE OR RETURN ONLY (SEE FIG. B, E, OR F)	RECEPTION COUNTER KIT(S) COVER ENTIRE UNIT (SEE FIG. C, G, OR H)
WAVEWORKS ADA COMPLIANT U-RECEPTION STATION			
Main Shell	WW1572TS	–	WW1578TS
ADA Shell	WW1154TS	–	WW1154TS
– 63" Bridge	–	WW1566TS	WW1572TS
WAVEWORKS U-RECEPTION STATION			
Main Shell	WW1572TS	–	WW1578TS
ADA Shell	WW1154TS	–	WW1154TS
– 63" Bridge	–	WW1554TS	WW1560TS
WAVEWORKS ADA COMPLIANT L-RECEPTION STATION			
ADA Shell	WW1154TS	–	WW1154TS
– 60" Return	–	WW1566TS	WW1566TS
WAVEWORKS RECEPTION U-UNIT			
2 Main Shells	WW1572TS x 2	–	WW1578TS x 2
– 63" Bridge	–	WW15109TS	WW1584TS
WAVEWORKS RECEPTION U-UNIT			
2 Main Shells	WW1572TS x 2	–	WW1578TS x 2
– 63" Bridge	–	WW1597TS	WW1572TS
WAVEWORKS RECEPTION L-UNIT			
Main Shell	WW1572TS	–	WW1578TS
– 60" Return	–	WW1566TS	WW1572TS

WAVEWORKS RECEPTION - THOUGHT STARTERS

WAVEWORKS

ASSEMBLED

PRODUCT SPECIFICATIONS

- Wood and laminate tops and chassis available; refer to page 336 for options
- Refer to pages 717-760 for accessories
- Assembled units and component units are interchangeable
- If specifying wood, you must specify the same finish for all options
- Refer to page 339 for grommet options and upcharge

TO ORDER, SPECIFY:

1. Model Number
2. Rim
3. PVC Rim Color (laminated models)
4. Pull
5. Grommet
6. Locking
7. Laminate Top Color (laminated/combo models)
8. Laminate Door/Drawer (laminated models)
9. Veneer Chassis Finish/Laminated Chassis Color

• See pages 334-339 for all options available in WaveWorks

WAVEWORKS ADA COMPLIANT RECEPTION STATION



ITEM	PAGE	MODEL NO./DESCRIPTION	LIST	QTY	EXT. LIST
WOOD CHASSIS/WORKSURFACE					\$ 10,570
A.	371	WW2572DSTFW Reception Desk-Main Shell	\$ 4565	1	4,565
B.	373	WW2866BSTFW Reception Bridge-66"	1076	1	1,076
C.	372	WW2575DSTFRW Main Right-Shell-ADA	4929	1	4,929
ADDITIONAL ADD-ONS:					\$ 2596
	462	WW2418CPTW Cornice Top for ADA Tower	\$ 589	1	589
	500	WW2318PUBBFW Undersurface Box/Box/File Pedestal	1361	1	1,361
	378	WW1572TSW Reception Counter Kit	646	1	646
LAMINATE CHASSIS/WORKSURFACE:					\$ 8419
A.	371	WW2572DSTFL Reception Desk-Main Shell	\$ 3697	1	3,697
B.	373	WW2866BSTFL Reception Bridge-66"	742	1	742
C.	372	WW2575DSTFRL Main Right-Shell-ADA	3980	1	3,980
ADDITIONAL ADD-ONS:					\$ 2052
	462	WW2418CPTL Cornice Top for ADA Tower	\$ 573	1	573
	500	WW2318PUBBFL Undersurface Box/Box/File Pedestal	853	1	853
	378	WW1572TSL Reception Counter Kit	626	1	626
WOOD CHASSIS/LAMINATE WORKSURFACE WITH WOOD RIM					\$ 10,570
A.	371	WW2572DSTFLW Reception Desk-Main Shell	\$ 4565	1	4,565
B.	373	WW2866BSTFLW Reception Bridge-66"	1076	1	1,076
C.	372	WW2575DSTFRLW Main Right-Shell-ADA	4929	1	4,929
ADDITIONAL ADD-ONS:					\$ 1235
	462	WW2418CPTLW Cornice Top for ADA Tower	\$ 589	1	589
	378	WW1572TSLW Reception Counter Kit	646	1	646

THOUGHT STARTERS - WAVEWORKS RECEPTION

WAVEWORKS

PRODUCT SPECIFICATIONS

- Wood and laminate tops and chassis available; refer to page 336 for options
- Refer to pages 717-760 for accessories
- Assembled units and component units are interchangeable
- If specifying wood, you must specify the same finish for all options
- Refer to page 339 for grommet options and upcharge

TO ORDER, SPECIFY:

1. Model Number
2. Rim
3. PVC Rim Color (laminate models)
4. Pull
5. Grommet
6. Locking
7. Laminate Top Color (laminate/combo models)
8. Laminate Door/Drawer (laminate models)
9. Veneer Chassis Finish/Laminate Chassis Color

• See pages 334-339 for all options available in WaveWorks

WAVEWORKS RECEPTION U-UNIT

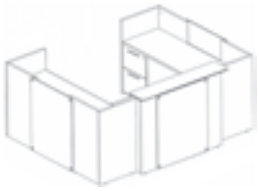

ITEM	PAGE	MODEL NO./DESCRIPTION	LIST	QTY	EXT. LIST
WOOD CHASSIS/WORKSURFACE					\$ 10,236
A.	371	WW2572DSTFW Reception Desk-Main Shell	\$ 4565	2	9,130
B.	373	WW2866BSTFW Reception Bridge-66"	1076	1	1,076
C.		Racetrack Grommet	30	1	30
ADDITIONAL ADD-ONS:					\$ 2722
	500	WW2318PUBBFW Undersurface Box/Box/File Pedestal	\$ 1361	2	2,722
LAMINATE CHASSIS/WORKSURFACE:					\$ 8166
A.	371	WW2572DSTFL Reception Desk-Main Shell	\$ 3697	2	7,394
B.	373	WW2866BSTFL Reception Bridge-66"	742	1	742
C.		Racetrack Grommet	30	1	30
ADDITIONAL ADD-ONS:					\$ 1706
	500	WW2318PUBBFL Undersurface Box/Box/File Pedestal	\$ 853	2	1,706
WOOD CHASSIS/LAMINATE WORKSURFACE WITH WOOD RIM					\$ 10,236
A.	371	WW2572DSTFLW Reception Desk-Main Shell	\$ 4565	2	9,130
B.	373	WW2866BSTFLW Reception Bridge-66"	1076	1	1,076
C.		Racetrack Grommet	30	1	30

ASSEMBLED

WAVEWORKS RECEPTIONS - THOUGHT STARTERS

PRODUCT SPECIFICATIONS

- Wood and laminate tops and chassis available; refer to page 336 for options
- Refer to pages 717-760 for accessories
- Refer to page 341 for filing capabilities
- Assembled units and component units are interchangeable
- Refer to page 340 for grommet locations and page 339 for grommet options and upcharge
- If specifying wood, you must specify the same finish for all options

TO ORDER, SPECIFY:

1. Model Number
 2. Rim
 3. PVC Rim Color (laminated models)
 4. Pull
 5. Grommet
 6. Locking
 7. Laminate Top Color (laminated/combo models)
 8. Laminate Door/Drawer (laminated models)
 9. Veneer Chassis Finish/Laminated Chassis Color
- See pages 334-339 for all options available in WaveWorks

WAVEWORKS RECEPTION L-UNIT



ITEM	PAGE	MODEL NO./DESCRIPTION	LIST	QTY	EXT. LIST
WOOD CHASSIS/WORKSURFACE					\$ 7605
A.	371	WW2572DSTFW Reception Desk-Main Shell	\$ 4565	1	4,565
B.	374	WW2860RSTFLW Reception Return-Left	1649	1	1,649
C.	501	WW2318PUFFW Undersurface File/File Pedestal	1361	1	1,361
D.		Racetrack Grommet Grommet	30	1	30
ADDITIONAL ADD-ONS:					\$ 646
	378	WW1572TSW Reception Counter Kit	\$ 646	1	646
LAMINATE CHASSIS/WORKSURFACE:					\$ 6119
A.	371	WW2572DSTFL Reception Desk-Main Shell	\$ 3697	1	3,697
B.	374	WW2860RSTFLL Reception Return-Left	1539	1	1,539
C.	501	WW2318PUFFL Undersurface File/File Pedestal	853	1	853
D.		Racetrack Grommet Grommet	30	1	30
ADDITIONAL ADD-ONS:					\$ 626
	378	WW1572TSL Reception Counter Kit	\$ 626	1	626
WOOD CHASSIS/LAMINATE WORKSURFACE WITH WOOD RIM					\$ 6244
A.	371	WW2572DSTFLW Reception Desk-Main Shell	\$ 4565	1	4,565
B.	374	WW2860RSTFLLW Reception Return-Left	1649	1	1,649
C.		Racetrack Grommet Grommet	30	1	30
ADDITIONAL ADD-ONS:					\$ 646
	378	WW1572TSLW Reception Counter Kit	\$ 646	1	646

WAVEWORKS

PRODUCT SPECIFICATIONS

- Wood and laminate tops and chassis available; refer to page 336 for options
- Refer to pages 717-760 for accessories
- Refer to page 341 for filing capabilities
- Assembled units and component units are interchangeable
- Refer to page 340 for grommet locations and page 339 for grommet options and upcharge
- If specifying wood, you must specify the same finish for all options

TO ORDER, SPECIFY:

1. Model Number
2. Rim
3. PVC Rim Color (laminite models)
4. Pull
5. Grommet
6. Locking
7. Laminate Top Color (laminite/combo models)
8. Laminate Door/Drawer Color (laminite models)
9. Veneer Chassis Finish/ Laminate Chassis Color

SAMPLE MODEL NUMBERS:

WW2442RREFW1 P 7SN G1C KRB AC
 WW2442RREFL1 NAC2 7SN G1C KRB 405 AC2 AC2
 WW2442RREFLW1 P 7SN G1C KRB 405 AC

- See pages 334-339 for all options available in WaveWorks

MODEL NO./DESCRIPTION	LIST PRICE	DIMENSIONS					CARTONED CUBIC	
		D	W	H	A	KW	WEIGHT	FEET
1 1/2" TOP THICKNESS								
RETURN BOX/BOX/FILE								
LEFT RETURN								
RIGHT RETURN								
WWN2460RLEFW1	Wood \$ 2496	24	60	29 3/8	1/16	44	180 lbs.	28.9
WWN2460RLEFLW1	Laminate/Wood 2496	24	60	29 3/8	1/16	44	180 lbs.	28.9
WWN2460RLEFL1	Laminate 1565	24	60	29 3/8	1/16	44	180 lbs.	28.9
WWN2448RLEFW1	Wood \$ 2403	24	48 1/16	29 3/8	1/16	33	160 lbs.	24.7
WWN2448RLEFLW1	Laminate/Wood 2403	24	48 1/16	29 3/8	1/16	33	160 lbs.	24.7
WWN2448RLEFL1	Laminate 1464	24	48 1/16	29 3/8	1/16	33	160 lbs.	24.7
WWN2442RLEFW1	Wood \$ 2309	24	42 1/16	29 3/8	1/16	27	140 lbs.	20.5
WWN2442RLEFLW1	Laminate/Wood 2309	24	42 1/16	29 3/8	1/16	27	140 lbs.	20.5
WWN2442RLEFL1	Laminate 1406	24	42 1/16	29 3/8	1/16	27	140 lbs.	20.5
1 3/8" TOP THICKNESS								
LEFT RETURN								
RIGHT RETURN								
WW2460RLEFW1	Wood \$ 2269	24	60	28 1/16	1/16	44	186 lbs.	33.7
WW2460RLEFLW1	Laminate/Wood 2269	24	60	28 1/16	1/16	44	186 lbs.	33.7
WW2460RLEFL1	Laminate 1423	24	60	28 1/16	1/16	44	186 lbs.	33.7
WW2460RLEFLL1	TFL 1139	24	60	28 3/8	1/16	44	186 lbs.	33.7
WW2448RLEFW1	Wood \$ 2185	24	48 1/16	28 1/16	1/16	33	175 lbs.	27.6
WW2448RLEFLW1	Laminate/Wood 2185	24	48 1/16	28 1/16	1/16	33	175 lbs.	27.6
WW2448RLEFL1	Laminate 1333	24	48 1/16	28 1/16	1/16	33	175 lbs.	27.6
WW2448RLEFLL1	TFL 1066	24	48 1/16	28 3/8	1/16	33	175 lbs.	27.6
WW2442RLEFW1	Wood \$ 2100	24	42 1/16	28 1/16	1/16	27	166 lbs.	24.5
WW2442RLEFLW1	Laminate/Wood 2100	24	42 1/16	28 1/16	1/16	27	166 lbs.	24.5
WW2442RLEFL1	Laminate 1277	24	42 1/16	28 1/16	1/16	27	166 lbs.	24.5
WW2442RLEFLL1	TFL 1024	24	42 1/16	28 3/8	1/16	27	166 lbs.	24.5

- Grain direction runs front-to-back
- Random lock core (KRB, KRS) and specified lock core (KS1B, KS1S) available

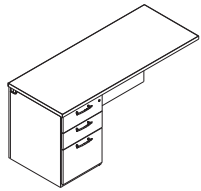

Left shown

PRODUCT SPECIFICATIONS

- Wood and laminate tops and chassis available; refer to page 336 for options
- Refer to pages 717-760 for accessories
- Refer to page 341 for filing capabilities
- Assembled units and component units are interchangeable
- Refer to page 340 for grommet locations and page 339 for grommet options and upcharge
- If specifying wood, you must specify the same finish for all options

TO ORDER, SPECIFY:

1. Model Number
2. Rim
3. PVC Rim Color (laminite models)
4. Pull
5. Grommet
6. Locking
7. Laminate Top Color (laminite/combo models)
8. Laminate Door/Drawer Color (laminite models)
9. Veneer Chassis Finish/ Laminate Chassis Color

SAMPLE MODEL NUMBERS:

WW2442RREFW2 P 7SN G1C KS1B AC
 WW2442RREFL2 NAC2 7SN G1C KS1B 405 AC2 AC2
 WW2442RREFLW2 P 7SN G1C KS1B 405 AC

• See pages 334-339 for all options available in WaveWorks

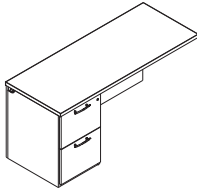
RETURN FILE/FILE	MODEL NO./DESCRIPTION	LIST PRICE	DIMENSIONS				CARTONED WEIGHT	CUBIC FEET			
			D	W	H	A			KW		
 <p>Left shown</p>	1 1/8" TOP THICKNESS										
		LEFT RETURN	RIGHT RETURN								
	WWN2460RLEFW2	WWN2460RREFW2	Wood	\$ 2496	24	60	29 3/8	1/16	44	180 lbs.	28.9
	WWN2460RLEFLW2	WWN2460RREFLW2	Laminate/Wood	2496	24	60	29 3/8	1/16	44	180 lbs.	28.9
	WWN2460RLEFL2	WWN2460RREFL2	Laminate	1565	24	60	29 3/8	1/16	44	180 lbs.	28.9
	WWN2448RLEFW2	WWN2448RREFW2	Wood	\$ 2403	24	48 1/16	29 3/8	1/16	33	160 lbs.	24.7
	WWN2448RLEFLW2	WWN2448RREFLW2	Laminate/Wood	2403	24	48 1/16	29 3/8	1/16	33	160 lbs.	24.7
	WWN2448RLEFL2	WWN2448RREFL2	Laminate	1464	24	48 1/16	29 3/8	1/16	33	160 lbs.	24.7
	WWN2442RLEFW2	WWN2442RREFW2	Wood	\$ 2309	24	42 1/16	29 3/8	1/16	27	140 lbs.	20.5
	WWN2442RLEFLW2	WWN2442RREFLW2	Laminate/Wood	2309	24	42 1/16	29 3/8	1/16	27	140 lbs.	20.5
	WWN2442RLEFL2	WWN2442RREFL2	Laminate	1406	24	42 1/16	29 3/8	1/16	27	140 lbs.	20.5
		1 3/8" TOP THICKNESS									
		LEFT RETURN	RIGHT RETURN								
	WW2460RLEFW2	WW2460RREFW2	Wood	\$ 2269	24	60	28 1/16	1/16	44	186 lbs.	33.7
	WW2460RLEFLW2	WW2460RREFLW2	Laminate/Wood	2269	24	60	28 1/16	1/16	44	186 lbs.	33.7
	WW2460RLEFL2	WW2460RREFL2	Laminate	1423	24	60	28 1/16	1/16	44	186 lbs.	33.7
	WW2460RLEFLL2	WW2460RREFLL2	TFL	1139	24	60	28 3/8	1/16	44	186 lbs.	33.7
	WW2448RLEFW2	WW2448RREFW2	Wood	\$ 2185	24	48 1/16	28 1/16	1/16	33	175 lbs.	27.6
WW2448RLEFLW2	WW2448RREFLW2	Laminate/Wood	2185	24	48 1/16	28 1/16	1/16	33	175 lbs.	27.6	
WW2448RLEFL2	WW2448RREFL2	Laminate	1333	24	48 1/16	28 1/16	1/16	33	175 lbs.	27.6	
WW2448RLEFLL2	WW2448RREFLL2	TFL	1066	24	48 1/16	28 3/8	1/16	33	175 lbs.	27.6	
WW2442RLEFW2	WW2442RREFW2	Wood	\$ 2100	24	42 1/16	28 1/16	1/16	27	166 lbs.	24.5	
WW2442RLEFLW2	WW2442RREFLW2	Laminate/Wood	2100	24	42 1/16	28 1/16	1/16	27	166 lbs.	24.5	
WW2442RLEFL2	WW2442RREFL2	Laminate	1277	24	42 1/16	28 1/16	1/16	27	166 lbs.	24.5	
WW2442RLEFLL2	WW2442RREFLL2	TFL	1024	24	42 1/16	28 3/8	1/16	27	166 lbs.	24.5	

- Grain direction runs front-to-back
- Random lock core (KRB, KRS) and specified lock core (KS1B, KS1S) available

WAVEWORKS

WAVEWORKS

ASSEMBLED

PRODUCT SPECIFICATIONS

- Wood and laminate tops and chassis available; refer to page 336 for options
- Refer to pages 717-760 for accessories
- Refer to page 341 for filling capabilities
- Refer to page 340 for grommet locations and page 339 for grommet options and upcharge
- If specifying wood, you must specify the same finish for all options

TO ORDER, SPECIFY:

1. Model Number
2. Rim
3. PVC Rim Color (laminate models)
4. Grommet
5. Laminate Top Color (laminate/combo models)
6. Veneer Chassis Finish/ Laminate Chassis Color

SAMPLE MODEL NUMBERS:

WWN2442BEFW F X N MC
 WWN2442BEFLW F X NM NM
 WWN2442BEFL F G1C PB PB

- See pages 334-339 for all options available in WaveWorks

MODEL NO./DESCRIPTION	LIST PRICE	DIMENSIONS					CARTONED WEIGHT	CUBIC FEET
		D	W	H	A	KW		
BRIDGE								
1 1/16" TOP THICKNESS								
WWN2448BEFW Wood	\$ 1009	24	48 1/16	29 3/8	1/16	—	80 lbs.	4.1
WWN2448BEFLW Laminate/Wood	1009	24	48 1/16	29 3/8	1/16	—	80 lbs.	4.1
WWN2448BEFL Laminate	617	24	48 1/16	29 3/8	1/16	—	80 lbs.	4.1
1 1/2" TOP THICKNESS								
WWN2442BEFW Wood	\$ 952	24	42 1/16	29 3/8	1/16	—	72 lbs.	3.7
WWN2442BEFLW Laminate/Wood	952	24	42 1/16	29 3/8	1/16	—	72 lbs.	3.7
WWN2442BEFL Laminate	556	24	42 1/16	29 3/8	1/16	—	72 lbs.	3.7
1 3/16" TOP THICKNESS								
WW2448BEFW Wood	\$ 918	24	48 1/16	28 13/16	1/16	—	80 lbs.	4.1
WW2448BEFLW Laminate/Wood	918	24	48 1/16	28 13/16	1/16	—	80 lbs.	4.1
WW2448BEFL Laminate	558	24	48 1/16	28 13/16	1/16	—	80 lbs.	4.1
WW2448BEFL TFL	447	24	48 1/16	28 3/8	1/16	—	80 lbs.	4.1
1 1/2" TOP THICKNESS								
WW2442BEFW Wood	\$ 865	24	42 1/16	28 13/16	1/16	—	72 lbs.	3.7
WW2442BEFLW Laminate/Wood	865	24	42 1/16	28 13/16	1/16	—	72 lbs.	3.7
WW2442BEFL Laminate	504	24	42 1/16	28 13/16	1/16	—	72 lbs.	3.7
WW2442BEFL TFL	404	24	42 1/16	28 3/8	1/16	—	72 lbs.	3.7

- Some assembly required
- Grain direction runs front-to-back

PRODUCT SPECIFICATIONS

- Wood and laminate tops and chassis available; refer to page 336 for options
- Refer to pages 717-760 for accessories
- Refer to page 341 for filing capabilities
- Refer to page 340 for grommet locations and page 339 for grommet options and upcharge
- If specifying wood, you must specify the same finish for all options

TO ORDER, SPECIFY:

1. Model Number
2. Rim
3. PVC Rim Color (laminated models)
4. Grommet
5. Laminate Top Color (laminated/combo models)
6. Veneer Chassis Finish/ Laminate Chassis Color

SAMPLE MODEL NUMBERS:

WWN2448BEFHW FX CW
 WWN2448BEFHL FX 793 793
 WWN2448BEFHLW FX PB PB

- See pages 334-339 for all options available in WaveWorks

	MODEL NO./DESCRIPTION	LIST PRICE	DIMENSIONS				KW	CARTONED WEIGHT	CUBIC FEET	
			D	W	H	A				
BRIDGE WITH HINGED MODESTY	1 1/16" TOP THICKNESS									
	WWN2448BEFHW	Wood	\$ 1078	24	48 1/16	29 3/8	1/16	—	80 lbs.	4.1
	WWN2448BEFHLW	Laminate/Wood	1078	24	48 1/16	29 3/8	1/16	—	80 lbs.	4.1
	WWN2448BEFHL	Laminate	682	24	48 1/16	29 3/8	1/16	—	80 lbs.	4.1
	WWN2442BEFHW	Wood	\$ 1022	24	42 1/16	29 3/8	1/16	—	72 lbs.	3.7
	WWN2442BEFHLW	Laminate/Wood	1022	24	42 1/16	29 3/8	1/16	—	72 lbs.	3.7
	WWN2442BEFHL	Laminate	623	24	42 1/16	29 3/8	1/16	—	72 lbs.	3.7
	1 1/16" TOP THICKNESS									
	WW2448BEFHW	Wood	\$ 988	24	48 1/16	28 1/16	1/16	—	80 lbs.	4.1
	WW2448BEFHLW	Laminate/Wood	988	24	48 1/16	28 1/16	1/16	—	80 lbs.	4.1
	WW2448BEFHL	Laminate	625	24	48 1/16	28 1/16	1/16	—	80 lbs.	4.1
	WW2448BEFHLL	TFL	499	24	48 1/16	28 3/8	1/16	—	80 lbs.	4.1
WW2442BEFHW	Wood	\$ 934	24	42 1/16	28 1/16	1/16	—	72 lbs.	3.7	
WW2442BEFHLW	Laminate/Wood	934	24	42 1/16	28 1/16	1/16	—	72 lbs.	3.7	
WW2442BEFHL	Laminate	576	24	42 1/16	28 1/16	1/16	—	72 lbs.	3.7	
WW2442BEFHLL	TFL	460	24	42 1/16	28 3/8	1/16	—	72 lbs.	3.7	

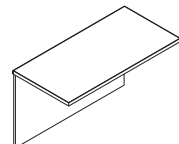

- Some assembly required
- Unit has flexible grommet in modesty for cord management
- Modesty is hinged for access to cords
- Grain direction runs front-to-back

WAVEWORKS

PRODUCT SPECIFICATIONS

- Wood and laminate tops and chassis available; refer to page 336 for options
- Refer to pages 717-760 for accessories
- Refer to page 341 for filing capabilities
- Refer to page 340 for grommet locations and page 339 for grommet options and upcharge
- If specifying wood, you must specify the same finish for all options

TO ORDER, SPECIFY:

1. Model Number
2. Rim
3. PVC Rim Color (laminate models)
4. Pull
5. Grommet
6. Locking
7. Laminate Top Color (laminate/combo models)
8. Laminate Door/Drawer Color (laminate models)
9. Veneer Chassis Finish/ Laminate Chassis Color

SAMPLE MODEL NUMBERS:

WW2472CSFW P 7SN X KRB AC
 WW2472CSFL NAC2 7SN X KRB 405 AC2 AC2
 WW2472CSFLW P 7SN X KRB 405 AC

- See pages 334-339 for all options available in WaveWorks

STORAGE CREDENZA

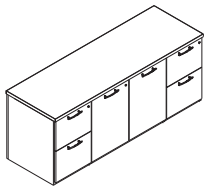

MODEL NO./DESCRIPTION	LIST PRICE	DIMENSIONS					CARTONED CUBIC	
		D	W	H	A	KW	WEIGHT	FEET
1 1/8" TOP THICKNESS								
WWN2472CSFW Wood	\$ 4268	24	71 1/16	29 3/8	3/16	—	383 lbs.	36.3
WWN2472CSFLW Laminate/Wood	4268	24	71 1/16	29 3/8	3/16	—	383 lbs.	36.3
WWN2472CSFL Laminate	3400	24	71 1/16	29 3/8	3/16	—	383 lbs.	36.3
WWN2466CSFW Wood	\$ 4009	24	66	29 3/8	3/16	—	355 lbs.	32.7
WWN2466CSFLW Laminate/Wood	4009	24	66	29 3/8	3/16	—	355 lbs.	32.7
WWN2466CSFL Laminate	3269	24	66	29 3/8	3/16	—	355 lbs.	32.7
WWN2460CSFW Wood	\$ 3899	24	60	29 3/8	3/16	—	325 lbs.	28.9
WWN2460CSFLW Laminate/Wood	3899	24	60	29 3/8	3/16	—	325 lbs.	28.9
WWN2460CSFL Laminate	3208	24	60	29 3/8	3/16	—	325 lbs.	28.9
1 3/16" TOP THICKNESS								
WW2472CSFW Wood	\$ 3883	24	71 1/16	28 1/16	3/16	—	346 lbs.	39.8
WW2472CSFLW Laminate/Wood	3883	24	71 1/16	28 1/16	3/16	—	346 lbs.	39.8
WW2472CSFL Laminate	3090	24	71 1/16	28 1/16	3/16	—	346 lbs.	39.8
WW2472CSFLL TFL	2473	24	71 1/16	28 7/8	3/16	—	346 lbs.	39.8
WW2466CSFW Wood	\$ 3643	24	66	28 1/16	3/16	—	334 lbs.	32.7
WW2466CSFLW Laminate/Wood	3643	24	66	28 1/16	3/16	—	334 lbs.	32.7
WW2466CSFL Laminate	2971	24	66	28 1/16	3/16	—	334 lbs.	32.7
WW2466CSFLL TFL	2377	24	66	28 7/8	3/16	—	334 lbs.	32.7
WW2460CSFW Wood	\$ 3543	24	60	28 1/16	3/16	—	318 lbs.	33.7
WW2460CSFLW Laminate/Wood	3543	24	60	28 1/16	3/16	—	318 lbs.	33.7
WW2460CSFL Laminate	2917	24	60	28 1/16	3/16	—	318 lbs.	33.7
WW2460CSFLL TFL	2334	24	60	28 7/8	3/16	—	318 lbs.	33.7

- 72" credenza features an adjustable shelf (20% deep x 34 3/16 wide)
- 66" credenza features an adjustable shelf (20% deep x 28 3/16 wide)
- 60" credenza features an adjustable shelf (20% deep x 22 3/16 wide)
- Random lock core (KRB, KRS) and specified lock core (KS3B, KS3S) available

PRODUCT SPECIFICATIONS

- Wood and laminate tops and chassis available; refer to page 336 for options
- Refer to pages 717-760 for accessories
- Refer to page 341 for filing capabilities
- Refer to page 340 for grommet locations and page 339 for grommet options and upcharge
- If specifying wood, you must specify the same finish for all options

TO ORDER, SPECIFY:

1. Model Number
2. Rim
3. PVC Rim Color (laminated models)
4. Pull
5. Grommet
6. Locking
7. Laminate Top Color (laminated/combo models)
8. Laminate Door/Drawer Color (laminated models)
9. Veneer Chassis Finish/ Laminate Chassis Color

SAMPLE MODEL NUMBERS:

WWN2472CBVW P 7MB G1L KS2B AC
 WWN2472CBVL VHN2 7MB X KS2B HN2 HN2
 WWN2472CBVLW R 7MB X KS2B 405 AC

- See pages 334-339 for all options available in WaveWorks

MODEL NO./DESCRIPTION	LIST PRICE	DIMENSIONS					CARTONED WEIGHT	CUBIC FEET
		D	W	H	A	KW		
MEDIA STORAGE CREDENZA								
72"–1½" TOP THICKNESS								
WWN2472CVMSW Wood	\$ 6103	24	72	35½	–	–	383 lbs.	36.3
WWN2472CVMSLW Laminate/Wood	6103	24	72	35½	–	–	383 lbs.	36.3
WWN2472CVMSL Laminate	5383	24	72	35½	–	–	383 lbs.	36.3
60"–1½" TOP THICKNESS								
WWN2460CVMSW Wood	\$ 5911	24	60	35½	–	–	325 lbs.	28.9
WWN2460CVMSLW Laminate/Wood	5911	24	60	35½	–	–	325 lbs.	28.9
WWN2460CVMSL Laminate	5188	24	60	35½	–	–	325 lbs.	28.9
48"–1½" TOP THICKNESS								
WWN2448CVMSW Wood	\$ 5717	24	48½	35½	–	–	290 lbs.	24.7
WWN2448CVMSLW Laminate/Wood	5717	24	48½	35½	–	–	290 lbs.	24.7
WWN2448CVMSL Laminate	4990	24	48½	35½	–	–	290 lbs.	24.7
<ul style="list-style-type: none"> • Infrared Repeater (IR) included with credenza which allows multi-media equipment to be stored and controlled behind solid doors • Back panel is not fully finished and includes cutouts for venting • Rim profile on front and sides only, 1½" thick worksurface available • Matching wood grommets in end panels for wire access • Features an adjustable shelf • Inside dimension of each storage section is 21¼" deep x 34½" wide x 24¾" high for the WWN2472CVMS models, 21¼" deep x 28½" wide x 24¾" high for the WWN2460CVMS models and 21¼" deep x 22½" wide x 24¾" high for the WWN2448CVMS models • Random lock core (KRB, KRS) and specified lock core (KS2B, KS2S) available 								

ENTERTAINMENT CREDENZA

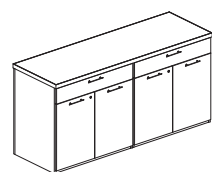

1½" TOP THICKNESS								
MODEL NO./DESCRIPTION	LIST PRICE	D	W	H	A	KW	CARTONED WEIGHT	CUBIC FEET
WWN2472CBVW Wood	\$ 4813	24	71½	35½	–	–	381 lbs.	46.7
WWN2472CBVLW Laminate/Wood	4813	24	71½	35½	–	–	381 lbs.	46.7
WWN2472CBVL Laminate	3931	24	71½	35½	–	–	381 lbs.	46.7
1" TOP THICKNESS								
WW2472CBVW Wood	\$ 4292	24	71½	35½	–	–	381 lbs.	46.7
WW2472CBVLW Laminate/Wood	4292	24	71½	35½	–	–	381 lbs.	46.7
WW2472CBVL Laminate	3503	24	71½	35½	–	–	381 lbs.	46.7
WW2472CBVLL TFL	2802	24	71½	35	–	–	381 lbs.	46.7
<ul style="list-style-type: none"> • Back panel is not fully finished and includes cutouts for venting • Rim profile on front and sides only • Features an adjustable shelf • Inside dimension of each storage section is 21¼" deep x 34½" wide x 24¾" high • Random lock core (KRB, KRS) and specified lock core (KS2B, KS2S) available 								

WAVEWORKS

PRODUCT SPECIFICATIONS

- Wood and laminate tops and chassis available; refer to page 336 for options
- Refer to pages 717-760 for accessories
- Refer to page 341 for filing capabilities
- Refer to page 340 for grommet locations and page 339 for grommet options and upcharge
- If specifying wood, you must specify the same finish for all options

TO ORDER, SPECIFY:

1. Model Number
2. Rim
3. PVC Rim Color (laminated models)
4. Pull
5. Locking
6. Laminate Top Color (laminated/combo models)
7. Laminate Door/Drawer Color (laminated models)
8. Veneer Chassis Finish/ Laminate Chassis Color

SAMPLE MODEL NUMBERS:

WW2472CBW P 7MB KS2B AC
 WW2472CBL VHN2 7MB KS2B HN2 HN2 HN2
 WW2472CBLW R 7MB KS2B 405 AC

- See pages 334-339 for all options available in WaveWorks

MODEL NO./DESCRIPTION	LIST PRICE	DIMENSIONS					CARTONED CUBIC	
		D	W	H	A	KW	WEIGHT	FEET
1 1/8" TOP THICKNESS								
WWN2472CBW Wood	\$ 4813	24	71 1/16	35 1/16	—	—	381 lbs.	46.7
WWN2472CBLW Laminate/Wood	4813	24	71 1/16	35 1/16	—	—	381 lbs.	46.7
WWN2472CBL Laminate	3931	24	71 1/16	35 1/16	—	—	381 lbs.	46.7
1 3/8" TOP THICKNESS								
WW2472CBW Wood	\$ 4292	24	71 1/16	35 1/16	—	—	381 lbs.	46.7
WW2472CBLW Laminate/Wood	4292	24	71 1/16	35 1/16	—	—	381 lbs.	46.7
WW2472CBL Laminate	3503	24	71 1/16	35 1/16	—	—	381 lbs.	46.7
WW2472CBL TFL	2802	24	71 1/16	35	—	—	381 lbs.	46.7

BUFFET CREDENZA

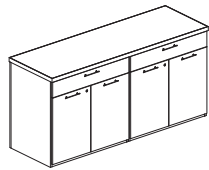

- Grommet option not available
- Features an adjustable shelf behind each set of doors
- Rim profile on front and sides only
- Features a fully finished back
- Inside dimension of each storage section is 21 1/4" deep x 34 1/2" wide x 24 3/4" high
- Random lock core (KRB, KRS) and specified lock core (KS2B, KS2S) available

BUFFET CREDENZA WITH TRASH RECEPTACLE

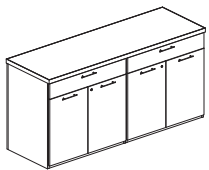

Left shown

1 1/8" TOP THICKNESS				LIST PRICE	DIMENSIONS					CARTONED CUBIC WEIGHT
LEFT	RIGHT				D	W	H	A	KW	
WWN2472CBTLW	WWN2472CBTRW	Wood	\$ 4867	24	71 1/16	35 1/16	—	—	lbs.	
WWN2472CBTLLW	WWN2472CBTRLW	Laminate/Wood	4867	24	71 1/16	35 1/16	—	—	lbs.	
WWN2472CBTLL	WWN2472CBTRL	Laminate	3958	24	71 1/16	35 1/16	—	—	lbs.	
1 3/8" TOP THICKNESS										
LEFT	RIGHT				D	W	H	A	KW	
WW2472CBTLW	WW2472CBTRW	Wood	\$ 4400		24	71 1/16	35 1/16	—	—	lbs.
WW2472CBTLLW	WW2472CBTRLW	Laminate/Wood	4400		24	71 1/16	35 1/16	—	—	lbs.
WW2472CBTLL	WW2472CBTRL	Laminate	3557	24	71 1/16	35 1/16	—	—	lbs.	
WW2472CBTLLL	WW2472CBTRLL	TFL	2908	24	71 1/16	35 1/16	—	—	lbs.	

- Specify a left model to have the trash receptacle on the far left side; right to have it on the right
- Includes 7 gallon trash receptacle

PRODUCT SPECIFICATIONS

- Wood and laminate tops and chassis available; refer to page 336 for options
- Refer to pages 717-760 for accessories
- Refer to page 341 for filing capabilities
- Refer to page 340 for grommet locations and page 339 for grommet options and upcharge
- If specifying wood, you must specify the same finish for all options

TO ORDER, SPECIFY:

1. Model Number
2. Rim
3. PVC Rim Color (laminate models)
4. Pull
5. Grommet
6. Locking
7. Laminate Top Color (laminate/combo models)
8. Laminate Door/Drawer Color (laminate models)
9. Veneer Chassis Finish/ Laminate Chassis Color

SAMPLE MODEL NUMBERS:

WWN2472CFFW	P	7MB	G1L	KS2B	AC			
WWN2472CFFL	VHN2	7MB	X	KS2B	HN2	HN2	HN2	
WWN2472CFFLW	R	7MB	X	KS2B	405	AC		

- See pages 334-339 for all options available in WaveWorks

MODEL NO./DESCRIPTION	LIST PRICE	DIMENSIONS				CARTONED WEIGHT	CUBIC FEET
		D	W	H	A		
1 1/8" TOP THICKNESS							
LEFT							
WWN287241CBFLW	5949	28	71 1/16	41 1/16	—	—	lbs.
WWN287241CBFLW	5949	28	71 1/16	41 1/16	—	—	lbs.
WWN287241CBFL	4607	28	71 1/16	41 1/16	—	—	lbs.
1 1/8" TOP THICKNESS							
RIGHT							
WWN287236CBFLW	5624	28	71 1/16	35 1/16	—	—	lbs.
WWN287236CBFLW	5624	28	71 1/16	35 1/16	—	—	lbs.
WWN287236CBFL	4499	28	71 1/16	35 1/16	—	—	lbs.
1 1/8" TOP THICKNESS							
LEFT							
WW287241CBFLW	5482	28	71 1/16	41 3/8	—	—	lbs.
WW287241CBFLW	5482	28	71 1/16	41 3/8	—	—	lbs.
WW287241CBFL	3881	28	71 1/16	41 3/8	—	—	lbs.
WW287241CBFL	3178	28	71 1/16	41 3/8	—	—	lbs.
1 1/8" TOP THICKNESS							
RIGHT							
WW287236CBFLW	5157	28	71 1/16	35 1/8	—	—	lbs.
WW287236CBFLW	5157	28	71 1/16	35 1/8	—	—	lbs.
WW287236CBFL	3773	28	71 1/16	35 1/8	—	—	lbs.
WW287236CBFL	3070	28	71 1/16	35 1/8	—	—	lbs.

- Specify a left model to have the refrigerator on the far left side; right to have it on the right, 7 gallon trash receptacle in center section
- Back panel not fully finished and includes cutouts for venting in refrigerator section
- 36" H models only: Maximum refrigerator size 21 1/4" deep, 21 1/2" wide, x 27 1/16" high
- 41" H models only: Maximum refrigerator size 21 1/4" deep, 21 1/2" wide, x 32 1/16" high

LATERAL FILE CREDENZA

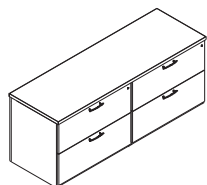

1 1/8" TOP THICKNESS							
WWN2472CFFW	Wood	4547	24	71 1/16	29 3/8	3/16	346 lbs. 36.3
WWN2472CFFLW	Laminate/Wood	4547	24	71 1/16	29 3/8	3/16	346 lbs. 36.3
WWN2472CFFL	Laminate	2969	24	71 1/16	29 3/8	3/16	346 lbs. 36.3
1 1/8" TOP THICKNESS							
WW2472CFFW	Wood	4133	24	71 1/16	28 1/16	3/16	346 lbs. 39.8
WW2472CFFLW	Laminate/Wood	4133	24	71 1/16	28 1/16	3/16	346 lbs. 39.8
WW2472CFFL	Laminate	2702	24	71 1/16	28 1/16	3/16	346 lbs. 39.8
WW2472CFFL	TFL	2160	24	71 1/16	28 1/8	3/16	346 lbs. 39.8

- Random lock core (KRB, KRS) and specified lock core (KS2B, KS2S) available
- When specifying Horizon pulls, lateral files will have 2 pulls on each drawer front
- End panel grommets come standard

WAVEWORKS

PRODUCT SPECIFICATIONS

- Wood and laminate tops and chassis available; refer to page 336 for options
- Refer to pages 717-760 for accessories
- Refer to page 341 for filing capabilities
- Assembled units and component units are interchangeable
- Refer to page 340 for grommet locations and page 339 for grommet options and upcharge
- If specifying wood, you must specify the same finish for all options

TO ORDER, SPECIFY:

1. Model Number
2. Rim
3. PVC Rim Color (laminate models)
4. Pull
5. Grommet
6. Locking
7. Laminate Top Color (laminate/combo models)
8. Laminate Door/Drawer Color (laminate models)
9. Veneer Chassis Finish/ Laminate Chassis Color

SAMPLE MODEL NUMBERS:

WWN2472CKFW2 P 7MB G1L KRB AC
 WWN2472CKFL2 VHN2 7MB X KRB HN2 HN2
 WWN2472CKFLW2 R 7MB X KRB 405 AC

• See pages 334-339 for all options available in WaveWorks

KNEESPACE CREDENZA

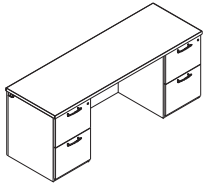

MODEL NO./DESCRIPTION	LIST PRICE	DIMENSIONS					CARTONED WEIGHT	CUBIC FEET
		D	W	H	A	KW		
1 1/8" TOP THICKNESS								
WWN2472CKFW2 Wood	\$ 3797	24	71 1/16	29 3/8	3/16	35 5/8	273 lbs.	36.3
WWN2472CKFLW2 Laminate/Wood	3797	24	71 1/16	29 3/8	3/16	35 5/8	273 lbs.	36.3
WWN2472CKFL2 Laminate	2571	24	71 1/16	29 3/8	3/16	35 5/8	273 lbs.	36.3
1 1/8" TOP THICKNESS								
WWN2466CKFW2 Wood	\$ 3492	24	66	29 3/8	3/16	35 5/8	264 lbs.	32.7
WWN2466CKFLW2 Laminate/Wood	3492	24	66	29 3/8	3/16	35 5/8	264 lbs.	32.7
WWN2466CKFL2 Laminate	2456	24	66	29 3/8	3/16	35 5/8	264 lbs.	32.7
1 1/8" TOP THICKNESS								
WWN2460CKFW2 Wood	\$ 3384	24	60	29 3/8	3/16	29 1/16	250 lbs.	28.9
WWN2460CKFLW2 Laminate/Wood	3384	24	60	29 3/8	3/16	29 1/16	250 lbs.	28.9
WWN2460CKFL2 Laminate	2413	24	60	29 3/8	3/16	29 1/16	250 lbs.	28.9
1 3/16" TOP THICKNESS								
WW2472CKFW2 Wood	\$ 3454	24	71 1/16	28 1/16	3/16	35 5/8	279 lbs.	39.8
WW2472CKFLW2 Laminate/Wood	3454	24	71 1/16	28 1/16	3/16	35 5/8	279 lbs.	39.8
WW2472CKFL2 Laminate	2338	24	71 1/16	28 1/16	3/16	35 5/8	279 lbs.	39.8
WW2472CKFLL2 TFL	1871	24	71 1/16	28 7/8	3/16	35 5/8	279 lbs.	39.8
1 3/16" TOP THICKNESS								
WW2466CKFW2 Wood	\$ 3175	24	66	28 1/16	3/16	35 5/8	267 lbs.	32.7
WW2466CKFLW2 Laminate/Wood	3175	24	66	28 1/16	3/16	35 5/8	267 lbs.	32.7
WW2466CKFL2 Laminate	2232	24	66	28 1/16	3/16	35 5/8	267 lbs.	32.7
WW2466CKFLL2 TFL	1786	24	66	28 7/8	3/16	35 5/8	267 lbs.	32.7
1 3/16" TOP THICKNESS								
WW2460CKFW2 Wood	\$ 3075	24	60	28 1/16	3/16	29 1/16	256 lbs.	33.7
WW2460CKFLW2 Laminate/Wood	3075	24	60	28 1/16	3/16	29 1/16	256 lbs.	33.7
WW2460CKFL2 Laminate	2194	24	60	28 1/16	3/16	29 1/16	256 lbs.	33.7
WW2460CKFLL2 TFL	1756	24	60	28 7/8	3/16	29 1/16	256 lbs.	33.7

• Random lock core (KRB, KRS) and specified lock core (KS2B, KS2S) available

PRODUCT SPECIFICATIONS

- Wood and laminate tops and chassis available; refer to page 336 for options
- Refer to pages 717-760 for accessories
- Refer to page 341 for filing capabilities
- Assembled units and component units are interchangeable
- Refer to page 340 for grommet locations and page 339 for grommet options and upcharge
- If specifying wood, you must specify the same finish for all options

TO ORDER, SPECIFY:

1. Model Number
2. Rim
3. PVC Rim Color (laminite models)
4. Pull
5. Grommet
6. Locking
7. Laminate Top Color (laminite/combo models)
8. Laminate Door/Drawer Color (laminite models)
9. Veneer Chassis Finish/ Laminate Chassis Color

SAMPLE MODEL NUMBERS:

WW2472CRFW2 P 7MB G1L KRB AC
 WW2472CRFL2 VHN2 7MB X KRB HN2 HN2
 WW2472CRFLW2 R 7MB X KRB 405 AC

- See pages 334-339 for all options available in WaveWorks

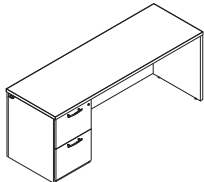
	MODEL NO./DESCRIPTION	LIST PRICE	DIMENSIONS				CARTONED WEIGHT	CUBIC FEET			
			D	W	H	A			KW		
SINGLE PEDESTAL CREDENZA FILE/FILE 	1 1/4" TOP THICKNESS										
		LEFT PEDESTAL	RIGHT PEDESTAL								
	WWN2472CLFW2	WWN2472CRFW2	Wood	\$ 2867	24	71 1/16	29 3/8	3 1/16	52 1/16	223 lbs.	36.3
	WWN2472CLFLW2	WWN2472CRFLW2	Laminate/Wood	2867	24	71 1/16	29 3/8	3 1/16	52 1/16	223 lbs.	36.3
	WWN2472CLFL2	WWN2472CRFL2	Laminate	2049	24	71 1/16	29 3/8	3 1/16	52 1/16	223 lbs.	36.3
	WWN2466CLFW2	WWN2466CRFW2	Wood	\$ 2819	24	66	29 3/8	3 1/16	52 1/16	214 lbs.	32.7
	WWN2466CLFLW2	WWN2466CRFLW2	Laminate/Wood	2819	24	66	29 3/8	3 1/16	52 1/16	214 lbs.	32.7
	WWN2466CLFL2	WWN2466CRFL2	Laminate	1958	24	66	29 3/8	3 1/16	52 1/16	214 lbs.	32.7
	WWN2460CLFW2	WWN2460CRFW2	Wood	\$ 2767	24	60	29 3/8	3 1/16	43 1/16	205 lbs.	28.9
	WWN2460CLFLW2	WWN2460CRFLW2	Laminate/Wood	2767	24	60	29 3/8	3 1/16	43 1/16	205 lbs.	28.9
	WWN2460CLFL2	WWN2460CRFL2	Laminate	1922	24	60	29 3/8	3 1/16	43 1/16	205 lbs.	28.9
		1 3/8" TOP THICKNESS									
	LEFT PEDESTAL	RIGHT PEDESTAL									
WW2472CLFW2	WW2472CRFW2	Wood	\$ 2607	24	71 1/16	28 1/16	3 1/16	52 1/16	239 lbs.	39.8	
WW2472CLFLW2	WW2472CRFLW2	Laminate/Wood	2607	24	71 1/16	28 1/16	3 1/16	52 1/16	239 lbs.	39.8	
WW2472CLFL2	WW2472CRFL2	Laminate	1863	24	71 1/16	28 1/16	3 1/16	52 1/16	239 lbs.	39.8	
WW2472CLFLL2	WW2472CRFLL2	TFL	1490	24	71 1/16	28 3/8	3 1/16	52 1/16	239 lbs.	39.8	
WW2466CLFW2	WW2466CRFW2	Wood	\$ 2565	24	66	28 1/16	3 1/16	52 1/16	227 lbs.	32.7	
WW2466CLFLW2	WW2466CRFLW2	Laminate/Wood	2565	24	66	28 1/16	3 1/16	52 1/16	227 lbs.	32.7	
WW2466CLFL2	WW2466CRFL2	Laminate	1782	24	66	28 1/16	3 1/16	52 1/16	227 lbs.	32.7	
WW2466CLFLL2	WW2466CRFLL2	TFL	1425	24	66	28 3/8	3 1/16	52 1/16	227 lbs.	32.7	
WW2460CLFW2	WW2460CRFW2	Wood	\$ 2517	24	60	28 1/16	3 1/16	43 1/16	216 lbs.	33.7	
WW2460CLFLW2	WW2460CRFLW2	Laminate/Wood	2517	24	60	28 1/16	3 1/16	43 1/16	216 lbs.	33.7	
WW2460CLFL2	WW2460CRFL2	Laminate	1747	24	60	28 1/16	3 1/16	43 1/16	216 lbs.	33.7	
WW2460CLFLL2	WW2460CRFLL2	TFL	1399	24	60	28 3/8	3 1/16	43 1/16	216 lbs.	33.7	

- Random lock core (KRB, KRS) and specified lock core (KS1B, KS1S) available

WAVEWORKS

WAVEWORKS

ASSEMBLED

PRODUCT SPECIFICATIONS

- Wood and laminate tops and chassis available; refer to page 336 for options
- Refer to pages 717-760 for accessories
- Refer to page 341 for filing capabilities
- Assembled units and component units are interchangeable
- Refer to page 340 for grommet locations and page 339 for grommet options and upcharge
- If specifying wood, you must specify the same finish for all options

TO ORDER, SPECIFY:

1. Model Number
2. Rim
3. PVC Rim Color (laminate models)
4. Pull
5. Grommet
6. Locking
7. Laminate Top Color (laminate/combo models)
8. Laminate Door/Drawer Color (laminate models)
9. Veneer Chassis Finish/ Laminate Chassis Color

SAMPLE MODEL NUMBERS:

WW2472CLFW12 F 7MB G1L KS2S AC
 WW2472CLFL12 VHN2 7MB G1LX KS2S HN2 461 HN2
 WW2472CLFLW12 F 7MB G1L KS2S 461 HN

- See pages 334-339 for all options available in WaveWorks

MODEL NO./DESCRIPTION	LIST PRICE	DIMENSIONS					CARTONED WEIGHT	CUBIC FEET		
		D	W	H	A	KW				
SINGLE PEDESTAL CREDENZA LATERAL FILE										
1 1/8" TOP THICKNESS										
LEFT PEDESTAL	RIGHT PEDESTAL									
WWN2472CLFW6	WWN2472CRFW6	Wood	\$ 3436	24	71 1/16	29 3/8	3/16	34 3/4	223 lbs.	36.3
WWN2472CLFLW6	WWN2472CRFLW6	Laminate/Wood	3436	24	71 1/16	29 3/8	3/16	34 3/4	223 lbs.	36.3
WWN2472CLFL6	WWN2472CRFL6	Laminate	2239	24	71 1/16	29 3/8	3/16	34 3/4	223 lbs.	36.3
1 1/8" TOP THICKNESS										
LEFT PEDESTAL	RIGHT PEDESTAL									
WW2472CLFW6	WW2472CRFW6	Wood	\$ 3124	24	71 1/16	28 1/16	3/16	34 3/4	279 lbs.	39.8
WW2472CLFLW6	WW2472CRFLW6	Laminate/Wood	3124	24	71 1/16	28 1/16	3/16	34 3/4	279 lbs.	39.8
WW2472CLFL6	WW2472CRFL6	Laminate	2035	24	71 1/16	28 1/16	3/16	34 3/4	279 lbs.	39.8
WW2472CLFLL6	WW2472CRFLL6	TFL	1629	24	71 1/16	28 3/8	3/16	34 3/4	279 lbs.	39.8

- To prevent tipping, it is recommended that cabinets be ganged together or anchored to a suitable wall or floor
- Random lock core (KRB, KRS) and specified lock core (KS1B, KS1S) available
- When specifying Horizon pulls, lateral files will have 2 pulls on each drawer front

SINGLE PEDESTAL CREDENZA BOX/BOX/FILE FILE/FILE

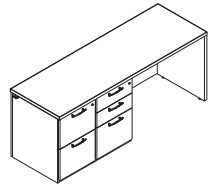

MODEL NO./DESCRIPTION	LIST PRICE	DIMENSIONS					CARTONED WEIGHT	CUBIC FEET		
		D	W	H	A	KW				
SINGLE PEDESTAL CREDENZA BOX/BOX/FILE FILE/FILE										
1 1/8" TOP THICKNESS										
LEFT PEDESTAL	RIGHT PEDESTAL									
WWN2472CLFW12	WWN2472CRFW12	Wood	\$ 3603	24	71 1/16	29 3/8	3/16	34 3/4	223 lbs.	36.3
WWN2472CLFLW12	WWN2472CRFLW12	Laminate/Wood	3603	24	71 1/16	29 3/8	3/16	34 3/4	223 lbs.	36.3
WWN2472CLFL12	WWN2472CRFL12	Laminate	2571	24	71 1/16	29 3/8	3/16	34 3/4	223 lbs.	36.3
1 1/8" TOP THICKNESS										
LEFT PEDESTAL	RIGHT PEDESTAL									
WW2472CLFW12	WW2472CRFW12	Wood	\$ 3274	24	71 1/16	28 1/16	3/16	34 3/4	279 lbs.	39.8
WW2472CLFLW12	WW2472CRFLW12	Laminate/Wood	3274	24	71 1/16	28 1/16	3/16	34 3/4	279 lbs.	39.8
WW2472CLFL12	WW2472CRFL12	Laminate	2338	24	71 1/16	28 1/16	3/16	34 3/4	279 lbs.	39.8
WW2472CLFLL12	WW2472CRFLL12	TFL	1871	24	71 1/16	28 3/8	3/16	34 3/4	279 lbs.	39.8

- Random lock core (KRB, KRS) and specified lock core (KS2B, KS2S) available

PRODUCT SPECIFICATIONS

- Wood and laminate chassis and doors available; refer to page 336 for options
- Tops of units are finished with flat edge detail
- Adjustable hinged doors
- If specifying wood, you must specify the same finish for all options
- Tack boards, task lights and vertical pigeon hole storage are available—see accessories section pages 717-760

TO ORDER, SPECIFY:

1. Model Number
2. Locking
3. Veneer Chassis Finish/
Laminate Chassis Color

SAMPLE MODEL NUMBERS:

WW7238HBHW KRB HN
WW7238HBHL KRB AC2 AC2

- See pages 334-339 for all options available in WaveWorks

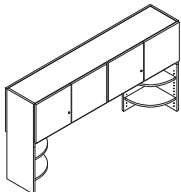
	MODEL NO./DESCRIPTION	LIST PRICE	DIMENSIONS					CARTONED WEIGHT	CUBIC FEET
			D	W	H	A	KW		
HIGHBACK ORGANIZER OPEN BACK 	38" HIGH—4 DOORS								
	WW7238HBHW	Wood	\$ 2654	14 $\frac{3}{4}$	71 $\frac{1}{16}$	38	—	—	200 lbs. 16.2
	WW7238HBHL	Laminate	1301	14 $\frac{3}{4}$	71 $\frac{1}{16}$	38	—	—	200 lbs. 16.2
	WW6638HBHW	Wood	\$ 2511	14 $\frac{3}{4}$	65 $\frac{1}{16}$	38	—	—	180 lbs. 14.9
	WW6638HBHL	Laminate	1213	14 $\frac{3}{4}$	65 $\frac{1}{16}$	38	—	—	180 lbs. 14.9
	WW6038HBHW	Wood	\$ 2369	14 $\frac{3}{4}$	59 $\frac{1}{16}$	38	—	—	160 lbs. 13.6
	WW6038HBHL	Laminate	1124	14 $\frac{3}{4}$	59 $\frac{1}{16}$	38	—	—	160 lbs. 13.6
	38" HIGH—3 DOORS								
	WW4838HBHW	Wood	\$ 2185	14 $\frac{3}{4}$	47 $\frac{7}{8}$	38	—	—	145 lbs. 11.9
	WW4838HBHL	Laminate	1040	14 $\frac{3}{4}$	47 $\frac{7}{8}$	38	—	—	145 lbs. 11.9

- Units feature 4 adjustable curved shelves and partially open back
- All units have 4 doors except 48" unit which has 3 doors
- An end panel, support panel, or pedestal must be located under end panels of highback for proper support
- For tack board options, see pages 752-759
- Random lock core (KRB, KRS) and specified lock core (KS2B, KS2S) available

**HIGHBACK ORGANIZER
OPEN BACK - NO DOORS**

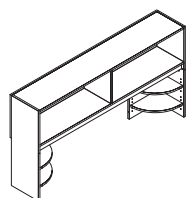

	MODEL NO./DESCRIPTION	LIST PRICE	DIMENSIONS					CARTONED WEIGHT	CUBIC FEET
			D	W	H	A	KW		
	38" HIGH—NO DOORS								
	WW7238HBEW	Wood	\$ 2391	13 $\frac{3}{16}$	71 $\frac{1}{16}$	38	—	—	200 lbs. 16.2
	WW7238HBEL	Laminate	1036	13 $\frac{3}{16}$	71 $\frac{1}{16}$	38	—	—	200 lbs. 16.2
	WW6638HBEW	Wood	\$ 2248	13 $\frac{3}{16}$	65 $\frac{1}{16}$	38	—	—	180 lbs. 14.9
	WW6638HBEL	Laminate	945	13 $\frac{3}{16}$	65 $\frac{1}{16}$	38	—	—	180 lbs. 14.9
	WW6038HBEW	Wood	\$ 2105	13 $\frac{3}{16}$	59 $\frac{1}{16}$	38	—	—	160 lbs. 13.6
	WW6038HBEL	Laminate	858	13 $\frac{3}{16}$	59 $\frac{1}{16}$	38	—	—	160 lbs. 13.6
	WW4838HBEW	Wood	\$ 2025	13 $\frac{3}{16}$	47 $\frac{7}{8}$	38	—	—	145 lbs. 11.9
	WW4838HBEL	Laminate	878	13 $\frac{3}{16}$	47 $\frac{7}{8}$	38	—	—	145 lbs. 11.9

- Units feature 4 adjustable curved shelves and partially open back
- Specify chassis finish only
- An end panel, support panel, or pedestal must be located under end panels of highback for proper support
- For tack board options, see pages 752-759

WAVEWORKS

PRODUCT SPECIFICATIONS

- Wood and laminate chassis and doors available; refer to page 336 for options
- Tops of units are finished with flat edge detail
- Adjustable hinged doors
- If specifying wood, you must specify the same finish for all options
- Tack boards, task lights and vertical pigeon hole storage are available—see accessories section pages 717-760

TO ORDER, SPECIFY:

1. Model Number
2. Locking
3. Door Frame Color (glass door models)
4. Veneer Chassis Finish/
Laminate Chassis Color

SAMPLE MODEL NUMBERS:

WW9050HBH2W KS3S NH
WW9050HBH2L KS3S 440 AC2

- See pages 334-339 for all options available in WaveWorks

HIGHBACK ORGANIZER FULL BACK

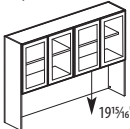
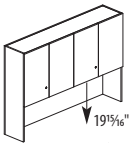
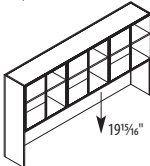
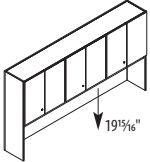
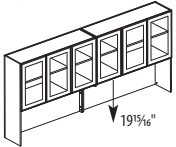
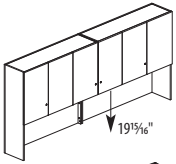

MODEL NO./DESCRIPTION

50" HIGH—6 DOORS

MODEL NO./DESCRIPTION	LIST PRICE	D	W	H	A	KW	CARTONED WEIGHT	CUBIC FEET
WW10850HBH2GW Glass/Wood 2 Pieces	\$ 4806	14 3/4	107 1/16	49 1/16	—	—	378 lbs.	72.9
WW10850HBH2GL Glass/Laminate 2 Pieces	4436	14 3/4	107 1/16	49 1/16	—	—	378 lbs.	72.9
WW10850HBH2W Wood 2 Pieces	3602	14 3/4	107 1/16	49 1/16	—	—	378 lbs.	72.9
WW10850HBH2L Laminate 2 Pieces	2174	14 3/4	107 1/16	49 1/16	—	—	378 lbs.	72.9

- Random lock core (KRB, KRS) and specified lock core (KS4B, KS4S) available
- 49" task lights will not work under 2 piece highbacks

WW10250HBH2GW Glass/Wood 2 Pieces	\$ 4659	14 3/4	101 3/4	49 1/16	—	—	362 lbs.	69.3
WW10250HBH2GL Glass/Laminate 2 Pieces	4305	14 3/4	101 3/4	49 1/16	—	—	362 lbs.	69.3
WW10250HBH2W Wood 2 Pieces	3462	14 3/4	101 3/4	49 1/16	—	—	362 lbs.	69.3
WW10250HBH2L Laminate 2 Pieces	2038	14 3/4	101 3/4	49 1/16	—	—	362 lbs.	69.3

- Random lock core (KRB, KRS) and specified lock core (KS4B, KS4S) available
- 49" task lights will not work under 2 piece highbacks

WW9650HBH2GW Glass/Wood 2 Pieces	\$ 4510	14 3/4	95 3/4	49 1/16	—	—	346 lbs.	61.9
WW9650HBH2GL Glass/Laminate 2 Pieces	4167	14 3/4	95 3/4	49 1/16	—	—	346 lbs.	61.9
WW9650HBH2W Wood 2 Pieces	3325	14 3/4	95 3/4	49 1/16	—	—	346 lbs.	61.9
WW9650HBH2L Laminate 2 Pieces	1902	14 3/4	95 3/4	49 1/16	—	—	346 lbs.	61.9

- Random lock core (KRB, KRS) and specified lock core (KS4B, KS4S) available
- 49" task lights will not work under 2 piece highbacks

WW9050HBH2GW Glass/Wood	\$ 4361	14 3/4	89 3/4	49 1/16	—	—	313 lbs.	58.3
WW9050HBH2GL Glass/Laminate	4026	14 3/4	89 3/4	49 1/16	—	—	313 lbs.	58.3
WW9050HBH2W Wood	3290	14 3/4	89 3/4	49 1/16	—	—	313 lbs.	58.3
WW9050HBH2L Laminate	1868	14 3/4	89 3/4	49 1/16	—	—	313 lbs.	58.3

- Random lock core (KRB, KRS) and specified lock core (KS3B, KS3S) available

50" HIGH—4 DOORS

WW8450HBH2GW Glass/Wood	\$ 4210	14 3/4	83 3/4	49 1/16	—	—	281 lbs.	54.6
WW8450HBH2GL Glass/Laminate	3890	14 3/4	83 3/4	49 1/16	—	—	281 lbs.	54.6
WW8450HBH2W Wood	3254	14 3/4	83 3/4	49 1/16	—	—	281 lbs.	54.6
WW8450HBH2L Laminate	1836	14 3/4	83 3/4	49 1/16	—	—	281 lbs.	54.6

- Random lock core (KRB, KRS) and specified lock core (KS2B, KS2S) available

- Glass doors do not lock
- Not intended for use on table desking
- An end panel, support panel, or pedestal must be located under end and center panels of highback for proper support
- Features an adjustable shelf
- For tack board options, see pages 752-759

PRODUCT SPECIFICATIONS

- Wood and laminate chassis and doors available; refer to page 336 for options
- Tops of units are finished with flat edge detail
- Adjustable hinged doors
- If specifying wood, you must specify the same finish for all options
- Tack boards, task lights and vertical pigeon hole storage are available—see accessories section pages 717-760

TO ORDER, SPECIFY:

1. Model Number
2. Locking
3. Door Frame Color (glass door models)
4. Veneer Chassis Finish/
Laminate Chassis Color

SAMPLE MODEL NUMBERS:

WW7250HBH2W KS2S NH
WW7250HBH2L KS2S 440 AC2

- See pages 334-339 for all options available in WaveWorks

	MODEL NO./DESCRIPTION	LIST PRICE	DIMENSIONS					CARTONED CUBIC		
			D	W	H	A	KW	WEIGHT	FEET	
HIGHBACK ORGANIZER FULL BACK	50" HIGH—4 DOORS									
	WW7850HBH2GW	Glass/Wood	\$ 4059	14¾	77¼	49¼	—	—	261 lbs.	51.0
	WW7850HBH2GL	Glass/Laminate	3750	14¾	77¼	49¼	—	—	261 lbs.	51.0
	WW7850HBH2W	Wood	3186	14¾	77¼	49¼	—	—	261 lbs.	51.0
	WW7850HBH2L	Laminate	1768	14¾	77¼	49¼	—	—	261 lbs.	51.0
	WW7250HBH2GW	Glass/Wood	\$ 3909	14¾	71¼	49¼	—	—	242 lbs.	47.4
	WW7250HBH2GL	Glass/Laminate	3612	14¾	71¼	49¼	—	—	242 lbs.	47.4
	WW7250HBH2W	Wood	3047	14¾	71¼	49¼	—	—	242 lbs.	47.4
	WW7250HBH2L	Laminate	1632	14¾	71¼	49¼	—	—	242 lbs.	47.4
	WW6650HBH2GW	Glass/Wood	\$ 3774	14¾	65¼	49¼	—	—	223 lbs.	43.7
	WW6650HBH2GL	Glass/Laminate	3484	14¾	65¼	49¼	—	—	223 lbs.	43.7
	WW6650HBH2W	Wood	2905	14¾	65¼	49¼	—	—	223 lbs.	43.7
WW6650HBH2L	Laminate	1498	14¾	65¼	49¼	—	—	223 lbs.	43.7	
WW6050HBH2GW	Glass/Wood	\$ 3624	14¾	59¼	49¼	—	—	203 lbs.	40.1	
WW6050HBH2GL	Glass/Laminate	3349	14¾	59¼	49¼	—	—	203 lbs.	40.1	
WW6050HBH2W	Wood	2770	14¾	59¼	49¼	—	—	203 lbs.	40.1	
WW6050HBH2L	Laminate	1364	14¾	59¼	49¼	—	—	203 lbs.	40.1	
	50" HIGH—3 DOORS									
	WW4850HBH2GW	Glass/Wood	\$ 3372	14¾	47¾	49¼	—	—	173 lbs.	32.8
	WW4850HBH2GL	Glass/Laminate	2787	14¾	47¾	49¼	—	—	173 lbs.	32.8
	WW4850HBH2W	Wood	2732	14¾	47¾	49¼	—	—	173 lbs.	32.8
	WW4850HBH2L	Laminate	1301	14¾	47¾	49¼	—	—	173 lbs.	32.8

HIGHBACK ORGANIZER FULL BACK

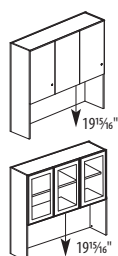
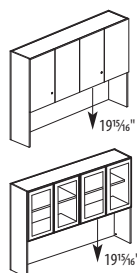

- Not intended for use on table desking
- An end panel, support panel, or pedestal must be located under end panels of highback for proper support
- Features an adjustable shelf
- For tack board options, see pages 752-759
- Glass doors do not lock
- Random lock core (KRB, KRS) and specified lock core (KS2B, KS2S) available

WAVEWORKS

PRODUCT SPECIFICATIONS

- Wood and laminate chassis and doors available; refer to page 336 for options
- Tops of units are finished with flat edge detail
- Adjustable hinged doors
- If specifying wood, you must specify the same finish for all options
- Tack boards, task lights and vertical pigeon hole storage are available—see accessories section pages 717-760

TO ORDER, SPECIFY:

1. Model Number
2. Locking
3. Door Frame Color (glass door models)
4. Veneer Chassis Finish/
Laminate Chassis Color

SAMPLE MODEL NUMBERS:

WW9038HBH2W KS3S NH
 WW9038HBH2L KS3S 440 AC2
 WW9038HBH2GW 503 HN

- See pages 334-339 for all options available in WaveWorks

HIGHBACK ORGANIZER FULL BACK

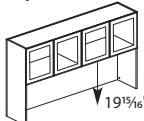
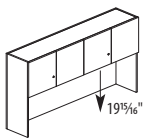
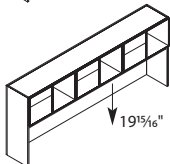
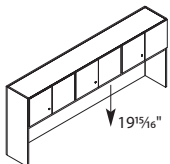
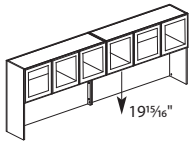
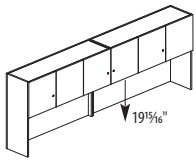

MODEL NO./DESCRIPTION	LIST PRICE	DIMENSIONS					CARTONED CUBIC	
		D	W	H	A	KW	WEIGHT	FEET
38" HIGH-6 DOORS								
WW10838HBH2GW Glass/Wood 2 Pieces	\$ 4181	14 3/4	107 1/16	38 3/8	—	—	282 lbs.	56.9
WW10838HBH2GL Glass/Laminate 2 Pieces	3859	14 3/4	107 1/16	38 3/8	—	—	282 lbs.	56.9
WW10838HBH2W Wood 2 Pieces	3547	14 3/4	107 1/16	38 3/8	—	—	282 lbs.	56.9
WW10838HBH2L Laminate 2 Pieces	1900	14 3/4	107 1/16	38 3/8	—	—	282 lbs.	56.9
<ul style="list-style-type: none"> • Random lock core (KRB, KRS) and specified lock core (KS4B, KS4S) available • 49" task lights will not work under 2 piece highbacks 								
WW10238HBH2GW Glass/Wood 2 Pieces	\$ 4035	14 3/4	101 3/4	38 3/8	—	—	266 lbs.	54.1
WW10238HBH2GL Glass/Laminate 2 Pieces	3727	14 3/4	101 3/4	38 3/8	—	—	266 lbs.	54.1
WW10238HBH2W Wood 2 Pieces	3399	14 3/4	101 3/4	38 3/8	—	—	266 lbs.	54.1
WW10238HBH2L Laminate 2 Pieces	1767	14 3/4	101 3/4	38 3/8	—	—	266 lbs.	54.1
<ul style="list-style-type: none"> • Random lock core (KRB, KRS) and specified lock core (KS4B, KS4S) available • 49" task lights will not work under 2 piece highbacks 								
WW9638HBH2GW Glass/Wood 2 Pieces	\$ 3893	14 3/4	95 3/4	38 3/8	—	—	252 lbs.	48.3
WW9638HBH2GL Glass/Laminate 2 Pieces	3595	14 3/4	95 3/4	38 3/8	—	—	252 lbs.	48.3
WW9638HBH2W Wood 2 Pieces	3246	14 3/4	95 3/4	38 3/8	—	—	252 lbs.	48.3
WW9638HBH2L Laminate 2 Pieces	1631	14 3/4	95 3/4	38 3/8	—	—	252 lbs.	48.3
<ul style="list-style-type: none"> • Random lock core (KRB, KRS) and specified lock core (KS4B, KS4S) available • 49" task lights will not work under 2 piece highbacks 								
WW9038HBH2GW Glass/Wood	\$ 3737	14 3/4	89 3/4	38 3/8	—	—	233 lbs.	45.5
WW9038HBH2GL Glass/Laminate	3451	14 3/4	89 3/4	38 3/8	—	—	233 lbs.	45.5
WW9038HBH2W Wood	3097	14 3/4	89 3/4	38 3/8	—	—	233 lbs.	45.5
WW9038HBH2L Laminate	1497	14 3/4	89 3/4	38 3/8	—	—	233 lbs.	45.5
<ul style="list-style-type: none"> • Random lock core (KRB, KRS) and specified lock core (KS3B, KS3S) available 								
38" HIGH-4 DOORS								
WW8438HBH2GW Glass/Wood	\$ 3587	14 3/4	83 3/4	38 3/8	—	—	210 lbs.	42.6
WW8438HBH2GL Glass/Laminate	3313	14 3/4	83 3/4	38 3/8	—	—	210 lbs.	42.6
WW8438HBH2W Wood	2946	14 3/4	83 3/4	38 3/8	—	—	210 lbs.	42.6
WW8438HBH2L Laminate	1451	14 3/4	83 3/4	38 3/8	—	—	210 lbs.	42.6
<ul style="list-style-type: none"> • Random lock core (KRB, KRS) and specified lock core (KS2B, KS2S) available • Glass doors do not lock • Not intended for use on table desking • An end panel, support panel, or pedestal must be located under end and center panels of highback for proper support • For tack board options, see pages 752-759 								

PRODUCT SPECIFICATIONS

- Wood and laminate chassis and doors available; refer to page 336 for options
- Tops of units are finished with flat edge detail
- Adjustable hinged doors
- If specifying wood, you must specify the same finish for all options
- Tack boards, task lights and vertical pigeon hole storage are available—see accessories section pages 717-760

TO ORDER, SPECIFY:

1. Model Number
2. Locking
3. Door Frame Color (glass door models)
4. Veneer Chassis Finish/
Laminate Chassis Color

SAMPLE MODEL NUMBERS:

WW7838HBH2W KS2S NH
 WW7838HBH2L KS2S 440 AC2
 WW7838HBH2GW 503 HN

- See pages 334-339 for all options available in WaveWorks



Shaded model numbers are available on our "To You in 10 Days or Less" Quick Delivery program and will be delivered in 10 days or less.

**HIGHBACK ORGANIZER
FULL BACK**

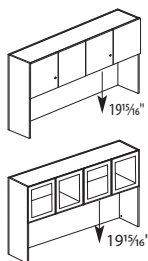

MODEL NO./DESCRIPTION	LIST PRICE	DIMENSIONS					CARTONED WEIGHT	CUBIC FEET
		D	W	H	A	KW		
38" HIGH—4 DOORS								
WW7838HBH2GW Glass/Wood	\$ 3436	14 3/4	77 1/16	38 3/8	—	—	194 lbs.	39.8
WW7838HBH2GL Glass/Laminate	3172	14 3/4	77 1/16	38 3/8	—	—	194 lbs.	39.8
WW7838HBH2W Wood	2802	14 3/4	77 1/16	38 3/8	—	—	194 lbs.	39.8
WW7838HBH2L Laminate	1387	14 3/4	77 1/16	38 3/8	—	—	194 lbs.	39.8
<hr/>								
WW7238HBH2GW Glass/Wood	\$ 3287	14 3/4	71 1/16	38 3/8	—	—	179 lbs.	37.0
WW7238HBH2GL Glass/Laminate	3036	14 3/4	71 1/16	38 3/8	—	—	179 lbs.	37.0
QWW7238HBH2W Wood	2654	14 3/4	71 1/16	38 3/8	—	—	179 lbs.	37.0
WW7238HBH2W Wood	2654	14 3/4	71 1/16	38 3/8	—	—	179 lbs.	37.0
QWW7238HBH2L Laminate	1301	14 3/4	71 1/16	38 3/8	—	—	179 lbs.	37.0
WW7238HBH2L Laminate	1301	14 3/4	71 1/16	38 3/8	—	—	179 lbs.	37.0
<hr/>								
WW6638HBH2GW Glass/Wood	\$ 3143	14 3/4	65 1/16	38 3/8	—	—	164 lbs.	34.1
WW6638HBH2GL Glass/Laminate	2901	14 3/4	65 1/16	38 3/8	—	—	164 lbs.	34.1
WW6638HBH2W Wood	2511	14 3/4	65 1/16	38 3/8	—	—	164 lbs.	34.1
WW6638HBH2L Laminate	1213	14 3/4	65 1/16	38 3/8	—	—	164 lbs.	34.1
<hr/>								
WW6038HBH2GW Glass/Wood	\$ 2999	14 3/4	59 1/16	38 3/8	—	—	148 lbs.	31.3
WW6038HBH2GL Glass/Laminate	2768	14 3/4	59 1/16	38 3/8	—	—	148 lbs.	31.3
WW6038HBH2W Wood	2369	14 3/4	59 1/16	38 3/8	—	—	148 lbs.	31.3
WW6038HBH2L Laminate	1124	14 3/4	59 1/16	38 3/8	—	—	148 lbs.	31.3
<hr/>								
38" HIGH—3 DOORS								
WW4838HBH2GW Glass/Wood	\$ 2872	14 3/4	47 7/8	38 3/8	—	—	126 lbs.	25.6
WW4838HBH2GL Glass/Laminate	2653	14 3/4	47 7/8	38 3/8	—	—	126 lbs.	25.6
WW4838HBH2W Wood	2185	14 3/4	47 7/8	38 3/8	—	—	126 lbs.	25.6
WW4838HBH2L Laminate	1040	14 3/4	47 7/8	38 3/8	—	—	126 lbs.	25.6

- Not intended for use on table desking
- An end panel, support panel, or pedestal must be located under end panels of highback for proper support
- For tack board options, see pages 752-759
- Glass doors do not lock
- Random lock core (KRB, KRS) and specified lock core (KS2B, KS2S) available

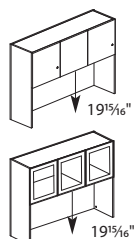

WAVEWORKS

PRODUCT SPECIFICATIONS

- Wood or laminate chassis available, refer to page 336 for options
- If specifying wood, you must specify the same finish for all options
- Tops of units are finished with flat edge detail
- Tack boards, task lights and vertical pigeon hole storage are available—see accessories section pages 717-760

TO ORDER, SPECIFY:

1. Model Number
2. Veneer Chassis Finish/
Laminate Chassis Color

SAMPLE MODEL NUMBERS:

WW10838HBE2W AC
WW10838HBE2L 440

- See pages 334-339 for all options available in WaveWorks

HIGHBACK ORGANIZER FULL BACK - NO DOORS

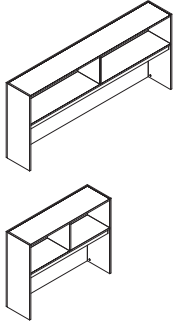

MODEL NO./DESCRIPTION		LIST PRICE	DIMENSIONS					CARTONED WEIGHT	CUBIC FEET
			D	W	H	A	KW		
38" HIGH—NO DOORS									
WW10838HBE2W	Wood	\$ 3146	13 ¹⁰ / ₁₆	107 ¹¹ / ₁₆	38 ³ / ₈	—	—	282 lbs.	56.9
WW10838HBE2L	Laminate	1497	13 ¹⁰ / ₁₆	107 ¹¹ / ₁₆	38 ³ / ₈	—	—	282 lbs.	56.9
• 49" task lights will not work under 2 piece highbacks									
WW10238HBE2W	Wood	\$ 2998	13 ¹⁰ / ₁₆	101 ³ / ₄	38 ³ / ₈	—	—	266 lbs.	54.1
WW10238HBE2L	Laminate	1364	13 ¹⁰ / ₁₆	101 ³ / ₄	38 ³ / ₈	—	—	266 lbs.	54.1
• 49" task lights will not work under 2 piece highbacks									
WW9638HBE2W	Wood	\$ 2846	13 ¹⁰ / ₁₆	95 ³ / ₄	38 ³ / ₈	—	—	252 lbs.	48.3
WW9638HBE2L	Laminate	1226	13 ¹⁰ / ₁₆	95 ³ / ₄	38 ³ / ₈	—	—	252 lbs.	48.3
• 49" task lights will not work under 2 piece highbacks									
WW9038HBE2W	Wood	\$ 2697	13 ¹⁰ / ₁₆	89 ³ / ₄	38 ³ / ₈	—	—	233 lbs.	45.5
WW9038HBE2L	Laminate	1093	13 ¹⁰ / ₁₆	89 ³ / ₄	38 ³ / ₈	—	—	233 lbs.	45.5
WW8438HBE2W	Wood	\$ 2683	13 ¹⁰ / ₁₆	83 ³ / ₄	38 ³ / ₈	—	—	210 lbs.	42.6
WW8438HBE2L	Laminate	1184	13 ¹⁰ / ₁₆	83 ³ / ₄	38 ³ / ₈	—	—	210 lbs.	42.6
WW7838HBE2W	Wood	\$ 2537	13 ¹⁰ / ₁₆	77 ¹³ / ₁₆	38 ³ / ₈	—	—	194 lbs.	39.8
WW7838HBE2L	Laminate	1123	13 ¹⁰ / ₁₆	77 ¹³ / ₁₆	38 ³ / ₈	—	—	194 lbs.	39.8
WW7238HBE2W	Wood	\$ 2391	13 ¹⁰ / ₁₆	71 ¹³ / ₁₆	38 ³ / ₈	—	—	179 lbs.	37.0
WW7238HBE2L	Laminate	1036	13 ¹⁰ / ₁₆	71 ¹³ / ₁₆	38 ³ / ₈	—	—	179 lbs.	37.0
WW6638HBE2W	Wood	\$ 2248	13 ¹⁰ / ₁₆	65 ¹³ / ₁₆	38 ³ / ₈	—	—	164 lbs.	34.1
WW6638HBE2L	Laminate	945	13 ¹⁰ / ₁₆	65 ¹³ / ₁₆	38 ³ / ₈	—	—	164 lbs.	34.1
WW6038HBE2W	Wood	\$ 2105	13 ¹⁰ / ₁₆	59 ¹³ / ₁₆	38 ³ / ₈	—	—	148 lbs.	31.3
WW6038HBE2L	Laminate	878	13 ¹⁰ / ₁₆	59 ¹³ / ₁₆	38 ³ / ₈	—	—	148 lbs.	31.3
WW4838HBE2W	Wood	\$ 2025	13 ¹⁰ / ₁₆	47 ⁷ / ₈	38 ³ / ₈	—	—	126 lbs.	25.6
WW4838HBE2L	Laminate	858	13 ¹⁰ / ₁₆	47 ⁷ / ₈	38 ³ / ₈	—	—	126 lbs.	25.6
<ul style="list-style-type: none"> • Not intended for use on table desking • Specify chassis finish only • An end panel, support panel, or pedestal must be located under end panels of highbacks for proper support • For tack board options, see pages 752-759 									

PRODUCT SPECIFICATIONS

- Wood, laminate, glass or no doors and wood or laminate chassis available; refer to page 336 for options
- All shelves are ¾" thick
- Tops of units are finished with flat edge detail
- Adjustable hinged doors
- If specifying wood, you must specify the same finish for all options
- Tack boards, slat walls, task lights and vertical pigeon hole storage are available—see accessories section pages 717-760
- National will not be liable for Exhibit mount cabinets or wall mount cabinets that are not properly installed
- Cabinets have a full height back panel

TO ORDER, SPECIFY:

1. Model Number
2. Locking
3. Door Frame Color (glass door models)
4. Veneer Chassis Finish/
Laminate Chassis Color

SAMPLE MODEL NUMBERS:

WW3030SOHMGW KS1B AC
 WW3030SOHML KS1B 440 AC2
 WW3030SOHMGW 501 AC

- See pages 334-339 for all options available in WaveWorks

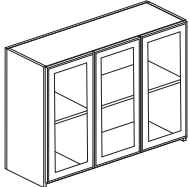
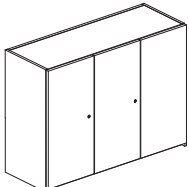
	MODEL NO./DESCRIPTION	LIST PRICE	DIMENSIONS					CARTONED WEIGHT	CUBIC FEET	
			D	W	H	A	KW			
OVERHEAD STORAGE CABINET WALL MOUNT  	30" HIGH—3 DOORS									
	WW4830SOHMGW	Glass/Wood	\$ 2464	14¾	47⅞	29⅞	—	—	150 lbs.	34.0
	WW4830SOHMGL	Glass/Laminate	1622	14¾	47⅞	29⅞	—	—	150 lbs.	34.0
	WW4830SOHMGW	Wood	1774	14¾	47⅞	29⅞	—	—	150 lbs.	34.0
	WW4830SOHML	Laminate	1152	14¾	47⅞	29⅞	—	—	150 lbs.	34.0
		<ul style="list-style-type: none"> • Glass doors do not lock • Random lock core (KRB, KRS) and specified lock core (KS2B, KS2S) available 								
	WW4230SOHMGW	Glass/Wood	\$ 2375	14¾	41⅞	29⅞	—	—	129 lbs.	29.2
	WW4230SOHMGL	Glass/Laminate	1532	14¾	41⅞	29⅞	—	—	129 lbs.	29.2
	WW4230SOHMGW	Wood	1691	14¾	41⅞	29⅞	—	—	129 lbs.	29.2
	WW4230SOHML	Laminate	1094	14¾	41⅞	29⅞	—	—	129 lbs.	29.2
		<ul style="list-style-type: none"> • Glass doors do not lock • Random lock core (KRB, KRS) and specified lock core (KS2B, KS2S) available 								
		30" HIGH—2 DOORS								
WW3630SOHMGW	Glass/Wood	\$ 2284	14¾	35⅞	29⅞	—	—	102 lbs.	25.5	
WW3630SOHMGL	Glass/Laminate	1445	14¾	35⅞	29⅞	—	—	102 lbs.	25.5	
WW3630SOHMGW	Wood	1613	14¾	35⅞	29⅞	—	—	102 lbs.	25.5	
WW3630SOHML	Laminate	1037	14¾	35⅞	29⅞	—	—	102 lbs.	25.5	
	<ul style="list-style-type: none"> • Glass doors do not lock • Random lock core (KRB, KRS) and specified lock core (KS1B, KS1S) available 									
WW3030SOHMGW	Glass/Wood	\$ 2184	14¾	29⅞	29⅞	—	—	89 lbs.	21.9	
WW3030SOHMGL	Glass/Laminate	1348	14¾	29⅞	29⅞	—	—	89 lbs.	21.9	
WW3030SOHMGW	Wood	1531	14¾	29⅞	29⅞	—	—	89 lbs.	21.9	
WW3030SOHML	Laminate	972	14¾	29⅞	29⅞	—	—	89 lbs.	21.9	
	<ul style="list-style-type: none"> • Glass doors do not lock • Random lock core (KRB, KRS) and specified lock core (KS1B, KS1S) available • Wall mount bracket, for attachment to wall, is included • National recommends that each overhead cabinet be secured by a minimum of 2 mounting locations (studs) • Features an adjustable shelf • For tack board options, see pages 752-759 • Wall mount overheads can be utilized with DIRTT antler extrusion; see page 129 									

WAVEWORKS

WAVEWORKS

ASSEMBLED

PRODUCT SPECIFICATIONS

- Wood, laminate, glass or no doors and wood or laminate chassis available; refer to page 336 for options
- All shelves are ¾" thick
- Tops of units are finished with flat edge detail
- Adjustable hinged doors
- If specifying wood, you must specify the same finish for all options
- Tack boards, slat walls, task lights and vertical pigeon hole storage are available—see accessories section pages 717-760
- National will not be liable for Exhibit mount cabinets or wall mount cabinets that are not properly installed
- Cabinets have a full height back panel

TO ORDER, SPECIFY:

1. Model Number
2. Veneer Chassis Finish/
Laminate Chassis Color

SAMPLE MODEL NUMBERS:

WW4830SOEMW AC
WW4830SOEML 440

- See pages 334-339 for all options available in WaveWorks

	MODEL NO./DESCRIPTION	LIST PRICE	DIMENSIONS					CARTONED CUBIC		
			D	W	H	A	KW	WEIGHT	FEET	
OVERHEAD STORAGE CABINET NO DOORS - WALL MOUNT	30" HIGH—CENTER DIVIDER PANEL									
	WW4830SOEMW	Wood	\$ 1774	13 ³ / ₁₆	47 ⁷ / ₈	29 ¹⁵ / ₁₆	—	—	140 lbs.	34.0
	WW4830SOEML	Laminate	1152	13 ³ / ₁₆	47 ⁷ / ₈	29 ¹⁵ / ₁₆	—	—	140 lbs.	34.0
	WW4230SOEMW	Wood	\$ 1691	13 ³ / ₁₆	41 ⁷ / ₈	29 ¹⁵ / ₁₆	—	—	119 lbs.	29.2
	WW4230SOEML	Laminate	1094	13 ³ / ₁₆	41 ⁷ / ₈	29 ¹⁵ / ₁₆	—	—	119 lbs.	29.2
	30" HIGH—NO DIVIDER PANEL									
WW3630SOEMW	Wood	\$ 1613	13 ³ / ₁₆	35 ⁷ / ₈	29 ¹⁵ / ₁₆	—	—	92 lbs.	25.5	
WW3630SOEML	Laminate	1037	13 ³ / ₁₆	35 ⁷ / ₈	29 ¹⁵ / ₁₆	—	—	92 lbs.	25.5	
WW3030SOEMW	Wood	\$ 1531	13 ³ / ₁₆	29 ¹⁵ / ₁₆	29 ¹⁵ / ₁₆	—	—	79 lbs.	21.9	
WW3030SOEML	Laminate	972	13 ³ / ₁₆	29 ¹⁵ / ₁₆	29 ¹⁵ / ₁₆	—	—	79 lbs.	21.9	

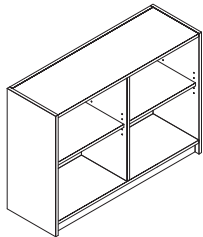

WW4230SOEMW shown-
Center Divider Panel

- Wall mount bracket, for attachment to wall, is included
- Cabinets are open and do not have doors
- National recommends that each overhead cabinet be secured by a minimum of 2 mounting locations (studs)
- Features an adjustable shelf
- For tack board options, see pages 752-759
- Wall mount overheads can be utilized with DIRTT antler extrusion; see page 129

PRODUCT SPECIFICATIONS

- Wood, laminate, glass or no doors and wood or laminate chassis available; refer to page 336 for options
- All shelves are ¾" thick
- Tops of units are finished with flat edge detail
- Adjustable hinged doors
- If specifying wood, you must specify the same finish for all options
- Tack boards, slat walls, task lights and vertical pigeon hole storage are available—see accessories section pages 717-760
- National will not be liable for Exhibit mount cabinets or wall mount cabinets that are not properly installed
- Cabinets have a full height back panel

TO ORDER, SPECIFY:

1. Model Number
2. Locking
3. Door Frame Color (glass door models)
4. Veneer Chassis Finish/
Laminate Chassis Color

SAMPLE MODEL NUMBERS:

WW3018SOHMGW KS1B AC
 WW3018SOHML KS1B 440 AC2
 WW3018SOHMGW 501 AC

- See pages 334-339 for all options available in WaveWorks

QD Shaded model numbers are available on our "To You in 10 Days or Less" Quick Delivery program and will be delivered in 10 days or less.

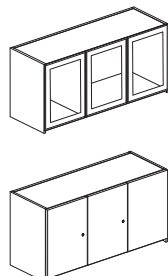
	MODEL NO./DESCRIPTION	LIST PRICE	DIMENSIONS					CARTONED WEIGHT	CUBIC FEET	
			D	W	H	A	KW			
	18" HIGH—3 DOORS									
	WW4818SOHMGW	Glass/Wood	\$ 1761	14¾"	47¾"	18½"	—	—	115 lbs.	11.8
	WW4818SOHMGL	Glass/Laminate	1191	14¾"	47¾"	18½"	—	—	115 lbs.	11.8
	WW4818SOHMGW	Wood	1412	14¾"	47¾"	18½"	—	—	115 lbs.	11.8
	WW4818SOHML	Laminate	855	14¾"	47¾"	18½"	—	—	115 lbs.	11.8
	<ul style="list-style-type: none"> • Glass doors do not lock • Random lock core (KRB, KRS) and specified lock core (KS2B, KS2S) available 									
	WW4218SOHMGW	Glass/Wood	\$ 1700	14¾"	41¾"	18½"	—	—	100 lbs.	11.1
	WW4218SOHMGL	Glass/Laminate	1135	14¾"	41¾"	18½"	—	—	100 lbs.	11.1
	WW4218SOHMGW	Wood	1353	14¾"	41¾"	18½"	—	—	100 lbs.	11.1
	WW4218SOHML	Laminate	796	14¾"	41¾"	18½"	—	—	100 lbs.	11.1
	<ul style="list-style-type: none"> • Glass doors do not lock • Random lock core (KRB, KRS) and specified lock core (KS2B, KS2S) available 									
	18" HIGH—2 DOORS									
	WW3618SOHMGW	Glass/Wood	\$ 1640	14¾"	35¾"	18½"	—	—	76 lbs.	7.7
	WW3618SOHMGL	Glass/Laminate	1076	14¾"	35¾"	18½"	—	—	76 lbs.	7.7
	QWW3618SOHMGW	Wood	1292	14¾"	35¾"	18½"	—	—	76 lbs.	7.7
	WW3618SOHMGW	Wood	1292	14¾"	35¾"	18½"	—	—	76 lbs.	7.7
	QWW3618SOHML	Laminate	738	14¾"	35¾"	18½"	—	—	76 lbs.	7.7
	WW3618SOHML	Laminate	738	14¾"	35¾"	18½"	—	—	76 lbs.	7.7
<ul style="list-style-type: none"> • Glass doors do not lock • Random lock core (KRB, KRS) and specified lock core (KS1B, KS1S) available 										
WW3018SOHMGW	Glass/Wood	\$ 1571	14¾"	29½"	18½"	—	—	64 lbs.	6.4	
WW3018SOHMGL	Glass/Laminate	1011	14¾"	29½"	18½"	—	—	64 lbs.	6.4	
QWW3018SOHMGW	Wood	1224	14¾"	29½"	18½"	—	—	64 lbs.	6.4	
WW3018SOHMGW	Wood	1224	14¾"	29½"	18½"	—	—	64 lbs.	6.4	
QWW3018SOHML	Laminate	676	14¾"	29½"	18½"	—	—	64 lbs.	6.4	
WW3018SOHML	Laminate	676	14¾"	29½"	18½"	—	—	64 lbs.	6.4	
<ul style="list-style-type: none"> • Glass doors do not lock • Random lock core (KRB, KRS) and specified lock core (KS1B, KS1S) available 										
<ul style="list-style-type: none"> • Wall mount bracket, for attachment to wall, is included • 30" and 36" units have 2 doors; the 42" and 48" units have 3 doors • National recommends that each overhead cabinet be secured by a minimum of 2 mounting locations (studs); National will not be liable for wall mount cabinets that are not properly installed • For tack board options, see pages 752-759 • Wall mount overheads can be utilized with DIRTT antler extrusion; see page 129 										

WAVEWORKS

PRODUCT SPECIFICATIONS

- Wood, laminate, glass or no doors and wood or laminate chassis available; refer to page 336 for options
- All shelves are ¾" thick
- Tops of units are finished with flat edge detail
- Adjustable hinged doors
- If specifying wood, you must specify the same finish for all options
- Tack boards, slat walls, task lights and vertical pigeon hole storage are available—see accessories section pages 717-760
- National will not be liable for Exhibit mount cabinets or wall mount cabinets that are not properly installed
- Cabinets have a full height back panel

TO ORDER, SPECIFY:

1. Model Number
2. Veneer Chassis Finish/
Laminate Chassis Color

SAMPLE MODEL NUMBERS:

WW4818SOEMW AC
WW4818SOEML 440

- See pages 334-339 for all options available in WaveWorks

QD Shaded model numbers are available on our "To You in 10 Days or Less" Quick Delivery program and will be delivered in 10 days or less.

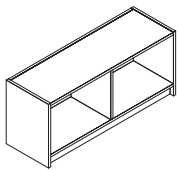
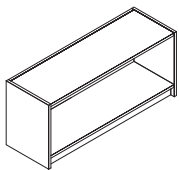
	MODEL NO./DESCRIPTION	LIST PRICE	DIMENSIONS					CARTONED CUBIC		
			D	W	H	A	KW	WEIGHT	FEET	
 Center Divider Panel shown	18" HIGH—CENTER DIVIDER PANEL									
	WW4818SOEMW	Wood	\$ 1412	13 ¹ / ₁₆	47 ⁷ / ₁₆	18 ¹ / ₁₆	—	—	90 lbs.	13.0
	WW4818SOEML	Laminate	855	13 ¹ / ₁₆	47 ⁷ / ₁₆	18 ¹ / ₁₆	—	—	90 lbs.	13.0
	WW4218SOEMW	Wood	\$ 1353	13 ¹ / ₁₆	41 ¹ / ₁₆	18 ¹ / ₁₆	—	—	80 lbs.	11.1
	WW4218SOEML	Laminate	796	13 ¹ / ₁₆	41 ¹ / ₁₆	18 ¹ / ₁₆	—	—	80 lbs.	11.1
	18" HIGH—NO DIVIDER PANEL									
	QWW3618SOEMW	Wood	\$ 1292	13 ¹ / ₁₆	35 ⁵ / ₁₆	18 ¹ / ₁₆	—	—	70 lbs.	7.7
	WW3618SOEMW	Wood	1292	13 ¹ / ₁₆	35 ⁵ / ₁₆	18 ¹ / ₁₆	—	—	70 lbs.	7.7
QWW3618SOEML	Laminate	738	13 ¹ / ₁₆	35 ⁵ / ₁₆	18 ¹ / ₁₆	—	—	70 lbs.	7.7	
WW3618SOEML	Laminate	738	13 ¹ / ₁₆	35 ⁵ / ₁₆	18 ¹ / ₁₆	—	—	70 lbs.	7.7	
 No Divider Panel shown	QWW3018SOEMW	Wood	\$ 1224	13 ¹ / ₁₆	29 ¹ / ₁₆	18 ¹ / ₁₆	—	—	60 lbs.	6.4
	WW3018SOEMW	Wood	1224	13 ¹ / ₁₆	29 ¹ / ₁₆	18 ¹ / ₁₆	—	—	60 lbs.	6.4
	QWW3018SOEML	Laminate	676	13 ¹ / ₁₆	29 ¹ / ₁₆	18 ¹ / ₁₆	—	—	60 lbs.	6.4
	WW3018SOEML	Laminate	676	13 ¹ / ₁₆	29 ¹ / ₁₆	18 ¹ / ₁₆	—	—	60 lbs.	6.4

- Wall mount bracket, for attachment to wall, is included
- Cabinets are open and do not have doors
- National recommends that each overhead cabinet be secured by a minimum of 2 mounting locations (studs)
- For tack board options, see pages 752-759
- Wall mount overheads can be utilized with DIRTT antler extrusion; see below

DIRTT OVERHEAD MOUNTING KITS

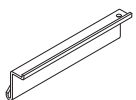

NAC480K	For 48" Overhead	\$ 192	1	6	1 ¹ / ₁₆	—	—	8 lbs.	2.0
NAC420K	For 42" Overhead	186	1	6	1 ¹ / ₁₆	—	—	8 lbs.	2.0
NAC360K	For 36" Overhead	178	1	6	1 ¹ / ₁₆	—	—	8 lbs.	2.0
NAC300K	For 30" Overhead	164	1	6	1 ¹ / ₁₆	—	—	8 lbs.	1.5

- Available in black only
- For use with Epic, Renegade, and WaveWorks wall mount cabinets
- Bracket designed to interact with the DIRTT antler extrusion
- Can be used with 13", 18", and 30" high cabinets
- 30" comes with 2 brackets; 36"-48" comes with 3 brackets; each kit also includes a mounting extrusion strip that matches the size of the overhead

PRODUCT SPECIFICATIONS

- Wood or laminate chassis available; refer to page 336 for options
- All shelves are 3/4" thick
- Tops of units are finished with flat edge detail
- Tack boards, slat walls, task lights and vertical pigeon hole storage are available—see accessories section pages 717-760
- National will not be liable for Exhibit mount cabinets or wall mount cabinets that are not properly installed
- Cabinets have a full height back panel

TO ORDER, SPECIFY:

1. Model Number
2. Locking
3. Door Frame Color (glass door models)
4. Veneer Chassis Finish/
Laminate Chassis Color

SAMPLE MODEL NUMBERS:

WW4230SOHTGW 503 HN
 WW4230SOHTL KRS 440 HN2
 WW4230SOHTW KRS HN

- See pages 334-339 for all options available in WaveWorks

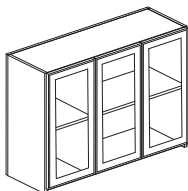
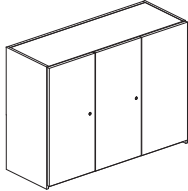
	MODEL NO./DESCRIPTION	LIST PRICE	DIMENSIONS					CARTONED CUBIC		
			D	W	H	A	KW	WEIGHT	FEET	
OVERHEAD STORAGE CABINET EXHIBIT MOUNT  	30" HIGH—3 DOORS									
	WW4830SOHTGW	Glass/Wood	\$ 2464	14¾	47⅞	29⅞	—	—	150 lbs.	34.0
	WW4830SOHTGL	Glass/Laminate	1622	14¾	47⅞	29⅞	—	—	150 lbs.	34.0
	WW4830SOHTW	Wood	1774	14¾	47⅞	29⅞	—	—	150 lbs.	34.0
	WW4830SOHTL	Laminate	1152	14¾	47⅞	29⅞	—	—	150 lbs.	34.0
		<ul style="list-style-type: none"> • Glass doors do not lock • Random lock core (KRB, KRS) and specified lock core (KS2B, KS2S) available 								
	WW4230SOHTGW	Glass/Wood	\$ 2375	14¾	41⅞	29⅞	—	—	129 lbs.	29.2
	WW4230SOHTGL	Glass/Laminate	1532	14¾	41⅞	29⅞	—	—	129 lbs.	29.2
	WW4230SOHTW	Wood	1691	14¾	41⅞	29⅞	—	—	129 lbs.	29.2
	WW4230SOHTL	Laminate	1094	14¾	41⅞	29⅞	—	—	129 lbs.	29.2
		<ul style="list-style-type: none"> • Glass doors do not lock • Random lock core (KRB, KRS) and specified lock core (KS2B, KS2S) available 								
		30" HIGH—2 DOORS								
	WW3630SOHTGW	Glass/Wood	\$ 2284	14¾	35⅞	29⅞	—	—	102 lbs.	25.5
	WW3630SOHTGL	Glass/Laminate	1445	14¾	35⅞	29⅞	—	—	102 lbs.	25.5
	WW3630SOHTW	Wood	1613	14¾	35⅞	29⅞	—	—	102 lbs.	25.5
	WW3630SOHTL	Laminate	1037	14¾	35⅞	29⅞	—	—	102 lbs.	25.5
	<ul style="list-style-type: none"> • Glass doors do not lock • Random lock core (KRB, KRS) and specified lock core (KS1B, KS1S) available 									
WW3030SOHTGW	Glass/Wood	\$ 2184	14¾	29⅞	29⅞	—	—	89 lbs.	21.9	
WW3030SOHTGL	Glass/Laminate	1348	14¾	29⅞	29⅞	—	—	89 lbs.	21.9	
WW3030SOHTW	Wood	1531	14¾	29⅞	29⅞	—	—	89 lbs.	21.9	
WW3030SOHTL	Laminate	972	14¾	29⅞	29⅞	—	—	89 lbs.	21.9	
	<ul style="list-style-type: none"> • Glass doors do not lock • Random lock core (KRB, KRS) and specified lock core (KS1B, KS1S) available • Exhibit mount bracket is included, must order Exhibit wall rail separately • It is recommended that overheads are not slid to a new location when there are tack board inserts behind the overheads • If an overhead needs to be relocated, the overhead must be removed from the Exhibit rail and reinstalled in another location on the Exhibit rail • See page 408 for Exhibit Wall Rail and Filler Strip • Features an adjustable shelf 									

WAVEWORKS

WAVEWORKS

PRODUCT SPECIFICATIONS

- Wood or laminate chassis available; refer to page 336 for options
- All shelves are ¾" thick
- Tops of units are finished with flat edge detail
- Tack boards, slat walls, task lights and vertical pigeon hole storage are available—see accessories section pages 717-760
- National will not be liable for Exhibit mount cabinets or wall mount cabinets that are not properly installed
- Cabinets have a full height back panel

TO ORDER, SPECIFY:

1. Model Number
2. Veneer Chassis Finish/
Laminate Chassis Color

SAMPLE MODEL NUMBERS:

WW4830SOETW AC
WW4830SOETL 440

- See pages 334-339 for all options available in WaveWorks

	MODEL NO./DESCRIPTION	LIST PRICE	DIMENSIONS					CARTONED CUBIC		
			D	W	H	A	KW	WEIGHT	FEET	
OVERHEAD STORAGE CABINET NO DOORS - EXHIBIT MOUNT	30" HIGH—CENTER DIVIDER PANEL									
	WW4830SOETW	Wood	\$ 1774	13 ³ / ₁₆	47 ⁷ / ₈	29 ¹ / ₁₆	—	—	140 lbs.	34.0
	WW4830SOETL	Laminate	1152	13 ³ / ₁₆	47 ⁷ / ₈	29 ¹ / ₁₆	—	—	140 lbs.	34.0
	WW4230SOETW	Wood	\$ 1691	13 ³ / ₁₆	41 ⁷ / ₈	29 ¹ / ₁₆	—	—	119 lbs.	29.2
	WW4230SOETL	Laminate	1094	13 ³ / ₁₆	41 ⁷ / ₈	29 ¹ / ₁₆	—	—	119 lbs.	29.2
	30" HIGH—NO DIVIDER PANEL									
WW3630SOETW	Wood	\$ 1613	13 ³ / ₁₆	35 ⁷ / ₈	29 ¹ / ₁₆	—	—	92 lbs.	25.5	
WW3630SOETL	Laminate	1037	13 ³ / ₁₆	35 ⁷ / ₈	29 ¹ / ₁₆	—	—	92 lbs.	25.5	
WW3030SOETW	Wood	\$ 1531	13 ³ / ₁₆	29 ¹ / ₁₆	29 ¹ / ₁₆	—	—	79 lbs.	21.9	
WW3030SOETL	Laminate	972	13 ³ / ₁₆	29 ¹ / ₁₆	29 ¹ / ₁₆	—	—	79 lbs.	21.9	

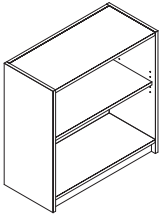

WW3030SOETW shown-
No Divider Panel

- Exhibit mount bracket is included, Exhibit wall rail must be ordered separately
- It is recommended that overheads are not slid to a new location when there are tack board inserts behind the overheads
- If an overhead needs to be relocated, the overhead must be removed from the Exhibit rail and reinstalled in another location on the Exhibit rail
- See page 408 for Exhibit Wall Rail and Filler Strip
- Features an adjustable shelf

ASSEMBLED

PRODUCT SPECIFICATIONS

- Wood, laminate, glass or no doors and wood or laminate chassis available; refer to page 336 for options
- Tack boards, slat walls, task lights and vertical pigeon hole storage are available—see accessories section pages 717-760
- Tops of units are finished with flat edge detail
- Adjustable hinged doors
- If specifying wood, you must specify the same finish for all options
- National will not be liable for Exhibit mount cabinets or wall mount cabinets that are not properly installed
- Cabinets have a full height back panel

TO ORDER, SPECIFY:

1. Model Number
2. Locking
3. Door Frame Color (glass door models)
4. Veneer Chassis Finish/
Laminate Chassis Color

SAMPLE MODEL NUMBERS:

WW4218SOHTGW 503 HN
 WW4218SOHTL KRS 440 HN2
 WW4218SOHTW KRS HN

• See pages 334-339 for all options available in WaveWorks

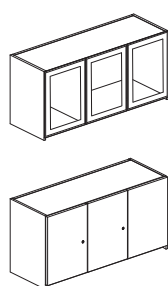
	MODEL NO./DESCRIPTION	LIST PRICE	DIMENSIONS					CARTONED WEIGHT	CUBIC FEET	
			D	W	H	A	KW			
OVERHEAD STORAGE CABINET - EXHIBIT MOUNT 	18" HIGH—3 DOORS									
	WW4818SOHTGW	Glass/Wood	\$ 1761	14¾	47¾	18¾	—	—	115 lbs.	11.8
	WW4818SOHTGL	Glass/Laminate	1191	14¾	47¾	18¾	—	—	115 lbs.	11.8
	WW4818SOHTW	Wood	1412	14¾	47¾	18¾	—	—	115 lbs.	11.8
	WW4818SOHTL	Laminate	855	14¾	47¾	18¾	—	—	115 lbs.	11.8
	<ul style="list-style-type: none"> • Glass doors do not lock • Random lock core (KRB, KRS) and specified lock core (KS2B, KS2S) available 									
	WW4218SOHTGW	Glass/Wood	\$ 1700	14¾	41¾	18¾	—	—	100 lbs.	11.1
	WW4218SOHTGL	Glass/Laminate	1135	14¾	41¾	18¾	—	—	100 lbs.	11.1
	WW4218SOHTW	Wood	1353	14¾	41¾	18¾	—	—	100 lbs.	11.1
	WW4218SOHTL	Laminate	796	14¾	41¾	18¾	—	—	100 lbs.	11.1
	<ul style="list-style-type: none"> • Glass doors do not lock • Random lock core (KRB, KRS) and specified lock core (KS2B, KS2S) available 									
	18" HIGH—2 DOORS									
	WW3618SOHTGW	Glass/Wood	\$ 1640	14¾	35¾	18¾	—	—	76 lbs.	7.7
	WW3618SOHTGL	Glass/Laminate	1076	14¾	35¾	18¾	—	—	76 lbs.	7.7
WW3618SOHTW	Wood	1292	14¾	35¾	18¾	—	—	76 lbs.	7.7	
WW3618SOHTL	Laminate	738	14¾	35¾	18¾	—	—	76 lbs.	7.7	
<ul style="list-style-type: none"> • Glass doors do not lock • Random lock core (KRB, KRS) and specified lock core (KS1B, KS1S) available 										
WW3018SOHTGW	Glass/Wood	\$ 1571	14¾	29 ¹ / ₁₆	18¾	—	—	64 lbs.	6.4	
WW3018SOHTGL	Glass/Laminate	1011	14¾	29 ¹ / ₁₆	18¾	—	—	64 lbs.	6.4	
WW3018SOHTW	Wood	1224	14¾	29 ¹ / ₁₆	18¾	—	—	64 lbs.	6.4	
WW3018SOHTL	Laminate	676	14¾	29 ¹ / ₁₆	18¾	—	—	64 lbs.	6.4	
<ul style="list-style-type: none"> • Glass doors do not lock • Random lock core (KRB, KRS) and specified lock core (KS1B, KS1S) available 										
<ul style="list-style-type: none"> • Exhibit mount bracket is included, Exhibit Wall Rail needs to be ordered separately • It is recommended that overheads are not slid to a new location when there are tack board inserts behind the overheads • If an overhead needs to be relocated, the overhead must be removed from the Exhibit rail and reinstalled in another location on the Exhibit rail • See page 408 for Exhibit Wall Rail and Filler Strip 										

WAVEWORKS

PRODUCT SPECIFICATIONS

- Wood, laminate, glass or no doors and wood or laminate chassis available; refer to page 336 for options
- Tack boards, slat walls, task lights and vertical pigeon hole storage are available—see accessories section pages 717-760
- Tops of units are finished with flat edge detail
- Adjustable hinged doors
- If specifying wood, you must specify the same finish for all options
- National will not be liable for Exhibit mount cabinets or wall mount cabinets that are not properly installed
- Cabinets have a full height back panel

TO ORDER, SPECIFY:

1. Model Number
2. Veneer Chassis Finish/
Laminate Chassis Color

SAMPLE MODEL NUMBERS:

WW4818SOETW AC
WW4818SOETL 440

- See pages 334-339 for all options available in WaveWorks

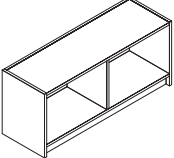
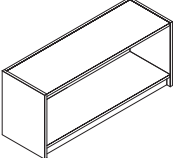
	MODEL NO./DESCRIPTION	LIST PRICE	DIMENSIONS					CARTONED WEIGHT	CUBIC FEET	
			D	W	H	A	KW			
 Center Divider Panel shown	18" HIGH—CENTER DIVIDER PANEL									
	WW4818SOETW	Wood	\$ 1412	13 ¹ / ₁₆	47 ⁷ / ₁₆	18 ¹ / ₁₆	—	—	115 lbs.	11.8
	WW4818SOETL	Laminate	855	13 ¹ / ₁₆	47 ⁷ / ₁₆	18 ¹ / ₁₆	—	—	115 lbs.	11.8
	WW4218SOETW	Wood	\$ 1353	13 ¹ / ₁₆	41 ¹ / ₁₆	18 ¹ / ₁₆	—	—	100 lbs.	11.1
	WW4218SOETL	Laminate	796	13 ¹ / ₁₆	41 ¹ / ₁₆	18 ¹ / ₁₆	—	—	100 lbs.	11.1
	 No Divider Panel shown	18" HIGH—NO DIVIDER PANEL								
WW3618SOETW		Wood	\$ 1292	13 ¹ / ₁₆	35 ⁵ / ₁₆	18 ¹ / ₁₆	—	—	76 lbs.	7.7
WW3618SOETL		Laminate	738	13 ¹ / ₁₆	35 ⁵ / ₁₆	18 ¹ / ₁₆	—	—	76 lbs.	7.7
WW3018SOETW		Wood	\$ 1224	13 ¹ / ₁₆	29 ¹ / ₁₆	18 ¹ / ₁₆	—	—	64 lbs.	6.4
WW3018SOETL		Laminate	676	13 ¹ / ₁₆	29 ¹ / ₁₆	18 ¹ / ₁₆	—	—	64 lbs.	6.4

- Exhibit mount bracket is included, Exhibit Wall Rail must be ordered separately
- Cabinets are open and do not have doors
- It is recommended that overheads are not slid to a new location when there are tack board inserts behind the overheads
- If an overhead needs to be relocated, the overhead must be removed from the Exhibit rail and reinstalled in another location on the Exhibit rail
- See below for Exhibit Wall Rail and Filler Strip

OVERHEAD STORAGE CABINET FILLER PANEL

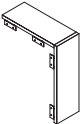

FILLER PANELS

WW1329CPOFPL		\$ 103	6	14	29 ¹ / ₁₆	—	—	—	0.8
WW1318CPOFPL		92	6	14	14 ³ / ₁₆	—	—	—	0.4

- To be used with overhead storage cabinets to fill in space as needed
- Can be field cut to desired width

EXHIBIT WALL RAIL

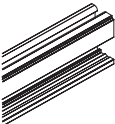

WALL RAIL

11N72EXP1	1 Rail/No faceplate	\$ 100	¾	72	1 ³ / ₄	—	—	6 lbs.	0.7
11N144EXP1	1 Rail/No faceplate	145	¾	144	1 ³ / ₄	—	—	12 lbs.	1.4

- Includes 1 wall rail and 2 alignment brackets
- Specify 423 Concrete, 462 Cinder, 463 Iron, 501 Platinum Metallic or 503 Satin Nickel Metallic
- For use when hanging a worksurface or overhead without the use of an insert

FILLER STRIP KIT EXHIBIT MOUNT

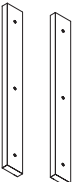

11NCPFSW	Wood	\$ 53	1	3	27 ¹ / ₄	—	—	3 lbs.	1.0
11NCPFSL	Laminate	28	1	3	27 ¹ / ₄	—	—	3 lbs.	1.0

- For use with Exhibit mounted overheads when an insert is not used behind the overhead
- Must be field scribed for 18" and 13" high overhead models
- Specify solid/woodgrain/Gallery laminate or wood finish

PRODUCT SPECIFICATIONS

- Wood, laminate, glass doors and wood or laminate chassis available; refer to page 336 for options
- Refer to pages 717-760 for accessories
- Tops of units are finished with flat edge detail
- Adjustable hinged doors
- If specifying wood, you must specify the same finish for all options
- Wood drawers feature dowel construction
- Wood drawers feature sides and backs that are ½" thick, bottoms are ¼" thick with veneer faces that are sealed and finished with a clear coat

TO ORDER, SPECIFY:

1. Model Number
2. Rim
3. Rim Color (laminate units only)
4. Pull
5. Locking
6. Top Finish (laminate units only)
7. Drawer Finish (laminate units only)
8. Chassis Finish

SAMPLE MODEL NUMBERS:

WW2436LFF2W C 7MB KRB MC
 WW2436LFF2L VMH 7MB KRB 480 480
 WW2436LFF2LW V 440 7MB KRB MH

• See pages 334-339 for all options available in WaveWorks

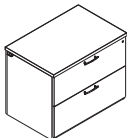
	MODEL NO./DESCRIPTION	LIST PRICE	DIMENSIONS					CARTONED WEIGHT	CUBIC FEET	
			D	W	H	A	KW			
LATERAL FILE 2 DRAWER 	1 1/16" TOP THICKNESS									
	WWN2436LFF2W	Wood	\$ 2557	24	36 1/16	29 3/8	—	—	155 lbs.	22.2
	WWN2436LFF2LW	Laminate/Wood	2557	24	36 1/16	29 3/8	—	—	155 lbs.	22.2
	WWN2436LFF2L	Laminate	1686	24	36 1/16	29 3/8	—	—	155 lbs.	22.2
	1 3/16" TOP THICKNESS									
	WW2436LFF2W	Wood	\$ 2325	24	36 1/16	28 1/16	—	—	155 lbs.	22.2
	WW2436LFF2LW	Laminate/Wood	2325	24	36 1/16	28 1/16	—	—	155 lbs.	22.2
	WW2436LFF2L	Laminate	1533	24	36 1/16	28 1/16	—	—	155 lbs.	22.2
	WW2436LFF2LL	TFL	1226	24	36 1/16	28 3/8	—	—	155 lbs.	22.2
	<ul style="list-style-type: none"> • Interlock mechanism allows only 1 drawer to be open at a time • Random lock core (KRB, KRS) and specified lock core (KS1B, KS1S) available • When specifying Horizon pulls, lateral files will have 2 pulls on each drawer front • Wood drawers can be specified on 1 3/16" Wood models; add a "W" to the end of the model number and add \$248 to the list price 									

**LATERAL FILE
3 DRAWER**



1 1/16" TOP THICKNESS									
WWN2436LFF3W	Wood	\$ 3449	24	36 1/16	41 7/8	—	—	210 lbs.	30.0
WWN2436LFF3LW	Laminate/Wood	3449	24	36 1/16	41 7/8	—	—	210 lbs.	30.0
WWN2436LFF3L	Laminate	2273	24	36 1/16	41 7/8	—	—	210 lbs.	30.0
1 3/16" TOP THICKNESS									
WW2436LFF3W	Wood	\$ 3134	24	36 1/16	41 1/2	—	—	210 lbs.	30.0
WW2436LFF3LW	Laminate/Wood	3134	24	36 1/16	41 1/2	—	—	210 lbs.	30.0
WW2436LFF3L	Laminate	2066	24	36 1/16	41 1/2	—	—	210 lbs.	30.0
WW2436LFF3LL	TFL	1654	24	36 1/16	41 1/8	—	—	210 lbs.	30.0
<ul style="list-style-type: none"> • Interlock mechanism allows only 1 drawer to be open at a time • Random lock core (KRB, KRS) and specified lock core (KS1B, KS1S) available • When specifying Horizon pulls, lateral files will have 2 pulls on each drawer front 									

WAVEWORKS

PRODUCT SPECIFICATIONS

- Wood and laminate doors/drawers and chassis available; refer to page 336 for options
- Refer to page 341 for filing capabilities
- If specifying wood, you must specify the same finish for all options
- Wood drawers feature dowel construction
- Wood drawers feature sides and backs that are ½" thick, bottoms are ¼" thick with veneer faces that are sealed and finished with a clear coat

TO ORDER, SPECIFY:

1. Model Number
2. Rim
3. Rim Color (laminite units only)
4. Pull
5. Locking
6. Top Finish (laminite units only)
7. Drawer Finish (laminite units only)
8. Chassis Finish

SAMPLE MODEL NUMBERS:

WWN2436PF33W C 7MB KS1B MC
 WWN2436PF33L VMH 7MB KS1B 480 480
 WWN2436PF33LW V 440 7MB KS1B MH

• See pages 334-339 for all options available in WaveWorks

LATERAL FILE 4 DRAWER



MODEL NO./DESCRIPTION

1 1/8" TOP THICKNESS

MODEL NO./DESCRIPTION	LIST PRICE
WWN2436LFF4W Wood	\$ 4123
WWN2436LFF4LW Laminate/Wood	4123
WWN2436LFF4L Laminate	2606

1 3/8" TOP THICKNESS

MODEL NO./DESCRIPTION	LIST PRICE
WW2436LFF4W Wood	\$ 3744
WW2436LFF4LW Laminate/Wood	3744
WW2436LFF4L Laminate	2371
WW2436LFF4LL TFL	1897

DIMENSIONS

D	W	H	A	KW	CARTONED WEIGHT	CUBIC FEET
24	36 1/16	54 7/16	—	—	265 lbs.	33.4
24	36 1/16	54 7/16	—	—	265 lbs.	33.4
24	36 1/16	54 7/16	—	—	265 lbs.	33.4
24	36 1/16	54 7/16	—	—	265 lbs.	33.4
24	36 1/16	54 7/16	—	—	265 lbs.	33.4
24	36 1/16	54	—	—	265 lbs.	33.4

- Interlock mechanism allows only 1 drawer to be open at a time
- Random lock core (KRB, KRS) and specified lock core (KS1B, KS1S) available
- When specifying Horizon pulls, lateral files will have 2 pulls on each drawer front
- Wood drawers can be specified on 1 3/8" Wood models; add a "W" to the end of the model number and add \$496 to the list price

MIXED STORAGE CABINET

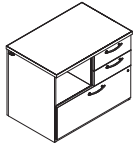

Left shown

1 1/8" TOP THICKNESS

OPEN STORAGE ON LEFT

OPEN STORAGE ON RIGHT

MODEL NO./DESCRIPTION	LIST PRICE
WWN2436PF33W Wood	\$ 2887
WWN2436PF33LW Lam/Wood	2887
WWN2436PF33L Laminate	1860

1 3/8" TOP THICKNESS

OPEN STORAGE ON LEFT

OPEN STORAGE ON RIGHT

MODEL NO./DESCRIPTION	LIST PRICE
WW2436PF33W Wood	\$ 2654
WW2436PF33LW Lam/Wood	2654
WW2436PF33L Laminate	1706
WW2436PF33LL TFL	1364

D	W	H	A	KW	CARTONED WEIGHT	CUBIC FEET
24	36 1/16	29 3/8	—	—	130 lbs.	22.2
24	36 1/16	29 3/8	—	—	130 lbs.	22.2
24	36 1/16	29 3/8	—	—	130 lbs.	22.2
24	36 1/16	28 1/8	—	—	130 lbs.	22.2
24	36 1/16	28 1/8	—	—	130 lbs.	22.2
24	36 1/16	28 1/8	—	—	130 lbs.	22.2

- Interior dimensions of open storage are 16 3/4" W, 12" H
- Locking only on lateral file
- Random lock core (KRB, KRS) and specified lock core (KS1B, KS1S) available
- When specifying Horizon pulls, lateral files will have 2 pulls on each drawer front

PRODUCT SPECIFICATIONS

- Wood and laminate doors/drawers and chassis available; refer to page 336 for options
- Refer to page 341 for filing capabilities
- If specifying wood, you must specify the same finish for all options
- Wood drawers feature dowel construction
- Wood drawers feature sides and backs that are ½" thick, bottoms are ¼" thick with veneer faces that are sealed and finished with a clear coat

TO ORDER, SPECIFY:

1. Model Number
2. Rim
3. Rim Color (laminite units only)
4. Pull
5. Locking
6. Top Finish (laminite units only)
7. Drawer Finish (laminite units only)
8. Chassis Finish

SAMPLE MODEL NUMBERS:

WW2436PFHW C 7MB KS1B MC
 WW2436PFHL VMH 7MB KS1B 480 480
 WW2436PFHLW V 440 7MB KS1B MH

• See pages 334-339 for all options available in WaveWorks

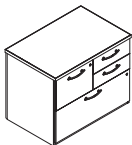
	MODEL NO./DESCRIPTION	LIST PRICE	DIMENSIONS					CARTONED WEIGHT	CUBIC FEET		
			D	W	H	A	KW				
 <p>Left shown</p>	1 ½" TOP THICKNESS										
	FILE DRAWER ON LEFT	FILE DRAWER ON RIGHT									
	WWN2436PF11W	WWN2436PF10W	Wood	\$ 3351	24	36 7/16	29 3/8	—	—	130 lbs.	22.2
	WWN2436PF11LW	WWN2436PF10LW	Lam/Wood	3351	24	36 7/16	29 3/8	—	—	130 lbs.	22.2
	WWN2436PF11L	WWN2436PF10L	Laminite	2329	24	36 7/16	29 3/8	—	—	130 lbs.	22.2
	1 ½" TOP THICKNESS										
	FILE DRAWER ON LEFT	FILE DRAWER ON RIGHT									
	WW2436PF11W	WW2436PF10W	Wood	\$ 3120	24	36 7/16	28 1/16	—	—	130 lbs.	22.2
	WW2436PF11LW	WW2436PF10LW	Lam/Wood	3120	24	36 7/16	28 1/16	—	—	130 lbs.	22.2
WW2436PF11L	WW2436PF10L	Laminite	2176	24	36 7/16	28 1/16	—	—	130 lbs.	22.2	
WW2436PF11LL	WW2436PF10LL	TFL	1741	24	36 7/16	28 3/8	—	—	130 lbs.	22.2	

- Locking only on file drawer and lateral file
- Random lock core (KRB, KRS) and specified lock core (KS2B, KS2S) available
- When specifying Horizon pulls, lateral files will have 2 pulls on each drawer front

DOUBLE DOOR UNIT

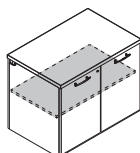

1 ½" TOP THICKNESS									
WWN2436PFHW	Wood	\$ 2448	24	36 7/16	29 3/8	—	—	130 lbs.	22.2
WWN2436PFHLW	Laminite/Wood	2448	24	36 7/16	29 3/8	—	—	130 lbs.	22.2
WWN2436PFHL	Laminite	1425	24	36 7/16	29 3/8	—	—	130 lbs.	22.2
1 ½" TOP THICKNESS									
WW2436PFHW	Wood	\$ 2224	24	36 7/16	28 1/16	—	—	130 lbs.	22.2
WW2436PFHLW	Laminite/Wood	2224	24	36 7/16	28 1/16	—	—	130 lbs.	22.2
WW2436PFHL	Laminite	1297	24	36 7/16	28 1/16	—	—	130 lbs.	22.2
WW2436PFHLL	TFL	1037	24	36 7/16	28 3/8	—	—	130 lbs.	22.2

- Features an adjustable shelf
- Unit features a 110° door hinge
- Random lock core (KRB, KRS) and specified lock core (KS1B, KS1S) available

WAVEWORKS

PRODUCT SPECIFICATIONS

- Wood drawers feature dowel construction
- Wood drawers feature sides and backs that are ½" thick, bottoms are ¼" thick with veneer faces that are sealed and finished with a clear coat

TO ORDER, SPECIFY:

1. Model Number
2. Pull
3. Grommet
4. Locking
5. Laminate Door Color
6. Finish/Laminate Chassis Color

SAMPLE MODEL NUMBERS:

WW301853VPO1LW	6CC	G37PB	KRB	405	MH
WW301853VPO1LL	61R	X	KRB	405	MH
WW0653VSSPW	X		405		
WW0653VSSPL	CT1		405		

- See pages 334-339 for all options available in WaveWorks

MODEL NO./DESCRIPTION	LIST PRICE	DIMENSIONS					CARTONED WEIGHT	CUBIC FEET	
		D	W	H	A	KW			
PULLOUT STORAGE									
									
30" DEPTH									
LEFT			RIGHT						
WW301853VPO1LW	WW301853VPO1RW	Wood	\$ 4769	29½	17½	52½	—	—	lbs.
WW301853VPO1LL	WW301853VPO1RL	Laminate	3380	29½	17½	52½	—	—	lbs.
<hr/>									
WW301841VPO1LW	WW301841VPO1RW	Wood	\$ 4553	29½	17½	40½	—	—	lbs.
WW301841VPO1LL	WW301841VPO1RL	Laminate	3164	29½	17½	40½	—	—	lbs.
<hr/>									
24" DEPTH									
LEFT			RIGHT						
WW241853VPO1LW	WW241853VPO1RW	Wood	\$ 4337	23½	17½	52½	—	—	lbs.
WW241853VPO1LL	WW241853VPO1RL	Laminate	2947	23½	17½	52½	—	—	lbs.
<hr/>									
WW241841VPO1LW	WW241841VPO1RW	Wood	\$ 4120	23½	17½	40½	—	—	lbs.
WW241841VPO1LL	WW241841VPO1RL	Laminate	2731	23½	17½	40½	—	—	lbs.
<hr/>									
<ul style="list-style-type: none"> • See pages for component top for pullout storage pages 497-498 • Random lock core (KRB, KRS) and specified lock core (KS1B, KS1S) available • All WaveWorks pull options available with exception of Horizon • 1 coathook • 2 adjustable shelves • 1 full shelf at top where electrical is mounted 									

PULLOUT STORAGE SPACER

								
WW0653VSSPW	Wood	\$ 712	6	17½	52½	—	—	lbs.
WW0653VSSPL	Laminate	442	6	17½	52½	—	—	lbs.
<hr/>								
WW0641VSSPW	Wood	\$ 699	6	17½	40½	—	—	lbs.
WW0641VSSPL	Laminate	428	6	17½	40½	—	—	lbs.
<hr/>								
WW1253VSSPW	Wood	\$ 1426	11½	17½	52½	—	—	lbs.
WW1253VSSPL	Laminate	885	11½	17½	52½	—	—	lbs.
<hr/>								
WW1241VSSPW	Wood	\$ 1398	11½	17½	40½	—	—	lbs.
WW1241VSSPL	Laminate	857	11½	17½	40½	—	—	lbs.
<hr/>								
<ul style="list-style-type: none"> • Specify spacer to pass thru electrical when ganging 2 pullout storage back to back • Specify grommet cutout option and finish/laminate only • Can be used with Alloy 								

PRODUCT SPECIFICATIONS

- Wood, laminate or glass doors and wood or laminate chassis available; refer to page 336 for options
- Refer to page 341 for filing capabilities
- If specifying wood, you must specify the same finish for all options

TO ORDER, SPECIFY:

1. Model Number
2. Locking
3. Door Frame Color (glass door models)
4. Veneer Door Finish/Laminate Door Color (laminate/combo models)
5. Veneer Chassis Finish/
Laminate Chassis Color

SAMPLE MODEL NUMBERS:

WWN1880VSWHLW	KRB	MH	
WWN1880VSWHLL	KRB	405	405
WWN1880VSWHLGW	503	MH	
WWN1880VSWHLGL	503	405	

• See pages 334-339 for all options available in WaveWorks

**WARDROBE/STORAGE CABINET
SINGLE DOOR**

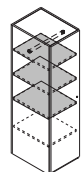
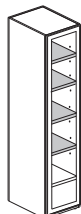

Left shown

MODEL NO./DESCRIPTION	LIST PRICE	DIMENSIONS					CARTONED CUBIC WEIGHT	CUBIC FEET			
		D	W	H	A	KW					
INTENDED FOR USE WITH 1 1/8" THICK WORKSURFACE MODELS											
LEFT HINGED			RIGHT HINGED								
WWN1880VSWHLGW		WWN1880VSWHRGW	Glass/Wood	\$ 3817	23 3/16	17 1/16	79 1/16	—	—	197 lbs.	31.0
WWN1880VSWHLGL		WWN1880VSWHRGL	Glass/Lam	2450	23 3/16	17 1/16	79 1/16	—	—	197 lbs.	31.0
WWN1880VSWHLW		WWN1880VSWHRW	Wood	2930	23 3/16	17 1/16	79 1/16	—	—	197 lbs.	31.0
WWN1880VSWHLL		WWN1880VSWHRL	Laminate	1659	23 3/16	17 1/16	79 1/16	—	—	197 lbs.	31.0
INTENDED FOR USE WITH 1 1/8" THICK WORKSURFACE MODELS											
WWN1869VSWHLGW	\$ 3333	WWN1869VSWHRGW	Glass/Wood		23 3/16	17 1/16	67 1/4	—	—	160 lbs.	26.7
WWN1869VSWHLGL	2139	WWN1869VSWHRGL	Glass/Lam		23 3/16	17 1/16	67 1/4	—	—	160 lbs.	26.7
WWN1869VSWHLW	2570	WWN1869VSWHRW	Wood		23 3/16	17 1/16	67 1/4	—	—	160 lbs.	26.7
WWN1869VSWHLL	1456	WWN1869VSWHRL	Laminate		23 3/16	17 1/16	67 1/4	—	—	160 lbs.	26.7
INTENDED FOR USE WITH 1 1/8" THICK WORKSURFACE MODELS											
LEFT HINGED			RIGHT HINGED								
WW1879VSWHLGW	\$ 3817	WW1879VSWHRGW	Glass/Wood		23 3/16	17 1/16	79 1/4	—	—	197 lbs.	31.0
WW1879VSWHLGL	2450	WW1879VSWHRGL	Glass/Lam		23 3/16	17 1/16	79 1/4	—	—	197 lbs.	31.0
WW1879VSWHLW	2930	WW1879VSWHRW	Wood		23 3/16	17 1/16	79 1/4	—	—	197 lbs.	31.0
WW1879VSWHLL	1659	WW1879VSWHRL	Laminate		23 3/16	17 1/16	79 1/4	—	—	197 lbs.	31.0
WW1868VSWHLGW	\$ 3333	WW1868VSWHRGW	Glass/Wood		23 3/16	17 1/16	66 7/8	—	—	160 lbs.	26.7
WW1868VSWHLGL	2139	WW1868VSWHRGL	Glass/Lam		23 3/16	17 1/16	66 7/8	—	—	160 lbs.	26.7
WW1868VSWHLW	2570	WW1868VSWHRW	Wood		23 3/16	17 1/16	66 7/8	—	—	160 lbs.	26.7
WW1868VSWHLL	1456	WW1868VSWHRL	Laminate		23 3/16	17 1/16	66 7/8	—	—	160 lbs.	26.7

- Can be used as a wardrobe unit by removing adjustable shelves
- Removable coat rod standard
- Shaded shelves are adjustable, 1868 and 1869 models have 1 fixed shelf and 3 adjustable shelves, 1879 and 1880 models have 1 fixed shelf and 4 adjustable shelves
- Glass doors do not lock
- Random lock core (KRB, KRS) and specified lock core (KS1B, KS1S) available
- Almond Horizontal (ADH), Portobello Horizontal (PBH), Portico Horizontal (PTH), Skyline Horizontal (SKH), Sonoma Horizontal (SMH), Designer White Linear Horizontal (491H), Cinder Linear Horizontal (492H) and Sable Horizontal (792H) laminate options available on models 60" H or less

WAVEWORKS

PRODUCT SPECIFICATIONS

- Wood, laminate or glass doors and wood or laminate chassis available; refer to page 336 for options
- Refer to page 341 for filing capabilities
- If specifying wood, you must specify the same finish for all options

TO ORDER, SPECIFY:

1. Model Number
2. Locking
3. Door Frame Color (glass door models)
4. Veneer Door Finish/Laminate Door Color (laminate/combo models)
5. Veneer Chassis Finish/Laminate Chassis Color

SAMPLE MODEL NUMBERS:

WWN1880VSHLW	KRB	MH
WWN1880VSHLL	KRB	405
WWN1880VSHLGW	503	MH
WWN1880VSHLGL	503	405

- See pages 334-339 for all options available in WaveWorks

MEDIA STORAGE TOWER SINGLE DOOR

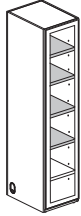

MODEL NO./DESCRIPTION	LIST PRICE	DIMENSIONS					CARTONED CUBIC	
		D	W	H	A	KW	WEIGHT	FEET
LEFT HINGED								
RIGHT HINGED								
WWN1880VSHLW	\$ 3122	23 ³ / ₁₆	17 ¹ / ₁₆	79 ³ / ₄	—	—	197 lbs.	31.0
WWN1880VSHLL	1854	23 ³ / ₁₆	17 ¹ / ₁₆	79 ³ / ₄	—	—	197 lbs.	31.0
WWN1880VSHLGW	4011	23 ³ / ₁₆	17 ¹ / ₁₆	79 ³ / ₄	—	—	197 lbs.	31.0
WWN1880VSHLGL	2645	23 ³ / ₁₆	17 ¹ / ₁₆	79 ³ / ₄	—	—	197 lbs.	31.0

- Glass units feature opaque glass with aluminum frame
- Shaded shelves are adjustable 1 fixed and 4 adjustable shelves
- Shortened shelves allow for easy wire access in the back of the cabinet
- Features grommets in end panels for wire access
- Glass doors do not lock
- Random lock core (KRB, KRS) and specified lock core (KS1B, KS1S) available
- Almond Horizontal (ADH), Portobello Horizontal (PBH), Portico Horizontal (PTH), Skyline Horizontal (SKH), Sonoma Horizontal (SMH), Designer White Linear Horizontal (491H), Cinder Linear Horizontal (492H) and Sable Horizontal (792H) laminate options available on models 60" H or less

STORAGE/WARDROBE WITH FILE/FILE PEDESTAL



Left shown

INTENDED FOR USE WITH 1³/₁₆" THICK WORKSURFACE MODELS

MODEL NO./DESCRIPTION	LIST PRICE	DIMENSIONS					CARTONED CUBIC	
		D	W	H	A	KW	WEIGHT	FEET
LEFT HINGED								
RIGHT HINGED								
WWN2480VHHL2W	\$ 4000	23 ³ / ₁₆	24	79 ¹ / ₁₆	—	—	250 lbs.	31.3
WWN2480VHHL2L	2539	23 ³ / ₁₆	24	79 ¹ / ₁₆	—	—	250 lbs.	31.3
WWN2469VHHL2W	\$ 3629	23 ³ / ₁₆	24	67 ³ / ₄	—	—	213 lbs.	27.0
WWN2469VHHL2L	2330	23 ³ / ₁₆	24	67 ³ / ₄	—	—	213 lbs.	27.0

INTENDED FOR USE WITH 1³/₁₆" THICK WORKSURFACE MODELS

MODEL NO./DESCRIPTION	LIST PRICE	DIMENSIONS					CARTONED CUBIC	
		D	W	H	A	KW	WEIGHT	FEET
LEFT HINGED								
RIGHT HINGED								
WW2479VHHL2W	\$ 4000	23 ³ / ₁₆	24	79 ³ / ₄	—	—	250 lbs.	31.3
WW2479VHHL2L	2539	23 ³ / ₁₆	24	79 ³ / ₄	—	—	250 lbs.	31.3
WW2468VHHL2W	\$ 3629	23 ³ / ₁₆	24	66 ⁷ / ₈	—	—	213 lbs.	27.0
WW2468VHHL2L	2330	23 ³ / ₁₆	24	66 ⁷ / ₈	—	—	213 lbs.	27.0

- Removable coat rod is standard
- Storage cabinet contains 2 adjustable shelves in 2468 and 2469 models and 3 adjustable shelves in the 2479 and 2480 models
- Wardrobe door is 5¹/₂" wide, interior width is 5"
- Random lock core (KRB, KRS) and specified lock core (KS2B, KS2S) available
- Almond Horizontal (ADH), Portobello Horizontal (PBH), Portico Horizontal (PTH), Skyline Horizontal (SKH), Sonoma Horizontal (SMH), Designer White Linear Horizontal (491H), Cinder Linear Horizontal (492H) and Sable Horizontal (792H) laminate options available on models 60" H or less

PRODUCT SPECIFICATIONS

- Wood and laminate doors/drawers and chassis available; refer to page 336 for options
- Refer to page 341 for filing capabilities
- If specifying wood, you must specify the same finish for all options

TO ORDER, SPECIFY:

1. Model Number
2. Pull
3. Locking
4. Veneer Door Finish/Laminate Door Color (laminate/combo models)
5. Veneer Chassis Finish/Laminate Chassis Color

SAMPLE MODEL NUMBERS:

WWN2480VBWHL2W 7SN KS1B HN
 WWN2480VBWHL2L 7SN KS1B 461 461

- See pages 334-339 for all options available in WaveWorks

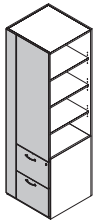
	MODEL NO./DESCRIPTION		LIST PRICE	DIMENSIONS					CARTONED CUBIC WEIGHT	CUBIC FEET	
				D	W	H	A	KW			
STORAGE SIDE BOOKCASE/WARDROBE WITH FILE/FILE PEDESTAL  Left shown with Wood/Laminate	INTENDED FOR USE WITH 1 1/4" THICK WORKSURFACE MODELS										
		LEFT HINGED	RIGHT HINGED								
	WWN2480VBWHL2W	WWN2480VBWHR2W	Wood	\$ 4191	23 3/16	24	79 1/16	—	—	250 lbs.	31.3
	WWN2480VBWHL2L	WWN2480VBWHR2L	Laminate	2733	23 3/16	24	79 1/16	—	—	250 lbs.	31.3
	WWN2469VBWHL2W	WWN2469VBWHR2W	Wood	\$ 3821	23 3/16	24	67 1/4	—	—	213 lbs.	27.0
	WWN2469VBWHL2L	WWN2469VBWHR2L	Laminate	2524	23 3/16	24	67 1/4	—	—	213 lbs.	27.0
	INTENDED FOR USE WITH 1 1/4" THICK WORKSURFACE MODELS										
		LEFT HINGED	RIGHT HINGED								
	WW2479VBWHL2W	WW2479VBWHR2W	Wood	\$ 4191	23 3/16	24	79 3/4	—	—	250 lbs.	31.3
	WW2479VBWHL2L	WW2479VBWHR2L	Laminate	2733	23 3/16	24	79 3/4	—	—	250 lbs.	31.3
	WW2468VBWHL2W	WW2468VBWHR2W	Wood	\$ 3821	23 3/16	24	66 3/8	—	—	213 lbs.	27.0
	WW2468VBWHL2L	WW2468VBWHR2L	Laminate	2524	23 3/16	24	66 3/8	—	—	213 lbs.	27.0

- Removable coat rod is standard
- Open bookcase contains 2 adjustable shelves in 2468 and 2469 models and 3 adjustable shelves in the 2479 and 2480 models
- Wardrobe door is 5 1/2" wide, interior width is 5"
- Random lock core (KRB, KRS) and specified lock core (KS1B, KS1S) available
- Wardrobe door features a standard pull
- Almond Horizontal (ADH), Portobello Horizontal (PBH), Portico Horizontal (PTH), Skyline Horizontal (SKH), Sonoma Horizontal (SMH), Designer White Linear Horizontal (491H), Cinder Linear Horizontal (492H) and Sable Horizontal (792H) laminate options available on models 60" H or less

WAVEWORKS

PRODUCT SPECIFICATIONS

- Wood, laminate or glass doors and wood or laminate drawer fronts and chassis available; refer to page 336 for options
- Refer to page 341 for filing capabilities
- If specifying wood, you must specify the same finish for all options

TO ORDER, SPECIFY:

1. Model Number
2. Pull
3. Locking
4. Veneer Door-Drawer Finish/Laminate Door-Drawer Color (laminate/combo models)
5. Veneer Chassis Finish/Laminate Chassis Color

SAMPLE MODEL NUMBERS:

WWN1880VBL2W 7SN KS1B HN
 WWN1880VBR2L 7SN KS1B 461 461

- See pages 334-339 for all options available in WaveWorks

MODEL NO./DESCRIPTION	LIST PRICE	DIMENSIONS					CARTONED WEIGHT	CUBIC FEET
		D	W	H	A	KW		
STORAGE SIDE BOOKCASE WITH FILE/FILE PEDESTAL								
INTENDED FOR USE WITH 1⁵/₁₆" THICK WORKSURFACE MODELS								
LEFT UNIT								
WWN1880VBL2W	Wood \$ 3170	23 ³ / ₁₆	17 ¹ / ₁₆	79 ¹ / ₁₆	—	—	207 lbs.	31.0
WWN1880VBL2L	Laminate 1864	23 ³ / ₁₆	17 ¹ / ₁₆	79 ¹ / ₁₆	—	—	207 lbs.	31.0
RIGHT UNIT								
WWN1869VBL2W	Wood \$ 2802	23 ³ / ₁₆	17 ¹ / ₁₆	67 ¹ / ₄	—	—	175 lbs.	26.7
WWN1869VBL2L	Laminate 1659	23 ³ / ₁₆	17 ¹ / ₁₆	67 ¹ / ₄	—	—	175 lbs.	26.7
INTENDED FOR USE WITH 1⁵/₁₆" THICK WORKSURFACE MODELS								
LEFT UNIT								
WW1879VBL2W	Wood \$ 3170	23 ³ / ₁₆	17 ¹ / ₁₆	79 ¹ / ₄	—	—	207 lbs.	31.0
WW1879VBL2L	Laminate 1864	23 ³ / ₁₆	17 ¹ / ₁₆	79 ¹ / ₄	—	—	207 lbs.	31.0
RIGHT UNIT								
WW1868VBL2W	Wood \$ 2802	23 ³ / ₁₆	17 ¹ / ₁₆	66 ⁷ / ₈	—	—	175 lbs.	26.7
WW1868VBL2L	Laminate 1659	23 ³ / ₁₆	17 ¹ / ₁₆	66 ⁷ / ₈	—	—	175 lbs.	26.7

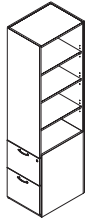

Left shown

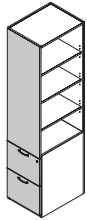

Left shown with Wood/Laminate

- Open bookcase contains 2 adjustable shelves in 1868 and 1869 models and 3 adjustable shelves in the 1879 and 1880 models
- Shaded area denotes wood drawer fronts and wood panel
- Random lock core (KRB, KRS) and specified lock core (KS1B, KS1S) available
- Almond Horizontal (ADH), Portobello Horizontal (PBH), Portico Horizontal (PTH), Skyline Horizontal (SKH), Sonoma Horizontal (SMH), Designer White Linear Horizontal (491H), Cinder Linear Horizontal (492H) and Sable Horizontal (792H) laminate options available on models 60" H or less

PRODUCT SPECIFICATIONS

- Wood, laminate or glass doors and wood or laminate drawer fronts and chassis available; refer to page 336 for options
- Refer to page 341 for filing capabilities
- If specifying wood, you must specify the same finish for all options

TO ORDER, SPECIFY:

1. Model Number
2. Locking
3. Door Frame Color (glass door models)
4. Veneer Door-Drawer Finish/Laminate Door-Drawer Color (laminate/combo models)
5. Veneer Chassis Finish/Laminate Chassis Color

SAMPLE MODEL NUMBERS:

WW3680VSWHGW 501 MH
 WW3680VSWHW KS1B MH
 WW3680VSWHL KS1B MH MH

- See pages 334-339 for all options available in WaveWorks

MODEL NO./DESCRIPTION	LIST PRICE	DIMENSIONS					CARTONED WEIGHT	CUBIC FEET
		D	W	H	A	KW		
WARDROBE/STORAGE CABINET DOUBLE DOOR								
INTENDED FOR USE WITH 1⁵/₁₆" THICK WORKSURFACE MODELS								
WWN3680VSWHGW Glass/Wood	\$ 6177	23 ³ / ₁₆	35 ³ / ₈	79 ¹ / ₁₆	—	—	345 lbs.	51.4
WWN3680VSWHGL Glass/Laminate	3967	23 ³ / ₁₆	35 ³ / ₈	79 ¹ / ₁₆	—	—	345 lbs.	51.4
WWN3680VSWHW Wood	5861	23 ³ / ₁₆	35 ³ / ₈	79 ¹ / ₁₆	—	—	345 lbs.	51.4
WWN3680VSWHL Laminate	3318	23 ³ / ₁₆	35 ³ / ₈	79 ¹ / ₁₆	—	—	345 lbs.	51.4
INTENDED FOR USE WITH 1⁵/₁₆" THICK WORKSURFACE MODELS								
WWN3669VSWHGW Glass/Wood	\$ 5355	23 ³ / ₁₆	35 ³ / ₈	67 ¹ / ₄	—	—	160 lbs.	44.1
WWN3669VSWHGL Glass/Laminate	3437	23 ³ / ₁₆	35 ³ / ₈	67 ¹ / ₄	—	—	160 lbs.	44.1
WWN3669VSWHW Wood	5140	23 ³ / ₁₆	35 ³ / ₈	67 ¹ / ₄	—	—	160 lbs.	44.1
WWN3669VSWHL Laminate	2910	23 ³ / ₁₆	35 ³ / ₈	67 ¹ / ₄	—	—	160 lbs.	44.1
INTENDED FOR USE WITH 1⁵/₁₆" THICK WORKSURFACE MODELS								
WW3679VSWHGW Glass/Wood	\$ 6177	23 ³ / ₁₆	35 ³ / ₈	79 ¹ / ₄	—	—	345 lbs.	51.4
WW3679VSWHGL Glass/Laminate	3967	23 ³ / ₁₆	35 ³ / ₈	79 ¹ / ₄	—	—	345 lbs.	51.4
WW3679VSWHW Wood	5861	23 ³ / ₁₆	35 ³ / ₈	79 ¹ / ₄	—	—	345 lbs.	51.4
WW3679VSWHL Laminate	3318	23 ³ / ₁₆	35 ³ / ₈	79 ¹ / ₄	—	—	345 lbs.	51.4
INTENDED FOR USE WITH 1⁵/₁₆" THICK WORKSURFACE MODELS								
WW3668VSWHGW Glass/Wood	\$ 5355	23 ³ / ₁₆	35 ³ / ₈	66 ³ / ₈	—	—	160 lbs.	44.1
WW3668VSWHGL Glass/Laminate	3437	23 ³ / ₁₆	35 ³ / ₈	66 ³ / ₈	—	—	160 lbs.	44.1
WW3668VSWHW Wood	5140	23 ³ / ₁₆	35 ³ / ₈	66 ³ / ₈	—	—	160 lbs.	44.1
WW3668VSWHL Laminate	2910	23 ³ / ₁₆	35 ³ / ₈	66 ³ / ₈	—	—	160 lbs.	44.1

WARDROBE/STORAGE CABINET DOUBLE DOOR

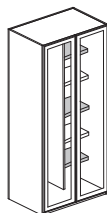

- Coat rod standard
- Shaded shelves are adjustable, 3668 and 3669 models have 1 fixed and 3 adjustable shelves, 3679 and 3680 models have 2 fixed and 3 adjustable shelves
- Glass doors do not lock
- Random lock core (KRB, KRS) and specified lock core (KS1B, KS1S) available
- Almond Horizontal (ADH), Portobello Horizontal (PBH), Portico Horizontal (PTH), Skyline Horizontal (SKH), Sonoma Horizontal (SMH), Designer White Linear Horizontal (491H), Cinder Linear Horizontal (492H) and Sable Horizontal (792H) laminate options available on models 60" H or less

WAVEWORKS

PRODUCT SPECIFICATIONS

- Wood, laminate or glass doors and wood or laminate drawer fronts and chassis available; refer to page 336 for options
- Refer to page 341 for filing capabilities
- If specifying wood, you must specify the same finish for all options

TO ORDER, SPECIFY:

1. Model Number
2. Locking
3. Door Frame Color (glass door models)
4. Veneer Door-Drawer Finish/Laminate Door-Drawer Color (laminate/combo models)
5. Veneer Chassis Finish/Laminate Chassis Color

SAMPLE MODEL NUMBERS:

WWN3680VSHGW 501 MH
 WWN3680VSHW KS1B MH
 WWN3680VSHL KS1B MH MH

- See pages 334-339 for all options available in WaveWorks

DOUBLE DOOR STORAGE CABINET

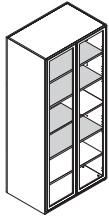
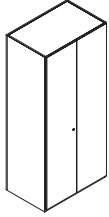

MODEL NO./DESCRIPTION	LIST PRICE	DIMENSIONS					CARTONED WEIGHT	CUBIC FEET
		D	W	H	A	KW		
INTENDED FOR USE WITH 1⁵/₁₆" THICK WORKSURFACE MODELS								
WWN3680VSHGW Glass/Wood	\$ 5740	23 ³ / ₁₆	35 ³ / ₈	79 ¹ / ₁₆	—	—	345 lbs.	51.4
WWN3680VSHGL Glass/Laminate	3520	23 ³ / ₁₆	35 ³ / ₈	79 ¹ / ₁₆	—	—	345 lbs.	51.4
WWN3680VSHW Wood	5420	23 ³ / ₁₆	35 ³ / ₈	79 ¹ / ₁₆	—	—	345 lbs.	51.4
WWN3680VSHL Laminate	2874	23 ³ / ₁₆	35 ³ / ₈	79 ¹ / ₁₆	—	—	345 lbs.	51.4
INTENDED FOR USE WITH 1⁵/₁₆" THICK WORKSURFACE MODELS								
WWN3669VSHGW Glass/Wood	\$ 4917	23 ³ / ₁₆	35 ³ / ₈	67 ¹ / ₄	—	—	160 lbs.	44.1
WWN3669VSHGL Glass/Laminate	2995	23 ³ / ₁₆	35 ³ / ₈	67 ¹ / ₄	—	—	160 lbs.	44.1
WWN3669VSHW Wood	4704	23 ³ / ₁₆	35 ³ / ₈	67 ¹ / ₄	—	—	160 lbs.	44.1
WWN3669VSHL Laminate	2467	23 ³ / ₁₆	35 ³ / ₈	67 ¹ / ₄	—	—	160 lbs.	44.1
INTENDED FOR USE WITH 1⁵/₁₆" THICK WORKSURFACE MODELS								
WW3679VSHGW Glass/Wood	\$ 5740	23 ³ / ₁₆	35 ³ / ₈	79 ¹ / ₄	—	—	345 lbs.	51.4
WW3679VSHGL Glass/Laminate	3520	23 ³ / ₁₆	35 ³ / ₈	79 ¹ / ₄	—	—	345 lbs.	51.4
WW3679VSHW Wood	5420	23 ³ / ₁₆	35 ³ / ₈	79 ¹ / ₄	—	—	345 lbs.	51.4
WW3679VSHL Laminate	2874	23 ³ / ₁₆	35 ³ / ₈	79 ¹ / ₄	—	—	345 lbs.	51.4
INTENDED FOR USE WITH 1⁵/₁₆" THICK WORKSURFACE MODELS								
WW3668VSHGW Glass/Wood	\$ 4917	23 ³ / ₁₆	35 ³ / ₈	66 ³ / ₈	—	—	160 lbs.	44.1
WW3668VSHGL Glass/Laminate	2995	23 ³ / ₁₆	35 ³ / ₈	66 ³ / ₈	—	—	160 lbs.	44.1
WW3668VSHW Wood	4704	23 ³ / ₁₆	35 ³ / ₈	66 ³ / ₈	—	—	160 lbs.	44.1
WW3668VSHL Laminate	2467	23 ³ / ₁₆	35 ³ / ₈	66 ³ / ₈	—	—	160 lbs.	44.1

- 3668 and 3669 models have 2 fixed and 2 adjustable shelves, 3679 and 3680 models have 2 fixed and 3 adjustable shelves
- Units includes shelves from top to bottom, see above bullet for correct number of shelves according to size
- Glass doors do not lock
- Random lock core (KRB, KRS) and specified lock core (KS1B, KS1S) available
- Almond Horizontal (ADH), Portobello Horizontal (PBH), Portico Horizontal (PTH), Skyline Horizontal (SKH), Sonoma Horizontal (SMH), Designer White Linear Horizontal (491H), Cinder Linear Horizontal (492H) and Sable Horizontal (792H) laminate options available on models 60" H or less

PRODUCT SPECIFICATIONS

- Wood, laminate or glass doors and wood or laminate drawer fronts and chassis available; refer to page 336 for options
- Refer to page 341 for filing capabilities
- If specifying wood, you must specify the same finish for all options

TO ORDER, SPECIFY:

1. Model Number
2. Pull
3. Locking
4. Door Frame Color (glass door models)
5. Veneer Door-Drawer Finish/Laminate Door-Drawer Color (laminate/combo models)
6. Veneer Chassis Finish/Laminate Chassis Color

SAMPLE MODEL NUMBERS:

WWN3680VHF2GW 501 MH
 WWN3680VHF2W KS1B MH
 WWN3680VHF2L KS1B MH MH

- See pages 334-339 for all options available in WaveWorks

STORAGE/LATERAL FILE CABINET

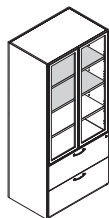
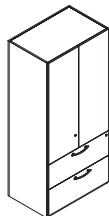

MODEL NO./DESCRIPTION	LIST PRICE	DIMENSIONS					CARTONED WEIGHT	CUBIC FEET
		D	W	H	A	KW		
INTENDED FOR USE WITH 1 3/8" THICK WORKSURFACE MODELS								
WWN3680VHF2GW Glass/Wood	\$ 5870	23 3/16	35 3/8	79 1/16	—	—	345 lbs.	56.5
WWN3680VHF2GL Glass/Laminate	3606	23 3/16	35 3/8	79 1/16	—	—	345 lbs.	56.5
WWN3680VHF2W Wood	5501	23 3/16	35 3/8	79 1/16	—	—	345 lbs.	56.5
WWN3680VHF2L Laminate	2920	23 3/16	35 3/8	79 1/16	—	—	345 lbs.	56.5
INTENDED FOR USE WITH 1 3/8" THICK WORKSURFACE MODELS								
WWN3669VHF2GW Glass/Wood	\$ 5038	23 3/16	35 3/8	67 1/4	—	—	160 lbs.	48.6
WWN3669VHF2GL Glass/Laminate	3070	23 3/16	35 3/8	67 1/4	—	—	160 lbs.	48.6
WWN3669VHF2W Wood	4770	23 3/16	35 3/8	67 1/4	—	—	160 lbs.	48.6
WWN3669VHF2L Laminate	2508	23 3/16	35 3/8	67 1/4	—	—	160 lbs.	48.6
INTENDED FOR USE WITH 1 3/8" THICK WORKSURFACE MODELS								
WW3679VHF2GW Glass/Wood	\$ 5870	23 3/16	35 3/8	79 3/4	—	—	345 lbs.	56.5
WW3679VHF2GL Glass/Laminate	3606	23 3/16	35 3/8	79 3/4	—	—	345 lbs.	56.5
WW3679VHF2W Wood	5501	23 3/16	35 3/8	79 3/4	—	—	345 lbs.	56.5
WW3679VHF2L Laminate	2920	23 3/16	35 3/8	79 3/4	—	—	345 lbs.	56.5
INTENDED FOR USE WITH 1 3/8" THICK WORKSURFACE MODELS								
WW3668VHF2GW Glass/Wood	\$ 5038	23 3/16	35 3/8	66 3/8	—	—	160 lbs.	48.6
WW3668VHF2GL Glass/Laminate	3070	23 3/16	35 3/8	66 3/8	—	—	160 lbs.	48.6
WW3668VHF2W Wood	4770	23 3/16	35 3/8	66 3/8	—	—	160 lbs.	48.6
WW3668VHF2L Laminate	2508	23 3/16	35 3/8	66 3/8	—	—	160 lbs.	48.6

- 3679 and 3680 models have 1 fixed and 2 adjustable shelves, 3668 and 3669 models have 1 fixed and 1 adjustable shelf
- For glass/wood or glass/laminate units: random lock core (KRB, KRS) and specified lock core (KS1B, KS1S) available
- For wood, wood/laminate or laminate units: random lock core (KRB, KRS) and specified lock core (KS2B, KS2S) available
- When specifying Horizon pulls, lateral files will have 2 pulls on each drawer front
- Almond Horizontal (ADH), Portobello Horizontal (PBH), Portico Horizontal (PTH), Skyline Horizontal (SKH), Sonoma Horizontal (SMH), Designer White Linear Horizontal (491H), Cinder Linear Horizontal (492H) and Sable Horizontal (792H) laminate options available on models 60" H or less

WAVEWORKS

PRODUCT SPECIFICATIONS

- Wood, laminate or glass doors and wood or laminate drawer fronts and chassis available; refer to page 336 for options
- Refer to page 341 for filing capabilities
- Tops of units are finished with flat edge detail
- Adjustable hinged doors
- If specifying wood, you must specify the same finish for all options

TO ORDER, SPECIFY:

1. Model Number
2. Pull
3. Locking
4. Door Frame Color (glass door models)
5. Veneer Door-Drawer Finish/Laminate Door-Drawer Color (laminate/combo models)
6. Veneer Chassis Finish/Laminate Chassis Color

SAMPLE MODEL NUMBERS:

- | | | | |
|--------------|------|------|--------|
| WW1868VHL2GW | 75PL | 501 | MH |
| WW1868VHL2GL | 75PL | 501 | 480 |
| WW1868VHL2W | 75PL | KS2B | MH |
| WW1868VHL2L | 75PL | KS2B | 480 MH |
- See pages 334-339 for all options available in WaveWorks

STORAGE CABINET WITH FILE/FILE PEDESTAL

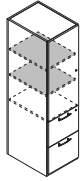
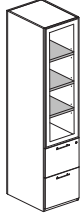

MODEL NO./DESCRIPTION		LIST PRICE	DIMENSIONS					CARTONED CUBIC	
			D	W	H	A	KW	WEIGHT	FEET
INTENDED FOR USE WITH 1⁵/₁₆" THICK WORKSURFACE MODELS									
LEFT HINGED					RIGHT HINGED				
WWN1880VHL2GW	WWN1880VHR2GW	Glass/Wood	\$ 3947	23 ³ / ₁₆	17 ¹ / ₁₆	79 ¹ / ₁₆	—	—	207 lbs. 31.0
WWN1880VHL2GL	WWN1880VHR2GL	Glass/Lam	2534	23 ³ / ₁₆	17 ¹ / ₁₆	79 ¹ / ₁₆	—	—	207 lbs. 31.0
WWN1880VHL2W	WWN1880VHR2W	Wood	3009	23 ³ / ₁₆	17 ¹ / ₁₆	79 ¹ / ₁₆	—	—	207 lbs. 31.0
WWN1880VHL2L	WWN1880VHR2L	Laminate	1705	23 ³ / ₁₆	17 ¹ / ₁₆	79 ¹ / ₁₆	—	—	207 lbs. 31.0
WWN1869VHL2GW	WWN1869VHR2GW	Glass/Wood	\$ 3454	23 ³ / ₁₆	17 ¹ / ₁₆	67 ¹ / ₄	—	—	175 lbs. 26.7
WWN1869VHL2GL	WWN1869VHR2GL	Glass/Lam	2215	23 ³ / ₁₆	17 ¹ / ₁₆	67 ¹ / ₄	—	—	175 lbs. 26.7
WWN1869VHL2W	WWN1869VHR2W	Wood	2641	23 ³ / ₁₆	17 ¹ / ₁₆	67 ¹ / ₄	—	—	175 lbs. 26.7
WWN1869VHL2L	WWN1869VHR2L	Laminate	1496	23 ³ / ₁₆	17 ¹ / ₁₆	67 ¹ / ₄	—	—	175 lbs. 26.7
INTENDED FOR USE WITH 1⁵/₁₆" THICK WORKSURFACE MODELS									
LEFT HINGED					RIGHT HINGED				
WW1879VHL2GW	WW1879VHR2GW	Glass/Wood	\$ 3947	23 ³ / ₁₆	17 ¹ / ₁₆	79 ¹ / ₄	—	—	207 lbs. 31.0
WW1879VHL2GL	WW1879VHR2GL	Glass/Lam	2534	23 ³ / ₁₆	17 ¹ / ₁₆	79 ¹ / ₄	—	—	207 lbs. 31.0
WW1879VHL2W	WW1879VHR2W	Wood	3009	23 ³ / ₁₆	17 ¹ / ₁₆	79 ¹ / ₄	—	—	207 lbs. 31.0
WW1879VHL2L	WW1879VHR2L	Laminate	1705	23 ³ / ₁₆	17 ¹ / ₁₆	79 ¹ / ₄	—	—	207 lbs. 31.0
WW1868VHL2GW	WW1868VHR2GW	Glass/Wood	\$ 3454	23 ³ / ₁₆	17 ¹ / ₁₆	66 ⁷ / ₈	—	—	175 lbs. 26.7
WW1868VHL2GL	WW1868VHR2GL	Glass/Lam	2215	23 ³ / ₁₆	17 ¹ / ₁₆	66 ⁷ / ₈	—	—	175 lbs. 26.7
WW1868VHL2W	WW1868VHR2W	Wood	2641	23 ³ / ₁₆	17 ¹ / ₁₆	66 ⁷ / ₈	—	—	175 lbs. 26.7
WW1868VHL2L	WW1868VHR2L	Laminate	1496	23 ³ / ₁₆	17 ¹ / ₁₆	66 ⁷ / ₈	—	—	175 lbs. 26.7

- Shaded shelves are adjustable
- 1879 and 1880 models include 3 adjustable shelves, 1868 and 1869 models include 2 adjustable shelves
- For glass/wood or glass/laminate units: random lock core (KRB, KRS) and specified lock core (KS1B, KS1S) available
- For wood, wood/laminate or laminate units: random lock core (KRB, KRS) and specified lock core (KS2B, KS2S) available
- Almond Horizontal (ADH), Portobello Horizontal (PBH), Portico Horizontal (PTH), Skyline Horizontal (SKH), Sonoma Horizontal (SMH), Designer White Linear Horizontal (491H), Cinder Linear Horizontal (492H) and Sable Horizontal (792H) laminate options available on models 60" H or less

PRODUCT SPECIFICATIONS

- Laminate only; refer to page 336 for options
- Tops of units are finished with flat edge detail
- Adjustable hinged doors

TO ORDER, SPECIFY:

1. Model Number
2. Pull
3. Locking
4. Laminate Door-Drawer Color
5. Laminate Chassis Color

SAMPLE MODEL NUMBER:

WW241879VPL1LL 87MB KS1B 461 PT
 • See pages 334-339 for all options available in WaveWorks

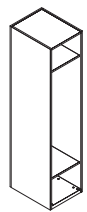
	MODEL NO./DESCRIPTION	LIST PRICE	DIMENSIONS					CARTONED WEIGHT	CUBIC FEET	
			D	W	H	A	KW			
OPEN LOCKER 	LOCKERS/OPEN									
	WW241879VPL1OL	Laminate	\$ 1415	22 ³ / ₄	17 ¹ / ₁₆	78 ¹ / ₁₆	—	—	—	25.8
	WW241579VPL1OL	Laminate	1415	22 ³ / ₄	14 ¹ / ₁₆	78 ¹ / ₁₆	—	—	—	21.8
	WW241868VPL1OL	Laminate	\$ 1213	22 ³ / ₄	17 ¹ / ₁₆	66 ⁷ / ₈	—	—	—	22.3
	WW241568VPL1OL	Laminate	1213	22 ³ / ₄	14 ¹ / ₁₆	66 ⁷ / ₈	—	—	—	18.9
	WW181879VPL1OL	Laminate	\$ 1373	16 ⁷ / ₈	17 ¹ / ₁₆	78 ¹ / ₁₆	—	—	—	20.3
	WW181579VPL1OL	Laminate	1373	16 ⁷ / ₈	14 ¹ / ₁₆	78 ¹ / ₁₆	—	—	—	17.2
	WW181868VPL1OL	Laminate	\$ 1169	16 ⁷ / ₈	17 ¹ / ₁₆	66 ⁷ / ₈	—	—	—	17.5
	WW181568VPL1OL	Laminate	1169	16 ⁷ / ₈	14 ¹ / ₁₆	66 ⁷ / ₈	—	—	—	14.8

- Lockers offered in laminate model only
- Included are 2 fixed shelves and 2 coat hooks
- If using 1 locker by itself it MUST be attached to a wall
- If using more than 1 locker side by side they MUST be ganged together
- If using more than 1 locker back to back, a cluster of 4 lockers MUST be ordered and ganged both side to side and front to back

LOCKER 1 DOOR



Right shown

	LOCKERS/1 DOOR		LIST PRICE	DIMENSIONS					CARTONED WEIGHT	CUBIC FEET
	LEFT HINGED	RIGHT HINGED		D	W	H	A	KW		
WW241879VPL1LL	WW241879VPL1RL	Laminate	\$ 1503	23 ³ / ₁₆	17 ¹ / ₁₆	78 ¹ / ₁₆	—	—	—	26.8
WW241579VPL1LL	WW241579VPL1RL	Laminate	1503	23 ³ / ₁₆	14 ¹ / ₁₆	78 ¹ / ₁₆	—	—	—	22.5
WW241868VPL1LL	WW241868VPL1RL	Laminate	\$ 1299	23 ³ / ₁₆	17 ¹ / ₁₆	66 ⁷ / ₈	—	—	—	23.0
WW241568VPL1LL	WW241568VPL1RL	Laminate	1299	23 ³ / ₁₆	14 ¹ / ₁₆	66 ⁷ / ₈	—	—	—	19.5
WW181879VPL1LL	WW181879VPL1RL	Laminate	\$ 1459	17 ¹ / ₁₆	17 ¹ / ₁₆	78 ¹ / ₁₆	—	—	—	21.1
WW181579VPL1LL	WW181579VPL1RL	Laminate	1459	17 ¹ / ₁₆	14 ¹ / ₁₆	78 ¹ / ₁₆	—	—	—	17.9
WW181868VPL1LL	WW181868VPL1RL	Laminate	\$ 1255	17 ¹ / ₁₆	17 ¹ / ₁₆	66 ⁷ / ₈	—	—	—	18.2
WW181568VPL1LL	WW181568VPL1RL	Laminate	1255	17 ¹ / ₁₆	14 ¹ / ₁₆	66 ⁷ / ₈	—	—	—	15.4

- Lockers offered in laminate only
- 2 fixed shelves and 2 coat hooks included
- If using 1 locker by itself it MUST be attached to a wall
- If using more than 1 locker side by side they MUST be ganged together
- If using more than 1 locker back to back, a cluster of 4 lockers MUST be ordered and ganged both side to side and front to back
- Pulls will be installed vertically. All Waveworks pull options available with the exception of Horizon
- If specifying the "no pull" option, unit will have a touch latch closure

WAVEWORKS

WAVEWORKS

PRODUCT SPECIFICATIONS

- Laminate only; refer to page 336 for options
- Tops of units are finished with flat edge detail
- Adjustable hinged doors

TO ORDER, SPECIFY:

1. Model Number
2. Pull
3. Locking
4. Laminate Door-Drawer Color
5. Laminate Chassis Color

SAMPLE MODEL NUMBERS:

WW241879VPL2LL 87MB KS2B PT PT
 WW241879VPL3LL 87MB KRB PT PT

- See pages 334-339 for all options available in WaveWorks

LOCKER 2 DOOR

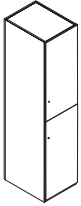

Right shown

MODEL NO./DESCRIPTION

LIST
PRICE

DIMENSIONS

D W H A KW

CARTONED CUBIC
WEIGHT FEET

LOCKERS/2 DOOR LEFT HINGED

RIGHT HINGED

MODEL NO./DESCRIPTION	LIST PRICE	D	W	H	A	KW	CARTONED CUBIC WEIGHT	FEET
WW241879VPL2LL	\$ 1611	23 ³ / ₁₆	17 ¹ / ₁₆	78 ¹ / ₁₆	—	—	—	26.8
WW241579VPL2LL	1611	23 ³ / ₁₆	14 ¹ / ₁₆	78 ¹ / ₁₆	—	—	—	22.5
WW241868VPL2LL	\$ 1407	23 ³ / ₁₆	17 ¹ / ₁₆	66 ⁷ / ₁₆	—	—	—	23.0
WW241568VPL2LL	1407	23 ³ / ₁₆	14 ¹ / ₁₆	66 ⁷ / ₁₆	—	—	—	19.5
WW181879VPL2LL	\$ 1567	17 ¹ / ₁₆	17 ¹ / ₁₆	78 ¹ / ₁₆	—	—	—	21.1
WW181579VPL2LL	1567	17 ¹ / ₁₆	14 ¹ / ₁₆	78 ¹ / ₁₆	—	—	—	17.9
WW181868VPL2LL	\$ 1363	17 ¹ / ₁₆	17 ¹ / ₁₆	66 ⁷ / ₁₆	—	—	—	18.2
WW181568VPL2LL	1363	17 ¹ / ₁₆	14 ¹ / ₁₆	66 ⁷ / ₁₆	—	—	—	15.4

- Lockers offered in laminate only
- 2 coat hooks behind each door
- If using 1 locker by itself it MUST be attached to a wall
- If using more than 1 locker side by side they MUST be ganged together
- If using more than 1 locker back to back, a cluster of 4 lockers MUST be ordered and ganged both side to side and front to back
- Pulls will be installed vertically. All WaveWorks pull options available with the exception of Horizon
- If specifying the "no pull" option, unit will have a touch latch closure

LOCKER 3 DOOR

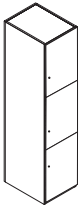

Right shown

LOCKERS/3 DOOR LEFT HINGED

RIGHT HINGED

MODEL NO./DESCRIPTION	LIST PRICE	D	W	H	A	KW	CARTONED CUBIC WEIGHT	FEET
WW241879VPL3LL	\$ 1719	23 ³ / ₁₆	17 ¹ / ₁₆	78 ¹ / ₁₆	—	—	—	26.8
WW241579VPL3LL	1719	23 ³ / ₁₆	14 ¹ / ₁₆	78 ¹ / ₁₆	—	—	—	22.5
WW241868VPL3LL	\$ 1515	23 ³ / ₁₆	17 ¹ / ₁₆	66 ⁷ / ₁₆	—	—	—	23.0
WW241568VPL3LL	1515	23 ³ / ₁₆	14 ¹ / ₁₆	66 ⁷ / ₁₆	—	—	—	19.5
WW181879VPL3LL	\$ 1675	17 ¹ / ₁₆	17 ¹ / ₁₆	78 ¹ / ₁₆	—	—	—	21.1
WW181579VPL3LL	1675	17 ¹ / ₁₆	14 ¹ / ₁₆	78 ¹ / ₁₆	—	—	—	17.9
WW181868VPL3LL	\$ 1472	17 ¹ / ₁₆	17 ¹ / ₁₆	66 ⁷ / ₁₆	—	—	—	18.2
WW181568VPL3LL	1472	17 ¹ / ₁₆	14 ¹ / ₁₆	66 ⁷ / ₁₆	—	—	—	15.4

- Lockers offered in laminate only
- 2 coat hooks behind each door
- If using 1 locker by itself it MUST be attached to a wall
- If using more than 1 locker side by side they MUST be ganged together
- If using more than 1 locker back to back, a cluster of 4 lockers MUST be ordered and ganged both side to side and front to back
- Pulls will be installed vertically. All WaveWorks pull options available with the exception of Horizon
- If specifying the "no pull" option, unit will have a touch latch closure

ASSEMBLED

PRODUCT SPECIFICATIONS

- Laminate only; refer to page 336 for options
- Tops of units are finished with flat edge detail
- Adjustable hinged doors

TO ORDER, SPECIFY:

1. Model Number
2. E lock color
3. Laminate Door-Drawer Color
4. Laminate Chassis Color

SAMPLE MODEL NUMBERS:

- WW241879VPL1LEL B PB PB
- See pages 334-339 for all options available in WaveWorks

	MODEL NO./DESCRIPTION			LIST PRICE	DIMENSIONS					CARTONED WEIGHT	CUBIC FEET
					D	W	H	A	KW		
LOCKER 1 DOOR ELECTRONIC LOCK 	LOCKERS/1 DOOR/ELECTRONIC LOCK										
	LEFT HINGED			RIGHT HINGED							
	WW241879VPL1LEL	WW241879VPL1REL	Laminate	\$ 1893	23 ³ / ₁₆	17 ¹ / ₁₆	78 ¹ / ₁₆	—	—	—	26.8
	WW241579VPL1LEL	WW241579VPL1REL	Laminate	1893	23 ³ / ₁₆	14 ¹ / ₁₆	78 ¹ / ₁₆	—	—	—	22.5
	WW241868VPL1LEL	WW241868VPL1REL	Laminate	\$ 1689	23 ³ / ₁₆	17 ¹ / ₁₆	66 ⁷ / ₈	—	—	—	23.0
	WW241568VPL1LEL	WW241568VPL1REL	Laminate	1689	23 ³ / ₁₆	14 ¹ / ₁₆	66 ⁷ / ₈	—	—	—	19.5
	WW181879VPL1LEL	WW181879VPL1REL	Laminate	\$ 1849	17 ¹ / ₁₆	17 ¹ / ₁₆	78 ¹ / ₁₆	—	—	—	21.1
	WW181579VPL1LEL	WW181579VPL1REL	Laminate	1849	17 ¹ / ₁₆	14 ¹ / ₁₆	78 ¹ / ₁₆	—	—	—	17.9
	WW181868VPL1LEL	WW181868VPL1REL	Laminate	\$ 1645	17 ¹ / ₁₆	17 ¹ / ₁₆	66 ⁷ / ₈	—	—	—	18.2
	WW181568VPL1LEL	WW181568VPL1REL	Laminate	1645	17 ¹ / ₁₆	14 ¹ / ₁₆	66 ⁷ / ₈	—	—	—	15.4

- Locks ship separately and require field installation
- 2 fixed shelves and 2 coat hooks included
- If using 1 locker by itself it MUST be attached to a wall
- If using more than 1 locker side by side they MUST be ganged together
- If using more than 1 locker back to back, a cluster of 4 lockers MUST be ordered and ganged both side to side and front to back
- Do not specify pull when ordering electronic locking units
- Electronic locking features passcode operation; can be used for multi-use or single use
- Rechargeable lithium battery included. Charge with either a wired USB charger or USB power pack

**LOCKER
2 DOOR
ELECTRONIC LOCK**



	MODEL NO./DESCRIPTION			LIST PRICE	DIMENSIONS					CARTONED WEIGHT	CUBIC FEET
					D	W	H	A	KW		
LOCKERS/2 DOOR/ELECTRONIC LOCK 	LOCKERS/2 DOOR/ELECTRONIC LOCK										
	LEFT HINGED			RIGHT HINGED							
	WW241879VPL2LEL	WW241879VPL2REL	Laminate	\$ 2391	23 ³ / ₁₆	17 ¹ / ₁₆	78 ¹ / ₁₆	—	—	—	26.8
	WW241579VPL2LEL	WW241579VPL2REL	Laminate	2391	23 ³ / ₁₆	14 ¹ / ₁₆	78 ¹ / ₁₆	—	—	—	22.5
	WW241868VPL2LEL	WW241868VPL2REL	Laminate	\$ 2187	23 ³ / ₁₆	17 ¹ / ₁₆	66 ⁷ / ₈	—	—	—	23.0
	WW241568VPL2LEL	WW241568VPL2REL	Laminate	2187	23 ³ / ₁₆	14 ¹ / ₁₆	66 ⁷ / ₈	—	—	—	19.5
	WW181879VPL2LEL	WW181879VPL2REL	Laminate	\$ 2347	17 ¹ / ₁₆	17 ¹ / ₁₆	78 ¹ / ₁₆	—	—	—	21.1
	WW181579VPL2LEL	WW181579VPL2REL	Laminate	2347	17 ¹ / ₁₆	14 ¹ / ₁₆	78 ¹ / ₁₆	—	—	—	17.9
	WW181868VPL2LEL	WW181868VPL2REL	Laminate	\$ 2143	17 ¹ / ₁₆	17 ¹ / ₁₆	66 ⁷ / ₈	—	—	—	18.2
	WW181568VPL2LEL	WW181568VPL2REL	Laminate	2143	17 ¹ / ₁₆	14 ¹ / ₁₆	66 ⁷ / ₈	—	—	—	15.4

- Locks ship separately and require field installation
- 2 coat hooks behind each door
- If using 1 locker by itself it MUST be attached to a wall
- If using more than 1 locker side by side they MUST be ganged together
- If using more than 1 locker back to back, a cluster of 4 lockers MUST be ordered and ganged both side to side and front to back
- Do not specify pull when ordering electronic locking units
- Electronic locking features passcode operation; can be used for multi-use or single use
- Rechargeable lithium battery included. Charge with either a wired USB charger or USB power pack

WAVEWORKS

PRODUCT SPECIFICATIONS

- Laminate only; refer to page 336 for options
- Tops of units are finished with flat edge detail
- Adjustable hinged doors

TO ORDER, SPECIFY:

1. Model Number
2. E lock color
3. Laminate Door-Drawer Color
4. Laminate Chassis Color

SAMPLE MODEL NUMBERS:

WW241879VPL3LEL S MC MC
WW2379CPFPL CW

- See pages 334-339 for all options available in WaveWorks

MODEL NO./DESCRIPTION	LIST PRICE	DIMENSIONS					CARTONED CUBIC	
		D	W	H	A	KW	WEIGHT	FEET
LOCKER 3 DOOR ELECTRONIC LOCK								
LOCKERS/3 DOOR/ELECTRONIC LOCK LEFT HINGED RIGHT HINGED								
WW241879VPL3LEL WW241879VPL3REL Laminate	\$ 2889	23 ³ / ₁₆	17 ¹ / ₁₆	78 ¹ / ₁₆	—	—	—	26.8
WW241579VPL3LEL WW241579VPL3REL Laminate	2889	23 ³ / ₁₆	14 ¹ / ₁₆	78 ¹ / ₁₆	—	—	—	22.5
WW241868VPL3LEL WW241868VPL3REL Laminate	\$ 2685	23 ³ / ₁₆	17 ¹ / ₁₆	66 ⁷ / ₈	—	—	—	23.0
WW241568VPL3LEL WW241568VPL3REL Laminate	2685	23 ³ / ₁₆	14 ¹ / ₁₆	66 ⁷ / ₈	—	—	—	19.5
WW181879VPL3LEL WW181879VPL3REL Laminate	\$ 2845	17 ¹ / ₁₆	17 ¹ / ₁₆	78 ¹ / ₁₆	—	—	—	21.1
WW181579VPL3LEL WW181579VPL3REL Laminate	2845	17 ¹ / ₁₆	14 ¹ / ₁₆	78 ¹ / ₁₆	—	—	—	17.9
WW181868VPL3LEL WW181868VPL3REL Laminate	\$ 2642	17 ¹ / ₁₆	17 ¹ / ₁₆	66 ⁷ / ₈	—	—	—	18.2
WW181568VPL3LEL WW181568VPL3REL Laminate	2642	17 ¹ / ₁₆	14 ¹ / ₁₆	66 ⁷ / ₈	—	—	—	15.4



- Locks ship separately and require field installation
- 2 coat hooks behind each door
- If using 1 locker by itself it MUST be attached to a wall
- If using more than 1 locker side by side they MUST be ganged together
- If using more than 1 locker back to back, a cluster of 4 lockers MUST be ordered and ganged both side to side and front to back
- Do not specify pull when ordering electronic locking units
- Electronic locking features passcode operation; can be used for multi-use or single use
- Rechargeable lithium battery included. Charge with either a wired USB charger or USB power pack

WARDROBE/STORAGE CABINETS AND LOCKERS FILLER PANELS



23" DEPTH								
WW2379CPFPL	\$ 211	6	23 ³ / ₁₆	78 ¹ / ₄	—	—	—	1.5
WW2368CPFPL	171	6	23 ³ / ₁₆	66 ⁷ / ₁₆	—	—	—	0.9
17" DEPTH								
WW1779CPFPL	\$ 157	6	17 ¹ / ₁₆	78 ¹ / ₄	—	—	—	1.5
WW1768CPFPL	140	6	17 ¹ / ₁₆	66 ⁷ / ₁₆	—	—	—	1.3

- To be used with Wardrobe Storage Cabinets and Lockers to fill in space as needed
- Can be field cut to desired width

PRODUCT SPECIFICATIONS

- Wood and laminate doors and chassis available; refer to page 336 for options
- Tops of units are finished with flat edge detail
- If specifying wood, you must specify the same finish for all options

TO ORDER, SPECIFY:

1. Model Number
2. Veneer Chassis Finish/Laminate Chassis Color

SAMPLE MODEL NUMBERS:

- WWN3680BCOFW MH
 WWN3680BCOFL AD
- See pages 334-339 for all options available in WaveWorks



Shaded model numbers are available on our "To You in 10 Days or Less" Quick Delivery program and will be delivered in 10 days or less.

MODEL NO./DESCRIPTION	LIST PRICE	DIMENSIONS					CARTONED WEIGHT	CUBIC FEET
		D	W	H	A	KW		

5 SHELF OPEN BOOKCASE

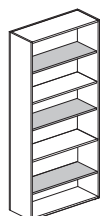

INTENDED FOR USE WITH 1 1/8" THICK WORKSURFACE MODELS									
WWN3680BCOFW	Wood	\$ 2106	13 1/16	35 1/8	79 1/16	—	—	184 lbs.	38.3
WWN3680BCOFL	Laminate	1046	13 1/16	35 1/8	79 1/16	—	—	184 lbs.	38.3
INTENDED FOR USE WITH 1 3/16" THICK WORKSURFACE MODELS									
QWW3679BCOFW	Wood	\$ 2106	13 1/16	35 1/8	79 1/4	—	—	184 lbs.	38.3
WW3679BCOFW	Wood	2106	13 1/16	35 1/8	79 1/4	—	—	184 lbs.	38.3
QWW3679BCOFL	Laminate	1046	13 1/16	35 1/8	79 1/4	—	—	184 lbs.	38.3
WW3679BCOFL	Laminate	1046	13 1/16	35 1/8	79 1/4	—	—	184 lbs.	38.3

- Specify chassis finish only
- Shaded shelves are adjustable
- Not intended for use as set-on surface storage
- Almond Horizontal (ADH), Portobello Horizontal (PBH), Portico Horizontal (PTH), Skyline Horizontal (SKH), Sonoma Horizontal (SMH), Designer White Linear Horizontal (491H), Cinder Linear Horizontal (492H) and Sable Horizontal (792H) laminate options available on models 60" H or less

4 SHELF OPEN BOOKCASE

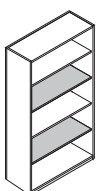

INTENDED FOR USE WITH 1 1/8" THICK WORKSURFACE MODELS									
WWN3669BCOFW	Wood	\$ 1831	13 1/16	35 1/8	67 1/4	—	—	188 lbs.	31.6
WWN3669BCOFL	Laminate	911	13 1/16	35 1/8	67 1/4	—	—	188 lbs.	31.6
INTENDED FOR USE WITH 1 3/16" THICK WORKSURFACE MODELS									
QWW3668BCOFW	Wood	\$ 1831	13 1/16	35 1/8	66 7/8	—	—	188 lbs.	31.6
WW3668BCOFW	Wood	1831	13 1/16	35 1/8	66 7/8	—	—	188 lbs.	31.6
QWW3668BCOFL	Laminate	911	13 1/16	35 1/8	66 7/8	—	—	188 lbs.	31.6
WW3668BCOFL	Laminate	911	13 1/16	35 1/8	66 7/8	—	—	188 lbs.	31.6

- Specify chassis finish only
- Shaded shelves are adjustable
- Not intended for use as set-on surface storage
- Almond Horizontal (ADH), Portobello Horizontal (PBH), Portico Horizontal (PTH), Skyline Horizontal (SKH), Sonoma Horizontal (SMH), Designer White Linear Horizontal (491H), Cinder Linear Horizontal (492H) and Sable Horizontal (792H) laminate options available on models 60" H or less

3 SHELF OPEN BOOKCASE

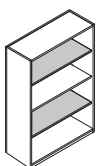

QWW3653BCOFW	Wood	\$ 1682	13 1/16	35 1/8	52 1/16	—	—	140 lbs.	26.7
WW3653BCOFW	Wood	1682	13 1/16	35 1/8	52 1/16	—	—	140 lbs.	26.7
QWW3653BCOFL	Laminate	823	13 1/16	35 1/8	52 1/16	—	—	140 lbs.	26.7
WW3653BCOFL	Laminate	823	13 1/16	35 1/8	52 1/16	—	—	140 lbs.	26.7

- Specify chassis finish only
- Shaded shelves are adjustable
- Not intended for use as set-on surface storage

WAVEWORKS

PRODUCT SPECIFICATIONS

- Wood and laminate doors and chassis available; refer to page 336 for options
- Tops of units are finished with flat edge detail
- Adjustable hinged doors
- If specifying wood, you must specify the same finish for all options

TO ORDER, SPECIFY:

1. Model Number
2. Pull
3. Locking
4. Veneer Door-Drawer Finish/Laminate Door-Drawer Color (laminate/combo models)
5. Veneer Chassis Finish/Laminate Chassis Color

SAMPLE MODEL NUMBERS:

WW3640BCOFW AC
WW3640BCOFL AC2

- See pages 334-339 for all options available in WaveWorks

QD Shaded model numbers are available on our "To You in 10 Days or Less" Quick Delivery program and will be delivered in 10 days or less.

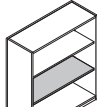
	MODEL NO./DESCRIPTION	LIST PRICE	DIMENSIONS					CARTONED CUBIC	
			D	W	H	A	KW	WEIGHT	FEET
	QWW3640BCOFW Wood	\$ 1426	13 ¹ / ₁₆	35 ³ / ₁₆	40 ³ / ₁₆	—	—	112 lbs.	20.6
	WW3640BCOFW Wood	1426	13 ¹ / ₁₆	35 ³ / ₁₆	40 ³ / ₁₆	—	—	112 lbs.	20.6
	QWW3640BCOFL Laminate	719	13 ¹ / ₁₆	35 ³ / ₁₆	40 ³ / ₁₆	—	—	112 lbs.	20.6
	WW3640BCOFL Laminate	719	13 ¹ / ₁₆	35 ³ / ₁₆	40 ³ / ₁₆	—	—	112 lbs.	20.6

- Specify chassis finish only
- Shaded shelf is adjustable
- Not intended for use as set-on surface storage

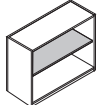
	MODEL NO./DESCRIPTION	LIST PRICE	DIMENSIONS					CARTONED CUBIC	
			D	W	H	A	KW	WEIGHT	FEET
	QWW3628BCOFW Wood	\$ 1247	13 ¹ / ₁₆	35 ³ / ₁₆	27 ³ / ₁₆	—	—	75 lbs.	13.7
	WW3628BCOFW Wood	1247	13 ¹ / ₁₆	35 ³ / ₁₆	27 ³ / ₁₆	—	—	75 lbs.	13.7
	QWW3628BCOFL Laminate	617	13 ¹ / ₁₆	35 ³ / ₁₆	27 ³ / ₁₆	—	—	75 lbs.	13.7
	WW3628BCOFL Laminate	617	13 ¹ / ₁₆	35 ³ / ₁₆	27 ³ / ₁₆	—	—	75 lbs.	13.7



- Specify chassis finish only
- Shaded shelf is adjustable
- Not intended for use as set-on surface storage

BOOKCASE WITH DOORS

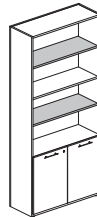
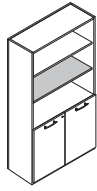
INTENDED FOR USE WITH 1¹/₁₆" THICK WORKSURFACES

	WWN3680BCOHFW Wood	\$ 2577	14 ³ / ₁₆	35 ³ / ₁₆	79 ¹ / ₁₆	—	—	220 lbs.	35.0
	WWN3680BCOHFL Laminate	1463	14 ³ / ₁₆	35 ³ / ₁₆	79 ¹ / ₁₆	—	—	220 lbs.	35.0
	WWN3669BCOHFW Wood	\$ 2241	14 ³ / ₁₆	35 ³ / ₁₆	67 ³ / ₁₆	—	—	193 lbs.	31.6
	WWN3669BCOHFL Laminate	1272	14 ³ / ₁₆	35 ³ / ₁₆	67 ³ / ₁₆	—	—	193 lbs.	31.6

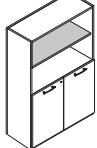
INTENDED FOR USE WITH 1¹/₁₆" THICK WORKSURFACES

	WW3679BCOHFW Wood	\$ 2577	14 ³ / ₁₆	35 ³ / ₁₆	79 ³ / ₁₆	—	—	220 lbs.	35.0
	WW3679BCOHFL Laminate	1463	14 ³ / ₁₆	35 ³ / ₁₆	79 ³ / ₁₆	—	—	220 lbs.	35.0
	WW3668BCOHFW Wood	\$ 2241	14 ³ / ₁₆	35 ³ / ₁₆	66 ³ / ₁₆	—	—	193 lbs.	31.6
	WW3668BCOHFL Laminate	1272	14 ³ / ₁₆	35 ³ / ₁₆	66 ³ / ₁₆	—	—	193 lbs.	31.6
	WW3653BCOHFW Wood	\$ 2084	14 ³ / ₁₆	35 ³ / ₁₆	52 ³ / ₁₆	—	—	145 lbs.	26.7
	WW3653BCOHFL Laminate	1179	14 ³ / ₁₆	35 ³ / ₁₆	52 ³ / ₁₆	—	—	145 lbs.	26.7

- Shaded shelves are adjustable
- Cabinet features an adjustable shelf in bottom storage behind doors
- Random lock core (KRB, KRS) and specified lock core (KS1B, KS1S) available
- Almond Horizontal (ADH), Portobello Horizontal (PBH), Portico Horizontal (PTH), Skyline Horizontal (SKH), Sonoma Horizontal (SMH), Designer White Linear Horizontal (491H), Cinder Linear Horizontal (492H) and Sable Horizontal (792H) laminate options available on models 60" H or less

PRODUCT SPECIFICATIONS

- Wood and laminate doors and chassis available; refer to page 336 for options
- Tops of units are finished with flat edge detail
- If specifying wood, you must specify the same finish for all options

TO ORDER, SPECIFY:

1. Model Number
2. Veneer Chassis Finish/Laminate Chassis Color

SAMPLE MODEL NUMBERS:

- WW3650BCOW AC
 WW3650BCOL AC2
- See pages 334-339 for all options available in WaveWorks

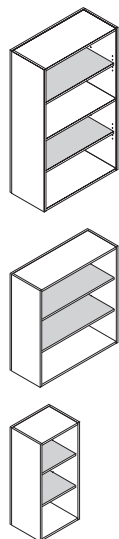
	MODEL NO./DESCRIPTION	LIST PRICE	DIMENSIONS					CARTONED CUBIC		
			D	W	H	A	KW	WEIGHT	FEET	
OPEN BOOKCASE SET-ON SURFACE 	50" HIGH									
	WW3650BCOW	Wood	\$ 1485	13 ¹ / ₁₆	35 ⁷ / ₈	50	—	—	109 lbs.	25.5
	WW3650BCOL	Laminate	850	13 ¹ / ₁₆	35 ⁷ / ₈	50	—	—	109 lbs.	25.5
	WW3050BCOW	Wood	\$ 1383	13 ¹ / ₁₆	29 ¹ / ₁₆	50	—	—	97 lbs.	21.9
	WW3050BCOL	Laminate	796	13 ¹ / ₁₆	29 ¹ / ₁₆	50	—	—	97 lbs.	21.9
	WW1850BCOW	Wood	\$ 1217	13 ¹ / ₁₆	17 ¹ / ₁₆	50	—	—	81 lbs.	14.7
	WW1850BCOL	Laminate	719	13 ¹ / ₁₆	17 ¹ / ₁₆	50	—	—	81 lbs.	14.7
	WW1550BCOW	Wood	\$ 1117	13 ¹ / ₁₆	14 ¹ / ₁₆	50	—	—	68 lbs.	9.5
	WW1550BCOL	Laminate	661	13 ¹ / ₁₆	14 ¹ / ₁₆	50	—	—	68 lbs.	9.5
	38" HIGH									
	WW3638BCOW	Wood	\$ 1172	13 ¹ / ₁₆	35 ⁷ / ₈	38	—	—	100 lbs.	20.6
	WW3638BCOL	Laminate	563	13 ¹ / ₁₆	35 ⁷ / ₈	38	—	—	100 lbs.	20.6
WW3038BCOW	Wood	\$ 1076	13 ¹ / ₁₆	29 ¹ / ₁₆	38	—	—	85 lbs.	16.8	
WW3038BCOL	Laminate	511	13 ¹ / ₁₆	29 ¹ / ₁₆	38	—	—	85 lbs.	16.8	
WW1838BCOW	Wood	\$ 912	13 ¹ / ₁₆	17 ¹ / ₁₆	38	—	—	60 lbs.	11.0	
WW1838BCOL	Laminate	434	13 ¹ / ₁₆	17 ¹ / ₁₆	38	—	—	60 lbs.	11.0	
WW1538BCOW	Wood	\$ 814	13 ¹ / ₁₆	14 ¹ / ₁₆	38	—	—	55 lbs.	9.5	
WW1538BCOL	Laminate	382	13 ¹ / ₁₆	14 ¹ / ₁₆	38	—	—	55 lbs.	9.5	

- Specify chassis finish only
- Not intended for use on table desking
- Shaded shelves are adjustable
- 50" high models have 3 adjustable shelves; 38" high models have 2 adjustable shelves

WAVEWORKS

PRODUCT SPECIFICATIONS

- Wood, laminate or glass doors and wood or laminate chassis available; refer to page 336 for options
- Tops of units are finished with flat edge detail
- If specifying wood, you must specify the same finish for all options

TO ORDER, SPECIFY:

1. Model Number
2. Locking
3. Door Frame Color (glass door models)
4. Veneer Door-Drawer Finish/Laminate Door-Drawer Color (laminate/combo models)
5. Veneer Chassis Finish/Laminate Chassis Color

SAMPLE MODEL NUMBERS:

WW3650BCHW KRB CW
WW3650BCHL KRB 405 405

- See pages 334-339 for all options available in WaveWorks

MODEL NO./DESCRIPTION	LIST PRICE	DIMENSIONS					CARTONED WEIGHT	CUBIC FEET
		D	W	H	A	KW		
BOOKCASE WITH DOORS SET-ON SURFACE								
50" HIGH								
WW3650BCHGW Glass/Wood	\$ 3300	14 $\frac{3}{4}$	35 $\frac{5}{8}$	49 $\frac{1}{16}$	—	—	144 lbs.	25.5
WW3650BCHGL Glass/Laminate	2567	14 $\frac{3}{4}$	35 $\frac{5}{8}$	49 $\frac{1}{16}$	—	—	144 lbs.	25.5
WW3650BCHW Wood	1613	14 $\frac{3}{4}$	35 $\frac{5}{8}$	49 $\frac{1}{16}$	—	—	144 lbs.	25.5
WW3650BCHL Laminate	894	14 $\frac{3}{4}$	35 $\frac{5}{8}$	49 $\frac{1}{16}$	—	—	144 lbs.	25.5
38" HIGH								
WW3050BCHGW Glass/Wood	\$ 2999	14 $\frac{3}{4}$	29 $\frac{1}{16}$	49 $\frac{1}{16}$	—	—	126 lbs.	21.9
WW3050BCHGL Glass/Laminate	2332	14 $\frac{3}{4}$	29 $\frac{1}{16}$	49 $\frac{1}{16}$	—	—	126 lbs.	21.9
WW3050BCHW Wood	1515	14 $\frac{3}{4}$	29 $\frac{1}{16}$	49 $\frac{1}{16}$	—	—	126 lbs.	21.9
WW3050BCHL Laminate	824	14 $\frac{3}{4}$	29 $\frac{1}{16}$	49 $\frac{1}{16}$	—	—	126 lbs.	21.9
38" HIGH								
WW3638BCHGW Glass/Wood	\$ 2944	14 $\frac{3}{4}$	35 $\frac{5}{8}$	38 $\frac{3}{8}$	—	—	110 lbs.	19.9
WW3638BCHGL Glass/Laminate	1591	14 $\frac{3}{4}$	35 $\frac{5}{8}$	38 $\frac{3}{8}$	—	—	110 lbs.	19.9
WW3638BCHW Wood	1297	14 $\frac{3}{4}$	35 $\frac{5}{8}$	38 $\frac{3}{8}$	—	—	110 lbs.	19.9
WW3638BCHL Laminate	609	14 $\frac{3}{4}$	35 $\frac{5}{8}$	38 $\frac{3}{8}$	—	—	110 lbs.	19.9
38" HIGH								
WW3038BCHGW Glass/Wood	\$ 2675	14 $\frac{3}{4}$	29 $\frac{1}{16}$	38 $\frac{3}{8}$	—	—	94 lbs.	17.1
WW3038BCHGL Glass/Laminate	1445	14 $\frac{3}{4}$	29 $\frac{1}{16}$	38 $\frac{3}{8}$	—	—	94 lbs.	17.1
WW3038BCHW Wood	1199	14 $\frac{3}{4}$	29 $\frac{1}{16}$	38 $\frac{3}{8}$	—	—	94 lbs.	17.1
WW3038BCHL Laminate	540	14 $\frac{3}{4}$	29 $\frac{1}{16}$	38 $\frac{3}{8}$	—	—	94 lbs.	17.1

- Not intended for use on table desking
- Shaded shelves are adjustable
- 50" high models have 3 adjustable shelves; 38" high models have 2 adjustable shelves
- Glass doors do not lock
- Random lock core (KRB, KRS) and specified lock core (KS1B, KS1S) available

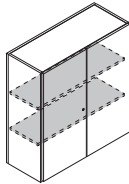
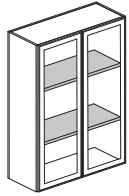

WAVEWORKS

ASSEMBLED

PRODUCT SPECIFICATIONS

- Wood, laminate or glass doors and wood or laminate chassis available; refer to page 336 for options
- Tops of units are finished with flat edge detail
- If specifying wood, you must specify the same finish for all options

TO ORDER, SPECIFY:

1. Model Number
2. Locking
3. Door Frame Color (glass door models)
4. Veneer Door-Drawer Finish/Laminate Door-Drawer Color (laminate/combo models)
5. Veneer Chassis Finish/Laminate Chassis Color

SAMPLE MODEL NUMBERS:

WW1850BCHLW KRB CW
 WW1850BCHLL KRB 405 405

- See pages 334-339 for all options available in WaveWorks

	MODEL NO./DESCRIPTION			LIST PRICE	DIMENSIONS					CARTONED WEIGHT	CUBIC FEET	
					D	W	H	A	KW			
BOOKCASE WITH DOOR SET-ON SURFACE	50" HIGH											
		LEFT HINGED	RIGHT HINGED									
		WW1850BCHLGW	WW1850BCHRGW	Glass/Wood	\$ 2726	14 $\frac{3}{4}$	17 $\frac{1}{16}$	49 $\frac{1}{16}$	—	—	98 lbs.	14.7
		WW1850BCHLGL	WW1850BCHRGL	Glass/Lam	1916	14 $\frac{3}{4}$	17 $\frac{1}{16}$	49 $\frac{1}{16}$	—	—	98 lbs.	14.7
		WW1850BCHLW	WW1850BCHRW	Wood	1273	14 $\frac{3}{4}$	17 $\frac{1}{16}$	49 $\frac{1}{16}$	—	—	98 lbs.	14.7
		WW1850BCHLL	WW1850BCHRL	Laminate	743	14 $\frac{3}{4}$	17 $\frac{1}{16}$	49 $\frac{1}{16}$	—	—	98 lbs.	14.7
		WW1550BCHLGW	WW1550BCHRGW	Glass/Wood	\$ 2573	14 $\frac{3}{4}$	14 $\frac{1}{16}$	49 $\frac{1}{16}$	—	—	98 lbs.	14.7
		WW1550BCHLGL	WW1550BCHRGL	Glass/Lam	1404	14 $\frac{3}{4}$	14 $\frac{1}{16}$	49 $\frac{1}{16}$	—	—	98 lbs.	14.7
		WW1550BCHLW	WW1550BCHRW	Wood	1189	14 $\frac{3}{4}$	14 $\frac{1}{16}$	49 $\frac{1}{16}$	—	—	98 lbs.	14.7
		WW1550BCHLL	WW1550BCHRL	Laminate	682	14 $\frac{3}{4}$	14 $\frac{1}{16}$	49 $\frac{1}{16}$	—	—	98 lbs.	14.7
		38" HIGH										
		LEFT HINGED	RIGHT HINGED									
		WW1838BCHLGW	WW1838BCHRGW	Glass/Wood	\$ 1750	14 $\frac{3}{4}$	17 $\frac{1}{16}$	38 $\frac{3}{8}$	—	—	77 lbs.	11.4
		WW1838BCHLGL	WW1838BCHRGL	Glass/Lam	945	14 $\frac{3}{4}$	17 $\frac{1}{16}$	38 $\frac{3}{8}$	—	—	77 lbs.	11.4
		WW1838BCHLW	WW1838BCHRW	Wood	966	14 $\frac{3}{4}$	17 $\frac{1}{16}$	38 $\frac{3}{8}$	—	—	77 lbs.	11.4
		WW1838BCHLL	WW1838BCHRL	Laminate	460	14 $\frac{3}{4}$	17 $\frac{1}{16}$	38 $\frac{3}{8}$	—	—	77 lbs.	11.4
	WW1538BCHLGW	WW1538BCHRGW	Glass/Wood	\$ 1624	14 $\frac{3}{4}$	14 $\frac{1}{16}$	38 $\frac{3}{8}$	—	—	77 lbs.	11.4	
	WW1538BCHLGL	WW1538BCHRGL	Glass/Lam	878	14 $\frac{3}{4}$	14 $\frac{1}{16}$	38 $\frac{3}{8}$	—	—	77 lbs.	11.4	
	WW1538BCHLW	WW1538BCHRW	Wood	884	14 $\frac{3}{4}$	14 $\frac{1}{16}$	38 $\frac{3}{8}$	—	—	77 lbs.	11.4	
	WW1538BCHLL	WW1538BCHRL	Laminate	400	14 $\frac{3}{4}$	14 $\frac{1}{16}$	38 $\frac{3}{8}$	—	—	77 lbs.	11.4	

BOOKCASE WITH DOOR SET-ON SURFACE

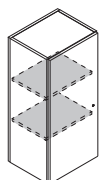
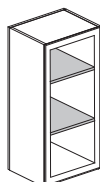

Left shown

- Not intended for use on table desking
- Shaded shelves are adjustable
- 50" high models have 3 adjustable shelves; 38" high models have 2 adjustable shelves
- Glass doors do not lock
- Random lock core (KRB, KRS) and specified lock core (KS1B, KS1S) available

WAVEWORKS

PRODUCT SPECIFICATIONS

- Wood and laminate doors and chassis available; refer to page 336 for options
- Tops of units are finished with flat edge detail
- If specifying wood, you must specify the same finish for all options

TO ORDER, SPECIFY:

1. Model Number
2. Finish (wood models)
3. Door Laminate Color (laminate models)
4. Laminate Color (laminate models)

SAMPLE MODEL NUMBERS:

WW3664BCOHHMALW CW
 WW3664BCOHHMALL 405 PB

- See pages 334-339 for all options available in WaveWorks

SET-ON BOOKCASE STYLE A

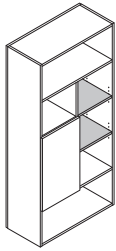

Left shown

MODEL NO./DESCRIPTION	LIST PRICE	DIMENSIONS					CARTONED CUBIC	
		D	W	H	A	KW	WEIGHT	FEET
64" HIGH								
LEFT			RIGHT					
WW3664BCOHHMALW	Wood	\$ 2455	14¾	35½	63¾	—	—	lbs.
WW3664BCOHHMALL	Laminate	1590	14¾	35½	63¾	—	—	lbs.
<hr/>								
WW3064BCOHHMALW	Wood	\$ 2380	14¾	29½	63¾	—	—	lbs.
WW3064BCOHHMALL	Laminate	1514	14¾	29½	63¾	—	—	lbs.

- Cornice frames are available. See pages 463-469
- Not intended for table desking
- Shaded shelves are adjustable
- Back not finished; for use with wall
- Not to be used in open plan; however, units can be used if back to back and ganged
- Must be attached to wall
- Non-locking, no pull

SET-ON BOOKCASE STYLE B

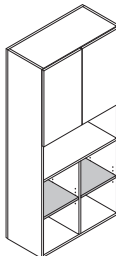

64" HIGH								
WW3664BCOHHMBW	Wood	\$ 2455	14¾	35½	63¾	—	—	lbs.
WW3664BCOHHMBL	Laminate	1590	14¾	35½	63¾	—	—	lbs.
<hr/>								
WW3064BCOHHMBW	Wood	\$ 2380	14¾	29½	63¾	—	—	lbs.
WW3064BCOHHMBL	Laminate	1514	14¾	29½	63¾	—	—	lbs.

- Cornice frames are available. See pages 463-469
- Not intended for table desking
- Shaded shelves are adjustable
- Back not finished; for use with wall
- Not to be used in open plan; however, units can be used if back to back and ganged
- Must be attached to wall
- Non-locking, no pull

SET-ON BOOKCASE STYLE C

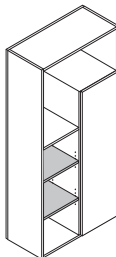

Right shown

MODEL NO./DESCRIPTION	LIST PRICE	DIMENSIONS					CARTONED CUBIC	
		D	W	H	A	KW	WEIGHT	FEET
64" HIGH								
LEFT			RIGHT					
WW3664BCOHHMCLW	Wood	\$ 2455	14¾	35½	63¾	—	—	lbs.
WW3664BCOHHMCLL	Laminate	1590	14¾	35½	63¾	—	—	lbs.
<hr/>								
WW3064BCOHHMCLW	Wood	\$ 2380	14¾	29½	63¾	—	—	lbs.
WW3064BCOHHMCLL	Laminate	1514	14¾	29½	63¾	—	—	lbs.

- Cornice frames are available. See pages 463-469
- Not intended for table desking
- Shaded shelves are adjustable
- Back not finished; for use with wall
- Not to be used in open plan; however, units can be used if back to back and ganged
- Must be attached to wall
- Non-locking, no pull

PRODUCT SPECIFICATIONS

- Wood and laminate doors and chassis available; refer to page 336 for options
- Tops of units are finished with flat edge detail
- If specifying wood, you must specify the same finish for all options

TO ORDER, SPECIFY:

1. Model Number
2. Finish (wood models)
3. Door Laminate Color (laminate models)
4. Laminate Color (laminate models)

SAMPLE MODEL NUMBERS:

WW3050BCOHMALW MC
 WW3050BCOHMALL 405 462

- See pages 334-339 for all options available in WaveWorks

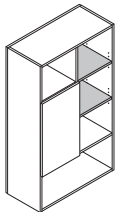
	MODEL NO./DESCRIPTION		LIST PRICE	DIMENSIONS					CARTONED CUBIC		
				D	W	H	A	KW	WEIGHT	FEET	
SET-ON BOOKCASE STYLE A  Left shown	50" HIGH										
		LEFT	RIGHT								
	WW3650BCOHMALW	WW3650BCOHMARW	Wood	\$ 1915	14¾	35½	50	—	—	lbs.	
	WW3650BCOHMALL	WW3650BCOHMARL	Laminate	1374	14¾	35½	50	—	—	lbs.	
	WW3050BCOHMALW	WW3050BCOHMARW	Wood	\$ 1839	14¾	29⅞	50	—	—	lbs.	
	WW3050BCOHMALL	WW3050BCOHMARL	Laminate	1298	14¾	29⅞	50	—	—	lbs.	
	<ul style="list-style-type: none"> • Cornice frames are available. See pages 463-469 • Not intended for table desking • Shaded shelves are adjustable • Back not finished; for use with wall • Not to be used in open plan; however, units can be used if back to back and ganged • Must be attached to wall • Non-locking, no pull 										

**SET-ON BOOKCASE
STYLE B**

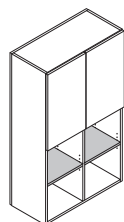

	50" HIGH									
WW3650BCOHWMBW	Wood		\$ 1915	14¾	35½	50	—	—	lbs.	
WW3650BCOHWMBL	Laminate		1374	14¾	35½	50	—	—	lbs.	
WW3050BCOHWMBW	Wood		\$ 1839	14¾	29⅞	50	—	—	lbs.	
WW3050BCOHWMBL	Laminate		1298	14¾	29⅞	50	—	—	lbs.	
<ul style="list-style-type: none"> • Cornice frames are available. See pages 463-469 • Not intended for table desking • Shaded shelves are adjustable • Back not finished; for use with wall • Not to be used in open plan; however, units can be used if back to back and ganged • Must be attached to wall • Non-locking, no pull 										

**SET-ON BOOKCASE
STYLE C**

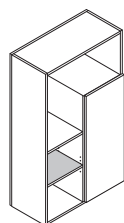

	50" HIGH									
	LEFT	RIGHT								
WW3650BCOHWMLW	WW3650BCOHWMLRW	Wood	\$ 1915	14¾	35½	50	—	—	lbs.	
WW3650BCOHWMLL	WW3650BCOHWMLRL	Laminate	1374	14¾	35½	50	—	—	lbs.	
WW3050BCOHWMLW	WW3050BCOHWMLRW	Wood	\$ 1839	14¾	29⅞	50	—	—	lbs.	
WW3050BCOHWMLL	WW3050BCOHWMLRL	Laminate	1298	14¾	29⅞	50	—	—	lbs.	
<ul style="list-style-type: none"> • Cornice frames are available. See pages 463-469 • Not intended for table desking • Shaded shelf is adjustable • Back not finished; for use with wall • Not to be used in open plan; however, units can be used if back to back and ganged • Must be attached to wall • Non-locking, no pull 										

WAVEWORKS

PRODUCT SPECIFICATIONS

- Wood and laminate doors and chassis available; refer to page 336 for options
- Tops of units are finished with flat edge detail
- If specifying wood, you must specify the same finish for all options

TO ORDER, SPECIFY:

1. Model Number
2. Finish (wood models)
3. Door Laminate Color (laminate models)
4. Laminate Color (laminate models)

SAMPLE MODEL NUMBERS:

WW3638BCOHWALW MC
WW3638BCOHWALL 462 PB

- See pages 334-339 for all options available in WaveWorks

MODEL NO./DESCRIPTION	LIST PRICE	DIMENSIONS					CARTONED CUBIC	
		D	W	H	A	KW	WEIGHT	FEET
SET-ON BOOKCASE STYLE A								
38" HIGH								
LEFT			RIGHT					
WW3638BCOHWALW	Wood	\$ 1698	14 $\frac{3}{4}$	35 $\frac{5}{8}$	38	—	—	lbs.
WW3638BCOHWALL	Laminate	1158	14 $\frac{3}{4}$	35 $\frac{5}{8}$	38	—	—	lbs.
<hr/>								
WW3038BCOHWALW	Wood	\$ 1622	14 $\frac{3}{4}$	29 $\frac{1}{16}$	38	—	—	lbs.
WW3038BCOHWALL	Laminate	1082	14 $\frac{3}{4}$	29 $\frac{1}{16}$	38	—	—	lbs.
<ul style="list-style-type: none"> • Cornice frames are available. See pages 463-469 • Not intended for table desking • Shaded shelf is adjustable • Back not finished; for use with wall • Not to be used in open plan; however, units can be used if back to back and ganged • Must be attached to wall • Non-locking, no pull 								

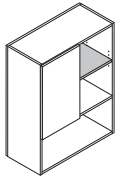

Left shown

SET-ON BOOKCASE STYLE B

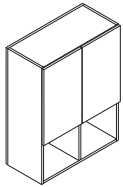

38" HIGH								
WW3638BCOHWMBW	Wood	\$ 1698	14 $\frac{3}{4}$	35 $\frac{5}{8}$	38	—	—	lbs.
WW3638BCOHWMBL	Laminate	1158	14 $\frac{3}{4}$	35 $\frac{5}{8}$	38	—	—	lbs.
<hr/>								
WW3038BCOHWMBW	Wood	\$ 1622	14 $\frac{3}{4}$	29 $\frac{1}{16}$	38	—	—	lbs.
WW3038BCOHWMBL	Laminate	1082	14 $\frac{3}{4}$	29 $\frac{1}{16}$	38	—	—	lbs.
<ul style="list-style-type: none"> • Cornice frames are available. See pages 463-469 • Not intended for table desking • Back not finished; for use with wall • Not to be used in open plan; however, units can be used if back to back and ganged • Must be attached to wall • Non-locking, no pull 								

SET-ON BOOKCASE STYLE C

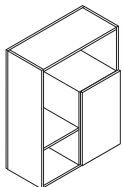

Right shown

38" HIGH								
LEFT			RIGHT					
WW3638BCOHWMLW	Wood	\$ 1698	14 $\frac{3}{4}$	35 $\frac{5}{8}$	38	—	—	lbs.
WW3638BCOHWMLL	Laminate	1158	14 $\frac{3}{4}$	35 $\frac{5}{8}$	38	—	—	lbs.
<hr/>								
WW3038BCOHWMLW	Wood	\$ 1622	14 $\frac{3}{4}$	29 $\frac{1}{16}$	38	—	—	lbs.
WW3038BCOHWMLL	Laminate	1082	14 $\frac{3}{4}$	29 $\frac{1}{16}$	38	—	—	lbs.
<ul style="list-style-type: none"> • Cornice frames are available. See pages 463-469 • Not intended for table desking • Back not finished; for use with wall • Not to be used in open plan; however, units can be used if back to back and ganged • Must be attached to wall • Non-locking, no pull 								

PRODUCT SPECIFICATIONS

- Wood and laminate doors and chassis available; refer to page 336 for options
- If specifying wood, you must specify the same finish for all options

TO ORDER, SPECIFY:

1. Model Number
2. Rim
3. PVC Rim Color
4. Pull
5. Grommet
6. Locking
7. Laminate Top Color (laminated models)
8. Laminate Door/Drawer Color (laminated models)
9. Veneer Chassis Finish/Laminated Chassis Color
10. Metal Color

SAMPLE MODEL NUMBERS:

WWN2415PFBBFW F 3CC KRB
 WWN2415PFBBFL F 6CC KRB

- See pages 334-339 for all options available in WaveWorks

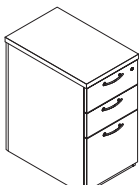
	MODEL NO./DESCRIPTION	LIST PRICE	DIMENSIONS					CARTONED WEIGHT	CUBIC FEET	
			D	W	H	A	KW			
FREESTANDING PEDESTAL BOX/BOX/FILE 	1 1/16" TOP THICKNESS									
	WWN2415PFBBFW	Wood	\$ 1791	23 1/16	15 3/16	29 3/4	—	—	83 lbs.	11.4
	WWN2415PFBBFL	Laminate	1134	23 1/16	15 3/16	29 3/4	—	—	83 lbs.	11.4
	1 3/16" TOP THICKNESS									
	WW2415PFBBFW	Wood	\$ 1427	23 1/16	15 3/16	28 3/8	—	—	83 lbs.	11.4
	WW2415PFBBFL	Laminate	940	23 1/16	15 3/16	28 3/8	—	—	83 lbs.	11.4

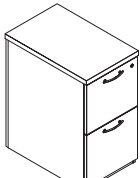
FREESTANDING PEDESTAL FILE/FILE 	1 1/16" TOP THICKNESS									
	WWN2415PFFFW	Wood	\$ 1791	23 1/16	15 3/16	29 3/4	—	—	83 lbs.	11.4
	WWN2415PFFFL	Laminate	1134	23 1/16	15 3/16	29 3/4	—	—	83 lbs.	11.4
	1 3/16" TOP THICKNESS									
	WW2415PFFFW	Wood	\$ 1427	23 1/16	15 3/16	28 3/8	—	—	83 lbs.	11.4
	WW2415PFFFL	Laminate	940	23 1/16	15 3/16	28 3/8	—	—	83 lbs.	11.4

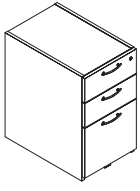
MOBILE PEDESTAL BOX/BOX/FILE WITH TOP 	WW2315PMBBF2W	Wood	\$ 1751	22 3/16	14 1/16	25 3/8	—	—	75 lbs.	9.9
	WW2315PMBBF2L	Laminate	1110	22 3/16	14 1/16	25 3/8	—	—	75 lbs.	9.9

WAVEWORKS

WAVEWORKS

ASSEMBLED

PRODUCT SPECIFICATIONS

- Wood and laminate doors and chassis available; refer to page 336 for options
- If specifying wood, you must specify the same finish for all options

TO ORDER, SPECIFY:

1. Model Number
2. Rim
3. PVC Rim Color
4. Pull
5. Grommet
6. Locking
7. Laminate Top Color (laminate models)
8. Laminate Door/Drawer Color (laminate models)
9. Veneer Chassis Finish/Laminate Chassis Color
10. Metal Color

SAMPLE MODEL NUMBER:

WW2315PMFFW 6MB KRB HN

- See pages 334-339 for all options available in WaveWorks

MODEL NO./DESCRIPTION	LIST PRICE	DIMENSIONS					CARTONED WEIGHT	CUBIC FEET
		D	W	H	A	KW		
MOBILE PEDESTAL FILE/FILE WW2315PMFFW Wood	\$ 1544	23 ³ / ₁₆	15 ⁵ / ₈	26 ⁵ / ₁₆	—	—	70 lbs.	9.9
WW2315PMFFL Laminate	978	23 ³ / ₁₆	15 ⁵ / ₈	26 ⁵ / ₁₆	—	—	70 lbs.	9.9

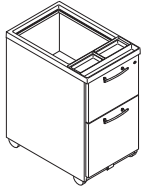

- Unit features a finished back
- Top is a black, high impact polystyrene organizer tray with exposed, easy access filing
- Top drawer does not pull out due to filing from the top
- 4 double wheel non-locking casters standard
- Random lock core (KRB, KRS) and specified lock core (KS1B, KS1S) available

MOBILE PEDESTAL BOX/FILE WW2315PMBFW Wood	\$ 1505	23 ³ / ₁₆	15 ⁵ / ₈	26 ⁵ / ₁₆	—	—	70 lbs.	9.9
WW2315PMBFL Laminate	955	23 ³ / ₁₆	15 ⁵ / ₈	26 ⁵ / ₁₆	—	—	70 lbs.	9.9

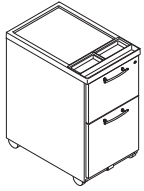

- Unit features a finished back
- Top is a black, high impact polystyrene organizer tray
- 4 double wheel non-locking casters standard
- Random lock core (KRB, KRS) and specified lock core (KS1B, KS1S) available

MOBILE PEDESTAL BOX/FILE WITH TOP WW2315PMBF2W Wood	\$ 1751	22 ¹ / ₁₆	15 ⁵ / ₈	21 ⁵ / ₈	—	—	76 lbs.	8.7
WW2315PMBF2L Laminate	1110	22 ¹ / ₁₆	15 ⁵ / ₈	21 ⁵ / ₈	—	—	76 lbs.	8.7



- 4 double wheel non-locking casters standard
- Maximum weight unit can hold is 300 pounds
- Do not specify rim option
- Random lock core (KRB, KRS) and specified lock core (KS1B, KS1S) available

MOBILE PEDESTAL FILE/FILE WITH TOP WW2315PMFF2W Wood	\$ 1751	22 ¹ / ₁₆	14 ¹ / ₁₆	25 ⁵ / ₈	—	—	75 lbs.	9.9
WW2315PMFF2L Laminate	1110	22 ¹ / ₁₆	14 ¹ / ₁₆	25 ⁵ / ₈	—	—	75 lbs.	9.9

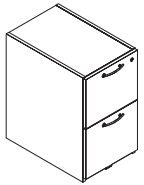

PRODUCT SPECIFICATIONS

- Wood and laminate doors and chassis available; refer to page 336 for options
- If specifying wood, you must specify the same finish for all options

TO ORDER, SPECIFY:

1. Model Number
2. Rim
3. PVC Rim Color
4. Pull
5. Grommet
6. Locking
7. Laminate Top Color (laminate models)
8. Laminate Door/Drawer Color (laminate models)
9. Veneer Chassis Finish/Laminate Chassis Color
10. Metal Color

SAMPLE MODEL NUMBER:

WW2315PMBFCW 6MB KRB 4 41301 HN
 • See pages 334-339 for all options available in WaveWorks

MOBILE PEDESTAL CUSHION TOP



MODEL NO./DESCRIPTION

		GRADE / LIST PRICE							
		1	2/COM	3/COL	4	5	6	7	
WW2315PMBFCW	Wood	\$ 1545	1567	1577	1593	1611	1640	1680	

ALLIANCE GRADE / LIST PRICE

	A	B	C	D	E	F	G	H	I	J
\$	1582	1605	1622	1641	1662	1684	1702	1724	1748	1769
	K	L	M	N	O	P	Q	R	S	T
\$	1805	1876	1920	1943	1967	1990	2013	2035	2058	2080

GRADE / LIST PRICE

		1	2/COM	3/COL	4	5	6	7
WW2315PMBFCL	Laminate	\$ 1090	1112	1122	1138	1156	1185	1225

ALLIANCE GRADE / LIST PRICE

	A	B	C	D	E	F	G	H	I	J
\$	1127	1150	1167	1186	1207	1229	1247	1269	1293	1314
	K	L	M	N	O	P	Q	R	S	T
\$	1350	1421	1465	1488	1512	1535	1558	1580	1603	1625

DIMENSIONS

Depth	22 ³ / ₁₆	Height	23	Weight	78
Width	15 ¹ / ₂			Cubic Ft.	9.2

- Maximum weight unit can hold is 300 pounds
- Refer to pages 13-20 and www.NationalOfficeFurniture.com/Alliance for available upholstery options
- Specify fabric grade and color for cushion top
- Random lock core (KRB, KRS) and specified lock core (KS1B, KS1S) available

WAVEWORKS

WAVEWORKS

ASSEMBLED

PRODUCT SPECIFICATIONS

- Wood and laminate doors and chassis available; refer to page 336 for options
- If specifying wood, you must specify the same finish for all options

TO ORDER, SPECIFY:

1. Model Number
2. Rim
3. PVC Rim Color
4. Pull
5. Grommet
6. Locking
7. Laminate Top Color (laminate models)
8. Laminate Door/Drawer Color (laminate models)
9. Veneer Chassis Finish/Laminate Chassis Color
10. Metal Color

SAMPLE MODEL NUMBER:

WWN2436MUCW 6MB KRB HN

- See pages 334-339 for all options available in WaveWorks

MODEL NO./DESCRIPTION	LIST PRICE	DIMENSIONS					CARTONED WEIGHT	CUBIC FEET
		D	W	H	A	KW		
MOBILE UTILITY CART								
1¹/₆" TOP THICKNESS								
WWN2436MUCW Wood	\$ 2198	26 ⁷ / ₁₆	36 ¹ / ₁₆	34 ⁷ / ₈	—	—	155 lbs.	17.1
WWN2436MUCLW Laminate/Wood	2198	26 ⁷ / ₁₆	36 ¹ / ₁₆	34 ⁷ / ₈	—	—	155 lbs.	17.1
WWN2436MUCL Laminate	1647	26 ⁷ / ₁₆	36 ¹ / ₁₆	34 ⁷ / ₈	—	—	155 lbs.	17.1
1³/₁₆" TOP THICKNESS								
WW2436MUCW Wood	\$ 1998	26 ⁷ / ₁₆	36 ¹ / ₁₆	34 ¹ / ₂	—	—	155 lbs.	17.1
WW2436MUCLW Laminate/Wood	1998	26 ⁷ / ₁₆	36 ¹ / ₁₆	34 ¹ / ₂	—	—	155 lbs.	17.1
WW2436MUCL Laminate	1497	26 ⁷ / ₁₆	36 ¹ / ₁₆	34 ¹ / ₂	—	—	155 lbs.	17.1
WW2436MUCLL TFL	1197	26 ⁷ / ₁₆	36 ¹ / ₁₆	34 ¹ / ₁₆	—	—	155 lbs.	17.1

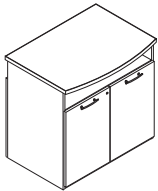

- Can function as a serving cart or media cart
- 1 adjustable shelf behind hinged doors
- 4 double wheel non-locking casters standard
- Center grommet option available
- Random lock core (KRB, KRS) and specified lock core (KS1B, KS1S) available

MOBILE COMPUTER CART

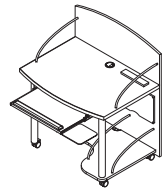

WW2436MCCW Wood	\$ 2521	27 ³ / ₁₆	36 ³ / ₈	43 ¹ / ₄	—	—	85 lbs.	24.5
WW2436MCCL Laminate	2018	27 ³ / ₁₆	36 ³ / ₈	43 ¹ / ₄	—	—	85 lbs.	24.5
WW2436MCCLL TFL	1614	27 ³ / ₁₆	36 ³ / ₈	43 ³ / ₁₆	—	—	85 lbs.	24.5

- Do not specify pull, grommet or door finish
- Mesh cord manager included
- Power director included in worksurface
- 4 double wheel locking casters standard
- Worksurface height is 28³/₄"
- This unit is available with Cinder (462) or Silver Platinum (508) metal components; must specify metal color

TO ORDER, SPECIFY:

1. Model Number
2. Rim
3. Finish
4. Laminate
5. Paint

SAMPLE MODEL NUMBER:

WW243626NKBW F CW

• See pages 334-339 for all options available in WaveWorks

**NESTING TABLE
KIDNEY SHAPED**

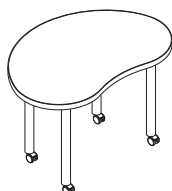

MODEL NO./DESCRIPTION	LIST PRICE	DIMENSIONS					CARTONED CUBIC	
		D	W	H	A	KW	WEIGHT	FEET
WW243626NKBW Wood	\$ 1431	24	36	26 ³ / ₄	—	—	45 lbs.	5.8
WW243626NKBLW Laminate/Wood	1431	24	36	26 ³ / ₄	—	—	45 lbs.	5.8
WW243626NKBL Laminate	1035	24	36	26 ³ / ₄	—	—	45 lbs.	5.8
WW243626NKBLL TFL	829	24	36	26 ¹ / ₆	—	—	45 lbs.	5.8

- Unit shipped with 4 legs
- Table height is 26³/₄"; slides underneath standard worksurface
- Locking casters
- Zip rim option does not have "run-out" on curves of kidney shaped table
- Table leg finishes:
 - 462 Cinder
 - 501 Platinum Metallic
 - 503 Satin Nickel Metallic

**NESTING TABLE
CONVEX SHAPED**

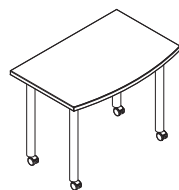

WW243626NCVW Wood	\$ 1431	24	36	26 ³ / ₄	—	—	45 lbs.	5.8
WW243626NCVLW Laminate/Wood	1431	24	36	26 ³ / ₄	—	—	45 lbs.	5.8
WW243626NCVL Laminate	1035	24	36	26 ³ / ₄	—	—	45 lbs.	5.8
WW243626NCVLL TFL	829	24	36	26 ¹ / ₆	—	—	45 lbs.	5.8

- Unit shipped with 4 legs
- Table height is 26³/₄"; slides underneath standard worksurface
- Locking casters
- Table leg finishes:
 - 462 Cinder
 - 501 Platinum Metallic
 - 503 Satin Nickel Metallic

