Coalesse Seating and Occasional Tables

Volume 5a

► For more detailed product information, see the *Coalesse Specification Guides* or consult your Steelcase dealer.

Terms and Conditions	2
Sample Order Form	10
Participating Steelcase Dealers	12
Steelcase Showrooms and Manufacturing Locations	17

Seating/Occasional Tables	19
Lounge Seating	45
Guest/Side/Stack Seating	175
Collaboration Seating	217
Occasional Tables	225
Outdoor	243

Surface Materials	259
Resources	299

► For a list of all trademarks, refer to the last page of this specification guide.

Terms and Conditions

Customer Information

For more information, please contact your participating Steelcase GSA dealer.

For more information, please contact your participating Steelcase GSA dealer.

For more information, please contact your participating Steelcase GSA dealer.

For more information, please contact your participating Steelcase GSA dealer.

For more information, please contact your participating Steelcase GSA dealer.

For more information, please contact your participating Steelcase GSA dealer.

For more information, please contact your participating Steelcase GSA dealer.

For more information, please contact your participating Steelcase GSA dealer.

Sample Order Form

Sample Order Form

ORDER FOR SUPPLIES OR SERVICES				PAGE	OF	PAGES
IMPORTANT: Mark all packages and papers with contract and/or order numbers.						
DATE OF ORDER 1 6-1-04	CONTRACT NO. (If any) 2 GS-27F-0014V	ORDER NO. 3 10 - 000	REQUISITION/REFERENCE NO.			
ISSUING OFFICE (Address correspondence to) 4 GSA 1 Town Street City, State, Zip Name and Telephone Number			SHIP TO: (Consignee and address, ZIP Code) 5 GSA 2 Town Street City, State, Zip Name and Telephone Number			
TO: CONTRACTOR (Name, address and ZIP Code) 6 Steelcase Inc. c/o Participating Dealer 901 44th Street, SE Grand Rapids, MI 49508 Attn: Solutions Fullfillment Team CH-2W-SS (GSA)			Cage Code: 39880		TYPE OF ORDER <input type="checkbox"/> A. PURCHASE — Reference your _____ Please furnish the following on the terms and conditions specified on both sides of this order and on the attached sheets, if any, including delivery as indicated. This purchase is negotiated under authority of: <input type="checkbox"/> B. DELIVERY — Except for billing instructions on the reverse, this delivery order is subject to instructions contained on this side only of this form and is issued subject to the terms and conditions of the above-numbered contract.	
ACCOUNTING AND APPROPRIATION DATA			REQUISITIONING OFFICE			
			BUSINESS CLASSIFICATION (Check appropriate box(es)) 20 <input type="checkbox"/> SMALL <input checked="" type="checkbox"/> OTHER THAN SMALL <input type="checkbox"/> DIS-ADVANTAGED <input type="checkbox"/> WOMEN-OWNED			
FCA DESTINATION 7		GOVERNMENT NO.	DELIVER TO FCA DESTINATION ON OR BEFORE (Date) 8 ARO date		DISCOUNT TERMS 9 Net 30 days	
PLACE OF INSPECTION AND ACCEPTANCE						

(See reverse for Rejections)

ITEM NO. (A)	SUPPLIES OR SERVICES (B)	QUANTITY ORDERED (C)	UNIT (D)	UNIT PRICE (E)	AMOUNT (F)	QUANTITY ACCEPTED (G)	
1	10 One lot of Steelcase Office Furniture: See attached specifications	13 1		14 \$000	15 \$000		
2	11 Design: \$55.41/hour	2 hrs		\$000	\$000		
3	12 Installation	1		\$000	\$000		
SEE BILLING INSTRUCTIONS ON REVERSE		SHIPPING POINT		GROSS SHIPPING WEIGHT		INVOICE NO.	
		MAIL INVOICE TO: (Include ZIP Code) 17 GSA, 3 Town Street, City, State, Zip				16 \$000	(H) TOT. (Cont. pages) ◀ (I) GRAND TOTAL ◀
UNITED STATES OF AMERICA BY (Signature) 18 Contracting Officer signature and telephone no.				NAME (Typed) 19 John Doe, Department Manager TITLE: CONTRACTING/ORDERING OFFICER			

NSN 7540_01_152_8083

50347-101

OPTIONAL FORM 347 (10-83)
Prescribed by GSA
FAR (48 CFR) 53.213 (e)

- 1 Order date
- 2 Contract number
- 3 Order number
- 4 Issuing office: Requester name and telephone number
- 5 Shipping address: Contact name and telephone number
- 6 Contractor:
Steelcase Inc.
c/o Participating Dealer
901 - 44th Street, S.E.
Grand Rapids, MI 49508
Attn: Solutions Fulfillment Team
- 7 FCA destination
- 8 ARO date (After Receipt of Order)
- 9 Terms: Net 30 days
- 10 Complete product description, including SIN number, style number, all applicable surface materials.
- 11 Separate line for design
- 12 Separate line for installation
- 13 Quantity ordered
- 14 Individual unit price
- 15 Amount (quantity x unit price)
- 16 Total cost
- 17 Invoice address
- 18 Authorized contracting officer signature and telephone number
- 19 Authorized contracting officer name and title (typed)
- 20 Steelcase is the seller of record and is not registered as "small," "disadvantaged," or "woman-owned." If one of these boxes is checked in error, a modification will be required.

Please note on order that all invoice payments must be sent to:

Steelcase Inc.
62087 Collection Center Dr.
Chicago, IL 60693-0620

Storage and Delays

(Open Market) In the event that the site is not accessible, or safe and adequate storage space is not available during installation, the furnishings will be stored until delivery or installation can be accomplished. Pricing for storage will be negotiated on a project-by-project basis. Invoices will be sent to the local government purchasing facility upon delivery of the furniture to a designated storage facility. Steelcase shall provide notice to the Government purchasing facility that the furnishings are available for inspection by the Government at the Storage facility. Upon this notice, the Government, or representative for the Government, must inspect and accept the furniture prior to payment of any invoice. The inspection and acceptance must be completed within reasonable time frame agreed upon by both parties. Payment will be made by the Government 30 days after acceptance of the furniture.

Participating Steelcase Dealers

Alabama

Dekalb Office of Alabama
2901 Second Ave South
Birmingham, AL 35233
Phone: (205) 933-9100

Kyser OfficeWorks Inc.
2400 Spruce Street
Montgomery, AL 36107-3150
Phone: (334) 834-9400
Fax: (334) 262-0701

OEC Business Interiors
104 East I-65 Service Road North
Mobile, AL 36607-2501
Phone: (251) 471-3368
Fax: (251) 471-0019

Office Interiors by OSCO
1300 Meridian Street
Suite 203
Huntsville, AL 35801
Phone: (256) 604-5696
Fax: (256) 604-5699

OSCO Inc.
229 Grant Street SE
Decatur, AL 35601-2511
Phone: (256) 340-5100
Fax: (256) 340-5108

Alaska

Capital Office Systems
1120 East 35th Avenue
Anchorage, AK 99508-4257
Phone: (907) 777-1500
Fax: (907) 777-1515

Capital Office Systems
3201 Industrial Avenue
Fairbanks, AK 99701-7370
Phone: (907) 456-3946
Fax: (907) 452-6257

Capital Office Systems
3143 Channel Drive
Juneau, AK 99801-7214
Phone: (907) 780-3636
Fax: (907) 780-2290

Arizona

Atmosphere Commercial Interiors
8530 S Priest Drive
Tempe, Arizona 85284-1902
Phone: (602) 252-6971
Fax: (602) 252-8222

Atmosphere Commercial Interiors
Suite 105
4585 South Coach Drive
Tucson, Arizona 85714-3462
Phone: (520) 792-4200
Fax: (540) 791-9568

Atmosphere Commercial Interiors
Suite 100
88 East Broadway Boulevard
Tucson, Arizona 85701-1720
Phone: (520) 792-4200
Fax: (540) 791-9568

Arkansas

ImageWorks
Suite B
1424 North Shackelford
Little Rock, AR 72211
Phone: (501) 944-7501

Today's Office Inc.
717 West 7th Street
Little Rock, AR 72201-4044
Phone: (501) 375-5050
Fax: (501) 375-1350

Today's Office Inc.
3157 West Sunset Avenue
Springdale, AR 72762-4945
Phone: (479) 751-5861
Fax: (479) 756-2233

California

BKM Office Environments
816 Via Alondra
Camarillo, CA 93012
Phone: (877) 256-1256
Fax: (805) 339-9032

BKM San Diego
Suite 100
9201 Spectrum Center Blvd.
San Diego, CA 92123-1407
Phone: (858) 569-4700
Fax: (858) 277-8931

One Workplace L. Ferrari
2500 De La Cruz Blvd.
Santa Clara, CA 95050
Phone: (669) 800-2500
Fax: (669) 800-2501

One Workplace L. Ferrari
7220 Edgewater Drive
Oakland, CA 94621
Phone: (510) 729-7800
Fax: (510) 729-7801

One Workplace L. Ferrari
475 Brannan Street
San Francisco, CA 94107-1731
Phone: (415) 357-2200
Fax: (415) 357-2201

Peninsula Business Interiors
325 Main Street
Salinas, CA 93901-2705
Phone: (831) 757-4107
Fax: (831) 757-1339

Tangram Interiors
Suite 102
4057 W Shaw Ave
Fresno, CA 93722-6212
Phone: (559) 275-7070
Fax: (559) 275-7080

Tangram Interiors
Suite 100
2850 South Red Hill Avenue
Santa Ana, CA 92705-5532
Phone: (949) 955-6700
Fax: (949) 955-6799

Tangram Interiors
9200 Sorensen Avenue
Santa Fe Springs, CA 90670-2645
Phone: (562) 365-5000
Fax: (562) 365-5399

United Corporate Furnishings
1780 North Market Blvd.
Sacramento, CA 95834-1997
Phone: (916) 553-5900
Fax: (916) 553-5800

Colorado

Office Outfitters & Planners Inc.
749 Main Street
Grand Junction, CO 81501-3535
Phone: (970) 245-6300
Fax: (970) 245-6301

OfficeScapes
2506 Zeppelin Rd
Colorado Springs, CO 80916
Phone: (719) 574-1113
Fax: (719) 574-1133

OfficeScapes
9900 East 51st Avenue
Fort Collins, CO 80525-6222
Phone: (303) 574-1115
Fax: (303) 574-1116

OfficeScapes
Suite 180
4812 McMurry Avenue
Fort Collins, CO 80525-6222
Phone: (970) 223-5959
Fax: (970) 223-5858

Connecticut

Red Thread
300 East River Drive
East Hartford, CT 06108-4205
Phone: (860) 528-9981
Fax: (860) 528-1843

Red Thread
488 Wheelers Farm Rd.
Milford, CT 06461
Phone: (203) 874-7754
Fax: (203) 876-7915

Red Thread
700 Canal St 3rd Fl
Stamford, CT 06902
Phone: (860) 528-9981

Red Thread
40 Main Street
Torrington, CT 06790
Phone: (860) 482-2679
Fax: (860) 482-3590

Delaware

Corporate Interiors Inc.
223 Lisa Drive
New Castle, DE 19720-4193
Phone: (302) 323-9100
Fax: (302) 323-9251

Florida

American Business Interiors
215 Waverly Place
Melbourne, FL 32901-5444
Phone: (321) 723-5003
Fax: (321) 984-4221

Empire Office
Suite 140
2 Oakwood Boulevard
Hollywood, FL 33020
Phone: (954) 707-6200

Empire Office
South Florida
3201 Commerce Parkway
Miramar, FL 33025-3908
Phone: (954) 435-7300
Fax: (954) 435-7212

Empire Office
Suite 17
2315 Lynx Lane
Orlando, FL 32804
Phone: (407) 628-2400

Empire Office
5112 West Linebaugh Avenue
Tampa, FL 33624
Phone: (813) 418-3300

Empire Office
Suite 2
7830 Byron Drive
West Palm Beach, FL 33404-3332
Phone: (561) 840-8600
Fax: (561) 840-1873

Leitz & Reed Office Products
1119 Florida Avenue
Lynn Haven, FL 32444-4622
Phone: (850) 271-2600
Fax: (850) 271-0076

OEC Business Interiors
1601 NW 80th Boulevard
Gainesville, FL 32606-9140
Phone: (352) 332-1192
Fax: (352) 333-8002

· OEC Business Interiors
· 2393 SW College Road
· Ocala, FL 34474-1661
· Phone: (352) 620-2888
· Fax: (352) 620-2891

· OEC Business Interiors
· 6254 North W Street
· Pensacola, FL 32503-2746
· Phone: (850) 438-1100
· Fax: (850) 432-0003

· Office Furniture & Design Concepts
· 11866 Metro Parkway
· Ft. Myers, FL 33966-1307
· Phone: (239) 337-1212
· Fax: (239) 337-4910

· Perdue Office Interiors
· Suite 100
· 5 W Forsyth
· Jacksonville, FL 32256-7440
· Phone: (904) 737-5858
· Fax: (904) 737-6088

· Perdue Office Interiors
· Suite C7
· 1516 Capital Circle SE
· Tallahassee, FL 32301
· Phone: (850) 383-4225

Georgia

· Advent Business Interiors
· 1318 U.S. HWY 82 West
· Leesburg, GA 31721
· Phone: (229) 439-7418
· Fax: (229) 435-1279

· Advent Business Interiors
· 110 West Macon Park Dr.
· Macon, GA 31210
· Phone: (478) 471-0600

· DeKalb Office Environments
· 1320 Ridgeland Parkway
· Alpharetta, GA 30004-8442
· Phone: (770) 360-0200
· Fax: (770) 360-0305

· McWaters Inc.
· 3708 Benchmark Drive
· Augusta, GA 30907
· Phone: (706) 396-5400
· Fax: (706) 396-5401

· McWaters Inc.
· 117 Prosperity Drive
· Savannah, GA 31408-9551
· Phone: (912) 352-9000
· Fax: (912) 352-2034

Hawaii

· Interior Showplace Ltd.
· 956 Queen Street
· Honolulu, HI 96814-4118
· Phone: (808) 593-8420
· Fax: (808) 591-8324

Idaho

· Porter's Office Products
· 435 West Center Street
· Pocatello, ID 83204-3241
· Phone: (208) 232-1233
· Fax: (208) 232-8759

· Porter's Office Products
· 1050 North 2nd East
· Rexburg, ID 83440-5127
· Phone: (208) 356-4616
· Fax: (208) 356-8901

· Office Environment Company
· 623 South Americana Blvd.
· Boise, ID 83702-5120
· Phone: (208) 385-0507
· Fax: (208) 385-9392

Illinois

· A. Pomerantz
· Suite 940
· 222 Merchandise Mart Plaza
· Chicago, IL 60654-1223
· Phone: (312) 929-3335
· Fax: (312) 929-3311

· Egyptian Business Furniture
· 129 West Main Street
· Belleville, IL 62220-1501
· Phone: (618) 234-2323
· Fax: (618) 236-3295

· Interiors for Business Inc.
· 409 N River Street
· Batavia, IL 60510-2359
· Phone: (630) 761-1070
· Fax: (630) 761-1065

· Lincoln Office
· 205 Eastgate Drive
· Washington, IL 61571-9238
· Phone: (309) 427-2500
· Fax: (309) 427-2625

· Forward Space
· Suite 614
· 222 Merchandise Mart Plaza
· Chicago, IL 60654-1223
· Phone: (312) 563-5206

· Forward Space
· 1142 N North Branch Street
· Chicago, IL 60642
· Phone: (312) 942-1100
· Fax: (312) 942-9840

· Forward Space
· 13820 West Business Center Drive
· Lake Forest, IL 60045-1181
· Phone: (847) 573-8890
· Fax: (847) 573-8891

· Forward Space
· Suite 150
· 1111 West 22nd Street
· Oak Brook, IL 60523
· Phone: (312) 563-5206

Indiana

· Business Furnishings LLC
· 4102 Meghan Beeler Court
· South Bend, IN 46628
· Phone: (574) 243-3255
· Fax: (574) 243-3266

· Business Furniture LLC
· 6102 Victory Way
· Indianapolis, IN 46278-2934
· Phone: (317) 216-1600
· Fax: (317) 216-1601

· Corporate Design Inc.
· Suite 400
· 1419 West Lloyd Expressway
· Evansville, IN 47710-1002
· Phone: (812) 422-3000
· Fax: (812) 422-3413

· Lincoln Office
· 1200 Arrowhead Court
· Crown Point, IN 46307-8222
· Phone: (219) 662-2777
· Fax: (219) 662-7770

Iowa

· Lincoln Office
· 1026 Mound St
· Davenport, IA 52803
· Phone: (563) 322-5660

· Tallgrass Business Resources
· Highway 6 West
· 218 Second Street
· Coralville, IA 52241-2608
· Phone: (319) 338-3135
· Fax: (319) 338-7484

· Workspace Inc.
· 309 Locust Street
· Des Moines, IA 50309-1788
· Phone: (515) 288-7090
· Fax: (515) 288-0250

Kansas

· Design Central Inc.
· 152 South 5th Street
· Salina, KS 67401
· Phone: (785) 825-4131
· Fax: (785) 825-4778

· Scott Rice Office Interiors
· 224 East Douglas
· Wichita, KS 67211-1640
· Phone: (316) 269-2700
· Fax: (316) 269-3527

· Scott Rice Office Works
· 14720 West 105th Street
· Lenexa, KS 66215-4414
· Phone: (913) 888-7600
· Fax: (913) 227-7793

Kentucky

· Office Resources Inc.
· 530 Corvette Drive
· Bowling Green, KY 42101-7132
· Phone: (270) 781-5858
· Fax: (270) 781-5884

· Office Resources Inc.
· 101 Bradley Drive
· Nicholasville, KY 40356-9121
· Phone: (859) 885-6161
· Fax: (859) 885-9610

· Office Resources Inc.
· 816 East Broadway
· Louisville, KY 40204-1053
· Phone: (502) 589-8400
· Fax: (502) 589-8408

Louisiana

· Frost-Barber Inc.
· 9322 Interline Avenue
· Baton Rouge, LA 70809-1966
· Phone: (225) 926-5000
· Fax: (225) 926-5011

· Workplace Solutions
· 401 St. Joseph Street.
· New Orleans, LA 70130
· Phone: (504) 522-9558
· Fax: (504) 522-7070

Maine

· Red Thread
· One City Center
· Portland, ME 04101
· Phone: (207) 774-4900
· Fax: (207) 774-8155

Maryland

· Arbee Associates
· 6311 Ammendale Road
· Beltsville, MD 20705-1249
· Phone: (410) 385-5180
· Fax: (410) 385-5199

· Arbee Associates
· 9300 Gaither Road
· Gaithersburg, MD 20877
· Phone: (301) 963-3900
· Fax: (301) 977-1734

· Dancker, Sellev & Douglas Inc.
· Suite 309
· 509 Exeter Street
· Baltimore, MD 21202
· Phone: (301) 671-2541
· Fax: (301) 797-1504

· Dancker, Sellev & Douglas Inc.
· 9200 Alaking Court
· Suite 100
· Capitol Heights, MD 20743
· Phone: (301) 350-8700
· Fax: (301) 350-9393

Participating Steelcase Dealers, continued

Massachusetts

Red Thread
Suite 600
101 Seaport Blvd.
Boston, MA 02210-1838
Phone: (617) 439-4900
Fax: (617) 439-4131

Red Thread
Suite 150
293 Boston Post Road West
Marlborough, MA 01752-4615
Phone: (508) 449-6550
Fax: (508) 449-6570

Red Thread
Suite 1108
1350 Main Street
Springfield, MA 01103
Phone: (413) 736-1802

Red Thread
100 Fordham Road
Wilmington, MA 01887
Phone: (978) 658-3900
Fax: (978) 694-4107

Michigan

Custer Office Environments Inc.
2435 Plaza Drive
Benton Harbor, MI 49022-2229
Phone: (616) 926-8719
Fax: (616) 926-9482

Custer Office Environments Inc.
217 Grandville Ave SW
Grand Rapids, MI 49503-4013
Phone: (616) 458-6322
Fax: (616) 458-1117

Custer Office Environments Inc.
5737 East Cork Street
Kalamazoo, MI 49048-9668
Phone: (269) 342-3919
Fax: (269) 342-3923

Custer Office Environments
442 East Michigan
Marquette, MI 49885
Phone: (906) 226-1161
Fax: (906) 226-1164

Custer Office Environments
120 East Front Street
Traverse City, MI 49684
Phone: (616) 402-8489

NBS
701 Salzburg Avenue
Bay City, MI 48706-5390
Phone: (989) 895-8574
Fax: (989) 895-8545

NBS
5133 West Grand River Avenue
Lansing, MI 48906-9117
Phone: (517) 886-0072
Fax: (517) 886-0014

NBS
2595 Bellingham Drive
Troy, MI 48083-2036
Phone: (248) 823-5400
Fax: (248) 823-5401

Minnesota

Atmosphere Commercial Interiors
Suite 350
81 South 9th Street
Minneapolis, MN 55402-3226
Phone: (612) 343-0868
Fax: (612) 332-5733

Burgher Office Equipment Company
101 East Chestnut Street
Virginia, MN 55792-2512
Phone: (218) 749-2661
Fax: (218) 749-2662

Duluth Typewriter & Business Furniture
30 N 3rd. Ave W
Duluth, MN 55802-1607
Phone: (218) 722-5811
Fax: (218) 722-4876

General Office Products Company
4521 Highway 7
Minneapolis, MN 55416-4098
Phone: (952) 925-7500
Fax: (952) 925-7531

Mississippi

Workplace Solutions
251 West South Street
Jackson, MS 39203-3636
Phone: (601) 354-4960
Fax: (601) 353-6231

Workplace Solutions
2207 5th Street
Meridian, MS 38652
Phone: (601) 484-7279

Workplace Solutions
520 Main Street
Natchez, MS 39120
Phone: (601) 442-1494
Fax: (601) 442-0457

Workplace Solutions
718 West Bankhead St.
New Albany, MS 38652
Phone: (662) 534-0882
Fax: (662) 534-5753

OEC Business Interiors
12199 Highway 49 N.
Suite 300
Gulfport, MS 39503-3167
Phone: (228) 539-9575
Fax: (228) 539-9566

Missouri

Color-Art Integrated Interiors
1325 North Warson Road
Saint Louis, MO 63132-1807
Phone: (314) 432-3000
Fax: (314) 993-2752

Marathon Office Interiors
1715 Paris Road
Columbia, MO 65201-5571
Phone: (573) 875-7115
Fax: (573) 875-7116

Montana

KR Office Interiors
119 North 7th Avenue
Bozeman, MT 59715
Phone: (406) 587-3775
Fax: (406) 587-4636

KR Office Interiors
1710 North Montana Avenue
Helena, MT 59601
Phone: (406) 513-1004
Fax: (406) 513-1006

Missoula's Office City
115 West Broadway Street
Missoula, MT 59802-4217
Phone: (406) 543-7171
Fax: (406) 543-4254

Peterson's Quality Office Equipment
502 North 32nd Street
Billings, MT 59101-6003
Phone: (406) 245-5151
Fax: (406) 245-7516

Western Office Equipment
317 2nd Street South
Great Falls, MT 59405-1802
Phone: (406) 761-7473
Fax: (406) 761-0245

Nebraska

Eakes Office Plus
2911 13th Street
Columbus, NE 68601-4829
Phone: (402) 564-2679
Fax: (402) 564-0295

Eakes Office Plus
Suite 201
2630 North Yager Road
Fremont, NE 68025-7800
Phone: (402) 941-5001
Fax: (402) 941-5002

Eakes Office Plus
617 West Third Street
Grand Island, NE 68801-5946
Phone: (308) 382-8026
Fax: (308) 382-7401

Eakes Office Plus
839 West Second Street
Hastings, NE 68901-5099
Phone: (402) 463-2537
Fax: (402) 463-6802

Eakes Office Plus
2401 Avenue A
Kearney, NE 68847-5498
Phone: (308) 234-2538
Fax: (308) 234-2540

Eakes Office Plus
110 N 35th Street
Lincoln, NE 68503
Phone: (402) 438-6700
Fax: (402) 438-6701

Eakes Office Plus
1803 North 6th Street
Beatrice, NE 68310
Phone: (402) 228-7202
Fax: (402) 228-0262

Eakes Office Plus
120 Norris Avenue
McCook, NE 69001
Phone: (308) 345-5447
Fax: (308) 345-5237

Eakes Office Plus
510 W. 13th Street
Souix City, NE 68776
Phone: (402) 412-2334

Eakes Office Plus
201 South 1st Street
Norfolk, NE 68701-5303
Phone: (402) 371-4181
Fax: (402) 371-5139

Eakes Office Plus
520 North Vine Street
North Platte, NE 69101-3954
Phone: (308) 534-7800
Fax: (308) 534-3936

Eakes Office Plus
710 North Lincoln Ave.
York, NE 68467
Phone: (402) 362-5442
Fax: (402) 362-7530

Sheppard's Business Interiors Inc.
725 South 72nd Street
Omaha, NE 68114-4665
Phone: (402) 393-8888
Fax: (402) 393-0113

Nevada

Machabee Office Environments
6435 Sunset Corporate Drive
Las Vegas, NV 89120-2798
Phone: (702) 263-8800
Fax: (702) 263-8801

Machabee Office Environments
1335 Greg Parkway #101
Sparks, NV 89431
Phone: (775) 329-3145
Fax: (775) 786-5710

New Hampshire

Red Thread
Suite 103
650 Elm Street
Manchester, NH 03101-1160
Phone: (603) 668-5511
Fax: (603) 668-6851

New Jersey

Arbee Associates
1531 South Washington Avenue
Piscataway, NJ 08854-3815
Phone: (732) 424-3900
Fax: (732) 752-6034

Concepts Office Furnishings
280 North Midland Avenue
Building J
Saddle Brook, NJ 07663-5708
Phone: (201) 727-9110
Fax: (201) 727-9112

Dancker, Sellw, and Douglas
291 Evans Way
Somerville, NJ 08876-3766
Phone: (908) 231-1600
Fax: (908) 231-6469

W.S. Goff Company Inc.
5104 Oakland Blvd.
Mays Landing, NJ 08330-2016
Phone: (609) 625-5600
Fax: (609) 625-5633

New Mexico

Business Environments
5351 Wilshire Avenue, N.E.
Albuquerque, NM 87113-1834
Phone: (505) 888-4400
Fax: (505) 889-9146

New York

AFD Contract Furniture Inc
810 7th Avenue
New York, NY 10019
Phone: (212) 721-7100
Fax: (212) 721-7175

Merkel-Donohue
1 Interstate Avenue
Albany, NY 12205
Phone: (518) 273-9359
Fax: (518) 272-1552

Empire Office Inc.
105 Madison Avenue
New York, NY 10016-8810
Phone: (212) 607-5500
Fax: (212) 607-5654

Merkel-Donohue
1349 University Avenue Suite 2
Rochester, NY 14607
Phone: (585) 325-7696
Fax: (585) 325-3065

Prentice Office Environments
472 Franklin Street
Buffalo, NY 14202-1302
Phone: (716) 884-8452
Fax: (716) 884-0894

Stevens Office Interiors
6804 Manlius Center Road
East Syracuse, NY 13057-3902
Phone: (315) 479-5595
Fax: (315) 428-1688

Waldner's Business Environments
125 Route 110
Farmingdale, NY 11735-4864
Phone: (631) 844-9300
Fax: (631) 694-3503

Waldner's Business Environments
215 Lexington Avenue, 9th Floor
New York, NY 10016-6023
Phone: (212) 696-7500
Fax: (212) 696-7699

Waldner's Business Environments
411 Theodore Fremd Avenue
3rd Floor, South Building
Rye, NY 10580-1410
Phone: (914) 921-8500
Fax: (914) 921-0991

North Carolina

Office Environments Inc.
11407 Granite Street
Charlotte, NC 28273-6429
Phone: (704) 714-7200
Fax: (704) 714-7400

Young Office Environments
of Asheville Inc.
71 Thompson St
Asheville, NC 28803-2328
Phone: (888) 202-0508
Fax: (828) 505-1974

Storr Office Environments Inc.
496 Gallimore Dairy Road
Greensboro, NC 27409-9202
Phone: (336) 217-4500
Fax: (336) 217-4501

Storr Office Environments Inc.
10800 World Trade Blvd.
Raleigh, NC 27617-4200
Phone: (919) 313-3700
Fax: (919) 313-3701

Williams Office Environments Inc.
407 Ray Avenue
Fayetteville, NC 28301-4915
Phone: (910) 483-0354
Fax: (910) 486-4077

North Dakota

Fireside Office Products Inc.
1713 East Bismarck Expressway
Bismarck, ND 58504-6706
Phone: (701) 258-8586
Fax: (701) 223-9598

Hannaher's
1809 13th Avenue North
Grand Forks, ND 58203-2323
Phone: (701) 746-6466
Fax: (701) 746-0737

Hannaher's Inc.
4324 20th Avenue SW
Fargo, ND 58103-4434
Phone: (701) 277-7222
Fax: (701) 277-7097

Ohio

Business Furniture
8 North Main Street
Dayton, OH 45439
Phone: (937) 293-1010
Fax: (937) 293-7501

Loth Inc.
3574 East Kemper Road
Cincinnati, OH 45241-2009
Phone: (513) 554-4900
Fax: (513) 554-8737

Loth Company
855 Grandview Avenue
Columbus, OH 43215-1123
Phone: (614) 487-4000
Fax: (614) 487-4306

NBS
4 North St. Clair Street
Toledo, OH 43604
Phone: (419) 662-2040
Fax: (419) 662-2041

Ohio Desk
34 Swartz Road
Akron, OH 44319
Phone: (330) 499-1030

Ohio Desk
1122 Prospect Avenue
Cleveland, OH 44115-1292
Phone: (216) 623-0600
Fax: (216) 623-0611

Ohio Desk
5100 Market Street
Youngstown, OH 44512
Phone: (330) 782-3331

Oklahoma

Scott Rice
2900 North Hemlock Circle
Broken Arrow, OK 74012-1185
Phone: (918) 362-4300
Fax: (918) 362-4303

Scott Rice
7501 Broadway Ext
Oklahoma City, OK 73116-9015
Phone: (405) 848-2224
Fax: (405) 848-3999

Oregon

Hypn
Suite 103/104
150 SW Scalehouse Loop
Bend, OR 97702
Phone: (541) 317-8777
Fax: (541) 317-2833

Hypn
620 NE 19th Avenue
Portland, OR 97232-2832
Phone: (503) 226-4151
Fax: (503) 226-9233

Pennsylvania

A. Pomerantz & Company
Suite 7000
701 Market Street
Philadelphia, PA 19106-1597
Phone: (215) 408-2100
Fax: (215) 408-2110

Corporate Interiors
Suite 200
161 Washington Street
Conshohocken, PA 19428-2083
Phone: (610) 631-5400
Fax: (610) 631-2720

Interior Workplace Solutions LLC.
145 Stewart Road
Wilkes-Barre, PA 18706
Phone: (570) 288-7211
Fax: (570) 970-5817

Franklin Interiors
Suite 600
2740 Smallman Street
Pittsburgh, PA 15222-4720
Phone: (412) 261-2525
Fax: (412) 255-4089

Participating Steelcase Dealers, continued

Pennsylvania

Interior Workplace Solutions LLC.
6765 Ambassador Drive
Allentown, PA 18106-9510
Phone: (610) 391-0733
Fax: (610) 391-1155

Interior Workplace Solutions LLC.
Suite B-25
2209 Quarry Drive
Reading, PA 19609-1155
Phone: (610) 670-1800
Fax: (610) 670-8181

McCartney's Inc.
819 Howard Avenue
Altoona, PA 16601-4727
Phone: (814) 505-1111
Fax: (814) 949-6197

Phillips Workplace Interiors
6345 Flank Drive
Harrisburg, PA 17112
Phone: (844) 228-2600

South Carolina

Aiken Office Supply Inc.
2560 Whiskey Road
Aiken, SC 29803-9664
Phone: (803) 648-8339
Fax: (803) 649-4470

McWaters Inc.
1104 Shop Road
Columbia, SC 29201-4743
Phone: (803) 256-8303
Fax: (803) 252-5567

McWaters Inc.
3841 Commercial Center Drive
Ladson, SC 29456-4146
Phone: (843) 486-1823

Wulbern-Koval Company Inc.
1111 Morrison Drive
Charleston, SC 29403-3119
Phone: (843) 577-7666
Fax: (843) 577-7299

Young Office Environments
1280 Ridge Road
Greenville, SC 29607-4626
Phone: (864) 281-9500
Fax: (864) 281-9555

South Dakota

Interstate Office Products Inc.
228 South Main Avenue
Sioux Falls, SD 57104-6310
Phone: (605) 339-0300
Fax: (605) 339-1989

Western Stationers
714 Saint Joseph Street
Rapid City, SD 57701-2721
Phone: (605) 342-3310
Fax: (605) 342-4746

Tennessee

Bentco Office Solutions
1501 Stuart Street
Chattanooga, TN 37406
Phone: (423) 756-4437
Fax: (423) 756-6198

Memphis Business Interiors
4539 West Distriplex Drive
Memphis, TN 38118-7280
Phone: (901) 360-8899
Fax: (901) 360-8370

Office Resources Inc.
4020 Armory Oaks Drive
Nashville, TN 37204
Phone: (615) 376-1200
Fax: (615) 376-1245

Workspace Interiors
Suite 300
200 E. Main Street
Kingsport, TN 37660-4354
Phone: (423) 392-2600
Fax: (423) 392-2601

Workspace Interiors
2820 Middlebrook Pike
Knoxville, TN 39721
Phone: (865) 223-5404
Fax: (865) 223-5405

Texas

Abilene Printing & Stationery
218 Cedar Street
Abilene, TX 79601-5720
Phone: (915) 677-2673
Fax: (915) 675-6963

BKM Total Office of Texas
9755 Clifford Drive
Dallas, TX 75220
Phone: (214) 902-7200
Fax: (214) 902-7201

Business Interiors
1111 Valley View Lane
Irving, TX 75061-6008
Phone: (817) 858-2000
Fax: (817) 858-2020

McCoys Inc.
6869 Old Katy Road
Houston, TX 77024-2105
Phone: (713) 862-4600
Fax: (713) 862-7676

Rockford Business Interiors
211 East Riverside Drive
Austin, TX 78704-1203
Phone: (512) 442-0703
Fax: (512) 442-6555

Texas Wilson Office Furniture &
Services
5801 George McVay Drive
McAllen, Texas 78503
Phone: (210) 647-8800
Fax: (210) 647-3110

Texas Wilson Office Furniture &
Services

6812 Fairgrounds Pkwy
San Antonio, TX 78238-4536
Phone: (210) 647-8800
Fax: (210) 647-3110

West Supply Company
1601 Scurry
Big Spring, TX 79720
Phone: (432) 264-1788
Fax: (432) 264-1789

West Supply Company
2 South Chadbourne Street
San Angelo, TX 76903-5875
Phone: (325) 655-8181
Fax: (325) 655-5480

Utah

MidWest Office Furniture
987 South West Temple
Salt Lake City, UT 84101-2988
Phone: (801) 359-7681
Fax: (801) 355-2713

Vermont

Red Thread
180 Battery St Ste 210
Burlington, VT 05401-5212
Phone: (802) 862-0434
Fax: (802) 862-0729

Virginia

Barrows
1302 Rockland Avenue
Roanoke, VA 24012-3838
Phone: (540) 362-5700
Fax: (540) 362-4826

Creative Office Environments
11798 North Lakeridge Boulevard
Ashland, VA 23005-8152
Phone: (804) 329-0400
Fax: (804) 321-3134

Creative Office Environments LLC
650 Peter Jefferson Parkway #140
Charlottesville, VA 22911
Phone: (434) 327-1898
Fax: (434) 327-1896

Creative Office Environments LLC
Suite C
500 Woodlake Circle
Chesapeake, VA 23320-2807
Phone: (757) 549-4801
Fax: (757) 549-2795

reDistrict
Suite 30
66 Canal Center Plaza
Arlington, VA 22314
Phone: (703) 276-8901
Fax: (703) 276-8908

Washington

OpenSquare
6th Floor
5601 Sixth Avenue South
Seattle, WA 98108-2522
Phone: (206) 768-8000
Fax: (206) 768-0236

OpenSquare
126 South Sheridan Street
Spokane, WA 99202-1527
Phone: (509) 483-1000
Fax: (509) 483-1011

Wisconsin

Atmosphere Commercial Interiors
999 Fourier Drive Suite 200
Madison, WI 53717
Phone: (608) 257-0521
Fax: (608) 257-1859

Puerto Rico

AFD Contract Furnishings
Suite 250
350 Chardon Avenue
Torre Chardon
San Juan, Puerto Rico 00918-2123
Phone: (787) 754-2938
Fax: (787) 754-8076

Showrooms

Atlanta

Steelcase Inc.
Suite AL-175
303 Peachtree Center
Atlanta, GA 30303
Phone: (404) 523-2201

Chicago

Steelcase Worklife Chicago
Suite 300
222 Merchandise Mart
Chicago, IL 60654-1174
Phone: (312) 321-3720

Chicago

Coalesse
Suite 1032
222 Merchandise Mart
Chicago, IL 60654
Phone: (312) 467-1783

Dallas

Steelcase Inc.
1616 Hi Line Drive
Dallas, TX 75207
Phone: (214) 871-3044

Grand Rapids

Steelcase Inc.
901 44th Street, SE
Grand Rapids, MI 49508-7594
Phone: (616) 247-2710

New York

Steelcase Worklife New York
4 Columbus Circle
New York, NY 10019-1100
Phone: (212) 445-8800

Philadelphia

Steelcase Inc.
One Liberty Place
1650 Market Street, 3rd Floor
Philadelphia, PA 19103-7307
Phone: (215) 561-5331

San Francisco

Steelcase Inc.
Suite 110
475 Brannan Street
San Francisco, CA 94107
Phone: (415) 344-6700

Santa Monica

Steelcase Inc.
1217 2nd Street
Santa Monica, CA 90401-1180
Phone: (310) 633-2200

Washington D.C.

Steelcase Inc.
1121 14th Street NW
4th Floor
Washington, DC 20005

Manufacturing Sites

Amex de Mexico

Calle 5 Sur No.160
Ciudad Industrial
Tijuana, Mexico B.C. 22500
Phone: 52-662-342-6234

Athens

214 Durham Drive
Athens, AL 35611
Phone: (256) 232-8112

Grand Rapids Wood Furniture

4100 68th Street SE
Caledonia, MI 49316
Phone: (616) 698-5735

Kentwood Distribution Center

4384 52nd Street SE
Kentwood, MI 49512-9673

Kentwood West

4360 52nd Street SE
Kentwood, MI 49512

Details

901 44th Street SE
Grand Rapids, MI 49508
Phone: (616) 247-2710

Reynosa Plant

Ave. Prologis S/N Ed. 8 Suite
801 Prologis Park Pharr Bridge
Reynosa,
Tamaulipas, Mx CP. 88780
Phone: 52-899-263-9000



Seating/Occasional Tables

Statement of Line 20

Lounge Seating	45
Guest/Side/Stack Seating	175
Collaboration Seating	217
Occasional Tables	225
Outdoor	243

Statement of Line

Lounge Seating

Await Lounge System

Specifying
▶ Page 46

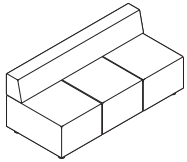

Three-Seat Lounge

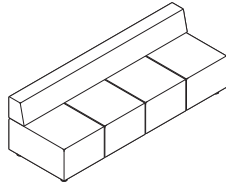

Four-Seat Lounge

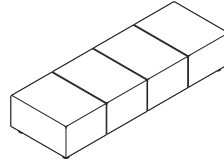

Four-Seat Bench



Mobile Ottoman

Await Lounge System Connector Benches and Tables

Specifying
▶ Page 48

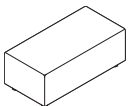

1-Section Connector Bench

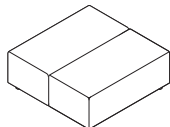

2-Section Connector Bench

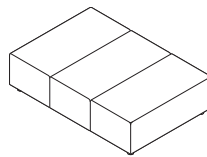

3-Section Connector Bench

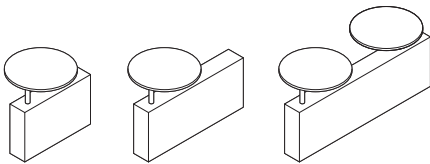

Connector Tables

Bix Lounge System Lounge Chairs

Specifying
▶ Page 52

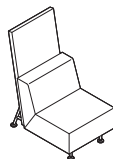

Bix Lounge System Sled Lounge Chairs

Specifying
▶ Page 53

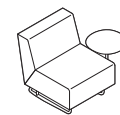
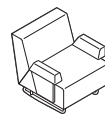
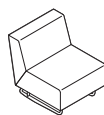

Statement of Line

Lounge Seating, continued

Bix Lounge System Sectional Seating

Specifying
► Page 54

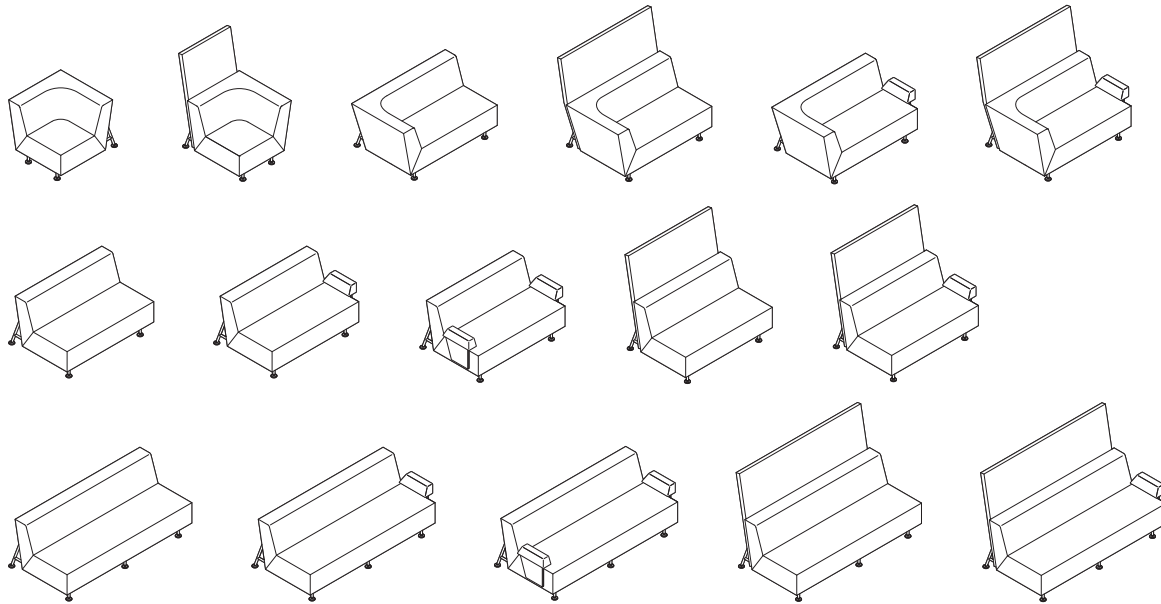

Bix Lounge System Benches

Specifying
► Page 60

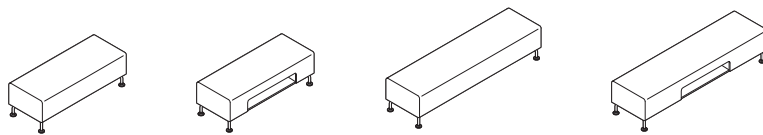

Bix Lounge System Podium

Specifying
► Page 62

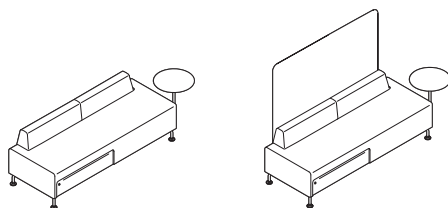

Statement of Line *continued*

Lounge Seating, continued

Bix Lounge System Bridge Tables

Specifying
▶ Page 68

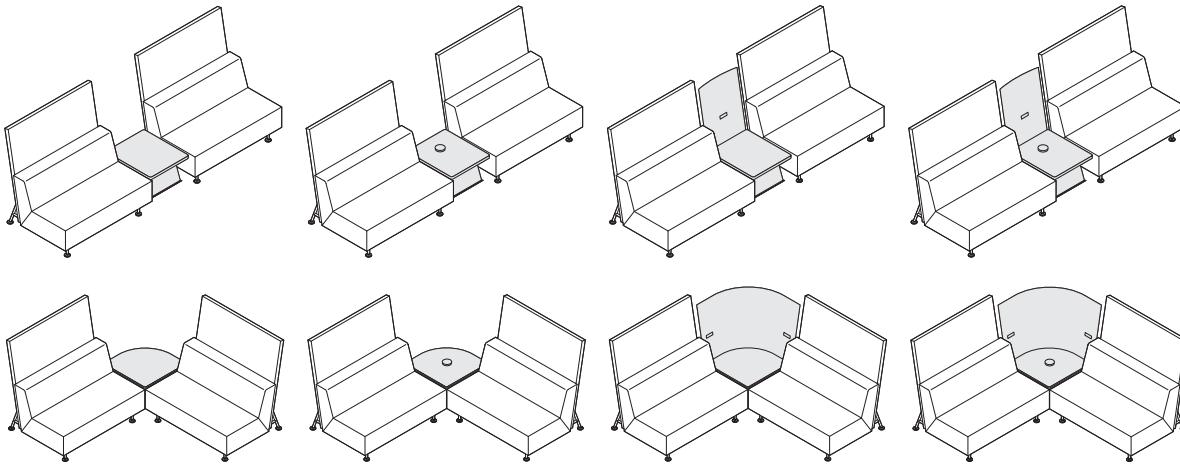

Bob Lounge Chairs

Specifying
▶ Page 74



Lounge Chair



Lounge Chair with
Headrest

Statement of Line

Lounge Seating, continued

Circa Lounge System

Specifying
► Page 76

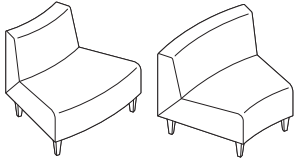

30° Outside/Inside
Facing Wedge
1-Seat Lounge

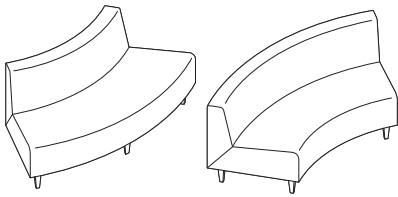

60° Wedge
2-Seat Lounge

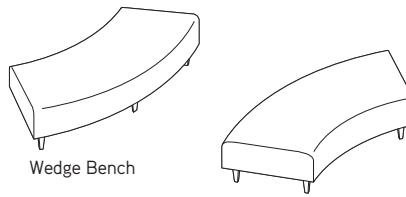

Wedge Bench

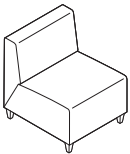

Straight Seat
1-Seat Lounge

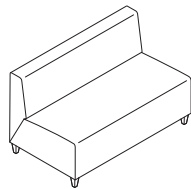

Straight
2-Seat Lounge

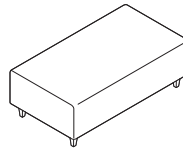

Straight Bench

Lounge Seating, continued

Circa Lounge System Upholstered Modular Arm Rests and Ottoman

Specifying
▶ Page 80



Straight Armrest
Intermediate without Legs

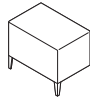

Straight Armrest
End-of-Run with Two Legs



15° Inside Armrest
Intermediate without Legs

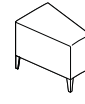

15° Inside Armrest
End-of-Run with Two Legs



15° Outside Armrest
Intermediate without Legs



15° Outside Armrest
End-of-Run with Two Legs

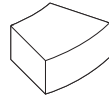

30° Inside Armrest
Intermediate without Legs

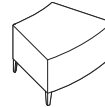

30° Inside Armrest
End-of-Run with Two Legs

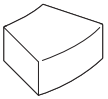

30° Outside Armrest
Intermediate without Legs

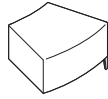

30° Outside Armrest
End-of-Run with Two Legs

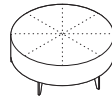

Round Ottoman

Statement of Line

Lounge Seating, continued

Circa Lounge System Modular Tables

Specifying
► Page 82

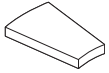

15° Low Wedge Table, Ganging

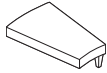

15° Low Wedge Table, End-of-Run, Two Legs

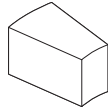

15° High Wedge Table, Ganging

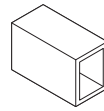

Straight High Table, Ganging

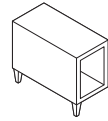

Straight High Table, End-of-Run, Two Legs

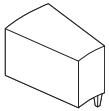

15° High Wedge Table, End-of-Run, Two Legs

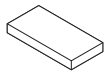

Straight Low Table, Ganging

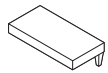

Straight Low Table, End-of-Run, Two Legs

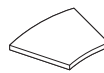

30° Low Wedge Table, Ganging

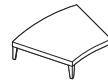

30° Low Wedge Table, End-of-Run, Two Legs



30° End-of-Run with One Leg

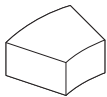

30° High Wedge Table, Ganging

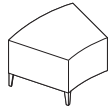

30° High Wedge Table, End-of-Run, Two Legs

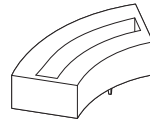

60° Planter Table, Ganging, Two Legs

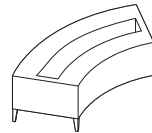

60° Planter Table, End-of-Run, Three Legs

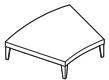

30° Low Wedge Table, Freestanding, Four Legs

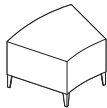

30° High Wedge Table, Freestanding, Four Legs

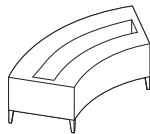

60° Planter Table, Freestanding, Five Legs

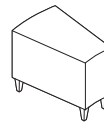

High Wedge

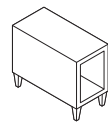

High Straight

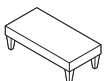

Low Straight

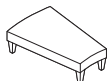

Low Wedge

Circa Lounge System Freestanding Round Table

Specifying
► Page 86

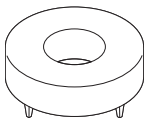

Round

Statement of Line *continued*

Lounge Seating, continued

Coupe Lounge Seating

Specifying
▶ Page 88

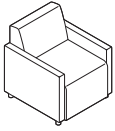

Lounge Chair

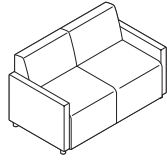

Two-Seat Lounge

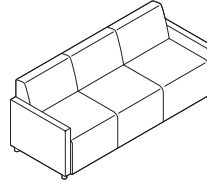

Three-Seat Lounge



Ottoman

Coupe Grande/Mobile Lounge Seating

Specifying
▶ Page 90

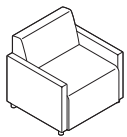

Grande Lounge Chair

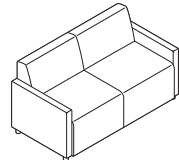

Grande Two-Seat
Lounge

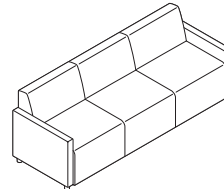

Grande Three-Seat Lounge

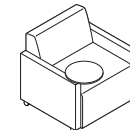

Grande Mobile
Lounge Chair

Coupe Wood Lounge Chair

Specifying
▶ Page 92

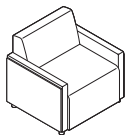

Wood Lounge Chair

Joel Lounge Chair

Specifying
▶ Page 93



Ripple Bench

Specifying
▶ Page 95

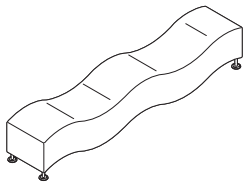

Upholstered
Wave Seat

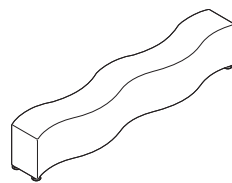

Upholstered
Flat Seat

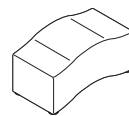

Little Ripple
Wave Seat

Statement of Line

Lounge Seating, continued

Sidewalk Lounge Seating

Specifying
▶ Page 96

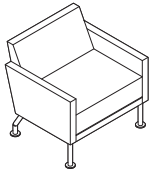

Low-Back Lounge Chair

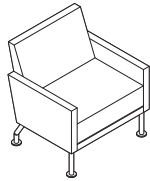

High-Back Lounge Chair

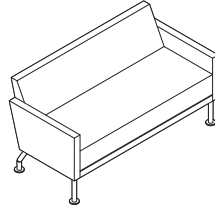

Two-Seat Lounge

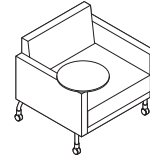

Mobile Low-Back Lounge
Chair with Tablet

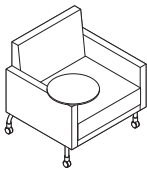

Mobile High-Back Lounge
Chair with Tablet



Arm Bolster

Sidewalk Collaborative Lounge Seating

Specifying
▶ Page 100

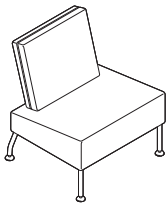

Lounge Chair

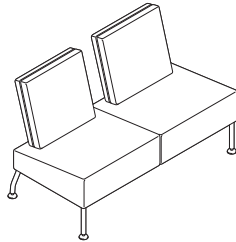

Two-Seat Lounge

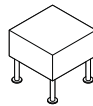

Ottoman

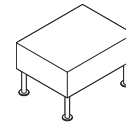
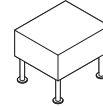

Sidewalk Lounge Seating Benches/Ottoman

Specifying
▶ Page 102

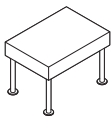

Benches

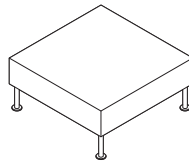
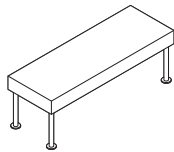
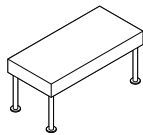

Ottoman

Swathmore Lounge Seating

Specifying
▶ Page 104

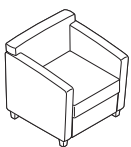

Lounge Chair with
Wood Legs

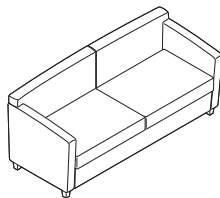

Three-Seat Lounge with
Wood Legs

Statement of Line *continued*

Lounge Seating, continued

Swathmore Lounge Seating Louver

Specifying
▶ Page 105

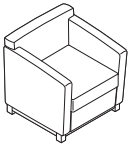

Lounge Chair with
Wood Louver Base

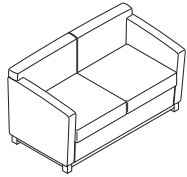

Two-Seat Lounge with
Wood Louver Base

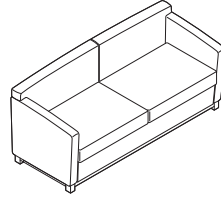

Three-Seat Lounge with
Wood Louver Base

Swathmore Grande Lounge Seating with Wood Legs

Specifying
▶ Page 106

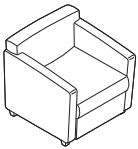

Chair with Wood Legs

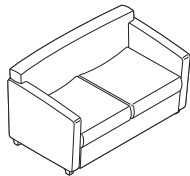

Two-Seat Lounge
with Wood Legs

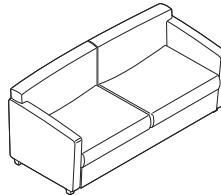

Three-Seat Lounge
with Wood Legs

Swathmore Grande Louver

Specifying
▶ Page 107

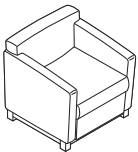

Grande Lounge
Chair with Wood
Louver Base

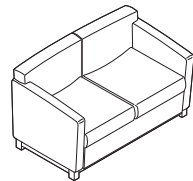

Grande Two-Seat
Lounge with Wood
Louver Base

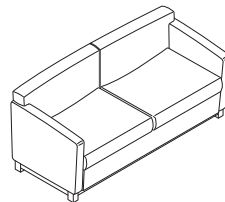

Grande Three-Seat
Lounge with Wood
Louver Base

Swathmore Grande Lounge Seating Mobile

Specifying
▶ Page 108

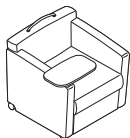

Grande Mobile Lounge
Chair/Tablet Left Facing

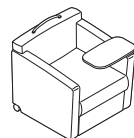

Grande Mobile Lounge
Chair/Tablet Right Facing

Statement of Line

Lounge Seating, continued

Topo Lounge Seating

Specifying
▶ Page 110



Lounge Chair



Lounge Jr.

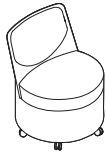

Mobile Lounge
Chair

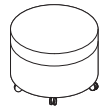

Mobile Lounge Jr.

Davos Lounge Seating

Specifying
▶ Page 114

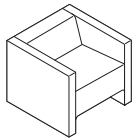

Lounge Chair

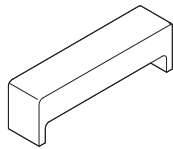

Large Bench

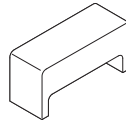

Medium Bench



Small Bench

Hosu Lounge Seating

Specifying
▶ Page 116



Lounge Chair with
Lumbar Pillow

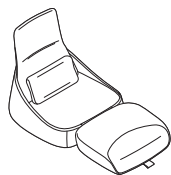

Lounge Chair with Ottoman
and Lumbar Pillow

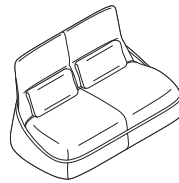

Two-Seat Lounge with
Two Lumbar Pillows

Millbrae Lifestyle Lounge Seating

Specifying
▶ Page 118

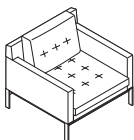

Lounge

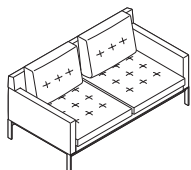

Two-Seat Lounge

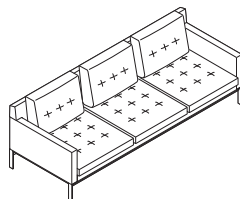

Three-Seat Lounge



Round Arm Bolster



Square Arm Bolster

Lounge Seating, continued

Millbrae Contract Lounge Seating

Specifying
▶ Page 118

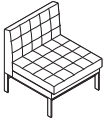

Lounge
without Arms

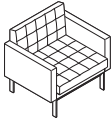

Lounge
with Arms



Lounge
with Left Arm Facing

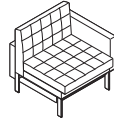

Lounge
with Right Arm Facing

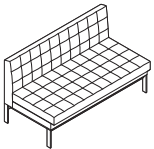

Two-Seat Lounge
without Arms

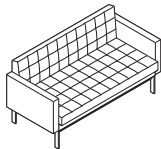

Two-Seat Lounge
with Arms

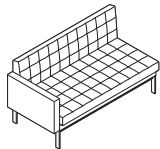

Two-Seat Lounge
with Left Arm Facing

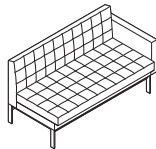

Two-Seat Lounge
with Right Arm Facing

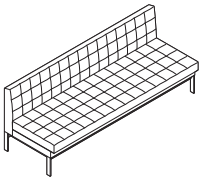

Three-Seat Lounge
without Arms

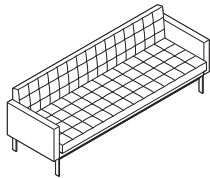

Three-Seat Lounge
with Arms

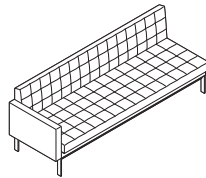

Three-Seat Lounge
with Left Arm Facing

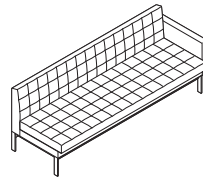

Three-Seat Lounge
with Right Arm Facing

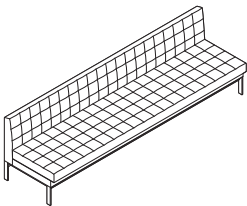

Four-Seat Lounge
without Arms

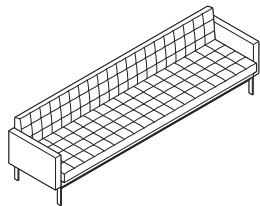

Four-Seat Lounge
with Arms

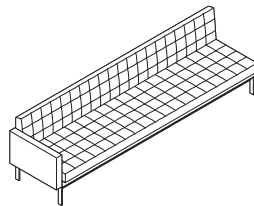

Four-Seat Lounge
with Left Arm Facing

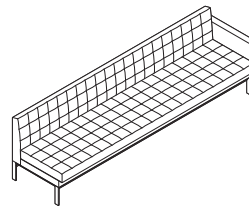

Four-Seat Lounge
with Right Arm Facing

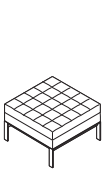

One-Seat
Bench

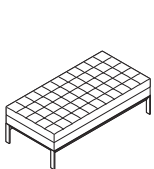

Two-Seat Bench

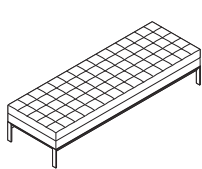

Three-Seat Bench

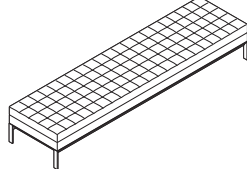

Four-Seat Bench

Statement of Line

Lounge Seating, continued

Lagunitas Lounge System

Specifying
▶ Pages 124-153

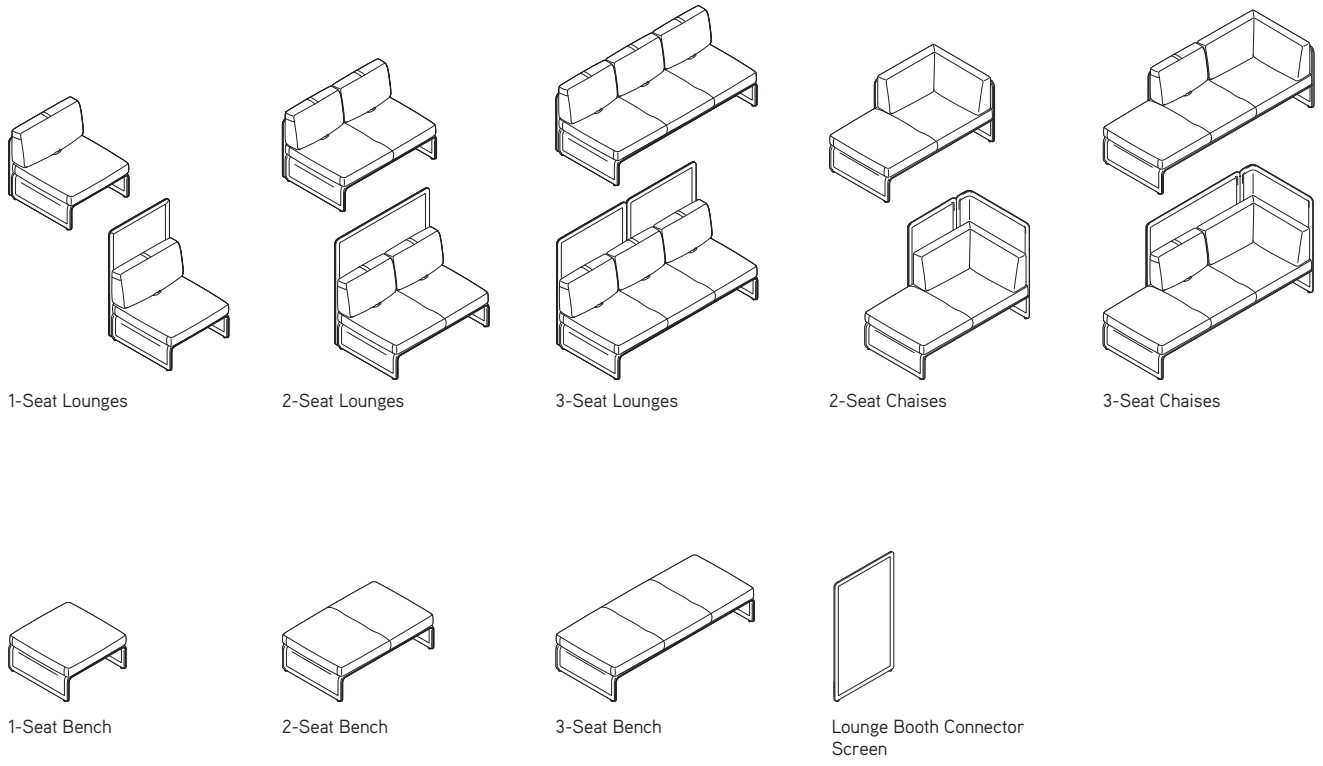

Lagunitas Focus Nook

Specifying
▶ Page 154

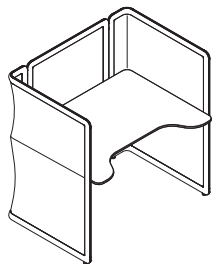

Statement of Line *continued*

Lounge Seating, continued

Passerelle Lounge Seating

Specifying
▶ Pages 156-159

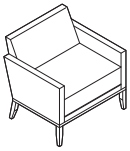

Lounge Chair

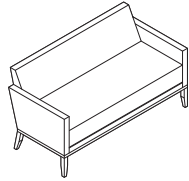

2-Seat Lounge

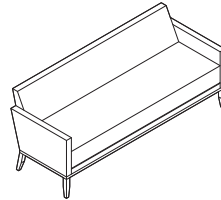

3-Seat Lounge



Arm Bolster

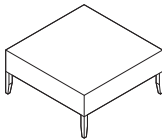
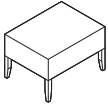
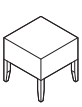

Ottomans

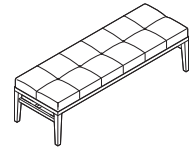
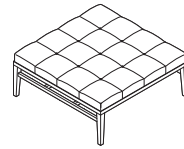
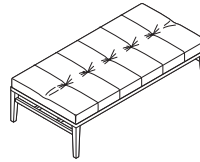

Benches

Switch Lounge Seating

Specifying
▶ Page 160



Lounge Chair

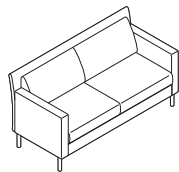

Two-Seat Lounge

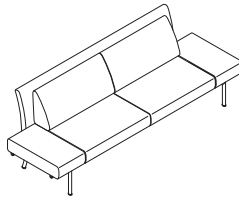

Two-Seat Lounge with Extensions

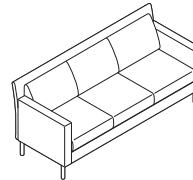

Three-Seat Lounge



Arm Bolster

SW_1 Lounge Seating

Specifying
▶ Page 162



Low-Back Collaborative Lounge Chair



High-Back Collaborative Lounge Chair



Ottoman

Statement of Line

Lounge Seating, continued

Together Bench

Specifying
▶ Page 166

70½"D 96½"W 31"H

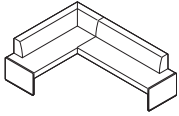

Left Corner with Back 8" Offset

97¼"D 96½"W 31"H

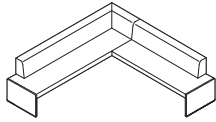

Left Corner with Back 1½" Offset

70½"D 123¼"W 31"H

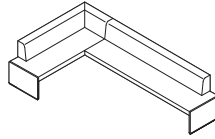

Right Corner with Back 8" Offset

97¼"D 123¼"W 31"H

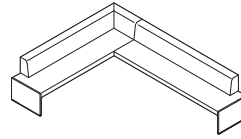

Right Corner with Back 1.5" Offset

70½"D 96½"W 31"H

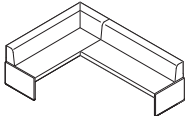

Straight with 8" Offset Back

97¼"D 96½"W 31"H

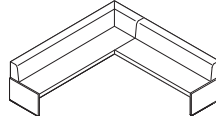

Straight with 1.5" Offset Back

70½"D 123¼"W 31"H

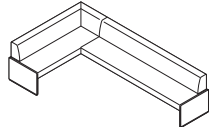

Straight without Back

97¼"D 123¼"W 31"H

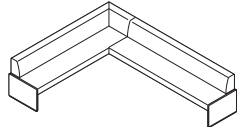

70½"D 96½"W 31"H

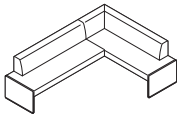

70½"D 96½"W 31"H

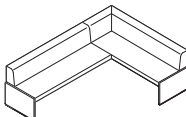

26¾"D 69¾"W 31"H

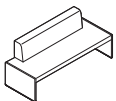

97¼"D 96½"W 31"H

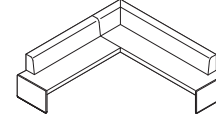

26¾"D 96½"W 31"H

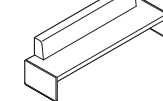

70½"D 123¼"W 31"H

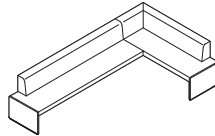

70½"D 123¼"W 31"H

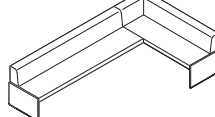

26¾"D 69¾"W 31"H

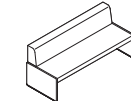

97¼"D 123¼"W 31"H

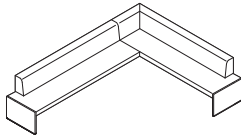

26¾"D 96½"W 31"H

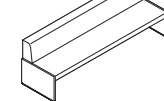

Statement of Line *continued*

Lounge Seating, continued

Visalia Lounge Seating

Specifying
▶ Page 172

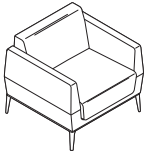

Lounge Chair

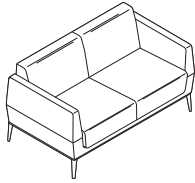

Two-Seat Lounge

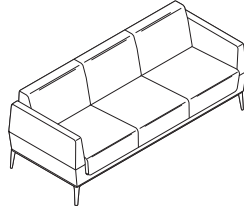

Three-Seat Lounge

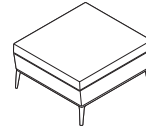

Ottoman

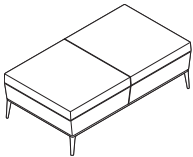

Bench

Statement of Line

Guest/Side/Stack Seating

Bindu Chairs

Specifying
▶ Page 176



Low-Back Chair



Mid-Back Chair

Bob Chair

Specifying
▶ Page 177



Guest Chair

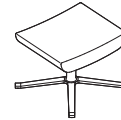

Ottoman

Capa Chair

Specifying
▶ Page 178



Enea Stacker Chairs

Specifying
▶ Page 180



Wood Seat and Back with Arms



Metal Stacker with Upholstered Seat and Back with Arms



Metal Stacker with Upholstered Seat and Wood Back with Arms



Metal Stacker with Polypropylene Seat and Back with Arms



Wood Seat and Back without Arms

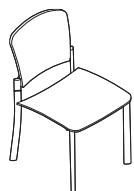

Upholstered Seat and Back without Arms



Upholstered Seat and Wood Back without Arms



Polypropylene Seat and Back without Arms

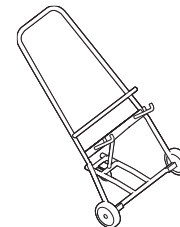

Dolly

Statement of Line *continued*

Guest/Side/Stack Seating, continued

Specifying
▶ Page 184

Enea Bar Stools

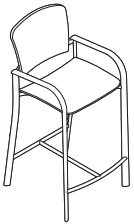

Bar-Height Stool with Wood Seat and Back with Arms

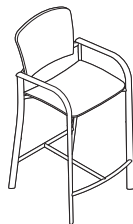

Bar-Height Stool with Upholstered Seat and Back with Arms

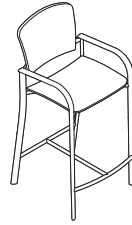

Bar-Height Stool with Upholstered Seat and Wood Back with Arms

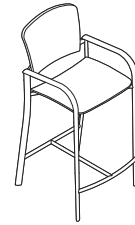

Bar-Height Stool with Polypropylene Seat and Back with Arms

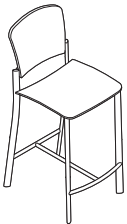

Bar-Height Stool with Wood Seat and Back without Arms

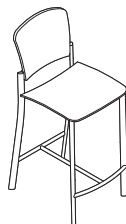

Bar-Height Stool with Upholstered Seat and Back without Arms

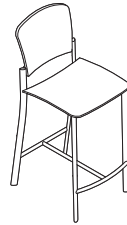

Bar-Height Stool with Upholstered Seat and Wood Back without Arms

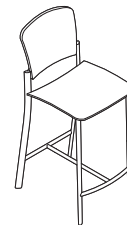

Bar-Height Stool with Polypropylene Seat and Back without Arms

Enea Café Post Stools

Specifying
▶ Page 190



Café Counter-Height Stool with Back



Café Bar-Height Stool with Back



Low Stool Upholstered Seat



Café Counter-Height Stool Upholstered Seat



Café Bar-Height Stool Upholstered Seat

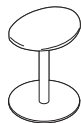

Low Stool



Café Counter-Height Stool

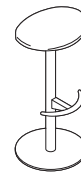

Café Bar-Height Stool

Statement of Line

Guest/Side/Stack Seating, continued

Enea Lottus Seating

Specifying
▶ Page 192

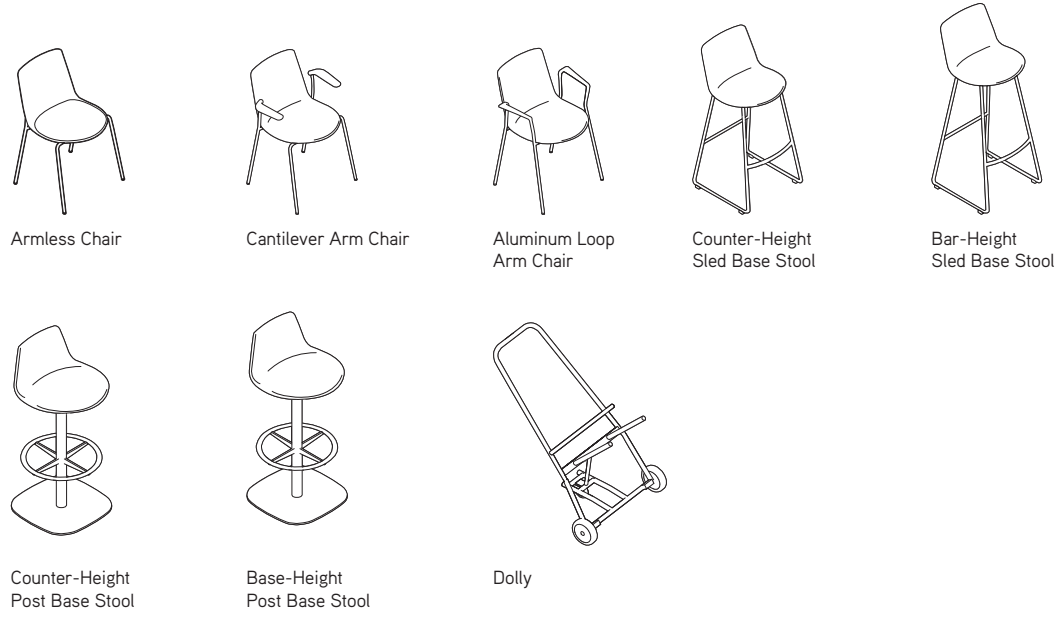

Kathryn Chairs

Specifying
▶ Page 200



Last Minute Stools

Specifying
▶ Page 202

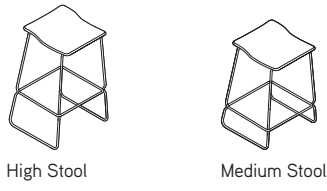

Lox Stools

Specifying
▶ Page 203

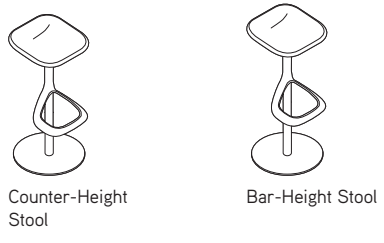

Statement of Line *continued*

Guest/Side/Stack Seating, continued

Switch Chairs and Stools

Specifying
▶ Page 204

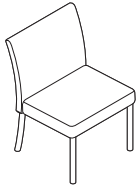

Armless Chair

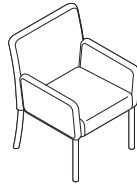

Arm Chair

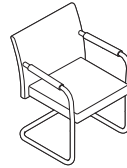

Low-Back Sled Base Chair

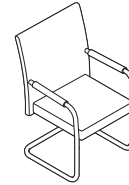

High-Back Sled Base Chair

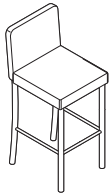

Counter-Height Stool

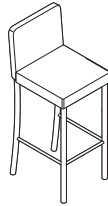

Bar-Height Stool

Montara650 Chairs and Stools

Specifying
▶ Page 208



Wood Shell, Wood Shell with Upholstered Seat, Wood Shell with $\frac{3}{4}$ Upholstery, and Fully Upholstered



Counter-Height or Bar-Height Stool: Wood Shell, Wood Shell with Upholstered Seat, and Fully Upholstered



Wood Shell with Upholstered Seat, Wood Shell with $\frac{3}{4}$ Upholstery, and Fully Upholstered

Montara650 Rocker

Specifying
▶ Page 214



Wood Shell with Upholstered Seat, Wood Shell with $\frac{3}{4}$ Upholstery, and Fully Upholstered

Wrapp Chairs

Specifying
▶ Page 216



Four-Leg Chair

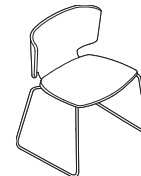

Sled-Base Chair

Statement of Line

Collaboration Seating

Bindu Conference Seating

Specifying
► Page 218



Mid-Back Conference
Chair



High-Back Conference
Chair

Chord Conference Seating

Specifying
► Page 220



Conference Narrow



Mid-Back



High-Back Narrow



High-Back/Large Scale

SW_1 Conference Seating

Specifying
► Page 222



Conference Chair
with 4-Star Base



Conference Chair
with 5-Star Base

Statement of Line *continued*

Occasional Tables

Await Occasional Tables

Specifying
▶ Page 226

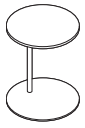

Freestanding
Low Round

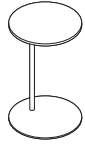

Freestanding
High Round

Bix 18"H Occasional Tables

Specifying
▶ Pages 70 and 228

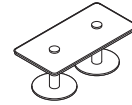
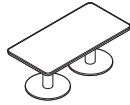

Bix 27" Work-Booth Tables

Specifying
▶ Page 71

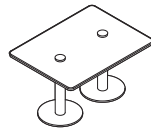
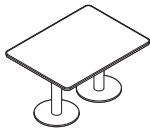

Bix Side Table

Specifying
▶ Pages 72 and 227

Statement of Line

Occasional Tables, continued

Enea Single Base

Specifying
▶ Page 230

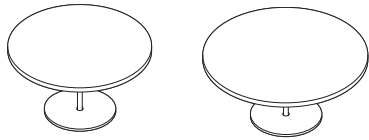

Occasional

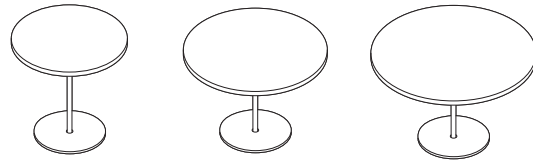

Conference

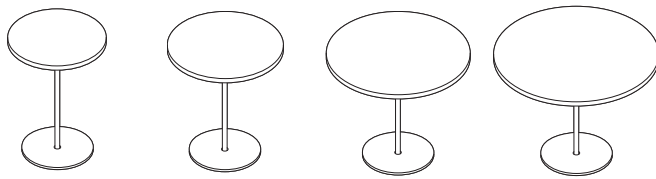

Café/Counter Height

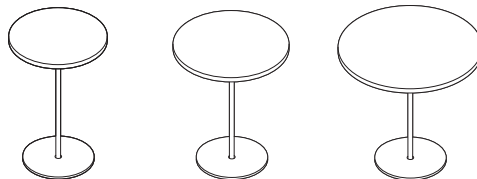

Café/Bar Height

Enea Twin Bases

Specifying
▶ Pages 232

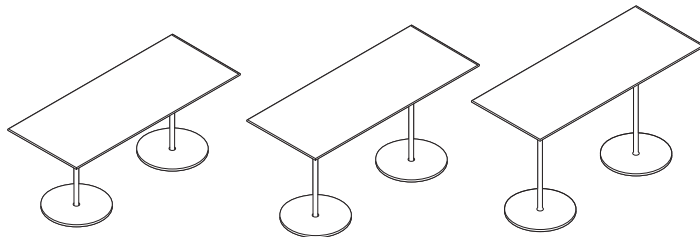

Rectangular



Oval

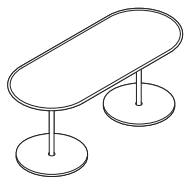

Conference
Racetrack

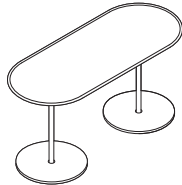

Counter Racetrack

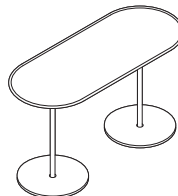

Café Racetrack

Statement of Line *continued*

Occasional Tables, continued

Enea Lottus Tables

Specifying
▶ Page 235

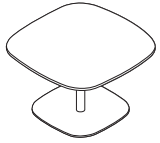

Occasional



Conference

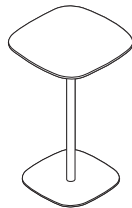

Café Counter Height

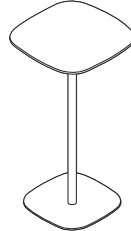

Café Bar Height

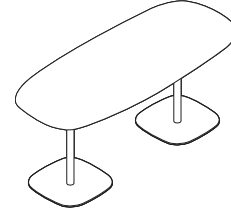

Rectangular

Sebastopol Occasional Tables

Specifying
▶ Page 240

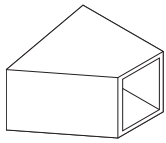

16" High Tables

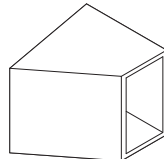
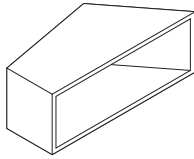

22" High Tables

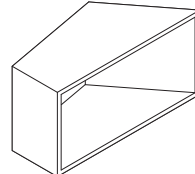

Sidewalk Occasional Tables

Specifying
▶ Page 241

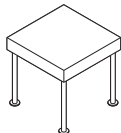
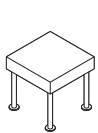

Trees Occasional Tables

Specifying
▶ Page 242

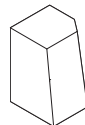

Bevel High-
Embossed Wood



Bevel Medium-
Embossed Wood

Statement of Line

Outdoor

Emu Heaven

Specifying
▶ Page 244

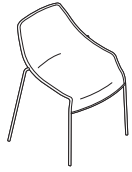

Chair

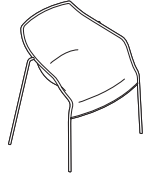

Arm Chair

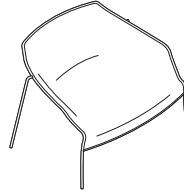

Lounge Chair



Pouf/Side Table

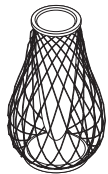

Low Vase



High Vase



Cushions

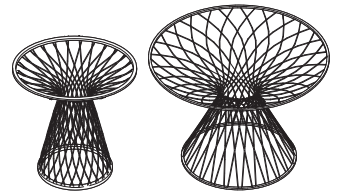

Round Table Bases

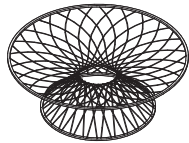

Low Table Base

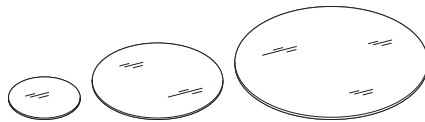

Glass Tops

Tip: Cushions are available for indoor and outdoor use.

Emu Ivy

Specifying
▶ Page 250



Side Chair



Side Arm Chair

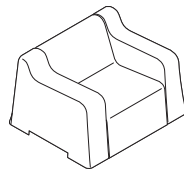

Arm Chair

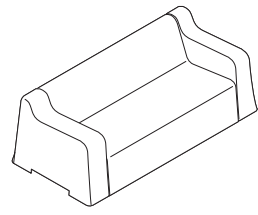

Lounge



Pouf

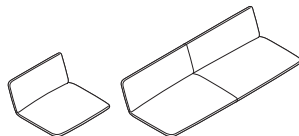

Cushions

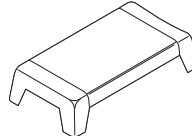

Rectangular Side Table

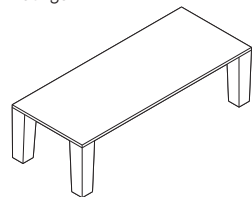

Rectangular Metal Top Table

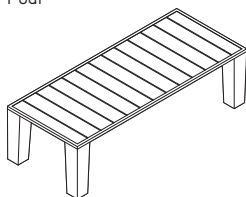

Rectangular Teak Top Table

Tip: Cushions are available for indoor and outdoor use.

Statement of Line *continued*

Outdoor, continued

Emu Re-Trouvé

Specifying
▶ Page 254



Midback Chair



Highback Chair



Pouf



Low Vase Frame



High Vase Frame

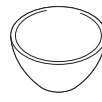

Vase Insert



Cushions

Tip: Cushions are available for indoor and outdoor use.

Emu Round

Specifying
▶ Page 256

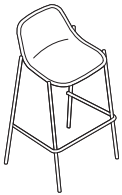

Stool



Chair



Arm Chair

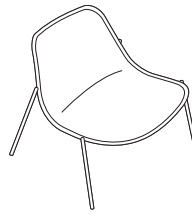

Lounge

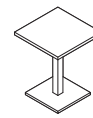

Square Tables

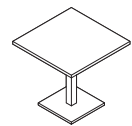
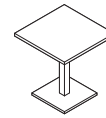

Round Table

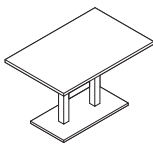

Rectangle Table

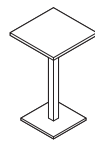

Counter Table

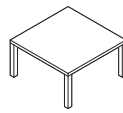

Side Tables

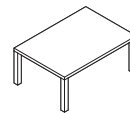

Lounge Seating

Await (SIN 711.16)	46
Bix (SIN 711.18)	52
Bob Chairs (SIN 711.18)	74
Circa (SIN 711.17)	76
Coupe (SIN 711.16)	88
Coupe Grande/Mobile (SIN 711.16)	90
Joel Lounge (SIN 711.16)	93
Ripple (SIN 711.16)	95
Sidewalk (SIN 711.16)	96
Swathmore (SIN 711.16)	104
Swathmore Grande (SIN 711.16)	106
Topo (SIN 711.16)	110
Davos (SIN 711.16)	114
Hosu (SIN 711.16)	116
Millbrae (SIN 711.16)	118
Lagunitas (SIN 711.16)	124
Lagunitas Focus Nook (SIN 711.16)	154
Passerelle (SIN 711.16)	156
Switch (SIN 711.16)	160
SW_1 (SIN 711.18)	162
Together Bench (SIN 711.16)	166
Visalia (SIN 711.16)	172

Await Lounge System

DESIGN E00S

SIN 711.16

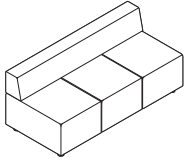

Tip: Recommended leathers are Elmosoft Grade C and Elmorustical Grade E.

Tip: Special color match, consult Customer Service.

Tip: For Customer's Own Material or Leather, see necessary requirements, important processing instructions, and ordering information.
 ▶ Page 262

Tip: Contrasting option available only on lounges.

Tip: Please include sketch for ganging.

Tip: Fabrics and leathers will appear loose with comfort wrinkles when upholstered.

Standard Includes		Required to Specify
<ul style="list-style-type: none"> ▶ Need help? Product details, see <i>Coalesse Seating and Outdoor Specification Guide</i> 	<ul style="list-style-type: none"> • Frame: unibody construction with finger-jointed plywood • Multiple densities of polyurethane foam and polyester foam and polyester fiber • Lounge: <ul style="list-style-type: none"> - Seat and back: fabric or leather - Legs: black high-density polyurethane resin - Glides: non-adjustable • Ottoman: <ul style="list-style-type: none"> - Seat: fabric or leather - Casters: non-locking 	<ol style="list-style-type: none"> 1 Style number 2 Number of fabrics if contrasting fabric style number is selected 3 Fabric or leather color number for upholstery on seat and back 4 Options, if selected (see below) ▶ See <i>Surface Materials</i> , page 260.
Options	Price	Required to Specify
Surface Materials <ul style="list-style-type: none"> • Contrasting fabric <hr/> Fire code seating <ul style="list-style-type: none"> • 3-seat lounge, four-seat lounge, and bench • Ottoman <hr/> Acrylic backer <ul style="list-style-type: none"> • 3-seat lounge • Four-seat lounge • Four-seat bench • Ottoman 	+\$118 per fabric +\$600 +\$231 +\$ 54 +\$ 67 +\$ 46 +\$ 15	Add suffix K to the style number and select fabric color number. Specify with <i>fire code seating</i> . Specify with <i>fire code seating</i> . ▶ See <i>Fire Code Seating</i> , page 264. Specify with <i>acrylic backer</i> . Specify with <i>acrylic backer</i> . Specify with <i>acrylic backer</i> . Specify with <i>acrylic backer</i> . ▶ See <i>Surface Materials</i> , page 260.
Floor Mount Legs <ul style="list-style-type: none"> • Floor mount legs 	+\$123 per unit	Specify with <i>floor mount legs</i>
Related Products <ul style="list-style-type: none"> • Connector benches • Occasional tables 		▶ Page 48 ▶ Page 226

Await Lounge System

DESIGN EOOS

SIN 711.16

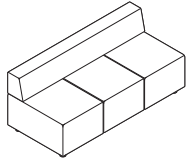

Overall: 30"D 66"W 27"H
 Inside: 22"D 66"W 27"H
 Seat: 16½"H
 Arm: 10½"H

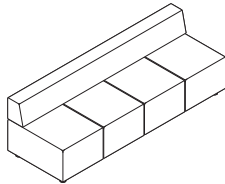

Overall: 30"D 88"W 27"H
 Inside: 22"D 88"W 27"H
 Seat: 16½"H
 Arm: 10½"H

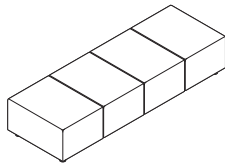

Overall: 30"D 88"W 16½"H
 Seat: 16½"H



Overall: 22"D 22"W 16½"H

Specification Information

Style Number	Base Prices										Leather Grades:		
	Fabric Grades:										COL	C	E
	COM	6	7	8	9	10	11	12	13	14			

3-Seat Lounge

460-3	\$3345	\$3392	\$3430	\$3494	\$3689	\$3815	\$3962	\$4063	\$4244	\$4495	\$3489	\$6041	\$6502
COM/yds = 5¾, COL/sq ft = 147													

Four-Seat Lounge

460-4	\$4079	\$4178	\$4225	\$4306	\$4552	\$4711	\$4896	\$5024	\$5252	\$5569	\$4223	\$7459	\$8035
COM/yds = 7¼, COL/sq ft = 185													

Four-Seat Bench

460-4B	\$3026	\$3065	\$3101	\$3162	\$3349	\$3469	\$3609	\$3707	\$3880	\$4120	\$3170	\$5613	\$6049
COM/yds = 5½, COL/sq ft = 100													

Mobile Ottoman

460-H	\$ 749	\$ 749	\$ 759	\$ 776	\$ 827	\$ 860	\$ 898	\$ 925	\$ 972	\$1037	\$ 992	\$1625	\$1740
COM/yds = 1½, COL/sq ft = 33													

Await Lounge System Connector Benches

DESIGN E00S

SIN 711.16

Tip: Recommended leathers are Elmosoft Grade C and Elmorustical Grade E.

Tip: Special color match, consult Customer Service.

Tip: For Customer's Own Material or Leather, see necessary requirements, important processing instructions, and ordering information.

► Page 262

Tip: Please include sketch for ganging.

Tip: Fabrics and leathers will appear loose with comfort wrinkles when upholstered.

Standard Includes		Required to Specify	
	<ul style="list-style-type: none"> Bench: fabric or leather Frame: unibody construction with finger-jointed plywood Multiple densities of polyurethane foam Fixed seat Top and double needle stitching on seams Legs: black high-density polyurethane resin Glides 		<ol style="list-style-type: none"> Style number Fabric or leather color number for upholstery on bench Options, if selected (see below) ► See <i>Surface Materials</i> , page 260.
Surface Materials	Options	Price	Required to Specify
	Fire code seating <ul style="list-style-type: none"> One-section connector bench +\$231 Two-section connector bench +\$461 Three-section connector bench +\$600 		Specify with <i>fire code seating</i> . Specify with <i>fire code seating</i> . Specify with <i>fire code seating</i> . ► See <i>Fire Code Seating</i> , page 264.
	Acrylic backer <ul style="list-style-type: none"> One-section connector bench +\$ 22 Two-section connector bench +\$ 33 Three-section connector bench +\$ 48 		Specify with <i>acrylic backer</i> . Specify with <i>acrylic backer</i> . Specify with <i>acrylic backer</i> . ► See <i>Surface Materials</i> , page 260.
Floor Mount Legs	<ul style="list-style-type: none"> Field-installed Floor mount legs 	+\$123 per unit	Specify with <i>floor mount legs</i> .
Related Products	<ul style="list-style-type: none"> Occasional tables 		► Page 226

Specification Information													
Style Number	Base Prices											Leather Grades:	
	Fabric Grades:											COL	C
	COM	6	7	8	9	10	11	12	13	14			

One-Section Connector Bench

461-1B	\$1381	\$1381	\$1396	\$1421	\$1497	\$1547	\$1604	\$1644	\$1715	\$1813	\$1598	\$2571	\$2746
COM/yds = 2¼, COL/sq ft = 53													

Two-Section Connector Bench

461-2B	\$2123	\$2123	\$2147	\$2189	\$2316	\$2399	\$2494	\$2560	\$2678	\$2842	\$2288	\$3937	\$4236
COM/yds = 3¾, COL/sq ft = 105													

Three-Section Connector Bench

461-3B	\$2924	\$2963	\$2999	\$3060	\$3247	\$3367	\$3507	\$3605	\$3778	\$4018	\$3068	\$5397	\$5814
COM/yds = 5½, COL/sq ft = 145													

Ganging Kit

460-GANGPKG	\$ 46
--------------------	-------

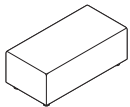

Overall: 44"D 22"W 16½"H

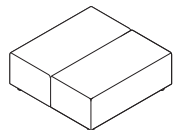

Overall: 44"D 44"W 16½"H

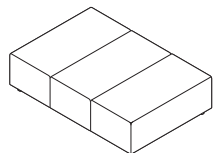

Overall: 44"D 66"W 16½"H

Await Lounge System Connector Tables

DESIGN EOOS

SIN 711.16

Tip: Await connector tables are not recommended to be used in end-of-run applications.

Tip: Await connector tables are not made for ganging to Await mobile ottoman.

Standard Includes	Required to Specify
<ul style="list-style-type: none"> Need help? Product details, see <i>Coalesse Seating and Outdoor Specification Guide</i> Connector table frame: panels are black, white, or gray Top: High-Pressure Laminate top with matching 3 mm edge band Glass top (tablet): <ul style="list-style-type: none"> - 1/2" thick - Radiused edges Ganging plate: 1/4" thick ganging plates attach to the bottom of units to the seating unit plates 	<ol style="list-style-type: none"> Style number Laminate top and tablets, if selected: <ul style="list-style-type: none"> 2746 Black 2730 Arctic White 290N North Sea Glass color number for top, if selected <ul style="list-style-type: none"> ▶ See <i>Coalesse Surface Materials Reference Guide</i>.

Related Products
<ul style="list-style-type: none"> Occasional tables ▶ Page 226 Lounge seating ▶ Page 47

Specification Information

Style Number	Prices								
	Laminate Top:			Glass Tablet:					
	No Tablet	Tablet	Power/Data	Clear Green/Clear Green Frosted Glass Tablet	Clear Green/Clear Green Frosted Tablet and Power/Data	Absolute Clear/Clear Frosted Glass Tablet	Absolute Clear/Clear Frosted Tablet and Power/Data	Colored Glass Tablet	Colored Tablet and Power/Data
460-SE22	\$646	\$1483	N.A.	\$1542	N.A.	\$1564	N.A.	\$1725	N.A.
460-SE22PD	N.A.	N.A.	\$1763	N.A.	\$1867	N.A.	\$1888	N.A.	\$2048

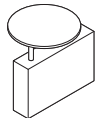

Overall: 20"D 4 1/2"W 15 3/4"H
With Tablet: 15 3/4" Dia. and 25 3/8"H

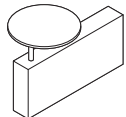

Overall: 28"D 4 1/2"W 15 3/4"H
With Tablet: 15 3/4" Dia. and 25 3/8"H

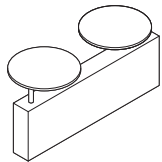

Overall: 42"D 4 1/2"W 25 3/8"H
With Tablets: 15 3/4" Dia. and 25 3/8"H

460-SE30	\$739	\$1576	N.A.	\$1635	N.A.	\$1662	N.A.	\$1818	N.A.
460-SE30PD	N.A.	N.A.	\$1861	N.A.	\$1965	N.A.	\$1986	N.A.	\$2146
460-SE44	\$908	\$2582	N.A.	\$2626	N.A.	\$2671	N.A.	\$2987	N.A.
460-SE44PD	N.A.	N.A.	\$2858	N.A.	\$2996	N.A.	\$3039	N.A.	\$3361

Lounge Seating

Await Ganging Diagrams by Model (Underside View)

DESIGN E00S

SIN 711.16

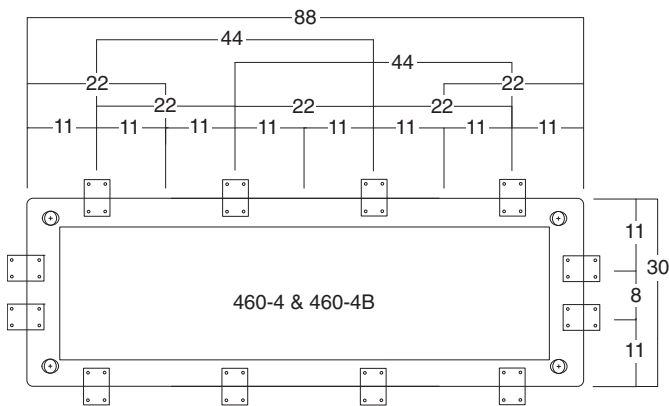
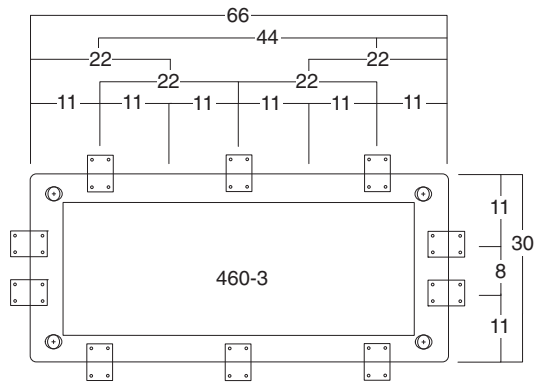
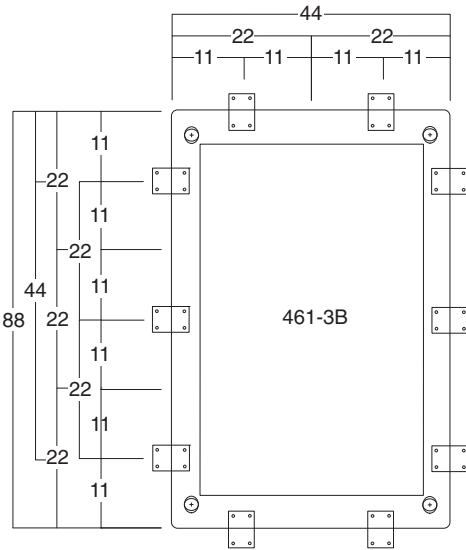
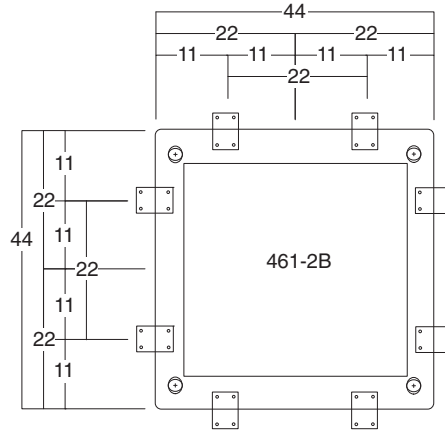
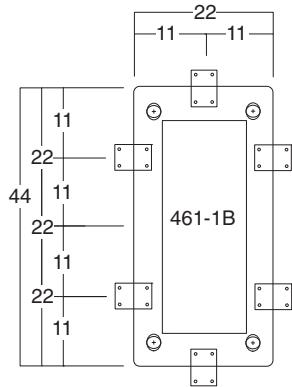

Await Multi-Fabric Diagram

SIN 711.16

TO: _____

FROM: _____

DATE: _____

FAX...888.413.5161

A Seat (upholstery selections default for entire unit if B is not selected):

B Back: _____

\$118 list per contrasting fabric specified. List price based on highest fabric grade usage.

Specify Model below:

460-3K

460-4K

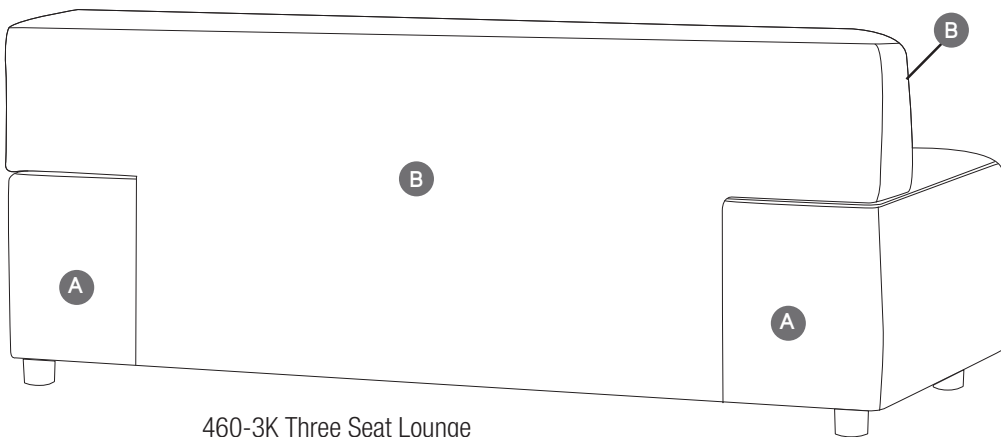
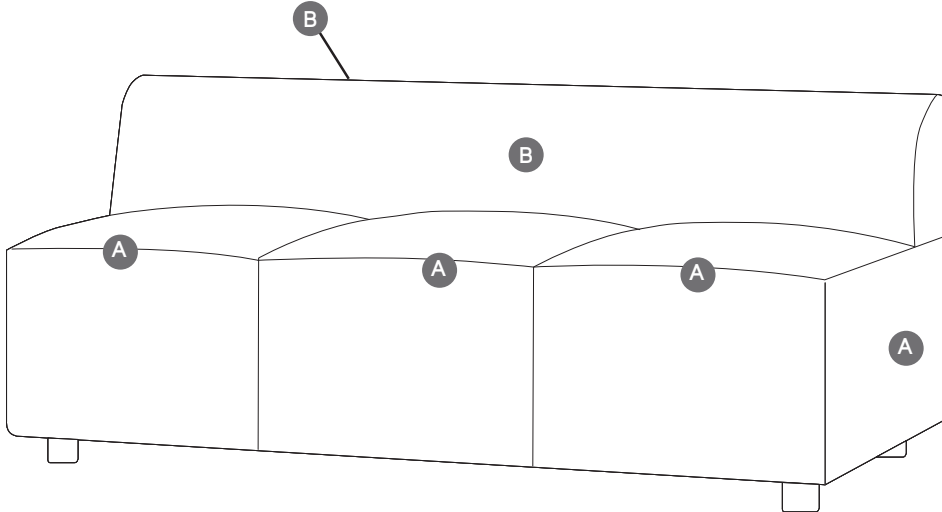

460-3K Three Seat Lounge

Bix Lounge System Lounge Chairs

DESIGN METRO DESIGN GROUP

SIN 711.18

Tip: Fabric for the seat and back is specified separate from the back screen, if selected. For a monochromatic look, specify the same fabric for both the seat and back and back screen.

Tip: Fabrics and leathers will appear loose with comfort wrinkles when upholstered.

Tip: When specifying fabric in different price grades, the highest price grade prevails.

Tip: The COM yards and COL square footage listed on this page reflect the requirements for a single fabric that are based on non-directional 54"W material applied railroaded. For multi-fabric COM requirements, please refer to Multi-Fabric Yardage.

► Page 65

Standard Includes	Required to Specify
<p>► Need help? Product details, see <i>Coalesse Seating and Outdoor Specification Guide</i></p> <ul style="list-style-type: none"> • Seat, back, and arms, if selected: fabric or leather • Legs: paint • Adjustable glides: paint to match legs • Back screen, if selected: fabric 	<ol style="list-style-type: none"> 1 Style number 2 Number of fabrics if contrasting fabric style number is selected 3 Fabric or leather color number for seat, back, and arms, if selected 4 Paint color number for legs and glides 5 Fabric color number for back screen, if selected 6 Options, if selected (see below) <p>► See <i>Surface Materials</i>, page 260.</p>

Options	Price	Required to Specify
<p>Surface Materials</p> <ul style="list-style-type: none"> • Contrasting fabric <hr/> <p>Acrylic backer</p> <ul style="list-style-type: none"> • Lounge chair +\$ 34 • Lounge chair with arms +\$ 46 • Lounge chair with back screen +\$ 56 	<p>+\$118 per fabric</p>	<p>Add suffix K to the style number and select fabric color number.</p> <hr/> <p>Specify with acrylic backer. Specify with acrylic backer. Specify with acrylic backer.</p> <p>► See <i>Surface Materials</i>, page 260.</p>
<p>Seat Height</p> <ul style="list-style-type: none"> • 18" seat height 	<p>+\$227</p>	<p>Specify with 18" seat height.</p>
<p>Related Products</p> <ul style="list-style-type: none"> • Sectional seating • Bench • Podium • Occasional tables • Work booth tables • Side table 		<p>► Page 54 ► Page 60 ► Page 62 ► Page 70 ► Page 71 ► Page 72</p>

Specification Information

Style Number	Base Prices														Leather Grades:		
	Fabric Grades:														COL	C	E
	COM	6	7	8	9	10	11	12	13	14							

Lounge Chair

BL26XX	\$1702	\$1702	\$1720	\$1751	\$1844	\$1905	\$1975	\$2023	\$2110	\$2230	\$1859	\$2772	\$2938
COM/yds = 2¾, COL/sq ft = 55													

Lounge Chair with Arms

BL26AA	\$2381	\$2381	\$2405	\$2447	\$2574	\$2657	\$2752	\$2818	\$2936	\$3100	\$2603	\$3605	\$3805
COM/yds = 3¾, COL/sq ft = 73													

Lounge Chair with Back Screen

BLB26XX	\$2454	\$2458	\$2488	\$2538	\$2691	\$2790	\$2904	\$2984	\$3125	\$3322	\$2664	\$4033	\$4300
Chair: COM/yds = 2¾, COL/sq ft = 55													
Screen: COM/yds = 1¾													

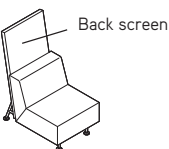
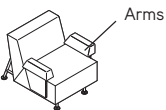

Bix Lounge System Sled Lounge Chairs

DESIGN METRO DESIGN GROUP

SIN 711.18

Tip: The COM yards and COL square footage listed on this page reflect the requirements for a single fabric that are based on non-directional 54"W material applied railroaded. For multi-fabric COM requirements, please refer to Multi-Fabric Yardage.

► Page 65

Tip: When specifying fabric in different price grades, the highest price grade prevails.

Standard Includes	Required to Specify
<p>► Need help? Product details, see <i>Coalesse Seating and Outdoor Specification Guide</i></p> <ul style="list-style-type: none"> • Seat, back, and arms, if selected: fabric or leather • Base and tablet support, if selected: paint • Glides • Tablet surface: bronco onyx vinyl 	<ol style="list-style-type: none"> 1 Style number 2 Number of fabrics if contrasting fabric style number is selected 3 Fabric or leather color number for seat, back, and arms, if selected 4 Paint color number for base and tablet, if selected 5 Options, if selected (see below) <p>► See <i>Surface Materials</i>, page 260.</p>

Options	Price	Required to Specify
<p>Surface Materials</p> <ul style="list-style-type: none"> • Contrasting fabric 	+\$118 per fabric	Add suffix K to the style number and select fabric color number.
<p>Acrylic backer</p> <ul style="list-style-type: none"> • Lounge chair and lounge chair with tablet arm • Lounge chair with arms 	<p>+\$ 34</p> <p>+\$ 46</p>	<p>Specify with acrylic backer.</p> <p>Specify with acrylic backer.</p> <p>► See <i>Surface Materials</i>, page 260.</p>
<p>Related Products</p> <ul style="list-style-type: none"> • Bench • Podium • Occasional tables • Side table 		<p>► Page 60</p> <p>► Page 62</p> <p>► Page 70</p> <p>► Page 72</p>

Specification Information														
Style Number	Base Prices											Leather Grades:		
	Fabric Grades:											COL	C	E
COM	6	7	8	9	10	11	12	13	14					

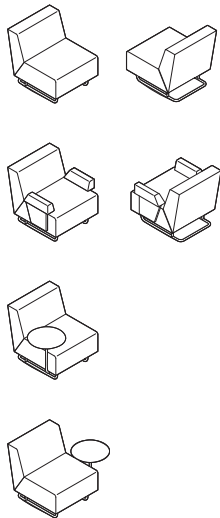

Sled Lounge Chair													
BLD26XX	\$1520	\$1520	\$1538	\$1569	\$1662	\$1723	\$1793	\$1841	\$1928	\$2048	\$1606	\$2590	\$2756
COM/yds = 2¾, COL/sq ft = 55													

Sled Lounge Chair with Arms													
BLD26AA	\$2199	\$2199	\$2223	\$2265	\$2392	\$2475	\$2570	\$2636	\$2754	\$2918	\$2312	\$3423	\$3623
COM/yds = 3¾, COL/sq ft = 73													

Sled Lounge Chair with Left-Hand Facing Tablet Arm													
BLD26TX	\$1836	\$1836	\$1854	\$1885	\$1978	\$2039	\$2109	\$2157	\$2244	\$2364	\$1954	\$2906	\$3072
COM/yds = 2¾, COL/sq ft = 55													

Sled Lounge Chair with Right-Hand Facing Tablet Arm													
BLD26XT	\$1836	\$1836	\$1854	\$1885	\$1978	\$2039	\$2109	\$2157	\$2244	\$2364	\$1954	\$2906	\$3072
COM/yds = 2¾, COL/sq ft = 55													

Bix Lounge System Sectional Seating

DESIGN METRO DESIGN GROUP

SIN 711.18

Tip: Fabric for the seat and back is specified separate from the back screen, if selected. For a monochromatic look, specify the same fabric for both the seat and back, and back screen.

Tip: The COM yards and COL square footage listed on these pages reflect the requirements for a single fabric that are based on non-directional 54"W material applied railroaded. For multi-fabric COM requirements, please refer to Multi-Fabric Yardage.
▶ Page 65

Tip: When specifying fabric in different price groups, the highest price group prevails.

Tip: Fabrics and leathers will appear loose with comfort wrinkles when upholstered.

Tip: 30"W corner sections are available with two seat fabric direction options – railroaded or cut-right. Illustrations assume a striped patterned fabric.
▶ Page 66

Standard Includes	Required to Specify
<ul style="list-style-type: none"> ▶ Need help? Product details, see <i>Coalesse Seating and Outdoor Specification Guide</i> • Seat, back, and arms, if selected: fabric or leather • Legs: paint • Adjustable glides: paint to match legs • Back screen, if selected: fabric 	<ol style="list-style-type: none"> 1 Style number 2 Number of fabrics if contrasting fabric style number is selected 3 Fabric or leather color number for seat, back, and arms, if selected 4 Paint color number for legs and glides 5 Fabric color number for back screen, if selected 6 Options, if selected (see below) <p>▶ See <i>Surface Materials</i>, page 260.</p>

Options	Price	Required to Specify
Surface Materials <ul style="list-style-type: none"> • Contrasting fabric 	+\$118 per fabric	Add suffix K to the style number and select fabric color number.
Acrylic backer <ul style="list-style-type: none"> • 30"W sections • 30"W sections with back screen • 48"W sections • 48"W sections with back screen • 54"W sections • 72"W sections • 54"W and 72"W sections with back screen 	+\$ 46 +\$ 67 +\$ 54 +\$ 83 +\$ 83 +\$ 72 +\$125	Specify with acrylic backer. Specify with acrylic backer. Specify with acrylic backer. Specify with acrylic backer. Specify with acrylic backer. Specify with acrylic backer. Specify with acrylic backer. ▶ See <i>Surface Materials</i> , page 260.
Seat Height <ul style="list-style-type: none"> • 18" seat height 	+\$227	Specify with 18" seat height.
Related Products <ul style="list-style-type: none"> • Bench • Podium • Bridge tables • Occasional tables • Work booth tables • Side table 		▶ Page 60 ▶ Page 62 ▶ Page 68 ▶ Page 70 ▶ Page 71 ▶ Page 72

Specification Information

Style Number	Base Prices														Leather Grades:		
	Fabric Grades:														COL	C	E
COM	6	7	8	9	10	11	12	13	14								

30"W Corner Section–Left Section with Seat Fabric Railroaded

BSC30LA	\$2439	\$2443	\$2473	\$2523	\$2676	\$2775	\$2889	\$2969	\$3110	\$3307	\$2645	\$3642	\$3842
COM/yds = 4½, COL/sq ft = 90													

▶ Specification Information, continued on next page

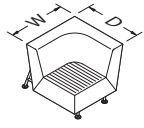

Bix Lounge System Sectional Seating

DESIGN METRO DESIGN GROUP

SIN 711.18

► Specification Information, continued from previous page

Specification Information

Style Number	Base Prices											Leather Grades:		
	Fabric Grades:											COL	C	E
	COM	6	7	8	9	10	11	12	13	14				

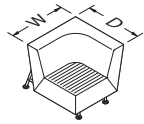

30"W Corner Section–Left Section with Seat Fabric Cut-Right

BSC30LB	\$2439	\$2443	\$2473	\$2523	\$2676	\$2775	\$2889	\$2969	\$3110	\$3307	\$2645	\$3642	\$3842
----------------	--------	--------	--------	--------	--------	--------	--------	--------	--------	--------	--------	--------	--------

COM/yds = 4½, COL/sq ft = 90

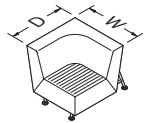

30"W Corner Section–Right Section with Seat Fabric Railroaded

BSC30RA	\$2439	\$2443	\$2473	\$2523	\$2676	\$2775	\$2889	\$2969	\$3110	\$3307	\$2645	\$3642	\$3842
----------------	--------	--------	--------	--------	--------	--------	--------	--------	--------	--------	--------	--------	--------

COM/yds = 4½, COL/sq ft = 90

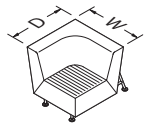

30"W Corner Section–Right Section with Seat Fabric Cut-Right

BSC30RB	\$2439	\$2443	\$2473	\$2523	\$2676	\$2775	\$2889	\$2969	\$3110	\$3307	\$2645	\$3642	\$3842
----------------	--------	--------	--------	--------	--------	--------	--------	--------	--------	--------	--------	--------	--------

COM/yds = 4½, COL/sq ft = 90

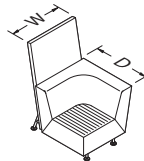

30"W Corner Section with Back Screen–Left Section with Seat Fabric Railroaded

BSCB30LA	\$3199	\$3272	\$3314	\$3387	\$3608	\$3750	\$3916	\$4031	\$4235	\$4519	\$3510	\$5156	\$5490
-----------------	--------	--------	--------	--------	--------	--------	--------	--------	--------	--------	--------	--------	--------

Chair: COM/yds = 4½, COL/sq ft = 90
Screen: COM/yds = 2

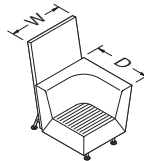

30"W Corner Section with Back Screen–Left Section with Seat Fabric Cut-Right

BSCB30LB	\$3199	\$3272	\$3314	\$3387	\$3608	\$3750	\$3916	\$4031	\$4235	\$4519	\$3510	\$5156	\$5490
-----------------	--------	--------	--------	--------	--------	--------	--------	--------	--------	--------	--------	--------	--------

Chair: COM/yds = 4½, COL/sq ft = 90
Screen: COM/yds = 2

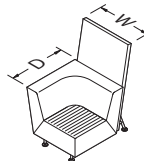

30"W Corner Section with Back Screen–Right Section with Seat Fabric Railroaded

BSCB30RA	\$3199	\$3272	\$3314	\$3387	\$3608	\$3750	\$3916	\$4031	\$4235	\$4519	\$3510	\$5156	\$5490
-----------------	--------	--------	--------	--------	--------	--------	--------	--------	--------	--------	--------	--------	--------

Chair: COM/yds = 4½, COL/sq ft = 90
Screen: COM/yds = 2

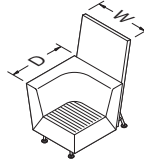

30"W Corner Section with Back Screen–Right Section with Seat Fabric Cut-Right

BSCB30RB	\$3199	\$3272	\$3314	\$3387	\$3608	\$3750	\$3916	\$4031	\$4235	\$4519	\$3510	\$5156	\$5490
-----------------	--------	--------	--------	--------	--------	--------	--------	--------	--------	--------	--------	--------	--------

Chair: COM/yds = 4½, COL/sq ft = 90
Screen: COM/yds = 2

► Specification Information, continued on next page

Bix Lounge System Sectional Seating *continued*

DESIGN METRO DESIGN GROUP

SIN 711.18

Tip: Extended corner sections are standard with a railroaded seat and back fabric direction.
▶ Page 66

Tip: Fabrics and leathers will appear loose with comfort wrinkles when upholstered.

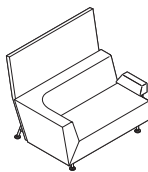
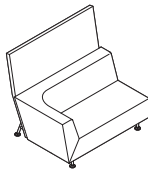
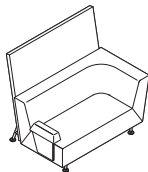
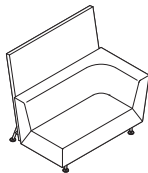
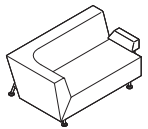
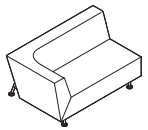
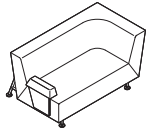
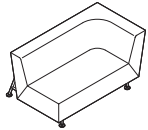

▶ Specification Information, continued from previous page

Specification Information

Style Number	Base Prices														Leather Grades:		
	Fabric Grades:														COL	C	E
	COM	6	7	8	9	10	11	12	13	14							

54"W Extended Corner Section–Left Section

BSE54LX	\$3344	\$3434	\$3480	\$3558	\$3796	\$3949	\$4127	\$4251	\$4471	\$4777	\$3677	\$5113	\$5412
COM/yds = 7, COL/sq ft = 140													

54"W Extended Corner Section–Left Section with Arm

BSE54LA	\$3667	\$3774	\$3823	\$3907	\$4162	\$4326	\$4517	\$4650	\$4885	\$5213	\$4043	\$5624	\$5958
COM/yds = 7½, COL/sq ft = 149													

54"W Extended Corner Section–Right Section

BSE54RX	\$3344	\$3434	\$3480	\$3558	\$3796	\$3949	\$4127	\$4251	\$4471	\$4777	\$3677	\$5113	\$5412
COM/yds = 7, COL/sq ft = 140													

54"W Extended Corner Section–Right Section with Arm

BSE54RA	\$3667	\$3774	\$3823	\$3907	\$4162	\$4326	\$4517	\$4650	\$4885	\$5213	\$4043	\$5624	\$5958
COM/yds = 7½, COL/sq ft = 149													

54"W Extended Corner Section–Left Section with Back Screen

BSEB54LX	\$4292	\$4519	\$4591	\$4714	\$5088	\$5329	\$5609	\$5803	\$6149	\$6630	\$4754	\$7286	\$7802
Chair: COM/yds = 7, COL/sq ft = 140													
Screen: COM/yds = 4													

54"W Extended Corner Section–Left Section with Back Screen and Arm

BSEB54LA	\$4613	\$4857	\$4933	\$5061	\$5452	\$5704	\$5996	\$6200	\$6561	\$7064	\$5117	\$7984	\$8567
Chair: COM/yds = 7½, COL/sq ft = 149													
Screen: COM/yds = 4													

54"W Extended Corner Section–Right Section with Back Screen

BSEB54RX	\$4292	\$4519	\$4591	\$4714	\$5088	\$5329	\$5609	\$5803	\$6149	\$6630	\$4754	\$7286	\$7802
Chair: COM/yds = 7, COL/sq ft = 140													
Screen: COM/yds = 4													

54"W Extended Corner Section–Right Section with Back Screen and Arm

BSEB54RA	\$4613	\$4857	\$4933	\$5061	\$5452	\$5704	\$5996	\$6200	\$6561	\$7064	\$5117	\$7984	\$8567
Chair: COM/yds = 7½, COL/sq ft = 149													
Screen: COM/yds = 4													

▶ Specification Information, continued on next page

Bix Lounge System Sectional Seating

DESIGN METRO DESIGN GROUP

SIN 711.18

Tip: Straight sections are standard with a railroaded seat and back fabric direction.

▶ Page 66

▶ Specification Information, continued from previous page

Specification Information

Style Number	Base Prices										Leather Grades:		
	Fabric Grades:										COL	C	E
	COM	6	7	8	9	10	11	12	13	14			

48"W Straight Section

BSS48XX	\$2519	\$2523	\$2553	\$2603	\$2756	\$2855	\$2969	\$3049	\$3190	\$3387	\$2737	\$4005	\$4254
----------------	--------	--------	--------	--------	--------	--------	--------	--------	--------	--------	--------	--------	--------

COM/yds = 4½, COL/sq ft = 90

48"W Straight Section with Left Arm

BSS48AX	\$2842	\$2863	\$2896	\$2952	\$3122	\$3231	\$3359	\$3447	\$3604	\$3823	\$3104	\$4421	\$4688
----------------	--------	--------	--------	--------	--------	--------	--------	--------	--------	--------	--------	--------	--------

COM/yds = 5, COL/sq ft = 99

48"W Straight Section with Right Arm

BSS48XA	\$2842	\$2863	\$2896	\$2952	\$3122	\$3231	\$3359	\$3447	\$3604	\$3823	\$3104	\$4421	\$4688
----------------	--------	--------	--------	--------	--------	--------	--------	--------	--------	--------	--------	--------	--------

COM/yds = 5, COL/sq ft = 99

48"W Straight Section with Two Arms

BSS48AA	\$3164	\$3203	\$3239	\$3300	\$3487	\$3607	\$3747	\$3845	\$4018	\$4258	\$3469	\$4933	\$5232
----------------	--------	--------	--------	--------	--------	--------	--------	--------	--------	--------	--------	--------	--------

COM/yds = 5½, COL/sq ft = 108

48"W Straight Section with Back Screen

BSSB48XX	\$3397	\$3504	\$3553	\$3637	\$3892	\$4056	\$4247	\$4380	\$4615	\$4943	\$3738	\$6015	\$6463
-----------------	--------	--------	--------	--------	--------	--------	--------	--------	--------	--------	--------	--------	--------

Chair: COM/yds = 4½, COL/sq ft = 90
Screen: COM/yds = 3

48"W Straight Section with Back Screen and Left Arm

BSSB48AX	\$3719	\$3843	\$3896	\$3985	\$4257	\$4432	\$4636	\$4777	\$5029	\$5378	\$4103	\$6431	\$6896
-----------------	--------	--------	--------	--------	--------	--------	--------	--------	--------	--------	--------	--------	--------

Chair: COM/yds = 5, COL/sq ft = 99
Screen: COM/yds = 3

48"W Straight Section with Back Screen and Right Arm

BSSB48XA	\$3719	\$3843	\$3896	\$3985	\$4257	\$4432	\$4636	\$4777	\$5029	\$5378	\$4103	\$6431	\$6896
-----------------	--------	--------	--------	--------	--------	--------	--------	--------	--------	--------	--------	--------	--------

Chair: COM/yds = 5, COL/sq ft = 99
Screen: COM/yds = 3

▶ Specification Information, continued on next page

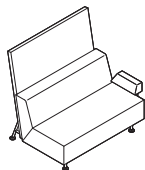
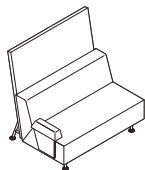
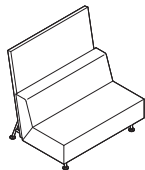
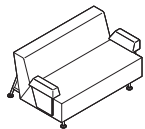
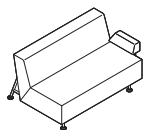
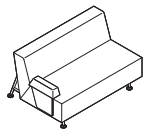
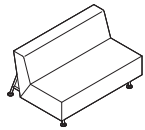

Lounge Seating

Bix Lounge System Sectional Seating *continued*

DESIGN METRO DESIGN GROUP

SIN 711.18

Tip: Straight sections are standard with a railroaded seat and back fabric direction.

▶ Page 66

Tip: Fabrics and leathers will appear loose with comfort wrinkles when upholstered.

▶ Specification Information, continued from previous page

Specification Information

Style Number	Base Prices														Leather Grades:		
	Fabric Grades:														COL	C	E
	COM	6	7	8	9	10	11	12	13	14							

72"W Straight Section

BSS72XX	\$3515	\$3588	\$3630	\$3703	\$3924	\$4066	\$4232	\$4347	\$4551	\$4835	\$3869	\$5472	\$5806
----------------	--------	--------	--------	--------	--------	--------	--------	--------	--------	--------	--------	--------	--------

COM/yds = 6½, COL/sq ft = 130

72"W Straight Section with Left Arm

BSS72AX	\$3835	\$3925	\$3971	\$4049	\$4287	\$4440	\$4618	\$4742	\$4962	\$5268	\$4237	\$5981	\$6347
----------------	--------	--------	--------	--------	--------	--------	--------	--------	--------	--------	--------	--------	--------

COM/yds = 7, COL/sq ft = 139

72"W Straight Section with Right Arm

BSS72XA	\$3835	\$3925	\$3971	\$4049	\$4287	\$4440	\$4618	\$4742	\$4962	\$5268	\$4237	\$5981	\$6347
----------------	--------	--------	--------	--------	--------	--------	--------	--------	--------	--------	--------	--------	--------

COM/yds = 7, COL/sq ft = 139

72"W Straight Section with Two Arms

BSS72AA	\$4159	\$4266	\$4315	\$4399	\$4654	\$4818	\$5009	\$5142	\$5377	\$5705	\$4602	\$6495	\$6892
----------------	--------	--------	--------	--------	--------	--------	--------	--------	--------	--------	--------	--------	--------

COM/yds = 7½, COL/sq ft = 148

72"W Straight Section with Back Screen

BSSB72XX	\$4686	\$4913	\$4985	\$5108	\$5482	\$5723	\$6003	\$6197	\$6543	\$7024	\$5202	\$8340	\$8972
-----------------	--------	--------	--------	--------	--------	--------	--------	--------	--------	--------	--------	--------	--------

Chair: COM/yds = 6½, COL/sq ft = 130
Screen: COM/yds = 4½

72"W Straight Section with Back Screen and Left Arm

BSSB72AX	\$5005	\$5249	\$5325	\$5453	\$5844	\$6096	\$6388	\$6592	\$6953	\$7456	\$5565	\$8847	\$9513
-----------------	--------	--------	--------	--------	--------	--------	--------	--------	--------	--------	--------	--------	--------

Chair: COM/yds = 7, COL/sq ft = 139
Screen: COM/yds = 4½

72"W Straight Section with Back Screen and Right Arm

BSSB72XA	\$5005	\$5249	\$5325	\$5453	\$5844	\$6096	\$6388	\$6592	\$6953	\$7456	\$5565	\$8847	\$9513
-----------------	--------	--------	--------	--------	--------	--------	--------	--------	--------	--------	--------	--------	--------

Chair: COM/yds = 7, COL/sq ft = 139
Screen: COM/yds = 4½

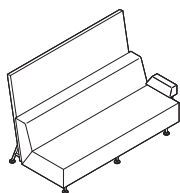
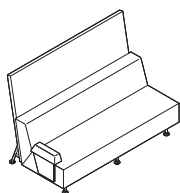
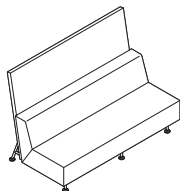
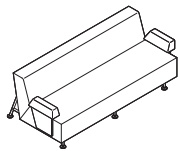
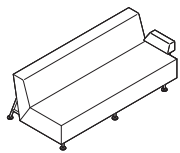
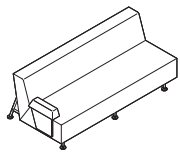
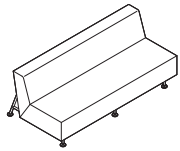

Bix Multi-Fabric Diagram

DESIGN METRO DESIGN GROUP

SIN 711.18

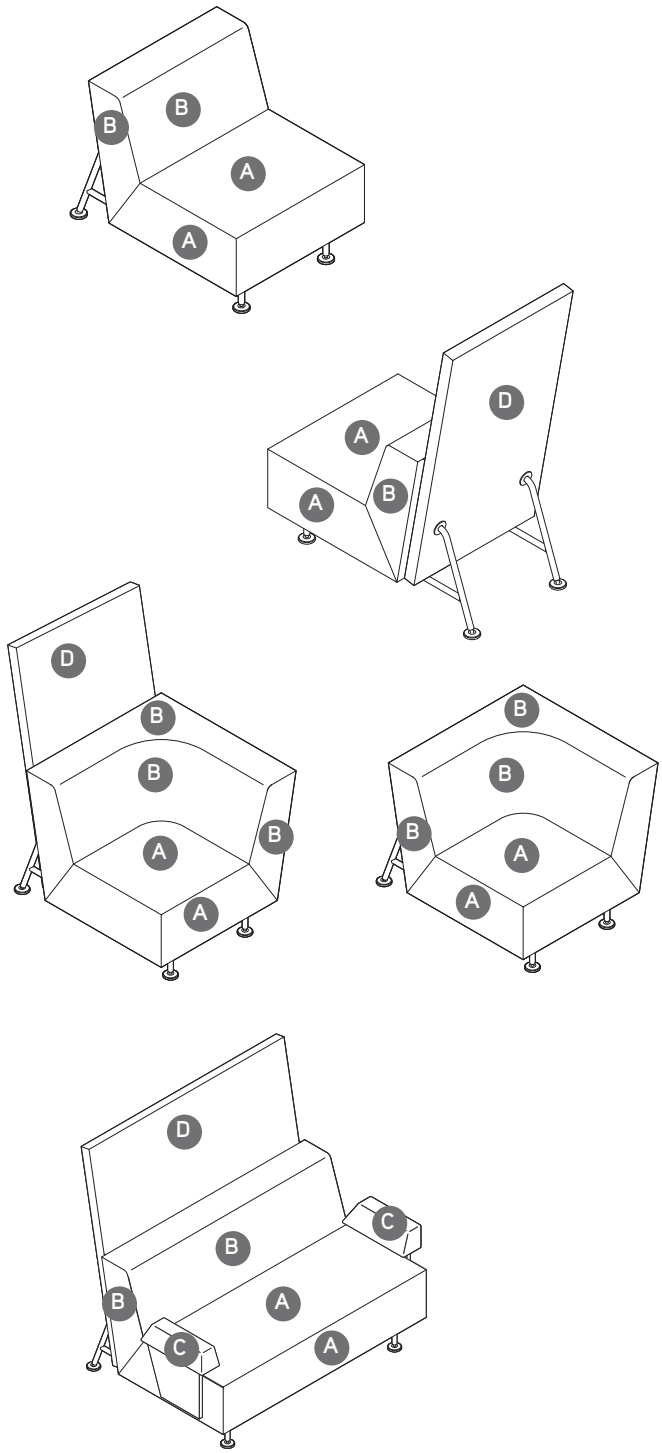

TO: _____

FROM: _____

DATE: _____

FAX...888.413.5161

Lounge Seating

A Seat (upholstery selections default for entire unit if B is not selected): _____

B Back: _____

C Arms (if applicable): _____

D Backscreen (if applicable): _____

**Back screen defined separately when ordered.*

**\$118 list per contrasting fabric specified. List price based on highest fabric grade usage.*

Bix Lounge System Benches

DESIGN METRO DESIGN GROUP

SIN 711.18

Tip: Fabrics and leathers will appear loose with comfort wrinkles when upholstered.

Tip: The COM yards and COL square footage listed on this page reflect the requirements for a single fabric that are based on non-directional 54"W material applied railroaded.

Standard Includes		Required to Specify
<ul style="list-style-type: none"> Need help? Product details, see <i>Coalesse Seating and Outdoor Specification Guide</i> 	<ul style="list-style-type: none"> Seat: fabric or leather Legs and open storage interior, if selected: paint Adjustable glides: paint to match legs 	<ol style="list-style-type: none"> Style number Fabric or leather color number for seat Paint color number for legs, glides, and open storage interior, if selected Options, if selected (see below) <p>▶ See <i>Surface Materials</i>, page 260.</p>

Options	Price	Required to Specify
Surface Materials <ul style="list-style-type: none"> Acrylic backer 48"W benches 72"W benches 	<ul style="list-style-type: none"> +\$ 22 +\$ 29 	<p>Specify with acrylic backer. Specify with acrylic backer. ▶ See <i>Surface Materials</i>, page 260.</p>
Seat Height <ul style="list-style-type: none"> 18" seat height 	<ul style="list-style-type: none"> +\$227 	<p>Specify with 18" seat height.</p>
Related Products <ul style="list-style-type: none"> Lounge chairs Sectional seating Podium Side table 		<ul style="list-style-type: none"> ▶ Page 52 ▶ Page 54 ▶ Page 62 ▶ Page 72

Specification Information

Style Number	Base Prices											Leather Grades:		
	Fabric Grades:											COL	C	E
	COM	6	7	8	9	10	11	12	13	14				

48"W Bench

BB48	\$1526	\$1526	\$1541	\$1566	\$1642	\$1692	\$1749	\$1789	\$1860	\$1958	\$1688	\$2519	\$2669
COM/yds = 2¼, COL/sq ft = 41													

72"W Bench

BB72	\$1845	\$1845	\$1865	\$1898	\$2000	\$2066	\$2142	\$2195	\$2289	\$2420	\$2024	\$3095	\$3295
COM/yds = 3, COL/sq ft = 54													

48"W Bench with Open Storage

BBS48	\$1760	\$1760	\$1775	\$1800	\$1876	\$1926	\$1983	\$2023	\$2094	\$2192	\$1955	\$2753	\$2903
COM/yds = 2¼, COL/sq ft = 41													

72"W Bench with Open Storage

BBS72	\$2080	\$2080	\$2100	\$2133	\$2235	\$2301	\$2377	\$2430	\$2524	\$2655	\$2291	\$3330	\$3530
COM/yds = 3, COL/sq ft = 54													

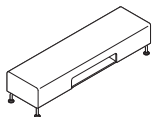
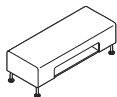
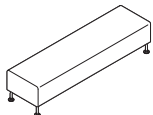
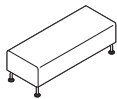

Coalesse

Bix Lounge System Benches

DESIGN METRO DESIGN GROUP

SIN 711.18

Bix Lounge System Podiums

DESIGN METRO DESIGN GROUP

SIN 711.18

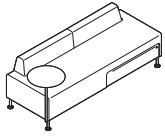

Tip: The COM yards and COL square footage listed on this page reflect the requirements for a single fabric that are based on non-directional 54"W material applied railroaded. For multi-fabric COM requirements, please refer to Multi-Fabric Yardage and Square Footage Requirements.

► Page 65

Tip: When specifying fabric in different price groups, the highest price group prevails.

Tip: Wood veneer storage drawers are available in high sheen finishes only.

Standard Includes

- Need help? Product details, see *Coalesse Seating and Outdoor Specification Guide*
- Seat and bolster: fabric or leather
- Legs, tablet support, drawer pull, and projection screen frame, if selected: paint
- Tablet surface: bronco onyx vinyl
- Drawer front: laminate
- Face-mounted lock, keyed random: black only
- Projection screen, if selected: sand color mesh
- Adjustable glides: paint to match legs

Required to Specify

- 1 Style number
 - 2 Number of fabrics if contrasting fabric style number is selected
 - 3 Fabric or leather color number for seat and bolster
 - 4 Paint color number for legs, glides, tablet support, drawer pull, and projection screen frame, if selected
 - 5 Laminate color number for drawer front
 - 6 Options, if selected (see below)
- See *Surface Materials*, page 260.

Options

Options	Price	Required to Specify
Surface Materials		
• Contrasting fabric	+\$118 per fabric	Add suffix K to the style number and select fabric color number.
Acrylic backer		
• Backer	+\$ 63	Specify with acrylic backer. ► See <i>Surface Materials</i> , page 260.
Storage drawer front		
• Wood veneer Grade 1	+\$ 33	Specify with <i>wood drawer front</i> and select wood veneer grade 1 color number.
• Wood veneer Grade 2	+\$ 52	Specify with <i>wood drawer front</i> and select wood veneer grade 2 color number.
• Grade 2 laminate drawer front	No cost	► Specify laminate color number.
Wood		
• Custom wood finish		► Page 272
Seat Height		
• 18" seat height	+\$227	Specify with <i>18" seat height</i> .
Related Products		
• Lounge chairs		► Page 52
• Sectional seating		► Page 54
• Bench		► Page 60
• Side table		► Page 72

Bix Lounge System Podiums

DESIGN METRO DESIGN GROUP

SIN 711.18

Specification Information

Style Number	Base Prices											Leather Grades:		
	Fabric Grades:											COL	C	E
	COM	6	7	8	9	10	11	12	13	14				

Podium with Left Tablet

BP72TX	\$4071	\$4127	\$4166	\$4233	\$4437	\$4568	\$4721	\$4827	\$5016	\$5278	\$4506	\$6407	\$6804
COM/yds = 6, COL/sq ft = 108													

Podium with Right Tablet

BP72XT	\$4071	\$4127	\$4166	\$4233	\$4437	\$4568	\$4721	\$4827	\$5016	\$5278	\$4506	\$6407	\$6804
COM/yds = 6, COL/sq ft = 108													

Podium with Projection Screen and Left Tablet

BPP72TX	\$4947	\$5003	\$5042	\$5109	\$5313	\$5444	\$5597	\$5703	\$5892	\$6154	\$5504	\$7283	\$7680
COM/yds = 6, COL/sq ft = 108													

Podium with Projection Screen and Right Tablet

BPP72XT	\$4947	\$5003	\$5042	\$5109	\$5313	\$5444	\$5597	\$5703	\$5892	\$6154	\$5504	\$7283	\$7680
COM/yds = 6, COL/sq ft = 108													

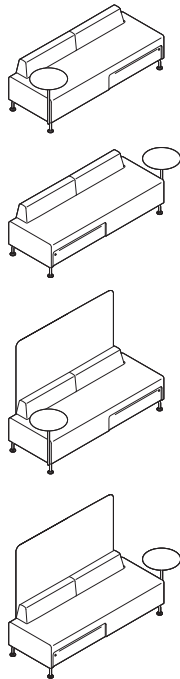

Lounge Seating

Bix Multi-Fabric Diagram

DESIGN METRO DESIGN GROUP

SIN 711.18

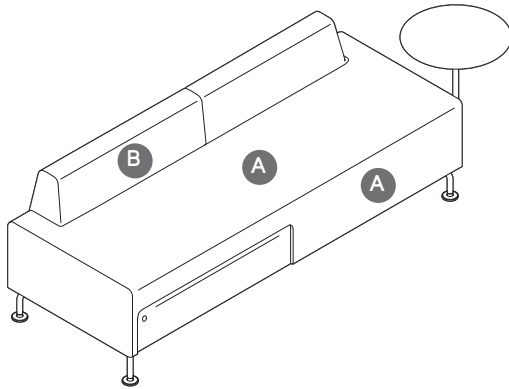

TO: _____

FROM: _____

DATE: _____

FAX....888.413.5161

A Seat (upholstery selections default for entire unit if B is not selected): _____

B Back: _____

** \$118 list per contrasting fabric specified. List price based on highest fabric grade usage.*

Bix Multi-Fabric Yardage

DESIGN METRO DESIGN GROUP

SIN 711.18

Multi-Fabric Yardage

DESCRIPTION	STYLE NUMBER	COM YDS*			
		SEAT	BACK	ARM(S)	BACK SCREEN
Lounge chair	BL26XX	1¾	1¾	N.A.	N.A.
Lounge chair with arms	BL26AA	1¾	1¾	1	N.A.
Lounge chair with back screen	BLB26XX	1¾	1¾	N.A.	1¾
Sled lounge chair	BLD26XX	1¾	1¾	N.A.	N.A.
Sled lounge chair with arms	BLD26AA	1¾	1¾	1	N.A.
Sled lounge chair with left-hand tablet arm	BLD26TX	1¾	1¾	N.A.	N.A.
Sled lounge chair with right-hand tablet arm	BLD26XT	1¾	1¾	N.A.	N.A.
30"W corner section-left section with seat fabric railroaded	BSC30LA	2	2½	N.A.	N.A.
30"W corner section-left section with seat fabric cut-right	BSC30LB	2	2½	N.A.	N.A.
30"W corner section-right section with seat fabric railroaded	BSC30RA	2	2½	N.A.	N.A.
30"W corner section-right section with seat fabric cut-right	BSC30RB	2	2½	N.A.	N.A.
30"W corner section with back screen-left section with seat fabric railroaded	BSCB30LA	2	2½	N.A.	2
30"W corner section with back screen-left section with seat fabric cut-right	BSCB30LB	2	2½	N.A.	2
30"W corner section with back screen-right section with seat fabric railroaded	BSCB30RA	2	2½	N.A.	2
30"W corner section with back screen-right section with seat fabric cut-right	BSCB30RB	2	2½	N.A.	2
54"W extended corner section-left section	BSE54LX	2½	3	N.A.	N.A.
54"W extended corner section-left section with arm	BSE54LA	2½	3	½	N.A.
54"W extended corner section-right section	BSE54RX	2½	3	N.A.	N.A.
54"W extended corner section-right section with arm	BSE54RA	2½	3	½	N.A.
54"W extended corner section-left section with back screen	BSEB54LX	2½	3	N.A.	4
54"W extended corner section-left section with back screen and arm	BSEB54LA	2½	3	½	4
54"W extended corner section-right section with back screen	BSEB54RX	2½	3	N.A.	4
54"W extended corner section-right section with back screen and arm	BSEB54RA	2½	3	½	4
48"W straight section	BSS48XX	2½	2½	N.A.	N.A.
48"W straight section with left arm	BSS48AX	2½	2½	½	N.A.
48"W straight section with right arm	BSS48XA	2½	2½	½	N.A.
48"W straight section with two arms	BSS48AA	2½	2½	1	N.A.
48"W straight section with back screen	BSSB48XX	2½	2½	N.A.	3
48"W straight section with back screen and left arm	BSSB48AX	2½	2½	½	3
48"W straight section with back screen and right arm	BSSB48XA	2½	2½	½	3
72"W straight section	BSS72XX	4½	4½	N.A.	N.A.
72"W straight section with left arm	BSS72AX	4½	4½	½	N.A.
72"W straight section with right arm	BSS72XA	4½	4½	½	N.A.
72"W straight section with two arms	BSS72AA	4½	4½	1	N.A.
72"W straight section with back screen	BSSB72XX	4½	4½	N.A.	5
72"W straight section with back screen and left arm	BSSB72AX	4½	4½	½	5
72"W straight section with back screen and right arm	BSSB72XA	4½	4½	½	5

*Fabric yardage is based on non-directional/solid fabrics. use conversion chart on the following page for repeat/printed fabric yardage.

Bix Multi-Fabric Yardage *continued*

DESIGN METRO DESIGN GROUP

SIN 711.18

Multi-Fabric Yardage

DESCRIPTION	STYLE NUMBER	COM YDS*			
		SEAT CUSHION	BACK CUSHION	ARM(S)	BACK SCREEN
Podium with left tablet	BP72TX	3½	2½	N.A.	N.A.
Podium with right tablet	BP72XT	3½	2½	N.A.	N.A.
Podium with projection screen and left tablet	BPP72TX	3½	2½	N.A.	N.A.
Podium with projection screen and right tablet	BPP72XT	3½	2½	N.A.	N.A.

*Fabric yardage is based on non-directional/solid fabrics. Use conversion chart below for repeat/printed fabric yardage.

Non-standard fabric requirements

Yardage requirements shown are based on non-directional 54"W material applied railroaded. Coalesse will apply fabric railroaded unless instructed otherwise on the dealer's purchase order. The following conversion chart should be used to determine yardage requirements when COM has a repeat of 2' or more. Please contact Coalesse Customer Service for a yardage quotation if the fabric is less than 54" wide, has a repeat of more than 24", or if the fabric must be cut-right.

CONVERSION CHART

PRODUCT	REPEAT		
	2' -8"	9" -14"	15" -24"
Bix	15%	30%	75%

Yardage quotations will also be provided for order of 10 or more pieces.

Pattern matching on Bix

Due to Coalesse's high standards for pattern matching, we reserve the right to apply the following upcharges for extra labor incurred by a pattern or material that poses such challenges.

Customers will be informed if an upcharge will be applied to their order during the approval process. Should Coalesse receive an order without prior approval, it will be held as pending until the customer accepts such charges. The upcharge will be applied per item where applicable.

Cutting direction guidelines

Cutting direction is based on the fabric width and the way the fabric is cut from the roll and applied to Coalesse products. There are two cutting directions: railroaded or cut-right.

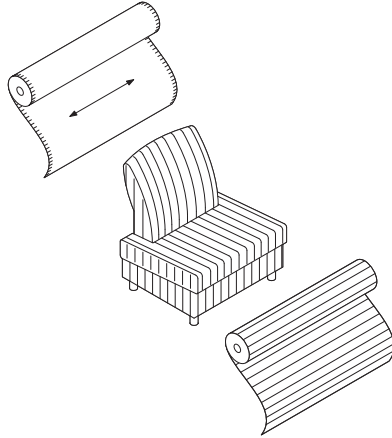

Horizontal or railroaded (across roll, warp horizontal) means fabric is cut across the roll; selvages are on the top and bottom.

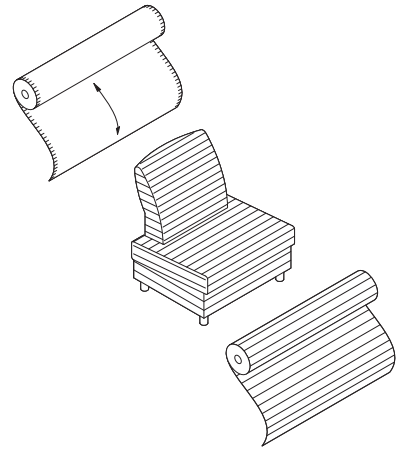

Vertical or cut-right (down roll, warp vertical) means fabric is cut in the same direction it is woven; selvages are on the left and right sides.

Coalesse reserves the right to railroad or apply fabric according to weave unless instructions specify otherwise. Fabrics are railroaded when possible to avoid seams in large upholstered areas and/or single cushion units. If a fabric is questionable, a cutting of adequate size showing full repeat (if any) should be sent to Coalesse for a fabric requirement quotation.

Coalesse

Bix Multi-Fabric Yardage

DESIGN METRO DESIGN GROUP

SIN 711.18

Bix Lounge System Bridge Tables

DESIGN METRO DESIGN GROUP

SIN 711.18

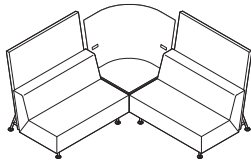

► Need help?
Product details, see *Coalesse Seating and Outdoor Specification Guide*

Standard Includes

- Top:
 - Laminate top (Grade 1 laminates) with matching plastic edge
 - Laminate top (Grade 1 Steelcase) with contrasting plastic edge
 - Wood top with matching flat wood edge
- Frame, tilted display surface for rectangular tables, and support leg for corner tables, if selected: paint
- Grommet, if selected: black plastic only
- Screens, if selected: translucent material only
- Wire management clips: black plastic only
- Attachment hardware

Required to Specify

- 1 Style number
- 2 Laminate or wood color number for top
► See *Hardwood and Veneer Matrix*, page 274
- 3 Plastic edge color number for top with Grade 1 Steelcase or Grade 2 laminate, if selected
- 4 Paint color number for frame, tilted display surface for rectangular tables, and support leg for corner tables, if selected
- 5 Options, if selected (see below)
► See *Surface Materials*, page 260.

Tip: 20" table height must be used in conjunction with 18" seat height in the sectional seating.

Options	Price	Required to Specify
Cable Management	• PDV module: black plastic +\$373	Specify with PDV module.
Corner Bridge Table Height	• 20" table height +\$227	Specify with 20" table height.
Related Products	• Sectional seating	► Page 54

Specification Information

Dimensions			Style Number	Base Prices			
D	W	H		Lam 1	Lam 2	Wood 1	Wood 2

Rectangular Bridge Table

26"	22"	18"	BTB2226	\$888	\$934	\$1100	\$1214
-----	-----	-----	---------	-------	-------	--------	--------

Rectangular Bridge Table with Grommet

26"	22"	18"	BTB2226U	\$943	\$992	\$1155	\$1269
-----	-----	-----	----------	-------	-------	--------	--------

► Specification Information, continued on next page

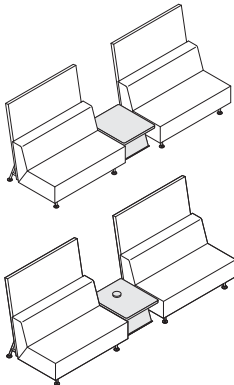

Edge Profiles

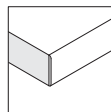

Plastic edge

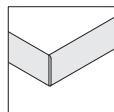

Wood edge

Bix Lounge System Bridge Tables

DESIGN METRO DESIGN GROUP

SIN 711.18

► Specification Information, continued from previous page

Specification Information

Dimensions			Style Number	Base Prices			
D	W	H		Lam 1	Lam 2	Wood 1	Wood 2

Rectangular Bridge Table with Screen

26"	22"	46"	BTBS2226	\$1341	\$1409	\$1553	\$1667
-----	-----	-----	----------	--------	--------	--------	--------

Rectangular Bridge Table with Grommet and Screen

26"	22"	46"	BTBS2226U	\$1398	\$1469	\$1610	\$1724
-----	-----	-----	-----------	--------	--------	--------	--------

Corner Bridge Table

26"	26"	18"	BTB2626	\$1006	\$1057	\$1245	\$1359
-----	-----	-----	---------	--------	--------	--------	--------

Corner Bridge Table with Grommet

26"	26"	18"	BTB2626U	\$1062	\$1117	\$1301	\$1415
-----	-----	-----	----------	--------	--------	--------	--------

Corner Bridge Table with Screen

26"	22"	18"	BTB2226	\$ 888	\$ 934	\$1100	\$1214
26"	26"	46"	BTBS2626	\$1599	\$1680	\$1838	\$1952

Corner Bridge Table with Grommet and Screen

26"	26"	46"	BTBS2626U	\$1654	\$1740	\$1893	\$2007
-----	-----	-----	-----------	--------	--------	--------	--------

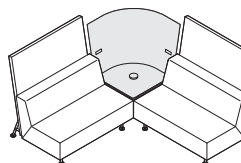
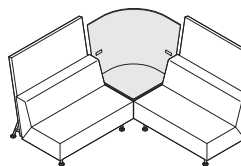
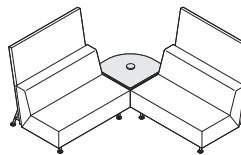
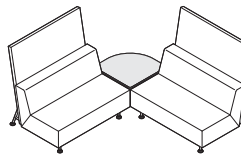
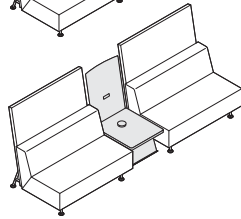
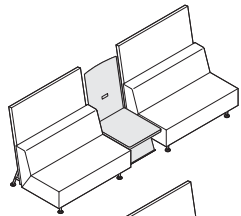

Bix 18"H Occasional Tables

DESIGN METRO DESIGN GROUP

SIN 711.18

Standard Includes		Required to Specify
<p>► Need help? Product details, see <i>Coalesse Seating and Outdoor Specification Guide</i></p> <ul style="list-style-type: none"> • Top: <ul style="list-style-type: none"> - Laminate top (Grade 1 laminates) with matching plastic edge - Laminate top (Grade 1 Steelcase) with contrasting plastic edge - Wood top with matching flat wood edge • Base: textured paints only • Grommet, if selected: black plastic only 	<ul style="list-style-type: none"> 1 Style number 2 Laminate or wood color number for top ► See <i>Hardwood and Veneer Matrix</i>, page 274 3 Plastic edge color number for top with Grade 1 Steelcase or Grade 2 laminate, if selected 4 Textured paint color number for base 5 Options, if selected (see below) ► See <i>Surface Materials</i>, page 260. 	

Options	Price	Required to Specify
<p>Cable Management</p> <ul style="list-style-type: none"> • PDV module: black plastic 	+\$373 each	Specify with PDV module.
<p>Related Products</p> <ul style="list-style-type: none"> • Lounge seating • Sectional seating 		<ul style="list-style-type: none"> ► Page 52 ► Page 54

Tip: One or two power, data, and voice modules are available on rectangular occasional tables.

Specification Information

Dimensions				Style Number	Base Prices			
D	W	H	Diameter		Lam 1	Lam 2	Wood 1	Wood 2

Round Occasional Tables

N.A.	N.A.	18"	20"	BTC20001	\$1028	\$1080	\$1138	\$1191
N.A.	N.A.	18"	28"	BTC28001	\$1071	\$1126	\$1190	\$1304

Round Occasional Table with Grommet

N.A.	N.A.	18"	28"	BTC28001U	\$1141	\$1199	\$1260	\$1374
------	------	-----	-----	-----------	--------	--------	--------	--------

Square Occasional Table

24"	24"	18"	N.A.	BTC24241	\$1056	\$1110	\$1172	\$1244
-----	-----	-----	------	----------	--------	--------	--------	--------

Square Occasional Table with Grommet

24"	24"	18"	N.A.	BTC24241U	\$1127	\$1185	\$1243	\$1315
-----	-----	-----	------	-----------	--------	--------	--------	--------

Rectangular Table

24"	48"	18"	N.A.	BTC24481	\$1709	\$1797	\$1889	\$2036
24"	72"	18"	N.A.	BTC24721	\$1751	\$1841	\$1952	\$2168

Rectangular Occasional Tables with Grommets

24"	48"	18"	N.A.	BTC24481U	\$1849	\$1943	\$2029	\$2176
24"	72"	18"	N.A.	BTC24721U	\$1892	\$1989	\$2093	\$2309

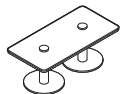
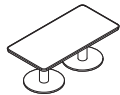

Edge Profiles

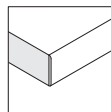

Plastic edge

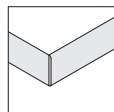

Wood edge

Bix 27"H Work-Booth Tables

DESIGN METRO DESIGN GROUP

SIN 711.18

Tip: One or two power, data, and voice modules are available on rectangular occasional tables.

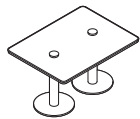
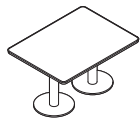

Standard Includes

► Need help?
Product details, see *Coalesse Seating and Outdoor Specification Guide*

- Top:
 - Laminate top (Grade 1 laminates) with matching plastic edge
 - Laminate top (Grade 1 Steelcase) with contrasting plastic edge
 - Wood top with matching flat wood edge
- Base: textured paints only
- Grommet, if selected: black plastic only

Required to Specify

- 1 Style number
- 2 Laminate or wood color number for top
► See *Hardwood and Veneer Matrix*, page 274
- 3 Plastic edge color number for top with Grade 1 Steelcase or Grade 2 laminate, if selected
- 4 Textured paint color number for base
- 5 Options, if selected (see below)
► See *Surface Materials*, page 260

Options

Cable Management

- PDV module: black plastic

Price
+\$373 each

Required to Specify

Specify with PDV module.

Related Products

- Lounge seating
- Sectional seating

► Page 52
► Page 54

Specification Information

Dimensions				Style Number	Base Prices			
D	W	H	Diameter		Lam 1	Lam 2	Wood 1	Wood 2

Round Work-Booth Tables

N.A.	N.A.	27"	20"	BTW20003	\$1056	\$1110	\$1166	\$1219
N.A.	N.A.	27"	28"	BTW28003	\$1099	\$1155	\$1218	\$1332

Round Work-Booth Table with Grommet

N.A.	N.A.	27"	28"	BTW28003U	\$1168	\$1227	\$1287	\$1401
------	------	-----	-----	-----------	--------	--------	--------	--------

Rectangular Work-Booth Tables

36"	48"	27"	N.A.	BTW36483	\$2009	\$2113	\$2239	\$2456
36"	72"	27"	N.A.	BTW36723	\$2223	\$2337	\$2453	\$2780

Rectangular Work-Booth Tables with Grommets

36"	48"	27"	N.A.	BTW36483U	\$2148	\$2258	\$2378	\$2595
36"	72"	27"	N.A.	BTW36723U	\$2362	\$2483	\$2592	\$2919

Edge Profiles

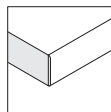

Plastic edge

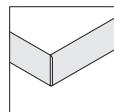

Wood edge

Bix Side Table—Vinyl Version

DESIGN METRO DESIGN GROUP

SIN 711.18



Standard Includes

- Base: paint
- Table surface and base cover: bronco onyx vinyl

Required to Specify

- 1 Style number
- 2 Paint color number for base
- ▶ See *Surface Materials*, page 260.

Related Products

- Lounge chairs ▶ Page 52
- Sectional seating ▶ Page 54
- Podium ▶ Page 62

Specification Information

Dimensions		Style Number	Price
Diameter	H		
16"	23"	BTS1700	\$512

Coalesse

Bix Side Table—Vinyl Version

DESIGN METRO DESIGN GROUP

SIN 711.18

Bob Lounge Chairs by Walter Knoll

DESIGN PEARSON LLOYD

SIN 711.18

Tip: For Customer's Own Material or Leather, see necessary requirements, important processing instructions, and ordering information.
 ▶ Page 260.

Tip: Fabrics and leathers will appear loose with comfort wrinkles when upholstered.

Standard Includes		Required to Specify
▶ Need help? Product details, see <i>Coalesse Seating and Outdoor Specification Guide</i>	<ul style="list-style-type: none"> • Base: 8040 Aluminum Matte Polished or grade 1 paint • Swivel base for lounge chairs, if selected • Upholstery for chair: fabric or leather • Glides 	1 Style number 2 Paint or metal color for base 3 Number of fabrics if contrasting fabric style number is selected 4 Fabric or leather color number for upholstery 5 Options, if selected (see below) ▶ See <i>Surface Materials</i> , page 260.

Options	Price	Required to Specify
Surface Materials		
• Contrasting fabric	+\$118 per fabric	Add suffix K to the style number and select fabric color number.
Fire code seating		
• Fire code seating	+\$231	Specify with <i>fire code seating</i> . ▶ See <i>Fire Code Seating</i> , page 264.
Acrylic backer		
• Lounge chair	+\$ 29	Specify with <i>acrylic backer</i> .
• Lounge chair with headrest	+\$ 33	Specify with <i>acrylic backer</i> .
• Ottoman	+\$ 10	Specify with <i>acrylic backer</i> . ▶ See <i>Surface Materials</i> , page 260.
Base		
Lounge chair with standard swivel mechanism		
• Aluminum matte polished	No cost	Specify with <i>standard swivel</i> and select aluminum matte polished.
• Grade 1 paint	No cost	Specify with <i>standard swivel</i> and select paint color number.
• Grade 3 paint	+\$ 75	Specify with <i>standard swivel</i> and select paint color number.
Lounge chair with return swivel mechanism		
• Aluminum matte polished	+\$260	Specify with <i>return swivel</i> and select aluminum matte polished.
Glides		
• Felted glides	+\$ 16	Specify with <i>felted glides</i> .

Specification Information													
Style Number	Base Prices											Leather Grades:	
	Fabric Grades:											COL	C
COM	6	7	8	9	10	11	12	13	14				

Lounge Chair

216	\$2337	\$2337	\$2357	\$2390	\$2492	\$2558	\$2634	\$2687	\$2781	\$2912	\$2517	\$3762	\$3988
-----	--------	--------	--------	--------	--------	--------	--------	--------	--------	--------	--------	--------	--------

COM/yds = 3, COL/sq ft = 72



Overall: 34¼"D 35"W 31¾"H
 Inside: 21¾"D 20"W 17¼"H
 Seat: 17"H
 Arm: 21¾"H

Lounge Chair with Headrest

221	\$2770	\$2770	\$2793	\$2832	\$2951	\$3028	\$3117	\$3179	\$3289	\$3441	\$2933	\$4391	\$4656
-----	--------	--------	--------	--------	--------	--------	--------	--------	--------	--------	--------	--------	--------

COM/yds = 3½, COL/sq ft = 77



Overall: 34¼"D 35"W 41¼"H
 Inside: 21¾"D 20"W 27½"H
 Seat: 17"H
 Arm: 21¾"H

▶ Specification Information, continued on next page

Coalesse

Bob Lounge Chairs by Walter Knoll

DESIGN PEARSON LLOYD

SIN 711.18

► Specification Information, continued from previous page

Specification Information

Style Number	Base Prices											Leather Grades:		
	Fabric Grades:											COL	C	E
	COM	6	7	8	9	10	11	12	13	14				



Overall: 18½"D 19¾"W 15¼"H

Ottoman

221-H	\$859	\$853	\$860	\$871	\$905	\$927	\$952	\$970	\$1001	\$1045	\$1102	\$1482	\$1557
COM/yds = 1, COL/sq ft = 22													

Lounge Seating

Circa Lounge System Upholstered Individual Lounge Units

DESIGN ALISON SPEAR, AIA

SIN 711.17

Tip: Fabrics and leathers will appear loose with comfort wrinkles when upholstered.

Tip: For contrasting fabric, pricing is based on highest grade textile specified.

Tip: For Customer's Own Material or Leather, see necessary requirements, important processing instructions, and ordering information
▶Page 262

Tip: Benches are flat and 1-seat and 2-seat lounges are angled; therefore, seat angles will not be aligned when placed next to each other. A table is recommended between the units to minimize the difference.

Standard Includes		Required to Specify
▶ Need help? Product details, see <i>Coalesse Seating and Outdoor Specification Guide</i>	<ul style="list-style-type: none"> • Frame: unibody construction of hardwood plywood utilizing box joinery • Upholstery: multiple densities of polyurethane foam fixed seat and back with top stitch on seams • Legs: <ul style="list-style-type: none"> - Tapered leg, if selected: solid maple or walnut - Cylinder leg, if selected: solid oak 	<ol style="list-style-type: none"> 1 Style number 2 Number of fabrics if contrasting fabric style number is selected 3 Fabric or leather color number for upholstery on seat and back 4 Wood leg type 5 Wood color number for legs 6 Options, if selected (see below) ▶ See <i>Surface Materials</i> , page 260.

Options	Price	Required to Specify	
Surface Materials	<ul style="list-style-type: none"> • Contrasting fabric 	+\$118 per fabric	Add suffix K to the style number and select fabric color number.
	Acrylic backer		
	<ul style="list-style-type: none"> • 30° outside facing wedge 1-seat lounge 	+\$ 31	Specify with acrylic backer.
	<ul style="list-style-type: none"> • 30° inside facing wedge seat 1-seat lounge 	+\$ 33	Specify with acrylic backer.
	<ul style="list-style-type: none"> • 60° outside and inside wedge 2-seat lounge 	+\$ 58	Specify with acrylic backer.
	<ul style="list-style-type: none"> • 60° benches 	+\$ 39	Specify with acrylic backer.
	<ul style="list-style-type: none"> • Straight 1-seat lounge 	+\$ 22	Specify with acrylic backer.
	<ul style="list-style-type: none"> • Straight 2-seat lounge 	+\$ 46	Specify with acrylic backer.
	<ul style="list-style-type: none"> • Straight bench 	+\$ 29	Specify with acrylic backer. ▶ See <i>Surface Materials</i> , page 260.
Shared Leg Application	<ul style="list-style-type: none"> • Cylinder wood legs • Modern metal legs 	-\$190 -\$190	Specify with cylinder wood legs. Specify with modern metal legs.
Metal Legs	Tapered legs		
	<ul style="list-style-type: none"> • Grade 1 paint 	+\$134 per leg	Specify with tapered metal legs and select paint color number. ▶ See <i>Surface Materials</i> , page 260.
	<ul style="list-style-type: none"> • Grade 3 paint 	+\$154 per leg	Specify with tapered metal legs and select paint color number. ▶ See <i>Surface Materials</i> , page 260.
	Modern legs		
	<ul style="list-style-type: none"> • Grade 1 paint 	+\$134 per leg	Specify with modern metal legs and select paint color number. ▶ See <i>Surface Materials</i> , page 260.
	<ul style="list-style-type: none"> • Grade 3 paint 	+\$154 per leg	Specify with modern metal legs and select paint color number. ▶ See <i>Surface Materials</i> , page 260.

Specification Information

Style Number	Base Prices											Leather Grades:		
	Fabric Grades:											COL	C	E
	COM	6	7	8	9	10	11	12	13	14				

30° Outside Facing Wedge 1-Seat Lounge

451-3730FO	\$1384	\$1384	\$1406	\$1442	\$1552	\$1624	\$1706	\$1764	\$1866	\$2008	\$1600	\$3151	\$3436
COM/yds = 3¼, COL/sq ft = 72													

▶ Specification Information, continued on next page

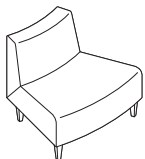

Overall: 28"D 36¾"W 29½"H
 Inside: 20"D 36¾"W 12¼"H
 Seat: 17¼"H
 Angle Degree: 30°

Circa Lounge System Upholstered Individual Lounge Units

DESIGN ALISON SPEAR, AIA

SIN 711.17

► Specification Information, continued from previous page

Specification Information

Style Number	Base Prices										Leather Grades:		
	Fabric Grades:										COL	C	E
	COM	6	7	8	9	10	11	12	13	14			

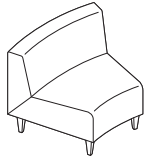

Overall: 28"D 36¾"W 29½"H
 Inside: 20"D 36¾"W 12¼"H
 Seat: 17¼"H
 Angle Degree: 30°

30° Inside Facing Wedge 1-Seat Lounge

451-3730FI	\$1384	\$1384	\$1406	\$1442	\$1552	\$1624	\$1706	\$1764	\$1866	\$2008	\$1600	\$3151	\$3436
-------------------	--------	--------	--------	--------	--------	--------	--------	--------	--------	--------	--------	--------	--------

COM/yds = 3¾, COL/sq ft = 72

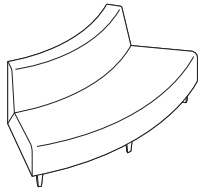

Overall: 28"D 71"W 29½"H
 Inside: 20"D 71"W 12¼"H
 Seat: 17¼"H
 Angle Degree: 60°

60° Outside Wedge 2-Seat Lounge

451-7460FO	\$2200	\$2273	\$2315	\$2388	\$2609	\$2751	\$2917	\$3032	\$3236	\$3520	\$2366	\$5527	\$6095
-------------------	--------	--------	--------	--------	--------	--------	--------	--------	--------	--------	--------	--------	--------

COM/yds = 4½, COL/sq ft = 99

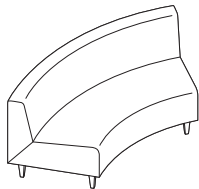

Overall: 28"D 71"W 29½"H
 Inside: 20"D 71"W 12¼"H
 Seat: 17¼"H
 Angle Degree: 60°

60° Inside Wedge 2-Seat Lounge

451-7460FI	\$2200	\$2273	\$2315	\$2388	\$2609	\$2751	\$2917	\$3032	\$3236	\$3520	\$2366	\$5527	\$6095
-------------------	--------	--------	--------	--------	--------	--------	--------	--------	--------	--------	--------	--------	--------

COM/yds = 4¾, COL/sq ft = 105

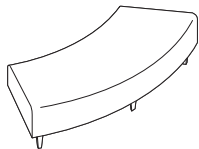

Overall: 28"D 71"W 17¼"H
 Seat: 17¼"H
 Angle Degree: 60°

60° Outside Wedge Bench

451-B7460FO	\$1743	\$1743	\$1763	\$1796	\$1898	\$1964	\$2040	\$2093	\$2187	\$2318	\$1961	\$3392	\$3658
--------------------	--------	--------	--------	--------	--------	--------	--------	--------	--------	--------	--------	--------	--------

COM/yds = 3, COL/sq ft = 66

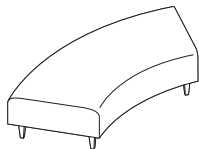

Overall: 28"D 71"W 17¼"H
 Seat: 17¼"H
 Angle Degree: 60°

60° Inside Wedge Bench

451-B7460FI	\$1743	\$1743	\$1763	\$1796	\$1898	\$1964	\$2040	\$2093	\$2187	\$2318	\$1961	\$3392	\$3658
--------------------	--------	--------	--------	--------	--------	--------	--------	--------	--------	--------	--------	--------	--------

COM/yds = 3, COL/sq ft = 66

► Specification Information, continued on next page

Circa Lounge System Upholstered Individual Lounge Units *continued*

DESIGN ALISON SPEAR, AIA

SIN 711.17

► Specification Information, continued from previous page

Specification Information

Style Number	Base Prices													
	Fabric Grades:											Leather Grades:		
	COM	6	7	8	9	10	11	12	13	14	COL	C	E	

Straight 1-Seat Lounge

451-2500	\$1243	\$1243	\$1259	\$1287	\$1372	\$1427	\$1490	\$1535	\$1613	\$1722	\$1478	\$2659	\$2877
COM/yds = 2½, COL/sq ft = 55													

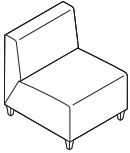

Overall: 28"D 25"W 29½"H
 Inside: 20"D 25"W 12¼"H
 Seat: 17¼"H
 Angle Degree: 0°

Straight 2-Seat Lounge

451-5000	\$1784	\$1805	\$1838	\$1894	\$2064	\$2173	\$2301	\$2389	\$2546	\$2765	\$1955	\$4371	\$4807
COM/yds = 4, COL/sq ft = 83													

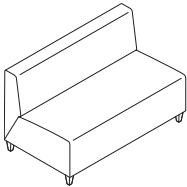

Overall: 28"D 50"W 29½"H
 Inside: 20"D 50"W 12¼"H
 Seat: 17¼"H
 Angle Degree: 0°

Straight Bench

451-B5000	\$1587	\$1587	\$1607	\$1640	\$1742	\$1808	\$1884	\$1937	\$2031	\$2162	\$1800	\$3241	\$3495
COM/yds = 3, COL/sq ft = 66													

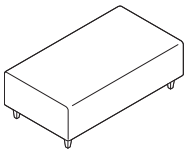

Overall: 28"D 50"W 17¼"H
 Seat: 17¼"H
 Angle Degree: 0°

Tip: Please submit sketch for modular application. One package is required per two chairs.

Ganging Kit

451-GANGPKG	\$ 38	N.A.	N.A.	N.A.	N.A.	N.A.	N.A.	N.A.	N.A.	N.A.	N.A.	N.A.	N.A.
-------------	-------	------	------	------	------	------	------	------	------	------	------	------	------

Coalesse

Circa Lounge System Upholstered Individual Lounge Units

DESIGN ALISON SPEAR, AIA

SIN 711.17

Circa Lounge System Upholstered Modular Arm Rests—Straight, 15°, 30°, and Ottoman

DESIGN ALISON SPEAR, AIA

SIN 711.17

Tip: Fabrics and leathers will appear loose with comfort wrinkles when upholstered.

Tip: Cylinder wood and modern metal legs cannot be in shared position with armrests. The legs will always be on the lounge side.

Tip: For Customer's Own Material or Leather, see necessary requirements, important processing instructions, and ordering information
▶ Page 262

Standard Includes		Required to Specify
▶ Need help? Product details, see <i>Coalesse Seating and Outdoor Specification Guide</i>	<ul style="list-style-type: none"> • Frame: hardwood panels • Upholstery: multiple densities of polyurethane • Top stitch on seams • Legs: <ul style="list-style-type: none"> - Tapered leg, if selected: solid maple or walnut - Cylinder leg, if selected: solid oak 	1 Style number 2 Fabric or leather color number for arm rests 3 Wood leg type 4 Wood color number for legs 5 Options, if selected (see below) ▶ See <i>Surface Materials</i> , page 260.

Options	Price	Required to Specify
Surface Materials	<ul style="list-style-type: none"> • Contrasting fabric on ottoman +\$118 	Add suffix K to the style number and select fabric color number.
	Acrylic backer	
	<ul style="list-style-type: none"> • Straight armrests and 15° armrests +\$ 19 • 30° armrests and ottoman +\$ 31 	Specify with <i>acrylic backer</i> . ▶ See <i>Surface Materials</i> , page 260. Specify with <i>acrylic backer</i> . ▶ See <i>Surface Materials</i> , page 260.
Metal Legs	Tapered legs	
	<ul style="list-style-type: none"> • Grade 1 paint +\$134 per leg • Grade 3 paint +\$154 per leg 	Specify with <i>tapered metal legs</i> and select paint color number. ▶ See <i>Surface Materials</i> , page 260. Specify with <i>tapered metal legs</i> and select paint color number. ▶ See <i>Surface Materials</i> , page 260.
	Modern legs	
	<ul style="list-style-type: none"> • Grade 1 paint +\$134 per leg • Grade 3 paint +\$154 per leg 	Specify with <i>modern metal legs</i> and select paint color number. ▶ See <i>Surface Materials</i> , page 260. Specify with <i>modern metal legs</i> and select paint color number. ▶ See <i>Surface Materials</i> , page 260.

Specification Information													
Style Number	Base Prices											Leather Grades:	
	Fabric Grades:											COL	C
	COM	6	7	8	9	10	11	12	13	14			

Straight Armrest—Intermediate without Legs													
451-A1800G	\$766	\$766	\$781	\$806	\$ 882	\$ 932	\$ 989	\$1029	\$1100	\$1198	\$972	\$1894	\$2063
COM/yds = 2¼, COL/sq ft = 50													

Straight Armrest—End of Run with Two Legs													
451-A1800ER	\$889	\$889	\$904	\$929	\$1005	\$1055	\$1112	\$1152	\$1223	\$1321	\$1095	\$2017	\$2186
COM/yds = 2¼, COL/sq ft = 50													

15° Inside Armrest—Intermediate without Legs													
451-A1815FIG	\$758	\$758	\$771	\$793	\$ 861	\$ 905	\$ 956	\$ 991	\$1054	\$1141	\$972	\$1786	\$1934
COM/yds = 2, COL/sq ft = 44													

15° Inside Armrest—End of Run with Two Legs													
451-A1815FIER	\$930	\$930	\$943	\$965	\$1033	\$1077	\$1128	\$1163	\$1226	\$1313	\$1144	\$1958	\$2106
COM/yds = 2, COL/sq ft = 44													

▶ Specification Information, continued on next page



Overall: 28"D 18½"W 17"H



Overall: 28"D 18½"W 23½"H
Tip: Specify left or right facing.



Overall: 28¾"D 18½"W 23½"H



Overall: 28¾"D 18½"W 23½"H
Tip: Specify left or right facing.

Circa Lounge System Upholstered Modular Arm Rests—Straight, 15°, 30°, and Ottoman

DESIGN ALISON SPEAR, AIA

SIN 711.17

► Specification Information, continued from previous page

Specification Information

Style Number	Base Prices											Leather Grades:		
	Fabric Grades:											COL	C	E
	COM	6	7	8	9	10	11	12	13	14				

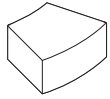

Overall: 29½"D 36¾"W 17"H

30° Inside Arm Rest—Intermediate without Legs

451-A3730FIG	\$1083	\$1083	\$1103	\$1136	\$1238	\$1304	\$1380	\$1433	\$1527	\$1658	\$1263	\$2508	\$2734
--------------	--------	--------	--------	--------	--------	--------	--------	--------	--------	--------	--------	--------	--------

COM/yds = 3, COL/sq ft = 66

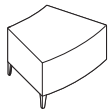

Overall: 29½"D 36¾"W 23½"H
Tip: Specify left or right facing.

30° Inside Arm Rest—End of Run with Two Legs

451-A3730FIER	\$1215	\$1215	\$1235	\$1268	\$1370	\$1436	\$1512	\$1565	\$1659	\$1790	\$1395	\$2640	\$2866
---------------	--------	--------	--------	--------	--------	--------	--------	--------	--------	--------	--------	--------	--------

COM/yds = 3, COL/sq ft = 66



Overall: 28¾"D 18½"W 17"H

15° Outside Armrest—Intermediate without Legs

451-A1815FOG	\$ 758	\$ 758	\$ 771	\$ 793	\$ 861	\$ 905	\$ 956	\$ 991	\$1054	\$1141	\$ 972	\$1786	\$1934
--------------	--------	--------	--------	--------	--------	--------	--------	--------	--------	--------	--------	--------	--------

COM/yds = 2, COL/sq ft = 44



Overall: 28¾"D 18½"W 23½"H
Tip: Specify left or right facing.

15° Outside Armrest—End of Run with Two Legs

451-A1815FOER	\$ 930	\$ 930	\$ 943	\$ 965	\$1033	\$1077	\$1128	\$1163	\$1226	\$1313	\$1144	\$1958	\$2106
---------------	--------	--------	--------	--------	--------	--------	--------	--------	--------	--------	--------	--------	--------

COM/yds = 2, COL/sq ft = 44

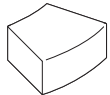

Overall: 29½"D 36¾"W 17"H

30° Outside Arm Rest—Intermediate without Legs

451-A3730FOG	\$1083	\$1083	\$1103	\$1136	\$1238	\$1304	\$1380	\$1433	\$1527	\$1658	\$1263	\$2508	\$2734
--------------	--------	--------	--------	--------	--------	--------	--------	--------	--------	--------	--------	--------	--------

COM/yds = 3, COL/sq ft = 66

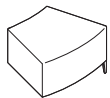

Overall: 29½"D 36¾"W 23½"H
Tip: Specify left or right facing.

30° Outside Arm Rest—End of Run with Two Legs

451-A3730FOER	\$1215	\$1215	\$1235	\$1268	\$1370	\$1436	\$1512	\$1565	\$1659	\$1790	\$1395	\$2640	\$2866
---------------	--------	--------	--------	--------	--------	--------	--------	--------	--------	--------	--------	--------	--------

COM/yds = 3, COL/sq ft = 66

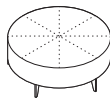

Overall: 42"Dia. 17"H

Round Ottoman with Five Legs

451-B42RD	\$1721	\$1721	\$1743	\$1779	\$1889	\$1961	\$2043	\$2101	\$2203	\$2345	\$1893	\$3248	\$3490
-----------	--------	--------	--------	--------	--------	--------	--------	--------	--------	--------	--------	--------	--------

COM/yds = 3¼, COL/sq ft = 72

Tip: Please submit sketch for modular application. One kit is required per two chairs.

Ganging Kit

451-GANGPKG	\$ 38	N.A.	N.A.	N.A.	N.A.	N.A.	N.A.	N.A.	N.A.	N.A.	N.A.	N.A.	N.A.
-------------	-------	------	------	------	------	------	------	------	------	------	------	------	------

Lounge Seating

Circa Lounge System Modular Tables

DESIGN ALISON SPEAR, AIA

SIN 711.17

Standard Includes		Required to Specify
<ul style="list-style-type: none"> ► Need help? Product details, see <i>Coalesse Seating and Outdoor Specification Guide</i> 	<ul style="list-style-type: none"> • Table: hardwood veneer • Legs: <ul style="list-style-type: none"> - Tapered leg, if selected: solid maple or walnut - Cylinder leg, if selected: solid oak • Brackets and hardware, if ganging or end-of-run tables selected 	<ol style="list-style-type: none"> 1 Style number 2 Wood color number for table 3 Wood leg type 4 Wood color number for legs 5 Options, if selected (see below) <ul style="list-style-type: none"> ► See <i>Surface Materials</i>, page 260.

Options	Price	Required to Specify
Surface Materials <ul style="list-style-type: none"> • Table • Laminate with self edge 	Prices below and at right	Specify <i>with laminate</i> and select laminate color number. ► See <i>Surface Materials</i> , page 260.
Metal Legs <ul style="list-style-type: none"> • Tapered legs • Grade 1 paint 	+\$134 per leg	Specify <i>with tapered metal legs</i> and select paint color number. ► See <i>Surface Materials</i> , page 260.
<ul style="list-style-type: none"> • Modern legs • Grade 1 paint 	+\$134 per leg	Specify <i>with modern metal legs</i> and select paint color number. ► See <i>Surface Materials</i> , page 260.

Specification Information

Style Number	Base Prices	
	Laminate	Wood Veneer

15° Low Wedge Table, Ganging

45-T1815LG	\$1074	\$1260
------------	--------	--------

15° Low Wedge Table, End-of-Run, Two Legs

45-T1815LER	\$1139	\$1428
-------------	--------	--------

15° Low Wedge Table, Freestanding, Four Legs

45-T1815L	\$1204	\$1602
-----------	--------	--------

15° High Wedge Table, Ganging

45-T1815HG	\$1346	\$1738
------------	--------	--------

► Specification Information, continued on next page

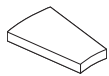

Overall: 28"D 18½"W 8½"H
Angle Degree: 15°

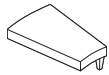

Overall: 28"D 18½"W 8½"H
Angle Degree: 15°

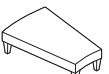

Overall: 28"D 18½"W 8½"H
Angle Degree: 15°

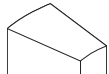

Overall: 28"D 18½"W 22½"H
Angle Degree: 15°

Circa Lounge System Modular Tables

DESIGN ALISON SPEAR, AIA

SIN 711.17

► Specification Information, continued from previous page

Specification Information

Style Number	Base Prices	
	Laminate	Wood Veneer

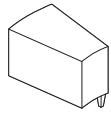

Overall: 28"D 18½"W 22½"H
Angle Degree: 15°

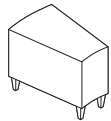

Overall: 28"D 18½"W 22½"H
Angle Degree: 15°

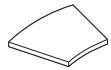

Overall: 29"D 36⅝"W 2"H
(8½" from floor once assembled)

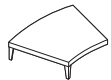

Overall: 29"D 36⅝"W 8½"H

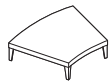

Overall: 29½"D 36⅝"W 8½"H

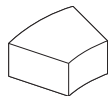

Overall: 29"D 36⅝"W 16"H

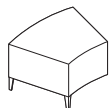

Overall: 29"D 36⅝"W 22½"H

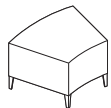

Overall: 29"D 36⅞"W 22½"H

15° High Wedge Table, End-of-Run, Two Legs

45-T1815HER	\$1411	\$1900
-------------	--------	--------

15° High Wedge Table, Freestanding, Four Legs

45-T1815H	\$1476	\$2073
-----------	--------	--------

30° Low Wedge Table, Ganging

45-T3730LG	\$1352	\$1543
------------	--------	--------

30° Low Wedge Table, End-of-Run, Two Legs

45-T3730LER	\$1417	\$1726
-------------	--------	--------

30° Low Wedge Table, Freestanding, Four Legs

45-T3730L	\$1480	\$1914
-----------	--------	--------

30° High Wedge Table, Ganging

45-T3730HG	\$1893	\$2198
------------	--------	--------

30° High Wedge Table, End-of-Run, Two Legs

45-T3730HER	\$1958	\$2377
-------------	--------	--------

30° High Wedge Table, Freestanding, Four Legs

45-T3730H	\$2022	\$2566
-----------	--------	--------

► Specification Information, continued on next page

Circa Lounge System Modular Tables *continued*

DESIGN ALISON SPEAR, AIA

SIN 711.17

► Specification Information, continued from previous page

Specification Information

Style Number	Base Prices	
	Laminate	Wood Veneer

Straight Low Table, Ganging

45-T1300LG	\$1076	\$1230
------------	--------	--------

Straight Low Table, End-of-Run, Two Legs

45-T1300LER	\$1139	\$1428
-------------	--------	--------

Straight Low Table, Freestanding, Four Legs

45-T1300L	\$1213	\$1602
-----------	--------	--------

Straight High Table, Ganging

45-T1300HG	\$1699	\$2106
------------	--------	--------

Straight High Table, End-of-Run, Two Legs

45-T1300HER	\$1762	\$2308
-------------	--------	--------

► Specification Information, continued on next page

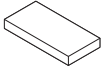

Overall: 27½"D 13½"W 8½"H
Angle Degree: 0°

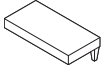

Overall: 27½"D 13½"W 8½"H
Angle Degree: 0°

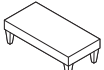

Overall: 27½"D 13½"W 8½"H
Angle Degree: 0°

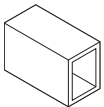

Overall: 27½"D 13½"W 22½"H
Angle Degree: 0°

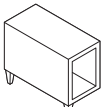

Overall: 27½"D 13½"W 22½"H
Angle Degree: 0°

Circa Lounge System Modular Tables

DESIGN ALISON SPEAR, AIA

SIN 711.17

► Specification Information, continued from previous page

Specification Information

Style Number	Base Prices	
	Laminate	Wood Veneer

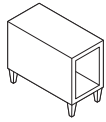

Overall: 27½"D 13½"W 22½"H
Angle Degree: 0°

Straight High Table, Freestanding, Four Legs

45-T1300H	\$1829	\$2445
-----------	--------	--------



Overall: 13¾"D 27½"W 22¼"H
(8½" from floor once assembled)
Tip: Model 45-T28HER has only a single width tapered leg, no corner.

30° End-of-Run, One Leg

45-T28HER	\$1467	\$1862
-----------	--------	--------

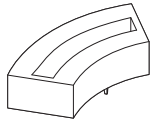

Overall: 33¼"D 70¾"W 22½"H

60° Planter Table, Ganging, Two Legs

45-T7460HPG	\$4538	\$4883
-------------	--------	--------

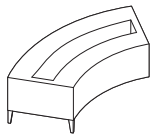

Overall: 33¼"D 70¾"W 22½"H

60° Planter Table, End-of-Run, Three Legs

45-T7460HPER	\$4610	\$4929
--------------	--------	--------

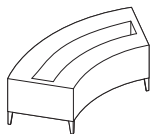

Overall: 33¼"D 70¾"W 22½"H

60° Planter Table, Freestanding, Five Legs

45-T7460HP	\$4674	\$5107
------------	--------	--------

Options for Creating 90° Applications:

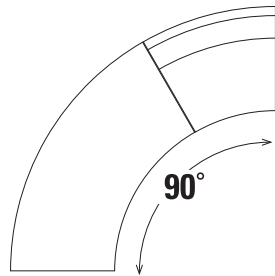

- (1) 30° Outside or Inside Facing Wedge Seat
- (1) 60° Wedge Bench

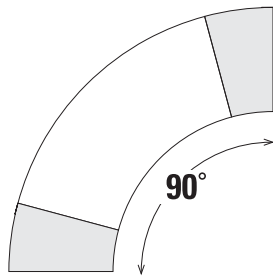

- (2) 15° Wedge Tables
- (1) 60° Wedge Bench

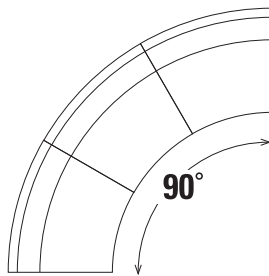

- (3) 30° Outside or Inside Facing Wedge Seats

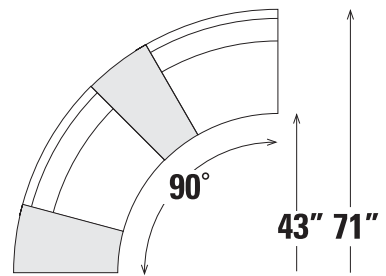

- (2) 30° Outside or Inside Facing Wedge Seats
- (2) 15° Wedge Tables

Circa Lounge System Freestanding Round Table

DESIGN ALISON SPEAR, AIA

SIN 711.17

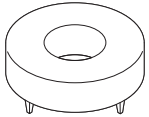

Overall: 42" dia. 15¾"H

Tip: Tapered wood and metal legs have a thin, blade aesthetic.

Tip: The round plate that houses the power/data module is powder coated to complement the power/data module finish. For the black anodized aluminum module, the round plate will be painted in 4710 Low Gloss Black. For the silver anodized aluminum module, the round plate will be painted 4799 Platinum.

Standard Includes	Required to Specify
-------------------	---------------------

- | | |
|---|---|
| <ul style="list-style-type: none"> ▶ Need help? Product details, see <i>Coalesse Seating and Outdoor Specification Guide</i> | <ul style="list-style-type: none"> • Table: laminate • Legs: <ul style="list-style-type: none"> - Tapered leg, if selected: solid maple or walnut - Cylinder leg, if selected: solid oak |
|---|---|

- 1 Style number
 - 2 Wood color number for table
 - 3 Wood leg type
 - 4 Wood color number for legs
 - 5 Options, if selected (see below)
- ▶ See *Surface Materials*, page 260.

Surface Materials	Options	Price	Required to Specify
-------------------	---------	-------	---------------------

Surface Materials	Table		
	<ul style="list-style-type: none"> • Wood veneer 	Price below	Specify with <i>wood veneer</i> and select wood color number. ▶ See <i>Surface Materials</i> , page 260.
	<ul style="list-style-type: none"> • Sunburst wood veneer 	Price below	Specify with <i>sunburst wood veneer</i> and select wood color number. ▶ See <i>Surface Materials</i> , page 260.

Metal Legs	Tapered legs		
	<ul style="list-style-type: none"> • Grade 1 paint 	+\$134 per leg	Specify with <i>tapered metal legs</i> and select paint color number. ▶ See <i>Surface Materials</i> , page 260.

Metal Legs	Modern legs		
	<ul style="list-style-type: none"> • Grade 1 paint 	+\$134 per leg	Specify with <i>modern metal legs</i> and select paint color number. ▶ See <i>Surface Materials</i> , page 260.

Glass Insert	<ul style="list-style-type: none"> • Green tinted glass insert ¾" thick with white enamel bottom square edge detail 	+\$248	Specify with <i>glass insert</i> .
---------------------	--	--------	------------------------------------

Power/Data Module	<ul style="list-style-type: none"> • Two power/two data ports black anodized aluminum or silver anodized aluminum 	+\$368	Specify finish color number.
--------------------------	--	--------	------------------------------

Specification Information

Style Number	Base Prices		
	Laminate	Wood Veneer	Sunburst Wood Veneer

Round Table, Freestanding, Four Legs

45-T42RD	\$2546	\$3464	\$3748
----------	--------	--------	--------

Circa Lounge System Multi-Fabric Diagram

DESIGN ALISON SPEAR, AIA

SIN 711.17

Applies to all Circa models including: Straight 1-Seat Lounge, Wedge, and Straight 2-Seat Lounge

TO: _____

FROM: _____

DATE: _____

FAX...888.413.5161

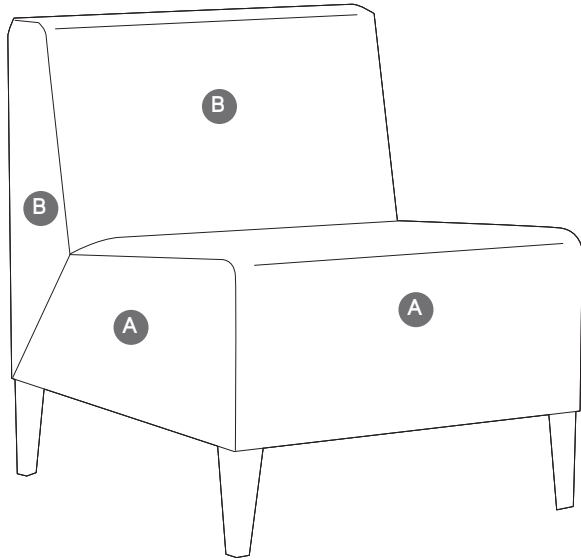

A Upholstery Selection (default for entire unit if B is not selected):

B Back: _____

**\$118 list per contrasting fabric specified. List price based on highest fabric grade usage.*

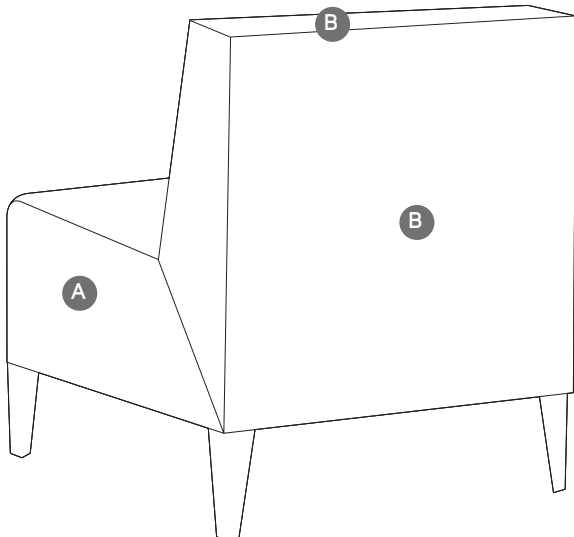

Specify model below:

- 451-7460FOK Outside Facing
- 451-7460FIK Inside Facing
- 451-5000K
- 451-2500K
- 451-3730FOK Outside Facing
- 451-3730FIK Inside Facing

Coupe

DESIGN DENNIE PIMENTAL / JOHN DUFFY

SIN 711.16

Tip: Fabrics and leathers will appear loose with comfort wrinkles when upholstered.

Tip: Recommended leathers are Elmosoft Grade C and Elmorustical Grade E.

Tip: Special color match, consult Customer Service.

Tip: Pricing based on highest grade textile specified.

Tip: For Customer's Own Material or Leather, see necessary requirements, important processing instructions, and ordering information.

▶ Page 262

Standard Includes	Required to Specify
<p>▶ Need help? Product details, see <i>Coalesse Seating and Outdoor Specification Guide</i></p> <ul style="list-style-type: none"> • Frame: unibody construction of hardwood plywood utilizing box joinery • Legs: solid beech • Glides: non-adjustable • Upholstery: multiple densities of laminated polyurethane foam and polyester fiber on seat and back with top stitch sewing detail 	<ol style="list-style-type: none"> 1 Style number 2 Number of fabrics if contrasting fabric style number is selected 3 Wood color number for legs ▶ See <i>Hardwood and Veneer Matrix</i>, page 274 4 Fabric or leather color number for upholstery on seat and back 5 Options, if selected (see below) ▶ See <i>Surface Materials</i>, page 260.

Options	Price	Required to Specify
<p>Surface Materials</p> <ul style="list-style-type: none"> • Contrasting fabric <hr/> <p>Acrylic backer</p> <ul style="list-style-type: none"> • Lounge chair • 2-seat lounge • 3-seat lounge • Ottoman 	<p>+\$118 per fabric</p> <hr/> <p>+\$ 39 +\$ 52 +\$ 63 +\$ 17</p>	<p>Add suffix K to the style number and select fabric color number.</p> <hr/> <p>Specify with acrylic backer. Specify with acrylic backer. Specify with acrylic backer. Specify with acrylic backer. ▶ See <i>Surface Materials</i>, page 260.</p>
<p>Legs</p> <ul style="list-style-type: none"> • Brushed aluminum • Powder coat <hr/> <ul style="list-style-type: none"> • Acrylic: clear 	<p>+\$162 +\$128</p> <hr/> <p>+\$226</p>	<p>Specify with brushed aluminum legs. Specify with powder coat legs and select color: 4138 Graphite Gloss 4140 Arctic White Gloss 4142 Platinum Gloss 4144 Black Gloss 4148 Midnight Brown Gloss Specify with acrylic legs.</p>
<p>Casters</p> <ul style="list-style-type: none"> • Ottoman casters 	<p>+\$142</p>	<p>Specify with casters.</p>

Specification Information

Style Number	Base Prices										Leather Grades:		
	Fabric Grades:										COL	C	E
	COM	6	7	8	9	10	11	12	13	14			

Lounge Chair

470	\$1492	\$1492	\$1520	\$1567	\$1711	\$1805	\$1913	\$1988	\$2121	\$2307	\$1656	\$3583	\$3932
-----	--------	--------	--------	--------	--------	--------	--------	--------	--------	--------	--------	--------	--------

COM/yds = 4¼, COL/sq ft = 94

▶ Specification Information, continued on next page

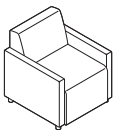

Overall: 28"D 26½"W 30"H
 Inside: 20"D 22"W 13"H
 Seat: 17"H
 Arm: 22"H

Coupe

DESIGN DENNIE PIMENTAL / JOHN DUFFY

SIN 711.16

► Specification Information, continued from previous page

Specification Information

Style Number	Base Prices										Leather Grades:		
	Fabric Grades:										COL	C	E
	COM	6	7	8	9	10	11	12	13	14			

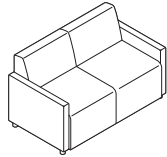

Overall: 28"D 52½"W 30"H
 Inside: 20"D 48"W 13"H
 Seat: 17"H
 Arm: 22"H

2-Seat Lounge

470-2	\$2220	\$2267	\$2305	\$2369	\$2564	\$2690	\$2837	\$2938	\$3119	\$3370	\$2380	\$5193	\$5377
-------	--------	--------	--------	--------	--------	--------	--------	--------	--------	--------	--------	--------	--------

COM/yds = 5¾, COL/sq ft = 127

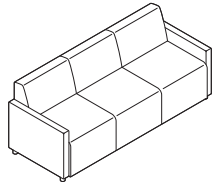

Overall: 28"D 72"W 30"H
 Inside: 20"D 67½"W 13"H
 Seat: 17"H
 Arm: 22"H

3-Seat Lounge

470-3	\$2561	\$2651	\$2697	\$2775	\$3013	\$3166	\$3344	\$3468	\$3688	\$3994	\$2713	\$5930	\$6505
-------	--------	--------	--------	--------	--------	--------	--------	--------	--------	--------	--------	--------	--------

COM/yds = 7, COL/sq ft = 154



Overall: 20"D 25"W 18"H

Ottoman

470-H	\$ 706	\$ 706	\$ 719	\$ 741	\$ 809	\$ 853	\$ 904	\$ 939	\$1002	\$1089	\$ 937	\$1821	\$1988
-------	--------	--------	--------	--------	--------	--------	--------	--------	--------	--------	--------	--------	--------

COM/yds = 2, COL/sq ft = 44

Coupe Grande/Mobile

DESIGN DENNIE PIMENTAL / JOHN DUFFY

SIN 711.16

Tip: Fabrics and leathers will appear loose with comfort wrinkles when upholstered.

Tip: Recommended leathers are Elmosoft Grade C and Elmorustical Grade E.

Tip: Special color match, consult Customer Service.

Tip: For Customer's Own Material or Leather, see necessary requirements, important processing instructions, and ordering information.
▶ Page 262

Tip: Pricing based on highest grade textile specified.

Standard Includes		Required to Specify
▶ Need help? Product details, see <i>Coalesse Seating and Outdoor Specification Guide</i>	<ul style="list-style-type: none"> • Frame: unibody construction of hardwood plywood utilizing box joinery • Legs: solid beech • Glides: non-adjustable • Upholstery: multiple densities of laminated polyurethane foam and polyester fiber on seat and back with top stitch sewing detail • On 476M model: <ul style="list-style-type: none"> - Casters: swivel hard - Locking and non-locking wheels Tablet: <ul style="list-style-type: none"> - Laminate - 13½" diameter 	1 Style number 2 Number of fabrics if contrasting fabric style number is selected 3 Wood color number for legs ▶ See <i>Hardwood and Veneer Matrix</i> , page 274 4 Fabric or leather color number for seat and back 5 Laminate color number for 476M tablet, if selected 6 Options, if selected (see below) ▶ See <i>Surface Materials</i> , page 260.

Options	Price	Required to Specify	
Surface Materials	<ul style="list-style-type: none"> • Contrasting fabric 	+\$118 per fabric	Add suffix K to the style number and select fabric color number.
Acrylic backer	<ul style="list-style-type: none"> • Lounge chair • 2-seat lounge • 3-seat lounge 	+\$ 46 +\$ 60 +\$ 72	Specify with acrylic backer. Specify with acrylic backer. Specify with acrylic backer. ▶ See <i>Surface Materials</i> , page 260.
Castors (476M only)	<ul style="list-style-type: none"> • Soft casters • Brushed aluminum • Powder coat 	No cost +\$162 +\$128	Specify with soft casters. Specify with brushed aluminum legs. Specify with powder coat legs and select color: 4138 Graphite Gloss 4140 Arctic White Gloss 4142 Platinum Gloss 4144 Black Gloss 4148 Midnight Brown Gloss Specify with acrylic legs.
Legs	<ul style="list-style-type: none"> • Acrylic: clear 	+\$226	
Tablet (476M only)	<ul style="list-style-type: none"> • Anodized aluminum • Wood • Omit tablet 	+\$220 +\$122 -\$161	Specify with anodized aluminum tablet. Specify with wood tablet and select wood color number. Specify with remove tablet.

Specification Information

Style Number	Base Prices														Leather Grades:		
	Fabric Grades:														COL	C	E
	COM	6	7	8	9	10	11	12	13	14							

Lounge Chair

476	\$1703	\$1724	\$1757	\$1813	\$1983	\$2092	\$2220	\$2308	\$2465	\$2684	\$1855	\$4139	\$4550
-----	--------	--------	--------	--------	--------	--------	--------	--------	--------	--------	--------	--------	--------

COM/yds = 5, COL/sq ft = 110
 ▶ Specification Information, continued on next page

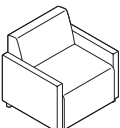

Overall: 28"D 31"W 30"H
 Inside: 20"D 25"W 13"H
 Seat: 17"H
 Arm: 22"H

Coupe Grande/Mobile

DESIGN DENNIE PIMENTAL / JOHN DUFFY

SIN 711.16

► Specification Information, continued from previous page

Specification Information

Style Number	Base Prices										Leather Grades:		
	Fabric Grades:										COL	C	E
	COM	6	7	8	9	10	11	12	13	14			

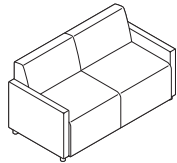

Overall: 28"D 61½"W 30"H
 Inside: 20"D 55½"W 13"H
 Seat: 17"H
 Arm: 22"H

2-Seat Lounge

476-2	\$3089	\$3145	\$3184	\$3251	\$3455	\$3586	\$3739	\$3845	\$4034	\$4296	\$3239	\$5990	\$6481
-------	--------	--------	--------	--------	--------	--------	--------	--------	--------	--------	--------	--------	--------

COM/yds = 6, COL/sq ft = 132

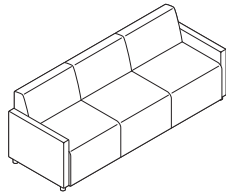

Overall: 28"D 80"W 30"H
 Inside: 20"D 74"W 13"H
 Seat: 17"H
 Arm: 22"H

3-Seat Lounge

476-3	\$3504	\$3594	\$3640	\$3718	\$3956	\$4109	\$4287	\$4411	\$4631	\$4937	\$3654	\$6872	\$7448
-------	--------	--------	--------	--------	--------	--------	--------	--------	--------	--------	--------	--------	--------

COM/yds = 7, COL/sq ft = 154

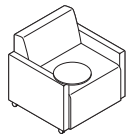

Overall: 28"D 31"W 30"H
 Inside: 20"D 25"W 13"H
 Seat: 17"H
 Arm: 22"H

Mobile Chair

476M	\$2291	\$2312	\$2345	\$2401	\$2571	\$2680	\$2808	\$2896	\$3053	\$3272	\$2443	\$4720	\$5133
------	--------	--------	--------	--------	--------	--------	--------	--------	--------	--------	--------	--------	--------

COM/yds = 5, COL/sq ft = 110

Coupe Wood Lounge Chairs

DESIGN DENNIE PIMENTAL / JOHN DUFFY

SIN 711.16

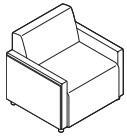

Overall: 29"D 28"W 30"H
 Inside: 20"D 22"W 13"H
 Seat: 17"H
 Arm: 22"H

Tip: Fabrics and leathers will appear loose with comfort wrinkles when upholstered.

Tip: Recommended leathers are Elmosoft Grade C and Elmorustical Grade E.

Tip: Special color match, consult Customer Service.

Tip: For Customer's Own Material or Leather, see necessary requirements, important processing instructions, and ordering information.

► Page 262

Standard Includes		Required to Specify
<ul style="list-style-type: none"> ► Need help? Product details, see <i>Coalesse Seating and Outdoor Specification Guide</i> 	<ul style="list-style-type: none"> • Frame: unibody construction of hardwood plywood utilizing box joinery • Side panels and legs: solid wood • Glides: non-adjustable • Upholstery: multiple densities of laminated polyurethane foam and polyester fiber on seat and back with top stitch sewing detail 	<ol style="list-style-type: none"> 1 Style number 2 Number of fabrics if contrasting fabric style number is selected 3 Wood finish number for legs and side panels ► See <i>Hardwood and Veneer Matrix</i>, page 274 4 Fabric or leather color number for upholstery on seat and back 5 Options, if selected (see below) ► See <i>Surface Materials</i>, page 260.

Options	Price	Required to Specify
Surface Materials <ul style="list-style-type: none"> • Contrasting fabric 	+\$118 per fabric	Add suffix K to the style number and select fabric color number.
Acrylic backer <ul style="list-style-type: none"> • Chair 	+\$ 39	Specify with acrylic backer. ► See <i>Surface Materials</i> , page 260.
Legs <ul style="list-style-type: none"> • Brushed aluminum • Powder coat 	+\$162 +\$128	Specify with brushed aluminum legs. Specify with powder coat legs and select color: 4138 Graphite Gloss 4140 Arctic White Gloss 4142 Platinum Gloss 4144 Black Gloss 4148 Midnight Brown Gloss Specify with acrylic legs.
<ul style="list-style-type: none"> • Acrylic: clear 	+\$226	

Specification Information

Style Number	Base Prices										Leather Grades:		
	Fabric Grades:										COL	C	E
	COM	6	7	8	9	10	11	12	13	14			
473MAPLE	\$3654	\$3654	\$3682	\$3729	\$3873	\$3967	\$4075	\$4150	\$4283	\$4469	\$3810	\$5736	\$6087
473WALNUT	\$3741	\$3741	\$3769	\$3816	\$3960	\$4054	\$4162	\$4237	\$4370	\$4556	\$3895	\$5830	\$6181

COM/yds = 4¼, COL/sq ft = 94

Coalesse

Joel Lounge by Walter Knoll

DESIGN EOOS

SIN 711.16



Overall: 29"D 30¼"W 27½"H
Seat: 16¼"H
Arm: 26¼"H
Inside: 21½"D x 16½"-23"W x 11"H

Tip: Fabrics and leathers will appear loose with comfort wrinkles when upholstered.

Tip: For Customer's Own Material or Leather, see necessary requirements, important processing instructions, and ordering information.

► Page 262

Standard Includes	Required to Specify
<ul style="list-style-type: none"> ► Need help? Product details, see <i>Coalesse Seating and Outdoor Specification Guide</i> • Base frame: steel with molded rigid foam • Seat frame: plywood with molded foam • Base: chrome plated steel • Auto swivel return mechanism 	<ol style="list-style-type: none"> 1 Style number 2 Number of fabrics if contrasting fabric style number is selected 3 Fabric or leather color number for upholstery 4 Options, if selected (see below) <p>► See <i>Surface Materials</i>, page 260.</p>

Options	Price	Required to Specify
Surface Materials		
• Contrasting fabric	+\$118 per fabric	Add suffix K to the style number and select fabric color number.
• Fire code seating	+\$231	Specify with <i>fire code seating</i> . ► See <i>Fire Code Seating</i> , page 264.
Acrylic backer		
• Backer	+\$ 33	Specify with <i>acrylic backer</i> . ► See <i>Surface Materials</i> , page 260.

Specification Information

Style Number	Base Prices											Leather Grades:		
	Fabric Grades:											COL	C	E
	COM	6	7	8	9	10	11	12	13	14				
COWK100	\$1989	\$1989	\$2012	\$2051	\$2170	\$2247	\$2336	\$2398	\$2508	\$2660	\$2143	\$3626	\$3799	

COM/yds = 3½, COL/sq ft = 77

Lounge Seating

Coalesse

Joel Lounge Multi-Fabric Diagram

DESIGN E00S

SIN 711.16

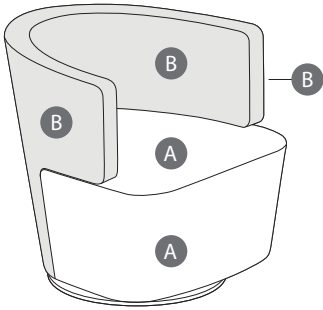

TO: _____

FROM: _____

DATE: _____

FAX...888.413.5161

A Seat (upholstery selections default for entire unit if B is not selected): _____

B Back: _____

** \$118 list upcharge for each contrasting textile pricing based on highest grade textile specified.*

Ripple Benches

DESIGN LAURINDA SPEAR,FAIA

SIN 711.16

Tip: Fabrics and leathers will appear loose with comfort wrinkles when upholstered.

Tip: Pricing based on highest grade textile specified.

Tip: Due to the design and construction techniques of Ripple lounge, only certain textiles can be successfully applied, therefore COM fabrics must be submitted to Coalesse for approval prior to order acceptance. Solid patterns with no repeat are recommended.

Tip: Recommended leathers are Elmosoft Grade C and Elmorustical Grade E.

Tip: Special color match, consult Customer Service.

Tip: For Customer's Own Material or Leather, see necessary requirements, important processing instructions, and ordering information.
▶ Page 262

Tip: 96" is a three-seat lounge.

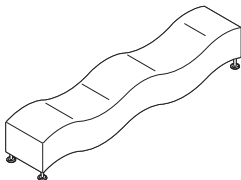

Overall: 19¼"D 97"W 19¼"H
Dip: 14"H

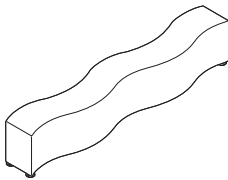

Overall: 19¼"D 97"W 19¼"H
Seat Surface: 19"H

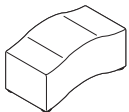

Overall: 19"D 35¾"W 19¼"H

Standard Includes		Required to Specify
▶ Need help? Product details, see <i>Coalesse Seating and Outdoor Specification Guide</i>	<ul style="list-style-type: none"> • Frame: unibody construction with finger jointed plywood • Upholstery: multiple densities of laminated polyurethane foam • Glides: height adjustable with stainless steel finish leveling polyurethane glides • Double needle stitch seams 	<ol style="list-style-type: none"> 1 Style number 2 Number of fabrics if contrasting fabric style number is selected 3 Fabric or leather color number for upholstery on bench 4 Options, if selected (see below) ▶ See <i>Surface Materials</i> , page 260.

Options	Price	Required to Specify
Surface Materials	<ul style="list-style-type: none"> • Contrasting fabric +\$118 per fabric 	Add suffix K to the style number and select fabric color number.
	Acrylic backer <ul style="list-style-type: none"> • Wave and flat seats +\$ 67 • Little Ripple wave and flat seats +\$ 29 	Specify with acrylic backer. Specify with acrylic backer. ▶ See <i>Surface Materials</i> , page 260.

Specification Information													
Style Number	Base Prices											Leather Grades:	
	Fabric Grades:											COL	C
	COM	6	7	8	9	10	11	12	13	14			

Upholstered Wave Seat													
490-B96VRT	\$2087	\$2194	\$2243	\$2327	\$2582	\$2746	\$2937	\$3070	\$3305	\$3633	\$2263	\$5419	\$5987
COM/yds = 7½, COL/sq ft = 143													

Upholstered Flat Seat													
490-B96HRZ	\$2087	\$2194	\$2243	\$2327	\$2582	\$2746	\$2937	\$3070	\$3305	\$3633	\$2263	\$5419	\$5987
COM/yds = 7½, COL/sq ft = 143													

Little Ripple Wave Seat													
490-B35VRT	\$ 880	\$ 880	\$ 895	\$ 920	\$ 996	\$1046	\$1103	\$1143	\$1214	\$1312	\$1119	\$2179	\$2371
COM/yds = 2¼, COL/sq ft = 50													

Sidewalk Lounge/Mobile

DESIGN STUDIO B

SIN 711.16

Tip: Fabrics and leathers will appear loose with comfort wrinkles when upholstered.

Tip: Coordinating Sidewalk tables, ottomans, and benches are available.

► Pages 102 and 241

Tip: Recommended leathers are Elmosoft Grade C and Elmorustical Grade E.

Tip: Special color match, consult Customer Service.

Tip: Multi-fabric diagram available.

► Page 98

Tip: For Customer's Own Material or Leather, see necessary requirements, important processing instructions, and ordering information.

► Page 262

Tip: Specify tablet from facing position.

Tip: Tablet can be installed on mobile models only.

Tip: Cup holder must be specified with tablet.

Tip: Extra pivoter allows tablet to be moved side to side.

Standard Includes		Required to Specify	
► Need help? Product details, see <i>Coalesse Seating and Outdoor Specification Guide</i>	<ul style="list-style-type: none"> • Frame: unibody construction with finger jointed plywood • Upholstery: multiple densities of polyurethane foam and polyester fiber on seat, back, and arms. • Lounge: <ul style="list-style-type: none"> - Legs: silver powder coat steel legs with "go" glide • Mobile: <ul style="list-style-type: none"> - 13½" diameter tablet: laminate - Legs: Silver powder coat steel legs with casters - Casters: four non-locking 	<ol style="list-style-type: none"> 1 Style number 2 Number of fabrics if contrasting fabric style number is selected 3 Fabric or leather color number for upholstery on seat, back, and arms 4 Options, if selected (see below) 	► See <i>Surface Materials</i> , page 260.
Options		Price	Required to Specify
Surface Materials	<ul style="list-style-type: none"> • Contrasting fabric 	+\$118 per fabric	Add suffix K to the style number and select fabric color number.
	Acrylic backer		
	<ul style="list-style-type: none"> • Lounge chair • Lounge two-seat chair • Arm bolster 	+\$ 37 +\$ 50 +\$ 8	Specify with acrylic backer. Specify with acrylic backer. Specify with acrylic backer.
			► See <i>Surface Materials</i> , page 260.
Tablet on Mobile Models only	<ul style="list-style-type: none"> • Wood • Anodized aluminum 	+\$134 +\$220	Specify with wood and select wood color. Specify with anodized aluminum.
Tablet Position	<ul style="list-style-type: none"> • Left-side facing • Right-side facing 	No cost No cost	Specify with left-side facing. Specify with right-side facing.
Cup Holder	<ul style="list-style-type: none"> • Cup holder 	+\$ 49	Specify with cup holder.
Tablet Side Storage	<ul style="list-style-type: none"> • Tablet side storage 	+\$ 73	Specify with tablet side storage.
Extra Pivoter	<ul style="list-style-type: none"> • Extra pivoter 	+\$179	Specify with extra pivoter.
Omit Tablet	<ul style="list-style-type: none"> • Omit tablet 	-\$154	Specify with omit tablet.
Glides	Lounge <ul style="list-style-type: none"> • "No go" ½" polyethylene glide 	No cost	Specify with "no go".
	Mobile <ul style="list-style-type: none"> • Go glides 	No cost	Specify with go glides.
Casters	<ul style="list-style-type: none"> • Locking casters 	No cost	Specify with locking casters.
Related Products	<ul style="list-style-type: none"> • Ottomans/benches • Sidewalk tables 		► Page 102 ► Page 241

Specification Information

Style Number	Base Prices											Leather Grades:		
	Fabric Grades:											COL	C	E
COM	6	7	8	9	10	11	12	13	14					

Low-Back Lounge Chair

444	\$1506	\$1506	\$1532	\$1577	\$1713	\$1801	\$1902	\$1973	\$2099	\$2274	\$1701	\$3724	\$4057
-----	--------	--------	--------	--------	--------	--------	--------	--------	--------	--------	--------	--------	--------

COM/yds = 4, COL/sq ft = 88

► Specification Information, continued on next page

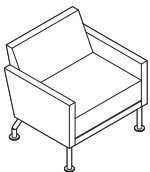

Overall: 27"D 30½"W 29"H
 Inside: 19"D 26"W 17"H
 Seat: 17½"H
 Arm: 23"H

Sidewalk Lounge/Mobile

DESIGN STUDIO B

SIN 711.16

► Specification Information, continued from previous page

Specification Information

Style Number	Base Prices										Leather Grades:		
	Fabric Grades:										COL	C	E
	COM	6	7	8	9	10	11	12	13	14			

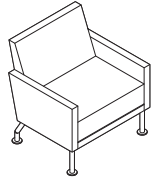

Overall: 27"D 30½"W 32"H
 Inside: 19"D 26"W 20"H
 Seat: 17½"H
 Arm: 23"H

High-Back Lounge Chair

446	\$1660	\$1664	\$1694	\$1744	\$1897	\$1996	\$2110	\$2190	\$2331	\$2528	\$1850	\$4012	\$4350
-----	--------	--------	--------	--------	--------	--------	--------	--------	--------	--------	--------	--------	--------

COM/yds = 4½, COL/sq ft = 99

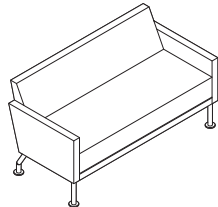

Overall: 27"D 56½"W 29"H
 Inside: 19"D 52"W 17"H
 Seat: 17½"H
 Arm: 23"H

2-Seat Lounge

444-2	\$2343	\$2382	\$2418	\$2479	\$2666	\$2786	\$2926	\$3024	\$3197	\$3437	\$2533	\$5336	\$5711
-------	--------	--------	--------	--------	--------	--------	--------	--------	--------	--------	--------	--------	--------

COM/yds = 5½, COL/sq ft = 121

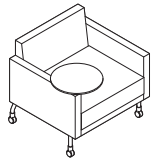

Overall: 27"D 30½"W 29"H
 Inside: 19"D 26"W 17"H
 Seat: 17½"H
 Arm: 22½"H

Low-Back Mobile Lounge Chair with Tablet

444M	\$2044	\$2044	\$2070	\$2115	\$2251	\$2339	\$2440	\$2511	\$2637	\$2812	\$2233	\$4256	\$4630
------	--------	--------	--------	--------	--------	--------	--------	--------	--------	--------	--------	--------	--------

COM/yds = 4, COL/sq ft = 88

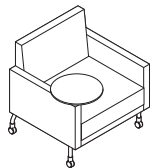

Overall: 27"D 30½"W 32"H
 Inside: 19"D 26"W 20"H
 Seat: 17½"H
 Arm: 22½"H

High-Back Mobile Lounge Chair with Tablet

446M	\$2203	\$2207	\$2237	\$2287	\$2440	\$2539	\$2653	\$2733	\$2874	\$3071	\$2385	\$4669	\$5081
------	--------	--------	--------	--------	--------	--------	--------	--------	--------	--------	--------	--------	--------

COM/yds = 4½, COL/sq ft = 99



Overall: 17½"H 5¾" Dia

Arm Bolster

440-B	\$ 274	\$ 279	\$ 287	\$ 300	\$ 331	\$ 382	\$ 420	\$ 429	\$ 446	\$ 464	\$ 561	\$ 852	\$1144
-------	--------	--------	--------	--------	--------	--------	--------	--------	--------	--------	--------	--------	--------

COM/yds = 1, COL/sq ft = 18

Sidewalk Multi-Fabric Diagram

DESIGN STUDIO B

SIN 711.16

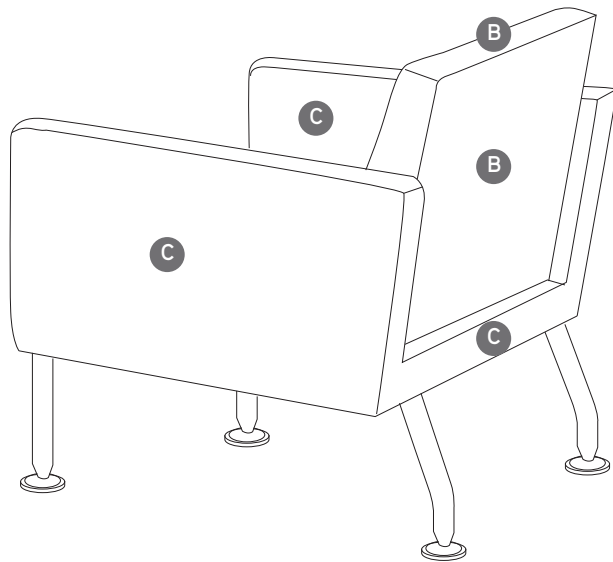
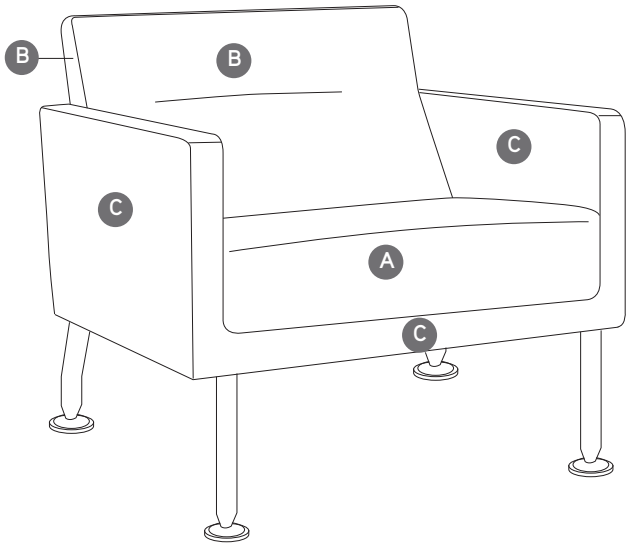

TO: _____

FROM: _____

DATE: _____

FAX....888.413.5161

A Upholstery Selection (default for entire unit if B is not selected):

B Back: _____

C Arms: _____

Total list price upcharge for contrasting fabrics: \$ _____

**\$118 list per contrasting fabric specified. List price based on highest fabric grade usage.*

Specify Model below:

- 444K Sidewalk Low-Back Lounge Chair or Mobile
- 446K Sidewalk High-Back Lounge Chair or Mobile
- 444-2K Sidewalk 2-Seat Lounge

Coalesse

Sidewalk Multi-Fabric Diagram

DESIGN STUDIO B

SIN 711.16

Lounge Seating

Sidewalk Collaborative

DESIGN STUDIO B

SIN 711.16

Tip: Fabrics and leathers will appear loose with comfort wrinkles when upholstered.

Tip: Recommended leathers are Elmosoft Grade C and Elmorustical Grade E.

Tip: Special color match, consult Customer Service.

Tip: For Customer's Own Material or Leather, see necessary requirements, important processing instructions, and ordering information.
▶ Page 262

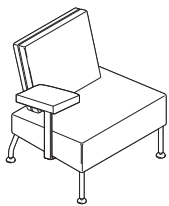

Tip: Overall width dimensions with arm options: 430: 35"W 430-2: 49"W. Overall inside width dimensions with arm options: 430: 19 1/2"W 430-2: 49"W.

▶ See Sidewalk multi-fabric diagram,
▶ Page 103

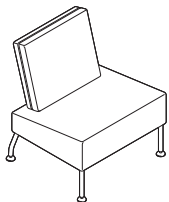

Overall: 27"D 27"W 30 1/2"H
Inside: 17"D 27"W 18"H
Seat: 17"H
Arm: 21"H

Standard Includes		Required to Specify	
▶ Need help? Product details, see <i>Coalesse Seating and Outdoor Specification Guide</i>	<ul style="list-style-type: none"> • Frame: unibody construction with finger jointed plywood • Upholstery: multiple densities of polyurethane foam and polyester fiber on seat and back • Legs: silver powder coat steel with "go" glides 	<ol style="list-style-type: none"> 1 Style number 2 Number of fabrics if contrasting fabric style number is selected 3 Fabric or leather color number for upholstery on seat and back 4 Options, if selected (see below) 	▶ See <i>Surface Materials</i> , page 260.

Options	Price	Required to Specify	
Surface Materials	<ul style="list-style-type: none"> • Contrasting fabric +\$118 per fabric 	Add suffix K to the style number and select fabric color number.	
	Acrylic backer <ul style="list-style-type: none"> • Lounge chair +\$ 22 • 2-seat Chair +\$ 39 • 17"D x 17"W and 17"D x 20"W ottomans +\$ 12 • 20"D x 26"W ottoman +\$ 17 	Specify with <i>acrylic backer</i> . Specify with <i>acrylic backer</i> . Specify with <i>acrylic backer</i> . ▶ See <i>Surface Materials</i> , page 260.	
Attachment Straps	<ul style="list-style-type: none"> • Attachment straps available on 430 model +\$ 63 • Attachment straps available on 430-2 model +\$126 	Specify with <i>attachment straps</i> . Specify with <i>attachment straps</i> .	
Arms	<ul style="list-style-type: none"> • Arms on 430 and 430-2 +\$ 44 per arm 3/4 yard or 14 sq. ft. required for COM/COL	Specify with <i>arms</i> .	
Glides	<ul style="list-style-type: none"> • "No go" 1/2" polyethylene glides No cost 	Specify with <i>"no go" glides</i> .	

Specification Information

Style Number	Base Prices														Leather Grades:		
	Fabric Grades:														COL	C	E
	COM	6	7	8	9	10	11	12	13	14							

Lounge Chair

430	\$1411	\$1411	\$1429	\$1460	\$1553	\$1614	\$1684	\$1732	\$1819	\$1939	\$1649	\$2885	\$3206
-----	--------	--------	--------	--------	--------	--------	--------	--------	--------	--------	--------	--------	--------

COM/yds = 2 3/4, COL/sq ft = 77

▶ Specification Information, continued on next page

► Specification Information, continued from previous page

Specification Information

Style Number	Base Prices											Leather Grades:		
	Fabric Grades:											COL	C	E
	COM	6	7	8	9	10	11	12	13	14				

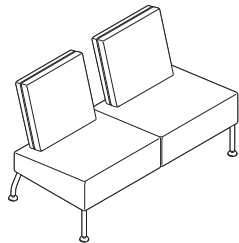

Overall: 27"D 49"W 30½"H
 Inside: 17"D 49"W 18"H
 Seat: 17"H
 Arm: 21"H

2-Seat Lounge

430-2	\$2096	\$2096	\$2124	\$2171	\$2315	\$2409	\$2517	\$2592	\$2725	\$2911	\$2290	\$4147	\$4510
-------	--------	--------	--------	--------	--------	--------	--------	--------	--------	--------	--------	--------	--------

COM/yds = 4¼, COL/sq ft = 115

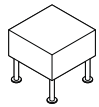

Overall: 17"D 17"W 17"H

Ottoman

430-H1717	\$857	\$857	\$867	\$884	\$935	\$968	\$1006	\$1033	\$1080	\$1145	\$1146	\$1491	\$1740
-----------	-------	-------	-------	-------	-------	-------	--------	--------	--------	--------	--------	--------	--------

COM/yds = 1½, COL/sq ft = 22½

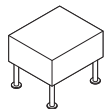

Overall: 17"D 20"W 17"H

430-H1720	\$857	\$857	\$867	\$884	\$935	\$968	\$1006	\$1033	\$1080	\$1145	\$1146	\$1491	\$1740
-----------	-------	-------	-------	-------	-------	-------	--------	--------	--------	--------	--------	--------	--------

COM/yds = 1½, COL/sq ft = 24

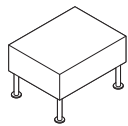

Overall: 20"D 26"W 17"H

430-H2026	\$1028	\$1028	\$1041	\$1063	\$1131	\$1175	\$1226	\$1261	\$1324	\$1411	\$1285	\$1836	\$2092
-----------	--------	--------	--------	--------	--------	--------	--------	--------	--------	--------	--------	--------	--------

COM/yds = 2, COL/sq ft = 36

Sidewalk Ottoman/Benches

DESIGN STUDIO B

SIN 711.16

Tip: Fabrics and leathers will appear loose with comfort wrinkles when upholstered.

Tip: Recommended leathers are Elmosoft Grade C and Elmorustical Grade E.

Tip: Special color match, consult Customer Service.

Tip: For Customer's Own Material or Leather, see necessary requirements, important processing instructions, and ordering information.
▶Page 262

Standard Includes		Required to Specify	
▶Need help? Product details, see <i>Coalesse Seating and Outdoor Specification Guide</i>	<ul style="list-style-type: none"> • Frame: unibody construction with finger jointed plywood. • Upholstery: multiple densities of polyurethane foam and polyester fiber on ottoman/benches • Legs: silver powder coat steel with "go" glides 	1 Style number 2 Fabric or leather color number for upholstery on ottoman/benches 3 Options, if selected (see below) ▶See <i>Surface Materials</i> , page 260.	
Options		Required to Specify	
Surface Materials	Acrylic backer <ul style="list-style-type: none"> • 17"D x 24"W bench +\$12 • 17"D x 36"W bench +\$17 • 17"D x 48"W bench +\$22 • Ottoman +\$29 	Specify with <i>acrylic backer</i> . Specify with <i>acrylic backer</i> . Specify with <i>acrylic backer</i> . Specify with <i>acrylic backer</i> . ▶See <i>Surface Materials</i> , page 260.	
Glides	<ul style="list-style-type: none"> • "No go" 1/2" polyethylene glides 	No cost	Specify with "no go" glides.

Specification Information

Style Number	Base Prices											Leather Grades:		
	Fabric Grades:	6	7	8	9	10	11	12	13	14	COL	C	E	

Benches

430-B1724	\$ 929	\$ 929	\$ 939	\$ 956	\$ 1007	\$ 1040	\$ 1078	\$ 1105	\$ 1152	\$ 1217	\$ 1217	\$ 1617	\$ 1853
COM/yds = 1½, COL/sq ft = 27													

430-B1736	\$ 1093	\$ 1093	\$ 1106	\$ 1128	\$ 1196	\$ 1240	\$ 1291	\$ 1326	\$ 1389	\$ 1476	\$ 1358	\$ 1910	\$ 2176
COM/yds = 2, COL/sq ft = 36													

430-B1748	\$ 1262	\$ 1262	\$ 1278	\$ 1306	\$ 1391	\$ 1446	\$ 1509	\$ 1554	\$ 1632	\$ 1741	\$ 1502	\$ 2206	\$ 2473
COM/yds = 2½, COL/sq ft = 45													

Ottoman

430-H3636	\$ 1276	\$ 1276	\$ 1294	\$ 1325	\$ 1418	\$ 1479	\$ 1549	\$ 1597	\$ 1684	\$ 1804	\$ 1508	\$ 2902	\$ 3199
COM/yds = 2¾, COL/sq ft = 61													

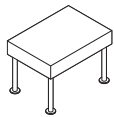

Overall: 17"D 24"W 17"H

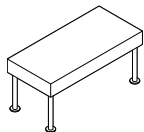

Overall: 17"D 36"W 17"H

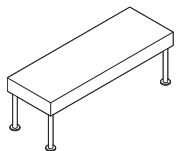

Overall: 17"D 48"W 17"H

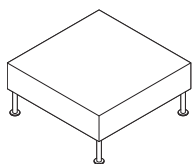

Overall: 36"D 36"W 17"H

Sidewalk Collaborative Multi-Fabric Diagram

DESIGN STUDIO B

SIN 711.16

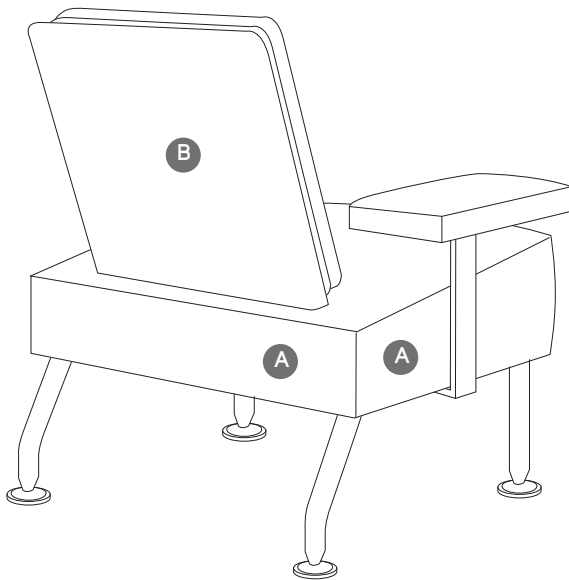
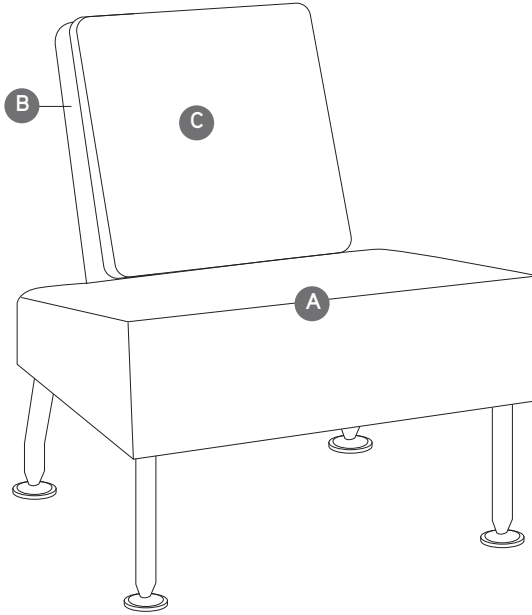

TO: _____

FROM: _____

DATE: _____

FAX....888.413.5161

A Upholstery Selection (default for entire unit if B is not selected): _____

B Back: _____

C Back Cushion: _____

Total list price upcharge for contrasting fabrics: \$ _____

**\$118 list per contrasting fabric specified. List price based on highest fabric grade usage.*

Swathmore Wood Leg

DESIGN MICHAEL SHIELDS

SIN 711.16

Tip: Fabrics and leathers will appear loose with comfort wrinkles when upholstered.

Tip: All cushions are attached.

Tip: Recommended leathers are Elmosoft Grade C and Elmorustical Grade E.

Tip: Special color match, consult Customer Service.

Tip: When contrasting fabric and non-contrasting welt are selected, the welt will match base frame.

Tip: For Customer's Own Material or Leather, see necessary requirements, important processing instructions, and ordering information.
▶ Page 262

Standard Includes		Required to Specify	
▶ Need help? Product details, see <i>Coalesse Seating and Outdoor Specification Guide</i>	<ul style="list-style-type: none"> • Frame: unibody construction with finger jointed plywood. • Upholstery: multiple densities of polyurethane foam and polyester fiber on seat, back, and arm cushions • Legs: solid maple • Glides: 1½" dia. non-adjustable metal 	<ol style="list-style-type: none"> 1 Style number 2 Number of fabrics if contrasting fabric style number is selected 3 Fabric or leather color number for upholstery on seat, back, and arms 4 Wood color number for legs 	<ul style="list-style-type: none"> ▶ See <i>Hardwood and Veneer Matrix</i>, page 274 5 Options, if selected (see below) ▶ See <i>Surface Materials</i>, page 260.
Options		Price	Required to Specify
Surface Materials	• Contrasting fabric	+\$118 per fabric	Add suffix K to the style number and select fabric color number. Specify with <i>contrasting welt</i> and select fabric color number.
	• Contrasting welt	+\$134	
	Acrylic backer		Specify with <i>acrylic backer</i> . Specify with <i>acrylic backer</i> . Specify with <i>acrylic backer</i> . ▶ See <i>Surface Materials</i> , page 260.
	• Lounge chair	+\$ 37	
	• 2-seat lounge	+\$ 50	
	• 3-seat lounge	+\$ 76	
Arm Caps	• Wood arm caps	+\$210	Add suffix WA to the style number.

Specification Information

Style Number	Base Prices											Leather Grades:		
	Fabric Grades:											COL	C	E
	COM	6	7	8	9	10	11	12	13	14				

Lounge Chair with Wood Legs

240	\$1454	\$1470	\$1532	\$1591	\$1718	\$1787	\$1837	\$1933	\$1984	\$2218	\$1649	\$3019	\$3424
-----	--------	--------	--------	--------	--------	--------	--------	--------	--------	--------	--------	--------	--------

COM/yds = 4, COL/sq ft = 88

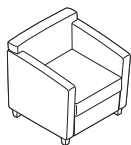

Overall: 27½"D 27"W 28½"H
Inside: 19"D 20"W 14"H
Seat: 17"H
Arm: 25"H

Two-Seat Lounge with Wood Legs

240-2	\$2463	\$2445	\$2523	\$2626	\$2770	\$2961	\$3138	\$3197	\$3280	\$3685	\$2645	\$4396	\$4899
-------	--------	--------	--------	--------	--------	--------	--------	--------	--------	--------	--------	--------	--------

COM/yds = 5½, COL/sq ft = 121

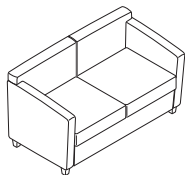

Overall: 27½"D 51"W 29"H
Inside: 19"D 44"W 14"H
Seat: 17"H
Arm: 25"H

Three-Seat Lounge with Wood Legs

240-3	\$3082	\$3115	\$3217	\$3353	\$3542	\$3771	\$4006	\$4057	\$4163	\$4679	\$3258	\$5614	\$6172
-------	--------	--------	--------	--------	--------	--------	--------	--------	--------	--------	--------	--------	--------

COM/yds = 7, COL/sq ft = 154

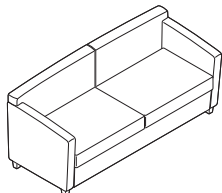

Overall: 27½"D 67"W 29½"H
Inside: 19"D 60"W 14"H
Seat: 17"H
Arm: 25"H

Swathmore Louver

DESIGN MICHAEL SHIELDS

SIN 711.16

Tip: Fabrics and leathers will appear loose with comfort wrinkles when upholstered.

Tip: All cushions are attached.

Tip: Recommended leathers are Elmosoft Grade C and Elmorustical Grade E.

Tip: Special color match, consult Customer Service.

Tip: When contrasting fabric and non-contrasting welt are selected, the welt will match base frame.

Tip: For Customer's Own Material or Leather, see necessary requirements, important processing instructions, and ordering information.

▶ Page 262

Standard Includes		Required to Specify	
▶ Need help? Product details, see <i>Coalesse Seating and Outdoor Specification Guide</i>	<ul style="list-style-type: none"> • Frame: unibody construction with finger jointed plywood. • Upholstery: multiple densities of polyurethane foam and polyester fiber on seat, back, and arm cushions • Base/legs: solid maple • Glides: 1½" dia. non-adjustable metal 	<ol style="list-style-type: none"> 1 Style number 2 Number of fabrics if contrasting fabric style number is selected 3 Fabric or leather color number for upholstery on seat, back, and arms 4 Wood color number for base 	<p>▶ See <i>Hardwood and Veneer Matrix</i>, page 274</p> <p>▶ See <i>Surface Materials</i>, page 260.</p>
Options		Price	Required to Specify
Surface Materials	• Contrasting fabric	+\$118 per fabric	Add suffix K to the style number and select fabric color number. Specify <i>with contrasting welt</i> and select fabric color number.
	• Contrasting welt	+\$134	
	Acrylic backer		Specify <i>with acrylic backer</i> . Specify <i>with acrylic backer</i> . Specify <i>with acrylic backer</i> . ▶ See <i>Surface Materials</i> , page 260.
	• Lounge chair	+\$ 37	
	• 2-seat lounge	+\$ 50	
	• 3-seat lounge	+\$ 76	
Arm Caps	• Wood arm caps	+\$210	Add suffix WA to the style number.

Specification Information

Style Number	Base Prices										Leather Grades:		
	Fabric Grades:										COL	C	E
	COM	6	7	8	9	10	11	12	13	14			

Lounge Chair with Wood Louver Base

241	\$2043	\$2020	\$2089	\$2167	\$2281	\$2434	\$2573	\$2625	\$2695	\$3028	\$2232	\$3559	\$3984
-----	--------	--------	--------	--------	--------	--------	--------	--------	--------	--------	--------	--------	--------

COM/yds = 4, COL/sq ft = 88

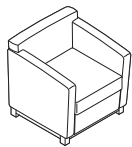

Overall: 27½"D 27"W 28½"H
Inside: 19"D 20"W 14"H
Seat: 17"H
Arm: 25"H

2-Seat Lounge with Wood Louver Base

241-2	\$3051	\$3002	\$3100	\$3199	\$3358	\$3563	\$3759	\$3810	\$3939	\$4443	\$3233	\$5124	\$5686
-------	--------	--------	--------	--------	--------	--------	--------	--------	--------	--------	--------	--------	--------

COM/yds = 5½, COL/sq ft = 121

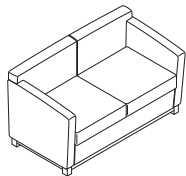

Overall: 27½"D 51"W 29"H
Inside: 19"D 44"W 14"H
Seat: 17"H
Arm: 25"H

3-Seat Lounge with Wood Louver Base

241-3	\$3932	\$3908	\$4086	\$4228	\$4494	\$4749	\$5015	\$5074	\$5227	\$5886	\$4109	\$6745	\$7325
-------	--------	--------	--------	--------	--------	--------	--------	--------	--------	--------	--------	--------	--------

COM/yds = 7, COL/sq ft = 154

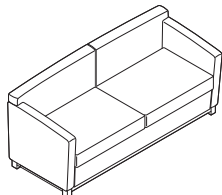

Overall: 27½"D 67"W 29½"H
Inside: 19"D 60"W 14"H
Seat: 17"H
Arm: 25"H

Swathmore Grande Wood Leg

DESIGN MICHAEL SHIELDS

SIN 711.16

Tip: Fabrics and leathers will appear loose with comfort wrinkles when upholstered.

Tip: All cushions are attached.

Tip: Recommended leathers are Elmosoft Grade C and Elmorustical Grade E.

Tip: Special color match, consult Customer Service.

Tip: When contrasting fabric and non-contrasting welt are selected, the welt will match base frame.

Tip: Arm caps can only be specified if contrasting fabric is selected.

Tip: Tablet not available on wood arm cap models.

Tip: Tablet worksurface is 21⁵/₈" x 11⁵/₈".

Standard Includes		Required to Specify
<ul style="list-style-type: none"> ▶ Need help? Product details, see <i>Coalesse Seating and Outdoor Specification Guide</i> 	<ul style="list-style-type: none"> • Frame: unibody construction with finger jointed plywood • Upholstery: multiple densities of polyurethane foam and polyester fiber on seat, back, and arm cushions • Legs: solid maple • Glides: 1¹/₈" dia. non-adjustable metal 	<ol style="list-style-type: none"> 1 Style number 2 Number of fabrics if contrasting fabric style number is selected 3 Fabric or leather color number for upholstery on seat, back, and arms 4 Wood color number for legs <p>▶ See <i>Hardwood and Veneer Matrix</i>, page 274</p> <ol style="list-style-type: none"> 5 Options, if selected (see below) <p>▶ See <i>Surface Materials</i>, page 260.</p>

Options	Price	Required to Specify
Surface Materials	<ul style="list-style-type: none"> • Contrasting fabric +\$118 per fabric • Contrasting welt +\$134 	Add suffix K to the style number and select fabric color number. Specify <i>with contrasting welt</i> and select fabric color number.
Acrylic backer	<ul style="list-style-type: none"> • Lounge chair +\$ 46 • 3-seat lounge +\$ 76 	Specify <i>with acrylic backer</i> . Specify <i>with acrylic backer</i> . ▶ See <i>Surface Materials</i> , page 260.
Arm Caps	<ul style="list-style-type: none"> • Wood arm caps +\$210 	Add suffix WA to the style number.
Tablet (243 only)	<ul style="list-style-type: none"> • Laminate tablet +\$327 • Wood tablet +\$554 	Specify <i>with laminate tablet</i> . Specify <i>with wood tablet</i> .

Specification Information													
Style Number	Base Prices												
	Fabric Grades:										Leather Grades:		
	COM	6	7	8	9	10	11	12	13	14	COL	C	E

Grande Lounge Chair with Wood Legs

243	\$1913	\$1922	\$1993	\$2077	\$2265	\$2420	\$2572	\$2666	\$2718	\$3036	\$2090	\$3550	\$3986
-----	--------	--------	--------	--------	--------	--------	--------	--------	--------	--------	--------	--------	--------

COM/yds = 5, COL/sq ft = 110

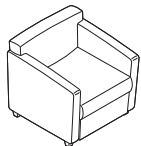

Overall: 30"D 30"W 29¹/₂"H
Inside: 20"D 21³/₄"W 15"H
Seat: 16³/₄"H
Arm: 24"H

Tip: For Customer's Own Material or Leather, see necessary requirements, important processing instructions, and ordering information.

▶ Page 262

Grande 3-Seat Lounge with Wood Legs

243-3	\$3492	\$3558	\$3679	\$3827	\$4035	\$4309	\$4569	\$4626	\$4737	\$5321	\$3676	\$6424	\$7036
-------	--------	--------	--------	--------	--------	--------	--------	--------	--------	--------	--------	--------	--------

COM/yds = 8, COL/sq ft = 176

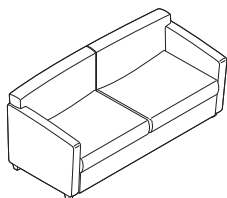

Overall: 30"D 70"W 30¹/₂"H
Inside: 20"D 61³/₄"W 15"H
Seat: 16³/₄"H
Arm: 24"H

Swathmore Grande Louver

DESIGN MICHAEL SHIELDS

SIN 711.16

Tip: Fabrics and leathers will appear loose with comfort wrinkles when upholstered.

Tip: All cushions are attached.

Tip: Recommended leathers are Elmosoft Grade C and Elmorustical Grade E.

Tip: Special color match, consult Customer Service.

Tip: When contrasting fabric and non-contrasting welt are selected, the welt will match base frame.

Tip: For Customer's Own Material or Leather, see necessary requirements, important processing instructions, and ordering information.
▶ Page 262

Standard Includes		Required to Specify
▶ Need help? Product details, see <i>Coalesse Seating and Outdoor Specification Guide</i>	<ul style="list-style-type: none"> • Frame: unibody construction with finger jointed plywood • Upholstery: multiple densities of polyurethane foam and polyester fiber on seat, back, and arm cushions • Legs: solid maple • Glides: 1½" dia. non-adjustable metal 	<ol style="list-style-type: none"> 1 Style number 2 Number of fabrics if contrasting fabric style number is selected 3 Fabric or leather color number for upholstery on seat, back, and arms 4 Wood color number for frame and legs <p>▶ See <i>Hardwood and Veneer Matrix</i>, page 274</p> <p>▶ See <i>Surface Materials</i>, page 260.</p>

Options	Price	Required to Specify
Surface Materials	<ul style="list-style-type: none"> • Contrasting fabric +\$118 per fabric • Contrasting welt +\$134 	<p>Add suffix K to the style number and select fabric color number.</p> <p>Specify with <i>contrasting welt</i> and select fabric color number.</p>
Acrylic backer	<ul style="list-style-type: none"> • Lounge chair +\$ 46 • 2-seat lounge +\$ 60 • 3-seat lounge +\$ 76 	<p>Specify with <i>acrylic backer</i>.</p> <p>Specify with <i>acrylic backer</i>.</p> <p>Specify with <i>acrylic backer</i>.</p> <p>▶ See <i>Surface Materials</i>, page 260.</p>
Arm Caps	<ul style="list-style-type: none"> • Wood arm caps +\$210 	Add suffix WA to the style number.

Specification Information													
Style Number	Base Prices											Leather Grades:	
	Fabric Grades:											COL	C
	COM	6	7	8	9	10	11	12	13	14			

Grande Lounge Chair with Wood Louver

244	\$2578	\$2570	\$2627	\$2726	\$2861	\$3021	\$3191	\$3249	\$3349	\$3771	\$2762	\$4342	\$4795
-----	--------	--------	--------	--------	--------	--------	--------	--------	--------	--------	--------	--------	--------

COM/yds = 5, COL/sq ft = 110

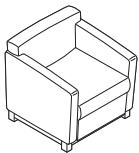

Overall: 30"D 30"W 29½"H
Inside: 20"D 21¾"W 15"H
Seat: 16¾"H
Arm: 24"H

Grande 2-Seat Lounge with Wood Louver

244-2	\$3633	\$3615	\$3713	\$3839	\$4024	\$4246	\$4480	\$4533	\$4688	\$5292	\$3822	\$6056	\$6663
-------	--------	--------	--------	--------	--------	--------	--------	--------	--------	--------	--------	--------	--------

COM/yds = 6½, COL/sq ft = 143

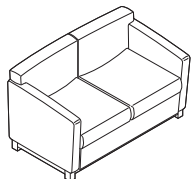

Overall: 30"D 54"W 30"H
Inside: 20"D 45¾"W 15"H
Seat: 16¾"H
Arm: 24"H

Grande 3-Seat Lounge with Wood Louver

244-3	\$4188	\$4186	\$4381	\$4546	\$4864	\$5156	\$5443	\$5526	\$5671	\$6378	\$4372	\$7437	\$8078
-------	--------	--------	--------	--------	--------	--------	--------	--------	--------	--------	--------	--------	--------

COM/yds = 8, COL/sq ft = 176

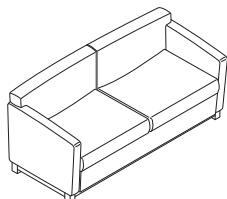

Overall: 30"D 70"W 30½"H
Inside: 20"D 61¾"W 15"H
Seat: 16¾"H
Arm: 24"H

Swathmore Grande Mobile

DESIGN MICHAEL SHIELDS

SIN 711.16

Tip: Fabrics and leathers will appear loose with comfort wrinkles when upholstered.

Tip: Soft casters are not available.

Tip: Wilsonart standard laminate colors.

►Page 276

Tip: Recommended leathers are Elmosoft Grade C and Elmorustical Grade E.

Tip: Special color match, consult Customer Service.

Tip: When contrasting fabric and non-contrasting welt are selected, the welt will match base frame.

Tip: For Customer's Own Material or Leather, see necessary requirements, important processing instructions, and ordering information.

►Page 262

Tip: Tablet worksurface is 21⁵/₈" x 11⁵/₈".

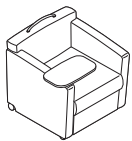

Overall: 30"D 30"W 29½"H
Inside: 20"D 21¾"W 15"H
Seat: 16¾"H
Arm: 24"H

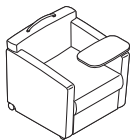

Overall: 30"D 30"W 29½"H
Inside: 20"D 21¾"W 15"H
Seat: 16¾"H
Arm: 24"H

Standard Includes		Required to Specify
► Need help? Product details, see <i>Coalesse Seating and Outdoor Specification Guide</i>	<ul style="list-style-type: none"> • Frame: unibody construction with finger jointed plywood • Hard casters: rear locking • Steel push handle: black • Pivoting worksurface tablet: laminate 	<ol style="list-style-type: none"> 1 Style number 2 Number of fabrics if contrasting fabric style number is selected 3 Fabric or leather color number for upholstery on seat, back, and arms 4 Laminate color for tablet 5 Options, if selected (see below) ► See <i>Surface Materials</i> , page 260.

Options	Price	Required to Specify
Surface Materials	<ul style="list-style-type: none"> • Contrasting fabric +\$118 per fabric • Contrasting welt +\$134 	Add suffix K to the style number and select fabric color number. Specify <i>with contrasting welt</i> and select fabric color number.
Acrylic backer	<ul style="list-style-type: none"> • Backer +\$ 46 	Specify <i>with acrylic backer</i> . ► See <i>Surface Materials</i> , page 260.
Tablet	<ul style="list-style-type: none"> • Omit tablet -\$239 • Wood tablet +\$276 	Specify <i>with omit tablet</i> . Specify <i>with wood tablet</i> .
Omit Push Handle	<ul style="list-style-type: none"> • Omit push handle -\$ 30 	Specify <i>with omit push handle</i> .

Specification Information													
Style Number	Base Prices											Leather Grades:	
	Fabric Grades:											COL	C
COM	6	7	8	9	10	11	12	13	14				

Grande Mobile Lounge Chair with Tablet Left Facing

243MTL	\$2432	\$2429	\$2492	\$2595	\$2808	\$2980	\$3159	\$3249	\$3334	\$3739	\$2614	\$4285	\$4752
--------	--------	--------	--------	--------	--------	--------	--------	--------	--------	--------	--------	--------	--------

COM/yds = 5, COL/sq ft = 110

Grande Mobile Lounge Chair with Tablet Right Facing

243MTR	\$2432	\$2429	\$2492	\$2595	\$2808	\$2980	\$3159	\$3249	\$3334	\$3739	\$2614	\$4285	\$4752
--------	--------	--------	--------	--------	--------	--------	--------	--------	--------	--------	--------	--------	--------

COM/yds = 5, COL/sq ft = 110

Swathmore/Grande Lounge Seating Multi-Fabric Diagram

SIN 711.16

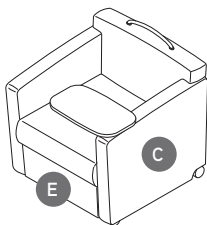
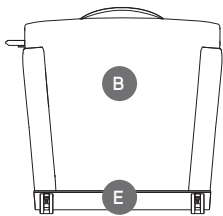
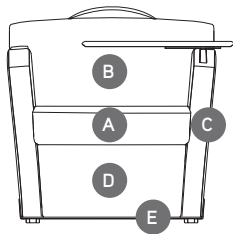
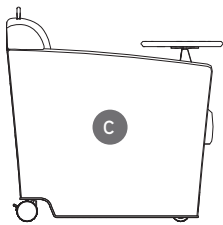
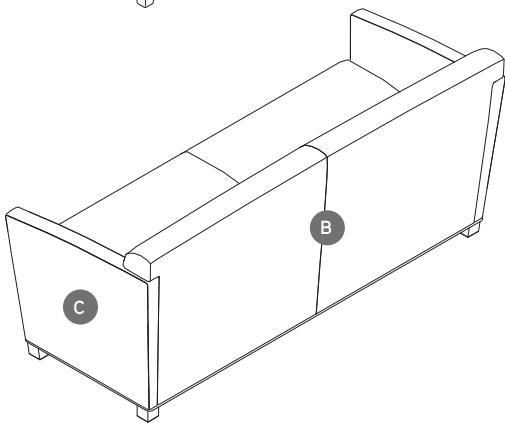
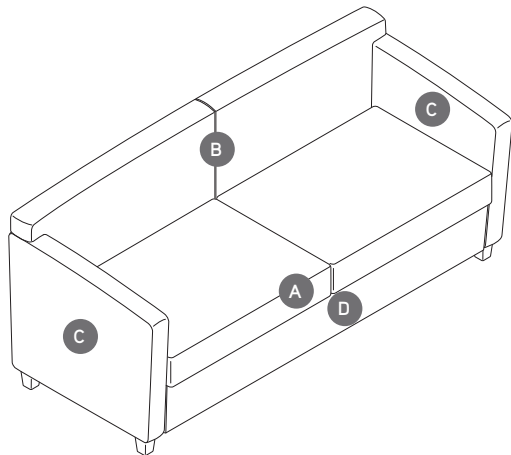

TO: _____

FROM: _____

DATE: _____

FAX....888.413.5161

- A** Seat (upholstery selections default for entire unit if B is not selected): _____
- B** Back: _____
- C** Arms: _____
- D** Base Frame: _____
- E** Welt: _____

Contrasting fabric charges will apply. List price based on highest grade textile specified. \$118 list upcharge for each contrasting textile pricing based on highest grade textile specified.

*Contrasting welt offered as a separate option. \$134 upcharge.
Tip: When contrasting fabric and non-contrasting welt are selected, the welt will match base frame.

Specify model below:

- 240 Lounge Chair with Wood Legs
- 240-2 2-Seat Lounge with Wood Legs
- 240-3 3-Seat Lounge with Wood Legs
- 241 Lounge Chair with Wood Louver Base
- 241-2 2-Seat Lounge with Wood Louver Base
- 241-3 3-Seat Lounge with Wood Louver Base
- 243 Grande Lounge Chair with Wood Legs
- 243-3 Grande 3-Seat Lounge with Wood Legs
- 244 Grande Lounge Chair with Wood Louver Base
- 244-2 Grande 2-Seat Lounge with Wood Louver Base
- 244-3 Grande 3-Seat Lounge with Wood Louver Base
- 243MTL Grande Mobile Lounge Chair with Tablet Left Facing
- 243MTR Grande Mobile Lounge Chair with Tablet Right Facing

Topo Lounge and Lounge Jr.

DESIGN METRO DESIGN GROUP

SIN 711.16

Tip: For Customer's Own Material or Leather, see necessary requirements, important processing instructions, and ordering information.
 ▶ Page 262

Tip: When specifying fabric in different price grades, the highest price grade prevails.

Tip: Fabrics and leathers will appear loose with comfort wrinkles when upholstered.

Tip: The COM yards and COL square footage listed on this page reflect the requirements for a single fabric that are based on non-directional 54"W material applied railroaded. For multi-fabric COM requirements, please refer to multi-fabric yardage.

Standard Includes		Required to Specify
▶ Need help? Product details, see <i>Coalesse Seating and Outdoor Specification Guide</i>	<ul style="list-style-type: none"> Lounge - seat, inside back, outside back and base frame: fabric or leather Lounge Jr. - seat and base frame: fabric or leather Four-arm swivel base: paint Adjustable glides: silver only 	<ol style="list-style-type: none"> Style number Number of fabrics if contrasting fabric style number is selected Fabric or leather color number for seat, inside back, outside back, and base frame, if selected Paint color number for base Options, if selected (see below) ▶ See <i>Surface Materials</i> , page 260.

Options	Price	Required to Specify
Surface Materials	<ul style="list-style-type: none"> Contrasting fabric +\$118 per fabric 	Add suffix K to the style number and select fabric color number.
Contrasting upholstery on lounge Jr.		
<ul style="list-style-type: none"> Contrasting fabric on base frame 	+\$118	Specify fabric color number for baseframe. ▶ See <i>Topo multi-fabric diagram and yardage request form</i> , page 112.
Acrylic backer		
<ul style="list-style-type: none"> Lounge Lounge jr. 	+\$ 29 +\$ 15	Specify with acrylic backer. Specify with acrylic backer. ▶ See <i>Surface Materials</i> , page 260.

Specification Information

Style Number	Base Prices												Leather Grades:		
	Fabric Grades:												COL	C	E
	COM	6	7	8	9	10	11	12	13	14					

Lounge Chair

PL2431	\$1546	\$1546	\$1562	\$1590	\$1675	\$1730	\$1793	\$1838	\$1916	\$2025	\$1671	\$2624	\$2790
COM/yds = 2½, COL/sq ft = 50													

Lounge Jr.

PLJ2417	\$1103	\$1097	\$1104	\$1115	\$1149	\$1171	\$1196	\$1214	\$1245	\$1289	\$1192	\$1662	\$1728
COM/yds = 1, COL/sq ft = 20													



Topo Mobile Lounge and Mobile Lounge Jr.

DESIGN METRO DESIGN GROUP

SIN 711.16

Tip: For Customer's Own Material or Leather, see necessary requirements, important processing instructions, and ordering information.
 ▶Page 262

Tip: When specifying fabric in different price grades, the highest price grade prevails.

Tip: Fabrics and leathers will appear loose with comfort wrinkles when upholstered.

Tip: The COM yards and COL square footage listed on this page reflect the requirements for a single fabric that are based on non-directional 54"W material applied railroaded. For multi-fabric COM requirements, please refer to multi-fabric yardage.

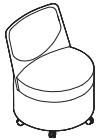

Standard Includes		Required to Specify
▶ Need help? Product details, see <i>Coalesse Seating and Outdoor Specification Guide</i>	<ul style="list-style-type: none"> Mobile lounge - seat, inside back, outside back and base frame: fabric or leather Mobile lounge Jr. - seat and base frame: fabric or leather Non-locking casters: black plastic 	1 Style number 2 Number of fabrics if contrasting fabric style number is selected 3 Fabric or leather color number for seat, inside back, outside back, and base frame, if selected 4 Options, if selected (see below) ▶ See <i>Surface Materials</i> , page 260.

Options	Price	Required to Specify
Surface Materials	<ul style="list-style-type: none"> Contrasting fabric +\$118 per fabric 	Add suffix K to the style number and select fabric color number.
	Contrasting upholstery on lounge Jr.	
<ul style="list-style-type: none"> Contrasting fabric on base frame +\$118 		Specify fabric color number for baseframe. ▶ See <i>Topo multi-fabric diagram and yardage request form</i> , page 112.
	Acrylic backer	
<ul style="list-style-type: none"> Backer +\$ 31 		Specify with <i>acrylic backer</i> . ▶ See <i>Surface Materials</i> , page 260.

Specification Information													
Style Number	Base Prices												
	Fabric Grades:												
	COM	6	7	8	9	10	11	12	13	14	Leather Grades:		
											COL	C	E

Mobile Lounge Chair

PLM2431	\$1563	\$1563	\$1583	\$1616	\$1718	\$1784	\$1860	\$1913	\$2007	\$2138	\$1759	\$2813	\$3013
COM/yds = 3, COL/sq ft = 60													

Mobile Lounge Jr.

PLMJ2417	\$1166	\$1166	\$1186	\$1219	\$1321	\$1387	\$1463	\$1516	\$1610	\$1741	\$1321	\$2416	\$2616
COM/yds = 3, COL/sq ft = 60													

Topo Multi-Fabric Diagram

DESIGN METRO DESIGN GROUP

SIN 711.16

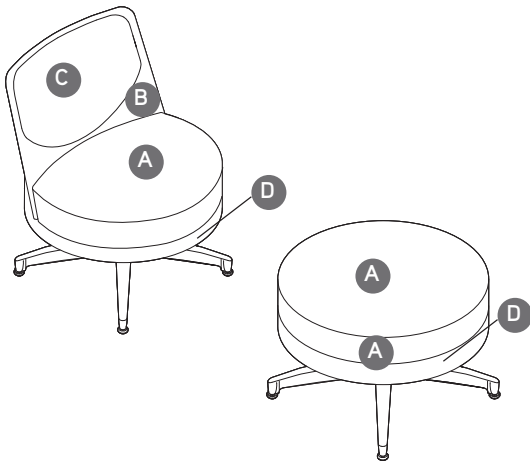
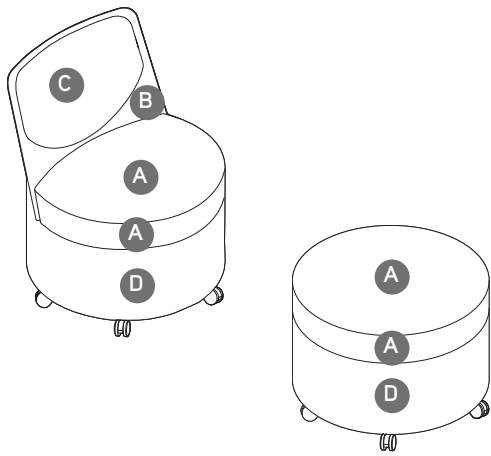

TO: _____

FROM: _____

DATE: _____

FAX....888.413.5161

Topo Lounge

A Seat (upholstery selections default for entire unit if B is not selected): _____

B Back: _____

C Back Cushion: _____

D Base Frame: _____

Topo Jr. Lounge

A Seat: _____

B Base Frame: _____

** \$118 list per contrasting fabric specified. List price based on highest fabric grade usage.*

Topo Multi-Fabric Yardage

DESIGN METRO DESIGN GROUP

SIN 711.16

Multi-Fabric Yardage

DESCRIPTION	STYLE NUMBER	COM YDS*			
		SEAT CUSHION	BACK CUSHION	ARM(S)	BACK SCREEN
Lounge	PL2431	2¼	1	1	2¼
Lounge Jr.	PLJ2417	2½	N.A.	N.A.	2½
Mobile lounge	PLM2431	2½	1	1	2½
Mobile lounge Jr.	PLMJ2417	2½	N.A.	N.A.	2½

*Fabric yardage is based on non-directional/solid fabrics. Use conversion chart below for repeat/printed fabric yardage.

Non-standard fabric requirements

Yardage requirements shown are based on non-directional 54"W material applied railroaded. Coalesse will apply fabric railroaded unless instructed otherwise on the dealer's purchase order. The following conversion chart should be used to determine yardage requirements when COM has a repeat of 2" or more. Please contact Coalesse Customer Service for a yardage quotation if the fabric is less than 54" wide, has a repeat of more than 24", or if the fabric must be cut-right.

CONVERSION CHART

PRODUCT	REPEAT		
	2" - 8"	9" - 14"	15" - 24"
All other products	15%	25%	35%

Yardage quotations will also be provided for order of 10 or more pieces.

Cutting direction guidelines

Cutting direction is based on the fabric width and the way the fabric is cut from the roll and applied to Coalesse products. There are two cutting directions: railroaded or cut-right.

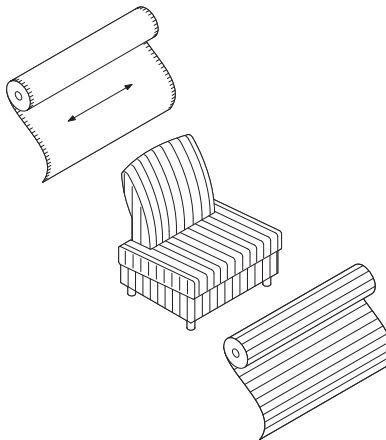

Horizontal or railroaded (across roll, warp horizontal) means fabric is cut across the roll; selvages are on the top and bottom.

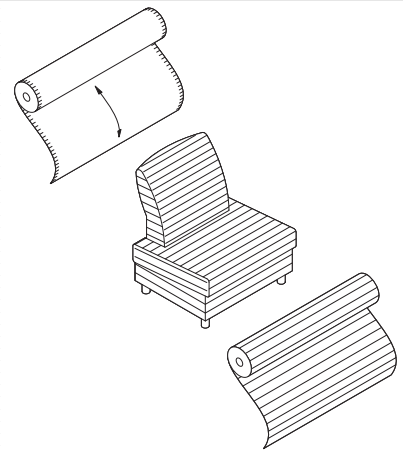

Vertical or cut-right (down roll, warp vertical) means fabric is cut in the same direction it is woven; selvages are on the left and right sides.

Coalesse reserves the right to railroad or apply fabric according to weave unless instructions specify otherwise. Fabrics are railroaded when possible to avoid seams in large upholstered areas and/or single cushion units. If a fabric is questionable, a cutting of adequate size showing full repeat (if any) should be sent to Coalesse for a fabric requirement quotation.

Davos by Viccarbe

DESIGN JEFFREY BERNETT

SIN 711.16

Tip: For Customer's Own Material or Leather, see necessary requirements, important processing instructions, and ordering information.
 ▶ Page 262

Tip: Fabrics and leathers will appear loose with comfort wrinkles when upholstered.

Tip: K suffix must be specified for leather underside.

Tip: Models with fabric underside include black denim section to allow for proper air flow. If this aesthetic is not desired, select contrasting option with leather underside.

Standard Includes		Required to Specify
▶ Need help? Product details, see <i>Coalesse Seating and Outdoor Specification Guide</i>	<ul style="list-style-type: none"> Upholstery for chair or bench: fabric or leather Glides: non-adjustable metal 	1 Style number 2 Number of fabrics if contrasting fabric style number is selected 3 Fabric or leather color number for upholstery 4 Options, if selected (see below) ▶ See <i>Surface Materials</i> , page 260.

Options	Price	Required to Specify
Surface Materials	• Contrasting fabric	+ \$118 per fabric
	Acrylic backer	
	• Chair	+ \$ 54
	• Large bench	+ \$ 33
	• Medium bench	+ \$ 24
	• Small bench	+ \$ 15
		Add suffix K to the style number and select fabric color number. Specify with acrylic backer. Specify with acrylic backer. Specify with acrylic backer. Specify with acrylic backer. ▶ See <i>Surface Materials</i> , page 260.

Specification Information													
Style Number	Base Prices											Leather Grades:	
	Fabric Grades:											COL	C
	COM	6	7	8	9	10	11	12	13	14			

Lounge Chair

CODAV	\$2222	\$2243	\$2276	\$2332	\$2502	\$2611	\$2739	\$2827	\$2984	\$3203	\$2346	\$4064	\$4357
COM/yds = 5, COL/sq ft = 110													

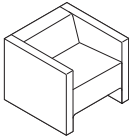

Overall: 30"D 30"W 25½"H
 Seat: 19"D 24"W 16½"H

Large Bench

CODAV60	\$1828	\$1828	\$1850	\$1886	\$1996	\$2068	\$2150	\$2208	\$2310	\$2452	\$1991	\$2984	\$3148
COM/yds = 3¼, COL/sq ft = 71½													

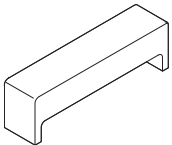

Overall: 13¼"D 59½"W 17½"H

Medium Bench

CODAV38	\$1312	\$1312	\$1328	\$1356	\$1441	\$1496	\$1559	\$1604	\$1682	\$1791	\$1500	\$2388	\$2535
COM/yds = 2½, COL/sq ft = 55													

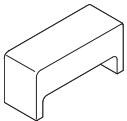

Overall: 13¼"D 38"W 17½"H

Small Bench

CODAV16	\$ 795	\$ 795	\$ 806	\$ 826	\$ 885	\$ 924	\$ 968	\$ 999	\$1054	\$1131	\$1009	\$1692	\$1822
COM/yds = 1¾, COL/sq ft = 39													



Overall: 13¼"D 18½"W 17½"H

Coalesse

Davos by Viccarbe

DESIGN JEFFREY BERNETT

SIN 711.16

Hosu

DESIGN PATRICIA URQUIOLA

SIN 711.16

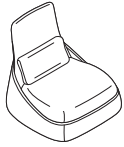

Tip: Fabrics and leathers will appear loose with comfort wrinkles when upholstered.

Tip: Recommended leathers are Elmosoft Grade C and Elmorustical Grade E.

Tip: Frame design allows back to flex to support occupants back shape.

Tip: Due to the design and construction techniques of the Hosu lounge only certain textiles can be successfully applied, therefore all COM fabrics must be submitted to Coalesse for approval prior to order acceptance.

Tip: Hexa fabrics (fabric group 10) were specifically designed by Patricia Urquiola for Hosu lounge seating.

► See Coalesse Surface Materials Reference Guide for complete listing of Hexa fabrics.

Standard Includes	Required to Specify
<p>► Need help? Product details, see <i>Coalesse Seating and Outdoor Specification Guide</i></p> <ul style="list-style-type: none"> • Frame: plywood tab construction • Multiple densities of polyurethane foam and polyester fiber • Seat and back: fabric or leather • Wrap: made from ABS plastic • Footrest on fabric chair, if selected: Fusion fabric or leather • Footrest on leather chair, if selected: Fashion fabric or leather to match seat and back • Glides: non-adjustable • Pull tab on ottoman, if selected: Nylon strap • Grommet for wire pass-through on models COURQLO and COURQLOK, if selected • Pillow: fabric or leather 	<ol style="list-style-type: none"> 1 Style number 2 Number of fabrics if contrasting fabric style number is selected 3 Fabric or leather color number for upholstery on seat, back, and pillow 4 Fusion color number for footrest, if selected: CL60 Caviar CL61 Portobello CL62 Graphite CL63 Java 5 Color number for pull tab with ottoman, if selected: CL40 Red CL41 Blue CL42 Black 6 Options, if selected (see below) ► See <i>Surface Materials</i>, page 260.

Options	Price	Required to Specify
<p>Surface Materials</p> <p>Pillow for lounge chair and lounge chair with ottoman</p> <ul style="list-style-type: none"> • Fabric groups 6-10 No cost • Fabric group 11 +\$145 • Fabric group 12 +\$164 • Fabric group 13 +\$198 • Fabric group 14 +\$246 • Fabric group C +\$346 • Fabric group E +\$417 • Customer's Own Material (COM) +\$ 40 • Customer's Own Leather (COL) +\$274 		<p>Specify fabric color number. Specify fabric color number. Specify fabric color number. Specify fabric color number. Specify fabric color number. Specify fabric color number. Specify fabric color number. ► See <i>Surface Materials</i>, page 260. ► See <i>Surface Materials</i>, page 260.</p>
<p>Pillows for two-seat lounge</p> <ul style="list-style-type: none"> • Fabric groups 6-10 No cost • Fabric group 11 +\$254 • Fabric group 12 +\$287 • Fabric group 13 +\$347 • Fabric group 14 +\$430 • Fabric group C +\$613 • Fabric group E +\$740 • Customer's Own Material (COM) +\$ 40 • Customer's Own Leather (COL) +\$274 		<p>Specify fabric color number. Specify fabric color number. Specify fabric color number. Specify fabric color number. Specify fabric color number. Specify fabric color number. Specify fabric color number. ► See <i>Surface Materials</i>, page 260. ► See <i>Surface Materials</i>, page 260.</p>
<ul style="list-style-type: none"> • Contrasting fabric 	+\$118 per fabric	Add suffix K to the style number and select fabric color number.
<p>Acrylic backer</p> <ul style="list-style-type: none"> • Lounge chair • Lounge chair with ottoman • 2-seat lounge 	<ul style="list-style-type: none"> +\$ 39 +\$ 54 +\$ 72 	<p>Specify with acrylic backer. Specify with acrylic backer. Specify with acrylic backer. ► See <i>Surface Materials</i>, page 260.</p>

Hosu

DESIGN PATRICIA URQUIOLA

SIN 711.16

Specification Information

Style Number	Base Prices										Leather Grades:		
	Fabric Grades:										COL	C	E
	COM	6	7	8	9	10	11	12	13	14			

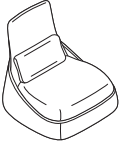

Overall: 35³/₈"D 34³/₈"W 35"H
 Inside: 24"D 31"W 14"H
 Pillow: 3"D 20¹/₁₆"W 10¹/₈"H

Lounge Chair with Lumbar Pillow

COURQL	\$2282	\$2312	\$2346	\$2405	\$2583	\$2698	\$2832	\$2925	\$3090	\$3319	\$2406	\$3722	\$3890
---------------	--------	--------	--------	--------	--------	--------	--------	--------	--------	--------	--------	--------	--------

Lounge: COM/yds = 4¹/₄, COL/sq ft = 94
 Pillow: COM/yds = 1, COL/sq ft = 22

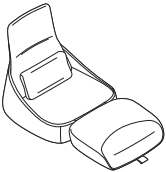

Overall: 35³/₈"D 34³/₈"W 35"H
 Overall extended: 57"L
 Inside: 24"D 31"W 14"H
 Inside extended: 48"L
 Pillow: 3"D 20¹/₁₆"W 10¹/₈"H
 Ottoman: 24"D 31"W 8¹/₂"H

Lounge Chair with Ottoman and Lumbar Pillow

COURQLO	\$2709	\$2790	\$2835	\$2910	\$3139	\$3287	\$3459	\$3578	\$3791	\$4085	\$2833	\$4690	\$4915
----------------	--------	--------	--------	--------	--------	--------	--------	--------	--------	--------	--------	--------	--------

Lounge: COM/yds = 5³/₄, COL/sq ft = 126
 Pillow: COM/yds = 1, COL/sq ft = 22



Overall: 35³/₈"D 64¹/₈"W 35"H
 Inside: 24"D 57¹/₈"W 14"H
 Pillows: 3"D 24"W 10¹/₈"H

2-Seat Lounge with Two Lumbar Pillows

COURQS	\$3561	\$3702	\$3758	\$3853	\$4142	\$4328	\$4544	\$4695	\$4962	\$5333	\$3685	\$5830	\$6085
---------------	--------	--------	--------	--------	--------	--------	--------	--------	--------	--------	--------	--------	--------

Lounge: COM/yds = 6³/₄, COL/sq ft = 143
 Pillows: COM/yds = 1³/₄, COL/sq ft = 39

Millbrae Lounge

DESIGN COALESSE DESIGN GROUP

SIN 711.16

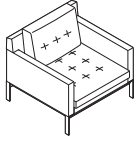

Tip: Fabrics and leathers will appear loose with comfort wrinkles when upholstered.

Tip: For Customer's Own Material or Leather, see necessary requirements, important processing instructions, and ordering information.

▶ Page 262

Standard Includes		Required to Specify		
<p>▶ Need help? Product details, see <i>Coalesse Seating and Outdoor Specification Guide</i></p> <ul style="list-style-type: none"> • Frame: constructed with finger jointed plywood • Multiple densities of polyurethane foams and polyester fiber on seat and back: fabric or leather • The lifestyle collection has tufted pattern accents and separate back cushions with double needle top stitch: fabric or leather • The contract collection has quilted pattern accents with double needle top stitch: fabric or leather • Steel base: paint • Ganging kit with attachment hardware, if selected 		<ol style="list-style-type: none"> 1 Style number 2 Fabric or leather color number for seat, back, and arms 3 Paint color number for base 4 Options, if selected (see below) <p>▶ See <i>Surface Materials</i>, page 260.</p>		
Surface Materials	Options	Price	Required to Specify	
	<ul style="list-style-type: none"> • Contrasting fabric 	+\$ 118 per fabric	<p>Add suffix K to the style number and select fabric color number.</p> <p>▶ See <i>Surface Materials</i>, page 260</p>	
	Acrylic backer lifestyle chairs			
	<ul style="list-style-type: none"> • Lounge chair • 2-seat lounge • 3-seat lounge 	<ul style="list-style-type: none"> +\$ 56 +\$ 93 +\$ 128 	<p>Specify with acrylic backer.</p> <p>Specify with acrylic backer.</p> <p>Specify with acrylic backer.</p>	
	Acrylic backer contract chairs			
	<ul style="list-style-type: none"> • Lounge chair armless • Lounge chair with arms • Lounge chair left or right arm facing • 2-seat lounge armless • 2-seat lounge with arms • 2-seat lounge left or right arm facing • 3-seat lounge armless • 3-seat lounge with arms • 3-seat lounge left or right arm facing • Four-seat lounge armless • Four-seat lounge with arms • Four-seat lounge left or right arm facing • Bench • 2-seat bench • 3-seat bench • Four-seat bench 	<ul style="list-style-type: none"> +\$ 22 +\$ 37 +\$ 31 +\$ 37 +\$ 50 +\$ 44 +\$ 50 +\$ 63 +\$ 56 +\$ 63 +\$ 76 +\$ 69 +\$ 15 +\$ 22 +\$ 31 +\$ 37 	<p>Specify with acrylic backer.</p> <p>Specify with acrylic backer.</p> <p>Specify with acrylic backer.</p> <p>Specify with acrylic backer.</p> <p>Specify with acrylic backer.</p> <p>Specify with acrylic backer.</p> <p>Specify with acrylic backer.</p> <p>Specify with acrylic backer.</p> <p>Specify with acrylic backer.</p> <p>Specify with acrylic backer.</p> <p>Specify with acrylic backer.</p> <p>Specify with acrylic backer.</p> <p>Specify with acrylic backer.</p> <p>Specify with acrylic backer.</p> <p>Specify with acrylic backer.</p> <p>Specify with acrylic backer.</p> <p>Specify with acrylic backer.</p>	
	Bolsters			
	<ul style="list-style-type: none"> • Square or round bolster pillows 	+\$ 8	<p>Specify with acrylic backer.</p> <p>▶ See <i>Surface Materials</i>, page 260.</p>	
	Base			
	<ul style="list-style-type: none"> • Lux Coating 	+\$ 105	Specify Lux Coating color number.	
	Plated metal			
	<ul style="list-style-type: none"> • Lounge chair • 2-seat lounge • 3-seat lounge • Four-seat lounge • One-seat bench • 2-seat bench • 3-seat bench • Four-seat bench 	<ul style="list-style-type: none"> +\$ 777 +\$ 880 +\$1294 +\$1403 +\$ 777 +\$ 880 +\$1294 +\$1403 	<p>Specify with 9238 Brushed Nickel base.</p> <p>Specify with 9238 Brushed Nickel base.</p> <p>Specify with 9238 Brushed Nickel base.</p> <p>Specify with 9238 Brushed Nickel base.</p> <p>Specify with 9238 Brushed Nickel base.</p> <p>Specify with 9238 Brushed Nickel base.</p> <p>Specify with 9238 Brushed Nickel base.</p> <p>Specify with 9238 Brushed Nickel base.</p>	
	Bolster/Pillow Attachment Rings	<ul style="list-style-type: none"> • Attachment rings for bolster/pillow attach to lounge attachment straps 	+\$ 63	Specify with attachment rings.
	Lounge Attachment Straps	<ul style="list-style-type: none"> • Attachment straps for lounge attach to bolster/pillow attachment rings 	No cost	Specify with attachment straps for left and right sides.
	Related Products	<ul style="list-style-type: none"> • Occasional tables 		▶ See <i>GSA Volume 5b Specification Guide</i> .

Tip: Attachment straps are standard on back cushions of Lifestyle lounge.

Millbrae Lounge

DESIGN COALESSE DESIGN GROUP

SIN 711.16

Specification Information

Style Number	Base Prices										Leather Grades:		
	Fabric Grades:										COL	C	E
	COM	6	7	8	9	10	11	12	13	14			

Lifestyle Lounge Seating

Lounge

COMSL1	\$2441	\$2471	\$2505	\$2564	\$2742	\$2857	\$2991	\$3084	\$3249	\$3478	\$2565	\$4270	\$4480
--------	--------	--------	--------	--------	--------	--------	--------	--------	--------	--------	--------	--------	--------

COM/yds = 5¼, COL/sq ft = 115

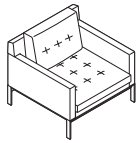

Overall: 35"D 35"W 28¾"H
Overall inside: 29"D 29"W 17"H
Inside to pillow: 22"D 29"W 17"H

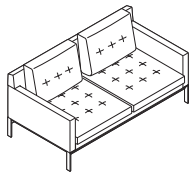

Overall: 35"D 64"W 28¾"H
Overall inside: 29"D 58"W 17"H
Inside to pillow: 22"D 58"W 17"H

2-Seat Lounge

COMSL2	\$3617	\$3750	\$3804	\$3896	\$4176	\$4357	\$4567	\$4713	\$4972	\$5333	\$3741	\$6583	\$6913
--------	--------	--------	--------	--------	--------	--------	--------	--------	--------	--------	--------	--------	--------

COM/yds = 8¼, COL/sq ft = 181

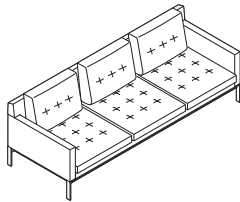

Overall: 35"D 92½"W 28¾"H
Overall inside: 29"D 87"W 17"H
Inside to pillow: 22"D 87"W 17"H

3-Seat Lounge

COMSL3	\$4484	\$4694	\$4763	\$4880	\$5237	\$5467	\$5734	\$5920	\$6250	\$6708	\$4608	\$8311	\$8730
--------	--------	--------	--------	--------	--------	--------	--------	--------	--------	--------	--------	--------	--------

COM/yds = 10½, COL/sq ft = 231

Contract Lounge Chairs

Without Arms

COMFL1	\$2076	\$2076	\$2094	\$2125	\$2218	\$2279	\$2349	\$2397	\$2484	\$2604	\$2256	\$2929	\$3030
--------	--------	--------	--------	--------	--------	--------	--------	--------	--------	--------	--------	--------	--------

COM/yds = 2¾, COL/sq ft = 60

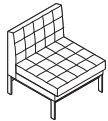

Overall: 30"D 26"W 31"H
Inside seat height: 22"D 17"H

With Arms

COMFLA1	\$2366	\$2366	\$2392	\$2437	\$2573	\$2661	\$2762	\$2833	\$2959	\$3134	\$2503	\$3744	\$3904
---------	--------	--------	--------	--------	--------	--------	--------	--------	--------	--------	--------	--------	--------

COM/yds = 4, COL/sq ft = 88



Overall: 30"D 32"W 31"H
Inside: 22"D 26½"W 17"H

With Left Arm Facing

COMFLLA1	\$2216	\$2216	\$2238	\$2274	\$2384	\$2456	\$2538	\$2596	\$2698	\$2840	\$2379	\$3344	\$3475
----------	--------	--------	--------	--------	--------	--------	--------	--------	--------	--------	--------	--------	--------

COM/yds = 3¼, COL/sq ft = 72



Overall: 30"D 29"W 31"H
Inside: 22"D 26½"W 17"H

With Right Arm Facing

COMFLRA1	\$2216	\$2216	\$2238	\$2274	\$2384	\$2456	\$2538	\$2596	\$2698	\$2840	\$2379	\$3344	\$3475
----------	--------	--------	--------	--------	--------	--------	--------	--------	--------	--------	--------	--------	--------

COM/yds = 3¼, COL/sq ft = 72

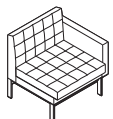

Overall: 30"D 29"W 31"H
Inside: 22"D 26½"W 17"H

► Specification Information, continued on next page

Millbrae Lounge *continued*

DESIGN COALESSE DESIGN GROUP

SIN 711.16

► Specification Information, continued from previous page

Specification Information

Style Number	Base Prices										Leather Grades:		
	Fabric Grades:										COL	C	E
	COM	6	7	8	9	10	11	12	13	14			

Contract 2-Seat Lounges

Without Arms

COMFL2	\$3308	\$3312	\$3342	\$3392	\$3545	\$3644	\$3758	\$3838	\$3979	\$4176	\$3432	\$4673	\$4833
--------	--------	--------	--------	--------	--------	--------	--------	--------	--------	--------	--------	--------	--------

COM/yds = 4½, COL/sq ft = 99

With Arms

COMFLA2	\$3555	\$3602	\$3640	\$3704	\$3899	\$4025	\$4172	\$4273	\$4454	\$4705	\$3679	\$5488	\$5708
---------	--------	--------	--------	--------	--------	--------	--------	--------	--------	--------	--------	--------	--------

COM/yds = 5¾, COL/sq ft = 126

With Left Arm Facing

COMFLLA2	\$3432	\$3453	\$3486	\$3542	\$3712	\$3821	\$3949	\$4037	\$4194	\$4413	\$3556	\$5073	\$5261
----------	--------	--------	--------	--------	--------	--------	--------	--------	--------	--------	--------	--------	--------

COM/yds = 5, COL/sq ft = 110

With Right Arm Facing

COMFLRA2	\$3432	\$3453	\$3486	\$3542	\$3712	\$3821	\$3949	\$4037	\$4194	\$4413	\$3556	\$5073	\$5261
----------	--------	--------	--------	--------	--------	--------	--------	--------	--------	--------	--------	--------	--------

COM/yds = 5, COL/sq ft = 110

► Specification Information, continued on next page

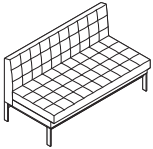

Overall: 30"D 52"W 31"H
Inside seat height: 22"D 17"H

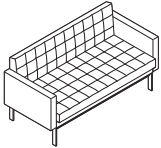

Overall: 30"D 58"W 31"H
Inside: 22"D 52½"W 17"H

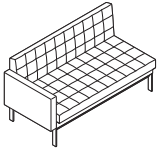

Overall: 30"D 55"W 31"H
Inside: 22"D 52¾"W 17"H

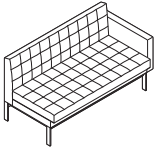

Overall: 30"D 55"W 31"H
Inside: 22"D 52¾"W 17"H

Millbrae Lounge

DESIGN COALESSE DESIGN GROUP

SIN 711.16

► Specification Information, continued from previous page

Specification Information

Style Number	Base Prices														Leather Grades:		
	Fabric Grades:														COL	C	E
	COM	6	7	8	9	10	11	12	13	14							

Contract 3-Seat Lounges

Without Arms

COMFL3	\$4112	\$4168	\$4207	\$4274	\$4478	\$4609	\$4762	\$4868	\$5057	\$5319	\$4236	\$6045	\$6265
---------------	--------	--------	--------	--------	--------	--------	--------	--------	--------	--------	--------	--------	--------

COM/yds = 6, COL/sq ft = 132

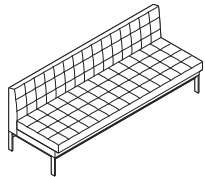

Overall: 30"D 78"W 31"H
Inside seat height: 22"D 17"H

With Arms

COMFLA3	\$4360	\$4467	\$4516	\$4600	\$4855	\$5019	\$5210	\$5343	\$5578	\$5906	\$4484	\$6862	\$7142
----------------	--------	--------	--------	--------	--------	--------	--------	--------	--------	--------	--------	--------	--------

COM/yds = 7½, COL/sq ft = 159

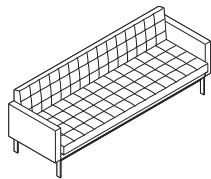

Overall: 30"D 84"W 31"H
Inside: 22"D 78½"W 17"H

With Left Arm Facing

COMFLLA3	\$4236	\$4317	\$4362	\$4437	\$4666	\$4814	\$4986	\$5105	\$5318	\$5612	\$4360	\$6462	\$6712
-----------------	--------	--------	--------	--------	--------	--------	--------	--------	--------	--------	--------	--------	--------

COM/yds = 6¾, COL/sq ft = 148

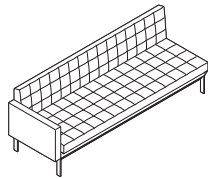

Overall: 30"D 81"W 31"H
Inside: 22"D 78¾"W 17"H

With Right Arm Facing

COMFLRA3	\$4236	\$4317	\$4362	\$4437	\$4666	\$4814	\$4986	\$5105	\$5318	\$5612	\$4360	\$6462	\$6712
-----------------	--------	--------	--------	--------	--------	--------	--------	--------	--------	--------	--------	--------	--------

COM/yds = 6¾, COL/sq ft = 148

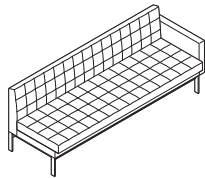

Overall: 30"D 81"W 31"H
Inside: 22"D 78¾"W 17"H

► Specification Information, continued on next page

Millbrae Lounge *continued*

DESIGN COALESSE DESIGN GROUP

SIN 711.16

► Specification Information, continued from previous page

Specification Information

Style Number	Base Prices											Leather Grades:		
	Fabric Grades:											COL	C	E
	COM	6	7	8	9	10	11	12	13	14				

Contract Four-Seat Lounges

Without Arms

COMFL4	\$4360	\$4476	\$4527	\$4613	\$4876	\$5046	\$5243	\$5380	\$5624	\$5963	\$4484	\$6862	\$7142
COM/yds = 7¾, COL/sq ft = 170													

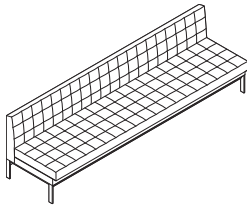

Overall: 30"D 104"W 31"H
Inside seat height: 22"D 17"H

With Arms

COMFLA4	\$4608	\$4758	\$4815	\$4913	\$5210	\$5402	\$5625	\$5779	\$6054	\$6437	\$4732	\$7678	\$8018
COM/yds = 8¾, COL/sq ft = 192													

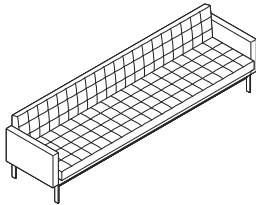

Overall: 30"D 110"W 31"H
Inside: 22"D 104½"W 17"H

With Left Arm Facing

COMFLLA4	\$4484	\$4617	\$4671	\$4763	\$5043	\$5224	\$5434	\$5580	\$5839	\$6200	\$4608	\$7260	\$7570
COM/yds = 8¼, COL/sq ft = 181													

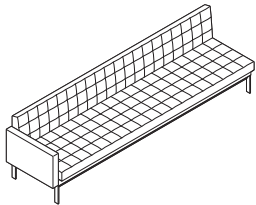

Overall: 30"D 107"W 31"H
Inside: 22"D 104¾"W 17"H

With Right Arm Facing

COMFLRA4	\$4484	\$4617	\$4671	\$4763	\$5043	\$5224	\$5434	\$5580	\$5839	\$6200	\$4608	\$7260	\$7570
COM/yds = 8¼, COL/sq ft = 181													

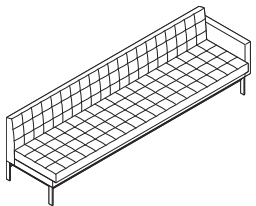

Overall: 30"D 107"W 31"H
Inside: 22"D 104¾"W 17"H

► Specification Information, continued on next page

Millbrae Lounge

DESIGN COALESSE DESIGN GROUP

SIN 711.16

► Specification Information, continued from previous page

Specification Information

Style Number	Base Prices													
	Fabric Grades:											Leather Grades:		
	COM	6	7	8	9	10	11	12	13	14	COL	C	E	

Contract Lounge Benches

One-Seat Bench

COMFLB1	\$1670	\$1670	\$1681	\$1701	\$1760	\$1799	\$1843	\$1874	\$1929	\$2006	\$1884	\$2282	\$2352
---------	--------	--------	--------	--------	--------	--------	--------	--------	--------	--------	--------	--------	--------

COM/yds = 1¾, COL/sq ft = 39

2-Seat Bench

COMFLB2	\$2323	\$2323	\$2341	\$2372	\$2465	\$2526	\$2596	\$2644	\$2731	\$2851	\$2503	\$3176	\$3277
---------	--------	--------	--------	--------	--------	--------	--------	--------	--------	--------	--------	--------	--------

COM/yds = 2¾, COL/sq ft = 60

3-Seat Bench

COMFLB3	\$2712	\$2712	\$2734	\$2770	\$2880	\$2952	\$3034	\$3092	\$3194	\$3336	\$2875	\$3840	\$3971
---------	--------	--------	--------	--------	--------	--------	--------	--------	--------	--------	--------	--------	--------

COM/yds = 3¼, COL/sq ft = 72

Four-Seat Bench

COMFLB4	\$2998	\$3002	\$3032	\$3082	\$3235	\$3334	\$3448	\$3528	\$3669	\$3866	\$3122	\$4363	\$4523
---------	--------	--------	--------	--------	--------	--------	--------	--------	--------	--------	--------	--------	--------

COM/yds = 4½, COL/sq ft = 93

Contract Lounge Round Arm Bolster

COMLPRND	\$ 300	\$ 286	\$ 291	\$ 299	\$ 324	\$ 341	\$ 360	\$ 373	\$ 397	\$ 430	\$ 534	\$ 552	\$ 583
----------	--------	--------	--------	--------	--------	--------	--------	--------	--------	--------	--------	--------	--------

COM/yds = ¾, COL/sq ft = 17

Contract Lounge Square Arm Bolster

COMLPSQR	\$ 300	\$ 294	\$ 301	\$ 312	\$ 346	\$ 368	\$ 393	\$ 411	\$ 442	\$ 486	\$ 534	\$ 638	\$ 679
----------	--------	--------	--------	--------	--------	--------	--------	--------	--------	--------	--------	--------	--------

COM/yds = 1, COL/sq ft = 22

Contract Lounge Ganging Kit

COMF1	\$ 68	N.A.	N.A.	N.A.	N.A.	N.A.	N.A.	N.A.	N.A.	N.A.	N.A.	N.A.	N.A.
-------	-------	------	------	------	------	------	------	------	------	------	------	------	------

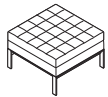

Overall: 26"D 26"W 16½"H

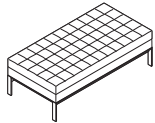

Overall: 26"D 52"W 16½"H

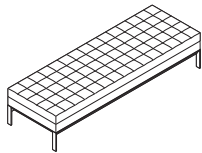

Overall: 26"D 78"W 16½"H

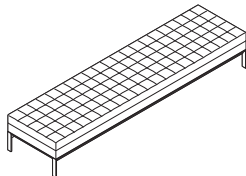

Overall: 26"D 104"W 16½"H



Overall: 18½"D 7"W 7"H



Overall: 18½"D 7"W 7"H

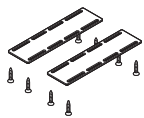

Lounge Seating

Lagunitas Lounge System 1-Seat Lounges

DESIGN TOAN NGUYEN

SIN 711.16

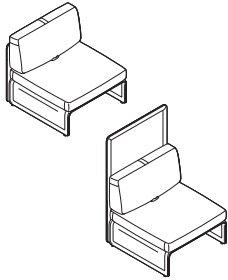

Standard Includes	Required to Specify
<ul style="list-style-type: none"> ▶ Need help? Product details, see <i>Coalesse Seating and Outdoor Specification Guide</i>. • Screen: grade 1 knit • Seat deck: grade 1 knit to match screen • Non-contrasting seat cushion, articulating back cushion and pulls, back corner cushion, and end arm cushions: fabric or leather • Bracket: paint • Six adjustable glides • Ships assembled 	<ol style="list-style-type: none"> 1 Style number 2 Knit color number for screen 3 Fabric or leather color number for non-contrasting seat cushion, articulating back cushion and pulls, and end arm cushions, if selected 4 Paint color number for bracket: 4141 Platinum Matte 4710 Low Gloss Black 5 Options, if selected (see below) <p>▶ See <i>Coalesse Surface Materials Reference Guide</i>.</p>

Options	Price	Required to Specify
Surface Materials <ul style="list-style-type: none"> • 1-seat lounge with low-back screen +\$179 • 1-seat lounge with low-back screen and two side screens +\$332 • 1-seat lounge with high-back screen +\$205 • 1-seat lounge with high-back screen and two side screens +\$408 		Specify with <i>screen type fabric</i> . Specify with <i>screen type fabric</i> .
<ul style="list-style-type: none"> • Contrasting fabric for screen +\$118 • Contrasting fabric for cushion +\$118 		Specify with <i>contrasting fabric</i> and select fabric or leather color number. Specify with <i>contrasting fabric</i> and select fabric or leather color number.
<ul style="list-style-type: none"> • Contrasting fabric for top and bottom articulating back pulls +\$118 		Specify with <i>contrasting fabric</i> and select fabric or leather color number.
<ul style="list-style-type: none"> • Fabric upcharges Prices at right 		Specify fabric color number.
Knit screen <ul style="list-style-type: none"> • Grade 1 knit screen No cost • Grade 2 knit screen <ul style="list-style-type: none"> – 1-seat lounge with low-back screen +\$180 – 1-seat lounge with low-back screen and two side screens +\$385 – 1-seat lounge with high-back screen +\$205 – 1-seat lounge with high-back screen and two side screens +\$461 		Specify with <i>screen type knit</i> and select knit color number. Specify with <i>screen type knit</i> and select knit color number. Specify with <i>screen type knit</i> and select knit color number. Specify with <i>screen type knit</i> and select knit color number.
Acrylic backer <ul style="list-style-type: none"> • 1-seat lounge with low-back screen +\$ 33 • 1-seat lounge with low-back screen and two side screens +\$ 68 • 1-seat lounge with high-back screen +\$ 55 • 1-seat lounge with high-back screen and two side screens +\$ 90 		Specify with <i>acrylic backer</i> . Specify with <i>acrylic backer</i> . Specify with <i>acrylic backer</i> . Specify with <i>acrylic backer</i> . ▶ See <i>Coalesse Surface Materials Reference Guide</i> .
<ul style="list-style-type: none"> • COM +\$150 		Specify with <i>COM</i> and select fabric color number. ▶ See <i>Coalesse Surface Materials Reference Guide</i> .
<ul style="list-style-type: none"> • COL +\$274 		Specify with <i>COL</i> and select leather color number. ▶ See <i>Coalesse Surface Materials Reference Guide</i> .

▶ Options, continued on next page

Tip: If contrasting screen is selected, it is required to specify whether seat deck finish will match inner screen or outer screen.

Tip: Contrasting fabric for articulating back pulls upcharge is applied one time per style number.

Tip: When contrasting fabric for articulating back pulls is selected, only one contrasting fabric can be specified and will apply to all pulls.

Tip: For Customer's Own Material or Leather, see necessary requirements, important processing instructions and ordering information.

▶ See *Coalesse Surface Materials Reference Guide*.

Tip: For any portion of the product that requires a COM, the additional upcharge is a one time charge per product.

Tip: For any portion of the product that requires a COL, the additional upcharge is a one time charge per product.

Lagunitas Lounge System 1-Seat Lounges

DESIGN TOAN NGUYEN

SIN 711.16

Tip: For each USB port specified, there is one USB per port.

► Options, continued from previous page

	Options	Price	Required to Specify
Power/USB Configuration	• One power module: two power in 4710 Low Gloss Black paint	+\$306	Specify with one power module, with two power.
	• One power module: one USB/ one power in 4710 Low Gloss Black paint	+\$406	Specify with one power module, with one power/one USB.

- Related Products**
- Bench
 - Chaise
 - Lagunitas tables
 - Lounge booth connector screen and alignment connector

- Page 150
- Pages 142-146
- See *GSA Volume 5b Specification Guide*.
- Page 152

► Specification Information, on next page

Lagunitas Lounge System 1-Seat Lounges *continued*

DESIGN TOAN NGUYEN

SIN 711.16

► Options, on previous page

Specification Information

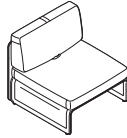

One articulating back
Overall: 32¾"W x 34"D x 32¾"H
Inside (Lounge): 32¾"W x 22½"D
Inside (Task): 32¾"W x 17¾"D
Seat: 16"H

Style Number Base Price

1-Seat Lounge with Low-Back Screen

COLAGLL11 \$1938

Fabric Upcharges

	Fabric Grades:										Leather Grades:	
	6	7	8	9	10	11	12	13	14	C	E	
Articulating Back Pulls (if top and bottom contrasting pulls are selected)	+\$ 19	+\$ 23	+\$ 29	+\$ 49	+\$ 61	+\$ 75	+\$ 85	+\$103	+\$128	+\$184	+\$216	
Seat Cushion	+\$ 84	+\$100	+\$127	+\$211	+\$264	+\$327	+\$370	+\$447	+\$555	+\$801	+\$941	
Back Cushion	+\$ 84	+\$100	+\$127	+\$211	+\$264	+\$327	+\$370	+\$447	+\$555	+\$801	+\$941	
Inside Screen	+\$102	+\$123	+\$156	+\$258	+\$324	+\$401	+\$455	+\$549	+\$680	N.A.	N.A.	
Outside Screen	+\$149	+\$177	+\$227	+\$374	+\$470	+\$579	+\$657	+\$794	+\$983	N.A.	N.A.	

Tip: Articulating back pull fabric upcharges only apply when contrasting pulls are selected.

One Articulating Back: Seat Deck: 2.6 yards, Inside Screen: 1.4 yards, Outside Screen: 1.6 yards, Seat Cushion: 2.2 yards, 48.4 sq ft, Back Cushion: 2.2 yards, 48.4 sq ft, Contrasting Pulls on Articulating Back Cushion: 0.5 yards, 1.1 sq ft

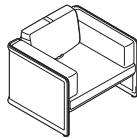

One articulating back and end arm cushions
Overall: 49¼"W x 34"D x 32¾"H
Seat: 16"H

Style Number Base Price

1-Seat Lounge with Low-Back Screen and Two Side Screens

COLAGLL13 \$3060

Fabric Upcharges

	Fabric Grades:										Leather Grades:	
	6	7	8	9	10	11	12	13	14	C	E	
Articulating Back Pulls (if top and bottom contrasting pulls are selected)	+\$ 19	+\$ 23	+\$ 29	+\$ 49	+\$ 61	+\$ 75	+\$ 85	+\$ 103	+\$ 128	+\$ 184	+\$ 216	
Seat Cushion	+\$ 99	+\$ 118	+\$ 151	+\$249	+\$313	+\$ 386	+\$ 438	+\$ 529	+\$ 655	+\$ 946	+\$ 1112	
Back Cushion	+\$210	+\$250	+\$ 319	+\$527	+\$661	+\$ 817	+\$ 926	+\$ 1118	+\$1386	+\$2002	+\$2353	
Inside Screen	+\$204	+\$243	+\$ 310	+\$512	+\$643	+\$ 795	+\$ 900	+\$1088	+\$1348	N.A.	N.A.	
Outside Screen	+\$270	+\$ 321	+\$409	+\$675	+\$848	+\$1047	+\$ 1186	+\$1433	+\$1776	N.A.	N.A.	

Tip: Articulating back pull fabric upcharges only apply when contrasting pulls are selected.

One Articulating Back and End Arm Cushions: Arm: 0, Seat Deck: 1.8 yards, Inside Screen: 4.4 yards, Outside Screen: 5.1 yards, Seat Cushion: 2.6 yards, 57.2 sq ft, Back Cushion: 5.5 yards, 121 sq ft, Contrasting Pulls on Articulating Back Cushion: 0.5 yards, 1.1 sq ft

► Specification Information, continued on next page

Lagunitas Lounge System 1-Seat Lounges

DESIGN TOAN NGUYEN

SIN 711.16

► Specification Information, continued from previous page

Specification Information

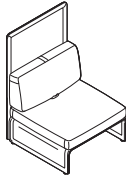

One articulating back
Overall: 32¾"W x 34"D x 50"H
Inside (Lounge): 32¾"W x 22½"D
Inside (Task): 32¾"W x 17¾"D
Seat: 16"H

Style Number Base Price

1-Seat Lounge with High-Back Screen

COLAGLH11 \$2244

Fabric Upcharges

	Fabric Grades:										Leather Grades:	
	6	7	8	9	10	11	12	13	14	C	E	
Articulating Back Pulls (if top and bottom contrasting pulls are selected)	+\$ 19	+\$ 23	+\$ 29	+\$ 49	+\$ 61	+\$ 75	+\$ 85	+\$103	+\$128	+\$184	+\$216	
Seat Cushion	+\$ 84	+\$100	+\$127	+\$211	+\$264	+\$327	+\$370	+\$447	+\$555	+\$801	+\$941	
Back Cushion	+\$ 84	+\$100	+\$127	+\$211	+\$264	+\$327	+\$370	+\$447	+\$555	+\$801	+\$941	
Inside Screen	+\$102	+\$123	+\$156	+\$258	+\$324	+\$401	+\$455	+\$549	+\$680	N.A.	N.A.	
Outside Screen	+\$149	+\$177	+\$227	+\$374	+\$470	+\$579	+\$657	+\$794	+\$983	N.A.	N.A.	

Tip: Articulating back pulls fabric upcharges only apply when contrasting pulls are selected.

One Articulating Back: Seat Deck: 2.6 yards, Inside Screen: 1.4 yards, Outside Screen: 1.6 yards, Seat Cushion: 2.2 yards, 48.4 sq ft, Back Cushion: 2.2 yards, 48.4 sq ft, Contrasting Pulls on Articulating Back Cushion: 0.5 yards, 1.1 sq ft

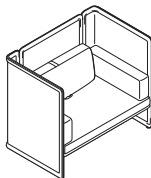

One articulating back and end arm cushions
Overall: 49¼"W x 34"D x 50"H
Seat: 16"H

Style Number Base Price

1-Seat Lounge with High-Back Screen and Two Side Screens

COLAGLH13 \$4080

Fabric Upcharges

	Fabric Grades:										Leather Grades:	
	6	7	8	9	10	11	12	13	14	C	E	
Articulating Back Pulls (if top and bottom contrasting pulls are selected)	+\$ 19	+\$ 23	+\$ 29	+\$ 49	+\$ 61	+\$ 75	+\$ 85	+\$103	+\$128	+\$184	+\$216	
Seat Cushion	+\$ 99	+\$118	+\$151	+\$249	+\$313	+\$386	+\$438	+\$529	+\$655	+\$946	+\$1112	
Back Cushion	+\$210	+\$250	+\$319	+\$527	+\$661	+\$817	+\$926	+\$1118	+\$1386	+\$2002	+\$2353	
Inside Screen	+\$204	+\$243	+\$310	+\$512	+\$643	+\$795	+\$900	+\$1088	+\$1348	N.A.	N.A.	
Outside Screen	+\$270	+\$321	+\$409	+\$675	+\$848	+\$1047	+\$1186	+\$1433	+\$1776	N.A.	N.A.	

Tip: Articulating back pulls fabric upcharges only apply when contrasting pulls are selected.

One Articulating Back and End Arm Cushions: Arm: 0, Seat Deck: 1.8 yards, Inside Screen: 4.4 yards, Outside Screen: 5.1 yards, Seat Cushion: 2.6 yards, 57.2 sq ft, Back Cushion: 5.5 yards, 121 sq ft, Contrasting Pulls on Articulating Back Cushion: 0.5 yards, 1.1 sq ft

Lagunitas Lounge System 2-Seat Lounges

DESIGN TOAN NGUYEN

SIN 711.16

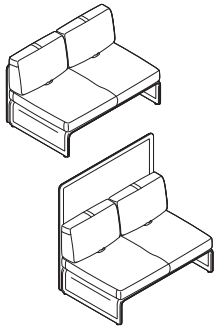

Standard Includes		Required to Specify
<ul style="list-style-type: none"> ▶ Need help? Product details, see <i>Coalesse Seating and Outdoor Specification Guide</i>. • Screen: grade 1 knit • Seat deck: grade 1 knit to match screen • Non-contrasting seat cushion, articulating back cushion and pulls, back corner cushion, and end arm cushions: fabric or leather • Bracket: paint • Six adjustable glides • Ships assembled 	<ol style="list-style-type: none"> 1 Style number 2 Handedness (see below under Required Selections) 3 Knit color number for screen 4 Fabric or leather color number for non-contrasting seat cushion, articulating back cushion and pulls, back corner cushion, and end arm cushions, if selected 5 Paint color number for bracket: 4141 Platinum Matte 4710 Low Gloss Black 6 Options, if selected (see below) 	
		▶ See <i>Coalesse Surface Materials Reference Guide</i> .

Required Sections	Price	Required to Specify
Handedness		
• Left-hand, 2-seat lounges only (seated position)	No cost	Specify with <i>left-hand configuration</i> .
• Right-hand, 2-seat lounges only (seated position)	No cost	Specify with <i>right-hand configuration</i> .

Options	Price	Required to Specify
Surface Materials		
Fabric screen		
• 2-seat lounge with low-back screen	+\$153	Specify with <i>screen type fabric</i> .
• 2-seat lounge with low-back screen and one side screen	+\$230	Specify with <i>screen type fabric</i> .
• 2-seat lounge with low-back screen and two side screens	+\$306	Specify with <i>screen type fabric</i> .
• 2-seat lounge with high-back screen	+\$179	Specify with <i>screen type fabric</i> .
• 2-seat lounge with high-back screen and one side screen	+\$281	Specify with <i>screen type fabric</i> .
• 2-seat lounge with high-back screen and two side screens	+\$383	Specify with <i>screen type fabric</i> .
• Contrasting fabric for screen	+\$118	Specify with <i>contrasting fabric</i> and select fabric or leather color number.
• Contrasting fabric for cushion	+\$118	Specify with <i>contrasting fabric</i> and select fabric or leather color number.
• Contrasting fabric for top and bottom articulating back pulls	+\$118	Specify with <i>contrasting fabric</i> and select fabric or leather color number.
• Fabric upcharges	Prices at right	Specify fabric color number.
Knit screen		
• Grade 1 knit screen	No cost	Specify with <i>screen type knit</i> and select knit color number.
• Grade 2 knit screen		
– 2-seat lounge with low-back screen	+\$231	Specify with <i>screen type knit</i> and select knit color number.
– 2-seat lounge with low-back screen and one side screen	+\$359	Specify with <i>screen type knit</i> and select knit color number.
– 2-seat lounge with low-back screen and two side screens	+\$487	Specify with <i>screen type knit</i> and select knit color number.
– 2-seat lounge with high-back screen	+\$257	Specify with <i>screen type knit</i> and select knit color number.
– 2-seat lounge with high-back screen and one side screen	+\$411	Specify with <i>screen type knit</i> and select knit color number.
– 2-seat lounge with high-back screen and two side screens	+\$564	Specify with <i>screen type knit</i> and select knit color number.

▶ Options, continued on next page

Tip: If contrasting screen is selected, it is required to specify whether seat deck finish will match inner screen or outer screen.

Tip: Contrasting fabric for articulating back pulls upcharge is applied one time per style number.

Tip: When contrasting fabric for articulating back pulls is selected, only one contrasting fabric can be specified and will apply to all pulls.

Lagunitas Lounge System 2-Seat Lounges

DESIGN TOAN NGUYEN

SIN 711.16

► Options, continued from previous page

	Options	Price	Required to Specify
Surface Materials, continued	Acrylic backer		
	• 2-seat lounge with low-back screen	+\$ 53	Specify with acrylic backer.
	• 2-seat lounge with low-back screen and one side screen	+\$ 81	Specify with acrylic backer.
	• 2-seat lounge with low-back screen and two side screens	+\$109	Specify with acrylic backer.
	• 2-seat lounge with high-back screen	+\$ 81	Specify with acrylic backer.
	• 2-seat lounge with low-back screen and one side screen	+\$123	Specify with acrylic backer.
	• 2-seat lounge with high-back screen and two side screens	+\$165	Specify with acrylic backer. ► See Coalesse Surface Materials Reference Guide.
	• COM	+\$150	Specify with COM and select fabric color number. ► See Coalesse Surface Materials Reference Guide.
	• COL	+\$274	Specify with COL and select leather color number. ► See Coalesse Surface Materials Reference Guide.
Power/USB Configuration	• One power module: two power in 4710 Low Gloss Black paint	+\$306	Specify with one power module, with two power.
	• One power module: one USB/one power in 4710 Low Gloss Black paint	+\$406	Specify with one power module, with one power/one USB.
	• Two power modules: two power each in 4710 Low Gloss Black paint	+\$612	Specify with two power modules, with two power.
	• Two power modules: one USB/one power each in 4710 Low Gloss Black paint	+\$812	Specify with two power modules, with one power/one USB.
Related Products	• Bench		► Page 150
	• Chaise		► Pages 142-146
	• Lagunitas tables		► See GSA Volume 5b Specification Guide.
	• Lounge booth connector screen and alignment connector		► Page 152

Tip: For Customer's Own Material or Leather, see necessary requirements, important processing instructions and ordering information.

► See Coalesse Surface Materials Reference Guide.

Tip: For any portion of the product that requires a COM, the additional upcharge is a one time charge per product.

Tip: For any portion of the product that requires a COL, the additional upcharge is a one time charge per product.

Tip: For each USB port specified, there is one USB per port.

► Specification Information, on next page

Lagunitas Lounge System 2-Seat Lounges *continued*

DESIGN TOAN NGUYEN

SIN 711.16

► Options, on previous page

Specification Information

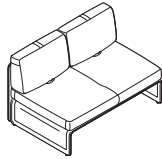

Two articulating backs
Overall: 51¼"W x 34"D x 32¾"H
Inside (Lounge): 51¼"W x 22½"D
Inside (Task): 51¼"W x 17¾"D
Seat: 16"H

Style Number Base Price

2-Seat Lounge with Low-Back Screen

COLAGLL21 \$2907

Fabric Upcharges

	Fabric Grades:									Leather Grades:	
	6	7	8	9	10	11	12	13	14	C	E
Articulating Back Pulls (if top and bottom contrasting pulls are selected)	+\$ 19	+\$ 23	+\$ 29	+\$ 49	+\$ 61	+\$ 75	+\$ 85	+\$ 103	+\$ 128	+\$ 184	+\$ 216
Seat Cushion	+\$ 99	+\$118	+\$151	+\$249	+\$313	+\$386	+\$ 438	+\$ 529	+\$ 655	+\$ 946	+\$1112
Back Cushion	+\$141	+\$168	+\$214	+\$355	+\$445	+\$549	+\$ 622	+\$ 752	+\$ 932	+\$1347	+\$1583
Inside Screen	+\$153	+\$182	+\$232	+\$383	+\$481	+\$594	+\$ 672	+\$ 813	+\$1008	N.A.	N.A.
Outside Screen	+\$196	+\$232	+\$295	+\$489	+\$614	+\$758	+\$ 859	+\$1037	+\$1285	N.A.	N.A.

Tip: Articulating back pull fabric upcharges only apply when contrasting pulls are selected.

Two Articulating Backs: Seat Deck: 3.4 yards, Inside Screen: 2 yards, Outside Screen: 2.2 yards, Seat Cushion: 2.6 yards, 57.2 sq ft, Back Cushion: 3.7 yards, 81.4 sq ft, Contrasting Pulls on Articulating Back Cushions: 0.5 yards, 2.2 sq ft

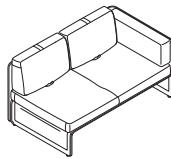

Two articulating backs
Overall: 59¾"W x 34"D x 32¾"H
Seat: 16"H

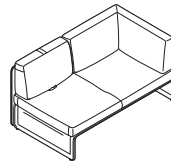

One articulating back and one corner cushion
Overall: 59¾"W x 34"D x 32¾"H
Seat: 16"H

Style Number Base Price

2-Seat Lounge with Low-Back Screen and One Side Screen

COLAGLL22 \$3468

Fabric Upcharges

	Fabric Grades:									Leather Grades:	
	6	7	8	9	10	11	12	13	14	C	E
Articulating Back Pulls (if top and bottom contrasting pulls are selected)	+\$ 19	+\$ 23	+\$ 29	+\$ 49	+\$ 61	+\$ 75	+\$ 85	+\$ 103	+\$ 128	+\$ 184	+\$ 216
Seat Cushion	+\$ 99	+\$ 118	+\$ 151	+\$249	+\$313	+\$386	+\$ 438	+\$ 529	+\$ 655	+\$946	+\$1112
Back Cushion	+\$179	+\$ 214	+\$272	+\$450	+\$565	+\$698	+\$ 791	+\$ 955	+\$1184	+\$1711	+\$2011
Inside Screen	+\$188	+\$225	+\$287	+\$ 474	+\$594	+\$735	+\$ 833	+\$1005	+\$1247	N.A.	N.A.
Outside Screen	+\$244	+\$289	+\$368	+\$608	+\$764	+\$944	+\$1068	+\$1291	+\$1600	N.A.	N.A.

Tip: Articulating back pull fabric upcharges only apply when contrasting pulls are selected.

Two Articulating Backs: Arm: 0, Seat Deck: 2.7 yards, Inside Screen: 3.5 yards, Outside Screen: 3.9 yards, Seat Cushion: 2.6 yards, 57.2 sq ft, Back Cushion: 4.7 yards, 103.4 sq ft, Contrasting Pulls on Articulating Back Cushions: 0.5 yards, 2.2 sq ft

One Articulating Back and One Corner Cushion: Arm: 0, Seat Deck: 2.7 yards, Inside Screen: 3.5 yards, Outside Screen: 3.9 yards, Seat Cushion: 2.6 yards, 57.2 sq ft, Back Cushion: 4.7 yards, 103.4 sq ft, Contrasting Pulls on Articulating Back Cushion: 0.5 yards, 1.1 sq ft

► Specification Information, continued on next page

Lagunitas Lounge System 2-Seat Lounges

DESIGN TOAN NGUYEN

SIN 711.16

► Specification Information, continued from previous page

Specification Information

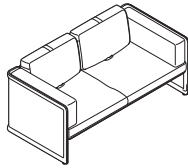

Two articulating backs
Overall: 67¾"W x 34"D x 32¾"H
Seat: 16"H

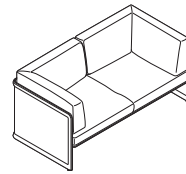

Two corner cushions
Overall: 67¾"W x 34"D x 32¾"H
Seat: 16"H

Style Number Base Price

2-Seat Lounge with Low-Back Screen and Two Side Screens

COLAGLL23 \$4029

Fabric Upcharges

	Fabric Grades:										Leather Grades:	
	6	7	8	9	10	11	12	13	14	C	E	
Articulating Back Pulls (if top and bottom contrasting pulls are selected)	+\$ 19	+\$ 23	+\$ 29	+\$ 49	+\$ 61	+\$ 75	+\$ 85	+\$ 103	+\$ 128	+\$ 184	+\$ 216	
Seat Cushion	+\$ 111	+\$ 132	+\$ 168	+\$ 278	+\$ 349	+\$ 431	+\$ 488	+\$ 589	+\$ 731	+\$ 1056	+\$ 1240	
Back Cushion	+\$ 263	+\$ 314	+\$ 400	+\$ 661	+\$ 829	+\$ 1025	+\$ 1161	+\$ 1402	+\$ 1738	+\$ 2512	+\$ 2952	
Inside Screen	+\$ 235	+\$ 280	+\$ 356	+\$ 589	+\$ 739	+\$ 913	+\$ 1034	+\$ 1250	+\$ 1549	N.A.	N.A.	
Outside Screen	+\$ 304	+\$ 361	+\$ 460	+\$ 762	+\$ 956	+\$ 1181	+\$ 1338	+\$ 1616	+\$ 2003	N.A.	N.A.	

Tip: Articulating back pull fabric upcharges only apply when contrasting pulls are selected.

Two Articulating Backs: Arm: 0, Seat Deck: 1.6 yards, Inside Screen: 4.9 yards, Outside Screen: 5.6 yards, Seat Cushion: 2.9 yards, 63.8 sq ft, Back Cushion: 6.9 yards, 151.8 sq ft, Contrasting Pulls on Articulating Back Cushions: 0.5 yards, 2.2 sq ft

Two Corner Cushions: Arm: 0, Seat Deck: 1.6 yards, Inside Screen: 4.9 yards, Outside Screen: 5.6 yards, Seat Cushion: 2.9 yards, 63.8 sq ft, Back Cushion: 6.9 yards, 151.8 sq ft

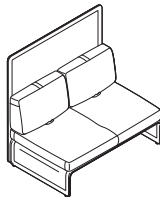

Two articulating backs
Overall: 51¼"W x 34"D x 50"H
Inside (Lounge): 51¼"W x 22½"D
Inside (Task): 51¼"W x 17¾"D
Seat: 16"H

Style Number Base Price

2-Seat Lounge with High-Back Screen

COLAGLH21 \$3519

Fabric Upcharges

	Fabric Grades:										Leather Grades:	
	6	7	8	9	10	11	12	13	14	C	E	
Articulating Back Pulls (if top and bottom contrasting pulls are selected)	+\$ 19	+\$ 23	+\$ 29	+\$ 49	+\$ 61	+\$ 75	+\$ 85	+\$ 103	+\$ 128	+\$ 184	+\$ 216	
Seat Cushion	+\$ 99	+\$ 118	+\$ 151	+\$ 249	+\$ 313	+\$ 386	+\$ 438	+\$ 529	+\$ 655	+\$ 946	+\$ 1112	
Back Cushion	+\$ 141	+\$ 168	+\$ 214	+\$ 355	+\$ 445	+\$ 549	+\$ 622	+\$ 752	+\$ 932	+\$ 1347	+\$ 1583	
Inside Screen	+\$ 153	+\$ 182	+\$ 232	+\$ 383	+\$ 481	+\$ 594	+\$ 672	+\$ 813	+\$ 1008	N.A.	N.A.	
Outside Screen	+\$ 196	+\$ 232	+\$ 295	+\$ 489	+\$ 614	+\$ 758	+\$ 859	+\$ 1037	+\$ 1285	N.A.	N.A.	

Tip: Articulating back pull fabric upcharges only apply when contrasting pulls are selected.

Two Articulating Backs: Seat Deck: 3.4 yards, Inside Screen: 2 yards, Outside Screen: 2.2 yards, Seat Cushion: 2.6 yards, 57.2 sq ft, Back Cushion: 3.7 yards, 81.4 sq ft, Contrasting Pulls on Articulating Back Cushions: 0.5 yards, 2.2 sq ft

► Specification Information, continued on next page

Lounge Seating

Lagunitas Lounge System 2-Seat Lounges *continued*

DESIGN TOAN NGUYEN

SIN 711.16

► Specification Information, continued from previous page

Specification Information

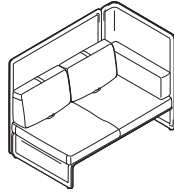

Two articulating backs
Overall: 59³/₈"W x 34"D x 50"H
Seat: 16"H

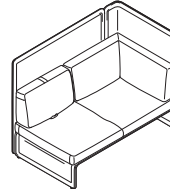

One articulating back and one corner cushion
Overall: 59³/₈"W x 34"D x 50"H
Seat: 16"H

Style Number Base Price

2-Seat Lounge with High-Back Screen and One Side Screen

COLAGLH22 \$4437

Fabric Upcharges

	Fabric Grades:								Leather Grades:		
	6	7	8	9	10	11	12	13	14	C	E
Articulating Back Pulls (if top and bottom contrasting pulls are selected)	+\$ 19	+\$ 23	+\$ 29	+\$ 49	+\$ 61	+\$ 75	+\$ 85	+\$ 103	+\$ 128	+\$184	+\$ 216
Seat Cushion	+\$ 99	+\$ 118	+\$ 151	+\$249	+\$ 313	+\$386	+\$ 438	+\$ 529	+\$ 655	+\$946	+\$1112
Back Cushion	+\$ 179	+\$214	+\$272	+\$450	+\$565	+\$698	+\$ 791	+\$ 955	+\$ 1184	+\$1711	+\$2011
Inside Screen	+\$188	+\$225	+\$287	+\$474	+\$594	+\$735	+\$ 833	+\$1005	+\$ 1247	N.A.	N.A.
Outside Screen	+\$244	+\$289	+\$368	+\$608	+\$764	+\$944	+\$1068	+\$ 1291	+\$1600	N.A.	N.A.

Tip: Articulating back pull fabric upcharges only apply when contrasting pulls are selected.

Three Articulating Backs: Arm: 0, Seat Deck: 2.7 yards, Inside Screen: 3.5 yards, Outside Screen: 3.9 yards, Seat Cushion: 2.6 yards, 57.2 sq ft, Back Cushion: 4.7 yards, 103.4 sq ft, Contrasting Pulls on Articulating Back Cushions: 0.5 yards, 2.2 sq ft
One Articulating Back and One Corner Cushion: Arm: 0, Seat Deck: 2.7 yards, Inside Screen: 3.5 yards, Outside Screen: 3.9 yards, Seat Cushion: 2.6 yards, 57.2 sq ft, Back Cushion: 4.7 yards, 103.4 sq ft, Contrasting Pulls on Articulating Back Cushion: 0.5 yards, 1.1 sq ft

► Specification Information, continued on next page

Lagunitas Lounge System 2-Seat Lounges

DESIGN TOAN NGUYEN

SIN 711.16

► Specification Information, continued from previous page

Specification Information

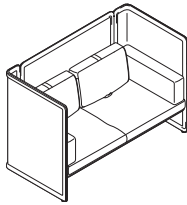

Two articulating backs
Overall: 67³/₄"W x 34"D x 50"H
Seat: 16"H

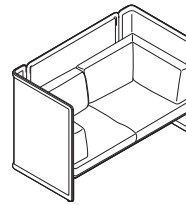

Two corner cushions
Overall: 67³/₄"W x 34"D x 50"H
Seat: 16"H

Style Number Base Price

2-Seat Lounge with High-Back Screen and Two Side Screens

COLAGLH23 \$5355

Fabric Upcharges

	Fabric Grades:										Leather Grades:	
	6	7	8	9	10	11	12	13	14	C	E	
Articulating Back Pulls (if top and bottom contrasting pulls are selected)	+\$ 19	+\$ 23	+\$ 29	+\$ 49	+\$ 61	+\$ 75	+\$ 85	+\$ 103	+\$ 128	+\$ 184	+\$ 216	
Seat Cushion	+\$111	+\$132	+\$168	+\$278	+\$349	+\$ 431	+\$ 488	+\$ 589	+\$ 731	+\$1056	+\$1240	
Back Cushion	+\$263	+\$314	+\$400	+\$661	+\$829	+\$1025	+\$1161	+\$1402	+\$1738	+\$2512	+\$2952	
Inside Screen	+\$235	+\$280	+\$356	+\$589	+\$739	+\$ 913	+\$1034	+\$1250	+\$1549	N.A.	N.A.	
Outside Screen	+\$304	+\$361	+\$460	+\$762	+\$956	+\$ 1181	+\$1338	+\$1616	+\$2003	N.A.	N.A.	

Tip: Articulating back pull fabric upcharges only apply when contrasting pulls are selected.

Two Articulating Backs: Arm: 0, Seat Deck: 1.6 yards, Inside Screen: 4.9 yards, Outside Screen: 5.6 yards, Seat Cushion: 2.9 yards, 63.8 sq ft, Back Cushion: 6.9 yards, 151.8 sq ft, Contrasting Pulls on Articulating Back Cushions: 0.5 yards, 2.2 sq ft

Two Corner Cushions: Arm: 0, Seat Deck: 1.6 yards, Inside Screen: 4.9 yards, Outside Screen: 5.6 yards, Seat Cushion: 2.9 yards, 63.8 sq ft, Back Cushion: 6.9 yards, 151.8 sq ft

Lagunitas Lounge System 3-Seat Lounges

DESIGN TOAN NGUYEN

SIN 711.16

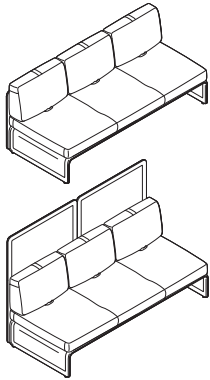

Standard Includes		Required to Specify
<ul style="list-style-type: none"> ▶ Need help? Product details, see <i>Coalesse Seating and Outdoor Specification Guide</i>. • Screen: grade 1 knit • Seat deck: grade 1 knit to match screen • Non-contrasting seat cushion, articulating back cushion and pulls, back corner cushion, and end arm cushions: fabric or leather • Bracket: paint • Eight adjustable glides • Ships assembled 	<ol style="list-style-type: none"> 1 Style number 2 Handedness (see below under Required Selections) 3 Knit color number for screen 4 Fabric or leather color number for non-contrasting seat cushion, articulating back cushion and pulls, back corner cushion, and end arm cushions, if selected 5 Paint color number for bracket: 4141 Platinum Matte 4710 Low Gloss Black 6 Options, if selected (see below) 	
		▶ See <i>Coalesse Surface Materials Reference Guide</i> .

Required Sections	Price	Required to Specify
Handedness		
• Left-hand, 3-seat lounges only (seated position)	No cost	Specify <i>left-hand configuration</i> .
• Right-hand, 3-seat lounges only (seated position)	No cost	Specify <i>right-hand configuration</i> .

Options	Price	Required to Specify
Surface Materials		
Fabric screen		
• 3-seat lounge with low-back screen	+\$230	Specify with screen type fabric.
• 3-seat lounge with low-back screen and one side screen	+\$306	Specify with screen type fabric.
• 3-seat lounge with low-back screen and two side screens	+\$383	Specify with screen type fabric.
• 3-seat lounge with high-back screen	+\$230	Specify with screen type fabric.
• 3-seat lounge with high-back screen and one side screen	+\$332	Specify with screen type fabric.
• 3-seat lounge with high-back screen and two side screens	+\$434	Specify with screen type fabric.
• Contrasting fabric for screen	+\$118	Specify <i>with contrasting fabric</i> and select fabric or leather color number.
• Contrasting fabric for cushion	+\$118	Specify <i>with contrasting fabric</i> and select fabric or leather color number.
• Contrasting fabric for top and bottom articulating back pulls	+\$118	Specify <i>with contrasting fabric</i> and select fabric or leather color number.
• Fabric upcharges	Prices at right	Specify fabric color number.
Knit screen		
• Grade 1 knit screen	No cost	Specify <i>with screen type knit</i> and select knit color number.
• Grade 2 knit screen		
– 3-seat lounge with low-back screen	+\$282	Specify <i>with screen type knit</i> and select knit color number.
– 3-seat lounge with low-back screen and one side screen	+\$436	Specify <i>with screen type knit</i> and select knit color number.
– 3-seat lounge with low-back screen and two side screens	+\$589	Specify <i>with screen type knit</i> and select knit color number.
– 3-seat lounge with high-back screen	+\$307	Specify <i>with screen type knit</i> and select knit color number.
– 3-seat lounge with high-back screen and one side screen	+\$487	Specify <i>with screen type knit</i> and select knit color number.
– 3-seat lounge with high-back screen and two side screens	+\$666	Specify <i>with screen type knit</i> and select knit color number.

Tip: If contrasting screen is selected, it is required to specify whether seat deck finish will match inner screen or outer screen.

Tip: Contrasting fabric for articulating back pulls upcharge is applied one time per style number.

Tip: When contrasting fabric for articulating back pulls is selected, only one contrasting fabric can be specified and will apply to all pulls.

▶ Options, continued on next page

Lagunitas Lounge System 3-Seat Lounges

DESIGN TOAN NGUYEN

SIN 711.16

► Options, continued from previous page

	Options	Price	Required to Specify
Surface Materials, continued	Acrylic backer		
	• 3-seat lounge with low-back screen	+\$ 71	Specify with acrylic backer.
	• 3-seat lounge with low-back screen and one side screen	+\$107	Specify with acrylic backer.
	• 3-seat lounge with low-back screen and two side screens	+\$ 144	Specify with acrylic backer.
	• 3-seat lounge with high-back screen	+\$123	Specify with acrylic backer.
	• 3-seat lounge with high-back screen and one side screen	+\$159	Specify with acrylic backer.
	• 3-seat lounge with high-back screen and two side screens	+\$196	Specify with acrylic backer. ► See Coalesse Surface Materials Reference Guide.
	• COM	+\$150	Specify with COM and select fabric color number. ► See Coalesse Surface Materials Reference Guide.
	• COL	+\$274	Specify with COL and select leather color number. ► See Coalesse Surface Materials Reference Guide
Power/USB Configuration	• One power module: two power in 4710 Low Gloss Black paint	+\$306	Specify with one power module, with two power.
	• One power module: one USB/one power in 4710 Low Gloss Black paint	+\$406	Specify with one power module, with one power/one USB.
	• Two power modules: two power each in 4710 Low Gloss Black paint	+\$612	Specify with two power modules, with two power.
	• Two power modules: one USB/one power each in 4710 Low Gloss Black paint	+\$812	Specify with two power modules, with one power/one USB.
Related Products	• Bench		► Page 150
	• Chaise		► Pages 142–146
	• Lagunitas tables		► See GSA Volume 5b Specification Guide.
	• Lounge booth connector screen and alignment connector		► Page 152

► Specification Information, on next page

Tip: For Customer's Own Material or Leather, see necessary requirements, important processing instructions and ordering information.
► See Coalesse Surface Materials Reference Guide.

Tip: For any portion of the product that requires a COM, the additional upcharge is a one time charge per product.

Tip: For any portion of the product that requires a COL, the additional upcharge is a one time charge per product.

Tip: For each USB port specified, there is one USB per port.

Lagunitas Lounge System 3-Seat Lounges *continued*

DESIGN TOAN NGUYEN

SIN 711.16

► Options, on previous page

Specification Information

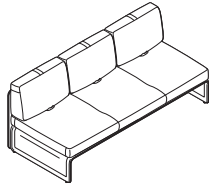

Three articulating backs
Overall: 76¾"W x 34"D x 32¾"H
Inside (Lounge): 76¾"W x 22½"D
Inside (Task): 76¾"W x 17¾"D
Seat: 16"H

Style Number Base Price

3-Seat Lounge with Low-Back Screen

COLAGLL31 \$3978

Fabric Upcharges

	Fabric Grades:										Leather Grades:	
	6	7	8	9	10	11	12	13	14	C	E	
Articulating Back Pulls (if top and bottom contrasting pulls are selected)	+\$ 19	+\$ 23	+\$ 29	+\$ 49	+\$ 61	+\$ 75	+\$ 85	+\$ 103	+\$ 128	+\$ 184	+\$ 216	
Seat Cushion	+\$137	+\$ 164	+\$208	+\$344	+\$433	+\$535	+\$ 606	+\$ 732	+\$ 907	+\$ 1311	+\$ 1541	
Back Cushion	+\$210	+\$250	+\$ 319	+\$527	+\$ 661	+\$ 817	+\$ 926	+\$ 1118	+\$1386	+\$2002	+\$2353	
Inside Screen	+\$200	+\$239	+\$305	+\$502	+\$630	+\$780	+\$ 883	+\$1067	+\$1323	N.A.	N.A.	
Outside Screen	+\$254	+\$303	+\$ 386	+\$638	+\$799	+\$989	+\$1119	+\$1352	+\$1676	N.A.	N.A.	

Tip: Articulating back pull fabric upcharges only apply when contrasting pulls are selected.

Three Articulating Backs: Seat Deck: 3.6 yards, Inside Screen: 3.2 yards, Outside Screen: 3.7 yards, Seat Cushion: 3.6 yards, 79.2 sq ft, Back Cushion: 5.5 yards, 121 sq ft, Contrasting Pulls on Articulating Back Cushions: 0.5 yards, 3.3 sq ft

► Specification Information, continued on next page

Lagunitas Lounge System 3-Seat Lounges

DESIGN TOAN NGUYEN

SIN 711.16

► Specification Information, continued from previous page

Specification Information

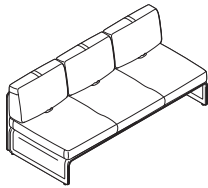

Three articulating backs
Overall: 85"W x 34"D x 32³/₈"H
Seat: 16"H

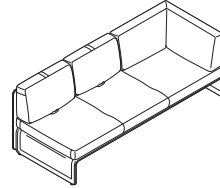

Two articulating backs and one corner cushion
Overall: 85"W x 34"D x 32³/₈"H
Seat: 16"H

Style Number Base Price

3-Seat Lounge with Low-Back Screen and One Side Screen

COLAGLL32 \$4539

Fabric Upcharges

	Fabric Grades:										Leather Grades:	
	6	7	8	9	10	11	12	13	14	C	E	
Articulating Back Pulls (if top and bottom contrasting pulls are selected)	+\$ 19	+\$ 23	+\$ 29	+\$ 49	+\$ 61	+\$ 75	+\$ 85	+\$ 103	+\$ 128	+\$ 184	+\$ 216	
Seat Cushion	+\$130	+\$155	+\$197	+\$326	+\$409	+\$ 505	+\$ 572	+\$ 691	+\$ 857	+\$1238	+\$1454	
Back Cushion	+\$248	+\$296	+\$376	+\$622	+\$781	+\$ 966	+\$1094	+\$1321	+\$ 1638	+\$2366	+\$2781	
Inside Screen	+\$243	+\$291	+\$371	+\$613	+\$768	+\$ 951	+\$1077	+\$1301	+\$ 1612	N.A.	N.A.	
Outside Screen	+\$313	+\$373	+\$474	+\$785	+\$987	+\$ 1219	+\$1380	+\$1667	+\$2066	N.A.	N.A.	

Tip: Articulating back pull fabric upcharges only apply when contrasting pulls are selected.

Three Articulating Backs: Arm: 0, Seat Deck: 2.3 yards, Inside Screen: 4.6 yards, Outside Screen: 5.4 yards, Seat Cushion: 3.4 yards, 74.8 sq ft, Back Cushion: 6.5 yards, 143 sq ft, Contrasting Pulls on Articulating Back Cushions: 0.5 yards, 3.3 sq ft

Two Articulating Backs and One Corner Cushion: Arm: 0, Seat Deck: 2.3 yards, Inside Screen: 4.6 yards, Outside Screen: 5.4 yards, Seat Cushion: 3.4 yards, 74.8 sq ft, Back Cushion: 6.5 yards, 143 sq ft, Contrasting Pulls on Articulating Back Cushions: 0.5 yards, 2.2 sq ft

► Specification Information, continued on next page

Lagunitas Lounge System 3-Seat Lounges *continued*

DESIGN TOAN NGUYEN

SIN 711.16

► Specification Information, continued from previous page

Specification Information

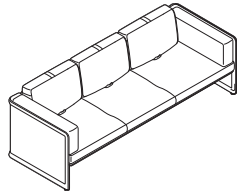

Three articulating backs
Overall: 93¼"W x 34"D x 32¾"H
Seat: 16"H

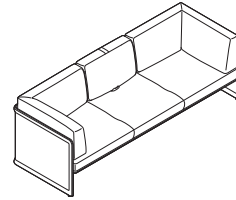

One articulating back and two corner cushions
Overall: 93¼"W x 34"D x 32¾"H
Seat: 16"H

Style Number Base Price

3-Seat Lounge with Low-Back Screen and Two Side Screens

COLAGLL33 \$5100

Fabric Upcharges

	Fabric Grades:										Leather Grades:	
	6	7	8	9	10	11	12	13	14	C	E	
Articulating Back Pulls (if top and bottom contrasting pulls are selected)	+\$ 19	+\$ 23	+\$ 29	+\$ 49	+\$ 61	+\$ 75	+\$ 85	+\$ 103	+\$ 128	+\$ 184	+\$ 216	
Seat Cushion	+\$137	+\$164	+\$208	+\$344	+\$ 433	+\$ 535	+\$ 606	+\$ 732	+\$ 907	+\$1311	+\$ 1541	
Back Cushion	+\$332	+\$396	+\$503	+\$833	+\$1046	+\$1293	+\$1464	+\$1768	+\$2192	+\$3167	+\$3722	
Inside Screen	+\$285	+\$339	+\$432	+\$713	+\$ 895	+\$1106	+\$1253	+\$1514	+\$1876	N.A.	N.A.	
Outside Screen	+\$366	+\$435	+\$554	+\$914	+\$1149	+\$1419	+\$1607	+\$1941	+\$2407	N.A.	N.A.	

Tip: Articulating back pull fabric upcharges only apply when contrasting pulls are selected.

Three Articulating Backs: Arm: 0, Seat Deck: 2 yards, Inside Screen: 6.1 yards, Outside Screen: 7.1 yards, Seat Cushion: 3.6 yards, 79.2 sq ft, Back Cushion: 8.7 yards, 191.4 sq ft, Contrasting Pulls on Articulating Back Cushions: 0.5 yards, 3.3 sq ft

One Articulating Back and Two Corner Cushions: Arm: 0, Seat Deck: 2 yards, Inside Screen: 6.1 yards, Outside Screen: 7.1 yards, Seat Cushion: 3.6 yards, 79.2 sq ft, Back Cushion: 8.7 yards, 191.4 sq ft, Contrasting Pulls on Articulating Back Cushion: 0.5 yards, 1.1 sq ft

► Specification Information, continued on next page

Lagunitas Lounge System 3-Seat Lounges

DESIGN TOAN NGUYEN

SIN 711.16

► Specification Information, continued from previous page

Specification Information

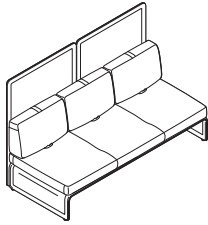

Three articulating backs
Overall: 76⁷/₈"W x 34"D x 50"H
Inside (Lounge): 76⁷/₈"W x 22¹/₂"D
Inside (Task): 76⁷/₈"W x 17³/₄"D
Seat: 16"H

Style Number Base Price

3-Seat Lounge with High-Back Screen

COLAGLH31 \$4794

Fabric Upcharges

	Fabric Grades:										Leather Grades:	
	6	7	8	9	10	11	12	13	14	C	E	
Articulating Back Pulls (if top and bottom contrasting pulls are selected)	+\$ 19	+\$ 23	+\$ 29	+\$ 49	+\$ 61	+\$ 75	+\$ 85	+\$ 103	+\$ 128	+\$ 184	+\$ 216	
Seat Cushion	+\$137	+\$164	+\$208	+\$344	+\$433	+\$535	+\$ 606	+\$ 732	+\$ 907	+\$ 1311	+\$ 1541	
Back Cushion	+\$210	+\$250	+\$319	+\$527	+\$661	+\$817	+\$ 926	+\$ 1118	+\$1386	+\$2002	+\$2353	
Inside Screen	+\$200	+\$239	+\$305	+\$502	+\$630	+\$780	+\$ 883	+\$1067	+\$1323	N.A.	N.A.	
Outside Screen	+\$254	+\$303	+\$386	+\$638	+\$799	+\$989	+\$1119	+\$1352	+\$1676	N.A.	N.A.	

Tip: Articulating back pull fabric upcharges only apply when contrasting pulls are selected.

Three Articulating Backs: Seat Deck: 3.6 yards, Inside Screen: 3.2 yards, Outside Screen: 3.7 yards, Seat Cushion: 3.6 yards, 79.2 sq ft, Back Cushion: 5.5 yards, 121 sq ft, Contrasting Pulls on Articulating Back Cushions: 0.5 yards, 3.3 sq ft

► Specification Information, continued on next page

Lagunitas Lounge System 3-Seat Lounges *continued*

DESIGN TOAN NGUYEN

SIN 711.16

► Specification Information, continued from previous page

Specification Information

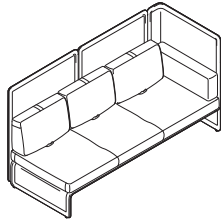

Three articulating backs
Overall: 85"W x 34½"D x 50"H
Seat: 16"H

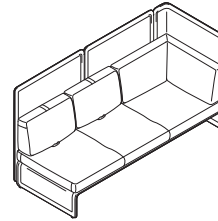

Two articulating backs with one corner cushion
Overall: 85"W x 34½"D x 50"H
Seat: 16"H

Style Number Base Price

3-Seat Lounge with High-Back Screen and One Side Screen

COLAGLH32 \$5712

Fabric Upcharges

	Fabric Grades:										Leather Grades:	
	6	7	8	9	10	11	12	13	14	C	E	
Articulating Back Pulls (if top and bottom contrasting pulls are selected)	+\$ 19	+\$ 23	+\$ 29	+\$ 49	+\$ 61	+\$ 75	+\$ 85	+\$ 103	+\$ 128	+\$ 184	+\$ 216	
Seat Cushion	+\$130	+\$155	+\$197	+\$326	+\$409	+\$505	+\$ 572	+\$ 691	+\$ 857	+\$1238	+\$1454	
Back Cushion	+\$248	+\$296	+\$376	+\$622	+\$781	+\$ 966	+\$1094	+\$1321	+\$ 1638	+\$2366	+\$2781	
Inside Screen	+\$243	+\$291	+\$371	+\$613	+\$768	+\$ 951	+\$1077	+\$1301	+\$ 1612	N.A.	N.A.	
Outside Screen	+\$313	+\$373	+\$474	+\$785	+\$987	+\$1219	+\$1380	+\$1667	+\$2066	N.A.	N.A.	

Tip: Articulating back pull fabric upcharges only apply when contrasting pulls are selected.

Three Articulating Backs: Arm: 0, Seat Deck: 2.3 yards, Inside Screen: 4.6 yards, Outside Screen: 5.4 yards, Seat Cushion: 3.4 yards, 74.8 sq ft, Back Cushion: 6.5 yards, 143 sq ft, Contrasting Pulls on Articulating Back Cushions: 0.5 yards, 3.3 sq ft
Two Articulating Backs with One Corner Cushion: Arm: 0, Seat Deck: 2.3 yards, Inside Screen: 4.6 yards, Outside Screen: 5.4 yards, Seat Cushion: 3.4 yards, 74.8 sq ft, Back Cushion: 6.5 yards, 143 sq ft, Contrasting Pulls on Articulating Back Cushions: 0.5 yards, 2.2 sq ft

► Specification Information, continued on next page

Lagunitas Lounge System 3-Seat Lounges

DESIGN TOAN NGUYEN

SIN 711.16

► Specification Information, continued from previous page

Specification Information

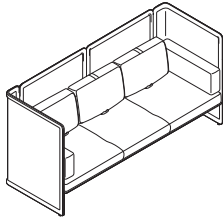

Three articulating backs
Overall: 93³/₈"W x 34"D x 50"H
Seat: 16"H

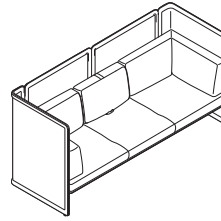

One articulating back and two corner cushions
Overall: 93³/₈"W x 34"D x 32³/₈"H
Seat: 16"H

Style Number Base Price

3-Seat Lounge with High-Back Screen and Two Side Screens

COLAGLH33 \$6630

Fabric Upcharges

	Fabric Grades:										Leather Grades:	
	6	7	8	9	10	11	12	13	14	C	E	
Articulating Back Pulls (if top and bottom contrasting pulls are selected)	+\$ 19	+\$ 23	+\$ 29	+\$ 49	+\$ 61	+\$ 75	+\$ 85	+\$ 103	+\$ 128	+\$ 184	+\$ 216	
Seat Cushion	+\$137	+\$164	+\$208	+\$344	+\$ 433	+\$ 535	+\$ 606	+\$ 732	+\$ 907	+\$1311	+\$ 1541	
Back Cushion	+\$332	+\$396	+\$503	+\$833	+\$1046	+\$1293	+\$1464	+\$1768	+\$2192	+\$3167	+\$3722	
Inside Screen	+\$285	+\$339	+\$432	+\$ 713	+\$ 895	+\$1106	+\$1253	+\$1514	+\$1876	N.A.	N.A.	
Outside Screen	+\$366	+\$435	+\$554	+\$ 914	+\$ 1149	+\$1419	+\$1607	+\$1941	+\$2407	N.A.	N.A.	

Tip: Articulating back pull fabric upcharges only apply when contrasting pulls are selected.

Three Articulating Backs: Arm: 0, Seat Deck: 2 yards, Inside Screen: 6.1 yards, Outside Screen: 7.1 yards, Seat Cushion: 3.6 yards, 79.2 sq ft, Back Cushion: 8.7 yards, 191.4 sq ft, Contrasting Pulls on Articulating Back Cushions: 0.5 yards, 3.3 sq ft

One Articulating Back and Two Corner Cushions: Arm: 0, Seat Deck: 2 yards, Inside Screen: 6.1 yards, Outside Screen: 7.1 yards, Seat Cushion: 3.6 yards, 79.2 sq ft, Back Cushion: 8.7 yards, 191.4 sq ft, Contrasting Pulls on Articulating Back Cushion: 0.5 yards, 1.1 sq ft

Lagunitas Lounge System 2-Seat Chaises

DESIGN TOAN NGUYEN

SIN 711.16

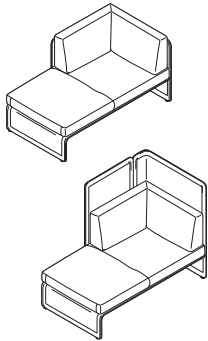

► Need help?
Product details, see *Coalesse Seating and Outdoor Specification Guide*

Standard Includes

- Screen: grade 1 knit
- Seat deck: grade 1 knit to match screen
- Non-contrasting seat cushion, articulating back cushion and pulls, back corner cushion, and end arm cushion, if selected: fabric or leather
- Bracket: paint
- Six adjustable glides
- Ships assembled

Required to Specify

- 1 Style number
 - 2 Handedness (see below under Required Selections)
 - 3 Knit color number for screen
 - 4 Fabric or leather color number for non-contrasting seat cushion, articulating back cushion and pull, back corner cushion, and end arm cushion, if selected
 - 5 Paint color number for bracket:
4141 Platinum Matte
4710 Low Gloss Black
 - 6 Options, if selected (see below)
- See *Surface Materials*, page 260

	Required Selections	Price	Required to Specify
Handedness	• Left-hand, 2-seat chaises only (seated position)	No cost	Specify with <i>left-hand configuration</i> .
	• Right-hand, 2-seat chaises only (seated position)	No cost	Specify with <i>right-hand configuration</i> .

	Options	Price	Required to Specify
Surface Materials	Fabric screen		
	• 2-seat chaise with one low-back screen and one right- or one left-hand screen	+\$230	Specify with <i>screen type fabric</i> .
	• 2-seat chaise with one high-back screen and one right- or one left-hand screen	+\$281	Specify with <i>screen type fabric</i> .
	• Contrasting fabric for screen	+\$118	Specify with <i>contrasting fabric</i> and select fabric or leather color number.
	• Contrasting fabric for cushion	+\$118	Specify with <i>contrasting fabric</i> and select fabric or leather color number.
	• Contrasting fabric for articulating back pulls	+\$118	Specify with <i>contrasting fabric</i> and select fabric or leather color number. ► See <i>Surface Materials</i> , page 260
	• Fabric upcharges	Prices at right	Specify fabric color number.
	Knit screen		
	• Grade 1 knit screen	No cost	Specify with <i>screen type knit</i> and select knit color number.
	• Grade 2 knit screen		
– 2-seat chaise with one low-back screen and one right- or one left-hand screen	+\$230	Specify with <i>screen type knit</i> and select knit color number.	
– 2-seat chaise with one high-back screen and one right- or one left-hand screen	+\$281	Specify with <i>screen type knit</i> and select knit color number.	
Acrylic backer			
• 2-seat chaise with one low-back screen and one right- or one left-hand screen	+\$ 68	Specify with acrylic backer.	
• 2-seat chaise with one high-back screen and one right- or one left-hand screen	+\$101	Specify with acrylic backer. ► See <i>Surface Materials</i> , page 260	
• COM	+\$150	Specify with COM and select fabric color number. ► See <i>Surface Materials</i> , page 262	
• COL	+\$274	Specify with COL and select leather color number. ► See <i>Surface Materials</i> , page 262	

► Options, continued on next page

Tip: If contrasting screen is selected, it is required to specify whether seat deck finish will match inner screen or outer screen.

Tip: Contrasting fabric for articulating back pull upcharge is applied one time per style number.

*Tip: For Customer's Own Material or Leather, see necessary requirements, important processing instructions and ordering information.
► See *Coalesse Surface Materials Reference Guide*.*

Tip: For any portion of the product that requires a COM, the additional upcharge is a one time charge per product.

Tip: For any portion of the product that requires a COL, the additional upcharge is a one time charge per product.

Tip: Must combine seat deck and list screen pricing choice (knit grade 1, knit grade 2, or fabric) from either non-contrasting or contrasting pricing list with seat and back cushion list pricing (fabric and leather) from either non-contrasting or contrasting pricing list to obtain completed list price.

Lagunitas Lounge System 2-Seat Chaises

DESIGN TOAN NGUYEN

SIN 711.16

Tip: For each USB port specified, there is one USB per port.

► Options, continued from previous page

Options	Price	Required to Specify
Power/USB Configuration	<ul style="list-style-type: none"> One power module: two power in 4710 Black paint +\$306 One power module: one USB/one power in 4710 Black paint +\$406 Two power modules: two power each in 4710 Black paint +\$612 Two power modules: one USB/one power each in 4710 Black paint +\$812 	<p>Specify with one power module, with two power.</p> <p>Specify with one power module, with one power/one USB.</p> <p>Specify with two power modules, with two power.</p> <p>Specify with two power modules, with one power/one USB.</p>

Related Products	<ul style="list-style-type: none"> Lagunitas tables Lounge Bench 	<ul style="list-style-type: none"> ► See GSA Volume 5b Specification Guide. ► Pages 124-134 ► Page 150
-------------------------	---	---

Specification Information

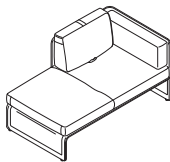

One articulating back
Overall: 59³/₈"W x 34"D x 32³/₈"H
Seat: 16"H

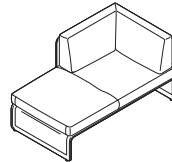

One corner cushion
Overall: 59³/₈"W x 34"D x 32³/₈"H
Seat: 16"H

Style Number	Base Price
--------------	------------

2-Seat Chaise with Low-Back Screen and One Side Screen

COLAGCL2 \$2907

Fabric Upcharges

	Fabric Grades:										Leather Grades:	
	6	7	8	9	10	11	12	13	14	C	E	
Articulating Back Pulls (if contrasting pull selected)	+\$ 19	+\$ 23	+\$ 29	+\$ 49	+\$ 61	+\$ 75	+\$ 85	+\$ 103	+\$ 128	+\$ 184	+\$ 216	
Seat Cushion	+\$114	+\$136	+\$ 172	+\$286	+\$359	+\$444	+\$502	+\$ 607	+\$ 752	+\$1086	+\$1277	
Back Cushion	+\$ 111	+\$132	+\$168	+\$278	+\$349	+\$431	+\$488	+\$ 589	+\$ 731	+\$1056	+\$1240	
Inside Screen	+\$159	+\$189	+\$241	+\$397	+\$499	+\$616	+\$698	+\$ 842	+\$1046	N.A.	N.A.	
Outside Screen	+\$213	+\$253	+\$322	+\$532	+\$668	+\$825	+\$934	+\$1128	+\$1399	N.A.	N.A.	

One Articulating Back: Arm: 0, Seat Deck: 2.7 yards, Inside Screen: 2.7 yards, Outside Screen: 3.2 yards, Seat Cushion: 3 yards, 66 sq ft, Back Cushion: 2.9 yards, 63.8 sq ft

One Corner Cushion: Arm: 0, Seat Deck: 2.7 yards, Inside Screen: 2.7 yards, Outside Screen: 3.2 yards, Seat Cushion: 3 yards, 66 sq ft, Back Cushion: 2.9 yards, 63.8 sq ft

► Specification Information, continued on next page

Tip: Handedness is determined while in the seated position. Illustration above shows left-hand chaise.

Tip: Articulating back pull fabric upcharges only apply when contrasting pull is selected.

Lagunitas Lounge System 2-Seat Chaises *continued*

DESIGN TOAN NGUYEN

SIN 711.16

► Specification Information, continued from previous page

Specification Information

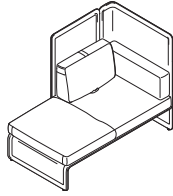

One articulating back
Overall: 59³/₈"W x 34"D x 50"H
Seat: 16"H

Tip: Handedness is determined while in the seated position. Illustration above shows left-hand chaise.

Style Number	Base Price
--------------	------------

2-Seat Chaise with High-Back Screen and One Side Screen

COLAGCH2	\$3750
----------	--------

Fabric Upcharges

	Fabric Grades:										Leather Grades:	
	6	7	8	9	10	11	12	13	14	C	E	
Articulating Back Pulls (if contrasting pull selected)	+\$ 19	+\$ 23	+\$ 29	+\$ 49	+\$ 61	+\$ 75	+\$ 85	+\$ 103	+\$ 128	+\$ 184	+\$ 216	
Seat Cushion	+\$114	+\$136	+\$172	+\$286	+\$359	+\$444	+\$502	+\$ 607	+\$ 752	+\$1086	+\$1277	
Back Cushion	+\$ 111	+\$132	+\$168	+\$278	+\$349	+\$431	+\$488	+\$ 589	+\$ 731	+\$1056	+\$1240	
Inside Screen	+\$159	+\$189	+\$241	+\$397	+\$499	+\$616	+\$698	+\$ 842	+\$1046	N.A.	N.A.	
Outside Screen	+\$213	+\$253	+\$322	+\$532	+\$668	+\$825	+\$934	+\$1128	+\$1399	N.A.	N.A.	

Tip: Articulating back pull fabric upcharges only apply when contrasting pull is selected.

One Articulating Back: Arm: 0, Seat Deck: 2.7 yards, Inside Screen: 2.7 yards, Outside Screen: 3.2 yards, Seat Cushion: 3 yards, 66 sq ft, Back Cushion: 2.9 yards, 63.8 sq ft

One Corner Cushion: Arm: 0, Seat Deck: 2.7 yards, Inside Screen: 2.7 yards, Outside Screen: 3.2 yards, Seat Cushion: 3 yards, 66 sq ft, Back Cushion: 2.9 yards, 63.8 sq ft

Coalesse

Lagunitas Lounge System 2-Seat Chaises

DESIGN TOAN NGUYEN

SIN 711.16

Lagunitas Lounge System 3-Seat Chaises

DESIGN TOAN NGUYEN

SIN 711.16

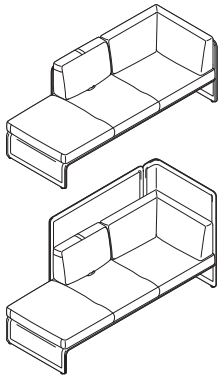

► Need help?
Product details, see *Coalesse Seating and Outdoor Specification Guide*

Standard Includes

- Screen: grade 1 knit
- Seat deck: grade 1 knit to match screen
- Non-contrasting seat cushion, articulating back cushion and pulls, back corner cushion, and end arm cushion, if selected: fabric or leather
- Bracket: paint
- Six adjustable glides
- Ships assembled

Required to Specify

- 1 Style number
 - 2 Handedness (see below under Required Selections)
 - 3 Knit color number for screen
 - 4 Fabric or leather color number for non-contrasting seat cushion, articulating back cushion and pull, back corner cushion, and end arm cushion, if selected
 - 5 Paint color number for bracket:
4141 Platinum Matte
4710 Low Gloss Black
 - 6 Options, if selected (see below)
- See *Surface Materials*, page 260

	Required Selections	Price	Required to Specify
Handedness	• Left-hand, 3-seat chaises only (seated position)	No cost	Specify with <i>left-hand configuration</i> .
	• Right-hand, 3-seat chaises only (seated position)	No cost	Specify with <i>right-hand configuration</i> .

	Options	Price	Required to Specify
Surface Materials	Fabric screen		
	• 3-seat chaise with one low-back screen and one right- or one left-hand screen	+\$306	Specify with <i>screen type fabric</i> .
	• 3-seat chaise with one high-back screen and one right- or one left-hand screen	+\$332	Specify with <i>screen type fabric</i> .
	• Contrasting fabric for screen	+\$118	Specify with <i>contrasting fabric</i> and select fabric or leather color number.
	• Contrasting fabric for cushion	+\$118	Specify with <i>contrasting fabric</i> and select fabric or leather color number.
	• Contrasting fabric for articulating back pulls	+\$118	Specify with <i>contrasting fabric</i> and select fabric or leather color number. ► See <i>Surface Materials</i> , page 260
	• Fabric upcharges	Prices at right	Specify fabric color number.
	Knit screen		
	• Grade 1 knit screen	No cost	Specify with <i>screen type knit</i> and select knit color number.
	• Grade 2 knit screen		
– 3-seat chaise with one low-back screen and one right- or one left-hand screen	+\$436	Specify with <i>screen type knit</i> and select knit color number.	
– 3-seat chaise with one high-back screen and one right- or one left-hand screen	+\$487	Specify with <i>screen type knit</i> and select knit color number.	
Acrylic backer			
• 3-seat chaise with one low-back screen and one right- or one left-hand screen	+\$ 89	Specify with acrylic backer.	
• 3-seat chaise with one high-back screen and one right- or one left-hand screen	+\$141	Specify with acrylic backer. ► See <i>Surface Materials</i> , page 260	
• COM	+\$150	Specify with COM and select fabric color number. ► See <i>Surface Materials</i> , page 262	
• COL	+\$274	Specify with COL and select leather color number. ► See <i>Surface Materials</i> , page 262	

► Options, continued on next page

Tip: If contrasting screen is selected, it is required to specify whether seat deck finish will match inner screen or outer screen.

Tip: Contrasting fabric for articulating back pull upcharge is applied one time per style number.

Tip: For Customer's Own Material or Leather, see necessary requirements, important processing instructions and ordering information.
► See *Coalesse Surface Materials Reference Guide*.

Tip: For any portion of the product that requires a COM, the additional upcharge is a one time charge per product.

Tip: For any portion of the product that requires a COL, the additional upcharge is a one time charge per product.

Tip: Must combine seat deck and list screen pricing choice (knit grade 1, knit grade 2, or fabric) from either non-contrasting or contrasting pricing list with seat and back cushion list pricing (fabric and leather) from either non-contrasting or contrasting pricing list to obtain completed list price.

Lagunitas Lounge System 3-Seat Chaises

DESIGN TOAN NGUYEN

SIN 711.16

► Options, continued from previous page

Tip: For each USB port specified, there is one USB per port.

Options	Price	Required to Specify
Power/USB Configuration	<ul style="list-style-type: none"> One power module: two power in 4710 Black paint +\$306 One power module: one USB/one power in 4710 Black paint +\$406 Two power modules: two power each in 4710 Black paint +\$612 Two power modules: one USB/one power each in 4710 Black paint +\$812 	<p>Specify with one power module, with two power.</p> <p>Specify with one power module, with one power/one USB.</p> <p>Specify with two power modules, with two power.</p> <p>Specify with two power modules, with one power/one USB.</p>

Related Products	<ul style="list-style-type: none"> Lagunitas tables Lounge Bench 	<ul style="list-style-type: none"> ► See GSA Volume 5b Specification Guide. ► Pages 124-134 ► Page 150
-------------------------	---	---

Specification Information

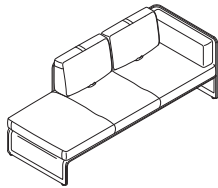

Two articulating backs
Overall: 85"W x 34"D x 32³/₈"H
Seat: 16"H

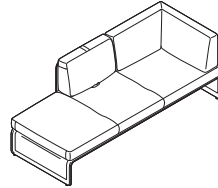

One articulating back and one corner cushion
Overall: 85"W x 34"D x 32³/₈"H
Seat: 16"H

Style Number	Base Price
--------------	------------

3-Seat Chaise with Low-Back Screen and One Side Screen

COLAGCL3	\$3825
-----------------	--------

Fabric Upcharges

	Fabric Grades:										Leather Grades:	
	6	7	8	9	10	11	12	13	14	C	E	
Articulating Back Pulls (if contrasting pull selected)	+\$ 19	+\$ 23	+\$ 29	+\$ 49	+\$ 61	+\$ 75	+\$ 85	+\$ 103	+\$ 128	+\$ 184	+\$ 216	
Seat Cushion	+\$156	+\$ 186	+\$237	+\$ 391	+\$ 491	+\$606	+\$686	+\$ 829	+\$1028	+\$1485	+\$1745	
Back Cushion	+\$179	+\$ 214	+\$272	+\$450	+\$565	+\$698	+\$ 791	+\$ 955	+\$ 1184	+\$1711	+\$2011	
Inside Screen	+\$201	+\$ 241	+\$307	+\$507	+\$636	+\$787	+\$892	+\$1077	+\$1335	N.A.	N.A.	
Outside Screen	+\$257	+\$305	+\$388	+\$ 641	+\$806	+\$996	+\$1127	+\$1362	+\$1688	N.A.	N.A.	

Two Articulating Backs: Arm: 0, Seat Deck: 3.7 yards, Inside Screen: 3.5 yards, Outside Screen: 3.9 yards, Seat Cushion: 4.1 yards, 90.2 sq ft, Back Cushion: 4.7 yards, 103.4 sq ft

One Articulating Back and One Corner Cushion: Arm: 0, Seat Deck: 3.7 yards, Inside Screen: 3.5 yards, Outside Screen: 3.9 yards, Seat Cushion: 4.1 yards, 90.2 sq ft, Back Cushion: 4.7 yards, 103.4 sq ft

► Specification Information, continued on next page

Tip: Handedness is determined while in the seated position. Illustration above shows left-hand chaise.

Tip: Articulating back pull fabric upcharges only apply when contrasting pull is selected.

Lagunitas Lounge System 3-Seat Chaises *continued*

DESIGN TOAN NGUYEN

SIN 711.16

► Specification Information, continued from previous page

Specification Information

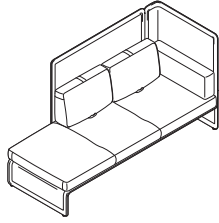

Two articulating backs
Overall: 85"W x 34"D x 50"H
Seat: 16"H

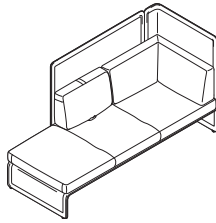

One articulating back and one corner cushion
Overall: 85"W x 34"D x 50"H
Seat: 16"H

Tip: Handedness is determined while in the seated position. Illustration above shows left-hand chaise.

Style Number	Base Price
--------------	------------

3-Seat Chaise with High-Back Screen and One Side Screen

COLAGCH3	\$4488
----------	--------

Fabric Upcharges

	Fabric Grades:								Leather Grades:		
	6	7	8	9	10	11	12	13	14	C	E
Articulating Back Pulls (if contrasting pull selected)	+\$ 19	+\$ 23	+\$ 29	+\$ 49	+\$ 61	+\$ 75	+\$ 85	+\$ 103	+\$ 128	+\$ 184	+\$ 216
Seat Cushion	+\$156	+\$186	+\$237	+\$391	+\$491	+\$606	+\$ 686	+\$ 829	+\$1028	+\$1485	+\$1745
Back Cushion	+\$179	+\$214	+\$272	+\$450	+\$565	+\$698	+\$ 791	+\$ 955	+\$1184	+\$1711	+\$2011
Inside Screen	+\$201	+\$241	+\$307	+\$507	+\$636	+\$787	+\$ 892	+\$1077	+\$1335	N.A.	N.A.
Outside Screen	+\$257	+\$305	+\$388	+\$641	+\$806	+\$996	+\$1127	+\$1362	+\$1688	N.A.	N.A.

Tip: Articulating back pull fabric upcharges only apply when contrasting pull is selected.

Two Articulating Backs: Arm: 0, Seat Deck: 3.7 yards, Inside Screen: 3.5 yards, Outside Screen: 3.9 yards, Seat Cushion: 4.1 yards, 90.2 sq ft, Back Cushion: 4.7 yards, 103.4 sq ft

One Articulating Back and One Corner Cushion: Arm: 0, Seat Deck: 3.7 yards, Inside Screen: 3.5 yards, Outside Screen: 3.9 yards, Seat Cushion: 4.1 yards, 90.2 sq ft, Back Cushion: 4.7 yards, 103.4 sq ft

Coalesse

Lagunitas Lounge System 3-Seat Chaises

DESIGN TOAN NGUYEN

SIN 711.16

Lagunitas Lounge System Benches

DESIGN TOAN NGUYEN

SIN 711.16

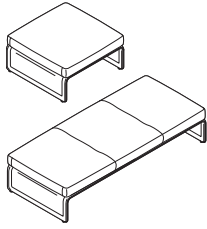

Standard Includes		Required to Specify
<ul style="list-style-type: none"> ▶ Need help? Product details, see <i>Coalesse Seating and Outdoor Specification Guide</i> 	<ul style="list-style-type: none"> • Seat deck: grade 1 knit • Seat cushion: fabric or leather • Four adjustable glides • Ships assembled 	<ol style="list-style-type: none"> 1 Style number 2 Knit or fabric color number for seat deck 3 Fabric or leather color number for seat cushion 4 Options, if selected (see below) <ul style="list-style-type: none"> ▶ See <i>Surface Materials</i>, page 260

Options	Price	Required to Specify
Surface Materials <ul style="list-style-type: none"> • Acrylic backer <ul style="list-style-type: none"> • 1-seat bench cushion +\$ 16 • 2-seat bench cushion +\$ 21 • 3-seat bench cushion +\$ 27 		Specify with acrylic backer. Specify with acrylic backer. Specify with acrylic backer. ▶ See <i>Surface Materials</i> , page 260
<ul style="list-style-type: none"> • Fabric seat deck 	Prices at right	Specify with fabric seat deck and select fabric color number.
Knit seat deck <ul style="list-style-type: none"> • Grade 1 knit seat deck 	No cost	Specify with screen type knit and select fabric color number.
<ul style="list-style-type: none"> • Grade 2 knit seat deck <ul style="list-style-type: none"> - 1-seat bench +\$ 77 - 2-seat bench +\$103 - 3-seat bench +\$128 		Specify with screen type knit and select fabric color number. Specify with screen type knit and select fabric color number. Specify with screen type knit and select fabric color number.
<ul style="list-style-type: none"> • COM 	+\$150	Specify with COM and select fabric color number. ▶ See <i>Surface Materials</i> , page 262
<ul style="list-style-type: none"> • COL 	+\$274	Specify with COL and select leather color number. ▶ See <i>Surface Materials</i> , page 262

Tip: For Customer's Own Material or Leather, see necessary requirements, important processing instructions and ordering information.
 ▶ See *Coalesse Surface Materials Reference Guide*.

Tip: For any portion of the product that requires a COM, the additional upcharge is a one time charge per product.

Tip: For any portion of the product that requires a COL, the additional upcharge is a one time charge per product.

Tip: Must combine seat deck and list screen pricing choice (knit grade 1, knit grade 2, or fabric) from either non-contrasting or contrasting pricing list with seat and back cushion list pricing (fabric and leather) from either non-contrasting or contrasting pricing list to obtain completed list price.

Power/USB Configuration	1-seat benches <ul style="list-style-type: none"> • One power module: two power in 4710 Black paint +\$306 • One power module: one USB/one power in 4710 Black paint +\$406 	Specify with one power module, with two power. Specify with one power module, with one power/one USB.
	2- and 3-seat benches <ul style="list-style-type: none"> • Two power modules: two power each in 4710 Black paint +\$612 • Two power modules: one USB/one power each in 4710 Black paint +\$812 	Specify with two power modules, with two power. Specify with two power modules, with one power/one USB.
Related Products	<ul style="list-style-type: none"> • Lagunitas tables • Lounge • Bench 	<ul style="list-style-type: none"> ▶ See <i>GSA Volume 5b Specification Guide</i>. ▶ Pages 124-134 ▶ Pages 142-146

Lagunitas Lounge System Benches

DESIGN TOAN NGUYEN

SIN 711.16

Specification Information

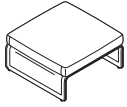

Overall: 32¾"W x 32¾"D x 16"H
Seat Deck: 2.8 yards
Seat Cushion: 2.6 yards, 57.2 sq ft

Style Number **Base Price**

1-Seat Bench

COLAGB1 \$1020

Fabric Upcharges

	Fabric Grades:									Leather Grades:	
	6	7	8	9	10	11	12	13	14	C	E
Seat Deck	+\$251	+\$279	+\$328	+\$475	+\$570	+\$681	+\$758	+\$ 894	+\$1085	N.A.	N.A.
Seat Cushion	+\$ 99	+\$118	+\$151	+\$249	+\$313	+\$386	+\$438	+\$ 529	+\$ 655	+\$ 946	+\$1112

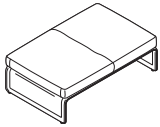

Overall: 51¼"W x 32¾"D x 16"H
Seat Deck: 3.1 yards
Seat Cushion: 3.2 yards, 70.4 sq ft

2-Seat Bench

COLAGB2 \$1429

Fabric Upcharges

	Fabric Grades:									Leather Grades:	
	6	7	8	9	10	11	12	13	14	C	E
Seat Deck	+\$261	+\$292	+\$344	+\$503	+\$606	+\$725	+\$807	+\$ 955	+\$1159	N.A.	N.A.
Seat Cushion	+\$122	+\$146	+\$186	+\$306	+\$384	+\$476	+\$538	+\$ 651	+\$ 807	+\$1164	+\$1369

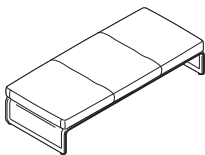

Overall: 76⅞"W x 32¾"D x 16"
Seat Deck: 3.5 yards
Seat Cushion: 4 yards, 88 sq ft

3-Seat Bench

COLAGB3 \$1836

Fabric Upcharges

	Fabric Grades:									Leather Grades:	
	6	7	8	9	10	11	12	13	14	C	E
Seat Deck	+\$277	+\$311	+\$369	+\$543	+\$654	+\$786	+\$876	+\$1037	+\$1261	N.A.	N.A.
Seat Cushion	+\$153	+\$182	+\$232	+\$383	+\$481	+\$595	+\$673	+\$ 813	+\$1009	+\$1457	+\$1712

Lagunitas Lounge System Accessories

DESIGN TOAN NGUYEN

SIN 711.16

Lounge Booth Connector Screen



Screen: 38½"W x 50"H

Tip: Lounge booth connector screen joins two high screen lounges, enclosing one side of booth.

Standard Includes	Required to Specify
<ul style="list-style-type: none"> ▶ Need help? Product details, see <i>Coalesse Seating and Outdoor Specification Guide</i> • Screen: grade 1 knit • Two bottom brackets: 4710 Low Gloss Black or 4141 Platinum Matte Paint • Two screen ganging alignment clips 	<ul style="list-style-type: none"> 1 Style number 2 Knit color number for screen 3 Paint color number for bracket 4 Options, if selected (see below) ▶ See <i>Surface Materials</i>, page 260

Options	Price	Required to Specify
Surface Materials	Knit screen	
• Grade 1 knit screen	No cost	Specify with <i>screen type knit</i> and select knit color number.
• Grade 2 knit screen	+\$ 85	Specify with <i>screen type knit</i> and select knit color number.
• Fabric screen	+\$220	Specify with <i>screen type fabric</i> .
• Contrasting fabric	+\$118	Specify with <i>contrasting fabric</i> and select fabric color number.
• Fabric upcharges	Prices below	Specify fabric color number.
• COM	+\$150	Specify with <i>COM</i> and select fabric color number. ▶ See <i>Coalesse Surface Materials Reference Guide</i>

Specification Information

Style Number	Base Price
COLAGLBS	\$695

	Fabric Grades:								
	6	7	8	9	10	11	12	13	14
Inside Screen	+\$102	+\$123	+\$156	+\$258	+\$324	+\$401	+\$455	+\$549	+\$680
Outside Screen	+\$149	+\$177	+\$227	+\$374	+\$470	+\$579	+\$657	+\$794	+\$983

Booth Connector Screen: Inside Screen: 1.4 yards, Outside Screen: 1.6 yards

Lagunitas Lounge System Accessories

DESIGN TOAN NGUYEN

SIN 711.16

Alignment Connector

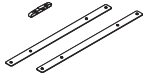

	Standard Includes	Required to Specify
▶ Need help? Product details, see <i>Coalesse Seating and Outdoor Specification Guide</i>	<ul style="list-style-type: none">• Screen and seat deck connector package: pin, bracket, and hardware• Ships ready to assemble	Style number

Related Products	
<ul style="list-style-type: none">• Lounge• Chaise	<ul style="list-style-type: none">▶ Pages 142▶ Pages 142

Specification Information	
Style Number	Price
COLAGCI	\$41

Lounge Seating

Lagunitas Focus Nook

SIN 711.16

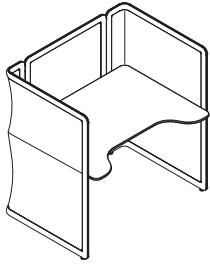

Tip: If a contrasting screen is specified, the fabric must be chosen from the same fabric family.

Tip: Grommets and power devices are specifiable on either the right or left side.

Tip: Power package must be specified when power and lighting grommet is specified.

Tip: Power simplex receptacles are tamper resistant.

Tip: When power module or power package in 4242 Milk Matte is specified, the 8' infeed cord will be white. When any other finish is specified, the infeed cord will be black.

Tip: Power/USB configuration upcharges are in addition to the power module or power package upcharge.

Standard Includes	Required to Specify
<ul style="list-style-type: none"> Need help? Product details, see <i>Coalesse Seating and Outdoor Specification Guide</i> Screen: grade 1 knit Worksurface: <ul style="list-style-type: none"> Grade 1 laminate with 3 mm flat plastic edge Brackets: 4710 Black Low Gloss Black paint Six adjustable glides Ships ready to assemble 	<ol style="list-style-type: none"> Style number Knit color number for screen Laminate color number for table top Plastic edge color number for laminate top, if selected Options, if selected (see below) <p>▶ See <i>Surface Materials</i>, page 260.</p>

Options	Price	Required to Specify
Surface Materials <ul style="list-style-type: none"> Fabric screen <ul style="list-style-type: none"> Fabric screen +\$408 Contrasting fabric for screen +\$ 118 Fabric upcharges <ul style="list-style-type: none"> Prices at right 		Specify with screen type fabric. Specify with contrasting fabric and select fabric color number. Specify fabric color number.
Knit screen <ul style="list-style-type: none"> Grade 1 knit screen <ul style="list-style-type: none"> No cost Grade 2 knit screen <ul style="list-style-type: none"> +\$461 		Specify with screen type knit and select knit color number. Specify with screen type knit and select knit color number.
<ul style="list-style-type: none"> COM <ul style="list-style-type: none"> +\$150 		Specify with COM and select fabric color number. ▶ See <i>Surface Materials</i> , page 260.
Worksurface <ul style="list-style-type: none"> Grade 2 laminate <ul style="list-style-type: none"> Prices at right Grade 1 wood veneer <ul style="list-style-type: none"> Prices at right Grade 2 wood veneer <ul style="list-style-type: none"> Prices at right Stain-to-Match <ul style="list-style-type: none"> No cost 		Specify with Grade 2 laminate and select laminate color number. Specify with Grade 1 wood veneer and select wood color number. Specify with Grade 2 wood veneer and select wood color number. Specify with Stain-to-Match. ▶ See <i>Surface Materials</i> , page 260.
2" Light Grommet <ul style="list-style-type: none"> 2" light grommet <ul style="list-style-type: none"> +\$ 25 		Specify with 2" grommet and select color number.
Power/USB Configuration <ul style="list-style-type: none"> Power options (with three magnetic wire management brackets) <ul style="list-style-type: none"> Power module <ul style="list-style-type: none"> +\$255 Power package (contains power module and below surface convenience plug for on-surface light) <ul style="list-style-type: none"> +\$443 		Specify with power module and select color number. Specify with power package and select color number.
Power/USB configurations <ul style="list-style-type: none"> Two TR simplex receptacles <ul style="list-style-type: none"> No cost One TR simplex receptacle and two USB A charging ports <ul style="list-style-type: none"> +\$100 One TR simplex receptacle, one USB A charging port, and one USB C charging port <ul style="list-style-type: none"> +\$100 		Specify with two power. Specify with one power, two USB A. Specify with one power, one USB A, one USB C.
Cable Management Tray <ul style="list-style-type: none"> Cable management tray <ul style="list-style-type: none"> +\$135 		Specify with tray and select color number.
Related Products <ul style="list-style-type: none"> Lagunitas lounge seating Lagunitas work and occasional tables 		▶ Page 124 ▶ See <i>GSA Volume 5b Specification Guide</i> .

Lagunitas Focus Nook

SIN 711.16

Specification Information

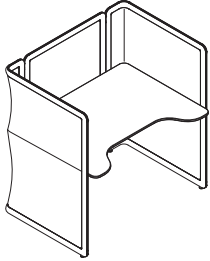

Knit Screen

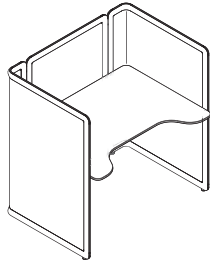

Fabric Screen

Style Number	Dimensions W D H			Base Prices			
				Flat Vinyl Edge on Laminate Top		Flat Wood Edge on Wood Top	
	Grade 1	Grade 2	Grade 1	Grade 2			
COLAGFN	49 1/4"	37"	50"	\$2870	\$3008	\$3937	\$4179

Fabric Upcharges

	Fabric Grades:								
	6	7	8	9	10	11	12	13	14
Inside Screen	+\$204	+\$243	+\$ 310	+\$512	+\$643	+\$ 795	+\$ 900	+\$1088	+\$ 1348
Outside Screen	+\$270	+\$321	+\$409	+\$675	+\$848	+\$1047	+\$1186	+\$1433	+\$1776

Inside screen: 4.4 yds, Outside screen: 5.1 yds

Lounge Seating

Passerelle Lounge

DESIGN STUDIO B

SIN 711.16

Tip: Fabrics and leathers will appear loose with comfort wrinkles when upholstered.

Tip: Recommended leathers are Elmosoft Grade C and Elmorustical Grade E.

Tip: Special color match, consult Customer Service.

Tip: For Customer's Own Material or Leather, see necessary requirements, important processing instructions, and ordering information
 ▶ See *Coalesse Surface Materials Reference Guide*.

Standard Includes		Required to Specify	
▶ Need help? Product details, see <i>Coalesse Seating and Outdoor Specification Guide</i>	<ul style="list-style-type: none"> • Frame: unibody construction with finger jointed plywood • Upholstery: multiple densities of polyurethane foam and polyester fiber on seat, back, and arms • Legs: solid maple with non-adjustable glides 	<ol style="list-style-type: none"> 1 Style number 2 Number of fabrics if contrasting fabric style number is selected 3 Fabric or leather color number for upholstery on seat, back, and arms 4 Wood color number for legs 5 Options, if selected (see below) ▶ See <i>Surface Materials</i> , page 260	
Options		Price	Required to Specify
Surface Materials	<ul style="list-style-type: none"> • Contrasting fabric 	+\$118 per fabric	Add suffix K to the style number and select fabric color number.
	Acrylic backer		
	<ul style="list-style-type: none"> • Lounge chair • 2-seat lounge • 3-seat lounge • Arm bolster 	+\$ 33 +\$ 44 +\$ 54 +\$ 8	Specify with acrylic backer. Specify with acrylic backer. Specify with acrylic backer. Specify with acrylic backer. ▶ See <i>Surface Materials</i> , page 260
Bolster/Pillow Attachment Rings	<ul style="list-style-type: none"> • Attachment rings for bolster/pillow attach to lounge attachment straps 	+\$ 63	Specify with attachment rings.
Lounge Attachment Straps	<ul style="list-style-type: none"> • Attachment straps for lounge attach to bolster/pillow attachment rings 	No cost	Specify with attachment straps for left and right sides.
Related Products	<ul style="list-style-type: none"> • Passerelle tables 		▶ See <i>GSA Volume 5b Specification Guide</i> .

Specification Information

Style Number	Base Prices												Leather Grades:			
	Fabric Grades:												COL	C	E	
	COM	6	7	8	9	10	11	12	13	14						

Lounge Chair

440-WB	\$1599	\$1621	\$1660	\$1698	\$1769	\$1837	\$2015	\$2137	\$2174	\$2397	\$1789	\$3884	\$4241
COM/yds = 4, COL/sq ft = 88													

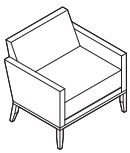

Overall: 27"D 30½"W 29"H
 Inside: 19"D 26"W 17"H
 Seat: 17½"H
 Arm: 23"H

2-Seat Lounge

440-2WB	\$2875	\$2955	\$3023	\$3067	\$3171	\$3253	\$3501	\$3679	\$3710	\$4119	\$3070	\$5983	\$6378
COM/yds = 5½, COL/sq ft = 121													

▶ Specification Information, continued on next page

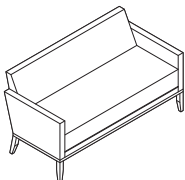

Overall: 27"D 56½"W 29"H
 Inside: 19"D 52"W 17"H
 Seat: 17½"H
 Arm: 23"H

Passerelle Lounge

DESIGN STUDIO B

SIN 711.16

► Specification Information, continued from previous page

Specification Information

Style Number	Base Prices										Leather Grades:		
	Fabric Grades:										COL	C	E
	COM	6	7	8	9	10	11	12	13	14			

3-Seat Lounge

440-3WB	\$3195	\$3325	\$3407	\$3463	\$3591	\$3693	\$4006	\$4203	\$4262	\$4724	\$3385	\$6999	\$7429
COM/yds = 6 ³ / ₄ , COL/sq ft = 149													

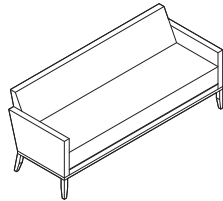

Overall: 27"D 72³/₄"W 29"H
 Inside: 19"D 68"W 17"H
 Seat: 17¹/₂"H

Arm: 23"H



Overall: 17¹/₂"W 5³/₄"Dia

Arm Bolster

440-B	\$ 274	\$ 279	\$ 287	\$ 300	\$ 331	\$ 382	\$ 420	\$ 429	\$ 446	\$ 464	\$ 561	\$ 852	\$1144
COM/yds = 1, COL/sq ft = 18													

Lounge Seating

Passerelle Ottoman

DESIGN STUDIO B

SIN 711.16

Tip: Fabrics and leathers will appear loose with comfort wrinkles when upholstered.

Tip: Recommended leathers are Elmosoft Grade C and Elmorustical Grade E.

Tip: Special color match, consult Customer Service.

Tip: For Customer's Own Material or Leather, see necessary requirements, important processing instructions, and ordering information
 ▶ See *Coalesse Surface Materials Reference Guide*.

Standard Includes

- ▶ Need help? Product details, see *Coalesse Seating and Outdoor Specification Guide*
- Frame: unibody construction with finger jointed plywood
- Upholstery: multiple densities of polyurethane foam and polyester fiber
- Legs: solid maple with non-adjustable glides

Required to Specify

- 1 Style number
 - 2 Fabric or leather color number for upholstery
 - 3 Wood color number for legs
 - 4 Options, if selected (see below)
- ▶ See *Surface Materials*, page 260

Options

Surface Materials	Acrylic backer	Price
	• 17"D x 17"W ottoman	+\$ 8
	• 20"D x 26"W ottoman	+\$12
	• 36"D x 36"W ottoman	+\$24

Required to Specify

- Specify with acrylic backer.
 Specify with acrylic backer.
 Specify with acrylic backer.
 ▶ See *Surface Materials*, page 260

Specification Information

Style Number	Base Prices														Leather Grades:		
	Fabric Grades:														COL	C	E
	COM	6	7	8	9	10	11	12	13	14							

Ottoman

440-H1717WB	\$ 953	\$ 958	\$ 972	\$ 996	\$1021	\$1042	\$1110	\$1156	\$1168	\$1301	\$1234	\$1997	\$2257
COM/yds = 1½, COL/sq ft = 33													

440-H2026WB	\$1131	\$1137	\$1163	\$1175	\$1225	\$1259	\$1339	\$1410	\$1415	\$1574	\$1393	\$2421	\$2701
COM/yds = 2, COL/sq ft = 44													

440-H3636WB	\$1480	\$1489	\$1521	\$1545	\$1598	\$1642	\$1763	\$1853	\$1874	\$2080	\$1713	\$3161	\$3469
COM/yds = 2¾, COL/sq ft = 61													



Overall: 17"D 17"W 17"H

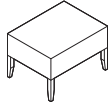

Overall: 20"D 26"W 17"H

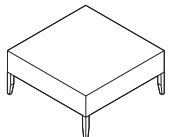

Overall: 36"D 36"W 17"H

Passerelle Benches

DESIGN STUDIO B

SIN 711.16

Tip: Fabrics and leathers will appear loose with comfort wrinkles when upholstered.

Tip: For plain upholstery option or contrasting textiles, contact Customer Service.

Tip: Recommended leathers are Elmosoft Grade C and Elmorustical Grade E.

Tip: Special color match, consult Customer Service.

Tip: For Customer's Own Material or Leather, see necessary requirements, important processing instructions, and ordering information
 ▶ See *Coalesse Surface Materials Reference Guide*.

Standard Includes		Required to Specify
▶ Need help?	<ul style="list-style-type: none"> • Frame: solid maple • Upholstery: multiple densities of polyurethane foam • Legs: solid maple with non-adjustable glides • Button detail: tufted and double needled 	1 Style number 2 Fabric or leather color number for upholstery on bench 3 Wood color number for legs 4 Options, if selected (see below) ▶ See <i>Surface Materials</i> , page 260
Product details, see <i>Coalesse Seating and Outdoor Specification Guide</i>		

Options	Price	Required to Specify
Surface Materials	Acrylic backer	
	• 20"D x 60"W bench	+ \$24
	• 40"D x 40"W bench	+ \$33
	• 30"D x 60"W bench	+ \$37
		Specify with acrylic backer. Specify with acrylic backer. Specify with acrylic backer. ▶ See <i>Surface Materials</i> , page 260

Specification Information													
Style Number	Base Prices											Leather Grades:	
	Fabric Grades:											COL	C
COM	6	7	8	9	10	11	12	13	14				

Bench

440-B3060WB	\$1949	\$1960	\$2017	\$2047	\$2120	\$2176	\$2308	\$2423	\$2470	\$2742	\$2158	\$4265	\$4645
COM/yds = 4, COL/sq ft = 88													

440-B4040WB	\$1893	\$1902	\$1935	\$1974	\$2037	\$2094	\$2202	\$2311	\$2350	\$2615	\$2121	\$3956	\$4282
COM/yds = 3½, COL/sq ft = 77													

440-B2060WB	\$1698	\$1705	\$1746	\$1762	\$1814	\$1865	\$1934	\$2025	\$2063	\$2302	\$1949	\$3391	\$3657
COM/yds = 2¾, COL/sq ft = 61													

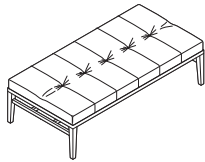

Overall: 30"D 60"W 17"H

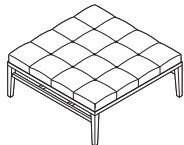

Overall: 40"D 40"W 17"H

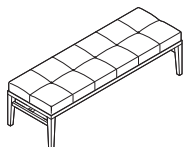

Overall: 20"D 60"W 17"H

Lounge Seating

Switch

DESIGN E00S

SIN 711.16

Tip: Fabrics and leathers will appear loose with comfort wrinkles when upholstered.

Tip: Due to seat conversion arms are 4 1/2"W. Lowered arm has weight limit of 100 lb.

Tip: Recommended leathers are Elmosoft Grade C and Elmorustical Grade E.

Tip: Loose cushions standard.

Tip: Arm bolsters must be specified separately.

Tip: Special color match, consult Customer Service.

Tip: For Customer's Own Material or Leather, see necessary requirements, important processing instructions, and ordering information
 ► See Coalesse Surface Materials Reference Guide.

Tip: 391-4 two seat with extensions, when extended: Both arms = 96"W overall One arm = 84"W overall Arms not extended = 71"W overall (closed).

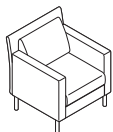

Overall: 29 1/2"D 28"W 32 1/2"H
Inside: 19"D 20"W 17"H
Seat: 17 1/2"H
Arm: 26"H

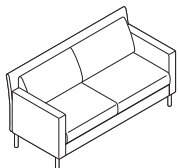

Overall: 24 1/2"D 62"W 33"H
Inside: 19"D 54 1/2"W 33"H
Seat: 19 1/2"H
Arm: 26 1/4"H

Standard Includes		Required to Specify
► Need help? Product details, see <i>Coalesse Seating and Outdoor Specification Guide</i>	<ul style="list-style-type: none"> Selected solid hardwood and wood veneer frame Two seat with extension: tubular steel frame with solid hardwood arms <ul style="list-style-type: none"> - Arms are 4.5" wide Upholstery: multiple densities of polyurethane foam and polyester fiber on seat back and arms Legs: matte chrome finish on steel Arm bolster, if selected: fabric or leather 	<ol style="list-style-type: none"> Style number Number of fabrics if contrasting fabric style number is selected Fabric or leather color number for upholstery on seat, back, and arms, or arm bolsters, if selected Options, if selected (see below) ► See <i>Surface Materials</i>, page 260

Options	Price	Required to Specify
Surface Materials	• Contrasting fabric +\$118 per fabric	Add suffix K to the style number and select fabric color number.
Acrylic backer		Specify with acrylic backer.
• Lounge chair	+\$ 39	Specify with acrylic backer.
• 2-seat lounge	+\$ 72	Specify with acrylic backer.
• 3-seat lounge	+\$ 76	Specify with acrylic backer.
• 2-seat lounge with extensions	+\$ 91	Specify with acrylic backer.
• Arm bolster	+\$ 8	Specify with acrylic backer. ► See <i>Surface Materials</i> , page 260
Attachment Straps		Specify with attachment straps.
• 391	+\$123	Specify with attachment straps.
• 391-2	+\$246	Specify with attachment straps.
• 391-3	+\$369	Specify with attachment straps.
• 391-4	+\$246	Specify with attachment straps.
• Bolster	+\$ 63	Specify with attachment straps.

Related Products • Switch tables ► See *GSA Volume 5b Specification Guide*.

Specification Information

Style Number	Base Prices										Leather Grades:		
	Fabric Grades:										COL	C	E
	COM	6	7	8	9	10	11	12	13	14			

Lounge Chair

391	\$2456	\$2460	\$2490	\$2540	\$2693	\$2792	\$2906	\$2986	\$3127	\$3324	\$2628	\$5152	\$5828
COM/yds = 4 1/2, COL/sq ft = 99													

2-Seat Lounge

391-2	\$3761	\$3868	\$3917	\$4001	\$4256	\$4420	\$4611	\$4744	\$4979	\$5307	\$3934	\$8042	\$9019
COM/yds = 7 1/2, COL/sq ft = 165													

► Specification Information, continued on next page

Switch

DESIGN EOOS

SIN 711.16

► Specification Information, continued from previous page

Specification Information

Style Number	Base Prices										Leather Grades:		
	Fabric Grades:										COL	C	E
	COM	6	7	8	9	10	11	12	13	14			

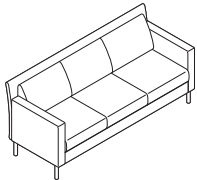

Overall: 30½"D 73"W 33"H
 Inside: 20"D 66"W 33"H
 Seat: 20"D 18½"W
 Arm: 26¼"H

3-Seat Lounge

391-3	\$4940	\$5064	\$5117	\$5206	\$5478	\$5653	\$5857	\$5998	\$6250	\$6599	\$5113	\$10,612	\$11,841
--------------	--------	--------	--------	--------	--------	--------	--------	--------	--------	--------	--------	----------	----------

COM/yds = 8, COL/sq ft = 176

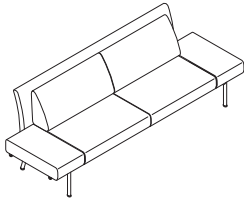

Lounge overall: 35"D 70½"W 33"H
 Overall extended: 35"D 95½"W 33"H
 Seat: 23"D 16½"W
 Arm: 29"D 26½"W
 One arm up: 77"H

2-Seat Lounge with Extensions

391-4	\$5233	\$5392	\$5451	\$5551	\$5857	\$6054	\$6283	\$6442	\$6725	\$7118	\$5406	\$11,705	\$13,078
--------------	--------	--------	--------	--------	--------	--------	--------	--------	--------	--------	--------	----------	----------

COM/yds = 9, COL/sq ft = 198



Overall: 17½"D 5¾"Dia

Arm Bolster

391-B	\$ 245	\$ 239	\$ 246	\$ 257	\$ 291	\$ 313	\$ 338	\$ 356	\$ 387	\$ 431	\$ 533	\$ 797	\$ 1061
--------------	--------	--------	--------	--------	--------	--------	--------	--------	--------	--------	--------	--------	---------

COM/yds = 1, COL/sq ft = 18

SW_1 Lounge Seating

DESIGN SCOTT WILSON & MINIMAL

SIN 711.18



Tip: For Customer's Own Material or Leather, see necessary requirements, important processing instructions, and ordering information
 ▶ See page 262

Standard Includes		Required to Specify
▶ Need help? Product details, see <i>Coalesse Seating and Outdoor Specification Guide</i>	<ul style="list-style-type: none"> • Seat: fabric or leather • Back: knit • Base: 8040 Aluminum Matte Polished • Frame: steel tube • Glides: aluminum with non marring plastic insert • Swivel return mechanism • Ottoman, if selected: fabric or leather 	1 Style number 2 Fabric or leather color number for seat or ottoman, if selected 3 Knit color number for back 4 Options, if selected (see below) ▶ See <i>Surface Materials</i> , page 260

Options	Price	Required to Specify
Surface Materials		
• Contrasting fabric	+\$118	Specify with <i>contrasting fabric</i> and select fabric color number.
Fire code seating		
• Chairs and ottoman	+\$231	Specify with <i>fire code seating</i> .
Acrylic backer		
• Chairs	+\$ 29	Specify with <i>acrylic backer</i> .
• Ottoman	+\$ 12	Specify with <i>acrylic backer</i> . ▶ See <i>Surface Materials</i> , page 260
Lumbar pillow for lounge chairs		
• Fabric group 6	+\$ 26	Specify fabric color number.
• Fabric group 7	+\$ 31	Specify fabric color number.
• Fabric group 8	+\$ 39	Specify fabric color number.
• Fabric group 9	+\$ 64	Specify fabric color number.
• Fabric group 10	+\$ 81	Specify fabric color number.
• Fabric group 11	+\$100	Specify fabric color number.
• Fabric group 12	+\$ 113	Specify fabric color number.
• Fabric group 13	+\$ 137	Specify fabric color number.
• Fabric group 14	+\$ 170	Specify fabric color number.
• Leather group C	+\$ 251	Specify leather color number.
• Leather group E	+\$258	Specify leather color number.
• Customer's Own Material (COM)	+\$ 40	Specify fabric color number. ▶ See <i>Surface Materials</i> , page 262
• Customer's Own Leather (COL)	+\$274	Specify leather color number. ▶ See <i>Surface Materials</i> , page 262
Lumbar Pillow		
• No pillow	No cost	Specify with <i>no pillow</i> .
• Pillow	+\$224	Specify with <i>pillow</i> .
Swivel Mechanism		
• Swivel-only mechanism (omit return feature)	No cost	Specify with <i>swivel-only mechanism</i> .
Tablet		
• No tablet	No cost	Specify with <i>no tablet</i> .
• Right tablet (seated position)	+\$670	Specify with <i>right tablet</i> and select 6000 Black or 6052 Milk finish.
• Left tablet (seated position)	+\$670	Specify with <i>left tablet</i> and select 6000 Black or 6052 Milk finish.

Tip: Paint on lounge tablet arm support will complement 8040 Aluminum Matte polished base.



Top of Cushion to Bottom of Tablet: 8 1/2"H

Tip: Handedness is determined while in the seated position.

Related Products	<ul style="list-style-type: none"> • Collaborative and conference tables • Occasional tables • Collaboration seating 	▶ See <i>GSA Volume 5b Specification Guide</i> . ▶ See <i>GSA Volume 5b Specification Guide</i> . ▶ Page 217
-------------------------	---	--

SW_1 Lounge Seating

DESIGN SCOTT WILSON & MINIMAL

SIN 711.18

Specification Information

Style Number	Base Prices											Leather Grades:		
	Fabric Grades:											COL	C	E
	COM	6	7	8	9	10	11	12	13	14				



Overall: 28 1/4"D 32 1/4"W 36 3/4"H
 Seat: 16"H
 Arm: 23"H

Low-Back Collaborative Lounge Chair

COW613	Seat	\$2096	\$2096	\$2102	\$2112	\$2142	\$2162	\$2185	\$2201	\$2229	\$2268	\$2147	\$2378	\$2412
	Upper back	+\$ 72	+\$ 72	+\$ 86	+\$109	+\$181	+\$227	+\$280	+\$317	+\$383	+\$475	+\$192	+\$731	+\$809
COM/yds = 3, COL/sq ft = 60														
Pillow COM/yds = 1 1/4, COL/sq ft = 27 1/2														



Overall: 30"D 32 1/4"W 41 3/4"H
 Seat: 16"H
 Arm: 23"H

High-Back Collaborative Lounge Chair

COW713	Seat	\$2440	\$2440	\$2446	\$2456	\$2486	\$2506	\$2529	\$2545	\$2573	\$2612	\$2491	\$2722	\$2756
	Upper back	+\$ 72	+\$ 72	+\$ 86	+\$109	+\$181	+\$227	+\$280	+\$317	+\$383	+\$475	+\$192	+\$731	+\$809
COM/yds = 3, COL/sq ft = 60														
Pillow COM/yds = 1 1/4, COL/sq ft = 27 1/2														



Overall: 20"D 23"W 14"H

Ottoman

COW210	\$1088	\$1082	\$1089	\$1100	\$1134	\$1156	\$1181	\$1199	\$1230	\$1274	\$1322	\$1426	\$1467
COM/yds = 1, COL/sq ft = 22													

SW_1 Multi-Fabric Diagram

DESIGN STUDIO B

SIN 711.18

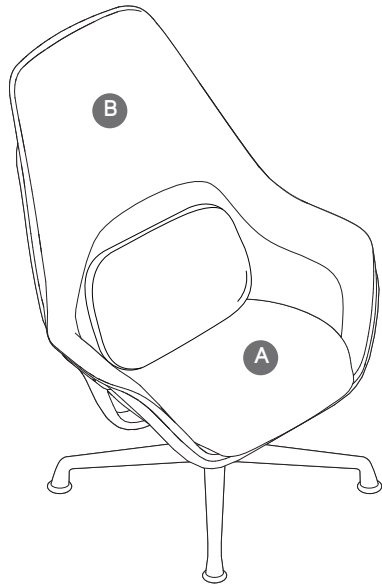

TO: _____

FROM: _____

DATE: _____

FAX...888.413.5161

A Seat: _____

B Arms/Back: _____

Contrasting fabric charges will apply. List price based on highest grade textile specified.

\$118 list upcharge for each contrasting textile pricing based on highest grade textile specified.

Specify Model below:

COW613 Low-Back Collaborative Lounge Chair

COW713 High-Back Collaborative Lounge Chair

Coalesse

SW_1 Multi-Fabric Diagram

DESIGN STUDIO B

SIN 711.18

Together Bench by Walter Knoll

DESIGN E00S

SIN 711.16

Tip: Fabrics and leathers will appear loose with comfort wrinkles when upholstered.

Tip: For Customer's Own Material or Leather, see necessary requirements, important processing instructions, and ordering information
 ▶ See *Coalesse Surface Materials Reference Guide*.

Standard Includes		Required to Specify
▶ Need help? Product details, see <i>Coalesse Seating and Outdoor Specification Guide</i>	<ul style="list-style-type: none"> Upholstery for chair: fabric or leather Glides 	1 Style number 2 Number of fabrics if contrasting fabric style number is selected 3 Fabric or leather color number for upholstery 4 Options, if selected (see below) ▶ See <i>Surface Materials</i> , page 260

Options	Price	Required to Specify	
Surface Materials	• Contrasting fabric	+\$118 per fabric	Add suffix K to the style number and select fabric color number.
	Acrylic backer		
	• 69¾"W straight bench without back	+\$ 35	Specify with acrylic backer.
	• 96½"W straight bench without back	+\$ 39	Specify with acrylic backer.
	• 26¾"D x 69¾"W benches	+\$ 48	Specify with acrylic backer.
	• 26¾"D x 96½"W benches	+\$ 58	Specify with acrylic backer.
	• 69¾"D x 96½"W benches	+\$ 93	Specify with acrylic backer.
	• 96½"D x 96½"W and 69¾"D x 123¼"W benches	+\$105	Specify with acrylic backer.
	• 96½"D x 123¼"W bench	+\$115	Specify with acrylic backer. ▶ See <i>Surface Materials</i> , page 260
Back Offset	• Back offset	No cost	Specify with back offset.

Specification Information													
Style Number	Base Prices											Leather Grades:	
	Fabric Grades:											COL	C
	COM	6	7	8	9	10	11	12	13	14			

Left Corner with Back, 8" Offset

COT09669L8	\$7749	\$7933	\$7997	\$8106	\$8437	\$8651	\$8899	\$9071	\$ 9378	\$ 9804	\$7873	\$11,865	\$12,578
COM/yds = 9¾, COL/sq ft = 215													

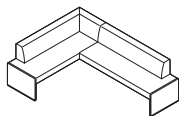

Overall: 70½"D 96½"W 31"H
 Seat: 19"D 18½"H

COT09696L8	\$8349	\$8568	\$8638	\$8758	\$9123	\$9359	\$9632	\$9822	\$10,160	\$10,630	\$8473	\$12,881	\$13,667
COM/yds = 10¾, COL/sq ft = 237													

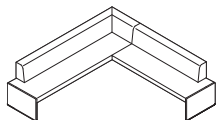

Overall: 97¼"D 96½"W 31"H
 Seat: 19"D 18½"H

▶ Specification Information, continued on next page

Together Bench by Walter Knoll

DESIGN E00S

SIN 711.16

► Specification Information, continued from previous page

Specification Information

Style Number	Base Prices											Leather Grades:		
	Fabric Grades:											COL	C	E
	COM	6	7	8	9	10	11	12	13	14				

Left Corner with Back, 8" Offset, continued

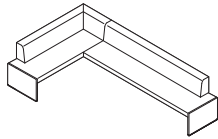

Overall: 70½"D 123¼"W 31"H
Seat: 19"D 18½"H

COTO12369L8	\$8585	\$8821	\$8894	\$9020	\$9402	\$ 9649	\$ 9935	\$10,134	\$10,488	\$10,979	\$8709	\$13,324	\$14,146
--------------------	--------	--------	--------	--------	--------	---------	---------	----------	----------	----------	--------	----------	----------

COM/yds = 11¼, COL/sq ft = 248

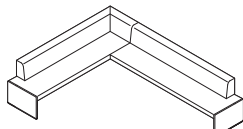

Overall: 97¼"D 123¼"W 31"H
Seat: 19"D 18½"H

COTO12396L8	\$9017	\$9296	\$9378	\$9517	\$9942	\$10,216	\$10,534	\$10,755	\$11,148	\$11,694	\$9141	\$14,169	\$15,067
--------------------	--------	--------	--------	--------	--------	----------	----------	----------	----------	----------	--------	----------	----------

COM/yds = 12½, COL/sq ft = 270

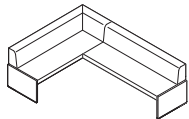

Overall: 70½"D 96½"W 31"H
Seat: 19"D 18½"H

Left Corner with Back, 1½" Offset

COTO9669L15	\$7912	\$8113	\$8181	\$8295	\$8643	\$ 8868	\$ 9129	\$ 9310	\$ 9632	\$10,080	\$8036	\$12,236	\$12,985
--------------------	--------	--------	--------	--------	--------	---------	---------	---------	---------	----------	--------	----------	----------

COM/yds = 10¼, COL/sq ft = 226

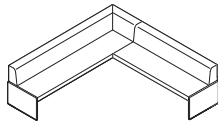

Overall: 97¼"D 96½"W 31"H
Seat: 19"D 18½"H

COTO9696L15	\$8513	\$8749	\$8822	\$8948	\$9330	\$ 9577	\$ 9863	\$10,062	\$10,416	\$10,907	\$8637	\$13,252	\$14,074
--------------------	--------	--------	--------	--------	--------	---------	---------	----------	----------	----------	--------	----------	----------

COM/yds = 11¼, COL/sq ft = 248

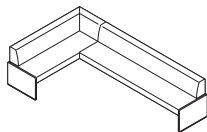

Overall: 70½"D 123¼"W 31"H
Seat: 19"D 18½"H

COTO12369L15	\$8747	\$9000	\$9077	\$9208	\$9607	\$ 9865	\$10,164	\$10,371	\$10,741	\$11,254	\$8871	\$13,694	\$14,553
---------------------	--------	--------	--------	--------	--------	---------	----------	----------	----------	----------	--------	----------	----------

COM/yds = 11¾, COL/sq ft = 259

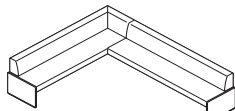

Overall: 97¼"D 123¼"W 31"H
Seat: 19"D 18½"H

COTO12396L15	\$9178	\$9465	\$9549	\$9691	\$10,124	\$10,404	\$10,728	\$10,953	\$11,354	\$11,911	\$9302	\$14,538	\$15,471
---------------------	--------	--------	--------	--------	----------	----------	----------	----------	----------	----------	--------	----------	----------

COM/yds = 12¾, COL/sq ft = 281

► Specification Information, continued on next page

Together Bench by Walter Knoll *continued*

DESIGN E00S

SIN 711.16

Tip: For Customer's Own Material or Leather, see necessary requirements, important processing instructions, and ordering information
 ▶ See Coalesse Surface Materials Reference Guide.

Tip: Fabrics and leathers will appear loose with comfort wrinkles when upholstered.

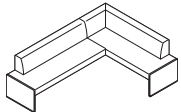

Overall: 70½"D 96½"W 31"H
 Seat: 19"D 18½"H

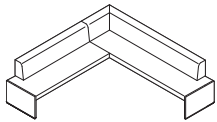

Overall: 97¼"D 96½"W 31"H
 Seat: 19"D 18½"H

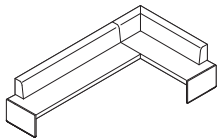

Overall: 70½"D 123¼"W 31"H
 Seat: 19"D 18½"H

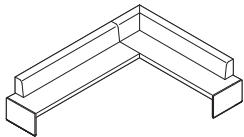

Overall: 97¼"D 123¼"W 31"H
 Seat: 19"D 18½"H

▶ Specification Information, continued from previous page

Specification Information

Style Number	Base Prices														Leather Grades:		
	Fabric Grades:														COL	C	E
	COM	6	7	8	9	10	11	12	13	14							

Right Corner with Back, 8" Offset

COT09669R8	\$7749	\$7933	\$7997	\$8106	\$8437	\$ 8651	\$ 8899	\$ 9071	\$ 9378	\$ 9804	\$7873	\$11,865	\$12,578
COM/yds = 9¾, COL/sq ft = 215													

COT09696R8	\$8349	\$8568	\$8638	\$8758	\$9123	\$ 9359	\$ 9632	\$ 9822	\$10,160	\$10,630	\$8473	\$12,881	\$13,667
COM/yds = 10¾, COL/sq ft = 237													

COT12369R8	\$8585	\$8821	\$8894	\$9020	\$9402	\$ 9649	\$ 9935	\$10,134	\$10,488	\$10,979	\$8709	\$13,324	\$14,146
COM/yds = 11¼, COL/sq ft = 248													

COT12396R8	\$9017	\$9296	\$9378	\$9517	\$9942	\$10,216	\$10,534	\$10,755	\$11,148	\$11,694	\$9141	\$14,169	\$15,067
COM/yds = 12½, COL/sq ft = 270													

▶ Specification Information, continued on next page

Together Bench by Walter Knoll

DESIGN EOOS

SIN 711.16

► Specification Information, continued from previous page

Specification Information

Style Number	Base Prices														Leather Grades:		
	Fabric Grades:														COL	C	E
	COM	6	7	8	9	10	11	12	13	14							

Right Corner with Back, 1 1/2" Offset

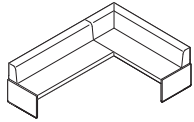

Overall: 70 1/2"D 96 1/2"W 31"H
Seat: 19"D 18 1/2"H

COT09669R15	\$7912	\$8113	\$8181	\$8295	\$ 8643	\$ 8868	\$ 9129	\$ 9310	\$ 9632	\$10,080	\$8036	\$12,236	\$12,985
	COM/yds = 10 1/4, COL/sq ft = 226												

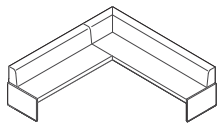

Overall: 97 1/4"D 96 1/2"W 31"H
Seat: 19"D 18 1/2"H

COT09696R15	\$8513	\$8749	\$8822	\$8948	\$ 9330	\$ 9577	\$ 9863	\$10,062	\$10,416	\$10,907	\$8637	\$13,252	\$14,074
	COM/yds = 11 1/4, COL/sq ft = 248												

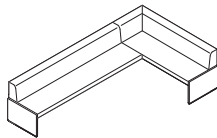

Overall: 70 1/2"D 123 1/4"W 31"H
Seat: 19"D 18 1/2"H

COT01239R15	\$8747	\$9000	\$9077	\$9208	\$ 9607	\$ 9865	\$10,164	\$10,371	\$10,741	\$11,254	\$8871	\$13,694	\$14,553
	COM/yds = 11 3/4, COL/sq ft = 259												

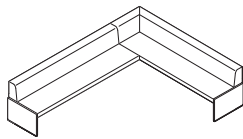

Overall: 97 1/4"D 123 1/4"W 31"H
Seat: 19"D 18 1/2"H

COT012396R15	\$9178	\$9465	\$9549	\$9691	\$10,124	\$10,404	\$10,728	\$10,953	\$11,354	\$11,911	\$9302	\$14,538	\$15,471
	COM/yds = 12 3/4, COL/sq ft = 281												

► Specification Information, continued on next page

Together Bench by Walter Knoll *continued*

DESIGN E00S

SIN 711.16

Tip: For Customer's Own Material or Leather, see necessary requirements, important processing instructions, and ordering information

► See Coalesse Surface Materials Reference Guide.

Tip: Fabrics and leathers will appear loose with comfort wrinkles when upholstered.

► Specification Information, continued from previous page

Specification Information

Style Number	Base Prices											Leather Grades:		
	Fabric Grades:											COL	C	E
	COM	6	7	8	9	10	11	12	13	14				

Straight with Back, 8" Offset

COTO69WB8	\$3837	\$3850	\$3881	\$3934	\$4095	\$4200	\$4320	\$4404	\$4554	\$4761	\$3961	\$5879	\$6228
COM/yds = 4¾, COL/sq ft = 105													

COTO96WB8	\$4388	\$4452	\$4493	\$4563	\$4775	\$4912	\$5071	\$5182	\$5378	\$5651	\$4512	\$7054	\$7510
COM/yds = 6¼, COL/sq ft = 138													

Straight with Back, 1½" Offset

COTO69WB15	\$3998	\$4019	\$4052	\$4108	\$4278	\$4387	\$4515	\$4603	\$4760	\$4979	\$4122	\$6144	\$6510
COM/yds = 5, COL/sq ft = 110													

COTO96WB15	\$4550	\$4623	\$4665	\$4738	\$4959	\$5101	\$5267	\$5382	\$5586	\$5870	\$4674	\$7318	\$7794
COM/yds = 6½, COL/sq ft = 143													

► Specification Information, continued on next page

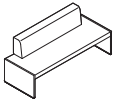

Overall: 26¾"D 69¾"W 31"H
Seat: 19"D 18½"H

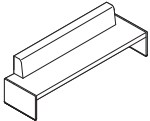

Overall: 26¾"D 96½"W 31"H
Seat: 19"D 18½"H

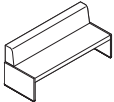

Overall: 26¾"D 69¾"W 31"H
Seat: 19"D 18½"H

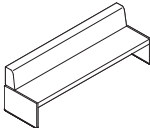

Overall: 26¾"D 96½"W 31"H
Seat: 19"D 18½"H

Coalesse

Together Bench by Walter Knoll

DESIGN EOOS

SIN 711.16

► Specification Information, continued from previous page

Specification Information

Style Number	Base Prices											Leather Grades:		
	Fabric Grades:											COL	C	E
	COM	6	7	8	9	10	11	12	13	14				

Straight without Back

COT069	\$2762	\$2762	\$2788	\$2833	\$2969	\$3057	\$3158	\$3229	\$3355	\$3530	\$2899	\$4506	\$4799
---------------	--------	--------	--------	--------	--------	--------	--------	--------	--------	--------	--------	--------	--------

COM/yds = 4, COL/sq ft = 88

COT096	\$3150	\$3163	\$3194	\$3247	\$3408	\$3513	\$3633	\$3717	\$3867	\$4074	\$3274	\$5192	\$5541
---------------	--------	--------	--------	--------	--------	--------	--------	--------	--------	--------	--------	--------	--------

COM/yds = 4³/₄, COL/sq ft = 105

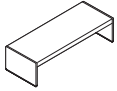

Overall: 26³/₄"D 69³/₄"W 18¹/₂"H
Seat: 18¹/₂"H

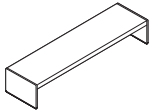

Overall: 26³/₄"D 96¹/₂"W 18¹/₂"H
Seat: 18¹/₂"H

Lounge Seating

Visalia Lounge

DESIGN COALESSE DESIGN GROUP

SIN 711.16

Specification Information

Lounge Chair

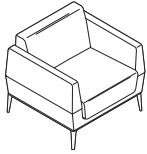

Overall: 29"D 31¾"W 28"H
 Seat height: 16¼"H
 Arm height to the floor: 23"H
 Inside: 19"D 23"W 16¼"H

Style Number Upholstery

2-Seat Lounge

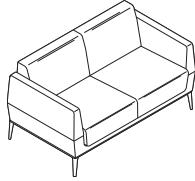

Overall: 29"D 53¾"W 28"H
 Seat height: 16¼"H
 Arm height to the floor: 23"H
 Inside: 19"D 45"W 16¼"H

3-Seat Lounge

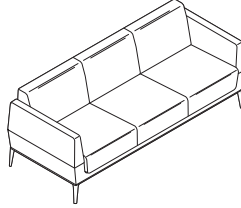

Overall: 29"D 73¾"W 28"H
 Seat height: 16¼"H
 Arm height to the floor: 23"H
 Inside: 19"D 65"W 16¼"H

Ottoman

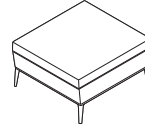

Overall: 29"D 30"W 16¼"H

Bench

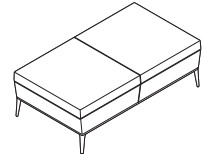

Overall: 29"D 52"W 16¼"H

Base Prices

Fabric Grades:

COM 6 7 8 9 10 11 12 13 14

Leather Grades:

COL C E

Lounge Chair with Single Fabric

COJHL100	\$2234	\$2234	\$2258	\$2300	\$2427	\$2510	\$2605	\$2671	\$2789	\$2953	\$2379	\$3344	\$3475
	COM/yds = 3¾, COL/sq ft = 83												

Lounge Chair with Accent Upholstery

COJHLC100	Standard Upholstery	\$2296	\$2296	\$2316	\$2349	\$2451	\$2517	\$2593	\$2646	\$2740	\$2871	\$2401	\$3330	\$3450
		COM/yds = 3, COL/sq ft = 66												
	Accent Upholstery	+\$ 6	No cost	+\$ 7	+\$ 18	+\$ 52	+\$ 74	+\$ 99	+\$117	+\$148	+\$192	+\$240	+\$344	+\$385
		COM/yds = 1, COL/sq ft = 22												

2-Seat Lounge with Single Fabric

COJHL200	\$3432	\$3453	\$3486	\$3542	\$3712	\$3821	\$3949	\$4037	\$4194	\$4413	\$3556	\$4987	\$5166
	COM/yds = 5, COL/sq ft = 110												

2-Seat Lounge with Accent Upholstery

COJHLC200	Standard Upholstery	\$3529	\$3533	\$3563	\$3613	\$3766	\$3865	\$3979	\$4059	\$4200	\$4397	\$3653	\$5071	\$5250
		COM/yds = 4½, COL/sq ft = 99												
	Accent Upholstery	No cost	No cost	+\$ 8	+\$ 22	+\$ 64	+\$ 92	+\$ 124	+\$146	+\$185	+\$240	+\$231	+\$434	+\$485
		COM/yds = 1¼, COL/sq ft = 27												

3-Seat Lounge with Single Fabric

COJHL300	\$3927	\$3983	\$4022	\$4089	\$4293	\$4424	\$4577	\$4683	\$4872	\$5134	\$4051	\$5963	\$6194
	COM/yds = 6, COL/sq ft = 132												

3-Seat Lounge with Accent Upholstery

COJHLC300	Standard Upholstery	\$4041	\$4080	\$4116	\$4177	\$4364	\$4484	\$4624	\$4722	\$4895	\$5135	\$4165	\$5984	\$6205
		COM/yds = 5½, COL/sq ft = 121												
	Accent Upholstery	No cost	No cost	+\$ 11	+\$ 31	+\$ 90	+\$ 129	+\$173	+\$204	+\$259	+\$336	+\$214	+\$601	+\$671
		COM/yds = 1¾, COL/sq ft = 39												

► Specification Information, continued on next page

Visalia Lounge *continued*

DESIGN COALESSE DESIGN GROUP

SIN 711.16

► Specification Information, continued from previous page

Specification Information

Lounge Chair

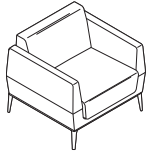

Overall: 29"D 31¾"W 28"H
 Seat height: 16¼"H
 Arm height to the floor: 23"H
 Inside: 19"D 23"W 16¼"H

2-Seat Lounge

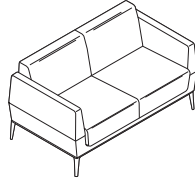

Overall: 29"D 53¾"W 28"H
 Seat height: 16¼"H
 Arm height to the floor: 23"H
 Inside: 19"D 45"W 16¼"H

3-Seat Lounge

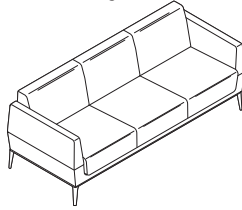

Overall: 29"D 73¾"W 28"H
 Seat height: 16¼"H
 Arm height to the floor: 23"H
 Inside: 19"D 65"W 16¼"H

Ottoman

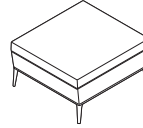

Overall: 29"D 30"W 16¼"H

Bench

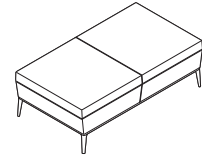

Overall: 29"D 52"W 16¼"H

Style
Number

Upholstery

Base Prices

Fabric Grades:

COM 6 7 8 9 10 11 12 13 14

Leather Grades:

COL C E

Ottoman with Single Fabric

COJHB100	\$1191	\$1191	\$1206	\$1231	\$1307	\$1357	\$1414	\$1454	\$1525	\$1623	\$1388	\$1870	\$1951
COM/yds = 2, COL/sq ft = 44													

Ottoman with Accent Upholstery

COJHBC100	Standard Upholstery	\$1242	\$1236	\$1243	\$1254	\$1288	\$1310	\$1335	\$1353	\$1384	\$1428	\$1476	\$1580	\$1621
COM/yds = 1, COL/sq ft = 22														
	Accent Upholstery	+\$ 6	No cost	+\$ 7	+\$ 18	+\$ 52	+\$ 74	+\$ 99	+\$ 117	+\$ 148	+\$ 192	+\$ 240	+\$ 344	+\$ 385
COM/yds = 1, COL/sq ft = 22														

2-Seat Bench with Single Fabric

COJHB200	\$1739	\$1739	\$1763	\$1805	\$1932	\$2015	\$2110	\$2176	\$2294	\$2458	\$1884	\$2661	\$2771
COM/yds = 3, COL/sq ft = 50													

2-Seat Bench with Accent Upholstery

COJHBC200	Standard Upholstery	\$1767	\$1767	\$1778	\$1798	\$1857	\$1896	\$1940	\$1971	\$2026	\$2103	\$1981	\$2369	\$2439
COM/yds = 1¾, COL/sq ft = 39														
	Accent Upholstery	No cost	No cost	+\$ 8	+\$ 22	+\$ 64	+\$ 92	+\$ 124	+\$146	+\$ 185	+\$ 240	+\$ 231	+\$ 434	+\$ 485
COM/yds = 1, COL/sq ft = 22														

Guest/Side/Stack Seating

Bindu Chairs (SIN 711.18)	176
Bob Chair (SIN 711.18)	177
Capa Chairs (SIN 711.19)	178
Enea Stacker Chairs (SIN 711.19)	180
Enea Bar Stools (SIN 711.18)	184
Enea Café Post Stools (SIN 711.18)	188
Enea Lottus Chairs (SIN 711.19)	192
Enea Lottus Sled Stools (SIN 71.205)	196
Enea Lottus Post Stools (SIN 711.18)	198
Kathryn Chairs (SIN 711.18)	200
Last Minute Stools (SIN 711.18)	202
Lox Stools (SIN 711.18)	203
Switch (SIN 711.18)	204
Montara650 (SIN 711.18)	208
Montara650 Rocker (SIN 711.18)	214
Wrapp Chairs (SIN 711.18)	216

Bindu Chairs

DESIGN BRIAN KANE

SIN 711.18

Tip: Fabrics and leathers will appear loose with comfort wrinkles when upholstered.

Tip: Craft in upholstery cautions the use of stripes and patterns on Bindu. Please use fabric database when specifying.

Tip: For Customer's Own Material or Leather, see necessary requirements, important processing instructions, and ordering information
 ▶ See Coalesse Surface Materials Reference Guide.

Tip: For fabric with large pattern and specific pattern location is desired, contact Customer Service.



Overall: 25"D 24½"W 33¾"H
Inside: 18¾"D 18½"-19½"W 15"H
Seat: 17¾"H
Arm: 26¼"H



Overall: 25"D 24½"W 37¾"H
Inside: 18¾"D 18½"-19½"W 21"H
Seat: 17¾"H
Arm: 26¼"H

Standard Includes		Required to Specify
▶ Need help? Product details, see <i>Coalesse Seating and Outdoor Specification Guide</i>	<ul style="list-style-type: none"> Bent plywood frame Chair: fabric Molded polypropylene foam Frame: 4144 Black Gloss Glides: black, non-marring 	1 Style number 2 Fabric or leather color number for upholstery 3 Options, if selected (see below) ▶ See <i>Surface Materials</i> , page 260

Options	Price	Required to Specify
Surface Materials Acrylic backer • Backer	+\$ 29	Specify with acrylic backer. ▶ See <i>Surface Materials</i> , page 260
Base • 9207 polished trivalent chrome	+\$147	Specify with 9207 polished trivalent chrome.

Specification Information													
Style Number	Base Prices											Leather Grades:	
	Fabric Grades:											COL	C
COM	6	7	8	9	10	11	12	13	14				

Low-Back Chair

CO200G	\$1213	\$1213	\$1233	\$1266	\$1368	\$1434	\$1510	\$1563	\$1657	\$1788	\$1384	\$2577	\$2796
--------	--------	--------	--------	--------	--------	--------	--------	--------	--------	--------	--------	--------	--------

COM/yds = 3, COL/sq ft = 66

Mid-Back Chair

CO300G	\$1393	\$1393	\$1413	\$1446	\$1548	\$1614	\$1690	\$1743	\$1837	\$1968	\$1564	\$2757	\$2976
--------	--------	--------	--------	--------	--------	--------	--------	--------	--------	--------	--------	--------	--------

COM/yds = 3, COL/sq ft = 66

Bob Chair by Walter Knoll

DESIGN PEARSON LLOYD

SIN 711.18

Tip: For Customer's Own Material or Leather, see necessary requirements, important processing instructions, and ordering information.
▶ Page 262

Tip: Fabrics and leathers will appear loose with comfort wrinkles when upholstered.

Standard Includes		Required to Specify			
▶ Need help? Product details, see <i>Coalesse Seating and Outdoor Specification Guide</i>	<ul style="list-style-type: none"> • Base: 8040 aluminum matte polished • Upholstery for chair: fabric or leather • Glides 	<ol style="list-style-type: none"> 1 Style number 2 Number of fabrics if contrasting fabric style number is selected 3 Fabric or leather color number for upholstery 4 Options, if selected (see below) 	▶ See <i>Surface Materials</i> , page 260.		
Options		Price		Required to Specify	
Surface Materials	• Contrasting fabric	+\$118 per fabric		Add suffix K to the style number and select fabric color number.	
	• Fire code seating	+\$231		Specify with fire code seating. ▶ See <i>Fire Code Seating</i> , page 264.	
Acrylic backer					
• Guest chair		+\$ 22		Specify with acrylic backer.	
• Ottoman		+\$ 10		Specify with acrylic backer. ▶ See <i>Surface Materials</i> , page 260.	
Glides	• Felted glides	+\$ 16		Specify with felted glides.	
Related Products	• Bob tables	▶ See <i>GSA Volume 5b Specification Guide</i> .			

Specification Information

Style Number	Base Prices												Leather Grades:			
	Fabric Grades:												COL	C	E	
	COM	6	7	8	9	10	11	12	13	14						

Guest Chair

231	\$1913	\$1913	\$1926	\$1948	\$2016	\$2060	\$2111	\$2146	\$2209	\$2296	\$2127	\$2941	\$3090
COM/yds = 2, COL/sq ft = 44													

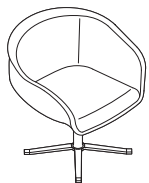

Overall: 25¼"D 27¼"W 29¾"H
Inside: 18"D 18"W 12½"H
Seat: 18½"H
Arm: 26½"H



Overall: 18½"D 19¾"W 15¼"H

Ottoman

221-H	\$ 859	\$ 853	\$ 860	\$ 871	\$ 905	\$ 927	\$ 952	\$ 970	\$1001	\$1045	\$1102	\$1482	\$1557
COM/yds = 1, COL/sq ft = 22													

Capa Chairs

DESIGN E00S

SIN 711.19



Overall: 24¾"D 23¾"W 31½"H
 Inside: 18"D 16½"W 15"H
 Seat: 18"H
 Arm: 28"H

Tip: Fabrics and leathers will appear loose with comfort wrinkles when upholstered.

Tip: Frame design allows back to flex to match occupant's back shape.

Tip: Due to the design and construction techniques of the Capa Chair only certain textiles can be successfully applied, therefore all COM fabrics must be submitted to Coalesse for approval prior to order acceptance.

Tip: Recommended leathers are Elmosoft Grade C and Elmorustical Grade E.

Tip: Special color match, consult Customer Service.

Tip: For Customer's Own Material or Leather, see necessary requirements, important processing instructions, and ordering information
 ▶ See *Coalesse Surface Materials Reference Guide*.

Tip: Chair stacks five high with stacking dolly and three high on floor.

Standard Includes		Required to Specify
▶ Need help? Product details, see <i>Coalesse Seating and Outdoor Specification Guide</i>	<ul style="list-style-type: none"> • Frame: hardwood plywood, steel tubing and bar stock • Arms: solid steel rod and bar stock • Upholstery: arms, back, and seat foam are molded around the frame components • Legs: matte chrome (M) or polished chrome (PC) leg finish 	1 Style number 2 Number of fabrics if contrasting fabric style number is selected 3 Fabric or leather color number for upholstery 4 Options, if selected (see below) ▶ See <i>Coalesse Surface Materials Reference Guide</i> .

Options	Price	Required to Specify
Surface Materials	<ul style="list-style-type: none"> • Contrasting fabric +\$118 per fabric 	Add suffix K to the style number and select fabric color number.
<ul style="list-style-type: none"> • Acrylic backer • Backer 	+\$ 17	Specify with <i>acrylic backer</i> . ▶ See <i>Coalesse Surface Materials Reference Guide</i> .

Specification Information														
Style Number	Base Prices												Leather Grades:	
	Fabric Grades:												COL	C
	COM	6	7	8	9	10	11	12	13	14				

Chairs

1810M	\$1113	\$1113	\$1126	\$1148	\$1216	\$1260	\$1311	\$1346	\$1409	\$1496	\$1378	\$2365	\$2546
1810PC	\$1141	\$1141	\$1154	\$1176	\$1244	\$1288	\$1339	\$1374	\$1437	\$1524	\$1406	\$2398	\$2574

COM/yds = 2, COL/sq ft = 44

Stacking Dolly

9014S	\$ 749	N.A.	N.A.	N.A.	N.A.	N.A.	N.A.	N.A.	N.A.	N.A.	N.A.	N.A.	N.A.
-------	--------	------	------	------	------	------	------	------	------	------	------	------	------

Coalesse

Capa Chairs

DESIGN E00S

SIN 711.19

Guest/Side/Stack
Seating

Enea Stacker Chairs With Arms

DESIGN JACOB LLUSCA

SIN 711.19

Tip: Due to the design and construction techniques of the Enea Chair only certain textiles can be successfully applied, therefore all COM fabrics must be submitted to Coalesse for approval prior to order acceptance.

Tip: Fabrics and leathers will appear loose with comfort wrinkles when upholstered.

Tip: For Customer's Own Material or Leather, see necessary requirements, important processing instructions, and ordering information.

► Page 262

Tip: Contrasting fabric option available on model 3501 only.

Tip: Need sketch for ganging.

Tip: Tablet is 11"D x 9"W.

Tip: Arm chairs stack nine high. Arm chair with tablet stacks six high.

Standard Includes	Required to Specify
<ul style="list-style-type: none"> ► Need help? Product details, see <i>Coalesse Seating and Outdoor Specification Guide</i> • Frame: constructed of steel tubing • Seat and back: molded nylon, wood, or upholstery (wood is laminated layers of hard maple veneer) 	<ol style="list-style-type: none"> 1 Style number 2 Fabric or leather color number for upholstery, if selected 3 Plastic or wood finish color number for seat and back, if selected 4 Base/frame finish: black gloss, white gloss, or silver metallic 5 Options, if selected (see below) <p>► See <i>Surface Materials</i>, page 260.</p>

Options	Price	Required to Specify
Surface Materials <ul style="list-style-type: none"> • Contrasting fabric 	+\$118 per fabric	Add suffix K to the style number and select fabric color number.
Acrylic backer <ul style="list-style-type: none"> • Chair with upholstered seat and back • Chair with upholstered seat and wood back 	+\$ 17 +\$ 8	Specify with acrylic backer. Specify with acrylic backer. ► See <i>Surface Materials</i> , page 260.
Ganging <ul style="list-style-type: none"> • Ganging 	+\$ 64	Specify with ganging.
Tablet <ul style="list-style-type: none"> • Black powder coat 	+\$335	Specify with tablet and specify side as facing.
Related Products <ul style="list-style-type: none"> • Café and conference tables 		► Page 230 and 231

Specification Information														
Style Number	Base Prices												Leather Grades:	
	Fabric Grades:												COL	C
	COM	6	7	8	9	10	11	12	13	14				

Wood Seat and Back Stacker Chair

3500	\$926	N.A.	N.A.	N.A.	N.A.	N.A.	N.A.	N.A.	N.A.	N.A.	N.A.	N.A.	N.A.
------	-------	------	------	------	------	------	------	------	------	------	------	------	------



Overall: 22½"D 22½"W 33¼"H
 Inside: 18"D 18"W 15¼"H
 Seat: 18"H
 Arm: 26¾"H

Upholstered Seat and Back Chair

3501	\$867	\$867	\$877	\$894	\$945	\$978	\$1016	\$1043	\$1090	\$1155	\$1126	\$1332	\$1462
------	-------	-------	-------	-------	-------	-------	--------	--------	--------	--------	--------	--------	--------

COM/yds = 1, COL/sq ft = 22

► Specification Information, continued on next page



Overall: 22½"D 22½"W 33¼"H
 Inside: 18"D 18"W 15¼"H
 Seat: 18"H
 Arm: 26¾"H

Enea Stacker Chairs With Arms

DESIGN JACOB LLUSCA

SIN 711.19

► Specification Information, continued from previous page

Specification Information

Style Number	Base Prices											Leather Grades:		
	Fabric Grades:											COL	C	E
	COM	6	7	8	9	10	11	12	13	14				

Upholstered Seat and Wood Back Chair

3502	\$929	\$915	\$920	\$928	\$953	\$970	\$989	\$1002	\$1026	\$1059	\$1199	\$1293	\$1364
------	-------	-------	-------	-------	-------	-------	-------	--------	--------	--------	--------	--------	--------

COM/yds = 3/4, COL/sq ft = 17



Overall: 22½"D 22½"W 33¼"H
 Inside: 18"D 18"W 15¼"H
 Seat: 18"H
 Arm: 26¾"H

Polypropylene Seat and Back Chair

3503	\$535	N.A.	N.A.	N.A.	N.A.	N.A.	N.A.	N.A.	N.A.	N.A.	N.A.	N.A.	N.A.
------	-------	------	------	------	------	------	------	------	------	------	------	------	------



Overall: 22½"D 22½"W 33¼"H
 Inside: 18"D 18"W 15¼"H
 Seat: 18"H
 Arm: 26¾"H

Stacking Dolly

9014S	\$749	N.A.	N.A.	N.A.	N.A.	N.A.	N.A.	N.A.	N.A.	N.A.	N.A.	N.A.	N.A.
-------	-------	------	------	------	------	------	------	------	------	------	------	------	------

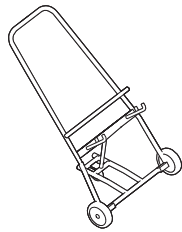

Overall: 34"D 26"W 34"H

Guest/ Side/Stack Seating

Enea Stacker Chairs Without Arms

DESIGN JACOB LLUSCA

SIN 711.19

Tip: Due to the design and construction techniques of the Enea Chair only certain textiles can be successfully applied, therefore all COM fabrics must be submitted to Coalesse for approval prior to order acceptance.

Tip: Pricing based on highest grade textiles specified.

Tip: Armless chairs stack nine high.

Tip: Fabrics and leathers will appear loose with comfort wrinkles when upholstered.

Tip: For Customer's Own Material or Leather, see necessary requirements, important processing instructions, and ordering information.
▶ Page 262

Tip: Contrasting fabric option available on model 3501S only.

Tip: No tablet or ganging available on armless models.



Overall: 22½"D 18"W 33¼"H
Inside: 18"D 18"W 15¼"H
Seat: 18"H



Overall: 22½"D 18"W 33¼"H
Inside: 18"D 18"W 15¼"H
Seat: 18"H

Standard Includes

- ▶ Need help?
Product details, see *Coalesse Seating and Outdoor Specification Guide*
- Frame: steel tubing
- Seat and back: molded nylon, wood, or upholstery (wood is laminated layers of hard maple veneer)

Required to Specify

- 1 Style number
 - 2 Fabric or leather color number for upholstery, if selected
 - 3 Plastic or wood finish color number for seat and back, if selected
 - 4 Base/frame finish: black gloss, white gloss, or silver metallic
 - 5 Options, if selected (see below)
- ▶ See *Surface Materials*, page 260.

Options

Options	Price	Required to Specify
Surface Materials	• Contrasting fabric	+ \$118 per fabric
	Acrylic backer	
	• Chair with upholstered seat and back	+ \$ 17
	• Chair with upholstered seat and wood back	+ \$ 8
Related Products	• Café and conference tables	

▶ See *Surface Materials*, page 260.

▶ Page 230 and 231

Specification Information

Style Number	Base Prices											Leather Grades:		
	Fabric Grades:											COL	C	E
	COM	6	7	8	9	10	11	12	13	14				

Wood Seat and Back Chair

3500S	\$816	N.A.	N.A.	N.A.	N.A.	N.A.	N.A.	N.A.	N.A.	N.A.	N.A.	N.A.	N.A.
-------	-------	------	------	------	------	------	------	------	------	------	------	------	------

Upholstered Seat and Back Chair

3501S	\$755	\$755	\$763	\$777	\$819	\$847	\$879	\$901	\$940	\$995	\$1014	\$1232	\$1353
-------	-------	-------	-------	-------	-------	-------	-------	-------	-------	-------	--------	--------	--------

COM/yds = 1, COL/sq ft = 22

▶ Specification Information, continued on next page

Enea Stacker Chairs Without Arms

DESIGN JACOB LLUSCA

SIN 711.19

► Specification Information, continued from previous page

Specification Information

Style Number	Base Prices										Leather Grades:		
	Fabric Grades:										COL	C	E
	COM	6	7	8	9	10	11	12	13	14			

Upholstered Seat and Wood Back Chair

3502S	\$819	\$805	\$810	\$818	\$843	\$860	\$879	\$892	\$916	\$949	\$1095	\$1177	\$1254
-------	-------	-------	-------	-------	-------	-------	-------	-------	-------	-------	--------	--------	--------

COM/yds = 3/4, COL/sq ft = 17



Overall: 22½"D 18"W 33¼"H
 Inside: 18"D 18"W 15¼"H
 Seat: 18"H

Polypropylene Seat and Back Chair

3503S	\$497	N.A.	N.A.	N.A.	N.A.	N.A.	N.A.	N.A.	N.A.	N.A.	N.A.	N.A.	N.A.
-------	-------	------	------	------	------	------	------	------	------	------	------	------	------



Overall: 22½"D 18"W 33¼"H
 Inside: 18"D 18"W 15¼"H
 Seat: 18"H

Stacking Dolly

9014S	\$749	N.A.	N.A.	N.A.	N.A.	N.A.	N.A.	N.A.	N.A.	N.A.	N.A.	N.A.	N.A.
-------	-------	------	------	------	------	------	------	------	------	------	------	------	------

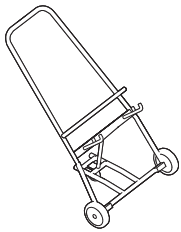

Overall: 34"D 26"W 34"H

Guest/ Side/Stack Seating

Enea Bar Stools Bar-Height with Arms

DESIGN JACOB LLUSCA

SIN 711.18

Tip: Due to the design and construction techniques of the Enea Barstool only certain textiles can be successfully applied, therefore all COM fabrics must be submitted to Coalesse for approval prior to order acceptance.

Tip: Pricing based on highest grade textile specified.

Tip: Fabrics and leathers will appear loose with comfort wrinkles when upholstered.

Tip: For Customer's Own Material or Leather, see necessary requirements, important processing instructions, and ordering information.
 ▶ Page 262

Tip: Contrasting fabric option available on model 3511 only.

Standard Includes

- ▶ Need help? Product details, see *Coalesse Seating and Outdoor Specification Guide*
- Constructed of steel tubing with cast aluminum arms
- Seat and back: polypropylene, wood, or upholstery (wood is laminated layers of hard maple veneer)
- Footrest with leg stretchers: chrome-plated

Required to Specify

- 1 Style number
 - 2 Number of fabrics if contrasting fabric style number is selected
 - 3 Fabric or leather color number for upholstery, if selected
 - 4 Plastic or wood finish color number for seat and back, if selected
 - 5 Base/frame finish: black gloss, white gloss, or silver metallic
 - 6 Options, if selected (see below)
- ▶ See *Surface Materials*, page 260.

Options

Options	Price	Required to Specify
Surface Materials	• Contrasting fabric	+\$118 per fabric
	Acrylic backer	
	• Chair with upholstered seat and back	+\$ 12
	• Chair with upholstered seat and wood back	+\$ 6
Related Products	• Café and conference tables	▶ Page 230 and 231

Specification Information

Style Number	Base Prices											Leather Grades:		
	COM	6	7	8	9	10	11	12	13	14	COL	C	E	

Wood Seat and Back

3510	\$1006	N.A.	N.A.	N.A.	N.A.	N.A.	N.A.	N.A.	N.A.	N.A.	N.A.	N.A.	N.A.
------	--------	------	------	------	------	------	------	------	------	------	------	------	------

Upholstered Seat and Back

3511	\$ 947	\$947	\$957	\$974	\$1025	\$1058	\$1096	\$1123	\$1170	\$1235	\$1219	\$1437	\$1571
------	--------	-------	-------	-------	--------	--------	--------	--------	--------	--------	--------	--------	--------

COM/yds = 1, COL/sq ft = 22
 ▶ Specification Information, continued on next page

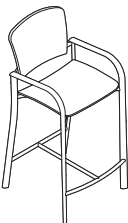

Overall: 24¾"D 22¼"W 45½"H
Inside: 18½"D 17¾"W 15¼"H
Seat: 30½"H
Arm: 39¼"H

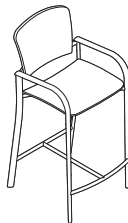

Overall: 24¾"D 22¼"W 45½"H
Inside: 18½"D 17¾"W 15¼"H
Seat: 30½"H
Arm: 39¼"H

Enea Bar Stools Bar-Height with Arms

DESIGN JACOB LLUSCA

SIN 711.18

► Specification Information, continued from previous page

Specification Information

Style Number	Base Prices										Leather Grades:			
	Fabric Grades:										14	COL	C	E
	COM	6	7	8	9	10	11	12	13					

Upholstered Seat and Wood Back

3512	\$1016	\$1002	\$1007	\$1015	\$1040	\$1057	\$1076	\$1089	\$1113	\$1146	\$1294	\$1400	\$1477
------	--------	--------	--------	--------	--------	--------	--------	--------	--------	--------	--------	--------	--------

COM/yds = ¾, COL/sq ft = 17

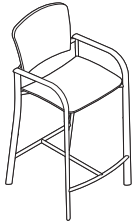

Overall: 24¾"D 22¼"W 45½"H
 Inside: 18½"D 17¾"W 15¼"H
 Seat: 30½"H
 Arm: 39¼"H

Polypropylene Seat and Back

3513	\$ 690	N.A.	N.A.	N.A.	N.A.	N.A.	N.A.	N.A.	N.A.	N.A.	N.A.	N.A.	N.A.
------	--------	------	------	------	------	------	------	------	------	------	------	------	------

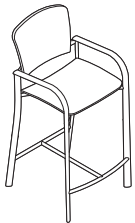

Overall: 24¾"D 22¼"W 45½"H
 Inside: 18½"D 17¾"W 15¼"H
 Seat: 30½"H
 Arm: 39¼"H

Guest/ Side/Stack Seating

Enea Bar Stools Bar-Height without Arms

DESIGN JACOB LLUSCA

SIN 711.18

Tip: Due to the design and construction techniques of the Enea Barstool only certain textiles can be successfully applied, therefore all COM fabrics must be submitted to Coalesse for approval prior to order acceptance.

Tip: Pricing based on highest grade textile specified.

Tip: For Customer's Own Material or Leather, see necessary requirements, important processing instructions, and ordering information.
▶Page 262

Tip: Fabrics and leathers will appear loose with comfort wrinkles when upholstered.

Tip: Contrasting fabric option available on model 3511S only.

Standard Includes		Required to Specify
▶Need help? Product details, see <i>Coalesse Seating and Outdoor Specification Guide</i>	<ul style="list-style-type: none"> Base/frame: steel tubing and base with non-skid strip Seat and back: molded polypropylene, wood, or upholstery (wood is laminated layers of hard maple veneer) Footrest: polished aluminum Upholstered seat / back: Laminations of multiple density polyurethane foam and polyester fiber 	<ol style="list-style-type: none"> Style number Number of fabrics if contrasting fabric style number is selected Fabric or leather color number for upholstery, if selected Plastic or wood finish color number for seat and back, if selected Base/frame finish: black gloss, white gloss, or silver metallic Options, if selected (see below) ▶See <i>Surface Materials</i> , page 260.

Options	Price	Required to Specify
Surface Materials	<ul style="list-style-type: none"> Contrasting fabric 	+\$118 per fabric
	Acrylic backer	
	<ul style="list-style-type: none"> Chair with upholstered seat and back 	+\$ 12
	<ul style="list-style-type: none"> Chair with upholstered seat and wood back 	+\$ 6
Related Products	<ul style="list-style-type: none"> Café and conference tables 	▶Page 230 and 231

Specification Information														
Style Number	Base Prices											Leather Grades:		
	Fabric Grades:											COL	C	E
	COM	6	7	8	9	10	11	12	13	14				

Wood Seat and Back

3510S	\$976	N.A.	N.A.	N.A.	N.A.	N.A.	N.A.	N.A.	N.A.	N.A.	N.A.	N.A.	N.A.
-------	-------	------	------	------	------	------	------	------	------	------	------	------	------

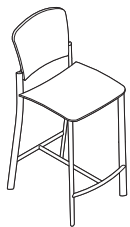

Overall: 25"D 18½"W 45¾"H
Inside: 18½"D 17¾"W 15¼"H
Seat: 30½"H

Upholstered Seat and Back

3511S	\$871	\$871	\$881	\$898	\$949	\$982	\$1020	\$1047	\$1094	\$1159	\$1148	\$1367	\$1502
-------	-------	-------	-------	-------	-------	-------	--------	--------	--------	--------	--------	--------	--------

COM/yds = 1, COL/sq ft = 22

▶Specification Information, continued on next page

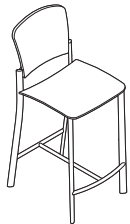

Overall: 25"D 18½"W 45¾"H
Inside: 18½"D 17¾"W 15¼"H
Seat: 30½"H

Enea Bar Stools Bar-Height without Arms

DESIGN JACOB LLUSCA

SIN 711.18

► Specification Information, continued from previous page

Specification Information

Style Number	Base Prices											Leather Grades:		
	Fabric Grades:											COL	C	E
	COM	6	7	8	9	10	11	12	13	14				

Upholstered Seat and Wood Back

3512S	\$936	\$922	\$927	\$935	\$960	\$977	\$996	\$1009	\$1033	\$1066	\$1219	\$1315	\$1390
-------	-------	-------	-------	-------	-------	-------	-------	--------	--------	--------	--------	--------	--------

COM/yds = ¾, COL/sq ft = 17

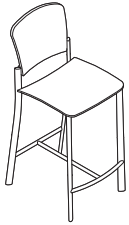

Overall: 25"D 18½"W 45¾"H
 Inside: 18½"D 17¾"W 15¼"H
 Seat: 30½"H

Polypropylene Seat and Back

3513S	\$598	N.A.	N.A.	N.A.	N.A.	N.A.	N.A.	N.A.	N.A.	N.A.	N.A.	N.A.	N.A.
-------	-------	------	------	------	------	------	------	------	------	------	------	------	------

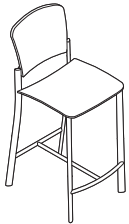

Overall: 25"D 18½"W 45¾"H
 Inside: 18½"D 17¾"W 15¼"H
 Seat: 30½"H

Guest/ Side/Stack Seating

Enea Café Post Stools Café with Back

DESIGN JACOB LLUSCA

SIN 711.18

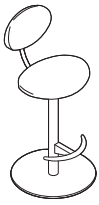

Tip: For Customer's Own Material or Leather, see necessary requirements, important processing instructions, and ordering information.

► Page 262

Tip: Fabrics and leathers will appear loose with comfort wrinkles when upholstered.

Standard Includes	Required to Specify
-------------------	---------------------

- | | | |
|---|--|--|
| <ul style="list-style-type: none"> ► Need help? Product details, see <i>Coalesse Seating and Outdoor Specification Guide</i> | <ul style="list-style-type: none"> • Base/frame: steel tubing and base with non-skid strip • Seat and back: molded polypropylene, wood, or upholstery (wood is laminated layers of hard maple veneer) • Footrest: polished aluminum • Upholstered seat/back: Laminations of multiple density polyurethane foam and polyester fiber | <ol style="list-style-type: none"> 1 Style number 2 Number of fabrics if contrasting fabric style number is selected 3 Fabric or leather color number for upholstery, if selected 4 Plastic or wood finish color number for seat and back, if selected 5 Base/frame finish: black gloss, white gloss, or silver metallic 6 Options, if selected (see below) <p>► See <i>Surface Materials</i>, page 260.</p> |
|---|--|--|

Options	Price	Required to Specify
---------	-------	---------------------

Surface Materials	<ul style="list-style-type: none"> • Contrasting fabric +\$118 per fabric 	Add suffix K to the style number and select fabric color number.
	<p>Acrylic backer</p> <ul style="list-style-type: none"> • Stool with upholstered seat and back +\$ 6 • Backer for stool with upholstered seat and wood back +\$ 4 	<p>Specify with acrylic backer.</p> <p>Specify with acrylic backer.</p> <p>► See <i>Surface Materials</i>, page 260.</p>

Related Products	<ul style="list-style-type: none"> • Café and conference tables 	► Page 230 and 231
-------------------------	--	--------------------

Enea Café Post Stools Café with Back

DESIGN JACOB LLUSCA

SIN 711.18

Specification Information

Style Number	Base Prices														Leather Grades:			Wood	Poly-Propylene
	Fabric Grades:														COL	C	E		
	COM	6	7	8	9	10	11	12	13	14									

Café Counter-Height Stools, 19" Base

Upholstered Seat and Back

H351-SB2719	\$1058	\$1044	\$1049	\$1057	\$1082	\$1099	\$1118	\$1131	\$1155	\$1188	\$1310	\$1531	\$1583	N.A.	N.A.
-------------	--------	--------	--------	--------	--------	--------	--------	--------	--------	--------	--------	--------	--------	------	------

COM/yds = 3/4, COL/sq ft = 13 1/2

Upholstered Seat with Wood Back

H352-SB2719	\$1115	\$1094	\$1097	\$1104	\$1122	\$1134	\$1148	\$1158	\$1175	\$1199	\$1367	\$1517	\$1552	N.A.	N.A.
-------------	--------	--------	--------	--------	--------	--------	--------	--------	--------	--------	--------	--------	--------	------	------

COM/yds = 5/9, COL/sq ft = 10

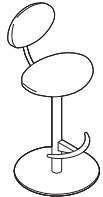

Overall: 19"D 19"W 38 1/4"H
 Inside: 14 1/4"D 17"W 12 5/8"H
 Seat: 25 5/8"H



Overall: 19"D 19"W 42 1/4"H
 Inside: 14 1/4"D 17"W 12 5/8"H
 Seat: 29 5/8"H

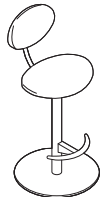

Overall: 19"D 19"W 38 1/4"H
 Inside: 14 1/4"D 17"W 12 5/8"H
 Seat: 25 5/8"H



Overall: 19"D 19"W 42 1/4"H
 Inside: 14 1/4"D 17"W 12 5/8"H
 Seat: 29 5/8"H

Café Bar-Height Stools, 19" Base

Upholstered Seat and Back

H351-SB3119	\$1063	\$1049	\$1054	\$1062	\$1087	\$1104	\$1123	\$1136	\$1160	\$1193	\$1315	\$1536	\$1588	N.A.	N.A.
-------------	--------	--------	--------	--------	--------	--------	--------	--------	--------	--------	--------	--------	--------	------	------

COM/yds = 3/4, COL/sq ft = 13 1/2

Upholstered Seat with Wood Back

H352-SB3119	\$1121	\$1100	\$1103	\$1110	\$1128	\$1140	\$1154	\$1164	\$1181	\$1205	\$1373	\$1523	\$1564	N.A.	N.A.
-------------	--------	--------	--------	--------	--------	--------	--------	--------	--------	--------	--------	--------	--------	------	------

Café Counter-Height Stools, 19" Base

Wood Seat and Back

H350-SB2719	N.A.	N.A.	N.A.	N.A.	N.A.	N.A.	N.A.	N.A.	N.A.	N.A.	N.A.	N.A.	N.A.	\$1139	N.A.
-------------	------	------	------	------	------	------	------	------	------	------	------	------	------	--------	------

Polypropylene Seat and Back

H353-SB2719	N.A.	N.A.	N.A.	N.A.	N.A.	N.A.	N.A.	N.A.	N.A.	N.A.	N.A.	N.A.	N.A.	N.A.	\$856
-------------	------	------	------	------	------	------	------	------	------	------	------	------	------	------	-------

Café Bar-Height Stools, 19" Base

Wood Seat and Back

H350-SB3119	N.A.	N.A.	N.A.	N.A.	N.A.	N.A.	N.A.	N.A.	N.A.	N.A.	N.A.	N.A.	N.A.	\$1147	N.A.
-------------	------	------	------	------	------	------	------	------	------	------	------	------	------	--------	------

Polypropylene Seat and Back

H353-SB3119	N.A.	N.A.	N.A.	N.A.	N.A.	N.A.	N.A.	N.A.	N.A.	N.A.	N.A.	N.A.	N.A.	N.A.	\$862
-------------	------	------	------	------	------	------	------	------	------	------	------	------	------	------	-------

Guest/ Side/Stack Seating

Enea Café Post Stools

DESIGN JACOB LLUSCA

SIN 711.18

Tip: Due to the design and construction techniques of the Enea Barstool only certain textiles can be successfully applied, therefore all COM fabrics must be submitted to Coalesse for approval prior to order acceptance.

Tip: Recommended leathers are Elmosoft Grade C and Elmorustical Grade E.

Tip: Special color match, consult Customer Service.

Tip: For Customer's Own Material or Leather, see necessary requirements, important processing instructions, and ordering information.
 ▶ Page 262

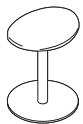

Overall: 14½"D 17"W 19¼"H
 Seat: 17⅝"H



Overall: 14½"D 17"W 27¼"H
 Seat: 25⅝"H

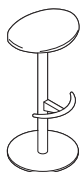

Overall: 14½"D 17"W 31¼"H
 Seat: 29⅝"H

Standard Includes

- ▶ Need help? Product details, see *Coalesse Seating and Outdoor Specification Guide*
- Base/frame: steel tubing and base with non-skid strip
- Seat: molded polypropylene, wood, or upholstery (wood is laminated layers of hard maple veneer)
- Footrest: polished aluminum
- Upholstered seat/back: Laminations of multiple density polyurethane foam and polyester fiber

Required to Specify

- 1 Style number
 - 2 Plastic or wood finish color number for seat
 - 3 Fabric or leather color number for upholstery
 - 4 Base/frame finish: black gloss, white gloss, or silver metallic
 - 5 Options, if selected (see below)
- ▶ See *Surface Materials*, page 260.

Options

Surface Material	Options	Price	Required to Specify
	Acrylic backer	+\$4	
	• Backer		Specify with acrylic backer. ▶ See <i>Surface Materials</i> , page 260.

Related Products • Café and conference tables ▶ Page 230 and 231

Specification Information

Style Number	Base Prices												Leather Grades:			
	Fabric Grades:												COL	C	E	
	COM	6	7	8	9	10	11	12	13	14						

Low Stool with Upholstered Seat

H352-S19	\$826	\$805	\$808	\$815	\$833	\$845	\$859	\$869	\$886	\$910	\$ 966	\$1147	\$1188
COM/yds = 5/9, COL/sq ft = 10													

Café Counter-Height Stool with Upholstered Seat

H352-S27	\$860	\$839	\$842	\$849	\$867	\$879	\$893	\$903	\$920	\$944	\$1007	\$1187	\$1222
COM/yds = 5/9, COL/sq ft = 10													

Café Bar-Height Stool with Upholstered Seat

H352-S31	\$899	\$878	\$881	\$888	\$906	\$918	\$932	\$942	\$959	\$983	\$1039	\$1220	\$1261
COM/yds = 5/9, COL/sq ft = 10													

▶ Specification Information, continued on next page

Enea Café Post Stools

DESIGN JACOB LLUSCA

SIN 711.18

► Specification Information, continued from previous page

Specification Information

Style Number	Base Prices														Leather Grades:			Wood	Poly-Propylene
	Fabric Grades:														COL	C	E		
	COM	6	7	8	9	10	11	12	13	14									

Low Stool

Wood Seat

H350-S19	N.A.	N.A.	N.A.	N.A.	N.A.	N.A.	N.A.	N.A.	N.A.	N.A.	N.A.	N.A.	N.A.	N.A.	\$749	N.A.
----------	------	------	------	------	------	------	------	------	------	------	------	------	------	------	-------	------

Polypropylene Seat

H353-S19	N.A.	N.A.	N.A.	N.A.	N.A.	N.A.	N.A.	N.A.	N.A.	N.A.	N.A.	N.A.	N.A.	N.A.	N.A.	\$588
----------	------	------	------	------	------	------	------	------	------	------	------	------	------	------	------	-------

Café Counter-Height Stool

Wood Seat

H350-S27	N.A.	N.A.	N.A.	N.A.	N.A.	N.A.	N.A.	N.A.	N.A.	N.A.	N.A.	N.A.	N.A.	N.A.	\$786	N.A.
----------	------	------	------	------	------	------	------	------	------	------	------	------	------	------	-------	------

Polypropylene Seat

H353-S27	N.A.	N.A.	N.A.	N.A.	N.A.	N.A.	N.A.	N.A.	N.A.	N.A.	N.A.	N.A.	N.A.	N.A.	N.A.	\$653
----------	------	------	------	------	------	------	------	------	------	------	------	------	------	------	------	-------

Café Bar-Height Stool

Wood Seat

H350-S31	N.A.	N.A.	N.A.	N.A.	N.A.	N.A.	N.A.	N.A.	N.A.	N.A.	N.A.	N.A.	N.A.	N.A.	\$820	N.A.
----------	------	------	------	------	------	------	------	------	------	------	------	------	------	------	-------	------

Polypropylene Seat

H353-S31	N.A.	N.A.	N.A.	N.A.	N.A.	N.A.	N.A.	N.A.	N.A.	N.A.	N.A.	N.A.	N.A.	N.A.	N.A.	\$711
----------	------	------	------	------	------	------	------	------	------	------	------	------	------	------	------	-------

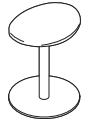

Overall: 14½"D 17"W 19¼"H
Seat: 17½"H



Overall: 14½"D 17"W 27¼"H
Seat: 25½"H

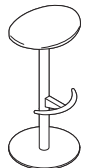

Overall: 14½"D 17"W 31¼"H
Seat: 29½"H

Guest/Side/Stack Seating

Enea Lottus Chairs Armless

DESIGN LIEVORE ALTHERR MOLINA

SIN 711.19

Tip: For Customer's Own Material or Leather, see necessary requirements, important processing instructions, and ordering information.
 ▶Page 262

Standard Includes		Required to Specify
▶Need help? Product details, see <i>Coalesse Seating and Outdoor Specification Guide</i>	<ul style="list-style-type: none"> • Base and frame constructed of steel tubing • Seat and back: polypropylene • Insert, if selected: polypropylene or upholstery 	1 Style number 2 Plastic color number for seat and back 3 Fabric or leather color number for upholstery insert, if selected 4 Paint color number for base and frame 5 Options, if selected (see below) ▶See <i>Surface Materials</i> , page 260.

Options	Price	Required to Specify
Surface Acrylic backer • Chair with upholstered insert	+\$ 6	Specify with acrylic backer. ▶See <i>Surface Materials</i> , page 260.
Felt Glides • Glides	No cost	Specify with felt glides.
Related Products • Café and conference tables		▶Pages 230 and 236

Specification Information

Style Number	Base Prices													Leather Grades:			Polypropylene
	Fabric Grades:																
COM	6	7	8	9	10	11	12	13	14	COL	C	E					

Tip: Lottus chair with no insert stacks 10 high on floor. Lottus chair with polypropylene or upholstered insert stacks four high on floor. Lottus chairs stack six high with dolly.



Overall: 20¾"D 20¾"W 30½"H
 Seat: 18"H

Armless Chair with No Insert

COEL100	\$349	N.A.	N.A.	N.A.	N.A.	N.A.	N.A.	N.A.	N.A.	N.A.	N.A.	N.A.	N.A.	N.A.
---------	-------	------	------	------	------	------	------	------	------	------	------	------	------	------



Overall: 20¾"D 20¾"W 30½"H
 Seat: 18"H

Armless Chair with Polypropylene Insert

COEL100INSERT	N.A.	N.A.	N.A.	N.A.	N.A.	N.A.	N.A.	N.A.	N.A.	N.A.	N.A.	N.A.	N.A.	N.A.	\$390
---------------	------	------	------	------	------	------	------	------	------	------	------	------	------	------	-------



Overall: 20¾"D 20¾"W 30½"H
 Seat: 18"H

Armless Chair with Upholstered Insert

COEL100UPH	\$523	\$509	\$514	\$522	\$547	\$564	\$583	\$596	\$620	\$653	\$743	\$755	\$784	N.A.
------------	-------	-------	-------	-------	-------	-------	-------	-------	-------	-------	-------	-------	-------	------

COM/yds = ¾, COL/sq ft = 15

▶Specification Information, continued on next page

Coalesse

Enea Lottus Chairs Armless

DESIGN LIEVORE ALTHERR MOLINA

SIN 711.19

► Specification Information, continued from previous page

Specification Information

Style Number	Price
-----------------	-------

Stacking Dolly

COELDOLLY	\$735
-----------	-------

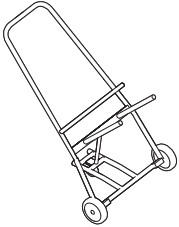

Overall: 27"D 25"W 46"H

Tip: Dolly can be used with any Enea Lottus chair.

Tip: Armless chairs, cantilever arm chairs, and loop arm chairs stack six high on dolly.

Guest/Side/Stack
Seating

Enea Lottus Chairs Cantilever Arm

DESIGN LIEVORE ALTHERR MOLINA

SIN 711.19

Tip: Cantilever arm can hook on table to provide storing option.

Tip: Cantilever arm stacks six high.

Tip: Can specify arm cap in any plastic color for Lottus.

Tip: For Customer's Own Material or Leather, see necessary requirements, important processing instructions, and ordering information.
▶Page 262

Standard Includes

- ▶ Need help?
- Product details, see *Coalesse Seating and Outdoor Specification Guide*
- Base and frame constructed of steel tubing
- Seat and back: polypropylene
- Arm cap: polypropylene
- Insert, if selected: polypropylene or upholstery

Required to Specify

- 1 Style number
 - 2 Plastic color number for seat, back, and arm cap
 - 3 Fabric or leather color number for upholstery insert, if selected
 - 4 Paint color number for base and frame
 - 5 Options, if selected (see below)
- ▶ See *Surface Materials*, page 260.

Options

Options	Price	Required to Specify
Surface Materials Acrylic backer	+\$6	Specify with acrylic backer. ▶ See <i>Surface Materials</i> , page 260.
Felt Glides	No cost	Specify with felt glides.
Related Products	• Café and conference tables	▶ Page 230 and 231

Specification Information

Style Number	Base Prices														
	Fabric Grades:													Leather Grades:	
COM	6	7	8	9	10	11	12	13	14	COL	C	E			

Cantilever Arm Chair with No Insert

COEL200	\$431	N.A.	N.A.	N.A.	N.A.	N.A.	N.A.	N.A.	N.A.	N.A.	N.A.	N.A.	N.A.	N.A.
---------	-------	------	------	------	------	------	------	------	------	------	------	------	------	------



Overall: 20¾"D 23¾"W 30½"H
Seat: 18"H
Arm: 26"H

Cantilever Arm Chair with Polypropylene Insert

COEL200INSERT	N.A.	N.A.	N.A.	N.A.	N.A.	N.A.	N.A.	N.A.	N.A.	N.A.	N.A.	N.A.	N.A.	N.A.	\$471
---------------	------	------	------	------	------	------	------	------	------	------	------	------	------	------	-------



Overall: 20¾"D 23¾"W 30½"H
Seat: 18"H
Arm: 26"H

Cantilever Arm Chair with Upholstered Insert

COEL200UPH	\$602	\$588	\$593	\$601	\$626	\$643	\$662	\$675	\$699	\$732	\$822	\$834	\$863	N.A.
------------	-------	-------	-------	-------	-------	-------	-------	-------	-------	-------	-------	-------	-------	------

COM/yds = ¾, COL/sq ft = 15



Overall: 20¾"D 23¾"W 30½"H
Seat: 18"H
Arm: 26"H

Enea Lottus Chairs Aluminum Loop Arm

DESIGN LIEVORE ALTHERR MOLINA

SIN 711.19

Tip: Arm chair stacks six high.

Tip: For Customer's Own Material or Leather, see necessary requirements, important processing instructions, and ordering information.

▶Page 262

Standard Includes		Required to Specify
▶Need help? Product details, see <i>Coalesse Seating and Outdoor Specification Guide</i>	<ul style="list-style-type: none"> • Base and frame constructed of steel tubing • Seat and back: polypropylene • Arm: aluminum • Insert, if selected: polypropylene or upholstery 	<ol style="list-style-type: none"> 1 Style number 2 Plastic color number for seat, back, and arm cap 3 Fabric or leather color number for upholstery insert, if selected 4 Paint color number for base and frame 5 Options, if selected (see below) ▶See <i>Surface Materials</i> , page 260.

Options	Price	Required to Specify
Surface Materials Acrylic backer • Chair with upholstered insert	+\$6	Specify with acrylic backer. ▶See <i>Surface Materials</i> , page 260.
Felt Glides • Glides	No cost	Specify with felt glides.
Related Products • Café and conference tables		▶Page 230 and 231

Specification Information													
Style Number	Base Prices												
	Fabric Grades:										Leather Grades:		Polypropylene
COM	6	7	8	9	10	11	12	13	14	COL	C	E	

Aluminum Loop Arm Chair with No Insert

COEL300	\$465	N.A.	N.A.	N.A.	N.A.	N.A.	N.A.	N.A.	N.A.	N.A.	N.A.	N.A.	N.A.	N.A.
---------	-------	------	------	------	------	------	------	------	------	------	------	------	------	------



Overall: 20¾"D 22"W 30½"H
Seat: 18"H
Arm: 26"H

Aluminum Loop Arm Chair with Polypropylene Insert

COEL300INSERT	N.A.	N.A.	N.A.	N.A.	N.A.	N.A.	N.A.	N.A.	N.A.	N.A.	N.A.	N.A.	N.A.	N.A.	\$505
---------------	------	------	------	------	------	------	------	------	------	------	------	------	------	------	-------



Overall: 20¾"D 22"W 30½"H
Seat: 18"H
Arm: 26"H

Aluminum Loop Arm Chair with Upholstered Insert

COEL300UPH	\$637	\$623	\$628	\$636	\$661	\$678	\$697	\$710	\$734	\$767	\$871	\$869	\$898	N.A.
------------	-------	-------	-------	-------	-------	-------	-------	-------	-------	-------	-------	-------	-------	------

COM/yds = ¾, COL/sq ft = 15



Enea Lottus Sled Stools Sled Base

DESIGN LIEVORE ALTHERR MOLINA

SIN 71.205

Tip: For Customer's Own Material or Leather, see necessary requirements, important processing instructions, and ordering information.
 ▶Page 262

Standard Includes	Required to Specify
▶ Need help? Product details, see <i>Coalesse Seating and Outdoor Specification Guide</i>	1 Style number 2 Plastic color number for seat and back 3 Fabric or leather color number for upholstery insert, if selected 4 Paint color number for base and frame 5 Options, if selected (see below) ▶ See <i>Surface Materials</i> , page 260.
<ul style="list-style-type: none"> • Base and frame constructed of painted steel tubing • Seat and back: polypropylene • Insert, if selected: polypropylene or upholstery 	

Options	Price	Required to Specify
Surface Base <ul style="list-style-type: none"> • Grade 1 paint • Grade 3 paint 	No cost +\$75	Specify paint color number. Specify paint color number.
Materials Acrylic backer <ul style="list-style-type: none"> • Chair with upholstered insert 	+\$ 6	Specify with acrylic backer. ▶ See <i>Surface Materials</i> , page 260.
Related Products <ul style="list-style-type: none"> • Café and conference tables 		▶ Page 230 and 231

Specification Information

Style Number	Base Prices													
	Fabric Grades:										Leather Grades:			Poly-propylene
	COM	6	7	8	9	10	11	12	13	14	COL	C	E	

Sled-Base Counter-Height Stool with No Insert

COEL500	\$510	N.A.	N.A.	N.A.	N.A.	N.A.	N.A.	N.A.	N.A.	N.A.	N.A.	N.A.	N.A.	N.A.
---------	-------	------	------	------	------	------	------	------	------	------	------	------	------	------



Overall: 18"D 18 1/4"W 34 1/2"H
 Seat: 26 1/4"H

Sled-Base Counter-Height Stool with Polypropylene Insert

COEL500INSERT	N.A.	N.A.	N.A.	N.A.	N.A.	N.A.	N.A.	N.A.	N.A.	N.A.	N.A.	N.A.	N.A.	\$540
---------------	------	------	------	------	------	------	------	------	------	------	------	------	------	-------



Overall: 18"D 18 1/4"W 34 1/2"H
 Seat: 26 1/4"H

Sled Base Counter-Height Stool with Upholstered Insert

COEL500UPH	\$671	\$657	\$662	\$670	\$695	\$712	\$731	\$744	\$768	\$801	\$905	\$903	\$932	N.A.
------------	-------	-------	-------	-------	-------	-------	-------	-------	-------	-------	-------	-------	-------	------

COM/yds = 3/4, COL/sq ft = 15

▶ Specification Information, continued on next page



Overall: 18"D 18 1/4"W 34 1/2"H
 Seat: 26 1/4"H

Enea Lottus Sled Stools Sled Base

DESIGN LIEVORE ALTHERR MOLINA

SIN 71.205

► Specification Information, continued from previous page

Specification Information

Style Number	Base Prices													
	Fabric Grades:													Leather Grades:
	COM	6	7	8	9	10	11	12	13	14	COL	C	E	

Sled Base Bar-Height Stool with No Insert

COEL400	\$562	N.A.	N.A.	N.A.	N.A.	N.A.	N.A.	N.A.	N.A.	N.A.	N.A.	N.A.	N.A.	N.A.	N.A.
---------	-------	------	------	------	------	------	------	------	------	------	------	------	------	------	------



Overall: 18"D 18¼"W 38½"H
Seat: 30"H

Sled Base Bar-Height Stool with Polypropylene Insert

COEL400INSERT	N.A.	N.A.	N.A.	N.A.	N.A.	N.A.	N.A.	N.A.	N.A.	N.A.	N.A.	N.A.	N.A.	N.A.	\$592
---------------	------	------	------	------	------	------	------	------	------	------	------	------	------	------	-------



Overall: 18"D 18¼"W 38½"H
Seat: 30"H

Sled Base Bar-Height Stool with Upholstered Insert

COEL400UPH	\$723	\$709	\$714	\$722	\$747	\$764	\$783	\$796	\$820	\$853	\$957	\$955	\$984	N.A.
------------	-------	-------	-------	-------	-------	-------	-------	-------	-------	-------	-------	-------	-------	------

COM/yds = ¾, COL/sq ft = 15



Overall: 18"D 18¼"W 38½"H
Seat: 30"H

Guest/ Side/Stack Seating

Enea Lottus Post Stools Post Base

DESIGN LIEVORE ALTHERR MOLINA

SIN 711.18

Tip: Post stool seat swivels.

Tip: For Customer's Own Material or Leather, see necessary requirements, important processing instructions, and ordering information.

▶Page 262

Standard Includes	Required to Specify
-------------------	---------------------

- | | |
|---|---|
| <ul style="list-style-type: none"> ▶ Need help? Product details, see <i>Coalesse Seating and Outdoor Specification Guide</i> • Base and frame constructed of painted steel tubing • Seat and back: polypropylene • Insert, if selected: polypropylene or upholstery • Foot ring: paint to match the base and frame | <ul style="list-style-type: none"> 1 Style number 2 Plastic color number for seat and back 3 Fabric or leather color number for upholstery insert, if selected 4 Paint color number for base and frame 5 Options, if selected (see below) ▶ See <i>Surface Materials</i>, page 260. |
|---|---|

Options	Price	Required to Specify
---------	-------	---------------------

Surface Materials	Base <ul style="list-style-type: none"> • Grade 1 paint • Grade 3 paint 	No cost +\$105	Specify paint color number. Specify paint color number.
	Acrylic backer <ul style="list-style-type: none"> • Chair with upholstered insert 	+\$ 6	Specify with acrylic backer. ▶ See <i>Surface Materials</i> , page 260.
	<ul style="list-style-type: none"> • Polished trivalent chrome ring 	+\$ 60	Specify with trivalent chrome ring.

Related Products	<ul style="list-style-type: none"> • Café and conference tables ▶ Page 230 and 231
-------------------------	---

Specification Information													
---------------------------	--	--	--	--	--	--	--	--	--	--	--	--	--

Style Number	Base Prices													Leather Grades:			Polypropylene
	Fabric Grades:													COL	C	E	
	COM	6	7	8	9	10	11	12	13	14							

Post Base Counter-Height Stool with No Insert

COEL700	\$987	N.A.	N.A.	N.A.	N.A.	N.A.	N.A.	N.A.	N.A.	N.A.	N.A.	N.A.	N.A.	N.A.	N.A.	N.A.
---------	-------	------	------	------	------	------	------	------	------	------	------	------	------	------	------	------

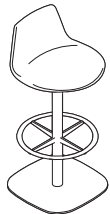

Overall: 19¾"D 19¾"W 34½"H
Seat: 26¼"H

Post Base Counter-Height Stool with Polypropylene Insert

COEL700INSERT	N.A.	N.A.	N.A.	N.A.	N.A.	N.A.	N.A.	N.A.	N.A.	N.A.	N.A.	N.A.	N.A.	N.A.	N.A.	N.A.	\$1016
---------------	------	------	------	------	------	------	------	------	------	------	------	------	------	------	------	------	--------

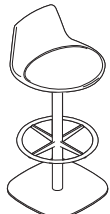

Overall: 19¾"D 19¾"W 34½"H
Seat: 26¼"H

Post Base Counter-Height Stool with Upholstered Insert

COEL700UPH	\$1147	\$1133	\$1138	\$1146	\$1171	\$1188	\$1207	\$1220	\$1244	\$1277	\$1381	\$1379	\$1408	N.A.
------------	--------	--------	--------	--------	--------	--------	--------	--------	--------	--------	--------	--------	--------	------

COM/yds = ¾, COL/sq ft = 15

▶ Specification Information, continued on next page

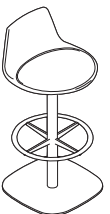

Overall: 19¾"D 19¾"W 34½"H
Seat: 26¼"H

Enea Lottus Post Stools Post Base

DESIGN LIEVORE ALTHERR MOLINA

SIN 711.18

► Specification Information, continued from previous page

Specification Information

Style Number	Base Prices													
	Fabric Grades:													Leather Grades:
	COM	6	7	8	9	10	11	12	13	14	COL	C	E	

Post Base Bar-Height Stool with No Insert

COEL600	\$ 998	N.A.	N.A.	N.A.	N.A.	N.A.	N.A.	N.A.	N.A.	N.A.	N.A.	N.A.	N.A.	N.A.	N.A.
---------	--------	------	------	------	------	------	------	------	------	------	------	------	------	------	------

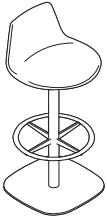

Overall: 19¾"D 19¾"W 38½"H
Seat: 30"H

Post Base Bar-Height Stool with Polypropylene Insert

COEL600INSERT	N.A.	N.A.	N.A.	N.A.	N.A.	N.A.	N.A.	N.A.	N.A.	N.A.	N.A.	N.A.	N.A.	N.A.	\$1028
---------------	------	------	------	------	------	------	------	------	------	------	------	------	------	------	--------

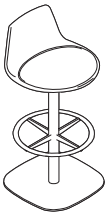

Overall: 19¾"D 19¾"W 38½"H
Seat: 30"H

Post Base Bar-Height Stool with Upholstered Insert

COEL600UPH	\$1160	\$1146	\$1151	\$1159	\$1184	\$1201	\$1220	\$1233	\$1257	\$1290	\$1394	\$1392	\$1421	N.A.
------------	--------	--------	--------	--------	--------	--------	--------	--------	--------	--------	--------	--------	--------	------

COM/yds = ¾, COL/sq ft = 15

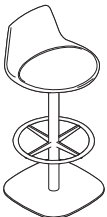

Overall: 19¾"D 19¾"W 38½"H
Seat: 30"H

Guest/Side/Stack Seating

Kathryn Chairs

DESIGN STUDIO B

SIN 711.18

Tip: Fabrics and leathers will appear loose with comfort wrinkles when upholstered.

Tip: Recommended leathers are Elmosoft Grade C and Elmorustical Grade E.

Tip: Special color match, consult Customer Service.

Tip: For Customer's Own Material or Leather, see necessary requirements, important processing instructions, and ordering information.

▶ Page 262

Standard Includes		Required to Specify
▶ Need help? Product details, see <i>Coalesse Seating and Outdoor Specification Guide</i>	<ul style="list-style-type: none"> • Frame: European beech hardwood • Mortise and tenon joinery • Upholstery: multiple densities of laminated polyurethane foam and polyester fiber • Glides: non-adjustable 	1 Style number 2 Number of fabrics if contrasting fabric style number is selected 3 Fabric or leather color number for upholstery 4 Wood color number for frame ▶ See <i>Hardwood and Veneer Matrix</i> , page 274 5 Options, if selected (see below) ▶ See <i>Surface Materials</i> , page 260.

Options	Price	Required to Specify
Surface Materials		
• Contrasting fabric	+\$118 per fabric	Add suffix K to the style number and select fabric color number.
• Contrasting welt	+\$134	Specify with <i>contrasting welt</i> and select fabric color number.
Acrylic backer		
• Chair with open back	+\$ 8	Specify with <i>acrylic backer</i> .
• Chair with upholstery	+\$ 12	Specify with <i>acrylic backer</i> . ▶ See <i>Surface Materials</i> , page 260.

Specification Information													
Style Number	Base Prices											Leather Grades:	
	Fabric Grades:											COL	C
	COM	6	7	8	9	10	11	12	13	14			

Wood with Open Back Chair

2540-1	\$ 973	\$ 967	\$ 978	\$ 984	\$ 997	\$1010	\$1048	\$1075	\$1111	\$1183	\$1227	\$1504	\$1570
--------	--------	--------	--------	--------	--------	--------	--------	--------	--------	--------	--------	--------	--------

COM/yds = 1, COL/sq ft = 18

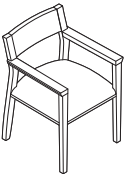

Overall: 22¾"D 22¾"W 32"H
 Inside: 19"D 18½"W 14"H
 Seat: 18"H
 Arm: 26"H

Wood/Upholstered with Panel Back Chair

2542-1	\$1015	\$1018	\$1031	\$1044	\$1062	\$1082	\$1139	\$1202	\$1228	\$1289	\$1261	\$1700	\$1803
--------	--------	--------	--------	--------	--------	--------	--------	--------	--------	--------	--------	--------	--------

COM/yds = 1½, COL/sq ft = 27

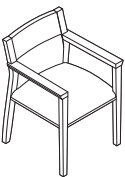

Overall: 22¾"D 22¾"W 32"H
 Inside: 19"D 18½"W 14"H
 Seat: 18"H
 Arm: 26"H

Fully Upholstered Back

2547-1	\$1144	\$1147	\$1165	\$1173	\$1191	\$1211	\$1268	\$1306	\$1366	\$1433	\$1390	\$1829	\$1932
--------	--------	--------	--------	--------	--------	--------	--------	--------	--------	--------	--------	--------	--------

COM/yds = 1½, COL/sq ft = 27

▶ Specification Information, continued on next page

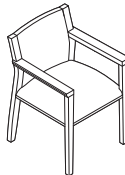

Overall: 22¾"D 22¾"W 32"H
 Inside: 19"D 18½"W 14"H
 Seat: 18"H
 Arm: 26"H

Kathryn Chairs

DESIGN STUDIO B

SIN 711.18

► Specification Information, continued from previous page

Specification Information

Style Number	Base Prices											Leather Grades:		
	Fabric Grades:											COL	C	E
	COM	6	7	8	9	10	11	12	13	14				

Fully Upholstered Back with Ribbed Upholstery

2547-1RIBD	\$1180	\$1183	\$1201	\$1209	\$1227	\$1247	\$1304	\$1342	\$1402	\$1469	\$1426	\$1865	\$1968
------------	--------	--------	--------	--------	--------	--------	--------	--------	--------	--------	--------	--------	--------

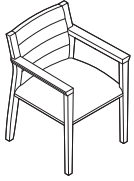

Last Minute Stools by Viccarbe

DESIGN PATRICIA URQUILOA

SIN 711.18

Tip: Fabrics and leathers will appear loose with comfort wrinkles when upholstered.

Tip: For Customer's Own Material or Leather, see necessary requirements, important processing instructions, and ordering information.

▶ Page 262

Standard Includes		Required to Specify
▶ Need help? Product details, see <i>Coalesse Seating and Outdoor Specification Guide</i>	<ul style="list-style-type: none"> Upholstery for stool: fabric or leather Frame: polished trivalent chrome 	1 Style number 2 Fabric or leather color number for upholstery 3 Options, if selected (see below) ▶ See <i>Surface Materials</i> , page 260.

Options	Price	Required to Specify
Surface Materials Acrylic backer <ul style="list-style-type: none"> Backer 	+\$6	Specify with acrylic backer. ▶ See <i>Surface Materials</i> , page 259.

Specification Information

Style Number	Base Prices											Leather Grades:		
	Fabric Grades:											COL	C	E
	COM	6	7	8	9	10	11	12	13	14				

Medium Stool

COLMS25	\$1125	\$1111	\$1116	\$1124	\$1149	\$1166	\$1185	\$1198	\$1222	\$1255	\$1359	\$1618	\$1672
---------	--------	--------	--------	--------	--------	--------	--------	--------	--------	--------	--------	--------	--------

COM/yds = 3/4, COL/sq ft = 17

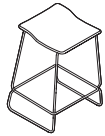

Overall: 17"D 17¼"W 26½"H
Seat: 23¾"H

High Stool

COLMS30	\$1174	\$1160	\$1165	\$1173	\$1198	\$1215	\$1234	\$1247	\$1271	\$1304	\$1408	\$1667	\$1721
---------	--------	--------	--------	--------	--------	--------	--------	--------	--------	--------	--------	--------	--------

COM/yds = 3/4, COL/sq ft = 17

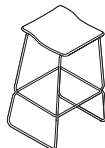

Overall: 17"D 17¼"W 31½"H
Seat: 29¾"H

Lox Stools

DESIGN PEARSONLLOYD

SIN 711.18

Tip: Due to the design and construction techniques of the Lox stools only certain textiles can be successfully applied, therefore all COM fabrics must be submitted to Coalesse for approval prior to order acceptance.

Tip: For Customer's Own Material or Leather, see necessary requirements, important processing instructions, and ordering information.
▶Page 262

Tip: In high-traffic applications, scuff marks on footrest may be visible in white gloss.



Overall: 17"D 17"W 28"-32"H
Seat: 26"-30"H



Overall: 17"D 17"W 31"-34"H
Seat: 29"-33"H

Standard Includes		Required to Specify
▶Need help? Product details, see <i>Coalesse Seating and Outdoor Specification Guide</i>	<ul style="list-style-type: none"> • Shell and ribbon-shaped footrest: plastic • Base: 9251 Brushed Chrome • Seat: upholstered foam • Swivel mechanism • Height-adjustable button under seat • Felt glides 	1 Style number 2 Plastic color number for shell: 6347 Black Gloss 6348 White Gloss 3 Fabric or leather color number for upholstery 4 Options, if selected (see below) ▶See <i>Surface Materials</i> , page 260.

Options	Price	Required to Specify
Surface Materials • Acrylic backer • Backer	+ \$6	Specify with acrylic backer. ▶See <i>Surface Materials</i> , page 259.

Specification Information

Style Number	Base Prices														Leather Grades:		
	Fabric Grades:														COL	C	E
	COM	6	7	8	9	10	11	12	13	14							

Counter-Height Stool

COLX200	\$1265	\$1251	\$1256	\$1264	\$1289	\$1306	\$1325	\$1338	\$1362	\$1395	\$1499	\$1449	\$1473
COM/yds = 3/4, COL/sq ft = 13													

Bar-Height Stool

COLX210	\$1320	\$1306	\$1311	\$1319	\$1344	\$1361	\$1380	\$1393	\$1417	\$1450	\$1554	\$1504	\$1528
COM/yds = 3/4, COL/sq ft = 13													

Switch Guest

DESIGN E00S

SIN 711.18

Tip: Fabrics and leathers will appear loose with comfort wrinkles when upholstered.

Tip: Recommended leathers are Elmosoft Grade C and Elmorustical Grade E.

Tip: Special color match, consult Customer Service.

Tip: For Customer's Own Material or Leather, see necessary requirements, important processing instructions, and ordering information.
▶Page 262

Tip: Pricing based on highest grade textile specified.

Tip: Steel springs allow back to flex to match occupant's back shape.

Tip: Upholstered arm caps fit firmly on arms in coordinating textiles, COM yardage required 1/4 yards, COL square feet required 4 1/2 (1519 and 1529 only).

Tip: Glide on sled base chair has a felt pad made for hard floors. Movement on carpet is more difficult.

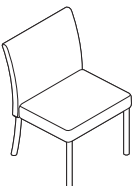

Overall: 22 1/2"D 21 1/2"W 33 1/2"H
Inside: 18 1/2"D 19 1/4"W 15 1/2"H
Seat: 18 1/2"H

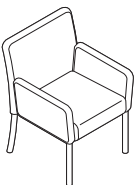

Overall: 22 1/2"D 25 3/4"W 33 1/2"H
Inside: 18 1/2"D 19"W 15 1/2"H
Seat: 18 1/2"H
Arm: 26 1/2"H

Standard Includes

- ▶Need help? Product details, see *Coalesse Seating and Outdoor Specification Guide*
- Frame: Constructed of steel tubing and bar stock
- Arms: solid steel rod and bar stock
- Upholstery: Back and seat are molded foam and fiber
- Legs: matte chrome (M) or polished chrome (PC) leg finish

Required to Specify

- 1 Style number
 - 2 Number of fabrics if contrasting fabric style number is selected
 - 3 Fabric or leather color number for upholstery on seat
 - 4 Options, if selected (see below)
- ▶See *Surface Materials*, page 260

Options

Surface Materials	Options	Price	Required to Specify
	• Contrasting fabric	+\$118 per fabric	Add suffix K to the style number and select fabric color number.
	Acrylic backer		
	• Armless chair and lowback sledbase	+\$ 17	Specify with acrylic backer.
	• Highback sledbase	+\$ 19	Specify with acrylic backer.
	• Arm chair	+\$ 24	Specify with acrylic backer. ▶See <i>Surface Materials</i> , page 260

Specification Information

Style Number	Base Prices											Leather Grades:		
	Fabric Grades:											COL	C	E
	COM	6	7	8	9	10	11	12	13	14				

Armless Chairs

1500M	\$1160	\$1160	\$1170	\$1187	\$1238	\$1271	\$1309	\$1336	\$1383	\$1448	\$1427	\$2129	\$2256
1500PC	\$1203	\$1203	\$1213	\$1230	\$1281	\$1314	\$1352	\$1379	\$1426	\$1491	\$1470	\$2172	\$2300

COM/yds = 1 1/2, COL/sq ft = 27

Arm Chairs

1510M	\$1328	\$1328	\$1344	\$1372	\$1457	\$1512	\$1575	\$1620	\$1698	\$1807	\$1565	\$2763	\$2978
1510PC	\$1376	\$1376	\$1392	\$1420	\$1505	\$1560	\$1623	\$1668	\$1746	\$1855	\$1613	\$2798	\$3026

COM/yds = 2 1/2, COL/sq ft = 45

▶Specification Information, continued on next page

Coalesse

Switch Guest

DESIGN EOOS

SIN 711.18

► Specification Information, continued from previous page

Specification Information

Style Number	Base Prices											Leather Grades:		
	Fabric Grades:											COL	C	E
	COM	6	7	8	9	10	11	12	13	14				

Low-Back Sled Base Chairs

1519M	\$1359	\$1359	\$1372	\$1394	\$1462	\$1506	\$1557	\$1592	\$1655	\$1742	\$1613	\$2554	\$2734
1519PC	\$1388	\$1388	\$1401	\$1423	\$1491	\$1535	\$1586	\$1621	\$1684	\$1771	\$1642	\$2584	\$2763

COM/yds = 2, COL/sq ft = 36

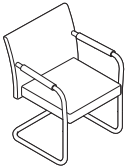

Overall: 23½"D 23¼"W 34¼"H
 Inside: 18"D 17¾"W 15½"H
 Seat: 18½"H
 Arm: 26½"H

High-Back Sled Base Chairs

1529M	\$1499	\$1499	\$1514	\$1539	\$1615	\$1665	\$1722	\$1762	\$1833	\$1931	\$1750	\$2819	\$3012
1529PC	\$1542	\$1542	\$1557	\$1582	\$1658	\$1708	\$1765	\$1805	\$1876	\$1974	\$1783	\$2857	\$3049

COM/yds = 2¼, COL/sq ft = 41

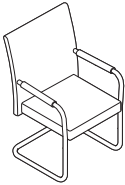

Overall: 23½"D 24"W 38½"H
 Inside: 17¾"D 17¾"W 15½"H
 Seat: 18½"H
 Arm: 26½"H

Guest/ Side/Stack Seating

Switch Stools without Arms

DESIGN E00S

SIN 711.18

Tip: Fabrics and leathers will appear loose with comfort wrinkles when upholstered.

Tip: Recommended leathers are Elmosoft Grade C and Elmorustical Grade E.

Tip: Special color match, consult Customer Service.

Tip: Pricing based on highest grade textile specified.

Tip: For Customer's Own Material or Leather, see necessary requirements, important processing instructions, and ordering information.

► Page 262

Standard Includes		Required to Specify	
► Need help? Product details, see <i>Coalesse Seating and Outdoor Specification Guide</i>	<ul style="list-style-type: none"> Frame: Constructed of steel tubing and bar stock. Upholstery: back foam are molded around the frame components. Seat foam is molded with "comfort pockets" Legs: matte chrome (M) or polished chrome (PC) leg finish 	<ol style="list-style-type: none"> Style number Number of fabrics if contrasting fabric style number is selected Fabric or leather color number for upholstery Options, if selected (see below) 	► See <i>Surface Materials</i> , page 260.
Options		Required to Specify	
Surface Materials	<ul style="list-style-type: none"> Contrasting fabric 	+\$118 per fabric	Add suffix K to the style number and select fabric color number.
	Acrylic backer		
	<ul style="list-style-type: none"> Backer 	+\$ 10	Specify with <i>acrylic backer</i> . ► See <i>Surface Materials</i> , page 259.
Related Products	<ul style="list-style-type: none"> Guest seating Occasional tables 		► Page 204 ► See <i>GSA Volume 5b Specification Guide</i> .

Specification Information

Style Number	Base Prices											Leather Grades:		
	Fabric Grades:											COL	C	E
	COM	6	7	8	9	10	11	12	13	14				

Counter-Height Stools

1404M	\$1260	\$1260	\$1268	\$1282	\$1324	\$1352	\$1384	\$1406	\$1445	\$1500	\$1540	\$2109	\$2218
1404PC	\$1285	\$1285	\$1293	\$1307	\$1349	\$1377	\$1409	\$1431	\$1470	\$1525	\$1565	\$2134	\$2250

COM/yds = 1¼, COL/sq ft = 23

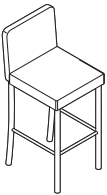

Overall: 19"D 16"W 38"H
Inside: 15"D 15"W 11¾"H
Seat: 27¾"H

Bar-Height Stools

1405M	\$1297	\$1297	\$1305	\$1319	\$1361	\$1389	\$1421	\$1443	\$1482	\$1537	\$1572	\$2146	\$2255
1405PC	\$1333	\$1333	\$1341	\$1355	\$1397	\$1425	\$1457	\$1479	\$1518	\$1573	\$1613	\$2182	\$2291

COM/yds = 1¼, COL/sq ft = 23

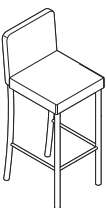

Overall: 19¾"D 16"W 41½"H
Inside: 15"D 15"W 11¾"H
Seat: 31¼"H

Coalesse

Switch Stools without Arms

DESIGN E00S

SIN 711.18

Montara650 Chairs

DESIGN LIEVORE ALTHERR MOLINA

SIN 711.18



Tip: Chairs stack six high.

Tip: Leathers will appear loose with comfort wrinkles when upholstered.

Tip: For Customer's Own Material or Leather, see necessary requirements, important processing instructions, and ordering information.

▶ Page 262

Standard Includes	Required to Specify
-------------------	---------------------

<ul style="list-style-type: none"> ▶ Need help? Product details, see <i>Coalesse Seating and Outdoor Specification Guide</i> 	<ul style="list-style-type: none"> • Seat and back: upholstery, if selected • Shell: wood shell, wood shell with upholstered seat, ¾ upholstery with wood shell, if selected: wood veneer grade 1 • Base: paint • Glides 	<ol style="list-style-type: none"> 1 Style number 2 Upholstery version (see below under Required Selections) 3 Contrasting fabric on ¾ or fully upholstered, if selected (see below under Required Selections) 4 Fabric and/or leather color number for seat and/or back, if selected 5 Wood finish on shell, if selected 6 Base type (see below under Required Selections) 7 Paint color number for base 8 Options, if selected (see below) <p>▶ See <i>Surface Materials</i>, page 260</p>
--	--	--

Required Selections	Price	Required to Specify
---------------------	-------	---------------------

Upholstery Version	<ul style="list-style-type: none"> • Wood shell • Wood shell with upholstered seat • Wood shell with ¾ upholstery • Fully upholstered 	Price below Prices at right Prices at right Prices at right	Specify with <i>wood seat and back</i> . Specify with <i>upholstered seat, wood back</i> . Specify with <i>¾ upholstered</i> . Specify with <i>upholstered seat and back</i> .
Contrasting Fabric on ¾ and Fully Upholstered	<ul style="list-style-type: none"> • Non contrasting fabric • Contrasting fabric 	No cost +\$ 118	Specify with <i>non contrasting fabric</i> . Specify with <i>contrasting fabric</i> .
Base Type	<ul style="list-style-type: none"> • 4-leg • Sled base • Sled base with cantilever arms • 4-leg base with loop arms 	No cost +\$ 50 +\$ 99 +\$ 120	Specify with <i>4-leg</i> . Specify with <i>sled base</i> . Specify with <i>sled cantilever arm</i> . Specify with <i>4-leg loop arm</i> .

Options	Price	Required to Specify
---------	-------	---------------------

Surface Materials	Base, armless <ul style="list-style-type: none"> • Polished trivalent chrome base • Grade 3 paint 	+\$ 50 +\$ 75	Specify with <i>polished trivalent chrome</i> . Specify paint color number.
	Base, with arms <ul style="list-style-type: none"> • Polished trivalent chrome base Shell • Grade 3 paint 	+\$169 +\$ 75	Specify with <i>polished trivalent chrome</i> . Specify paint color number.
	Wood shell <ul style="list-style-type: none"> • Grade 1 wood veneer • Grade 2 wood veneer 	No cost +\$ 60	Specify with <i>VP01 Oak Light, VP03 Black Oak, or VP05 White Oak</i> . Specify with <i>VP02 Smoked Oak or VP04 Grey Oak</i> .
	Acrylic backer <ul style="list-style-type: none"> • Seat • Seat and back 	+\$ 8 +\$ 17	Specify with <i>acrylic backer</i> . Specify with <i>acrylic backer</i> .

Related Products	<ul style="list-style-type: none"> • Tables • Stools 	▶ See <i>GSA Volume 5b Specification Guide</i> . ▶ Pages 212
-------------------------	--	---

Montara650 Chairs

DESIGN LIEVORE ALTHERR MOLINA

SIN 711.18

Specification Information



4-leg, armless
Overall: 20½"W x 20½"D x 31"H
Seat: 17½"H



4-leg with loop arms
Overall: 24"W x 20½"D x 31"H
Seat: 17½"H
Arms: 25¼"H



Sled base, armless
Overall: 20½"W x 20½"D x 31"H
Seat: 17½"H



Sled base with cantilever arms
Overall: 22"W x 20½"D x 31"H
Seat: 17½"H
Arms: 25"H

Style
Number

Base Price

Wood Shell Chair

COSFZCH	Seat	\$525
---------	------	-------

Style
Number

Base Prices

Fabric Grades:

COM	6	7	8	9	10	11	12	13	14	Leather Grades:		
										COL	C	E

Wood Shell Chair with Upholstered Seat

COSFZCH	Seat	\$665	\$644	\$647	\$653	\$672	\$684	\$697	\$707	\$724	\$748	\$877	\$782	\$815
---------	------	-------	-------	-------	-------	-------	-------	-------	-------	-------	-------	-------	-------	-------

Wood Shell Chair with ¾ Upholstery

COSFZCH	Seat	\$765	\$744	\$747	\$753	\$772	\$784	\$797	\$807	\$824	\$848	\$977	\$882	\$915
	Back	+\$40	+\$19	+\$22	+\$28	+\$47	+\$59	+\$72	+\$82	+\$99	+\$123	+\$81	+\$157	+\$190

Fully Upholstered Chair

COSFZCH	Seat	\$690	\$669	\$672	\$678	\$697	\$709	\$722	\$732	\$749	\$773	\$902	\$807	\$840
	Back	+\$40	+\$37	+\$44	+\$56	+\$93	+\$117	+\$145	+\$164	+\$198	+\$246	+\$81	+\$346	+\$417

Guest/Side/Stack Seating

Montara650 Lounge Chair

DESIGN LIEVORE ALTHERR MOLINA

SIN 711.18



Tip: Leathers will appear loose with comfort wrinkles when upholstered.

Tip: For Customer's Own Material or Leather, see necessary requirements, important processing instructions, and ordering information.

► See *Coalesse Surface Materials Reference Guide* and online fabric database at <http://fabric.coalesse.com>.

Standard Includes	Required to Specify
-------------------	---------------------

<p>► Need help? Product details, see <i>Coalesse Seating and Outdoor Specification Guide</i></p> <ul style="list-style-type: none"> • Seat and back upholstery, if selected • Shell: wood shell with ³/₄ upholstery or wood shell with upholstered seat, if selected: wood veneer grade 1 • Sled base: grade 1 paint • Glides 	<ol style="list-style-type: none"> 1 Style number 2 Upholstery version (see below under Required Selections) 3 Contrasting fabric on ³/₄ upholstered or fully upholstered, if selected (see below under Required Selections) 4 Fabric and/or leather color number for seat and/or back, if selected 5 Wood finish on shell, if selected 6 Paint color number for base 7 Options, if selected (see below) <p>► See <i>Coalesse Surface Materials Reference Guide</i>.</p>
---	---

Required Selections	Price	Required to Specify
---------------------	-------	---------------------

<p>Upholstery Version</p> <ul style="list-style-type: none"> • Wood shell with ³/₄ upholstery • Wood shell with upholstered seat • Fully upholstered 	<p>Prices at right Prices at right Prices at right</p>	<p>Specify with ³/₄ upholstered. Specify with upholstered seat and wood back. Specify with upholstered seat and back.</p>
<p>Contrasting Fabric on Fully Upholstered</p> <ul style="list-style-type: none"> • Non contrasting fabric • Contrasting fabric 	<p>No cost +\$118</p>	<p>Specify with non contrasting fabric. Specify with contrasting fabric.</p>

Options	Price	Required to Specify
---------	-------	---------------------

<p>Surface Materials</p> <p>Base</p> <ul style="list-style-type: none"> • Grade 3 paint • Polished trivalent chrome base <p>Shell</p> <ul style="list-style-type: none"> • Grade 1 wood veneer • Grade 2 wood veneer <p>Acrylic backer</p> <ul style="list-style-type: none"> • Seat • Seat and back 	<p>+\$ 75 +\$ 75 No cost +\$ 60 +\$ 8 +\$ 17</p>	<p>Specify paint color number. Specify with polished trivalent chrome. Specify with VP01 Oak Light, VP03 Black Oak, or VP05 White Oak. Specify with VP02 Smoked Oak or VP04 Grey Oak. Specify with acrylic backer. Specify with acrylic backer.</p>
--	--	---

<p>Related Products</p> <ul style="list-style-type: none"> • Guest seating • Stools • Café tables • Occasional tables 	<p>► See <i>Coalesse Seating and Outdoor Specification Guide</i>. ► See <i>Coalesse Seating and Outdoor Specification Guide</i>. ► See <i>Coalesse Tables, Storage, and Accessories Specification Guide</i>. ► See <i>Coalesse Tables, Storage, and Accessories Specification Guide</i>.</p>
--	--

Coalesse

Montara650 Lounge Chair

DESIGN LIEVORE ALTHERR MOLINA

SIN 711.18



Overall: 25½"D x 29"W x 21¼"H
Seat: 16"

Overall: 25½"D x 29"W x 21¼"H
Seat: 16"

Overall: 25½"D x 29"W x 21¼"H
Seat: 16"

Specification Information

Style Number	Base Prices													
	Fabric Grades:											Leather Grades:		
	COM	6	7	8	9	10	11	12	13	14	COL	C	E	

Wood Shell Lounge Chair with Upholstered Seat

COSFZLC	Seat	\$ 915	\$ 913	\$ 920	\$ 933	\$ 971	\$ 995	\$1023	\$1043	\$1078	\$1126	\$1127	\$1068	\$1108
COM/yds = 1, COL/sq ft = 9														

Wood Shell Lounge Chair with ¾ Upholstered Back

COSFZLC	Seat	\$1016	\$1013	\$1020	\$1033	\$1071	\$1095	\$1123	\$1143	\$1178	\$1226	\$1227	\$1168	\$1208
	Back	+\$ 40	+\$ 29	+\$ 34	+\$ 43	+\$ 72	+\$ 90	+\$ 111	+\$126	+\$152	+\$188	+\$ 81	+\$386	+\$465
COM/yds = 1, COL/sq ft = 17														

Fully Upholstered Lounge Chair

COSFZLC	Seat	\$ 941	\$ 938	\$ 945	\$ 958	\$ 996	\$1020	\$1048	\$1068	\$ 1103	\$ 1151	\$1152	\$1093	\$ 1133
	Back	+\$ 40	+\$ 57	+\$ 68	+\$ 87	+\$143	+\$180	+\$222	+\$252	+\$304	+\$377	+\$ 81	+\$482	+\$582
COM/yds = 2½, COL/sq ft = 32														

Guest/ Side/Stack Seating

Montara650 Stools

DESIGN LIEVORE ALTHERR MOLINA

SIN 711.18



Tip: Leathers will appear loose with comfort wrinkles when upholstered.

Tip: For Customer's Own Material or Leather, see necessary requirements, important processing instructions, and ordering information.

► Page 262



Stool at bar height
Overall: 18¾"W x 19½"D x 39½"H
Seat: 30"H

COM yardage:
Seat: ¾ yards
Fully uph. back: 1¼ yards

COL yardage:
Seat: 7 yards
Fully uph. back: 18 yards

Overall: 18½"W x 19½"D x 35½"H
Seat: 26"H

Standard Includes

- Need help? Product details, see *Coalesse Seating and Outdoor Specification Guide*
- Seat and back upholstery, if selected
- Shell: wood shell or wood shell with upholstered seat, if selected: wood veneer grade 1
- Sled base: grade 1 paint
- Glides

Required to Specify

- 1 Style number
 - 2 Application (see below under Required Selections)
 - 3 Upholstery version (see below under Required Selections)
 - 4 Contrasting fabric on fully upholstered, if selected (see below under Required Selections)
 - 5 Fabric and/or leather color number for seat and/or back, if selected
 - 6 Wood finish on shell, if selected
 - 7 Paint color number for base
 - 8 Options, if selected (see below)
- See *Surface Materials*, page 260.

Required Selections

Application	Required Selections	Price	Required to Specify
Application	<ul style="list-style-type: none"> • Counter height • Bar height 	No cost +\$ 50	Specify with counter height. Specify with bar height.
Upholstery Version	<ul style="list-style-type: none"> • Wood shell • Wood shell with upholstered seat • Fully upholstered 	Price below Prices at right Prices at right	Specify with wood seat and back. Specify with upholstered seat and wood back. Specify with upholstered seat and back.
Contrasting Fabric on Fully Upholstered	<ul style="list-style-type: none"> • Non contrasting fabric • Contrasting fabric 	No cost +\$118	Specify with non contrasting fabric. Specify with contrasting fabric.

Options

Surface Materials	Options	Price	Required to Specify
Surface Materials	Base		
	<ul style="list-style-type: none"> • Grade 3 paint • Polished trivalent chrome base 	+\$ 75 +\$ 75	Specify paint color number. Specify with polished trivalent chrome.
Surface Materials	Shell		
	<ul style="list-style-type: none"> • Grade 1 wood veneer • Grade 2 wood veneer 	No cost +\$ 60	Specify with VP01 Oak Light, VP03 Black Oak, or VP05 White Oak. Specify with VP02 Smoked Oak or VP04 Grey Oak.
Surface Materials	Acrylic Backer		
	<ul style="list-style-type: none"> • Seat • Seat and back 	+\$ 8 +\$ 17	Specify with acrylic backer. Specify with acrylic backer.

Related Products	Options	Required to Specify
<ul style="list-style-type: none"> • Tables • Chairs • Café tables • Occasional tables 		<ul style="list-style-type: none"> ► See <i>GSA Volume 5b Specification Guide</i>. ► Page 208 ► See <i>GSA Volume 5b Specification Guide</i>. ► See <i>GSA Volume 5b Specification Guide</i>.

Specification Information

Style Number	Base Price
--------------	------------

Wood Shell Stool

COSFZST	\$725
---------	-------

► Specification Information, continued on next page

Montara650 Stools

DESIGN LIEVORE ALTHERR MOLINA

SIN 711.18

► Specification Information, continued from previous page

Specification Information

Style Number	Base Prices											Leather Grades:		
	Fabric Grades:											COL	C	E
	COM	6	7	8	9	10	11	12	13	14				

Wood Shell Stool with Upholstered Seat

COSFZST	Seat	\$865	\$844	\$847	\$853	\$872	\$884	\$897	\$907	\$924	\$948	\$1077	\$1018	\$1058
---------	------	-------	-------	-------	-------	-------	-------	-------	-------	-------	-------	--------	--------	--------



Overall: 18½"W x 19½"D x 35½"H
Seat: 26"H

Fully Upholstered Stool

COSFZST	Seat	\$890	\$869	\$872	\$878	\$897	\$909	\$922	\$932	\$949	\$973	\$1142	\$1007	\$1040
	Back	+\$40	+\$37	+\$44	+\$56	+\$93	+\$117	+\$145	+\$164	+\$198	+\$246	+\$292	+\$346	+\$417

Overall: 18½"W x 19½"D x 35½"H
Seat: 26"H

Montara650 Rocker

DESIGN LIEVORE ALTHERR MOLINA

SIN 711.18



Tip: Leathers will appear loose with comfort wrinkles when upholstered.

Tip: For Customer's Own Material or Leather, see necessary requirements, important processing instructions, and ordering information.

▶ See page 260.



With arms

Standard Includes	Required to Specify
-------------------	---------------------

<p>▶ Need help? Product details, see <i>Coalesse Seating and Outdoor Specification Guide</i></p> <ul style="list-style-type: none"> • Seat and back upholstery, if selected • Shell: wood shell with ³/₄ upholstery or wood shell with upholstered seat, if selected: wood veneer grade 1 • Base: paint • Runners: solid oak in clear finish 	<ol style="list-style-type: none"> 1 Style number 2 Upholstery version (see below under Required Selections) 3 Contrasting fabric on ³/₄ upholstered or fully upholstered, if selected (see below under Required Selections) 4 Fabric and/or leather color number for seat and/or back, if selected 5 Wood finish on shell, if selected 6 Paint color number for base 7 Options, if selected (see below) <p>▶ See <i>Surface Materials</i>, page 260.</p>
--	--

Required Selections	Price	Required to Specify
---------------------	-------	---------------------

<p>Upholstery Version</p> <ul style="list-style-type: none"> • Wood shell with ³/₄ upholstery • Wood shell with upholstered seat • Fully upholstered 	<p>Prices at right Prices at right Prices at right</p>	<p>Specify with ³/₄ upholstered. Specify with upholstered seat and wood back. Specify with upholstered seat and back.</p>
<p>Contrasting Fabric on ³/₄ and Fully Upholstered</p> <ul style="list-style-type: none"> • Non contrasting fabric • Contrasting fabric 	<p>No cost +\$ 118</p>	<p>Specify with non contrasting fabric. Specify with contrasting fabric.</p>
<p>Arm Type</p> <ul style="list-style-type: none"> • Armless • With arms 	<p>No cost +\$100</p>	<p>Specify with no arms. Specify with arms.</p>

Options	Price	Required to Specify
---------	-------	---------------------

<p>Surface Materials</p> <p>Base, armless</p> <ul style="list-style-type: none"> • Polished trivalent chrome base • Lux Coatings <p>Base, with arms</p> <ul style="list-style-type: none"> • Polished trivalent chrome base • Lux Coatings <p>Wood shell</p> <ul style="list-style-type: none"> • Grade 1 wood veneer • Grade 2 wood veneer <p>Acrylic backer</p> <ul style="list-style-type: none"> • Seat • Seat and back 	<p>+\$ 75 +\$ 75</p> <p>+\$ 168 +\$ 75</p> <p>No cost +\$ 60</p> <p>+\$ 8 +\$ 17</p>	<p>Specify with polished trivalent chrome. Specify Lux Coatings color number.</p> <p>Specify with polished trivalent chrome. Specify Lux Coatings color number.</p> <p>Specify with VP01 Oak Light, VP03 Black Oak, or VP05 White Oak. Specify with VP02 Smoked Oak or VP04 Grey Oak.</p> <p>Specify with acrylic backer. Specify with acrylic backer.</p>
<p>Related Products</p> <ul style="list-style-type: none"> • Guest seating • Stools • Café tables • Occasional tables 	<p>▶ Page 208 ▶ Page 212 ▶ See <i>GSA Volume 5b Specification Guide</i>. ▶ See <i>GSA Volume 5b Specification Guide</i>.</p>	

Coalesse

Montara650 Rocker

DESIGN LIEVORE ALTHERR MOLINA

SIN 711.18



Overall: 29"D x 28½"W x 30"H
Seat: 16"

Overall: 29"D x 28½"W x 30"H
Seat: 16"

Overall: 29"D x 28½"W x 30"H
Seat: 16"

Specification Information

Style Number	Base Prices													
	Fabric Grades:											Leather Grades:		
	COM	6	7	8	9	10	11	12	13	14	COL	C	E	

Wood Shell Rocker with Upholstered Seat

COSFZRC	Seat	\$1428	\$1426	\$1433	\$1446	\$1484	\$1508	\$1536	\$1556	\$1591	\$1639	\$1640	\$1581	\$1621
COM/yds = 1, COL/sq ft = 9														

Wood Shell Rocker with ¾ Upholstered Back

COSFZRC	Seat	\$1528	\$1526	\$1533	\$1546	\$1584	\$1608	\$1636	\$1656	\$1691	\$1739	\$1740	\$1681	\$1721
	Back	+\$ 40	+\$ 29	+\$ 34	+\$ 43	+\$ 72	+\$ 90	+\$111	+\$126	+\$152	+\$188	+\$ 81	+\$386	+\$465
COM/yds = 1, COL/sq ft = 17														

Fully Upholstered Rocker

COSFZRC	Seat	\$1453	\$1451	\$1458	\$1471	\$1509	\$1533	\$1561	\$1581	\$1616	\$1664	\$1665	\$1606	\$1646
	Back	+\$ 40	+\$ 57	+\$68	+\$ 87	+\$143	+\$180	+\$222	+\$252	+\$304	+\$377	+\$ 81	+\$482	+\$582
COM/yds = 2½, COL/sq ft = 32														

Guest/ Side/Stack Seating

Wrapp Chairs by Viccarbe

DESIGN MARK KRUSIN

SIN 711.18

Tip: Fabrics and leathers will appear loose with comfort wrinkles when upholstered.

Tip: Stacking is not recommended as the frame will dent the foam on the seat on which it is being stacked.

Tip: For Customer's Own Material or Leather, see necessary requirements, important processing instructions, and ordering information
 ▶ See *Coalesse Surface Materials Reference Guide*.

Standard Includes		Required to Specify
▶ Need help? Product details, see <i>Coalesse Seating and Outdoor Specification Guide</i>	<ul style="list-style-type: none"> Upholstery for chair: fabric or leather Frame: polished trivalent chrome 	1 Style number 2 Number of fabrics if contrasting fabric style number is selected 3 Fabric or leather color number for upholstery 4 Options, if selected (see below) ▶ See <i>Coalesse Surface Materials Reference Guide</i> .

Options	Price	Required to Specify
Surface Materials	<ul style="list-style-type: none"> Contrasting fabric 	+\$118 per fabric
	<ul style="list-style-type: none"> Acrylic backer Backer 	+\$ 12
		Add suffix K to the style number and select fabric color number. Specify with <i>acrylic backer</i> . ▶ See <i>Coalesse Surface Materials Reference Guide</i> .

Specification Information													
Style Number	Base Prices												
	Fabric Grades:												
	COM	6	7	8	9	10	11	12	13	14	Leather Grades:		
											COL	C	E

Four-Leg Chair

COWRP4LEG	\$1221	\$1221	\$1231	\$1248	\$1299	\$1332	\$1370	\$1397	\$1444	\$1509	\$1444	\$2014	\$2123
COM/yds = 1½, COL/sq ft = 33													



Overall: 21"D 25¼"W 29½"H
 Inside: 16"D 19½"W 17½"H
 Seat: 17½"H

Sled-Base Chair

COWRPSLD	\$1265	\$1265	\$1275	\$1292	\$1343	\$1376	\$1414	\$1441	\$1488	\$1553	\$1488	\$2058	\$2167
COM/yds = 1½, COL/sq ft = 33													

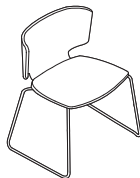

Overall: 20¼"D 24½"W 28¾"H
 Inside: 16"D 19½"W 17½"H
 Seat: 17½"H

Collaboration Seating

Bindu Conference Seating (SIN 711.18)	218
Chord Conference Seating (SIN 711.18)	220
SW_1 Conference Seating (SIN 711.18)	222

Bindu Conference Seating

DESIGN BRIAN KANE

SIN 711.18

Tip: Fabrics and leathers will appear loose with comfort wrinkles when upholstered.

Tip: For Customer's Own Material or Leather, see necessary requirements, important processing instructions, and ordering information.
▶ Page 262

Tip: Craft in upholstery cautions the use of stripes and patterns on Bindu. Please use fabric database when specifying.

Tip: For fabric with a large pattern and a specific pattern location is desired, contact Customer Service.

Standard Includes		Required to Specify
▶ Need help? Product details, see <i>Coalesse Seating and Outdoor Specification Guide</i>	<ul style="list-style-type: none"> Bent plywood frame Chair: fabric Molded polypropylene foam Base: 6205 Black Resin Dual wheel hard casters, conference Back tilt lock 	1 Style number 2 Fabric or leather color number for upholstery 3 Options, if selected (see below) ▶ See <i>Surface Materials</i> , page 260.

Options	Price	Required to Specify
Surface Materials	<ul style="list-style-type: none"> Acrylic backer +\$ 29 Mid-back chair +\$ 31 High-back chair 	Specify with acrylic backer. Specify with acrylic backer. ▶ See <i>Surface Materials</i> , page 260.
Base	<ul style="list-style-type: none"> 8046 Polished Aluminum (available on CO300 & CO400) +\$147 	Specify with 8046 Polished Aluminum.
Casters	<ul style="list-style-type: none"> Soft casters +\$ 23 	Specify with soft casters.

Specification Information													
Style Number	Base Prices											Leather Grades:	
	Fabric Grades:											COL	C
	COM	6	7	8	9	10	11	12	13	14			

Mid-Back Conference Chair

CO300	\$1451	\$1451	\$1471	\$1504	\$1606	\$1672	\$1748	\$1801	\$1895	\$2026	\$1622	\$2815	\$3034
COM/yds = 3, COL/sq ft = 66													



Overall: 25"D 25"W 35½"-40¼"H
 Inside: 18¾"D 18½"-19½"W 21"H
 Seat: 16"-20½"H
 Arm: 24¼"-29"H

High-Back Conference Chair

CO400	\$1693	\$1693	\$1715	\$1751	\$1861	\$1933	\$2015	\$2073	\$2175	\$2317	\$1856	\$3152	\$3390
COM/yds = 3.25, COL/sq ft = 72													



Overall: 25"D 25"W 45½"-50¼"H
 Inside: 18¾"D 18½"-19½"W 31"H
 Seat: 16"-20½"H
 Arm: 24¼"-29"H

Coalesse

Bindu Conference Seating

DESIGN BRIAN KANE

SIN 711.18

Chord Conference Seating

DESIGN MICHAEL SHIELDS

SIN 711.18

Tip: Fabrics and leathers will appear loose with comfort wrinkles when upholstered.

Tip: For Customer's Own Material or Leather, see necessary requirements, important processing instructions, and ordering information.
 ▶Page 262

Tip: Arm is cast from 100% recycled material then hand buffed to a mirror finish. Arm caps are molded in black.

Tip: List price based on highest fabric grade usage.

Tip: Contrasting option available only on 798-P and 796-P.

Standard Includes		Required to Specify
▶Need help? Product details, see <i>Coalesse Seating and Outdoor Specification Guide</i>	<ul style="list-style-type: none"> • Frame: hardwood plywood assembled into unibody structures utilizing interlocking finger joinery • Cushioning: <ul style="list-style-type: none"> - back: multiple laminations of high-density polyurethane foam over an elastic sheet suspension system for lumbar support - seat: closed cell, contour molded urethane foam • Upholstery: <ul style="list-style-type: none"> - seams are double needle stitched with seam binding for extended durability - unique wrap around welt detail and is cut from the same fabric as specified on chair • Arms: resilient self-skinned urethane molded around carbon steel armature, black or aluminum arm with urethane cap, if selected • Chair controls: tilt-swivel with tilt tension, pneumatic height adjustment, and tilt lockout • Bases: five star black resin • Casters: black hooded dual wheel 	<ol style="list-style-type: none"> 1 Style number 2 Number of fabrics if contrasting fabric style number is selected 3 Fabric or leather color number for upholstery on seat and back 4 Options, if selected (see below) ▶See <i>Surface Materials</i> , page 260.

Options	Price	Required to Specify
Surface Materials		
Welt detail		
• Contrasting fabric welt	+\$ 62	Specify with <i>contrasting fabric welt</i> and select fabric color number.
• Contrasting leather welt	+\$ 91	Specify with <i>contrasting leather welt</i> and select fabric color number.
Contrasting fabric		
• Contrasting fabric	+\$118 per fabric	Add suffix K to the style number and select fabric color number.
Acrylic backer		
• Conference, midback, and high back large chairs	+\$ 19	Specify with <i>acrylic backer</i> .
• High back large chair	+\$ 22	Specify with <i>acrylic backer</i> .
• Midback with pillow chairs	+\$ 29	Specify with <i>acrylic backer</i> .
• High back with pillow chairs	+\$ 31	▶ See <i>Surface Materials</i> , page 260.
Base		
• Polished aluminum with black, hooded dual wheel casters	+\$ 62	Specify with <i>polished aluminum base</i> .
Casters		
• Soft wheel casters	+\$ 48	Specify with <i>soft casters</i> .
Control		
• Knee-tilt with pneumatic height adjustment and tilt lockout	+\$153	Specify with <i>knee-tilt</i> .

Specification Information

Style Number	Base Prices														Leather Grades:		
	Fabric Grades:														COL	C	E
	COM	6	7	8	9	10	11	12	13	14							

Conference Narrow/Narrow with Urethane Arms

795	\$1109	\$1107	\$1128	\$1148	\$1171	\$1200	\$1274	\$1331	\$1396	\$1525	\$1340	\$2055	\$2190
COM/yds = 2, COL/sq ft = 36													

Conference Narrow/Narrow with Aluminum Arms

795AU	\$1475	\$1473	\$1494	\$1514	\$1537	\$1566	\$1640	\$1697	\$1762	\$1891	\$1706	\$2421	\$2556
--------------	--------	--------	--------	--------	--------	--------	--------	--------	--------	--------	--------	--------	--------

▶Specification Information, continued on next page



Overall: 26½"D 26½"W 36"-39"H
 Inside: 18"D 20"W 18½"H
 Seat: 18½"-21½"H
 Arm: 25¾"-28¾"H

Chord Conference Seating

DESIGN MICHAEL SHIELDS

SIN 711.18

► Specification Information, continued from previous page

Specification Information

Style Number	Base Prices										Leather Grades:		
	Fabric Grades:										COL	C	E
	COM	6	7	8	9	10	11	12	13	14			



Overall: 26½"D 26½"W 37½"-40½"H
 Inside: 19"D 21½"W 21½"H
 Seat: 21½"H
 Arm: 25¾"-28¾"H

Mid Back with Urethane Arms

796	\$1242	\$1235	\$1256	\$1272	\$1297	\$1330	\$1407	\$1457	\$1529	\$1675	\$1473	\$2188	\$2316
-----	--------	--------	--------	--------	--------	--------	--------	--------	--------	--------	--------	--------	--------

COM/yds = 2, COL/sq ft = 36

Mid Back with Aluminum Arms

796AU	\$1608	\$1601	\$1622	\$1638	\$1663	\$1696	\$1773	\$1823	\$1895	\$2041	\$1839	\$2554	\$2682
-------	--------	--------	--------	--------	--------	--------	--------	--------	--------	--------	--------	--------	--------



Overall: 26½"D 26½"W 37½"-40½"H
 Inside: 18½"D 21½"W 19"H
 Seat: 19"-22"H
 Arm: 25¾"-28¾"H

Mid Back/Pillow Upholstery with Urethane Arms

796-P	\$1536	\$1531	\$1556	\$1578	\$1629	\$1666	\$1786	\$1863	\$1966	\$2139	\$1732	\$2829	\$3029
-------	--------	--------	--------	--------	--------	--------	--------	--------	--------	--------	--------	--------	--------

COM/yds = 3, COL/sq ft = 54

Mid Back/Pillow Upholstery with Aluminum Arms

796-PAU	\$1902	\$1897	\$1922	\$1944	\$1995	\$2032	\$2152	\$2229	\$2332	\$2505	\$2098	\$3195	\$3395
---------	--------	--------	--------	--------	--------	--------	--------	--------	--------	--------	--------	--------	--------

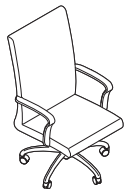

Overall: 26½"D 26½"W 24½"H
 Inside: 18"D 20"W 18½"H
 Seat: 18½"-21½"H
 Arm: 25¾"-28¾"H

High Back Narrow/Narrow with Urethane Arms

797	\$1539	\$1537	\$1563	\$1578	\$1601	\$1627	\$1704	\$1761	\$1826	\$2020	\$1770	\$2328	\$2461
-----	--------	--------	--------	--------	--------	--------	--------	--------	--------	--------	--------	--------	--------

COM/yds = 2, COL/sq ft = 36

High Back Narrow/Narrow with Aluminum Arms

797AU	\$1905	\$1903	\$1929	\$1944	\$1967	\$1993	\$2070	\$2127	\$2192	\$2386	\$2136	\$2694	\$2827
-------	--------	--------	--------	--------	--------	--------	--------	--------	--------	--------	--------	--------	--------

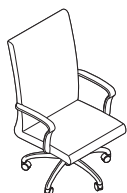

Overall: 26½"D 26½"W 46"-49"H
 Inside: 19"D 21½"W 18½"H
 Seat: 18½"-21½"H
 Arm: 25¾"-28¾"H

High Back/Large Scale with Urethane Arms

798	\$1560	\$1550	\$1571	\$1591	\$1614	\$1640	\$1717	\$1774	\$1839	\$2036	\$1790	\$2336	\$2469
-----	--------	--------	--------	--------	--------	--------	--------	--------	--------	--------	--------	--------	--------

COM/yds = 2, COL/sq ft = 44

High Back/Large Scale with Aluminum Arms

798AU	\$1926	\$1916	\$1937	\$1957	\$1980	\$2006	\$2083	\$2140	\$2205	\$2402	\$2156	\$2702	\$2835
-------	--------	--------	--------	--------	--------	--------	--------	--------	--------	--------	--------	--------	--------



Overall: 26½"D 26½"W 46"-49"H
 Inside: 19"D 21½"W 19"H
 Seat: 19"-22"H
 Arm: 26¾"H-28¾"H

High Back/Large Scale with Pillow Upholstery with Urethane Arms

798-P	\$1670	\$1659	\$1685	\$1712	\$1763	\$1800	\$1914	\$1997	\$2100	\$2293	\$1866	\$2957	\$3156
-------	--------	--------	--------	--------	--------	--------	--------	--------	--------	--------	--------	--------	--------

COM/yds = 3, COL/sq ft = 66

High Back/Large Scale with Pillow Upholstery with Aluminum Arms

798-PAU	\$2036	\$2025	\$2051	\$2078	\$2129	\$2166	\$2280	\$2363	\$2466	\$2659	\$2232	\$3323	\$3522
---------	--------	--------	--------	--------	--------	--------	--------	--------	--------	--------	--------	--------	--------

SW_1 Conference Seating

DESIGN SCOTT WILSON & MINIMAL

SIN 711.18

Tip: For Customer's Own Material or Leather, see necessary requirements, important processing instructions, and ordering information.

▶ Page 262

Standard Includes		Required to Specify
▶ Need help? Product details, see <i>Coalesse Seating and Outdoor Specification Guide</i>	<ul style="list-style-type: none"> • Seat: fabric or leather • Back: knit • Base: 8040 Aluminum Matte Polished • Frame: steel tube • Glides on conference chair with 4-star base, if selected: aluminum with non marring plastic insert • Casters on conference chair with 5-star base, if selected: dual wheel hard casters, black only • Swivel return mechanism on conference chair with 4-star base, if selected • Swivel mechanism on conference chair with 5-star base, if selected 	1 Style number 2 Upholstery color number for seat 3 Knit color number for back 4 Options, if selected (see below) ▶ See <i>Surface Materials</i> , page 260

Options	Price	Required to Specify
Surface Materials		
• Contrasting fabric	+\$ 118	Specify with <i>contrasting fabric</i> and select fabric color number.
Fire code seating		
• Fire code seating	+\$231	Specify with <i>fire code seating</i> .
Acrylic backer		
• Backer	+\$ 29	Specify with <i>acrylic backer</i> . ▶ See <i>Surface Materials</i> , page 260
Mechanism		
• Full swivel (omit swivel-return feature)	No cost	Specify with <i>swivel-only mechanism</i> .
Casters		
• Black soft casters	+\$ 22	Specify with <i>soft casters</i> .
• Hard black casters with polished aluminum body	+\$ 67	Specify with <i>hard polished aluminum casters</i> .
• Soft black casters with polished aluminum body	+\$ 89	Specify with <i>soft polished aluminum casters</i> .
Related Products		
<ul style="list-style-type: none"> • Collaborative and conference tables • Occasional tables • Lounge seating 		▶ See <i>GSA Volume 5b Specification Guide</i> . ▶ See <i>GSA Volume 5b Specification Guide</i> . ▶ Page 162

Specification Information

Style Number	Base Prices											Leather Grades:		
	Fabric Grades:	6	7	8	9	10	11	12	13	14	COL	C	E	

Conference Chair with 4-Star Base

COW413	Seat	\$1867	\$1867	\$1873	\$1883	\$1913	\$1933	\$1956	\$1972	\$2000	\$2039	\$1918	\$2149	\$2183
	Upper back	+\$ 72	+\$ 72	+\$ 86	+\$109	+\$181	+\$227	+\$280	+\$317	+\$383	+\$475	+\$192	+\$731	+\$809

COM/yds = 3, COL/sq ft = 60

Conference Chair with 5-Star Base

COW415	Seat	\$1867	\$1867	\$1873	\$1883	\$1913	\$1933	\$1956	\$1972	\$2000	\$2039	\$1918	\$2149	\$2183
	Upper back	+\$ 72	+\$ 72	+\$ 86	+\$109	+\$181	+\$227	+\$280	+\$317	+\$383	+\$475	+\$192	+\$731	+\$809



Overall: 25¼"D 28"W 31½"H
 Seat: 18"H
 Arm: 25¼"H



Overall: 25¼"D 28"W 29½"H-33"H
 Seat: 16¼"H-19¾"H
 Arm: 23½"H-27"H

SW_1 Conference Seating Multi-Fabric Diagram

DESIGN SCOTT WILSON & MINIMAL

SIN 711.18

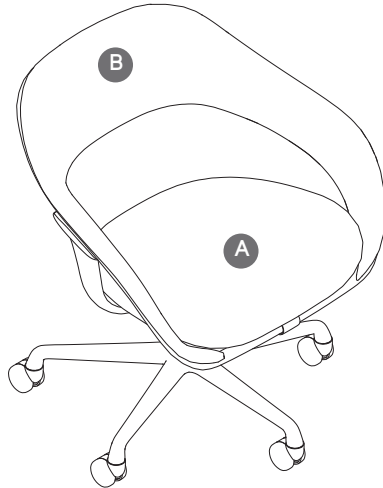

TO: _____

FROM: _____

DATE: _____

FAX....888.413.5161

A Seat: _____

B Arms/Back: _____

Contrasting fabric charges will apply. List price based on highest grade textile specified.

\$118 list upcharge for each contrasting textile pricing based on highest grade textile specified.

Specify Model below:

COW413 Conference Chair with 4-Star Base

COW415 Conference Chair with 5-Star Base

Occasional Tables

Await (SIN 711.11)	226
Bix (SIN 711.18)	227
Enea Tables with Single Base (SIN 711.11)	230
Enea Tables with Twin Base (SIN 711.11)	232
Enea Lottus (SIN 711.11)	235
Sebastopol Occasional Tables (SIN 711.11)	240
Sidewalk (SIN 711.8)	241
Trees (SIN 711.11)	242

Await Occasional Tables

DESIGN E00S

SIN 711.11

Standard Includes		Required to Specify
<ul style="list-style-type: none"> ▶ Need help? Product details, see <i>Coalesse Tables, Storage, and Accessories Specification Guide</i> 	<ul style="list-style-type: none"> • Freestanding table frame: 4142 Platinum Gloss • Top: High-Pressure Laminate top with matching 3 mm edge band • Glass top: <ul style="list-style-type: none"> - 1/2" thick - Radiused edges 	<ol style="list-style-type: none"> 1 Style number 2 Laminate top and tablets, if selected: <ul style="list-style-type: none"> 2730 Arctic White 2746 Black 290N North Sea 3 Glass color number for top, if selected <p>▶ See <i>Coalesse Surface Materials Reference Guide</i>.</p>

Related Products	
<ul style="list-style-type: none"> • Lounge seating • Connector benches 	<ul style="list-style-type: none"> ▶ Page 52 ▶ Page 48

Specification Information					
Style Number	Prices				
	Top Surface:				
	Laminate	Absolute Clear Green Glass	Absolute Clear Glass	Acid Etched 6511	Absolute Colored Glass

Round, Low, Freestanding Table

46-T1	\$1048	\$1253	\$1276	\$1276	\$1444
-------	--------	--------	--------	--------	--------

Round, High, Freestanding Table

46-T2	\$1369	\$1574	\$1597	\$1597	\$1765
-------	--------	--------	--------	--------	--------

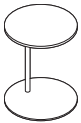

Overall: 15 3/4" Dia. 19"H

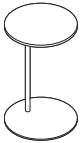

Overall: 15 3/4" Dia. 25"H

Bix Side Table—Vinyl Version

DESIGN METRO DESIGN GROUP

SIN 711.18



Standard Includes

- Base: paint
- Table surface and base cover: bronco onyx vinyl

Required to Specify

- 1 Style number
- 2 Paint color number for base
- ▶ See *Surface Materials*, page 259.

Related Products

- Lounge chairs ▶ Page 52
- Sectional seating ▶ Page 54
- Podium ▶ Page 62

Specification Information

Dimensions		Style Number	Price
Diameter	H		
16"	23"	BTS1700	\$512

Bix 18"H Occasional Tables

DESIGN METRO DESIGN GROUP

SIN 711.18

Standard Includes	Required to Specify
<ul style="list-style-type: none"> • Top: <ul style="list-style-type: none"> - Laminate top (Grade 1 laminates) with matching plastic edge - Laminate top (Grade 1 Steelcase) with contrasting plastic edge - Wood top with matching flat wood edge • Base: textured paints only • Grommet, if selected: black plastic only 	1 Style number 2 Laminate or wood color number for top ▶ See Hardwood and Veneer Matrix, page 274 3 Plastic edge color number for top with Grade 1 Steelcase or Grade 2 laminate, if selected 4 Textured paint color number for base 5 Options, if selected (see below) ▶ See <i>Surface Materials</i> , page 259.

Options	Price	Required to Specify
Surface Materials <ul style="list-style-type: none"> • Wood • Custom wood finish 		▶ Page 272
Cable Management <ul style="list-style-type: none"> • PDV module: black plastic 	+ \$373 each	Specify with <i>PDV module</i> .
Related Products <ul style="list-style-type: none"> • Lounge chair • Sectional seating 		▶ Page 52 ▶ Page 54

Tip: One or two power, data, and voice modules are available on rectangular occasional tables.

Specification Information

Dimensions				Style Number	Base Prices			
D	W	H	Diameter		Lam 1	Lam 2	Wood 1	Wood 2

Round Occasional Tables

N.A.	N.A.	18"	20"	BTC20001	\$1028	\$1080	\$1138	\$1191
N.A.	N.A.	18"	28"	BTC28001	\$1071	\$1126	\$1190	\$1304

Round Occasional Table with Grommet

N.A.	N.A.	18"	28"	BTC28001U	\$1141	\$1199	\$1260	\$1374
------	------	-----	-----	-----------	--------	--------	--------	--------

Square Occasional Table

24"	24"	18"	N.A.	BTC24241	\$1056	\$1110	\$1172	\$1244
-----	-----	-----	------	----------	--------	--------	--------	--------

Square Occasional Table with Grommet

24"	24"	18"	N.A.	BTC24241U	\$1127	\$1185	\$1243	\$1315
-----	-----	-----	------	-----------	--------	--------	--------	--------

Rectangular Tables

24"	48"	18"	N.A.	BTC24481	\$1709	\$1797	\$1889	\$2036
24"	72"	18"	N.A.	BTC24721	\$1751	\$1841	\$1952	\$2168

Rectangular Occasional Tables with Grommets

24"	48"	18"	N.A.	BTC24481U	\$1849	\$1943	\$2029	\$2176
24"	72"	18"	N.A.	BTC24721U	\$1892	\$1989	\$2093	\$2309

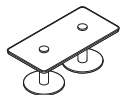
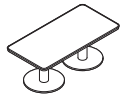

Edge Profiles

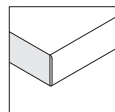

Plastic edge

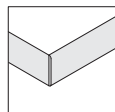

Wood edge

Coalesse

Bix 18"H Occasional Tables

DESIGN METRO DESIGN GROUP

SIN 711.18

Enea Tables

Single Base

DESIGN JOSEP LLUSCA

SIN 711.11

Tip: Shipped knocked down.

Tip: Disc bases are 24" diameter.

Tip: White laminate tops may exhibit slightly visible black specks inherent to the top manufacturing process.

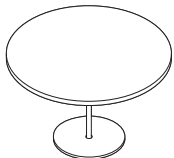
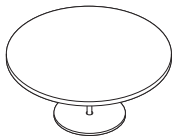
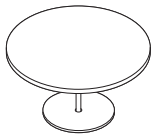

Standard Includes

- Laminate top: 3/4" thick with T-mold edge band
- Wood top: 3/4" thick with maple edge and maple veneer
- Base/frame: steel tubing and base: paint
- Glides: non-skid

Required to Specify

- 1 Style number
- 2 Laminate or wood top color number
▶ See Hardwood and Veneer Matrix, page 274
- 3 Plastic color for edge band of laminate top, if selected:
6D10 Silver Metallic
6D11 Black
6D12 White
- 4 Base/frame finish:
4016 White Gloss
4017 Black Gloss
4018 Silver Metallic
▶ See Surface Materials, page 260.

Specification Information

Dimensions		Style Number	Prices	
Diameter	H		Top Surface:	
			Laminate	Wood

Occasional Tables

36"	18"	H35-T3618L	\$ 942	N.A.
36"	18"	H35-T3618W	N.A.	\$1304

42"	18"	H35-T4218L	\$1135	N.A.
42"	18"	H35-T4218W	N.A.	\$1864

Conference Tables

30"	30"	H35-T3030L	\$1109	N.A.
30"	30"	H35-T3030W	N.A.	\$1728

36"	30"	H35-T3630L	\$1168	N.A.
36"	30"	H35-T3630W	N.A.	\$1923

42"	30"	H35-T4230L	\$1343	N.A.
42"	30"	H35-T4230W	N.A.	\$2077

▶ Specification Information, continued on next page

Enea Tables

Single Base

DESIGN JOSEF LLUSCA

SIN 711.11

► Specification Information, continued from previous page

Specification Information

Dimensions		Style	Prices	
Diameter	H	Number	Top Surface:	
			Laminate	Wood

Café/Counter Height Tables

24"	36"	H35-T2436L	\$1071	N.A.
24"	36"	H35-T2436W	N.A.	\$1742

30"	36"	H35-T3036L	\$1171	N.A.
30"	36"	H35-T3036W	N.A.	\$1949

36"	36"	H35-T3636L	\$1213	N.A.
36"	36"	H35-T3636W	N.A.	\$2123

42"	36"	H35-T4236L	\$1400	N.A.
42"	36"	H35-T4236W	N.A.	\$2832

Café/Bar Height Tables

24"	42"	H35-T2442L	\$1103	N.A.
24"	42"	H35-T2442W	N.A.	\$1788

30"	42"	H35-T3042L	\$1182	N.A.
30"	42"	H35-T3042W	N.A.	\$2001

36"	42"	H35-T3642L	\$1220	N.A.
36"	42"	H35-T3642W	N.A.	\$2175

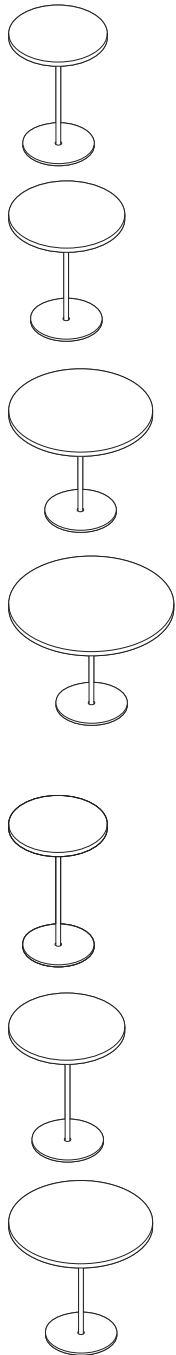

Enea Tables Twin Base

DESIGN JOSEP LLUSCA

SIN 711.11

Tip: Shipped knocked down.

Tip: Due to weight of steel bases, please lift or move tables by bases only (do not lift by tops) with at least two people.

Tip: White laminate tops may exhibit slightly visible black specks inherent to the top manufacturing process.

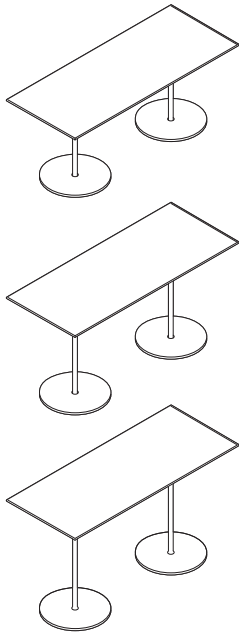

Standard Includes	Required to Specify
-------------------	---------------------

<ul style="list-style-type: none"> Base/frame: steel tubing and base: paint Glides: non-skid Disc bases are 24" diameter Laminate top: 3/4" thick with T-mold edge band Wood top: 3/4" thick with maple edge and maple veneer 	<ol style="list-style-type: none"> 1 Style number 2 Laminate or wood top color number ▶ See Hardwood and Veneer Matrix, page 274 3 Plastic color for edge band of laminate top, if selected: 6D10 Silver Metallic 6D11 Black 6D12 White 4 Base/frame finish: 4016 White Gloss 4017 Black Gloss 4018 Silver Metallic 5 Options, if selected (see below) ▶ See <i>Surface Materials</i>, page 260.
--	---

Options	Price	Required to Specify
---------	-------	---------------------

Interport Power/Data Module	<ul style="list-style-type: none"> Mho power/data module (available in clear anodized aluminum) 	+\$328 Specify with Mho power/data module.
------------------------------------	--	---

Specification Information						
---------------------------	--	--	--	--	--	--

Dimensions			Style	Base Prices		
D	W	H	Number	Top Surface:		
				Laminate	Wood	

Rectangular Tables

30"	72"	30"	H35-T307230GL	\$2754	N.A.
30"	72"	30"	H35-T307230GW	N.A.	\$3890
30"	72"	36"	H35-T307236GL	\$2890	N.A.
30"	72"	36"	H35-T307236GW	N.A.	\$4020
30"	72"	42"	H35-T307242GL	\$3192	N.A.
30"	72"	42"	H35-T307242GW	N.A.	\$4162

▶ Specification Information, continued on next page

Enea Tables

Twin Base

DESIGN JOSEP LLUSCA

SIN 711.11

► Specification Information, continued from previous page

Specification Information

Dimensions			Style Number	Base Prices	
D	W	H		Top Surface:	
				Laminate	Wood

Oval Tables

30"	72"	30"	H35-T307230VL	\$2748	N.A.
30"	72"	30"	H35-T307230VW	N.A.	\$4006

30"	72"	36"	H35-T307236VL	\$2770	N.A.
30"	72"	36"	H35-T307236VW	N.A.	\$4129

30"	72"	42"	H35-T307242VL	\$3025	N.A.
30"	72"	42"	H35-T307242VW	N.A.	\$4239

Conference/Racetrack Tables

30"	72"	30"	H35-T307230KL	\$2775	N.A.
30"	72"	30"	H35-T307230KW	N.A.	\$4051

Counter/Racetrack Tables

30"	72"	36"	H35-T307236KL	\$2896	N.A.
30"	72"	36"	H35-T307236KW	N.A.	\$4154

Café/Racetrack Tables

30"	72"	42"	H35-T307242KL	\$3065	N.A.
30"	72"	42"	H35-T307242KW	N.A.	\$4296

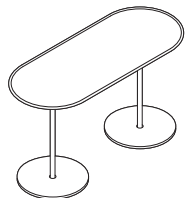
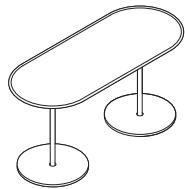
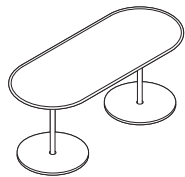
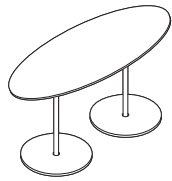
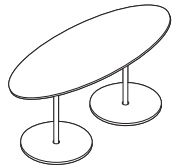

Enea Tables Mho Power Module for Enea Twin Base Tables

SIN 711.11

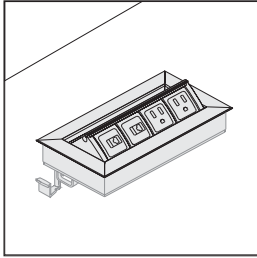
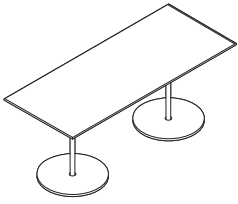

Available Models: **Options:** Available on wood, laminate and finesse covered tops only. Available in centered positions only. Mho not available on Coalesse and CoalesseSpaces.models. Check grid for model availability.

Enea			
Enea			
	H35-T307230GL	Yes	No
	H35-T307230GW	Yes	No
	H35-T307236GL	Yes	No
	H35-T307236GW	Yes	No
	H35-T307242GL	Yes	No
	H35-T307242GW	Yes	No
	H35-T307230VL	Yes	No
	H35-T307230VW	Yes	No
	H35-T307236VL	Yes	No
	H35-T307236VW	Yes	No
	H35-T307242VL	Yes	No
	H35-T307242VW	Yes	No
	H35-T307230KL	Yes	No
	H35-T307230KW	Yes	No
	H35-T307236KL	Yes	No
	H35-T307236KW	Yes	No
	H35-T307242KL	Yes	No
	H35-T307242KW	Yes	No

Color:
Anodized Aluminum

Enea Lottus Occasional Tables

DESIGN LIEVORE ALTHERR MOLINA

SIN 711.11

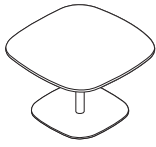

Standard Includes

- Top: laminate or wood veneer with 1/2" thick phenolic core
- Base and frame: steel tubing and base
- Glides: non-skid

Required to Specify

- 1 Style number
 - 2 Laminate or wood veneer color number for top
 - ▶ See Veneer Matrix, page 275
 - 3 Base/frame finish:
 - 4016 White Gloss
 - 4017 Black Gloss
 - 4217 Brown
 - 4218 Platinum Silver
- ▶ See *Surface Materials*, page 260.

Specification Information

Dimensions			Style Number	Prices		
D	W	H		Top Surface:		
				Laminate	Wood 1	Wood 2
30"	30"	18"	COEL1830	\$1240	\$1389	\$1500
36"	36"	18"	COEL1836	\$1440	\$1619	\$1754
42"	42"	18"	COEL1842	\$1755	\$1920	\$2076

Enea Lottus Conference Tables

DESIGN LIEVORE ALTHERR MOLINA

SIN 711.11



Standard Includes	Required to Specify
-------------------	---------------------

- Top: laminate or wood veneer with 1/2" thick phenolic core
- Base and frame: steel tubing and base
- Glides: non-skid

- 1 Style number
- 2 Laminate or wood veneer color number for top
 - ▶ See Veneer Matrix, page 275
- 3 Base/frame finish:
 - 4016 White Gloss
 - 4017 Black Gloss
 - 4217 Brown
 - 4218 Platinum Silver
 - ▶ See *Surface Materials*, page 260.

Specification Information

Dimensions			Style Number	Prices		
D	W	H		Top Surface:		
				Laminate	Wood 1	Wood 2
30"	30"	30"	COEL3030	\$1295	\$1444	\$1559
36"	36"	30"	COEL3036	\$1494	\$1661	\$1789
42"	42"	30"	COEL3042	\$1805	\$1974	\$2133

Enea Lottus Café Counter Height Tables

DESIGN LIEVORE ALTHERR MOLINA

SIN 711.11

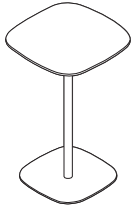

Standard Includes

- Top: laminate or wood veneer with 1/2" thick phenolic core
- Base and frame: steel tubing and base
- Glides: non-skid

Required to Specify

- 1 Style number
- 2 Laminate or wood veneer color number for top
▶ See Veneer Matrix, page 275
- 3 Base/frame finish:
4016 White Gloss
4017 Black Gloss
4217 Brown
4218 Platinum Silver
▶ See *Surface Materials*, page 260.

Specification Information

Dimensions			Style Number	Prices		
D	W	H		Top Surface:		
				Laminate	Wood 1	Wood 2
24"	24"	36"	COEL3624	\$1073	\$1166	\$1260
30"	30"	36"	COEL3630	\$1329	\$1481	\$1601
36"	36"	36"	COEL3636	\$1531	\$1710	\$1852
42"	42"	36"	COEL3642	\$1838	\$2007	\$2169

Enea Lottus Café Bar Height Tables

DESIGN LIEVORE ALTHERR MOLINA

SIN 711.11

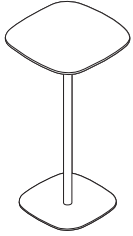

Standard Includes **Required to Specify**

- Top: laminate or wood veneer with 1/2" thick phenolic core
- Base and frame: steel tubing and base
- Glides: non-skid

- 1 Style number
 - 2 Laminate or wood veneer color number for top
 - ▶ See Veneer Matrix, page 275
 - 3 Base/frame finish:
 - 4016 White Gloss
 - 4017 Black Gloss
 - 4217 Brown
 - 4218 Platinum Silver
- ▶ See *Surface Materials*, page 260.

Specification Information

Dimensions			Style Number	Prices		
D	W	H		Top Surface:		
				Laminate	Wood 1	Wood 2
24"	24"	42"	COEL4224	\$1103	\$1200	\$1298
30"	30"	42"	COEL4230	\$1361	\$1510	\$ 1631
36"	36"	42"	COEL4236	\$1559	\$1708	\$ 1819
42"	42"	42"	COEL4242	\$1933	\$2102	\$2272

Enea Lottus Rectangular Tables

DESIGN LIEVORE ALTHERR MOLINA

SIN 711.11

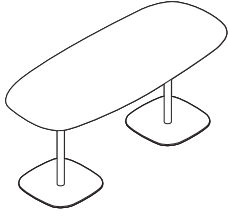

Standard Includes

- Top: laminate or wood veneer with 1/2" thick phenolic core
- Base and frame: steel tubing and base
- Glides: non-skid

Required to Specify

- 1 Style number
- 2 Laminate or wood veneer color number for top
▶ See Veneer Matrix, page 275
- 3 Base/frame finish:
4016 White Gloss
4017 Black Gloss
4217 Brown
4218 Platinum Silver
▶ See *Surface Materials*, page 260.

Specification Information

Dimensions			Style Number	Prices		
D	W	H		Top Surface:		
				Laminate	Wood 1	Wood 2
30"	72"	30"	COEL303072	\$2914	\$3285	\$3552
30"	72"	36"	COEL363072	\$2979	\$3350	\$3621
30"	72"	42"	COEL423072	\$3042	\$3413	\$3690

Sebastopol Occasional Tables

DESIGN EMILIA BORGTHORSDDOTTIR

SIN 711.11

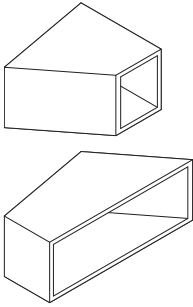

Tip: Optional grommet to accept PowerPod can be specified in milk white or black plastic.

Tip: If a grommet is specified with a PowerPod and the table is over a floor core, the floor core outlet cannot be flush to the floor, because the plug end will not allow the PowerPod to sit in the grommet. If the floor core is flush to the floor and the grommet and PowerPod are required, the table either cannot be set over the floor core, or a special plinth base will be required. Consult your specials representative for additional information on the plinth base.

Standard Includes	Required to Specify
-------------------	---------------------

- | | |
|---|--|
| <ul style="list-style-type: none"> ▶ Need help? Product details, see <i>Coalesse Seating and Outdoor Specification Guide</i> | <ul style="list-style-type: none"> • Exterior surface: veneer grade 1, oak, or walnut • Interior surface: glossy laminate • Glides: concealed adjustable glide with non-marking nylon pad |
|---|--|

- | |
|---|
| <ol style="list-style-type: none"> 1 Style number 2 Exterior surface wood finish number 3 Interior surface glossy laminate: <ul style="list-style-type: none"> 2001 Smoky White 2002 Studio Gray 2003 Wrought Iron 2004 Black Pearl 2005 Liberty Red 4 Options, if selected (see below) <p>▶ See <i>Coalesse Surface Materials Reference Guide</i>.</p> |
|---|

Options	Price	Required to Specify
---------	-------	---------------------

- | | | |
|---|--------|---|
| Grommet <ul style="list-style-type: none"> • Grommet to accept PowerPod | +\$110 | Specify <i>with grommet</i> and select finish color number either in milk white or black plastic. |
|---|--------|---|

Specification Information					
---------------------------	--	--	--	--	--

Dimensions			Style Number	Base Prices	
D	W	H		Top Surface:	
				Wood Grade 1	Wood Grade 2

16" High Tables

23"	27"	16"	COEB2723L	\$1213	\$1312
18"	41"	16"	COEB4118L	\$1436	\$1552

22" High Tables

23"	27"	22"	COEB2723H	\$1324	\$1432
18"	41"	22"	COEB4118H	\$1546	\$1671

Sidewalk Occasional Tables

DESIGN STUDIO B

SIN 711.8

Standard Includes

- Frames constructed of finger jointed select hard maple, reinforced with wood substrate
- Legs: silver powder coat steel with "go" glides
- Tops:
 - Laminate: 1/2" thick
 - Wood: 1/2" thick veneered tops and quarter cut book-matched hard maple veneer
 - Glass: 3/16" thick glass sandblasted with white on back surface
 - Ships ready to assemble

Required to Specify

- 1 Style number
- 2 Laminate color number for top, if selected
- 3 Wood color number for frame
 - ▶ See Hardwood and Veneer Matrix, page 274
 - ▶ See High-Pressure Laminate Matrix, page 278
- 4 Options, if selected (see below)
 - ▶ See *Surface Materials*, page 260.

Options

Options	Price	Required to Specify
Glides	• "No go" 1/2" polyethylene glides	No cost

Specification Information

Dimensions			Style Number	Prices		
D	W	H		Top Surface:		
				Laminate	Wood	Glass
17"	17"	17"	43-T171717	\$1502	\$1502	\$1763
22"	22"	22"	43-T222222	\$1764	\$1764	\$2019

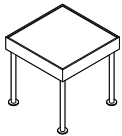
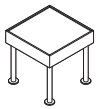

Occasional Tables

3/4/20 = Last order entry
April 19, 2020

Trees Occasional Tables

DESIGN NORMAN DIEKMAN

SIN 711.11

Tip: Tops come in the same wood and finish but with smooth surface.

Standard Includes		Required to Specify
<ul style="list-style-type: none"> ▶ Need help? Product details, see <i>Coalesse Tables, Storage, and Accessories Specification Guide</i> 	<ul style="list-style-type: none"> • Embossed wood is created under high pressure to add dimensionality and texture on all sides of the table <ul style="list-style-type: none"> - Interior frame is constructed from a combination of engineered lumber and hardwood veneers - Embossed hardwood veneer is applied to all vertical and slanted surfaces - Embossed wood in Natural EWNT 	1 Style number 2 Options, if selected (see below)

Options	Price	Required to Specify
Surface Materials <ul style="list-style-type: none"> • Bevel high embossed wood (Model 70-C-TPM) available in medium brown EWMB • Bevel medium embossed wood (Model 70-D-TPM) available in medium brown EWMB 	+\$69 +\$69	Specify with <i>medium brown</i> . Specify with <i>medium brown</i> .

Specification Information

Dimensions			Style	Base
D	W	H	Number	Price

Bevel High-Embossed Wood Table

15½"	14"	23"	70-C-TPM	\$2326
------	-----	-----	----------	--------

Bevel Medium-Embossed Wood Table

15½"	14"	19¾"	70-D-TPM	\$2265
------	-----	------	----------	--------

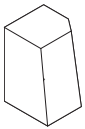

Outdoor



Emu Advanced Collection

Emu Heaven (SIN 71.207)	244
Emu Ivy (SIN 71.207)	250
Emu Re-Trouvé (SIN 71.207)	254
Emu Round (SIN 71.207)	256

Emu Advanced Collection Emu Heaven – Seating

DESIGN JEAN-MARIE MASSAUD

SIN 71.207

Tip: All chairs can stack four high.

Tip: COM outdoor fabric must be an approved outdoor fabric.

Tip: The following powder coat paint finishes are available with an upcharge, as shown at right: 4251 Emu Indian Brown, 4257 Antique Iron, 7272 Blue, 7273 Green, 7294 Emu Grey/Green, 7296 Emu Taupe, 7297 Emu Corten, 7298 Emu Copper, and 7391 Emu Poppy.

Standard Includes	Required to Specify
-------------------	---------------------

<p>► Need help? Product details, see <i>Coalesse Seating and Outdoor Specification Guide</i></p> <ul style="list-style-type: none"> • Frame: hand crafted woven steel mesh • Finish: outdoor grade powder coat paint • Glides: nylon • Cushions: fabric 	<ol style="list-style-type: none"> 1 Style number 2 Powder coat color for frame: 4256 Aluminum 7234 Emu Black 7271 Emu White 3 Fabric color number for upholstery on cushions, if selected 4 Options, if selected (see below) ► See <i>Surface Materials</i>, page 260.
---	---

Options	Price	Required to Specify
---------	-------	---------------------

<p>Surface Materials</p> <ul style="list-style-type: none"> • Acrylic backer • Outdoor cushions • Pouf and pillow cushions • Indoor chair back cushions • Indoor chair cushions • Indoor lounge back cushions • Other Emu paint (cost per pack) • Pouf table base • Chair • Arm chair • Lounge chair 	<p>+\$ 6</p> <p>+\$ 6</p> <p>+\$ 10</p> <p>+\$ 12</p> <p>+\$ 22</p> <p>+\$125</p> <p>+\$150</p> <p>+\$150</p> <p>+\$200</p>	<p>Specify with acrylic backer.</p> <p>Specify with acrylic backer.</p> <p>► See <i>Surface Materials</i>, page 260.</p> <p>Specify with acrylic backer.</p> <p>Specify with acrylic backer.</p> <p>Specify with acrylic backer.</p> <p>Specify paint color number.</p> <p>Specify paint color number.</p> <p>Specify paint color number.</p> <p>Specify paint color number.</p>
--	---	---

Specification Information				
---------------------------	--	--	--	--

Dimensions	Style	Quantity	Base	
D W H	Number		Price	

Chairs

23¼"	24½"	31"	CO2485	2	\$1063
------	------	-----	--------	---	--------



Seat height: 17¾"
Seat depth: 16⅞"

Arm Chairs

24"	27¼"	31"	CO2486	2	\$1220
-----	------	-----	--------	---	--------



Seat height: 17¾"
Seat depth: 16⅞"
Arm height: 26¾"

Lounge Chairs

30¾"	37"	27¼"	CO2487	2	\$2044
------	-----	------	--------	---	--------

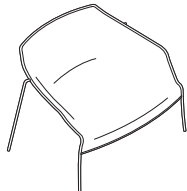

Seat height: 13¾"
Seat depth: 18½"
Arm height: 20½"

► Specification Information, continued on next page

Emu Advanced Collection Emu Heaven – Seating

DESIGN JEAN-MARIE MASSAUD

SIN 71.207

Tip: All cushions come in quantity of one.



20¾"D x 14½"W x 19"W x ¾"H

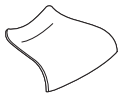

20¾"D x 23¾"W x ¾"H



Overall: ¾"D x 22"W x 15½"H

Tip: If a back cushion is specified, a seat cushion must also be specified. The back cushion is not functional without the seat cushion.

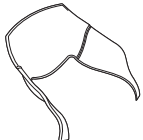

Overall: ¾"D x 28"W x 17½"H

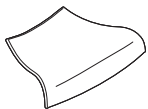

Overall: ¾"D x 34"W x 25"H

Tip: If a back cushion is specified, a seat cushion must also be specified. The back cushion is not functional without the seat cushion.

► Specification Information, continued from previous page

Specification Information

Style Number	Base Prices										Leather Grades:		
	Fabric Grades:										COL	C	E
	COM	6	7	8	9	10	11	12	13	14			

Chair Cushions

Outdoor Cushion

CO2485C	\$226	\$252	N.A.	N.A.	\$290	N.A.	N.A.	N.A.	N.A.	N.A.	N.A.	N.A.	N.A.
---------	-------	-------	------	------	-------	------	------	------	------	------	------	------	------

Indoor Cushion

CO2485B	\$266	\$252	\$257	\$265	\$290	\$307	\$326	\$339	\$363	\$396	\$383	\$ 601	\$ 647
---------	-------	-------	-------	-------	-------	-------	-------	-------	-------	-------	-------	--------	--------

COM/yds = ¾, COL/sq ft = 14

Arm Chair Cushions

Outdoor Cushion

CO2486C	\$272	\$266	N.A.	N.A.	\$318	N.A.	N.A.	N.A.	N.A.	N.A.	N.A.	N.A.	N.A.
---------	-------	-------	------	------	-------	------	------	------	------	------	------	------	------

Indoor Cushion

CO2486B	\$272	\$266	\$273	\$284	\$318	\$340	\$365	\$383	\$414	\$458	\$389	\$ 682	\$ 742
---------	-------	-------	-------	-------	-------	-------	-------	-------	-------	-------	-------	--------	--------

COM/yds = 1, COL/sq ft = 18

Chair Back Cushions

Outdoor Cushion

CO2480C	\$337	\$337	N.A.	N.A.	\$401	N.A.	N.A.	N.A.	N.A.	N.A.	N.A.	N.A.	N.A.
---------	-------	-------	------	------	-------	------	------	------	------	------	------	------	------

Indoor Cushion

CO2480B	\$337	\$337	\$345	\$359	\$401	\$429	\$461	\$483	\$522	\$577	\$451	\$ 924	\$1016
---------	-------	-------	-------	-------	-------	-------	-------	-------	-------	-------	-------	--------	--------

COM/yds = 1¼, COL/sq ft = 28

Arm Chair Back Cushions

Outdoor Cushion

CO2481C	\$350	\$350	N.A.	N.A.	\$428	N.A.	N.A.	N.A.	N.A.	N.A.	N.A.	N.A.	N.A.
---------	-------	-------	------	------	-------	------	------	------	------	------	------	------	------

Indoor Cushion

CO2481B	\$350	\$350	\$360	\$377	\$428	\$461	\$499	\$526	\$573	\$638	\$456	\$1032	\$1142
---------	-------	-------	-------	-------	-------	-------	-------	-------	-------	-------	-------	--------	--------

COM/yds = 1½, COL/sq ft = 33

Lounge Cushions

Outdoor Cushion

CO2487C	\$355	\$355	N.A.	N.A.	\$433	N.A.	N.A.	N.A.	N.A.	N.A.	N.A.	N.A.	N.A.
---------	-------	-------	------	------	-------	------	------	------	------	------	------	------	------

Indoor Cushion

CO2487B	\$355	\$355	\$365	\$382	\$433	\$466	\$504	\$531	\$578	\$643	\$461	\$1037	\$1147
---------	-------	-------	-------	-------	-------	-------	-------	-------	-------	-------	-------	--------	--------

COM/yds = 1½, COL/sq ft = 33

► Specification Information, continued on next page

Emu Advanced Collection Emu Heaven – Seating *continued*

DESIGN JEAN-MARIE MASSAUD

SIN 71.207

► Specification Information, continued from previous page

Specification Information

Style Number	Base Prices										Leather Grades:		
	Fabric Grades:										COL	C	E
	COM	6	7	8	9	10	11	12	13	14			

Lounge Back Cushions

Outdoor Cushion

CO2489C	\$464	\$464	N.A.	N.A.	\$593	N.A.	N.A.	N.A.	N.A.	N.A.	N.A.	N.A.	N.A.
---------	-------	-------	------	------	-------	------	------	------	------	------	------	------	------

Indoor Cushion

CO2489B	\$464	\$464	\$480	\$508	\$593	\$648	\$711	\$756	\$834	\$943	\$535	\$1526	\$1708
---------	-------	-------	-------	-------	-------	-------	-------	-------	-------	-------	-------	--------	--------

COM/yds = 2½, COL/sq ft = 55

Lounge Pillows

Outdoor Pillow

CO2488C	\$201	\$187	N.A.	N.A.	\$225	N.A.	N.A.	N.A.	N.A.	N.A.	N.A.	N.A.	N.A.
---------	-------	-------	------	------	-------	------	------	------	------	------	------	------	------

Indoor Pillow

CO2488B	\$201	\$187	\$192	\$200	\$225	\$242	\$261	\$274	\$298	\$331	\$318	\$583	\$638
---------	-------	-------	-------	-------	-------	-------	-------	-------	-------	-------	-------	-------	-------

COM/yds = ¾, COL/sq ft = 17

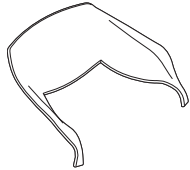

Overall: ¾"D x 34"W x 17½"H



Overall: 4¼"D x 17¼"W x 10½"H

Tip: Lounge pillow is for use with Heaven and Round Lounge chairs.

Specification Information

Dimensions	Style	Quantity	Base
Dia.	Number		Price

Pouf/Side Table Base

17¾"	18½"	CO2495	1	\$459
------	------	--------	---	-------

Glass Top for use with Pouf

17¾"	CO2495V	1	\$214
------	---------	---	-------



Tip: CO2495 pouf must be ordered with glass or cushion top, specified separately.

Tip: Cushions come in quantity of one.

Specification Information

Style Number	Base Prices										Leather Grades:		
	Fabric Grades:										COL	C	E
	COM	6	7	8	9	10	11	12	13	14			

Pouf Cushions

Outdoor Cushion

CO2495C	\$195	\$181	N.A.	N.A.	\$219	N.A.	N.A.	N.A.	N.A.	N.A.	N.A.	N.A.	N.A.
---------	-------	-------	------	------	-------	------	------	------	------	------	------	------	------

Indoor Cushion

CO2495B	\$195	\$181	\$186	\$194	\$219	\$236	\$255	\$268	\$292	\$325	\$312	\$577	\$632
---------	-------	-------	-------	-------	-------	-------	-------	-------	-------	-------	-------	-------	-------

COM/yds = ¾, COL/sq ft = 14



18"Dia. x 2"H

Emu Advanced Collection Emu Heaven – Seating

DESIGN JEAN-MARIE MASSAUD

SIN 71.207

Vases

Standard Includes	Required to Specify
<p>► Need help? Product details, see <i>Coalesse Seating and Outdoor Specification Guide</i></p> <ul style="list-style-type: none"> Vase: handcrafted woven steel mesh Finish: 7271 Emu White outdoor grade powder coat paint Planter insert: white plastic 	<p>Style number</p>

Specification Information

Dimensions		Style Number	Price
Dia.	H		

Low Vase

23½"	40½"	C02498	\$1485
------	------	--------	--------

High Vase

26¾"	64¼"	C02497	\$2093
------	------	--------	--------

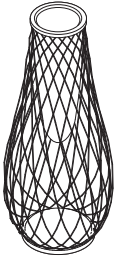

Planter insert dimensions:
Low: 36"H x 13½"Dia
High: 33"H x 13½"Dia

Outdoor

Emu Advanced Collection Emu Heaven – Tables

DESIGN JEAN-MARIE MASSAUD

SIN 71.207

Tip: Tables require glass top, specified separately.

Tip: The following powder coat paint finishes are available with an upcharge, as shown at right: 4251 Emu Indian Brown, 4257 Antique Iron, 7272 Blue, 7273 Green, 7294 Emu Grey/Green, 7296 Emu Taupe, 7297 Emu Corten, 7298 Emu Copper, and 7391 Emu Poppy.

Standard Includes		Required to Specify
<ul style="list-style-type: none"> ▶ Need help? Product details, see <i>Coalesse Seating and Outdoor Specification Guide</i> 	<ul style="list-style-type: none"> • Frame: interwoven steel rods • Finish: outdoor grade powder coat paint • Glides: nylon • Top: tempered glass 	<ol style="list-style-type: none"> 1 Style number 2 Powder coat color for base: 4256 Aluminum, 7271 Emu White 3 Glass top color number for glass top 4 Options, if selected (see below) <p>▶ See <i>Surface Materials</i>, page 260.</p>

Options	Price	Required to Specify
Other Emu paint <ul style="list-style-type: none"> • Round table bases • Low table base 	+\$200 +\$200	Specify paint color number. Specify paint color number.

Specification Information

Dimensions	Style	Base	
Dia.	H	Number	Price

Round Table Bases

For use with 31½" CO2493V Glass Top

31½"	29½"	CO2493	\$1004
------	------	--------	--------



Top of base: 27½" Diameter
Bottom of base: 17¾" Diameter

For use with 47¼" CO2494V Glass Top

47¼"	43⅓"	CO2494	\$2071
------	------	--------	--------

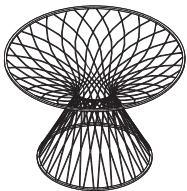

Top of base: 43⅓" Diameter
Bottom of base: 27½" Diameter

Low Table Base

43⅓"	15¼"	CO2496	\$1556
------	------	--------	--------

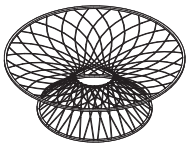

Top of base: 43⅓" Diameter
Bottom of base: 27½" Diameter

Glass Tops

For use with 27½" CO2493 Round Table Base

31½"	¼"	CO2493V	\$ 387
------	----	---------	--------



For use with 43⅓" CO2494 Round or CO2496 Low Table Base

47¼"	¼"	CO2494V	\$ 587
------	----	---------	--------



Coalesse

Emu Advanced Collection

Emu Heaven – Tables

DESIGN JEAN-MARIE MASSAUD

SIN 71.207

Outdoor

Emu Advanced Collection Emu Ivy – Seating

DESIGN PAOLA NAVONE

SIN 71.207

Tip: COM outdoor fabric must be an approved outdoor fabric.

Tip: Cushions must be specified separately.

Tip: Side chair without arms stacks ten high. Side chair with arms stacks eight high.

Tip: The following powder coat paint finishes are available with an upcharge, as shown at right: 4251 Emu Indian Brown, 4256 Aluminum, 4257 Antique Iron, 7234 Black, 7272 Blue, 7273 Green, 7294 Emu Grey/Green, 7296 Emu Taupe, 7297 Emu Corten, 7298 Emu Copper, and 7391 Emu Poppy.

Standard Includes	Required to Specify
-------------------	---------------------

<ul style="list-style-type: none"> ▶ Need help? Product details, see <i>Coalesse Seating and Outdoor Specification Guide</i> 	<ul style="list-style-type: none"> • Frame: steel mesh and rod • Finish: 7271 Emu White outdoor grade powder coat paint • Glides: nylon • Cushions: fabric
	<ol style="list-style-type: none"> 1 Style number 2 Fabric color number for upholstery on cushions, if selected 3 Options, if selected (see below) <p>▶ See <i>Surface Materials</i>, page 260.</p>

Options	Price	Required to Specify
---------	-------	---------------------

Surface Materials	Acrylic backer <ul style="list-style-type: none"> • Indoor arm chair and side cushions +\$ 6 • Indoor lounge cushions +\$ 8 	Specify with <i>acrylic backer</i> . Specify with <i>acrylic backer</i> . ▶ See <i>Surface Materials</i> , page 260.
	Other Emu paint (cost per pack) <ul style="list-style-type: none"> • Pouf +\$125 • Armless chair +\$200 • Chair with arms +\$200 • Lounge chair +\$300 • Lounge +\$500 	Specify paint color number. Specify paint color number. Specify paint color number. Specify paint color number. Specify paint color number. ▶ See <i>Coalesse Surface Materials Reference Guide</i> .

Specification Information				
---------------------------	--	--	--	--

Dimensions			Style	Quantity	Base
D	W	H	Number		Price

Armless Chairs

22½"	20½"	31"	CO2581	4	\$1688
------	------	-----	--------	---	--------



Seat height: 17¾"



Seat height: 17¾"
Arm height: 26"

Chairs with Arms

22½"	22¾"	31"	CO2582	4	\$1851
------	------	-----	--------	---	--------

Lounge Chairs

35½"	43¼"	26"	CO2585	1	\$2619
------	------	-----	--------	---	--------

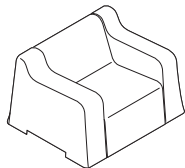

Seat height: 14½"
Seat depth: 21¼"
Arm height: 22½"

Lounge

35½"	75½"	26"	CO2586	1	\$4147
------	------	-----	--------	---	--------

▶ Specification Information, continued on next page

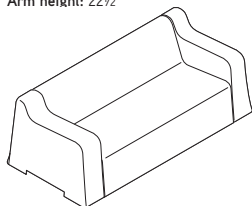

Seat height: 14½"
Seat depth: 21¼"
Arm height: 22½"

Emu Advanced Collection Emu Ivy – Seating

DESIGN PAOLA NAVONE

SIN 71.207

► Specification Information, continued from previous page



Tip: Pouf has solid sheet metal top with a photovoltaic panel filled with five LED lights. LED lights collect and store solar energy to illuminate the under structure at night.

Tip: Cushions come in quantity of one.

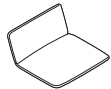

21"D x 24¼"W x 12½"H

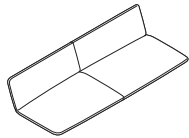

21"D x 56"W x 12½"H

Tip: Lounge cushion is two pieces.

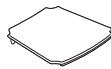

15"D x 15"W x ¾"H

Specification Information

Dimensions			Style Number	Quantity	Base Price
D	W	H			

Pouf

20¾" Dia.	15¾"	CO2595	1	\$918
-----------	------	---------------	---	-------

Specification Information

Style Number	Base Prices														Leather Grades:		
	Fabric Grades:														COL	C	E
COM	6	7	8	9	10	11	12	13	14								

Lounge Chair Cushions

Outdoor Cushion

CO2585C	\$ 475	\$ 475	N.A.	N.A.	\$ 565	N.A.	N.A.	N.A.	N.A.	N.A.	N.A.	N.A.	N.A.	N.A.
----------------	--------	--------	------	------	--------	------	------	------	------	------	------	------	------	------

Indoor Cushion

CO2585B	\$ 475	\$ 475	\$ 486	\$ 506	\$ 565	\$ 604	\$ 648	\$ 679	\$ 734	\$ 811	\$ 572	\$1356	\$1502
----------------	--------	--------	--------	--------	--------	--------	--------	--------	--------	--------	--------	--------	--------

COM/yds = 1¾, COL/sq ft = 32

Lounge Cushions

Outdoor Cushion

CO2586C	\$1002	\$1002	N.A.	N.A.	\$1144	N.A.	N.A.	N.A.	N.A.	N.A.	N.A.	N.A.	N.A.
----------------	--------	--------	------	------	--------	------	------	------	------	------	------	------	------

Indoor Cushion

CO2586B	\$1002	\$1002	\$1020	\$1051	\$1144	\$1205	\$1275	\$1323	\$1410	\$1530	\$1065	\$3093	\$3459
----------------	--------	--------	--------	--------	--------	--------	--------	--------	--------	--------	--------	--------	--------

COM/yds = 2¾, COL/sq ft = 50

Chair Cushions

Outdoor Cushion

CO2581C	\$ 288	\$ 282	N.A.	N.A.	\$ 334	N.A.	N.A.	N.A.	N.A.	N.A.	N.A.	N.A.	N.A.
----------------	--------	--------	------	------	--------	------	------	------	------	------	------	------	------

Indoor Cushion

CO2581B	\$ 288	\$ 282	\$ 289	\$ 300	\$ 334	\$ 356	\$ 381	\$ 399	\$ 430	\$ 474	\$ 405	\$ 623	\$ 669
----------------	--------	--------	--------	--------	--------	--------	--------	--------	--------	--------	--------	--------	--------

Emu Advanced Collection Emu Ivy – Tables

DESIGN PAOLA NAVONE

SIN 71.207

Tip: If selected, tiles ship unattached on the low, rectangular table to allow for customization. Please note, tiles are white when the bug design is selected and tiles are blue when the fish design is selected. Six of the thirty-two tiles have either the bug or fish design, depending on what is specified.

Tip: CO2592 contains a steel tube across the underneath of the top, ensuring top stability and structure.

Tip: The following powder coat paint finishes are available with an upcharge, as shown at right: 4251 Emu Indian Brown, 4256 Aluminum, 4257 Antique Iron, 7234 Black, 7272 Blue, 7273 Green, 7294 Emu Grey/Green, 7296 Emu Taupe, 7297 Emu Corten, 7298 Emu Copper, and 7391 Emu Poppy.

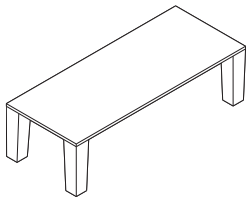
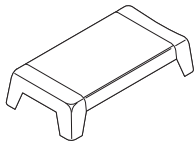

Standard Includes	Required to Specify
<ul style="list-style-type: none"> ▶ Need help? Product details, see <i>Coalesse Seating and Outdoor Specification Guide</i> • Top: <ul style="list-style-type: none"> – Low, rectangular table: formed steel mesh – Rectangular table: solid sheet metal or teak • Legs: formed steel mesh • Glides: nylon • Finish: 7271 Emu White outdoor grade powder coat paint 	<ul style="list-style-type: none"> 1 Style number 2 Options, if selected (see below)

Options	Price	Required to Specify
Surface Materials <ul style="list-style-type: none"> • Tiles for low, rectangular table • Blue fish tile • White bug tile 	<ul style="list-style-type: none"> + \$824 + \$824 	<ul style="list-style-type: none"> Specify with fish tile. Specify with bug tile.
<ul style="list-style-type: none"> • Other Emu paint • Low, rectangular table • Rectangular table, metal top 	<ul style="list-style-type: none"> + \$300 + \$500 	<ul style="list-style-type: none"> Specify paint color number. Specify paint color number.

Specification Information

Dimensions			Style	Base
D	W	H	Number	Price

Low, Rectangular Table

29¼"	53¼"	11¾"	CO2589	\$1612
------	------	------	--------	--------

Rectangular Table, Metal Top

44¾"	107¾"	29½"	CO2592	\$3586
------	-------	------	--------	--------

Coalesse

Emu Advanced Collection

Emu Ivy – Tables

DESIGN PAOLA NAVONE

SIN 71.207

Outdoor

Emu Advanced Collection Emu Re-Trouvé – Seating

DESIGN PATRICIA URQUIOLA

SIN 71.207

Tip: COM outdoor fabric must be an approved outdoor fabric.

Tip: Cushions must be specified separately.

Tip: The following powder coat paint finishes are available with an upcharge, as shown at right: 4251 Emu Indian Brown, 4256 Aluminum, 4257 Antique Iron, 7234 Black, 7272 Blue, 7273 Green, 7294 Emu Grey/Green, 7296 Emu Taupe, 7297 Emu Corten, 7298 Emu Copper, and 7391 Emu Poppy.

Standard Includes		Required to Specify
▶ Need help? Product details, see <i>Coalesse Seating and Outdoor Specification Guide</i>	<ul style="list-style-type: none"> • Frame: hot-dipped steel rod, hand welded • Finish: 7271 Emu White outdoor grade powder coat paint • Seat: steel tube and ironed sheet metal • Glides: PVC • Cushions: fabric 	<ol style="list-style-type: none"> 1 Style number 2 Fabric color number for upholstery on cushions, if selected 3 Options, if selected (see below) <p>▶ See <i>Surface Materials</i>, page 260.</p>

Options	Price	Required to Specify
Surface Materials		
Acrylic backer		
• Indoor chair seat and pouf cushions only	+\$ 8	Specify with acrylic backer
• Chair seat and back indoor cushions only	+\$ 12	Specify with acrylic backer. ▶ See <i>Surface Materials</i> , page 260.
Other Emu paint		
• Mid-back chair	+\$150	Specify paint color number.
• High-back chair	+\$150	Specify paint color number.
• Pouf	+\$150	Specify paint color number.

Specification Information

Dimensions	Style	Base
D W H	Number	Price

Mid-Back Chair

23½"	26"	30¾"	CO2565MB	\$1128
------	-----	------	----------	--------



Seat height: 17¾"

High-Back Chair

24"	30"	41¼"	CO2566HB	\$ 1333
-----	-----	------	----------	---------

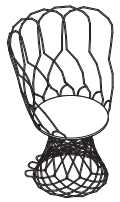

Seat height: 17¾"

Pouf

17¾" dia.	17¾"	CO2575	\$ 730
-----------	------	--------	--------



Tip: Cushions fit all chairs. Pouf requires seat cushion only.

Tip: Cushions come in quantity of one.

Specification Information

Style Number	Base Prices												Leather Grades:		
	Fabric Grades:												COL	C	E
COM	6	7	8	9	10	11	12	13	14						

Chair Seat and Pouf Cushions

Outdoor Cushion													
Style	Price	6	7	8	9	10	11	12	13	14	COL	C	E
CO2575C	\$235	\$229	N.A.	N.A.	\$281	N.A.	N.A.	N.A.	N.A.	N.A.	N.A.	N.A.	N.A.
Indoor Cushion													
CO2575B	\$235	\$229	\$236	\$247	\$281	\$303	\$328	\$346	\$377	\$421	\$352	\$721	\$794

▶ Specification Information, continued on next page

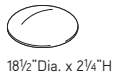

18½" Dia. x 2¼"H

Emu Advanced Collection Emu Re-Trouvé – Seating

DESIGN PATRICIA URQUIOLA

SIN 71.207

► Specification Information, continued from previous page

Specification Information

Style Number	Base Prices										Leather Grades:		
	Fabric Grades:										COL	C	E
COM	6	7	8	9	10	11	12	13	14				



20"D x 20½"W x 10"H

Chair Seat and Back Cushions

Outdoor Cushion

CO2566C	\$423	\$423	N.A.	N.A.	\$487	N.A.	N.A.	N.A.	N.A.	N.A.	N.A.	N.A.	N.A.
----------------	-------	-------	------	------	-------	------	------	------	------	------	------	------	------

Indoor Cushion

CO2566B	\$423	\$423	\$431	\$445	\$487	\$515	\$547	\$569	\$608	\$663	\$537	\$1217	\$1345
----------------	-------	-------	-------	-------	-------	-------	-------	-------	-------	-------	-------	--------	--------

COM/yds = 1¼, COL/sq ft = 27

Vase Frames and Vase Insert

Tip: The following powder coat paint finishes are available with an upcharge, as shown at right: 4251 Emu Indian Brown, 4256 Aluminum, 4257 Antique Iron, 7234 Black, 7272 Blue, 7273 Green, 7294 Emu Grey/Green, 7296 Emu Taupe, 7297 Emu Corten, 7298 Emu Copper, and 7391 Emu Poppy.

Standard Includes	Required to Specify
-------------------	---------------------

- | | |
|---|--|
| <ul style="list-style-type: none"> Frame: hot-dipped steel rod, hand welded Finish: 7271 Emu White outdoor grade powder coat paint Vase insert, if selected: white ceramic | <ol style="list-style-type: none"> 1 Style number 2 Options, if selected (see below) |
|---|--|

Options	Price	Required to Specify
---------	-------	---------------------

- | | | |
|---|--------------------------|--|
| <p>Other Emu paint</p> <ul style="list-style-type: none"> Low vase frame High vase frame | <p>+\$200
+\$200</p> | <p>Specify paint color number.
Specify paint color number.</p> |
|---|--------------------------|--|

Specification Information

Dimensions	Style	Base
Dia. H	Number	Price

Low Vase Frame

25½"	28"	CO2578	\$1450
------	-----	---------------	--------

High Vase Frame

28¼"	41¼"	CO2577	\$1806
------	------	---------------	--------

Vase Insert

24½"	14½"	CO2580	\$ 456
------	------	---------------	--------



Outdoor

Emu Advanced Collection Emu Round – Seating

DESIGN CHRISTOPHE PILLET

SIN 71.207

Tip: Stool and lounge stacks four high. Chair stacks eight high.

Tip: The following powder coat paint finishes are available with an upcharge, as shown at right: 4256 Aluminum, 7272 Blue, 7273 Green, 7294 Emu Grey/Green, 7296 Emu Taupe, 7297 Emu Corten, 7298 Emu Copper, and 7391 Emu Poppy.

Standard Includes Required to Specify

- | | | |
|--|---|---|
| <p>► Need help? Product details, see <i>Coalesse Seating and Outdoor Specification Guide</i></p> | <ul style="list-style-type: none"> • Frame: metal mesh seat, crafted using a deep drawing technique, welded to a tubular steel frame • Finish: outdoor grade powder coat paint • Glides: nylon | <ol style="list-style-type: none"> 1 Style number 2 Powder coat color for frame: 4251 Emu Indian Brown, 4257 Antique Iron, 7234 Emu Black, 7271 Emu White 3 Options, if selected (see below) |
|--|---|---|

Options Price Required to Specify

Surface Materials	Options	Price	Required to Specify
	Acrylic backer		
	• Indoor stool cushions only	+\$ 10	Specify with acrylic backer.
	• Indoor chair cushions only	+\$ 12	Specify with acrylic backer.
	• Indoor lounge cushions only	+\$ 22	Specify with acrylic backer.
	• Indoor pillow cushions only	+\$ 6	Specify with acrylic backer.
			► See <i>Surface Materials</i> , page 260.
	Other Emu paint (cost per pack)		
	• Stool	+\$150	Specify paint color number.
	• Armless chair	+\$200	Specify paint color number.
	• Arm chair	+\$200	Specify paint color number.
	• Lounge	+\$200	Specify paint color number.

Specification Information

Dimensions	Style	Quantity	Base
D W H	Number		Price

Stools

20½"	22¾"	39¼"	CO2467	2	\$1088
------	------	------	--------	---	--------

Armless Chairs

23¼"	24¾"	32"	CO2465	4	\$1391
------	------	-----	--------	---	--------

Arm Chairs

23¼"	24¾"	32"	CO2466	4	\$1524
------	------	-----	--------	---	--------

Lounges

34¼"	36¼"	33"	CO2469	2	\$1484
------	------	-----	--------	---	--------

► Specification Information, continued on next page

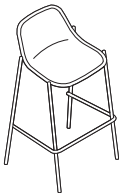

Seat height: 28"



Seat height: 17¾"



Seat height: 17¾"
Arm height: 26"

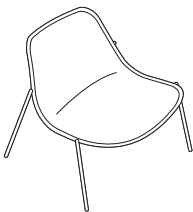

Seat height: 15"
Seat depth: 22½"

Emu Advanced Collection Emu Round – Seating

DESIGN CHRISTOPHE PILLET

SIN 71.207

Tip: All cushions come in quantity of one.

Tip: Cushions are one piece with a slit to allow for water drainage.



Overall: 3/4"D x 22"W x 28"H



Overall: 3/4"D x 18"W x 22 1/2"H

Tip: Chair cushion for use on chair and arm chair.

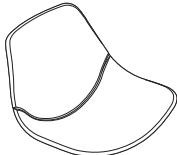

Overall: 3/4"D x 34"W x 40"H



Overall: 4 1/4"D x 17 1/4"W x 10 1/2"H

Tip: Lounge pillow is for use with Heaven and Round Lounge chairs.

► Specification Information, continued from previous page

Specification Information

Style Number	Base Prices										Leather Grades:		
	Fabric Grades:										COL	C	E
	COM	6	7	8	9	10	11	12	13	14			

Stool Cushions

Outdoor Cushion

CO2467C	\$320	\$320	N.A.	N.A.	\$384	N.A.	N.A.	N.A.	N.A.	N.A.	N.A.	N.A.	N.A.
---------	-------	-------	------	------	-------	------	------	------	------	------	------	------	------

Indoor Cushion

CO2467B	\$320	\$320	\$328	\$342	\$384	\$412	\$444	\$466	\$505	\$560	\$434	\$ 907	\$ 999
---------	-------	-------	-------	-------	-------	-------	-------	-------	-------	-------	-------	--------	--------

COM/yds = 1 1/4, COL/sq ft = 28

Chair Cushions

Outdoor Cushion

CO2465C	\$333	\$333	N.A.	N.A.	\$411	N.A.	N.A.	N.A.	N.A.	N.A.	N.A.	N.A.	N.A.
---------	-------	-------	------	------	-------	------	------	------	------	------	------	------	------

Indoor Cushion

CO2465B	\$333	\$333	\$343	\$360	\$411	\$444	\$482	\$509	\$556	\$621	\$439	\$1015	\$1125
---------	-------	-------	-------	-------	-------	-------	-------	-------	-------	-------	-------	--------	--------

COM/yds = 1 1/2, COL/sq ft = 33

Lounge Cushions and Pillows

Outdoor Cushion

CO2469C	\$460	\$460	N.A.	N.A.	\$589	N.A.	N.A.	N.A.	N.A.	N.A.	N.A.	N.A.	N.A.
---------	-------	-------	------	------	-------	------	------	------	------	------	------	------	------

Indoor Cushion

CO2469B	\$460	\$460	\$476	\$504	\$589	\$644	\$707	\$752	\$830	\$939	\$531	\$1522	\$1704
---------	-------	-------	-------	-------	-------	-------	-------	-------	-------	-------	-------	--------	--------

COM/yds = 2 1/2, COL/sq ft = 55

Outdoor Pillow

CO2488C	\$201	\$187	N.A.	N.A.	\$225	N.A.	N.A.	N.A.	N.A.	N.A.	N.A.	N.A.	N.A.
---------	-------	-------	------	------	-------	------	------	------	------	------	------	------	------

Indoor Pillow

CO2488B	\$201	\$187	\$192	\$200	\$225	\$242	\$261	\$274	\$298	\$331	\$318	\$ 583	\$ 638
---------	-------	-------	-------	-------	-------	-------	-------	-------	-------	-------	-------	--------	--------

COM/yds = 3/4, COL/sq ft = 17

Emu Advanced Collection Emu Round – Tables

DESIGN CHRISTOPHE PILLET

SIN 71.207

Tip: The following powder coat paint finishes are available with an upcharge, as shown at right: 4256 Aluminum, 7272 Blue, 7273 Green, 7294 Emu Grey/Green, 7296 Emu Taupe, 7297 Emu Corten, 7298 Emu Copper, and 7391 Emu Poppy.

Standard Includes	Required to Specify
-------------------	---------------------

- | | | |
|--|--|--|
| <p>► Need help? Product details, see <i>Coalesse Seating and Outdoor Specification Guide</i></p> | <ul style="list-style-type: none"> • Frame: table top and base are sheet metal with tubular steel mountings • Finish: outdoor grade powder coat paint • Glides: nylon | <ol style="list-style-type: none"> 1 Style number 2 Powder coat color for frame: <ul style="list-style-type: none"> 4251 Emu Indian Brown 4257 Antique Iron 7234 Emu Black 7271 Emu White 3 Options, if selected (see below) |
|--|--|--|

Options	Price	Required to Specify
---------	-------	---------------------

- | | | |
|--|--|--|
| <p>Other Emu paint</p> <ul style="list-style-type: none"> • Square tables +\$125 • Round table +\$125 • Counter table +\$125 • Side tables +\$125 • Rectangle table +\$150 | | <p>Specify paint color number.
Specify paint color number.
Specify paint color number.
Specify paint color number.
Specify paint color number.</p> |
|--|--|--|

Specification Information					
---------------------------	--	--	--	--	--

Dimensions			Style Number	Base Price
D	W	H		

Square Tables

23½"	23½"	29½"	CO2472	\$ 572
27½"	27½"	29½"	CO2471	\$ 674
31½"	31½"	29½"	CO2473	\$ 716

Round Table

35½" dia.	29½"	CO2470	\$ 764
-----------	------	--------	--------

Rectangle Table

31½"	47½"	29½"	CO2474	\$1115
------	------	------	--------	--------

Counter Table

23½"	23½"	41¼"	CO2475	\$ 690
------	------	------	--------	--------

Side Tables

31½"	31½"	16½"	CO2477	\$ 496
27½"	39¼"	16½"	CO2478	\$ 543

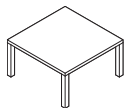
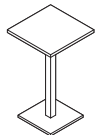
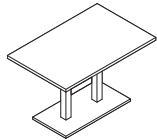
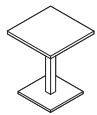

Surface Materials

► For more detailed Coalesse surface material information, see the *Coalesse Surface Materials Reference Guide* or consult your Steelcase dealer.

Surface Materials-Upholstery	260
Customer's Own Material	262
Flammability Information	264
Upholstery Matrix	265
Surface Materials-Leather/Faux	268
Cut Yardage Net Price List	270
Leather and Faux Leather Matrix	271
Surface Materials-Wood	272
Hardwood Matrix	274
Veneer Matrix	275
Surface Materials-Laminate	276
High-Pressure Laminate Matrix	278
Laminate Edge Band Matrix	282
Surface Materials-Glass	284
Glass Matrix	285
Surface Materials-Metal/Paint	286
Metal/Paint Matrix	288
Emu Advanced Collection Paint Matrix	290
Surface Materials-Miscellaneous	291
Ordering	294
Care and Maintenance	296

Surface Materials - Upholstery

Upholstery

All Coalesse textiles are priced by grades. Some Coalesse fabrics can be treated for flame retardancy, contact Customer Service. All Coalesse products are handcrafted making each unique. Certain fabrics and leathers will appear loose and may differ from like products due to comfort wrinkles when upholstered.

A contrasting welt is available on some products. Consult Customer Service for yardage or square feet requirements and prices. All stripes will be applied vertically unless customer specifies otherwise. Loose cushions on Coalesse products are not fully upholstered (not reversible).

Designtex, Maharam, Steelcase, and select Luna fabrics are graded in our pricing. Simply order Coalesse products with Designtex, Maharam, Steelcase, and select Luna specified. Designtex, Maharam, Steelcase, and select Luna fabrics are graded in on Coalesse products; however, Coalesse does not stock fabrics and can only respond based on Designtex, Maharam, Steelcase, and select Luna fabrics lead times. For current grades, refer to Coalesse website: www.Coalesse.com.

Special Fabric Applications

Backing

- Backing information is found on each product page. Select this option when ordering your product to have backing applied. Price varies by product according to yardage it requires.

Tip: Prices subject to change without notice and an additional 2 week lead time will apply for 54" wide fabrics. Wider fabrics will require 4 week additional lead time. Check fabric database to determine if backing is required at www.Coalesse.com.

Seating Upholstery

Coalesse fabrics are priced by grades from 6 through 14 and leathers C and E. Fabrics and leathers may be purchased separately as cut yardage, see page 270. All products are handcrafted, making each unique. Certain fabrics and leathers will appear loose and may differ from like products due to wrinkles when upholstered. A contrasting welt is available on some products. Consult Customer Service for yardage or square feet requirements for pricing.

All stripes will be applied vertically unless customer specifies otherwise. Loose cushions on Coalesse products are not fully upholstered (not reversible). Any graded-in or COM textile should be reviewed with supplier to verify availability. In some cases a textile supplier may require minimums that exceed your furniture order requirements. In these situations, you will be contacted with an option to select a different textile or continue with your original textile selection as a COM-DTP. If you choose to continue with your textile selection as COM-DTP to allow you to order the minimum required, please ship only the textile needed to Coalesse for your furniture order.

Emu Upholstery

Applies to: Emu Advanced Collection Outdura Collection

Fabric Grade 6

5G30	Natural White
5G31	Kona
5G32	Sandstone
5G33	Cadet Grey
5G34	Stone
5G35	China Red
5G36	Cardinal Red
5G37	Solid Aquamarine
5G38	Canary
5G39	Pesto
5G41	Island Blue

SW_1 Knit

Applies to: SW_1 Collection

5KG0	Stone
5KG1	Grey
5KG2	Brown
5KG3	Black
5KG4	Ivory
5KG5	Coal
5KG6	Garnet
5KG7	Golden
5KG8	Royal

Lagunitas Knit

Applies to: Lagunitas focus nook and lounge system

Grade 1

5K50	Stone
5K51	Grey
5K54	Black
5K58	Ivory
5K59	Coal

Grade 2

5K52	Cement
5K53	Brown
5K55	Garnet
5K56	Golden
5K57	Royal
5K60	Glacier
5K61	Cadet
5K62	Grass
5K63	Forest
5K64	Amber
5K65	Terracotta
5K66	Crimson
5K67	Berry
5K68	Violet
5K69	Khaki

Hexa Upholstery

Applies to: Hosu

Fabric Grade 10

CL50	Dark Grey
CL51	Light Grey
CL52	Blue
CL53	Green
CL54	Red
CL55	Yellow

Fusion Upholstery

Applies to: Hosu lounge and Lagunitas personal table

Fabric Grade 11

CL60	Caviar
CL61	Portobello
CL62	Graphite
CL63	Java
CL64	Steam*

* Not available on Hosu

Surface Materials - Steelcase Upholstery

Steelcase Upholstery

Coalesse offers a select palette of Steelcase fabrics as standard. This provides the convenience of an integrated finish offering and ease of specification. See the Steelcase Standard Fabric Matrix for availability by product line. For a visual reference, please refer to the Steelcase Finish Library.

Grade 6

Cogent: Connect

- 5S15 Coconut
- 5S16 Turmeric/Honey
- 5S17 Tangerine
- 5S18 Scarlet
- 5S19 Concord
- 5S20 Maya Blue
- 5S21 Blue Jay
- 5S23 Wasabi
- 5S24 Nickel
- 5S25 Graphite
- 5S26 Licorice
- 5S27 Malt
- 5S28 Root Beer
- 5S93 Blueprint
- 5S94 Lizard/Jungle
- 5S95 Sailor
- 5S96 Quicksilver
- 5S98 Canary
- 5S99 Lipstick/Merlot
- 5SD0 Royal Blue

Jacks

- 5B61 Taupe
- 5B62 Camel
- 5B64 Pewter
- 5B70 Midnight

Seating Vinyl

- 5801 Topaz
- 5805 Foggy Night
- 5809 Black
- 5810 Forest
- 5812 Navy
- 5813 Currant
- 5814 Leaf
- 5815 Seaside
- 5817 Pebble
- 5818 Spice
- 5819 Thistle
- 5820 Coffee
- 5822 Iris

Spyder

- 5B01 Foggy Night
- 5B04 Peri

Nitelights

- 5F58 Hazelnut
- 5F61 Earth
- 5F62 Shore
- 5F63 Moss
- 5F65 Regal Blue
- 5F66 Stone
- 5F67 Moon

Link

- 5A20 Burgundy
- 5A23 Green
- 5A24 Blue
- 5A25 Navy
- 5A26 Purple
- 5A27 Black
- 5A28 Ocean
- 5A30 Chamois

Grade 7

Stand In

- 5621 Sleet
- 5622 Lunar
- 5623 Cyclone
- 5624 Eclipse
- 5625 Powder
- 5626 Chardonnay
- 5627 Graham
- 5628 Sediment
- 5629 Allspice
- 5630 Apple
- 5631 Lava
- 5632 Cayenne
- 5633 Plantain
- 5634 Parsley
- 5635 Scallion
- 5636 Atlantis
- 5691 Orca
- 5740 Burlap
- 5741 Porter
- 5742 Tusk
- 5743 Putty
- 5744 Blueberry
- 5745 Chartreuse
- 5746 Mango
- 5747 Sedona
- 5748 Juniper
- 5749 Peanut

Cogent: Trails

- 5S29 Bronzite
- 5S85 Agate
- 5S86 Lapis
- 5S87 Malachite
- 5S88 Quartz
- 5S90 Tiger Eye
- 5S91 Travertine
- 5S92 Topaz

New Black

- 5J08 Jack
- 5J09 James
- 5J12 Harley

Imperma

- TM01 Toffee
- TM02 Pigeon
- TM03 Fossil
- TM04 Poppyseed
- TM05 Auburn
- TM06 Cumin
- TM07 Marble
- TM08 Cliff
- TM09 Tarragon
- TM10 Pesto
- TM11 Wave
- TM12 Niagara
- TM13 Tuscan
- TM14 Peppercorn

Grade 8

Billiard Multi-Use by Designtex

- 5H10 Bone
- 5H11 Poppy
- 5H12 Tangelo
- 5H13 Citron
- 5H14 Avocado
- 5H15 Hunter
- 5H16 Indigo
- 5H17 Mallard
- 5H18 Teak
- 5H19 Cumulus
- 5H20 Pewter
- 5H21 Gunmetal
- 5H22 Ink

Texel

- TM20 Angora
- TM21 Grist
- TM22 Galaxy
- TM23 Terracotta
- TM24 Nude
- TM25 Field
- TM26 Haze

Grade 9

Remix

- RE01 Rust
- RE02 Pumpkin
- RE03 Pebble
- RE04 Dark Chocolate
- RE05 Beige
- RE06 Linen Beige
- RE07 Hazelnut
- RE08 Concrete
- RE09 Sky Blue
- RE10 Blue Jean
- RE11 Ivy Green
- RE12 Primavera Yellow
- RE13 Night Blue

Bo Peep

- 5G66 Pita
- 5G67 Bone
- 5G68 Safari
- 5G69 Brown Sugar
- 5G70 Chocolate
- 5G71 Candlelight
- 5G72 Honey Mustard
- 5G73 Marmalade
- 5G74 Picnic
- 5G75 Pinot
- 5G76 Bloom
- 5G77 Grapevine
- 5G78 Firefly
- 5G79 Artichoke
- 5G80 Serpent
- 5G81 Carolina
- 5G82 Blue Bonnet
- 5G83 Nautical
- 5G84 Gravel
- 5G85 Sharkskin
- 5G86 Kohl

Customer's Own Material

CUSTOMER'S OWN MATERIAL

Coalesse is pleased to cooperate with COM/COL selections. Prior to order placement for exact yardage requirements, a sample cutting of actual COM/COL must be submitted to Coalesse for approval only if fabric approval is not found in Coalesse fabric database. Identify the name and number of units on which the fabric/leather is to be applied. If COM has a repeat the sample should be large enough to show the entire repeat. Coalesse will not accept nor use any painted leathers. A painted leather is described as any suede or leather which is not aniline dyed with the same color throughout the thickness of the hide.

Even after preliminary approval, Coalesse reserves the right to reject COM/COL if necessary when the quality is not satisfactory for the item it is intended to be used on. Once COM/COL is accepted Coalesse assumes no responsibility for its overall appearance, flammability, normal durability, colorfastness, or any other quality, after upholstered on a Coalesse product.

COALESSE STANDARD TO BUY PROGRAM

The Customer's Own Material (COM) Program offers the opportunity for customers to select fabrics that are not offered through the standard Coalesse surface materials program for use on our products. Through the COM program, Coalesse will test your materials for application on Coalesse products. Once approved, you can place your order. Coalesse will facilitate the entire ordering process and give you a production schedule. Coalesse will order the COM fabric directly from the textile manufacturer. For up-to-date information regarding fabric test results for all COM fabrics and details regarding yardage requirements for most Seating lines, visit the fabric database at www.coalesse.com.

CUSTOMERS TO BUY SCHEDULING POLICY/COM/COL POLICY

COM/COL must be received at manufacturing location no later than 20 working days prior to the order scheduled delivery date. If COM/COL is not received in this time frame, scheduling will move the order's delivery date out to the best available ship date. Customer Service will notify the dealer via e-mail of the order's new scheduled delivery date. Project size order shipment may be affected due to size of order. If the COM/COL is received and the COM/COL requires backing, scheduling will move order out to best available ship date. Backing charges will apply. If COM/COL is received defective or short yardage/sq. ft., the replacement COM/COL order must be received within 3 days to maintain scheduled delivery date on order. It is the responsibility of the dealer to advise Coalesse on what to do with defective materials. In addition, customers may request Coalesse to order for COM/COL materials.

SQUARE FOOTAGE/ YARDAGE REQUIREMENTS

COM and COL price includes application of Customer's Own Material or Leather to frames. All COM and COL should be shipped freight prepaid to designated manufacturing location. Labels will be provided by your Customer Service representative to ensure clear textile identification.

Please have customers send COM/COL and add TAG: COM/ COL.

COM and COL must be identified as follows to prevent order delays:

1. Name and address (Should match purchase order)
2. Your furniture purchase order number/sales order
3. Style number to which fabric is to be applied
4. Supplier name and fabric name, number, and color

COL hides must be rolled for shipment to manufacturing location in a neat manner, avoiding creases and excessive roll marks. All leathers will be rejected if sent in a folded manner.

To determine COL square footage, see COL requirements for each product. Square footage requirements are based on an average hide size of 45-50 square feet of clean, usable leather. If the COL has a smaller average hide size, please consult Customer Service for quotation. Please note, leather is a natural product and all square footage requirements are estimations. The shape of the COL hides supplied and the usable, clean square footage may make it necessary for us to request more leather after COL is received.

Yardage requirements shown are based on 54" width plain material. If fabric design requires vertical/top out, Customer Service should be consulted for additional yards required. If fabric is under 54", refer to fabric database at www.coalesse.com.

EXCESS COM/COL POLICY

All excess COM/COL will be disposed of after order is completed unless prior arrangements have been made with Coalesse Customer Service. Fedex account number and address to ship to must be referenced. Excess WILL NOT be returned with shipment of furniture.

Customer's Own Material

Cutting Direction Guidelines

Cutting direction is based on the fabric width and the way the fabric is cut from the roll and applied to Coalesse products. There are two cutting directions: railroaded or horizontal.

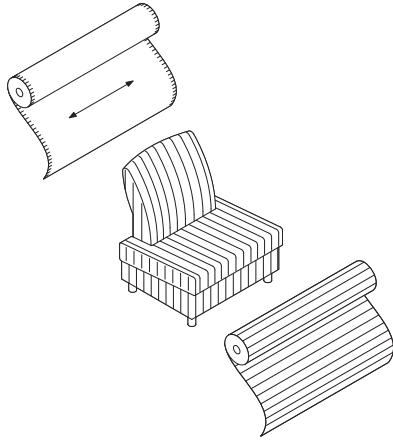

Horizontal or railroaded (across roll, warp horizontal) means fabric is cut across the roll; selvages are on the top and bottom.

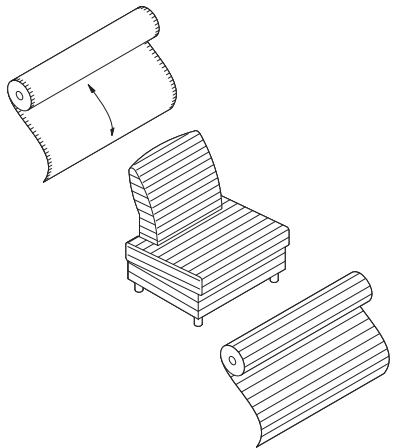

Vertical or top out (down roll, warp vertical) means fabric is cut in the same direction it is woven; selvages are on the left and right sides.

Flammability Information

California Technical Bulletin 133

Definition: California Technical Bulletin 133 (CAL 133) is a flammability test procedure for seating furniture specified in public occupancies. Specifications, test procedures and requirements pertaining to flammability regulations are changing rapidly. Coalesse will make every effort to keep our information and services pertaining to flammability specifications up-to-date.

Coalesse reserves the right to make deletions and additions and cannot guarantee fabric manufacturer materials nor its specifications will not change. A new evaluation will be necessary if materials are altered by manufacturer. This approval information on our website is subject to change without notice. Coalesse is not responsible for textile manufacturer's changes. Contact fabric manufacturer for availability.

For fabrics not pre-approved, please submit the fabric supplier name, fabric name, style number, content, weight, Coalesse product number, and fabric name to be applied to Customer Service at 1.800.627.6770 or fax to 888.413.5161. Our Customer Service representative will contact you within 48 hours of your request with information on the fabric's CAL 133 compliance. Actual fabric sample may be required. **If not approved, a burn test may be required at a fee. Contact Customer Service for a quote.**

UFAC – All upholstered seating is constructed to conform to UFAC (Upholstered Furniture Action Council) specifications. This is comparable to NFPA 260. All Coalesse fabrics and leathers meet UFAC specifications and NFPA 260 requirements.

California Bureau of Home Furnishings Technical Bulletin 117

All Coalesse upholstered seating, fabrics, and leathers meet California Technical Bulletin 117. All products manufactured after May 1, 1993 have CAL 117 label attached.

California Bureau of Home Furnishings Technical Bulletin 133

On March 1, 1992 Technical Bulletin 133 (TB 133), a fire test for seating furniture in public buildings, became law in California. On and after March 1, 1992 all seating furniture sold in California for use in the public buildings specified in the regulations, must be in compliance with the requirements of TB 133, and each product must be labeled stating that the furniture meets TB 133. If a building is fully sprinklered, compliance with TB 133 becomes discretionary, however, even in sprinklered buildings all furniture must meet the minimum fire standards of the bureau's Technical Bulletin 117.

California Technical Bulletin 133 requires special construction procedures and is based on fabric and product design. For applicable CAL 133 upcharge, refer to up-charge, refer to individual product pages in the specification guide or the fabric database at www.coalesse.com.

Pre-Approved Fabrics – www.coalesse.com If a model or fabric is not listed, consult Customer Service for details at 800.627.6770.

***Note** – California Technical Bulletin 133 is a unit test and requires specific product testing of unit for certification. If certification is required the test of a unit constructed exactly as the unit(s) to be specified in the installation, the cost of the test unit plus the cost of testing (\$500 net per test) must be added to obtain certification. Coalesse is not responsible for any charges for COM/COL purchased prior to evaluation if unit fails. Textile and unit cannot be returned.

Please consult Customer Service at 1.800.627.6770 or Fax 888.413.5161 for suggested fabrics/leathers, upcharges and minimums required for meeting California Technical Bulletin 133.

General Information

-Specifications, test procedures and requirements pertaining to flammability regulations are changing rapidly. Coalesse will make every effort to keep our information and services pertaining to flame specifications up-to-date. However, we do reserve the right to alter the products, fabrics/leathers or upcharges associated with any of the above or any other flame specifications.

When COM or COL is specified for use on Coalesse seating that is to meet the New York Port Authority Code, the COM or COL must be treated to meet this code prior to receipt by Coalesse. Coalesse is not responsible for the flammability treatment or certification of any COM or COL. All upcharges indicated are to be added to list prices. ▶ See specific product pages for CAL 133 approval, option, and pricing.

Upholstery Matrix

Note: Coalesse reserves the right to reject fabrics when necessary if the quality or construction is not satisfactory for intended use. For most up to date information on fabric usage, please check the fabric database on www.coalesse.com.

Legend

- = Not available
- = Available
- = Available but requires backer
- ⊙ = Available but requires contrasting fabric
- = Available but requires backer and contrasting fabric
- ▶ See specification pages for details.

	Chance Grade 12	Connoisseur 3 Grade 13	Conservation Grade 10	Divina Melange Grade 14/2CH	Frolic Grade 14	Hallingdal Grade 14/2CH	Link Grade 6	Pigment Grade 13	React Grade 10	Remix Grade 12	Restore Grade 10	Rocket Grade 9	Salon Grade 9	Samba Grade 12	Sequence Grade 12	Souvenir Grade 10	Square Grade 12	Steady Grade 11	Steelcut Grade 13	Sustain Grade 10	Swayed All Over Grade COM	Tempera Grade 14	Whimsy Grade 11
Bindu	■	□	•	□	■	□	■	□	•	■	•	□	•	■	•	•	•	•	■	■	■	□	•
Bix	■	□	⊙	□	■	□	■	□	□	■	□	□	□	■	■	•	⊙	•	■	■	■	□	⊙
Chord	■	□	■	□	■	□	■	□	■	■	■	□	□	■	■	•	■	•	■	■	■	□	■
Circa	■	□	•	□	■	□	■	□	•	■	•	□	•	■	•	•	•	•	■	■	■	□	•
Coupe	■	□	■	□	■	□	■	□	■	■	■	□	□	■	■	■	■	•	■	■	■	□	■
Enea	■	□	■	□	■	□	■	□	■	■	■	□	□	■	■	■	■	•	■	■	■	□	■
Kathryn	■	□	■	□	■	□	■	□	■	■	■	□	□	■	■	■	■	•	■	■	■	□	■
Ripple	■	□	•	□	■	□	■	□	•	■	•	□	•	■	•	•	•	•	■	■	■	□	•
Swathmore	■	□	■	□	■	□	■	□	■	■	■	□	□	■	■	■	■	•	■	■	■	□	■
Swathmore Grande	■	□	■	□	■	□	■	□	■	■	■	□	□	■	■	■	■	•	■	■	■	□	■

Disclaimer: Coalesse is pleased to provide this information. However, even after preliminary approval, Coalesse reserves the right to reject fabrics/leathers when necessary if the quality or construction is not satisfactory for the item it is intended for use on. Coalesse reserves the right to evaluate data daily and make any necessary changes or improvements to the information provided. Textile recommendations do not imply a warranty for the textiles. The textile manufacturer provides all warranties for textiles. All trademarks and trade names are the property of the different manufacturers. All pricing quotes for product should be obtained from your local Sales Representative or a Coalesse Customer Service Representative. Recommendations such as latex backing, Gore SP and CAL 133 will require additional cost and may require additional lead-time. All specifications are subject to change without notice.

Steelcase Upholstery Matrix

Note: Coalesse reserves the right to reject fabrics when necessary if the quality or construction is not satisfactory for intended use. For most up to date information on fabric usage please check the fabric database on www.coalesse.com.

Legend

- = Not available
- = Available
- ▶ See specification pages in the *Coalesse Specification Guides* for details.

	Steelcase Fabrics													
	Cogent: Connect Grade 06	Jacks Grade 06	Seating Vinyl Grade 06	Spyder Grade 06	Nitelights Grade 06	Link Grade 06	Stand In Grade 07	Cogent: Trails Grade 07	New Black Grade 07	Imperma Grade 07	Billiard Multi-Use by Designtex Grade 08	Texel Grade 08	Remix Grade 09	Bo Peep Grade 10
Await	•	■	■	■	■	■	■	■	■	■	■	■	■	■
Bindu	■	■	■	■	■	■	■	■	■	■	■	■	■	■
Bix Cushions	■	■	■	■	■	■	■	■	■	■	■	■	■	■
Bix Screen	■	■	•	■	•	■	■	■	■	■	■	■	■	■
Bob	■	■	■	■	■	■	■	■	■	■	■	■	■	■
Capa	■	■	■	■	■	■	■	■	■	■	■	■	■	■
Chord	■	■	■	■	■	■	■	■	■	■	■	■	■	■
Circa	•	■	■	■	■	■	■	■	■	■	■	■	■	■
Coupe	■	■	■	■	■	■	■	■	■	■	■	■	■	■
Davos	■	■	■	■	■	■	■	■	■	■	■	■	■	■
Elbow Chair CH20	•	•	•	•	•	•	•	•	•	•	•	•	•	•
Emu Outdoor Cushion	•	•	•	•	•	•	•	•	•	•	•	•	•	•
Emu Indoor Cushion	■	■	■	■	■	■	■	■	■	■	■	■	■	■
Emu Terramare	•	•	•	•	•	•	•	•	•	•	•	•	•	•
Enea	■	■	■	■	■	■	■	■	■	■	■	■	■	■
Enea Lottus	■	■	■	■	■	■	■	■	■	■	■	■	■	■
Exponents, Benches	■	■	■	■	■	■	■	■	■	■	■	■	■	■
Hosu	■	■	■	■	■	■	■	■	■	■	■	■	■	■
Joel	■	■	■	■	■	■	■	■	■	■	■	■	■	■
Kathryn	■	■	■	■	■	■	■	■	■	■	■	■	■	■
Last Minute	■	■	■	■	■	■	■	■	■	■	■	■	■	■
Lounge Seating CH100 Series	•	•	•	•	•	•	•	•	•	•	•	•	•	•
Millbrae Contract	■	■	■	■	■	■	■	■	■	■	■	■	■	■
Millbrae Lifestyle	•	■	■	■	■	■	■	■	■	■	•	■	•	■

▶ Continued on next page

The above Steelcase fabrics are available as standard without a backer on select Coalesse product lines. For those product lines that are noted as unavailable, it may be specifiable with a backer as a Graded-In fabric. Additional Steelcase fabrics are available through the Graded-In program. Please consult the Coalesse Fabric Database for availability. Disclaimer: Coalesse is pleased to provide this information. However, even after preliminary approval, Coalesse reserves the right to reject fabrics/leathers when necessary if the quality or construction is not satisfactory for the item it is intended for use on. Coalesse reserves the right to evaluate data daily and make any necessary changes or improvements to the information provided. Textile recommendations do not imply a warranty for the textiles. The textile manufacturer provides all warranties for textiles. All trademarks and trade names are the property of the different manufacturers. All pricing quotes for product should be obtained from your local Sales Representative or a Coalesse Customer Service Representative. Recommendations such as backing and CAL 133 will require additional cost and may require additional lead-time. All specifications are subject to change without notice.

Steelcase Upholstery Matrix

Note: Coalesse reserves the right to reject fabrics when necessary if the quality or construction is not satisfactory for intended use. For most up to date information on fabric usage please check the fabric database on www.coalesse.com.

► Continued, from previous page

Legend

- = Not available
- = Available
- See specification pages in the *Coalesse Specification Guides* for details.

	Steelcase Fabrics													
	Cogent: Connect Grade 06	Jacks Grade 06	Seating Vinyl Grade 06	Spyder Grade 06	Nitelights Grade 06	Link Grade 06	Stand In Grade 07	Cogent: Trails Grade 07	New Black Grade 07	Imperma Grade 07	Billiard Multi-Use by DesignTex Grade 08	Texel Grade 08	Remix Grade 09	Bo Peep Grade 10
Lagunitas Cushion	■	■	■	■	■	■	■	■	■	■	■	■	■	■
Lox	•	■	■	■	■	■	■	■	■	■	•	■	•	■
Montara650	■	■	■	■	■	■	■	■	■	■	■	■	■	■
Passerelle	■	■	■	■	■	■	■	■	■	■	■	■	■	■
Ripple	•	■	■	■	■	■	■	■	■	■	■	■	■	■
Sidewalk	■	■	■	■	■	■	■	■	■	■	■	■	■	■
SW_1	■	■	■	■	■	■	•	•	■	■	■	■	■	■
Swathmore	■	■	■	■	■	■	■	■	■	■	■	■	■	■
Swathmore Grande	■	■	■	■	■	■	■	■	■	■	■	■	■	■
Switch	■	■	■	■	■	■	■	■	■	■	■	■	■	■
Together	■	■	■	■	■	■	■	■	■	■	■	■	■	■
Topo Lounge	■	■	■	■	■	■	■	■	■	■	■	■	■	■
Topo Mobile Lounge	■	■	■	■	■	■	■	■	■	■	■	■	■	■
Visalia	■	■	■	■	■	■	■	■	■	■	■	■	■	■
Wrapp	•	■	■	■	■	■	■	■	■	■	•	■	•	■

The above Steelcase fabrics are available as standard without a backer on select Coalesse product lines. For those product lines that are noted as unavailable, it may be specifiable with a backer as a Graded-In fabric. Additional Steelcase fabrics are available through the Graded-In program. Please consult the Coalesse Fabric Database for availability. Disclaimer: Coalesse is pleased to provide this information. However, even after preliminary approval, Coalesse reserves the right to reject fabrics/leathers when necessary if the quality or construction is not satisfactory for the item it is intended for use on. Coalesse reserves the right to evaluate data daily and make any necessary changes or improvements to the information provided. Textile recommendations do not imply a warranty for the textiles. The textile manufacturer provides all warranties for textiles. All trademarks and trade names are the property of the different manufacturers. All pricing quotes for product should be obtained from your local Sales Representative or a Coalesse Customer Service Representative. Recommendations such as backing and CAL 133 will require additional cost and may require additional lead-time. All specifications are subject to change without notice.

Surface Materials - Leather/Faux

Leather

ELMOSOFT, ELMORUSTICAL LEATHER CARE

Only the finest hides are used for Elmo leather. Expect some color variations from hide to hide due to the aniline state of the product. Color fading may occur if leather is exposed to direct or intense light. Care is required to allow this product to achieve the rich natural patina that beautiful natural leather develops. The hallmarks of this leather include some naturally occurring markings, such as healed scars, insect bites, stretch marks, and fat wrinkles. Elmorustical's leather treatment is very natural with little protection from spills or body oils. This rich leather will exhibit stains and oils through normal use. Coalesse is not responsible for discoloration, spotting, or staining on this leather.

Special Color Match Leather

Coalesse can provide a special color match in its leather to any supplier's leather color, paint color, carpet color, wallpaper color, etc. Sample to match must be submitted to Coalesse with purchase order. Sample for approval can be supplied if requested.

Note: Minimum order 2,500 sq. ft.

Special Fabric Applications

Backing

- Backing information is found on each product page. Select this option when ordering your product to have backing applied. Price varies by product according to yardage it requires.

Tip: Prices subject to change without notice and an additional 2 week lead time will apply for 54" wide fabrics. Wider fabrics will require 4 week additional lead time.

Elmo Leather

Coalesse uses leathers that are provided by Elmo of Sweden. Elmosoft is a full grain, aniline dyed, semi-aniline finish. With Elmosoft leather, now recyclable and chromium-free, you have the opportunity to bid on green projects when requested. Elmosoft leathers are never corrected, buffed, or altered in any way. Coalesse purchases only original full grain leathers. The quality of this genuine leather can be felt in the hand immediately. Other leathers are often stiff because of the amount of pigment needed to cover the imperfections of an inferior hide. Using leather of low quality affects the overall quality of the furniture it is upholstered on. You can feel confident in leather purchased from Coalesse.

Elmosoft

Grade C

Elmosoft

- L110 Maritime Blue
- L111 Midnight Blue
- L112 Ebony
- L113 Gunmetal
- L114 Mica
- L115 Dove Grey
- L116 Plum Pleasure
- L122 Truffle
- L128 Red Birch
- L132 Violet
- L133 Espresso
- L134 Ruby
- L135 Scarlet
- L138 Bourbon
- L139 Cinder
- L140 Garnet
- L143 Pecan
- L144 Chamois
- L146 Russet
- L147 Saddle
- L151 White
- L709 Sugar
- L711 Parchment
- L712 Buff
- L716 Khaki
- L717 Cameo
- L721 Rock
- L722 Desert
- L723 Storm
- L725 Teal
- L727 Egyptian Blue
- L728 Bright Blue
- L730 Hunter
- L736 Lemon
- L737 Sunshine
- L738 Drama
- L740 Dazzle
- L743 Forest Green
- L744 Turtle
- L745 Grass
- L746 Envy
- L747 Cigar
- L748 Light Chocolate
- L749 Beaver
- L750 Bluffstone
- L751 Sienna
- L752 Oxblood
- L753 Dough
- L754 Acorn
- L755 Peanut Butter
- L756 Quinoa
- L757 Dark Sand
- L758 Mustard
- L759 Amber Orange
- L760 Bengal
- L761 Periwinkle
- L762 Canvas
- L763 Macadamia
- L764 True Blue
- L765 Storm Blue
- L766 Powder Blue
- L767 Blush
- L768 Tropical
- L769 Mauve
- L770 Cadet
- L771 Powder Mint
- L772 Timberwolf
- L773 Chalice
- L774 Oil
- L775 Coyote

Elmorustical Leather and Elmotique

Elmorustical and Elmotique is a full top grain, aniline dyed leather.

Elmorustical has a grain which varies in structure and offers outstanding comfort. It is an aniline leather with all the distinct features of the natural hide.

Elmotique is a thinner aniline leather with a batique-effect and displays all the features possessed by the original hide.

Only the finest hides are used for Elmorustical and Elmotique leathers. Expect some color variations from hide to hide due to the aniline state of the product. Color fading may occur if leather is exposed to direct or intense light. Care is required to allow this product to achieve the rich natural patina that beautiful leather develops. The hallmarks of this leather include some naturally occurring markings such as healed scars, insect bites, stretch marks, and fat wrinkles. Elmorustical and Elmotique's leather treatment is very natural with little protection from spills or body oils. This rich leather will exhibit stains and oils through normal use. Coalesse is not responsible for discoloration, spotting, or staining on this leather.

Grade E

Elmorustical

- L318 Loam
- L319 Ebony
- L321 Beige
- L323 Buff
- L325 Camel
- L326 Charbrown
- L330 Flame
- L332 Honey
- L334 Mist Green
- L337 Russet
- L338 Rust
- L363 Tendril
- L364 Fog
- L365 Sunflower
- L366 Terra Cotta
- L367 Cadet
- L368 Marine
- L369 Mallard
- L370 Smoke
- L371 Merlot
- LD54 Twilight

Elmotique

- L310 Sage Brush
- L311 Flaxen
- L312 Earth
- L313 Clay
- L314 Blue Mountain
- L315 Juniper

Faux Leather

Coalesse offers a variety of faux leathers. Not all faux leathers are available on all products, check seating matrix to determine availability. **►Page 271**

Grade 10

Brisa
(For a visual palette, please refer to the Steelcase Finish Library)

- BR01 Black Onyx
- BR04 Truffle
- BR06 Ash
- BR07 Sage
- BR08 Celery
- BR09 Sterling Blue
- BR10 Night Navy
- BR11 Cambridge Blue
- BR12 Abyss
- BR13 Canyon
- BR14 Pompeia
- BR15 Salsa
- BR16 Cinnabar
- BR17 Aztec
- BR18 New Sand
- BR19 Cream
- BR20 White
- BR21 Moccasin
- BR22 Buckskin
- BR23 Praire
- BR24 Mineral
- BR25 Skyway
- BR26 Iron
- BR27 Stormy
- BR28 Esmeralda
- BR29 Seaweed
- BR30 Bone
- BR31 Caramel
- BR32 Bridle
- BR33 Moon

Surface Materials - Leather/Faux

<p>Grade 11</p> <p>Destiny</p> <p>DY01 Black</p> <p>DY02 Raisin</p> <p>DY03 Blueberry</p> <p>DY04 Chestnut</p> <p>DY05 Cedar</p> <p>DY06 Black Rose</p> <p>DY07 Wine</p> <p>DY09 Dune</p> <p>DY10 Truffle</p> <p>DY11 Oak</p> <p>DY12 Newport</p> <p>DY13 Evergreen</p> <p>DY14 Storm</p> <p>DY15 Juniper</p> <p>DY16 Olive</p> <p>DY17 Mocha</p> <p>DY18 Ash</p> <p>DY21 Butter</p> <p>DY23 Deep Red</p> <p>DY24 Eggshell</p> <p>DY26 Parchment</p> <p>DY27 Periwinkle</p> <p>DY30 Royal Purple</p> <p>DY31 Saddle</p> <p>DY32 Cactus Green</p> <p>DY33 Cypress</p> <p>DY34 Mink</p> <p>DY35 Football</p> <p>DY36 Root</p> <p>Finesse</p> <p>AM00 White Cloud</p> <p>AM01 Gelato</p> <p>AM02 Winter White</p> <p>AM04 Mushroom</p> <p>AM06 Charbrown</p> <p>AM08 Iceberg</p> <p>AM09 Gravel</p> <p>AM10 Colonial Blue</p> <p>AM24 Rye</p> <p>AM25 Barley</p> <p>AM26 Stucco</p> <p>AM27 Beaver</p> <p>AM28 Otter</p> <p>AM65 Bordeaux</p> <p>AM66 Navy</p> <p>AM67 Cinder</p> <p>AM80 Cameo</p> <p>AM81 Oyster Grey</p> <p>AM83 Taupe</p> <p>AM85 Chestnut</p> <p>AM87 Indigo</p> <p>AM88 Bone</p> <p>AM89 Jet Black</p> <p>AM92 Burgundy</p> <p>AM93 Hunter Green</p> <p>AM98 Oxford Brown</p> <p>Ovation</p> <p>O500 Dark Brown</p> <p>O501 Light Grey</p> <p>O502 Sage</p> <p>O503 Indigo</p> <p>O504 Lilac</p> <p>O505 Terra</p> <p>O506 Moss</p> <p>O507 Teal</p> <p>O508 Stone</p> <p>O509 Cappuccino</p>	<p>Panache</p> <p>P800 Ebony</p> <p>P801 Cactus</p> <p>P802 Sherwood</p> <p>P803 Teal Blue</p> <p>P804 Sweet Sage</p> <p>P805 Coffee</p> <p>P806 True Taupe</p> <p>P807 Cashew</p> <p>P808 Acorn</p> <p>P809 Redwood</p> <p>P810 Exotic Orchid</p> <p>P811 Maize</p> <p>P812 Chartreuse</p> <p>P813 Regal Blue</p> <p>Prestige</p> <p>AFA1 Onyx</p> <p>AFB2 Soft White</p> <p>AFC3 Saxe Blue</p> <p>AFD3 Buff</p> <p>AFDG Antique White</p> <p>AFE1 Sandstone</p> <p>AFH1 Pecan</p> <p>AFH2 Buttercreme</p> <p>AFI1 Havana</p> <p>AFI2 Brick</p> <p>AFK1 Parchment</p> <p>AFL8 French Grey</p> <p>AFP1 Willow</p> <p>AFP2 Boxwood Green</p> <p>AFPA Tree Moss</p> <p>AFPC Celadon</p> <p>AFS3 Wild Plum</p>	<p>Grade 12</p> <p>Elegance</p> <p>EL01 Ivory</p> <p>EL02 Cream</p> <p>EL03 Char</p> <p>EL04 Saddle</p> <p>EL05 Dune</p> <p>EL06 Camel</p> <p>EL07 Sage</p> <p>EL08 Gray</p> <p>EL09 Walnut</p> <p>EL10 Burgundy</p> <p>EL11 Green</p> <p>EL12 Navy</p> <p>EL13 Black</p>	<p>Grade 13</p> <p>Destiny Perforated</p> <p>DP01 Black</p> <p>DP02 Raisin</p> <p>DP03 Blueberry</p> <p>DP04 Chestnut</p> <p>DP05 Cedar</p> <p>DP06 Black Rose</p> <p>DP07 Wine</p> <p>DP09 Dune</p> <p>DP10 Truffle</p> <p>DP11 Oak</p> <p>DP12 Newport</p> <p>DP13 Evergreen</p> <p>DP14 Storm</p> <p>DP15 Juniper</p> <p>DP16 Olive</p> <p>DP17 Mocha</p> <p>DP21 Butter</p> <p>DP23 Deep Red</p> <p>DP24 Eggshell</p> <p>DP26 Parchment</p> <p>DP27 Periwinkle</p> <p>DP30 Royal Purple</p> <p>DP31 Saddle</p> <p>DP32 Cactus Green</p> <p>DP33 Cypress</p> <p>DP34 Mink</p> <p>DP35 Football</p> <p>DP36 Root</p> <p>Finesse Perforated</p> <p>AP00 White Cloud</p> <p>AP01 Gelato</p> <p>AP02 Winter White</p> <p>AP04 Mushroom</p> <p>AP06 Charbrown</p> <p>AP08 Iceberg</p> <p>AP09 Gravel</p> <p>AP10 Colonial Blue</p> <p>AP24 Rye</p> <p>AP25 Barley</p> <p>AP26 Stucco</p> <p>AP27 Beaver</p> <p>AP28 Otter</p> <p>AP65 Bordeaux</p> <p>AP66 Navy</p> <p>AP67 Cinder</p> <p>AP80 Cameo</p> <p>AP81 Oyster Grey</p> <p>AP83 Taupe</p> <p>AP85 Chestnut</p> <p>AP87 Indigo</p> <p>AP88 Bone</p> <p>AP89 Jet Black</p> <p>AP92 Burgundy</p> <p>AP93 Hunter Green</p> <p>AP98 Oxford Brown</p>	<p>Panache Perforated</p> <p>PR00 Ebony</p> <p>PR01 Cactus</p> <p>PR02 Sherwood</p> <p>PR03 Teal Blue</p> <p>PR04 Sweet Sage</p> <p>PR05 Coffee</p> <p>PR06 True Taupe</p> <p>PR07 Cashew</p> <p>PR08 Acorn</p> <p>PR09 Redwood</p> <p>PR10 Exotic Orchid</p> <p>PR11 Maize</p> <p>PR12 Chartreuse</p> <p>PR13 Regal Blue</p> <p>Prestige Perforated</p> <p>APA1 Onyx</p> <p>APB2 Soft White</p> <p>APC3 Saxe Blue</p> <p>APD3 Buff</p> <p>APDG Antique White</p> <p>APE1 Sandstone</p> <p>APH1 Pecan</p> <p>APH2 Buttercream</p> <p>API1 Havana</p> <p>API2 Brick</p> <p>APK1 Parchment</p> <p>APL8 French Grey</p> <p>APP1 Willow</p> <p>APP2 Boxwood Green</p> <p>APPA Tree Moss</p> <p>APPC Celadon</p> <p>APSP3 Wild Plum</p>
--	---	---	---	--

Cut Yardage Net Price List

FABRIC NAME	Under 60 Yards	60 Yards & Over
Elegance®	\$84.00/yd.	\$80.00/yd.
Finesse®	\$51.00/yd.	\$50.00/yd.
Finesse® Perforated (min. 5 yds)	\$61.00/yd.	\$60.00/yd.
Prestige®	\$56.00/yd.	\$53.00/yd.
Prestige® Perforated (min. 5 yds)	\$66.00/yd.	\$63.00/yd.
Destiny®	\$57.00/yd.	\$55.00/yd.
Destiny® Perforated (min. 5 yds)	\$67.00/yd.	\$64.00/yd.
Ovation	\$57.00/yd.	\$53.00/yd.
Panache	\$57.00/yd.	\$55.00/yd.

LEATHER NAME	Under 500 sq. ft.	500-1000 sq. ft.	Over 1000 sq. ft.
Elmosoft	\$9.00/sq. ft.	\$8.00/sq. ft.	\$7.50/sq. ft.
Elmorustical*	\$11.00/sq. ft.	\$9.00/sq. ft.	\$8.50/sq. ft.

ORDERING INFORMATION

- Minimum Order Requirements
 - Fabric: 1 yd. - 1/8 yd. increments.
 - Leather: 1 full hide (avg. sq. ft./hide - 50).
 - All orders will be filled in full hides only.
 - Overage will be invoiced accordingly.
- Special match leather: 2,500 sq. ft. minimum (Check delivery date)
- The embossing techniques used on Novasuede Perforated to achieve these looks involve very high temperatures. Color and shade may vary slightly based on the fiber density being embossed.
- Cancelled textile orders are subject to a 30% restocking fee. Order must be cancelled 5 days before ship date.
- Due to the natural processes of dyeing, sanding and embossing necessary to achieve these special looks, actual production may vary slightly in appearance from the swatches shown.

COALESSE TEXTILE WARRANTY

Coalesse textile merchandise is produced in accordance with Coalesse high standards. Coalesse does not guarantee, warrant or accept any responsibility whatsoever by reason of its fabrics or leathers fading, wearing, cracking, shrinking, stretching, tearing, seam slippage, alteration in color due to any finish treatment (flameproofing, stain repellent, etc.) or discoloration from liquid contact. Printed textiles are not warranted against irregularity in register. Coalesse is not responsible for dye lot differences or discrepancies in widths of fabrics. Coalesse does not guarantee, warrant or represent an exact color match to cuttings, tabs, memos or sample cards. Coalesse does not warrant exact matching of color or grain of leather. Leather hides may contain certain natural marks, scars, scratches, wrinkles and shade variations within hides, etc., considered by leather tanneries and Coalesse to be inherent characteristics part of the natural beauty of leather and the size or location of such markings cannot be controlled. In any event, upon inspection, Coalesse's responsibility shall be limited to either replacement of merchandise or refund of purchase price at Coalesse's option. The foregoing constitutes the sole and exclusive remedy of the customer. Coalesse is not responsible for the application or installation of our products. In no event shall Coalesse be responsible for any consequential damages or any charges, costs, expenses, or obligations other than as expressly herein set forth. Coalesse makes no other warranties, expressed or implied, as to any product sold by Coalesse. All other warranties (including any warranty of merchantability or fitness for any particular purpose) are hereby excluded.

Leather and Faux Leather Matrix

Note: Coalesse reserves the right to reject fabrics when necessary if the quality or construction is not satisfactory for intended use. For most up to date information on fabric usage, please check the fabric database on www.coalesse.com.

Legend

- = Not available
- = Available
- ☐ = Must be ordered as COM or COL
- ▣ = Available but will puddle
- ▶ See specification pages for details.

	Elmosoft Grade C	Elmoique Grade E	Elmorustical Grade E	Loke Leather	Brisa Grade 10	Destiny Grade 11	Destiny Perforated Grade 13	Prestige Grade 11	Prestige Perforated Grade 13	Finesse Grade 11	Finesse Perforated Grade 13	Elegance Grade 12	Panache Grade 11	Panache Perforated Grade 13	Ovation Grade 11
Await	■	•	■	☐	■	■	■	■	■	■	■	■	■	■	■
Bindu	■	•	■	☐	■	■	■	■	■	■	■	■	■	■	■
Bix	■	•	■	•	■	■	•	■	•	■	•	■	■	•	■
Bob	■	•	■	•	■	■	•	■	•	■	•	■	■	■	■
Capa	■	•	■	☐	■	■	■	■	■	■	■	■	■	■	■
Chord	■	•	■	☐	■	■	■	■	■	■	■	■	■	■	■
Circa	■	•	■	☐	■	■	■	■	■	■	■	■	■	■	■
Coupe	■	•	■	☐	■	■	■	■	■	■	■	■	■	■	■
Davos	■	•	■	•	■	■	•	■	•	■	•	■	■	•	■
Emu Indoor Cushion	■	■	■	•	■	■	■	■	■	■	■	■	■	•	■
Enea	■	•	■	☐	■	■	■	■	■	■	■	■	■	■	■
Enea Lottus	■	■	■	•	■	■	•	■	•	■	•	■	■	•	■
Exponents (Benches)	■	•	■	•	■	■	•	■	•	■	•	■	■	•	■
Joel	■	•	■	•	■	■	•	■	•	■	•	■	■	•	■
Kathryn	■	■	■	☐	■	■	■	■	■	■	■	■	■	■	■
Lagunitas	■	•	■	•	■	■	■	■	■	■	■	■	■	■	■
Lox	■	■	■	•	■	■	•	■	•	■	•	■	■	•	■
Millbrae Contract	■	•	■	☐	■	■	■	■	■	■	■	■	■	■	■
Millbrae Lifestyle	■	■	■	☐	■	■	■	■	■	■	■	■	■	■	■
Montara650	■	•	■	•	■	■	•	■	•	■	•	■	■	■	■
Passerelle	■	•	■	☐	■	■	■	■	■	■	■	■	■	■	■
Ripple	■	•	■	☐	■	■	■	■	■	■	■	■	■	■	■
SW_1	■	•	■	•	■	■	•	■	•	■	•	■	■	•	■
Swathmore	■	•	■	☐	■	■	■	■	■	■	■	■	■	■	■
Swathmore Grande	■	•	■	☐	■	■	■	■	■	■	■	■	■	■	■
Switch	■	•	■	☐	■	■	■	■	■	■	■	■	■	■	■
Together	▣	•	▣	•	▣	▣	•	▣	•	▣	•	▣	▣	•	■
Topo	■	•	■	•	■	■	•	■	•	■	•	■	■	•	■
Visalia	■	•	■	☐	■	■	■	■	■	■	■	■	■	■	■
Wrapp	■	•	■	•	■	■	■	■	■	■	■	■	■	■	■

Disclaimer: Coalesse is pleased to provide this information. However, even after preliminary approval, Coalesse reserves the right to reject fabrics/leathers when necessary if the quality or construction is not satisfactory for the item it is intended for use on. Coalesse reserves the right to evaluate data daily and make any necessary changes or improvements to the information provided. Textile recommendations do not imply a warranty for the textiles. The textile manufacturer provides all warranties for textiles. All trademarks and trade names are the property of the different manufacturers. All pricing quotes for product should be obtained from your local Sales Representative or a Coalesse Customer Service Representative. Recommendations such as latex backing, Gore SP and CAL 133 will require additional cost and may require additional lead-time. All specifications are subject to change without notice.

Surface Materials - Wood

Wood

Standard Wood Finishes

Coalesse's primary wood finish, Clarity, is a water-borne UV topcoat, which protects the environment while providing exceptional durability and resistance to water and chemical stains. Contoured products, such as wood guest chairs and occasional tables, are finished with post-catalyzed vinyl, which provides similar properties and matches the sheen and color of Clarity. Due to natural variations in wood, finished products may vary from samples in color, texture, and grain.

Wood will develop a deep, rich patina over time as the wood ages. Mineral streaks, gum pockets, and pin knots are some of the unique characteristics that are visible in veneers and solids.

All wood products will darken with age and exposure to ultraviolet light. This is especially apparent with cherry and maple veneer.

When storing your wood furniture, please follow the following guidelines:

- Do not store products in trailers
- Store products in areas that simulate office temperatures (60°F to 90°F)
- Store products in areas that maintain constant, office-like humidity levels
- Keep product away from light. Cover products to make sure they are not exposed to light.

Samples contact Customer Service at 1.800.627.6770

Steelcase Wood Finishes

Coalesse will match current Steelcase wood finishes at no upcharge. Finish matches are for color only and do not match the Steelcase finish in sheen. Samples will be provided upon request from Customer Service at 1.800.627.6770 and will be produced within 10 working days.

Stain-To-Match Wood Finish on cherry, maple, walnut, or oak

Coalesse will Stain-To-Match any wood finish at no upcharge. Samples submitted for matching must be at least 12" x 12" in surface dimension. Customers must specify cherry, maple, oak, or walnut species. Coalesse will produce a strike-off within 5 working days following acknowledgement of the order. Coalesse will not schedule the order for production until the strike-off has been approved and received by Coalesse.

Tip: For a visual palette, please refer to the Steelcase Finish Library.

Painted MDF

The painted medium density fiberboard (MDF) is utilizing molding grade MDF, therefore, the 45 lb density is consistent throughout the entire thickness of the board. This allows for a smooth edge when painted. Three coats of water reducible finish is applied to the board in a milk or black. The painted MDF has durability and care properties like a wood veneer, thus, must be treated as such.

Veneer Specifications

Cherry

- American Black Cherry
- Flat cut, plain sliced/book matched
- Quarter cut/book matched
- Narrow cathedrals, mild grain, minimal pitch
- 5-10" wide leaves of 1/42" thick veneer, balanced on panel
- No gaps between leaves
- PB (particle board) core
- Low sheen 15 or high sheen 35

Maple

- Eastern Hard White Maple
- Flat cut, plain sliced/slip matched
- Quarter cut/book matched
- Narrow cathedrals, mild grain, minimal pitch
- 5-10" wide leaves of 1/42" thick veneer, balanced on panel
- No gaps between leaves
- PB (particle board) core
- Low sheen 15 or high sheen 35

Oak

- White Oak
- Rift cut
- Slip match
- Mild grain
- 4-8" wide leaves of 1/42" thick veneer, balanced on panel
- No gaps between leaves
- PB (particle board) core
- Low sheen 15 or high sheen 35

Walnut

- American Black Walnut
- Flat cut, plain sliced/book matched
- Quarter cut/book matched
- Narrow cathedrals, mild grain
- 5-10" wide leaves of 1/42" thick veneer, balanced on panel
- No gaps between leaves
- PB (particle board) core
- Low sheen 15 or high sheen 35

Exclusive (by product)

Teak

- Quarter cut/book match
- 15 sheen

Ash (Grey)

- Quarter cut/book match
- 15 sheen

Flat-cut – High Sheen

Grade 1

- V10C FC/HS Natural Cherry
- V11C FC/HS Clear Cherry
- V12C FC/HS Medium Amber Cherry
- V13C FC/HS Dark Cherry
- V10M FC/HS Clear Maple
- V11M FC/HS Natural Beech on Maple
- V12M FC/HS Medium Maple
- V10W FC/HS Natural Walnut
- V11W FC/HS Clear Walnut
- V12W FC/HS Medium Walnut
- V13W FC/HS Black Walnut
- V14W FC/HS Dark Walnut

Flat-cut – Low Sheen

Grade 1

- V1AC FC/LS Natural Cherry
- V1BC FC/LS Clear Cherry
- V1CC FC/LS Medium Amber Cherry
- V1DC FC/LS Dark Cherry
- V1AM FC/LS Clear Maple
- V1BM FC/LS Natural Beech on Maple
- V1CM FC/LS Medium Maple
- V1AW FC/LS Natural Walnut
- V1BW FC/LS Clear Walnut
- V1CW FC/LS Medium Walnut
- V1EW FC/LS Dark Walnut

Rift-cut – High Sheen

Grade 1

- V30K RC/HS Natural Oak
- V31K RC/HS Desert Oak
- V32K RC/HS Medium Brown Oak
- V33K RC/HS Medium Gray Oak
- V34K RC/HS Black Brown Oak

Rift-cut – Low Sheen

Grade 1

- V3AK RC/LS Natural Oak
- V3BK RC/LS Desert Oak
- V3CK RC/LS Medium Brown Oak
- V3DK RC/LS Medium Gray Oak
- V3EK RC/LS Black Brown Oak

Quarter-cut – High Sheen

Grade 2

- V20C QC/HS Natural Cherry
- V21C QC/HS Clear Cherry
- V22C QC/HS Medium Amber Cherry
- V23C QC/HS Dark Cherry
- V20M QC/HS Clear Maple
- V21M QC/HS Natural Beech on Maple
- V22M QC/HS Medium Maple
- V20W QC/HS Natural Walnut
- V21W QC/HS Clear Walnut
- V22W QC/HS Medium Walnut
- V23W QC/HS Black Walnut
- V24W QC/HS Dark Walnut

FC=Flat Cut
RC=Rift Cut
QC=Quarter Cut
WL=Wedge Lay-up
HS=High Sheen
LS=Low Sheen

Surface Materials - Wood

Quarter-cut – Low Sheen

Grade 2

- V2AA QC/LS Ash Natural FSC
- V2AC QC/LS Natural Cherry
- V2BC QC/LS Clear Cherry
- V2CC QC/LS Medium Amber Cherry
- V2DC QC/LS Dark Cherry
- V2AM QC/LS Clear Maple
- V2BM QC/LS Natural Beech on Maple
- V2CM QC/LS Medium Maple
- V2AW QC/LS Natural Walnut
- V2BW QC/LS Clear Walnut
- V2CW QC/LS Medium Walnut
- V2EW QC/LS Dark Walnut
- V2AT QC/LS Teak Natural Raw FSC

Wedge Lay-up* – Flat cut – High Sheen

Grade 1

- W10C WC/FC/HS Natural (Raw) Cherry
- W11C WC/FC/HS Clear Cherry
- W12C WC/FC/HS Medium Amber Cherry
- W13C WC/FC/HS Dark Cherry
- W10M WC/FC/HS Clear Maple
- W11M WC/FC/HS Natural Beech on Maple
- W12M WC/FC/HS Medium Maple
- W10W WC/FC/HS Natural (Raw) Walnut
- W11W WC/FC/HS Clear Walnut
- W12W WC/FC/HS Medium Walnut
- W13W WC/FC/HS Black Walnut
- W14W WC/FC/HS Dark Walnut

Wedge Lay-up* – Flat cut – Low Sheen

Grade 1

- W1AC WC/FC/LS Natural (Raw) Cherry
- W1BC WC/FC/LS Clear Cherry
- W1CC WC/FC/LS Medium Amber Cherry
- W1DC WC/FC/LS Dark Cherry
- W1AM WC/FC/LS Clear Maple
- W1BM WC/FC/LS Natural Beech on Maple
- W1CM WC/FC/LS Medium Maple
- W1AW WC/FC/LS Natural (Raw) Walnut
- W1BW WC/FC/LS Clear Walnut
- W1CW WC/FC/LS Medium Walnut
- W1EW WC/FC/LS Dark Walnut

Wedge Lay-up* – Rift cut – High Sheen

Grade 1

- W30K WC/RC/HS Natural (Raw) Oak
- W31K WC/RC/HS Desert Oak
- W32K WC/RC/HS Medium Brown Oak
- W33K WC/RC/HS Medium Gray Oak
- W34K WC/RC/HS Black Brown Oak

Wedge Lay-up* – Rift cut – Low Sheen

Grade 1

- W3AK WC/RC/LS Natural (Raw) Oak
- W3BK WC/RC/LS Desert Oak
- W3CK WC/RC/LS Medium Brown Oak
- W3DK WC/RC/LS Medium Gray Oak
- W3EK WC/RC/LS Black Brown Oak

- FC=Flat Cut
- RC=Rift Cut
- QC=Quarter Cut
- WL=Wedge Lay-up
- HS=High Sheen
- LS=Low Sheen
- OP=Open Pore

Wedge Lay-up* – Quarter cut – High Sheen

Grade 2

- W20C WC/QC/HS Natural (Raw) Cherry
- W21C WC/QC/HS Clear Cherry
- W22C WC/QC/HS Medium Amber Cherry
- W23C WC/QC/HS Dark Cherry
- W20M WC/QC/HS Clear Maple
- W21M WC/QC/HS Natural Beech on Maple
- W22M WC/QC/HS Medium Maple
- W20W WC/QC/HS Natural (Raw) Walnut
- W21W WC/QC/HS Clear Walnut
- W22W WC/QC/HS Medium Walnut
- W23W WC/QC/HS Black Walnut
- W24W WC/QC/HS Dark Walnut

Wedge Lay-up* – Quarter cut – Low Sheen

Grade 2

- W2AC WC/QC/LS Natural (Raw) Cherry
- W2BC WC/QC/LS Clear Cherry
- W2CC WC/QC/LS Medium Amber Cherry
- W2DC WC/QC/LS Dark Cherry
- W2AM WC/QC/LS Clear Maple
- W2BM WC/QC/LS Natural Beech on Maple
- W2CM WC/QC/LS Medium Maple
- W2AW WC/QC/LS Natural (Raw) Walnut
- W2BW WC/QC/LS Clear Walnut
- W2CW WC/QC/LS Medium Walnut
- W2EW WC/QC/LS Dark Walnut

*Available on select tables, refer to pricing pages for availability.

Steelcase Veneers, Open Pore Only

Cherry, Flat Cut

Grade 1

- 3402 FC/OP Clear Cherry
- 3412 FC/OP Natural Cherry
- 3422 FC/OP Medium Cherry

Maple, Flat Cut

Grade 1

- 3522 FC/OP Clear Maple
- 3572 FC/OP Amber on Maple
- 3582 FC/OP Winter on Maple
- 3592 FC/OP Blonde on Maple

Maple, Quarter Cut

Grade 1

- 3222 QC/OP Clear Maple
- 3272 QC/OP Amber on Maple
- 3292 QC/OP Blonde on Maple

Walnut, Flat Cut

Grade 1

- 3062 FC/OP Graphite Walnut
- 3702 FC/OP Clear Walnut
- 3712 FC/OP Natural Walnut
- 3722 FC/OP Dark Mahogany on Walnut
- 3752 FC/OP Medium Walnut
- 3762 FC/OP Dark Walnut
- 3772 FC/OP Medium Mahogany on Walnut

Walnut, Quarter Cut

Grade 1

- 3302 QC/OP Clear Walnut
- 3312 QC/OP Natural Walnut
- 3322 QC/OP Dark Mahogany on Walnut
- 3352 QC/OP Medium Walnut
- 3362 QC/OP Dark Walnut
- 3372 QC/OP Medium Mahogany on Walnut
- 3382 QC/OP Graphite Walnut

Oak, Rift Cut

Grade 1

- 3602 RC/OP Desert Oak
- 3612 RC/OP Warm Oak
- 3692 RC/OP Espresso Oak

Natural Veneer

Grade 1

- 32A2 QC/OP Blanch Maple
- 33A2 QC/OP Thunder Walnut
- 3342 FC/OP Black Walnut
- 35A2 FC/OP Blanch Maple
- 36A2 RC/OP Volcanic Oak
- 37A2 FC/OP Thunder Walnut

Grade 2

- 3082 FC/OP Washed Walnut
- 3392 QC/OP Black Walnut

Planked Veneer

- 3P41 OP Planked Cherry
- 3P51 OP Planked Maple
- 3P61 OP Planked Oak
- 3P71 OP Planked Walnut

Painted MDF

Applies to: Exponents

- V145 Milk
- V197 Black

Hardwood Matrix

For Collaboration Chair Bases, Guest Chairs, Occasional Tables, and Lounge Chairs

Legend

- = Not available
- = Available
- ▣ = Stain color only on maple
- ▤ = Stain color only on beach
- ▶ See specification pages for details.

	Maple Flat Cut – High Sheen	Maple Flat Cut – Low Sheen	Maple Quarter Cut – High Sheen	Maple Quarter Cut – Low Sheen	Cherry Flat Cut – High Sheen	Cherry Flat Cut – Low Sheen	Cherry Quarter Cut – High Sheen	Cherry Quarter Cut – Low Sheen	Oak Rift Cut – High Sheen	Oak Rift Cut – Low Sheen	Walnut Flat Cut – High Sheen	Walnut Flat Cut – Low Sheen	Walnut Quarter Cut – High Sheen	Walnut Quarter Cut – Low Sheen	Teak Quarter Cut – High Sheen	Teak Quarter Cut – Low Sheen	Grey Ash – High Sheen	Grey Ash – Low Sheen	Exclusive Finishes for Trees	Carl Hansen Exclusive Wood Finishes
Seating																				
Circa	■	■	•	•	▣	▣	•	•	▣	▣	■	■	•	•	•	•	•	•	•	•
Coupe	■	■	•	•	▣	▣	•	•	▣	▣	■	■	•	•	•	•	•	•	•	•
Detour Tablet	■	■	•	•	▣	▣	•	•	▣	▣	▣	▣	•	•	•	•	•	•	•	•
Enea	■	■	•	•	▣	▣	•	•	▣	▣	▣	▣	•	•	•	•	•	•	•	•
Kathryn	▣	▣	•	•	▣	▣	•	•	▣	▣	▣	▣	•	•	•	•	•	•	•	•
Passerelle	■	■	•	•	▣	▣	•	•	▣	▣	▣	▣	•	•	•	•	•	•	•	•
Swathmore	■	■	•	•	▣	▣	•	•	▣	▣	▣	▣	•	•	•	•	•	•	•	•
Swathmore Grande	■	■	•	•	▣	▣	•	•	▣	▣	▣	▣	•	•	•	•	•	•	•	•
Occasional Tables																				
Bix Tables	■	■	•	•	■	■	•	•	■	■	■	■	•	•	•	•	•	•	•	•
Circa	■	■	•	•	▣	▣	•	•	▣	▣	■	■	•	•	•	•	•	•	•	•
Diekman	■	■	•	•	▣	▣	•	•	▣	▣	▣	▣	•	•	•	•	•	•	•	•
Enea	■	■	•	•	▣	▣	•	•	▣	▣	▣	▣	•	•	•	•	•	•	•	•
Passerelle	■	■	•	•	▣	▣	•	•	▣	▣	▣	▣	•	•	•	•	•	•	•	•
Sidewalk	■	■	•	•	▣	▣	•	•	▣	▣	▣	▣	•	•	•	•	•	•	•	•
Trees	•	•	•	•	•	•	•	•	•	•	•	•	•	•	•	•	•	•	■	•

Veneer Matrix

For Conference and Multipurpose Tables, Storage, Casegoods, Occasional Tables, and Seating

Legend

- = Not available
- = Available
- = Stain color only
- ▶ See specification pages for details.

Note: This matrix includes both Coalesse and Steelcase veneers.

Tables and Casegoods

	Maple Flat Cut - High Sheen	Maple Flat Cut - Low Sheen	Maple Quarter Cut - High Sheen	Maple Quarter Cut - Low Sheen	Cherry Flat Cut - High Sheen	Cherry Flat Cut - Low Sheen	Cherry Quarter Cut - High Sheen	Cherry Quarter Cut - Low Sheen	Oak Rift Cut - High Sheen	Oak Rift Cut - Low Sheen	Walnut Flat Cut - High Sheen	Walnut Flat Cut - Low Sheen	Walnut Quarter Cut - High Sheen	Walnut Quarter Cut - Low Sheen	Teak Quarter Cut - Low Sheen	Grey Ash - Low Sheen	Wedge Cut Veneers - Any Species	Transolid - Corian	Milk MDF	Black MDF	Composite Flat Cut-Select Surfaces	Composite Quarter Cut-Select Surfaces	Planked Veneers-Select Surfaces	Natural Veneers-Select Surfaces
E-Tables 2	■	■	■	■	■	■	■	■	■	■	■	■	■	■	•	•	•	•	•	•	■	■	■	■
Enea	■	■	•	•	■	■	•	•	■	■	■	■	■	•	•	•	•	•	•	•	•	•	•	•
Enea Lottus	■	■	•	•	■	■	•	•	■	■	■	■	■	■	•	•	•	•	•	•	■	■	•	•
Exponents	■	■	■	■	■	■	■	■	■	■	■	■	■	■	•	•	•	■	■	■	■	■	■	■
Host Collection	■	■	■	■	■	■	■	■	■	■	■	■	■	■	•	•	•	•	•	•	•	•	■	■
Lagunitas Tables	■	■	■	■	■	■	■	■	■	■	■	■	■	■	•	•	•	•	•	•	•	•	■	■
Lagunitas Focus Nook	■	■	■	■	■	■	■	■	■	■	■	■	■	■	•	•	•	•	•	•	•	•	■	■
Montara650	■	■	■	■	■	■	■	■	■	■	■	■	■	■	•	•	•	•	•	•	•	•	•	•
Reunion Collection	■	■	■	■	■	■	■	■	■	■	■	■	■	■	•	•	•	•	•	•	■	■	■	■
Sebastopol	•	•	•	•	■	■	■	■	■	■	■	■	■	■	•	•	•	•	•	•	■	■	■	■
SW_1	■	■	■	■	■	■	■	■	■	■	■	■	■	■	•	•	•	■	■	■	■	■	■	■

Seating

Montara650*	•	•	•	•	•	•	•	•	•	■	•	•	•	•	•	•	•	•	•	•	•	•	•	•
-------------	---	---	---	---	---	---	---	---	---	---	---	---	---	---	---	---	---	---	---	---	---	---	---	---

* Select colors only: VP01, VP02, VP03, VP04, and VP05

Surface Materials - Laminate

Laminate

Coalesse's graded laminate program includes our standard laminates, Steelcase High-Pressure Laminates, and standard High-Pressure Laminates from Nevamar, Wilsonart, Formica, and Pionite.

Coalesse Standard Laminate

Grade 1

Coalesse High-Pressure Laminates are priced as Grade 1.

High-Pressure Laminates listed below are not available on all products, check laminate matrix for availability.

- 2730 Arctic White
- 2746 Black
- 2826 White Nebula
- 2829 Poppysseed
- 2830 Charcoal
- 2884 Milk
- 2886 Maple
- 2887 Amber Cherry
- 2890 Folkstone BMW
- 2891 Ingot
- 2892 Ash
- 2894 Natural Cork
- 2895 Natural Walnut
- 2896 Dark Cork
- 2897 Desert Oak
- 2898 Satin Stainless

Steelcase Standard Laminate

Grade 1

Steelcase High-Pressure Laminates are priced as Grade 1. All Steelcase High-Pressure Laminates may be specified on Coalesse products with exception (must be ordered as Special): Awaiting tables, Enea tables, Enea Lottus tables, and Sidewalk tables. The use of Steelcase High-Pressure Laminate may be subject to extended lead times.

Tip: For a visual palette, please refer to the Steelcase Finish Library.

Fiber Laminate

- 2850 Vanadium Fiber
- 2851 Rhyme Fiber
- 2852 Tungsten Fiber
- 2854 Vellum Fiber
- 2859 Novell Fiber
- 2860 Granite Fiber
- 2861 Coconut Fiber
- 2862 Stucco Fiber

Micro Laminate

- 2920 Marl Micro
- 2921 Gypsum Micro
- 2922 Clay Micro
- 2923 Shadow Micro

Patina Laminate

- 2870 Blonde Bronze Patina
- 2871 Balckened Bronze Patina
- 2873 Instant Iron Patina

Solid Laminate

- 2722 Cream
- 2730 Arctic White
- 2746 Black
- 2759 Warm White
- 2811 Mist
- 2883 Seagull
- 2884 Milk
- 2885 Dune
- 2HMG Merle

Speckle Laminate

- 2820 Coffee Speckle
- 2822 Woodrose Speckle
- 2823 Driftwood Speckle
- 2824 Smoke Speckle
- 2825 Vanadium Speckle

Woodgrain Laminate

- 2406 Clear Cherry
- 2409 Clear Maple
- 2410 Graphite Walnut
- 2412 Natural Cherry
- 2422 Medium Cherry
- 2511 Winter on Maple
- 2538 Clear Walnut
- 2539 Warm Oak
- 2592 Blonde on Maple
- 2714 Natural Walnut
- 2772 Medium Mahogany on Walnut
- 2HAK Clear Oak
- 2HAN Ash Noce
- 2HAT Acacia
- 2HAW Ash Wenge
- 2HBN Bisque Noce
- 2HBW Bisque Wenge
- 2HCN Clay Noce
- 2HCW Clay Wenge
- 2HSN Storm Noce
- 2HSW Storm Wenge

turnstone Laminate Collection

A selection of laminates and edgebands are available on some Coalesse brand products. This collection is stocked and available with standard lead times and supported like standard laminates to help make ordering easy.

Tip: For a visual palette, please refer to the Steelcase Finish Library.

- 2535 Virginia Walnut
- 2536 Blackwood
- 2612 Marbled Maple
- 2614 Chocolate Walnut
- 2615 Marbled Cherry

Steelcase Select Surfaces Laminate

Grade 2

Textured Woodgrain Laminate

- 2TH2 Fawn Cypress
- 2TH3 Weathered Char
- 2TH4 Saddle Oak
- 2TH5 Veranda Teak
- 2TH6 Persian Cherry
- 2TH7 Walnut Heights

Tip: Because these finishes are part of Steelcase Select Surfaces, they may have additional lead times.

Textured Industrial Laminate

- 2UH1 Reclaimed Aggregate
- 2UH2 Reclaimed Gravel
- 2UH4 Cement*
- 2UH6 Sheetrock

Tip: Because these finishes are part of Steelcase Select Surfaces, they may have additional lead times.

*2UH4 Cement is only available on select table sizes.

Open Line Laminates

Customers can select laminates that are not offered as standard from select suppliers. Standard grade High-Pressure Laminates can be specified in Grade 1 (290A) or Grade 2 (290B) as indicated below (subject to availability). Grade 2 laminates will have extended lead time. Select from any Coalesse or Steelcase standard edge band finishes.

Contact Customer Service at 1.800.627.6770 to verify that your laminate selection falls within the categories noted below.

Directional patterns and woodgrains may be used on freestanding systems products, but will not be patterned matched.

Some standard High-Pressure Laminates, may not be available in the appropriate size to produce large products.

Wilsonart (Grade 1)
Standards (matte finish)
*Exceptions: High definition which must be quoted as a special.
Marker board which is grade 2.*

Nevamar (Grade 2)
Solids (textured finish)
Patterns (textured finish)

Formica (Grade 2)
Color portfolio (matte finish)
Patterns (matte finish)
Formations (matte finish)

Pionite (Grade 2)
Decorative surfaces (suede finish)

Non-Standard Laminates

Coalesse can supply additional laminates for an upcharge. Contact your Coalesse sales consultant for a custom quotation. Custom upcharges will vary based upon the cost of the material specified and additional labor required to manufacture the products. Some non-standard laminates will not be available in the appropriate size to produce large Coalesse products. A sample of the laminate may be requested for approval. Some non-standard laminates may be subject to extended lead times.

Coalesse does not use the following types of laminate materials on Topo:

- Formica solid surfacing – Surell Solids, Surell Granites
- Nevamar – Fountainhead
- Dupont – Corian
- Metal Laminates – textured, brushed or polished

Surface Materials - Laminate

High-Pressure Laminate Matrix

Legend

- = Not available
- = Available
- ▶ See specification pages for details.

	Standard Coalesse High-Pressure Laminate														Standard Steelcase High-Pressure Laminate														
	2730 Arctic White	2746 Black	2826 White Nebula	2829 Poppyseed	2830 Charcoal	2884 Milk	2886 Maple	2887 Amber Cherry	2890 Folkstone	2891 Ingot	2892 Ash	2894 Natural Cork	2895 Natural Walnut	2896 Dark Cork	2897 Desert Oak	2898 Satin Stainless	290N North Sea	2406 Clear Cherry	2409 Clear Maple	2410 Graphite Walnut	2412 Natural Cherry	2422 Medium Cherry	2503 Brushed Silver	2511 Winter on Maple	2535 Virginia Walnut	2536 Blackwood	2538 Clear Walnut		
Seating																													
Await	■	■	•	•	•	•	•	•	•	•	•	•	•	•	•	•	■	•	•	•	•	•	•	•	•	•	•	•	•
Bix Podium Drawer Front	■	■	■	■	■	■	■	■	■	■	■	■	■	■	■	■	■	■	■	■	■	■	■	■	■	■	■	■	■
Coupe	■	■	•	•	•	■	•	•	■	■	■	•	•	•	•	•	•	•	•	•	•	•	•	•	•	•	•	•	•
Sidewalk Tablet	■	■	■	■	■	■	■	■	■	■	■	■	■	■	■	■	■	■	■	■	■	■	■	■	■	■	■	■	■
Swathmore Grande	■	■	•	•	•	■	•	•	■	■	■	•	•	•	•	•	•	■	■	■	■	■	■	■	■	■	■	■	■
Occasional Tables																													
Await	■	■	•	•	•	•	•	•	•	•	•	•	•	•	•	•	■	•	•	•	•	•	•	•	•	•	•	•	•
Bix Tables	■	■	■	■	■	■	■	■	■	■	■	■	■	■	■	■	■	■	■	■	■	■	■	■	■	■	■	■	■
Bob Tables	■	■	■	■	■	■	■	■	■	■	■	■	■	■	■	■	■	■	■	■	■	■	■	•	■	■	■	■	■
Circa Tables	■	■	■	■	■	■	■	■	■	■	■	■	■	■	■	■	■	■	■	■	■	■	■	■	■	■	■	■	■
Enea	■	■	■	■	■	■	■	■	■	■	■	■	■	■	■	■	■	■	■	■	■	■	■	■	■	■	■	■	■
Enea Lottus	■	■	■	■	■	■	■	■	■	■	■	■	■	■	■	■	■	■	■	■	■	■	■	■	■	■	■	■	■
Lagunitas Tables	■	■	■	■	■	■	■	■	■	■	■	■	■	■	■	■	■	■	■	■	■	■	■	■	■	■	■	■	■
Lagunitas Focus Nook	■	■	■	■	■	■	■	■	■	■	■	■	■	■	■	■	■	■	■	■	■	■	■	■	■	■	■	■	■
Montara650	■	■	■	■	■	■	■	■	■	■	■	■	■	■	■	■	■	■	■	■	■	■	■	■	■	■	■	■	■
Sidewalk	■	■	■	■	■	■	■	■	■	■	■	■	■	■	■	■	■	■	■	■	■	■	■	■	■	■	■	■	■
SW_1	■	■	■	■	■	■	■	■	■	■	■	■	■	■	■	■	■	■	■	■	■	■	■	■	■	■	■	■	■
Tables and Casegoods																													
Au Lait	■	■	■	■	■	■	■	■	■	■	■	■	■	■	■	■	■	■	■	■	■	■	■	■	■	■	■	■	■
Ballet	■	■	■	■	■	■	■	■	■	■	■	■	■	■	■	■	■	■	■	■	■	■	■	■	■	■	■	■	■
E-Table 2 Top	■	■	■	■	■	■	■	■	■	■	■	■	■	■	■	■	■	■	■	■	■	■	■	■	■	■	■	■	■
E-Table 2 Laminate Base	■	■	•	•	•	■	•	•	■	■	■	•	•	•	•	•	•	■	■	■	■	■	■	■	■	■	■	■	
Enea	■	■	■	■	■	■	■	■	■	■	■	■	■	■	■	■	■	■	■	■	■	■	■	■	■	■	■	■	■
Enea Lottus	■	■	■	■	■	■	■	■	■	■	■	■	■	■	■	■	■	■	■	■	■	■	■	■	■	■	■	■	■
Host Collection	■	■	■	■	■	■	■	■	■	■	■	■	■	■	■	■	■	■	■	■	■	■	■	■	■	■	■	■	■
Montara650	■	■	■	■	■	■	■	■	■	■	■	■	■	■	■	■	■	■	■	■	■	■	■	■	■	■	■	■	■
Reunion Collection	■	■	■	■	■	■	■	■	■	■	■	■	■	■	■	■	■	■	■	■	■	■	■	■	■	■	■	■	■
SW_1	■	■	■	■	■	■	■	■	■	■	■	■	■	■	■	■	■	■	■	■	■	■	■	■	■	■	■	■	■
Train	■	■	■	■	■	■	■	■	■	■	■	■	■	■	■	■	■	■	■	■	■	■	■	■	■	■	■	■	■

High-Pressure Laminate Matrix *continued*

Legend

- = Not available
- = Available
- ▶ See specification pages for details.

	2HBW Bisque Wenge	2HCN Clay Noce	2HCW Clay Wenge	2HMG Merle	2HSN Storm Noce	2HSW Storm Wenge	Select Surfaces Steelcase High-Pressure Laminate*									
							2TH2 Fawn Cypress	2TH3 Weathered Char	2TH4 Saddle Oak	2TH5 Veranda Teak	2TH6 Persian Cherry	2TH7 Walnut Heights	2UH1 Reclaimed Aggregate	2UH2 Reclaimed Gravel	2UH4 Cement	2UH6 Sheetrock
Seating																
Await	•	•	•	•	•	•	•	•	•	•	•	•	•	•	•	•
Bix Podium Drawer Front	■	■	■	■	■	■	■	■	■	■	■	■	■	■	■	■
Coupe	•	•	•	•	•	•	•	•	•	•	•	•	•	•	•	•
Sidewalk Tablet	•	•	•	■	•	•	■	■	■	■	■	■	■	■	■	■
Swathmore Grande	•	•	•	•	•	•	•	•	•	•	•	•	•	•	•	•
Occasional Tables																
Await	•	•	•	•	•	•	•	•	•	•	•	•	•	•	•	•
Bix Tables	■	■	■	■	■	■	■	■	■	■	■	■	■	■	■	■
Bob Tables	■	■	■	■	■	■	■	■	■	■	■	■	■	■	■	■
Circa Tables	■	■	■	■	■	■	■	■	■	■	■	■	■	■	■	■
Enea	■	■	■	■	■	■	■	■	■	■	■	■	■	■	■	■
Enea Lottus	■	■	■	■	■	■	•	•	•	•	•	•	•	•	•	•
Lagunitas Tables	■	■	■	■	■	■	■	■	■	■	■	■	■	■	■	■
Lagunitas Focus Nook	■	■	■	■	■	■	■	■	■	■	■	■	■	■	■	■
Montara650	■	■	■	■	■	■	■	■	■	■	■	■	■	■	■	■
Sidewalk	■	■	■	■	■	■	■	■	■	■	■	■	■	■	■	■
SW_1	■	■	■	■	■	■	■	■	■	■	■	■	■	■	■	■
Tables and Casegoods																
Au Lait	■	■	■	■	■	■	■	■	■	■	■	■	■	■	■	■
Ballet	■	■	■	■	■	■	■	■	■	■	■	■	■	■	■	■
Bob	■	■	■	■	■	■	■	■	■	■	■	■	■	■	■	■
E-Table 2 Top	■	■	■	■	■	■	■	■	■	■	■	■	■	•	■	■
E-Table 2 Laminate Base	■	•	•	•	•	•	•	•	•	•	•	•	•	•	•	•
Enea	■	■	■	■	■	■	■	■	■	■	■	■	■	■	■	■
Enea Lottus	■	■	■	■	■	■	•	•	•	•	•	•	•	•	•	•
Host Collection	■	■	■	■	■	■	■	■	■	■	■	■	■	■	•	■
Montara650	■	■	■	■	■	■	■	■	■	■	■	■	■	■	■	■
Reunion Collection	■	■	■	■	■	■	■	■	■	■	■	■	■	■	■	■
SW_1	■	■	■	■	■	■	■	■	■	■	■	■	■	■	■	■
Train	■	■	■	■	■	■	■	■	■	■	■	■	■	■	■	■

* Because these finishes are part of Steelcase Select Surfaces, they may have additional lead times.

High-Pressure Laminate Matrix

Laminate Edge Band Matrix

Legend

- = Not available
- = Available
- ▶ See specification pages for details.

6000 Black	6001 Coffee	6009 Artic White	6011 Ash	6012 Ingot	6034 Natural Cherry	6036 Medium Cherry	6037 Winter on Maple	6038 Blonde on Maple	6041 Natural Walnut	6045 Medium Mahogany on Walnut	6052 Milk	6053 Seagull	6086 Folkstone	6090 Amber Cherry	6091 Fusion Maple	6093 Dove Grey	6125 Graystone	6126 Greige	6127 Stonedust	6128 Taupe	6130 Dark Gray	6134 North Sea	6213 Acacia	6219 Clear Oak	6231 Graphite Walnut	6234 Clear Cherry	6237 Clear Maple	6242 Virginia Walnut	6243 Blackwood	6245 Clear Walnut	6246 Warm Oak	6249 Platinum Solid
------------	-------------	------------------	----------	------------	---------------------	--------------------	----------------------	----------------------	---------------------	--------------------------------	-----------	--------------	----------------	-------------------	-------------------	----------------	----------------	-------------	----------------	------------	----------------	----------------	-------------	----------------	----------------------	-------------------	------------------	----------------------	----------------	-------------------	---------------	---------------------

Seating

Swathmore Grande Mobile Tablet Self Edge	■	•	•	•	•	•	•	•	•	•	•	•	•	•	•	•	•	•	•	•	•	•	•	•	•	•	•	•	•	•	•	•
--	---	---	---	---	---	---	---	---	---	---	---	---	---	---	---	---	---	---	---	---	---	---	---	---	---	---	---	---	---	---	---	---

Occasional Tables

Await Table 3 mm Edge	■	•	■	•	•	•	•	•	•	•	•	•	•	•	•	•	•	•	•	•	•	•	■	•	•	•	•	•	•	•	•	•	•	
Bix Edge	■	■	■	■	■	■	■	■	■	■	■	■	■	■	■	■	■	■	■	■	■	■	■	■	■	■	■	■	■	■	■	■	■	■
Enea T-Mold Edge	■	•	•	•	•	•	•	•	•	•	•	•	•	•	•	•	•	•	•	•	•	•	•	•	•	•	•	•	•	•	•	•	•	
Enea Lottus	■	•	•	•	•	•	•	•	•	•	•	•	•	•	•	•	•	•	•	•	•	•	•	•	•	•	•	•	•	•	•	•	•	
Montara650	■	■	■	■	■	■	■	■	■	■	■	■	■	■	■	■	■	■	■	■	■	■	■	■	■	■	■	■	■	■	■	■	■	■

Tables and Casegoods

Au Lait Convex Vinyl Edge	■	•	•	•	•	•	•	•	•	•	•	•	•	•	•	•	•	•	•	•	•	•	•	•	•	•	•	•	•	•	•	•	•	
Au Lait Cast Urethane Edge	■	•	•	•	•	•	•	•	•	•	•	•	•	•	•	•	•	•	•	•	•	•	•	•	•	•	•	•	•	•	•	•	•	
Await Table 3 mm Edge	■	•	■	•	•	•	•	•	•	•	•	•	•	•	•	•	•	•	•	•	•	•	■	•	•	•	•	•	•	•	•	•	•	
Ballet Ribbed Vinyl Edge	■	•	•	•	•	•	•	•	•	•	•	•	•	•	•	•	•	•	•	•	•	•	•	•	•	•	•	•	•	•	•	•	•	
Bix Edge (Bridge, work booth tables)	■	■	■	■	■	■	■	■	■	■	■	■	■	■	■	■	■	■	■	■	■	■	■	■	■	■	■	■	■	■	■	■	■	■
Bob Tables	■	■	■	■	■	■	■	■	■	■	■	■	■	■	■	■	■	■	■	■	■	■	■	■	■	■	■	■	■	■	■	■	■	■
E-Table 2 Convex Vinyl Edge	■	•	•	•	•	•	•	•	•	•	•	•	•	•	•	•	•	•	•	•	•	•	•	•	•	•	•	•	•	•	•	•	•	
E-Table 2 3 mm Edge	■	■	■	■	■	■	■	■	■	■	■	■	■	■	■	■	■	■	■	■	■	■	■	■	■	■	■	■	■	■	■	■	■	■
Enea T-mold edge	■	•	•	•	•	•	•	•	•	•	•	•	•	•	•	•	•	•	•	•	•	•	•	•	•	•	•	•	•	•	•	•	•	
Enea Lottus Phenolic Edge	■	•	•	•	•	•	•	•	•	•	•	•	•	•	•	•	•	•	•	•	•	•	•	•	•	•	•	•	•	•	•	•	•	
Host Collection	•	•	•	•	•	•	•	•	•	•	•	•	•	•	•	•	•	•	•	•	•	•	•	•	•	•	•	•	•	•	•	•	•	
Lagunitas Table 3 mm Edge	■	■	■	■	■	■	■	■	■	■	■	■	■	■	■	■	■	■	■	■	■	■	■	■	■	■	■	■	■	■	■	■	■	■
Lagunitas Focus Nook	■	■	■	■	■	■	■	■	■	■	■	■	■	■	■	■	■	■	■	■	■	■	■	■	■	■	■	■	■	■	■	■	■	■
Montara650	■	■	■	■	■	■	■	■	■	■	■	■	■	■	■	■	■	■	■	■	■	■	■	■	■	■	■	■	■	■	■	■	■	■
Reunion Collection Bullnose Vinyl Edge	■	•	•	•	•	•	•	•	•	•	•	•	•	•	•	•	•	•	•	•	•	•	•	•	•	•	•	•	•	•	•	•	•	
Reunion Seminar Flat Vinyl Edge	■	•	•	•	•	•	•	•	•	•	•	•	•	•	•	•	•	•	•	•	•	•	•	•	•	•	•	•	•	•	•	•	•	
SW_1	■	■	■	■	■	■	■	■	■	■	■	■	■	■	■	■	■	■	■	■	■	■	■	■	■	■	■	■	■	■	■	■	■	■
Train Signature Edge	■	•	•	•	•	•	•	•	•	•	•	•	•	•	•	•	•	•	•	•	•	•	•	•	•	•	•	•	•	•	•	•	•	

Laminate Edge Band Matrix

6271 Plywood	6527 Merle	6607 Woodrose	6609 Smoke	6615 Grey V5	6619 Ice	6631 Cream	6635 Dawn	6636 Mist	6654 Sand	6655 Warm White	6676 Marbled Maple	6677 Chocolate Walnut	6678 Marbled Cherry	6694 Slate	6695 Midnight	6697 Fog	6698 Fieldstone	6703 Ash Wenge	6704 Storm Wenge	6705 Bisque Wenge	6706 Clay Wenge	6707 Ash Noce	6708 Bisque Noce	6709 Clay Noce	6710 Storm Noce	6D10 Silver Metallic	6D11 Black	6D12 White	6T02 Fawn Cypress*	6T03 Weathered Char*	6T04 Saddle Oak*	6T05 Veranda Teak*	6T06 Persian Cherry*	6T07 Walnut Heights*	2UH1 Reclaimed Aggregate*	2UH2 Reclaimed Gravel*	2UH4 Cement*	2UH6 Sheetrock*											
•	•	•	•	•	•	•	•	•	•	•	•	•	•	•	•	•	•	•	•	•	•	•	•	•	•	•	•	•	•	•	•	•	•	•	•	•	•	•	•	•	•	•	•						
■	■	•	•	■	■	■	■	■	■	■	■	■	■	■	■	■	■	■	■	■	■	■	■	■	■	■	■	■	■	■	■	■	■	■	■	■	■	■	■	■	■	■	■	■					
•	•	•	•	•	•	•	•	•	•	•	•	•	•	•	•	•	•	•	•	•	•	•	•	•	•	•	•	•	•	•	•	•	•	•	•	•	•	•	•	•	•	•	•	•					
■	■	•	•	■	■	■	■	■	■	■	■	■	■	■	■	■	■	■	■	■	■	■	■	■	■	■	■	■	■	■	■	■	■	■	■	■	■	■	■	■	■	■	■	■	■	■			
•	•	■	■	•	•	•	•	•	•	•	•	•	•	•	•	•	•	•	•	•	•	•	•	•	•	•	•	•	•	•	•	•	•	•	•	•	•	•	•	•	•	•	•	•	•				
■	■	•	•	■	■	■	■	■	■	■	■	■	■	■	■	■	■	■	■	■	■	■	■	■	■	■	■	■	■	■	■	■	■	■	■	■	■	■	■	■	■	■	■	■	■	■	■		
•	•	•	•	•	•	•	•	•	•	•	•	•	•	•	•	•	•	•	•	•	•	•	•	•	•	•	•	•	•	•	•	•	•	•	•	•	•	•	•	•	•	•	•	•	•	•			
■	■	•	•	■	■	■	■	■	■	■	■	■	■	■	■	■	■	■	■	■	■	■	■	■	■	■	■	■	■	■	■	■	■	■	■	■	■	■	■	■	■	■	■	■	■	■	■	■	
•	•	•	•	•	•	•	•	•	•	•	•	•	•	•	•	•	•	•	•	•	•	•	•	•	•	•	•	•	•	•	•	•	•	•	•	•	•	•	•	•	•	•	•	•	•	•	•		
■	■	•	•	■	■	■	■	■	■	■	■	■	■	■	■	■	■	■	■	■	■	■	■	■	■	■	■	■	■	■	■	■	■	■	■	■	■	■	■	■	■	■	■	■	■	■	■	■	■

* Because these finishes are part of Steelcase Select Surfaces, they may have additional lead times.

Surface Materials - Glass

Glass

Not all glass selections are available on every product. Refer to glass matrix for availability by product.

Back-Painted Glass

6720	Sand
6721	Pewter
6722	Mojave
6723	Terra
6724	Jade
6725	Ocean
ACM	Absolute Clear with Moonlight
ACS	Absolute Clear with Sage
ACP	Absolute Clear with Poppy
ACG	Absolute Clear with Goldenrod
ACB	Absolute Clear with Black
ACC	Absolute Clear with Crystal Spring

Glass

6511	Acid Etched
AC	Absolute Clear
ACF	Absolute Clear Frosted
CG	Clear Green
CGF	Clear Green Laminated/Frosted Appearance

Exclusive to Emu products:

6547	Transparent
6548	Smoke Grey

Surface Materials - Metal/Paint

Metal/Paint

Coalesse powder coats all painted metal components for an exceptionally durable, environmentally responsible finish — eliminating VOC's (volatile organic compounds) from being released into the environment. Electrostatically charged powder coat material is applied to an exacting thickness and then temperature baked, resulting in a smooth, flawless finish that is abrasion and impact resistant. The following Coalesse metal finishes are available:

Paint

Coalesse Standard Paint—Neutrals

Grade 1

Standard Coat Paint

- 4138 Graphite Gloss
- 4140 Arctic White Gloss
- 4141 Platinum Matte
- 4142 Platinum Gloss
- 4144 Black Gloss (formerly anthracite gloss)
- 4145 Milk Gloss
- 4146 Champagne Matte
- 4147 Champagne Gloss
- 4148 Midnight Brown Gloss
- 4180 Graphite Matte
- 4193 Midnight Brown Matte
- 4242 Milk Matte
- 4710 Low Gloss Black
- 7196 Midnight Brown Textured
- 7197 Anthracite Textured

Coalesse Standard Paint—Colors

Grade 1

- 4065 Blue Ink Textured
- 4066 Ocean Textured
- 4067 Ice Textured
- 4068 Olive Textured
- 4069 Honey Textured
- 4070 Currant Textured
- 4071 Saffron Textured

Steelcase Select Surfaces Paint

Accent Paints

Grade 3

Allow customers to add trend-driven color to painted surfaces. We evolve this collection often, to ensure that fresh new colors are always available.

- 4AQB Wasabi
- 4AQ9 Scarlet
- 4AV3 Blue Jay
- 4AV4 Baltic
- 4AX0 Flash
- 4AX1 Citron
- 4AY2 Chili
- 4AZ5 Marlin
- 4BH7 Canary
- 4BQ7 Fuchsia
- 4CZ1 Aubergine
- 4CZ2 Peacock
- 4CZ3 Jungle
- 4CZ4 Merlot
- 4CZ5 Honey
- 4CZ6 Lagoon
- 4CZ7 Saffron
- 4CZ8 Light Peacock

Lux Coatings

Grade 3

Introduces a softer, more human-centered aesthetic to the workplace. These powder coat paints provide tasteful accent for your spaces.

- 4B20 Obsidian
- 4B22 Matte Brass
- 4B23 Burnished Bronze
- 4B24 Night Bronze
- 4B25 Matte Copper
- 4B26 Smoked Mica
- 4B27 Blue Steel
- 4B28 Silver Lilac
- 4B29 Cast Iron
- 4B30 Bright Gold

Applies to: Emu Advanced Collection*

- 4251 Emu Indian Brown
- 4256 Aluminum
- 4257 Antique Iron
- 7234 Emu Black
- 7271 Emu White
- 7272 Blue
- 7273 Green
- 7294 Emu Grey/Green
- 7296 Emu Taupe
- 7297 Emu Corten
- 7298 Emu Copper
- 7391 Emu Poppy

*Not all colors available on all products as standard, consult Emu advanced paint matrix.

Applies to: Enea

- 4018 Silver Metallic
- 4016 White Gloss
- 4017 Black Gloss

Applies to: Enea Lottus

- 4062 Anthracite Grey Textured
 - 4063 Cool Grey Textured
 - 4064 Sand Textured
 - 4216 Red*
 - 4217 Brown
 - 4218 Platinum Silver
 - 7207 Black Textured
 - 7241 Arctic White Textured
- *Not available on Enea Lottus tables.

Applies to: Exponents (Base, Accent Ribbon, Handle, and Grommet)

- 4135 Black Matte
- 4141 Platinum Matte

Applies to: Exponents mobile displays (Base, Handle, and Inner Frame)

- 4135 Black Matte
- 4145 Milk Gloss

Metal

Anodized Aluminum

Applies to: Rod or disc pulls
5200 Satin Aluminum

Brushed Aluminum

Applies to: Lox stool
9251 Brushed Aluminum

Polished Aluminum

Applies to: Lox chair, Potrero415, and Bindu conference bases
8046 Polished Aluminum

Applies to: Bob and SW_1

8040 Aluminum Matte Polished

Chrome

- 9201 Chrome
- 9207 Polished trivalent chrome
- 9208 Etched trivalent chrome

Brushed Nickel

Applies to: Millbrae seating and tables
9238 Brushed Nickel

Coalesce

Surface Materials - Metal/Paint

Metal/Paint Matrix

Legend

- = Not available
- = Available
- ▶ See specification pages for details.

Seating

Bindu Conference
Bindu Guest
Bix
Bob
Capa
Chord
Circa
Coupe
Enea
Enea Lottus
Lagunitas
Last Minute
Lox Stool
Millbrae
Montara650
SW_1
Switch
Topo Lounge
Visalia
Wrapp

Occasional Tables

Bix (vinyl version)
Bob
Circa
Enea
Enea Lottus
Lagunitas
Lagunitas Focus Nook
Millbrae
Montara650
Switch
SW_1

	Coalesse Standard Paint—Neutrals												Coalesse Standard Paint—Colors												Product Line Exclusives				
	4135 Black Matte	4138 Graphite Gloss	4140 Arctic White Gloss	4141 Platinum Matte	4142 Platinum Gloss	4144 Black Gloss	4145 Milk Gloss	4146 Champagne Matte	4147 Champagne Gloss	4148 Midnight Brown Gloss	4180 Graphite Matte	4193 Midnight Brown Matte	4242 Milk Matte	4710 Low Gloss Black	7196 Midnight Brown Textured	7197 Anthracite Textured	4065 Blue Ink Textured	4066 Ocean Textured	4067 Ice Textured	4068 Olive Textured	4069 Honey Textured	4070 Currant Textured	4071 Saffron Textured	LessThanFive	LessThanFive Essential	Enea Exclusive Finishes	Enea Café Wood Exclusive Finishes	Enea Lottus Exclusive Finishes	
Bindu Conference	•	•	•	•	•	•	•	•	•	•	•	•	•	•	•	•	•	•	•	•	•	•	•	•	•	•	•	•	
Bindu Guest	•	•	•	•	•	•	•	•	•	•	•	•	•	•	•	•	•	•	•	•	•	•	•	•	•	•	•	•	
Bix	•	■	■	■	■	■	■	■	■	■	■	■	■	■	■	■	•	•	•	•	•	•	•	•	•	•	•	•	
Bob	•	■	•	■	■	■	■	■	■	■	■	■	■	■	■	■	•	•	•	•	•	•	•	•	•	•	•	•	
Capa	•	•	•	•	•	•	•	•	•	•	•	•	•	•	•	•	•	•	•	•	•	•	•	•	•	•	•	•	
Chord	•	•	•	•	•	■	•	•	•	•	•	•	•	•	•	•	•	•	•	•	•	•	•	•	•	•	•	•	
Circa	•	■	■	■	■	■	■	■	■	■	■	■	■	■	■	■	•	•	•	•	•	•	•	•	•	•	•	•	
Coupe	•	■	■	•	■	■	•	•	•	■	•	•	•	•	•	•	•	•	•	•	•	•	•	•	•	•	•	•	
Enea	•	•	•	•	•	•	•	•	•	•	•	•	•	•	•	•	•	•	•	•	•	•	•	•	•	■	•	•	
Enea Lottus	•	•	■	•	■	■	■	■	■	•	•	•	•	•	•	•	■	■	■	■	■	■	■	■	•	•	•	■	
Lagunitas	•	•	•	■	•	•	•	•	•	•	•	•	•	■	•	•	•	•	•	•	•	•	•	•	•	•	•	•	
Last Minute	•	•	•	•	•	•	•	•	•	•	•	•	•	•	•	•	•	•	•	•	•	•	•	•	•	•	•	•	
Lox Stool	•	•	•	•	•	•	•	•	•	•	•	•	•	•	•	•	•	•	•	•	•	•	•	•	•	•	•	•	
Millbrae	•	■	•	■	•	■	■	•	•	■	■	■	■	■	■	■	•	•	•	•	•	•	•	•	•	•	•	•	
Montara650	•	■	•	■	•	■	■	■	■	■	■	■	■	■	■	■	•	•	•	•	•	•	•	•	•	•	•	•	
SW_1	•	•	•	•	•	•	•	•	•	•	•	•	•	•	•	•	•	•	•	•	•	•	•	•	•	•	•	•	
Switch	•	•	•	•	•	•	•	•	•	•	•	•	•	•	•	•	•	•	•	•	•	•	•	•	•	•	•	•	
Topo Lounge	•	■	■	■	■	■	■	■	■	■	■	■	■	■	■	■	•	•	•	•	•	•	•	•	•	•	•	•	
Visalia	•	■	•	■	•	■	■	•	•	■	■	■	■	■	■	■	•	•	•	•	•	•	•	•	•	•	•	•	
Wrapp	•	•	•	•	•	•	•	•	•	•	•	•	•	•	•	•	•	•	•	•	•	•	•	•	•	•	•	•	
Bix (vinyl version)	•	■	■	■	■	■	■	■	■	■	■	■	■	■	■	■	•	•	•	•	•	•	•	•	•	•	•	•	
Bob	•	■	•	■	■	■	■	■	■	■	■	■	■	■	■	■	•	•	•	•	•	•	•	•	•	•	•	•	
Circa	•	■	■	■	■	■	■	■	■	■	■	■	■	■	■	■	•	•	•	•	•	•	•	•	•	•	•	•	
Enea	•	•	•	•	•	•	•	•	•	•	•	•	•	•	•	•	•	•	•	•	•	•	•	•	•	■	•	•	
Enea Lottus	•	•	■	•	■	■	■	■	■	•	•	•	•	•	•	•	■	■	■	■	■	■	■	■	•	•	•	■	
Lagunitas	•	■	■	■	■	■	■	■	■	■	■	■	■	■	■	■	•	•	•	•	•	•	•	•	•	•	•	•	
Lagunitas Focus Nook	•	■	■	■	■	■	■	■	■	■	■	■	■	■	■	■	•	•	•	•	•	•	•	•	•	•	•	•	
Millbrae	•	■	•	■	•	■	■	•	•	■	■	■	■	■	■	■	•	•	•	•	•	•	•	•	•	•	•	•	
Montara650	•	■	•	■	•	■	■	■	■	■	■	■	■	■	■	■	•	•	•	•	•	•	•	•	•	•	•	•	
Switch	•	•	•	•	•	•	•	•	•	•	•	•	•	•	•	•	•	•	•	•	•	•	•	•	•	•	•	•	
SW_1	•	•	•	•	•	•	•	•	•	•	•	•	•	•	•	•	•	•	•	•	•	•	•	•	•	•	•	•	

Metal/Paint Matrix

Legend

- = Not available
- = Available
- ▶ See specification pages for details.

Tables and Casegoods

- Au Lait
- Ballet
- Bix
- Bob
- E-Table 2
- Enea
- Enea Lottus
- Exponents
- Exponents Mobile Display
- Lagunitas
- Millbrae
- Montara650
- Reunion Collection
- SW_1
- Train

Coalesse Standard Paint—Neutrals

4135 Black Matte	4138 Graphite Gloss	4140 Arctic White Gloss	4141 Platinum Matte	4142 Platinum Gloss	4144 Black Gloss	4145 Milk Gloss	4146 Champagne Matte	4147 Champagne Gloss	4148 Midnight Brown Gloss	4180 Graphite Matte	4193 Midnight Brown Matte	4242 Milk Matte	4710 Low Gloss Black	7196 Midnight Brown Textured	7197 Anthracite Textured
•	•	•	•	•	•	•	•	•	•	•	•	•	•	•	•
•	■	■	■	■	■	■	■	■	■	•	•	•	•	■	■
•	•	•	•	•	•	•	•	•	•	•	•	•	•	•	•
•	■	■	■	■	■	■	■	■	■	■	■	■	■	•	•
•	•	•	•	•	•	•	•	•	•	•	•	•	•	•	•
•	•	■	•	■	■	■	■	■	•	•	•	•	•	•	•
■	•	•	■	•	•	•	•	•	•	•	•	•	•	•	•
■	•	•	•	•	•	■	•	•	•	•	•	•	•	•	•
•	■	■	■	■	■	■	■	■	■	■	■	■	■	■	■
•	■	•	■	•	■	■	•	■	■	■	■	■	■	•	•
•	■	•	■	•	■	■	■	■	■	■	■	■	■	•	•
•	•	•	•	•	•	•	•	•	•	•	•	•	•	•	•
•	■	■	■	■	■	■	■	■	•	•	•	•	•	■	■
•	■	■	■	■	■	■	■	■	•	•	•	•	•	■	■

Coalesse Standard Paint—Colors

4065 Blue Ink Textured	4066 Ocean Textured	4067 Ice Textured	4068 Olive Textured	4069 Honey Textured	4070 Currant Textured	4071 Saffron Textured
•	•	•	•	•	•	•
•	•	•	•	•	•	•
•	•	•	•	•	•	•
•	•	•	•	•	•	•
•	•	•	•	•	•	•
•	•	•	•	•	•	•
•	•	•	•	•	•	•
•	•	•	•	•	•	•
•	•	•	•	•	•	•
•	•	•	•	•	•	•
•	•	•	•	•	•	•
•	•	•	•	•	•	•
•	•	•	•	•	•	•
•	•	•	•	•	•	•
•	•	•	•	•	•	•
•	•	•	•	•	•	•

Product Line Exclusives

LessThanFive	LessThanFive Essential	Enea Exclusive Finishes	Enea Café Wood Exclusive Finishes	Enea Lottus Exclusive Finishes
•	•	•	•	•
•	•	•	•	•
•	•	•	•	•
•	•	■	•	•
•	•	•	•	■
•	•	•	•	•
•	•	•	•	•
•	•	•	•	•
•	•	•	•	•
•	•	•	•	•
•	•	•	•	•
•	•	•	•	•
•	•	•	•	•
•	•	•	•	•
•	•	•	•	•
•	•	•	•	•

Emu Advanced Collection Paint Matrix

Legend

- = Not available
- = Available
- ▶ See specification pages for details.

	4251 Emu Indian Brown	4256 Aluminum	4257 Antique Iron	7234 Emu Black	7271 Emu White	7272 Blue	7273 Green	7294 Emu Grey/Green	7296 Emu Taupe	7297 Emu Corten	7298 Emu Copper	7391 Emu Poppy
Heaven Seating, Tables, and Pouf	•	■	•	■	■	•	•	•	•	•	•	•
Heaven Vases	•	•	•	•	■	•	•	•	•	•	•	•
Ivy Collection	•	•	•	•	■	•	•	•	•	•	•	•
Pattern Collection	•	•	•	■	■	■	■	•	•	•	•	■
Retrouvé Collection	•	•	•	•	■	•	•	•	•	•	•	•
Round Collection	■	•	■	■	■	•	•	•	•	•	•	•

Tip: Select product lines allow for other Emu paint finishes (those shown as not available on the matrix) as an available option. Consult the Coalesse Seating and Outdoor Specification Guide for details.

Surface Materials - Miscellaneous

Convex Vinyl Edge Band

- Applies to:
- Au Lait (includes cast urethane) and E-Table:
- 6000 Black
 - 6607 Woodrose
 - 6609 Smoke
 - 6655 Warm White

Cast Urethane Edge

- Applies to:
- Au Lait
- 6000 Black
 - 6607 Woodrose
 - 6609 Smoke
 - 6655 Warm White

Plastic

- Applies to:
- Enea
- 003 White
 - 0013 Sunset Orange
 - 0014 Clover Green
 - 0015 Sand
 - 0016 Walnut Brown
 - 0017 Cool Grey
 - 0400 Black
 - 0405 Periwinkle
 - 0406 Alabaster
 - 0409 Red
 - 0414 Anthracite Grey
 - 0421 Blue

- Applies to:
- Enea Lottus
- 003 White
 - 0013 Sunset Orange
 - 0014 Clover Green
 - 0015 Sand
 - 0016 Walnut Brown
 - 0017 Cool Grey
 - 0400 Black
 - 0409 Red
 - 0414 Anthracite Grey
 - 0421 Blue
 - 0422 Blue Ink
 - 0423 Ocean
 - 0424 Ice
 - 0425 Olive
 - 0426 Honey
 - 0427 Currant
 - 0428 Saffron

Tip: Not all colors available on all products. Consult the Enea plastic matrix for product line availability.

- Applies to:
- Exponents mobile cart, moby, and mobile display casters
- 6000 Black
 - 6009 Arctic White

- Applies to:
- Lox stools
- 6347 Black Gloss
 - 6348 White Gloss

- Applies to:
- SW_1 tablets, grommet, barrier, wire manager, sub-structure, lounge tablet, Sebastopol grommet
- 6000 Black
 - 6052 Milk

- Applies to:
- Grommet, spheres, flex-gangers, Mini-Port, Interport, casters, horizontal wire manager, and vertical wire manager
- Black plastic

- Applies to:
- Lagunitas focus nook
- 6000 Black
 - 6052 Milk
 - 6D03 Graphite

TAP Power Module Door Finishes

Brushed Anodized Aluminum

- Applies to:
- Host
- 8043 Silver
 - 8044 Black

Utility Bay

- Applies to:
- E-Table 2
- 4137 Matte Black
 - 4745 Nickel Mica
 - 4746 Silver Mica
 - 4747 Charcoal Mica

Glass Doors

- Applies to:
- Host credenzas
 - Frosted glass

Locks

- Applies to:
- Denizen and Exponents
- 9211 Nickel
 - 9250 Ember Chrome

Interior and Plinth

- Applies to:
- Host credenzas
- Black Melamine

Solid

- Applies to:
- Exponents and SW_1 tables
- 2801 Glacier White

Grommet

- Applies to:
- Exponents
- 4135 Black Matte
 - 4141 Platinum Black

Power, Voice Data Modules

- Applies to:
- Exponents
- 4140 Arctic White Gloss
 - 4141 Black Gloss

Glossy Laminate

- Applies to:
- Sebastopol
- 2001 Smoky White Glossy
 - 2002 Studio Grey Glossy
 - 2003 Wrought Iron Glossy
 - 2004 Black Pearl Glossy
 - 2005 Liberty Red Glossy

Ordering

How to Order

Coalesse furniture is available through authorized dealers and retailers. Select products are available for order from our web site. The authorized dealer can help you with everything from surface material selection and order placement, to specialized services, such as space planning and design, delivery and installation. Best of all, they are part of your local community, providing expert advice with a thorough understanding of local needs. For more information and a listing of dealers and retailers, visit www.coalesse.com or call 1.800.627.6770.

Coalesse reserves the right to limit distribution of any or all models.

Credit, Prices, and Terms

Credit may be established upon acceptance of satisfactory references. For payment terms, contact Coalesse's Credit Department. Coalesse may cancel or change credit terms at its discretion and may request advance payment at any time.

The order confirmation will be deemed by the customer and by Coalesse, as the final expression of agreement and will be deemed the exclusive statement of terms. The order confirmation supersedes all prior writings and may not be modified or rescinded, except by a revised Coalesse order confirmation signed by the customer. No changes are binding on Coalesse until delivery of the order confirmation.

Any storage charges and applicable sales taxes are in addition to the prices shown for merchandise. Inside delivery, uncartoning and installation are customer's responsibility unless separately quoted. All list pricing shown includes freight prepaid to one destination for delivery in the 48 contiguous United States. Hawaii and Alaska are not included. We reserve the right to increase prices without notice due to increases in labor and material costs. If timely payment is not made, customer is liable for reasonable collection costs, including attorney's fees.

Shipping and Storage

Coalesse reserves the right to select carrier and packaging method. Partial shipments may be delivered. Coalesse is not liable for delays or delivery failure due to strikes, lockouts, labor, or transportation difficulties, failure or delay of supply sources, accidents, fire, acts of God, or any other cause of like or unlike nature beyond Coalesse's control. Coalesse may transfer merchandise to storage if not accepted when shipment scheduled. Transfer and storage charges will be the customer's expense. Coalesse's invoice is payable upon transfer. If transfer is made prior to confirmed shipping date, storage expenses will be borne by customer.

Shipping charges MAY be calculated per order. Lead-times vary by product. Coalesse reserves the right to select carrier. Partial shipments may be delivered. Coalesse will make every effort to provide current and accurate lead-time information, however, Coalesse is not liable for delays or delivery failure due to strikes, lockouts, labor, or transportation difficulties, failure or delay of supply sources, accidents, fire, acts of God, or any other cause of like or unlike nature beyond Coalesse's control.

Freight is included on domestically manufactured products within the 48 contiguous states of the United States and standard freight service of Carl Hansen & Søn and Emu.

Claims

Merchandise shipped from Coalesse is thoroughly inspected and properly packed before leaving the factory. Responsibility of its safe delivery is assumed by the carrier at the time of shipment. Customer must match the freight delivered with the bill of lading. Customer must examine packaging material upon delivery and note any damage on the carrier bill of lading. If there is damage to the packaging material, inspect the furniture immediately. If concealed damage is found, contact the carrier within 10 days of delivery date. Save all packaging materials until after inspection.

Freight damage and claims must be reported by the purchaser to the carrier. Coalesse is not responsible for freight claims. Claims for loss or damage must not be deducted from our invoice, nor payment withheld awaiting adjustment of such claims. Do not return any merchandise to Coalesse without a Return Authorization number. By following these procedures carefully, Coalesse guarantees our full support of your claims to protect you against loss or damages. All claims against Coalesse for defects, errors or shortages must be made by customer in writing within ten (10) days after delivery. Failure to make claims within ten (10) days constitutes acceptance of merchandise and waives claims. Cutting of textiles deems acceptance of yardage and waives all defects, errors, and shortages. Coalesse is not liable for subsequent damages.

Special/Custom Products

Coalesse prides itself on being responsive to our customer's needs. Contact our Customer Service team at 1.800.627.6770 to discuss a special opportunity. Due to product modifications and engineering time, special orders may not be cancelled. Charges will apply.

FOR MORE INFORMATION (on ordering our products) Please contact Coalesse Customer Service at: 1.800.627.6770 .

Order Cancellations/Changes

All order change/cancellation requests must be submitted using the Coalesse order change/cancellation request form. Late changes could jeopardize the committed delivery of an order.

Rapid10 program, no change or cancellations allowed.

Coalesse Products:

- No charges will be assessed for change or cancellation 14 or more calendar days prior to the manufacturing completion date (excludes holidays and/or large quantity project size orders). For import products, charges may apply.

- No manufacturing changes are allowed 0-13 calendar days prior to the manufacturing completion date. Simple changes including shipping address changes are subject to approval but will be accommodated when possible.

- No cancellations or product changes will be accepted for quick ship or special/custom product orders including special laminates. A cancellation fee will be applicable for any custom product and/or change may jeopardize lead time.

- If COM/COL has been received at time of change or cancellation, it is the dealer's responsibility to advise disposition or return of materials. Coalesse will not store materials after 30 days.

Additional Charges

- Changes or cancellations that involve any of the following may be subject to a charge earlier and/or greater than shown above: Special engineering product, CSM, pre-ordered components, materials with extended lead times (e.g., veneers, special paint, etc.) or large quantities of standard materials.

- Use our Order Change/Cancellation Request Form for all order changes. It is Coalesse responsibility to accurately process change order requests. It is the dealer's responsibility to verify that we have accurately interpreted your change requests by checking the acknowledgement after the change has been made. If you do not use the web-based change order form process and an error occurs during our translation which cannot be corrected prior to ship, all costs will be shared on a 50/50 basis. Changing ship dates or adding product to your order is subject to the availability of manufacturing capacity.

- Cartoning changes and shipping address changes are subject to approval and to a change charge. Please consult your Customer Service for specific information pertaining to your order.

Reserved Fabric Policy

Prior to order receipt, reserving textiles (COM/COL, Maharam, Designtex, and select Luna Graded-In) is the responsibility of the dealer. Coalesse cannot reserve textiles based on projected orders. Coalesse cannot guarantee Maharam or Designtex fabric availability. If dealer reserves Maharam or Designtex textiles, Coalesse will require the reserve number and zip code for locating purposes when ordering.

Schedule Enhancements

Coalesse will entertain schedule enhancements on a case-by-case basis; however, please understand that we must receive complete information such as installation date, opening date, etc., to make informed scheduling decisions.

No order move-ups or move-outs are allowed on any order that falls within the 15-working day period of its manufacturing completion date. If it is within the 15-working day period, Coalesse will invoice at shipment but may offer storage options at a charge for manufactured product.

Ordering

Surface Materials

ELMO SOFT, ELMORUSTICAL LEATHER CARE

Only the finest hides are used for Elmo leather. Expect some color variations from hide to hide due to the aniline state of the product. Color fading may occur if leather is exposed to direct or intense light. Care is required to allow this product to achieve the rich natural patina that beautiful natural leather develops. The hallmarks of this leather include some naturally occurring markings, such as healed scars, insect bites, stretch marks, and fat wrinkles. Elmorustical's leather treatment is very natural with little protection from spills or body oils. This rich leather will exhibit stains and oils through normal use. Coalesse is not responsible for discoloration, spotting, or staining on this leather.

Special Color Match Leather

Coalesse can provide a special color match in its leather to any supplier's leather color, paint color, carpet color, wall-paper color, etc. Sample to match must be submitted to Coalesse with purchase order. Sample for approval can be supplied if requested.

Note: Minimum order 2,500 sq. ft.

Special Fabric Applications

(available on GradedIn or Coalesse to purchase orders)

Teflon protection

- Minimum charge:
- 1-30 yards \$125 list
 - 31+ yards \$2.50 list/per yard

Latex backing

- 1-50 yards \$260 list minimum charge
- 50+ yards \$8.00 list/per yard

Tip: Prices subject to change without notice and an additional 2 week lead time will apply for 54" wide fabrics. Wider fabrics will require 4 week additional lead time. Multiple rolls will incur additional charges per roll.

Upholstery

All Coalesse textiles are priced by grades. Some Coalesse fabrics can be treated for flame retardancy, contact Customer Service. All Coalesse products are handcrafted making each unique. Certain fabrics and leathers will appear loose and may differ from like products due to comfort wrinkles when upholstered.

A contrasting welt is available on some products. Consult Customer Service for yardage or square feet requirements and prices. All stripes will be applied vertically unless customer specifies otherwise. Loose cushions on Coalesse products are not fully upholstered (not reversible).

Designtex, Maharam, and select Luna fabrics are graded in our pricing. Simply order Coalesse products with Designtex, Maharam, and select Luna specified. Designtex and Maharam fabrics are graded in on Coalesse products; however, Coalesse does not stock fabrics and can only respond based on Designtex and Maharam lead times. For current grades, refer to Coalesse website: www.Coalesse.com.

Pre-approved CAL 133 Textiles Designtex and Maharam textiles have been graded into our pricing; however, not all textiles are recommended on all seating. For current grade and approval information, please visit our website and click on FABRICEVALUATIONS to obtain grade pricing for a specific pattern.

Wood and Finish Specifications

Solid hardwood is a renewable natural resource, and each section of a tree is unique. The color and grain pattern will vary emphasizing the natural beauty of each product built. Wood is a natural material and will accept stain differently. Coalesse cannot guarantee finished products to be an exact match to finish samples due to the natural characteristics of wood. Light finishes will exhibit some mineral streaks and dark graining due to the natural wood.

The finish used by Coalesse on hardwood frames and occasional tables is pre-catalyzed lacquer which can be easily repaired in the field if damage occurs. Veneer is sanded prior to finish application, and sanded between coats. The lacquer top coat is then polished after final application with wool wax. 4 to 6 layers of finish are applied during the process. The CH process varies from our internal processes.

Coalesse Tables and Casegoods

Coalesse's primary wood finish, Clarity, is a water-borne UV topcoat, which protects the environment while providing exceptional durability and resistance to water and chemical stains. contoured products, such as wood guest chairs & occasional tables, are finished with post-catalyzed vinyl, which provides similar properties and matches the sheen and color of Clarity, due to natural variations in wood, finished products may vary from samples in color, texture, and grain.

Stain-To-Match Program

Coalesse will offer a stain to match program at no additional upcharge for all products with wood finish options.

Customer must supply Coalesse Customer Service with sample to be matched. (internal note - CSR's will have samples of bare wood to compare and define species when applicable that will be used to accomplish the closest stain to match).

Coalesse high sheen will be standard unless specified by customer.

Sheen to match is available as part of the stain/sheen to match program at no upcharge.

Species to match is considered a special and requires to special request to Coalesse Customer Service. Species to match may require an upcharge.

Care and Maintenance

Chrome

Use commercial cleanser and polish, according to manufacturer's directions.

Fabric

Under normal use, clean with soft cloth dampened with water. For spots and spills, we recommend professional cleaning. For COM, refer to the specific cleaning instructions recommended by the fabric supplier.

Emu Outdoor Fabric:

Remove loose dirt with soft bristle brush or hose down with cold water. Clean with mixture of water and mild soap. Rub in mixture with soft brush and allow to thoroughly soak into fabric. Rinse thoroughly with cold water and air dry. Never use water over 100 degrees Fahrenheit. Do not machine dry. For light cleaning, avoid using detergents.

For stubborn stains use mixture of one gallon cold water, 1/2 cup bleach and 1/4 cup mild soap for one hour.

Detergents can be used without harm, though they may remove some of the water and stain resistant properties in the fabric.

SW_1 Knit:

Clean with warm water and soap. Wet sponge and wipe fabric. Household cleaners such as Windex™ may be used. Do NOT use cleaners containing bleach.

Laminate and solid phenolic

should be cleaned with soap and water. For stubborn stains, use a non-abrasive household cleaner.

SW_1 Tablet surfaces clean

with soft cloth dampened with water and soap, if needed. The use of general purpose cleaners are acceptable but must be void of citric content that has z-butoxyethanol in the formulation listing.

Cleaning Laminate

Markerboard Surface

Use dry erase markers only. Remove dry-erase markings with a markerboard eraser or soft cloth as often as possible. Change erasers, as they become dirty. Dirty erasers will leave ink residue on the surface.

For daily cleaning, or as needed, use a dry erase cleaner, or a non-abrasive household cleaner, such as glass cleaner. This may be done with a soft cloth or sponge. Dry the surface with a soft cloth prior to writing. All markings should be removed weekly.

Caution:

- Do not use permanent markers on markerboard surfaces. In the event a permanent marker is used, removal of markings may be attempted by using dry erase cleaner, or by writing over the marking with a dry erase marker and erasing with a markerboard eraser or soft cloth.
- Do not use abrasive cleaners or solvent type cleaning solutions, such as Ketones (Acetone, MEK, etc.) lacquer thinner, nail polish remover, etc. because they may remove the finish from the markerboard surface.

Cleaning CeramicSteel

Markerboard Surface

- Care and maintenance applies to both a³ CeramicSteel and e³ CeramicSteel.
- Wipe board with a clean cloth moistened by a liquid markerboard cleaner or a solution of 50% water and 50% isopropyl alcohol.
- Rinse with clear water.
- Wipe dry with a clean cloth. If your board is used daily, the cleaning should be performed at least 2-3 times a week.

More thorough cleaning may be required if writing is left on the board for more than two days.

Markers

Use any high-quality dry erase marker.

CAUTION! The use of Low Odor markers may cause ghosting to occur. If Low Odor markers have been used, the surface can be completely cleaned by following the cleaning instructions above. Remember to discard eraser if used with Low Odor markers.

Removing Permanent Marker

Option 1:

- Write over the top of the permanent marker ink with a dry-erase marker
- Simply erase

Option 2:

- Moisten a clean, dry cloth with isopropyl alcohol
- Wipe the board in a circular motion to loosen marker residue
- Rinse with clear water
- Dry the board with a clean cloth
- Repeat these steps as necessary

Installer's Instructions for Initial Cleaning at Time of Installation

NOTE: These initial cleaning instructions are shipped with every board.

- For initial cleaning, wipe your board with a clean cloth moistened by a mild, alcohol-based cleaner.
- Rinse with clear water. This step is simple, but very important.
- Wipe dry with a clean cloth.

Leather

Under normal use, regular dusting and vacuum cleaning are all that is necessary. For spots and spills, wipe excess liquid immediately. If necessary, use lukewarm water cleaning the entire area where spot occurred and air dry. For stubborn spots or stains, use a solution of mild non-detergent soap and air dry. For butter, oil, or grease, wipe excess with dry cloth and then leave alone. The spot will dissipate into the leather. Do not apply water.

Faux Leather

Under normal use, clean with soft cloth dampened with water. For spots and stains, use the recommended mixture of Woolite and water. Rinse with clean water and air dry.

Granite/Glass

Under normal use, clean with Windex and soft cotton cloth.

Powder coat finishes on chairs and table bases

should be cleaned with a liquid detergent and water. Remove stubborn stains with liquid cleanser, such as Formula 409.

Emu Outdoor Paint:

Store in an enclosed and dry area during winter to avoid condensation. Before winter and regularly every quarter, clean the metal surfaces with a cloth dipped in water or detergent and protect them with vasoline oil or car polish. Do not use ethyl alcohol or detergents that contain even in small quantities acetone, trichloroethylene, or ammonia (or solvents in general). When storing tables, do not stack them or put the table tops in direct contact with each other. Handle the seats with care when stacking them to avoid damaging the varnished surfaces.

Polished Aluminum finishes

on table bases should be cleaned with a commercial powder, liquid, or paste metal cleaner and polish. Follow the manufacturer's directions.

Veneers and painted MDF

should be cleaned regularly with mild soap and water and dried with a soft cloth. *Tip: Never use ammonia-based cleaners or wax on wood surfaces.*

Veneers should be cleaned regularly with mild soap and water and dried with a soft cloth.

Tip: Never use ammonia-based cleaners or wax on wood surfaces.

Protecting Wood Surfaces

Use desk pads and coasters to help protect the finish against dents, scratches, moisture and hot and cold liquids. Do not use desk pads that have plastic backing. Use felt or leather pads on the bottoms of office equipments and accessories.

Periodically move desk accessories and other objects kept on the worksurface to ensure even aging.

Lift objects when you move them, instead of pulling or pushing them across the surface, to avoid scratching the surface. Avoid leaving vinyl binders on worksurface for long periods.

If you use a protective glass top, insert felt pads between the glass and the worksurface to create an air space and allow the wood to breathe.

Keep your furniture away from direct sunlight. Avoid extreme temperatures and humidity. Maintain temperatures between 60 and 80 degrees Fahrenheit and humidity levels between 30 and 50 percent.

Cleaning Wood Surfaces

Keep a supply of soft, clean, absorbent cloths handy for wiping up spills and regular dusting.

To dust, wipe with a slightly damp, soft cloth, using another soft cloth to dry. Always wipe the surface in the direction of the woodgrain.

Use a quality cleaner or flax soap formulated especially for use on wood surfaces. Do not use oils or ammonia. Dilute the cleaner as directed by the manufacturer. Dampen but do not saturate a soft cloth with the diluted cleaning solution. Wipe the surface in the direction of the woodgrain to remove dirt and fingerprints. Wipe the surface clean with a soft, dry cloth.

Care and Maintenance

Vinyl

Under normal use, clean with soft cloth dampened with mild soap solution. For stubborn stains and spills, a sponge or soft brush may be used with mild non-abrasive cleaner.

Transolid/Corian:

Clean regularly with mild soap and water. Dry with a soft cloth.

Tables should be inspected and maintained regularly by tightening screws and bolts, inspecting casters and glides for damage, and inspecting all moving parts for damage and wear.

Resources



Lock and Keying	300
Style Number Index	302

Resources Lock and Keying

All locking products are standard with factory-installed, keyed-random locks. Specific and random keying are available as field-installed options.

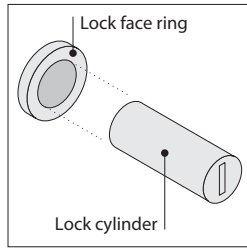

Locks consist of a factory- or field-installed lock cylinder and a factory-installed lock face ring.

One type of lock is available—the standard keying system (TA series).



Factory-Installed Keying

Factory-installed locks are always key random (standard). Key random means that the locks will be assigned arbitrarily at the factory with key numbers ranging from TA100 to TA149. All locks within a unit will be keyed alike.

Tip: Random keying can mean that different furniture units will have the same key number. If you must have all locks keyed differently, you should specify field-installed, key specific lock cylinders.

▶ See below.

Key Random

-  TA110
-  TA124
-  TA110

Field-Installed Keying

Field-installed locks are only available on products that include factory-installed lock mechanisms.

Specify "plug" when specifying furniture, and the product will ship without the lock cylinder.

Front-removable lock cylinders must be specified separately. You must also order a special lock tool to install or remove lock cylinders in the field.

Tip: Lock tools are reusable. You do not need to order additional lock tools with every furniture order.



Lock cylinders will be shipped separately so that you can install the locks when you are ready.

Two keying choices are available for field installation—random (standard) and specific.

Key random means that the locks will be assigned arbitrarily at the factory with key numbers ranging from TA100 to TA149.

Tip: Random keying can mean that different furniture units will have the same key number. If you must have all locks keyed differently, you should specify key specific lock cylinders.

Key Random



-  TA110
-  TA124
-  TA110

Key specific means that you can specify any key number from TA100 to TA149. This option can be used to key all the furniture units in a workstation or department the same.

Tip: Designate the quantity per key number in your specification.

▶ See example at right.

Key Specific

-  TA115
-  TA115
-  TA115

Example of a typical lock cylinder specification is shown below:

10	LOCK9211TA TA100
5	LOCK9211TA TA146
15	LOCK9211TA TA131

30 Total

1 4678137SR standard lock tool

Resources

Lock and Keying

Style Number Index

Style Number	Page	Description	Style Number	Page	Description
1404M	206	Switch Counter-Height Stool	391-B	161	Switch Arm Bolster
1404PC	206	Switch Counter-Height Stool	43-T171717	241	Sidewalk Occasional Table
1405M	206	Switch Bar-Height Stool	43-T222222	241	Sidewalk Occasional Table
1405PC	206	Switch Bar-Height Stool	430	100	Sidewalk Collaborative Chair
1500M	204	Switch Guest Armless Chair	430-2	101	Sidewalk Collaborative Two-Seat
1500PC	204	Switch Guest Armless Chair	430-B1724	102	Sidewalk Bench
1510M	204	Switch Guest Arm Chair	430-B1736	102	Sidewalk Bench
1510PC	204	Switch Guest Arm Chair	430-B1748	102	Sidewalk Bench
1519M	205	Switch Guest Lowback Sledbase	430-H1717	101	Sidewalk Collaborative Ottoman
1519PC	205	Switch Guest Lowback Sledbase	430-H1720	101	Sidewalk Collaborative Ottoman
1529M	205	Switch Guest Highback Sledbase	430-H2026	101	Sidewalk Collaborative Ottoman
1529PC	205	Switch Guest Highback Sledbase	430-H3636	102	Sidewalk Ottoman
1810M	178	Capa Chair	440-2WB	156	Passerelle Two-Seat Lounge
1810PC	178	Capa Chair	440-3WB	157	Passerelle Three-Seat Lounge
216	74	Bob Lounge Swivel Chair	440-B	97, 157	Passerelle Arm Bolster
221	74	Bob Lounge Chair w/Headrest	440-B2060WB	159	Passerelle Bench
221-H	75, 177	Bob Ottoman	440-B3060WB	159	Passerelle Bench
231	177	Bob Guest Chair	440-B4040WB	159	Passerelle Bench
240	104	Swathmore Chair Wood Leg	440-H1717WB	158	Passerelle Ottoman
240-2	104	Swathmore 2 St Lounge Wood Leg	440-H2026WB	158	Passerelle Ottoman
240-3	104	Swathmore 3 St Lounge Wood Leg	440-H3636WB	158	Passerelle Ottoman
241	105	Swathmore Chair Wood Base	440-WB	156	Passerelle Chair
241-2	105	Swathmore 2 St Lounge Wood Base	444	96	Sidewalk Lowback Chair
241-3	105	Swathmore 3 St Lounge Wood Base	444-2	97	Sidewalk Two-Seat
243	106	Swathmore Grande Chair Wd Leg	444M	97	Sidewalk Lowback Chair w/Tablet
243-3	106	Swathmore Grande 3 St Wd Leg	446	97	Sidewalk Highback Chair
243MTL	108	Swathmore Grande Mobile	446M	97	Sidewalk Mobile Highback Chair w/Tablet
243MTR	108	Swathmore Grande Mobile	45-T1300H	85	Circa Freestanding Table
244	107	Swathmore Grande Wd Base	45-T1300HER	84	Circa Ganging Table
244-2	107	Swathmore Grande 2 St Wd Base	45-T1300HG	84	Circa Ganging Table
244-3	107	Swathmore Grande 3 St Wd Base	45-T1300L	84	Circa Freestanding Table
2540-1	200	Kathryn Wood with Open Back	45-T1300LER	84	Circa Ganging Table
2542-1	200	Kathryn Wood/Uph with Panel Back	45-T1300LG	84	Circa Ganging Table
2547-1	200	Kathryn Fully Uphol Back	45-T1815H	83	Circa Freestanding Table
2547-1RIBD	201	Kathryn Fully Uphol Back w/Ribbed uph	45-T1815HER	83	Circa Ganging Table
3500	180	Enea Arm Chair	45-T1815HG	82	Circa Ganging Table
3500S	182	Enea Armless	45-T1815L	82	Circa Freestanding Table
3501	180	Enea Arm Chair	45-T1815LER	82	Circa Ganging Table
3501S	182	Enea Armless	45-T1815LG	82	Circa Ganging Table
3502	181	Enea Arm Chair	45-T28HER	85	Circa Ganging Table
3502S	183	Enea Armless	45-T3730H	83	Circa Freestanding Table
3503	181	Enea Arm Chair	45-T3730HER	83	Circa Ganging Table
3503S	183	Enea Armless	45-T3730HG	83	Circa Ganging Table
3510	184	Enea Bar-Height Stool w/Arms	45-T3730L	83	Circa Freestanding Table
3510S	186	Enea Armless Bar-Height Stool	45-T3730LER	83	Circa Ganging Table
3511	184	Enea Bar-Height Stool w/Arms	45-T3730LG	83	Circa Ganging Table
3511S	186	Enea Armless Bar-Height Stool	45-T42RD	86	Circa Freestanding Table
3512	185	Enea Bar-Height Stool w/Arms	45-T7460HP	85	Circa Freestanding Table
3512S	187	Enea Armless Bar-Height Stool	45-T7460HPER	85	Circa Ganging Table
3513	185	Enea Bar-Height Stool w/Arms	45-T7460HPG	85	Circa Ganging Table
3513S	187	Enea Armless Bar-Height Stool	451-2500	78	Circa Straight Seat Chair
391	160	Switch Chair	451-3730FI	77	Circa 30° Inside Wedge Armless Seat
391-2	160	Switch Two-Seat	451-3730FO	76	Circa 30° Outside Wedge Seat
391-3	161	Switch Three-Seat	451-5000	78	Circa Straight Loveseat
391-4	161	Switch Two-Seat w/Extensions	451-7460FI	77	Circa 60° Inside Wedge Loveseat

Style Number Index

Style Number	Page	Description	Style Number	Page	Description
451-7460FO	77	Circa 60° Outside Wedge Loveseat	798	221	Chord High-Back Chair
451-A1800ER	80	Circa Straight Armrest	798-P	221	Chord High-Back Chair
451-A1800G	80	Circa Straight Armrest	798-PAU	221	Chord Midback Chair
451-A1815FIER	80	Circa 15° Inside Armrest	798AU	221	Chord Midback Chair
451-A1815FIG	80	Circa 15° Inside Armrest	9014S	178, 181, 183	Stacking Dolly
451-A1815FOER	81	Circa 15° Outside Armrest	BB48	60	Bix Bench
451-A1815FOG	81	Circa 15° Outside Armrest	BB72	60	Bix Bench
451-A3730FIER	81	Circa 30° Inside Armrest	BBS48	60	Bix Bench
451-A3730FIG	81	Circa 30° Inside Armrest	BBS72	60	Bix Bench
451-A3730FOER	81	Circa 30° Outside Armrest	BL26AA	52	Bix Lounge Chair with Arms
451-A3730FOG	81	Circa 30° Outside Armrest	BL26XX	52	Bix Lounge Chair
451-B42RD	81	Circa Round Ottoman	BLB26XX	52	Bix Lounge Chair with Screen
451-B5000	78	Circa Straight Bench	BLD26AA	53	Bix Sled Lounge with Arms
451-B7460FI	77	Circa 60° Inside Wedge Bench	BLD26TX	53	Bix Sled Lounge Tablet Arm
451-B7460FO	77	Circa 60° Outside Wedge Bench	BLD26XT	53	Bix Sled Lounge Tablet Arm
451-GANGPKG	78, 81	Circa Ganging Kit	BLD26XX	53	Bix Sled Lounge
46-T1	226	Await Freestanding Table	BP72TX	63	Bix Podium
46-T2	226	Await Freestanding Table	BP72XT	63	Bix Podium
460-3	47	Await Modular Three-Seat Lounge	BPP72TX	63	Bix Podium
460-4	47	Await Modular Four-Seat Lounge	BPP72XT	63	Bix Podium
460-4B	47	Await Modular Four-Seat Bench	BSC30LA	54	Bix Sectional Seating
460-GANGPKG	48	Ganging Kit	BSC30LB	55	Bix Sectional Seating
460-H	47	Await Modular Ottoman	BSC30RA	55	Bix Sectional Seating
460-SE22	49	Await Lounge Table	BSC30RB	55	Bix Sectional Seating
460-SE22PD	49	Await Lounge Table	BSCB30LA	55	Bix Sectional Seating
460-SE30	49	Await Lounge Table	BSCB30LB	55	Bix Sectional Seating
460-SE30PD	49	Await Lounge Table	BSCB30RA	55	Bix Sectional Seating
460-SE44	49	Await Lounge Table	BSCB30RB	55	Bix Sectional Seating
460-SE44PD	49	Await Lounge Table	BSE54LA	56	Bix Sectional Seating
461-1B	48	Await Connector Bench	BSE54LX	56	Bix Sectional Seating
461-2B	48	Await Connector Bench	BSE54RA	56	Bix Sectional Seating
461-3B	48	Await Connector Bench	BSE54RX	56	Bix Sectional Seating
470	88	Coupe Lounge Chair	BSEB54LA	56	Bix Sectional Seating
470-2	89	Coupe Two-Seat Lounge	BSEB54LX	56	Bix Sectional Seating
470-3	89	Coupe Three-Seat Lounge	BSEB54RA	56	Bix Sectional Seating
470-H	89	Coupe Ottoman	BSEB54RX	56	Bix Sectional Seating
473MAPLE	92	Coupe Wood Lounge Chair	BSS48AA	57	Bix Sectional Seating
473WALNUT	92	Coupe Wood Lounge Chair	BSS48AX	57	Bix Sectional Seating
476	90	Coupe Grande Chair	BSS48XA	57	Bix Sectional Seating
476-2	91	Coupe Grande Two-Seat Lounge	BSS48XX	57	Bix Sectional Seating
476-3	91	Coupe Grande Three-Seat Lounge	BSS72AA	58	Bix Sectional Seating
476M	91	Coupe Grande Chair	BSS72AX	58	Bix Sectional Seating
490-B35VRT	95	Little Ripple Wave Bench	BSS72XA	58	Bix Sectional Seating
490-B96HRZ	95	Ripple Flat Seat Bench	BSS72XX	58	Bix Sectional seating
490-B96VRT	95	Ripple Wave Bench	BSSB48AX	57	Bix Sectional Seating
70-C-TPM	242	Tree Bevel High-Embossed Wood	BSSB48XA	57	Bix Sectional Seating
70-D-TPM	242	Tree Bevel Medium-Embossed Wood	BSSB48XX	57	Bix Sectional Seating
795	220	Chord Conference Chair	BSSB72AX	58	Bix Sectional Seating
795AU	220	Chord Conference Chair	BSSB72XA	58	Bix Sectional Seating
796	221	Chord Midback Chair	BSSB72XX	58	Bix Sectional Seating
796-P	221	Chord Midback Chair	BTB2226	68-69	Bix Bridge Table
796-PAU	221	Chord Midback Chair	BTB2226U	68	Bix Bridge Table
796AU	221	Chord Midback Chair	BTB2626	69	Bix Bridge Table
797	221	Chord High Back Chair	BTB2626U	69	Bix Bridge Table
797AU	221	Chord Midback Chair	BTBS2226	69	Bix Bridge Table

Style Number Index *continued*

Style Number	Page	Description	Style Number	Page	Description
BTBS2226U	69	Bix Bridge Table	CO2489C	246	Emu Heaven Lounge Back Cushion
BTBS2626	69	Bix Bridge Table	CO2493	248	Emu Heaven Round Table
BTBS2626U	69	Bix Bridge Table	CO2493V	248	Emu Heaven Glass Top
BTC20001	70, 228	Bix Occasional Table	CO2494	248	Emu Heaven Round Table
BTC24241	70, 228	Bix Occasional Table	CO2494V	248	Emu Heaven Glass Top
BTC24241U	70, 228	Bix Occasional Table	CO2495	246	Emu Heaven Pouf
BTC24481	70, 228	Bix Occasional Table	CO2495B	246	Emu Heaven Indoor Cushion
BTC24481U	70, 228	Bix Occasional Table	CO2495C	246	Emu Heaven Outdoor Cushion
BTC24721	70, 228	Bix Occasional Table	CO2495V	246	Emu Heaven Glass Top
BTC24721U	70, 228	Bix Occasional Table	CO2496	248	Emu Heaven Side Table
BTC28001	70, 228	Bix Occasional Table	CO2497	247	Emu Heaven High Vase
BTC28001U	70, 228	Bix Occasional Table	CO2498	247	Emu Heaven Low Vase
BTS1700	72, 227	Bix Side Table	CO2565MB	254	Emu Re-Trouvé Midback Chair
BTW20003	71	Bix Work-Booth Table	CO2566B	255	Emu Re-Trouvé Indoor Cushion
BTW28003	71	Bix Work-Booth Table	CO2566C	255	Emu Re-Trouvé Outdoor Cushion
BTW28003U	71	Bix Work-Booth Table	CO2566HB	254	Emu Re-Trouvé Highback Chair
BTW36483	71	Bix Work-Booth Table	CO2575	254	Emu Re-Trouvé Pouf
BTW36483U	71	Bix Work-Booth Table	CO2575B	254	Emu Re-Trouvé Indoor Cushion
BTW36723	71	Bix Work-Booth Table	CO2575C	254	Emu Re-Trouvé Outdoor Cushion
BTW36723U	71	Bix Work-Booth Table	CO2577	255	Emu Re-Trouvé High Vase Frame
CO200G	176	Bindu-Low Back Guest/Side Chair	CO2578	255	Emu Re-Trouvé Low Vase Frame
CO2465	256	Emu Round Chair	CO2580	255	Emu Re-Trouvé Vase Insert
CO2465B	257	Emu Round Stool Cushion	CO2581	250	Emu Ivy Side Chair
CO2465C	257	Emu Round Chair Cushion	CO2581B	251	Emu Ivy Side Chair Cushion
CO2466	256	Emu Round Arm Chair	CO2581C	251	Emu Ivy Side Chair Cushion
CO2467	256	Emu Round Stool	CO2582	250	Emu Ivy Side Arm Chair
CO2467B	257	Emu Round Stool Cushion	CO2585	250	Emu Ivy Arm Chair
CO2467C	257	Emu Round Stool Cushion	CO2585B	251	Emu Ivy Indoor Cushion
CO2469	256	Emu Round Lounge	CO2585C	251	Emu Ivy Outdoor Cushion
CO2469B	257	Emu Round Lounge Cushion	CO2586	250	Emu Ivy Lounge
CO2469C	257	Emu Round Lounge Cushion	CO2586B	251	Emu Ivy Lounge Cushion
CO2470	258	Emu Round Table	CO2586C	251	Emu Ivy Lounge Cushion
CO2471	258	Emu Square Table	CO2589	252	Emu Ivy Rectangle Side Table
CO2472	258	Emu Square Table	CO2592	252	Emu Ivy Rectangular Metal Top Table
CO2473	258	Emu Square Table	CO2595	251	Emu Ivy Pouf
CO2474	258	Emu Rectangle Table	CO300	218	Bindu-Mid Back Executive Chair
CO2475	258	Emu Counter Table	CO300G	176	Bindu-Mid Back Guest/Side Chair
CO2477	258	Emu Side Table	CO400	218	Bindu Mid-Back High Back Executive Chair
CO2478	258	Emu Side Table	CODAV	114	Davos Chair
CO2480B	245	Emu Heaven Chair Back Cushion	CODAV16	114	Davos Small Bench
CO2480C	245	Emu Heaven Chair Back Cushion	CODAV38	114	Davos Medium Bench
CO2481B	245	Emu Heaven Arm Chair Back Cushion	CODAV60	114	Davos Large Bench
CO2481C	245	Emu Heaven Arm Chair Back Cushion	COEB2723H	240	Sebastopol 22" High Table
CO2485	244	Emu Heaven Chair	COEB2723L	240	Sebastopol 16" High Table
CO2485B	245	Emu Heaven Indoor Cushion	COEB4118H	240	Sebastopol 22" High Table
CO2485C	245	Emu Heaven Outdoor Cushion	COEB4118L	240	Sebastopol 16" High Table
CO2486	244	Emu Heaven Arm Chair	COEL100	192	Enea Lottus Armless Chair
CO2486B	245	Emu Heaven Indoor Cushion	COEL100INSERT	192	Enea Lottus Armless Chair
CO2486C	245	Emu Heaven Outdoor Cushion	COEL100UPH	192	Enea Lottus Armless Chair
CO2487	244	Emu Heaven Lounge Chair	COEL1830	235	Enea Lottus Occasional Table
CO2487B	245	Emu Heaven Lounge Cushion	COEL1836	235	Enea Lottus Occasional Table
CO2487C	245	Emu Heaven Lounge Cushion	COEL1842	235	Enea Lottus Occasional Table
CO2488B	246, 257	Emu Heaven Lounge Pillow	COEL200	194	Enea Lottus Cantilever Arm Chair
CO2488C	246, 257	Emu Heaven Lounge Pillow	COEL200INSERT	194	Enea Lottus Cantilever Arm Chair
CO2489B	246	Emu Heaven Lounge Back Cushion	COEL200UPH	194	Enea Lottus Cantilever Arm Chair

Style Number Index

Style Number	Page	Description	Style Number	Page	Description
COEL300	195	Enea Lottus Aluminum Loop Arm Chair	COLAGLH31	139	Lagunitas 3-Seat Lnge w/ High-Bk Scrn
COEL300INSERT	195	Enea Lottus Aluminum Loop Arm Chair	COLAGLH32	140	Lagunitas 3-Seat Lnge w/ HB Scrn, 1 Side Scrn
COEL300UPH	195	Enea Lottus Aluminum Loop Arm Chair	COLAGLH33	141	Lagunitas 3-Seat Lnge w/ HB Scrn, 2 Side Scrns
COEL3030	236	Enea Lottus Conference Table	COLAGLL11	126	Lagunitas 1-Seat Lnge w/ Low-Bk Scrn
COEL303072	239	Enea Lottus Rectangular Table	COLAGLL13	126	Lagunitas 1-Seat Lnge w/ LB Scrn, 2 Side Scrns
COEL3036	236	Enea Lottus Conference Table	COLAGLL21	130	Lagunitas 2-Seat Lnge w/ Low-Bk Scrn
COEL3042	236	Enea Lottus Conference Table	COLAGLL22	130	Lagunitas 2-Seat Lnge w/ LB Scrn, 1 Side Scrn
COEL3624	237	Enea Lottus Café Counter-Height Table	COLAGLL23	131	Lagunitas 2-Seat Lnge w/ LB Scrn, 2 Side Scrns
COEL3630	237	Enea Lottus Café Counter-Height Table	COLAGLL31	136	Lagunitas 3-Seat Lnge w/ Low-Bk Scrn
COEL363072	239	Enea Lottus Rectangular Table	COLAGLL32	137	Lagunitas 3-Seat Lnge w/ LB Scrn, 1 Side Scrn
COEL3636	237	Enea Lottus Café Counter-Height Table	COLAGLL33	138	Lagunitas 3-Seat Lnge w/ LB Scrn, 2 Side Scrns
COEL3642	237	Enea Lottus Café Counter-Height Table	COLMS25	202	Last Minute Stool
COEL400	197	Enea Lottus Sled-Base Stool	COLMS30	202	Last Minute Stool
COEL400INSERT	197	Enea Lottus Sled-Base Stool	COLX200	203	Lox Stool
COEL400UPH	197	Enea Lottus Sled-Base Stool	COLX210	203	Lox Stool
COEL4224	238	Enea Lottus Café Bar-Height Table	COMF1	123	Millbrae Ganging Kit
COEL4230	238	Enea Lottus Café Bar-Height Table	COMFL1	119	Millbrae Lounge
COEL423072	239	Enea Lottus Rectangular Table	COMFL2	120	Millbrae Lounge
COEL4236	238	Enea Lottus Café Bar-Height Table	COMFL3	121	Millbrae 3-Seat Lounge
COEL4242	238	Enea Lottus Café Bar-Height Table	COMFL4	122	Millbrae 4-Seat Lounge
COEL500	196	Enea Lottus Sled-Base Stool	COMFLA1	119	Millbrae Lounge
COEL500INSERT	196	Enea Lottus Sled-Base Stool	COMFLA2	120	Millbrae 2-Seat Lounge
COEL500UPH	196	Enea Lottus Sled-Base Stool	COMFLA3	121	Millbrae 3-Seat Lounge
COEL600	199	Enea Lottus Post-Base Stool	COMFLA4	122	Millbrae 4-Seat Lounge
COEL600INSERT	199	Enea Lottus Post-Base Stool	COMFLB1	123	Millbrae 1-Seat Bench
COEL600UPH	199	Enea Lottus Post-Base Stool	COMFLB2	123	Millbrae 2-Seat Bench
COEL700	198	Enea Lottus Post-Base Stool	COMFLB3	123	Millbrae 3-Seat Bench
COEL700INSERT	198	Enea Lottus Post-Base Stool	COMFLB4	123	Millbrae 4-Seat Bench
COEL700UPH	198	Enea Lottus Post-Base Stool	COMFLLA1	119	Millbrae Lounge
COELDOLLY	193	Enea Lottus Stacking Dolly	COMFLLA2	120	Millbrae 2-Seat Lounge
COJHB100	174	Visalia Lounge	COMFLLA3	121	Millbrae 3-Seat Lounge
COJHB200	174	Visalia Lounge	COMFLLA4	122	Millbrae 4-Seat Lounge
COJHBC100	174	Visalia Lounge	COMFLRA1	119	Millbrae Lounge
COJHBC200	174	Visalia Lounge	COMFLRA2	120	Millbrae 2-Seat Lounge
COJHL100	173	Visalia Lounge	COMFLRA3	121	Millbrae 3-Seat Lounge
COJHL200	173	Visalia Lounge	COMFLRA4	122	Millbrae 4-Seat Lounge
COJHL300	173	Visalia Lounge	COMLPRND	123	Millbrae Round Arm Bolster
COJHLC100	173	Visalia Lounge	COMLPSQR	123	Millbrae Square Arm Bolster
COJHLC200	173	Visalia Lounge	COMSL1	119	Millbrae Lounge
COJHLC300	173	Visalia Lounge	COMSL2	119	Millbrae 2-Seat
COLAGB1	151	Lagunitas 1-Seat Bench	COMSL3	119	Millbrae 3-Seat
COLAGB2	151	Lagunitas 2-Seat Bench	COSFZCH	209	Montara650 Chair
COLAGB3	151	Lagunitas 3-Seat Bench	COSFZLC	211	Montara650 Lounge
COLAGCH2	144	Lagunitas 2-Seat Chaise	COSFZRC	215	Montara650 Rocker
COLAGCH3	148	Lagunitas 3-Seat Chaise	COSFZST	212-213	Montara650 Stools
COLAGCI	153	Alignment Connector	COTO12369L15	167	Together Bench
COLAGCL2	143	Lagunitas 2-Seat Chaise	COTO12369L8	167	Together Bench
COLAGCL3	147	Lagunitas 3-Seat Chaise	COTO12369R15	169	Together Bench
COLAGFN	155	Lagunitas Focus Nook	COTO12369R8	168	Together Bench
COLAGLBS	152	Lounge Booth Screen	COTO12396L15	167	Together Bench
COLAGLH11	127	Lagunitas 1-Seat Lnge w/ High-Bk Scrn	COTO12396L8	167	Together Bench
COLAGLH13	127	Lagunitas 1-Seat Lnge w/ HB Scrn, 2 Side Scrns	COTO12396R15	169	Together Bench
COLAGLH21	131	Lagunitas 2-Seat Lnge w/ High-Bk Scrn	COTO12396R8	168	Together Bench
COLAGLH22	132	Lagunitas 2-Seat Lnge w/ HB Scrn, 1 Side Scrn	COTO69	171	Together Bench
COLAGLH23	133	Lagunitas 2-Seat Lnge w/ HB Scrn, 2 Side Scrns	COTO69WB15	170	Together Bench

Style Number Index *continued*

Style Number	Page	Description	Style Number	Page	Description
COTO69WB8	170	Together Bench	H35-T3636L	231	Enea Table Single Base
COTO96	171	Together Bench	H35-T3636W	231	Enea Table Single Base
COTO9669L15	167	Together Bench	H35-T3642L	231	Enea Table Single Base
COTO9669L8	166	Together Bench	H35-T3642W	231	Enea Table Single Base
COTO9669R15	169	Together Bench	H35-T4218L	230	Enea Table Single Base
COTO9669R8	168	Together Bench	H35-T4218W	230	Enea Table Single Base
COTO9696L15	167	Together Bench	H35-T4230L	230	Enea Table Single Base
COTO9696L8	166	Together Bench	H35-T4230W	230	Enea Table Single Base
COTO9696R15	169	Together Bench	H35-T4236L	231	Enea Table Single Base
COTO9696R8	168	Together Bench	H35-T4236W	231	Enea Table Single Base
COTO96WB15	170	Together Bench	H350-S19	191	Enea Café Low Stool
COTO96WB8	170	Together Bench	H350-S27	191	Enea Café Counter-Height Stool
COURQL	117	Hosu Lounge w/Attached Lumbar	H350-S31	191	Enea Café Bar-Height Stool
COURQLO	117	Hosu Lounge w/Otto and Attached Lumbar	H350-SB2719	189	Enea Café Stool with Back
COURQS	117	Hosu 2-Seat Lounge	H350-SB3119	189	Enea Café Stool with Back
COW210	163	SW_1 Ottoman	H351-SB2719	189	Enea Café Stool with Back
COW413	222	SW_1 Conference Chair	H351-SB3119	189	Enea Café Stool with Back
COW415	222	SW_1 Conference Chair	H352-S19	190	Enea Café Low Stool
COW613	163	SW_1 Low-Back Collaborative Lounge Chair	H352-S27	190	Enea Café Counter-Height Stool
COW713	163	SW_1 High-Back Collaborative Lounge Chair	H352-S31	190	Enea Café Bar-Height Stool
COWK100	93	Joel Lounge	H352-SB2719	189	Enea Café Stool with Back
COWRP4LEG	216	Wrapp Chair, 4 Leg	H352-SB3119	189	Enea Café Stool with Back
COWRPSLD	216	Wrapp Chair, Sled-Base	H353-S19	191	Enea Café Low Stool
H35-T2436L	231	Enea Table Single Base	H353-S27	191	Enea Café Counter-Height Stool
H35-T2436W	231	Enea Table Single Base	H353-S31	191	Enea Café Bar-Height Stool
H35-T2442L	231	Enea Table Single Base	H353-SB2719	189	Enea Café Stool with Back
H35-T2442W	231	Enea Table Single Base	H353-SB3119	189	Enea Café Stool with Back
H35-T3030L	230	Enea Table Single Base	PL2431	110	Topo Lounge
H35-T3030W	230	Enea Table Single Base	PLJ2417	110	Topo Lounge
H35-T3036L	231	Enea Table Single Base	PLM2431	111	Topo Mobile
H35-T3036W	231	Enea Table Single Base	PLMJ2417	111	Topo Mobile Jr.
H35-T3042L	231	Enea Table Single Base			
H35-T3042W	231	Enea Table Single Base			
H35-T307230GL	232	Enea Table Twin Base			
H35-T307230GW	232	Enea Table Twin Base			
H35-T307230KLL	233	Enea Table Twin Base			
H35-T307230KW	233	Enea Table Twin Base			
H35-T307230VL	233	Enea Table Twin Base			
H35-T307230VW	233	Enea Table Twin Base			
H35-T307236GL	232	Enea Table Twin Base			
H35-T307236GW	232	Enea Table Twin Base			
H35-T307236KLL	233	Enea Table Twin Base			
H35-T307236KW	233	Enea Table Twin Base			
H35-T307236VL	233	Enea Table Twin Base			
H35-T307236VW	233	Enea Table Twin Base			
H35-T307242GL	232	Enea Table Twin Base			
H35-T307242GW	232	Enea Table Twin Base			
H35-T307242KLL	233	Enea Table Twin Base			
H35-T307242KW	233	Enea Table Twin Base			
H35-T307242VL	233	Enea Table Twin Base			
H35-T307242VW	233	Enea Table Twin Base			
H35-T3618L	230	Enea Table Single Base			
H35-T3618W	230	Enea Table Single Base			
H35-T3630L	230	Enea Table Single Base			
H35-T3630W	230	Enea Table Single Base			

Style Number Index

Trademark List

- The following are registered trademarks for products of Steelcase Inc. or one of its related corporate entities: 4 o'clock, 900 Series, à la carte, Airtouch, Ally, Amia, Answer, Archipelago, Avenir, Ballet, Bix, Brayton International, Cachet, Canopy, Canto, Chancellor, Coalesse, Confidante, Context, Convene, CopyCam, Criterion, Crushed Can, Currency, dash, Designtex, Details, Detour, Drive, Elective Elements, Ellipse, Ember Chrome, Emerge, E-Table 2, FYI, Garland, Gentry, Ginkgo Biloba, Groupwork, Ideo, Jacket, Jenny, Jersey, Kart, Kick, LaCosta, Leap, Let's B, LiveBack, Max-Stacker, media:scape, Metro, Migrations, Mitra, Montage, Nurture, Oriana, Parade, Pathways, PCT, Permiso, Player, Portal, Power Pincher, Progeny, Protégé, R2, Rally, Relevant, Reply, Rizzi Arc, Sensor, Series 9000, Siento, Sieste, Sine, Softcare, Springboard, Steelcase, Steelcase Design Partnership, Stella, Stow Davis, Swathmore, Sylvi, TeamWork, Technique, Texpress, Think, Thunder, Topo, Train, turnstone, Underline, Unison, Vecta, Viridian, Walden, Werndl, and X-Stack.
- The following registered trademarks are under license from AWI Licensing Company, Dover, DE: SoundScapes, DuraBrite, BioBlock, and Armstrong.
- The following registered trademarks are under license from Byrne Electrical, Rockford, MI: Interport, Mini-Port, Axil Z, and Ellora.
- The following is a registered trademark of DuPont, Wilmington, DE: Corian.
- The following is a registered trademark of Genlyte Thomas Company, Louisville, KY: Lightolier.
- The following is a registered trademark of Hilti Corporation, FL-9494 Schaan, Principality of Liechtenstein: Hilti.
- The following is a registered trademark of Leviton Manufacturing Company, Little Neck, NY: Decora.
- The following is a registered trademark of Mechanical Plastics Corp, Elmsford, NY: Toggler.
- The following is a registered trademark of Microsoft Corporation, Redmond, WA: Microsoft.
- The following is a registered trademark of Panduit Corporation, Lockport, IL: Panduit.
- The following is a registered trademark of Trav (Press), Cuneo, Italy: Assisa.
- The following is a registered trademark of Virtual Ink, Boston, MA: mimioActive.
- The following registered trademarks are under license from Wilkhahn Furniture Products: Avera, Senzo, Versal, and Wilkhahn FS.

- The following is a registered trademark of Wilsonart International, Temple, TX: Chemsurf.
- The following is a registered trademark of Wiremold, West Hartford, CT: Wiremold.
- The following is a registered trademark of EMU Group S.P.A., Perugia, Italy: Emu.
- The following is a registered trademark of Security People, Inc.: Digilock.
- The following are trademarks for products of Steelcase Inc. or one of its related corporate entities: Access, Active/Passive Shelf, Ainsley, Akira, Alcove, Alerion, Alight, Amaris, American Elect, American Tradition, ap40, Arbor, Arriva, Asana, Ascot, Aspekt, Astor, Await, Bassline, B-Free, Bira, Bivi, Bixby, Bottomline, Brody, Brook, Buoy, Burton, c:scape, Calla, Calm, Camber, Campfire, Capa, Cappuccino, Cesar, Chester, Chord, Circa, Clarendon, Classic Rectangular, Clipper, cobì, Collaboration, Community, Company, Convey, Cortex, Coupe, Crea, Crew, Cura, Cypress, Davenport, Dearborn, Deck, Déjà, Denizen, Denska, Derby, Divisio, Donovan, Dune, Duo, Echo, Edge, Elsna, Empath, Empress, Enea, ēno, EnSync, Enviro, Escapade, Exchange, Exponents, Field, Flat Top, FlexFrame, Flip Top, Flute, Folio, FrameOne, FreeFlow, Frontier, Galliei, Gesture, Ginger, Ginkgo, Go Wall, Grip, Groove, Hatchback, Hawthorne, Hitch, Host Collection, Hosu, Huddleboard, i2i, Impact, Indy, InfoLink, IOS, I-Solve, Jack, Jarrah, Jetty, Juice, Kami, Kast, Kathryn, Lagunitas, Lark, L'Attitude, LearnLab, Leela, LessThanFive, Lincoln, Linden, LiveSeat, Loria, Lyric, Malibu, Malibu Too, Mansfield, Marathon, Martini, Mason, Masque, Migration, Millbrae, Mineral, Mingle, Mystic, Mystic Metal, Mystic Wood, Montara650, Montreal, Move, Nadia, Neighbor, nesso, Nickel, Nikko, Nod, Node, Norfolk, Ology, Ontrak, Oom, Opus, Orchid, Outlook Collection, Ovation, Paloma, Paperflo, Parliament, Pasio, Passerelle, Patriarch, Payback, Peek, Pile File, Pisa, Pool, Potrero415, PUCK, QiVi, Quba, Rave, Reed, Regard, Relay, Reunion, Ripple, Riser, Roam, Rocco, Rocky, RoomWizard, Runner, Satellite, Sawyer, ScapeSeries, Senti, Sentinel, Senza, Sequoia, Session, ShareLink, Shield, Shortcut, Sidewalk, SILQ, Skylar, Slumber, Smoke, Snug, Soft Leaf, Sonata, Sorrel, SOTO, Southside, Stationkits, Steelcase Series, Stiletto, Surprise!, Surround, Switch, Symphony, Sync, TagWizard, Tava, TeamStudio, TeamTheater, Tenaro, Terrazzo, Theorem, Thread, Topaz, Touchdown, Tour, Tower Too, Trees, Trillium, Trolley, tX2, U-Free, Umami, Underscore, Uno, V.I.A., Verb, Verge, Verlay, Victor2, Visalia, Waldorf, Woodruff, Workspring, and X-tenz.
- The following is a trademark of Microsoft Corporation, Redmond, WA: Windows.
- The following is a trademark of Rodman Industries, Inc., Oconomowoc, WI: ResinCore1.
- The following is a trademark of Ultrafabrics, LLC, Elmsford, NY: Ultraleather.

- The following trademarks are under license from Wilkhahn Furniture products: Cana, Linus, Logon, Picto, Range, Stitz, Thema, Timetable, and Tubis.
- The following trademark is used under license from Cradle to Cradle Products Innovation Institute, Oakland, CA: Cradle to Cradle Certified.
- The following trademarks are under license from Walter Knoll: Andoo, Bob, Lazlo, Lox, Ribbon, and Together.
- The following trademarks are under license from PP Møbler: Bar and Flag Halyard.
- The following trademarks are under license from Viccarbe: Davos, Holy Day, Last Minute, RS, Sistema, and Wrapp.
- The following trademarks are under license from Carl Hansen: Elbow, Paddle, Shell, Wing, and Wishbone.
- The following trademarks are under license from Cambridge Sound Management, LLC, Cambridge, MA: QtPro Soundmasking, Qt Quiet Technology, and Sonet Qt.
- The following is a trademark of Electri-Cable Assemblies, Shelton, CT: Interact.
- The following is a trademark of Clestra Hauserman: IRYS.
- The following is a trademark of Wiesner-Hager Möbel GmbH: Nooi.
- The following are trademarks of PolyVision: a³, e³, Flow, Motif, PolyVision, Sans, and Serif.
- The following is a trademark of Bostock Company, Inc: SnapCab.
- The following is a trademark of Williams-Sonoma, Inc: West Elm.
- The following is a trademark of Elena Marquina Testor: nanimarquina.

Trademarks used here in are the property of Steelcase, Inc. or of their respective owners.

Coalesse Training/ Multipurpose Tables, Conferencing, and Storage

Volume 5b

Terms and Conditions	2
Sample Order Form	10
Participating Steelcase Dealers	12
Steelcase Showrooms and Manufacturing Locations	17

Coalesse	
Power and Data Access	19
Training/Multipurpose/Café Tables	31
Conference Tables	111
Storage/Ancillary	321

Surface Materials	349
Resources	389

► For a list of all trademarks, refer to the last page of this specification guide.

Terms and Conditions

Customer Information

For more information, please contact your participating Steelcase GSA dealer.

For more information, please contact your participating Steelcase GSA dealer.

For more information, please contact your participating Steelcase GSA dealer.

For more information, please contact your participating Steelcase GSA dealer.

For more information, please contact your participating Steelcase GSA dealer.

For more information, please contact your participating Steelcase GSA dealer.

For more information, please contact your participating Steelcase GSA dealer.

For more information, please contact your participating Steelcase GSA dealer.

Sample Order Form

Sample Order Form

ORDER FOR SUPPLIES OR SERVICES	PAGE	OF	PAGES
---------------------------------------	------	----	-------

IMPORTANT: Mark all packages and papers with contract and/or order numbers.

DATE OF ORDER 1 6-1-04	CONTRACT NO. (If any) 2 GS-27F-0014V	ORDER NO. 3 10 - 000	REQUISITION/REFERENCE NO.
----------------------------------	--	--------------------------------	---------------------------

ISSUING OFFICE (Address correspondence to) 4 GSA 1 Town Street City, State, Zip Name and Telephone Number	SHIP TO: (Consignee and address, ZIP Code) 5 GSA 2 Town Street City, State, Zip Name and Telephone Number
--	--

TO: CONTRACTOR (Name, address and ZIP Code) 6 Steelcase Inc. c/o Participating Dealer 901 44th Street, SE Grand Rapids, MI 49508 Attn: Solutions Fullfillment Team CH-2W-SS (GSA)	Cage Code: 39880	TYPE OF ORDER <input type="checkbox"/> A. PURCHASE — Reference your _____ Please furnish the following on the terms and conditions specified on both sides of this order and on the attached sheets, if any, including delivery as indicated. This purchase is negotiated under authority of: <input type="checkbox"/> B. DELIVERY — Except for billing instructions on the reverse, this delivery order is subject to instructions contained on this side only of this form and is issued subject to the terms and conditions of the above-numbered contract.
--	------------------	---

ACCOUNTING AND APPROPRIATION DATA	REQUISITIONING OFFICE
	BUSINESS CLASSIFICATION (Check appropriate box(es)) 20 <input type="checkbox"/> SMALL <input checked="" type="checkbox"/> OTHER THAN SMALL <input type="checkbox"/> DIS-ADVANTAGED <input type="checkbox"/> WOMEN-OWNED

FCA DESTINATION 7	GOVERNMENT NO.	DELIVER TO FCA DESTINATION ON OR BEFORE (Date) 8 ARO date	DISCOUNT TERMS 9 Net 30 days
PLACE OF INSPECTION AND ACCEPTANCE			

(See reverse for Rejections)

ITEM NO. (A)	SUPPLIES OR SERVICES (B)	QUANTITY ORDERED (C)	UNIT (D)	UNIT PRICE (E)	AMOUNT (F)	QUANTITY ACCEPTED (G)
1	10 One lot of Steelcase Office Furniture: See attached specifications	13 1		14 \$000	15 \$000	
2	11 Design: \$55.41/hour	2 hrs		\$000	\$000	
3	12 Installation	1		\$000	\$000	

SEE BILLING INSTRUCTIONS ON REVERSE	SHIPPING POINT	GROSS SHIPPING WEIGHT	INVOICE NO.		(H) TOT. (Cont. pages) ◀
	MAIL INVOICE TO: (Include ZIP Code) 17 GSA, 3 Town Street, City, State, Zip			16 \$000	(I). GRAND TOTAL ◀

UNITED STATES OF AMERICA BY (Signature) ▶ 18 Contracting Officer signature and telephone no.	NAME (Typed) 19 John Doe, Department Manager TITLE: CONTRACTING/ORDERING OFFICER
---	---

NSN 7540_01_152_8083

50347-101

OPTIONAL FORM 347 (10-83)
Prescribed by GSA
FAR (48 CFR) 53.213 (e)

- 1 Order date
- 2 Contract number
- 3 Order number
- 4 Issuing office: Requester name and telephone number
- 5 Shipping address: Contact name and telephone number
- 6 Contractor:
Steelcase Inc.
c/o Participating Dealer
901 - 44th Street, S.E.
Grand Rapids, MI 49508
Attn: Solutions Fulfillment Team
- 7 FCA destination
- 8 ARO date (After Receipt of Order)
- 9 Terms: Net 30 days
- 10 Complete product description, including SIN number, style number, all applicable surface materials.
- 11 Separate line for design
- 12 Separate line for installation
- 13 Quantity ordered
- 14 Individual unit price
- 15 Amount (quantity x unit price)
- 16 Total cost
- 17 Invoice address
- 18 Authorized contracting officer signature and telephone number
- 19 Authorized contracting officer name and title (typed)
- 20 Steelcase is the seller of record and is not registered as "small," "disadvantaged," or "woman-owned." If one of these boxes is checked in error, a modification will be required.

Please note on order that all invoice payments must be sent to:

Steelcase Inc.
62087 Collection Center Dr.
Chicago, IL 60693-0620

Storage and Delays

(Open Market) In the event that the site is not accessible, or safe and adequate storage space is not available during installation, the furnishings will be stored until delivery or installation can be accomplished. Pricing for storage will be negotiated on a project-by-project basis. Invoices will be sent to the local government purchasing facility upon delivery of the furniture to a designated storage facility. Steelcase shall provide notice to the Government purchasing facility that the furnishings are available for inspection by the Government at the Storage facility. Upon this notice, the Government, or representative for the Government, must inspect and accept the furniture prior to payment of any invoice. The inspection and acceptance must be completed within reasonable time frame agreed upon by both parties. Payment will be made by the Government 30 days after acceptance of the furniture.

Participating Steelcase Dealers

Alabama

Dekalb Office of Alabama
2901 Second Ave South
Birmingham, AL 35233
Phone: (205) 933-9100

Kyser OfficeWorks Inc.
2400 Spruce Street
Montgomery, AL 36107-3150
Phone: (334) 834-9400
Fax: (334) 262-0701

OEC Business Interiors
104 East I-65 Service Road North
Mobile, AL 36607-2501
Phone: (251) 471-3368
Fax: (251) 471-0019

Office Interiors by OSCO
1300 Meridian Street
Suite 203
Huntsville, AL 35801
Phone: (256) 604-5696
Fax: (256) 604-5699

OSCO Inc.
229 Grant Street SE
Decatur, AL 35601-2511
Phone: (256) 340-5100
Fax: (256) 340-5108

Alaska

Capital Office Systems
1120 East 35th Avenue
Anchorage, AK 99508-4257
Phone: (907) 777-1500
Fax: (907) 777-1515

Capital Office Systems
3201 Industrial Avenue
Fairbanks, AK 99701-7370
Phone: (907) 456-3946
Fax: (907) 452-6257

Capital Office Systems
3143 Channel Drive
Juneau, AK 99801-7214
Phone: (907) 780-3636
Fax: (907) 780-2290

Arizona

Atmosphere Commercial Interiors
8530 S Priest Drive
Tempe, Arizona 85284-1902
Phone: (602) 252-6971
Fax: (602) 252-8222

Atmosphere Commercial Interiors
Suite 105
4585 South Coach Drive
Tucson, Arizona 85714-3462
Phone: (520) 792-4200
Fax: (540) 791-9568

Atmosphere Commercial Interiors
Suite 100
88 East Broadway Boulevard
Tucson, Arizona 85701-1720
Phone: (520) 792-4200
Fax: (540) 791-9568

Arkansas

ImageWorks
Suite B
1424 North Shackelford
Little Rock, AR 72211
Phone: (501) 944-7501

Today's Office Inc.
717 West 7th Street
Little Rock, AR 72201-4044
Phone: (501) 375-5050
Fax: (501) 375-1350

Today's Office Inc.
3157 West Sunset Avenue
Springdale, AR 72762-4945
Phone: (479) 751-5861
Fax: (479) 756-2233

California

BKM Office Environments
816 Via Alondra
Camarillo, CA 93012
Phone: (877) 256-1256
Fax: (805) 339-9032

BKM San Diego
Suite 100
9201 Spectrum Center Blvd.
San Diego, CA 92123-1407
Phone: (858) 569-4700
Fax: (858) 277-8931

One Workplace L. Ferrari
2500 De La Cruz Blvd.
Santa Clara, CA 95050
Phone: (669) 800-2500
Fax: (669) 800-2501

One Workplace L. Ferrari
7220 Edgewater Drive
Oakland, CA 94621
Phone: (510) 729-7800
Fax: (510) 729-7801

One Workplace L. Ferrari
475 Brannan Street
San Francisco, CA 94107-1731
Phone: (415) 357-2200
Fax: (415) 357-2201

Peninsula Business Interiors
325 Main Street
Salinas, CA 93901-2705
Phone: (831) 757-4107
Fax: (831) 757-1339

Tangram Interiors
Suite 102
4057 W Shaw Ave
Fresno, CA 93722-6212
Phone: (559) 275-7070
Fax: (559) 275-7080

Tangram Interiors
Suite 100
2850 South Red Hill Avenue
Santa Ana, CA 92705-5532
Phone: (949) 955-6700
Fax: (949) 955-6799

Tangram Interiors
9200 Sorensen Avenue
Santa Fe Springs, CA 90670-2645
Phone: (562) 365-5000
Fax: (562) 365-5399

United Corporate Furnishings
1780 North Market Blvd.
Sacramento, CA 95834-1997
Phone: (916) 553-5900
Fax: (916) 553-5800

Colorado

Office Outfitters & Planners Inc.
749 Main Street
Grand Junction, CO 81501-3535
Phone: (970) 245-6300
Fax: (970) 245-6301

OfficeScapes
2506 Zeppelin Rd
Colorado Springs, CO 80916
Phone: (719) 574-1113
Fax: (719) 574-1133

OfficeScapes
9900 East 51st Avenue
Fort Collins, CO 80525-6222
Phone: (303) 574-1115
Fax: (303) 574-1116

OfficeScapes
Suite 180
4812 McMurry Avenue
Fort Collins, CO 80525-6222
Phone: (970) 223-5959
Fax: (970) 223-5858

Connecticut

Red Thread
300 East River Drive
East Hartford, CT 06108-4205
Phone: (860) 528-9981
Fax: (860) 528-1843

Red Thread
488 Wheelers Farm Rd.
Milford, CT 06461
Phone: (203) 874-7754
Fax: (203) 876-7915

Red Thread
700 Canal St 3rd Fl
Stamford, CT 06902
Phone: (860) 528-9981

Red Thread
40 Main Street
Torrington, CT 06790
Phone: (860) 482-2679
Fax: (860) 482-3590

Delaware

Corporate Interiors Inc.
223 Lisa Drive
New Castle, DE 19720-4193
Phone: (302) 323-9100
Fax: (302) 323-9251

Florida

American Business Interiors
215 Waverly Place
Melbourne, FL 32901-5444
Phone: (321) 723-5003
Fax: (321) 984-4221

Empire Office
Suite 140
2 Oakwood Boulevard
Hollywood, FL 33020
Phone: (954) 707-6200

Empire Office
South Florida
3201 Commerce Parkway
Miramar, FL 33025-3908
Phone: (954) 435-7300
Fax: (954) 435-7212

Empire Office
Suite 17
2315 Lynx Lane
Orlando, FL 32804
Phone: (407) 628-2400

Empire Office
5112 West Linebaugh Avenue
Tampa, FL 33624
Phone: (813) 418-3300

Empire Office
Suite 2
7830 Byron Drive
West Palm Beach, FL 33404-3332
Phone: (561) 840-8600
Fax: (561) 840-1873

Leitz & Reed Office Products
1119 Florida Avenue
Lynn Haven, FL 32444-4622
Phone: (850) 271-2600
Fax: (850) 271-0076

OEC Business Interiors
1601 NW 80th Boulevard
Gainesville, FL 32606-9140
Phone: (352) 332-1192
Fax: (352) 333-8002

· OEC Business Interiors
· 2393 SW College Road
· Ocala, FL 34474-1661
· Phone: (352) 620-2888
· Fax: (352) 620-2891

· OEC Business Interiors
· 6254 North W Street
· Pensacola, FL 32503-2746
· Phone: (850) 438-1100
· Fax: (850) 432-0003

· Office Furniture & Design Concepts
· 11866 Metro Parkway
· Ft. Myers, FL 33966-1307
· Phone: (239) 337-1212
· Fax: (239) 337-4910

· Perdue Office Interiors
· Suite 100
· 5 W Forsyth
· Jacksonville, FL 32256-7440
· Phone: (904) 737-5858
· Fax: (904) 737-6088

· Perdue Office Interiors
· Suite C7
· 1516 Capital Circle SE
· Tallahassee, FL 32301
· Phone: (850) 383-4225

Georgia

· Advent Business Interiors
· 1318 U.S. HWY 82 West
· Leesburg, GA 31721
· Phone: (229) 439-7418
· Fax: (229) 435-1279

· Advent Business Interiors
· 110 West Macon Park Dr.
· Macon, GA 31210
· Phone: (478) 471-0600

· DeKalb Office Environments
· 1320 Ridgeland Parkway
· Alpharetta, GA 30004-8442
· Phone: (770) 360-0200
· Fax: (770) 360-0305

· McWaters Inc.
· 3708 Benchmark Drive
· Augusta, GA 30907
· Phone: (706) 396-5400
· Fax: (706) 396-5401

· McWaters Inc.
· 117 Prosperity Drive
· Savannah, GA 31408-9551
· Phone: (912) 352-9000
· Fax: (912) 352-2034

Hawaii

· Interior Showplace Ltd.
· 956 Queen Street
· Honolulu, HI 96814-4118
· Phone: (808) 593-8420
· Fax: (808) 591-8324

Idaho

· Porter's Office Products
· 435 West Center Street
· Pocatello, ID 83204-3241
· Phone: (208) 232-1233
· Fax: (208) 232-8759

· Porter's Office Products
· 1050 North 2nd East
· Rexburg, ID 83440-5127
· Phone: (208) 356-4616
· Fax: (208) 356-8901

· Office Environment Company
· 623 South Americana Blvd.
· Boise, ID 83702-5120
· Phone: (208) 385-0507
· Fax: (208) 385-9392

Illinois

· A. Pomerantz
· Suite 940
· 222 Merchandise Mart Plaza
· Chicago, IL 60654-1223
· Phone: (312) 929-3335
· Fax: (312) 929-3311

· Egyptian Business Furniture
· 129 West Main Street
· Belleville, IL 62220-1501
· Phone: (618) 234-2323
· Fax: (618) 236-3295

· Interiors for Business Inc.
· 409 N River Street
· Batavia, IL 60510-2359
· Phone: (630) 761-1070
· Fax: (630) 761-1065

· Lincoln Office
· 205 Eastgate Drive
· Washington, IL 61571-9238
· Phone: (309) 427-2500
· Fax: (309) 427-2625

· Forward Space
· Suite 614
· 222 Merchandise Mart Plaza
· Chicago, IL 60654-1223
· Phone: (312) 563-5206

· Forward Space
· 1142 N North Branch Street
· Chicago, IL 60642
· Phone: (312) 942-1100
· Fax: (312) 942-9840

· Forward Space
· 13820 West Business Center Drive
· Lake Forest, IL 60045-1181
· Phone: (847) 573-8890
· Fax: (847) 573-8891

· Forward Space
· Suite 150
· 1111 West 22nd Street
· Oak Brook, IL 60523
· Phone: (312) 563-5206

Indiana

· Business Furnishings LLC
· 4102 Meghan Beeler Court
· South Bend, IN 46628
· Phone: (574) 243-3255
· Fax: (574) 243-3266

· Business Furniture LLC
· 6102 Victory Way
· Indianapolis, IN 46278-2934
· Phone: (317) 216-1600
· Fax: (317) 216-1601

· Corporate Design Inc.
· Suite 400
· 1419 West Lloyd Expressway
· Evansville, IN 47710-1002
· Phone: (812) 422-3000
· Fax: (812) 422-3413

· Lincoln Office
· 1200 Arrowhead Court
· Crown Point, IN 46307-8222
· Phone: (219) 662-2777
· Fax: (219) 662-7770

Iowa

· Lincoln Office
· 1026 Mound St
· Davenport, IA 52803
· Phone: (563) 322-5660

· Tallgrass Business Resources
· Highway 6 West
· 218 Second Street
· Coralville, IA 52241-2608
· Phone: (319) 338-3135
· Fax: (319) 338-7484

· Workspace Inc.
· 309 Locust Street
· Des Moines, IA 50309-1788
· Phone: (515) 288-7090
· Fax: (515) 288-0250

Kansas

· Design Central Inc.
· 152 South 5th Street
· Salina, KS 67401
· Phone: (785) 825-4131
· Fax: (785) 825-4778

· Scott Rice Office Interiors
· 224 East Douglas
· Wichita, KS 67211-1640
· Phone: (316) 269-2700
· Fax: (316) 269-3527

· Scott Rice Office Works
· 14720 West 105th Street
· Lenexa, KS 66215-4414
· Phone: (913) 888-7600
· Fax: (913) 227-7793

Kentucky

· Office Resources Inc.
· 530 Corvette Drive
· Bowling Green, KY 42101-7132
· Phone: (270) 781-5858
· Fax: (270) 781-5884

· Office Resources Inc.
· 101 Bradley Drive
· Nicholasville, KY 40356-9121
· Phone: (859) 885-6161
· Fax: (859) 885-9610

· Office Resources Inc.
· 816 East Broadway
· Louisville, KY 40204-1053
· Phone: (502) 589-8400
· Fax: (502) 589-8408

Louisiana

· Frost-Barber Inc.
· 9322 Interline Avenue
· Baton Rouge, LA 70809-1966
· Phone: (225) 926-5000
· Fax: (225) 926-5011

· Workplace Solutions
· 401 St. Joseph Street.
· New Orleans, LA 70130
· Phone: (504) 522-9558
· Fax: (504) 522-7070

Maine

· Red Thread
· One City Center
· Portland, ME 04101
· Phone: (207) 774-4900
· Fax: (207) 774-8155

Maryland

· Arbee Associates
· 6311 Ammendale Road
· Beltsville, MD 20705-1249
· Phone: (410) 385-5180
· Fax: (410) 385-5199

· Arbee Associates
· 9300 Gaither Road
· Gaithersburg, MD 20877
· Phone: (301) 963-3900
· Fax: (301) 977-1734

· Dancker, Sellev & Douglas Inc.
· Suite 309
· 509 Exeter Street
· Baltimore, MD 21202
· Phone: (301) 671-2541
· Fax: (301) 797-1504

· Dancker, Sellev & Douglas Inc.
· 9200 Alaking Court
· Suite 100
· Capitol Heights, MD 20743
· Phone: (301) 350-8700
· Fax: (301) 350-9393

Participating Steelcase Dealers, continued

Massachusetts

Red Thread
Suite 600
101 Seaport Blvd.
Boston, MA 02210-1838
Phone: (617) 439-4900
Fax: (617) 439-4131

Red Thread
Suite 150
293 Boston Post Road West
Marlborough, MA 01752-4615
Phone: (508) 449-6550
Fax: (508) 449-6570

Red Thread
Suite 1108
1350 Main Street
Springfield, MA 01103
Phone: (413) 736-1802

Red Thread
100 Fordham Road
Wilmington, MA 01887
Phone: (978) 658-3900
Fax: (978) 694-4107

Michigan

Custer Office Environments Inc.
2435 Plaza Drive
Benton Harbor, MI 49022-2229
Phone: (616) 926-8719
Fax: (616) 926-9482

Custer Office Environments Inc.
217 Grandville Ave SW
Grand Rapids, MI 49503-4013
Phone: (616) 458-6322
Fax: (616) 458-1117

Custer Office Environments Inc.
5737 East Cork Street
Kalamazoo, MI 49048-9668
Phone: (269) 342-3919
Fax: (269) 342-3923

Custer Office Environments
442 East Michigan
Marquette, MI 49885
Phone: (906) 226-1161
Fax: (906) 226-1164

Custer Office Environments
120 East Front Street
Traverse City, MI 49684
Phone: (616) 402-8489

NBS
701 Salzburg Avenue
Bay City, MI 48706-5390
Phone: (989) 895-8574
Fax: (989) 895-8545

NBS
5133 West Grand River Avenue
Lansing, MI 48906-9117
Phone: (517) 886-0072
Fax: (517) 886-0014

NBS
2595 Bellingham Drive
Troy, MI 48083-2036
Phone: (248) 823-5400
Fax: (248) 823-5401

Minnesota

Atmosphere Commercial Interiors
Suite 350
81 South 9th Street
Minneapolis, MN 55402-3226
Phone: (612) 343-0868
Fax: (612) 332-5733

Burgher Office Equipment Company
101 East Chestnut Street
Virginia, MN 55792-2512
Phone: (218) 749-2661
Fax: (218) 749-2662

Duluth Typewriter & Business Furniture
30 N 3rd. Ave W
Duluth, MN 55802-1607
Phone: (218) 722-5811
Fax: (218) 722-4876

General Office Products Company
4521 Highway 7
Minneapolis, MN 55416-4098
Phone: (952) 925-7500
Fax: (952) 925-7531

Mississippi

Workplace Solutions
251 West South Street
Jackson, MS 39203-3636
Phone: (601) 354-4960
Fax: (601) 353-6231

Workplace Solutions
2207 5th Street
Meridian, MS 38652
Phone: (601) 484-7279

Workplace Solutions
520 Main Street
Natchez, MS 39120
Phone: (601) 442-1494
Fax: (601) 442-0457

Workplace Solutions
718 West Bankhead St.
New Albany, MS 38652
Phone: (662) 534-0882
Fax: (662) 534-5753

OEC Business Interiors
12199 Highway 49 N.
Suite 300
Gulfport, MS 39503-3167
Phone: (228) 539-9575
Fax: (228) 539-9566

Missouri

Color-Art Integrated Interiors
1325 North Warson Road
Saint Louis, MO 63132-1807
Phone: (314) 432-3000
Fax: (314) 993-2752

Marathon Office Interiors
1715 Paris Road
Columbia, MO 65201-5571
Phone: (573) 875-7115
Fax: (573) 875-7116

Montana

KR Office Interiors
119 North 7th Avenue
Bozeman, MT 59715
Phone: (406) 587-3775
Fax: (406) 587-4636

KR Office Interiors
1710 North Montana Avenue
Helena, MT 59601
Phone: (406) 513-1004
Fax: (406) 513-1006

Missoula's Office City
115 West Broadway Street
Missoula, MT 59802-4217
Phone: (406) 543-7171
Fax: (406) 543-4254

Peterson's Quality Office Equipment
502 North 32nd Street
Billings, MT 59101-6003
Phone: (406) 245-5151
Fax: (406) 245-7516

Western Office Equipment
317 2nd Street South
Great Falls, MT 59405-1802
Phone: (406) 761-7473
Fax: (406) 761-0245

Nebraska

Eakes Office Plus
2911 13th Street
Columbus, NE 68601-4829
Phone: (402) 564-2679
Fax: (402) 564-0295

Eakes Office Plus
Suite 201
2630 North Yager Road
Fremont, NE 68025-7800
Phone: (402) 941-5001
Fax: (402) 941-5002

Eakes Office Plus
617 West Third Street
Grand Island, NE 68801-5946
Phone: (308) 382-8026
Fax: (308) 382-7401

Eakes Office Plus
839 West Second Street
Hastings, NE 68901-5099
Phone: (402) 463-2537
Fax: (402) 463-6802

Eakes Office Plus
2401 Avenue A
Kearney, NE 68847-5498
Phone: (308) 234-2538
Fax: (308) 234-2540

Eakes Office Plus
110 N 35th Street
Lincoln, NE 68503
Phone: (402) 438-6700
Fax: (402) 438-6701

Eakes Office Plus
1803 North 6th Street
Beatrice, NE 68310
Phone: (402) 228-7202
Fax: (402) 228-0262

Eakes Office Plus
120 Norris Avenue
McCook, NE 69001
Phone: (308) 345-5447
Fax: (308) 345-5237

Eakes Office Plus
510 W. 13th Street
Souix City, NE 68776
Phone: (402) 412-2334

Eakes Office Plus
201 South 1st Street
Norfolk, NE 68701-5303
Phone: (402) 371-4181
Fax: (402) 371-5139

Eakes Office Plus
520 North Vine Street
North Platte, NE 69101-3954
Phone: (308) 534-7800
Fax: (308) 534-3936

Eakes Office Plus
710 North Lincoln Ave.
York, NE 68467
Phone: (402) 362-5442
Fax: (402) 362-7530

Sheppard's Business Interiors Inc.
725 South 72nd Street
Omaha, NE 68114-4665
Phone: (402) 393-8888
Fax: (402) 393-0113

Nevada

Machabee Office Environments
6435 Sunset Corporate Drive
Las Vegas, NV 89120-2798
Phone: (702) 263-8800
Fax: (702) 263-8801

Machabee Office Environments
1335 Greg Parkway #101
Sparks, NV 89431
Phone: (775) 329-3145
Fax: (775) 786-5710

New Hampshire

Red Thread
Suite 103
650 Elm Street
Manchester, NH 03101-1160
Phone: (603) 668-5511
Fax: (603) 668-6851

New Jersey

Arbee Associates
1531 South Washington Avenue
Piscataway, NJ 08854-3815
Phone: (732) 424-3900
Fax: (732) 752-6034

Concepts Office Furnishings
280 North Midland Avenue
Building J
Saddle Brook, NJ 07663-5708
Phone: (201) 727-9110
Fax: (201) 727-9112

Dancker, Sellow, and Douglas
291 Evans Way
Somerville, NJ 08876-3766
Phone: (908) 231-1600
Fax: (908) 231-6469

W.S. Goff Company Inc.
5104 Oakland Blvd.
Mays Landing, NJ 08330-2016
Phone: (609) 625-5600
Fax: (609) 625-5633

New Mexico

Business Environments
5351 Wilshire Avenue, N.E.
Albuquerque, NM 87113-1834
Phone: (505) 888-4400
Fax: (505) 889-9146

New York

AFD Contract Furniture Inc
810 7th Avenue
New York, NY 10019
Phone: (212) 721-7100
Fax: (212) 721-7175

Merkel-Donohue
1 Interstate Avenue
Albany, NY 12205
Phone: (518) 273-9359
Fax: (518) 272-1552

Empire Office Inc.
105 Madison Avenue
New York, NY 10016-8810
Phone: (212) 607-5500
Fax: (212) 607-5654

Merkel-Donohue
1349 University Avenue Suite 2
Rochester, NY 14607
Phone: (585) 325-7696
Fax: (585) 325-3065

Prentice Office Environments
472 Franklin Street
Buffalo, NY 14202-1302
Phone: (716) 884-8452
Fax: (716) 884-0894

Stevens Office Interiors
6804 Manlius Center Road
East Syracuse, NY 13057-3902
Phone: (315) 479-5595
Fax: (315) 428-1688

Waldner's Business Environments
125 Route 110
Farmingdale, NY 11735-4864
Phone: (631) 844-9300
Fax: (631) 694-3503

Waldner's Business Environments
215 Lexington Avenue, 9th Floor
New York, NY 10016-6023
Phone: (212) 696-7500
Fax: (212) 696-7699

Waldner's Business Environments
411 Theodore Fremd Avenue
3rd Floor, South Building
Rye, NY 10580-1410
Phone: (914) 921-8500
Fax: (914) 921-0991

North Carolina

Office Environments Inc.
11407 Granite Street
Charlotte, NC 28273-6429
Phone: (704) 714-7200
Fax: (704) 714-7400

Young Office Environments
of Asheville Inc.
71 Thompson St
Asheville, NC 28803-2328
Phone: (888) 202-0508
Fax: (828) 505-1974

Storr Office Environments Inc.
496 Gallimore Dairy Road
Greensboro, NC 27409-9202
Phone: (336) 217-4500
Fax: (336) 217-4501

Storr Office Environments Inc.
10800 World Trade Blvd.
Raleigh, NC 27617-4200
Phone: (919) 313-3700
Fax: (919) 313-3701

Williams Office Environments Inc.
407 Ray Avenue
Fayetteville, NC 28301-4915
Phone: (910) 483-0354
Fax: (910) 486-4077

North Dakota

Fireside Office Products Inc.
1713 East Bismarck Expressway
Bismarck, ND 58504-6706
Phone: (701) 258-8586
Fax: (701) 223-9598

Hannaher's
1809 13th Avenue North
Grand Forks, ND 58203-2323
Phone: (701) 746-6466
Fax: (701) 746-0737

Hannaher's Inc.
4324 20th Avenue SW
Fargo, ND 58103-4434
Phone: (701) 277-7222
Fax: (701) 277-7097

Ohio

Business Furniture
8 North Main Street
Dayton, OH 45439
Phone: (937) 293-1010
Fax: (937) 293-7501

Loth Inc.
3574 East Kemper Road
Cincinnati, OH 45241-2009
Phone: (513) 554-4900
Fax: (513) 554-8737

Loth Company
855 Grandview Avenue
Columbus, OH 43215-1123
Phone: (614) 487-4000
Fax: (614) 487-4306

NBS
4 North St. Clair Street
Toledo, OH 43604
Phone: (419) 662-2040
Fax: (419) 662-2041

Ohio Desk
34 Swartz Road
Akron, OH 44319
Phone: (330) 499-1030

Ohio Desk
1122 Prospect Avenue
Cleveland, OH 44115-1292
Phone: (216) 623-0600
Fax: (216) 623-0611

Ohio Desk
5100 Market Street
Youngstown, OH 44512
Phone: (330) 782-3331

Oklahoma

Scott Rice
2900 North Hemlock Circle
Broken Arrow, OK 74012-1185
Phone: (918) 362-4300
Fax: (918) 362-4303

Scott Rice
7501 Broadway Ext
Oklahoma City, OK 73116-9015
Phone: (405) 848-2224
Fax: (405) 848-3999

Oregon

Hypfn
Suite 103/104
150 SW Scalehouse Loop
Bend, OR 97702
Phone: (541) 317-8777
Fax: (541) 317-2833

Hypfn
620 NE 19th Avenue
Portland, OR 97232-2832
Phone: (503) 226-4151
Fax: (503) 226-9233

Pennsylvania

A. Pomerantz & Company
Suite 7000
701 Market Street
Philadelphia, PA 19106-1597
Phone: (215) 408-2100
Fax: (215) 408-2110

Corporate Interiors
Suite 200
161 Washington Street
Conshohocken, PA 19428-2083
Phone: (610) 631-5400
Fax: (610) 631-2720

Interior Workplace Solutions LLC.
145 Stewart Road
Wilkes-Barre, PA 18706
Phone: (570) 288-7211
Fax: (570) 970-5817

Franklin Interiors
Suite 600
2740 Smallman Street
Pittsburgh, PA 15222-4720
Phone: (412) 261-2525
Fax: (412) 255-4089

Participating Steelcase Dealers, continued

Pennsylvania

Interior Workplace Solutions LLC.
6765 Ambassador Drive
Allentown, PA 18106-9510
Phone: (610) 391-0733
Fax: (610) 391-1155

Interior Workplace Solutions LLC.
Suite B-25
2209 Quarry Drive
Reading, PA 19609-1155
Phone: (610) 670-1800
Fax: (610) 670-8181

McCartney's Inc.
819 Howard Avenue
Altoona, PA 16601-4727
Phone: (814) 505-1111
Fax: (814) 949-6197

Phillips Workplace Interiors
6345 Flank Drive
Harrisburg, PA 17112
Phone: (844) 228-2600

South Carolina

Aiken Office Supply Inc.
2560 Whiskey Road
Aiken, SC 29803-9664
Phone: (803) 648-8339
Fax: (803) 649-4470

McWaters Inc.
1104 Shop Road
Columbia, SC 29201-4743
Phone: (803) 256-8303
Fax: (803) 252-5567

McWaters Inc.
3841 Commercial Center Drive
Ladson, SC 29456-4146
Phone: (843) 486-1823

Wulbern-Koval Company Inc.
1111 Morrison Drive
Charleston, SC 29403-3119
Phone: (843) 577-7666
Fax: (843) 577-7299

Young Office Environments
1280 Ridge Road
Greenville, SC 29607-4626
Phone: (864) 281-9500
Fax: (864) 281-9555

South Dakota

Interstate Office Products Inc.
228 South Main Avenue
Sioux Falls, SD 57104-6310
Phone: (605) 339-0300
Fax: (605) 339-1989

Western Stationers
714 Saint Joseph Street
Rapid City, SD 57701-2721
Phone: (605) 342-3310
Fax: (605) 342-4746

Tennessee

Bentco Office Solutions
1501 Stuart Street
Chattanooga, TN 37406
Phone: (423) 756-4437
Fax: (423) 756-6198

Memphis Business Interiors
4539 West Distriplex Drive
Memphis, TN 38118-7280
Phone: (901) 360-8899
Fax: (901) 360-8370

Office Resources Inc.
4020 Armory Oaks Drive
Nashville, TN 37204
Phone: (615) 376-1200
Fax: (615) 376-1245

Workspace Interiors
Suite 300
200 E. Main Street
Kingsport, TN 37660-4354
Phone: (423) 392-2600
Fax: (423) 392-2601

Workspace Interiors
2820 Middlebrook Pike
Knoxville, TN 39721
Phone: (865) 223-5404
Fax: (865) 223-5405

Texas

Abilene Printing & Stationery
218 Cedar Street
Abilene, TX 79601-5720
Phone: (915) 677-2673
Fax: (915) 675-6963

BKM Total Office of Texas
9755 Clifford Drive
Dallas, TX 75220
Phone: (214) 902-7200
Fax: (214) 902-7201

Business Interiors
1111 Valley View Lane
Irving, TX 75061-6008
Phone: (817) 858-2000
Fax: (817) 858-2020

McCoys Inc.
6869 Old Katy Road
Houston, TX 77024-2105
Phone: (713) 862-4600
Fax: (713) 862-7676

Rockford Business Interiors
211 East Riverside Drive
Austin, TX 78704-1203
Phone: (512) 442-0703
Fax: (512) 442-6555

Texas Wilson Office Furniture & Services
5801 George McVay Drive
McAllen, Texas 78503
Phone: (210) 647-8800
Fax: (210) 647-3110

Texas Wilson Office Furniture & Services
6812 Fairgrounds Pkwy
San Antonio, TX 78238-4536
Phone: (210) 647-8800
Fax: (210) 647-3110

West Supply Company
1601 Scurry
Big Spring, TX 79720
Phone: (432) 264-1788
Fax: (432) 264-1789

West Supply Company
2 South Chadbourne Street
San Angelo, TX 76903-5875
Phone: (325) 655-8181
Fax: (325) 655-5480

Utah

MidWest Office Furniture
987 South West Temple
Salt Lake City, UT 84101-2988
Phone: (801) 359-7681
Fax: (801) 355-2713

Vermont

Red Thread
180 Battery St Ste 210
Burlington, VT 05401-5212
Phone: (802) 862-0434
Fax: (802) 862-0729

Virginia

Barrows
1302 Rockland Avenue
Roanoke, VA 24012-3838
Phone: (540) 362-5700
Fax: (540) 362-4826

Creative Office Environments
11798 North Lakeridge Boulevard
Ashland, VA 23005-8152
Phone: (804) 329-0400
Fax: (804) 321-3134

Creative Office Environments LLC
650 Peter Jefferson Parkway #140
Charlottesville, VA 22911
Phone: (434) 327-1898
Fax: (434) 327-1896

Creative Office Environments LLC
Suite C
500 Woodlake Circle
Chesapeake, VA 23320-2807
Phone: (757) 549-4801
Fax: (757) 549-2795

reDistrict
Suite 30
66 Canal Center Plaza
Arlington, VA 22314
Phone: (703) 276-8901
Fax: (703) 276-8908

Washington

OpenSquare
6th Floor
5601 Sixth Avenue South
Seattle, WA 98108-2522
Phone: (206) 768-8000
Fax: (206) 768-0236

OpenSquare
126 South Sheridan Street
Spokane, WA 99202-1527
Phone: (509) 483-1000
Fax: (509) 483-1011

Wisconsin

Atmosphere Commercial Interiors
999 Fourier Drive Suite 200
Madison, WI 53717
Phone: (608) 257-0521
Fax: (608) 257-1859

Puerto Rico

AFD Contract Furnishings
Suite 250
350 Chardon Avenue
Torre Chardon
San Juan, Puerto Rico 00918-2123
Phone: (787) 754-2938
Fax: (787) 754-8076

Showrooms

Atlanta

Steelcase Inc.
Suite AL-175
303 Peachtree Center
Atlanta, GA 30303
Phone: (404) 523-2201

Chicago

Steelcase Worklife Chicago
Suite 300
222 Merchandise Mart
Chicago, IL 60654-1174
Phone: (312) 321-3720

Chicago

Coalesse
Suite 1032
222 Merchandise Mart
Chicago, IL 60654
Phone: (312) 467-1783

Dallas

Steelcase Inc.
1616 Hi Line Drive
Dallas, TX 75207
Phone: (214) 871-3044

Grand Rapids

Steelcase Inc.
901 44th Street, SE
Grand Rapids, MI 49508-7594
Phone: (616) 247-2710

New York

Steelcase Worklife New York
4 Columbus Circle
New York, NY 10019-1100
Phone: (212) 445-8800

Philadelphia

Steelcase Inc.
One Liberty Place
1650 Market Street, 3rd Floor
Philadelphia, PA 19103-7307
Phone: (215) 561-5331

San Francisco

Steelcase Inc.
Suite 110
475 Brannan Street
San Francisco, CA 94107
Phone: (415) 344-6700

Santa Monica

Steelcase Inc.
1217 2nd Street
Santa Monica, CA 90401-1180
Phone: (310) 633-2200

Washington D.C.

Steelcase Inc.
1121 14th Street NW
4th Floor
Washington, DC 20005

Manufacturing Sites

Amex de Mexico

Calle 5 Sur No.160
Ciudad Industrial
Tijuana, Mexico B.C. 22500
Phone: 52-662-342-6234

Athens

214 Durham Drive
Athens, AL 35611
Phone: (256) 232-8112

Grand Rapids Wood Furniture

4100 68th Street SE
Caledonia, MI 49316
Phone: (616) 698-5735

Kentwood Distribution Center

4384 52nd Street SE
Kentwood, MI 49512-9673

Kentwood West

4360 52nd Street SE
Kentwood, MI 49512

Details

901 44th Street SE
Grand Rapids, MI 49508
Phone: (616) 247-2710

Reynosa Plant

Ave. Prologis S/N Ed. 8 Suite
801 Prologis Park Pharr Bridge
Reynosa,
Tamaulipas, Mx CP. 88780
Phone: 52-899-263-9000



Power and Data Access

Grommets (SIN 711.2)	20
Spheres (SIN 711.2)	21
Interact (SIN 711.11)	23
Axil Z (SIN 711.11)	24
Ellora (SIN 711.11)	26
Base Power Infeeds (SIN 711.11)	28
Power Strip (SIN 711.11)	29
Wire Managers (SIN 711.11)	30

Power and Data Access Grommets

SIN 711.2

Grommets for Standard Locations



Tip: The grommet will be shipped with the table so it can be installed on site in the factory-cut opening.

Tip: Custom locations are possible. Custom locations require an engineering review to confirm practicality. Please send a drawing to your customer service representative to show the locations you want, confirm practicality, and obtain a quotation.

Tip: Please send a drawing of your arrangement along with your order to ensure that grommets are properly installed.

Tip: Additional tables may be able to accommodate grommets. Ask your Customer Service representative at 1.800.627.6770 to help you determine practicality.

Standard Includes	Required to Specify
<ul style="list-style-type: none"> • 2" diameter opening with snap out covers allow power cords and voice/data cables to pass through the worksurface: black plastic • Factory-installed in standard locations on Ballet K-Base, Reunion Seminar, Train, and Exponents credenzas 	Style number

Specification Information	
Style Number	Price
793215	\$68

Power and Data Access Spheres

SIN 711.2

Power and Communication Spheres for Standard Locations

Tip: The sphere will be shipped with the table so it can be installed on site in the factory-cut opening.

Tip: Field-installed sphere is practical on many table tops. Order unit separately and cut the required hole in the table top on site. Installation instructions will be shipped with the sphere.

Tip: Custom locations are possible. Custom locations require an engineering review to confirm practicality. Please send a drawing to your customer service representative to show the locations you want, confirm practicality, and obtain a quotation.

Tip: Please send a drawing of your arrangement along with your order to ensure that spheres are properly installed.

Tip: Additional tables may be able to accommodate spheres. Ask your Customer Service representative at 1.800.627.6770 to help you determine practicality.

Tip: If couplers are needed on PCS or CSP they must be ordered separately.



Standard Includes	Required to Specify
<ul style="list-style-type: none"> • 3³/₈" diameter and 1⁵/₈"H above table surface: black plastic • 6' power cord • Factory-installed in standard locations on Ballet K-Base and Reunion Seminar • Sphere selection: <ul style="list-style-type: none"> - Power sphere (PSP) with four simplex power outlets - Power and communication sphere (PCS) with two simplex power outlets and two spaces to connect RJ11 or RJ45 couplers on site - Communication sphere (CSP) with four spaces to connect RJ11 or RJ45 couplers on site 	Style number

Specification Information

Style Number	Price
Four Data Jack Locations	
CSP	\$168
Two Simplex Power Outlets and Two Data Jack Locations	
PCS	\$256
Four Simplex Power Outlets	
PSP	\$371

Power and Data Access Spheres *continued*

SIN 711.2

Data Jack Couplers

Standard Includes	Required to Specify
<ul style="list-style-type: none">• Data coupler	Style number

Specification Information

Style Number	Price
RJ11	\$12
RJ45	\$16

Power and Data Access Interact, 9" x 5³/₈"

SIN 711.11

Interact

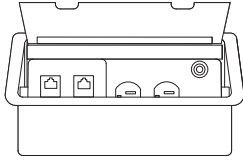

Tip: Can accommodate one, customer-supplied modular furniture faceplate for voice/data jacks.

Tip: For tables that require an Interact desktop module, a special engineering quote is mandatory. If you require a factory installed cutout in a location other than standard, send us a drawing with measurements indicating the exact location(s) required in the table top.

Tip: The hardwire Interact desktop module does not work with modular table power kits.

Tip: If a hardwire Interact desktop module is desired, then it should only be specified on tables with glides.

Standard Includes	Required to Specify
<ul style="list-style-type: none"> • Box, lid, and attachment bracket: steel, black textured powder coat surface • Requires 8³/₈" x 4³/₄" cutout • Contains two 15-amp power outlets with built-in circuit breaker • One additional 15-amp power outlet is included on the bottom of the box 	Style number

Specification Information

Dimensions			Style Number	Price
D	W	H		
Interact, 6' Cord				
5 ³ / ₈ "	9"	2 ³ / ₄ "	INTSC	\$391
Interact, 6' Hardwire				
5 ³ / ₈ "	9"	2 ³ / ₄ "	INTHW	\$391

Power and Data Access Axil Z, 8" x 3"

SIN 711.11

Axil Z, Cord

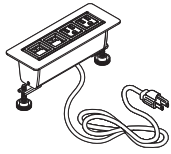

Tip: The Axil Z desktop module will ship with instructions and a hole cutout template for field installation, if needed.

Tip: For a factory installed cutout in the table top, specify Axil Z as an option for Train. If you do not specify Axil Z as an option, where applicable, the table top will require a field installed cutout.

► See *Coalesse Tables, Storage, and Accessories Specification Guide* for cutout locations.

Tip: For any other tables, other than Train, that require an Axil Z desktop module, a special engineering quote is mandatory. If you require a factory installed cutout in a location other than standard, send us a drawing with measurements indicating the exact location(s) required in the table top.

Tip: USB for charging is configured in the spot of one data port and is always configured on the end(s).

Tip: For each USB port specified, there are two USBs per port.

Standard Includes	Required to Specify
-------------------	---------------------

- Desktop module, mounts flat just above worksurface:
 - 4140 Arctic White
 - 4144 Black Gloss
- 6' power cord with 15-amp plug
- Requires 6¾" x 2" cutout
- Utilizes water-proof simplex (outlets)
- UL listed
- Voice|Data adaptor kit to accept couplers and jacks when needed (refer to telecommunications reference chart)

- 1 Style number
- 2 Desktop module configuration (see Required Selections below)
- 3 Paint color number for desktop module

Options	List Price	Required to Specify
---------	------------	---------------------

Power/Data/USB Configuration

- Two power/two data No cost
- Two power/one data/one USB +\$ 98
- Two power/two USB +\$196
- Three power/one data +\$ 5
- Three power/one USB +\$103
- Four power +\$ 67

- Specify *with two power/two data* and select color number.
 Specify *with two power/two data/one USB* and select color number.
 Specify *with two power/two USB* and select color number.
 Specify *with three power/one data* and select color number.
 Specify *with three power/one USB* and select color number.
 Specify *with four power* and select color number.

Specification Information				
Dimensions			Style Number	Base Price
D	W	H		

3"	8"	2¾"	CODPA4	\$196
----	----	-----	--------	-------

Power and Data Access Axil Z, 8" x 3"

SIN 711.11

Axil Z, Hardware

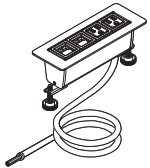

Tip: The Axil Z desktop module will ship with instructions and a hole cutout template for field installation, if needed.

Tip: For a factory installed cutout in the table top, specify Axil Z as an option for Train. If you do not specify Axil Z as an option, where applicable, the table top will require a field installed cutout.

► See *Coalesse Tables, Storage, and Accessories Specification Guide* for cutout locations.

Tip: For any other tables, other than Train, that require an Axil Z desktop module, a special engineering quote is mandatory. If you require a factory installed cutout in a location other than standard, send us a drawing with measurements indicating the exact location(s) required in the table top.

Tip: USB for charging is configured in the spot of one data port and is always configured on the end(s).

Tip: For each USB port specified, there are two USBs per port.

Tip: The hardware Axil Z desktop module does not work with modular table power kits.

Tip: If a hardware Axil Z desktop module is desired, then it should only be specified on tables with glides.

Standard Includes	Required to Specify
<ul style="list-style-type: none"> Desktop module, mounts flat just above worksurface: <ul style="list-style-type: none"> - 4140 Arctic White - 4144 Black Gloss 6' flexible steel hardware conduit Requires 6¾" x 2" cutout Utilizes water-proof simplex (outlets) UL listed Voice/data adaptor kit to accept couplers and jacks when needed (refer to telecommunications reference chart) 	<ol style="list-style-type: none"> Style number Desktop module configuration (see Required Selections below) Paint color number for desktop module

Options	List Price	Required to Specify
Power/Data/USB Configuration		
• Two power/two data	No cost	Specify <i>with two power/two data</i> and select color number.
• Two power/one data/one USB	+\$ 98	Specify <i>with two power/one data/one USB</i> and select color number.
• Two power/two USB	+\$196	Specify <i>with two power/two USB</i> and select color number.
• Three power/one data	+\$ 5	Specify <i>with three power/one data</i> and select color number.
• Three power/one USB	+\$103	Specify <i>with three power/one USB</i> and select color number.
• Four power	+\$ 67	Specify <i>with four power</i> and select color number.

Specification Information				
Dimensions			Style Number	Base Price
D	W	H		
3"	8"	2¾"	CODHA4	\$196

Power and Data Access Ellora, 8¼" x 5¼"

SIN 711.11

Ellora, Cord

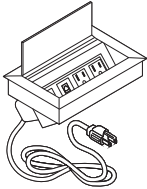

Tip: The Ellora desktop module will ship with instructions and a hole cutout template for field installation, if needed.

Tip: For a factory installed cutout in the table top, specify Ellora as an option for Train. If you do not specify Ellora as an option, where applicable, the table top will require a field installed cutout.

► See *Coalesse Tables, Storage, and Accessories Specification Guide* for cutout locations.

Tip: For any other tables, other than Train, that require an Ellora desktop module, a special engineering quote is mandatory. If you require a factory installed cutout in a location other than standard, send us a drawing with measurements indicating the exact location(s) required in the table top.

Tip: USB for charging is configured in the spot of one data port and is always configured on the end(s).

Tip: For each USB port specified, there are two USBs per port.

Standard Includes	Required to Specify
-------------------	---------------------

- | | |
|--|--|
| <ul style="list-style-type: none"> • Desktop module with lid, mounts flat just above worksurface: anodized aluminum with black faceplate • 6' power cord with 15-amp plug • Requires 8" x 5" cutout • Utilizes water-proof simplex (outlets) • UL listed • Voice/data adaptor kit to accept couplers and jacks when needed (refer to telecommunications reference chart) | <ol style="list-style-type: none"> 1 Style number 2 Desktop module configuration (see Required Selections below) |
|--|--|

Options	List Price	Required to Specify
---------	------------	---------------------

Options	List Price	Required to Specify
Power/Data/USB Configuration	<ul style="list-style-type: none"> • Two power/two data No cost • Two power/one data/one USB +\$ 98 • Two power/two USB +\$196 • Three power/one data +\$ 5 • Three power/one USB +\$103 • Four power +\$ 67 	<p>Specify with two power/two data.</p> <p>Specify with two power/one data/one USB.</p> <p>Specify with two power/two USB.</p> <p>Specify with three power/one data.</p> <p>Specify with three power/one USB.</p> <p>Specify with four power.</p>

Specification Information				
---------------------------	--	--	--	--

Dimensions			Style Number	Base Price
D	W	H		
5¼"	8¼"	3½"	CODPE4	\$309

Power and Data Access Ellora, 8¼" x 5¼"

SIN 711.11

Ellora, Hardware

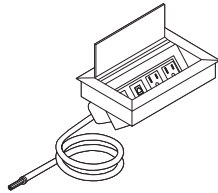

Tip: The Ellora desktop module will ship with instructions and a hole cutout template for field installation, if needed.

Tip: For a factory installed cutout in the table top, specify Ellora as an option for Train. If you do not specify Ellora as an option, where applicable, the table top will require a field installed cutout.

► See Coalesse Tables, Storage, and Accessories Specification Guide for cutout locations.

Tip: For any other tables, other than Train, that require an Ellora desktop module, a special engineering quote is mandatory. If you require a factory installed cutout in a location other than standard, send us a drawing with measurements indicating the exact location(s) required in the table top.

Tip: USB for charging is configured in the spot of one data port and is always configured on the end(s).

Tip: For each USB port specified, there are two USBs per port.

Tip: The hardware Ellora desktop module does not work with modular table power kits.

Tip: If a hardware Ellora desktop module is desired, then it should only be specified on tables with glides.

Standard Includes	Required to Specify
-------------------	---------------------

- | | |
|--|--|
| <ul style="list-style-type: none"> • Desktop module with lid, mounts flat just above worksurface: anodized aluminum with black faceplate • 6' flexible steel hardware conduit • Requires 8" x 5" cutout • Utilizes water-proof simplex (outlets) • UL listed • Voice/data adaptor kit to accept couplers and jacks when needed (refer to telecommunications reference chart) | <ol style="list-style-type: none"> 1 Style number 2 Desktop module configuration (see Required Selections below) |
|--|--|

Options	List Price	Required to Specify
---------	------------	---------------------

Power/Data/USB Configuration	<ul style="list-style-type: none"> • Two power/two data • Two power/one data/one USB • Two power/two USB • Three power/one data • Three power/one USB • Four power 	<p>No cost</p> <p>+\$ 98</p> <p>+\$196</p> <p>+\$ 5</p> <p>+\$103</p> <p>+\$ 67</p>	<p>Specify with two power/two data.</p> <p>Specify with two power/one data/one USB.</p> <p>Specify with two power/two USB.</p> <p>Specify with three power/one data.</p> <p>Specify with three power/one USB.</p> <p>Specify with four power.</p>
-------------------------------------	--	---	---

Specification Information				
Dimensions			Style Number	Base Price
D	W	H		

5¼"	8¼"	3½"	CODHE4	\$309
-----	-----	-----	--------	-------

Power and Data Access Base Power Infeeds

SIN 711.11

Single-Circuit 20-Amp Plug Base Power Infeed

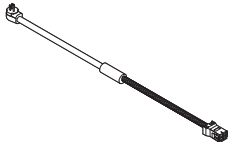

Tip: The hardwire desktop modules do not work with modular table power kits, therefore, do not require any type of infeeds.

Tip: The plug infeed can only be used with circuit 1 modular table power kits.

Tip: Plug infeed can be used on tables with glides or casters.

Standard Includes	Required to Specify
<ul style="list-style-type: none"> Single circuit (circuit 1) power infeed with 20-amp plug on one end and male modular connection on the other end: 24" of thick rubber on plug end with coupler attaching 48" of conduit with modular connection UL recognized 	Style number

Specification Information

Dimensions Length	Style Number	Price
72"	COBPIFMP20	\$221

Two-Circuit Hardwire Base Power Infeed



Tip: The hardwire desktop modules do not work with modular table power kits, therefore, do not require any type of infeeds.

Tip: The hardwire infeed must be used on tables with glides only.

Standard Includes	Required to Specify
<ul style="list-style-type: none"> 2 circuit power infeed with 4-wire pigtail for hardwire connection on one end and male modular connection on the other end: flexible steel conduit UL listed 	Style number

Specification Information

Dimensions Length	Style Number	Price
72"	COBPIFMH	\$237

Power and Data Access Power Strip

SIN 711.11

Power Strip

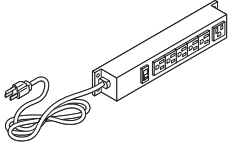

10 1/2"L x 1 3/4"W x 1 1/2"D

Standard Includes

- Power strip with 15' cord and three-prong plug; black
- Six 15-amp power outlets
- On-off switch
- Surge suppressor

Required to Specify

Style number

Specification Information

Style Number	Price
793330	\$250

Power and Data Access Wire Managers

SIN 711.11

Field-Installed Horizontal Wire Manager Channel

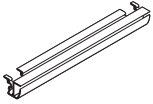

Tip: The wire manager is 1 1/8"W x 2 5/16"H.

Standard Includes	Required to Specify
<ul style="list-style-type: none"> Horizontal wire manager: black plastic Attachment hardware Installation instructions 	Style number

Specification Information		
Dimension Length	Style Number	Price
42"	793442	\$ 87
48"	793448	\$100
60"	793460	\$113
72"	793472	\$129

Vertical Wire Manager

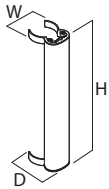

Standard Includes	Required to Specify
<ul style="list-style-type: none"> Vertical wire manager clips onto table leg: extruded aluminum with powder coat color to match leg Clips have three snap-fit features for one power cord and two CAT-5 cables: black plastic 	1 Style number 2 Powder coat color number 3 Options, if selected (see below)

	Options	List Price	Required to Specify
Surface Materials	• 8046 Polished Aluminum	+\$64	Specify with 8046 Polished Aluminum.

Specification Information				
Dimensions			Style Number	Base Price
D	W	H		

For Au Lait

37/8"	27/8"	181/4"	793893	\$128
-------	-------	--------	--------	-------

Training/Multipurpose/ Café Tables

Overview	32
Statement of Line	33

Au Lait (SIN 711.11)	41
Ballet (SIN 711.11)	49
Bob (SIN 711.11)	70
Diekman (SIN 711.11)	73
Enea (SIN 711.11)	75
Lagunitas (SIN 711.11)	80
Millbrae (SIN 711.11)	83
Passerelle (SIN 711.11)	84
Switch (SIN 711.11)	85
Montara650 (SIN 711.11)	87
Train (SIN 711.11)	93

Overview

Café Tables

- Au Lait, page 41
- Ballet, page 49
- Enea, page 75

Cafeteria/Dining/Commons

- Au Lait, page 41
- Ballet, page 49
- Enea, page 75

Training/Multi-Purpose/Classroom

- Ballet, page 49
- Train, page 93

Folding Tables

- Ballet, page 49

Flip-Top Tables

- Au Lait, page 41
- Train, page 93

Statement of Line

Au Lait Tables

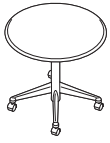

Specifying
► Page 42

Au Lait 28½"H Round Solid Core Top Café Tables on Standard Height Table

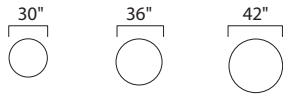

Specifying
► Page 44

Au Lait 28½"H Square Solid Core Top Café Tables on Standard Height Table

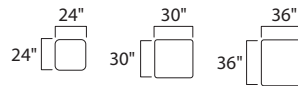

Specifying
► Page 46

Au Lait 28½"H Rectangular Solid Core Top Café Tables on Standard Height Table

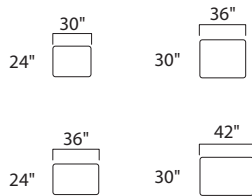

Specifying
► Page 42

Au Lait 33"H Round Solid Core Top Café Tables on Wheelchair Height Tables

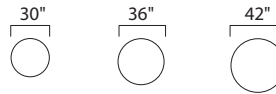

Statement of Line *continued*

Au Lait Tables



Specifying
▶ Page 44

Au Lait 33"H Square Solid Core Top Café Tables on Wheelchair Height Tables

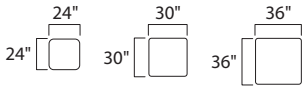

Specifying
▶ Page 46

Au Lait 33"H Rectangular Solid Core Top Café Tables on Wheelchair Height Tables

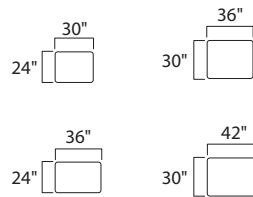

Specifying
▶ Page 42

Au Lait 42"H Round Solid Core Top Café Tables on Café Height Tables

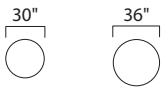

Specifying
▶ Page 44

Au Lait 42"H Square Solid Core Top Café Tables on Café Height Tables

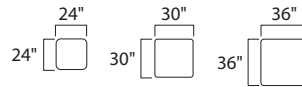

Statement of Line

Ballet Tables

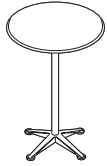

Specifying
▶ Page 50



Folding



Non-Folding

Specifying
▶ Page 51

Ballet Café Tables

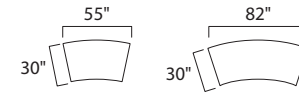
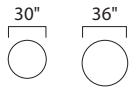

Ballet Non-Folding Side Tables

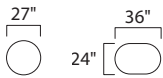

Ballet Round Pedestal Tables (Fixed and Flip Top)

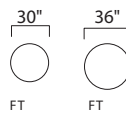

FT = Flip Top



Specifying
▶ Page 54

Ballet Square Pedestal Base Tables (Fixed and Flip Top)

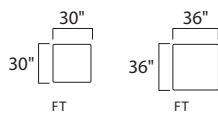

FT = Flip Top

Statement of Line *continued*

Ballet Tables



X- Folding



X- Non-Folding



K- Folding

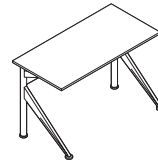

K- Non-Folding

Specifying
▶ Pages 56- 66

Ballet Rectangular X- and K-Base Tables

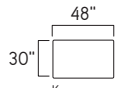
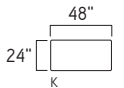
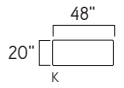

X = X-base
K = K-base

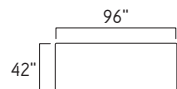
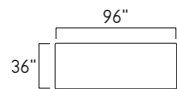
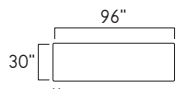
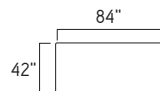
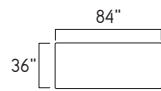
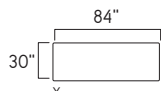
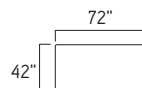
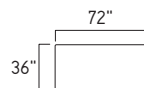
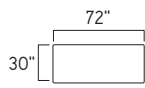
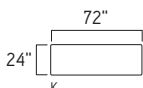
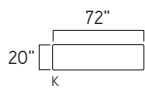
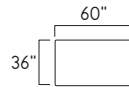
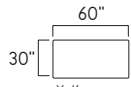
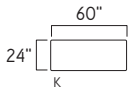
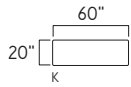

Specifying
▶ Page 67

Ballet Connecting Tops

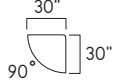
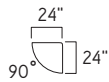
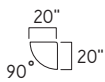

Statement of Line

Bob Tables

24"

30"

36"

42"

Specifying
▶ Page 70



Round Occasional



24"

30"

36"

42"



Round Conference



Training/Multipurpose/
Café Tables

Diekman Tables

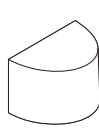
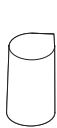
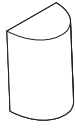
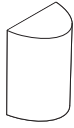
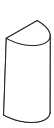

Wood

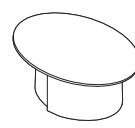

Wood Base with
Elliptical Top

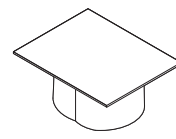

Wood Base with
Rectangle Top

Specifying
▶ Page 73

Enea Tables

Enea Single Base Tables

Specifying
▶ Page 76

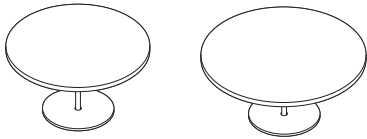

Occasional

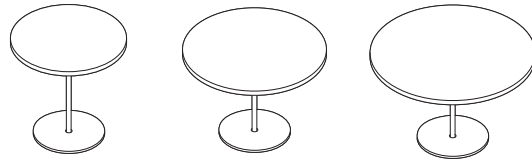

Conference

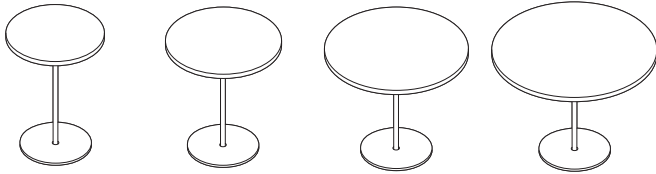

Café/Counter Height

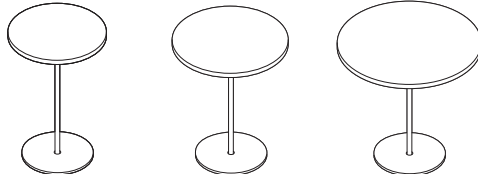

Café/Bar Height

Enea Twin Base Tables

Specifying
▶ Page 78

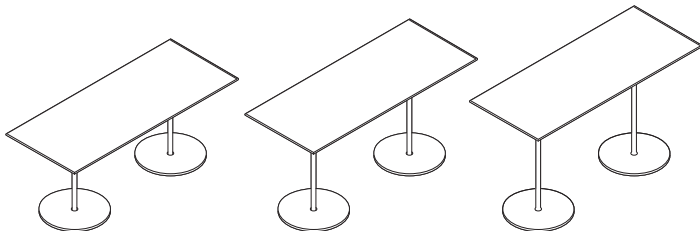

Rectangular



Oval

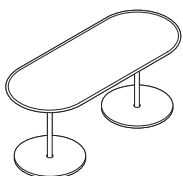

Conference
Racetrack

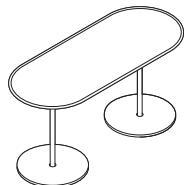

Counter Racetrack

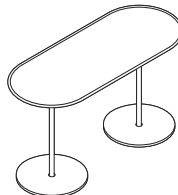

Café Racetrack

Statement of Line

Lagunitas Tables

Specifying
► Page 80

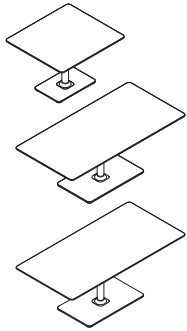

Work Tables

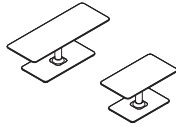

Occasional Tables



Personal Table

Millbrae Occasional Tables

Specifying
► Page 83

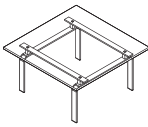

Square Tables

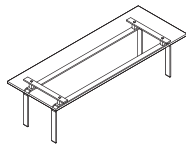

Rectangular Tables

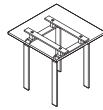

Side Table

Passerelle Occasional Tables

Specifying
► Page 84

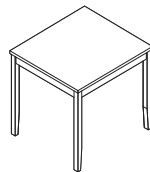
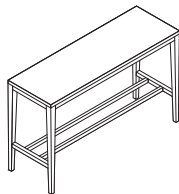
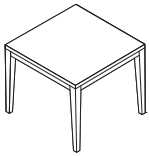

Switch Occasional Tables

Specifying
► Page 85

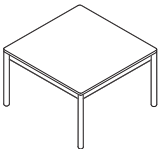

Square

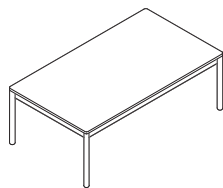

Rectangle

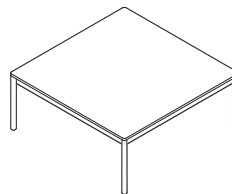

Square Table

Statement of Line *continued*

Specifying
▶ Page 88

Montara650 Tables

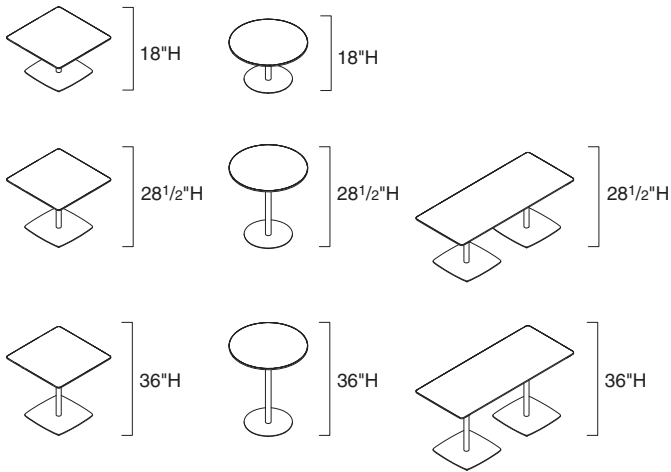

Train Tables

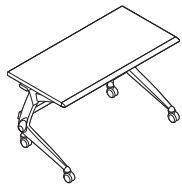

Specifying
▶ Page 94



Specifying
▶ Page 100

Train Rectangular Tables

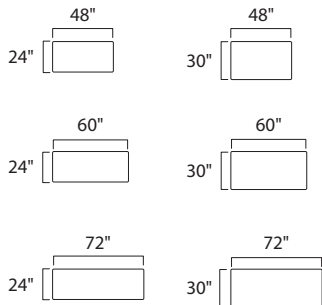

Train Corner Tops

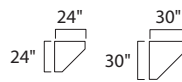

Au Lait

Round Tables with Solid Core Tops (SIN 711.11)	42
Square Tables with Solid Core Tops (SIN 711.11)	44
Rectangular Tables with Solid Core Tops (SIN 711.11)	46
Accessories (SIN 711.11)	48

Au Lait Round Tables with Solid Core Tops



SIN 711.11

Tip: Shipped knocked down.

Standard Includes	Required to Specify
<ul style="list-style-type: none"> ▶ Need help? Product details, see <i>Coalesse Tables, Storage, and Accessories Specification Guide</i>. • Top: 1/4" particle board core with High-Pressure Laminate • Edge: convex vinyl or self-skinning cast urethane • Base: 2 1/2" diameter steel column and glass-filled nylon feet with single textured powder coat • Fixed top with black steel spider • 2 3/8" diameter, locking, dual-wheel casters: black plastic 	<ol style="list-style-type: none"> 1 Style number 2 Textured powder coat color selection for base 3 Laminate color number for top 4 Edge selection: <ul style="list-style-type: none"> - Convex vinyl or cast urethane color number: <ul style="list-style-type: none"> 6000 Black 6607 Woodrose 6609 Smoke 6655 Warm White 5 Options, if selected (see below) <p>▶ See <i>Surface Materials</i>, page 350.</p>

Tip: Glides are the same height as casters. Glides adjust 1/2".

Options	Price	Required to Specify
Surface Materials <ul style="list-style-type: none"> • Top • Grade 2 laminate 	Prices below and at right	Specify with <i>Grade 2 laminate</i> and select
Glides <ul style="list-style-type: none"> • Glides 	No cost	Delete suffix C from the style number.
Related Products <ul style="list-style-type: none"> • Casters • Glides 		<ul style="list-style-type: none"> ▶ Page 48 ▶ Page 48

Specification Information			
Dimensions	Style Number	Finish	Prices
Dia H			
			 Convex Vinyl Edge:
			 Cast Urethane Edge:



Fixed Top with 28"W Base					
Dimensions	Style Number	Finish	Price	Price	Price
Dia H					
30" 28 1/2"	AL3000SC	Grade 1 Laminate	\$717	N.A.	
		Grade 2 Laminate	\$747	N.A.	
30" 28 1/2"	AL3000USC	Grade 1 Laminate	N.A.	\$1093	
		Grade 2 Laminate	N.A.	\$1123	
30" 33"	ALW3000SC	Grade 1 Laminate	\$743	N.A.	
		Grade 2 Laminate	\$773	N.A.	
30" 33"	ALW3000USC	Grade 1 Laminate	N.A.	\$1114	
		Grade 2 Laminate	N.A.	\$1144	



▶ Specification Information, continued on next page

Au Lait Round Tables with Solid Core Tops

SIN 711.11

► Specification Information, continued from previous page

Specification Information

Dimensions	Style	Finish	Prices
Dia H	Number		
			 
			Convex Vinyl Edge: Cast Urethane Edge:



Fixed Top with 28"W Base, continued

Dimensions	Style	Finish	Prices
Dia H	Number		
30" 42"	ALB3000SC	Grade 1 Laminate	\$772 N.A.
		Grade 2 Laminate	\$802 N.A.
30" 42"	ALB3000USC	Grade 1 Laminate	N.A. \$1144
		Grade 2 Laminate	N.A. \$1174
36" 28½"	AL3600SC	Grade 1 Laminate	\$767 N.A.
		Grade 2 Laminate	\$808 N.A.
36" 28½"	AL3600USC	Grade 1 Laminate	N.A. \$1187
		Grade 2 Laminate	N.A. \$1228
36" 33"	ALW3600SC	Grade 1 Laminate	\$790 N.A.
		Grade 2 Laminate	\$831 N.A.
36" 33"	ALW3600USC	Grade 1 Laminate	N.A. \$1207
		Grade 2 Laminate	N.A. \$1248



Fixed Top with 37"W Base

Dimensions	Style	Finish	Prices
Dia H	Number		
42" 28½"	AL4200MC	Grade 1 Laminate	\$ 812 N.A.
		Grade 2 Laminate	\$ 867 N.A.
42" 28½"	AL4200UMC	Grade 1 Laminate	N.A. \$1342
		Grade 2 Laminate	N.A. \$1397
42" 33"	ALW4200MC	Grade 1 Laminate	\$ 832 N.A.
		Grade 2 Laminate	\$ 887 N.A.
42" 33"	ALW4200UMC	Grade 1 Laminate	N.A. \$1362
		Grade 2 Laminate	N.A. \$1417
36" 42"	ALB3600MC	Grade 1 Laminate	\$ 820 N.A.
		Grade 2 Laminate	\$ 861 N.A.
36" 42"	ALB3600UMC	Grade 1 Laminate	N.A. \$1236
		Grade 2 Laminate	N.A. \$1277

Au Lait

Au Lait Square Tables with Solid Core Tops



SIN 711.11

Tip: Shipped knocked down.

Standard Includes	Required to Specify
<ul style="list-style-type: none"> ▶ Need help? Product details, see <i>Coalesse Tables, Storage, and Accessories Specification Guide</i>. • Top: 1/4" particle board core with High-Pressure Laminate • Edge: convex vinyl or self-skinning cast urethane • Base: 2 1/2" diameter steel column and glass-filled nylon feet with single textured powder coat • Fixed top with black steel spider • 2 3/8" diameter, locking, dual-wheel casters: black plastic 	<ol style="list-style-type: none"> 1 Style number 2 Textured powder coat color selection for base 3 Laminate color number for top 4 Edge selection: <ul style="list-style-type: none"> - Convex vinyl or cast urethane color number: <ul style="list-style-type: none"> 6000 Black 6607 Woodrose 6609 Smoke 6655 Warm White 5 Options, if selected (see below) <p>▶ See <i>Surface Materials</i>, page 350.</p>

Tip: Glides are the same height as casters. Glides adjust 1/2".

Options	Price	Required to Specify
Surface Materials <ul style="list-style-type: none"> • Top • Grade 2 laminate 	Prices below and at right	Specify with <i>Grade 2 laminate</i> and select color number.
Glides <ul style="list-style-type: none"> • Glides 	No cost	Delete suffix C from the style number.
Related Products <ul style="list-style-type: none"> • Casters • Glides 		<ul style="list-style-type: none"> ▶ Page 48 ▶ Page 48

Specification Information						
Dimensions			Style Number	Finish	Prices	
L	W	H			Convex Vinyl Edge:	Cast Urethane Edge:
						



Fixed Top with 28"W Base

Dimensions	Style Number	Grade 1 Laminate	Grade 2 Laminate
24" 24" 28 1/2"	AL2424SC	\$693	N.A.
		\$711	N.A.
24" 24" 28 1/2"	AL2424USC	N.A.	\$ 959
		N.A.	\$ 977
24" 24" 33"	ALW2424SC	\$715	N.A.
		\$733	N.A.
24" 24" 33"	ALW2424USC	N.A.	\$ 983
		N.A.	\$1001
24" 24" 42"	ALB2424SC	\$745	N.A.
		\$763	N.A.
24" 24" 42"	ALB2424USC	N.A.	\$1008
		N.A.	\$1026
30" 30" 28 1/2"	AL3030SC	\$714	N.A.
		\$744	N.A.
30" 30" 28 1/2"	AL3030USC	N.A.	\$1114
		N.A.	\$1144



▶ Specification Information, continued on next page

Au Lait Square Tables with Solid Core Tops

SIN 711.11

► Specification Information, continued from previous page

Specification Information

Dimensions			Style Number	Finish	Prices	
L	W	H				
					Convex Vinyl Edge:	Cast Urethane Edge:



Fixed Top with 28"W Base, continued

30"	30"	33"	ALW3030SC	Grade 1 Laminate	\$739	N.A.
				Grade 2 Laminate	\$769	N.A.
30"	30"	33"	ALW3030USC	Grade 1 Laminate	N.A.	\$1135
				Grade 2 Laminate	N.A.	\$1165



Fixed Top with 37"W Base

36"	36"	28½"	AL3636MC	Grade 1 Laminate	\$ 783	N.A.
				Grade 2 Laminate	\$ 824	N.A.
36"	36"	28½"	AL3636UMC	Grade 1 Laminate	N.A.	\$1200
				Grade 2 Laminate	N.A.	\$1241
36"	36"	33"	ALW3636MC	Grade 1 Laminate	\$ 806	N.A.
				Grade 2 Laminate	\$ 847	N.A.
36"	36"	33"	ALW3636UMC	Grade 1 Laminate	N.A.	\$1222
				Grade 2 Laminate	N.A.	\$1263
36"	36"	42"	ALB3636MC	Grade 1 Laminate	\$ 829	N.A.
				Grade 2 Laminate	\$ 870	N.A.
36"	36"	42"	ALB3636UMC	Grade 1 Laminate	N.A.	\$1250
				Grade 2 Laminate	N.A.	\$1291
30"	30"	42"	ALB3030MC	Grade 1 Laminate	\$ 763	N.A.
				Grade 2 Laminate	\$ 793	N.A.
30"	30"	42"	ALB3030UMC	Grade 1 Laminate	N.A.	\$1165
				Grade 2 Laminate	N.A.	\$1195

Au Lait



Au Lait Rectangular Tables with Solid Core Tops

SIN 711.11

Standard Includes		Required to Specify
<ul style="list-style-type: none"> ► Need help? Product details, see <i>Coalesse Tables, Storage, and Accessories Specification Guide</i>. 	<ul style="list-style-type: none"> • Top: 1/4" particle board core with High-Pressure Laminate • Edge: convex vinyl or self-skinning cast urethane • Base: 2 1/2" diameter steel column and glass-filled nylon feet with single textured powder coat • Fixed top with black steel spider • 2 3/8" diameter, locking, dual-wheel casters: black plastic 	<ol style="list-style-type: none"> 1 Style number 2 Textured powder coat color selection for base 3 Laminate color number for top 4 Edge selection: <ul style="list-style-type: none"> - Convex vinyl or cast urethane color number: <ul style="list-style-type: none"> 6000 Black 6607 Woodrose 6609 Smoke 6655 Warm White 5 Options, if selected (see below) <p>► See <i>Surface Materials</i>, page 350.</p>

Options	Price	Required to Specify
Surface Materials <ul style="list-style-type: none"> • Top • Grade 2 laminate 	Prices below and at right	Specify with <i>Grade 2 laminate</i> and select color number.
Glides <ul style="list-style-type: none"> • Glides 	No cost	Delete suffix C from the style number.
Related Products <ul style="list-style-type: none"> • Casters • Glides 		<p>► Page 48</p> <p>► Page 48</p>

Tip: Glides are the same height as casters. Glides adjust 1/2".

Specification Information						
Dimensions			Style Number	Finish	Prices	
L	W	H			Convex Vinyl Edge:	Cast Urethane Edge:
						



Tip: Shipped knocked down.

Fixed Top with 28"W Base

24"	30"	28 1/2"	AL2430SC	Grade 1 Laminate	\$716	N.A.
				Grade 2 Laminate	\$740	N.A.
24"	30"	28 1/2"	AL2430USC	Grade 1 Laminate	N.A.	\$1002
				Grade 2 Laminate	N.A.	\$1026
24"	30"	33"	ALW2430SC	Grade 1 Laminate	\$740	N.A.
				Grade 2 Laminate	\$764	N.A.
24"	30"	33"	ALW2430USC	Grade 1 Laminate	N.A.	\$1025
				Grade 2 Laminate	N.A.	\$1049
24"	36"	28 1/2"	AL2436SC	Grade 1 Laminate	\$736	N.A.
				Grade 2 Laminate	\$765	N.A.
24"	36"	28 1/2"	AL2436USC	Grade 1 Laminate	N.A.	\$1025
				Grade 2 Laminate	N.A.	\$1054
24"	36"	33"	ALW2436SC	Grade 1 Laminate	\$752	N.A.
				Grade 2 Laminate	\$781	N.A.
24"	36"	33"	ALW2436USC	Grade 1 Laminate	N.A.	\$1047
				Grade 2 Laminate	N.A.	\$1076
30"	36"	28 1/2"	AL3036SC	Grade 1 Laminate	\$759	N.A.
				Grade 2 Laminate	\$794	N.A.

► Specification Information, continued on next page

Au Lait Rectangular Tables with Solid Core Tops

SIN 711.11

► Specification Information, continued from previous page

Specification Information

Dimensions			Style Number	Finish	Prices	
L	W	H			Convex Vinyl Edge:	Cast Urethane Edge:



Convex Vinyl Edge:



Cast Urethane Edge:



Fixed Top with 28"W Base, continued

30"	36"	28½"	AL3036USC	Grade 1 Laminate	N.A.	\$1114
				Grade 2 Laminate	N.A.	\$1149
30"	36"	33"	ALW3036SC	Grade 1 Laminate	\$781	N.A.
				Grade 2 Laminate	\$816	N.A.
30"	36"	33"	ALW3036USC	Grade 1 Laminate	N.A.	\$1135
				Grade 2 Laminate	N.A.	\$1170



Fixed Top with 37"W Base

30"	42"	28½"	AL3042MC	Grade 1 Laminate	\$781	N.A.
				Grade 2 Laminate	\$821	N.A.
30"	42"	28½"	AL3042UMC	Grade 1 Laminate	N.A.	\$1152
				Grade 2 Laminate	N.A.	\$1192
30"	42"	33"	ALW3042MC	Grade 1 Laminate	\$803	N.A.
				Grade 2 Laminate	\$843	N.A.
30"	42"	33"	ALW3042UMC	Grade 1 Laminate	N.A.	\$1174
				Grade 2 Laminate	N.A.	\$1214

SIN 711.11

Casters



Standard Includes	Required to Specify
<ul style="list-style-type: none"> Set of four locking casters for field retrofit: black 	Style number

Specification Information

Style Number	Price
ALCASTER	\$147

Glides



Standard Includes	Required to Specify
<ul style="list-style-type: none"> Set of four glides for field retrofit: black 	Style number

Specification Information

Style Number	Price
ALGLIDE	\$147

Vertical Wire Manager

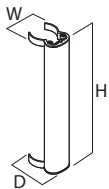

Standard Includes	Required to Specify
<ul style="list-style-type: none"> Vertical wire manager clips onto table leg: extruded aluminum with powder coat color to match leg Clips have three snap-fit features for one power cord and two CAT-5 cables: black plastic 	1 Style number 2 Powder coat color number 3 Options, if selected (see below)

Options	Price	Required to Specify
Surface Materials <ul style="list-style-type: none"> Polished Aluminum 	+\$64	Specify with <i>polished aluminum finish</i> .

Specification Information

Dimensions			Style Number	Base Price
D	W	H		
37/8"	27/8"	181/4"	793893	\$128

Ballet

Round Café Tables (SIN 711.11)	50
Arc Tables (SIN 711.11)	51
Non-Folding Side Tables (SIN 711.11)	52
Round Pedestal Base Tables (SIN 711.11)	53
Square Pedestal Base Tables (SIN 711.11)	54
Rectangular Folding X-Base Tables (SIN 711.11)	56
Rectangular Non-Folding X-Base Tables (SIN 711.11)	58
Rectangular Folding K-Base Tables (SIN 711.11)	60
Rectangular Non-Folding K-Base Tables (SIN 711.11)	64
Connecting Tops (SIN 711.11)	67
Accessories (SIN 711.11)	68

Ballet Round Café Tables

SIN 711.11

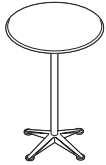

Tip: Shipped knocked down.

Tip: For installation of a grommet or sphere, submit a drawing indicating the desired location for a factory installed cutout. Field installation is also available. Both require the grommet or sphere to be ordered as a separate item.

Standard Includes	Required to Specify
-------------------	---------------------

- | | |
|---|--|
| <ul style="list-style-type: none"> ▶ Need help? Product details, see <i>Coalesse Tables, Storage, and Accessories Specification Guide</i> • Top: 3/4" particle board core with High-Pressure Laminate • Edge: black ribbed vinyl • Base: 2" diameter steel column and 4-prong cast aluminum feet with single powder coat • 19" cast aluminum technology spider • Adjustable leveling glides: non-marring, black plastic | <ul style="list-style-type: none"> 1 Style number 2 Powder coat color number for base 3 Laminate color number for top 4 Options, if selected (see below) ▶ See <i>Surface Materials</i>, page 350 |
|---|--|

Options	Price	Required to Specify
---------	-------	---------------------

Surface Materials <ul style="list-style-type: none"> • Grade 2 laminate 	Prices below	Specify with <i>Grade 2 laminate</i> and select color number.
--	--------------	---

Specification Information			
Dimensions	Style Number	Finish	Prices

Dimensions	Style Number	Finish	Prices
Dia H			
			Ballet Ribbed Vinyl Edge:
30" 41½"	933421T	Grade 1 Laminate	\$ 905
		Grade 2 Laminate	\$ 938
36" 41½"	934422T	Grade 1 Laminate	\$1030
		Grade 2 Laminate	\$1075

Ballet Arc Tables

SIN 711.11

Tip: Shipped knocked down.

Tip: For installation of a grommet or sphere, submit a drawing indicating the desired location for a factory installed cutout. Field installation is also available. Both require the grommet or sphere to be ordered as a separate item.

Standard Includes	Required to Specify
<ul style="list-style-type: none"> ▶ Need help? Product details, see <i>Coalesse Tables, Storage, and Accessories Specification Guide</i> • Top: 1" particle board core with High-Pressure Laminate • Edge: black ribbed vinyl with matching plastic corner inserts • X-base: cast aluminum legs and 1" x 3" extruded aluminum stretcher bar between legs with single powder coat color • Threaded inserts in underside of top for end-to-end ganging • Leveling glides: non-marring, black plastic 	<ul style="list-style-type: none"> 1 Style number 2 Powder coat color number for base 3 Laminate color number for top 4 Options, if selected (see below) ▶ See <i>Surface Materials</i>, page 350

Options	Price	Required to Specify
Surface Materials <ul style="list-style-type: none"> • Grade 2 laminate 	Prices below	Specify with <i>Grade 2 laminate</i> and select color number.
Related Products <ul style="list-style-type: none"> • Bar ganger package • Powerstrip 		<ul style="list-style-type: none"> ▶ Page 68 ▶ Page 68

Specification Information

Dimensions			Style	Finish	Price
L	W	H	Number		
					 <p>Ballet Ribbed Vinyl Edge:</p>



Folding Arc Tables

55"	30"	28½"	915415	Grade 1 Laminate	\$2129
				Grade 2 Laminate	\$2180
82"	30"	28½"	916416	Grade 1 Laminate	\$2310
				Grade 2 Laminate	\$2388

Non-Folding Arc Tables

55"	30"	28½"	915405	Grade 1 Laminate	\$1814
				Grade 2 Laminate	\$1865
82"	30"	28½"	916406	Grade 1 Laminate	\$1920
				Grade 2 Laminate	\$1998

Ballet Non-Folding Side Tables

SIN 711.11

Tip: Shipped knocked down.

Standard Includes		Required to Specify
<ul style="list-style-type: none"> ▶ Need help? Product details, see <i>Coalesse Tables, Storage, and Accessories Specification Guide</i> 	<ul style="list-style-type: none"> • Top: 3/4" particle board core with High-Pressure Laminate • Edge: black ribbed vinyl • Pedestal base: aluminum with powder coat • 19" cast aluminum technology spider • 2" diameter, locking, dual-wheel casters: black plastic 	<ol style="list-style-type: none"> 1 Style number 2 Powder coat color number for base 3 Laminate color number for top 4 Options, if selected (see below) <ul style="list-style-type: none"> ▶ See <i>Surface Materials</i>, page 350

Tip: When specifying glides height of table does not change.

Tip: For installation of a grommet or sphere, submit a drawing indicating the desired location for a factory installed cutout. Field installation is also available. Both require the grommet or sphere to be ordered as a separate item.

Options	Price	Required to Specify
Surface Materials <ul style="list-style-type: none"> • Top • Grade 2 laminate 	Prices below	Specify with <i>Grade 2 laminate</i> and select color number.
Glides <ul style="list-style-type: none"> • Leveling glides in place of casters: non-marring, black plastic 	-\$157	Delete suffix C from the style number.

Specification Information			
Dimensions	Style Number	Finish	Base Price
Dia H			 <p>Ballet Ribbed Vinyl Edge:</p>



Round Table			
Dimensions	Style Number	Finish	Base Price
27" 25 1/2"	919423C	Grade 1 Laminate	\$830
		Grade 2 Laminate	\$860

Racetrack Table			
Dimensions	Style Number	Finish	Base Price
36" 25 1/2"	920424C	Grade 1 Laminate	\$934
		Grade 2 Laminate	\$964

Ballet Round Pedestal Base Tables

SIN 711.11



Tip: Special table height available, call customer service for quote.

Tip: Shipped knocked down.

Tip: When specifying casters height of table does not change.

Tip: For installation of a grommet or sphere, submit a drawing indicating the desired location for a factory installed cutout. Field installation is also available. Both require the grommet or sphere to be ordered as a separate item.

Standard Includes		Required to Specify
<ul style="list-style-type: none"> ▶ Need help? Product details, see <i>Coalesse Tables, Storage, and Accessories Specification Guide</i> 	<ul style="list-style-type: none"> • Top: 3/4" particle board core with High-Pressure Laminate • Edge: black ribbed vinyl • Base: 2" diameter steel column and 4-prong cast aluminum feet with single powder coat • 19" cast aluminum technology spider • Adjustable leveling glides: non-marring, black plastic 	<ul style="list-style-type: none"> 1 Style number 2 Powder coat color number for base 3 Laminate or wood color number for top 4 Options, if selected (see below) ▶ See <i>Surface Materials</i>, page 350

Options	Price	Required to Specify
Surface Materials <ul style="list-style-type: none"> • Top • Grade 2 laminate 	Prices below	Specify with <i>Grade 2 laminate</i> and select color number.
Flip top <ul style="list-style-type: none"> • Flip top on tables 	+\$164	Add suffix F to the style number.
Casters <ul style="list-style-type: none"> • 2" diameter, locking, dual-wheel casters in place of leveling glides: black plastic 	+\$157	Add suffix C to the style number.

Specification Information				
Dimensions	Style Number	Finish	Base Price	
Dia H				
			Ballet Ribbed Vinyl Edge:	
30"	28½"	933421	Grade 1 Laminate	\$840
			Grade 2 Laminate	\$870
36"	28½"	934421	Grade 1 Laminate	\$936
			Grade 2 Laminate	\$977

Ballet Square Pedestal Base Tables

SIN 711.11



Tip: Special table height available, call customer service for quote.

Tip: Shipped knocked down.

Tip: When specifying casters height of table does not change.

Tip: For installation of a grommet or sphere, submit a drawing indicating the desired location for a factory installed cutout. Field installation is also available. Both require the grommet or sphere to be ordered as a separate item.

Standard Includes		Required to Specify
<ul style="list-style-type: none"> ▶ Need help? Product details, see <i>Coalesse Tables, Storage, and Accessories Specification Guide</i> 	<ul style="list-style-type: none"> • Top: 1" particle board core with High-Pressure Laminate • Edge: black ribbed vinyl with matching plastic corner inserts • Base: 2" diameter steel column and 4-prong cast aluminum feet with single powder coat • 19" cast aluminum technology spider • Adjustable leveling glides: non-marring, black plastic 	<ul style="list-style-type: none"> 1 Style number 2 Powder coat color number for base 3 Laminate color number for top 4 Options, if selected (see below) ▶ See <i>Surface Materials</i>, page 350

Options	Price	Required to Specify
Surface Materials <ul style="list-style-type: none"> • Top • Grade 2 laminate 	Prices below	Specify with <i>Grade 2 laminate</i> and select color number.
Flip top <ul style="list-style-type: none"> • Flip top on tables 	+\$164	Add suffix F to the style number.
Casters <ul style="list-style-type: none"> • 2" diameter, locking, dual-wheel casters in place of leveling glides: black plastic 	+\$157	Add suffix C to the style number.

Specification Information					
Dimensions			Style Number	Finish	Base Prices
L	W	H			
30"	30"	28½"	926421	Grade 1 Laminate	\$ 902
					Grade 2 Laminate
36"	36"	28½"	927422	Grade 1 Laminate	\$ 987
					Grade 2 Laminate



Ballet Ribbed Vinyl Edge:

Coalesse

Ballet Square Pedestal Base Tables

SIN 711.11

Ballet

Ballet Rectangular Folding X-Base Tables

SIN 711.11

Tip: Shipped assembled.

Tip: For installation of grommets or spheres, Mini-Port, Interport, and/or Interact, submit a drawing indicating the desired location for a factory installed cutout(s). Field installation is also available. All require the grommet(s) or sphere(s) to be ordered as a separate item.

Standard Includes		Required to Specify
<ul style="list-style-type: none"> ▶ Need help? Product details, see <i>Coalesse Tables, Storage, and Accessories Specification Guide</i> 	<ul style="list-style-type: none"> • Top: 1" multi-ply wood core with High-Pressure Laminate • Edge: black ribbed vinyl with matching plastic corner inserts • X-base: cast aluminum legs and 1" x 3" extruded aluminum stretcher bar between legs with single powder coat color • Modesty panel with horizontal wire management trough, if selected: extruded aluminum with powder coat color • Threaded inserts in underside of top for end-to-end ganging • Adjustable leveling glides: non-marring, black plastic 	<ol style="list-style-type: none"> 1 Style number 2 Powder coat color number for base 3 Laminate color number for top 4 Powder coat color number for modesty panel, if selected 5 Options, if selected (see below) <p>▶ See <i>Surface Materials</i>, page 350</p>

Options	Price	Required to Specify
Surface Materials Top <ul style="list-style-type: none"> • Grade 2 laminate 	Prices below and at right	Specify with <i>Grade 2 laminate</i> and select laminate color number.
Related Products <ul style="list-style-type: none"> • Bar ganger package • Power strips 		<ul style="list-style-type: none"> ▶ Page 68 ▶ Page 68

Specification Information					
Dimensions			Style	Finish	Price
L	W	H	Number		
					 <p>Ballet Ribbed Vinyl Edge:</p>

30"W Rectangular Folding X-Base Tables



Without Modesty Panel					
60"	30"	28½"	853411	Grade 1 Laminate	\$1667
				Grade 2 Laminate	\$1722
72"	30"	28½"	854412	Grade 1 Laminate	\$1713
				Grade 2 Laminate	\$1779
84"	30"	28½"	855413	Grade 1 Laminate	\$1938
				Grade 2 Laminate	\$2017
96"	30"	28½"	856414	Grade 1 Laminate	\$2034
				Grade 2 Laminate	\$2122



With Modesty Panel					
60"	30"	28½"	853461	Grade 1 Laminate	\$2086
				Grade 2 Laminate	\$2141
72"	30"	28½"	854462	Grade 1 Laminate	\$2143
				Grade 2 Laminate	\$2209
84"	30"	28½"	855463	Grade 1 Laminate	\$2375
				Grade 2 Laminate	\$2454
96"	30"	28½"	856464	Grade 1 Laminate	\$2477
				Grade 2 Laminate	\$2565

▶ Specification Information, continued on next page

Ballet Rectangular Folding X-Base Tables

SIN 711.11

► Specification Information, continued from previous page

Specification Information

Dimensions			Style Number	Finish	Price
L	W	H			
					 <p>Ballet Ribbed Vinyl Edge:</p>

36"W Rectangular Folding X-Base Tables



Without Modesty Panel

60"	36"	28½"	823411	Grade 1 Laminate	\$1751
				Grade 2 Laminate	\$1817
72"	36"	28½"	824412	Grade 1 Laminate	\$1784
				Grade 2 Laminate	\$1864
84"	36"	28½"	825413	Grade 1 Laminate	\$1980
				Grade 2 Laminate	\$2072
96"	36"	28½"	826414	Grade 1 Laminate	\$2143
				Grade 2 Laminate	\$2248



With Modesty Panel

60"	36"	28½"	823461	Grade 1 Laminate	\$2168
				Grade 2 Laminate	\$2234
72"	36"	28½"	824462	Grade 1 Laminate	\$2215
				Grade 2 Laminate	\$2295
84"	36"	28½"	825463	Grade 1 Laminate	\$2415
				Grade 2 Laminate	\$2507
96"	36"	28½"	826464	Grade 1 Laminate	\$2592
				Grade 2 Laminate	\$2697

42"W Rectangular Folding X-Base Tables



Without Modesty Panel

72"	42"	28½"	814412	Grade 1 Laminate	\$2309
				Grade 2 Laminate	\$2401
84"	42"	28½"	815413	Grade 1 Laminate	\$2347
				Grade 2 Laminate	\$2456
96"	42"	28½"	816414	Grade 1 Laminate	\$2424
				Grade 2 Laminate	\$2546



With Modesty Panel

72"	42"	28½"	814462	Grade 1 Laminate	\$2721
				Grade 2 Laminate	\$2813
84"	42"	28½"	815463	Grade 1 Laminate	\$2781
				Grade 2 Laminate	\$2890
96"	42"	28½"	816464	Grade 1 Laminate	\$2872
				Grade 2 Laminate	\$2994

Ballet Rectangular Non-Folding X-Base Tables

SIN 711.11

Tip: Shipped knocked down.

Tip: For installation of grommets, spheres, Mini-Port, Interport, and/or Interact, Axil Z, or Ellora, submit a drawing indicating the desired location for a factory installed cutout(s). Field installation is also available. All require the grommet(s), sphere(s), Mini-Port, Interport, and/or Interact, Axil Z, or Ellora to be ordered as a separate item.

Standard Includes		Required to Specify	
<ul style="list-style-type: none"> ▶ Need help? Product details, see <i>Coalesse Tables, Storage, and Accessories Specification Guide</i> • Top: 1" MDF core with High-Pressure Laminate • Edge: black ribbed vinyl with matching plastic corner inserts • X-base: cast aluminum legs and 1" x 3" extruded aluminum stretcher bar between legs with single powder coat color • Modesty panel with horizontal wire management trough, if selected: extruded aluminum with powder coat • Threaded inserts in underside of top for end-to-end ganging • Adjustable leveling glides: non-marring, black plastic 		<ol style="list-style-type: none"> 1 Style number 2 Powder coat color number for base 3 Laminate color number for top 4 Powder coat color number for modesty panel, if selected 5 Options, if selected (see below) <p>▶ See <i>Surface Materials</i>, page 350</p>	
Options	Price	Required to Specify	
Surface Materials <ul style="list-style-type: none"> • Top • Grade 2 laminate 	Prices below and at right	Specify with <i>Grade 2 laminate</i> and select color number.	
Related Products <ul style="list-style-type: none"> • Bar ganger package 		▶ Page 68	

Specification Information					
Dimensions			Style	Finish	Prices
L	W	H	Number		
					 <p>Ballet Ribbed Vinyl Edge:</p>

30"W Rectangular Non-Folding X-Base Tables



Without Modesty Panel					
60"	30"	28½"	873401	Grade 1 Laminate	\$1564
				Grade 2 Laminate	\$1619
72"	30"	28½"	874402	Grade 1 Laminate	\$1614
				Grade 2 Laminate	\$1680
84"	30"	28½"	875403	Grade 1 Laminate	\$1834
				Grade 2 Laminate	\$1913
96"	30"	28½"	876404	Grade 1 Laminate	\$1933
				Grade 2 Laminate	\$2021
With Modesty Panel					
60"	30"	28½"	873451	Grade 1 Laminate	\$1983
				Grade 2 Laminate	\$2038
72"	30"	28½"	874452	Grade 1 Laminate	\$2039
				Grade 2 Laminate	\$2105
84"	30"	28½"	875453	Grade 1 Laminate	\$2274
				Grade 2 Laminate	\$2353
96"	30"	28½"	876454	Grade 1 Laminate	\$2377
				Grade 2 Laminate	\$2465

▶ Specification Information, continued on next page

Ballet Rectangular Non-Folding X-Base Tables

SIN 711.11

► Specification Information, continued from previous page

Specification Information

Dimensions			Style Number	Finish	Prices
L	W	H			
					
					Ballet Ribbed Vinyl Edge:

36"W Rectangular Non-Folding X-Base Tables



Without Modesty Panel

60"	36"	28½"	883401	Grade 1 Laminate	\$1647
				Grade 2 Laminate	\$1713
72"	36"	28½"	884402	Grade 1 Laminate	\$1682
				Grade 2 Laminate	\$1762
84"	36"	28½"	885403	Grade 1 Laminate	\$1877
				Grade 2 Laminate	\$1969
96"	36"	28½"	886404	Grade 1 Laminate	\$2039
				Grade 2 Laminate	\$2144



With Modesty Panel

60"	36"	28½"	883451	Grade 1 Laminate	\$2065
				Grade 2 Laminate	\$2131
72"	36"	28½"	884452	Grade 1 Laminate	\$2108
				Grade 2 Laminate	\$2188
84"	36"	28½"	885453	Grade 1 Laminate	\$2316
				Grade 2 Laminate	\$2408
96"	36"	28½"	886454	Grade 1 Laminate	\$2489
				Grade 2 Laminate	\$2594

42"W Rectangular Non-Folding X-Base Tables

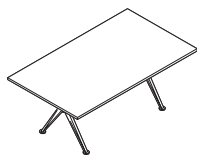

Without Modesty Panel

72"	42"	28½"	834402	Grade 1 Laminate	\$2190
				Grade 2 Laminate	\$2282
84"	42"	28½"	835403	Grade 1 Laminate	\$2243
				Grade 2 Laminate	\$2352
96"	42"	28½"	836404	Grade 1 Laminate	\$2322
				Grade 2 Laminate	\$2444



With Modesty Panel

72"	42"	28½"	834452	Grade 1 Laminate	\$2617
				Grade 2 Laminate	\$2709
84"	42"	28½"	835453	Grade 1 Laminate	\$2684
				Grade 2 Laminate	\$2793
96"	42"	28½"	836454	Grade 1 Laminate	\$2772
				Grade 2 Laminate	\$2894

Ballet Rectangular Folding K-Base Tables

SIN 711.11

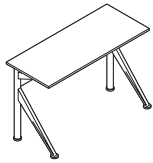

Tip: Shipped assembled.

	Standard Includes	Required to Specify
<ul style="list-style-type: none"> ▶ Need help? Product details, see <i>Coalesse Tables, Storage, and Accessories Specification Guide</i> 	<ul style="list-style-type: none"> • Top: 1" multi-ply wood core with High-Pressure Laminate • Edge: black vinyl with matching plastic corner inserts • K-base: cast aluminum legs and 1" x 3" extruded aluminum stretcher bar between legs with single powder coat • Modesty panel with horizontal wire management trough, if selected: extruded aluminum with powder coat • Threaded inserts in underside of top for end-to-end ganging • Adjustable leveling glides: non-marring, black plastic 	<ol style="list-style-type: none"> 1 Style number 2 Powder coat color number for base 3 Laminate color number for top 4 Powder coat color number for modesty panel, if selected 5 Options, if selected (see below) <ul style="list-style-type: none"> ▶ See <i>Surface Materials</i>, page 350

	Options	Price	Required to Specify
Surface Materials	Top <ul style="list-style-type: none"> • Grade 2 laminate 	Prices at right	Specify with <i>Grade 2 laminate</i> and select laminate color number.
Grommets	<ul style="list-style-type: none"> • One grommet: black plastic • Two grommets: black plastic • Three grommets: black plastic 	<ul style="list-style-type: none"> +\$ 68 +\$136 +\$204 	<ul style="list-style-type: none"> Specify with <i>grommet</i> and select location of left, right, or center. Specify with <i>two grommets</i> and select location of left/center, right/center, or right/left. Specify with <i>three grommets</i>.
Spheres	Factory-installed opening and sphere to be installed on site: black plastic only <ul style="list-style-type: none"> • CSP = Four data jack locations • PCS = Two simplex power outlets and two data jack locations • PSP = Four simplex power 	<ul style="list-style-type: none"> +\$172 each +\$262 each +\$380 each 	<ul style="list-style-type: none"> Specify with <i>CSP sphere</i> and select location of left, right, or center. Specify with <i>PCS sphere</i> and select location of left, right, or center. Specify with <i>PSP sphere</i> and select location of left, right, or center.
Casters	<ul style="list-style-type: none"> • 2" diameter, locking, dual-wheel casters in place of leveling glides on back legs of tables: black plastic only 	+\$ 68	Add suffix C to the style number.
Related Products	<ul style="list-style-type: none"> • Bar ganger package • Power strips • Spheres 		<ul style="list-style-type: none"> ▶ Page 68 ▶ Page 68 ▶ Page 21

Tip: When three grommets are specified, grommets will be located left, right, and center.

Tip: For sphere location availability, see *Coalesse Tables, Storage, and Accessories Specification Guide*.

Tip: If RJ11 or RJ45 data jack couplers are needed on PCS or CSP they must be ordered separately.

Tip: When specifying casters, height of table does not change.

Ballet Rectangular Folding K-Base Tables

SIN 711.11

Specification Information

Dimensions			Style Number	Finish	Base Price
L	W	H			
					 <p>Ballet Ribbed Vinyl Edge:</p>

20"W Rectangular Folding K-Base Tables

Without Modesty Panel

48"	20"	28½"	842511	Grade 1 Laminate	\$1551
				Grade 2 Laminate	\$1581
60"	20"	28½"	843512	Grade 1 Laminate	\$1643
				Grade 2 Laminate	\$1680
72"	20"	28½"	844513	Grade 1 Laminate	\$1687
				Grade 2 Laminate	\$1730

With Modesty Panel

48"	20"	28½"	842561	Grade 1 Laminate	\$1980
				Grade 2 Laminate	\$2010
60"	20"	28½"	843562	Grade 1 Laminate	\$2080
				Grade 2 Laminate	\$2117
72"	20"	28½"	844563	Grade 1 Laminate	\$2135
				Grade 2 Laminate	\$2178

24"W Rectangular Folding K-Base Tables

Without Modesty Panel

48"	24"	28½"	802511	Grade 1 Laminate	\$1594
				Grade 2 Laminate	\$1629
60"	24"	28½"	803512	Grade 1 Laminate	\$1682
				Grade 2 Laminate	\$1725
72"	24"	28½"	804513	Grade 1 Laminate	\$1730
				Grade 2 Laminate	\$1784

With Modesty Panel

48"	24"	28½"	802561	Grade 1 Laminate	\$2020
				Grade 2 Laminate	\$2055
60"	24"	28½"	803562	Grade 1 Laminate	\$2119
				Grade 2 Laminate	\$2162
72"	24"	28½"	804563	Grade 1 Laminate	\$2178
				Grade 2 Laminate	\$2230

► Specification Information, continued on next page

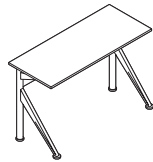

Ballet Rectangular Folding K-Base Tables *continued*

SIN 711.11

► Specification Information, continued from previous page

Specification Information

Dimensions			Style	Finish	Base Price
L	W	H	Number		
					
					Ballet Ribbed Vinyl Edge:

30"W Rectangular Folding K-Base Tables

Without Modesty Panel

48"	30"	28½"	902511	Grade 1 Laminate	\$1988
				Grade 2 Laminate	\$2031
60"	30"	28½"	903512	Grade 1 Laminate	\$2102
				Grade 2 Laminate	\$2157
72"	30"	28½"	904513	Grade 1 Laminate	\$2352
				Grade 2 Laminate	\$2418

With Modesty Panel

48"	30"	28½"	902561	Grade 1 Laminate	\$2417
				Grade 2 Laminate	\$2460
60"	30"	28½"	903562	Grade 1 Laminate	\$2538
				Grade 2 Laminate	\$2593
72"	30"	28½"	904563	Grade 1 Laminate	\$2801
				Grade 2 Laminate	\$2867



Coalesse

Ballet Rectangular Folding K-Base Tables

SIN 711.11

Ballet

Ballet Rectangular Non-Folding K-Base Tables

SIN 711.11



Tip: Shipped knocked down.

	Standard Includes	Required to Specify
<ul style="list-style-type: none"> ▶ Need help? 	<ul style="list-style-type: none"> • Top: 1" MDF core with High-Pressure Laminate • Edge: black ribbed vinyl with matching plastic corner inserts • K-base: cast aluminum legs and 1" x 3" extruded aluminum stretcher bar between legs with single powder coat • Threaded inserts in underside of top for end-to-end ganging • Adjustable leveling glides: non-marring, black plastic 	<ul style="list-style-type: none"> 1 Style number 2 Powder coat color number for base 3 Laminate color number for top 4 Options, if selected (see below) ▶ See <i>Surface Materials</i>, page 350

	Options	Price	Required to Specify
Surface Materials	Top <ul style="list-style-type: none"> • Grade 2 laminate 	Prices at right	Specify with <i>Grade 2 laminate</i> and select color number.
Grommets	<ul style="list-style-type: none"> • One grommet: black plastic • Two grommets: black plastic • Three grommets: black plastic 	<ul style="list-style-type: none"> +\$ 68 +\$136 +\$204 	<ul style="list-style-type: none"> Specify with <i>grommet</i> and select location of left, right, or center. Specify with <i>two grommets</i> and select location of left/center, right/center, or right/left. Specify with three grommets.
Spheres	Factory-installed opening and sphere to be installed on site: black plastic only <ul style="list-style-type: none"> • CSP = Four data jack locations • PCS = Two simplex power outlets and two data jack locations • PSP = Four simplex power 	<ul style="list-style-type: none"> +\$172 each +\$262 each +\$380 each 	<ul style="list-style-type: none"> Specify with <i>CSP sphere</i> and select location of left, right, or center. Specify with <i>PCS sphere</i> and select location of left, right, or center. Specify with <i>PSP sphere</i> and select location of left, right, or center.
Casters	<ul style="list-style-type: none"> • 2" diameter, locking, dual-wheel casters in place of leveling glides on back legs of tables: black plastic only 	+\$ 68	Add suffix C to the style number.
Related Products	<ul style="list-style-type: none"> • Bar ganger package • Power strips • Spheres 		<ul style="list-style-type: none"> ▶ Page 68 ▶ Page 68 ▶ Page 21

Tip: When three grommets are specified, grommets will be located left, right, and center.

Tip: For sphere location availability, see Coalesse Tables, Storage, and Accessories Specification Guide.

Tip: If RJ11 or RJ45 data jack couplers are needed on PCS or CSP they must be ordered separately.

Tip: When specifying casters, height of table does not change.

Tip: For installation of Mini-Port, Interport or Interact, Axil Z, or Ellora, submit a drawing indicating the desired location for a factory installed cutout(s). Mini-Port, Interport and/or Interact, Axil Z, or Ellora to be ordered as a separate item.

Ballet Rectangular Non-Folding K-Base Tables

SIN 711.11

Specification Information

Dimensions			Style Number	Finish	Base Prices
L	W	H			
					 <p>Ballet Ribbed Vinyl Edge:</p>

20"W Rectangular Non-Folding K-Base Tables

Without Modesty Panel

48"	20"	28½"	892501	Grade 1 Laminate	\$1500
				Grade 2 Laminate	\$1531
60"	20"	28½"	893502	Grade 1 Laminate	\$1594
				Grade 2 Laminate	\$1632
72"	20"	28½"	894503	Grade 1 Laminate	\$1635
				Grade 2 Laminate	\$1678

With Modesty Panel

48"	20"	28½"	892551	Grade 1 Laminate	\$1932
				Grade 2 Laminate	\$1963
60"	20"	28½"	893552	Grade 1 Laminate	\$2030
				Grade 2 Laminate	\$2068
72"	20"	28½"	894553	Grade 1 Laminate	\$2087
				Grade 2 Laminate	\$2130

24"W Rectangular Non-Folding K-Base Tables

Without Modesty Panel

48"	24"	28½"	862501	Grade 1 Laminate	\$1542
				Grade 2 Laminate	\$1579
60"	24"	28½"	863502	Grade 1 Laminate	\$1630
				Grade 2 Laminate	\$1673
72"	24"	28½"	864503	Grade 1 Laminate	\$1678
				Grade 2 Laminate	\$1730

With Modesty Panel

48"	24"	28½"	862551	Grade 1 Laminate	\$1970
				Grade 2 Laminate	\$2007
60"	24"	28½"	863552	Grade 1 Laminate	\$2071
				Grade 2 Laminate	\$2114
72"	24"	28½"	864553	Grade 1 Laminate	\$2129
				Grade 2 Laminate	\$2181

► Specification Information, continued on next page



Ballet Rectangular Non-Folding K-Base Tables *continued*

SIN 711.11

► Specification Information, continued from previous page

Specification Information

Dimensions			Style Number	Finish	Base Prices
L	W	H			



Ballet Ribbed Vinyl Edge:

30"W Rectangular Non-Folding K-Base Tables

Without Modesty Panel

48"	30"	28½"	912501	Grade 1 Laminate	\$1938
				Grade 2 Laminate	\$1981
60"	30"	28½"	913502	Grade 1 Laminate	\$2049
				Grade 2 Laminate	\$2104
72"	30"	28½"	914503	Grade 1 Laminate	\$2302
				Grade 2 Laminate	\$2368

With Modesty Panel

48"	30"	28½"	912551	Grade 1 Laminate	\$2368
				Grade 2 Laminate	\$2411
60"	30"	28½"	913552	Grade 1 Laminate	\$2489
				Grade 2 Laminate	\$2544
72"	30"	28½"	914553	Grade 1 Laminate	\$2750
				Grade 2 Laminate	\$2816



Ballet Connecting Tops

SIN 711.11



Standard Includes		Required to Specify
<ul style="list-style-type: none"> ▶ Need help? Product details, see <i>Coalesse Tables, Storage, and Accessories Specification Guide</i> 	<ul style="list-style-type: none"> • Top: 1" MDF core with High-Pressure Laminate • Edge: black ribbed vinyl with matching plastic corner inserts • Connecting hardware to attach to adjacent tables 	<ul style="list-style-type: none"> 1 Style number 2 Laminate color number for top 3 Options, if selected (see below) ▶ See <i>Surface Materials</i>, page 350

Options	Price	Required to Specify
Surface Materials <ul style="list-style-type: none"> • Top Grade 2 laminate 	Prices below	Specify with <i>Grade 2 laminate</i> and select laminate color number.

Specification Information			
Dimension	Style Number	Finish	Price
Width			 Ballet Ribbed Vinyl Edge:

90° Connecting Tops

Dimension	Style Number	Finish	Price
20"	849000	Grade 1 Laminate	\$531
		Grade 2 Laminate	\$568
24"	809000	Grade 1 Laminate	\$573
		Grade 2 Laminate	\$610
30"	909000	Grade 1 Laminate	\$646
		Grade 2 Laminate	\$683

Ballet Accessories

SIN 711.11

Power Strip

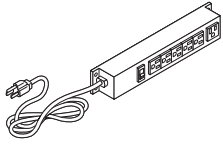

Standard Includes	Required to Specify
--------------------------	----------------------------

- Power strip with 15' cord and three-prong plug; black
- Six power outlets
- On-off switch
- Surge suppressor

Style number

Specification Information

Dimensions			Style	Price
L	D	W	Number	
16"	3/4"	2 1/4"	793330	\$250

Vertical Wire Manager



Standard Includes	Required to Specify
--------------------------	----------------------------

- Vertical wire manager to attach to Ballet K-legs; black plastic only

Style number

Specification Information

Dimensions			Style	Price
L	D	W	Number	
3/4"	1"	17"	793332	\$31

Bar Ganger Package

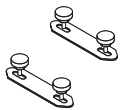

Standard Includes	Required to Specify
--------------------------	----------------------------

- Two field-installed steel bars and four threaded hand knobs; black steel only

Style number

Specification Information

Style	Price
Number	
793335	\$55

Ballet Accessories

SIN 711.11

Mobile Storage Cart

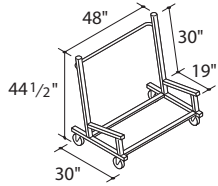

Tip: Shipped knocked down.

Tip: Mobile storage cart accommodates folding Ballet tables of lengths from 48"-72" and widths up to 42". Folded height is 35/8".

Standard Includes	Required to Specify
<ul style="list-style-type: none"> • Cart to accommodate up to five folding Ballet tables: black only • Bumpers: black 	Style number

Specification Information

Style Number	Price
45"L to Accommodate 48"L, 60"L, or 72"L Tables	
793333	\$2143

Bob Tables

DESIGN PEARSON LLOYD

SIN 711.11

Tip: Glass tops are 1/2" thick, except for the absolute clear frosted glass, which is 11/16" thick. 1/32" chamfers are applied to top and bottom edges.

Standard Includes	Required to Specify
<p>► Need help? Product details, see <i>Coalesse Tables, Storage, and Accessories Specification Guide</i></p> <ul style="list-style-type: none"> • Base: 8040 Aluminum Matte Polished or grade 1 paint • Top: clear green glass • Glides 	<ul style="list-style-type: none"> 1 Style number 2 Paint or metal color number for base 3 Color number for top 4 Options, if selected (see below) <p>► See <i>Surface Materials</i>, page 350</p>

Options	Price	Required to Specify
Surface Materials <ul style="list-style-type: none"> • Base • Aluminum matte polished • Grade 1 paint • Grade 3 paint 	No cost No cost +\$105	Specify aluminum matte polished. Specify paint color number. Specify paint color number.
Glides <ul style="list-style-type: none"> • Felted glides 	+\$ 16	Specify <i>with felted glides</i> .
Related Products <ul style="list-style-type: none"> • Bob seating 		► See <i>GSA Volume 5a Specification Guide</i> .

Specification Information

Dimensions Height	Style Number	Top Surface	Base Prices	Dimensions Height	Style Number	Top Surface	Base Prices
24" Diameter Round Occasional Table				30" Diameter Round Occasional Table			
15 ³ / ₄ "	100-T1	Clear Green Glass	\$1565	15 ³ / ₄ "	100-T2	Clear Green Glass	\$1794
15 ³ / ₄ "		Clear Green Laminated/ Frosted Appearance Glass	\$1712	15 ³ / ₄ "		Clear Green Laminate/ Frosted Appearance Glass	\$1940
15 ³ / ₄ "		Absolute Clear Frosted Glass	\$1838	15 ³ / ₄ "		Absolute Clear Frosted Glass	\$2164
15 ³ / ₄ "		Acid Etched 6511	\$1838	15 ³ / ₄ "		Acid Etched 6511	\$2164
15 ³ / ₄ "		Absolute Clear Glass	\$1847	15 ³ / ₄ "		Absolute Clear Glass	\$2248
15 ³ / ₄ "		Colored Glass	\$2171	15 ³ / ₄ "		Colored Glass	\$2795
15 ³ / ₄ "		Grade 1 Laminate	\$1014	15 ³ / ₄ "		Grade 1 Laminate	\$1047
15 ³ / ₄ "		Grade 2 Laminate	\$1036	15 ³ / ₄ "		Grade 2 Laminate	\$1070
15 ³ / ₄ "		Grade 1 Wood Veneer	\$1442	15 ³ / ₄ "		Grade 1 Wood Veneer	\$1651
15 ³ / ₄ "		Grade 2 Wood Veneer	\$1518	15 ³ / ₄ "		Grade 2 Wood Veneer	\$1739
15 ³ / ₄ "		Grade 1 Wedge Lay-up Veneer	N.A.	15 ³ / ₄ "		Grade 1 Wedge Lay-up Veneer	N.A.
15 ³ / ₄ "		Grade 2 Wedge Lay-up Veneer	N.A.	15 ³ / ₄ "		Grade 2 Wedge Lay-up Veneer	N.A.
15 ³ / ₄ "		Corian	\$1833	15 ³ / ₄ "		Corian	\$2096

► Specification Information, continued on next page



► Specification Information, continued from previous page

Specification Information



Dimensions Height	Style Number	Top Surface	Base Prices
36" Diameter Round Occasional Table			
15 ³ / ₄ "	100-T3	Clear Green Glass	\$2183
15 ³ / ₄ "		Clear Green Laminated/ Frosted Appearance Glass	\$2358
15 ³ / ₄ "		Absolute Clear Frosted Glass	\$2691
15 ³ / ₄ "		Acid Etched 6511	\$2691
15 ³ / ₄ "		Absolute Clear Glass	\$2826
15 ³ / ₄ "		Colored Glass	\$3783
15 ³ / ₄ "		Grade 1 Laminate	\$1126
15 ³ / ₄ "		Grade 2 Laminate	\$1157
15 ³ / ₄ "		Grade 1 Wood Veneer	\$2027
15 ³ / ₄ "		Grade 2 Wood Veneer	\$2178
15 ³ / ₄ "		Grade 1 Wedge Lay-up Veneer	\$3320
15 ³ / ₄ "		Grade 2 Wedge Lay-up Veneer	\$3492
15 ³ / ₄ "		Corian	\$2745

Dimensions Height	Style Number	Top Surface	Base Prices
42" Diameter Round Occasional Table			
15 ³ / ₄ "	100-T4	Clear Green Glass	\$2417
15 ³ / ₄ "		Clear Green Laminated/ Frosted Appearance Glass	\$2666
15 ³ / ₄ "		Absolute Clear Frosted Glass	\$3108
15 ³ / ₄ "		Acid Etched 6511	\$3108
15 ³ / ₄ "		Absolute Clear Glass	\$3287
15 ³ / ₄ "		Colored Glass	\$4308
15 ³ / ₄ "		Grade 1 Laminate	\$1197
15 ³ / ₄ "		Grade 2 Laminate	\$1237
15 ³ / ₄ "		Grade 1 Wood Veneer	\$2251
15 ³ / ₄ "		Grade 2 Wood Veneer	\$2466
15 ³ / ₄ "		Grade 1 Wedge Lay-up Veneer	\$3924
15 ³ / ₄ "		Grade 2 Wedge Lay-up Veneer	\$4168
15 ³ / ₄ "		Corian	\$2899



Dimensions Height	Style Number	Top Surface	Base Prices
24" Diameter Round Conference Dining Table			
29"	105-T1	Clear Green Glass	\$1667
29"		Clear Green Laminated/ Frosted Appearance Glass	\$1805
29"		Absolute Clear Frosted Glass	\$1934
29"		Acid Etched 6511	\$1934
29"		Absolute Clear Glass	\$1942
29"		Colored Glass	\$2286
29"		Grade 1 Laminate	\$1233
29"		Grade 2 Laminate	\$1255
29"		Grade 1 Wood Veneer	\$1661
29"		Grade 2 Wood Veneer	\$1737
29"		Grade 1 Wedge Lay-up Veneer	N.A.
29"		Grade 2 Wedge Lay-up Veneer	N.A.
29"		Corian	\$2052

Dimensions Height	Style Number	Top Surface	Base Prices
30" Diameter Round Conference Dining Table			
29"	105-T2	Clear Green Glass	\$1895
29"		Clear Green Laminated/ Frosted Appearance Glass	\$2036
29"		Absolute Clear Frosted Glass	\$2258
29"		Acid Etched 6511	\$2258
29"		Absolute Clear Glass	\$2343
29"		Colored Glass	\$2885
29"		Grade 1 Laminate	\$1267
29"		Grade 2 Laminate	\$1290
29"		Grade 1 Wood Veneer	\$1871
29"		Grade 2 Wood Veneer	\$1959
29"		Grade 1 Wedge Lay-up Veneer	N.A.
29"		Grade 2 Wedge Lay-up Veneer	N.A.
29"		Corian	\$2316

► Specification Information, continued on next page

► Specification Information, continued from previous page

Specification Information

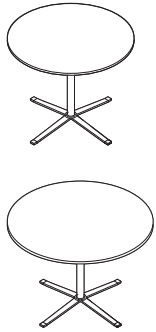

Dimensions Height	Style Number	Top Surface	Base Prices
36" Diameter Round Conference Dining Table			
29"	105-T3	Clear Green Glass	\$2254
29"		Clear Green Laminated/ Frosted Appearance Glass	\$2429
29"		Absolute Clear Frosted Glass	\$2762
29"		Acid Etched 6511	\$2762
29"		Absolute Clear Glass	\$2897
29"		Colored Glass	\$3815
29"		Grade 1 Laminate	\$1348
29"		Grade 2 Laminate	\$1379
29"		Grade 1 Wood Veneer	\$2249
29"		Grade 2 Wood Veneer	\$2400
29"		Grade 1 Wedge Lay-up Veneer	\$3542
29"		Grade 2 Wedge Lay-up Veneer	\$3714
29"		Corian	\$2967

Dimensions Height	Style Number	Top Surface	Base Prices
42" Diameter Round Conference Dining Table			
29"	105-T4	Clear Green Glass	\$2488
29"		Clear Green Laminated/ Frosted Appearance Glass	\$2729
29"		Absolute Clear Frosted Glass	\$3173
29"		Acid Etched 6511	\$3173
29"		Absolute Clear Glass	\$3352
29"		Colored Glass	\$4340
29"		Grade 1 Laminate	\$1418
29"		Grade 2 Laminate	\$1458
29"		Grade 1 Wood Veneer	\$2472
29"		Grade 2 Wood Veneer	\$2687
29"		Grade 1 Wedge Lay-up Veneer	\$4145
29"		Grade 2 Wedge Lay-up Veneer	\$4389
29"		Corian	\$3120

Standard Includes	Required to Specify
<ul style="list-style-type: none"> Need help? Product details, see <i>Coalesse Tables, Storage, and Accessories Specification Guide</i> Frame/top: hard maple veneer Glass top models: <ul style="list-style-type: none"> - 47-T17ELG and 47-T17RG1 models consist of two Diekman wood bases (47-T2617D and 47T2217E) with elliptical or rectangular glass tops - 1/2" thick clear glass top with radiused corners Glides: polyethylene, non-adjustable 	<ul style="list-style-type: none"> 1 Style number 2 Top color number 3 Frame finish <p>▶ See <i>Surface Materials</i>, page 350</p>

Specification Information

Dimensions			Style Number	Prices	
D	W	H		Top Surface:	
				Glass	Wood

Wood

9 1/4"	13"	26"	47-T1326C	N.A.	\$1474
10"	16"	23"	47-T1623A	N.A.	\$1403
10"	16"	23"	47-T1623B	N.A.	\$1403
13 1/2"	15 3/4"	23"	47-T23EL	N.A.	\$1429
16"	25 3/4"	17"	47-T2617D	N.A.	\$1583
14 1/2"	22 1/4"	17"	47-T2217E	N.A.	\$1556

Wood Base, Elliptical Top

32"	40"	17 3/4"	47-T17ELG	\$3576	N.A.
-----	-----	---------	-----------	--------	------

Wood Base, Rectangle Top

32"	40"	17 3/4"	47-T17RG1	\$3593	N.A.
-----	-----	---------	-----------	--------	------

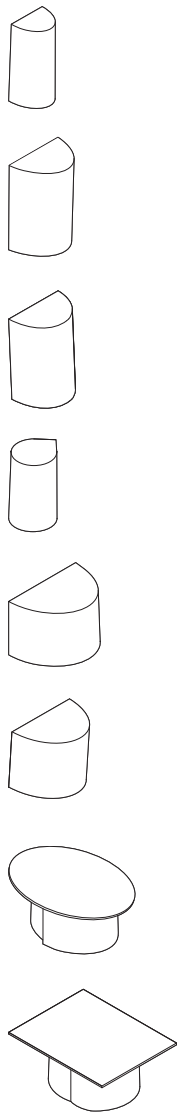

Bob Tables

Enea



Tables with Single Base (SIN 711.11)

76

Tables with Twin Base (SIN 711.11)

78

Enea Tables with Single Base

DESIGN JOSEF LLUSCA

SIN 711.11

Tip: Shipped knocked down.

Standard Includes	Required to Specify
<ul style="list-style-type: none"> Need help? Product details, see <i>Coalesse Tables, Storage, and Accessories Specification Guide</i> Laminate top: 3/4" thick with T-mold edge band Wood top: 3/4" thick with maple edge and maple veneer Base/frame: steel tubing and base Glides: non-skid 	<ol style="list-style-type: none"> Style number Laminate or wood top color number. Plastic color for edge band of laminate top, if selected: 6D10 Silver Metallic 6D11 Black 6D12 White Base/frame finish: 4016 White Gloss 4017 Black Gloss 4218 Platinum Silver <p>► See <i>Surface Materials</i>, page 350</p>

Specification Information				
Dimensions		Style	Prices	
Diameter	H	Number	Top Surface:	
			Laminate	Wood

Occasional Tables

36"	18"	H35-T3618L	\$ 942	N.A.
36"	18"	H35-T3618W	N.A.	\$1304
42"	18"	H35-T4218L	\$1135	N.A.
42"	18"	H35-T4218W	N.A.	\$1864

Café/Conference Height Tables

30"	30"	H35-T3030L	\$1109	N.A.
30"	30"	H35-T3030W	N.A.	\$1728
36"	30"	H35-T3630L	\$1168	N.A.
36"	30"	H35-T3630W	N.A.	\$1923
42"	30"	H35-T4230L	\$1343	N.A.
42"	30"	H35-T4230W	N.A.	\$2077

► Specification Information, continued on next page

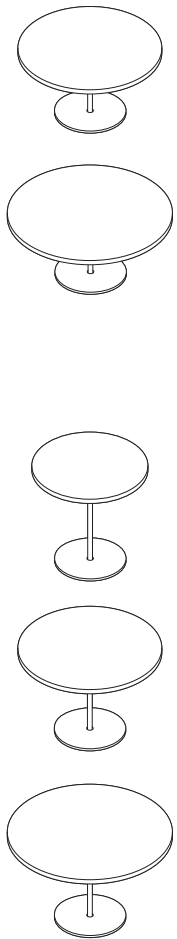

Enea Tables with Single Base
DESIGN JOSEP LLUSCA

SIN 711.11

► Specification Information, continued from previous page

Specification Information

Dimensions		Style	Prices	
Diameter	H	Number	Top Surface:	
			Laminate	Wood

Café/Counter Height Tables

24"	36"	H35-T2436L	\$1071	N.A.
24"	36"	H35-T2436W	N.A.	\$1742
30"	36"	H35-T3036L	\$1171	N.A.
30"	36"	H35-T3036W	N.A.	\$1949
36"	36"	H35-T3636L	\$1213	N.A.
36"	36"	H35-T3636W	N.A.	\$2123
42"	36"	H35-T4236L	\$1400	N.A.
42"	36"	H35-T4236W	N.A.	\$2832

Café/Bar Height Tables

24"	42"	H35-T2442L	\$1103	N.A.
24"	42"	H35-T2442W	N.A.	\$1788
30"	42"	H35-T3042L	\$1182	N.A.
30"	42"	H35-T3042W	N.A.	\$2001
36"	42"	H35-T3642L	\$1220	N.A.
36"	42"	H35-T3642W	N.A.	\$2175

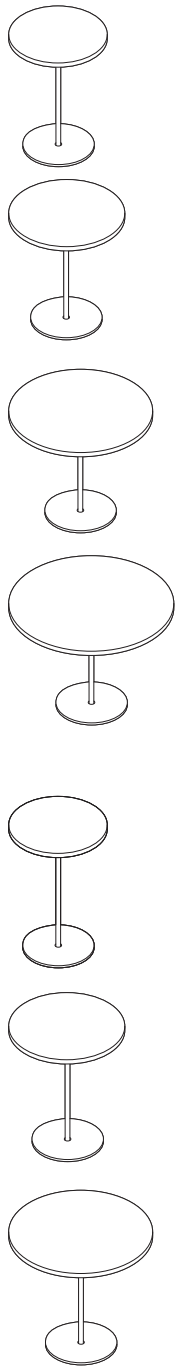

Enea Tables with Twin Base

DESIGN JOSEF LLUSCA

SIN 711.11

Tip: Shipped knocked down.

Tip: Due to weight of steel bases, please lift or move tables by bases only (do not lift by tops) with at least two people.

Tip: White laminate tops may exhibit slightly visible black specks inherent to the top manufacturing process.

Standard Includes

- ▶ Need help? Product details, see *Coalesse Tables, Storage, and Accessories Specification Guide*
- Base/frame: steel tubing and base
- Glides: non-skid
- Disc bases are 24" diameter
- Laminate top: 3/4" thick with T-mold edge band
- Wood top: 3/4" thick with maple edge and maple veneer

Required to Specify

- 1 Style number
- 2 Laminate or wood top color number
- 3 Plastic color for edge band of laminate top, if selected:
6D10 Silver Metallic
6D11 Black
6D12 White
- 4 Base/frame finish:
4016 White Gloss
4017 Black Gloss
4218 Platinum Silver
- ▶ See *Hardwood and Veneer Matrix*, pages 364-365
- 5 Options, if selected (see below)
- ▶ See *Surface Materials*, page 350

Options

Options	Price
Interport Power/Data Module	+\$328

- Interport power/data module (available in 8047 Silver Anodized Aluminum)

Required to Specify

Specify with *Interport power/data module*.

Specification Information

Dimensions			Style Number	Base Prices	
D	W	H		Top Surface: Laminate	Wood

Rectangular Tables

30"	72"	30"	H35-T307230GL	\$2754	N.A.
30"	72"	30"	H35-T307230GW	N.A.	\$3890

30"	72"	36"	H35-T307236GL	\$2890	N.A.
30"	72"	36"	H35-T307236GW	N.A.	\$4020

30"	72"	42"	H35-T307242GL	\$3192	N.A.
30"	72"	42"	H35-T307242GW	N.A.	\$4162

▶ Specification Information, continued on next page

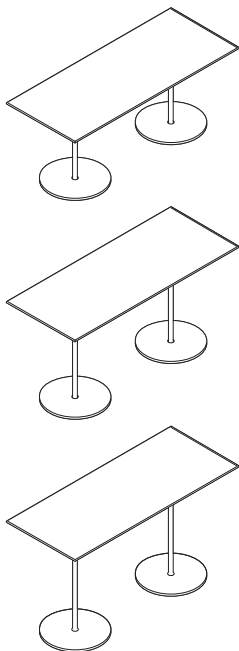

Enea Tables with Twin Base
DESIGN JOSEP LLUSCA

SIN 711.11

► Specification Information, continued from previous page

Specification Information

Dimensions			Style	Base Prices	
D	W	H	Number	Top Surface:	
				Laminate	Wood

Oval Tables

30"	72"	30"	H35-T307230VL	\$2748	N.A.
30"	72"	30"	H35-T307230VW	N.A.	\$4006

30"	72"	36"	H35-T307236VL	\$2770	N.A.
30"	72"	36"	H35-T307236VW	N.A.	\$4129

36"	72"	42"	H35-T307242VL	\$3025	N.A.
36"	72"	42"	H35-T307242VW	N.A.	\$4239

Conference/Racetrack Tables

30"	72"	30"	H35-T307230KL	\$2775	N.A.
30"	72"	30"	H35-T307230KW	N.A.	\$4051

Counter/Racetrack Tables

30"	72"	36"	H35-T307236KL	\$2896	N.A.
30"	72"	36"	H35-T307236KW	N.A.	\$4154

Café/Racetrack Tables

30"	72"	42"	H35-T307242KL	\$3065	N.A.
30"	72"	42"	H35-T307242KW	N.A.	\$4296

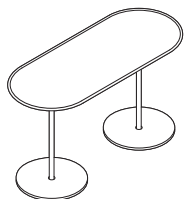
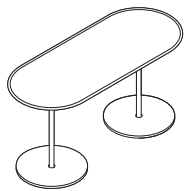
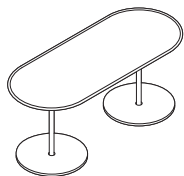
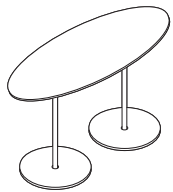

Lagunitas Work Tables

DESIGN TOAN NGUYEN

SIN 711.11

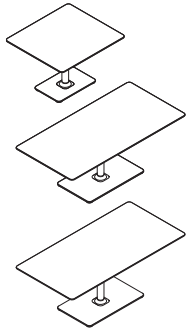

Tip: Column routes cables and wires when optional power or grommet are selected and exits through the base.

Tip: Devices and grommets are center location only to allow for routing of cords through the column and exits through the base.

Tip: Round power module is available in 4013 Silver/Black, 4180 Graphite Matte, 4242 Milk Smooth, or 4710 Low Gloss Black.

Tip: Power module configuration upcharges are in addition to the power module upcharge.

Tip: For each USB port specified, there are two USBs per port.

Tip: 26"H work tables are compatible with all Lagunitas seating.

Tip: 28½"H work tables are incompatible with Lagunitas seating, but are compatible with standard height seating.

Standard Includes		Required to Specify
<ul style="list-style-type: none"> ▶ Need help? Product details, see <i>Coalesse Tables, Storage, and Accessories Specification Guide</i> 	<ul style="list-style-type: none"> • Table top: <ul style="list-style-type: none"> – Grade 1 laminate with 3 mm flat plastic edge – Grade 1 wood with matching flat wood edge • Base with column: grade 1 paint • Six non-adjustable glides • Ships ready to assemble 	<ol style="list-style-type: none"> 1 Style number 2 Table top width 3 Laminate or wood color number for table top 4 Plastic edge color number for laminate table top, if selected 5 Paint color number for base with column 6 Options, if selected (see below) <p>▶ See <i>Surface Materials</i>, page 350</p>

Options	Price	Required to Specify
Surface Materials		
Work table top		
• Grade 2 laminate	Prices below	Specify with <i>Grade 2 laminate</i> and select color number.
• Grade 2 wood veneer	Prices below	Specify with <i>Grade 2 wood veneer</i> and select color number.
• Stain-to-Match	No cost	Specify with <i>Stain-to-Match</i> . ▶ See <i>Coalesse Surface Materials Reference Guide</i> .
Work table base		
• Grade 3 paint	+\$105	Specify paint color number.
Power/USB Configuration and Grommets		
• Power module	+\$255	Specify with <i>power module</i> .
- Two TR simplex receptacles	No cost	Specify with <i>two power</i> .
- One TR simplex receptacle and 2 USB A charging ports	+\$100	Specify with <i>one power, two USB A</i> .
- One TR simplex receptacle, one USB A charging port, and one USB C charging port	+\$100	Specify with <i>one power, one USB A, one USB C</i> .
3" metal grommet		
• One metal grommet in anodized silver finish (center only)	+\$ 77	Specify with <i>3" metal grommet</i> .
PowerPod grommet		
• One PowerPod grommet in 6052 Milk or 6000 Black plastic finish (center only)	+\$ 51	Specify with <i>PowerPod grommet</i> and select color number.

Related Products • Lagunitas lounge system ▶ See *GSA Volume 5a Specification Guide*.

Specification Information							
Style Number	Dimensions			Base Prices			
	D	W	H	Flat Vinyl Edge on Laminate Top		Flat Wood Edge on Wood Top	
				Grade 1	Grade 2	Grade 1	Grade 2

26"H Work Tables

COLAGTRECT	24"	30"	26"	\$1525	\$1595	\$2837	\$3016
	24"	36"	26"	\$1627	\$1702	\$2960	\$3154
	36"	40"	26"	\$1729	\$1812	\$3472	\$3700
	36"	48"	26"	\$2137	\$2238	\$3777	\$4047
	36"	57"	26"	\$2239	\$2346	\$3930	\$4215
	36"	72"	26"	\$2596	\$2720	\$4390	\$4697

28½"H Work Tables

COLAGTW	24"	30"	28½"	\$1545	\$1615	\$2857	\$3036
	24"	36"	28½"	\$1647	\$1702	\$2980	\$3174
	36"	40"	28½"	\$1749	\$1832	\$3492	\$3720
	36"	48"	28½"	\$2157	\$2258	\$3797	\$4067
	36"	57"	28½"	\$2259	\$2366	\$3950	\$4235
	36"	72"	28½"	\$2616	\$2740	\$4410	\$4717

Lagunitas Occasional Tables

SIN 711.11

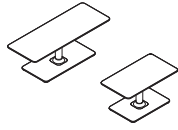

Standard Includes	Required to Specify
<p>► Need help? Product details, see <i>Coalesse Tables, Storage, and Accessories Specification Guide</i></p> <ul style="list-style-type: none"> Table top: <ul style="list-style-type: none"> Grade 1 laminate with 3 mm flat plastic edge Grade 1 wood with matching flat wood edge Base with column: grade 1 paint Six non-adjustable glides Ships ready to assemble 	<ol style="list-style-type: none"> Style number Table top width Laminate or wood color number for table top Plastic edge color number for laminate table top, if selected Paint color number for base with column Options, if selected (see below) <p>► See <i>Surface Materials</i>, page 350</p>

Options	Price	Required to Specify
Surface Materials		
Table top		
• Grade 2 laminate	Prices below	Specify with <i>Grade 2 laminate</i> and select color number.
• Grade 2 wood veneer	Prices below	Specify with <i>Grade 2 wood veneer</i> and select color number.
• Stain-to-Match	No cost	Specify with <i>Stain-to-Match</i> . ► See <i>Coalesse Surface Materials Reference Guide</i> .
Base		
• Grade 3 paint	+\$105	Specify paint color number.
Power/USB Configuration and Grommets		
• Power module	+\$255	Specify with <i>power module</i> .
- Two TR simplex receptacles	No cost	Specify with <i>two power</i> .
- One TR simplex receptacle and 2 USB A charging ports	+\$100	Specify with <i>one power, two USB A</i> .
- One TR simplex receptacle, one USB A charging port, and one USB C charging port	+\$100	Specify with <i>one power, one USB A, one USB C</i> .
3" metal grommet		
• One metal grommet in anodized silver finish (center only)	+\$ 77	Specify with <i>3" metal grommet</i> .
PowerPod grommet		
• One PowerPod grommet in 6052 Milk or 6000 Black plastic finish (center only)	+\$ 51	Specify with <i>PowerPod grommet</i> and select color number.

Tip: Column routes cables and wires when optional power or grommet are selected and exits through the base.

Tip: Devices and grommets are center location only to allow for routing of cords through the column and exits through the base.

Tip: Round power module is available in 4013 Silver/Black, 4180 Graphite Matte, 4242 Milk Smooth, or 4710 Low Gloss Black.

Tip: Power module configuration upcharges are in addition to the power module upcharge.

Tip: For each USB port specified, there are two USBs per port.

Style Number	Dimensions			Base Prices			
	D	W	H	Flat Vinyl Edge on Laminate Top		Flat Wood Edge on Wood Top	
				Grade 1	Grade 2	Grade 1	Grade 2
COLAGTO	18"	32"	16"	\$1474	\$1536	\$2786	\$2955
	18"	48"	16"	\$1734	\$1826	\$3477	\$3707

Lagunitas Personal Table

SIN 711.11



Standard Includes		Required to Specify
<ul style="list-style-type: none"> ► Need help? Product details, see <i>Coalesse Tables, Storage, and Accessories Specification Guide</i> 	<ul style="list-style-type: none"> • Table top: Grade 1 laminate with 3 mm flat plastic edge • Table base with column: grade 1 paint • Four non-adjustable glides • Ships ready to assemble 	<ol style="list-style-type: none"> 1 Style number 2 Laminate color number for table top 3 Plastic edge color number for laminate table top, if selected 4 Paint color number base with column 5 Options, if selected (see below) <ul style="list-style-type: none"> ► See <i>Surface Materials</i>, page 350

Options	Price	Required to Specify
Surface Materials Personal table top <ul style="list-style-type: none"> • Grade 2 laminate • Fusion fabric wrapped 	<p>Prices below</p> <p>Prices below</p>	<p>Specify with <i>Grade 2 laminate</i> and select color number.</p> <p>Specify with <i>Fusion fabric</i> and select color number.</p> <p>► See <i>Coalesse Surface Materials Reference Guide</i>.</p>
Personal table base <ul style="list-style-type: none"> • Grade 3 paint 	<p>+\$105</p>	<p>Specify paint color number.</p>

Specification Information						
Style Number	Dimensions			Base Prices		
	D	W	H	Laminate: Grade 1	Grade 2	Fusion: Fabric
COLAGTP	13"	24"	25"	\$611	\$642	\$867

Standard Includes	Required to Specify
<ul style="list-style-type: none"> ▶ Need help? Product details, see <i>Coalesse Tables, Storage, and Accessories Specification Guide</i> • Base: painted steel with 1/2" x 1 3/4" legs • Glass top: 3/4" thick glass • Glides 	<ol style="list-style-type: none"> 1 Style number 2 Glass color number for top 3 Paint color number for base 4 Options, if selected (see below) <p>▶ See <i>Surface Materials</i>, page 350</p>

Options	Price	Required to Specify
Surface Materials <ul style="list-style-type: none"> • Base • Grade 1 paint • Grade 3 paint • Plated metal for side table, 30" x 30" and 36" x 36" square tables, and 20" x 54" and 30" x 60" rectangular tables • Plated metal for 48" x 48" square table and rectangular tables 	No cost +\$ 75 +\$573 +\$660	Specify paint color number. Specify paint color number. Specify with 9238 Brushed Nickel. Specify with 9238 Brushed Nickel.

Related Products • Millbrae seating ▶ See *GSA Volume 5a Specification Guide*.

Tip: Absolute clear frosted glass on Millbrae tables utilizes a sandblast process to achieve a lightly frosted, translucent aesthetic.

Specification Information									
Dimensions			Style Number	Base Prices					
D	W	H		Top Surface:					
				Clear	Clear Green	Absolute Clear/	Acid	Absolute	Colored
				Green	Laminated/	Clear Frosted	Etched	Clear	Glass
					Clear Green	❌34/20	6511		
					Frosted Appearance	❌34/20			

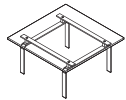

Square Tables

Dimensions	Style Number	Base Price	Top Surface	Acid Etched	Absolute Clear	Colored Glass
30" x 30" x 15"	COMOTL3030	\$1982	\$2022	\$2099	\$2099	\$2145
36" x 36" x 15"	COMOTL3636	\$2354	\$2404	\$2517	\$2517	\$2584
48" x 48" x 15"	COMOTL4848	\$3220	\$3305	\$3490	\$3490	\$3628

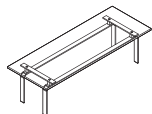

Rectangular Tables

Dimensions	Style Number	Base Price	Top Surface	Acid Etched	Absolute Clear	Colored Glass
20" x 54" x 15"	COMOTL2054	\$2601	\$2668	\$2742	\$2742	\$2798
30" x 60" x 15"	COMOTL3060	\$2848	\$2915	\$3066	\$3066	\$3173



Side Table

Dimensions	Style Number	Base Price	Top Surface	Acid Etched	Absolute Clear	Colored Glass
20" x 20" x 20"	COMOTL2020	\$1610	\$1639	\$1672	\$1672	\$1682

❌34/20 = Last order entry
April 19, 2020

Passerelle

DESIGN STUDIO B

SIN 711.11

Tip: Bases are not sold separately.

Tip: Interport is not available on 44-T164830.

Tip: Interport is for center location only.

Standard Includes		Required to Specify
<ul style="list-style-type: none"> ▶ Need help? Product details, see <i>Coalesse Tables, Storage, and Accessories Specification Guide</i> 	<ul style="list-style-type: none"> • Frame: Solid maple with mortise and tenon joinery for structural integrity • Glides: Polyethylene • Wood top: 1" thick, selected maple veneer • Ships ready-to-assemble 	<ul style="list-style-type: none"> 1 Style number 2 Top and frame finish 3 Options, if selected (see below) ▶ See <i>Surface Materials</i>, page 350

Options	Price	Required to Specify
Surface Materials <ul style="list-style-type: none"> • Top • Contrasting wood top 	+\$186	Specify with <i>contrasting wood top</i> .
Interport Power/Data Module <ul style="list-style-type: none"> • Interport Power/Data Module 	+\$321	Specify with <i>Interport</i> and select finish color number.
Related Products <ul style="list-style-type: none"> • Passerelle seating 		▶ See <i>GSA Volume 5a Specification Guide</i> .

Specification Information				
Dimensions			Style	Base Price
D	W	H	Number	Top Surface: Wood
24"	24"	17"	44-T242417	\$ 932

24"	24"	21"	44-T242421	\$1014
-----	-----	-----	------------	--------

16"	48"	30"	44-T164830	\$1395
-----	-----	-----	------------	--------

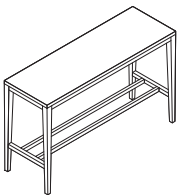
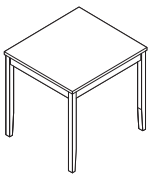
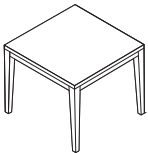

Switch

DESIGN E00S

SIN 711.11

Standard Includes **Required to Specify**

- Base: satin silver plated tubing
- Matte chrome finish
- Glass top: 5/8" thick, green tinted, tempered glass tops have radiused corners
- Adjustable glides

Style number

Related Products

- Switch seating

▶ See *GSA Volume 5a Specification Guide*.

Specification Information

Dimensions			Style	Price
D	W	H	Number	Top Surface: Glass

Square Table

24 ³ / ₈ "	24 ³ / ₈ "	15"	39-2424	\$1843
----------------------------------	----------------------------------	-----	---------	--------

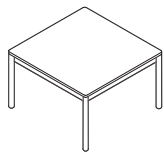

Rectangle Table

24 ³ / ₈ "	43 ¹ / ₄ "	15"	39-2442	\$2269
----------------------------------	----------------------------------	-----	---------	--------

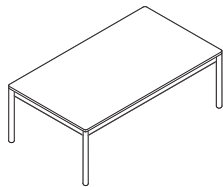

Square Table

36"	36"	15"	39-3636	\$2444
-----	-----	-----	---------	--------

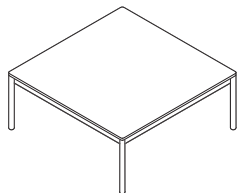

Montara650



Café Tables (SIN 711.11)

Work Height (SIN 711.11) 88

Café Height (SIN 711.11) 90

Occasional Tables (SIN 711.11) 92

Montara650 Work-Height Tables

DESIGN COALESSE DESIGN GROUP

SIN 711.11

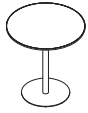

	Standard Includes	Required to Specify
<p>► Need help? Product details, see <i>Coalesse Tables, Storage, and Accessories Specification Guide</i></p>	<ul style="list-style-type: none"> Table top: <ul style="list-style-type: none"> Grade 1 laminate with 3 mm flat plastic edge Wood veneer with matching flat edge Base: grade 1 paint Glides Ships ready to assemble 	<ol style="list-style-type: none"> Style number Table top diameter for round table Table top width for square or rectangular table Table top depth for square or rectangular table Laminate or wood veneer color number for table top Plastic edge color number for laminate table top, if selected Paint color number for base Options, if selected (see below) <p>► See <i>Surface Materials</i>, page 350</p>

	Options	Price	Required to Specify
Surface Materials	Table Top		
	<ul style="list-style-type: none"> Grade 2 laminate 	Prices at right	Specify with <i>Grade 2 laminate</i> and select color number.
	<ul style="list-style-type: none"> Grade 2 wood veneer 	Prices at right	Specify with <i>Grade 2 wood veneer</i> and select color number.
	<ul style="list-style-type: none"> Stain-to-Match 	No cost	Specify with <i>Stain-to-Match</i> . ► See <i>Coalesse Surface Materials Reference Guide</i> .
	Base		
	<ul style="list-style-type: none"> Grade 3 paint on tables with single base 	+\$105	Specify paint color number.
	<ul style="list-style-type: none"> Grade 3 paint on tables with double base (30"D x 72"W) 	+\$210	Specify paint color number.
	Grommet		
	<ul style="list-style-type: none"> PowerPod grommet for 36"-60" diameter round and 36"W-42"W square tables (center only) 	+\$ 51	Specify with <i>PowerPod grommet</i> and select finish.
	<ul style="list-style-type: none"> PowerPod grommet for 30"D x 72"W rectangular tables 	+\$ 51 each grommet	Specify with <i>one or two PowerPod grommets</i> and select finish.
Related Products	<ul style="list-style-type: none"> Montara650 seating 		► See <i>GSA Volume 5a Specification Guide</i> .

Tip: Grade 3 paints are not available on 54" or 60" round tables.

Tip: PowerPod grommet is available in 6000 Black or 6052 Milk.

Montara650 Work-Height Tables

DESIGN COALESSE DESIGN GROUP

SIN 711.11

Specification Information

Style Number	Dimensions			Base Prices			
	D	W	H	Laminate Grade 1	Grade 2	Wood Veneer Grade 1	Grade 2

28½"H Round Café Tables

Style Number	Dimensions	H	Laminate Grade 1	Grade 2	Wood Veneer Grade 1	Grade 2
COSFZWTRD	24" diameter	28½"	\$1075	\$1125	\$1775	\$1975
	30" diameter	28½"	\$1150	\$1225	\$1850	\$2050
	36" diameter	28½"	\$1225	\$1325	\$1925	\$2125
	42" diameter	28½"	\$1400	\$1525	\$2200	\$2400
	54" diameter	28½"	\$2150	\$2325	\$3150	\$3350
	60" diameter	28½"	\$2250	\$2450	\$3450	\$3650

28½"H Square Café Tables

Style Number	D	W	H	Laminate Grade 1	Grade 2	Wood Veneer Grade 1	Grade 2
COSFZWTSQ	24"	24"	28½"	\$1075	\$1125	\$1775	\$1975
	30"	30"	28½"	\$1150	\$1225	\$1850	\$2050
	36"	36"	28½"	\$1225	\$1325	\$1925	\$2125
	42"	42"	28½"	\$1400	\$1525	\$2200	\$2400

28½"H Rectangular Café Tables

Style Number	D	W	H	Laminate Grade 1	Grade 2	Wood Veneer Grade 1	Grade 2
COSFZWTSQ	24"	30"	28½"	\$1125	\$1200	\$1825	\$2025
	30"	72"	28½"	\$2700	\$2925	\$4000	\$4200

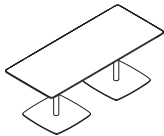
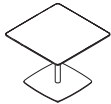

Tip: A 30"D x 72"W table has a double base.

Tip: One or two PowerPod grammets can be specified in 30"D x 72"W rectangular table.

Montara650 Café-Height Tables

DESIGN COALESSE DESIGN GROUP

SIN 711.11



	Standard Includes	Required to Specify
<p>► Need help? Product details, see <i>Coalesse Tables, Storage, and Accessories Specification Guide</i></p>	<ul style="list-style-type: none"> Table top: <ul style="list-style-type: none"> Grade 1 laminate with 3 mm flat plastic edge Wood veneer with matching flat edge Base: grade 1 paint Glides Ships ready to assemble 	<ol style="list-style-type: none"> Style number Application (see below under Required Selections) Table top diameter for round table Table top width for square or rectangular table Table top depth for square or rectangular table Laminate or wood veneer color number for table top Plastic edge color number for laminate top, if selected Paint color number for base Options, if selected (see below) <p>► See <i>Surface Materials</i>, page 350</p>

	Required Selections	Price	Required to Specify
Application	<ul style="list-style-type: none"> 36"H counter height table 42"H bar height table 	<p>No cost</p> <p>+\$ 25</p>	<p>Specify <i>with counter height</i>.</p> <p>Specify <i>with bar height</i>.</p>

	Options	Price	Required to Specify
Surface Materials	Table Top		
	<ul style="list-style-type: none"> Grade 2 laminate Grade 2 wood veneer Stain-to-Match 	<p>Prices at right</p> <p>Prices at right</p> <p>No cost</p>	<p>Specify <i>with Grade 2 laminate</i> and select color number.</p> <p>Specify <i>with Grade 2 wood veneer</i> and select color number.</p> <p>Specify <i>with Stain-to-Match</i>.</p> <p>► See <i>Coalesse Surface Materials Reference Guide</i>.</p>
	Base		
	<ul style="list-style-type: none"> Grade 3 paint on tables with single base Grade 3 paint on tables with double base (30"D x 72"W) 	<p>+\$105</p> <p>+\$210</p>	<p>Specify paint color number.</p> <p>Specify paint color number.</p>
Grommet	<ul style="list-style-type: none"> PowerPod grommet for 36"-42" diameter round and 36"W-42"W square tables (center only) PowerPod grommet for 30"D x 72"W rectangular tables 	<p>+\$ 51</p> <p>+\$ 51 each grommet</p>	<p>Specify <i>with PowerPod grommet</i> and select finish.</p> <p>Specify <i>with one or two PowerPod grommets</i> and select finish.</p>
Related Products	<ul style="list-style-type: none"> Montara650 seating 		<p>► See <i>GSA Volume 5a Specification Guide</i>.</p>

Tip: PowerPod grommet is available in 6000 Black or 6052 Milk.

Montara650 Café-Height Tables

DESIGN COALESSE DESIGN GROUP

SIN 711.11

Specification Information

Style Number	Dimensions			Base Prices			
	D	W	H	Laminate Grade 1	Grade 2	Wood Veneer Grade 1	Grade 2

36"H Round Café Tables

Style Number	Dimensions	H	Laminate Grade 1	Grade 2	Wood Veneer Grade 1	Grade 2
COSFZCTR	24" diameter	36"	\$1150	\$1200	\$1850	\$2050
	30" diameter	36"	\$1225	\$1300	\$1925	\$2125
	36" diameter	36"	\$1300	\$1400	\$2000	\$2200
	42" diameter	36"	\$1450	\$1575	\$2250	\$2450

36"H Square Café Tables

Style Number	D	W	H	Laminate Grade 1	Grade 2	Wood Veneer Grade 1	Grade 2
COSFZCTSQ	24"	24"	36"	\$1150	\$1200	\$1850	\$2050
	30"	30"	36"	\$1225	\$1300	\$1925	\$2125
	36"	36"	36"	\$1300	\$1400	\$2000	\$2200
	42"	42"	36"	\$1450	\$1575	\$2250	\$2450

36"H Rectangular Café Tables

Style Number	D	W	H	Laminate Grade 1	Grade 2	Wood Veneer Grade 1	Grade 2
COSFZCTSQ	24"	30"	36"	\$1200	\$1275	\$1900	\$2100
	30"	72"	36"	\$2775	\$3000	\$4075	\$4275

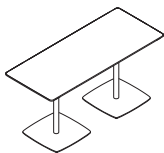
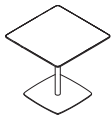

Tip: A 30"D x 72"W table has a double base.

Tip: One or two PowerPod grommets can be specified in 30"D x 72"W rectangular café table.

Montara650 Occasional-Height Tables

DESIGN COALESSE DESIGN GROUP

SIN 711.11

Standard Includes		Required to Specify
<ul style="list-style-type: none"> ► Need help? Product details, see <i>Coalesse Tables, Storage, and Accessories Specification Guide</i> 	<ul style="list-style-type: none"> • Table top: <ul style="list-style-type: none"> - Grade 1 laminate with 3 mm flat plastic edge - Wood veneer with matching flat edge • Base: grade 1 paint • Glides • Ships ready to assemble 	<ol style="list-style-type: none"> 1 Style number 2 Table top diameter for round table 3 Table top depth and width for square table 4 Laminate or wood veneer color number for table top 5 Plastic edge color number for laminate table top, if selected 6 Paint color number for base 7 Options, if selected (see below) <p>► See <i>Surface Materials</i>, page 350</p>

Options	Price	Required to Specify
Surface Materials <ul style="list-style-type: none"> • Table top • Grade 2 laminate • Grade 2 wood veneer • Stain-to-Match 	<p>Prices below</p> <p>Prices below</p> <p>No cost</p>	<p>Specify with <i>Grade 2 laminate</i> and select color number.</p> <p>Specify with <i>Grade 2 wood veneer</i> and select color number.</p> <p>Specify with <i>Stain-to-Match</i>.</p> <p>► See <i>Coalesse Surface Materials Reference Guide</i>.</p>
Base <ul style="list-style-type: none"> • Grade 3 paint 	<p>+\$105</p>	<p>Specify paint color number.</p>
Grommet <ul style="list-style-type: none"> • PowerPod grommet (center only) 	<p>+\$ 51</p>	<p>Specify with <i>PowerPod grommet</i> and select finish.</p>
Related Products <ul style="list-style-type: none"> • Montara650 seating 		<p>► See <i>GSA Volume 5a Specification Guide</i>.</p>

Tip: PowerPod grommet is available in 6000 Black or 6052 Milk.

Specification Information

Style Number	Dimensions			Base Prices			
	D	W	H	Laminate		Wood Veneer	
				Grade 1	Grade 2	Grade 1	Grade 2

Round Tables

COSFZOTRD	30" diameter		18"	\$1000	\$1075	\$1700	\$1900
	36" diameter		18"	\$1075	\$1175	\$1775	\$1975
	42" diameter		18"	\$1200	\$1325	\$2000	\$2200

Square Tables

COSFZOTSQ	30"	30"	18"	\$1000	\$1075	\$1700	\$1900
	36"	36"	18"	\$1075	\$1175	\$1775	\$1975
	42"	42"	18"	\$1200	\$1325	\$2000	\$2200

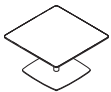

Train

Rectangular Tables (SIN 711.11)	94
90° Corner Tops (SIN 711.11)	100
Accessories (SIN 711.11)	101

Train Rectangular Tables

DESIGN VECTA DESIGN TEAM AND IDEO

SIN 711.11

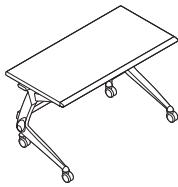

Tip: Shipped knocked down.

Tip: All electrical system components (raceways, receptacles, base power infeeds, etc.) must be the same wiring schematic.

Tip: Raceway has access doors on both aisle and kneewell sides.

Tip: Modular connector occupies one receptacle location in raceway.

Standard Includes	Required to Specify
<ul style="list-style-type: none"> ▶ Need help? Product details, see <i>Coalesse Tables, Storage, and Accessories Specification Guide</i> • Top: 1" particle board core with High-Pressure Laminate • Edge: black soft rolled front edge with black vinyl with black 3 mm sides and back • Base: cast aluminum legs and steel stretcher bar with single powder coat color • Coupling device to allow adjacent tables to be connected end-to-end • 3" diameter, locking, dual-wheel casters: black plastic 	<ol style="list-style-type: none"> 1 Style number 2 Powder coat color number for base 3 Laminate color number for top 4 Options, if selected (see below) <p>▶ See <i>Surface Materials</i>, page 350.</p>

Options	Price	Required to Specify
Surface Materials <ul style="list-style-type: none"> • Grade 2 laminate 	Prices at right	Specify with <i>Grade 2 laminate</i> and select color number.
Modesty panel Flip-down modesty panel <ul style="list-style-type: none"> • 48"W • 60"W • 72"W 	<ul style="list-style-type: none"> +\$ 569 +\$ 596 +\$ 624 	<ul style="list-style-type: none"> Specify with <i>48"W modesty panel</i>. Specify with <i>60"W modesty panel</i>. Specify with <i>72"W modesty panel</i>.
Raceways with 4-circuit electrical <ul style="list-style-type: none"> • 48"L Table • 60"L Table • 72"L Table 	<ul style="list-style-type: none"> +\$1197 +\$1290 +\$1348 	<ul style="list-style-type: none"> Specify with <i>48"L electrical raceway</i>, and the type of electrical system: 3+1 electrical, system, 2+2 electrical system, or three-circuit, separate neutrals electrical system. Specify with <i>60"L electrical raceway</i>, and the type of electrical system: 3+1 electrical, system, 2+2 electrical system, or three-circuit, separate neutrals electrical system. Specify with <i>72"L electrical raceway</i>, and the type of electrical system: 3+1 electrical, system, 2+2 electrical system, or three-circuit, separate neutrals electrical system.
Raceways without 4-circuit electrical system <ul style="list-style-type: none"> • 48"L Table • 60"L Table • 72"L Table 	<ul style="list-style-type: none"> +\$ 846 +\$ 911 +\$ 955 	<ul style="list-style-type: none"> Specify with <i>48"L raceway</i>, and no electrical system. Specify with <i>60"L raceway</i>, and no electrical system. Specify with <i>72"L raceway</i>, and no electrical system.
POD Power and communication module with hinged cover: black plastic with black painted steel septum <ul style="list-style-type: none"> • POD with 9' cord with 15-amp plug • POD with 6' conduit with hardwire in-feed • POD with 3+1 modular connector for attachment to power module in 3+1 raceway 	<ul style="list-style-type: none"> +\$ 352 +\$ 352 +\$ 352 	<ul style="list-style-type: none"> Specify with <i>POD, plug</i>. Specify with <i>POD, hardwire</i>. Specify with <i>POD, modular</i> and select circuit number 1, 2, 3, or 4.

▶ Options, continued on next page

Train Rectangular Tables

DESIGN VECTA DESIGN TEAM AND IDEO

SIN 711.11

►Options, continued from previous page

Tip: For Axil Z and Ellora, the USB for charging is configured in the spot of one data port and is always configured on the end(s).

Tip: For each USB port specified, there are two USBs per port.

Tip: The hardwire or modular POD, hardwire Axil Z, or hardwire Ellora desktop module does not work with modular table power kits.

Tip: If a hardwire or modular POD, hardwire Axil Z, or hardwire Ellora desktop module is desired, then it can only be specified on tables with glides.

Tip: If one Axil Z desktop unit is specified other than center location, it can only be used on tables specified without raceway. If raceway is specified, then center location is only available location.

Tip: When a four power Axil Z or Ellora corded device is specified, the 15-amp plug end requires a circuit breaker, therefore the plug end is different.

Tip: If one Axil Z desktop unit is specified other than center location, it can only be used on tables specified without raceway. If raceway is specified, then center location is only available location.

	Options	Price	Required to Specify
Axil Z	One 6' cord (48"L and center only)		
	• Two power/two data	+\$221	Specify with one center Axil Z cord with two power/two data and select color number.
	• Two power/one data/one USB	+\$319	Specify with one center Axil Z cord with two power/one data/one USB and select color number.
	• Two power/two USB	+\$417	Specify with one center Axil Z cord with two power/two USB and select color number.
	• Three power/one data	+\$227	Specify with one center Axil Z cord with three power/one data and select color number.
	• Three power/one USB	+\$324	Specify with one center Axil Z cord with three power/one USB and select color number.
	• Four power	+\$288	Specify with one center Axil Z cord with four power and select color number.
	One 6' hardwire (48"L and center only)		
	• Two power/two data	+\$221	Specify with one center Axil Z hardwire with two power/two data and select color number.
	• Two power/one data/one USB	+\$319	Specify with one center Axil Z hardwire with two power/one data/one USB and select color number.
	• Two power/two USB	+\$417	Specify with one center Axil Z hardwire with two power/two USB and select color number.
	• Three power/one data	+\$227	Specify with one center Axil Z hardwire with three power/one data and select color number.
• Three power/one USB	+\$324	Specify with one center Axil Z hardwire with three power/one USB and select color number.	
• Four power	+\$288	Specify with one center Axil Z hardwire with four power and select color number.	
Axil Z	One 6' cord (60"L and 72"L only)		
	• Two power/two data	+\$221	Specify with one Axil Z cord with two power/two data, select left, right, or center location and select color number.
	• Two power/one data/one USB	+\$319	Specify with one Axil Z cord with two power/one data/one USB, select left, right, or center location and select color number.
	• Two power/two USB	+\$417	Specify with one Axil Z cord with two power/two USB, select left, right, or center location and select color number.
	• Three power/one data	+\$227	Specify with one Axil Z cord with three power/one data, select left, right, or center location and select color number.
	• Three power/one USB	+\$324	Specify with one Axil Z cord with three power/one USB, select left, right, or center location and select color number.
	• Four power	+\$288	Specify with one Axil Z cord with four power, select left, right, or center location and select color number.
	One 6' hardwire (60"L and 72"L only)		
	• Two power/two data	+\$221	Specify with one Axil Z hardwire with two power/two data, select left, right, or center location and select color number.
	• Two power/one data/one USB	+\$319	Specify with one Axil Z hardwire with two power/one data/one USB, select left, right, or center location and select color number.
	• Two power/two USB	+\$417	Specify with one Axil Z hardwire with two power/two USB, select left, right, or center location and select color number.
	• Three power/one data	+\$227	Specify with one Axil Z hardwire with three power/one data, select left, right, or center location and select color number.
• Three power/one USB	+\$324	Specify with one Axil Z hardwire with three power/one USB, select left, right, or center location and select color number.	
• Four power	+\$288	Specify with one Axil Z hardwire with four power, select left, right, or center location and select color number.	

►Options, continued on next page

Train Rectangular Tables *continued*
 DESIGN VECTA DESIGN TEAM AND IDEO

SIN 711.11

►Options, continued from previous page

	Options	Price	Required to Specify
Axil Z, continued	Two 6' cords (60"L and 72"L only)		
	• Two power/two data	+\$442	Specify with two (left and right) Axil Z cords with two power/two data and select color number.
	• Two power/one data/one USB	+\$638	Specify with two (left and right) Axil Z cords with two power/one data/one USB and select color number.
	• Two power/two USB	+\$834	Specify with two (left and right) Axil Z cords with two power/two USB and select color number.
	• Three power/one data	+\$454	Specify with two (left and right) Axil Z cords with three power/one data and select color number.
	• Three power/one USB	+\$648	Specify with two (left and right) Axil Z cords with three power/one USB and select color number.
	• Four power	+\$576	Specify with two (left and right) Axil Z cords with four power and select color number.
	Two 6' hardwires (60"L and 72"L only)		
	• Two power/two data	+\$442	Specify with two (left and right) Axil Z hardwires with two power/two data and select color number.
	• Two power/one data/one USB	+\$638	Specify with two (left and right) Axil Z hardwires with two power/one data/one USB and select color number.
	• Two power/two USB	+\$834	Specify with two (left and right) Axil Z hardwires with two power/two USB and select color number.
	• Three power/one data	+\$454	Specify with two (left and right) Axil Z hardwires with three power/one data and select color number.
	• Three power/one USB	+\$648	Specify with two (left and right) Axil Z hardwires with three power/one USB and select color number.
	• Four power	+\$576	Specify with two (left and right) Axil Z hardwires with four power and select color number.
Ellora	One 6' cord (center only)		
	• Two power/two data	+\$335	Specify with one center Ellora cord with two power/two data.
	• Two power/one data/one USB	+\$433	Specify with one center Ellora cord with two power/one data/one USB.
	• Two power/two USB	+\$530	Specify with one center Ellora cord with two power/two USB.
	• Three power/one data	+\$340	Specify with one center Ellora cord with three power/one data.
	• Three power/one USB	+\$438	Specify with one center Ellora cord with three power/one USB.
	• Four power	+\$402	Specify with one center Ellora cord with four power.
	One 6' hardwire (center only)		
	• Two power/two data	+\$335	Specify with one center Ellora cord with two power/two data.
	• Two power/one data/one USB	+\$433	Specify with one center Ellora cord with two power/one data/one USB.
	• Two power/two USB	+\$530	Specify with one center Ellora cord with two power/two USB.
	• Three power/one data	+\$340	Specify with one center Ellora cord with three power/one data.
	• Three power/one USB	+\$438	Specify with one center Ellora cord with three power/one USB.
	• Four power	+\$402	Specify with one center Ellora cord with four power.

Tip: If two Ellora desktop units are specified, they can only be used on tables specified without raceway. If raceway is specified, then center location is only available location.

Tip: For a factory installed cutout in the tabletop, specify POD, Axil Z, or Ellora as an option. If a POD, Axil Z, or Ellora is not specified as an option, the table top will require a field installed cutout.

Tip: For POD, Axil Z, Ellora, and grommet locations, see Standard Locations Grommets, Spheres, Interport, Mini-Port, Interact, Axil Z, and Ellora Charts. ►See Coalesse Tables, Storage, and Accessories Specification Guide.

►Options, continued on next page

►Options, continued from previous page

	Options	Price	Required to Specify
Ellora, continued	Two 6' cords (30"W x 60"L and 30"W x 72"L only)		
	• Two power/two data	+\$ 670	Specify with one center Ellora cords with two power/two data.
	• Two power/one data/one USB	+\$ 866	Specify with one center Ellora cords with two power/one data/one USB.
	• Two power/two USB	+\$1060	Specify with one center Ellora cords with two power/two USB.
	• Three power/one data	+\$ 680	Specify with one center Ellora cords with three power/one data.
	• Three power/one USB	+\$ 876	Specify with one center Ellora cords with three power/one USB.
	• Four power	+\$ 804	Specify with one center Ellora cords with four power.
	Two 6' hardwires (30"W x 60"L and 30"W x 72"L only)		
	• Two power/two data	+\$ 670	Specify with one center Ellora cords with two power/two data.
	• Two power/one data/one USB	+\$ 866	Specify with one center Ellora cords with two power/one data/one USB.
	• Two power/two USB	+\$1060	Specify with one center Ellora cords with two power/two USB.
	• Three power/one data	+\$ 680	Specify with one center Ellora cords with three power/one data.
	• Three power/one USB	+\$ 876	Specify with one center Ellora cords with three power/one USB.
• Four power	+\$ 804	Specify with one center Ellora cords with four power.	

►Options, continued on next page

Train Rectangular Tables continued

DESIGN VECTA DESIGN TEAM AND IDEO

SIN 711.11

►Options, continued from previous page

Tip: Modular table power kits require either a 20-amp plug infeed or hardwire infeed to power the tables. A 20-amp plug infeed can only be used with Circuit 1 receptacles, and the hardwire infeed can be used with either or both, Circuit 1 and Circuit 2 receptacles.

Tip: Flex ganger or bar ganger package must be used when using modular power table kits in a table-to-table application.

Tip: The modular table power kit does not work with the raceways, with electrical or without electrical system, it can be used with or without a modesty panel.

Tip: The modular table power kit is a 2-circuit system and is not compatible with the 4-circuit electrical in the raceway. The connectors are also not compatible.

Tip: When three grommets are specified, grommets will be located left, right, and center.

	Options	Price	Required to Specify
2-Circuit Modular Table Power Kits	One circuit 1 duplex receptacle		
	• For 48"L tables - modular power kit with one center duplex receptacle, circuit 1	+\$216	Specify with 48"L modular power kit with circuit 1 duplex receptacle.
	• For 60"L tables - modular power kit with one center duplex receptacle, circuit 1	+\$231	Specify with 60"L modular power kit with circuit 1 duplex receptacle.
	• For 72"L tables - modular power kit with one center duplex receptacle, circuit 1	+\$245	Specify with 72"L modular power kit with circuit 1 duplex receptacle.
	One circuit 2 duplex receptacle (To be used with hardwire infeed only)		
	• For 48"L tables - modular power kit with one center duplex receptacle, circuit 2	+\$216	Specify with 48"L modular power kit with circuit 2 duplex receptacle.
	• For 60"L tables - modular power kit with one center duplex receptacle, circuit 2	+\$231	Specify with 60"L modular power kit with circuit 2 duplex receptacle.
	• For 72"L tables - modular power kit with one center duplex receptacle, circuit 2	+\$245	Specify with 72"L modular power kit with circuit 2 duplex receptacle.
	Two circuit 1 duplex receptacles (60"L and 72"L tables only)		
	• For 60"L tables - modular power kit with two center duplex receptacles, circuit 1	+\$299	Specify with 60"L modular power kit with circuit 1 duplex receptacles.
• For 72"L tables - modular power kit with two center duplex receptacles, circuit 1	+\$314	Specify with 72"L modular power kit with circuit 1 duplex receptacles.	
One circuit 1 and one circuit 2 duplex receptacles (60"L and 72"L tables only) (To be used with hardwire infeed only)			
• For 60"L tables - modular power kit with two center duplex receptacles, one circuit 1 and one circuit 2	+\$299	Specify with 60"L modular power kit with one circuit 1 and one circuit 2 duplex receptacles.	
• For 72"L tables - modular power kit with two center duplex receptacles, one circuit 1 and one circuit 2	+\$314	Specify with 72"L modular power kit with one circuit 1 and one circuit 2 duplex receptacles.	
Grommets	• One grommet: black plastic	+\$ 68	Specify with grommet and select left, right, or center location.
	• Two grommets: black plastic	+\$136	Specify with two grommets and select location of left/center, right/center, or right/left.
	• Three grommets: black plastic	+\$204	Specify with three grommets.
Glides	• Glides: aluminum with black textured powder coat	+\$153	Delete suffix C from the style number.

Train Rectangular Tables

DESIGN VECTA DESIGN TEAM AND IDEO

SIN 711.11

Specification Information

Dimensions			Style Number	Finish	Base Price
L	W	H			
					 Train Vinyl Edge:

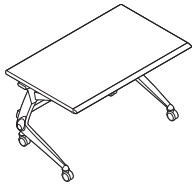
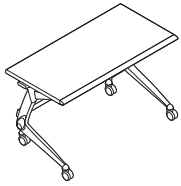

24"W Rectangular Tables

48"	24"	28½"	TN4824C	Grade 1 Laminate	\$1728
				Grade 2 Laminate	\$1774
60"	24"	28½"	TN6024C	Grade 1 Laminate	\$1873
				Grade 2 Laminate	\$1927
72"	24"	28½"	TN7224C	Grade 1 Laminate	\$1918
				Grade 2 Laminate	\$1982

30"W Rectangular Tables

48"	30"	28½"	TN4830C	Grade 1 Laminate	\$1812
				Grade 2 Laminate	\$1867
60"	30"	28½"	TN6030C	Grade 1 Laminate	\$1904
				Grade 2 Laminate	\$1974
72"	30"	28½"	TN7230C	Grade 1 Laminate	\$1976
				Grade 2 Laminate	\$2061

Train 90° Corner Tops

DESIGN VECTA DESIGN TEAM AND IDEO

SIN 711.11



Tip: Shipped knocked down.

Standard Includes		Required to Specify
<ul style="list-style-type: none"> ▶ Need help? Product details, see <i>Coalesse Tables, Storage, and Accessories Specification Guide</i> 	<ul style="list-style-type: none"> • Top: 1" particle board core with High-Pressure Laminate • Edge: black soft rolled front edge with black vinyl • Connecting hardware 	<ul style="list-style-type: none"> 1 Style number 2 Laminate color number for top 3 Options, if selected (see below) <p>▶ See <i>Coalesse Surface Materials Reference Guide</i>.</p>

Options	Price	Required to Specify
Surface Materials <ul style="list-style-type: none"> • Grade 2 laminate 	Prices below	Specify with <i>Grade 2 laminate</i> and select color number.
Corner raceways (for 4-circuit electrical system connection only) <ul style="list-style-type: none"> • Corner raceway with four-circuit, 3+1 electrical system • Corner raceway with four-circuit, 2+2 electrical system • Corner raceway with three-circuit, separate neutrals electrical system • Corner raceway with no electrical system harness or power blocks 	<ul style="list-style-type: none"> +\$413 +\$413 +\$413 +\$413 	<ul style="list-style-type: none"> Specify with <i>3+1 corner raceway</i>. Specify with <i>2+2 corner raceway</i>. Specify with <i>separate neutrals corner raceway</i>. Specify corner raceway with no electrical.
Jumper (for 2-circuit modular table power kit connection only) <ul style="list-style-type: none"> • Jumper kit with one male and one female modular connector 	+\$ 62	Specify with <i>jumper kit</i> .

Tip: All electrical system components (raceways, receptacles, base power infeeds, etc.) must be the same wiring schematic: 3+1, 2+2, or three-circuit, separate neutrals.

Tip: When using modular table power kits and connecting tops, a jumper kit must be specified for the corner, in order to maintain the power connection from table to table.

Tip: The modular table power jumper kit is a 2-circuit system and is not compatible with the 4-circuit electrical in the raceway. The connectors are also not compatible.

Specification Information			
Dimension	Style Number	Finish	Base Price
W			<p>Train Vinyl Edge:</p>

90° Corner Tops

24"	TN90D24	Grade 1 Laminate	\$556
		Grade 2 Laminate	\$580
30"	TN90D30	Grade 1 Laminate	\$608
		Grade 2 Laminate	\$648

Glides



Standard Includes		Required to Specify
<ul style="list-style-type: none"> Set of four glides for field retrofit: textured black powder coat 		Style number
Specification Information		
Style Number	Price	
TNGL	\$158	

Four-Circuit Receptacles



Tip: For alternative wiring configurations, see Options.

Tip: All electrical system components (raceways, receptacles, base power infeeds, etc.) must be the same wiring schematic: 3+1, 2+2, or three-circuit, separate neutrals.

Tip: Four-circuit receptacles are only compatible with raceway with electrical.

Standard Includes		Required to Specify
<ul style="list-style-type: none"> Duplex receptacle: black plastic only Four circuit, 3+1 wiring configuration 		1 Style number 2 Options, if selected (see below)
Options	Price	Required to Specify
Four-circuit, 2+2 wiring configuration	<ul style="list-style-type: none"> Four-circuit, 2+2 wiring configuration No cost	Add suffix Y to the style number.
Three-circuit, separate neutrals wiring configuration	<ul style="list-style-type: none"> Three-circuit, separate neutrals wiring configuration No cost	Add suffix Z to the style number.
Specification Information		
Style Number	Price	
Circuit 1		
321891	\$23	
Circuit 2		
321892	\$23	
Circuit 3		
321893	\$23	
Circuit 4, Isolated		
321894	\$23	

PODs

Tip: PODs in Train tables are specified by selecting the POD option when specifying a Train table. These PODs are field-installed and are not intended for use with tables other than Train.

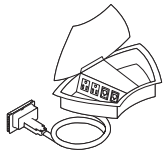
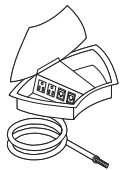

Tip: The modular POD connects to the power block in the raceway in place of a duplex receptacle.

Tip: Modular POD is only compatible with raceway with electrical.

Standard Includes	Required to Specify
<ul style="list-style-type: none"> Power and communication module with hinged cover: black plastic with black painted steel septum to separate power and data Two-port furniture faceplates, amp 	Style number

Specification Information

Style Number	Price
--------------	-------

9' Cord with Plug

PODPL	\$337
-------	-------

6' Conduit for Hardwire

PODHW	\$337
-------	-------

3' Conduit with Modular Connector

Circuit 1	
PODMD1	\$352
Circuit 2	
PODMD2	\$352
Circuit 3	
PODMD3	\$352
Circuit 4	
PODMD4	\$352

Axil Z, Cord

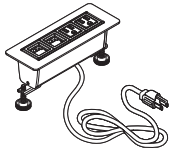

Tip: The Axil Z desktop module will ship with instructions and a hole cutout template for field installation, if needed.

Tip: For a factory installed cutout in the table top, specify Axil Z as an option for Train. If you do not specify Axil Z as an option, where applicable, the table top will require a field installed cutout.

► See Coalesse Tables, Storage, and Accessories Specification Guide for cutout locations.

Tip: For any other tables, other than Train, that require an Axil Z desktop module, a special engineering quote is mandatory. If you require a factory installed cutout in a location other than standard, send us a drawing with measurements indicating the exact location(s) required in the table top.

Tip: USB for charging is configured in the spot of one data port and is always configured on the end(s).

Tip: For each USB port specified, there are two USBs per port.

Tip: When a four power Axil Z or Ellora corded device is specified, the 15-amp plug end requires a circuit breaker, therefore the plug end is different.

Standard Includes **Required to Specify**

- Desktop module, mounts flat just above worksurface:
 - 4140 Arctic White
 - 4144 Black Gloss
- 6' power cord with 15-amp plug
- Requires 6¾" x 2" cutout
- Utilizes water-proof simplexes (outlets)
- UL listed
- Voice|Data adaptor kit to accept couplers and jacks when needed (refer to telecommunications reference chart)

- 1 Style number
- 2 Desktop module configuration (see Required Selections below)
- 3 Paint color number for desktop module

Options **Price** **Required to Specify**

Options	Price	Required to Specify
Power/Data/USB Configuration		
• Two power/two data	No cost	Specify with two power/two data and select color number.
• Two power/one data/one USB	+\$ 98	Specify with two power/two data/one USB and select color number.
• Two power/two USB	+\$196	Specify with two power/two USB and select color number.
• Three power/one data	+\$ 5	Specify with three power/one data and select color number.
• Three power/one USB	+\$103	Specify with three power/one USB and select color number.
• Four power	+\$ 67	Specify with four power and select color number.

Specification Information

Dimensions			Style Number	Base Price
D	W	H		
3"	8"	2¾"	CODPA4	\$196

Train

Axil Z, Hardwire

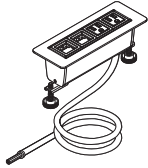

Tip: The Axil Z desktop module will ship with instructions and a hole cutout template for field installation, if needed.

Tip: For a factory installed cutout in the table top, specify Axil Z as an option for Train. If you do not specify Axil Z as an option, where applicable, the table top will require a field installed cutout.

► See Coalesse Tables, Storage, and Accessories Specification Guide for cutout locations.

Tip: For any other tables, other than Train, that require an Axil Z desktop module, a special engineering quote is mandatory. If you require a factory installed cutout in a location other than standard, send us a drawing with measurements indicating the exact location(s) required in the table top.

Tip: USB for charging is configured in the spot of one data port and is always configured on the end(s).

Tip: For each USB port specified, there are two USBs per port.

Tip: The hardwire Axil Z desktop module does not work with modular table power kits.

Tip: If a hardwire Axil Z desktop module is desired, then it should only be specified on tables with glides.

Standard Includes **Required to Specify**

- Desktop module, mounts flat just above worksurface:
 - 4140 Arctic White
 - 4144 Black Gloss
- 6' flexible steel hardwire conduit
- Requires 6³/₄" x 2" cutout
- Utilizes water-proof simplex (outlets)
- UL listed
- Voice/data adaptor kit to accept couplers and jacks when needed (refer to telecommunications reference chart)

- 1 Style number
- 2 Desktop module configuration (see Required Selections below)
- 3 Paint color number for desktop module

Options **Price** **Required to Specify**

Power/Data/USB Configuration

- Two power/two data No cost
- Two power/one data/one USB +\$ 98
- Two power/two USB +\$196
- Three power/one data +\$ 5
- Three power/one USB +\$103
- Four power +\$ 67

- Specify with *two power/two data* and select color number.
Specify with *two power/one data/one USB* and select color number.
Specify with *two power/two USB* and select color number.
Specify with *three power/one data* and select color number.
Specify with *three power/one USB* and select color number.
Specify with *four power* and select color number.

Specification Information

Dimensions			Style Number	Base Price
D	W	H		
3"	8"	2 ³ / ₈ "	CODHA4	\$196

Ellora, cord

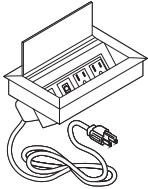

Tip: The Ellora desktop module will ship with instructions and a hole cutout template for field installation, if needed.

Tip: For a factory installed cutout in the table top, specify Ellora as an option for Train. If you do not specify Ellora as an option, where applicable, the table top will require a field installed cutout.

► See Coalesse Tables, Storage, and Accessories Specification Guide for cutout locations.

Tip: For any other tables, other than Train, that require an Ellora desktop module, a special engineering quote is mandatory. If you require a factory installed cutout in a location other than standard, send us a drawing with measurements indicating the exact location(s) required in the table top.

Tip: USB for charging is configured in the spot of one data port and is always configured on the end(s).

Tip: For each USB port specified, there are two USBs per port.

Tip: When a four power Axil Z or Ellora corded device is specified, the 15-amp plug end requires a circuit breaker, therefore the plug end is different.

Standard Includes **Required to Specify**

- Desktop module with lid, mounts flat just above worksurface: anodized aluminum with black faceplate
 - 6' power cord with 15-amp plug
 - Requires 8" x 5" cutout
 - Utilizes water-proof simplex (outlets)
 - UL listed
 - Voice/data adaptor kit to accept couplers and jacks when needed (refer to telecommunications reference chart)
- 1 Style number
2 Desktop module configuration (see Required Selections below)

Options **Price** **Required to Specify**

Power/Data/USB Configuration	Options	Price	Required to Specify
	• Two power/two data	No cost	Specify with two power/two data.
	• Two power/one data/one USB	+\$ 98	Specify with two power/one data/one USB.
	• Two power/two USB	+\$196	Specify with two power/two USB.
	• Three power/one data	+\$ 5	Specify with three power/one data.
	• Three power/one USB	+\$103	Specify with three power/one USB.
	• Four power	+\$ 67	Specify with four power.

Specification Information

Dimensions			Style Number	Base Price
D	W	H		
5¼"	8¼"	3½"	CODPE4	\$309

Ellora, Hardware

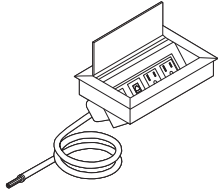

Tip: The Ellora desktop module will ship with instructions and a hole cutout template for field installation, if needed.

Tip: For a factory installed cutout in the table top, specify Ellora as an option for Train. If you do not specify Ellora as an option, where applicable, the table top will require a field installed cutout.

► See *Coalesse Tables, Storage, and Accessories Specification Guide* for cutout locations.

Tip: For any other tables, other than Train, that require an Ellora desktop module, a special engineering quote is mandatory. If you require a factory installed cutout in a location other than standard, send us a drawing with measurements indicating the exact location(s) required in the table top.

Tip: USB for charging is configured in the spot of one data port and is always configured on the end(s).

Tip: For each USB port specified, there are two USBs per port.

Tip: The hardware Ellora desktop module does not work with modular table power kits.

Tip: If a hardware Ellora desktop module is desired, then it should only be specified on tables with glides.

Standard Includes **Required to Specify**

- Desktop module with lid, mounts flat just above worksurface: anodized aluminum with black faceplate
 - 6' flexible steel hardware conduit
 - Requires 8" x 5" cutout
 - Utilizes water-proof simplex (outlets)
 - UL listed
 - Voice/data adaptor kit to accept couplers and jacks when needed (refer to telecommunications reference chart)
- 1 Style number
2 Desktop module configuration (see Required Selections below)

Options **Price** **Required to Specify**

Power/Data/USB Configuration	Options	Price	Required to Specify
	• Two power/two data	No cost	Specify with two power/two data.
	• Two power/one data/one USB	+\$ 98	Specify with two power/one data/one USB.
	• Two power/two USB	+\$196	Specify with two power/two USB.
	• Three power/one data	+\$ 5	Specify with three power/one data.
	• Three power/one USB	+\$103	Specify with three power/one USB.
	• Four power	+\$ 67	Specify with four power.

Specification Information

Dimensions			Style Number	Base Price
D	W	H		
5¼"	8¼"	3½"	CODHE4	\$309

Four-Circuit, Hardwire Base Power Infeed

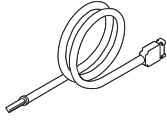

Tip: For alternative wiring configurations, see Options.

Tip: All electrical system components (raceways, receptacles, base power infeeds, etc.) must be the same wiring schematic: 3+1, 2+2, or three-circuit, separate neutrals.

Tip: Four-circuit hardwire base power infeed is only compatible with raceway with electrical.

Standard Includes		Required to Specify
<ul style="list-style-type: none"> Four-circuit power infeed with eight-wire pig tail for hardwire connection on one end and modular connector on the other end, 6'L: black 		1 Style number 2 Options, if selected (see below)

Options	Price	Required to Specify
Four-circuit, 2+2 wiring configuration <ul style="list-style-type: none"> Four-circuit, 2+2 wiring configuration 	No cost	Add suffix Y to the style number.
Three-circuit, separate neutrals wiring configuration <ul style="list-style-type: none"> Three-circuit, separate neutrals wiring configuration 	No cost	Add suffix Z to the style number.

Specification Information	
Style Number	Price
TNBPIHW	\$297
Approved for Use in New York City	
TNBPINY	\$297

Train

Four-Circuit Modular Base Power Infeeds

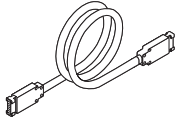

Tip: Modular base power infeed requires four-circuit wall jack, 321899.

▶ See below

Tip: For alternative wiring configurations, see Options.

Tip: All electrical system components (raceways, receptacles, base power infeeds, etc.) must be the same wiring schematic: 3+1, 2+2, or three-circuit, separate neutrals.

Tip: Four-circuit modular base power infeed is only compatible with raceway with electrical.

Standard Includes		Required to Specify	
<ul style="list-style-type: none"> Four-circuit power infeed with modular connectors on both ends, 6'L: black 		1 Style number 2 Options, if selected (see below)	

Options	Price	Required to Specify
Four-circuit, 2+2 wiring configuration <ul style="list-style-type: none"> Four-circuit, 2+2 wiring configuration 	No cost	Add suffix Y to the style number.

Three-circuit, separate neutrals wiring configuration <ul style="list-style-type: none"> Three-circuit, separate neutrals wiring configuration 	No cost	Add suffix Z to the style number.
--	---------	--

Specification Information	
Style Number	Price
TNBPIMD	\$297

Four-Circuit Wall Jack/Faceplate

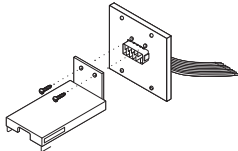

Tip: Wall jack requires 4 1/16" square wall junction box, not included.

Tip: Wall jack requires modular base power infeed.

▶ See above

Tip: Four-circuit wall jack is only compatible with raceway with electrical.

Standard Includes		Required to Specify	
<ul style="list-style-type: none"> Wall jack with four-circuit modular connector: black Strain relief bracket 		1 Style number 2 Options, if selected (see below)	

Options	Price	Required to Specify
Four-circuit, 2+2 wiring configuration <ul style="list-style-type: none"> Four-circuit, 2+2 wiring configuration 	No cost	Add suffix Y to the style number.

Three-circuit, separate neutrals wiring configuration <ul style="list-style-type: none"> Three-circuit, separate neutrals wiring configuration 	No cost	Add suffix Z to the style number.
--	---------	--

Specification Information	
Style Number	Price
321899	\$63

Single-Circuit 20-Amp Plug Base Power Infeed

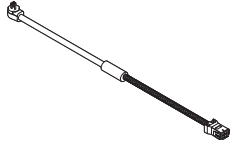

Tip: The hardwire desktop modules do not work with modular table power kits, therefore, do not require any type of infeeds.

Tip: The plug infeed can only be used with circuit 1 modular table power kits.

Tip: Plug infeed can be used on tables with glides or casters.

Standard Includes	Required to Specify
<ul style="list-style-type: none"> Single circuit (circuit 1) power infeed with 20-amp plug on one end and male modular connection on the other end: 24" of thick rubber on plug end with coupler attaching 48" of conduit with modular connection UL recognized 	Style number

Specification Information		
Dimensions Length	Style Number	Price
72"	COBPIFMP20	\$221

Two-Circuit Hardwire Base Power Infeed



Tip: The hardwire desktop modules do not work with modular table power kits, therefore, do not require any type of infeeds.

Tip: The hardwire infeed must be used on tables with glides only.

Standard Includes	Required to Specify
<ul style="list-style-type: none"> 2 circuit power infeed with 4-wire pigtail for hardwire connection on one end and male modular connection on the other end: flexible steel conduit UL listed 	Style number

Specification Information		
Dimensions Length	Style Number	Price
72"	COBPIFMH	\$237

Train Accessories *continued*

DESIGN VECTA DESIGN TEAM AND IDEO

SIN 711.11

Power Strip

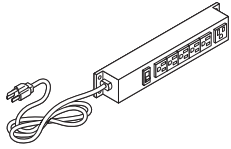

10 1/2" L x 1 3/4" W x 1 1/2" D

Standard Includes	Required to Specify
<ul style="list-style-type: none">• Power strip with 15' cord and three-prong plug; black• Six 15-amp power outlets• On-off switch• Surge suppressor	Style number

Specification Information

Style Number	Price
793330	\$250

Conference Tables

Overview	112
Statement of Line	113

E-Table 2 (SIN 711.11)	127
Host Collection (SIN 711.11)	163
Reunion Collection (SIN 711.11)	285
SW_1 (SIN 711.11)	305

Overview

Cafeteria/Dining/Commons

- Reunion Collection, page 285

Conference/Boardroom/Private Office

- E-Tables 2, page 127
- Host, page 163

Training/Multi-Purpose/Classroom

- Reunion Collection, page 285

Statement of Line

E-Table 2

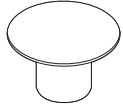

Specifying
▶ Page 128

E-Table 2 Round Tables

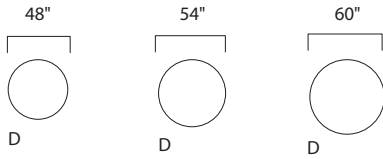

D = Drum base

Veneer and woodgrain
laminate direction



Statement of Line *continued*

E-Table 2, continued

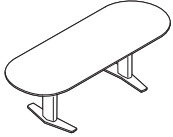

Specifying
▶ Pages 130-154

E-Table 2 Racetrack Tables

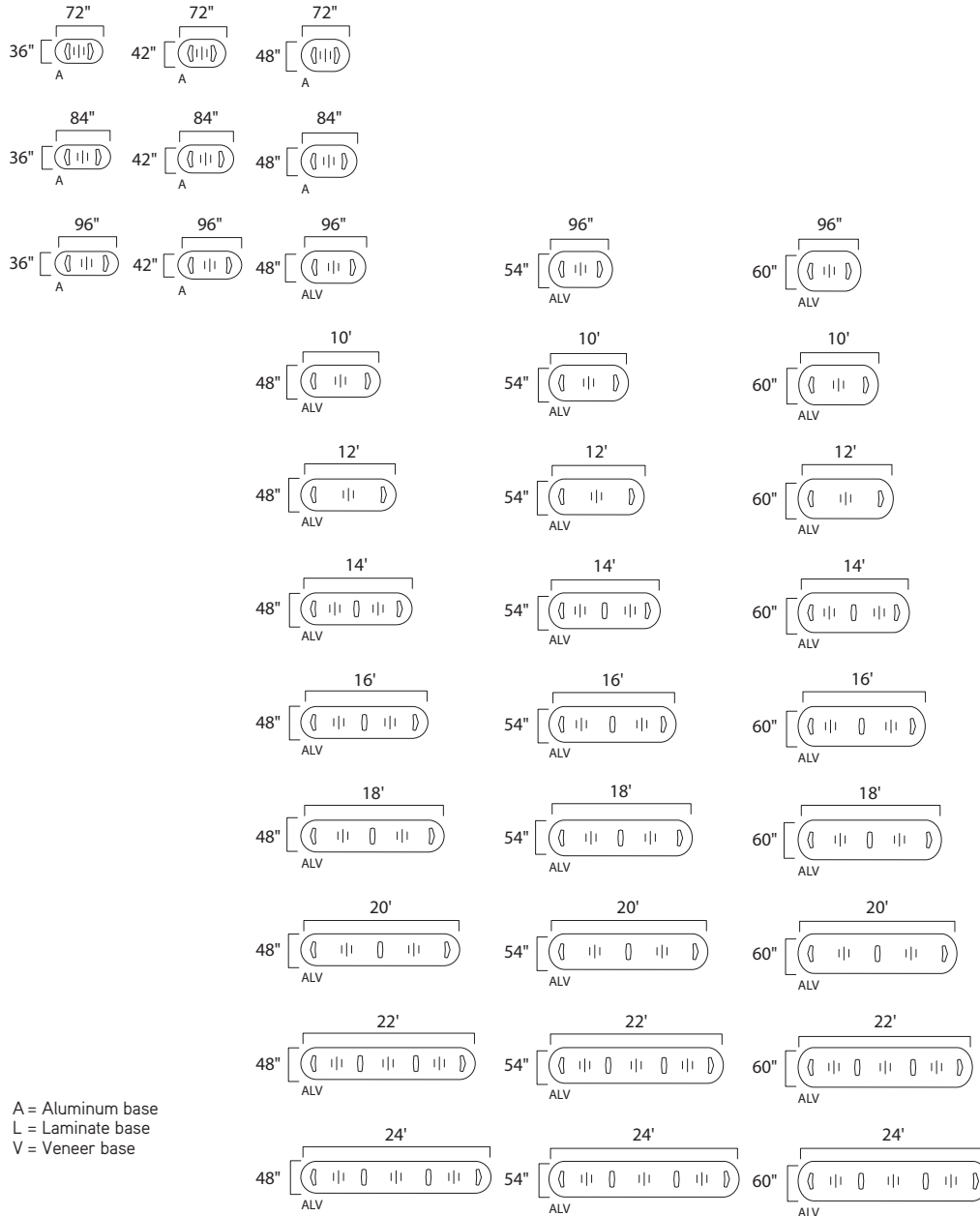

A = Aluminum base
L = Laminate base
V = Veneer base

Veneer and woodgrain
laminate direction

Statement of Line

E-Table 2, continued

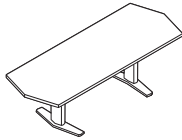

Specifying
▶ Pages 130-154

E-Table 2 Faceted Tables

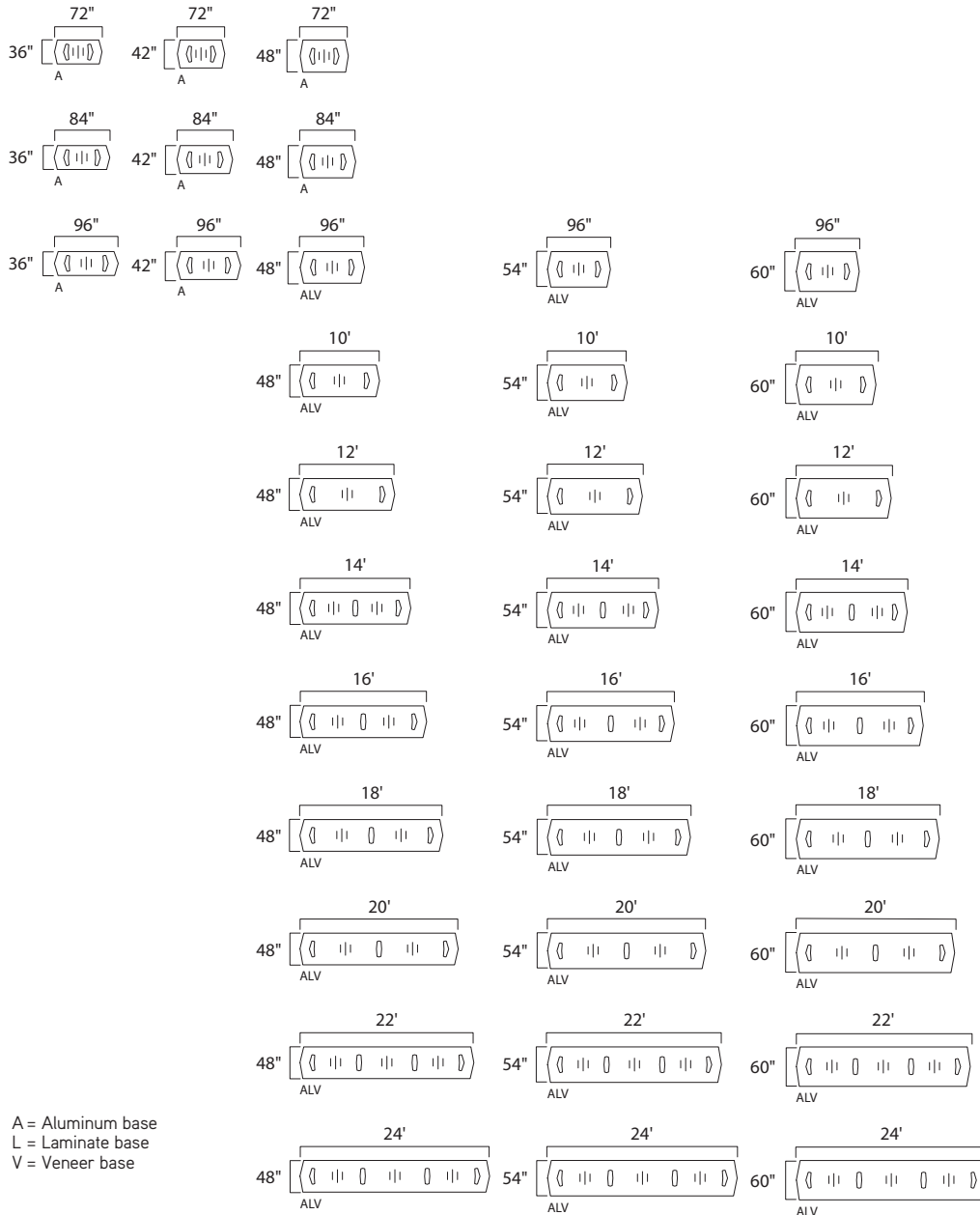

A = Aluminum base
L = Laminate base
V = Veneer base

Veneer and woodgrain
laminate direction

Conference Tables

Statement of Line *continued*

E-Table 2, continued

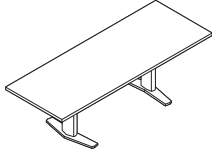

Specifying
▶ Pages 130-154

E-Table 2 Rectangular Tables

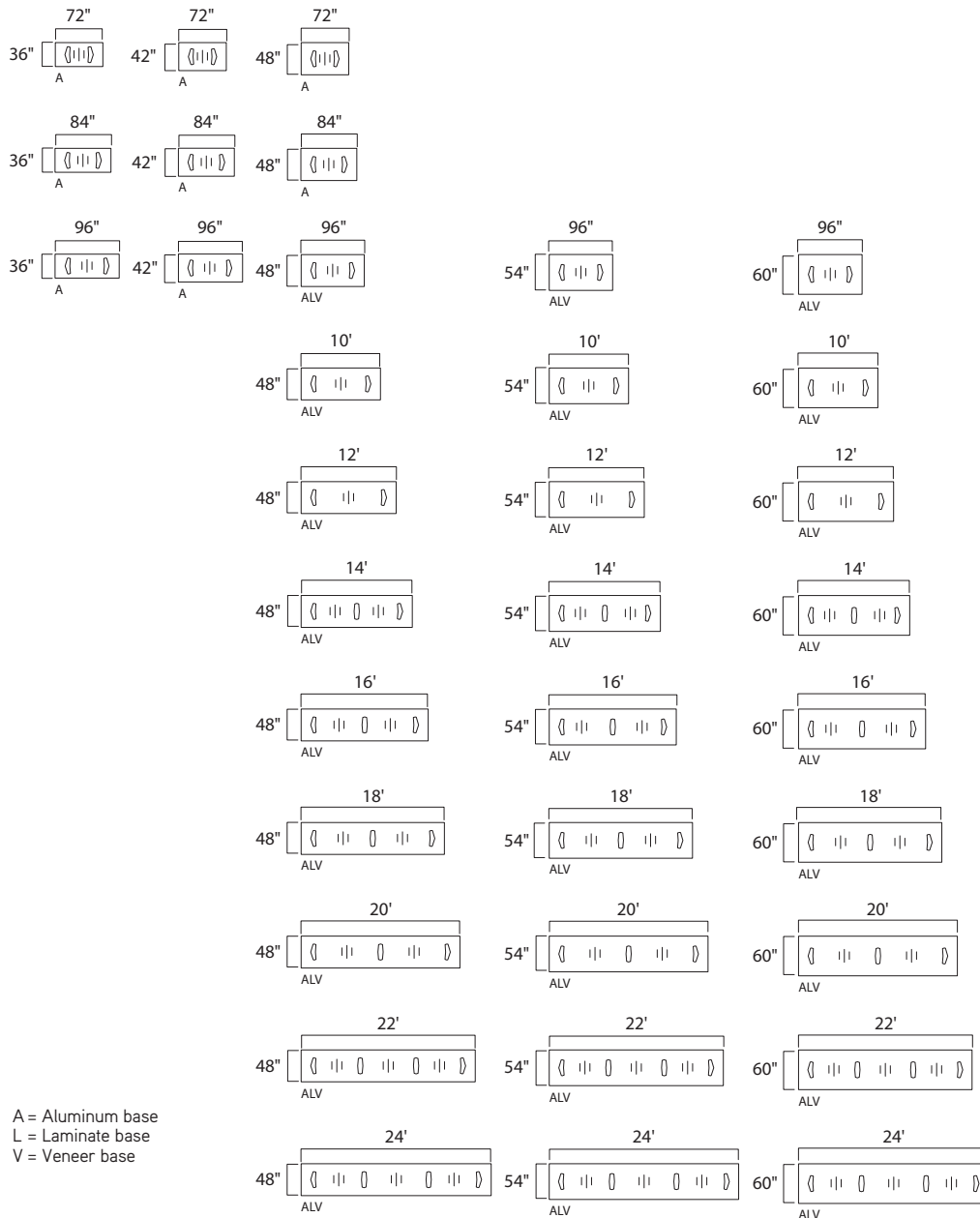

A = Aluminum base
L = Laminate base
V = Veneer base

Veneer and woodgrain
laminate direction



Statement of Line

E-Table 2, continued

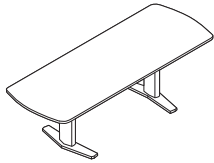

Specifying
▶ Pages 130-154

E-Table 2 Soft Radiused End Tables

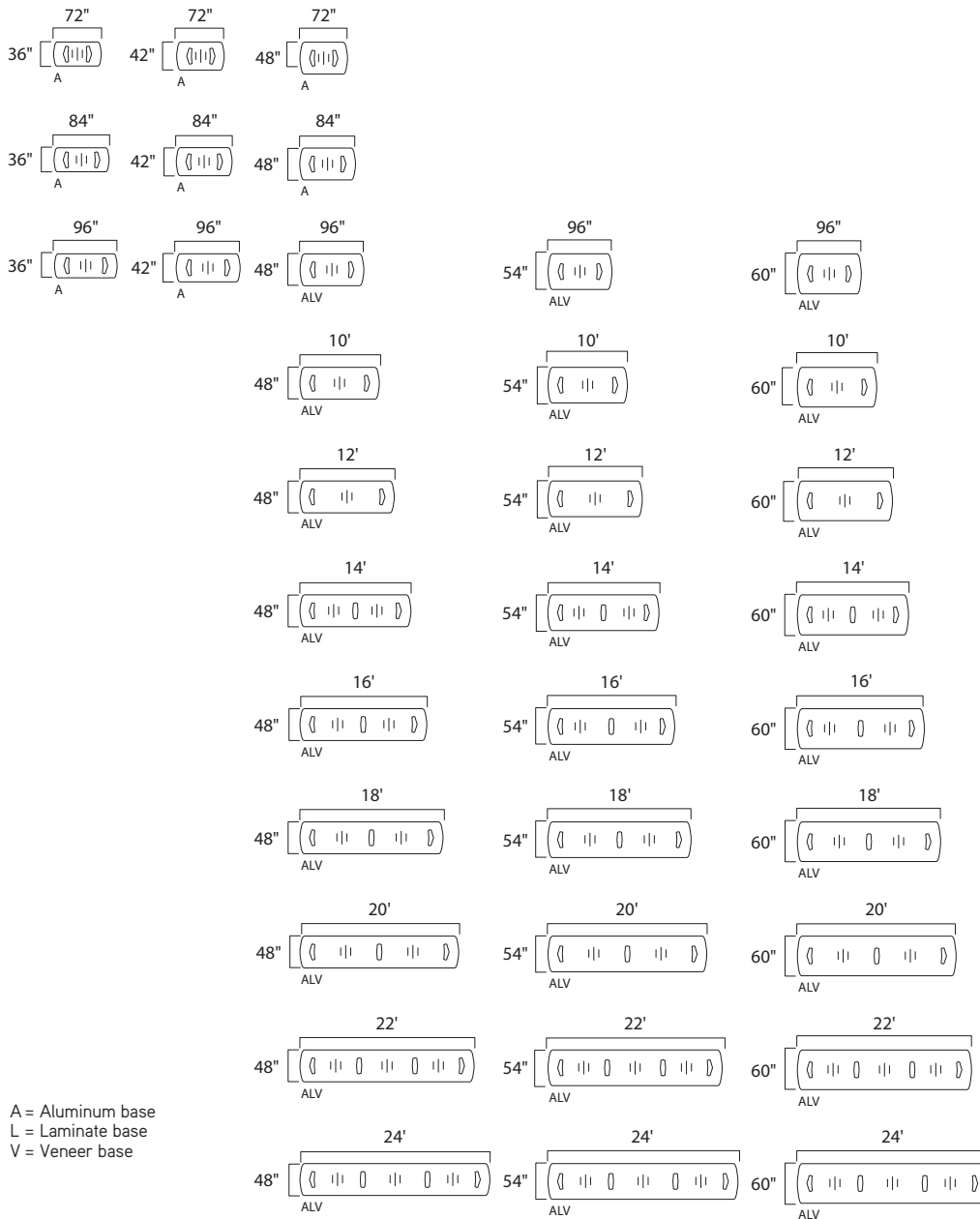

A = Aluminum base
L = Laminate base
V = Veneer base

Veneer and woodgrain
laminate direction

Conference Tables

Statement of Line *continued*

E-Table 2, continued

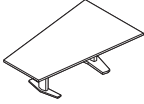

Specifying
▶ Pages 156-160

E-Table 2 Trapezoids Tables

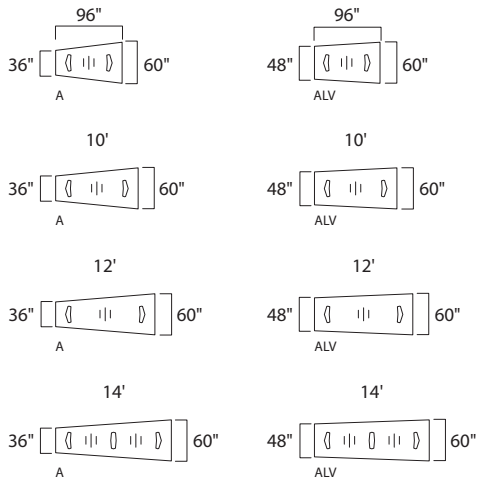

A = Aluminum base
L = Laminate base
V = Veneer base

Veneer and woodgrain
laminate direction

Statement of Line

Host Collection



Specifying
▶ Pages 164-165

Host Round Tables



Veneer and woodgrain laminate direction



Wedge direction

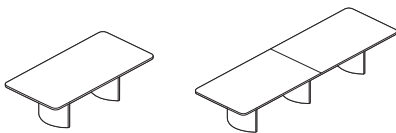

Specifying
▶ Pages 166-191

Host Rectangular Tables

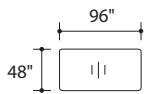

Veneer direction

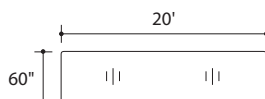
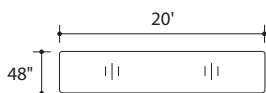
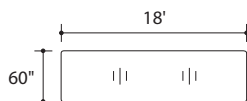
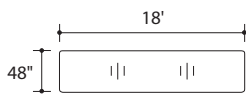
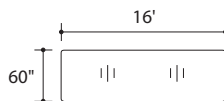
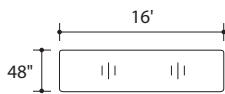
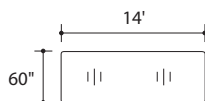
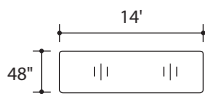
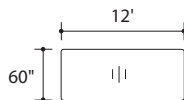
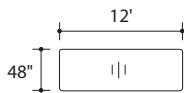
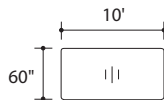
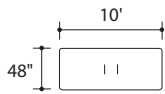

Statement of Line *continued*

Host Collection, continued

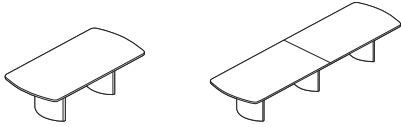

Specifying
▶ Pages 194-222

Host Soft Radiused Tables

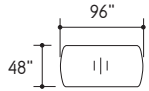

Veneer direction

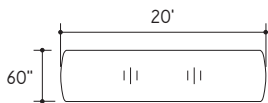
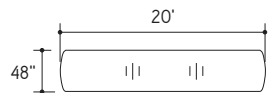
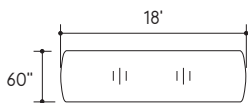
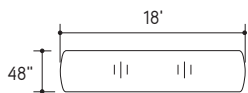
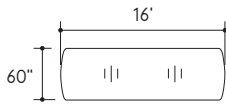
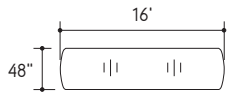
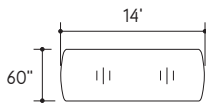
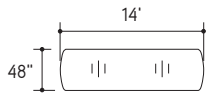
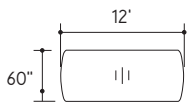
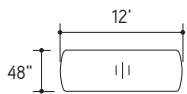
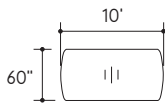
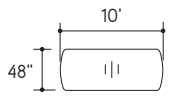

Statement of Line

Host Collection, continued

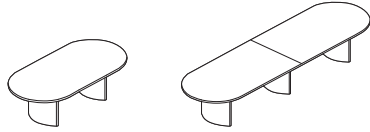

Specifying
► Pages 224–255

Host Racetrack Tables

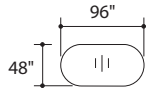

Veneer direction

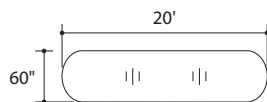
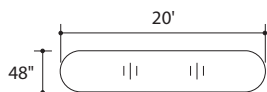
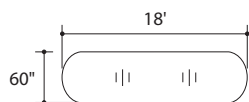
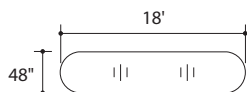
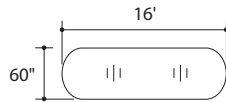
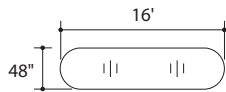
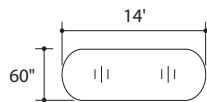
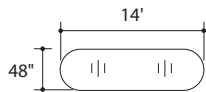
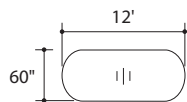
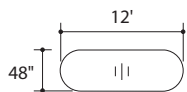
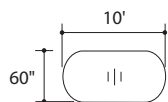
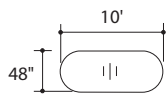

Statement of Line *continued*

Host Collection, continued

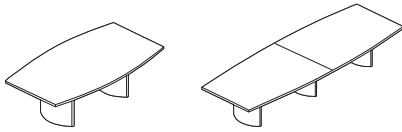

Specifying
▶ Pages 256-274

Host Boat Shaped Tables

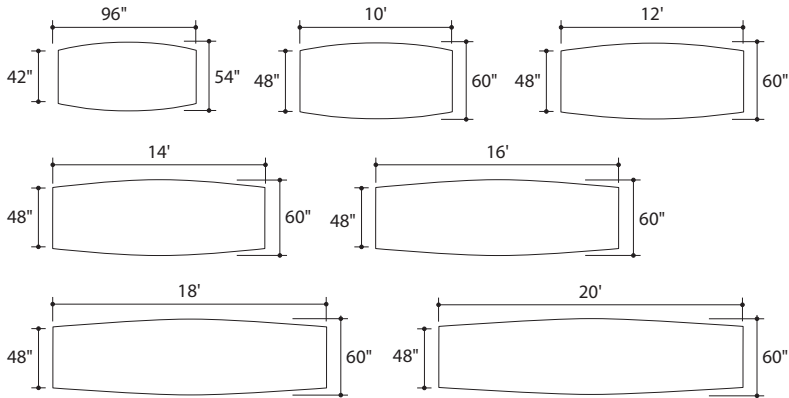

Veneer direction |||

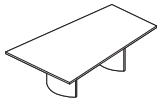

Specifying
▶ Pages 276-282

Host Trapezoid Tables with Two Bases

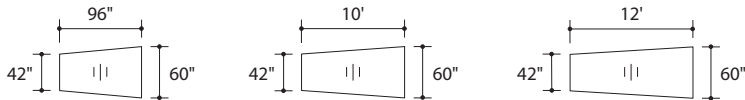

Veneer direction |||

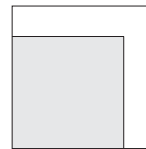

Flat, bullnose, and
beveled wood edges
with square corners

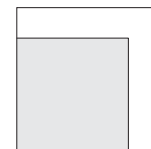

Flat, bullnose, and
beveled wood edges
with square corners

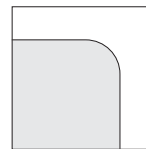

Tapered and horizon
wood edges with
4" radius corners

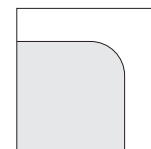

Tapered and horizon
wood edges with
4" radius corners

Statement of Line

Reunion

Seminar Tables

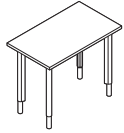

Specifying
▶ Pages 286–290

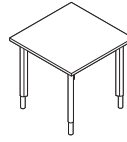

Specifying
▶ Pages 294–296

Reunion Rectangular, Snap Legs

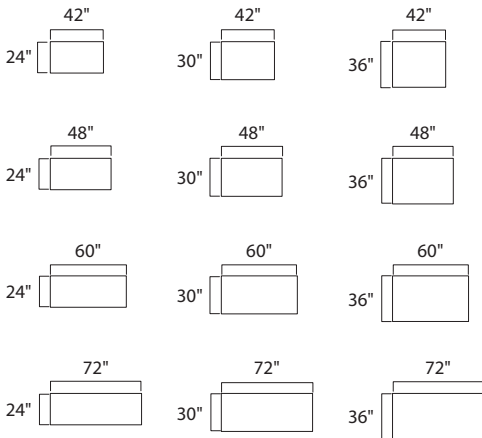

Veneer direction

Reunion Square, Snap Legs

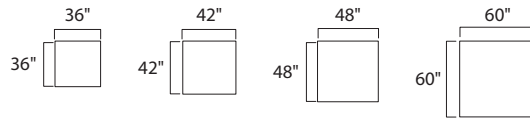

Veneer direction



Specifying
▶ Pages 298–299



Specifying
▶ Pages 300–301

Reunion Trapezoid, Snap Legs

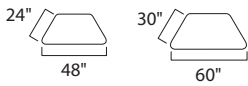

Veneer direction

Reunion Half Round, Snap Legs

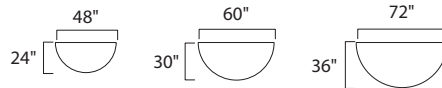

Veneer direction



Specifying
▶ Page 302

Reunion Connecting Tops

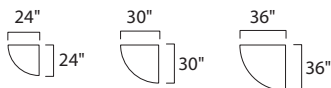

Veneer direction

Statement of Line *continued*

SW_1



Large Round
One-Piece Top



Large Round
Two-Piece Top



Square



Large Square
One-Piece Top



Rectangular
One-Piece Top

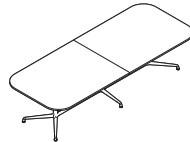

Rectangular
Two-Piece Top



Super Elliptical
One-Piece Top

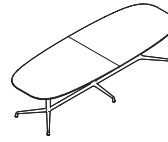

Super Elliptical
Two-Piece Top

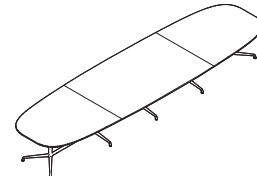

Super Elliptical
Three-Piece Top

Specifying
► Page 310

SW_1 Conference Tables

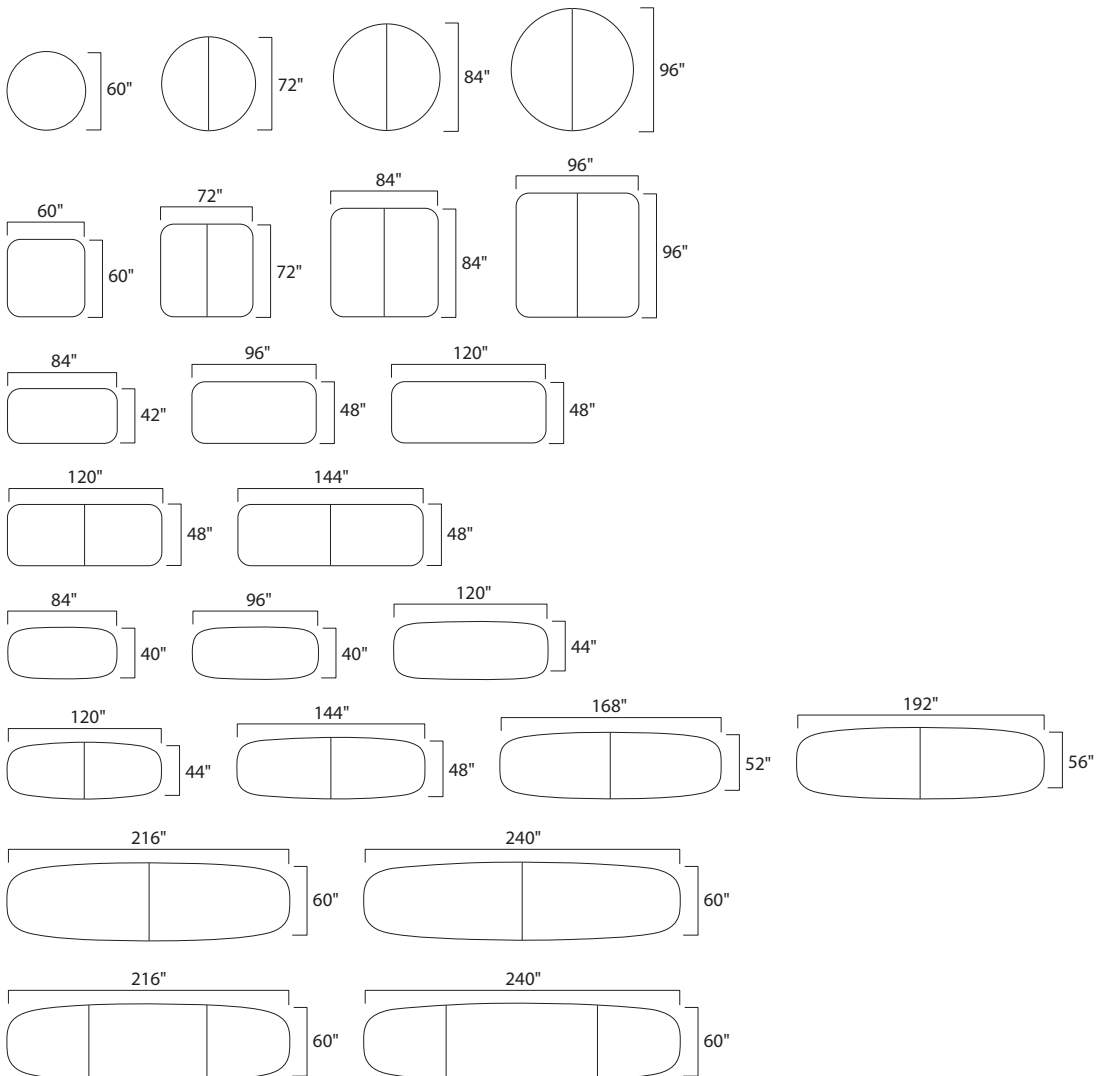

Statement of Line

SW_1, continued



Round



Square



Super Square

Specifying
▶ Page 314

SW_1 Round, Square, and Super-Square Tables

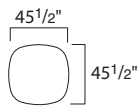
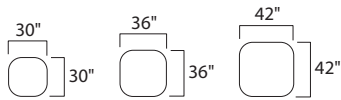
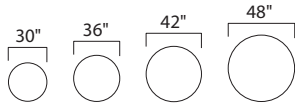

Round



Large Round



Square



Super Square



Large Square

Specifying
▶ Page 316



Rectangular



Super Elliptical

Specifying
▶ Page 318

SW_1 Occasional Tables

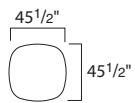
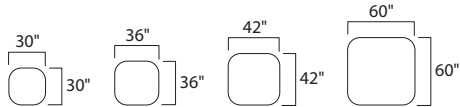
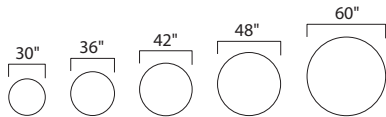

SW_1 Work Tables

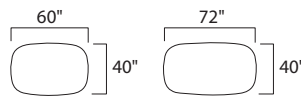
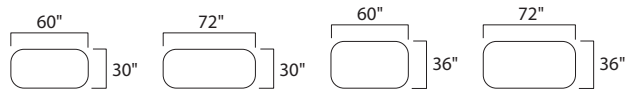

Conference Tables

E-Table 2

48", 54", and 60" Diameter Round Tables (SIN 711.11)	128
72"L, 84"L, and 96"L Racetrack, Faceted, Rectangular, and Soft Radiused End Tables (SIN 711.11)	130
96"L, 10'L, and 12'L Racetrack, Faceted, Rectangular, and Soft Radiused End Tables (SIN 711.11)	136
14'L, 16'L, 18'L, and 20'L Racetrack, Faceted, Rectangular, and Soft Radiused End Tables (SIN 711.11)	142
22'L and 24'L Racetrack, Faceted, Rectangular, and Soft Radiused End Tables (SIN 711.11)	150
36"W Trapezoid Tables with Aluminum Base Only (SIN 711.11)	156
48"W Trapezoid Tables (SIN 711.11)	158
Accessories (SIN 711.11)	161

E-Table 2

DESIGN JEFF CRONK

48", 54", and 60" Diameter Round Tables

SIN 711.11

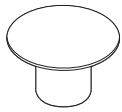

Tip: Shipped knocked down.

Tip: Top ships in one piece.

Tip: 1 mm self-edge is only available on a laminate top surface.

Tip: When a flat, plastic edge is specified on a veneer top, 6000 Black is the only edge finish available.

Tip: When a 3 mm wood edge is specified on a wood veneer top, the edge finish will match the top finish.

Tip: Flat edge is only available on wood veneer tops and is offered in 6000 Black only.

Tip: Each utility bay comes with two universal faceplate openings that accept customer-supplied faceplates in any of the following sizes: single-gang, double-gang, or triple-gang. ▶ See Coalesse Tables, Storage, and Accessories Specification Guide

Tip: Transformer kit must be the same wiring schematic as the table.

Tip: If you require your table top to be made into two pieces, this can be done as a special. Please contact Customer Service at 1.800.627.6770 to obtain a quote.

Tip: Tables available with zero or one utility bay.

Base veneer and woodgrain laminate direction



Standard Includes		Required to Specify	
▶ Need help? Product details, see <i>Coalesse Tables, Storage, and Accessories Specification Guide</i>	<ul style="list-style-type: none"> • Top: 1¼" particle board core with grade 1 laminate • Edge: 1 mm self-edge (laminate top only), 3 mm plastic edge, 3 mm wood edge, or convex vinyl edge • Base: black laminate on MDF core • Concealed leveling glides: non-marring, black plastic 	<ol style="list-style-type: none"> 1 Style number 2 Laminate color number for top 3 Edge selection: <ul style="list-style-type: none"> - 1 mm self-edge (laminate top only) to match laminate top, if selected - 3 mm flat plastic edge color number, if selected - Convex vinyl edge, if selected: <ul style="list-style-type: none"> 6000 Black 6607 Woodrose 6609 Smoke 6655 Warm White 4 Options, if selected (see below) 	▶ See <i>Surface Materials</i> , page 350.
Surface Materials	Options	Price	Required to Specify
	Top		
	• Grade 2 laminate	Prices at right	Specify with <i>Grade 2 laminate</i> and select color number.
	• Grade 1 wood veneer	Prices at right	Specify with <i>Grade 1 wood veneer</i> and select color number.
	• Grade 2 wood veneer	Prices at right	Specify with <i>Grade 2 wood veneer</i> and select color number.
	• Grade 1 wedge lay-up veneer	Prices at right	Specify with <i>Grade 1 wedge lay-up veneer</i> and select color number.
	• Grade 2 wedge lay-up veneer	Prices at right	Specify with <i>Grade 2 wedge lay-up veneer</i> and select color number.
	• Stain-to-Match	No cost	Specify with <i>Stain-to-Match</i> . ▶ Page 383
	Base		
	• Curated laminate base	+\$500	Specify with <i>curated laminate</i> and select color number.
	• Wood base	+\$648	Replace L suffix in the style number with V suffix and select wood color number.
	Edges		
	Wood veneer tops		
	• 3 mm plastic edge	Prices at right	Specify with <i>3 mm plastic edge</i> and select color number.
	• 3 mm wood edge	Prices at right	Specify with <i>3 mm wood edge</i> and select color number.
	• Convex vinyl edge	Prices at right	Specify with <i>convex vinyl edge</i> and select color number.
	• Flat edge (6000 Black)	Prices at right	Specify with <i>flat edge</i> .
	Wood veneer and laminate tops		
	• Bullnose wood edge	Prices at right	Specify with <i>bullnose wood edge</i> .
	• Beveled wood edge	Prices at right	Specify with <i>beveled wood edge</i> .
	• Knife wood edge	Prices at right	Specify with <i>knife wood edge</i> .
	Bay Option		
	• No bays	No cost	Specify with <i>no bays</i> .
	• One bay	+\$502	Specify with <i>one bay</i> and select color number.
	Duplex Wiring Schematic		
	Tables with bay door(s)		
	• 3+0 wireway	No cost	Specify with <i>3+0 wireway, duplex</i> .
	• 1+1 hardwire, 2 circuits	No cost	Specify with <i>1+1 hardwire, 2 circuits, duplex</i> .
	• Chicago powerway	No cost	Specify with <i>Chicago powerway</i> .
	USB Wiring Schematic		
	Tables with bay door(s)		
	• 3+0 wireway	+\$153 per bay	Specify with <i>3+0 wireway, USB</i> .
	• 1+1 hardwire, 2 circuits	+\$153 per bay	Specify with <i>1+1 hardwire, 2 circuits, USB</i> .
	Infeed		
	Tables with bay door(s)		
	• Plug (20 amp single circuit)	No cost	Specify with <i>plug</i> .
	• Hardwire	No cost	Specify with <i>hardwire</i> .
	• NYC hardwire infeed	No cost	Specify with <i>NYC hardwire infeed</i> .
	Related Products		
	• Transformer kit		▶ Page 161

▶ Options, continued on next page

E-Table 2

DESIGN JEFF CRONK

48", 54", and 60" Diameter Round Tables

SIN 711.11





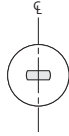

►Options, continued from previous page

Options	Price	Required to Specify
---------	-------	---------------------

Utility Bay Location



Specification Information

Style Number	Finish	Base Prices			
		  			
		1 mm Self-Edge, 3 mm Plastic/ 3 mm Wood Edge, Flat Edge, or Convex Vinyl Edge:	Bullnose Wood Edge:	Beveled Wood Edge:	Knife Wood Edge:

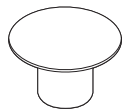

48" Diameter Round Table

E2RND48L	Grade 1 Laminate	\$1618	\$2423	\$2697	\$2924
	Grade 2 Laminate	\$1692	\$2497	\$2771	\$2998
	Grade 1 Wood Veneer	\$2349	\$3154	\$3428	\$3655
	Grade 2 Wood Veneer	\$2595	\$3400	\$3674	\$3901
	Grade 1 Wedge Lay-Up	\$4391	\$5196	\$5470	\$5697
	Grade 2 Wedge Lay-Up	\$4636	\$5441	\$5715	\$5942

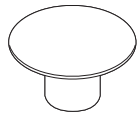

54" Diameter Round Table

E2RND54L	Grade 1 Laminate	\$1832	\$2733	\$3148	\$3460
	Grade 2 Laminate	\$1927	\$2828	\$3243	\$3555
	Grade 1 Wood Veneer	\$2969	\$3870	\$4285	\$4597
	Grade 2 Wood Veneer	\$3282	\$4183	\$4598	\$4910
	Grade 1 Wedge Lay-Up	\$4507	\$5408	\$5823	\$6135
	Grade 2 Wedge Lay-Up	\$4821	\$5722	\$6137	\$6449

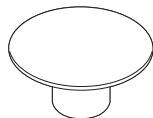

60" Diameter Round Table

E2RND60L	Grade 1 Laminate	\$1835	\$2801	\$3227	\$3624
	Grade 2 Laminate	\$1952	\$2918	\$3344	\$3741
	Grade 1 Wood Veneer	\$3101	\$4067	\$4493	\$4890
	Grade 2 Wood Veneer	\$3483	\$4449	\$4875	\$5272
	Grade 1 Wedge Lay-Up	\$4639	\$5605	\$6031	\$6428
	Grade 2 Wedge Lay-Up	\$5022	\$5988	\$6414	\$6811

E-Table 2 72"L, 84"L, and 96"L Racetrack, Faceted, Rectangular, and Soft Radiused End Tables with Aluminum Base Only

DESIGN JEFF CRONK

SIN 711.11



Tip: Shipped knocked down.

Tip: Top ships in one piece.

Tip: 1 mm self-edge is only available on a laminate top surface.

Tip: Flat edge is only available on wood veneer tops and is offered in 6000 Black only.

Tip: When a 3 mm wood edge is specified on a wood veneer top, the edge finish will match the top finish.

Tip: If you specify a wood edge on a top with woodgrain laminate, the edge and the top may not match.

Tip: Each utility bay comes with two universal faceplate openings that accept customer-supplied faceplates in any of the following sizes: single-gang, double-gang, or triple-gang. ▶ See Coalesse Tables, Storage, and Accessories Specification Guide

Tip: Transformer kit must be the same wiring schematic as the table.

Tip: For 72"L and 84"L tables, if you require your table top to be made into two pieces, this can be done as a special. Please contact Customer Service at 1.800.627.6770 to obtain a quote.

Tip: Tables available with zero, one, or two utility bays.

Base veneer and woodgrain laminate direction



Standard Includes	Required to Specify
<ul style="list-style-type: none"> ▶ Need help? Product details, see <i>Coalesse Tables, Storage, and Accessories Specification Guide</i> 	<ol style="list-style-type: none"> 1 Style number 2 Powder coat color number for base 3 Laminate color number for top 4 Edge selection: <ul style="list-style-type: none"> - 1 mm self-edge (laminate top only) to match laminate top, if selected - 3 mm flat plastic edge color number, if selected - Convex vinyl edge, if selected: <ul style="list-style-type: none"> 6000 Black 6607 Woodrose 6609 Smoke 6655 Warm White 5 Options, if selected (see below) <ul style="list-style-type: none"> ▶ See <i>Surface Materials</i>, page 350.

Options	Price	Required to Specify
Surface Materials <ul style="list-style-type: none"> • Top <ul style="list-style-type: none"> • Grade 2 laminate • Grade 1 wood veneer • Grade 2 wood veneer • Stain-to-Match 	<ul style="list-style-type: none"> Prices at right Prices at right Prices at right No cost 	<ul style="list-style-type: none"> Specify with <i>Grade 2 laminate</i> and select color number. Specify with <i>Grade 1 wood veneer</i> and select color number. Specify with <i>Grade 2 wood veneer</i> and select color number. Specify with <i>Stain-to-Match</i>. ▶ Page 383
Edges <ul style="list-style-type: none"> • Wood veneer tops <ul style="list-style-type: none"> • 3 mm plastic edge • 3 mm wood edge • Convex vinyl edge • Flat edge (6000 Black) • Wood veneer and laminate tops <ul style="list-style-type: none"> • Bullnose wood edge • Beveled wood edge • Knife wood edge • Waterfall wood edge • Faceted wood edge 	<ul style="list-style-type: none"> Prices at right Prices at right Prices at right Prices at right Prices at right Prices at right Prices at right Prices at right Prices at right 	<ul style="list-style-type: none"> Specify with <i>3 mm plastic edge</i> and select color number. Specify with <i>3 mm wood edge</i> and select color number. Specify with <i>convex vinyl edge</i> and select color number. Specify with <i>flat edge</i>. Specify with <i>bullnose wood edge</i>. Specify with <i>beveled wood edge</i>. Specify with <i>knife wood edge</i>. Specify with <i>waterfall wood edge</i>. Specify with <i>faceted wood edge</i>.
Sectioned top (96"L only) <ul style="list-style-type: none"> • Sectioned top 	<ul style="list-style-type: none"> +\$ 363 	<ul style="list-style-type: none"> Specify with <i>sectioned top</i>.
Bay Option <ul style="list-style-type: none"> • No bays • One bay • Two bays 	<ul style="list-style-type: none"> No cost +\$ 502 +\$1004 	<ul style="list-style-type: none"> Specify with <i>no bays</i>. Specify with <i>one bay</i> and select color number. Specify with <i>two bays</i> and select color number.
Duplex Wiring Schematic <ul style="list-style-type: none"> • Tables with bay door(s) <ul style="list-style-type: none"> • 3+0 wireway • 1+1 hardwire, 2 circuits • Chicago powerway 	<ul style="list-style-type: none"> No cost No cost No cost 	<ul style="list-style-type: none"> Specify with <i>3+0 wireway, duplex</i>. Specify with <i>1+1 hardwire, 2 circuits, duplex</i>. Specify with <i>Chicago powerway</i>.
USB Wiring Schematic <ul style="list-style-type: none"> • Tables with bay door(s) <ul style="list-style-type: none"> • 3+0 wireway • 1+1 hardwire, 2 circuits 	<ul style="list-style-type: none"> +\$ 153 per bay +\$ 153 per bay 	<ul style="list-style-type: none"> Specify with <i>3+0 wireway, USB</i>. Specify with <i>1+1 hardwire, 2 circuits, USB</i>.
Infeed <ul style="list-style-type: none"> • Tables with bay door(s) <ul style="list-style-type: none"> • Plug (20 amp single circuit) • Hardwire • NYC hardwire infeed 	<ul style="list-style-type: none"> No cost No cost No cost 	<ul style="list-style-type: none"> Specify with <i>plug</i>. Specify with <i>hardwire</i>. Specify with <i>NYC hardwire infeed</i>.

▶ Page 161

▶ Options, continued on next page

E-Table 2

72"L, 84"L, and 96"L Racetrack, Faceted, Rectangular, and Soft Radiused End Tables with Aluminum Base Only







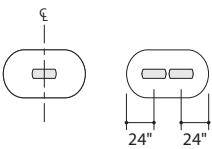
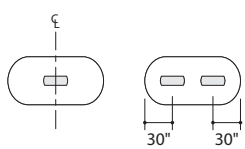
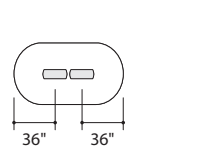



DESIGN JEFF CRONK

SIN 711.11

►Options, continued from previous page

Options		Price	Required to Specify
72"L Utility Bay Location	84"L Utility Bay Location	96"L Utility Bay Location	
			

Specification Information

Dimensions	Style	Finish	Base Prices
L W H	Number		
			    
			    



Tip: Racetrack tables are not available with waterfall or faceted wood edge.

Racetrack Tables with Two Bases

Dimensions	Style	Finish	Base Price	Price	Price	Price
L W H	Number					
72" 36" 29"	E2C7236A	Grade 1 Laminate	\$2955	\$3550	\$3617	\$3724
		Grade 2 Laminate	\$3042	\$3637	\$3704	\$3811
		Grade 1 Wood Veneer	\$3986	\$4581	\$4648	\$4755
		Grade 2 Wood Veneer	\$4314	\$4909	\$4976	\$5083
72" 42" 29"	E2C7242A	Grade 1 Laminate	\$3191	\$3953	\$3977	\$4121
		Grade 2 Laminate	\$3289	\$4051	\$4075	\$4219
		Grade 1 Wood Veneer	\$4476	\$5238	\$5262	\$5406
		Grade 2 Wood Veneer	\$4829	\$5591	\$5615	\$5759
72" 48" 29"	E2C7248A	Grade 1 Laminate	\$3263	\$4015	\$4042	\$4197
		Grade 2 Laminate	\$3379	\$4131	\$4158	\$4313
		Grade 1 Wood Veneer	\$4484	\$5236	\$5263	\$5418
		Grade 2 Wood Veneer	\$4862	\$5614	\$5641	\$5796
84" 36" 29"	E2C8436A	Grade 1 Laminate	\$3111	\$3986	\$4078	\$4234
		Grade 2 Laminate	\$3209	\$4084	\$4176	\$4332
		Grade 1 Wood Veneer	\$4599	\$5474	\$5566	\$5722
		Grade 2 Wood Veneer	\$5001	\$5876	\$5968	\$6124
84" 42" 29"	E2C8442A	Grade 1 Laminate	\$3231	\$4074	\$4144	\$4292
		Grade 2 Laminate	\$3347	\$4190	\$4260	\$4408
		Grade 1 Wood Veneer	\$4660	\$5503	\$5573	\$5721
		Grade 2 Wood Veneer	\$5097	\$5940	\$6010	\$6158
84" 48" 29"	E2C8448A	Grade 1 Laminate	\$3304	\$4138	\$4212	\$4372
		Grade 2 Laminate	\$3436	\$4270	\$4344	\$4504
		Grade 1 Wood Veneer	\$4666	\$5500	\$5574	\$5734
		Grade 2 Wood Veneer	\$5133	\$5967	\$6041	\$6201











►Specification Information, continued on next page

E-Table 2 72"L, 84"L, and 96"L Racetrack, Faceted, Rectangular, and Soft Radiused End Tables with Aluminum Base Only *continued*

DESIGN JEFF CRONK

SIN 711.11

► Specification Information, continued from previous page

Specification Information				Base Prices									
Dimensions		Style	Finish										
L	W	H	Number										
													
				1 mm Self-Edge, 3 mm Plastic/ 3 mm Wood Edge, Flat Edge, or Convex Vinyl Edge:	Bullnose Wood Edge:	Beveled Wood Edge:	Knife Wood Edge, Waterfall Wood Edge, or Faceted Wood Edge:						

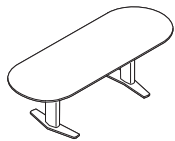

Tip: Racetrack tables are not available with waterfall or faceted wood edge.

Racetrack Tables with Two Bases, continued

Dimensions	Style	Finish	Grade 1 Laminate	Grade 2 Laminate	Grade 1 Wood Veneer	Grade 2 Wood Veneer
96" 36" 29"	E2C9636A	Grade 1 Laminate	\$3293	\$4117	\$4216	\$4375
		Grade 2 Laminate	\$3406	\$4230	\$4329	\$4488
		Grade 1 Wood Veneer	\$4682	\$5506	\$5605	\$5764
		Grade 2 Wood Veneer	\$5147	\$5971	\$6070	\$6229
96" 42" 29"	E2C9642A	Grade 1 Laminate	\$3588	\$4432	\$4503	\$4665
		Grade 2 Laminate	\$3719	\$4563	\$4634	\$4796
		Grade 1 Wood Veneer	\$5011	\$5855	\$5926	\$6088
		Grade 2 Wood Veneer	\$5534	\$6378	\$6449	\$6611

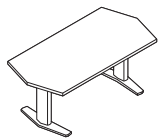

Tip: Faceted tables are not available with waterfall wood edge.

Faceted Tables with Two Bases

Dimensions	Style	Finish	Grade 1 Laminate	Grade 2 Laminate	Grade 1 Wood Veneer	Grade 2 Wood Veneer
72" 36" 29"	E2F7236A	Grade 1 Laminate	\$3111	\$3706	\$3773	\$3880
		Grade 2 Laminate	\$3198	\$3793	\$3860	\$3967
		Grade 1 Wood Veneer	\$4142	\$4737	\$4804	\$4911
		Grade 2 Wood Veneer	\$4470	\$5065	\$5132	\$5239
72" 42" 29"	E2F7242A	Grade 1 Laminate	\$3344	\$4106	\$4130	\$4274
		Grade 2 Laminate	\$3442	\$4204	\$4228	\$4372
		Grade 1 Wood Veneer	\$4629	\$5391	\$5415	\$5559
		Grade 2 Wood Veneer	\$4970	\$5732	\$5756	\$5900
72" 48" 29"	E2F7248A	Grade 1 Laminate	\$3420	\$4172	\$4199	\$4354
		Grade 2 Laminate	\$3536	\$4288	\$4315	\$4470
		Grade 1 Wood Veneer	\$4641	\$5393	\$5420	\$5575
		Grade 2 Wood Veneer	\$5019	\$5771	\$5798	\$5953
84" 36" 29"	E2F8436A	Grade 1 Laminate	\$3263	\$4138	\$4230	\$4386
		Grade 2 Laminate	\$3361	\$4236	\$4328	\$4484
		Grade 1 Wood Veneer	\$4589	\$5464	\$5556	\$5712
		Grade 2 Wood Veneer	\$4989	\$5864	\$5956	\$6112
84" 42" 29"	E2F8442A	Grade 1 Laminate	\$3384	\$4227	\$4297	\$4445
		Grade 2 Laminate	\$3500	\$4343	\$4413	\$4561
		Grade 1 Wood Veneer	\$4813	\$5656	\$5726	\$5874
		Grade 2 Wood Veneer	\$5250	\$6093	\$6163	\$6311
84" 48" 29"	E2F8448A	Grade 1 Laminate	\$3459	\$4293	\$4367	\$4527
		Grade 2 Laminate	\$3591	\$4425	\$4499	\$4659
		Grade 1 Wood Veneer	\$4821	\$5655	\$5729	\$5889
		Grade 2 Wood Veneer	\$5288	\$6122	\$6196	\$6356

► Specification Information, continued on next page









E-Table 2

72"L, 84"L, and 96"L Racetrack, Faceted, Rectangular, and Soft Radiused End Tables with Aluminum Base Only

DESIGN JEFF CRONK

SIN 711.11

► Specification Information, continued from previous page

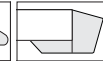
Specification Information				Base Prices								
Dimensions		Style	Finish									
L	W	H	Number									
												
				1 mm Self-Edge, 3 mm Plastic/ 3 mm Wood Edge, Flat Edge, or Convex Vinyl Edge:	Bullnose Wood Edge:	Beveled Wood Edge:	Knife Wood Edge, Waterfall Wood Edge, or Faceted Wood Edge:					

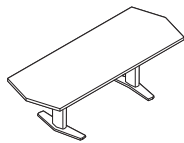

Tip: Faceted tables are not available with waterfall wood edge.

Tip: Vinyl edge profiles on faceted tables require a 4" radius on all corners.

Faceted Tables with Two Bases, continued

Dimensions	Style	Finish	Grade 1	Grade 2	Grade 1	Grade 2	Grade 1	Grade 2	
96" 36" 29"	E2F9636A	Grade 1 Laminate	\$3449	\$4273	\$4372	\$4531			
			Grade 2 Laminate	\$3562	\$4386	\$4485	\$4644		
			Grade 1 Wood Veneer	\$4838	\$5662	\$5761	\$5920		
			Grade 2 Wood Veneer	\$5303	\$6127	\$6226	\$6385		
96" 42" 29"	E2F9642A	Grade 1 Laminate	\$3745	\$4589	\$4660	\$4822			
			Grade 2 Laminate	\$3876	\$4720	\$4791	\$4953		
			Grade 1 Wood Veneer	\$5168	\$6012	\$6083	\$6245		
			Grade 2 Wood Veneer	\$5691	\$6535	\$6606	\$6768		

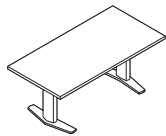

Tip: Vinyl edge profiles on rectangular tables require a 4" radius on all corners.

Rectangular Tables with Two Bases

Dimensions	Style	Finish	Grade 1	Grade 2	Grade 1	Grade 2	Grade 1	Grade 2	
72" 36" 29"	E2R7236A	Grade 1 Laminate	\$2801	\$3396	\$3463	\$3570			
			Grade 2 Laminate	\$2888	\$3483	\$3550	\$3657		
			Grade 1 Wood Veneer	\$3832	\$4427	\$4494	\$4601		
			Grade 2 Wood Veneer	\$4160	\$4755	\$4822	\$4929		
72" 42" 29"	E2R7242A	Grade 1 Laminate	\$3035	\$3797	\$3821	\$3965			
			Grade 2 Laminate	\$3133	\$3895	\$3919	\$4063		
			Grade 1 Wood Veneer	\$4320	\$5082	\$5106	\$5250		
			Grade 2 Wood Veneer	\$4661	\$5423	\$5447	\$5591		
72" 48" 29"	E2R7248A	Grade 1 Laminate	\$3111	\$3863	\$3890	\$4045			
			Grade 2 Laminate	\$3227	\$3979	\$4006	\$4161		
			Grade 1 Wood Veneer	\$4332	\$5084	\$5111	\$5266		
			Grade 2 Wood Veneer	\$4710	\$5462	\$5489	\$5644		
84" 36" 29"	E2R8436A	Grade 1 Laminate	\$2955	\$3830	\$3922	\$4078			
			Grade 2 Laminate	\$3053	\$3928	\$4020	\$4176		
			Grade 1 Wood Veneer	\$4443	\$5318	\$5410	\$5566		
			Grade 2 Wood Veneer	\$4845	\$5720	\$5812	\$5968		
84" 42" 29"	E2R8442A	Grade 1 Laminate	\$3076	\$3919	\$3989	\$4137			
			Grade 2 Laminate	\$3192	\$4035	\$4105	\$4253		
			Grade 1 Wood Veneer	\$4505	\$5348	\$5418	\$5566		
			Grade 2 Wood Veneer	\$4942	\$5785	\$5855	\$6003		
84" 48" 29"	E2R8448A	Grade 1 Laminate	\$3148	\$3982	\$4056	\$4216			
			Grade 2 Laminate	\$3280	\$4114	\$4188	\$4348		
			Grade 1 Wood Veneer	\$4510	\$5344	\$5418	\$5578		
			Grade 2 Wood Veneer	\$4977	\$5811	\$5885	\$6045		







► Specification Information, continued on next page

E-Table 2 72"L, 84"L, and 96"L Racetrack, Faceted, Rectangular, and Soft Radiused End Tables with Aluminum Base Only *continued*

DESIGN JEFF CRONK

SIN 711.11

► Specification Information, continued from previous page

Specification Information										
Dimensions		Style	Finish	Base Prices						
L	W	H	Number							

1 mm Self-Edge,
3 mm Plastic/
3 mm Wood Edge,
Flat Edge, or
Convex Vinyl Edge:

Bullnose
Wood
Edge:

Beveled
Wood
Edge:

Knife Wood Edge, Waterfall
Wood Edge, or Faceted
Wood Edge:

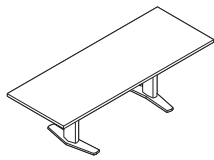

Tip: Vinyl edge profiles on rectangular tables require a 4" radius on all corners.

Rectangular Tables with Two Bases, continued

Dimensions	Style	Finish	1 mm Self-Edge, 3 mm Plastic/3 mm Wood Edge, Flat Edge, or Convex Vinyl Edge	Bullnose Wood Edge	Beveled Wood Edge	Knife Wood Edge, Waterfall Wood Edge, or Faceted Wood Edge
96" 36" 29"	E2R9636A	Grade 1 Laminate	\$3140	\$3964	\$4063	\$4222
		Grade 2 Laminate	\$3253	\$4077	\$4176	\$4335
		Grade 1 Wood Veneer	\$4529	\$5353	\$5452	\$5611
		Grade 2 Wood Veneer	\$4994	\$5818	\$5917	\$6076
96" 42" 29"	E2R9642A	Grade 1 Laminate	\$3436	\$4280	\$4351	\$4513
		Grade 2 Laminate	\$3567	\$4411	\$4482	\$4644
		Grade 1 Wood Veneer	\$4859	\$5703	\$5774	\$5936
		Grade 2 Wood Veneer	\$5382	\$6226	\$6297	\$6459

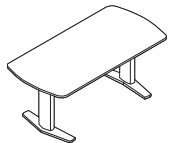

Tip: Vinyl edge profiles on soft radiused tables require a 4" radius on all corners.

Soft Radiused End Tables with Two Bases

Dimensions	Style	Finish	1 mm Self-Edge, 3 mm Plastic/3 mm Wood Edge, Flat Edge, or Convex Vinyl Edge	Bullnose Wood Edge	Beveled Wood Edge	Knife Wood Edge, Waterfall Wood Edge, or Faceted Wood Edge
72" 36" 29"	E2S7236A	Grade 1 Laminate	\$2955	\$3550	N.A.	N.A.
		Grade 2 Laminate	\$3042	\$3637	N.A.	N.A.
		Grade 1 Wood Veneer	\$3986	\$4581	N.A.	N.A.
		Grade 2 Wood Veneer	\$4314	\$4909	N.A.	N.A.
72" 42" 29"	E2S7242A	Grade 1 Laminate	\$3191	\$3953	N.A.	N.A.
		Grade 2 Laminate	\$3289	\$4051	N.A.	N.A.
		Grade 1 Wood Veneer	\$4476	\$5238	N.A.	N.A.
		Grade 2 Wood Veneer	\$4817	\$5579	N.A.	N.A.
72" 48" 29"	E2S7248A	Grade 1 Laminate	\$3263	\$4015	N.A.	N.A.
		Grade 2 Laminate	\$3379	\$4131	N.A.	N.A.
		Grade 1 Wood Veneer	\$4484	\$5236	N.A.	N.A.
		Grade 2 Wood Veneer	\$4862	\$5614	N.A.	N.A.
84" 36" 29"	E2S8436A	Grade 1 Laminate	\$3111	\$3986	N.A.	N.A.
		Grade 2 Laminate	\$3209	\$4084	N.A.	N.A.
		Grade 1 Wood Veneer	\$4599	\$5474	N.A.	N.A.
		Grade 2 Wood Veneer	\$5001	\$5876	N.A.	N.A.
84" 42" 29"	E2S8442A	Grade 1 Laminate	\$3231	\$4074	N.A.	N.A.
		Grade 2 Laminate	\$3347	\$4190	N.A.	N.A.
		Grade 1 Wood Veneer	\$4660	\$5503	N.A.	N.A.
		Grade 2 Wood Veneer	\$5097	\$5940	N.A.	N.A.
84" 48" 29"	E2S8448A	Grade 1 Laminate	\$3304	\$4138	N.A.	N.A.
		Grade 2 Laminate	\$3436	\$4270	N.A.	N.A.
		Grade 1 Wood Veneer	\$4666	\$5500	N.A.	N.A.
		Grade 2 Wood Veneer	\$5133	\$5967	N.A.	N.A.

► Specification Information, continued on next page









E-Table 2

72"L, 84"L, and 96"L Racetrack, Faceted, Rectangular, and Soft Radiused End Tables with Aluminum Base Only

DESIGN JEFF CRONK

SIN 711.11

► Specification Information, continued from previous page

Specification Information				Base Prices								
Dimensions			Style	Finish								
L	W	H	Number									
												
					1 mm Self-Edge, 3 mm Plastic/ 3 mm Wood Edge, Flat Edge, or Convex Vinyl Edge:		Bullnose Wood Edge:	Beveled Wood Edge:	Knife Wood Edge, Waterfall Wood Edge, or Faceted Wood Edge:			

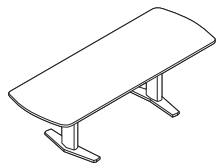

Tip: Vinyl edge profiles on soft radiused tables require a 4" radius on all corners.

Soft Radiused End Tables with Two Bases, continued

Dimensions	Style Number	Grade 1	Grade 2	Grade 1	Grade 2	Grade 1	Grade 2
96" 36" 29"	E2S9636A	Grade 1 Laminate	\$3293	\$4117	N.A.	N.A.	
		Grade 2 Laminate	\$3406	\$4230	N.A.	N.A.	
		Grade 1 Wood Veneer	\$4682	\$5506	N.A.	N.A.	
		Grade 2 Wood Veneer	\$5147	\$5971	N.A.	N.A.	
96" 42" 29"	E2S9642A	Grade 1 Laminate	\$3588	\$4432	N.A.	N.A.	
		Grade 2 Laminate	\$3719	\$4563	N.A.	N.A.	
		Grade 1 Wood Veneer	\$5011	\$5855	N.A.	N.A.	
		Grade 2 Wood Veneer	\$5534	\$6378	N.A.	N.A.	

E-Table 2

96"L, 10'L, and 12'L Racetrack, Faceted, Rectangular, and Soft Radiused End Tables

DESIGN JEFF CRONK

SIN 711.11

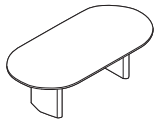

Tip: Shipped knocked down.

Tip: Top ships in one piece.

Tip: 1 mm self-edge is only available on a laminate top surface.

Tip: Flat edge is only available on wood veneer tops and is offered in 6000 Black only.

Tip: When a 3 mm wood edge is specified on a wood veneer top, the edge finish will match the top finish.

Tip: If you specify a wood edge on a top with woodgrain laminate, the edge and the top may not match.

Tip: Each utility bay comes with two universal faceplate openings that accept customer-supplied faceplates in any of the following sizes: single-gang, double-gang, or triple-gang.
 ▶ See Coalesse Tables, Storage, and Accessories Specification Guide

Tip: 96"L tables are available with zero or two utility bays. 10'L tables are available with zero, two or three utility bays. 12'L tables are available with zero, two, three or four utility bays.

Tip: Sectioned top option is a 2-piece top.

Tip: Transformer kit must be the same wiring schematic as the table.

Base veneer and woodgrain laminate direction



Standard Includes	Required to Specify
<ul style="list-style-type: none"> ▶ Need help? Product details, see <i>Coalesse Tables, Storage, and Accessories Specification Guide</i> 	<ol style="list-style-type: none"> 1 Style number 2 Laminate color number for top 3 Edge selection: <ul style="list-style-type: none"> - 1 mm self-edge (laminate top only) to match laminate top, if selected - 3 mm flat plastic edge color number, if selected - Convex vinyl edge, if selected: <ul style="list-style-type: none"> 6000 Black 6607 Woodrose 6609 Smoke 6655 Warm White 4 Options, if selected (see below) <p>▶ See <i>Surface Materials</i>, page 350.</p>

Options	Price	Required to Specify
Surface Materials <ul style="list-style-type: none"> • Grade 2 laminate • Grade 1 wood veneer • Grade 2 wood veneer • Stain-to-Match 	<ul style="list-style-type: none"> Prices at right Prices at right Prices at right No cost 	<ul style="list-style-type: none"> Specify with <i>Grade 2 laminate</i> and select color number. Specify with <i>Grade 1 wood veneer</i> and select color number. Specify with <i>Grade 2 wood veneer</i> and select color number. Specify with <i>Stain-to-Match</i>. <p>▶ Page 383</p>
Base <ul style="list-style-type: none"> • Aluminum base • Curated laminate base • Wood veneer base 	<ul style="list-style-type: none"> +\$ 135 +\$ 557 +\$2168 	<ul style="list-style-type: none"> Replace L suffix in the style number with A suffix and select powder coat color number. Specify with <i>curated laminate</i> and select color number. Replace L suffix in the style number with V suffix and select wood color number.
Edges <ul style="list-style-type: none"> • Wood veneer tops • 3 mm plastic edge • 3 mm wood edge • Convex vinyl edge • Flat edge (6000 Black) • Wood veneer and laminate tops <ul style="list-style-type: none"> • Bullnose wood edge • Beveled wood edge • Knife wood edge • Waterfall wood edge • Faceted wood edge 	<ul style="list-style-type: none"> Prices at right Prices at right Prices at right Prices at right Prices at right Prices at right Prices at right Prices at right Prices at right 	<ul style="list-style-type: none"> Specify with <i>3 mm plastic edge</i> and select color number. Specify with <i>3 mm wood edge</i> and select color number. Specify with <i>convex vinyl edge</i> and select color number. Specify with <i>flat edge</i>. Specify with <i>bullnose wood edge</i>. Specify with <i>beveled wood edge</i>. Specify with <i>knife wood edge</i>. Specify with <i>waterfall wood edge</i>. Specify with <i>faceted wood edge</i>.
Sectioned top <ul style="list-style-type: none"> • Sectioned top 	<ul style="list-style-type: none"> +\$ 363 	<ul style="list-style-type: none"> Specify with <i>sectioned top</i>.
Bay Option <ul style="list-style-type: none"> • No bays • Two bays • Three bays • Four bays 	<ul style="list-style-type: none"> No cost +\$1004 +\$1506 +\$2008 	<ul style="list-style-type: none"> Specify with <i>no bays</i>. Specify with <i>two bays</i> and select color number. Specify with <i>three bays</i> and select color number. Specify with <i>four bays</i> and select color number.
Duplex Wiring Schematic <ul style="list-style-type: none"> • Tables with bay door(s) • 3+0 wireway • 1+1 hardwire, 2 circuits • Chicago powerway 	<ul style="list-style-type: none"> No cost No cost No cost 	<ul style="list-style-type: none"> Specify with <i>3+0 wireway, duplex</i>. Specify with <i>1+1 hardwire, 2 circuits, duplex</i>. Specify with <i>Chicago powerway</i>.
USB Wiring Schematic <ul style="list-style-type: none"> • Tables with bay door(s) • 3+0 wireway • 1+1 hardwire, 2 circuits 	<ul style="list-style-type: none"> +\$ 153 per bay +\$ 153 per bay 	<ul style="list-style-type: none"> Specify with <i>3+0 wireway, USB</i>. Specify with <i>1+1 hardwire, 2 circuits, USB</i>.
Infeed <ul style="list-style-type: none"> • Tables with bay door(s) • Plug (20 amp single circuit) • Hardwire • NYC hardwire infeed 	<ul style="list-style-type: none"> No cost No cost No cost 	<ul style="list-style-type: none"> Specify with <i>plug</i>. Specify with <i>hardwire</i>. Specify with <i>NYC hardwire infeed</i>.

▶ Options, continued on next page

E-Table 2

DESIGN JEFF CRONK

SIN 711.11

96"L, 10'L, and 12'L Racetrack, Faceted, Rectangular, and Soft Radiused End Tables

►Options, continued from previous page

Options	Price	Required to Specify
Related Products	• Transformer kit	► Page 161

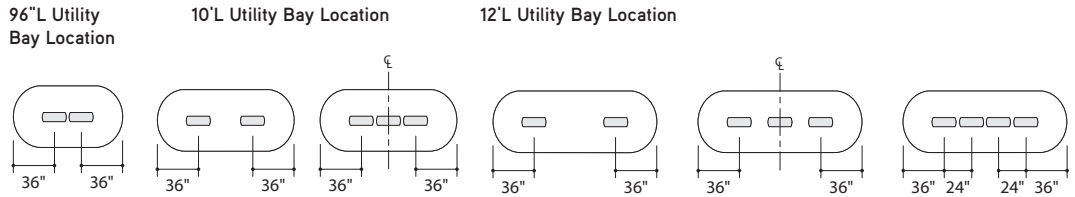

Specification Information			
Dimensions	Style	Finish	Base Prices
L W H	Number		
<p>1 mm Self-Edge, 3 mm Plastic/Wood Edge, Flat Edge, or Convex Vinyl Edge; Bullnose Wood Edge; Beveled Wood Edge; Knife Wood Edge, Waterfall Wood Edge, or Faceted Wood Edge.</p>			

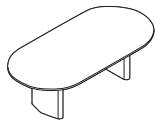

Tip: Racetrack tables are not available with waterfall or faceted wood edge.

Racetrack Tables with Two Bases

96" 48" 29"	E2C9648L	Grade 1 Laminate	\$3750	\$4608	\$4687	\$4850
		Grade 2 Laminate	\$3902	\$4760	\$4839	\$5002
		Grade 1 Wood Veneer	\$5209	\$6067	\$6146	\$6309
		Grade 2 Wood Veneer	\$5803	\$6661	\$6740	\$6903
96" 54" 29"	E2C9654L	Grade 1 Laminate	\$3864	\$4832	\$4918	\$5103
		Grade 2 Laminate	\$4034	\$5002	\$5088	\$5273
		Grade 1 Wood Veneer	\$5504	\$6472	\$6558	\$6743
		Grade 2 Wood Veneer	\$6116	\$7084	\$7170	\$7355
96" 60" 29"	E2C9660L	Grade 1 Laminate	\$3976	\$5050	\$5145	\$5352
		Grade 2 Laminate	\$4163	\$5237	\$5332	\$5539
		Grade 1 Wood Veneer	\$5799	\$6873	\$6968	\$7175
		Grade 2 Wood Veneer	\$6437	\$7511	\$7606	\$7813
10' 48" 29"	E2C1048L	Grade 1 Laminate	\$3993	\$5570	\$5727	\$6012
		Grade 2 Laminate	\$4179	\$5756	\$5913	\$6198
		Grade 1 Wood Veneer	\$5499	\$7076	\$7233	\$7518
		Grade 2 Wood Veneer	\$6244	\$7821	\$7978	\$8263
10' 54" 29"	E2C1054L	Grade 1 Laminate	\$4177	\$5951	\$6127	\$6445
		Grade 2 Laminate	\$4388	\$6162	\$6338	\$6656
		Grade 1 Wood Veneer	\$6004	\$7778	\$7954	\$8272
		Grade 2 Wood Veneer	\$6846	\$8620	\$8796	\$9114
10' 60" 29"	E2C1060L	Grade 1 Laminate	\$4358	\$6332	\$6525	\$6876
		Grade 2 Laminate	\$4591	\$6565	\$6758	\$7109
		Grade 1 Wood Veneer	\$6506	\$8480	\$8673	\$9024
		Grade 2 Wood Veneer	\$7443	\$9417	\$9610	\$9961









►Specification Information, continued on next page

E-Table 2
DESIGN JEFF CRONK

96"L, 10'L, and 12'L Racetrack, Faceted, Rectangular, and Soft Radiused End Tables *continued*

SIN 711.11

► Specification Information, continued from previous page

Specification Information				Base Prices							
Dimensions		Style	Finish								
L	W	H	Number								
											
				1 mm Self-Edge, 3 mm Plastic/ 3 mm Wood Edge, Flat Edge, or Convex Vinyl Edge:	Bullnose Wood Edge:	Beveled Wood Edge:	Knife Wood Edge, Waterfall Wood Edge, or Faceted Wood Edge:				

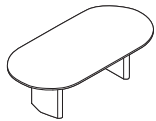

Tip: Racetrack tables are not available with waterfall or faceted wood edge.

Racetrack Tables with Two Bases, continued

Dimensions	Style	Finish	Grade 1	Grade 2	Waterfall	Faceted
12' 48" 29"	E2C1248L	Grade 1 Laminate	\$4029	\$ 6336	\$ 6529	\$ 6915
		Grade 2 Laminate	\$4252	\$ 6559	\$ 6752	\$ 7138
		Grade 1 Wood Veneer	\$6225	\$ 8532	\$ 8725	\$ 9111
		Grade 2 Wood Veneer	\$7120	\$ 9427	\$ 9620	\$10,006
12' 54" 29"	E2C1254L	Grade 1 Laminate	\$4237	\$ 6833	\$ 7044	\$ 7485
		Grade 2 Laminate	\$4492	\$ 7088	\$ 7299	\$ 7740
		Grade 1 Wood Veneer	\$6903	\$ 9499	\$ 9710	\$10,151
		Grade 2 Wood Veneer	\$7913	\$10,509	\$10,720	\$11,161
12' 60" 29"	E2C1260L	Grade 1 Laminate	\$4443	\$ 7327	\$ 7562	\$ 8058
		Grade 2 Laminate	\$4725	\$ 7609	\$ 7844	\$ 8340
		Grade 1 Wood Veneer	\$7575	\$10,459	\$10,694	\$11,190
		Grade 2 Wood Veneer	\$8701	\$11,585	\$11,820	\$12,316

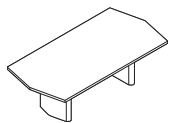

Tip: Faceted tables are not available with waterfall wood edge.

Faceted Tables with Two Bases

Dimensions	Style	Finish	Grade 1	Grade 2	Waterfall	Faceted
96" 48" 29"	E2F9648L	Grade 1 Laminate	\$3905	\$ 4763	\$ 4842	\$ 5005
		Grade 2 Laminate	\$4057	\$ 4915	\$ 4994	\$ 5157
		Grade 1 Wood Veneer	\$5364	\$ 6222	\$ 6301	\$ 6464
		Grade 2 Wood Veneer	\$5952	\$ 6810	\$ 6889	\$ 7052
96" 54" 29"	E2F9654L	Grade 1 Laminate	\$4018	\$ 4986	\$ 5072	\$ 5257
		Grade 2 Laminate	\$4188	\$ 5156	\$ 5242	\$ 5427
		Grade 1 Wood Veneer	\$5658	\$ 6626	\$ 6712	\$ 6897
		Grade 2 Wood Veneer	\$6270	\$ 7238	\$ 7324	\$ 7509
96" 60" 29"	E2F9660L	Grade 1 Laminate	\$4130	\$ 5204	\$ 5299	\$ 5504
		Grade 2 Laminate	\$4317	\$ 5391	\$ 5486	\$ 5691
		Grade 1 Wood Veneer	\$5953	\$ 7027	\$ 7122	\$ 7327
		Grade 2 Wood Veneer	\$6591	\$ 7665	\$ 7760	\$ 7965

► Specification Information, continued on next page

E-Table 2

DESIGN JEFF CRONK

96"L, 10'L, and 12'L Racetrack, Faceted, Rectangular, and Soft Radiused End Tables

SIN 711.11

► Specification Information, continued from previous page

Specification Information				Base Prices							
Dimensions			Style	Finish	Edge Profiles						
L	W	H	Number		1 mm Self-Edge, 3 mm Plastic/ 3 mm Wood Edge, Flat Edge, or Convex Vinyl Edge:	Bullnose Wood Edge:	Beveled Wood Edge:	Knife Wood Edge, Waterfall Wood Edge, or Faceted Wood Edge:			

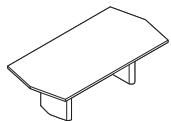

Tip: Faceted tables are not available with waterfall wood edge.

Tip: Vinyl edge profiles on faceted tables require a 4" radius on all corners.

Faceted Tables with Two Bases, continued

Dimensions	Style	Finish	Grade 1	Grade 2	1 mm Self-Edge, 3 mm Plastic/ 3 mm Wood Edge, Flat Edge, or Convex Vinyl Edge:	Bullnose Wood Edge:	Beveled Wood Edge:	Knife Wood Edge, Waterfall Wood Edge, or Faceted Wood Edge:
10' 48" 29"	E2F1048L	Grade 1 Laminate	\$4150	\$5727	\$5884	\$6169		
			Grade 2 Laminate	\$4336	\$5913	\$6070	\$6355	
			Grade 1 Wood Veneer	\$5656	\$7233	\$7390	\$7675	
			Grade 2 Wood Veneer	\$6392	\$7969	\$8126	\$8411	
10' 54" 29"	E2F1054L	Grade 1 Laminate	\$4331	\$6105	\$6281	\$6599		
			Grade 2 Laminate	\$4542	\$6316	\$6492	\$6810	
			Grade 1 Wood Veneer	\$6158	\$7932	\$8108	\$8426	
			Grade 2 Wood Veneer	\$6991	\$8765	\$8941	\$9259	
10' 60" 29"	E2F1060L	Grade 1 Laminate	\$4513	\$6487	\$6680	\$7035		
			Grade 2 Laminate	\$4746	\$6720	\$6913	\$7268	
			Grade 1 Wood Veneer	\$6661	\$8635	\$8828	\$9183	
			Grade 2 Wood Veneer	\$7592	\$9566	\$9759	\$10,114	
12' 48" 29"	E2F1248L	Grade 1 Laminate	\$4189	\$6496	\$6689	\$7075		
			Grade 2 Laminate	\$4412	\$6719	\$6912	\$7298	
			Grade 1 Wood Veneer	\$6385	\$8692	\$8885	\$9271	
			Grade 2 Wood Veneer	\$7272	\$9579	\$9772	\$10,158	
12' 54" 29"	E2F1254L	Grade 1 Laminate	\$4390	\$6986	\$7197	\$7638		
			Grade 2 Laminate	\$4645	\$7241	\$7452	\$7893	
			Grade 1 Wood Veneer	\$7056	\$9652	\$9863	\$10,304	
			Grade 2 Wood Veneer	\$8055	\$10,651	\$10,862	\$11,303	
12' 60" 29"	E2F1260L	Grade 1 Laminate	\$4596	\$7480	\$7715	\$8205		
			Grade 2 Laminate	\$4878	\$7762	\$7997	\$8487	
			Grade 1 Wood Veneer	\$7728	\$10,612	\$10,847	\$11,337	
			Grade 2 Wood Veneer	\$8845	\$11,729	\$11,964	\$12,454	

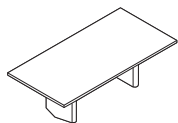

Tip: Vinyl edge profiles on rectangular tables require a 4" radius on all corners.

Rectangular Tables with Two Bases

Dimensions	Style	Grade 1	Grade 2	1 mm Self-Edge, 3 mm Plastic/ 3 mm Wood Edge, Flat Edge, or Convex Vinyl Edge:	Bullnose Wood Edge:	Beveled Wood Edge:	Knife Wood Edge, Waterfall Wood Edge, or Faceted Wood Edge:
96" 48" 29"	E2R9648L	Grade 1 Laminate	\$3598	\$4456	\$4535	\$4698	
		Grade 2 Laminate	\$3750	\$4608	\$4687	\$4850	
		Grade 1 Wood Veneer	\$5057	\$5915	\$5994	\$6157	
		Grade 2 Wood Veneer	\$5645	\$6503	\$6582	\$6745	









► Specification Information, continued on next page

E-Table 2
DESIGN JEFF CRONK

96"L, 10'L, and 12'L Racetrack, Faceted, Rectangular, and Soft Radiused End Tables *continued*

SIN 711.11

► Specification Information, continued from previous page

Specification Information				Base Prices							
Dimensions		Style	Finish								
L	W	H	Number								
											
				1 mm Self-Edge, 3 mm Plastic/ 3 mm Wood Edge, Flat Edge, or Convex Vinyl Edge:	Bullnose Wood Edge:	Beveled Wood Edge:	Knife Wood Edge, Waterfall Wood Edge, or Faceted Wood Edge:				

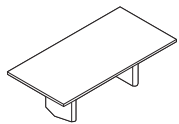

Tip: Vinyl edge profiles on rectangular tables require a 4" radius on all corners.

Rectangular Tables with Two Bases, continued

Dimensions	Style	Finish	Grade 1	Grade 2	1 mm Self-Edge	Bullnose Wood Edge	Beveled Wood Edge	Knife Wood Edge, Waterfall Wood Edge, or Faceted Wood Edge
L	W	H	Price	Price	Price	Price	Price	Price
96"	54"	29"	E2R9654L	Grade 1 Laminate	\$3708	\$ 4676	\$ 4762	\$ 4947
				Grade 2 Laminate	\$3878	\$ 4846	\$ 4932	\$ 5117
				Grade 1 Wood Veneer	\$5348	\$ 6316	\$ 6402	\$ 6587
				Grade 2 Wood Veneer	\$5960	\$ 6928	\$ 7014	\$ 7199
96"	60"	29"	E2R9660L	Grade 1 Laminate	\$3820	\$ 4894	\$ 4989	\$ 5194
				Grade 2 Laminate	\$4007	\$ 5081	\$ 5176	\$ 5381
				Grade 1 Wood Veneer	\$5643	\$ 6717	\$ 6812	\$ 7017
				Grade 2 Wood Veneer	\$6281	\$ 7355	\$ 7450	\$ 7655
10'	48"	29"	E2R1048L	Grade 1 Laminate	\$3841	\$ 5418	\$ 5575	\$ 5860
				Grade 2 Laminate	\$4027	\$ 5604	\$ 5761	\$ 6046
				Grade 1 Wood Veneer	\$5347	\$ 6924	\$ 7081	\$ 7366
				Grade 2 Wood Veneer	\$6083	\$ 7660	\$ 7817	\$ 8102
10'	54"	29"	E2R1054L	Grade 1 Laminate	\$4021	\$ 5795	\$ 5971	\$ 6289
				Grade 2 Laminate	\$4232	\$ 6006	\$ 6182	\$ 6500
				Grade 1 Wood Veneer	\$5848	\$ 7622	\$ 7798	\$ 8116
				Grade 2 Wood Veneer	\$6681	\$ 8455	\$ 8631	\$ 8949
10'	60"	29"	E2R1060L	Grade 1 Laminate	\$4202	\$ 6176	\$ 6369	\$ 6724
				Grade 2 Laminate	\$4435	\$ 6409	\$ 6602	\$ 6957
				Grade 1 Wood Veneer	\$6350	\$ 8324	\$ 8517	\$ 8872
				Grade 2 Wood Veneer	\$7281	\$ 9255	\$ 9448	\$ 9803
12'	48"	29"	E2R1248L	Grade 1 Laminate	\$3877	\$ 6184	\$ 6377	\$ 6763
				Grade 2 Laminate	\$4100	\$ 6407	\$ 6600	\$ 6986
				Grade 1 Wood Veneer	\$6073	\$ 8380	\$ 8573	\$ 8959
				Grade 2 Wood Veneer	\$6960	\$ 9267	\$ 9460	\$ 9846
12'	54"	29"	E2R1254L	Grade 1 Laminate	\$4082	\$ 6678	\$ 6889	\$ 7330
				Grade 2 Laminate	\$4337	\$ 6933	\$ 7144	\$ 7585
				Grade 1 Wood Veneer	\$6748	\$ 9344	\$ 9555	\$ 9996
				Grade 2 Wood Veneer	\$7747	\$10,343	\$10,554	\$10,995
12'	60"	29"	E2R1260L	Grade 1 Laminate	\$4288	\$ 7172	\$ 7407	\$ 7897
				Grade 2 Laminate	\$4570	\$ 7454	\$ 7689	\$ 8179
				Grade 1 Wood Veneer	\$7420	\$10,304	\$10,539	\$11,029
				Grade 2 Wood Veneer	\$8537	\$11,421	\$11,656	\$12,146

► Specification Information, continued on next page

E-Table 2
DESIGN JEFF CRONK

96"L, 10'L, and 12'L Racetrack, Faceted, Rectangular, and Soft Radiused End Tables

SIN 711.11

► Specification Information, continued from previous page

Specification Information				Base Prices						
Dimensions			Style	Finish	Edge Profiles					
L	W	H	Number		1 mm Self-Edge, 3 mm Plastic/ 3 mm Wood Edge, Flat Edge, or Convex Vinyl Edge:	Bullnose Wood Edge:	Beveled Wood Edge:	Knife Wood Edge, Waterfall Wood Edge, or Faceted Wood Edge:		

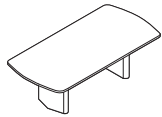

Tip: Vinyl edge profiles on soft radiused tables require a 4" radius on all corners.

Soft Radiused End Tables with Two Bases

Dimensions	Style Number	Finish	Grade 1 Price	Grade 2 Price	Grade 1 Veneer Price	Grade 2 Veneer Price	Other Price 1	Other Price 2
96" 48" 29"	E2S9648L	Grade 1 Laminate	\$3750	\$4608	N.A.	N.A.		
		Grade 2 Laminate	\$3902	\$4760	N.A.	N.A.		
		Grade 1 Wood Veneer	\$5209	\$6067	N.A.	N.A.		
		Grade 2 Wood Veneer	\$5797	\$6655	N.A.	N.A.		
96" 54" 29"	E2S9654L	Grade 1 Laminate	\$3864	\$4832	N.A.	N.A.		
		Grade 2 Laminate	\$4034	\$5002	N.A.	N.A.		
		Grade 1 Wood Veneer	\$5504	\$6472	N.A.	N.A.		
		Grade 2 Wood Veneer	\$6116	\$7084	N.A.	N.A.		
96" 60" 29"	E2S9660L	Grade 1 Laminate	\$3976	\$5050	N.A.	N.A.		
		Grade 2 Laminate	\$4163	\$5237	N.A.	N.A.		
		Grade 1 Wood Veneer	\$5799	\$6873	N.A.	N.A.		
		Grade 2 Wood Veneer	\$6437	\$7511	N.A.	N.A.		
10' 48" 29"	E2S1048L	Grade 1 Laminate	\$3993	\$5570	N.A.	N.A.		
		Grade 2 Laminate	\$4179	\$5756	N.A.	N.A.		
		Grade 1 Wood Veneer	\$5499	\$7076	N.A.	N.A.		
		Grade 2 Wood Veneer	\$6235	\$7812	N.A.	N.A.		
10' 54" 29"	E2S1054L	Grade 1 Laminate	\$4177	\$5951	N.A.	N.A.		
		Grade 2 Laminate	\$4388	\$6162	N.A.	N.A.		
		Grade 1 Wood Veneer	\$6004	\$7778	N.A.	N.A.		
		Grade 2 Wood Veneer	\$6837	\$8611	N.A.	N.A.		
10' 60" 29"	E2S1060L	Grade 1 Laminate	\$4358	\$6332	N.A.	N.A.		
		Grade 2 Laminate	\$4591	\$6565	N.A.	N.A.		
		Grade 1 Wood Veneer	\$6506	\$8480	N.A.	N.A.		
		Grade 2 Wood Veneer	\$7437	\$9411	N.A.	N.A.		
12' 48" 29"	E2S1248L	Grade 1 Laminate	\$4029	\$6336	N.A.	N.A.		
		Grade 2 Laminate	\$4252	\$6559	N.A.	N.A.		
		Grade 1 Wood Veneer	\$6225	\$8532	N.A.	N.A.		
		Grade 2 Wood Veneer	\$7112	\$9419	N.A.	N.A.		
12' 54" 29"	E2S1254L	Grade 1 Laminate	\$4237	\$6833	N.A.	N.A.		
		Grade 2 Laminate	\$4492	\$7088	N.A.	N.A.		
		Grade 1 Wood Veneer	\$6903	\$9499	N.A.	N.A.		
		Grade 2 Wood Veneer	\$7902	\$10,498	N.A.	N.A.		
12' 60" 29"	E2S1260L	Grade 1 Laminate	\$4443	\$7327	N.A.	N.A.		
		Grade 2 Laminate	\$4725	\$7609	N.A.	N.A.		
		Grade 1 Wood Veneer	\$7575	\$10,459	N.A.	N.A.		
		Grade 2 Wood Veneer	\$8692	\$11,576	N.A.	N.A.		

E-Table 2

DESIGN JEFF CRONK

14'L, 16'L, 18'L, and 20'L Racetrack, Faceted, Rectangular, and Soft Radiused End Tables

SIN 711.11

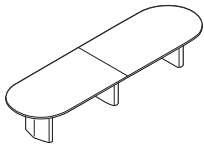

Tip: Top ships in two pieces. Hardware is included for field assembly.

Tip: Shipped knocked down.

Tip: Edge type is specified before top surface when specifying electronically.

Tip: Flat edge is only available on wood veneer tops and is offered in 6000 Black only.

Tip: When a 3 mm wood edge is specified on a wood veneer top, the edge finish will match the top finish.

Tip: If you specify a wood edge on a top with woodgrain laminate, the edge and the top may not match.

Tip: For tables with three or more bases, you must specify the entry point of the base power infeed, either an end base or a mid base location, in order to receive the correct length of base power infeed.

Tip: Each utility bay comes with two universal faceplate openings that accept customer-supplied faceplates in any of the following sizes: single-gang, double-gang, or triple-gang.
 ▶ See *Coalesse Tables, Storage, and Accessories Specification Guide*

Tip: 14'L and 16'L tables are available with zero, two, or four utility bays. 18'L and 20'L tables are available with zero, two, four or six utility bays.

Tip: If you require your table top to be made into four pieces, this can be done as a special. Please contact Customer Service at 1.800.627.6770 to obtain a quote.

Base veneer and woodgrain laminate direction



Standard Includes	Required to Specify
<ul style="list-style-type: none"> ▶ Need help? Product details, see <i>Coalesse Tables, Storage, and Accessories Specification Guide</i> • Top: 1¼" particle board core with grade 1 laminate • Edge: 1 mm self edge (laminated top only), 3 mm plastic edge, 3 mm wood edge, or convex vinyl edge • Three bases: black laminate on MDF core • Wireway: black steel C-channels and side panels and black plastic access door • Concealed leveling glides: non-marring, black plastic 	<ol style="list-style-type: none"> 1 Style number 2 Laminate color number for top 3 Edge selection: <ul style="list-style-type: none"> - 1 mm self-edge (laminated top only) to match laminate top, if selected - 3 mm flat plastic edge color number, if selected - Convex vinyl edge, if selected <p>6000 Black 6607 Woodrose 6609 Smoke 6655 Warm White</p> <ol style="list-style-type: none"> 4 Options, if selected (see below) ▶ See <i>Surface Materials</i> , page 350.

Options	Price	Required to Specify
Surface Materials <ul style="list-style-type: none"> • Grade 2 laminate • Grade 1 wood veneer • Grade 2 wood veneer • Stain-to-Match 	Prices at right Prices at right Prices at right No cost	Specify with <i>Grade 2 laminate</i> and select color number. Specify with <i>Grade 1 wood veneer</i> and select color number. Specify with <i>Grade 2 wood veneer</i> and select color number. Specify with <i>Stain-to-Match</i> . ▶ Page 383
Base <ul style="list-style-type: none"> • Aluminum base • Curated laminate base • Wood veneer base 	+\$ 362 +\$ 871 +\$3329	Replace L suffix in the style number with A suffix and select powder coat color number. Specify with <i>curated laminate</i> and select color number. Replace L suffix in the style number with V suffix and select wood color number.
Edges <ul style="list-style-type: none"> • Wood veneer tops • 3 mm plastic edge • 3 mm wood edge • Convex vinyl edge • Flat edge (6000 Black) • Wood veneer and laminate tops <ul style="list-style-type: none"> • Bullnose wood edge • Beveled wood edge • Knife wood edge • Waterfall wood edge • Faceted wood edge 	Prices at right Prices at right Prices at right Prices at right Prices at right Prices at right Prices at right Prices at right Prices at right	Specify with <i>3 mm plastic edge</i> and select color number. Specify with <i>3 mm wood edge</i> and select color number. Specify with <i>convex vinyl edge</i> and select color number. Specify with <i>flat edge</i> . Specify with <i>bullnose wood edge</i> . Specify with <i>beveled wood edge</i> . Specify with <i>knife wood edge</i> . Specify with <i>waterfall wood edge</i> . Specify with <i>faceted wood edge</i> .
Bay Option <ul style="list-style-type: none"> • No bays • Two bays • Four bays • Six bays 	No cost +\$1004 +\$2008 +\$3012	Specify with <i>no bays</i> . Specify with <i>two bays</i> and select color number. Specify with <i>four bays</i> and select color number. Specify with <i>six bays</i> and select color number.
Duplex Wiring Schematic <ul style="list-style-type: none"> • Tables with bay door(s) • 3+0 wireway • 1+1 hardwire, 2 circuits • Chicago powerway 	No cost No cost No cost	Specify with <i>3+0 wireway, duplex</i> . Specify with <i>1+1 hardwire, 2 circuits, duplex</i> . Specify with <i>Chicago powerway</i> .
USB Wiring Schematic <ul style="list-style-type: none"> • Tables with bay door(s) • 3+0 wireway • 1+1 hardwire, 2 circuits 	+\$ 153 per bay +\$ 153 per bay	Specify with <i>3+0 wireway, USB</i> . Specify with <i>1+1 hardwire, 2 circuits, USB</i> .
Infeed <ul style="list-style-type: none"> • Tables with bay door(s) • Plug (20 amp single circuit) • Hardwire • NYC hardwire infeed 	No cost No cost No cost	Specify with <i>plug</i> . Specify with <i>hardwire</i> . Specify with <i>NYC hardwire infeed</i> .

▶ Options, continued on next page

E-Table 2

DESIGN JEFF CRONK

14'L, 16'L, 18'L, and 20'L Racetrack, Faceted, Rectangular, and Soft Radiused End Tables

SIN 711.11

► Options, continued from previous page

Options	Price	Required to Specify
Infeed Location	Tables with bay doors	
	• End base power infeed	No cost
	• Mid base power infeed	No cost
		Specify with end base entry location for location base power infeed. Specify with mid base entry location for location base power infeed.

Tip: Transformer kit must be the same wiring schematic as the table.

Related Products	• Transformer kit	► Page 161
-------------------------	-------------------	------------

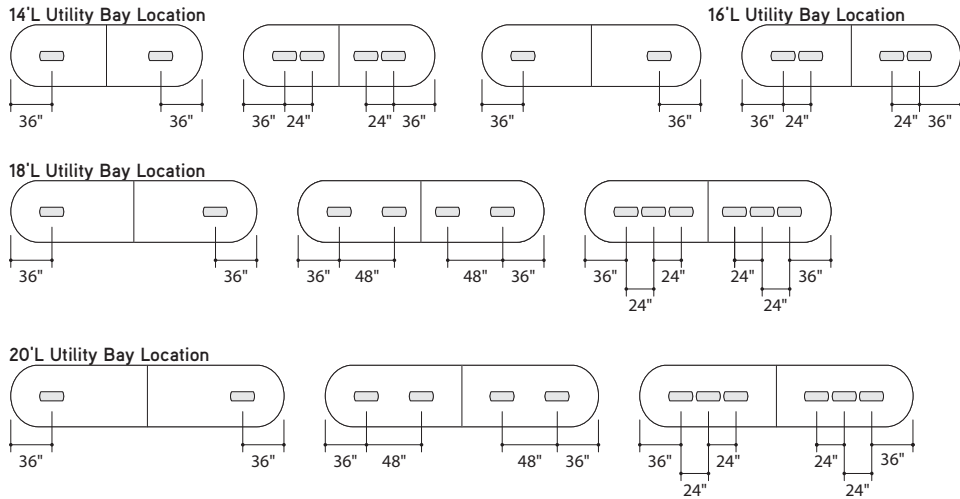

Specification Information

Dimensions	Style	Finish	Base Prices
L W H	Number		
			1 mm Self-Edge, 3 mm Plastic/ 3 mm Wood Edge, Flat Edge, or Convex Vinyl Edge:
			Bullnose Wood Edge:
			Beveled Wood Edge:
			Knife Wood Edge, Waterfall Wood Edge, or Faceted Wood Edge:

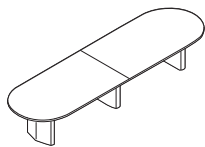

Tip: Racetrack tables are not available with waterfall or faceted wood edge

Racetrack Tables with Three Bases

14' 48" 29"	E2C1448L	Grade 1 Laminate	\$ 5768	\$ 9279	\$ 9458	\$ 10,072
		Grade 2 Laminate	\$ 6017	\$ 9528	\$ 9707	\$ 10,321
		Grade 1 Wood Veneer	\$10,355	\$13,866	\$14,045	\$14,659
		Grade 2 Wood Veneer	\$11,404	\$14,915	\$15,094	\$15,708
14' 54" 29"	E2C1454L	Grade 1 Laminate	\$ 6094	\$10,042	\$10,247	\$10,937
		Grade 2 Laminate	\$ 6374	\$10,322	\$10,527	\$11,217
		Grade 1 Wood Veneer	\$11,438	\$15,386	\$15,591	\$16,281
		Grade 2 Wood Veneer	\$12,628	\$16,576	\$16,781	\$17,471
14' 60" 29"	E2C1460L	Grade 1 Laminate	\$ 6419	\$10,807	\$11,032	\$11,798
		Grade 2 Laminate	\$ 6728	\$11,116	\$11,341	\$12,107
		Grade 1 Wood Veneer	\$12,522	\$16,910	\$17,135	\$17,901
		Grade 2 Wood Veneer	\$13,849	\$18,237	\$18,462	\$19,228









► Specification Information, continued on next page

E-Table 2
DESIGN JEFF CRONK

SIN 711.11

14'L, 16'L, 18'L, and 20'L Racetrack, Faceted, Rectangular, and Soft Radiused End Tables *continued*

► Specification information, continued from previous page

Specification Information				Base Prices							
Dimensions		Style	Finish								
L	W	H	Number								
											
				1 mm Self-Edge, 3 mm Plastic/ 3 mm Wood Edge, Flat Edge, or Convex Vinyl Edge:	Bullnose Wood Edge:	Beveled Wood Edge:	Knife Wood Edge, Waterfall Wood Edge, or Faceted Wood Edge:				

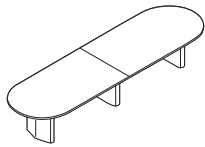

Tip: Racetrack tables are not available with waterfall or faceted wood edge

Racetrack Tables with Three Bases

Dimensions	Style	Finish	Grade 1	Grade 2	Grade 1	Grade 2	Grade 1	Grade 2
L	W	H	Laminate	Laminate	Wood Veneer	Wood Veneer	Laminate	Laminate
16'	48"	29"	E2C1648L	Grade 1 Laminate	\$ 5835	\$ 9495	\$ 9679	\$10,314
				Grade 2 Laminate	\$ 6119	\$ 9779	\$ 9963	\$10,598
				Grade 1 Wood Veneer	\$10,505	\$14,165	\$14,349	\$14,984
				Grade 2 Wood Veneer	\$11,699	\$15,359	\$15,543	\$16,178
16'	54"	29"	E2C1654L	Grade 1 Laminate	\$ 6189	\$10,305	\$10,510	\$11,225
				Grade 2 Laminate	\$ 6507	\$10,623	\$10,828	\$11,543
				Grade 1 Wood Veneer	\$11,634	\$15,750	\$15,955	\$16,670
				Grade 2 Wood Veneer	\$12,828	\$16,944	\$17,149	\$17,864
16'	60"	29"	E2C1660L	Grade 1 Laminate	\$ 6539	\$11,114	\$11,342	\$12,137
				Grade 2 Laminate	\$ 6892	\$11,467	\$11,695	\$12,490
				Grade 1 Wood Veneer	\$12,757	\$17,332	\$17,560	\$18,355
				Grade 2 Wood Veneer	\$14,268	\$18,843	\$19,071	\$19,866
18'	48"	29"	E2C1848L	Grade 1 Laminate	\$ 6051	\$ 9935	\$10,152	\$10,896
				Grade 2 Laminate	\$ 6369	\$10,253	\$10,470	\$11,214
				Grade 1 Wood Veneer	\$12,321	\$16,205	\$16,422	\$17,166
				Grade 2 Wood Veneer	\$13,672	\$17,556	\$17,773	\$18,517
18'	54"	29"	E2C1854L	Grade 1 Laminate	\$ 6447	\$10,823	\$11,058	\$11,896
				Grade 2 Laminate	\$ 6805	\$11,181	\$11,416	\$12,254
				Grade 1 Wood Veneer	\$13,687	\$18,063	\$18,298	\$19,136
				Grade 2 Wood Veneer	\$15,219	\$19,595	\$19,830	\$20,668
18'	60"	29"	E2C1860L	Grade 1 Laminate	\$ 6843	\$11,712	\$11,968	\$12,900
				Grade 2 Laminate	\$ 7242	\$12,111	\$12,367	\$13,299
				Grade 1 Wood Veneer	\$15,053	\$19,922	\$20,178	\$21,110
				Grade 2 Wood Veneer	\$16,765	\$21,634	\$21,890	\$22,822

► Specification Information, continued on next page









E-Table 2

DESIGN JEFF CRONK

SIN 711.11

14'L, 16'L, 18'L, and 20'L Racetrack, Faceted, Rectangular, and Soft Radiused End Tables

► Specification Information, continued from previous page

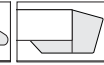
Specification Information				Base Prices								
Dimensions		Style	Finish									
L	W	H	Number									
												
				1 mm Self-Edge, 3 mm Plastic/ 3 mm Wood Edge, Flat Edge, or Convex Vinyl Edge:	Bullnose Wood Edge:	Beveled Wood Edge:	Knife Wood Edge, Waterfall Wood Edge, or Faceted Wood Edge:					

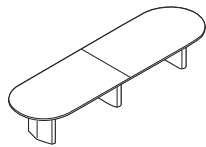

Tip: Racetrack tables are not available with waterfall or faceted wood edge

Racetrack Tables with Three Bases, continued

Dimensions	Style Number	Finish	Grade 1	Grade 2	Waterfall	Faceted	Soft Radiused
20' 48" 29"	E2C2048L	Grade 1 Laminate	\$ 6085	\$ 6085	\$10,361	\$10,609	\$11,392
		Grade 2 Laminate	\$ 6437	\$ 6437	\$10,713	\$10,961	\$11,744
		Grade 1 Wood Veneer	\$13,250	\$13,250	\$17,526	\$17,774	\$18,557
		Grade 2 Wood Veneer	\$14,743	\$14,743	\$19,019	\$19,267	\$20,050
20' 54" 29"	E2C2054L	Grade 1 Laminate	\$ 6506	\$ 6506	\$11,321	\$11,598	\$12,478
		Grade 2 Laminate	\$ 6903	\$ 6903	\$11,718	\$11,995	\$12,875
		Grade 1 Wood Veneer	\$14,750	\$14,750	\$19,565	\$19,842	\$20,722
		Grade 2 Wood Veneer	\$16,444	\$16,444	\$21,259	\$21,536	\$22,416
20' 60" 29"	E2C2060L	Grade 1 Laminate	\$ 6925	\$ 6925	\$12,282	\$12,582	\$13,559
		Grade 2 Laminate	\$ 7367	\$ 7367	\$12,724	\$13,024	\$14,001
		Grade 1 Wood Veneer	\$16,254	\$16,254	\$21,611	\$21,911	\$22,888
		Grade 2 Wood Veneer	\$18,145	\$18,145	\$23,502	\$23,802	\$24,779

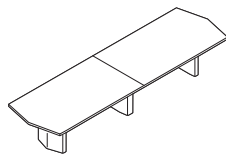

Tip: Faceted tables are not available with waterfall wood edge.

Tip: Vinyl edge profiles on faceted tables require a 4" radius on all corners.

Faceted Tables with Three Bases

Dimensions	Style Number	Finish	Grade 1	Grade 2	Waterfall	Faceted	Soft Radiused
14' 48" 29"	E2F1448L	Grade 1 Laminate	\$ 5915	\$ 5915	\$ 9426	\$ 9605	\$10,219
		Grade 2 Laminate	\$ 6164	\$ 6164	\$ 9675	\$ 9854	\$10,468
		Grade 1 Wood Veneer	\$10,502	\$10,502	\$14,013	\$14,192	\$14,806
		Grade 2 Wood Veneer	\$11,539	\$11,539	\$15,050	\$15,229	\$15,843
14' 54" 29"	E2F1454L	Grade 1 Laminate	\$ 6241	\$ 6241	\$10,189	\$10,394	\$11,084
		Grade 2 Laminate	\$ 6521	\$ 6521	\$10,469	\$10,674	\$11,364
		Grade 1 Wood Veneer	\$11,585	\$11,585	\$15,533	\$15,738	\$16,428
		Grade 2 Wood Veneer	\$12,767	\$12,767	\$16,715	\$16,920	\$17,610
14' 60" 29"	E2F1460L	Grade 1 Laminate	\$ 6568	\$ 6568	\$10,956	\$11,181	\$11,948
		Grade 2 Laminate	\$ 6877	\$ 6877	\$11,265	\$11,490	\$12,257
		Grade 1 Wood Veneer	\$12,671	\$12,671	\$17,059	\$17,284	\$18,051
		Grade 2 Wood Veneer	\$13,992	\$13,992	\$18,380	\$18,605	\$19,372
16' 48" 29"	E2F1648L	Grade 1 Laminate	\$ 5981	\$ 5981	\$ 9641	\$ 9825	\$10,460
		Grade 2 Laminate	\$ 6265	\$ 6265	\$ 9925	\$10,109	\$10,744
		Grade 1 Wood Veneer	\$10,651	\$10,651	\$14,311	\$14,495	\$15,130
		Grade 2 Wood Veneer	\$11,838	\$11,838	\$15,498	\$15,682	\$16,317

► Specification Information, continued on next page









E-Table 2

DESIGN JEFF CRONK

14'L, 16'L, 18'L, and 20'L Racetrack, Faceted, Rectangular, and Soft Radiused End Tables *continued*

SIN 711.11

► Specification Information, continued from previous page

Specification Information				Base Prices							
Dimensions		Style	Finish								
L	W	H	Number								
											
				1 mm Self-Edge, 3 mm Plastic/ 3 mm Wood Edge, Flat Edge, or Convex Vinyl Edge:	Bullnose Wood Edge:	Beveled Wood Edge:	Knife Wood Edge, Waterfall Wood Edge, or Faceted Wood Edge:				

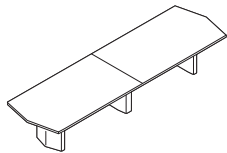

Tip: Faceted tables are not available with waterfall wood edge.

Tip: Vinyl edge profiles on faceted tables require a 4" radius on all corners.

Faceted Tables with Three Bases, continued

Dimensions	Style	Finish	Grade 1	Grade 2	Grade 1	Grade 2	Grade 1	Grade 2
L	W	H	Laminate	Laminate	Wood Veneer	Wood Veneer	Laminate	Laminate
16'	54"	29"	E2F1654L	Grade 1 Laminate	\$ 6333	\$10,449	\$10,654	\$11,369
				Grade 2 Laminate	\$ 6651	\$10,767	\$10,972	\$11,687
				Grade 1 Wood Veneer	\$11,778	\$15,894	\$16,099	\$16,814
				Grade 2 Wood Veneer	\$13,122	\$17,238	\$17,443	\$18,158
16'	60"	29"	E2F1660L	Grade 1 Laminate	\$ 6684	\$11,259	\$11,487	\$12,279
				Grade 2 Laminate	\$ 7037	\$11,612	\$11,840	\$12,632
				Grade 1 Wood Veneer	\$12,902	\$17,477	\$17,705	\$18,497
				Grade 2 Wood Veneer	\$14,403	\$18,978	\$19,206	\$19,998
18'	48"	29"	E2F1848L	Grade 1 Laminate	\$ 6196	\$10,080	\$10,297	\$11,041
				Grade 2 Laminate	\$ 6514	\$10,398	\$10,615	\$11,359
				Grade 1 Wood Veneer	\$12,466	\$16,350	\$16,567	\$17,311
				Grade 2 Wood Veneer	\$13,804	\$17,688	\$17,905	\$18,649
18'	54"	29"	E2F1854L	Grade 1 Laminate	\$ 6592	\$10,968	\$11,203	\$12,041
				Grade 2 Laminate	\$ 6950	\$11,326	\$11,561	\$12,399
				Grade 1 Wood Veneer	\$13,832	\$18,208	\$18,443	\$19,281
				Grade 2 Wood Veneer	\$15,352	\$19,728	\$19,963	\$20,801
18'	60"	29"	E2F1860L	Grade 1 Laminate	\$ 6990	\$11,859	\$12,115	\$13,047
				Grade 2 Laminate	\$ 7389	\$12,258	\$12,514	\$13,446
				Grade 1 Wood Veneer	\$15,200	\$20,069	\$20,325	\$21,257
				Grade 2 Wood Veneer	\$16,901	\$21,770	\$22,026	\$22,958
20'	48"	29"	E2F2048L	Grade 1 Laminate	\$ 6232	\$10,508	\$10,756	\$11,539
				Grade 2 Laminate	\$ 6584	\$10,860	\$11,108	\$11,891
				Grade 1 Wood Veneer	\$13,397	\$17,673	\$17,921	\$18,704
				Grade 2 Wood Veneer	\$14,878	\$19,154	\$19,402	\$20,185
20'	54"	29"	E2F2054L	Grade 1 Laminate	\$ 6651	\$11,466	\$11,743	\$12,623
				Grade 2 Laminate	\$ 7048	\$11,863	\$12,140	\$13,020
				Grade 1 Wood Veneer	\$14,895	\$19,710	\$19,987	\$20,867
				Grade 2 Wood Veneer	\$16,577	\$21,392	\$21,669	\$22,549
20'	60"	29"	E2F2060L	Grade 1 Laminate	\$ 7072	\$12,429	\$12,729	\$13,707
				Grade 2 Laminate	\$ 7514	\$12,871	\$13,171	\$14,149
				Grade 1 Wood Veneer	\$16,401	\$21,758	\$22,058	\$23,036
				Grade 2 Wood Veneer	\$18,281	\$23,638	\$23,938	\$24,916

► Specification Information, continued on next page

E-Table 2

DESIGN JEFF CRONK

14'L, 16'L, 18'L, and 20'L Racetrack, Faceted, Rectangular, and Soft Radiused End Tables

SIN 711.11

► Specification Information, continued from previous page

Specification Information				Base Prices						
Dimensions			Style	Finish	1 mm Self-Edge, 3 mm Plastic/ 3 mm Wood Edge, Flat Edge, or Convex Vinyl Edge:	Bullnose Wood Edge:	Beveled Wood Edge:	Knife Wood Edge, Waterfall Wood Edge, or Faceted Wood Edge:	Waterfall Wood Edge:	Faceted Wood Edge:
L	W	H	Number							

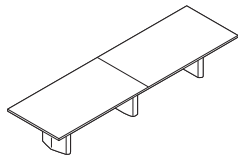

Tip: Vinyl edge profiles on rectangular tables require a 4" radius on all corners.

Rectangular Tables with Three Bases

Dimensions	Style	Finish	Grade 1	Grade 2	Grade 1	Grade 2	Grade 1	Grade 2
L	W	H	Laminate	Laminate	Wood Veneer	Wood Veneer	Wood Veneer	Wood Veneer
14'	48"	29"	E2R1448L	Grade 1 Laminate	\$ 5622	\$ 9133	\$ 9312	\$ 9926
				Grade 2 Laminate	\$ 5871	\$ 9382	\$ 9561	\$10,175
				Grade 1 Wood Veneer	\$10,209	\$13,720	\$13,899	\$14,513
				Grade 2 Wood Veneer	\$11,246	\$14,757	\$14,936	\$15,550
14'	54"	29"	E2R1454L	Grade 1 Laminate	\$ 5948	\$ 9896	\$10,101	\$10,791
				Grade 2 Laminate	\$ 6228	\$10,176	\$10,381	\$11,071
				Grade 1 Wood Veneer	\$11,292	\$15,240	\$15,445	\$16,135
				Grade 2 Wood Veneer	\$12,474	\$16,422	\$16,627	\$17,317
14'	60"	29"	E2R1460L	Grade 1 Laminate	\$ 6273	\$10,661	\$10,886	\$11,653
				Grade 2 Laminate	\$ 6582	\$10,970	\$11,195	\$11,962
				Grade 1 Wood Veneer	\$12,376	\$16,764	\$16,989	\$17,756
				Grade 2 Wood Veneer	\$13,697	\$18,085	\$18,310	\$19,077
16'	48"	29"	E2R1648L	Grade 1 Laminate	\$ 5689	\$ 9349	\$ 9533	\$10,168
				Grade 2 Laminate	\$ 5973	\$ 9633	\$ 9817	\$10,452
				Grade 1 Wood Veneer	\$10,359	\$14,019	\$14,203	\$14,838
				Grade 2 Wood Veneer	\$11,546	\$15,206	\$15,390	\$16,025
16'	54"	29"	E2R1654L	Grade 1 Laminate	\$ 6043	\$10,159	\$10,364	\$11,079
				Grade 2 Laminate	\$ 6361	\$10,477	\$10,682	\$11,397
				Grade 1 Wood Veneer	\$11,488	\$15,604	\$15,809	\$16,524
				Grade 2 Wood Veneer	\$12,832	\$16,948	\$17,153	\$17,868
16'	60"	29"	E2R1660L	Grade 1 Laminate	\$ 6393	\$10,968	\$11,196	\$11,988
				Grade 2 Laminate	\$ 6746	\$11,321	\$11,549	\$12,341
				Grade 1 Wood Veneer	\$12,611	\$17,186	\$17,414	\$18,206
				Grade 2 Wood Veneer	\$14,112	\$18,687	\$18,915	\$19,707
18'	48"	29"	E2R1848L	Grade 1 Laminate	\$ 5902	\$ 9786	\$10,003	\$10,747
				Grade 2 Laminate	\$ 6220	\$10,104	\$10,321	\$11,065
				Grade 1 Wood Veneer	\$12,172	\$16,056	\$16,273	\$17,017
				Grade 2 Wood Veneer	\$13,510	\$17,394	\$17,611	\$18,355
18'	54"	29"	E2R1854L	Grade 1 Laminate	\$ 6302	\$10,678	\$10,913	\$11,751
				Grade 2 Laminate	\$ 6660	\$11,036	\$11,271	\$12,109
				Grade 1 Wood Veneer	\$13,542	\$17,918	\$18,153	\$18,991
				Grade 2 Wood Veneer	\$15,062	\$19,438	\$19,673	\$20,511

► Specification Information, continued on next page









E-Table 2

DESIGN JEFF CRONK

14'L, 16'L, 18'L, and 20'L Racetrack, Faceted, Rectangular, and Soft Radiused End Tables *continued*

SIN 711.11

► Specification Information, continued from previous page

Specification Information				Base Prices								
Dimensions		Style	Finish									
L	W	H	Number									
												
				1 mm Self-Edge, 3 mm Plastic/ 3 mm Wood Edge, Flat Edge, or Convex Vinyl Edge:	Bullnose Wood Edge:	Beveled Wood Edge:	Knife Wood Edge, Waterfall Wood Edge, or Faceted Wood Edge:					

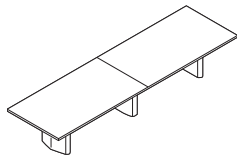

Tip: Vinyl edge profiles on rectangular tables require a 4" radius on all corners.

Rectangular Tables with Three Bases, continued

Dimensions	Style	Finish	Grade 1 Laminate	Grade 2 Laminate	Grade 1 Wood Veneer	Grade 2 Wood Veneer
18' 60" 29"	E2R1860L	Grade 1 Laminate	\$ 6700	\$11,569	\$11,825	\$12,757
		Grade 2 Laminate	\$ 7099	\$11,968	\$12,224	\$13,156
		Grade 1 Wood Veneer	\$14,910	\$19,779	\$20,035	\$20,967
		Grade 2 Wood Veneer	\$16,611	\$21,480	\$21,736	\$22,668
20' 48" 29"	E2R2048L	Grade 1 Laminate	\$ 5939	\$10,215	\$10,463	\$11,246
		Grade 2 Laminate	\$ 6291	\$10,567	\$10,815	\$11,598
		Grade 1 Wood Veneer	\$13,104	\$17,380	\$17,628	\$18,411
		Grade 2 Wood Veneer	\$14,585	\$18,861	\$19,109	\$19,892
20' 54" 29"	E2R2054L	Grade 1 Laminate	\$ 6359	\$11,174	\$11,451	\$12,331
		Grade 2 Laminate	\$ 6756	\$11,571	\$11,848	\$12,728
		Grade 1 Wood Veneer	\$14,603	\$19,418	\$19,695	\$20,575
		Grade 2 Wood Veneer	\$16,285	\$21,100	\$21,377	\$22,257
20' 60" 29"	E2R2060L	Grade 1 Laminate	\$ 6781	\$12,138	\$12,438	\$13,416
		Grade 2 Laminate	\$ 7223	\$12,580	\$12,880	\$13,858
		Grade 1 Wood Veneer	\$16,110	\$21,467	\$21,767	\$22,745
		Grade 2 Wood Veneer	\$17,990	\$23,347	\$23,647	\$24,625

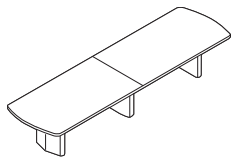

Tip: Vinyl edge profiles on soft radiused tables require a 4" radius on all corners.

Soft Radiused End Tables with Three Bases

Dimensions	Style	Finish	Grade 1 Laminate	Grade 2 Laminate	Grade 1 Wood Veneer	Grade 2 Wood Veneer
14' 48" 29"	E2S1448L	Grade 1 Laminate	\$ 5768	\$ 9279	N.A.	N.A.
		Grade 2 Laminate	\$ 6017	\$ 9528	N.A.	N.A.
		Grade 1 Wood Veneer	\$10,355	\$13,866	N.A.	N.A.
		Grade 2 Wood Veneer	\$11,392	\$14,903	N.A.	N.A.
14' 54" 29"	E2S1454L	Grade 1 Laminate	\$ 6094	\$10,042	N.A.	N.A.
		Grade 2 Laminate	\$ 6374	\$10,322	N.A.	N.A.
		Grade 1 Wood Veneer	\$11,438	\$15,386	N.A.	N.A.
		Grade 2 Wood Veneer	\$12,620	\$16,568	N.A.	N.A.
14' 60" 29"	E2S1460L	Grade 1 Laminate	\$ 6419	\$10,807	N.A.	N.A.
		Grade 2 Laminate	\$ 6728	\$11,116	N.A.	N.A.
		Grade 1 Wood Veneer	\$12,522	\$16,910	N.A.	N.A.
		Grade 2 Wood Veneer	\$13,843	\$18,231	N.A.	N.A.
16' 48" 29"	E2S1648L	Grade 1 Laminate	\$ 5835	\$ 9495	N.A.	N.A.
		Grade 2 Laminate	\$ 6119	\$ 9779	N.A.	N.A.
		Grade 1 Wood Veneer	\$10,505	\$14,165	N.A.	N.A.
		Grade 2 Wood Veneer	\$11,692	\$15,352	N.A.	N.A.

► Specification Information, continued on next page









E-Table 2

DESIGN JEFF CRONK

14'L, 16'L, 18'L, and 20'L Racetrack, Faceted, Rectangular, and Soft Radiused End Tables

SIN 711.11

► Specification Information, continued from previous page

Specification Information				Base Prices							
Dimensions		Style	Finish								
L	W	H	Number								
											
				1 mm Self-Edge, 3 mm Plastic/ 3 mm Wood Edge, Flat Edge, or Convex Vinyl Edge:	Bullnose Wood Edge:	Beveled Wood Edge:	Knife Wood Edge, Waterfall Wood Edge, or Faceted Wood Edge:				

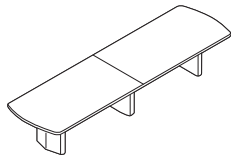

Tip: Vinyl edge profiles on soft radiused tables require a 4" radius on all corners.

Soft Radiused End Tables with Three Bases, continued

Dimensions	Style	Finish	Grade 1	Grade 2	Grade 1	Grade 2	Grade 1	Grade 2
L	W	H	Laminate	Laminate	Wood Veneer	Wood Veneer	Wood Edge	Wood Edge
16'	54"	29"	E2S1654L	Grade 1 Laminate	\$ 6189	\$10,305	N.A.	N.A.
				Grade 2 Laminate	\$ 6507	\$10,623	N.A.	N.A.
				Grade 1 Wood Veneer	\$11,634	\$15,750	N.A.	N.A.
				Grade 2 Wood Veneer	\$12,978	\$17,094	N.A.	N.A.
16'	60"	29"	E2S1660L	Grade 1 Laminate	\$ 6539	\$11,114	N.A.	N.A.
				Grade 2 Laminate	\$ 6892	\$11,467	N.A.	N.A.
				Grade 1 Wood Veneer	\$12,757	\$17,332	N.A.	N.A.
				Grade 2 Wood Veneer	\$14,258	\$18,833	N.A.	N.A.
18'	48"	29"	E2S1848L	Grade 1 Laminate	\$ 6051	\$ 9935	N.A.	N.A.
				Grade 2 Laminate	\$ 6369	\$10,253	N.A.	N.A.
				Grade 1 Wood Veneer	\$12,321	\$16,205	N.A.	N.A.
				Grade 2 Wood Veneer	\$13,659	\$17,543	N.A.	N.A.
18'	54"	29"	E2S1854L	Grade 1 Laminate	\$ 6447	\$10,823	N.A.	N.A.
				Grade 2 Laminate	\$ 6805	\$11,181	N.A.	N.A.
				Grade 1 Wood Veneer	\$13,687	\$18,063	N.A.	N.A.
				Grade 2 Wood Veneer	\$15,207	\$19,583	N.A.	N.A.
18'	60"	29"	E2S1860L	Grade 1 Laminate	\$ 6843	\$11,712	N.A.	N.A.
				Grade 2 Laminate	\$ 7242	\$12,111	N.A.	N.A.
				Grade 1 Wood Veneer	\$15,053	\$19,922	N.A.	N.A.
				Grade 2 Wood Veneer	\$16,754	\$21,623	N.A.	N.A.
20'	48"	29"	E2S2048L	Grade 1 Laminate	\$ 6085	\$10,361	N.A.	N.A.
				Grade 2 Laminate	\$ 6437	\$10,713	N.A.	N.A.
				Grade 1 Wood Veneer	\$13,250	\$17,526	N.A.	N.A.
				Grade 2 Wood Veneer	\$14,731	\$19,007	N.A.	N.A.
20'	54"	29"	E2S2054L	Grade 1 Laminate	\$ 6506	\$11,321	N.A.	N.A.
				Grade 2 Laminate	\$ 6903	\$11,718	N.A.	N.A.
				Grade 1 Wood Veneer	\$14,750	\$19,565	N.A.	N.A.
				Grade 2 Wood Veneer	\$16,432	\$21,247	N.A.	N.A.
20'	60"	29"	E2S2060L	Grade 1 Laminate	\$ 6925	\$12,282	N.A.	N.A.
				Grade 2 Laminate	\$ 7367	\$12,724	N.A.	N.A.
				Grade 1 Wood Veneer	\$16,254	\$21,611	N.A.	N.A.
				Grade 2 Wood Veneer	\$18,134	\$23,491	N.A.	N.A.

E-Table 2

22'L and 24'L Racetrack, Faceted, Rectangular, and Soft Radiused End Tables
DESIGN JEFF CRONK

SIN 711.11

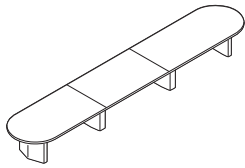

Tip: Top ships in three pieces. Hardware is included for field assembly.

Tip: Shipped knocked down.

Tip: 1 mm self-edge is only available on a laminate top surface.

Tip: Flat edge is only available on wood veneer tops and is offered in 6000 Black only.

Tip: When a 3 mm wood edge is specified on a wood veneer top, the edge finish will match the top finish.

Tip: If you specify a wood edge on a top with woodgrain laminate, the edge and the top may not match.

Tip: For table with three or more bases, you must specify the entry point of the base power infeed, either an end base or mid base location, in order to receive the correct length of base power infeed.

Tip: Each utility bay comes with two universal faceplate openings that accept customer-supplied faceplates in any of the following sizes: single-gang, double-gang, or triple-gang. ▶ See Coalesse Tables, Storage, and Accessories Specification Guide

Tip: If you require your table top to be made into four pieces, this can be done as a special. Please contact Customer Service at 1.800.627.6770 to obtain a quote.

Tip: Tables available with zero, two, four or seven utility bays.

Standard Includes		Required to Specify	
▶ Need help? Product details, see <i>Coalesse Tables, Storage, and Accessories Specification Guide</i>	<ul style="list-style-type: none"> • Top: 1¼" particle board core with grade 1 laminate • Edge: 1 mm self edge (laminate top only), 3 mm plastic edge, 3 mm wood edge, or convex vinyl edge • Four bases: black laminate on MDF core • Wireway: black steel C-channels and side panels and black plastic access door • Concealed leveling glides: non-marring, black plastic 	1 Style number 2 Laminate color number for top 3 Edge selection: <ul style="list-style-type: none"> - 1 mm self-edge (laminate top only) to match laminate top, if selected - 3 mm flat plastic edge color number, if selected - Convex vinyl edge, if selected: 6000 Black, 6607 Woodrose, 6609 Smoke, 6655 Warm White 4 Options, if selected (see below) ▶ See <i>Surface Materials</i> , page 350.	
Surface Materials	Options	Price	Required to Specify
	Top		
	• Grade 2 laminate	Prices at right	Specify with <i>Grade 2 laminate</i> and select color number.
	• Grade 1 wood veneer	Prices at right	Specify with <i>Grade 1 wood veneer</i> and select color number.
	• Grade 2 wood veneer	Prices at right	Specify with <i>Grade 2 wood veneer</i> and select color number.
	• Stain-to-Match	No cost	Specify with <i>Stain-to-Match</i> . ▶ Page 383
	Base		
	• Aluminum base	+\$ 583	Replace L suffix in the style number with A suffix and select powder coat color number.
	• Curated laminate base	+\$ 1187	Specify with <i>curated laminate</i> and select color number.
	• Wood veneer base	+\$4490	Replace L suffix in the style number with V suffix and select wood color number.
Edges	Wood veneer tops		
	• 3 mm plastic edge	Prices at right	Specify with <i>3 mm plastic edge</i> and select color number.
	• 3 mm wood edge	Prices at right	Specify with <i>3 mm wood edge</i> and select color number.
	• Convex vinyl edge	Prices at right	Specify with <i>convex vinyl edge</i> and select color number.
	• Flat edge (6000 Black)	Prices at right	Specify with <i>flat edge</i> .
	Wood veneer and laminate tops		
	• Bullnose wood edge	Prices at right	Specify with <i>bullnose wood edge</i> .
	• Beveled wood edge	Prices at right	Specify with <i>beveled wood edge</i> .
	• Knife wood edge	Prices at right	Specify with <i>knife wood edge</i> .
	• Waterfall wood edge	Prices at right	Specify with <i>waterfall wood edge</i> .
	• Faceted wood edge	Prices at right	Specify with <i>faceted wood edge</i> .
Bay Option			
	• No bays	No cost	Specify with <i>no bays</i> .
	• Two bays	+\$1004	Specify with <i>two bays</i> and select color number.
	• Four bays	+\$2008	Specify with <i>four bays</i> and select color number.
	• Seven bays	+\$3514	Specify with <i>seven bays</i> and select color number.
Duplex Wiring Schematic	Tables with bay door(s)		
	• 3+0 wireway	No cost	Specify with <i>3+0 wireway, duplex</i> .
	• 1+1 hardwire, 2 circuits	No cost	Specify with <i>1+1 hardwire, 2 circuits, duplex</i> .
	• Chicago powerway	No cost	Specify with <i>Chicago powerway</i> .
USB Wiring Schematic	Tables with bay door(s)		
	• 3+0 wireway	+\$ 153 per bay	Specify with <i>3+0 wireway, USB</i> .
	• 1+1 hardwire, 2 circuits	+\$ 153 per bay	Specify with <i>1+1 hardwire, 2 circuits, USB</i> .
Infeed	Tables with bay door(s)		
	• Plug (20 amp single circuit)	No cost	Specify with <i>plug</i> .
	• Hardwire	No cost	Specify with <i>hardwire</i> .
	• NYC hardwire infeed	No cost	Specify with <i>NYC hardwire infeed</i> .

▶ Options, continued on next page

E-Table 2

DESIGN JEFF CRONK

22'L and 24'L Racetrack, Faceted, Rectangular, and Soft Radiused End Tables

SIN 711.11

►Options, continued from previous page

Options	Price	Required to Specify
Infeed Location	Tables with bay doors	
	• End base power infeed	No cost
	• Mid base power infeed	No cost
		Specify with end base entry location for location base power infeed. Specify with mid base entry location for location base power infeed.

Tip: Transformer kit must be the same wiring schematic as the table.

Related Products	• Transformer kit	► Page 161
-------------------------	-------------------	------------

22'L Utility Bay Location

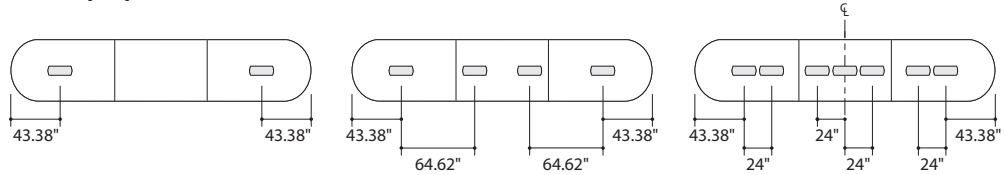

24'L Utility Bay Location

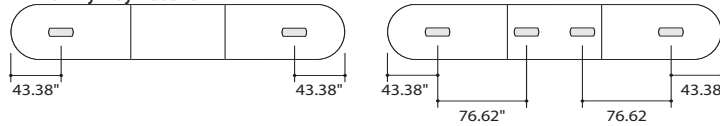

Base veneer and woodgrain laminate direction

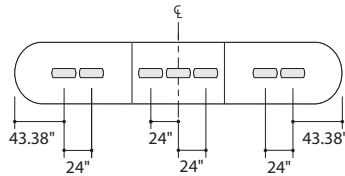

Specification Information

Dimensions	Style	Finish	Base Prices
L W H	Number		
			 1 mm Self-Edge, 3 mm Plastic/3 mm Wood Edge, Flat Edge, or Convex Vinyl Edge:
			 Bullnose Wood Edge:
			 Beveled Wood Edge:
			 Knife Wood Edge, Waterfall Wood Edge, or Faceted Wood Edge:

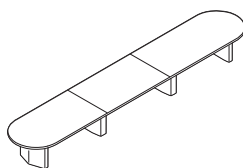

Tip: Racetrack tables are not available with waterfall or faceted wood edge.

Racetrack Tables with Four Bases

22' 48" 29"	E2C2248L	Grade 1 Laminate	\$ 8056	\$13,680	\$13,947	\$14,951
		Grade 2 Laminate	\$ 8440	\$14,064	\$14,331	\$15,335
		Grade 1 Wood Veneer	\$17,767	\$23,391	\$23,658	\$24,662
		Grade 2 Wood Veneer	\$19,411	\$25,035	\$25,302	\$26,306
22' 54" 29"	E2C2254L	Grade 1 Laminate	\$ 8614	\$14,923	\$15,228	\$16,376
		Grade 2 Laminate	\$ 9045	\$15,354	\$15,659	\$16,807
		Grade 1 Wood Veneer	\$19,715	\$26,024	\$26,329	\$27,477
		Grade 2 Wood Veneer	\$21,577	\$27,886	\$28,191	\$29,339
22' 60" 29"	E2C2260L	Grade 1 Laminate	\$ 9161	\$16,207	\$16,506	\$17,798
		Grade 2 Laminate	\$ 9640	\$16,686	\$16,985	\$18,277
		Grade 1 Wood Veneer	\$21,664	\$28,710	\$29,009	\$30,301
		Grade 2 Wood Veneer	\$23,748	\$30,794	\$31,093	\$32,385

►Specification Information, continued on next page

E-Table 2

DESIGN JEFF CRONK

22'L and 24'L Racetrack, Faceted, Rectangular, and Soft Radiused End Tables *continued*

SIN 711.11

► Specification information, continued from previous page

Specification Information				Base Prices							
Dimensions		Style	Finish								
L	W	H	Number								
				1 mm Self-Edge, 3 mm Plastic/ 3 mm Wood Edge, Flat Edge, or Convex Vinyl Edge:	Bullnose Wood Edge:	Beveled Wood Edge:	Knife Wood Edge, Waterfall Wood Edge, or Faceted Wood Edge:				

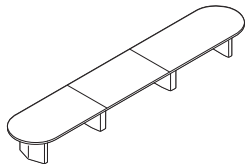

Tip: Racetrack tables are not available with waterfall or faceted wood edge.

Racetrack Tables with Four Bases

Dimensions	Style Number	Finish	1 mm Self-Edge, 3 mm Plastic/ 3 mm Wood Edge, Flat Edge, or Convex Vinyl Edge	Bullnose Wood Edge	Beveled Wood Edge	Knife Wood Edge, Waterfall Wood Edge, or Faceted Wood Edge
24' 48" 29"	E2C2448L	Grade 1 Laminate	\$ 8131	\$13,988	\$14,283	\$15,202
		Grade 2 Laminate	\$ 8548	\$14,405	\$14,700	\$15,619
		Grade 1 Wood Veneer	\$17,970	\$23,827	\$24,122	\$25,041
		Grade 2 Wood Veneer	\$19,777	\$25,634	\$25,929	\$26,848
24' 54" 29"	E2C2454L	Grade 1 Laminate	\$ 8725	\$15,260	\$15,535	\$16,690
		Grade 2 Laminate	\$ 9195	\$15,730	\$16,005	\$17,160
		Grade 1 Wood Veneer	\$19,929	\$26,464	\$26,739	\$27,894
		Grade 2 Wood Veneer	\$21,977	\$28,512	\$28,787	\$29,942
24' 60" 29"	E2C2460L	Grade 1 Laminate	\$ 9257	\$16,574	\$16,799	\$18,190
		Grade 2 Laminate	\$ 9779	\$17,096	\$17,321	\$18,712
		Grade 1 Wood Veneer	\$21,903	\$29,220	\$29,445	\$30,836
		Grade 2 Wood Veneer	\$24,194	\$31,511	\$31,736	\$33,127

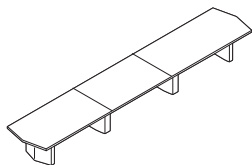

Tip: Faceted tables are not available with waterfall wood edge.

Tip: Vinyl edge profiles on faceted tables require a 4" radius on all corners.

Faceted Tables with Four Bases

Dimensions	Style Number	Finish	1 mm Self-Edge, 3 mm Plastic/ 3 mm Wood Edge, Flat Edge, or Convex Vinyl Edge	Bullnose Wood Edge	Beveled Wood Edge	Knife Wood Edge, Waterfall Wood Edge, or Faceted Wood Edge
22' 48" 29"	E2F2248L	Grade 1 Laminate	\$ 8203	\$13,827	\$14,094	\$15,098
		Grade 2 Laminate	\$ 8587	\$14,211	\$14,478	\$15,482
		Grade 1 Wood Veneer	\$17,914	\$23,538	\$23,805	\$24,809
		Grade 2 Wood Veneer	\$19,546	\$25,170	\$25,437	\$26,441
22' 54" 29"	E2F2254L	Grade 1 Laminate	\$ 8760	\$15,069	\$15,374	\$16,522
		Grade 2 Laminate	\$ 9191	\$15,500	\$15,805	\$16,953
		Grade 1 Wood Veneer	\$19,861	\$26,170	\$26,475	\$27,623
		Grade 2 Wood Veneer	\$21,713	\$28,022	\$28,327	\$29,475
22' 60" 29"	E2F2260L	Grade 1 Laminate	\$ 9307	\$16,353	\$16,652	\$17,922
		Grade 2 Laminate	\$ 9786	\$16,832	\$17,131	\$18,401
		Grade 1 Wood Veneer	\$21,810	\$28,856	\$29,155	\$30,425
		Grade 2 Wood Veneer	\$23,884	\$30,930	\$31,229	\$32,499

► Specification Information, continued on next page









E-Table 2

DESIGN JEFF CRONK

22'L and 24'L Racetrack, Faceted, Rectangular, and Soft Radiused End Tables

SIN 711.11

► Specification Information, continued from previous page

Specification Information				Base Prices							
Dimensions		Style	Finish								
L	W	H	Number								
											
				1 mm Self-Edge, 3 mm Plastic/ 3 mm Wood Edge, Flat Edge, or Convex Vinyl Edge:	Bullnose Wood Edge:	Beveled Wood Edge:	Knife Wood Edge, Waterfall Wood Edge, or Faceted Wood Edge:				

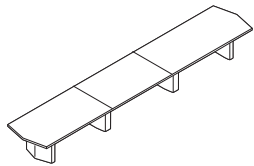

Tip: Faceted tables are not available with waterfall wood edge.

Tip: Vinyl edge profiles on faceted tables require a 4" radius on all corners.

Faceted Tables with Four Bases, continued

Dimensions	Style Number	Finish	Grade 1	Grade 2	Grade 1	Grade 2	Grade 1	Grade 2	
24' 48" 29"	E2F2448L	Grade 1 Laminate	\$ 8278	\$ 14,135	\$ 14,430	\$ 15,349			
			Grade 2 Laminate	\$ 8695	\$ 14,552	\$ 14,847	\$ 15,766		
			Grade 1 Wood Veneer	\$18,117	\$23,974	\$24,269	\$25,188		
			Grade 2 Wood Veneer	\$19,905	\$25,762	\$26,057	\$26,976		
24' 54" 29"	E2F2454L	Grade 1 Laminate	\$ 8871	\$ 15,406	\$ 15,681	\$ 16,836			
			Grade 2 Laminate	\$ 9341	\$ 15,876	\$ 16,151	\$ 17,306		
			Grade 1 Wood Veneer	\$20,075	\$26,610	\$26,885	\$28,040		
			Grade 2 Wood Veneer	\$22,107	\$28,642	\$28,917	\$30,072		
24' 60" 29"	E2F2460L	Grade 1 Laminate	\$ 9402	\$ 16,719	\$ 16,944	\$ 18,236			
			Grade 2 Laminate	\$ 9924	\$ 17,241	\$ 17,466	\$ 18,758		
			Grade 1 Wood Veneer	\$22,048	\$29,365	\$29,590	\$30,882		
			Grade 2 Wood Veneer	\$24,326	\$31,643	\$31,868	\$33,160		

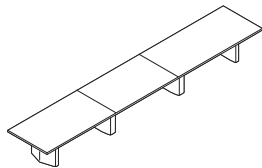

Tip: Vinyl edge profiles on rectangular tables require a 4" radius on all corners.

Rectangular Tables with Four Bases

Dimensions	Style Number	Finish	Grade 1	Grade 2	Grade 1	Grade 2	Grade 1	Grade 2	
22' 48" 29"	E2R2248L	Grade 1 Laminate	\$ 7909	\$ 13,533	\$ 13,800	\$ 14,804			
			Grade 2 Laminate	\$ 8293	\$ 13,917	\$ 14,184	\$ 15,188		
			Grade 1 Wood Veneer	\$17,620	\$23,244	\$23,511	\$24,515		
			Grade 2 Wood Veneer	\$19,252	\$24,876	\$25,143	\$26,147		
22' 54" 29"	E2R2254L	Grade 1 Laminate	\$ 8468	\$ 14,777	\$ 15,082	\$ 16,230			
			Grade 2 Laminate	\$ 8899	\$ 15,208	\$ 15,513	\$ 16,661		
			Grade 1 Wood Veneer	\$19,569	\$25,878	\$26,183	\$27,331		
			Grade 2 Wood Veneer	\$21,421	\$27,730	\$28,035	\$29,183		
22' 60" 29"	E2R2260L	Grade 1 Laminate	\$ 9015	\$ 16,061	\$ 16,360	\$ 17,630			
			Grade 2 Laminate	\$ 9494	\$ 16,540	\$ 16,839	\$ 18,109		
			Grade 1 Wood Veneer	\$21,518	\$28,564	\$28,863	\$30,133		
			Grade 2 Wood Veneer	\$23,592	\$30,638	\$30,937	\$32,207		
24' 48" 29"	E2R2448L	Grade 1 Laminate	\$ 7986	\$ 13,843	\$ 14,138	\$ 15,057			
			Grade 2 Laminate	\$ 8403	\$ 14,260	\$ 14,555	\$ 15,474		
			Grade 1 Wood Veneer	\$17,825	\$23,682	\$23,977	\$24,896		
			Grade 2 Wood Veneer	\$19,613	\$25,470	\$25,765	\$26,684		

► Specification Information, continued on next page









E-Table 2

DESIGN JEFF CRONK

22'L and 24'L Racetrack, Faceted, Rectangular, and Soft Radiused End Tables *continued*

SIN 711.11

► Specification Information, continued from previous page

Specification Information				Base Prices							
Dimensions		Style	Finish								
L	W	H	Number								
											
				1 mm Self-Edge, 3 mm Plastic/ 3 mm Wood Edge, Flat Edge, or Convex Vinyl Edge:	Bullnose Wood Edge:	Beveled Wood Edge:	Knife Wood Edge, Waterfall Wood Edge, or Faceted Wood Edge:				

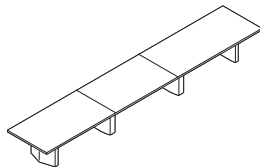

Tip: Vinyl edge profiles on rectangular tables require a 4" radius on all corners.

Rectangular Tables with Four Bases, continued

Dimensions	Style	Finish	Grade 1	Grade 2	Grade 1	Grade 2	Grade 1	Grade 2
L	W	H	Laminate	Laminate	Wood Veneer	Wood Veneer	Wood Veneer	Wood Veneer
24'	54"	29"	E2R2454L	Grade 1 Laminate	\$ 8579	\$15,114	\$15,389	\$16,544
				Grade 2 Laminate	\$ 9049	\$15,584	\$15,859	\$17,014
				Grade 1 Wood Veneer	\$19,783	\$26,318	\$26,593	\$27,748
				Grade 2 Wood Veneer	\$21,815	\$28,350	\$28,625	\$29,780
24'	60"	29"	E2R2460L	Grade 1 Laminate	\$ 9112	\$16,429	\$16,654	\$17,946
				Grade 2 Laminate	\$ 9634	\$16,951	\$17,176	\$18,468
				Grade 1 Wood Veneer	\$21,758	\$29,075	\$29,300	\$30,592
				Grade 2 Wood Veneer	\$24,036	\$31,353	\$31,578	\$32,870

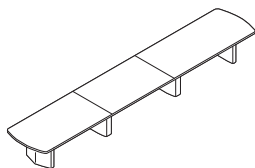

Tip: Vinyl edge profiles on soft radiused tables require a 4" radius on all corners.

Soft Radiused End Tables with Four Bases

Dimensions	Style	Finish	Grade 1	Grade 2	Grade 1	Grade 2	Grade 1	Grade 2
L	W	H	Laminate	Laminate	Wood Veneer	Wood Veneer	Wood Veneer	Wood Veneer
22'	48"	29"	E2S2248L	Grade 1 Laminate	\$ 8056	\$13,680	N.A.	N.A.
				Grade 2 Laminate	\$ 8440	\$14,064	N.A.	N.A.
				Grade 1 Wood Veneer	\$17,767	\$23,391	N.A.	N.A.
				Grade 2 Wood Veneer	\$19,399	\$25,023	N.A.	N.A.
22'	54"	29"	E2S2254L	Grade 1 Laminate	\$ 8614	\$14,923	N.A.	N.A.
				Grade 2 Laminate	\$ 9045	\$15,354	N.A.	N.A.
				Grade 1 Wood Veneer	\$19,715	\$26,024	N.A.	N.A.
				Grade 2 Wood Veneer	\$21,567	\$27,876	N.A.	N.A.
22'	60"	29"	E2S2260L	Grade 1 Laminate	\$ 9161	\$16,207	N.A.	N.A.
				Grade 2 Laminate	\$ 9640	\$16,686	N.A.	N.A.
				Grade 1 Wood Veneer	\$21,664	\$28,710	N.A.	N.A.
				Grade 2 Wood Veneer	\$23,738	\$30,784	N.A.	N.A.
24'	48"	29"	E2S2448L	Grade 1 Laminate	\$ 8131	\$13,988	N.A.	N.A.
				Grade 2 Laminate	\$ 8548	\$14,405	N.A.	N.A.
				Grade 1 Wood Veneer	\$17,970	\$23,827	N.A.	N.A.
				Grade 2 Wood Veneer	\$19,758	\$25,615	N.A.	N.A.
24'	54"	29"	E2S2454L	Grade 1 Laminate	\$ 8725	\$15,260	N.A.	N.A.
				Grade 2 Laminate	\$ 9195	\$15,730	N.A.	N.A.
				Grade 1 Wood Veneer	\$19,929	\$26,464	N.A.	N.A.
				Grade 2 Wood Veneer	\$21,961	\$28,496	N.A.	N.A.
24'	60"	29"	E2S2460L	Grade 1 Laminate	\$ 9257	\$16,574	N.A.	N.A.
				Grade 2 Laminate	\$ 9779	\$17,096	N.A.	N.A.
				Grade 1 Wood Veneer	\$21,903	\$29,220	N.A.	N.A.
				Grade 2 Wood Veneer	\$24,181	\$31,498	N.A.	N.A.

Coalesse

E-Table 2

DESIGN JEFF CRONK

22'L and 24'L Racetrack, Faceted, Rectangular, and Soft Radiused End Tables

SIN 711.11

E-Table 2

E-Table 2

DESIGN JEFF CRONK

36"W Trapezoid Tables with Aluminum Base Only

SIN 711.11

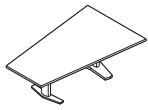

Tip: Shipped knocked down.

Tip: Top ships in one piece.

Tip: 1 mm self-edge is only available on a laminate top surface.

Tip: Flat edge is only available on wood veneer tops and is offered in 6000 Black only.

Tip: When a 3 mm wood edge is specified on a wood veneer top, the edge finish will match the top finish.

Tip: If you specify a wood edge on a top with woodgrain laminate, the edge and the top may not match.

Tip: For table with three or more bases, you must specify the entry point of the base power infeed, either an end base or a mid base location, in order to receive the correct length of base power infeed.

Tip: Each utility bay comes with two universal faceplate openings that accept customer-supplied faceplates in any of the following sizes: single-gang, double-gang, or triple-gang.
► See Coalesse Tables, Storage, and Accessories Specification Guide

Tip: 96"L tables available with zero or two utility bays. 10'L tables available with zero, two, or three utility bays. 12'L tables available with zero, two, three, or four utility bays. 14'L tables available with zero, two, or four utility bays.

Tip: For 14'L tables, your table top may be cut into three pieces, this can be done as a special. Please contact Customer Service at 1.800.627.6770 to obtain a quote.

Standard Includes		Required to Specify	
► Need help? Product details, see <i>Coalesse Tables, Storage, and Accessories Specification Guide</i>	<ul style="list-style-type: none"> • Top: 1¼" particle board core with grade 1 laminate • Edge: 1 mm self edge (laminate top only), 3 mm plastic edge, 3 mm wood edge, or convex vinyl edge • Bases: cast and extruded aluminum with powder coat • Wireway: black steel C-channels and side panels and black plastic access door • Concealed leveling glides: non-marring, black plastic 	<ol style="list-style-type: none"> 1 Style number 2 Powder coat color number for base 3 Laminate color number for top 4 Edge selection: <ul style="list-style-type: none"> - 1 mm self-edge (laminate top only) to match laminate top, if selected - 3 mm flat plastic edge color number, if selected - Convex vinyl edge, if selected: <ul style="list-style-type: none"> 6000 Black 6607 Woodrose 6609 Smoke 6655 Warm White 5 Options, if selected (see below) 	► See <i>Surface Materials</i> , page 350.
Options		Price	Required to Specify
Surface Materials	Top <ul style="list-style-type: none"> • Grade 2 laminate • Grade 1 wood veneer • Grade 2 wood veneer • Stain-to-Match 	Prices at right Prices at right Prices at right No cost	Specify with <i>Grade 2 laminate</i> and select color number. Specify with <i>Grade 1 wood veneer</i> and select color number. Specify with <i>Grade 2 wood veneer</i> and select color number. Specify with <i>Stain-to-Match</i> . ► Page 383
Edges	Wood veneer tops <ul style="list-style-type: none"> • 3 mm plastic edge • 3 mm wood edge • Convex vinyl edge • Flat edge (6000 Black) Wood veneer and laminate tops <ul style="list-style-type: none"> • Bullnose wood edge • Beveled wood edge • Knife wood edge • Waterfall wood edge • Faceted wood edge 	Prices at right Prices at right Prices at right Prices at right Prices at right Prices at right Prices at right Prices at right	Specify with <i>3 mm plastic edge</i> and select color number. Specify with <i>3 mm wood edge</i> and select color number. Specify with <i>convex vinyl edge</i> and select color number. Specify with <i>flat edge</i> . Specify with <i>bullnose wood edge</i> . Specify with <i>beveled wood edge</i> . Specify with <i>knife wood edge</i> . Specify with <i>waterfall wood edge</i> . Specify with <i>faceted wood edge</i> .
Sectioned top (96"L, 10'L, and 12'L only)	<ul style="list-style-type: none"> • Sectioned top 	+\$ 363	Specify with <i>sectioned top</i> .
Bay Option	<ul style="list-style-type: none"> • No bays • Two bays • Three bays • Four bays 	No cost +\$1004 +\$1506 +\$2008	Specify with <i>no bays</i> . Specify with <i>two bays</i> and select color number. Specify with <i>three bays</i> and select color number. Specify with <i>four bays</i> and select color number.
Duplex Wiring Schematic	Tables with bay door(s) <ul style="list-style-type: none"> • 3+0 wireway • 1+1 hardwire, 2 circuits • Chicago powerway 	No cost No cost No cost	Specify with <i>3+0 wireway, duplex</i> . Specify with <i>1+1 hardwire, 2 circuits, duplex</i> . Specify with <i>Chicago powerway</i> .
USB Wiring Schematic	Tables with bay door(s) <ul style="list-style-type: none"> • 3+0 wireway • 1+1 hardwire, 2 circuits 	+\$ 153 per bay +\$ 153 per bay	Specify with <i>3+0 wireway, USB</i> . Specify with <i>1+1 hardwire, 2 circuits, USB</i> .
Infeed	Tables with bay door(s) <ul style="list-style-type: none"> • Plug (20 amp single circuit) • Hardwire • NYC hardware infeed 	No cost No cost No cost	Specify with <i>plug</i> . Specify with <i>hardwire</i> . Specify with <i>NYC hardware infeed</i> .

► Options, continued on next page

E-Table 2

DESIGN JEFF CRONK

36"W Trapezoid Tables with Aluminum Base Only

SIN 711.11

► Options, continued from previous page

Options	Price	Required to Specify
Infeed Location (14'L table only)	<ul style="list-style-type: none"> Tables with bay doors • End base power infeed • Mid base power infeed 	<p>No cost</p> <p>No cost</p> <p>Specify with end base entry location for location base power infeed. Specify with mid base entry location for location base power infeed.</p>

Tip: Transformer kit must be the same wiring schematic as the table.

Related Products	• Transformer kit	► Page 161
-------------------------	-------------------	------------

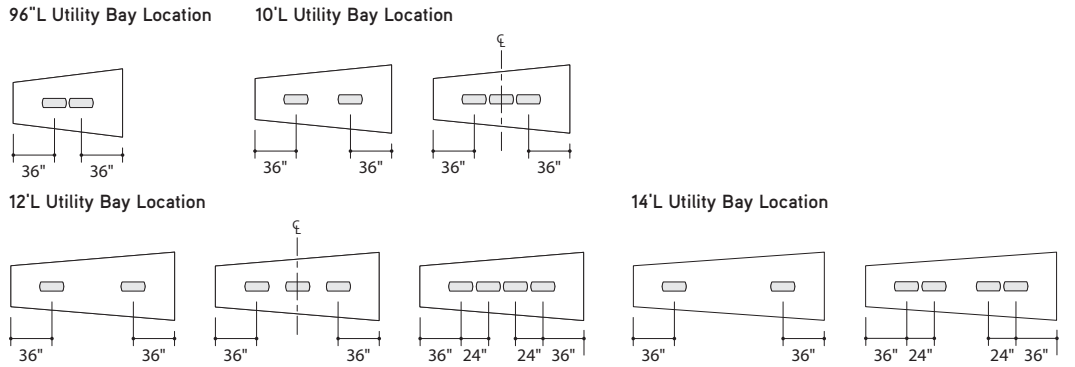

Base veneer and woodgrain laminate direction



Specification Information

Dimensions L W H	Style Number	Finish	Base Prices							
			1 mm Self-Edge, 3 mm Plastic/ 3 mm Wood Edge, Flat Edge, or Convex Vinyl Edge:	Bullnose Wood Edge:	Beveled Wood Edge:	Knife Wood Edge, Waterfall Wood Edge, or Faceted Wood Edge:				
96" 36" 29"	E2T9636A	Grade 1 Laminate	\$ 4280	\$ 5354	\$ 5449	\$ 5654				
		Grade 2 Laminate	\$ 4467	\$ 5541	\$ 5636	\$ 5841				
		Grade 1 Wood Veneer	\$ 6103	\$ 7177	\$ 7272	\$ 7477				
		Grade 2 Wood Veneer	\$ 6843	\$ 7917	\$ 8012	\$ 8217				
10' 36" 29"	E2T1036A	Grade 1 Laminate	\$ 4661	\$ 6635	\$ 6828	\$ 7183				
		Grade 2 Laminate	\$ 4894	\$ 6868	\$ 7061	\$ 7416				
		Grade 1 Wood Veneer	\$ 6809	\$ 8783	\$ 8976	\$ 9331				
		Grade 2 Wood Veneer	\$ 7734	\$ 9708	\$ 9901	\$10,256				
12' 36" 29"	E2T1236A	Grade 1 Laminate	\$ 4749	\$ 7633	\$ 7868	\$ 8358				
		Grade 2 Laminate	\$ 5031	\$ 7915	\$ 8150	\$ 8640				
		Grade 1 Wood Veneer	\$ 7881	\$10,765	\$11,000	\$11,490				
		Grade 2 Wood Veneer	\$ 8998	\$11,882	\$12,117	\$12,607				
14' 36" 29"	E2T1436A	Grade 1 Laminate	\$ 6926	\$11,314	\$11,539	\$12,306				
		Grade 2 Laminate	\$ 7235	\$11,623	\$11,848	\$12,615				
		Grade 1 Wood Veneer	\$13,029	\$17,417	\$17,642	\$18,409				
		Grade 2 Wood Veneer	\$ 14,371	\$18,759	\$18,984	\$19,751				

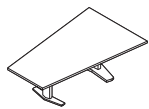

Tip: Vinyl edge profiles on trapezoid tables require a 4" radius on all corners.

Tip: 14'L tables are standard with three bases.

Tip: 14'L tops are manufactured and shipped in two pieces.

E-Table 2

DESIGN JEFF CRONK

48"W Trapezoid Tables

SIN 711.11

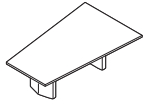

Tip: Shipped knocked down.

Tip: Top ships in one piece.

Tip: 1 mm self-edge is only available on a laminate top surface.

Tip: Flat edge is only available on wood veneer tops and is offered in 6000 Black only.

Tip: When a 3 mm wood edge is specified on a wood veneer top, the edge finish will match the top finish.

Tip: 96"L, 10'L, and 12'L tables have two bases. 14'L tables have three bases.

Tip: For table with three or more bases, you must specify the entry point of the base power infeed, either an end base or mid base location, in order to receive the correct length of base power infeed.

Tip: If you specify a wood edge on a top with woodgrain laminate, the edge and the top may not match.

Tip: For 14' tables, your table top may be cut into three pieces, this can be done as a special. Please contact Customer Service at 1.800.627.6770 to obtain a quote.

Tip: Each utility bay comes with two universal faceplate openings that accept customer-supplied faceplates in any of the following sizes: single-gang, double-gang, or triple-gang. ▶ See Coalesse Tables, Storage, and Accessories Specification Guide

Base veneer and woodgrain laminate direction



Standard Includes	Required to Specify
<ul style="list-style-type: none"> ▶ Need help? Product details, see <i>Coalesse Tables, Storage, and Accessories Specification Guide</i> • Top: 1/4" particle board core with laminate • Edge: 1 mm self-edge (laminate top only), 3 mm plastic edge, 3 mm wood edge, or convex vinyl edge • Bases: black laminate on MDF core • Wireway: black steel C-channels and side panels and black plastic access door • Concealed leveling glides: non-marring, black plastic 	<ol style="list-style-type: none"> Style number Laminate color number for top Edge selection: <ul style="list-style-type: none"> - 1 mm self-edge (laminate top only) to match laminate top, if selected - 3 mm flat plastic edge color number, if selected - Convex vinyl edge, if selected: <ul style="list-style-type: none"> 6000 Black 6607 Woodrose 6609 Smoke 6655 Warm White Options, if selected (see below) <p>▶ See <i>Surface Materials</i>, page 350.</p>

Options	Price	Required to Specify
Surface Materials <ul style="list-style-type: none"> • Grade 2 laminate • Grade 1 wood veneer • Grade 2 wood veneer • Stain-to-Match 	<ul style="list-style-type: none"> Prices at right Prices at right Prices at right No cost 	<ul style="list-style-type: none"> Specify with <i>Grade 2 laminate</i> and select color number. Specify with <i>Grade 1 wood veneer</i> and select color number. Specify with <i>Grade 2 wood veneer</i> and select color number. Specify with <i>Stain-to-Match</i>. <p>▶ Page 383</p>
Base <ul style="list-style-type: none"> • Two aluminum bases • Three aluminum bases • Two curated laminate bases • Three curated laminate bases • Two wood veneer bases • Three wood veneer bases 	<ul style="list-style-type: none"> +\$ 135 +\$ 362 +\$ 557 +\$ 871 +\$2168 +\$3229 	<ul style="list-style-type: none"> Replace L suffix in the style number with A suffix and select powder coat color number. Replace L suffix in the style number with A suffix and select powder coat color number. Specify with <i>curated laminate</i> and select color number. Specify with <i>curated laminate</i> and select color number. Replace L suffix in the style number with V suffix and select wood color number. Replace L suffix in the style number with V suffix and select wood color number.
Edges <ul style="list-style-type: none"> • Wood veneer tops <ul style="list-style-type: none"> • 3 mm plastic edge • 3 mm wood edge • Convex vinyl edge • Flat edge (6000 Black) • Wood veneer and laminate tops <ul style="list-style-type: none"> • Bullnose wood edge • Beveled wood edge • Knife wood edge • Waterfall wood edge • Faceted wood edge 	<ul style="list-style-type: none"> Prices at right Prices at right Prices at right Prices at right Prices at right Prices at right Prices at right Prices at right Prices at right Prices at right 	<ul style="list-style-type: none"> Specify with <i>3 mm plastic edge</i> and select color number. Specify with <i>3 mm wood edge</i> and select color number. Specify with <i>convex vinyl edge</i> and select color number. Specify with <i>flat edge</i>. Specify with <i>bullnose wood edge</i>. Specify with <i>beveled wood edge</i>. Specify with <i>knife wood edge</i>. Specify with <i>waterfall wood edge</i>. Specify with <i>faceted wood edge</i>.
Sectioned top (96"L, 10'L, and 12'L only) <ul style="list-style-type: none"> • Sectioned top 	<ul style="list-style-type: none"> +\$ 363 	<ul style="list-style-type: none"> Specify with <i>sectioned top</i>.
Bay Option <ul style="list-style-type: none"> • No bays • Two bays • Three bays • Four bays 	<ul style="list-style-type: none"> No cost +\$1004 +\$1506 +\$2008 	<ul style="list-style-type: none"> Specify with <i>no bays</i>. Specify with <i>two bays</i> and select color number. Specify with <i>three bays</i> and select color number. Specify with <i>four bays</i> and select color number.
Duplex Wiring Schematic <ul style="list-style-type: none"> • Tables with bay door(s) <ul style="list-style-type: none"> • 3+0 wireway • 1+1 hardwire, 2 circuits • Chicago powerway 	<ul style="list-style-type: none"> No cost No cost No cost 	<ul style="list-style-type: none"> Specify with <i>3+0 wireway, duplex</i>. Specify with <i>1+1 hardwire, 2 circuits, duplex</i>. Specify with <i>Chicago powerway</i>.

▶ Options, continued on next page

E-Table 2

DESIGN JEFF CRONK

48"W Trapezoid Tables

SIN 711.11

Tip: 96"L tables available with zero or two utility bays. 10'L tables available with zero, two, or three utility bays. 12'L tables available with zero, two, three, or four utility bays. 14'L tables available with zero, two, or four utility bays.

Tip: Transformer kit must be the same wiring schematic as the table.

►Options, continued from previous page

	Options	Price	Required to Specify
USB Wiring Schematic	Tables with bay door(s) <ul style="list-style-type: none"> • 3+0 wireway • 1+1 hardware, 2 circuits 	+\$153 per bay +\$153 per bay	Specify with <i>3+0 wireway, USB.</i> Specify with <i>1+1 hardware, 2 circuits, USB.</i>
Infeed	Tables with bay door(s) <ul style="list-style-type: none"> • Plug (20 amp single circuit) • Hardwire • NYC hardwire infeed 	No cost No cost No cost	Specify with <i>plug.</i> Specify with <i>hardwire.</i> Specify with <i>NYC hardwire infeed</i>
Infeed Location (14'L table only)	Tables with bay doors <ul style="list-style-type: none"> • End base power infeed • Mid base power infeed 	No cost No cost	Specify with <i>end base entry location for location base power infeed.</i> Specify with <i>mid base entry location for location base power infeed.</i>
Related Products	<ul style="list-style-type: none"> • Transformer kit 		► Page 161

96"L Utility Bay Location

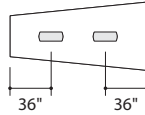
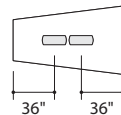

10'L Utility Bay Location

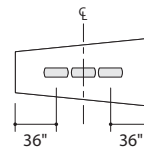

12'L Utility Bay Location

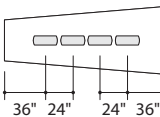
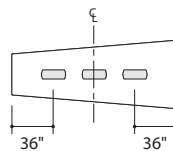
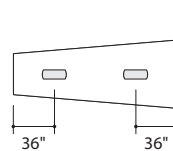

14'L Utility Bay Location

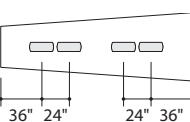
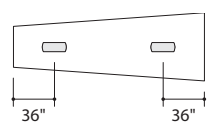

►Specification Information, on next page

E-Table 2

DESIGN JEFF CRONK

48"W Trapezoid Tables *continued*

SIN 711.11

► Options, on previous page

Specification Information

Dimensions			Style Number	Finish	Base Prices						
L	W	H			1 mm Self-Edge, 3 mm Plastic/ 3 mm Wood Edge, Flat Edge, or Convex Vinyl Edge:	Bullnose Wood Edge:	Beveled Wood Edge:	Knife Wood Edge, Waterfall Wood Edge, or Faceted Wood Edge:			

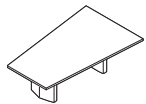
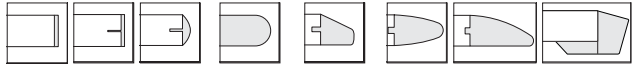

Tip: Vinyl edge profiles on trapezoid tables require a 4" radius on all corners.

96"	48"	29"	E2T9648L	Grade 1 Laminate	\$ 4130	\$ 5204	\$ 5299	\$ 5504
				Grade 2 Laminate	\$ 4317	\$ 5391	\$ 5486	\$ 5691
				Grade 1 Wood Veneer	\$ 5953	\$ 7027	\$ 7122	\$ 7327
				Grade 2 Wood Veneer	\$ 6693	\$ 7767	\$ 7862	\$ 8067
10'	48"	29"	E2T1048L	Grade 1 Laminate	\$ 4513	\$ 6487	\$ 6680	\$ 7035
				Grade 2 Laminate	\$ 4746	\$ 6720	\$ 6913	\$ 7268
				Grade 1 Wood Veneer	\$ 6661	\$ 8635	\$ 8828	\$ 9183
				Grade 2 Wood Veneer	\$ 7586	\$ 9560	\$ 9753	\$10,108
12'	48"	29"	E2T1248L	Grade 1 Laminate	\$ 4596	\$ 7480	\$ 7715	\$ 8205
				Grade 2 Laminate	\$ 4878	\$ 7762	\$ 7997	\$ 8487
				Grade 1 Wood Veneer	\$ 7728	\$10,612	\$10,847	\$11,337
				Grade 2 Wood Veneer	\$ 8845	\$11,729	\$11,964	\$12,454
14'	48"	29"	E2T1448L	Grade 1 Laminate	\$ 6568	\$10,956	\$11,181	\$11,948
				Grade 2 Laminate	\$ 6877	\$11,265	\$11,490	\$12,257
				Grade 1 Wood Veneer	\$12,671	\$17,059	\$17,284	\$18,051
				Grade 2 Wood Veneer	\$14,013	\$18,401	\$18,626	\$19,393

Tip: 14'L tables are standard with three bases.

Tip: 14'L tops are manufactured and shipped in two pieces.

E-Table 2 Accessories

SIN 711.11

Floor Monument Kit

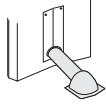

Tip: Wire manager can be cut on site to desired length.

Standard Includes	Required to Specify
<ul style="list-style-type: none"> • Shell: black plastic only • 72"L wire manager: black plastic only 	Style number

Specification Information

Style Number	Price
793369	\$105

Transformer Kit

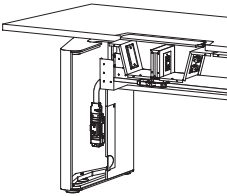

Tip: Transformer kit must be same wiring schematic as table.

Tip: Order the transformer kit to allow oversized transformers or other electronic devices to be accommodated inside the table base rather than inside the table's utility bay.

Tip: Transformer kit can only be attached on the opposite end of the table from where the base power infeed is attached.

Standard Includes	Required to Specify
<ul style="list-style-type: none"> • Jumper, power block, and two duplex receptacles for circuit 1: black • Three-circuit, 3+0 wiring schematic 	1 Style number 2 Options, if selected (see below)

Options	Price	Required to Specify
Two-circuit, separate neutrals	No cost	Add suffix Z to the style number.

Specification Information

Style Number	Price
E2TK	\$172

Host Collection

Round Tables (SIN 711.11)	164
Rectangular Tables (SIN 711.11)	166
Soft Radiused Tables (SIN 711.11)	194
Racetrack Tables (SIN 711.11)	224
Boat Shaped Tables (SIN 711.11)	256
Trapezoid Tables (SIN 711.11)	276
Accessories (SIN 711.11)	283

Host Collection Round Tables

DESIGN F/P DESIGN AND VECTA DESIGN TEAM

SIN 711.11



Tip: Shipped knocked down and top ships in one piece.

Tip: The wood edge on a table top with woodgrain laminate may not match the top.

Standard Includes	Required to Specify
<ul style="list-style-type: none"> ▶ Need help? Product details, see <i>Coalesse Tables, Storage, and Accessories Specification Guide</i> • Top: 1¼" particle board core with laminate • Flat wood edge • TAP, if selected: 10"W x 12"L opening(s) trimmed with a flat solid wood profile and with brushed anodized aluminum doors • Base: <ul style="list-style-type: none"> - Wood veneer - Concealed leveling glides: non-marring, black plastic 	<ol style="list-style-type: none"> 1 Top Style number 2 Wood color number for base 3 Laminate color number for table top, if selected 4 Wood color number for wood edge ▶ See <i>Hardwood and Veneer Matrix</i>, page 364 5 Door color number for storage tray or TAP doors, if selected <ul style="list-style-type: none"> - 8044 Black - 8047 Silver 6 Options, if selected (see below) ▶ See <i>Surface Materials</i>, page 350.

Veneer direction



Tip: You must send a sample of reasonable size for *Stain-to-Match*.

Options	Price	Required to Specify
Surface Materials <ul style="list-style-type: none"> • Top • Grade 2 laminate • Grade 1 wood veneer • Grade 2 wood veneer • Grade 1 wedge lay-up veneer • Grade 2 wedge lay-up veneer • Stain-to-Match 	<ul style="list-style-type: none"> Prices at right Prices at right Prices at right Prices at right Prices at right No cost 	<ul style="list-style-type: none"> Specify with <i>Grade 2 laminate</i> and select color number. Specify with <i>Grade 1 wood veneer</i> and select color number. Specify with <i>Grade 2 wood veneer</i> and select color number. Specify with <i>Grade 1 wedge lay-up veneer</i> and select color number. Specify with <i>Grade 2 wedge lay-up veneer</i> and select color number. Specify with <i>Stain-to-Match</i>. ▶ Page 383

Edges <ul style="list-style-type: none"> • Bullnose wood edge • Beveled wood edge • Horizon wood edge 	<ul style="list-style-type: none"> Prices at right Prices at right Prices at right 	<ul style="list-style-type: none"> Specify with <i>bullnose wood edge</i>. Specify with <i>beveled wood edge</i>. Specify with <i>Horizon wood edge</i>.
---	---	---

TAP Location

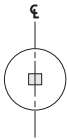

Tip: Tables available with zero or one TAP.

Tip: In addition to the data and audio/video AAPs available from Coalesse, other styles of AAPs are available through Extron Electronics. For an Extron dealer, call 1.800.633.9876.

Tip: See TAP options for electrical systems and faceplate list.

Tip: Wood veneer doors for storage tray or TAP will always be cross grain.

Tip: Veneer doors not recommended for wedge lay-up veneer tables.

Tip: Connectrac must be the same wiring schematic as the table.

TAP Electrical System with Faceplate Options <ul style="list-style-type: none"> • Field-wired tray (no electrical) <ul style="list-style-type: none"> - PAFW field-wired tray (no electrical) with blank AAPs - PDFW field-wired tray (no electrical) with two data AAPs - PVFW field-wired tray (no electrical) with two of each video/audio and data AAPs • Cord and plug tray (10' cord) <ul style="list-style-type: none"> - PACP cord and plug tray with outlets and blank AAPs - PDCCP cord and plug tray with outlets and two data AAPs - PAVC cord and plug tray with outlets and two of each video/audio and data AAPs • Hard-wired tray (6' conduit) <ul style="list-style-type: none"> - PAHW hard-wired tray with outlets and blank AAPs - PDHW hard-wired tray with outlets and two data AAPs - PAVH hard-wired tray with outlets and two of each video/audio and data AAPs 	<ul style="list-style-type: none"> No cost No cost No cost 	<ul style="list-style-type: none"> Specify with <i>power data</i>, and select TAP type and TAP door color number. Specify with <i>power data</i>, and select TAP type and TAP door color number. Specify with <i>power data</i>, and select TAP type and TAP door color number.
--	---	--

Storage Tray <ul style="list-style-type: none"> • Storage tray 	<ul style="list-style-type: none"> -\$579 	<ul style="list-style-type: none"> Specify with <i>storage tray</i> and select door color number.
--	--	--

Doors <ul style="list-style-type: none"> • Storage tray wood veneer doors • TAP wood veneer doors 	<ul style="list-style-type: none"> +\$291 per door +\$291 per door 	<ul style="list-style-type: none"> Specify with <i>wood doors</i>. Specify with <i>wood doors</i>.
--	--	--

Related Products <ul style="list-style-type: none"> • Floor kit: Connectrac 	<ul style="list-style-type: none"> ▶ Page 283
---	--





Host Collection Round Tables

DESIGN F/P DESIGN AND VECTA DESIGN TEAM

SIN 711.11

Tip: Last digit of style number indicates number of TAP(s).

Specification Information

Style Number	Finish	Base Prices			
		Flat Wood Edge:	Bullnose Wood Edge:	Beveled Wood Edge:	Horizon Wood Edge:
					

48"W Diameter One Piece Top

0 TAP

HS4800D10	Grade 1 Laminate	\$4247	\$4298	\$4369	\$4815
	Grade 2 Laminate	\$4295	\$4346	\$4417	\$4863
	Grade 1 Veneer	\$4646	\$4697	\$4768	\$5214
	Grade 2 Veneer	\$4892	\$4943	\$5014	\$5460
	Grade 1 Wedge Veneer	\$5076	\$5127	\$5198	\$5644
	Grade 2 Wedge Veneer	\$5766	\$5817	\$5888	\$6334



1 TAP

HS4800D11	Grade 1 Laminate	\$5795	\$5846	\$5917	\$6363
	Grade 2 Laminate	\$5843	\$5894	\$5965	\$6411
	Grade 1 Veneer	\$6194	\$6245	\$6316	\$6762
	Grade 2 Veneer	\$6440	\$6491	\$6562	\$7008
	Grade 1 Wedge Veneer	\$6624	\$6675	\$6746	\$7192
	Grade 2 Wedge Veneer	\$7314	\$7365	\$7436	\$7882



60" Diameter One Piece Top

0 TAP

HS6000D10	Grade 1 Laminate	\$4578	\$4641	\$4728	\$5190
	Grade 2 Laminate	\$4649	\$4712	\$4799	\$5261
	Grade 1 Veneer	\$5327	\$5390	\$5477	\$5939
	Grade 2 Veneer	\$5710	\$5773	\$5860	\$6322
	Grade 1 Wedge Veneer	\$6053	\$6116	\$6203	\$6665
	Grade 2 Wedge Veneer	\$7261	\$7324	\$7411	\$7873



1 TAP

HS6000D11	Grade 1 Laminate	\$6125	\$6188	\$6275	\$6737
	Grade 2 Laminate	\$6196	\$6259	\$6346	\$6808
	Grade 1 Veneer	\$6874	\$6937	\$7024	\$7486
	Grade 2 Veneer	\$7257	\$7320	\$7407	\$7869
	Grade 1 Wedge Veneer	\$7600	\$7663	\$7750	\$8212
	Grade 2 Wedge Veneer	\$8808	\$8871	\$8958	\$9420



Host Collection Rectangular Tables with Two Bases

DESIGN F/P DESIGN AND VECTA DESIGN TEAM

SIN 711.11

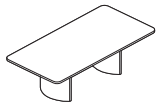

Tip: Shipped knocked down and top ships in one piece.

Tip: Grain direction for wood-grain laminate runs the length of the table.

Tip: Clips are provided with table: One clip per foot of table length.

Tip: The wood edge on a table top with woodgrain laminate may not match the top.

Tip: You must send a sample of reasonable size for Stain-to-Match.

Tip: 96" L tables available with zero, one, or two TAP(s). 10' L and 12' L tables available with zero, one, two, or three TAP(s).

Tip: In addition to the data and audio/video AAPs available from Coalesse, other styles of AAPs are available through Extron Electronics. For an Extron dealer, call 1.800.633.9876.

Tip: See TAP options for electrical systems and faceplate list.

Veneer direction



Standard Includes		Required to Specify	
<ul style="list-style-type: none"> ▶ Need help? Product details, see <i>Coalesse Tables, Storage, and Accessories Specification Guide</i> 	<ul style="list-style-type: none"> • Top: 1¼" particle board core with laminate • TAP(s) or storage tray, if selected: 10"W x 12"L opening(s) trimmed with a flat solid wood profile and with brushed anodized aluminum doors • Tech corridor: two aluminum beams for top support provide tracks for hinged aluminum doors that clip shut: satin anodized finish • Universal clip: black plastic • Two 27"W bases: wood veneer on MDF with aluminum universal bracket • Concealed leveling glides: non-marring, black plastic 	<ol style="list-style-type: none"> 1 Style number 2 Base selection (see below) and wood color number for base 3 Laminate color number for table top, if selected 4 Wood color number for wood edge 	<ul style="list-style-type: none"> ▶ See <i>Hardwood and Veneer Matrix</i>, page 364 5 Door color number for storage tray or TAP doors, if selected: <ul style="list-style-type: none"> - 8044 Black - 8047 Silver 6 Options, if selected (see below) ▶ See <i>Surface Materials</i>, page 350.
Options		Price	
Surface Materials		Required to Specify	
<p>Top</p> <ul style="list-style-type: none"> • Grade 2 laminate • Grade 1 wood veneer • Grade 2 wood veneer • Stain-to-Match 	<p>Prices at right</p> <p>Prices at right</p> <p>Prices at right</p> <p>No cost</p>	<p>Specify with <i>Grade 2 laminate</i> and select color number.</p> <p>Specify with <i>Grade 1 wood veneer</i> and select color number.</p> <p>Specify with <i>Grade 2 wood veneer</i> and select color number.</p> <p>Specify with <i>Stain-to-Match</i>.</p> <p>▶ Page 383</p>	
Edges		Wood	
<p>Wood</p> <ul style="list-style-type: none"> • Bullnose wood edge • Beveled wood edge • Tapered wood edge • Horizon wood edge 	<p>Prices at right</p> <p>Prices at right</p> <p>Prices at right</p> <p>Prices at right</p>	<p>Specify with <i>bullnose wood edge</i>.</p> <p>Specify with <i>beveled wood edge</i>.</p> <p>Specify with <i>tapered wood edge</i>.</p> <p>Specify with <i>Horizon wood edge</i>.</p>	
Bases		Price	
<p>Wood</p> <ul style="list-style-type: none"> • Two slim bases • One slim and one flared base • Two flared bases 	<p>No cost</p> <p>+\$807</p> <p>+\$1615</p>	<p>Specify with <i>two slim bases</i>.</p> <p>Specify with <i>one slim base</i> and one flared base.</p> <p>Specify with <i>two flared bases</i>.</p>	
<p>Slim Flared</p>			
TAP Electrical System with Faceplate Options		Price	
<p>Field Wired</p> <p>Cord and Plug</p> <p>Hardwired</p>	<ul style="list-style-type: none"> • Field-wired tray (no electrical) - PAFW field-wired tray (no electrical) with blank AAPs - PDFW field-wired tray (no electrical) with two data AAPs - PVFW field-wired tray (no electrical) with two of each video/audio and data AAPs • Cord and plug tray (10' cord) - PACP cord and plug tray with outlets and blank AAPs - PDCP cord and plug tray with outlets and two data AAPs - PAVC cord and plug tray with outlets and two of each video/audio and data AAPs • Hard-wired tray (6' conduit) - PAHW hard-wired tray with outlets and blank AAPs - PDHW hard-wired tray with outlets and two data AAPs - PAVH hard-wired tray with outlets and two of each video/audio and data AAPs 	<p>No cost</p> <p>No cost</p> <p>No cost</p>	<p>Specify with <i>power data</i>, and select TAP type and TAP door color number.</p> <p>Specify with <i>power data</i>, and select TAP type and TAP door color number.</p> <p>Specify with <i>power data</i>, and select TAP type and TAP door color number.</p>

▶ Options, continued on next page

Host Collection

Rectangular Tables with Two Bases
DESIGN F/P DESIGN AND VECTA DESIGN TEAM

SIN 711.11

Tip: For single TAP style numbers, the modular system tray is not available. Specify the hardwired tray option.

Tip: If the specified table has multiple TAPs, any one TAP can be replaced with a storage tray.

Tip: Wood veneer doors for storage tray and TAP will always be cross grain.

Tip: Connectrac must be the same wiring schematic as the table.

►Options, continued from previous page

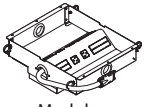
Options	Price	Required to Specify
TAP Electrical System with Faceplate Options  Modular	<ul style="list-style-type: none"> • Modular system tray (hardwire base power infeed) +\$138 each tray - PAMH modular system tray with outlets and blank AAPs - PDMH modular system tray with outlets and two data AAPs - PVMH modular system tray with outlets and two of each video/audio and data AAPs 	Specify with <i>modular power data</i> , and select TAP type and TAP door color number.
Storage Tray	<ul style="list-style-type: none"> • Storage tray -\$579 	Specify with <i>storage tray</i> and select door color number.
Doors	<ul style="list-style-type: none"> • Storage tray wood veneer doors +\$291 per door • TAP wood veneer doors +\$291 per door 	Specify with <i>wood doors</i> .
Related Products	<ul style="list-style-type: none"> • Floor kit: Connectrac • Corridor shelf 	► Page 283 ► Page 283

96"L x 48"W TAP Locations—One piece top

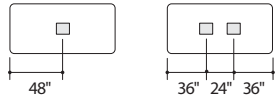

10"L x 48"W TAP Locations—One piece top

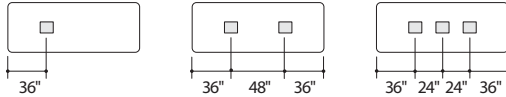

10"L x 48"W TAP Locations—Two piece top

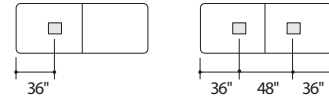

10"L x 60"W TAP Locations—One piece top

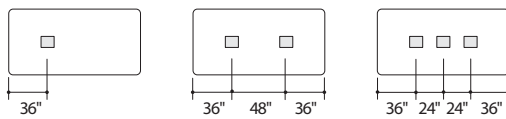

10"L x 60"W TAP Locations—Two piece top

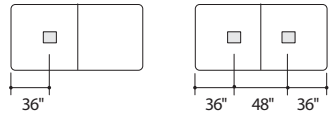

12"L x 48"W TAP Locations—One piece top

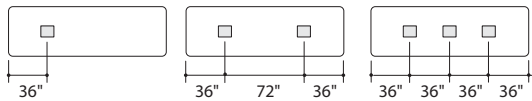

12"L x 48"W TAP Locations—Two piece top

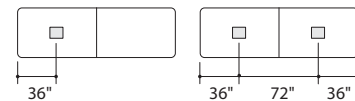

12"L x 60"W TAP Locations—One piece top

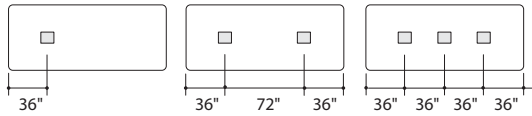

12"L x 60"W TAP Locations—Two piece top

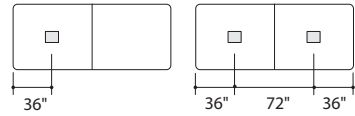

►Specification Information, on next page

Host Collection Rectangular Tables with Two Bases *continued*

DESIGN F/P DESIGN AND VECTA DESIGN TEAM





SIN 711.11

Tip: Prices shown include top, TAP(s), and slim bases.
 ▶ See base options for flared bases, page 166

Tip: Last digit of style number indicates number of TAP(s).

▶ Options, on previous page

Specification Information

Style Number	Finish	Base Prices			
					
		Flat Wood Edge:	Bullnose Wood Edge:	Beveled Wood Edge, Tapered Wood Edge:	Horizon Wood Edge:

96"L x 48"W One Piece Top

0 TAP

HS9648R10	Grade 1 Laminate	\$ 6588	\$ 6686	\$ 6820	\$ 8098
	Grade 2 Laminate	\$ 6703	\$ 6801	\$ 6935	\$ 8213
	Grade 1 Veneer	\$ 7084	\$ 7182	\$ 7316	\$ 8594
	Grade 2 Veneer	\$ 7672	\$ 7770	\$ 7904	\$ 9182

1 TAP

HS9648R11	Grade 1 Laminate	\$ 8135	\$ 8233	\$ 8367	\$ 9645
	Grade 2 Laminate	\$ 8250	\$ 8348	\$ 8482	\$ 9760
	Grade 1 Veneer	\$ 8631	\$ 8729	\$ 8863	\$ 10,141
	Grade 2 Veneer	\$ 9219	\$ 9317	\$ 9451	\$ 10,729

2 TAPS

HS9648R12	Grade 1 Laminate	\$ 9683	\$ 9781	\$ 9915	\$ 11,193
	Grade 2 Laminate	\$ 9798	\$ 9896	\$ 10,030	\$ 11,308
	Grade 1 Veneer	\$ 10,179	\$ 10,277	\$ 10,411	\$ 11,689
	Grade 2 Veneer	\$ 10,767	\$ 10,865	\$ 10,999	\$ 12,277

10'L x 48"W One Piece Top

0 TAP

HS1048R10	Grade 1 Laminate	\$ 7107	\$ 7220	\$ 7377	\$ 8680
	Grade 2 Laminate	\$ 7253	\$ 7366	\$ 7523	\$ 8826
	Grade 1 Veneer	\$ 7711	\$ 7824	\$ 7981	\$ 9284
	Grade 2 Veneer	\$ 8446	\$ 8559	\$ 8716	\$ 10,019

1 TAP

HS1048R11	Grade 1 Laminate	\$ 8655	\$ 8768	\$ 8925	\$ 10,228
	Grade 2 Laminate	\$ 8801	\$ 8914	\$ 9071	\$ 10,374
	Grade 1 Veneer	\$ 9259	\$ 9372	\$ 9529	\$ 10,832
	Grade 2 Veneer	\$ 9994	\$ 10,107	\$ 10,264	\$ 11,567

2 TAPS

HS1048R12	Grade 1 Laminate	\$ 10,203	\$ 10,316	\$ 10,473	\$ 11,776
	Grade 2 Laminate	\$ 10,349	\$ 10,462	\$ 10,619	\$ 11,922
	Grade 1 Veneer	\$ 10,807	\$ 10,920	\$ 11,077	\$ 12,380
	Grade 2 Veneer	\$ 11,542	\$ 11,655	\$ 11,812	\$ 13,115

▶ Specification Information, continued on next page

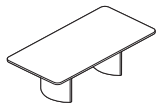

Tip: For tech corridor, 96"L tables have two long doors and four short doors.

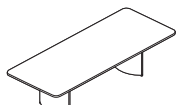
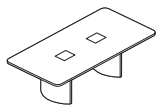
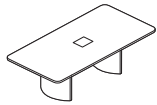

Tip: For tech corridor, 10'L tables have four long doors and four short doors.

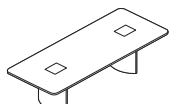
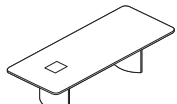

Host Collection

Rectangular Tables with Two Bases
DESIGN F/P DESIGN AND VECTA DESIGN TEAM





SIN 711.11

Tip: Prices shown include top, TAP(s), and slim bases.
► See base options for flared bases, page 166

Tip: Last digit of style number indicates number of TAP(s).

► Specification Information, continued from previous page

Specification Information

Style Number	Finish	Base Prices			
					
		Flat Wood Edge:	Bullnose Wood Edge:	Beveled Wood Edge, Tapered Wood Edge:	Horizon Wood Edge:

10'L x 48"W One Piece Top

3 TAPS

HS1048R13	Grade 1 Laminate	\$11,752	\$11,865	\$12,022	\$13,325
	Grade 2 Laminate	\$11,898	\$12,011	\$12,168	\$13,471
	Grade 1 Veneer	\$12,356	\$12,469	\$12,626	\$13,929
	Grade 2 Veneer	\$13,091	\$13,204	\$13,361	\$14,664

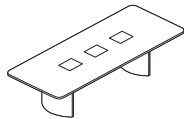

10'L x 48"W Two Piece Top

0 TAP

HS1048R20	Grade 1 Laminate	\$ 7478	\$ 7591	\$ 7748	\$ 9051
	Grade 2 Laminate	\$ 7624	\$ 7737	\$ 7894	\$ 9197
	Grade 1 Veneer	\$ 8082	\$ 8195	\$ 8352	\$ 9655
	Grade 2 Veneer	\$ 8817	\$ 8930	\$ 9087	\$10,390

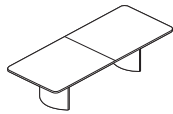

1 TAP

HS1048R21	Grade 1 Laminate	\$ 9026	\$ 9139	\$ 9296	\$10,599
	Grade 2 Laminate	\$ 9172	\$ 9285	\$ 9442	\$10,745
	Grade 1 Veneer	\$ 9630	\$ 9743	\$ 9900	\$11,203
	Grade 2 Veneer	\$10,365	\$10,478	\$10,635	\$11,938

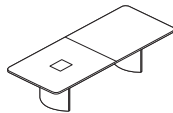

2 TAPS

HS1048R22	Grade 1 Laminate	\$10,574	\$10,687	\$10,844	\$12,147
	Grade 2 Laminate	\$10,720	\$10,833	\$10,990	\$12,293
	Grade 1 Veneer	\$11,178	\$11,291	\$11,448	\$12,751
	Grade 2 Veneer	\$11,913	\$12,026	\$12,183	\$13,486

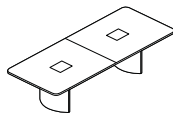

10'L x 60"W One Piece Top

0 TAP

HS1060R10	Grade 1 Laminate	\$ 7299	\$ 7420	\$ 7587	\$ 8904
	Grade 2 Laminate	\$ 7478	\$ 7599	\$ 7766	\$ 9083
	Grade 1 Veneer	\$ 8362	\$ 8483	\$ 8650	\$ 9967
	Grade 2 Veneer	\$ 9293	\$ 9414	\$ 9581	\$10,898

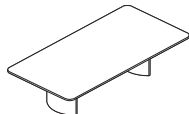

1 TAP

HS1060R11	Grade 1 Laminate	\$ 8848	\$ 8969	\$ 9136	\$10,453
	Grade 2 Laminate	\$ 9027	\$ 9148	\$ 9315	\$10,632
	Grade 1 Veneer	\$ 9911	\$10,032	\$10,199	\$11,516
	Grade 2 Veneer	\$10,842	\$10,963	\$11,130	\$12,447



► Specification Information, continued on next page

Host Collection

Rectangular Tables with Two Bases *continued*
 DESIGN F/P DESIGN AND VECTA DESIGN TEAM





SIN 711.11

Tip: Prices shown include top, TAP(s), and slim bases.
 ▶ See base options for flared bases, page 166

Tip: Last digit of style number indicates number of TAP(s).

▶ Specification Information, continued from previous page

Specification Information

Style Number	Finish	Base Prices			
					
		Flat Wood Edge:	Bullnose Wood Edge:	Beveled Wood Edge, Tapered Wood Edge:	Horizon Wood Edge:

10'L x 60"W One Piece Top, continued

2 TAPS

HS1060R12	Grade 1 Laminate	\$10,396	\$10,517	\$10,684	\$12,001
	Grade 2 Laminate	\$10,575	\$10,696	\$10,863	\$12,180
	Grade 1 Veneer	\$11,459	\$11,580	\$11,747	\$13,064
	Grade 2 Veneer	\$12,390	\$12,511	\$12,678	\$13,995

3 TAPS

HS1060R13	Grade 1 Laminate	\$11,946	\$12,067	\$12,234	\$13,551
	Grade 2 Laminate	\$12,125	\$12,246	\$12,413	\$13,730
	Grade 1 Veneer	\$13,009	\$13,130	\$13,297	\$14,614
	Grade 2 Veneer	\$13,940	\$14,061	\$14,228	\$15,545

10'L x 60"W Two Piece Top

0 TAP

HS1060R20	Grade 1 Laminate	\$ 7670	\$ 7791	\$ 7958	\$ 9275
	Grade 2 Laminate	\$ 7849	\$ 7970	\$ 8137	\$ 9454
	Grade 1 Veneer	\$ 8733	\$ 8854	\$ 9021	\$10,338
	Grade 2 Veneer	\$ 9664	\$ 9785	\$ 9952	\$11,269

1 TAP

HS1060R21	Grade 1 Laminate	\$ 9219	\$ 9340	\$ 9507	\$10,824
	Grade 2 Laminate	\$ 9398	\$ 9519	\$ 9686	\$11,003
	Grade 1 Veneer	\$10,282	\$10,403	\$10,570	\$11,887
	Grade 2 Veneer	\$11,213	\$11,334	\$11,501	\$12,818

2 TAPS

HS1060R22	Grade 1 Laminate	\$10,768	\$10,889	\$11,056	\$12,373
	Grade 2 Laminate	\$10,947	\$11,068	\$11,235	\$12,552
	Grade 1 Veneer	\$11,831	\$11,952	\$12,119	\$13,436
	Grade 2 Veneer	\$12,762	\$12,883	\$13,050	\$14,367

▶ Specification Information, continued on next page

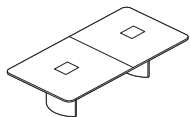
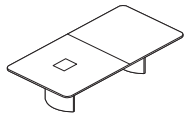
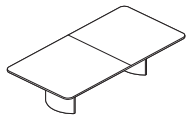
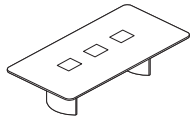
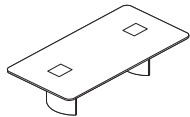

Host Collection

Rectangular Tables with Two Bases
DESIGN F/P DESIGN AND VECTA DESIGN TEAM





SIN 711.11

Tip: Prices shown include top, TAP(s), and slim bases.
► See base options for flared bases, page 166

Tip: Last digit of style number indicates number of TAP(s).

► Specification Information, continued from previous page

Specification Information

Style Number	Finish	Base Prices			
					
		Flat Wood Edge:	Bullnose Wood Edge:	Beveled Wood Edge, Tapered Wood Edge:	Horizon Wood Edge:

12'L x 48"W One Piece Top

0 TAP

HS1248R10	Grade 1 Laminate	\$ 7570	\$ 7698	\$ 7876	\$ 9205
	Grade 2 Laminate	\$ 7743	\$ 7871	\$ 8049	\$ 9378
	Grade 1 Veneer	\$ 8367	\$ 8495	\$ 8673	\$10,002
	Grade 2 Veneer	\$ 9255	\$ 9383	\$ 9561	\$10,890

1 TAP

HS1248R11	Grade 1 Laminate	\$ 9118	\$ 9246	\$ 9424	\$10,753
	Grade 2 Laminate	\$ 9291	\$ 9419	\$ 9597	\$10,926
	Grade 1 Veneer	\$ 9915	\$10,043	\$10,221	\$11,550
	Grade 2 Veneer	\$10,803	\$10,931	\$11,109	\$12,438

2 TAPS

HS1248R12	Grade 1 Laminate	\$10,666	\$10,794	\$10,972	\$12,301
	Grade 2 Laminate	\$10,839	\$10,967	\$11,145	\$12,474
	Grade 1 Veneer	\$11,463	\$11,591	\$11,769	\$13,098
	Grade 2 Veneer	\$12,351	\$12,479	\$12,657	\$13,986

3 TAPS

HS1248R13	Grade 1 Laminate	\$12,216	\$12,344	\$12,522	\$13,851
	Grade 2 Laminate	\$12,389	\$12,517	\$12,695	\$14,024
	Grade 1 Veneer	\$13,013	\$13,141	\$13,319	\$14,648
	Grade 2 Veneer	\$13,901	\$14,029	\$14,207	\$15,536

► Specification Information, continued on next page

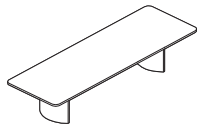

Tip: For tech corridor, 12'L tables have four long doors and four short doors.

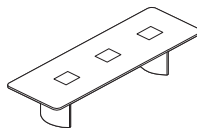
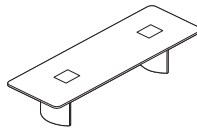
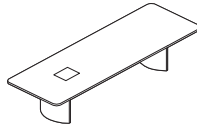

Host Collection

Rectangular Tables with Two Bases *continued*
 DESIGN F/P DESIGN AND VECTA DESIGN TEAM





SIN 711.11

Tip: Prices shown include top, TAP(s), and slim bases.
 ▶ See base options for flared bases, page 166

Tip: Last digit of style number indicates number of TAP(s).

▶ Specification Information, continued from previous page

Specification Information

Style Number	Finish	Base Prices			
					
		Flat Wood Edge:	Bullnose Wood Edge:	Beveled Wood Edge, Tapered Wood Edge:	Horizon Wood Edge:

12'L x 48"W Two Piece Top

0 TAP

HS1248R20	Grade 1 Laminate	\$ 7939	\$ 8067	\$ 8245	\$ 9574
	Grade 2 Laminate	\$ 8112	\$ 8240	\$ 8418	\$ 9747
	Grade 1 Veneer	\$ 8736	\$ 8864	\$ 9042	\$10,371
	Grade 2 Veneer	\$ 9624	\$ 9752	\$ 9930	\$11,259

1 TAP

HS1248R21	Grade 1 Laminate	\$ 9490	\$ 9618	\$ 9796	\$11,125
	Grade 2 Laminate	\$ 9663	\$ 9791	\$ 9969	\$11,298
	Grade 1 Veneer	\$10,287	\$10,415	\$10,593	\$11,922
	Grade 2 Veneer	\$11,175	\$11,303	\$11,481	\$12,810

2 TAPS

HS1248R22	Grade 1 Laminate	\$11,037	\$11,165	\$11,343	\$12,672
	Grade 2 Laminate	\$11,210	\$11,338	\$11,516	\$12,845
	Grade 1 Veneer	\$11,834	\$11,962	\$12,140	\$13,469
	Grade 2 Veneer	\$12,722	\$12,850	\$13,028	\$14,357

12'L x 60"W One Piece Top

0 TAP

HS1260R10	Grade 1 Laminate	\$ 7771	\$ 7906	\$ 8097	\$ 9437
	Grade 2 Laminate	\$ 7987	\$ 8122	\$ 8313	\$ 9653
	Grade 1 Veneer	\$ 9078	\$ 9213	\$ 9404	\$10,744
	Grade 2 Veneer	\$10,195	\$10,330	\$10,521	\$11,861

1 TAP

HS1260R11	Grade 1 Laminate	\$ 9321	\$ 9456	\$ 9647	\$10,987
	Grade 2 Laminate	\$ 9537	\$ 9672	\$ 9863	\$11,203
	Grade 1 Veneer	\$10,628	\$10,763	\$10,954	\$12,294
	Grade 2 Veneer	\$11,745	\$11,880	\$12,071	\$13,411

2 TAPS

HS1260R12	Grade 1 Laminate	\$10,868	\$11,003	\$11,194	\$12,534
	Grade 2 Laminate	\$11,084	\$11,219	\$11,410	\$12,750
	Grade 1 Veneer	\$12,175	\$12,310	\$12,501	\$13,841
	Grade 2 Veneer	\$13,292	\$13,427	\$13,618	\$14,958

▶ Specification Information, continued on next page

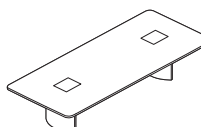
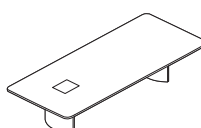
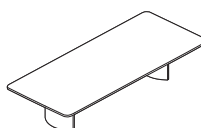
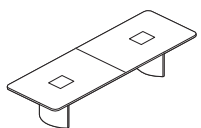
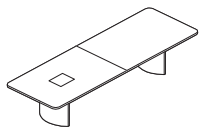
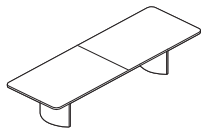

Host Collection

Rectangular Tables with Two Bases
DESIGN F/P DESIGN AND VECTA DESIGN TEAM





SIN 711.11

Tip: Prices shown include top, TAP(s), and slim bases.
▶ See base options for flared bases, page 166

Tip: Last digit of style number indicates number of TAP(s).

▶ Specification Information, continued from previous page

Specification Information

Style Number	Finish	Base Prices			
					
		Flat Wood Edge:	Bullnose Wood Edge:	Beveled Wood Edge, Tapered Wood Edge:	Horizon Wood Edge:

12'L x 60"W One Piece Top, continued

3 TAPS

HS1260R13	Grade 1 Laminate	\$12,417	\$12,552	\$12,743	\$14,083
	Grade 2 Laminate	\$12,633	\$12,768	\$12,959	\$14,299
	Grade 1 Veneer	\$13,724	\$13,859	\$14,050	\$15,390
	Grade 2 Veneer	\$14,841	\$14,976	\$15,167	\$16,507

12'L x 60"W Two Piece Top

0 TAP

HS1260R20	Grade 1 Laminate	\$ 8141	\$ 8276	\$ 8467	\$ 9807
	Grade 2 Laminate	\$ 8357	\$ 8492	\$ 8683	\$10,023
	Grade 1 Veneer	\$ 9448	\$ 9583	\$ 9774	\$11,114
	Grade 2 Veneer	\$10,565	\$10,700	\$10,891	\$12,231

1 TAP

HS1260R21	Grade 1 Laminate	\$ 9690	\$ 9825	\$10,016	\$11,356
	Grade 2 Laminate	\$ 9906	\$10,041	\$10,232	\$11,572
	Grade 1 Veneer	\$10,997	\$11,132	\$11,323	\$12,663
	Grade 2 Veneer	\$12,114	\$12,249	\$12,440	\$13,780

2 TAPS

HS1260R22	Grade 1 Laminate	\$11,239	\$11,374	\$11,565	\$12,905
	Grade 2 Laminate	\$11,455	\$11,590	\$11,781	\$13,121
	Grade 1 Veneer	\$12,546	\$12,681	\$12,872	\$14,212
	Grade 2 Veneer	\$13,663	\$13,798	\$13,989	\$15,329

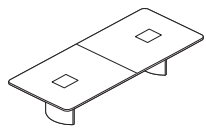
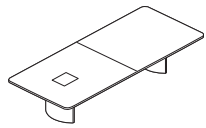
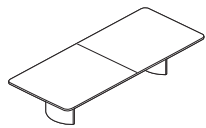
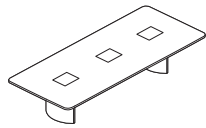

Host Collection

Rectangular Tables with Three Bases
 DESIGN F/P DESIGN AND VECTA DESIGN TEAM

SIN 711.11

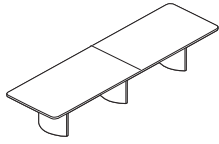

Tip: Shipped knocked down and top ships in one piece.

Tip: Grain direction for wood-grain laminate runs the length of the table.

Tip: Clips are provided with table: One clip per foot of table length.

Tip: The wood edge on a table top with woodgrain laminate may not match the top.

Tip: You must send a sample of reasonable size for Stain-to-Match.

Tip: 14'L and 16'L tables available with zero, one, two, or four TAP(s). 18'L and 20'L tables available with zero, one, two, four, or six TAP(s).

Tip: In addition to the data and audio/video AAPs available from Coalesse, other styles of AAPs are available through Extron Electronics. For an Extron dealer, call 1.800.633.9876.

Tip: See TAP options for electrical systems and faceplate list.

Veneer direction



Standard Includes		Required to Specify
<ul style="list-style-type: none"> ▶ Need help? Product details, see <i>Coalesse Tables, Storage, and Accessories Specification Guide</i> 	<ul style="list-style-type: none"> • Top: 1¼" particle board core with laminate • Flat wood edge • TAP(s), if selected: 10"W x 12"L opening(s) trimmed with a flat solid wood profile and with brushed anodized aluminum TAP doors • Tech corridor: four aluminum beams for top support provide tracks for hinged aluminum doors that clip shut: satin anodized finish • Universal clip: black plastic • Three 27"W bases: wood veneer on MDF with aluminum universal bracket • Concealed leveling glides: non-marring, black plastic 	<ol style="list-style-type: none"> 1 Style number 2 Base selection (see below) and wood color number for base 3 Laminate color number for table top, if selected 4 Wood color number for wood edge <p>▶ See <i>Hardwood and Veneer Matrix</i>, page 364</p> <ol style="list-style-type: none"> 5 Door color number for storage tray or TAP door, if selected: <ul style="list-style-type: none"> - 8044 Black - 8047 Silver 6 Options, if selected (see below) <p>▶ See <i>Surface Materials</i>, page 350.</p>

	Options	Price	Required to Specify
Surface Materials	<ul style="list-style-type: none"> • Top • Grade 2 laminate • Grade 1 wood veneer • Grade 2 wood veneer • Stain-to-Match 	<p>Prices at right</p> <p>Prices at right</p> <p>Prices at right</p> <p>No cost</p>	<p>Specify with <i>Grade 2 laminate</i> and select color number.</p> <p>Specify with <i>Grade 1 wood veneer</i> and select color number.</p> <p>Specify with <i>Grade 2 wood veneer</i> and select color number.</p> <p>Specify with <i>Stain-to-Match</i>.</p> <p>▶ Page 383</p>
Edges	<ul style="list-style-type: none"> • Wood • Bullnose wood edge • Beveled wood edge • Tapered wood edge • Horizon wood edge 	<p>Prices at right</p> <p>Prices at right</p> <p>Prices at right</p> <p>Prices at right</p>	<p>Specify with <i>bullnose wood edge</i>.</p> <p>Specify with <i>beveled wood edge</i>.</p> <p>Specify with <i>tapered wood edge</i>.</p> <p>Specify with <i>Horizon wood edge</i>.</p>
Bases	<ul style="list-style-type: none"> • Three slim bases • Two slim and one flared bases • One slim and two flared bases • Three flared bases 	<p>No cost</p> <p>+\$ 807</p> <p>+\$1615</p> <p>+\$2421</p>	<p>Specify with <i>three slim bases</i>.</p> <p>Specify with <i>two slim and one flared bases</i>.</p> <p>Specify with <i>one slim and two flared bases</i>.</p> <p>Specify with <i>three flared bases</i>.</p>

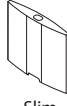
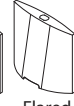
	TAP Electrical System with Faceplate Options	Price	Required to Specify
 Slim  Flared	<ul style="list-style-type: none"> • Field-wired tray (no electrical) <ul style="list-style-type: none"> - PAFW field-wired tray (no electrical) with blank AAPs - PDFW field-wired tray (no electrical) with two data AAPs - PVFW field-wired tray (no electrical) with two of each video/audio and data AAPs • Cord and plug tray (10' cord) <ul style="list-style-type: none"> - PACP cord and plug tray with outlets and blank AAPs - PDCP cord and plug tray with outlets and two data AAPs - PAVC cord and plug tray with outlets and two of each video/audio and data AAPs • Hard-wired tray (6' conduit) <ul style="list-style-type: none"> - PAHW hard-wired tray with outlets and blank AAPs - PDHW hard-wired tray with outlets and two data AAPs - PAVH hard-wired tray with outlets and two of each video/audio and data AAPs 	<p>No cost</p> <p>No cost</p> <p>No cost</p>	<p>Specify with <i>power data</i>, and select TAP type and TAP door color number.</p> <p>Specify with <i>power data</i>, and select TAP type and TAP door color number.</p> <p>Specify with <i>power data</i>, and select TAP type and TAP door color number.</p>

▶ Options, continued on next page

Host Collection

Rectangular Tables with Three Bases
DESIGN F/P DESIGN AND VECTA DESIGN TEAM

SIN 711.11

Tip: For single TAP style numbers, the modular system tray is not available. Specify the hard-wired tray option.

Tip: If the specified table has multiple TAP(s), any one TAP can be replaced with a storage tray.

Tip: Wood veneer doors for storage tray and TAP will always be cross grain.

Tip: Connectrac must be the same wiring schematic as the table.

►Options, continued from previous page

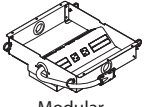
Options	Price	Required to Specify
TAP Electrical System with Faceplate Options  Modular	<ul style="list-style-type: none"> Modular system tray (hardwire base power infeed) - PAMH modular system tray with outlets and blank AAPs - PDMH modular system tray with outlets and two data AAPs - PVMH modular system tray with outlets and two of each video/audio and data AAPs 	+\$138 each tray Specify with <i>modular power data</i> , and select TAP type and TAP door color number.
Storage Tray	<ul style="list-style-type: none"> Storage tray 	-\$579 Specify with <i>storage tray</i> and select door color number.
Doors	<ul style="list-style-type: none"> Storage tray wood veneer doors TAP wood veneer doors 	+\$291 per door +\$291 per door Specify with <i>wood doors</i> . Specify with <i>wood doors</i> .
Related Products	<ul style="list-style-type: none"> Floor kit: Connectrac Corridor shelf 	► Page 283 ► Page 283

TAP Locations

14'L x 48"W TAP Locations—Two piece top

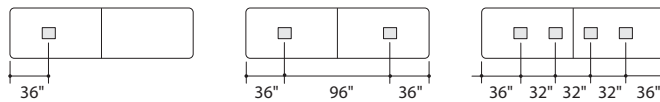

14'L x 48"W TAP Locations—Three piece top

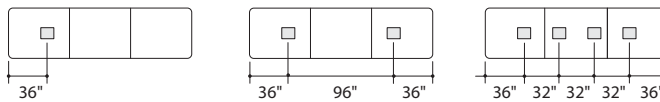

14'L x 60"W TAP Locations—Two piece top

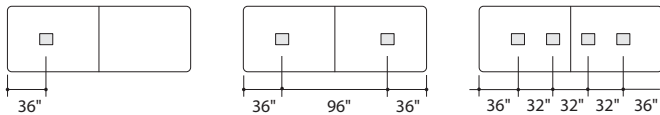

14'L x 60"W TAP Locations—Three piece top

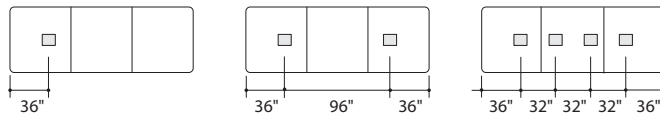

►Options, continued on next page

Host Collection

Rectangular Tables with Three Bases *continued*
DESIGN F/P DESIGN AND VECTA DESIGN TEAM

SIN 711.11

►Options, continued from previous page

TAP Locations

16'L x 48"W TAP Locations—Two piece top

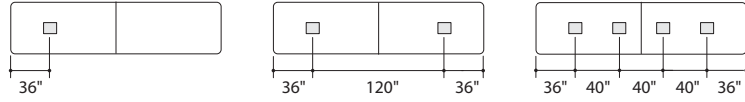

16'L x 48"W TAP Locations—Three piece top

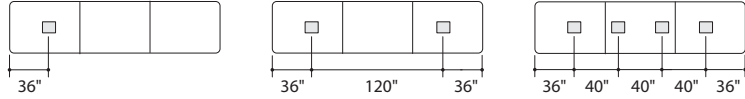

16'L x 60"W TAP Locations—Two piece top

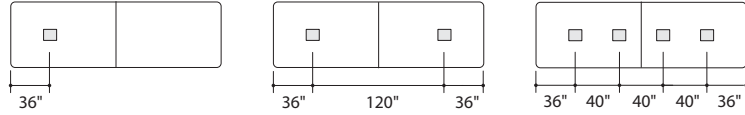

16'L x 60"W TAP Locations—Three piece top

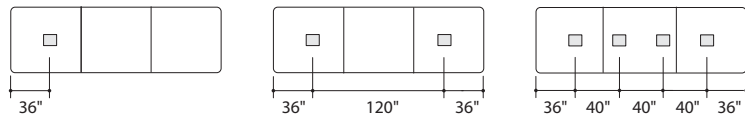

18'L x 48"W TAP Locations—Two piece top

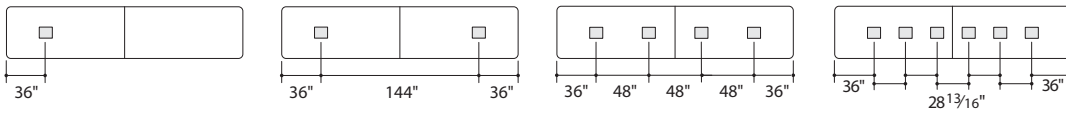

18'L x 48"W TAP Locations—Three piece top

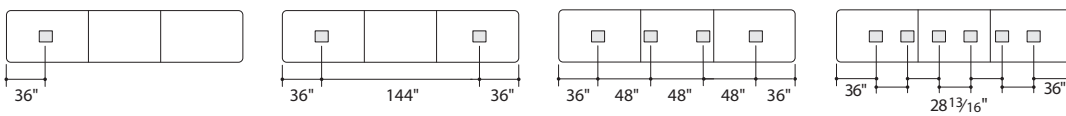

18'L x 60"W TAP Locations—Two piece top

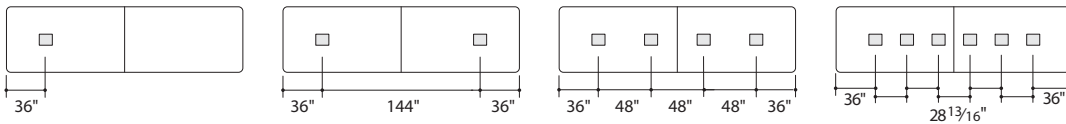

18'L x 60"W TAP Locations—Three piece top

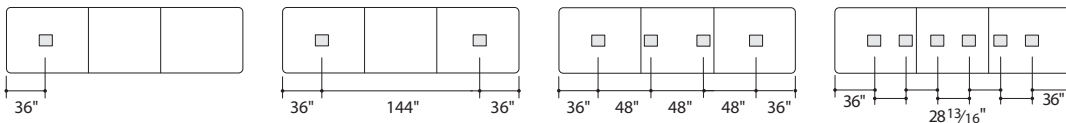

►Options, continued on next page

Host Collection

Rectangular Tables with Three Bases
DESIGN F/P DESIGN AND VECTA DESIGN TEAM

SIN 711.11

►Options, continued from previous page

TAP Locations

20'L x 48"W TAP Locations—Two piece top

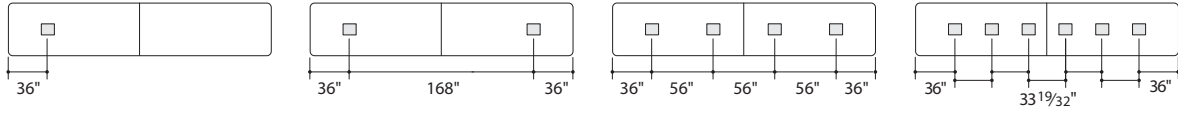

20'L x 48"W TAP Locations—Three piece top

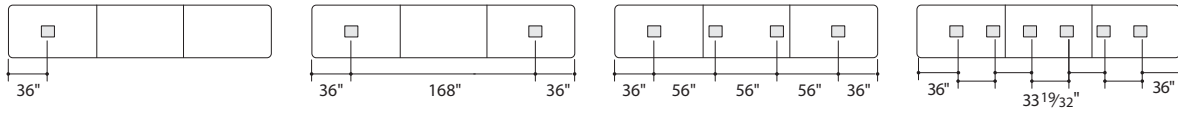

20'L x 60"W TAP Locations—Two piece top

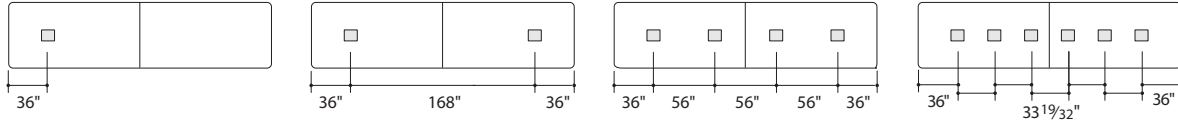

20'L x 60"W TAP Locations—Three piece top

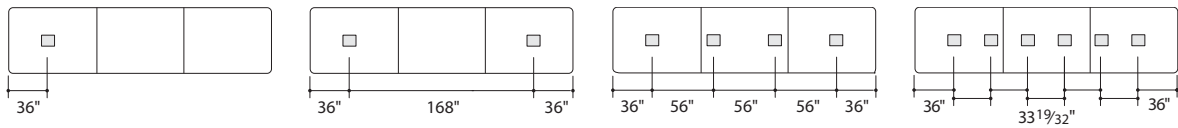

►Specification Information, on next page

Host Collection

Rectangular Tables with Three Bases *continued*
 DESIGN F/P DESIGN AND VECTA DESIGN TEAM

SIN 711.11

Tip: Prices shown include top, TAP(s), and slim bases.
 ▶ See base options for flared bases, page 174



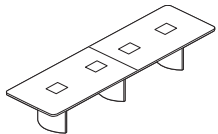
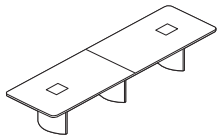
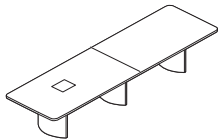
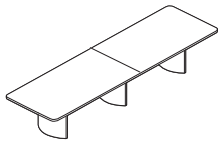

Tip: Last digit of style number indicates number of TAP(s).

Tip: For tech corridor, 14'L tables have four long doors and four short doors.



▶ Options, on previous page

Specification Information

Style Number	Finish	Base Prices			
					
		Flat Wood Edge:	Bullnose Wood Edge:	Beveled Wood Edge, Tapered Wood Edge:	Horizon Wood Edge:

14'L x 48''W Two Piece Top

0 TAP

Style Number	Finish	Flat Wood Edge	Bullnose Wood Edge	Beveled Wood Edge, Tapered Wood Edge	Horizon Wood Edge
HS1448R20	Grade 1 Laminate	\$10,282	\$10,428	\$10,625	\$11,979
	Grade 2 Laminate	\$10,485	\$10,631	\$10,828	\$12,182
	Grade 1 Veneer	\$11,403	\$11,549	\$11,746	\$13,100
	Grade 2 Veneer	\$12,443	\$12,589	\$12,786	\$14,140

1 TAP

Style Number	Finish	Flat Wood Edge	Bullnose Wood Edge	Beveled Wood Edge, Tapered Wood Edge	Horizon Wood Edge
HS1448R21	Grade 1 Laminate	\$11,830	\$11,976	\$12,173	\$13,527
	Grade 2 Laminate	\$12,033	\$12,179	\$12,376	\$13,730
	Grade 1 Veneer	\$12,951	\$13,097	\$13,294	\$14,648
	Grade 2 Veneer	\$13,991	\$14,137	\$14,334	\$15,688

2 TAPS

Style Number	Finish	Flat Wood Edge	Bullnose Wood Edge	Beveled Wood Edge, Tapered Wood Edge	Horizon Wood Edge
HS1448R22	Grade 1 Laminate	\$13,379	\$13,525	\$13,722	\$15,076
	Grade 2 Laminate	\$13,582	\$13,728	\$13,925	\$15,279
	Grade 1 Veneer	\$14,500	\$14,646	\$14,843	\$16,197
	Grade 2 Veneer	\$15,540	\$15,686	\$15,883	\$17,237

4 TAPS

Style Number	Finish	Flat Wood Edge	Bullnose Wood Edge	Beveled Wood Edge, Tapered Wood Edge	Horizon Wood Edge
HS1448R24	Grade 1 Laminate	\$16,475	\$16,621	\$16,818	\$18,172
	Grade 2 Laminate	\$16,678	\$16,824	\$17,021	\$18,375
	Grade 1 Veneer	\$17,596	\$17,742	\$17,939	\$19,293
	Grade 2 Veneer	\$18,636	\$18,782	\$18,979	\$20,333

▶ Specification Information, continued on next page

Host Collection

Rectangular Tables with Three Bases
DESIGN F/P DESIGN AND VECTA DESIGN TEAM

SIN 711.11

Tip: Prices shown include top, TAP(s), and slim bases.
► See base options for flared bases, page 174



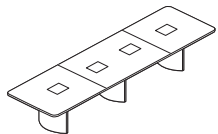
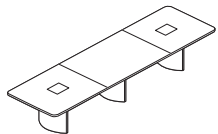
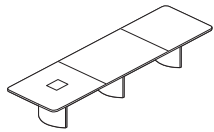
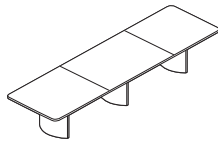

Tip: Last digit of style number indicates number of TAP(s).

Tip: For tech corridor, 14'L tables have four long doors and four short doors.



► Specification Information, continued from previous page

Specification Information

Style Number	Finish	Base Prices			
					
		Flat Wood Edge:	Bullnose Wood Edge:	Beveled Wood Edge, Tapered Wood Edge:	Horizon Wood Edge:

14'L x 48''W Three Piece Top

0 TAP

Style Number	Finish	Flat Wood Edge	Bullnose Wood Edge	Beveled Wood Edge, Tapered Wood Edge	Horizon Wood Edge
HS1448R30	Grade 1 Laminate	\$10,652	\$10,798	\$10,995	\$12,349
	Grade 2 Laminate	\$10,855	\$11,001	\$11,198	\$12,552
	Grade 1 Veneer	\$11,773	\$11,919	\$12,116	\$13,470
	Grade 2 Veneer	\$12,813	\$12,959	\$13,156	\$14,510

1 TAP

Style Number	Finish	Flat Wood Edge	Bullnose Wood Edge	Beveled Wood Edge, Tapered Wood Edge	Horizon Wood Edge
HS1448R31	Grade 1 Laminate	\$12,202	\$12,348	\$12,545	\$13,899
	Grade 2 Laminate	\$12,405	\$12,551	\$12,748	\$14,102
	Grade 1 Veneer	\$13,323	\$13,469	\$13,666	\$15,020
	Grade 2 Veneer	\$14,363	\$14,509	\$14,706	\$16,060

2 TAPS

Style Number	Finish	Flat Wood Edge	Bullnose Wood Edge	Beveled Wood Edge, Tapered Wood Edge	Horizon Wood Edge
HS1448R32	Grade 1 Laminate	\$13,751	\$13,897	\$14,094	\$15,448
	Grade 2 Laminate	\$13,954	\$14,100	\$14,297	\$15,651
	Grade 1 Veneer	\$14,872	\$15,018	\$15,215	\$16,569
	Grade 2 Veneer	\$15,912	\$16,058	\$16,255	\$17,609

4 TAPS

Style Number	Finish	Flat Wood Edge	Bullnose Wood Edge	Beveled Wood Edge, Tapered Wood Edge	Horizon Wood Edge
HS1448R34	Grade 1 Laminate	\$16,848	\$16,994	\$17,191	\$18,545
	Grade 2 Laminate	\$17,051	\$17,197	\$17,394	\$18,748
	Grade 1 Veneer	\$17,969	\$18,115	\$18,312	\$19,666
	Grade 2 Veneer	\$19,009	\$19,155	\$19,352	\$20,706

► Specification Information, continued on next page

Host Collection

Rectangular Tables with Three Bases *continued*
 DESIGN F/P DESIGN AND VECTA DESIGN TEAM

SIN 711.11

Tip: Prices shown include top, TAP(s), and slim bases.
 ▶ See base options for flared bases, page 174



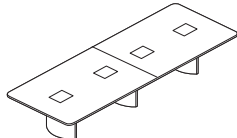
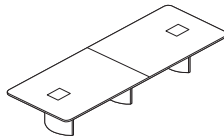
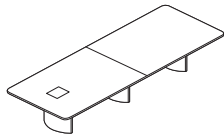
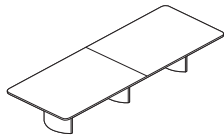

Tip: Last digit of style number indicates number of TAP(s).

Tip: For tech corridor, 14'L tables have four long doors and four short doors.



▶ Specification Information, continued from previous page

Specification Information

Style Number	Finish	Base Prices			
					
		Flat Wood Edge:	Bullnose Wood Edge:	Beveled Wood Edge, Tapered Wood Edge:	Horizon Wood Edge:

14'L x 60"W Two Piece Top

0 TAP

Style Number	Finish	Flat Wood Edge	Bullnose Wood Edge	Beveled Wood Edge, Tapered Wood Edge	Horizon Wood Edge
HS1460R20	Grade 1 Laminate	\$10,739	\$10,891	\$11,102	\$12,468
	Grade 2 Laminate	\$10,993	\$11,145	\$11,356	\$12,722
	Grade 1 Veneer	\$12,800	\$12,952	\$13,163	\$14,529
	Grade 2 Veneer	\$14,120	\$14,272	\$14,483	\$15,849

1 TAP

Style Number	Finish	Flat Wood Edge	Bullnose Wood Edge	Beveled Wood Edge, Tapered Wood Edge	Horizon Wood Edge
HS1460R21	Grade 1 Laminate	\$12,289	\$12,441	\$12,652	\$14,018
	Grade 2 Laminate	\$12,543	\$12,695	\$12,906	\$14,272
	Grade 1 Veneer	\$14,350	\$14,502	\$14,713	\$16,079
	Grade 2 Veneer	\$15,670	\$15,822	\$16,033	\$17,399

2 TAPS

Style Number	Finish	Flat Wood Edge	Bullnose Wood Edge	Beveled Wood Edge, Tapered Wood Edge	Horizon Wood Edge
HS1460R22	Grade 1 Laminate	\$13,836	\$13,988	\$14,199	\$15,565
	Grade 2 Laminate	\$14,090	\$14,242	\$14,453	\$15,819
	Grade 1 Veneer	\$15,897	\$16,049	\$16,260	\$17,626
	Grade 2 Veneer	\$17,217	\$17,369	\$17,580	\$18,946

4 TAPS

Style Number	Finish	Flat Wood Edge	Bullnose Wood Edge	Beveled Wood Edge, Tapered Wood Edge	Horizon Wood Edge
HS1460R24	Grade 1 Laminate	\$16,934	\$17,086	\$17,297	\$18,663
	Grade 2 Laminate	\$17,188	\$17,340	\$17,551	\$18,917
	Grade 1 Veneer	\$18,995	\$19,147	\$19,358	\$20,724
	Grade 2 Veneer	\$20,315	\$20,467	\$20,678	\$22,044

▶ Specification Information, continued on next page

Host Collection

Rectangular Tables with Three Bases
DESIGN F/P DESIGN AND VECTA DESIGN TEAM

SIN 711.11

Tip: Prices shown include top, TAP(s), and slim bases.
► See base options for flared bases, page 174



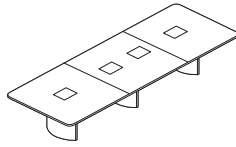
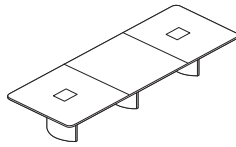
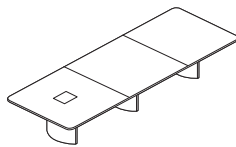
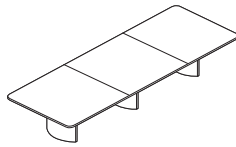

Tip: Last digit of style number indicates number of TAP(s).

Tip: For tech corridor, tables have four long doors and four short doors.



► Specification Information, continued from previous page

Specification Information

Style Number	Finish	Base Prices			
					
		Flat Wood Edge:	Bullnose Wood Edge:	Beveled Wood Edge, Tapered Wood Edge:	Horizon Wood Edge:

14'L x 60"W Three Piece Top

0 TAP

Style Number	Finish	Flat Wood Edge	Bullnose Wood Edge	Beveled Wood Edge, Tapered Wood Edge	Horizon Wood Edge
HS1460R30	Grade 1 Laminate	\$11,110	\$11,262	\$11,473	\$12,839
	Grade 2 Laminate	\$11,364	\$11,516	\$11,727	\$13,093
	Grade 1 Veneer	\$13,171	\$13,323	\$13,534	\$14,900
	Grade 2 Veneer	\$14,491	\$14,643	\$14,854	\$16,220

1 TAP

Style Number	Finish	Flat Wood Edge	Bullnose Wood Edge	Beveled Wood Edge, Tapered Wood Edge	Horizon Wood Edge
HS1460R31	Grade 1 Laminate	\$12,659	\$12,811	\$13,022	\$14,388
	Grade 2 Laminate	\$12,913	\$13,065	\$13,276	\$14,642
	Grade 1 Veneer	\$14,720	\$14,872	\$15,083	\$16,449
	Grade 2 Veneer	\$16,040	\$16,192	\$16,403	\$17,769

2 TAPS

Style Number	Finish	Flat Wood Edge	Bullnose Wood Edge	Beveled Wood Edge, Tapered Wood Edge	Horizon Wood Edge
HS1460R32	Grade 1 Laminate	\$14,208	\$14,360	\$14,571	\$15,937
	Grade 2 Laminate	\$14,462	\$14,614	\$14,825	\$16,191
	Grade 1 Veneer	\$16,269	\$16,421	\$16,632	\$17,998
	Grade 2 Veneer	\$17,589	\$17,741	\$17,952	\$19,318

4 TAPS

Style Number	Finish	Flat Wood Edge	Bullnose Wood Edge	Beveled Wood Edge, Tapered Wood Edge	Horizon Wood Edge
HS1460R34	Grade 1 Laminate	\$17,308	\$17,460	\$17,671	\$19,037
	Grade 2 Laminate	\$17,562	\$17,714	\$17,925	\$19,291
	Grade 1 Veneer	\$19,369	\$19,521	\$19,732	\$21,098
	Grade 2 Veneer	\$20,689	\$20,841	\$21,052	\$22,418

► Specification Information, continued on next page

Host Collection

Rectangular Tables with Three Bases *continued*
 DESIGN F/P DESIGN AND VECTA DESIGN TEAM

SIN 711.11

Tip: Prices shown include top, TAP(s), and slim bases.
 ▶ See base options for flared bases, page 174



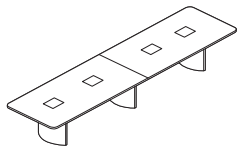
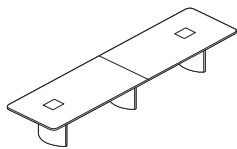
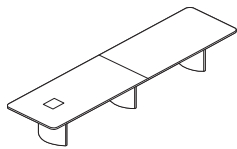
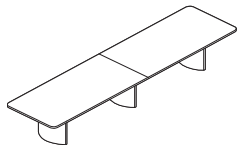

Tip: Last digit of style number indicates number of TAP(s).

Tip: For tech corridor, 16'L tables have eight long doors and four short doors.



► Specification Information, continued from previous page

Specification Information

Style Number	Finish	Base Prices			
					
		Flat Wood Edge:	Bullnose Wood Edge:	Beveled Wood Edge, Tapered Wood Edge:	Horizon Wood Edge:

16'L x 48''W Two Piece Top

0 TAP

Style Number	Finish	Flat Wood Edge	Bullnose Wood Edge	Beveled Wood Edge, Tapered Wood Edge	Horizon Wood Edge
HS1648R20	Grade 1 Laminate	\$10,702	\$10,861	\$11,083	\$12,462
	Grade 2 Laminate	\$10,933	\$11,092	\$11,314	\$12,693
	Grade 1 Veneer	\$11,818	\$11,977	\$12,199	\$13,578
	Grade 2 Veneer	\$13,004	\$13,163	\$13,385	\$14,764

1 TAP

Style Number	Finish	Flat Wood Edge	Bullnose Wood Edge	Beveled Wood Edge, Tapered Wood Edge	Horizon Wood Edge
HS1648R21	Grade 1 Laminate	\$12,250	\$12,409	\$12,631	\$14,010
	Grade 2 Laminate	\$12,481	\$12,640	\$12,862	\$14,241
	Grade 1 Veneer	\$13,366	\$13,525	\$13,747	\$15,126
	Grade 2 Veneer	\$14,552	\$14,711	\$14,933	\$16,312

2 TAPS

Style Number	Finish	Flat Wood Edge	Bullnose Wood Edge	Beveled Wood Edge, Tapered Wood Edge	Horizon Wood Edge
HS1648R22	Grade 1 Laminate	\$13,799	\$13,958	\$14,180	\$15,559
	Grade 2 Laminate	\$14,030	\$14,189	\$14,411	\$15,790
	Grade 1 Veneer	\$14,915	\$15,074	\$15,296	\$16,675
	Grade 2 Veneer	\$16,101	\$16,260	\$16,482	\$17,861

4 TAPS

Style Number	Finish	Flat Wood Edge	Bullnose Wood Edge	Beveled Wood Edge, Tapered Wood Edge	Horizon Wood Edge
HS1648R24	Grade 1 Laminate	\$16,895	\$17,054	\$17,276	\$18,655
	Grade 2 Laminate	\$17,126	\$17,285	\$17,507	\$18,886
	Grade 1 Veneer	\$18,011	\$18,170	\$18,392	\$19,771
	Grade 2 Veneer	\$19,197	\$19,356	\$19,578	\$20,957

► Specification Information, continued on next page

Host Collection

Rectangular Tables with Three Bases
DESIGN F/P DESIGN AND VECTA DESIGN TEAM

SIN 711.11

Tip: Prices shown include top, TAP(s), and slim bases.
► See base options for flared bases, page 174



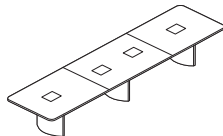
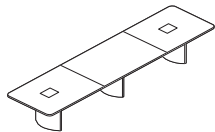
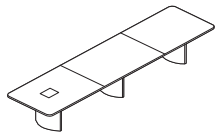
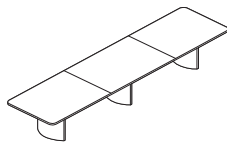

Tip: Last digit of style number indicates number of TAP(s).

Tip: For tech corridor, 16'L tables have eight long doors and four short doors.



► Specification Information, continued from previous page

Specification Information

Style Number	Finish	Base Prices			
					
		Flat Wood Edge:	Bullnose Wood Edge:	Beveled Wood Edge, Tapered Wood Edge:	Horizon Wood Edge:

16'L x 48''W Three Piece Top

0 TAP

Style Number	Finish	Flat Wood Edge	Bullnose Wood Edge	Beveled Wood Edge, Tapered Wood Edge	Horizon Wood Edge
HS1648R30	Grade 1 Laminate	\$11,074	\$11,233	\$11,455	\$12,834
	Grade 2 Laminate	\$11,305	\$11,464	\$11,686	\$13,065
	Grade 1 Veneer	\$12,190	\$12,349	\$12,571	\$13,950
	Grade 2 Veneer	\$13,376	\$13,535	\$13,757	\$15,136

1 TAP

Style Number	Finish	Flat Wood Edge	Bullnose Wood Edge	Beveled Wood Edge, Tapered Wood Edge	Horizon Wood Edge
HS1648R31	Grade 1 Laminate	\$12,622	\$12,781	\$13,003	\$14,382
	Grade 2 Laminate	\$12,853	\$13,012	\$13,234	\$14,613
	Grade 1 Veneer	\$13,738	\$13,897	\$14,119	\$15,498
	Grade 2 Veneer	\$14,924	\$15,083	\$15,305	\$16,684

2 TAPS

Style Number	Finish	Flat Wood Edge	Bullnose Wood Edge	Beveled Wood Edge, Tapered Wood Edge	Horizon Wood Edge
HS1648R32	Grade 1 Laminate	\$14,168	\$14,327	\$14,549	\$15,928
	Grade 2 Laminate	\$14,399	\$14,558	\$14,780	\$16,159
	Grade 1 Veneer	\$15,284	\$15,443	\$15,665	\$17,044
	Grade 2 Veneer	\$16,470	\$16,629	\$16,851	\$18,230

4 TAPS

Style Number	Finish	Flat Wood Edge	Bullnose Wood Edge	Beveled Wood Edge, Tapered Wood Edge	Horizon Wood Edge
HS1648R34	Grade 1 Laminate	\$17,266	\$17,425	\$17,647	\$19,026
	Grade 2 Laminate	\$17,497	\$17,656	\$17,878	\$19,257
	Grade 1 Veneer	\$18,382	\$18,541	\$18,763	\$20,142
	Grade 2 Veneer	\$19,568	\$19,727	\$19,949	\$21,328

► Specification Information, continued on next page

Host Collection

Rectangular Tables with Three Bases *continued*
 DESIGN F/P DESIGN AND VECTA DESIGN TEAM

SIN 711.11

Tip: Prices shown include top, TAP(s), and slim bases.
 ▶ See base options for flared bases, page 174

Tip: Last digit of style number indicates number of TAP(s).

Tip: For tech corridor, 16'L tables have eight long doors and four short doors.

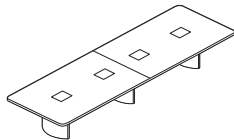
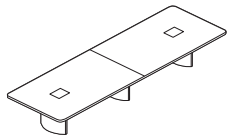
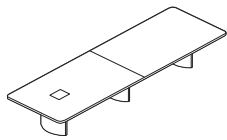
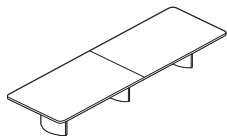

▶ Specification Information, continued from previous page

Specification Information

Style Number	Finish	Base Prices			
		Flat Wood Edge:	Bullnose Wood Edge:	Beveled Wood Edge, Tapered Wood Edge:	Horizon Wood Edge:

16'L x 60"W Two Piece Top

0 TAP

Style Number	Finish	Flat Wood Edge	Bullnose Wood Edge	Beveled Wood Edge, Tapered Wood Edge	Horizon Wood Edge
HS1660R20	Grade 1 Laminate	\$11,159	\$11,327	\$11,559	\$12,951
	Grade 2 Laminate	\$11,447	\$11,615	\$11,847	\$13,239
	Grade 1 Veneer	\$13,216	\$13,384	\$13,616	\$15,008
	Grade 2 Veneer	\$14,717	\$14,885	\$15,117	\$16,509

1 TAP

Style Number	Finish	Flat Wood Edge	Bullnose Wood Edge	Beveled Wood Edge, Tapered Wood Edge	Horizon Wood Edge
HS1660R21	Grade 1 Laminate	\$12,707	\$12,875	\$13,107	\$14,499
	Grade 2 Laminate	\$12,995	\$13,163	\$13,395	\$14,787
	Grade 1 Veneer	\$14,764	\$14,932	\$15,164	\$16,556
	Grade 2 Veneer	\$16,265	\$16,433	\$16,665	\$18,057

2 TAPS

Style Number	Finish	Flat Wood Edge	Bullnose Wood Edge	Beveled Wood Edge, Tapered Wood Edge	Horizon Wood Edge
HS1660R22	Grade 1 Laminate	\$14,256	\$14,424	\$14,656	\$16,048
	Grade 2 Laminate	\$14,544	\$14,712	\$14,944	\$16,336
	Grade 1 Veneer	\$16,313	\$16,481	\$16,713	\$18,105
	Grade 2 Veneer	\$17,814	\$17,982	\$18,214	\$19,606

4 TAPS

Style Number	Finish	Flat Wood Edge	Bullnose Wood Edge	Beveled Wood Edge, Tapered Wood Edge	Horizon Wood Edge
HS1660R24	Grade 1 Laminate	\$17,352	\$17,520	\$17,752	\$19,144
	Grade 2 Laminate	\$17,640	\$17,808	\$18,040	\$19,432
	Grade 1 Veneer	\$19,409	\$19,577	\$19,809	\$21,201
	Grade 2 Veneer	\$20,910	\$21,078	\$21,310	\$22,702

▶ Specification Information, continued on next page

Host Collection

Rectangular Tables with Three Bases
DESIGN F/P DESIGN AND VECTA DESIGN TEAM

SIN 711.11

Tip: Prices shown include top, TAP(s), and slim bases.
▶ See base options for flared bases, page 174



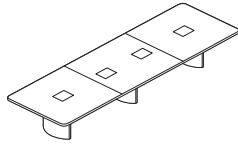
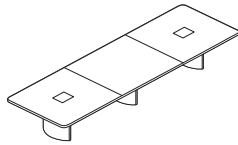
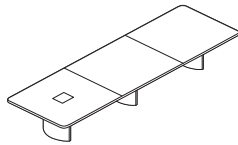
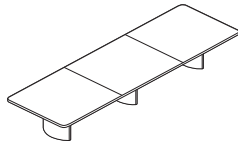

Tip: Last digit of style number indicates number of TAP(s).

Tip: For tech corridor, 16'L tables have eight long doors and four short doors.



▶ Specification Information, continued from previous page

Specification Information

Style Number	Finish	Base Prices			
					
		Flat Wood Edge:	Bullnose Wood Edge:	Beveled Wood Edge, Tapered Wood Edge:	Horizon Wood Edge:

16'L x 60"W Three Piece Top

0 TAP

Style Number	Finish	Flat Wood Edge	Bullnose Wood Edge	Beveled Wood Edge, Tapered Wood Edge	Horizon Wood Edge
HS1660R30	Grade 1 Laminate	\$11,530	\$11,698	\$11,930	\$13,322
	Grade 2 Laminate	\$11,818	\$11,986	\$12,218	\$13,610
	Grade 1 Veneer	\$13,587	\$13,755	\$13,987	\$15,379
	Grade 2 Veneer	\$15,088	\$15,256	\$15,488	\$16,880

1 TAP

Style Number	Finish	Flat Wood Edge	Bullnose Wood Edge	Beveled Wood Edge, Tapered Wood Edge	Horizon Wood Edge
HS1660R31	Grade 1 Laminate	\$13,079	\$13,247	\$13,479	\$14,871
	Grade 2 Laminate	\$13,367	\$13,535	\$13,767	\$15,159
	Grade 1 Veneer	\$15,136	\$15,304	\$15,536	\$16,928
	Grade 2 Veneer	\$16,637	\$16,805	\$17,037	\$18,429

2 TAPS

Style Number	Finish	Flat Wood Edge	Bullnose Wood Edge	Beveled Wood Edge, Tapered Wood Edge	Horizon Wood Edge
HS1660R32	Grade 1 Laminate	\$14,627	\$14,795	\$15,027	\$16,419
	Grade 2 Laminate	\$14,915	\$15,083	\$15,315	\$16,707
	Grade 1 Veneer	\$16,684	\$16,852	\$17,084	\$18,476
	Grade 2 Veneer	\$18,185	\$18,353	\$18,585	\$19,977

4 TAPS

Style Number	Finish	Flat Wood Edge	Bullnose Wood Edge	Beveled Wood Edge, Tapered Wood Edge	Horizon Wood Edge
HS1660R34	Grade 1 Laminate	\$17,723	\$17,891	\$18,123	\$19,515
	Grade 2 Laminate	\$18,011	\$18,179	\$18,411	\$19,803
	Grade 1 Veneer	\$19,780	\$19,948	\$20,180	\$21,572
	Grade 2 Veneer	\$21,281	\$21,449	\$21,681	\$23,073

▶ Specification Information, continued on next page

Host Collection

Rectangular Tables with Three Bases *continued*
 DESIGN F/P DESIGN AND VECTA DESIGN TEAM

SIN 711.11

Tip: Prices shown include top, TAP(s), and slim bases.
 ▶ See base options for flared bases, page 174

Tip: Last digit of style number indicates number of TAP(s).

Tip: For tech corridor, 18'L tables have eight long doors and four short doors.

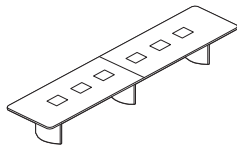
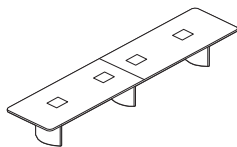
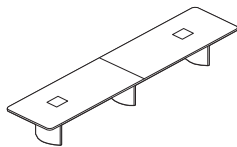
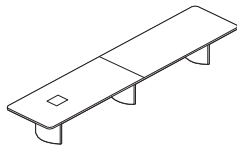
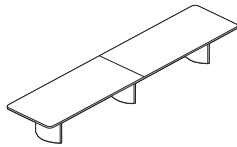

▶ Specification Information, continued from previous page

Specification Information

Style Number	Finish	Base Prices			
		Flat Wood Edge:	Bullnose Wood Edge:	Beveled Wood Edge, Tapered Wood Edge:	Horizon Wood Edge:

18'L x 48"W Two Piece Top

0 TAP

HS1848R20	Finish	Flat Wood Edge	Bullnose Wood Edge	Beveled Wood Edge, Tapered Wood Edge	Horizon Wood Edge
Grade 1 Laminate	\$11,367	\$11,542	\$11,784	\$13,190	
Grade 2 Laminate	\$11,627	\$11,802	\$12,044	\$13,450	
Grade 1 Veneer	\$12,792	\$12,967	\$13,209	\$14,615	
Grade 2 Veneer	\$14,128	\$14,303	\$14,545	\$15,951	

1 TAP

HS1848R21	Finish	Flat Wood Edge	Bullnose Wood Edge	Beveled Wood Edge, Tapered Wood Edge	Horizon Wood Edge
Grade 1 Laminate	\$12,915	\$13,090	\$13,332	\$14,738	
Grade 2 Laminate	\$13,175	\$13,350	\$13,592	\$14,998	
Grade 1 Veneer	\$14,340	\$14,515	\$14,757	\$16,163	
Grade 2 Veneer	\$15,676	\$15,851	\$16,093	\$17,499	

2 TAPS

HS1848R22	Finish	Flat Wood Edge	Bullnose Wood Edge	Beveled Wood Edge, Tapered Wood Edge	Horizon Wood Edge
Grade 1 Laminate	\$14,464	\$14,639	\$14,881	\$16,287	
Grade 2 Laminate	\$14,724	\$14,899	\$15,141	\$16,547	
Grade 1 Veneer	\$15,889	\$16,064	\$16,306	\$17,712	
Grade 2 Veneer	\$17,225	\$17,400	\$17,642	\$19,048	

4 TAPS

HS1848R24	Finish	Flat Wood Edge	Bullnose Wood Edge	Beveled Wood Edge, Tapered Wood Edge	Horizon Wood Edge
Grade 1 Laminate	\$17,560	\$17,735	\$17,977	\$19,383	
Grade 2 Laminate	\$17,820	\$17,995	\$18,237	\$19,643	
Grade 1 Veneer	\$18,985	\$19,160	\$19,402	\$20,808	
Grade 2 Veneer	\$20,321	\$20,496	\$20,738	\$22,144	

6 TAPS

HS1848R26	Finish	Flat Wood Edge	Bullnose Wood Edge	Beveled Wood Edge, Tapered Wood Edge	Horizon Wood Edge
Grade 1 Laminate	\$20,658	\$20,833	\$21,075	\$22,481	
Grade 2 Laminate	\$20,918	\$21,093	\$21,335	\$22,741	
Grade 1 Veneer	\$22,083	\$22,258	\$22,500	\$23,906	
Grade 2 Veneer	\$23,419	\$23,594	\$23,836	\$25,242	

▶ Specification Information, continued on next page

Host Collection

Rectangular Tables with Three Bases
DESIGN F/P DESIGN AND VECTA DESIGN TEAM

SIN 711.11

Tip: Prices shown include top, TAP(s), and slim bases.
▶ See base options for flared bases, page 174

Tip: Last digit of style number indicates number of TAP(s).

Tip: For tech corridor, 18'L tables have eight long doors and four short doors.

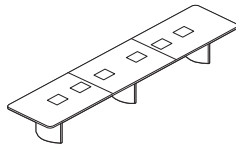
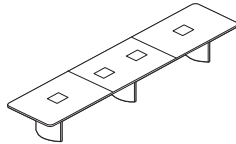
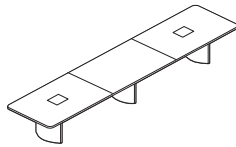
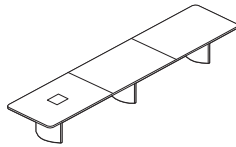
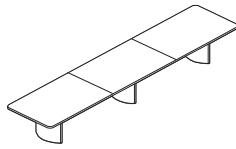

▶ Specification Information, continued from previous page

Specification Information

Style Number	Finish	Base Prices			
		Flat Wood Edge:	Bullnose Wood Edge:	Beveled Wood Edge, Tapered Wood Edge:	Horizon Wood Edge:

18'L x 48"W Three Piece Top

0 TAP

Style Number	Finish	Flat Wood Edge	Bullnose Wood Edge	Beveled Wood Edge, Tapered Wood Edge	Horizon Wood Edge
HS1848R30	Grade 1 Laminate	\$11,739	\$11,914	\$12,156	\$13,562
	Grade 2 Laminate	\$11,999	\$12,174	\$12,416	\$13,822
	Grade 1 Veneer	\$13,164	\$13,339	\$13,581	\$14,987
	Grade 2 Veneer	\$14,500	\$14,675	\$14,917	\$16,323

1 TAP

Style Number	Finish	Flat Wood Edge	Bullnose Wood Edge	Beveled Wood Edge, Tapered Wood Edge	Horizon Wood Edge
HS1848R31	Grade 1 Laminate	\$13,285	\$13,460	\$13,702	\$15,108
	Grade 2 Laminate	\$13,545	\$13,720	\$13,962	\$15,368
	Grade 1 Veneer	\$14,710	\$14,885	\$15,127	\$16,533
	Grade 2 Veneer	\$16,046	\$16,221	\$16,463	\$17,869

2 TAPS

Style Number	Finish	Flat Wood Edge	Bullnose Wood Edge	Beveled Wood Edge, Tapered Wood Edge	Horizon Wood Edge
HS1848R32	Grade 1 Laminate	\$14,833	\$15,008	\$15,250	\$16,656
	Grade 2 Laminate	\$15,093	\$15,268	\$15,510	\$16,916
	Grade 1 Veneer	\$16,258	\$16,433	\$16,675	\$18,081
	Grade 2 Veneer	\$17,594	\$17,769	\$18,011	\$19,417

4 TAPS

Style Number	Finish	Flat Wood Edge	Bullnose Wood Edge	Beveled Wood Edge, Tapered Wood Edge	Horizon Wood Edge
HS1848R34	Grade 1 Laminate	\$17,931	\$18,106	\$18,348	\$19,754
	Grade 2 Laminate	\$18,191	\$18,366	\$18,608	\$20,014
	Grade 1 Veneer	\$19,356	\$19,531	\$19,773	\$21,179
	Grade 2 Veneer	\$20,692	\$20,867	\$21,109	\$22,515

6 TAPS

Style Number	Finish	Flat Wood Edge	Bullnose Wood Edge	Beveled Wood Edge, Tapered Wood Edge	Horizon Wood Edge
HS1848R36	Grade 1 Laminate	\$21,028	\$21,203	\$21,445	\$22,851
	Grade 2 Laminate	\$21,288	\$21,463	\$21,705	\$23,111
	Grade 1 Veneer	\$22,453	\$22,628	\$22,870	\$24,276
	Grade 2 Veneer	\$23,789	\$23,964	\$24,206	\$25,612

▶ Specification Information, continued on next page

Host Collection

Rectangular Tables with Three Bases *continued*
 DESIGN F/P DESIGN AND VECTA DESIGN TEAM

SIN 711.11

Tip: Prices shown include top, TAP(s), and slim bases.
 ▶ See base options for flared bases, page 174

Tip: Last digit of style number indicates number of TAP(s).

Tip: For tech corridor, 18'L tables have eight long doors and four short doors.

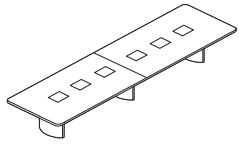
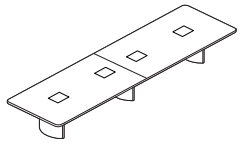
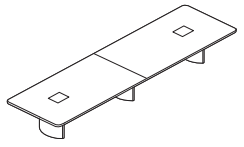
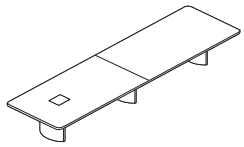
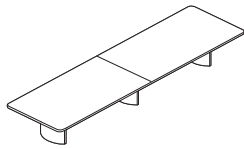

▶ Specification Information, continued from previous page

Specification Information

Style Number	Finish	Base Prices			
		Flat Wood Edge:	Bullnose Wood Edge:	Beveled Wood Edge, Tapered Wood Edge:	Horizon Wood Edge:

18'L x 60"W Two Piece Top

0 TAP

HS1860R20	Finish	Flat Wood Edge	Bullnose Wood Edge	Beveled Wood Edge, Tapered Wood Edge	Horizon Wood Edge
Grade 1 Laminate	\$11,611	\$11,792	\$12,048	\$13,465	
Grade 2 Laminate	\$11,936	\$12,117	\$12,373	\$13,790	
Grade 1 Veneer	\$14,361	\$14,542	\$14,798	\$16,215	
Grade 2 Veneer	\$16,064	\$16,245	\$16,501	\$17,918	

1 TAP

HS1860R21	Finish	Flat Wood Edge	Bullnose Wood Edge	Beveled Wood Edge, Tapered Wood Edge	Horizon Wood Edge
Grade 1 Laminate	\$13,161	\$13,342	\$13,598	\$15,015	
Grade 2 Laminate	\$13,486	\$13,667	\$13,923	\$15,340	
Grade 1 Veneer	\$15,911	\$16,092	\$16,348	\$17,765	
Grade 2 Veneer	\$17,614	\$17,795	\$18,051	\$19,468	

2 TAPS

HS1860R22	Finish	Flat Wood Edge	Bullnose Wood Edge	Beveled Wood Edge, Tapered Wood Edge	Horizon Wood Edge
Grade 1 Laminate	\$14,710	\$14,891	\$15,147	\$16,564	
Grade 2 Laminate	\$15,035	\$15,216	\$15,472	\$16,889	
Grade 1 Veneer	\$17,460	\$17,641	\$17,897	\$19,314	
Grade 2 Veneer	\$19,163	\$19,344	\$19,600	\$21,017	

4 TAPS

HS1860R24	Finish	Flat Wood Edge	Bullnose Wood Edge	Beveled Wood Edge, Tapered Wood Edge	Horizon Wood Edge
Grade 1 Laminate	\$17,807	\$17,988	\$18,244	\$19,661	
Grade 2 Laminate	\$18,132	\$18,313	\$18,569	\$19,986	
Grade 1 Veneer	\$20,557	\$20,738	\$20,994	\$22,411	
Grade 2 Veneer	\$22,260	\$22,441	\$22,697	\$24,114	

6 TAPS

HS1860R26	Finish	Flat Wood Edge	Bullnose Wood Edge	Beveled Wood Edge, Tapered Wood Edge	Horizon Wood Edge
Grade 1 Laminate	\$20,903	\$21,084	\$21,340	\$22,757	
Grade 2 Laminate	\$21,228	\$21,409	\$21,665	\$23,082	
Grade 1 Veneer	\$23,653	\$23,834	\$24,090	\$25,507	
Grade 2 Veneer	\$25,356	\$25,537	\$25,793	\$27,210	

▶ Specification Information, continued on next page

Host Collection

Rectangular Tables with Three Bases
DESIGN F/P DESIGN AND VECTA DESIGN TEAM

SIN 711.11

Tip: Prices shown include top, TAP(s), and slim bases.
▶ See base options for flared bases, page 174



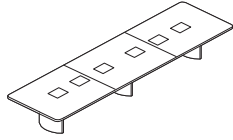
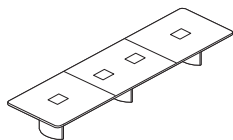
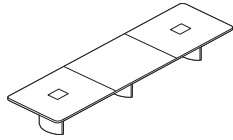
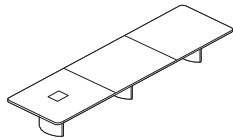
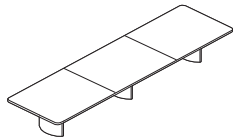

Tip: Last digit of style number indicates number of TAP(s).

Tip: For tech corridor, 18'L tables have eight long doors and four short doors.



▶ Specification Information, continued from previous page

Specification Information

Style Number	Finish	Base Prices			
					
		Flat Wood Edge:	Bullnose Wood Edge:	Beveled Wood Edge, Tapered Wood Edge:	Horizon Wood Edge:

18'L x 60"W Three Piece Top

0 TAP

Style Number	Finish	Flat Wood Edge	Bullnose Wood Edge	Beveled Wood Edge, Tapered Wood Edge	Horizon Wood Edge
HS1860R30	Grade 1 Laminate	\$11,983	\$12,164	\$12,420	\$13,837
	Grade 2 Laminate	\$12,308	\$12,489	\$12,745	\$14,162
	Grade 1 Veneer	\$14,733	\$14,914	\$15,170	\$16,587
	Grade 2 Veneer	\$16,436	\$16,617	\$16,873	\$18,290

1 TAP

Style Number	Finish	Flat Wood Edge	Bullnose Wood Edge	Beveled Wood Edge, Tapered Wood Edge	Horizon Wood Edge
HS1860R31	Grade 1 Laminate	\$13,532	\$13,713	\$13,969	\$15,386
	Grade 2 Laminate	\$13,857	\$14,038	\$14,294	\$15,711
	Grade 1 Veneer	\$16,282	\$16,463	\$16,719	\$18,136
	Grade 2 Veneer	\$17,985	\$18,166	\$18,422	\$19,839

2 TAPS

Style Number	Finish	Flat Wood Edge	Bullnose Wood Edge	Beveled Wood Edge, Tapered Wood Edge	Horizon Wood Edge
HS1860R32	Grade 1 Laminate	\$15,080	\$15,261	\$15,517	\$16,934
	Grade 2 Laminate	\$15,405	\$15,586	\$15,842	\$17,259
	Grade 1 Veneer	\$17,830	\$18,011	\$18,267	\$19,684
	Grade 2 Veneer	\$19,533	\$19,714	\$19,970	\$21,387

4 TAPS

Style Number	Finish	Flat Wood Edge	Bullnose Wood Edge	Beveled Wood Edge, Tapered Wood Edge	Horizon Wood Edge
HS1860R34	Grade 1 Laminate	\$18,178	\$18,359	\$18,615	\$20,032
	Grade 2 Laminate	\$18,503	\$18,684	\$18,940	\$20,357
	Grade 1 Veneer	\$20,928	\$21,109	\$21,365	\$22,782
	Grade 2 Veneer	\$22,631	\$22,812	\$23,068	\$24,485

6 TAPS

Style Number	Finish	Flat Wood Edge	Bullnose Wood Edge	Beveled Wood Edge, Tapered Wood Edge	Horizon Wood Edge
HS1860R36	Grade 1 Laminate	\$21,275	\$21,456	\$21,712	\$23,129
	Grade 2 Laminate	\$21,600	\$21,781	\$22,037	\$23,454
	Grade 1 Veneer	\$24,025	\$24,206	\$24,462	\$25,879
	Grade 2 Veneer	\$25,728	\$25,909	\$26,165	\$27,582

▶ Specification Information, continued on next page

Host Collection

Rectangular Tables with Three Bases *continued*
 DESIGN F/P DESIGN AND VECTA DESIGN TEAM

SIN 711.11





Tip: Prices shown include top, TAP(s), and slim bases.
 ▶ See base options for flared bases, page 174

Tip: Last digit of style number indicates number of TAP(s).

Tip: For tech corridor, 20'L tables have eight long doors and four short doors.

▶ Specification Information, continued from previous page

Specification Information

Style Number	Finish	Base Prices			
					
		Flat Wood Edge:	Bullnose Wood Edge:	Beveled Wood Edge, Tapered Wood Edge:	Horizon Wood Edge:

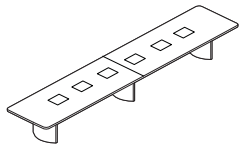
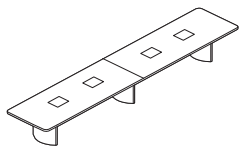
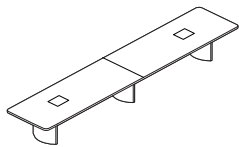
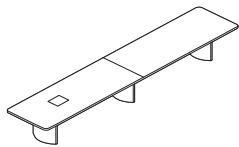
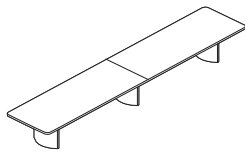

20'L x 48"W Two Piece Top

0 TAP

Style Number	Finish	Flat Wood Edge	Bullnose Wood Edge	Beveled Wood Edge, Tapered Wood Edge	Horizon Wood Edge
HS2048R20	Grade 1 Laminate	\$11,786	\$11,977	\$12,241	\$13,673
	Grade 2 Laminate	\$12,074	\$12,265	\$12,529	\$13,961
	Grade 1 Veneer	\$13,208	\$13,399	\$13,663	\$15,095
	Grade 2 Veneer	\$14,690	\$14,881	\$15,145	\$16,577

1 TAP

Style Number	Finish	Flat Wood Edge	Bullnose Wood Edge	Beveled Wood Edge, Tapered Wood Edge	Horizon Wood Edge
HS2048R21	Grade 1 Laminate	\$13,335	\$13,526	\$13,790	\$15,222
	Grade 2 Laminate	\$13,623	\$13,814	\$14,078	\$15,510
	Grade 1 Veneer	\$14,757	\$14,948	\$15,212	\$16,644
	Grade 2 Veneer	\$16,239	\$16,430	\$16,694	\$18,126

2 TAPS

Style Number	Finish	Flat Wood Edge	Bullnose Wood Edge	Beveled Wood Edge, Tapered Wood Edge	Horizon Wood Edge
HS2048R22	Grade 1 Laminate	\$14,883	\$15,074	\$15,338	\$16,770
	Grade 2 Laminate	\$15,171	\$15,362	\$15,626	\$17,058
	Grade 1 Veneer	\$16,305	\$16,496	\$16,760	\$18,192
	Grade 2 Veneer	\$17,787	\$17,978	\$18,242	\$19,674

4 TAPS

Style Number	Finish	Flat Wood Edge	Bullnose Wood Edge	Beveled Wood Edge, Tapered Wood Edge	Horizon Wood Edge
HS2048R24	Grade 1 Laminate	\$17,981	\$18,172	\$18,436	\$19,868
	Grade 2 Laminate	\$18,269	\$18,460	\$18,724	\$20,156
	Grade 1 Veneer	\$19,403	\$19,594	\$19,858	\$21,290
	Grade 2 Veneer	\$20,885	\$21,076	\$21,340	\$22,772

6 TAPS

Style Number	Finish	Flat Wood Edge	Bullnose Wood Edge	Beveled Wood Edge, Tapered Wood Edge	Horizon Wood Edge
HS2048R26	Grade 1 Laminate	\$21,077	\$21,268	\$21,532	\$22,964
	Grade 2 Laminate	\$21,365	\$21,556	\$21,820	\$23,252
	Grade 1 Veneer	\$22,499	\$22,690	\$22,954	\$24,386
	Grade 2 Veneer	\$23,981	\$24,172	\$24,436	\$25,868

▶ Specification Information, continued on next page

Host Collection

Rectangular Tables with Three Bases
DESIGN F/P DESIGN AND VECTA DESIGN TEAM

SIN 711.11





Tip: Prices shown include top, TAP(s), and slim bases.
▶ See base options for flared bases, page 174

Tip: Last digit of style number indicates number of TAP(s).

Tip: For tech corridor, 20'L tables have eight long doors and four short doors.

▶ Specification Information, continued from previous page

Specification Information

Style Number	Finish	Base Prices			
					
		Flat Wood Edge:	Bullnose Wood Edge:	Beveled Wood Edge, Tapered Wood Edge:	Horizon Wood Edge:

20'L x 48"W Three Piece Top

0 TAP

HS2048R30	Grade 1 Laminate	\$12,156	\$12,347	\$12,611	\$14,043
	Grade 2 Laminate	\$12,444	\$12,635	\$12,899	\$14,331
	Grade 1 Veneer	\$13,578	\$13,769	\$14,033	\$15,465
	Grade 2 Veneer	\$15,060	\$15,251	\$15,515	\$16,947

1 TAP

HS2048R31	Grade 1 Laminate	\$13,705	\$13,896	\$14,160	\$15,592
	Grade 2 Laminate	\$13,993	\$14,184	\$14,448	\$15,880
	Grade 1 Veneer	\$15,127	\$15,318	\$15,582	\$17,014
	Grade 2 Veneer	\$16,609	\$16,800	\$17,064	\$18,496

2 TAPS

HS2048R32	Grade 1 Laminate	\$15,254	\$15,445	\$15,709	\$17,141
	Grade 2 Laminate	\$15,542	\$15,733	\$15,997	\$17,429
	Grade 1 Veneer	\$16,676	\$16,867	\$17,131	\$18,563
	Grade 2 Veneer	\$18,158	\$18,349	\$18,613	\$20,045

4 TAPS

HS2048R34	Grade 1 Laminate	\$18,352	\$18,543	\$18,807	\$20,239
	Grade 2 Laminate	\$18,640	\$18,831	\$19,095	\$20,527
	Grade 1 Veneer	\$19,774	\$19,965	\$20,229	\$21,661
	Grade 2 Veneer	\$21,256	\$21,447	\$21,711	\$23,143

6 TAPS

HS2048R36	Grade 1 Laminate	\$21,448	\$21,639	\$21,903	\$23,335
	Grade 2 Laminate	\$21,736	\$21,927	\$22,191	\$23,623
	Grade 1 Veneer	\$22,870	\$23,061	\$23,325	\$24,757
	Grade 2 Veneer	\$24,352	\$24,543	\$24,807	\$26,239

▶ Specification Information, continued on next page

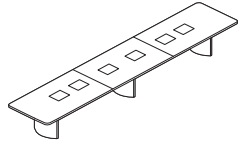
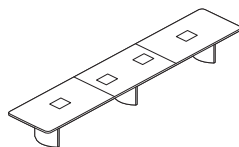
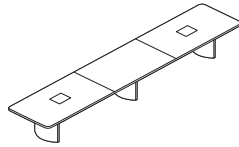
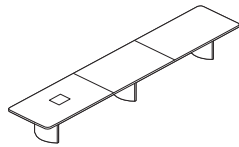
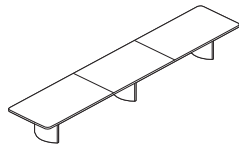

Host Collection

Rectangular Tables with Three Bases *continued*
 DESIGN F/P DESIGN AND VECTA DESIGN TEAM

SIN 711.11





Tip: Prices shown include top, TAP(s), and slim bases.
 ▶ See base options for flared bases, page 174

Tip: Last digit of style number indicates number of TAP(s).

Tip: For tech corridor, 20'L tables have eight long doors and four short doors.

▶ Specification Information, continued from previous page

Specification Information

Style Number	Finish	Base Prices			
					
		Flat Wood Edge:	Bullnose Wood Edge:	Beveled Wood Edge, Tapered Wood Edge:	Horizon Wood Edge:

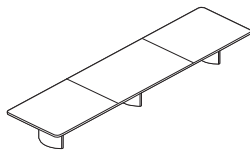

20'L x 60"W Two Piece Top

0 TAP

Style Number	Finish	Flat Wood Edge	Bullnose Wood Edge	Beveled Wood Edge, Tapered Wood Edge	Horizon Wood Edge
HS2060R20	Grade 1 Laminate	\$12,032	\$12,231	\$12,506	\$13,949
	Grade 2 Laminate	\$12,393	\$12,592	\$12,867	\$14,310
	Grade 1 Veneer	\$14,779	\$14,978	\$15,253	\$16,696
	Grade 2 Veneer	\$16,660	\$16,859	\$17,134	\$18,577

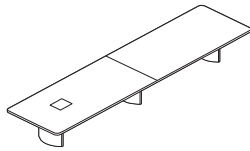

1 TAP

Style Number	Finish	Flat Wood Edge	Bullnose Wood Edge	Beveled Wood Edge, Tapered Wood Edge	Horizon Wood Edge
HS2060R21	Grade 1 Laminate	\$13,579	\$13,778	\$14,053	\$15,496
	Grade 2 Laminate	\$13,940	\$14,139	\$14,414	\$15,857
	Grade 1 Veneer	\$16,326	\$16,525	\$16,800	\$18,243
	Grade 2 Veneer	\$18,207	\$18,406	\$18,681	\$20,124

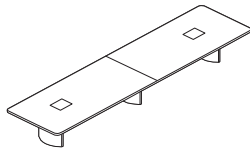

2 TAPS

Style Number	Finish	Flat Wood Edge	Bullnose Wood Edge	Beveled Wood Edge, Tapered Wood Edge	Horizon Wood Edge
HS2060R22	Grade 1 Laminate	\$15,129	\$15,328	\$15,603	\$17,046
	Grade 2 Laminate	\$15,490	\$15,689	\$15,964	\$17,407
	Grade 1 Veneer	\$17,876	\$18,075	\$18,350	\$19,793
	Grade 2 Veneer	\$19,757	\$19,956	\$20,231	\$21,674

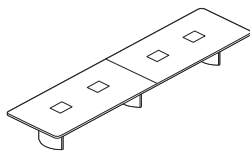

4 TAPS

Style Number	Finish	Flat Wood Edge	Bullnose Wood Edge	Beveled Wood Edge, Tapered Wood Edge	Horizon Wood Edge
HS2060R24	Grade 1 Laminate	\$18,224	\$18,423	\$18,698	\$20,141
	Grade 2 Laminate	\$18,585	\$18,784	\$19,059	\$20,502
	Grade 1 Veneer	\$20,971	\$21,170	\$21,445	\$22,888
	Grade 2 Veneer	\$22,852	\$23,051	\$23,326	\$24,769

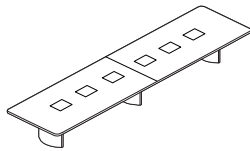

6 TAPS

Style Number	Finish	Flat Wood Edge	Bullnose Wood Edge	Beveled Wood Edge, Tapered Wood Edge	Horizon Wood Edge
HS2060R26	Grade 1 Laminate	\$21,321	\$21,520	\$21,795	\$23,238
	Grade 2 Laminate	\$21,682	\$21,881	\$22,156	\$23,599
	Grade 1 Veneer	\$24,068	\$24,267	\$24,542	\$25,985
	Grade 2 Veneer	\$25,949	\$26,148	\$26,423	\$27,866

▶ Specification Information, continued on next page

Host Collection

Rectangular Tables with Three Bases
DESIGN F/P DESIGN AND VECTA DESIGN TEAM

SIN 711.11





Tip: Prices shown include top, TAP(s), and slim bases.
▶ See base options for flared bases, page 174

Tip: Last digit of style number indicates number of TAP(s).

Tip: For tech corridor, 20'L tables have eight long doors and four short doors.

▶ Specification Information, continued from previous page

Specification Information

Style Number	Finish	Base Prices			
					
		Flat Wood Edge:	Bullnose Wood Edge:	Beveled Wood Edge, Tapered Wood Edge:	Horizon Wood Edge:

20'L x 60"W Three Piece Top

0 TAP

HS2060R30	Grade 1 Laminate	\$12,401	\$12,600	\$12,875	\$14,318
	Grade 2 Laminate	\$12,762	\$12,961	\$13,236	\$14,679
	Grade 1 Veneer	\$15,148	\$15,347	\$15,622	\$17,065
	Grade 2 Veneer	\$17,029	\$17,228	\$17,503	\$18,946

1 TAP

HS2060R31	Grade 1 Laminate	\$13,949	\$14,148	\$14,423	\$15,866
	Grade 2 Laminate	\$14,310	\$14,509	\$14,784	\$16,227
	Grade 1 Veneer	\$16,696	\$16,895	\$17,170	\$18,613
	Grade 2 Veneer	\$18,577	\$18,776	\$19,051	\$20,494

2 TAPS

HS2060R32	Grade 1 Laminate	\$15,499	\$15,698	\$15,973	\$17,416
	Grade 2 Laminate	\$15,860	\$16,059	\$16,334	\$17,777
	Grade 1 Veneer	\$18,246	\$18,445	\$18,720	\$20,163
	Grade 2 Veneer	\$20,127	\$20,326	\$20,601	\$22,044

4 TAPS

HS2060R34	Grade 1 Laminate	\$18,596	\$18,795	\$19,070	\$20,513
	Grade 2 Laminate	\$18,957	\$19,156	\$19,431	\$20,874
	Grade 1 Veneer	\$21,343	\$21,542	\$21,817	\$23,260
	Grade 2 Veneer	\$23,224	\$23,423	\$23,698	\$25,141

6 TAPS

HS2060R36	Grade 1 Laminate	\$21,692	\$21,891	\$22,166	\$23,609
	Grade 2 Laminate	\$22,053	\$22,252	\$22,527	\$23,970
	Grade 1 Veneer	\$24,439	\$24,638	\$24,913	\$26,356
	Grade 2 Veneer	\$26,320	\$26,519	\$26,794	\$28,237

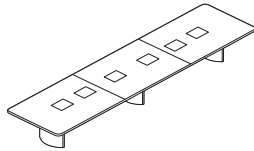
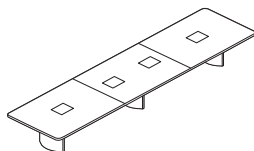
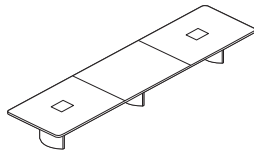
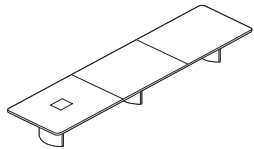
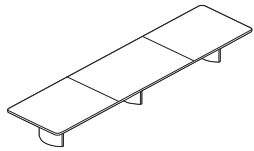

Host Collection Soft Radiused Tables with Two Bases

DESIGN F/P DESIGN AND VECTA DESIGN TEAM

SIN 711.11

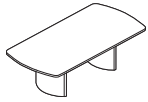

Tip: Shipped knocked down and top ships in one piece.

Tip: Grain direction for wood-grain laminate runs the length of the table.

Tip: Clips are provided with table. One clip per foot of table length.

Tip: The wood edge on a table top with woodgrain laminate may not match the top.

Tip: You must send a sample of reasonable size for Stain-to-Match.

Tip: 96"L tables available with zero, one, or two TAP(s). 10'L and 12'L tables available with zero, one, two, or three TAP(s).

Tip: In addition to the data and audio/video AAPs available from Coalesse, other styles of AAPs are available through Extron Electronics. For an Extron dealer, call 1-800-633-9876.

Tip: See TAP options for electrical systems and faceplate list.

Standard Includes	Required to Specify
<ul style="list-style-type: none"> Need help? Product details, see <i>Coalesse Tables, Storage, and Accessories Specification Guide</i> Top: 1¼" particle board core with laminate Flat wood edge TAP(s), if selected: 10"W x 12"L opening(s) trimmed with a flat solid wood profile and with brushed anodized aluminum TAP doors Tech corridor: two aluminum beams for top support provide tracks for hinged aluminum doors that clip shut: satin anodized finish Universal clip: black plastic Two 27"W bases: wood veneer on MDF with aluminum universal bracket Concealed leveling glides: non-marring, black plastic 	<ol style="list-style-type: none"> Style number Base selection (see below) and wood color number for base Laminate color number for table top, if selected Wood color number for wood edge <p>▶ See <i>Hardwood and Veneer Matrix</i>, page 364</p> <ol style="list-style-type: none"> Door color number for storage tray or TAP door, if selected: <ul style="list-style-type: none"> - 8044 Black - 8047 Silver Options, if selected (see below) <p>▶ See <i>Surface Materials</i>, page 350.</p>

Options	Price	Required to Specify
Surface Materials <ul style="list-style-type: none"> Top <ul style="list-style-type: none"> Grade 2 laminate Grade 1 wood veneer Grade 2 wood veneer Stain-to-Match 	<ul style="list-style-type: none"> Prices at right Prices at right Prices at right No cost 	<ul style="list-style-type: none"> Specify with <i>Grade 2 laminate</i> and select color number. Specify with <i>Grade 1 wood veneer</i> and select color number. Specify with <i>Grade 2 wood veneer</i> and select color number. Specify with <i>Stain-to-Match</i>. <p>▶ Page 383</p>

Edges	Wood	Price	Required to Specify
	<ul style="list-style-type: none"> Bullnose wood edge Horizon wood edge 	<ul style="list-style-type: none"> Prices at right Prices at right 	<ul style="list-style-type: none"> Specify with <i>bullnose wood edge</i>. Specify with <i>Horizon wood edge</i>.

Bases	Price	Required to Specify
<ul style="list-style-type: none"> Slim Flared 	<ul style="list-style-type: none"> Two slim bases: No cost One slim and one flared base: +\$ 807 Two flared bases: +\$1615 	<ul style="list-style-type: none"> Specify with <i>two slim bases</i>. Specify with <i>one slim base</i> and one flared base. Specify with <i>two flared bases</i>.

TAP Electrical System with Faceplate Options	Price	Required to Specify
<p>Field Wired</p> <ul style="list-style-type: none"> Field-wired tray (no electrical) - PAFW field-wired tray (no electrical) with blank AAPs - PDFW field-wired tray (no electrical) with two data AAPs - PVFW field-wired tray (no electrical) with two of each video/audio and data AAPs 	No cost	Specify with <i>power data</i> , and select TAP type and TAP door color number.
<p>Cord and Plug</p> <ul style="list-style-type: none"> Cord and plug tray (10' cord) - PACP cord and plug tray with outlets and blank AAPs - PDCP cord and plug tray with outlets and two data AAPs - PAVC cord and plug tray with outlets and two of each video/audio and data AAPs 	No cost	Specify with <i>power data</i> , and select TAP type and TAP door color number.
<p>Hardwired</p> <ul style="list-style-type: none"> Hard-wired tray (6' conduit) - PAHW hard-wired tray with outlets and blank AAPs - PDHW hard-wired tray with outlets and two data AAPs - PAVH hard-wired tray with outlets and two of each video/audio and data AAPs 	No cost	Specify with <i>power data</i> , and select TAP type and TAP door color number.

▶ Options, continued on next page

Host Collection

Soft Radiused Tables with Two Bases
DESIGN F/P DESIGN AND VECTA DESIGN TEAM

SIN 711.11

► Options, continued from previous page

Tip: For single TAP style numbers, the modular system tray is not available. Specify the hard-wired tray option.

Tip: If the specified table has multiple TAP(s), any one TAP can be replaced with a storage tray.

Tip: Wood veneer doors for storage tray and TAP will always be cross grain.

Tip: Connectrac must be the same wiring schematic as the table.

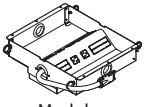
Options	Price	Required to Specify
TAP Electrical System with Faceplate Options  Modular	<ul style="list-style-type: none"> Modular system tray (hardwire base power infeed) <ul style="list-style-type: none"> - PAMH modular system tray with outlets and blank AAPs - PDMH modular system tray with outlets and two data AAPs - PVMH modular system tray with outlets and two of each video/audio and data AAPs +\$138 each tray	Specify with modular power data, and select TAP type and TAP door color number.
Storage Tray	<ul style="list-style-type: none"> Storage tray -\$579	Specify with storage tray and select door color number.
Doors	<ul style="list-style-type: none"> Storage tray wood veneer doors TAP wood veneer doors +\$291 per door +\$291 per door	Specify with wood doors. Specify with wood doors.
Related Products	<ul style="list-style-type: none"> Floor kit: Connectrac Corridor shelf 	► Page 283 ► Page 283

TAP Locations

96"L x 48"W TAP Locations—One piece top

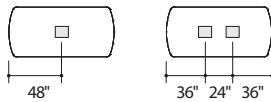

10'L x 48"W TAP Locations—One piece top

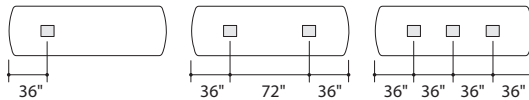

10'L x 48"W TAP Locations—Two piece top

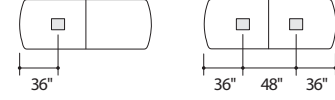

10'L x 60"W TAP Locations—One piece top

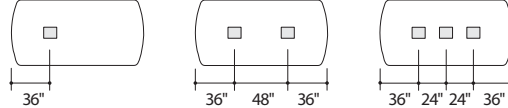

10'L x 60"W TAP Locations—Two piece top

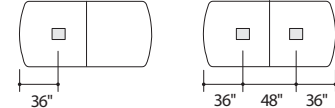

12'L x 48"W TAP Locations—One piece top

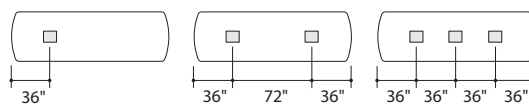

12'L x 48"W TAP Locations—Two piece top

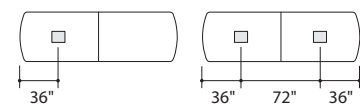

12'L x 60"W TAP Locations—One piece top

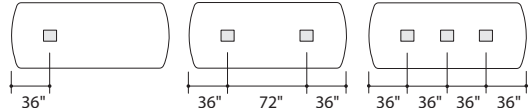

12'L x 60"W TAP Locations—Two piece top

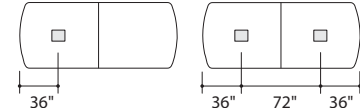

► Specification Information, on next page

Host Collection Soft Radiused Tables with Two Bases *continued*

DESIGN F/P DESIGN AND VECTA DESIGN TEAM



SIN 711.11

Tip: Prices shown include top, TAP(s), and slim bases.
 ▶ See base options for flared bases, page 194

Tip: Last digit of style number indicates number of TAP(s).

▶ Options, on previous page

Specification Information

Style Number	Finish	Base Prices		
				
		Flat Wood Edge:	Bullnose Wood Edge:	Horizon Wood Edge:

96"L x 48"W One Piece Top

0 TAP

HS9648S10	Grade 1 Laminate	\$ 6588	\$ 6686	\$ 8614
	Grade 2 Laminate	\$ 6703	\$ 6801	\$ 8729
	Grade 1 Veneer	\$ 7084	\$ 7182	\$ 9110
	Grade 2 Veneer	\$ 7672	\$ 7770	\$ 9698

1 TAP

HS9648S11	Grade 1 Laminate	\$ 8135	\$ 8233	\$10,161
	Grade 2 Laminate	\$ 8250	\$ 8348	\$10,276
	Grade 1 Veneer	\$ 8631	\$ 8729	\$10,657
	Grade 2 Veneer	\$ 9219	\$ 9317	\$11,245

2 TAPS

HS9648S12	Grade 1 Laminate	\$ 9683	\$ 9781	\$11,708
	Grade 2 Laminate	\$ 9798	\$ 9896	\$11,823
	Grade 1 Veneer	\$10,179	\$10,277	\$12,204
	Grade 2 Veneer	\$10,767	\$10,865	\$12,792

▶ Specification Information, continued on next page



Tip: For tech corridor, 96"L tables have two long doors and four short doors.

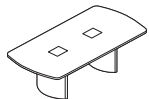

Host Collection

Soft Radiused Tables with Two Bases
DESIGN F/P DESIGN AND VECTA DESIGN TEAM



SIN 711.11

Tip: Prices shown include top, TAP(s), and slim bases.
▶ See base options for flared bases, page 194

Tip: Last digit of style number indicates number of TAP(s).

▶ Specification Information, continued from previous page

Specification Information

Style Number	Finish	Base Prices		
				
		Flat Wood Edge:	Bullnose Wood Edge:	Horizon Wood Edge:

10'L x 48"W One Piece Top

0 TAP

HS1048S10	Grade 1 Laminate	\$ 7107	\$ 7220	\$ 9285
	Grade 2 Laminate	\$ 7253	\$ 7366	\$ 9431
	Grade 1 Veneer	\$ 7711	\$ 7824	\$ 9889
	Grade 2 Veneer	\$ 8446	\$ 8559	\$10,624

1 TAP

HS1048S11	Grade 1 Laminate	\$ 8655	\$ 8768	\$10,833
	Grade 2 Laminate	\$ 8801	\$ 8914	\$10,979
	Grade 1 Veneer	\$ 9259	\$ 9372	\$11,437
	Grade 2 Veneer	\$ 9994	\$10,107	\$12,172

2 TAPS

HS1048S12	Grade 1 Laminate	\$10,203	\$10,316	\$12,381
	Grade 2 Laminate	\$10,349	\$10,462	\$12,527
	Grade 1 Veneer	\$10,807	\$10,920	\$12,985
	Grade 2 Veneer	\$11,542	\$11,655	\$13,720

3 TAPS

HS1048S13	Grade 1 Laminate	\$11,752	\$11,865	\$13,930
	Grade 2 Laminate	\$11,898	\$12,011	\$14,076
	Grade 1 Veneer	\$12,356	\$12,469	\$14,534
	Grade 2 Veneer	\$13,091	\$13,204	\$15,269

▶ Specification Information, continued on next page

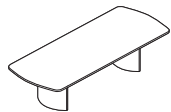

Tip: For tech corridor, 10'L tables have four long doors and four short doors.

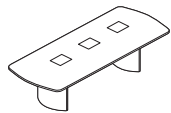
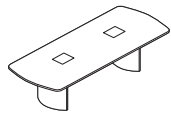
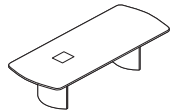

Host Collection

Soft Radiused Tables with Two Bases *continued*
 DESIGN F/P DESIGN AND VECTA DESIGN TEAM



SIN 711.11

Tip: Prices shown include top, TAP(s), and slim bases.
 ▶ See base options for flared bases, page 194

Tip: Last digit of style number indicates number of TAP(s).

▶ Specification Information, continued from previous page

Specification Information

Style Number	Finish	Base Prices		
				
		Flat Wood Edge:	Bullnose Wood Edge:	Horizon Wood Edge:

10'L x 48"W Two Piece Top

0 TAP

HS1048S20	Grade 1 Laminate	\$ 7478	\$ 7591	\$ 9656
	Grade 2 Laminate	\$ 7624	\$ 7737	\$ 9802
	Grade 1 Veneer	\$ 8082	\$ 8195	\$10,260
	Grade 2 Veneer	\$ 8817	\$ 8930	\$10,995

1 TAP

HS1048S21	Grade 1 Laminate	\$ 9026	\$ 9139	\$11,204
	Grade 2 Laminate	\$ 9172	\$ 9285	\$11,350
	Grade 1 Veneer	\$ 9630	\$ 9743	\$11,808
	Grade 2 Veneer	\$10,365	\$10,478	\$12,543

2 TAPS

HS1048S22	Grade 1 Laminate	\$10,574	\$10,687	\$12,752
	Grade 2 Laminate	\$10,720	\$10,833	\$12,898
	Grade 1 Veneer	\$11,178	\$11,291	\$13,356
	Grade 2 Veneer	\$11,913	\$12,026	\$14,091

10'L x 60"W One Piece Top

0 TAP

HS1060S10	Grade 1 Laminate	\$ 7299	\$ 7420	\$ 9500
	Grade 2 Laminate	\$ 7478	\$ 7599	\$ 9679
	Grade 1 Veneer	\$ 8362	\$ 8483	\$10,563
	Grade 2 Veneer	\$ 9293	\$ 9414	\$11,494

1 TAP

HS1060S11	Grade 1 Laminate	\$ 8848	\$ 8969	\$11,049
	Grade 2 Laminate	\$ 9027	\$ 9148	\$11,228
	Grade 1 Veneer	\$ 9911	\$10,032	\$12,112
	Grade 2 Veneer	\$10,842	\$10,963	\$13,043

2 TAPS

HS1060S12	Grade 1 Laminate	\$10,396	\$10,517	\$12,597
	Grade 2 Laminate	\$10,575	\$10,696	\$12,776
	Grade 1 Veneer	\$11,459	\$11,580	\$13,660
	Grade 2 Veneer	\$12,390	\$12,511	\$14,591

▶ Specification Information, continued on next page

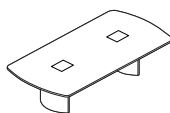
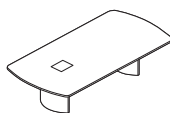
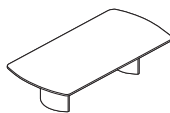
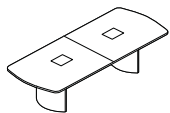
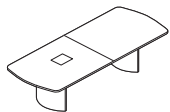
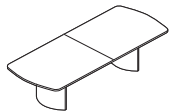

Host Collection

Soft Radiused Tables with Two Bases
DESIGN F/P DESIGN AND VECTA DESIGN TEAM



SIN 711.11

Tip: Prices shown include top, TAP(s), and slim bases.
▶ See base options for flared bases, page 194

Tip: Last digit of style number indicates number of TAP(s).

▶ Specification Information, continued from previous page

Specification Information

Style Number	Finish	Base Prices		
				
		Flat Wood Edge:	Bullnose Wood Edge:	Horizon Wood Edge:

10'L x 60"W One Piece Top, continued

3 TAPS

HS1060S13	Grade 1 Laminate	\$11,946	\$12,067	\$14,147
	Grade 2 Laminate	\$12,125	\$12,246	\$14,326
	Grade 1 Veneer	\$13,009	\$13,130	\$15,210
	Grade 2 Veneer	\$13,940	\$14,061	\$16,141

10'L x 60"W Two Piece Top

0 TAP

HS1060S20	Grade 1 Laminate	\$ 7670	\$ 7791	\$ 9871
	Grade 2 Laminate	\$ 7849	\$ 7970	\$10,050
	Grade 1 Veneer	\$ 8733	\$ 8854	\$10,934
	Grade 2 Veneer	\$ 9664	\$ 9785	\$11,865

1 TAP

HS1060S21	Grade 1 Laminate	\$ 9219	\$ 9340	\$11,420
	Grade 2 Laminate	\$ 9398	\$ 9519	\$11,599
	Grade 1 Veneer	\$10,282	\$10,403	\$12,483
	Grade 2 Veneer	\$11,213	\$11,334	\$13,414

2 TAPS

HS1060S22	Grade 1 Laminate	\$10,768	\$10,889	\$12,969
	Grade 2 Laminate	\$10,947	\$11,068	\$13,148
	Grade 1 Veneer	\$11,831	\$11,952	\$14,032
	Grade 2 Veneer	\$12,762	\$12,883	\$14,963

12'L x 48"W One Piece Top

0 TAP

HS1248S10	Grade 1 Laminate	\$ 7570	\$ 7698	\$ 9787
	Grade 2 Laminate	\$ 7743	\$ 7871	\$ 9960
	Grade 1 Veneer	\$ 8367	\$ 8495	\$10,584
	Grade 2 Veneer	\$ 9255	\$ 9383	\$11,472

1 TAP

HS1248S11	Grade 1 Laminate	\$ 9118	\$ 9246	\$11,335
	Grade 2 Laminate	\$ 9291	\$ 9419	\$11,508
	Grade 1 Veneer	\$ 9915	\$10,043	\$12,132
	Grade 2 Veneer	\$10,803	\$10,931	\$13,020

▶ Specification Information, continued on next page

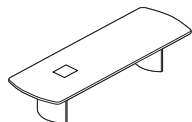
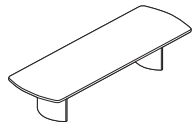
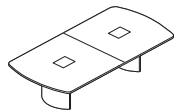
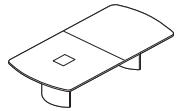
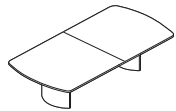
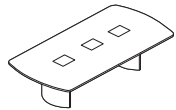

Host Collection Soft Radiused Tables with Two Bases *continued*

DESIGN F/P DESIGN AND VECTA DESIGN TEAM

SIN 711.11

Tip: Prices shown include top, TAP(s), and slim bases.
 ▶ See base options for flared bases, page 194

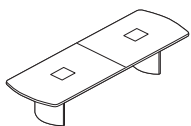
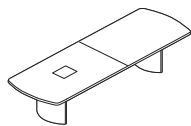
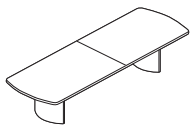
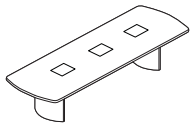
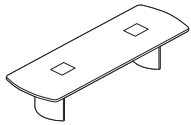

Tip: Last digit of style number indicates number of TAP(s).

Tip: For tech corridor, 12'L tables have four long doors and four short doors.



▶ Specification Information, continued from previous page

Specification Information

Style Number	Finish	Base Prices		
				
		Flat Wood Edge:	Bullnose Wood Edge:	Horizon Wood Edge:

12'L x 48" W One Piece Top, continued

2 TAPS

Style Number	Finish	Flat Wood Edge	Bullnose Wood Edge	Horizon Wood Edge
HS1248S12	Grade 1 Laminate	\$10,666	\$10,794	\$12,883
	Grade 2 Laminate	\$10,839	\$10,967	\$13,056
	Grade 1 Veneer	\$11,463	\$11,591	\$13,680
	Grade 2 Veneer	\$12,351	\$12,479	\$14,568

3 TAPS

Style Number	Finish	Flat Wood Edge	Bullnose Wood Edge	Horizon Wood Edge
HS1248S13	Grade 1 Laminate	\$12,216	\$12,344	\$14,433
	Grade 2 Laminate	\$12,389	\$12,517	\$14,606
	Grade 1 Veneer	\$13,013	\$13,141	\$15,230
	Grade 2 Veneer	\$13,901	\$14,029	\$16,118

12'L x 48" W Two Piece Top

0 TAP

Style Number	Finish	Flat Wood Edge	Bullnose Wood Edge	Horizon Wood Edge
HS1248S20	Grade 1 Laminate	\$ 7939	\$ 8067	\$10,156
	Grade 2 Laminate	\$ 8112	\$ 8240	\$10,329
	Grade 1 Veneer	\$ 8736	\$ 8864	\$10,953
	Grade 2 Veneer	\$ 9624	\$ 9752	\$11,841

1 TAP

Style Number	Finish	Flat Wood Edge	Bullnose Wood Edge	Horizon Wood Edge
HS1248S21	Grade 1 Laminate	\$ 9490	\$ 9618	\$11,707
	Grade 2 Laminate	\$ 9663	\$ 9791	\$11,880
	Grade 1 Veneer	\$10,287	\$10,415	\$12,504
	Grade 2 Veneer	\$11,175	\$11,303	\$13,392

2 TAPS

Style Number	Finish	Flat Wood Edge	Bullnose Wood Edge	Horizon Wood Edge
HS1248S22	Grade 1 Laminate	\$11,037	\$11,165	\$13,254
	Grade 2 Laminate	\$11,210	\$11,338	\$13,427
	Grade 1 Veneer	\$11,834	\$11,962	\$14,051
	Grade 2 Veneer	\$12,722	\$12,850	\$14,939

▶ Specification Information, continued on next page

Host Collection

Soft Radiused Tables with Two Bases
DESIGN F/P DESIGN AND VECTA DESIGN TEAM



SIN 711.11

Tip: Prices shown include top, TAP(s), and slim bases.
▶ See base options for flared bases, page 194

Tip: Last digit of style number indicates number of TAP(s).

▶ Specification Information, continued from previous page

Specification Information

Style Number	Finish	Base Prices		
				
		Flat Wood Edge:	Bullnose Wood Edge:	Horizon Wood Edge:

12'L x 60"W One Piece Top

0 TAP

HS1260S10	Grade 1 Laminate	\$ 7771	\$ 7906	\$10,012
	Grade 2 Laminate	\$ 7987	\$ 8122	\$10,228
	Grade 1 Veneer	\$ 9078	\$ 9213	\$11,319
	Grade 2 Veneer	\$10,195	\$10,330	\$12,436

1 TAP

HS1260S11	Grade 1 Laminate	\$ 9321	\$ 9456	\$11,562
	Grade 2 Laminate	\$ 9537	\$ 9672	\$11,778
	Grade 1 Veneer	\$10,628	\$10,763	\$12,869
	Grade 2 Veneer	\$11,745	\$11,880	\$13,986

2 TAPS

HS1260S12	Grade 1 Laminate	\$10,868	\$11,003	\$13,109
	Grade 2 Laminate	\$11,084	\$11,219	\$13,325
	Grade 1 Veneer	\$12,175	\$12,310	\$14,416
	Grade 2 Veneer	\$13,292	\$13,427	\$15,533

3 TAPS

HS1260S13	Grade 1 Laminate	\$12,417	\$12,552	\$14,658
	Grade 2 Laminate	\$12,633	\$12,768	\$14,874
	Grade 1 Veneer	\$13,724	\$13,859	\$15,965
	Grade 2 Veneer	\$14,841	\$14,976	\$17,082

▶ Specification Information, continued on next page

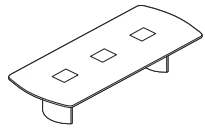
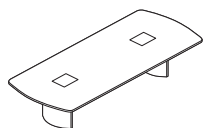
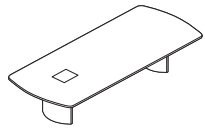
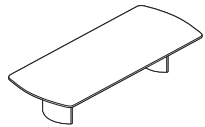

Host Collection

Soft Radiused Tables with Two Bases *continued*
 DESIGN F/P DESIGN AND VECTA DESIGN TEAM



SIN 711.11

Tip: Prices shown include top, TAP(s), and slim bases.
 ▶ See base options for flared bases, page 194

Tip: Last digit of style number indicates number of TAP(s).

▶ Specification Information, continued from previous page

Specification Information

Style Number	Finish	Base Prices		
				
		Flat Wood Edge:	Bullnose Wood Edge:	Horizon Wood Edge:

12'L x 60"W Two Piece Top

0 TAP

HS1260S20	Grade 1 Laminate	\$ 8141	\$ 8276	\$10,382
	Grade 2 Laminate	\$ 8357	\$ 8492	\$10,598
	Grade 1 Veneer	\$ 9448	\$ 9583	\$11,689
	Grade 2 Veneer	\$10,565	\$10,700	\$12,806

1 TAP

HS1260S21	Grade 1 Laminate	\$ 9690	\$ 9825	\$11,931
	Grade 2 Laminate	\$ 9906	\$10,041	\$12,147
	Grade 1 Veneer	\$10,997	\$11,132	\$13,238
	Grade 2 Veneer	\$12,114	\$12,249	\$14,355

2 TAPS

HS1260S22	Grade 1 Laminate	\$11,239	\$11,374	\$13,480
	Grade 2 Laminate	\$11,455	\$11,590	\$13,696
	Grade 1 Veneer	\$12,546	\$12,681	\$14,787
	Grade 2 Veneer	\$13,663	\$13,798	\$15,904

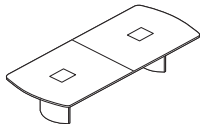
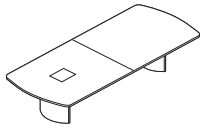
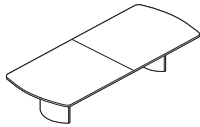

Coalesse

Host Collection

Soft Radiused Tables with Two Bases
DESIGN F/P DESIGN AND VECTA DESIGN TEAM

SIN 711.11

Host Collection

Soft Radiused Tables with Three Bases
 DESIGN F/P DESIGN AND VECTA DESIGN TEAM

SIN 711.11

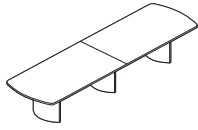

Tip: Shipped knocked down and top ships in one piece.

Tip: Grain direction for wood-grain laminate runs the length of the table.

Tip: Clips are provided with table. One clip per foot of table length.

Tip: The wood edge on a table top with woodgrain laminate may not match the top.

Tip: You must send a sample of reasonable size for Stain-to-Match.

Tip: 14'L and 16'L tables available with zero, one, two, or four TAP(s). 18'L and 20'L tables available with zero, one, two, four, or six TAP(s).

Tip: In addition to the data and audio/video AAPs available from Coalesse, other styles of AAPs are available through Extron Electronics. For an Extron dealer, call 1-800-633-9876.

Tip: See TAP options for electrical systems and faceplate list.

Veneer direction



Standard Includes	Required to Specify
<ul style="list-style-type: none"> ▶ Need help? Product details, see <i>Coalesse Tables, Storage, and Accessories Specification Guide</i> • Top: 1¼" particle board core with laminate • Flat wood edge • TAP(s), if selected: 10"W x 12"L opening(s) trimmed with a flat solid wood profile and with brushed anodized aluminum TAP doors • Tech corridor: four aluminum beams for top support provide tracks for hinged aluminum doors that clip shut: satin anodized finish • Universal clip: black plastic • Three 27"W bases: wood veneer on MDF with aluminum universal bracket, see below • Concealed leveling glides: non-marring, black plastic 	<ol style="list-style-type: none"> 1 Style number 2 Base selection (see below) and wood color number for base 3 Laminate color number for table top, if selected 4 Wood color number for wood edge <ul style="list-style-type: none"> ▶ See <i>Veneer Matrix</i>, page 365 5 Door color number for storage tray or TAP door, if selected: <ul style="list-style-type: none"> - 8044 Black - 8047 Silver 6 Options, if selected (see below) <ul style="list-style-type: none"> ▶ See <i>Surface Materials</i>, page 350.

Options	Price	Required to Specify
Surface Materials <ul style="list-style-type: none"> • Top <ul style="list-style-type: none"> • Grade 2 laminate • Grade 1 wood veneer • Grade 2 wood veneer • Stain-to-Match 	<ul style="list-style-type: none"> Prices at right Prices at right Prices at right No cost 	<ul style="list-style-type: none"> Specify with <i>Grade 2 laminate</i> and select color number. Specify with <i>Grade 1 wood veneer</i> and select color number. Specify with <i>Grade 2 wood veneer</i> and select color number. Specify with <i>Stain-to-Match</i>. ▶ Page 383

Edges	Wood	Price	Required to Specify
	<ul style="list-style-type: none"> • Bullnose wood edge • Horizon wood edge 	<ul style="list-style-type: none"> Prices at right Prices at right 	<ul style="list-style-type: none"> Specify with <i>bullnose wood edge</i>. Specify with <i>Horizon wood edge</i>.

Bases	Price	Required to Specify
<ul style="list-style-type: none"> • Three slim bases • Two slim and one flared bases • One slim and two flared bases • Three flared bases 	<ul style="list-style-type: none"> No cost +\$ 807 +\$1615 +\$2421 	<ul style="list-style-type: none"> Specify with <i>three slim bases</i>. Specify with <i>two slim and one flared bases</i>. Specify with <i>one slim and two flared bases</i>. Specify with <i>three flared bases</i>.

TAP Electrical System with Faceplate Options	Price	Required to Specify
<ul style="list-style-type: none"> • Field-wired tray (no electrical) <ul style="list-style-type: none"> - PAFW field-wired tray (no electrical) with blank AAPs - PDFW field-wired tray (no electrical) with two data AAPs - PVFW field-wired tray (no electrical) with two of each video/audio and data AAPs 	<ul style="list-style-type: none"> No cost 	<ul style="list-style-type: none"> Specify with <i>power data</i>, and select TAP type and TAP door color number.
<ul style="list-style-type: none"> • Cord and plug tray (10' cord) <ul style="list-style-type: none"> - PACP cord and plug tray with outlets and blank AAPs - PDCP cord and plug tray with outlets and two data AAPs - PAVC cord and plug tray with outlets and two of each video/audio and data AAPs 	<ul style="list-style-type: none"> No cost 	<ul style="list-style-type: none"> Specify with <i>power data</i>, and select TAP type and TAP door color number.
<ul style="list-style-type: none"> • Hard-wired tray (6' conduit) <ul style="list-style-type: none"> - PAHW hard-wired tray with outlets and blank AAPs - PDHW hard-wired tray with outlets and two data AAPs - PAVH hard-wired tray with outlets and two of each video/audio and data AAPs 	<ul style="list-style-type: none"> No cost 	<ul style="list-style-type: none"> Specify with <i>power data</i>, and select TAP type and TAP door color number.

▶ Options, continued on next page

Host Collection

Soft Radiused Tables with Three Bases
DESIGN F/P DESIGN AND VECTA DESIGN TEAM

SIN 711.11

► Options, continued from previous page

Tip: For single TAP style numbers, the modular system tray is not available. Specify the hard-wired tray option.

Tip: If the specified table has multiple TAPs, any one TAP can be replaced with a storage tray.

Tip: Wood veneer doors for storage tray or TAP will always be cross grain.

Tip: Connectrac must be the same wiring schematic as the table.

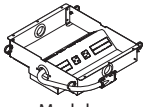
Options	Price	Required to Specify
TAP Electrical System with Faceplate Options  Modular	<ul style="list-style-type: none"> • Modular system tray (hardwire base power infeed) <ul style="list-style-type: none"> - PAMH modular system tray with outlets and blank AAPs - PDMH modular system tray with outlets and two data AAPs - PVMH modular system tray with outlets and two of each video/audio and data AAPs +\$138 each tray	Specify with <i>modular power data</i> , and select TAP type and TAP door color number.
Storage Tray	<ul style="list-style-type: none"> • Storage tray -\$579	Specify with <i>storage tray</i> and select door color number.
Doors	<ul style="list-style-type: none"> • Storage tray wood veneer doors • TAP wood veneer doors +\$291 per door +\$291 per door	Specify with <i>wood doors</i> . Specify with <i>wood doors</i> .
Related Products	<ul style="list-style-type: none"> • Floor kit: Connectrac • Corridor shelf 	► Page 283 ► Page 283

TAP Locations

14' L x 48" W TAP Locations—Two piece top

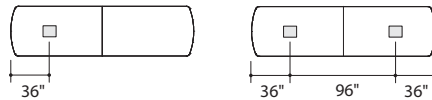

14' L x 48" W TAP Locations—Three piece top

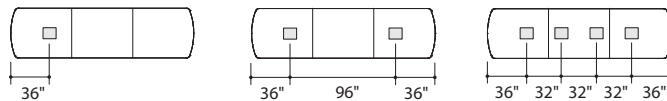

14' L x 60" W TAP Locations—Two piece top

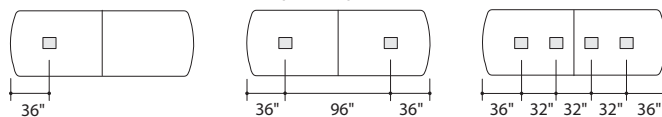

14' L x 60" W TAP Locations—Three piece top

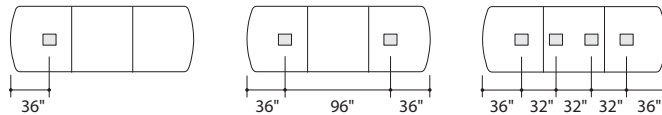

16' L x 48" W TAP Locations—Two piece top

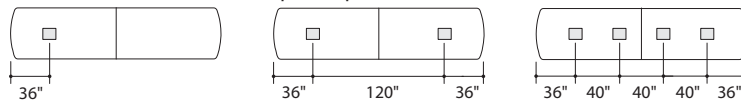

16' L x 48" W TAP Locations—Three piece top



16' L x 60" W TAP Locations—Two piece top

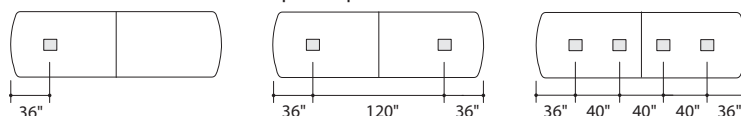

Host Collection Soft Radiused Tables with Three Bases *continued*

DESIGN F/P DESIGN AND VECTA DESIGN TEAM

SIN 711.11

►Options, continued from previous page

TAP Locations

16'L x 60"W TAP Locations—Three piece top

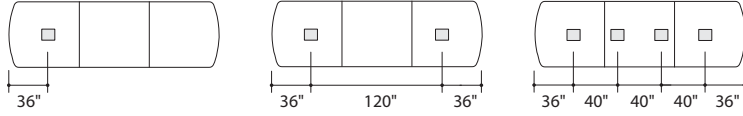

18'L x 48"W TAP Locations—Two piece top

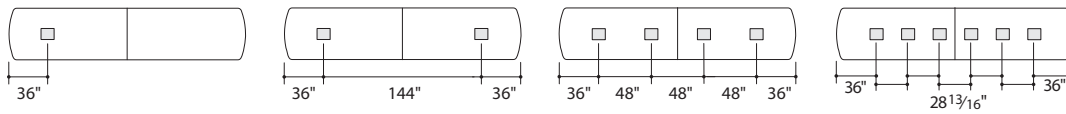

18'L x 48"W TAP Locations—Three piece top

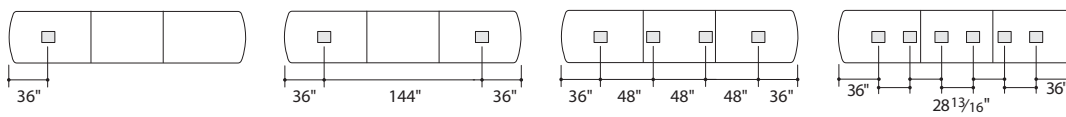

18'L x 60"W TAP Locations—Two piece top

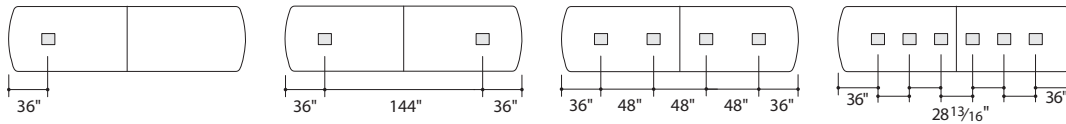

18'L x 60"W TAP Locations—Three piece top

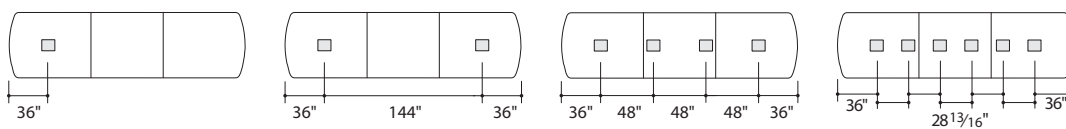

20'L x 48"W TAP Locations—Two piece top

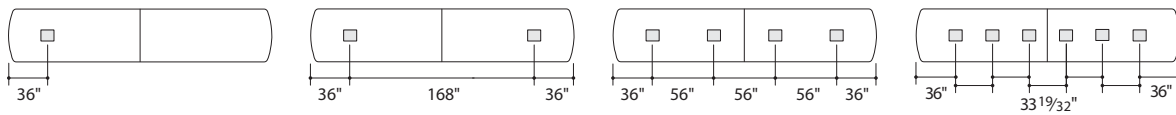

20'L x 48"W TAP Locations—Three piece top

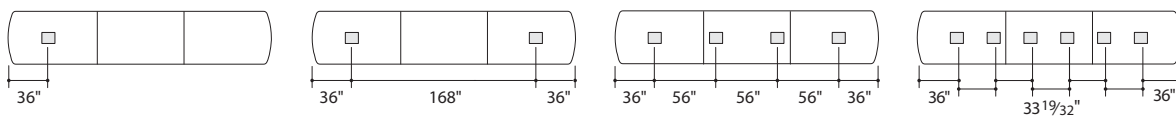

20'L x 60"W TAP Locations—Two piece top

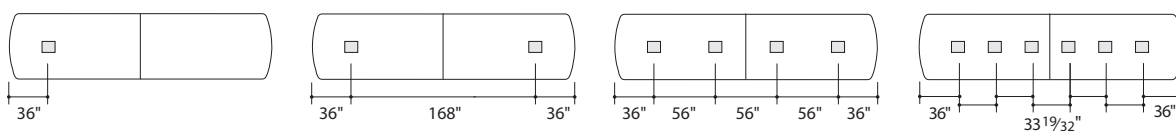

20'L x 60"W TAP Locations—Three piece top

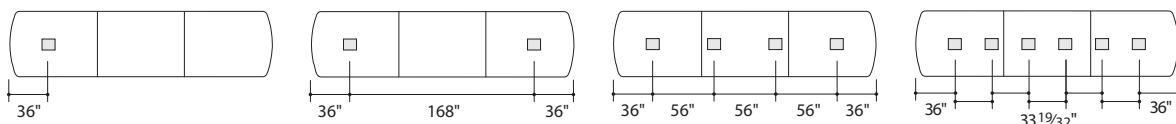

Host Collection

Soft Radiused Tables with Three Bases
DESIGN F/P DESIGN AND VECTA DESIGN TEAM

SIN 711.11



Tip: Prices shown include top, TAP(s), and slim bases.
► See base options for flared bases, page 204

Tip: Last digit of style number indicates number of TAP(s).

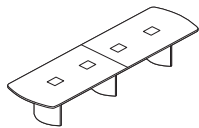
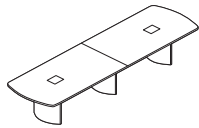
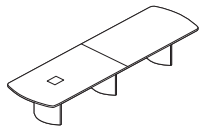
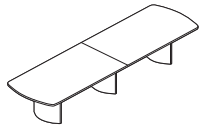
Tip: For tech corridor, 14'L tables have four long doors and four short doors.



Specification Information

Style Number	Finish	Base Prices		
				
		Flat Wood Edge:	Bullnose Wood Edge:	Horizon Wood Edge:

14'L x 48"W Two Piece Top

0 TAP				
HS1448S20	Grade 1 Laminate	\$10,282	\$10,428	\$12,539
	Grade 2 Laminate	\$10,485	\$10,631	\$12,742
	Grade 1 Veneer	\$11,403	\$11,549	\$13,660
	Grade 2 Veneer	\$12,443	\$12,589	\$14,700
1 TAP				
HS1448S21	Grade 1 Laminate	\$11,830	\$11,976	\$14,087
	Grade 2 Laminate	\$12,033	\$12,179	\$14,290
	Grade 1 Veneer	\$12,951	\$13,097	\$15,208
	Grade 2 Veneer	\$13,991	\$14,137	\$16,248
2 TAPS				
HS1448S22	Grade 1 Laminate	\$13,379	\$13,525	\$15,636
	Grade 2 Laminate	\$13,582	\$13,728	\$15,839
	Grade 1 Veneer	\$14,500	\$14,646	\$16,757
	Grade 2 Veneer	\$15,540	\$15,686	\$17,797
4 TAPS				
HS1448S24	Grade 1 Laminate	\$16,475	\$16,621	\$18,732
	Grade 2 Laminate	\$16,678	\$16,824	\$18,935
	Grade 1 Veneer	\$17,596	\$17,742	\$19,853
	Grade 2 Veneer	\$18,636	\$18,782	\$20,893

► Specification Information, continued on next page

Host Collection

Soft Radiused Tables with Three Bases *continued*
 DESIGN F/P DESIGN AND VECTA DESIGN TEAM

SIN 711.11

Tip: Prices shown include top, TAP(s), and slim bases.
 ▶ See base options for flared bases, page 204

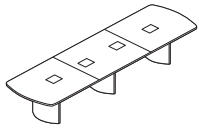
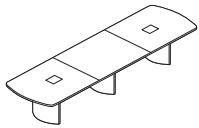
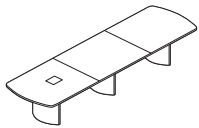
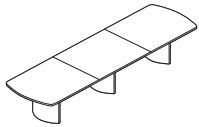

Tip: Last digit of style number indicates number of TAP(s).

Tip: For tech corridor, 14'L tables have four long doors and four short doors.



▶ Specification Information, continued from previous page

Specification Information

Style Number	Finish	Base Prices		
				
		Flat Wood Edge:	Bullnose Wood Edge:	Horizon Wood Edge:

14'L x 48"W Three Piece Top

0 TAP

HS1448S30	Grade 1 Laminate	\$10,652	\$10,798	\$12,909
	Grade 2 Laminate	\$10,855	\$11,001	\$13,112
	Grade 1 Veneer	\$11,773	\$11,919	\$14,030
	Grade 2 Veneer	\$12,813	\$12,959	\$15,070

1 TAP

HS1448S31	Grade 1 Laminate	\$12,202	\$12,348	\$14,459
	Grade 2 Laminate	\$12,405	\$12,551	\$14,662
	Grade 1 Veneer	\$13,323	\$13,469	\$15,580
	Grade 2 Veneer	\$14,363	\$14,509	\$16,620

2 TAPS

HS1448S32	Grade 1 Laminate	\$13,751	\$13,897	\$16,008
	Grade 2 Laminate	\$13,954	\$14,100	\$16,211
	Grade 1 Veneer	\$14,872	\$15,018	\$17,129
	Grade 2 Veneer	\$15,912	\$16,058	\$18,169

4 TAPS

HS1448S34	Grade 1 Laminate	\$16,846	\$16,992	\$19,103
	Grade 2 Laminate	\$17,049	\$17,195	\$19,306
	Grade 1 Veneer	\$17,967	\$18,113	\$20,224
	Grade 2 Veneer	\$19,007	\$19,153	\$21,264

▶ Specification Information, continued on next page

Host Collection

Soft Radiused Tables with Three Bases
DESIGN F/P DESIGN AND VECTA DESIGN TEAM

SIN 711.11

Tip: Prices shown include top, TAP(s), and slim bases.
▶ See base options for flared bases, page 204

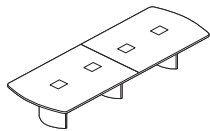
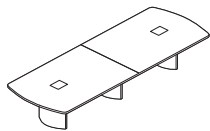
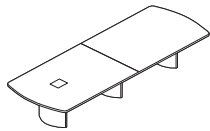
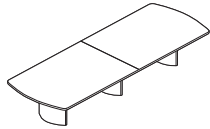

Tip: Last digit of style number indicates number of TAP(s).

Tip: For tech corridor, 14'L tables have four long doors and four short doors.



▶ Specification Information, continued from previous page

Specification Information

Style Number	Finish	Base Prices		
				
		Flat Wood Edge:	Bullnose Wood Edge:	Horizon Wood Edge:

14'L x 60"W Two Piece Top

0 TAP				
HS1460S20	Grade 1 Laminate	\$10,739	\$10,891	\$13,012
	Grade 2 Laminate	\$10,993	\$11,145	\$13,266
	Grade 1 Veneer	\$12,800	\$12,952	\$15,073
	Grade 2 Veneer	\$14,120	\$14,272	\$16,393
1 TAP				
HS1460S21	Grade 1 Laminate	\$12,289	\$12,441	\$14,562
	Grade 2 Laminate	\$12,543	\$12,695	\$14,816
	Grade 1 Veneer	\$14,350	\$14,502	\$16,623
	Grade 2 Veneer	\$15,670	\$15,822	\$17,943
2 TAPS				
HS1460S22	Grade 1 Laminate	\$13,836	\$13,988	\$16,109
	Grade 2 Laminate	\$14,090	\$14,242	\$16,363
	Grade 1 Veneer	\$15,897	\$16,049	\$18,170
	Grade 2 Veneer	\$17,217	\$17,369	\$19,490
4 TAPS				
HS1460S24	Grade 1 Laminate	\$16,934	\$17,086	\$19,207
	Grade 2 Laminate	\$17,188	\$17,340	\$19,461
	Grade 1 Veneer	\$18,995	\$19,147	\$21,268
	Grade 2 Veneer	\$20,315	\$20,467	\$22,588

▶ Specification Information, continued on next page

Host Collection

Soft Radiused Tables with Three Bases *continued*
 DESIGN F/P DESIGN AND VECTA DESIGN TEAM

SIN 711.11

Tip: Prices shown include top, TAP(s), and slim bases.
 ▶ See base options for flared bases, page 204

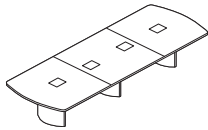
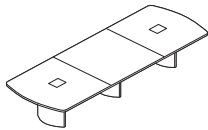
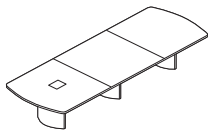
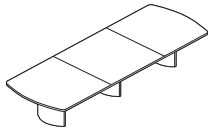

Tip: Last digit of style number indicates number of TAP(s).

Tip: For tech corridor, 14'L tables have four long doors and four short doors.



▶ Specification Information, continued from previous page

Specification Information

Style Number	Finish	Base Prices		
				
		Flat Wood Edge:	Bullnose Wood Edge:	Horizon Wood Edge:

14'L x 60"W Three Piece Top

0 TAP

HS1460S30	Grade 1 Laminate	\$11,110	\$11,262	\$13,383
	Grade 2 Laminate	\$11,364	\$11,516	\$13,637
	Grade 1 Veneer	\$13,171	\$13,323	\$15,444
	Grade 2 Veneer	\$14,491	\$14,643	\$16,764

1 TAP

HS1460S31	Grade 1 Laminate	\$12,659	\$12,811	\$14,932
	Grade 2 Laminate	\$12,913	\$13,065	\$15,186
	Grade 1 Veneer	\$14,720	\$14,872	\$16,993
	Grade 2 Veneer	\$16,040	\$16,192	\$18,313

2 TAPS

HS1460S32	Grade 1 Laminate	\$14,208	\$14,360	\$16,481
	Grade 2 Laminate	\$14,462	\$14,614	\$16,735
	Grade 1 Veneer	\$16,269	\$16,421	\$18,542
	Grade 2 Veneer	\$17,589	\$17,741	\$19,862

4 TAPS

HS1460S34	Grade 1 Laminate	\$17,305	\$17,457	\$19,578
	Grade 2 Laminate	\$17,559	\$17,711	\$19,832
	Grade 1 Veneer	\$19,366	\$19,518	\$21,639
	Grade 2 Veneer	\$20,686	\$20,838	\$22,959

▶ Specification Information, continued on next page

Host Collection

Soft Radiused Tables with Three Bases
DESIGN F/P DESIGN AND VECTA DESIGN TEAM

SIN 711.11

Tip: Prices shown include top, TAP(s), and slim bases.
► See base options for flared bases, page 204

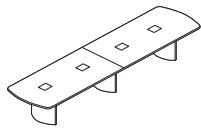
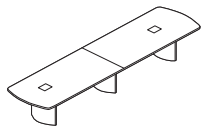
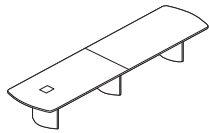
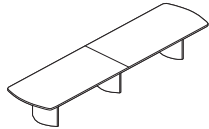

Tip: Last digit of style number indicates number of TAP(s).

Tip: For tech corridor, 16'L tables have eight long doors and four short doors.



► Specification Information, continued from previous page

Specification Information

Style Number	Finish	Base Prices		
				
		Flat Wood Edge:	Bullnose Wood Edge:	Horizon Wood Edge:

16'L x 48"W Two Piece Top

0 TAP				
HS1648S20	Grade 1 Laminate	\$10,702	\$10,861	\$12,998
	Grade 2 Laminate	\$10,933	\$11,092	\$13,229
	Grade 1 Veneer	\$11,818	\$11,977	\$14,114
	Grade 2 Veneer	\$13,004	\$13,163	\$15,300
1 TAP				
HS1648S21	Grade 1 Laminate	\$12,250	\$12,409	\$14,546
	Grade 2 Laminate	\$12,481	\$12,640	\$14,777
	Grade 1 Veneer	\$13,366	\$13,525	\$15,662
	Grade 2 Veneer	\$14,552	\$14,711	\$16,848
2 TAPS				
HS1648S22	Grade 1 Laminate	\$13,799	\$13,958	\$16,095
	Grade 2 Laminate	\$14,030	\$14,189	\$16,326
	Grade 1 Veneer	\$14,915	\$15,074	\$17,211
	Grade 2 Veneer	\$16,101	\$16,260	\$18,397
4 TAPS				
HS1648S24	Grade 1 Laminate	\$16,895	\$17,054	\$19,191
	Grade 2 Laminate	\$17,126	\$17,285	\$19,422
	Grade 1 Veneer	\$18,011	\$18,170	\$20,307
	Grade 2 Veneer	\$19,197	\$19,356	\$21,493

► Specification Information, continued on next page

Host Collection

Soft Radiused Tables with Three Bases *continued*
 DESIGN F/P DESIGN AND VECTA DESIGN TEAM

SIN 711.11

Tip: Prices shown include top, TAP(s), and slim bases.
 ▶ See base options for flared bases, page 204

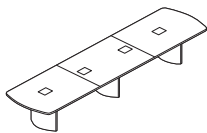
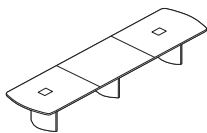
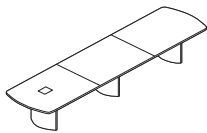
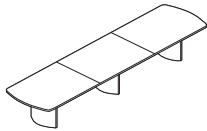

Tip: Last digit of style number indicates number of TAP(s).

Tip: For tech corridor, 16'L tables have eight long doors and four short doors.



▶ Specification Information, continued from previous page

Specification Information

Style Number	Finish	Base Prices		
				
		Flat Wood Edge:	Bullnose Wood Edge:	Horizon Wood Edge:

16'L x 48"W Three Piece Top

0 TAP

HS1648S30	Grade 1 Laminate	\$11,074	\$11,233	\$13,370
	Grade 2 Laminate	\$11,305	\$11,464	\$13,601
	Grade 1 Veneer	\$12,190	\$12,349	\$14,486
	Grade 2 Veneer	\$13,376	\$13,535	\$15,672

1 TAP

HS1648S31	Grade 1 Laminate	\$12,622	\$12,781	\$14,918
	Grade 2 Laminate	\$12,853	\$13,012	\$15,149
	Grade 1 Veneer	\$13,738	\$13,897	\$16,034
	Grade 2 Veneer	\$14,924	\$15,083	\$17,220

2 TAPS

HS1648S32	Grade 1 Laminate	\$14,168	\$14,327	\$16,464
	Grade 2 Laminate	\$14,399	\$14,558	\$16,695
	Grade 1 Veneer	\$15,284	\$15,443	\$17,580
	Grade 2 Veneer	\$16,470	\$16,629	\$18,766

4 TAPS

HS1648S34	Grade 1 Laminate	\$17,266	\$17,425	\$19,562
	Grade 2 Laminate	\$17,497	\$17,656	\$19,793
	Grade 1 Veneer	\$18,382	\$18,541	\$20,678
	Grade 2 Veneer	\$19,568	\$19,727	\$21,864

▶ Specification Information, continued on next page

Host Collection

Soft Radiused Tables with Three Bases
DESIGN F/P DESIGN AND VECTA DESIGN TEAM

SIN 711.11

Tip: Prices shown include top, TAP(s), and slim bases.
▶ See base options for flared bases, page 204

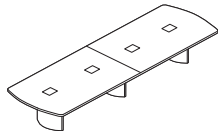
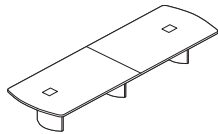
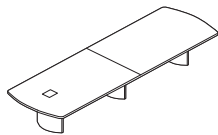
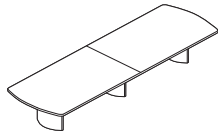

Tip: Last digit of style number indicates number of TAP(s).

Tip: For tech corridor, 16'L tables have eight long doors and four short doors.



▶ Specification Information, continued from previous page

Specification Information

Style Number	Finish	Base Prices		
				
		Flat Wood Edge:	Bullnose Wood Edge:	Horizon Wood Edge:

16'L x 60"W Two Piece Top

0 TAP				
HS1660S20	Grade 1 Laminate	\$11,159	\$11,327	\$13,498
	Grade 2 Laminate	\$11,447	\$11,615	\$13,786
	Grade 1 Veneer	\$13,216	\$13,384	\$15,555
	Grade 2 Veneer	\$14,717	\$14,885	\$17,056
1 TAP				
HS1660S21	Grade 1 Laminate	\$12,707	\$12,875	\$15,046
	Grade 2 Laminate	\$12,995	\$13,163	\$15,334
	Grade 1 Veneer	\$14,764	\$14,932	\$17,103
	Grade 2 Veneer	\$16,265	\$16,433	\$18,604
2 TAPS				
HS1660S22	Grade 1 Laminate	\$14,256	\$14,424	\$16,595
	Grade 2 Laminate	\$14,544	\$14,712	\$16,883
	Grade 1 Veneer	\$16,313	\$16,481	\$18,652
	Grade 2 Veneer	\$17,814	\$17,982	\$20,153
4 TAPS				
HS1660S24	Grade 1 Laminate	\$17,352	\$17,520	\$19,691
	Grade 2 Laminate	\$17,640	\$17,808	\$19,979
	Grade 1 Veneer	\$19,409	\$19,577	\$21,748
	Grade 2 Veneer	\$20,910	\$21,078	\$23,249

▶ Specification Information, continued on next page

Host Collection

Soft Radiused Tables with Three Bases *continued*
 DESIGN F/P DESIGN AND VECTA DESIGN TEAM

SIN 711.11

Tip: Prices shown include top, TAP(s), and slim bases.
 ▶ See base options for flared bases, page 204

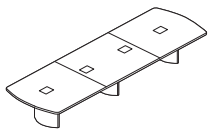
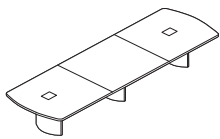
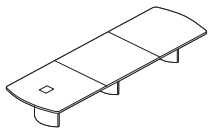
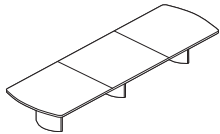

Tip: Last digit of style number indicates number of TAP(s).

Tip: For tech corridor, 16'L tables have eight long doors and four short doors.



▶ Specification Information, continued from previous page

Specification Information

Style Number	Finish	Base Prices		
				
		Flat Wood Edge:	Bullnose Wood Edge:	Horizon Wood Edge:

16'L x 60"W Three Piece Top

0 TAP

HS1660S30	Grade 1 Laminate	\$11,530	\$11,698	\$13,869
	Grade 2 Laminate	\$11,818	\$11,986	\$14,157
	Grade 1 Veneer	\$13,587	\$13,755	\$15,926
	Grade 2 Veneer	\$15,088	\$15,256	\$17,427

1 TAP

HS1660S31	Grade 1 Laminate	\$13,079	\$13,247	\$15,418
	Grade 2 Laminate	\$13,367	\$13,535	\$15,706
	Grade 1 Veneer	\$15,136	\$15,304	\$17,475
	Grade 2 Veneer	\$16,637	\$16,805	\$18,976

2 TAPS

HS1660S32	Grade 1 Laminate	\$14,627	\$14,795	\$16,966
	Grade 2 Laminate	\$14,915	\$15,083	\$17,254
	Grade 1 Veneer	\$16,684	\$16,852	\$19,023
	Grade 2 Veneer	\$18,185	\$18,353	\$20,524

4 TAPS

HS1660S34	Grade 1 Laminate	\$17,723	\$17,891	\$20,062
	Grade 2 Laminate	\$18,011	\$18,179	\$20,350
	Grade 1 Veneer	\$19,780	\$19,948	\$22,119
	Grade 2 Veneer	\$21,281	\$21,449	\$23,620

▶ Specification Information, continued on next page

Host Collection

Soft Radiused Tables with Three Bases
DESIGN F/P DESIGN AND VECTA DESIGN TEAM

SIN 711.11

Tip: Prices shown include top, TAP(s), and slim bases.
▶ See base options for flared bases, page 204

Tip: Last digit of style number indicates number of TAP(s).

Tip: For tech corridor, 18'L tables have eight long doors and four short doors.

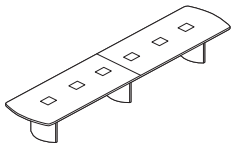
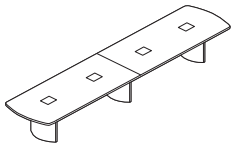
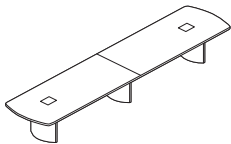
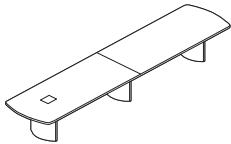
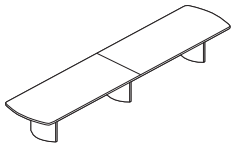

▶ Specification Information, continued from previous page

Specification Information

Style Number	Finish	Base Prices		
		Flat Wood Edge:	Bullnose Wood Edge:	Horizon Wood Edge:

18'L x 48"W Two Piece Top

0 TAP				
HS1848S20	Grade 1 Laminate	\$11,367	\$11,542	\$13,717
	Grade 2 Laminate	\$11,627	\$11,802	\$13,977
	Grade 1 Veneer	\$12,792	\$12,967	\$15,142
	Grade 2 Veneer	\$14,128	\$14,303	\$16,478
1 TAP				
HS1848S21	Grade 1 Laminate	\$12,915	\$13,090	\$15,265
	Grade 2 Laminate	\$13,175	\$13,350	\$15,525
	Grade 1 Veneer	\$14,340	\$14,515	\$16,690
	Grade 2 Veneer	\$15,676	\$15,851	\$18,026
2 TAPS				
HS1848S22	Grade 1 Laminate	\$14,464	\$14,639	\$16,814
	Grade 2 Laminate	\$14,724	\$14,899	\$17,074
	Grade 1 Veneer	\$15,889	\$16,064	\$18,239
	Grade 2 Veneer	\$17,225	\$17,400	\$19,575
4 TAPS				
HS1848S24	Grade 1 Laminate	\$17,560	\$17,735	\$19,910
	Grade 2 Laminate	\$17,820	\$17,995	\$20,170
	Grade 1 Veneer	\$18,985	\$19,160	\$21,335
	Grade 2 Veneer	\$20,321	\$20,496	\$22,671
6 TAPS				
HS1848S26	Grade 1 Laminate	\$20,658	\$20,833	\$23,008
	Grade 2 Laminate	\$20,918	\$21,093	\$23,268
	Grade 1 Veneer	\$22,083	\$22,258	\$24,433
	Grade 2 Veneer	\$23,419	\$23,594	\$25,769

▶ Specification Information, continued on next page

Host Collection

Soft Radiused Tables with Three Bases *continued*
 DESIGN F/P DESIGN AND VECTA DESIGN TEAM

SIN 711.11

Tip: Prices shown include top, TAP(s), and slim bases.
 ▶ See base options for flared bases, page 204

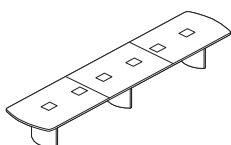
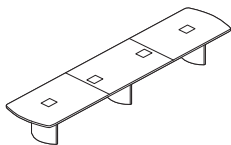
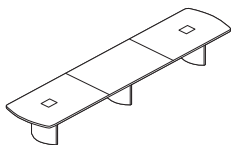
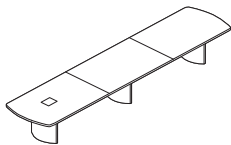
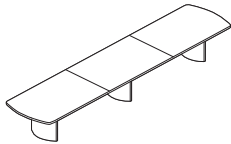

Tip: Last digit of style number indicates number of TAP(s).

Tip: For tech corridor, 18'L tables have eight long doors and four short doors.



▶ Specification Information, continued from previous page

Specification Information

Style Number	Finish	Base Prices		
				
		Flat Wood Edge:	Bullnose Wood Edge:	Horizon Wood Edge:

18'L x 48"W Three Piece Top

0 TAP

HS1848S30	Grade 1 Laminate	\$11,739	\$11,914	\$14,089
	Grade 2 Laminate	\$11,999	\$12,174	\$14,349
	Grade 1 Veneer	\$13,164	\$13,339	\$15,514
	Grade 2 Veneer	\$14,500	\$14,675	\$16,850

1 TAP

HS1848S31	Grade 1 Laminate	\$13,285	\$13,460	\$15,635
	Grade 2 Laminate	\$13,545	\$13,720	\$15,895
	Grade 1 Veneer	\$14,710	\$14,885	\$17,060
	Grade 2 Veneer	\$16,046	\$16,221	\$18,396

2 TAPS

HS1848S32	Grade 1 Laminate	\$14,833	\$15,008	\$17,183
	Grade 2 Laminate	\$15,093	\$15,268	\$17,443
	Grade 1 Veneer	\$16,258	\$16,433	\$18,608
	Grade 2 Veneer	\$17,594	\$17,769	\$19,944

4 TAPS

HS1848S34	Grade 1 Laminate	\$17,931	\$18,106	\$20,281
	Grade 2 Laminate	\$18,191	\$18,366	\$20,541
	Grade 1 Veneer	\$19,356	\$19,531	\$21,706
	Grade 2 Veneer	\$20,692	\$20,867	\$23,042

6 TAPS

HS1848S36	Grade 1 Laminate	\$21,028	\$21,203	\$23,378
	Grade 2 Laminate	\$21,288	\$21,463	\$23,638
	Grade 1 Veneer	\$22,453	\$22,628	\$24,803
	Grade 2 Veneer	\$23,789	\$23,964	\$26,139

▶ Specification Information, continued on next page

Host Collection

Soft Radiused Tables with Three Bases
DESIGN F/P DESIGN AND VECTA DESIGN TEAM

SIN 711.11

Tip: Prices shown include top, TAP(s), and slim bases.
▶ See base options for flared bases, page 204

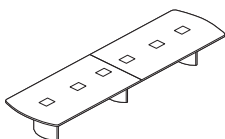
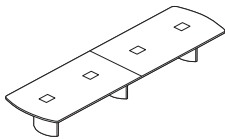
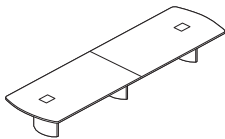
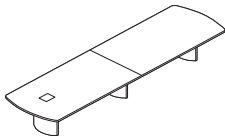
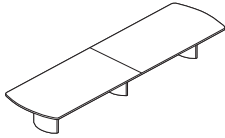

Tip: Last digit of style number indicates number of TAP(s).

Tip: For tech corridor, 18'L tables have eight long doors and four short doors.



▶ Specification Information, continued from previous page

Specification Information

Style Number	Finish	Base Prices		
				
		Flat Wood Edge:	Bullnose Wood Edge:	Horizon Wood Edge:

18'L x 60"W Two Piece Top

0 TAP

HS1860S20	Grade 1 Laminate	\$11,611	\$11,792	\$14,000
	Grade 2 Laminate	\$11,936	\$12,117	\$14,325
	Grade 1 Veneer	\$14,361	\$14,542	\$16,750
	Grade 2 Veneer	\$16,064	\$16,245	\$18,453

1 TAP

HS1860S21	Grade 1 Laminate	\$13,161	\$13,342	\$15,550
	Grade 2 Laminate	\$13,486	\$13,667	\$15,875
	Grade 1 Veneer	\$15,911	\$16,092	\$18,300
	Grade 2 Veneer	\$17,614	\$17,795	\$20,003

2 TAPS

HS1860S22	Grade 1 Laminate	\$14,710	\$14,891	\$17,099
	Grade 2 Laminate	\$15,035	\$15,216	\$17,424
	Grade 1 Veneer	\$17,460	\$17,641	\$19,849
	Grade 2 Veneer	\$19,163	\$19,344	\$21,552

4 TAPS

HS1860S24	Grade 1 Laminate	\$17,807	\$17,988	\$20,196
	Grade 2 Laminate	\$18,132	\$18,313	\$20,521
	Grade 1 Veneer	\$20,557	\$20,738	\$22,946
	Grade 2 Veneer	\$22,260	\$22,441	\$24,649

6 TAPS

HS1860S26	Grade 1 Laminate	\$20,903	\$21,084	\$23,292
	Grade 2 Laminate	\$21,228	\$21,409	\$23,617
	Grade 1 Veneer	\$23,653	\$23,834	\$26,042
	Grade 2 Veneer	\$25,356	\$25,537	\$27,745

▶ Specification Information, continued on next page

Host Collection

Soft Radiused Tables with Three Bases *continued*
 DESIGN F/P DESIGN AND VECTA DESIGN TEAM

SIN 711.11

Tip: Prices shown include top, TAP(s), and slim bases.
 ▶ See base options for flared bases, page 204

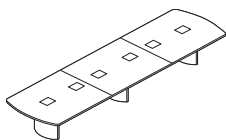
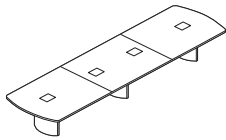
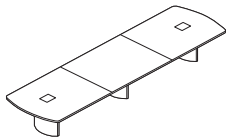
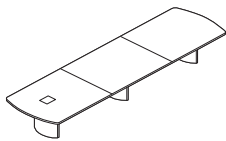
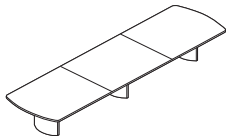

Tip: Last digit of style number indicates number of TAP(s).

Tip: For tech corridor, 18'L tables have eight long doors and four short doors.



▶ Specification Information, continued from previous page

Specification Information

Style Number	Finish	Base Prices		
				
		Flat Wood Edge:	Bullnose Wood Edge:	Horizon Wood Edge:

18'L x 60"W Three Piece Top

0 TAP

Style Number	Finish	Flat Wood Edge	Bullnose Wood Edge	Horizon Wood Edge
HS1860S30	Grade 1 Laminate	\$11,983	\$12,164	\$14,372
	Grade 2 Laminate	\$12,308	\$12,489	\$14,697
	Grade 1 Veneer	\$14,733	\$14,914	\$17,122
	Grade 2 Veneer	\$16,436	\$16,617	\$18,825

1 TAP

Style Number	Finish	Flat Wood Edge	Bullnose Wood Edge	Horizon Wood Edge
HS1860S31	Grade 1 Laminate	\$13,532	\$13,713	\$15,921
	Grade 2 Laminate	\$13,857	\$14,038	\$16,246
	Grade 1 Veneer	\$16,282	\$16,463	\$18,671
	Grade 2 Veneer	\$17,985	\$18,166	\$20,374

2 TAPS

Style Number	Finish	Flat Wood Edge	Bullnose Wood Edge	Horizon Wood Edge
HS1860S32	Grade 1 Laminate	\$15,080	\$15,261	\$17,469
	Grade 2 Laminate	\$15,405	\$15,586	\$17,794
	Grade 1 Veneer	\$17,830	\$18,011	\$20,219
	Grade 2 Veneer	\$19,533	\$19,714	\$21,922

4 TAPS

Style Number	Finish	Flat Wood Edge	Bullnose Wood Edge	Horizon Wood Edge
HS1860S34	Grade 1 Laminate	\$18,178	\$18,359	\$20,567
	Grade 2 Laminate	\$18,503	\$18,684	\$20,892
	Grade 1 Veneer	\$20,928	\$21,109	\$23,317
	Grade 2 Veneer	\$22,631	\$22,812	\$25,020

6 TAPS

Style Number	Finish	Flat Wood Edge	Bullnose Wood Edge	Horizon Wood Edge
HS1860S36	Grade 1 Laminate	\$21,275	\$21,456	\$23,664
	Grade 2 Laminate	\$21,600	\$21,781	\$23,989
	Grade 1 Veneer	\$24,025	\$24,206	\$26,414
	Grade 2 Veneer	\$25,728	\$25,909	\$28,117

▶ Specification Information, continued on next page

Host Collection

Soft Radiused Tables with Three Bases
DESIGN F/P DESIGN AND VECTA DESIGN TEAM

SIN 711.11

Tip: Prices shown include top, TAP(s), and slim bases.
▶ See base options for flared bases, page 204

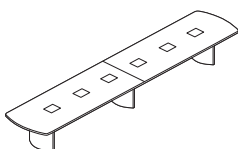
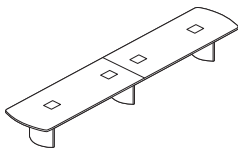
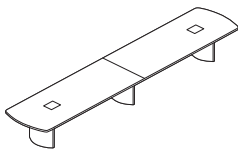
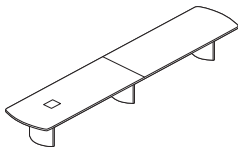
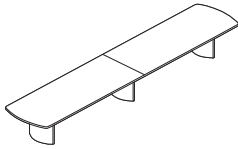

Tip: Last digit of style number indicates number of TAP(s).

Tip: For tech corridor, 20'L tables have eight long doors and four short doors.



▶ Specification Information, continued from previous page

Specification Information

Style Number	Finish	Base Prices		
				
		Flat Wood Edge:	Bullnose Wood Edge:	Horizon Wood Edge:

20'L x 48"W Two Piece Top

0 TAP				
HS2048S20	Grade 1 Laminate	\$11,786	\$11,977	\$14,298
	Grade 2 Laminate	\$12,074	\$12,265	\$14,586
	Grade 1 Veneer	\$13,208	\$13,399	\$15,720
	Grade 2 Veneer	\$14,690	\$14,881	\$17,202
1 TAP				
HS2048S21	Grade 1 Laminate	\$13,335	\$13,526	\$15,847
	Grade 2 Laminate	\$13,623	\$13,814	\$16,135
	Grade 1 Veneer	\$14,757	\$14,948	\$17,269
	Grade 2 Veneer	\$16,239	\$16,430	\$18,751
2 TAPS				
HS2048S22	Grade 1 Laminate	\$14,883	\$15,074	\$17,395
	Grade 2 Laminate	\$15,171	\$15,362	\$17,683
	Grade 1 Veneer	\$16,305	\$16,496	\$18,817
	Grade 2 Veneer	\$17,787	\$17,978	\$20,299
4 TAPS				
HS2048S24	Grade 1 Laminate	\$17,981	\$18,172	\$20,493
	Grade 2 Laminate	\$18,269	\$18,460	\$20,781
	Grade 1 Veneer	\$19,403	\$19,594	\$21,915
	Grade 2 Veneer	\$20,885	\$21,076	\$23,397
6 TAPS				
HS2048S26	Grade 1 Laminate	\$21,077	\$21,268	\$23,589
	Grade 2 Laminate	\$21,365	\$21,556	\$23,877
	Grade 1 Veneer	\$22,499	\$22,690	\$25,011
	Grade 2 Veneer	\$23,981	\$24,172	\$26,493

▶ Specification Information, continued on next page

Host Collection

Soft Radiused Tables with Three Bases *continued*
 DESIGN F/P DESIGN AND VECTA DESIGN TEAM

SIN 711.11

Tip: Prices shown include top, TAP(s), and slim bases.
 ▶ See base options for flared bases, page 204

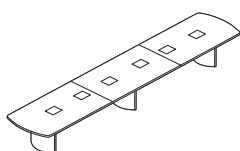
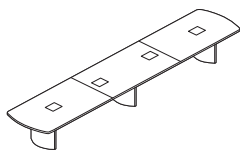
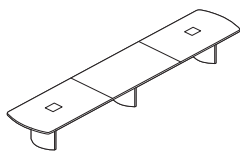
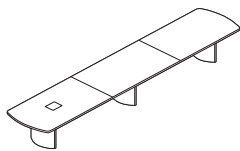
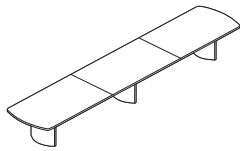

Tip: Last digit of style number indicates number of TAP(s).

Tip: For tech corridor, 20'L tables have eight long doors and four short doors.



▶ Specification Information, continued from previous page

Specification Information

Style Number	Finish	Base Prices		
				
		Flat Wood Edge:	Bullnose Wood Edge:	Horizon Wood Edge:

20'L x 48''W Three Piece Top

0 TAP				
HS2048S30	Grade 1 Laminate	\$12,156	\$12,347	\$14,668
	Grade 2 Laminate	\$12,444	\$12,635	\$14,956
	Grade 1 Veneer	\$13,578	\$13,769	\$16,090
	Grade 2 Veneer	\$15,060	\$15,251	\$17,572
1 TAP				
HS2048S31	Grade 1 Laminate	\$13,705	\$13,896	\$16,217
	Grade 2 Laminate	\$13,993	\$14,184	\$16,505
	Grade 1 Veneer	\$15,127	\$15,318	\$17,639
	Grade 2 Veneer	\$16,609	\$16,800	\$19,121
2 TAPS				
HS2048S32	Grade 1 Laminate	\$15,254	\$15,445	\$17,766
	Grade 2 Laminate	\$15,542	\$15,733	\$18,054
	Grade 1 Veneer	\$16,676	\$16,867	\$19,188
	Grade 2 Veneer	\$18,158	\$18,349	\$20,670
4 TAPS				
HS2048S34	Grade 1 Laminate	\$18,352	\$18,543	\$20,862
	Grade 2 Laminate	\$18,640	\$18,831	\$21,150
	Grade 1 Veneer	\$19,774	\$19,965	\$22,284
	Grade 2 Veneer	\$21,256	\$21,447	\$23,766
6 TAPS				
HS2048S36	Grade 1 Laminate	\$21,448	\$21,639	\$23,958
	Grade 2 Laminate	\$21,736	\$21,927	\$24,246
	Grade 1 Veneer	\$22,870	\$23,061	\$25,380
	Grade 2 Veneer	\$24,352	\$24,543	\$26,862

▶ Specification Information, continued on next page

Host Collection

Soft Radiused Tables with Three Bases
DESIGN F/P DESIGN AND VECTA DESIGN TEAM

SIN 711.11

Tip: Prices shown include top, TAP(s), and slim bases.
▶ See base options for flared bases, page 204

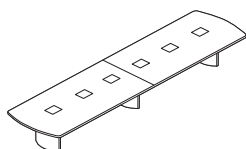
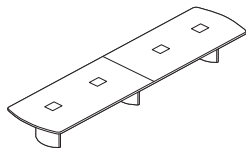
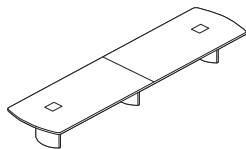
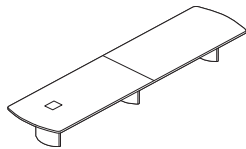
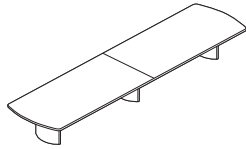

Tip: Last digit of style number indicates number of TAP(s).

Tip: For tech corridor, 20'L tables have eight long doors and four short doors.



▶ Specification Information, continued from previous page

Specification Information

Style Number	Finish	Base Prices		
				
		Flat Wood Edge:	Bullnose Wood Edge:	Horizon Wood Edge:

20'L x 60''W Two Piece Top

0 TAP				
HS2060S20	Grade 1 Laminate	\$12,032	\$12,231	\$14,596
	Grade 2 Laminate	\$12,393	\$12,592	\$14,957
	Grade 1 Veneer	\$14,779	\$14,978	\$17,343
	Grade 2 Veneer	\$16,660	\$16,859	\$19,224
1 TAP				
HS2060S21	Grade 1 Laminate	\$13,579	\$13,778	\$16,143
	Grade 2 Laminate	\$13,940	\$14,139	\$16,504
	Grade 1 Veneer	\$16,326	\$16,525	\$18,890
	Grade 2 Veneer	\$18,207	\$18,406	\$20,771
2 TAPS				
HS2060S22	Grade 1 Laminate	\$15,129	\$15,328	\$17,693
	Grade 2 Laminate	\$15,490	\$15,689	\$18,054
	Grade 1 Veneer	\$17,876	\$18,075	\$20,440
	Grade 2 Veneer	\$19,757	\$19,956	\$22,321
4 TAPS				
HS2060S24	Grade 1 Laminate	\$18,224	\$18,423	\$20,788
	Grade 2 Laminate	\$18,585	\$18,784	\$21,149
	Grade 1 Veneer	\$20,971	\$21,170	\$23,535
	Grade 2 Veneer	\$22,852	\$23,051	\$25,416
6 TAPS				
HS2060S26	Grade 1 Laminate	\$21,321	\$21,520	\$23,885
	Grade 2 Laminate	\$21,682	\$21,881	\$24,246
	Grade 1 Veneer	\$24,068	\$24,267	\$26,632
	Grade 2 Veneer	\$25,949	\$26,148	\$28,513

▶ Specification Information, continued on next page

Host Collection

Soft Radiused Tables with Three Bases *continued*
 DESIGN F/P DESIGN AND VECTA DESIGN TEAM

SIN 711.11

Tip: Prices shown include top, TAP(s), and slim bases.
 ▶ See base options for flared bases, page 204

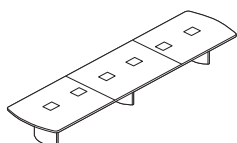
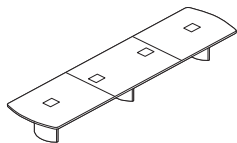
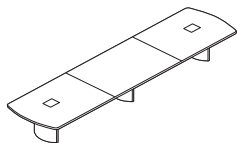
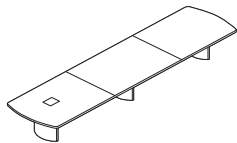
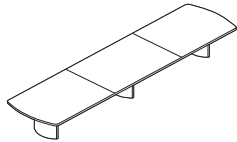

Tip: Last digit of style number indicates number of TAP(s).

Tip: For tech corridor, 20'L tables have eight long doors and four short doors.



▶ Specification Information, continued from previous page

Specification Information

Style Number	Finish	Base Prices		
				
		Flat Wood Edge:	Bullnose Wood Edge:	Horizon Wood Edge:

20'L x 60"W Three Piece Top

0 TAP

Style Number	Finish	Flat Wood Edge	Bullnose Wood Edge	Horizon Wood Edge
HS2060S30	Grade 1 Laminate	\$12,401	\$12,600	\$14,965
	Grade 2 Laminate	\$12,762	\$12,961	\$15,326
	Grade 1 Veneer	\$15,148	\$15,347	\$17,712
	Grade 2 Veneer	\$17,029	\$17,228	\$19,593

1 TAP

Style Number	Finish	Flat Wood Edge	Bullnose Wood Edge	Horizon Wood Edge
HS2060S31	Grade 1 Laminate	\$13,949	\$14,148	\$16,513
	Grade 2 Laminate	\$14,310	\$14,509	\$16,874
	Grade 1 Veneer	\$16,696	\$16,895	\$19,260
	Grade 2 Veneer	\$18,577	\$18,776	\$21,141

2 TAPS

Style Number	Finish	Flat Wood Edge	Bullnose Wood Edge	Horizon Wood Edge
HS2060S32	Grade 1 Laminate	\$15,499	\$15,698	\$18,063
	Grade 2 Laminate	\$15,860	\$16,059	\$18,424
	Grade 1 Veneer	\$18,246	\$18,445	\$20,810
	Grade 2 Veneer	\$20,127	\$20,326	\$22,691

4 TAPS

Style Number	Finish	Flat Wood Edge	Bullnose Wood Edge	Horizon Wood Edge
HS2060S34	Grade 1 Laminate	\$18,596	\$18,795	\$21,160
	Grade 2 Laminate	\$18,957	\$19,156	\$21,521
	Grade 1 Veneer	\$21,343	\$21,542	\$23,907
	Grade 2 Veneer	\$23,224	\$23,423	\$25,788

6 TAPS

Style Number	Finish	Flat Wood Edge	Bullnose Wood Edge	Horizon Wood Edge
HS2060S36	Grade 1 Laminate	\$21,692	\$21,891	\$24,256
	Grade 2 Laminate	\$22,053	\$22,252	\$24,617
	Grade 1 Veneer	\$24,439	\$24,638	\$27,003
	Grade 2 Veneer	\$26,320	\$26,519	\$28,884

Coalesse

Host Collection

Soft Radiused Tables with Three Bases
DESIGN F/P DESIGN AND VECTA DESIGN TEAM

SIN 711.11

Host Collection Racetrack Tables with Two Bases

DESIGN F/P DESIGN AND VECTA DESIGN TEAM

SIN 711.11

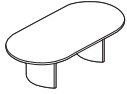

Tip: Shipped knocked down.

Tip: Grain direction for wood-grain laminate runs the length of the table.

Tip: Clips are provided with table: one clip per foot of table length.

Tip: The wood edge on a table top with woodgrain laminate may not match the top.

Tip: You must send a sample of reasonable size for Stain-to-Match.

Standard Includes		Required to Specify
<ul style="list-style-type: none"> ▶ Need help? Product details, see <i>Coalesse Tables, Storage, and Accessories Specification Guide</i> 	<ul style="list-style-type: none"> • Top: 1¼" particle board core with laminate • Flat wood edge • TAP(s), if selected: 10"W x 12"L opening(s) trimmed with a flat solid wood profile and with brushed anodized aluminum TAP doors • Tech corridor: two aluminum beams for top support provide tracks for hinged aluminum doors that clip shut: satin anodized finish • Universal clip: black plastic • Two 27"W bases: wood veneer on MDF with aluminum universal bracket • Concealed leveling glides: non-marring, black plastic 	<ol style="list-style-type: none"> 1 Style number 2 Base selection (see below) and wood color number for base 3 Laminate color number for table top, if selected 4 Wood color number for wood edge <ul style="list-style-type: none"> ▶ See <i>Veneer Matrix</i>, page 365 5 Door color number for storage tray or TAP door, if selected: <ul style="list-style-type: none"> - 8044 Black - 8047 Silver 6 Options, if selected (see below) <ul style="list-style-type: none"> ▶ See <i>Surface Materials</i>, page 350.

Options	Price	Required to Specify
Surface Materials <ul style="list-style-type: none"> • Top • Grade 2 laminate • Grade 1 wood veneer • Grade 2 wood veneer • Stain-to-Match 	<ul style="list-style-type: none"> Prices at right Prices at right Prices at right No cost 	<ul style="list-style-type: none"> Specify with <i>Grade 2 laminate</i> and select color number. Specify with <i>Grade 1 wood veneer</i> and select color number. Specify with <i>Grade 2 wood veneer</i> and select color number. Specify with <i>Stain-to-Match</i>. ▶ Page 383

Edges	Wood	Price	Required to Specify
	<ul style="list-style-type: none"> • Bullnose wood edge • Beveled wood edge • Horizon wood edge 	<ul style="list-style-type: none"> Prices at right Prices at right Prices at right 	<ul style="list-style-type: none"> Specify with <i>bullnose wood edge</i>. Specify with <i>beveled wood edge</i>. Specify with <i>Horizon wood edge</i>.

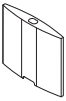
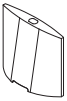
Bases	Options	Price	Required to Specify
 Slim  Flared	<ul style="list-style-type: none"> • Two slim bases • One slim and one flared base • Two flared bases 	<ul style="list-style-type: none"> No cost +\$ 807 +\$1615 	<ul style="list-style-type: none"> Specify with <i>two slim bases</i>. Specify with <i>one slim base</i> and one flared base. Specify with <i>two flared bases</i>.

Tip: 96"L tables available with zero, one, or two TAP(s). 10'L and 12'L tables available with zero, one, two, or three TAP(s).

Tip: In addition to the data and audio/video AAPs available from Coalesse, other styles of AAPs are available through Extron Electronics. For an Extron dealer, call 1-800-633-9876.

Tip: See TAP options for electrical systems and faceplate list.

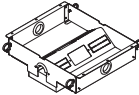
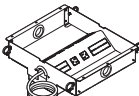
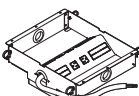
TAP Electrical System with Faceplate Options	Options	Price	Required to Specify
 Field Wired	<ul style="list-style-type: none"> • Field-wired tray (no electrical) <ul style="list-style-type: none"> - PAFW field-wired tray (no electrical) with blank AAPs - PDFW field-wired tray (no electrical) with two data AAPs - PVFW field-wired tray (no electrical) with two of each video/audio and data AAPs 	<ul style="list-style-type: none"> No cost 	<ul style="list-style-type: none"> Specify with <i>power data</i>, and select TAP type and TAP door color number.
 Cord and Plug	<ul style="list-style-type: none"> • Cord and plug tray (10' cord) <ul style="list-style-type: none"> - PACP cord and plug tray with outlets and blank AAPs - PDCP cord and plug tray with outlets and two data AAPs - PAVC cord and plug tray with outlets and two of each video/audio and data AAPs 	<ul style="list-style-type: none"> No cost 	<ul style="list-style-type: none"> Specify with <i>power data</i>, and select TAP type and TAP door color number.
 Hardwired	<ul style="list-style-type: none"> • Hard-wired tray (6' conduit) <ul style="list-style-type: none"> - PAHW hard-wired tray with outlets and blank AAPs - PDHW hard-wired tray with outlets and two data AAPs - PAVH hard-wired tray with outlets and two of each video/audio and data AAPs 	<ul style="list-style-type: none"> No cost 	<ul style="list-style-type: none"> Specify with <i>power data</i>, and select TAP type and TAP door color number.

▶ Options, continued on next page

Host Collection

Racetrack Tables with Two Bases
DESIGN F/P DESIGN AND VECTA DESIGN TEAM

SIN 711.11

► Options, continued from previous page

Tip: For single TAP style numbers, the modular system tray is not available. Specify the hard-wired tray option.

Tip: If the specified table has multiple TAP(s), any one TAP can be replaced with a storage tray.

Tip: Wood veneer doors for storage tray and TAP will always be cross grain.

Tip: Connectrac must be the same wiring schematic as the table.

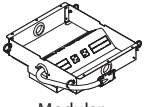
Options	Price	Required to Specify
TAP Electrical System with Faceplate Options  Modular	<ul style="list-style-type: none"> Modular system tray (hardwire base power infeed) <ul style="list-style-type: none"> - PAMH modular system tray with outlets and blank AAPs - PDMH modular system tray with outlets and two data AAPs - PVMH modular system tray with outlets and two of each video/audio and data AAPs +\$138 each tray	Specify with modular power data, and select TAP type and TAP door color number.
Storage Tray	<ul style="list-style-type: none"> Storage tray -\$579	Specify with storage tray and select door color number.
Doors	<ul style="list-style-type: none"> Storage tray wood veneer doors TAP wood veneer doors +\$291 per door +\$291 per door	Specify with wood doors. Specify with wood doors.
Related Products	<ul style="list-style-type: none"> Floor kit: Connectrac Corridor shelf 	► Page 283 ► Page 283

TAP Locations

96"L x 48"W TAP Locations—One piece top

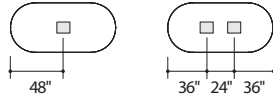

10'L x 48"W TAP Locations—One piece top

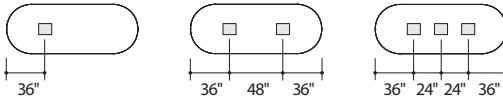

10'L x 48"W TAP Locations—Two piece top

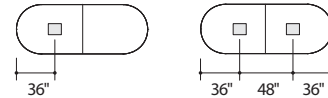

10'L x 60"W TAP Locations—One piece top

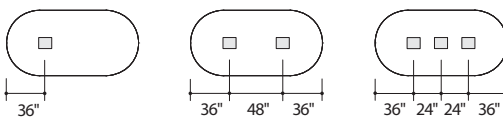

10'L x 60"W TAP Locations—Two piece top

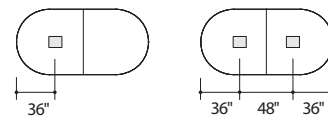

12'L x 48"W TAP Locations—One piece top

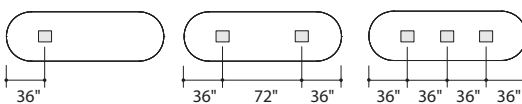

12'L x 48"W TAP Locations—Two piece top

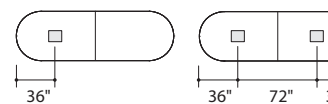

12'L x 60"W TAP Locations—One piece top

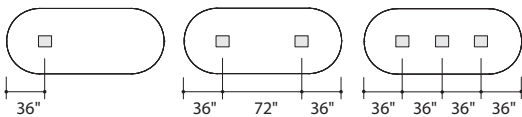

12'L x 60"W TAP Locations—Two piece top

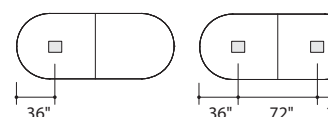

► Specification Information, on next page

Host Collection Racetrack Tables with Two Bases *continued*

DESIGN F/P DESIGN AND VECTA DESIGN TEAM

SIN 711.11

Tip: Prices shown include top, TAP(s), and slim bases.
 ▶ See base options for flared bases, page 224



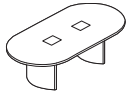
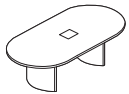
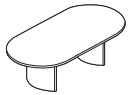

Tip: Last digit of style number indicates number of TAP(s).

Tip: For tech corridor, 96"L tables have two long doors and four short doors.



▶ Options, on previous page

Specification Information

Style Number	Finish	Base Prices			
					
		Flat Wood Edge:	Bullnose Wood Edge:	Beveled Wood Edge:	Horizon Wood Edge:

96"L x 48"W One Piece Top

0 TAP

HS9648C10	Grade 1 Laminate	\$ 6716	\$ 6814	\$ 6948	\$ 8775
	Grade 2 Laminate	\$ 6831	\$ 6929	\$ 7063	\$ 8890
	Grade 1 Veneer	\$ 7399	\$ 7497	\$ 7631	\$ 9458
	Grade 2 Veneer	\$ 7994	\$ 8092	\$ 8226	\$10,053

1 TAP

HS9648C11	Grade 1 Laminate	\$ 8264	\$ 8362	\$ 8496	\$10,323
	Grade 2 Laminate	\$ 8379	\$ 8477	\$ 8611	\$10,438
	Grade 1 Veneer	\$ 8947	\$ 9045	\$ 9179	\$11,006
	Grade 2 Veneer	\$ 9542	\$ 9640	\$ 9774	\$11,601

2 TAPS

HS9648C12	Grade 1 Laminate	\$ 9812	\$ 9910	\$10,044	\$11,871
	Grade 2 Laminate	\$ 9927	\$10,025	\$10,159	\$11,986
	Grade 1 Veneer	\$10,495	\$10,593	\$10,727	\$12,554
	Grade 2 Veneer	\$11,090	\$11,188	\$11,322	\$13,149

▶ Specification Information, continued on next page

Host Collection Racetrack Tables with Two Bases

DESIGN F/P DESIGN AND VECTA DESIGN TEAM

SIN 711.11

Tip: Prices shown include top, TAP(s), and slim bases.
 ▶ See base options for flared bases, page 224



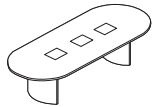
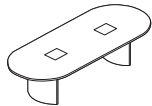
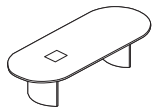
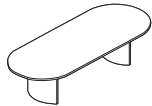

Tip: Last digit of style number indicates number of TAP(s).

Tip: For tech corridor, 10'L tables have four long doors and four short doors.



▶ Specification Information, continued from previous page

Specification Information

Style Number	Finish	Base Prices			
					
		Flat Wood Edge:	Bullnose Wood Edge:	Beveled Wood Edge:	Horizon Wood Edge:

10'L x 48"W One Piece Top

0 TAP					
HS1048C10	Grade 1 Laminate	\$ 7306	\$ 7419	\$ 7576	\$ 9401
	Grade 2 Laminate	\$ 7452	\$ 7565	\$ 7722	\$ 9547
	Grade 1 Veneer	\$ 8130	\$ 8243	\$ 8400	\$10,225
	Grade 2 Veneer	\$ 8876	\$ 8989	\$ 9146	\$10,971
1 TAP					
HS1048C11	Grade 1 Laminate	\$ 8855	\$ 8968	\$ 9125	\$10,950
	Grade 2 Laminate	\$ 9001	\$ 9114	\$ 9271	\$11,096
	Grade 1 Veneer	\$ 9679	\$ 9792	\$ 9949	\$11,774
	Grade 2 Veneer	\$10,425	\$10,538	\$10,695	\$12,520
2 TAPS					
HS1048C12	Grade 1 Laminate	\$10,402	\$10,515	\$10,672	\$12,497
	Grade 2 Laminate	\$10,548	\$10,661	\$10,818	\$12,643
	Grade 1 Veneer	\$11,227	\$11,340	\$11,497	\$13,322
	Grade 2 Veneer	\$11,972	\$12,085	\$12,242	\$14,067
3 TAPS					
HS1048C13	Grade 1 Laminate	\$11,952	\$12,065	\$12,222	\$14,047
	Grade 2 Laminate	\$12,098	\$12,211	\$12,368	\$14,193
	Grade 1 Veneer	\$12,776	\$12,889	\$13,046	\$14,871
	Grade 2 Veneer	\$13,522	\$13,635	\$13,792	\$15,617

▶ Specification Information, continued on next page

Host Collection Racetrack Tables with Two Bases *continued*

DESIGN F/P DESIGN AND VECTA DESIGN TEAM

SIN 711.11

Tip: Prices shown include top, TAP(s), and slim bases.
 ▶ See base options for flared bases, page 224



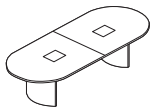
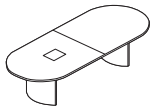
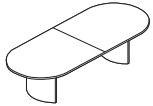

Tip: Last digit of style number indicates number of TAP(s).

Tip: For tech corridor, 10'L tables have four long doors and four short doors.



▶ Specification Information, continued from previous page

Specification Information

Style Number	Finish	Base Prices			
					
		Flat Wood Edge:	Bullnose Wood Edge:	Beveled Wood Edge:	Horizon Wood Edge:

10'L x 48"W Two Piece Top

0 TAP

HS1048C20	Grade 1 Laminate	\$ 7677	\$ 7790	\$ 7947	\$ 9772
	Grade 2 Laminate	\$ 7823	\$ 7936	\$ 8093	\$ 9918
	Grade 1 Veneer	\$ 8501	\$ 8614	\$ 8771	\$10,596
	Grade 2 Veneer	\$ 9247	\$ 9360	\$ 9517	\$11,342

1 TAP

HS1048C21	Grade 1 Laminate	\$ 9226	\$ 9339	\$ 9496	\$11,321
	Grade 2 Laminate	\$ 9372	\$ 9485	\$ 9642	\$11,467
	Grade 1 Veneer	\$10,050	\$10,163	\$10,320	\$12,145
	Grade 2 Veneer	\$10,796	\$10,909	\$11,066	\$12,891

2 TAPS

HS1048C22	Grade 1 Laminate	\$10,774	\$10,887	\$11,044	\$12,869
	Grade 2 Laminate	\$10,920	\$11,033	\$11,190	\$13,015
	Grade 1 Veneer	\$11,598	\$11,711	\$11,868	\$13,693
	Grade 2 Veneer	\$12,344	\$12,457	\$12,614	\$14,439

▶ Specification Information, continued on next page

Host Collection Racetrack Tables with Two Bases

DESIGN F/P DESIGN AND VECTA DESIGN TEAM

SIN 711.11

Tip: Prices shown include top, TAP(s), and slim bases.
 ▶ See base options for flared bases, page 224

Tip: Last digit of style number indicates number of TAP(s).

Tip: For tech corridor, 10'L tables have four long doors and four short doors.

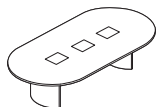
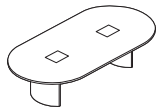
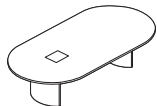
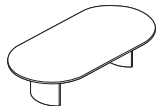

▶ Specification Information, continued from previous page

Specification Information

Style Number	Finish	Base Prices			
		Flat Wood Edge:	Bullnose Wood Edge:	Beveled Wood Edge:	Horizon Wood Edge:

10'L x 60"W One Piece Top

0 TAP					
HS1060C10	Grade 1 Laminate	\$ 7458	\$ 7579	\$ 7746	\$ 9572
	Grade 2 Laminate	\$ 7637	\$ 7758	\$ 7925	\$ 9751
	Grade 1 Veneer	\$ 8756	\$ 8877	\$ 9044	\$10,870
	Grade 2 Veneer	\$ 9694	\$ 9815	\$ 9982	\$11,808
1 TAP					
HS1060C11	Grade 1 Laminate	\$ 9007	\$ 9128	\$ 9295	\$11,121
	Grade 2 Laminate	\$ 9186	\$ 9307	\$ 9474	\$11,300
	Grade 1 Veneer	\$10,305	\$10,426	\$10,593	\$12,419
	Grade 2 Veneer	\$11,243	\$11,364	\$11,531	\$13,357
2 TAPS					
HS1060C12	Grade 1 Laminate	\$10,557	\$10,678	\$10,845	\$12,671
	Grade 2 Laminate	\$10,736	\$10,857	\$11,024	\$12,850
	Grade 1 Veneer	\$11,855	\$11,976	\$12,143	\$13,969
	Grade 2 Veneer	\$12,793	\$12,914	\$13,081	\$14,907
3 TAPS					
HS1060C13	Grade 1 Laminate	\$12,106	\$12,227	\$12,394	\$14,220
	Grade 2 Laminate	\$12,285	\$12,406	\$12,573	\$14,399
	Grade 1 Veneer	\$13,404	\$13,525	\$13,692	\$15,518
	Grade 2 Veneer	\$14,342	\$14,463	\$14,630	\$16,456

▶ Specification Information, continued on next page

Host Collection Racetrack Tables with Two Bases *continued*

DESIGN F/P DESIGN AND VECTA DESIGN TEAM

SIN 711.11

Tip: Prices shown include top, TAP(s), and slim bases.
 ▶ See base options for flared bases, page 224



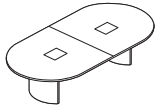
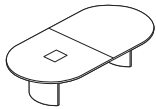
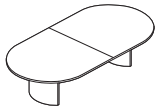

Tip: Last digit of style number indicates number of TAP(s).

Tip: For tech corridor, 10'L tables have four long doors and four short doors.



▶ Specification Information, continued from previous page

Specification Information

Style Number	Finish	Base Prices			
					
		Flat Wood Edge:	Bullnose Wood Edge:	Beveled Wood Edge:	Horizon Wood Edge:

10'L x 60"W Two Piece Top

0 TAP

Style Number	Finish	Flat Wood Edge	Bullnose Wood Edge	Beveled Wood Edge	Horizon Wood Edge
HS1060C20	Grade 1 Laminate	\$ 7830	\$ 7951	\$ 8118	\$ 9944
	Grade 2 Laminate	\$ 8009	\$ 8130	\$ 8297	\$10,123
	Grade 1 Veneer	\$ 9128	\$ 9249	\$ 9416	\$11,242
	Grade 2 Veneer	\$10,066	\$10,187	\$10,354	\$12,180

1 TAP

Style Number	Finish	Flat Wood Edge	Bullnose Wood Edge	Beveled Wood Edge	Horizon Wood Edge
HS1060C21	Grade 1 Laminate	\$ 9379	\$ 9500	\$ 9667	\$11,493
	Grade 2 Laminate	\$ 9558	\$ 9679	\$ 9846	\$11,672
	Grade 1 Veneer	\$10,677	\$10,798	\$10,965	\$12,791
	Grade 2 Veneer	\$11,615	\$11,736	\$11,903	\$13,729

2 TAPS

Style Number	Finish	Flat Wood Edge	Bullnose Wood Edge	Beveled Wood Edge	Horizon Wood Edge
HS1060C22	Grade 1 Laminate	\$10,926	\$11,047	\$11,214	\$13,040
	Grade 2 Laminate	\$11,105	\$11,226	\$11,393	\$13,219
	Grade 1 Veneer	\$12,224	\$12,345	\$12,512	\$14,338
	Grade 2 Veneer	\$13,162	\$13,283	\$13,450	\$15,276

▶ Specification Information, continued on next page

Host Collection

Racetrack Tables with Two Bases
DESIGN F/P DESIGN AND VECTA DESIGN TEAM

SIN 711.11

Tip: Prices shown include top, TAP(s), and slim bases.
▶ See base options for flared bases, page 224

Tip: Last digit of style number indicates number of TAP(s).

Tip: For tech corridor, 12'L tables have four long doors and four short doors.

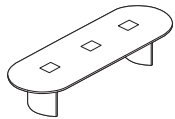
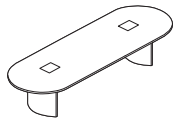
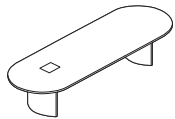
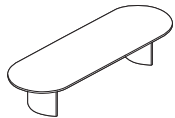

▶ Specification Information, continued from previous page

Specification Information

Style Number	Finish	Base Prices			
		Flat Wood Edge:	Bullnose Wood Edge:	Beveled Wood Edge:	Horizon Wood Edge:

12'L x 48"W One Piece Top

0 TAP					
HS1248C10	Grade 1 Laminate	\$ 7839	\$ 7967	\$ 8145	\$ 9973
	Grade 2 Laminate	\$ 8012	\$ 8140	\$ 8318	\$10,146
	Grade 1 Veneer	\$ 8896	\$ 9024	\$ 9202	\$11,030
	Grade 2 Veneer	\$ 9793	\$ 9921	\$10,099	\$11,927
1 TAP					
HS1248C11	Grade 1 Laminate	\$ 9388	\$ 9516	\$ 9694	\$11,522
	Grade 2 Laminate	\$ 9561	\$ 9689	\$ 9867	\$11,695
	Grade 1 Veneer	\$10,445	\$10,573	\$10,751	\$12,579
	Grade 2 Veneer	\$11,342	\$11,470	\$11,648	\$13,476
2 TAPS					
HS1248C12	Grade 1 Laminate	\$10,937	\$11,065	\$11,243	\$13,071
	Grade 2 Laminate	\$11,110	\$11,238	\$11,416	\$13,244
	Grade 1 Veneer	\$11,994	\$12,122	\$12,300	\$14,128
	Grade 2 Veneer	\$12,891	\$13,019	\$13,197	\$15,025
3 TAPS					
HS1248C13	Grade 1 Laminate	\$12,484	\$12,612	\$12,790	\$14,618
	Grade 2 Laminate	\$12,657	\$12,785	\$12,963	\$14,791
	Grade 1 Veneer	\$13,541	\$13,669	\$13,847	\$15,675
	Grade 2 Veneer	\$14,438	\$14,566	\$14,744	\$16,572

▶ Specification Information, continued on next page

Host Collection

Racetrack Tables with Two Bases *continued*
 DESIGN F/P DESIGN AND VECTA DESIGN TEAM

SIN 711.11

Tip: Prices shown include top, TAP(s), and slim bases.
 ▶ See base options for flared bases, page 224



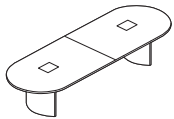
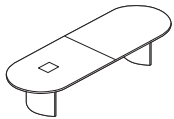
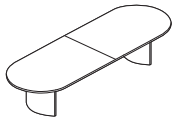

Tip: Last digit of style number indicates number of TAP(s).

Tip: For tech corridor, 12'L tables have four long doors and four short doors.



▶ Specification Information, continued from previous page

Specification Information

Style Number	Finish	Base Prices			
					
		Flat Wood Edge:	Bullnose Wood Edge:	Beveled Wood Edge:	Horizon Wood Edge:

12'L x 48"W Two Piece Top

0 TAP

HS1248C20	Grade 1 Laminate	\$ 8210	\$ 8338	\$ 8516	\$10,344
	Grade 2 Laminate	\$ 8383	\$ 8511	\$ 8689	\$10,517
	Grade 1 Veneer	\$ 9267	\$ 9395	\$ 9573	\$11,401
	Grade 2 Veneer	\$10,164	\$10,292	\$10,470	\$12,298

1 TAP

HS1248C21	Grade 1 Laminate	\$ 9759	\$ 9887	\$10,065	\$11,893
	Grade 2 Laminate	\$ 9932	\$10,060	\$10,238	\$12,066
	Grade 1 Veneer	\$10,816	\$10,944	\$11,122	\$12,950
	Grade 2 Veneer	\$11,713	\$11,841	\$12,019	\$13,847

2 TAPS

HS1248C22	Grade 1 Laminate	\$11,307	\$11,435	\$11,613	\$13,441
	Grade 2 Laminate	\$11,480	\$11,608	\$11,786	\$13,614
	Grade 1 Veneer	\$12,364	\$12,492	\$12,670	\$14,498
	Grade 2 Veneer	\$13,261	\$13,389	\$13,567	\$15,395

▶ Specification Information, continued on next page

Host Collection

Racetrack Tables with Two Bases
DESIGN F/P DESIGN AND VECTA DESIGN TEAM

SIN 711.11

Tip: Prices shown include top, TAP(s), and slim bases.
▶ See base options for flared bases, page 224



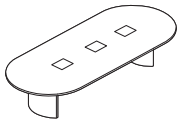
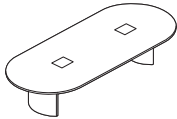
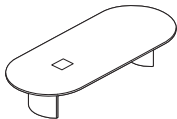
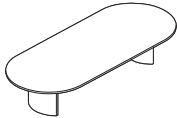

Tip: Last digit of style number indicates number of TAP(s).

Tip: For tech corridor, 12'L tables have four long doors and four short doors.



▶ Specification Information, continued from previous page

Specification Information

Style Number	Finish	Base Prices			
					
		Flat Wood Edge:	Bullnose Wood Edge:	Beveled Wood Edge:	Horizon Wood Edge:

12'L x 60"W One Piece Top

0 TAP

HS1260C10	Grade 1 Laminate	\$ 8003	\$ 8138	\$ 8329	\$10,156
	Grade 2 Laminate	\$ 8219	\$ 8354	\$ 8545	\$10,372
	Grade 1 Veneer	\$ 9579	\$ 9714	\$ 9905	\$11,732
	Grade 2 Veneer	\$10,706	\$10,841	\$11,032	\$12,859

1 TAP

HS1260C11	Grade 1 Laminate	\$ 9552	\$ 9687	\$ 9878	\$11,705
	Grade 2 Laminate	\$ 9768	\$ 9903	\$10,094	\$11,921
	Grade 1 Veneer	\$11,128	\$11,263	\$11,454	\$13,281
	Grade 2 Veneer	\$12,255	\$12,390	\$12,581	\$14,408

2 TAPS

HS1260C12	Grade 1 Laminate	\$11,099	\$11,234	\$11,425	\$13,252
	Grade 2 Laminate	\$11,315	\$11,450	\$11,641	\$13,468
	Grade 1 Veneer	\$12,675	\$12,810	\$13,001	\$14,828
	Grade 2 Veneer	\$13,802	\$13,937	\$14,128	\$15,955

3 TAPS

HS1260C13	Grade 1 Laminate	\$12,648	\$12,783	\$12,974	\$14,801
	Grade 2 Laminate	\$12,864	\$12,999	\$13,190	\$15,017
	Grade 1 Veneer	\$14,224	\$14,359	\$14,550	\$16,377
	Grade 2 Veneer	\$15,351	\$15,486	\$15,677	\$17,504

▶ Specification Information, continued on next page

Host Collection Racetrack Tables with Two Bases *continued*

DESIGN F/P DESIGN AND VECTA DESIGN TEAM

SIN 711.11

Tip: Prices shown include top, TAP(s), and slim bases.
 ▶ See base options for flared bases, page 224



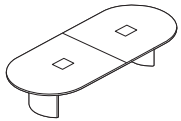
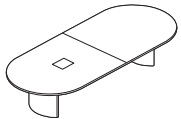
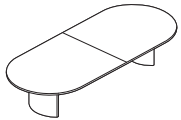

Tip: Last digit of style number indicates number of TAP(s).

Tip: For tech corridor, 12'L tables have four long doors and four short doors.



▶ Specification Information, continued from previous page

Specification Information

Style Number	Finish	Base Prices			
					
		Flat Wood Edge:	Bullnose Wood Edge:	Beveled Wood Edge:	Horizon Wood Edge:

12'L x 60"W Two Piece Top

0 TAP

HS1260C20	Grade 1 Laminate	\$ 8374	\$ 8509	\$ 8700	\$10,527
	Grade 2 Laminate	\$ 8590	\$ 8725	\$ 8916	\$10,743
	Grade 1 Veneer	\$ 9950	\$10,085	\$10,276	\$12,103
	Grade 2 Veneer	\$11,077	\$11,212	\$11,403	\$13,230

1 TAP

HS1260C21	Grade 1 Laminate	\$ 9922	\$10,057	\$10,248	\$12,075
	Grade 2 Laminate	\$10,138	\$10,273	\$10,464	\$12,291
	Grade 1 Veneer	\$11,498	\$11,633	\$11,824	\$13,651
	Grade 2 Veneer	\$12,625	\$12,760	\$12,951	\$14,778

2 TAPS

HS1260C22	Grade 1 Laminate	\$11,470	\$11,605	\$11,796	\$13,623
	Grade 2 Laminate	\$11,686	\$11,821	\$12,012	\$13,839
	Grade 1 Veneer	\$13,046	\$13,181	\$13,372	\$15,199
	Grade 2 Veneer	\$14,173	\$14,308	\$14,499	\$16,326

Coalesse

Host Collection

Racetrack Tables with Two Bases
DESIGN F/P DESIGN AND VECTA DESIGN TEAM

SIN 711.11

Host Collection Racetrack Tables with Three Bases

DESIGN F/P DESIGN AND VECTA DESIGN TEAM

SIN 711.11

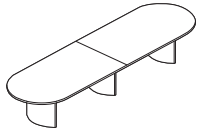

Tip: Shipped knocked down.

Tip: Grain direction for wood-grain laminate runs the length of the table.

Tip: Clips are provided with table: One clip per foot of table length.

Tip: The wood edge on a table top with woodgrain laminate may not match the top.

Tip: You must send a sample of reasonable size for Stain-to-Match.

Standard Includes		Required to Specify
<ul style="list-style-type: none"> ▶ Need help? Product details, see <i>Coalesse Tables, Storage, and Accessories Specification Guide</i> 	<ul style="list-style-type: none"> • Top: 1¼" particle board core with laminate • Flat wood edge • TAP(s), if selected: 10"W x 12"L opening(s) trimmed with a flat solid wood profile and with brushed anodized aluminum TAP doors • Tech corridor: four aluminum beams for top support provide tracks for hinged aluminum doors that clip shut: satin anodized finish • Universal clip: black plastic • Three 27"W bases: wood veneer on MDF with aluminum universal bracket, see below • Concealed leveling glides: non-marring, black plastic 	<ol style="list-style-type: none"> 1 Style number 2 Base selection (see below) and wood color number for base 3 Laminate color number for table top, if selected 4 Wood color number for wood edge <ul style="list-style-type: none"> ▶ See <i>Veneer Matrix</i>, page 365 5 Door color number for storage tray or TAP door, if selected: <ul style="list-style-type: none"> - 8044 Black - 8047 Silver 6 Options, if selected (see below) <ul style="list-style-type: none"> ▶ See <i>Surface Materials</i>, page 350.

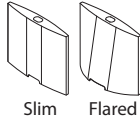
Options	Price	Required to Specify	
Surface Materials <ul style="list-style-type: none"> • Top • Grade 2 laminate • Grade 1 wood veneer • Grade 2 wood veneer • Stain-to-Match 	<ul style="list-style-type: none"> Prices at right Prices at right Prices at right No cost 	<ul style="list-style-type: none"> Specify with <i>Grade 2 laminate</i> and select color number. Specify with <i>Grade 1 wood veneer</i> and select color number. Specify with <i>Grade 2 wood veneer</i> and select color number. Specify with <i>Stain-to-Match</i>. ▶ Page 383 	
Edges <ul style="list-style-type: none"> • Wood • Bullnose wood edge • Beveled wood edge • Horizon wood edge 	<ul style="list-style-type: none"> Prices at right Prices at right Prices at right 	<ul style="list-style-type: none"> Specify with <i>bullnose wood edge</i>. Specify with <i>beveled wood edge</i>. Specify with <i>Horizon wood edge</i>. 	
Bases  <ul style="list-style-type: none"> • Slim • Flared 	<ul style="list-style-type: none"> • Three slim bases • Two slim and one flared bases • One slim and two flared bases • Three flared bases 	<ul style="list-style-type: none"> No cost +\$ 807 +\$1615 +\$2421 	<ul style="list-style-type: none"> Specify with <i>three slim bases</i>. Specify with <i>two slim</i> and one flared bases. Specify with <i>one slim</i> and two flared bases. Specify with <i>three flared bases</i>.

Tip: 14'L and 16'L tables available with zero, one, two, or four TAP(s). 18'L and 20'L tables available with zero, one, two, four, or six TAP(s).

Tip: In addition to the data and audio/video AAPs available from Coalesse, other styles of AAPs are available through Extron Electronics. For an Extron dealer, call 1.800.633.9876.

Tip: See TAP options for electrical systems and faceplate list.

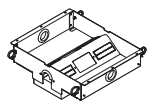
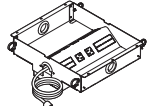
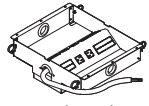
TAP Electrical System with Faceplate Options	Price	Required to Specify
 <ul style="list-style-type: none"> • Field Wired 	<ul style="list-style-type: none"> No cost 	<ul style="list-style-type: none"> Specify with <i>power data</i>, and select TAP type and TAP door color number.
 <ul style="list-style-type: none"> • Cord and Plug 	<ul style="list-style-type: none"> No cost 	<ul style="list-style-type: none"> Specify with <i>power data</i>, and select TAP type and TAP door color number.
 <ul style="list-style-type: none"> • Hardwired 	<ul style="list-style-type: none"> No cost 	<ul style="list-style-type: none"> Specify with <i>power data</i>, and select TAP type and TAP door color number.

▶ Options, continued on next page

Host Collection

Racetrack Tables with Three Bases
DESIGN F/P DESIGN AND VECTA DESIGN TEAM

SIN 711.11

►Options, continued from previous page

Tip: For single TAP style numbers, the modular system tray is not available. Specify the hard-wired tray option.

Tip: If the specified table has multiple TAP(s), any one TAP can be replaced with a storage tray.

Tip: Wood veneer doors for storage tray and TAP will always be cross grain.

Tip: Connectrac must be the same wiring schematic as the table.

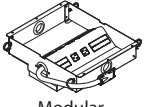
Options	Price	Required to Specify
TAP Electrical System with Faceplate Options  Modular	<ul style="list-style-type: none"> Modular system tray (hardwire base power infeed) <ul style="list-style-type: none"> - PAMH modular system tray with outlets and blank AAPs - PDMH modular system tray with outlets and two data AAPs - PVMH modular system tray with outlets and two of each video/audio and data AAPs +\$138 each tray	Specify with <i>modular power data</i> , and select TAP type and TAP door color number.
Storage Tray	<ul style="list-style-type: none"> Storage tray -\$579	Specify with <i>storage tray</i> and select door color number.
Doors	<ul style="list-style-type: none"> Storage tray wood veneer doors TAP wood veneer doors +\$291 per door +\$291 per door	Specify with <i>wood doors</i> . Specify with <i>wood doors</i> .
Related Products	<ul style="list-style-type: none"> Floor kit: Connectrac Corridor shelf 	► Page 283 ► Page 283

TAP Locations

14'L x 48"W TAP Locations—Two piece top

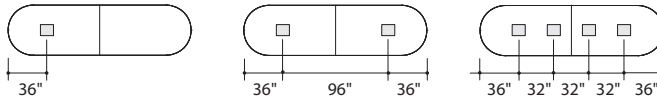

14'L x 48"W TAP Locations—Three piece top

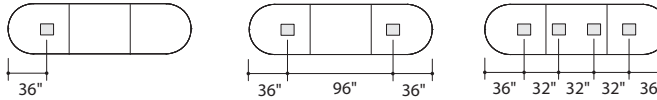

14'L x 60"W TAP Locations—Two piece top

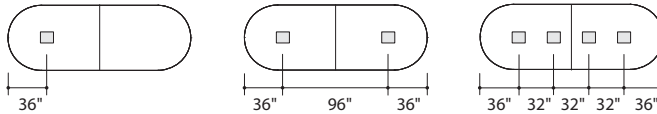

14'L x 60"W TAP Locations—Three piece top

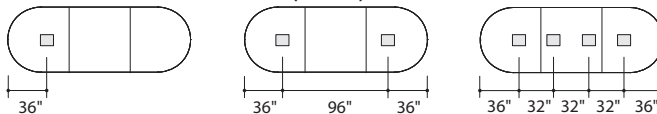

►Options, continued on next page

Host Collection

Racetrack Tables with Three Bases *continued*
DESIGN F/P DESIGN AND VECTA DESIGN TEAM

SIN 711.11

► Options, continued from previous page

TAP Locations

16'L x 48"W TAP Locations—Two piece top

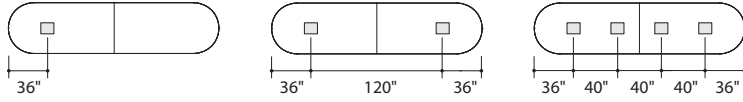

16'L x 48"W TAP Locations—Three piece top

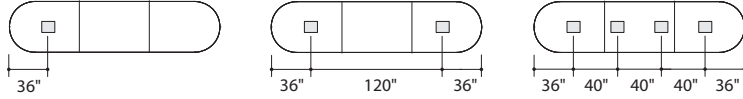

16'L x 60"W TAP Locations—Two piece top

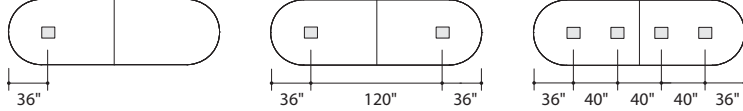

16'L x 60"W TAP Locations—Three piece top

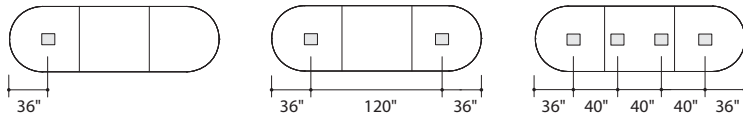

18'L x 48"W TAP Locations—Two piece top

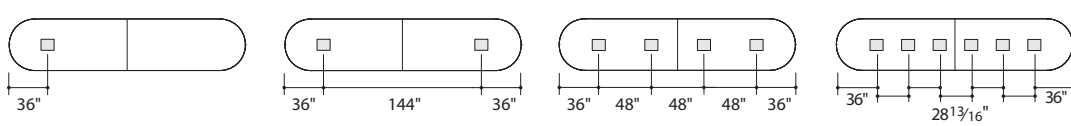

18'L x 48"W TAP Locations—Three piece top

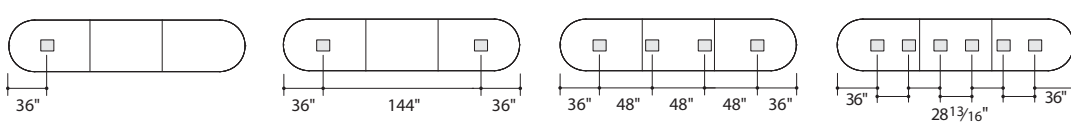

18'L x 60"W TAP Locations—Two piece top

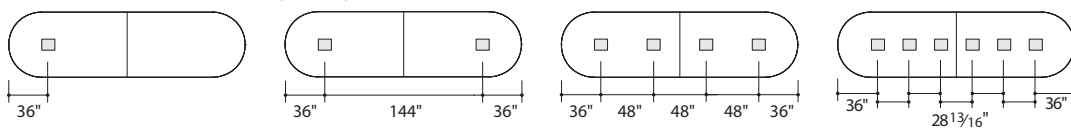

18'L x 60"W TAP Locations—Three piece top

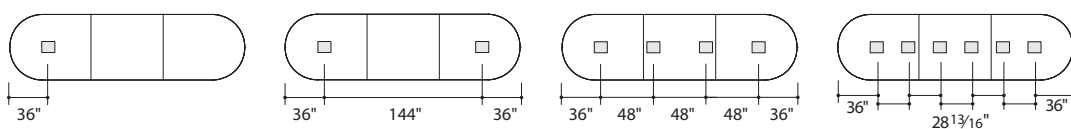

► Options, continued on next page

Host Collection

Racetrack Tables with Three Bases
DESIGN F/P DESIGN AND VECTA DESIGN TEAM

SIN 711.11

► Options, continued from previous page

TAP Locations

20'L x 48"W TAP Locations—Two piece top

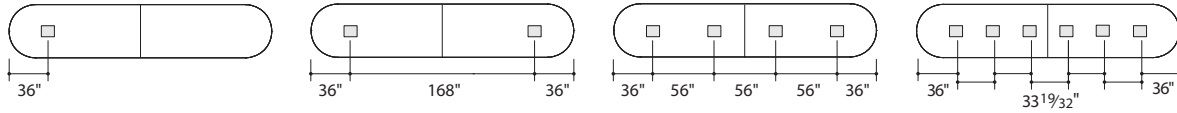

20'L x 48"W TAP Locations—Three piece top

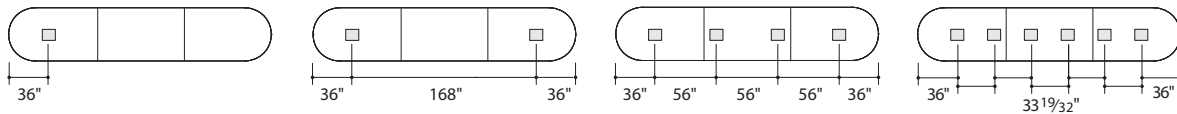

20'L x 60"W TAP Locations—Two piece top

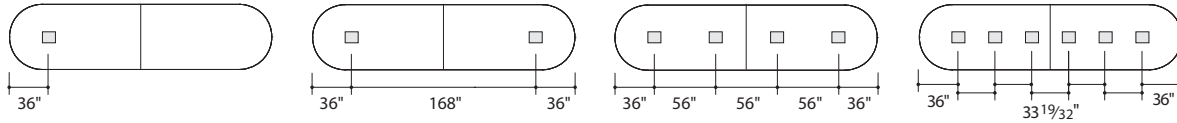

20'L x 60"W TAP Locations—Three piece top

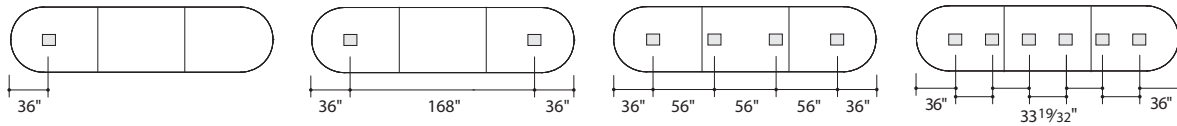

► Specification Information, on next page

Host Collection

Racetrack Tables with Three Bases *continued*
 DESIGN F/P DESIGN AND VECTA DESIGN TEAM

SIN 711.11

Tip: Prices shown include top, TAP(s), and slim bases.
 ▶ See base options for flared bases, page 236



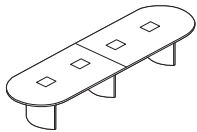
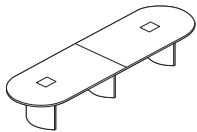
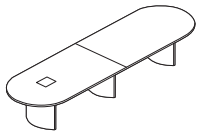
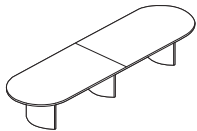

Tip: Last digit of style number indicates number of TAP(s).

Tip: For tech corridor, 14'L tables have four long doors and four short doors.



▶ Options, on previous page

Specification Information

Style Number	Finish	Base Prices			
					
		Flat Wood Edge:	Bullnose Wood Edge:	Beveled Wood Edge:	Horizon Wood Edge:

14'L x 48"W Two Piece Top

0 TAP

HS1448C20	Grade 1 Laminate	\$10,614	\$10,760	\$10,957	\$12,788
	Grade 2 Laminate	\$10,817	\$10,963	\$11,160	\$12,991
	Grade 1 Veneer	\$12,031	\$12,177	\$12,374	\$14,205
	Grade 2 Veneer	\$13,080	\$13,226	\$13,423	\$15,254

1 TAP

HS1448C21	Grade 1 Laminate	\$12,160	\$12,306	\$12,503	\$14,334
	Grade 2 Laminate	\$12,363	\$12,509	\$12,706	\$14,537
	Grade 1 Veneer	\$13,577	\$13,723	\$13,920	\$15,751
	Grade 2 Veneer	\$14,626	\$14,772	\$14,969	\$16,800

2 TAPS

HS1448C22	Grade 1 Laminate	\$13,710	\$13,856	\$14,053	\$15,884
	Grade 2 Laminate	\$13,913	\$14,059	\$14,256	\$16,087
	Grade 1 Veneer	\$15,127	\$15,273	\$15,470	\$17,301
	Grade 2 Veneer	\$16,176	\$16,322	\$16,519	\$18,350

4 TAPS

HS1448C24	Grade 1 Laminate	\$16,808	\$16,954	\$17,151	\$18,982
	Grade 2 Laminate	\$17,011	\$17,157	\$17,354	\$19,185
	Grade 1 Veneer	\$18,225	\$18,371	\$18,568	\$20,399
	Grade 2 Veneer	\$19,274	\$19,420	\$19,617	\$21,448

▶ Specification Information, continued on next page

Host Collection

Racetrack Tables with Three Bases
DESIGN F/P DESIGN AND VECTA DESIGN TEAM

SIN 711.11

Tip: Prices shown include top, TAP(s), and slim bases.
► See base options for flared bases, page 236



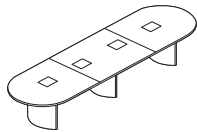
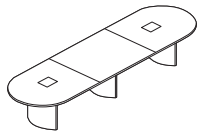
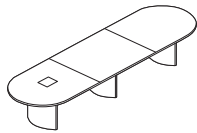
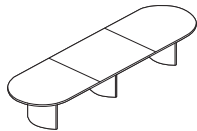

Tip: Last digit of style number indicates number of TAP(s).

Tip: For tech corridor, 14'L tables have four long doors and four short doors.



► Specification Information, continued from previous page

Specification Information

Style Number	Finish	Base Prices			
					
		Flat Wood Edge:	Bullnose Wood Edge:	Beveled Wood Edge:	Horizon Wood Edge:

14'L x 48"W Three Piece Top

0 TAP

HS1448C30	Grade 1 Laminate	\$10,984	\$11,130	\$11,327	\$13,158
	Grade 2 Laminate	\$11,187	\$11,333	\$11,530	\$13,361
	Grade 1 Veneer	\$12,401	\$12,547	\$12,744	\$14,575
	Grade 2 Veneer	\$13,450	\$13,596	\$13,793	\$15,624

1 TAP

HS1448C31	Grade 1 Laminate	\$12,532	\$12,678	\$12,875	\$14,706
	Grade 2 Laminate	\$12,735	\$12,881	\$13,078	\$14,909
	Grade 1 Veneer	\$13,949	\$14,095	\$14,292	\$16,123
	Grade 2 Veneer	\$14,998	\$15,144	\$15,341	\$17,172

2 TAPS

HS1448C32	Grade 1 Laminate	\$14,081	\$14,227	\$14,424	\$16,255
	Grade 2 Laminate	\$14,284	\$14,430	\$14,627	\$16,458
	Grade 1 Veneer	\$15,498	\$15,644	\$15,841	\$17,672
	Grade 2 Veneer	\$16,547	\$16,693	\$16,890	\$18,721

4 TAPS

HS1448C34	Grade 1 Laminate	\$17,177	\$17,323	\$17,520	\$19,351
	Grade 2 Laminate	\$17,380	\$17,526	\$17,723	\$19,554
	Grade 1 Veneer	\$18,594	\$18,740	\$18,937	\$20,768
	Grade 2 Veneer	\$19,643	\$19,789	\$19,986	\$21,817

► Specification Information, continued on next page

Host Collection Racetrack Tables with Three Bases *continued*

DESIGN F/P DESIGN AND VECTA DESIGN TEAM

SIN 711.11

Tip: Prices shown include top, TAP(s), and slim bases.
 ▶ See base options for flared bases, page 236



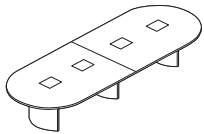
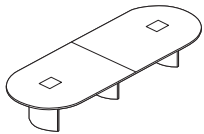
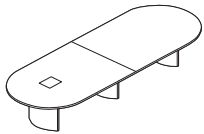
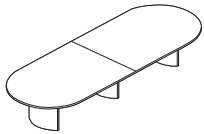

Tip: Last digit of style number indicates number of TAP(s).

Tip: For tech corridor, 14'L tables have four long doors and four short doors.



▶ Specification Information, continued from previous page

Specification Information

Style Number	Finish	Base Prices			
					
		Flat Wood Edge:	Bullnose Wood Edge:	Beveled Wood Edge:	Horizon Wood Edge:

14'L x 60"W Two Piece Top

0 TAP

HS1460C20	Grade 1 Laminate	\$11,030	\$11,182	\$11,393	\$13,224
	Grade 2 Laminate	\$11,284	\$11,436	\$11,647	\$13,478
	Grade 1 Veneer	\$13,397	\$13,549	\$13,760	\$15,591
	Grade 2 Veneer	\$14,726	\$14,878	\$15,089	\$16,920

1 TAP

HS1460C21	Grade 1 Laminate	\$12,580	\$12,732	\$12,943	\$14,774
	Grade 2 Laminate	\$12,834	\$12,986	\$13,197	\$15,028
	Grade 1 Veneer	\$14,947	\$15,099	\$15,310	\$17,141
	Grade 2 Veneer	\$16,276	\$16,428	\$16,639	\$18,470

2 TAPS

HS1460C22	Grade 1 Laminate	\$14,128	\$14,280	\$14,491	\$16,322
	Grade 2 Laminate	\$14,382	\$14,534	\$14,745	\$16,576
	Grade 1 Veneer	\$16,495	\$16,647	\$16,858	\$18,689
	Grade 2 Veneer	\$17,824	\$17,976	\$18,187	\$20,018

4 TAPS

HS1460C24	Grade 1 Laminate	\$17,224	\$17,376	\$17,587	\$19,418
	Grade 2 Laminate	\$17,478	\$17,630	\$17,841	\$19,672
	Grade 1 Veneer	\$19,591	\$19,743	\$19,954	\$21,785
	Grade 2 Veneer	\$20,920	\$21,072	\$21,283	\$23,114

▶ Specification Information, continued on next page

Host Collection Racetrack Tables with Three Bases

DESIGN F/P DESIGN AND VECTA DESIGN TEAM

SIN 711.11

Tip: Prices shown include top, TAP(s), and slim bases.
 ▶ See base options for flared bases, page 236



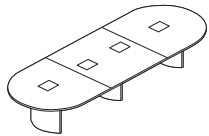
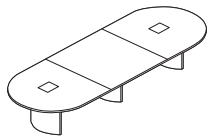
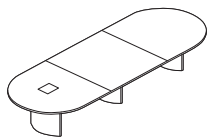
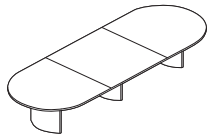

Tip: Last digit of style number indicates number of TAP(s).

Tip: For tech corridor, 14'L tables have four long doors and four short doors.



▶ Specification Information, continued from previous page

Specification Information

Style Number	Finish	Base Prices			
					
		Flat Wood Edge:	Bullnose Wood Edge:	Beveled Wood Edge:	Horizon Wood Edge:

14'L x 60"W Three Piece Top

0 TAP					
HS1460C30	Grade 1 Laminate	\$11,402	\$11,554	\$11,765	\$13,596
	Grade 2 Laminate	\$11,656	\$11,808	\$12,019	\$13,850
	Grade 1 Veneer	\$13,769	\$13,921	\$14,132	\$15,963
	Grade 2 Veneer	\$15,098	\$15,250	\$15,461	\$17,292
1 TAP					
HS1460C31	Grade 1 Laminate	\$12,949	\$13,101	\$13,312	\$15,143
	Grade 2 Laminate	\$13,203	\$13,355	\$13,566	\$15,397
	Grade 1 Veneer	\$15,316	\$15,468	\$15,679	\$17,510
	Grade 2 Veneer	\$16,645	\$16,797	\$17,008	\$18,839
2 TAPS					
HS1460C32	Grade 1 Laminate	\$14,498	\$14,650	\$14,861	\$16,692
	Grade 2 Laminate	\$14,752	\$14,904	\$15,115	\$16,946
	Grade 1 Veneer	\$16,865	\$17,017	\$17,228	\$19,059
	Grade 2 Veneer	\$18,194	\$18,346	\$18,557	\$20,388
4 TAPS					
HS1460C34	Grade 1 Laminate	\$17,596	\$17,748	\$17,959	\$19,790
	Grade 2 Laminate	\$17,850	\$18,002	\$18,213	\$20,044
	Grade 1 Veneer	\$19,963	\$20,115	\$20,326	\$22,157
	Grade 2 Veneer	\$21,292	\$21,444	\$21,655	\$23,486

▶ Specification Information, continued on next page

Host Collection Racetrack Tables with Three Bases *continued*

DESIGN F/P DESIGN AND VECTA DESIGN TEAM

SIN 711.11

Tip: Prices shown include top, TAP(s), and slim bases.
 ▶ See base options for flared bases, page 236



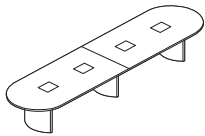
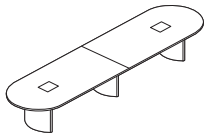
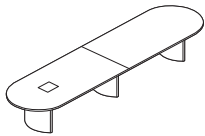
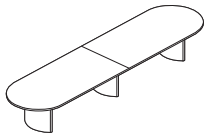

Tip: Last digit of style number indicates number of TAP(s).

Tip: For tech corridor, 16'L tables have eight long doors and four short doors.



▶ Specification Information, continued from previous page

Specification Information

Style Number	Finish	Base Prices			
					
		Flat Wood Edge:	Bullnose Wood Edge:	Beveled Wood Edge:	Horizon Wood Edge:

16'L x 48''W Two Piece Top

0 TAP					
HS1648C20	Grade 1 Laminate	\$11,103	\$11,262	\$11,484	\$13,315
	Grade 2 Laminate	\$11,334	\$11,493	\$11,715	\$13,546
	Grade 1 Veneer	\$12,551	\$12,710	\$12,932	\$14,763
	Grade 2 Veneer	\$13,745	\$13,904	\$14,126	\$15,957
1 TAP					
HS1648C21	Grade 1 Laminate	\$12,651	\$12,810	\$13,032	\$14,863
	Grade 2 Laminate	\$12,882	\$13,041	\$13,263	\$15,094
	Grade 1 Veneer	\$14,099	\$14,258	\$14,480	\$16,311
	Grade 2 Veneer	\$15,293	\$15,452	\$15,674	\$17,505
2 TAPS					
HS1648C22	Grade 1 Laminate	\$14,199	\$14,358	\$14,580	\$16,411
	Grade 2 Laminate	\$14,430	\$14,589	\$14,811	\$16,642
	Grade 1 Veneer	\$15,647	\$15,806	\$16,028	\$17,859
	Grade 2 Veneer	\$16,841	\$17,000	\$17,222	\$19,053
4 TAPS					
HS1648C24	Grade 1 Laminate	\$17,295	\$17,454	\$17,676	\$19,507
	Grade 2 Laminate	\$17,526	\$17,685	\$17,907	\$19,738
	Grade 1 Veneer	\$18,743	\$18,902	\$19,124	\$20,955
	Grade 2 Veneer	\$19,937	\$20,096	\$20,318	\$22,149

▶ Specification Information, continued on next page

Host Collection

Racetrack Tables with Three Bases
DESIGN F/P DESIGN AND VECTA DESIGN TEAM

SIN 711.11

Tip: Prices shown include top, TAP(s), and slim bases.
▶ See base options for flared bases, page 236

Tip: Last digit of style number indicates number of TAP(s).

Tip: For tech corridor, 16'L tables have eight long doors and four short doors.

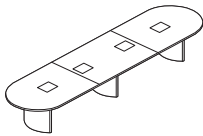
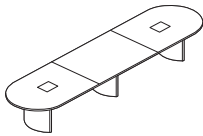
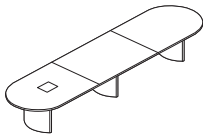
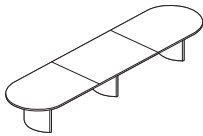

▶ Specification Information, continued from previous page

Specification Information

Style Number	Finish	Base Prices			
		Flat Wood Edge:	Bullnose Wood Edge:	Beveled Wood Edge:	Horizon Wood Edge:

16'L x 48"W Three Piece Top

0 TAP

Style Number	Finish	Flat Wood Edge	Bullnose Wood Edge	Beveled Wood Edge	Horizon Wood Edge
HS1648C30	Grade 1 Laminate	\$11,473	\$11,632	\$11,854	\$13,685
	Grade 2 Laminate	\$11,704	\$11,863	\$12,085	\$13,916
	Grade 1 Veneer	\$12,921	\$13,080	\$13,302	\$15,133
	Grade 2 Veneer	\$14,115	\$14,274	\$14,496	\$16,327

1 TAP

Style Number	Finish	Flat Wood Edge	Bullnose Wood Edge	Beveled Wood Edge	Horizon Wood Edge
HS1648C31	Grade 1 Laminate	\$13,022	\$13,181	\$13,403	\$15,234
	Grade 2 Laminate	\$13,253	\$13,412	\$13,634	\$15,465
	Grade 1 Veneer	\$14,470	\$14,629	\$14,851	\$16,682
	Grade 2 Veneer	\$15,664	\$15,823	\$16,045	\$17,876

2 TAPS

Style Number	Finish	Flat Wood Edge	Bullnose Wood Edge	Beveled Wood Edge	Horizon Wood Edge
HS1648C32	Grade 1 Laminate	\$14,571	\$14,730	\$14,952	\$16,783
	Grade 2 Laminate	\$14,802	\$14,961	\$15,183	\$17,014
	Grade 1 Veneer	\$16,019	\$16,178	\$16,400	\$18,231
	Grade 2 Veneer	\$17,213	\$17,372	\$17,594	\$19,425

4 TAPS

Style Number	Finish	Flat Wood Edge	Bullnose Wood Edge	Beveled Wood Edge	Horizon Wood Edge
HS1648C34	Grade 1 Laminate	\$17,667	\$17,826	\$18,048	\$19,879
	Grade 2 Laminate	\$17,898	\$18,057	\$18,279	\$20,110
	Grade 1 Veneer	\$19,115	\$19,274	\$19,496	\$21,327
	Grade 2 Veneer	\$20,309	\$20,468	\$20,690	\$22,521

▶ Specification Information, continued on next page

Host Collection

Racetrack Tables with Three Bases *continued*
 DESIGN F/P DESIGN AND VECTA DESIGN TEAM

SIN 711.11

Tip: Prices shown include top, TAP(s), and slim bases.
 ▶ See base options for flared bases, page 236



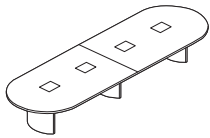
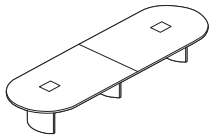
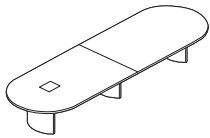
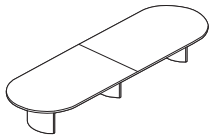

Tip: Last digit of style number indicates number of TAP(s).

Tip: For tech corridor, 16'L tables have eight long doors and four short doors.



▶ Specification Information, continued from previous page

Specification Information

Style Number	Finish	Base Prices			
					
		Flat Wood Edge:	Bullnose Wood Edge:	Beveled Wood Edge:	Horizon Wood Edge:

16'L x 60"W Two Piece Top

0 TAP

HS1660C20	Grade 1 Laminate	\$11,520	\$11,688	\$11,920	\$13,756
	Grade 2 Laminate	\$11,808	\$11,976	\$12,208	\$14,044
	Grade 1 Veneer	\$13,917	\$14,085	\$14,317	\$16,153
	Grade 2 Veneer	\$15,429	\$15,597	\$15,829	\$17,665

1 TAP

HS1660C21	Grade 1 Laminate	\$13,068	\$13,236	\$13,468	\$15,304
	Grade 2 Laminate	\$13,356	\$13,524	\$13,756	\$15,592
	Grade 1 Veneer	\$15,465	\$15,633	\$15,865	\$17,701
	Grade 2 Veneer	\$16,977	\$17,145	\$17,377	\$19,213

2 TAPS

HS1660C22	Grade 1 Laminate	\$14,616	\$14,784	\$15,016	\$16,852
	Grade 2 Laminate	\$14,904	\$15,072	\$15,304	\$17,140
	Grade 1 Veneer	\$17,013	\$17,181	\$17,413	\$19,249
	Grade 2 Veneer	\$18,525	\$18,693	\$18,925	\$20,761

4 TAPS

HS1660C24	Grade 1 Laminate	\$17,714	\$17,882	\$18,114	\$19,950
	Grade 2 Laminate	\$18,002	\$18,170	\$18,402	\$20,238
	Grade 1 Veneer	\$20,111	\$20,279	\$20,511	\$22,347
	Grade 2 Veneer	\$21,623	\$21,791	\$22,023	\$23,859

▶ Specification Information, continued on next page

Host Collection

Racetrack Tables with Three Bases
DESIGN F/P DESIGN AND VECTA DESIGN TEAM

SIN 711.11

Tip: Prices shown include top, TAP(s), and slim bases.
▶ See base options for flared bases, page 236



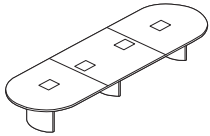
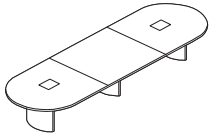
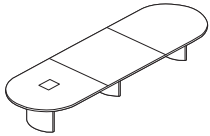
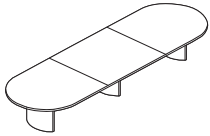

Tip: Last digit of style number indicates number of TAP(s).

Tip: For tech corridor, 16'L tables have eight long doors and four short doors.



▶ Specification Information, continued from previous page

Specification Information

Style Number	Finish	Base Prices			
					
		Flat Wood Edge:	Bullnose Wood Edge:	Beveled Wood Edge:	Horizon Wood Edge:

16'L x 60"W Three Piece Top

0 TAP

HS1660C30	Grade 1 Laminate	\$11,890	\$12,058	\$12,290	\$14,126
	Grade 2 Laminate	\$12,178	\$12,346	\$12,578	\$14,414
	Grade 1 Veneer	\$14,287	\$14,455	\$14,687	\$16,523
	Grade 2 Veneer	\$15,799	\$15,967	\$16,199	\$18,035

1 TAP

HS1660C31	Grade 1 Laminate	\$13,439	\$13,607	\$13,839	\$15,675
	Grade 2 Laminate	\$13,727	\$13,895	\$14,127	\$15,963
	Grade 1 Veneer	\$15,836	\$16,004	\$16,236	\$18,072
	Grade 2 Veneer	\$17,348	\$17,516	\$17,748	\$19,584

2 TAPS

HS1660C32	Grade 1 Laminate	\$14,988	\$15,156	\$15,388	\$17,224
	Grade 2 Laminate	\$15,276	\$15,444	\$15,676	\$17,512
	Grade 1 Veneer	\$17,385	\$17,553	\$17,785	\$19,621
	Grade 2 Veneer	\$18,897	\$19,065	\$19,297	\$21,133

4TAPS

HS1660C34	Grade 1 Laminate	\$18,086	\$18,254	\$18,486	\$20,322
	Grade 2 Laminate	\$18,374	\$18,542	\$18,774	\$20,610
	Grade 1 Veneer	\$20,483	\$20,651	\$20,883	\$22,719
	Grade 2 Veneer	\$21,995	\$22,163	\$22,395	\$24,231

▶ Specification Information, continued on next page

Host Collection Racetrack Tables with Three Bases continued

DESIGN F/P DESIGN AND VECTA DESIGN TEAM

SIN 711.11

Tip: Prices shown include top, TAP(s), and slim bases.
 ▶ See base options for flared bases, page 236



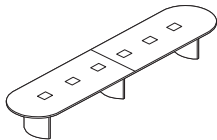
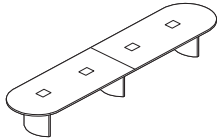
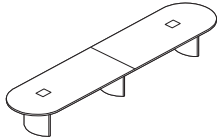
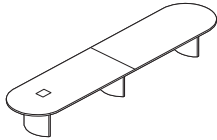
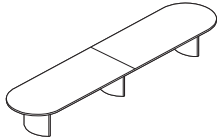

Tip: Last digit of style number indicates number of TAP(s).

Tip: For tech corridor, 18'L tables have eight long doors and four short doors.



► Specification Information, continued from previous page

Specification Information

Style Number	Finish	Base Prices			
					
		Flat Wood Edge:	Bullnose Wood Edge:	Beveled Wood Edge:	Horizon Wood Edge:

18'L x 48"W Two Piece Top

0 TAP

HS1848C20	Grade 1 Laminate	\$11,842	\$12,017	\$12,259	\$14,115
	Grade 2 Laminate	\$12,102	\$12,277	\$12,519	\$14,375
	Grade 1 Veneer	\$13,634	\$13,809	\$14,051	\$15,907
	Grade 2 Veneer	\$14,983	\$15,158	\$15,400	\$17,256

1 TAP

HS1848C21	Grade 1 Laminate	\$13,390	\$13,565	\$13,807	\$15,663
	Grade 2 Laminate	\$13,650	\$13,825	\$14,067	\$15,923
	Grade 1 Veneer	\$15,182	\$15,357	\$15,599	\$17,455
	Grade 2 Veneer	\$16,531	\$16,706	\$16,948	\$18,804

2 TAPS

HS1848C22	Grade 1 Laminate	\$14,938	\$15,113	\$15,355	\$17,211
	Grade 2 Laminate	\$15,198	\$15,373	\$15,615	\$17,471
	Grade 1 Veneer	\$16,730	\$16,905	\$17,147	\$19,003
	Grade 2 Veneer	\$18,079	\$18,254	\$18,496	\$20,352

4 TAPS

HS1848C24	Grade 1 Laminate	\$18,036	\$18,211	\$18,453	\$20,309
	Grade 2 Laminate	\$18,296	\$18,471	\$18,713	\$20,569
	Grade 1 Veneer	\$19,828	\$20,003	\$20,245	\$22,101
	Grade 2 Veneer	\$21,177	\$21,352	\$21,594	\$23,450

6 TAPS

HS1848C26	Grade 1 Laminate	\$21,133	\$21,308	\$21,550	\$23,406
	Grade 2 Laminate	\$21,393	\$21,568	\$21,810	\$23,666
	Grade 1 Veneer	\$22,925	\$23,100	\$23,342	\$25,198
	Grade 2 Veneer	\$24,274	\$24,449	\$24,691	\$26,547

► Specification Information, continued on next page

Host Collection Racetrack Tables with Three Bases

DESIGN F/P DESIGN AND VECTA DESIGN TEAM

SIN 711.11

Tip: Prices shown include top, TAP(s), and slim bases.
 ▶ See base options for flared bases, page 236

Tip: Last digit of style number indicates number of TAP(s).

Tip: For tech corridor, 18'L tables have eight long doors and four short doors.

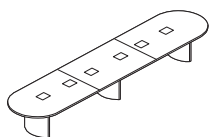
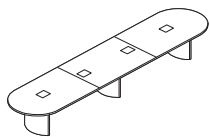
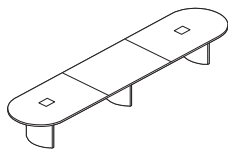
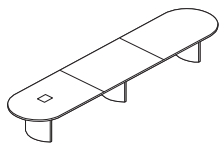
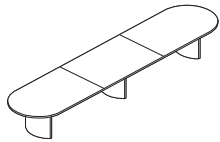

▶ Specification Information, continued from previous page

Specification Information

Style Number	Finish	Base Prices			
		Flat Wood Edge:	Bullnose Wood Edge:	Beveled Wood Edge:	Horizon Wood Edge:

18'L x 48"W Three Piece Top

0 TAP					
HS1848C30	Grade 1 Laminate	\$12,212	\$12,387	\$12,629	\$14,485
	Grade 2 Laminate	\$12,472	\$12,647	\$12,889	\$14,745
	Grade 1 Veneer	\$14,004	\$14,179	\$14,421	\$16,277
	Grade 2 Veneer	\$15,353	\$15,528	\$15,770	\$17,626
1 TAP					
HS1848C31	Grade 1 Laminate	\$13,761	\$13,936	\$14,178	\$16,034
	Grade 2 Laminate	\$14,021	\$14,196	\$14,438	\$16,294
	Grade 1 Veneer	\$15,553	\$15,728	\$15,970	\$17,826
	Grade 2 Veneer	\$16,902	\$17,077	\$17,319	\$19,175
2 TAPS					
HS1848C32	Grade 1 Laminate	\$15,310	\$15,485	\$15,727	\$17,583
	Grade 2 Laminate	\$15,570	\$15,745	\$15,987	\$17,843
	Grade 1 Veneer	\$17,102	\$17,277	\$17,519	\$19,375
	Grade 2 Veneer	\$18,451	\$18,626	\$18,868	\$20,724
4 TAPS					
HS1848C34	Grade 1 Laminate	\$18,407	\$18,582	\$18,824	\$20,680
	Grade 2 Laminate	\$18,667	\$18,842	\$19,084	\$20,940
	Grade 1 Veneer	\$20,199	\$20,374	\$20,616	\$22,472
	Grade 2 Veneer	\$21,548	\$21,723	\$21,965	\$23,821
6 TAPS					
HS1848C36	Grade 1 Laminate	\$21,503	\$21,678	\$21,920	\$23,776
	Grade 2 Laminate	\$21,763	\$21,938	\$22,180	\$24,036
	Grade 1 Veneer	\$23,295	\$23,470	\$23,712	\$25,568
	Grade 2 Veneer	\$24,644	\$24,819	\$25,061	\$26,917

▶ Specification Information, continued on next page

Host Collection Racetrack Tables with Three Bases continued

DESIGN F/P DESIGN AND VECTA DESIGN TEAM

SIN 711.11

Tip: Prices shown include top, TAP(s), and slim bases.
 ▶ See base options for flared bases, page 236



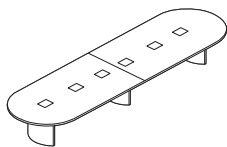
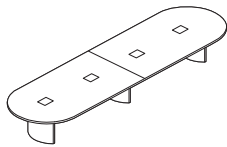
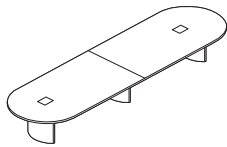
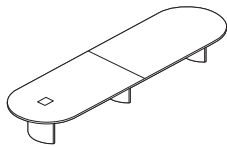
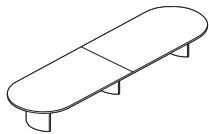

Tip: Last digit of style number indicates number of TAP(s).

Tip: For tech corridor, 18'L tables have eight long doors and four short doors.



▶ Specification Information, continued from previous page

Specification Information

Style Number	Finish	Base Prices			
					
		Flat Wood Edge:	Bullnose Wood Edge:	Beveled Wood Edge:	Horizon Wood Edge:

18'L x 60"W Two Piece Top

0 TAP

HS1860C20	Grade 1 Laminate	\$12,044	\$12,225	\$12,481	\$14,335
	Grade 2 Laminate	\$12,369	\$12,550	\$12,806	\$14,660
	Grade 1 Veneer	\$15,172	\$15,353	\$15,609	\$17,463
	Grade 2 Veneer	\$16,884	\$17,065	\$17,321	\$19,175

1 TAP

HS1860C21	Grade 1 Laminate	\$13,594	\$13,775	\$14,031	\$15,885
	Grade 2 Laminate	\$13,919	\$14,100	\$14,356	\$16,210
	Grade 1 Veneer	\$16,722	\$16,903	\$17,159	\$19,013
	Grade 2 Veneer	\$18,434	\$18,615	\$18,871	\$20,725

2 TAPS

HS1860C22	Grade 1 Laminate	\$15,142	\$15,323	\$15,579	\$17,433
	Grade 2 Laminate	\$15,467	\$15,648	\$15,904	\$17,758
	Grade 1 Veneer	\$18,270	\$18,451	\$18,707	\$20,561
	Grade 2 Veneer	\$19,982	\$20,163	\$20,419	\$22,273

4 TAPS

HS1860C24	Grade 1 Laminate	\$18,238	\$18,419	\$18,675	\$20,529
	Grade 2 Laminate	\$18,563	\$18,744	\$19,000	\$20,854
	Grade 1 Veneer	\$21,366	\$21,547	\$21,803	\$23,657
	Grade 2 Veneer	\$23,078	\$23,259	\$23,515	\$25,369

6 TAPS

HS1860C26	Grade 1 Laminate	\$21,336	\$21,517	\$21,773	\$23,627
	Grade 2 Laminate	\$21,661	\$21,842	\$22,098	\$23,952
	Grade 1 Veneer	\$24,464	\$24,645	\$24,901	\$26,755
	Grade 2 Veneer	\$26,176	\$26,357	\$26,613	\$28,467

▶ Specification Information, continued on next page

Host Collection Racetrack Tables with Three Bases

DESIGN F/P DESIGN AND VECTA DESIGN TEAM

SIN 711.11

Tip: Prices shown include top, TAP(s), and slim bases.
 ▶ See base options for flared bases, page 236

Tip: Last digit of style number indicates number of TAP(s).

Tip: For tech corridor, 18'L tables have eight long doors and four short doors.

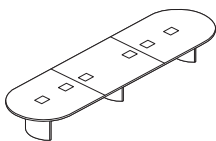
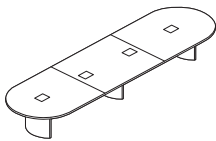
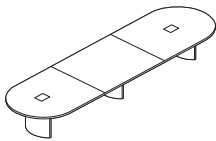
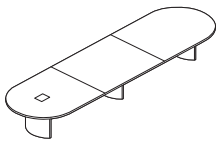
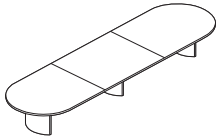

▶ Specification Information, continued from previous page

Specification Information

Style Number	Finish	Base Prices			
		Flat Wood Edge:	Bullnose Wood Edge:	Beveled Wood Edge:	Horizon Wood Edge:

18'L x 60"W Three Piece Top

0 TAP

Style Number	Finish	Flat Wood Edge	Bullnose Wood Edge	Beveled Wood Edge	Horizon Wood Edge
HS1860C30	Grade 1 Laminate	\$12,416	\$12,597	\$12,853	\$14,707
	Grade 2 Laminate	\$12,741	\$12,922	\$13,178	\$15,032
	Grade 1 Veneer	\$15,544	\$15,725	\$15,981	\$17,835
	Grade 2 Veneer	\$17,256	\$17,437	\$17,693	\$19,547

1 TAP

Style Number	Finish	Flat Wood Edge	Bullnose Wood Edge	Beveled Wood Edge	Horizon Wood Edge
HS1860C31	Grade 1 Laminate	\$13,964	\$14,145	\$14,401	\$16,255
	Grade 2 Laminate	\$14,289	\$14,470	\$14,726	\$16,580
	Grade 1 Veneer	\$17,092	\$17,273	\$17,529	\$19,383
	Grade 2 Veneer	\$18,804	\$18,985	\$19,241	\$21,095

2 TAPS

Style Number	Finish	Flat Wood Edge	Bullnose Wood Edge	Beveled Wood Edge	Horizon Wood Edge
HS1860C32	Grade 1 Laminate	\$15,513	\$15,694	\$15,950	\$17,804
	Grade 2 Laminate	\$15,838	\$16,019	\$16,275	\$18,129
	Grade 1 Veneer	\$18,641	\$18,822	\$19,078	\$20,932
	Grade 2 Veneer	\$20,353	\$20,534	\$20,790	\$22,644

4 TAPS

Style Number	Finish	Flat Wood Edge	Bullnose Wood Edge	Beveled Wood Edge	Horizon Wood Edge
HS1860C34	Grade 1 Laminate	\$18,610	\$18,791	\$19,047	\$20,901
	Grade 2 Laminate	\$18,935	\$19,116	\$19,372	\$21,226
	Grade 1 Veneer	\$21,738	\$21,919	\$22,175	\$24,029
	Grade 2 Veneer	\$23,450	\$23,631	\$23,887	\$25,741

6 TAPS

Style Number	Finish	Flat Wood Edge	Bullnose Wood Edge	Beveled Wood Edge	Horizon Wood Edge
HS1860C36	Grade 1 Laminate	\$21,707	\$21,888	\$22,144	\$23,998
	Grade 2 Laminate	\$22,032	\$22,213	\$22,469	\$24,323
	Grade 1 Veneer	\$24,835	\$25,016	\$25,272	\$27,126
	Grade 2 Veneer	\$26,547	\$26,728	\$26,984	\$28,838

▶ Specification Information, continued on next page

Host Collection

Racetrack Tables with Three Bases *continued*
 DESIGN F/P DESIGN AND VECTA DESIGN TEAM

SIN 711.11

Tip: Prices shown include top, TAP(s), and slim bases.
 ▶ See base options for flared bases, page 236



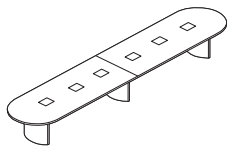
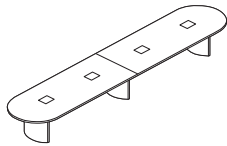
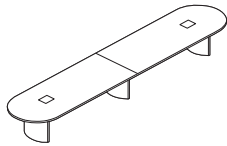
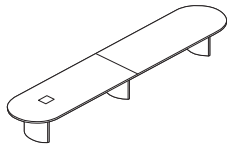
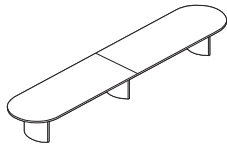

Tip: Last digit of style number indicates number of TAP(s).

Tip: For tech corridor, 20'L tables have eight long doors and four short doors.



▶ Specification Information, continued from previous page

Specification Information

Style Number	Finish	Base Prices			
					
		Flat Wood Edge:	Bullnose Wood Edge:	Beveled Wood Edge:	Horizon Wood Edge:

20'L x 48''W Two Piece Top

0 TAP

HS2048C20	Grade 1 Laminate	\$12,332	\$12,523	\$12,787	\$14,642
	Grade 2 Laminate	\$12,620	\$12,811	\$13,075	\$14,930
	Grade 1 Veneer	\$14,157	\$14,348	\$14,612	\$16,467
	Grade 2 Veneer	\$15,649	\$15,840	\$16,104	\$17,959

1 TAP

HS2048C21	Grade 1 Laminate	\$13,880	\$14,071	\$14,335	\$16,190
	Grade 2 Laminate	\$14,168	\$14,359	\$14,623	\$16,478
	Grade 1 Veneer	\$15,705	\$15,896	\$16,160	\$18,015
	Grade 2 Veneer	\$17,197	\$17,388	\$17,652	\$19,507

2 TAPS

HS2048C22	Grade 1 Laminate	\$15,429	\$15,620	\$15,884	\$17,739
	Grade 2 Laminate	\$15,717	\$15,908	\$16,172	\$18,027
	Grade 1 Veneer	\$17,254	\$17,445	\$17,709	\$19,564
	Grade 2 Veneer	\$18,746	\$18,937	\$19,201	\$21,056

4 TAPS

HS2048C24	Grade 1 Laminate	\$18,527	\$18,718	\$18,982	\$20,837
	Grade 2 Laminate	\$18,815	\$19,006	\$19,270	\$21,125
	Grade 1 Veneer	\$20,352	\$20,543	\$20,807	\$22,662
	Grade 2 Veneer	\$21,844	\$22,035	\$22,299	\$24,154

6 TAPS

HS2048C26	Grade 1 Laminate	\$21,624	\$21,815	\$22,079	\$23,934
	Grade 2 Laminate	\$21,912	\$22,103	\$22,367	\$24,222
	Grade 1 Veneer	\$23,449	\$23,640	\$23,904	\$25,759
	Grade 2 Veneer	\$24,941	\$25,132	\$25,396	\$27,251

▶ Specification Information, continued on next page

Host Collection

Racetrack Tables with Three Bases
DESIGN F/P DESIGN AND VECTA DESIGN TEAM

SIN 711.11

Tip: Prices shown include top, TAP(s), and slim bases.
▶ See base options for flared bases, page 236



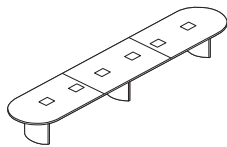
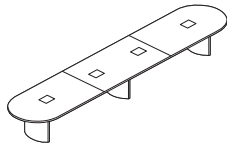
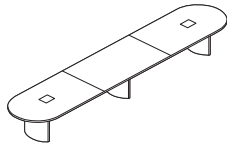
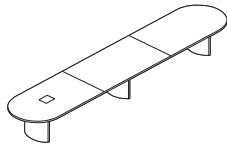
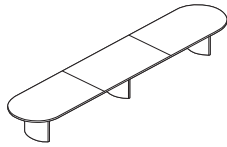

Tip: Last digit of style number indicates number of TAP(s).

Tip: For tech corridor, 20'L tables have eight long doors and four short doors.



▶ Specification Information, continued from previous page

Specification Information

Style Number	Finish	Base Prices			
					
		Flat Wood Edge:	Bullnose Wood Edge:	Beveled Wood Edge:	Horizon Wood Edge:

20'L x 48''W Three Piece Top

0 TAP

HS2048C30	Grade 1 Laminate	\$12,703	\$12,894	\$13,158	\$15,013
	Grade 2 Laminate	\$12,991	\$13,182	\$13,446	\$15,301
	Grade 1 Veneer	\$14,528	\$14,719	\$14,983	\$16,838
	Grade 2 Veneer	\$16,020	\$16,211	\$16,475	\$18,330

1 TAP

HS2048C31	Grade 1 Laminate	\$14,251	\$14,442	\$14,706	\$16,561
	Grade 2 Laminate	\$14,539	\$14,730	\$14,994	\$16,849
	Grade 1 Veneer	\$16,076	\$16,267	\$16,531	\$18,386
	Grade 2 Veneer	\$17,568	\$17,759	\$18,023	\$19,878

2 TAPS

HS2048C32	Grade 1 Laminate	\$15,800	\$15,991	\$16,255	\$18,110
	Grade 2 Laminate	\$16,088	\$16,279	\$16,543	\$18,398
	Grade 1 Veneer	\$17,625	\$17,816	\$18,080	\$19,935
	Grade 2 Veneer	\$19,117	\$19,308	\$19,572	\$21,427

4 TAPS

HS2048C34	Grade 1 Laminate	\$18,898	\$19,089	\$19,353	\$21,208
	Grade 2 Laminate	\$19,186	\$19,377	\$19,641	\$21,496
	Grade 1 Veneer	\$20,723	\$20,914	\$21,178	\$23,033
	Grade 2 Veneer	\$22,215	\$22,406	\$22,670	\$24,525

6 TAPS

HS2048C36	Grade 1 Laminate	\$21,994	\$22,185	\$22,449	\$24,304
	Grade 2 Laminate	\$22,282	\$22,473	\$22,737	\$24,592
	Grade 1 Veneer	\$23,819	\$24,010	\$24,274	\$26,129
	Grade 2 Veneer	\$25,311	\$25,502	\$25,766	\$27,621

▶ Specification Information, continued on next page

Host Collection

Racetrack Tables with Three Bases *continued*
 DESIGN F/P DESIGN AND VECTA DESIGN TEAM

SIN 711.11

Tip: Prices shown include top, TAP(s), and slim bases.
 ▶ See base options for flared bases, page 236



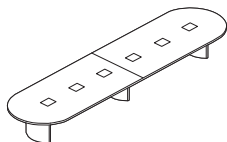
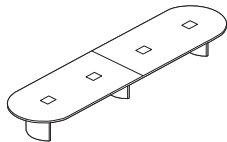
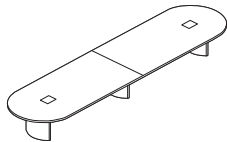
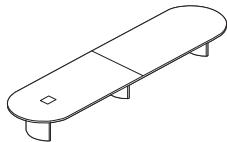
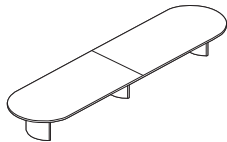

Tip: Last digit of style number indicates number of TAP(s).

Tip: For tech corridor, 20'L tables have eight long doors and four short doors.



► Specification Information, continued from previous page

Specification Information

Style Number	Finish	Base Prices			
					
		Flat Wood Edge:	Bullnose Wood Edge:	Beveled Wood Edge:	Horizon Wood Edge:

20'L x 60"W Two Piece Top

0 TAP

HS2060C20	Grade 1 Laminate	\$12,534	\$12,733	\$13,008	\$14,860
	Grade 2 Laminate	\$12,895	\$13,094	\$13,369	\$15,221
	Grade 1 Veneer	\$15,696	\$15,895	\$16,170	\$18,022
	Grade 2 Veneer	\$17,588	\$17,787	\$18,062	\$19,914

1 TAP

HS2060C21	Grade 1 Laminate	\$14,083	\$14,282	\$14,557	\$16,409
	Grade 2 Laminate	\$14,444	\$14,643	\$14,918	\$16,770
	Grade 1 Veneer	\$17,245	\$17,444	\$17,719	\$19,571
	Grade 2 Veneer	\$19,137	\$19,336	\$19,611	\$21,463

2 TAPS

HS2060C22	Grade 1 Laminate	\$15,632	\$15,831	\$16,106	\$17,958
	Grade 2 Laminate	\$15,993	\$16,192	\$16,467	\$18,319
	Grade 1 Veneer	\$18,794	\$18,993	\$19,268	\$21,120
	Grade 2 Veneer	\$20,686	\$20,885	\$21,160	\$23,012

4 TAPS

HS2060C24	Grade 1 Laminate	\$18,730	\$18,929	\$19,204	\$21,056
	Grade 2 Laminate	\$19,091	\$19,290	\$19,565	\$21,417
	Grade 1 Veneer	\$21,892	\$22,091	\$22,366	\$24,218
	Grade 2 Veneer	\$23,784	\$23,983	\$24,258	\$26,110

6 TAPS

HS2060C26	Grade 1 Laminate	\$21,826	\$22,025	\$22,300	\$24,152
	Grade 2 Laminate	\$22,187	\$22,386	\$22,661	\$24,513
	Grade 1 Veneer	\$24,988	\$25,187	\$25,462	\$27,314
	Grade 2 Veneer	\$26,880	\$27,079	\$27,354	\$29,206

► Specification Information, continued on next page

Host Collection

Racetrack Tables with Three Bases
DESIGN F/P DESIGN AND VECTA DESIGN TEAM

SIN 711.11





Tip: Prices shown include top, TAP(s), and slim bases.
▶ See base options for flared bases, page 236

Tip: Last digit of style number indicates number of TAP(s).

Tip: For tech corridor, 20'L tables have eight long doors and four short doors.

▶ Specification Information, continued from previous page

Specification Information

Style Number	Finish	Base Prices			
					
		Flat Wood Edge:	Bullnose Wood Edge:	Beveled Wood Edge:	Horizon Wood Edge:

20'L x 60"W Three Piece Top

0 TAP

HS2060C30	Grade 1 Laminate	\$12,906	\$13,105	\$13,380	\$15,232
	Grade 2 Laminate	\$13,267	\$13,466	\$13,741	\$15,593
	Grade 1 Veneer	\$16,068	\$16,267	\$16,542	\$18,394
	Grade 2 Veneer	\$17,960	\$18,159	\$18,434	\$20,286

1 TAP

HS2060C31	Grade 1 Laminate	\$14,453	\$14,652	\$14,927	\$16,779
	Grade 2 Laminate	\$14,814	\$15,013	\$15,288	\$17,140
	Grade 1 Veneer	\$17,615	\$17,814	\$18,089	\$19,941
	Grade 2 Veneer	\$19,507	\$19,706	\$19,981	\$21,833

2 TAPS

HS2060C32	Grade 1 Laminate	\$16,003	\$16,202	\$16,477	\$18,329
	Grade 2 Laminate	\$16,364	\$16,563	\$16,838	\$18,690
	Grade 1 Veneer	\$19,165	\$19,364	\$19,639	\$21,491
	Grade 2 Veneer	\$21,057	\$21,256	\$21,531	\$23,383

4 TAPS

HS2060C34	Grade 1 Laminate	\$19,099	\$19,298	\$19,573	\$21,425
	Grade 2 Laminate	\$19,460	\$19,659	\$19,934	\$21,786
	Grade 1 Veneer	\$22,261	\$22,460	\$22,735	\$24,587
	Grade 2 Veneer	\$24,153	\$24,352	\$24,627	\$26,479

6 TAPS

HS2060C36	Grade 1 Laminate	\$22,196	\$22,395	\$22,670	\$24,522
	Grade 2 Laminate	\$22,557	\$22,756	\$23,031	\$24,883
	Grade 1 Veneer	\$25,358	\$25,557	\$25,832	\$27,684
	Grade 2 Veneer	\$27,250	\$27,449	\$27,724	\$29,576

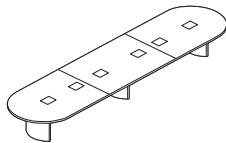
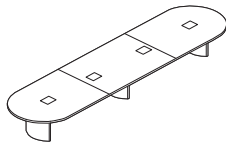
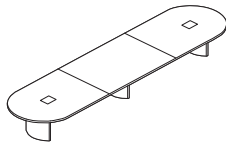
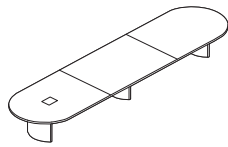
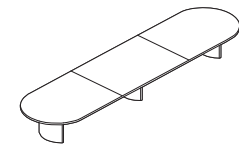

Host Collection Boat Shaped Tables with Two Bases

DESIGN F/P DESIGN AND VECTA DESIGN TEAM

SIN 711.11

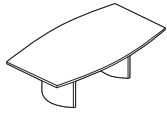

Tip: Shipped knocked down.

Tip: Grain direction for wood-grain laminate runs the length of the table.

Tip: Clips are provided with table: One clip per foot of table length.

Tip: The wood edge on a table top with woodgrain laminate may not match the top.

Tip: You must send a sample of reasonable size for Stain-to-Match.

Tip: 96" L tables available with zero, one, or two TAP(s). 10' L and 12' L tables available with zero, one, two, or three TAP(s).

Tip: Last digit of style number indicates number of TAP(s).



Tip: In addition to the data and audio/video AAPs available from Coalesse, other styles of AAPs are available through Extron Electronics. For an Extron dealer, call 1-800-633-9876.

Tip: See TAP options for electrical systems and faceplate list.

Standard Includes		Required to Specify
<ul style="list-style-type: none"> ▶ Need help? Product details, see <i>Coalesse Tables, Storage, and Accessories Specification Guide</i> 	<ul style="list-style-type: none"> • Top: 1¼" particle board core with laminate • Flat wood edge • TAP(s), if selected: 10"W x 12"L opening(s) trimmed with a flat solid wood profile and with brushed anodized aluminum TAP doors • Tech corridor: two aluminum beams for top support provide tracks for hinged aluminum doors that clip shut: satin anodized finish • Universal clip: black plastic • Two 27"W bases: wood veneer on MDF with aluminum universal bracket • Concealed leveling glides: non-marring, black plastic 	<ol style="list-style-type: none"> 1 Style number 2 Base section (see below) and wood color number for base 3 Laminate color number for table top, if selected 4 Wood color number for wood edge <p>▶ See <i>Hardwood and Veneer Matrix</i>, page 364</p> <ol style="list-style-type: none"> 5 Door color number for storage tray or TAP door, if selected: <ul style="list-style-type: none"> - 8044 Black - 8047 Silver 6 Options, if selected (see below) <p>▶ See <i>Surface Materials</i>, page 350.</p>

Options	Price	Required to Specify
Surface Materials <ul style="list-style-type: none"> • Top • Grade 2 laminate • Grade 1 wood veneer • Grade 2 wood veneer • Stain-to-Match 	<ul style="list-style-type: none"> Prices at right Prices at right Prices at right No cost 	<ul style="list-style-type: none"> Specify with <i>Grade 2 laminate</i> and select color number. Specify with <i>Grade 1 wood veneer</i> and select color number. Specify with <i>Grade 2 wood veneer</i> and select color number. Specify with <i>Stain-to-Match</i>. <p>▶ Page 383</p>

Edges	Wood	Price	Required to Specify
	<ul style="list-style-type: none"> • Bullnose wood edge 	Prices at right	Specify with <i>bullnose wood edge</i> .

Bases	Options	Price	Required to Specify
  <p>Slim Flared</p>	<ul style="list-style-type: none"> • Two slim bases • One slim and one flared base • Two flared bases 	<ul style="list-style-type: none"> No cost +\$807 +\$1615 	<ul style="list-style-type: none"> Specify with <i>two slim bases</i>. Specify with <i>one slim base</i> and one flared base. Specify with <i>two flared bases</i>.

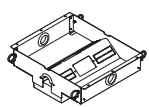
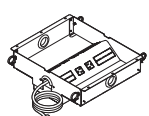
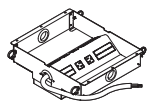
TAP Electrical System with Faceplate Options	Options	Price	Required to Specify
 <p>Field Wired</p>	<ul style="list-style-type: none"> • Field-wired tray (no electrical) <ul style="list-style-type: none"> - PAFW field-wired tray (no electrical) with blank AAPs - PDFW field-wired tray (no electrical) with two data AAPs - PVFW field-wired tray (no electrical) with two of each video/audio and data AAPs 	No cost	Specify with <i>power data</i> , and select TAP type and TAP door color number.
 <p>Cord and Plug</p>	<ul style="list-style-type: none"> • Cord and plug tray (10' cord) <ul style="list-style-type: none"> - PACP cord and plug tray with outlets and blank AAPs - PDCP cord and plug tray with outlets and two data AAPs - PAVC cord and plug tray with outlets and two of each video/audio and data AAPs 	No cost	Specify with <i>power data</i> , and select TAP type and TAP door color number.
 <p>Hardwired</p>	<ul style="list-style-type: none"> • Hard-wired tray (6' conduit) <ul style="list-style-type: none"> - PAHW hard-wired tray with outlets and blank AAPs - PDHW hard-wired tray with outlets and two data AAPs - PAVH hard-wired tray with outlets and two of each video/audio and data AAPs 	No cost	Specify with <i>power data</i> , and select TAP type and TAP door color number.

▶ Options, continued on next page

Host Collection

Boat Shaped Tables with Two Bases
DESIGN F/P DESIGN AND VECTA DESIGN TEAM

SIN 711.11

Tip: For single TAP style numbers, the modular system tray is not available. Specify the hardwired tray option.

Tip: If the specified table has multiple TAP(s), any one TAP can be replaced with a storage tray.

Tip: Wood veneer doors for storage tray and TAP(s) will always be cross grain.

Tip: Connectrac must be the same wiring schematic as the table.

► Options, continued from previous page

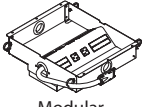
Options	Price	Required to Specify
TAP Electrical System with Faceplate Options  Modular	<ul style="list-style-type: none"> Modular system tray (hardwire base power infeed) <ul style="list-style-type: none"> - PAMH modular system tray with outlets and blank AAPs - PDMH modular system tray with outlets and two data AAPs - PVMH modular system tray with outlets and two of each video/audio and data AAPs +\$138 each tray	Specify with <i>modular power data</i> , and select TAP type and TAP door color number.
Storage Tray	<ul style="list-style-type: none"> Storage tray -\$579	Specify with <i>storage tray</i> and select door color number.
Doors	<ul style="list-style-type: none"> Storage tray wood veneer doors +\$291 per door TAP wood veneer doors +\$291 per door 	Specify with <i>wood doors</i> .
Related Products	<ul style="list-style-type: none"> Floor kit: Connectrac Corridor shelf 	► Page 283 ► Page 283

TAP Locations

96"L, 54"W Center, 42"W End TAP Locations—One piece top

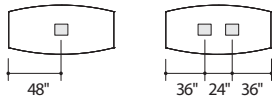

10'L, 60"W Center, 48"W End TAP Locations—One piece top

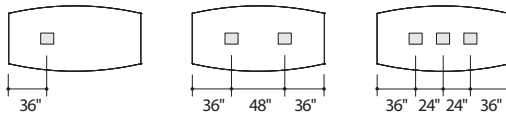

10'L, 60"W Center, 48"W End TAP Locations—Two piece top

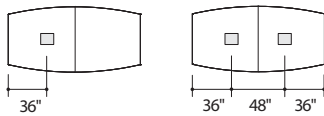

12'L, 60"W Center, 48"W End TAP Locations—One piece top

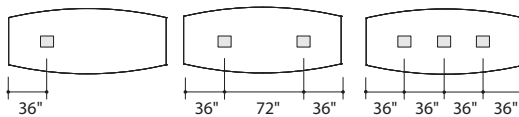

12'L, 60"W Center, 48"W Ends TAP Locations—Two piece top

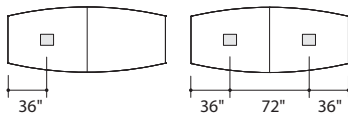

► Specification Information, on next page

Host Collection

Boat Shaped Tables with Two Bases *continued*
 DESIGN F/P DESIGN AND VECTA DESIGN TEAM

SIN 711.11

Tip: Prices shown include top, TAP(s), and slim bases.
 ▶ See base options for flared bases, page 256

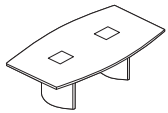
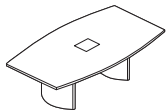
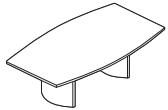

Tip: Last digit of style number indicates number of TAP(s).

Tip: For tech corridor, 96"L tables have two long doors and four short doors.



▶ Options, on previous page

Specification Information

Style Number	Finish	Base Prices	
			
		Flat Wood Edge:	Bullnose Wood Edge:

96"L, 54"W Center, 42"W End One Piece Top

0 TAP

Style Number	Finish	Flat Wood Edge	Bullnose Wood Edge
HS9654B10	Grade 1 Laminate	\$ 6716	\$ 6814
	Grade 2 Laminate	\$ 6831	\$ 6929
	Grade 1 Veneer	\$ 7399	\$ 7497
	Grade 2 Veneer	\$ 7994	\$ 8092

1 TAP

Style Number	Finish	Flat Wood Edge	Bullnose Wood Edge
HS9654B11	Grade 1 Laminate	\$ 8264	\$ 8362
	Grade 2 Laminate	\$ 8379	\$ 8477
	Grade 1 Veneer	\$ 8947	\$ 9045
	Grade 2 Veneer	\$ 9542	\$ 9640

2 TAPS

Style Number	Finish	Flat Wood Edge	Bullnose Wood Edge
HS9654B12	Grade 1 Laminate	\$ 9812	\$ 9910
	Grade 2 Laminate	\$ 9927	\$10,025
	Grade 1 Veneer	\$10,495	\$10,593
	Grade 2 Veneer	\$11,090	\$11,188

▶ Specification Information, continued on next page

Host Collection

Boat Shaped Tables with Two Bases
DESIGN F/P DESIGN AND VECTA DESIGN TEAM

SIN 711.11

Tip: Prices shown include top, TAP(s), and slim bases.
▶ See base options for flared bases, page 256

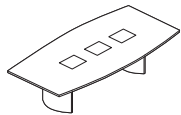
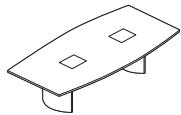
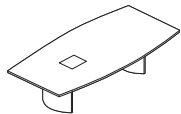
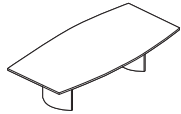

Tip: Last digit of style number indicates number of TAP(s).

Tip: For tech corridor, 10'L tables have four long doors and four short doors.



▶ Specification Information, continued from previous page

Specification Information

Style Number	Finish	Base Prices	
			
		Flat Wood Edge:	Bullnose Wood Edge:

10'L, 60"W Center, 48"W End One Piece Top

0 TAP			
HS1060B10	Grade 1 Laminate	\$ 7458	\$ 7579
	Grade 2 Laminate	\$ 7637	\$ 7758
	Grade 1 Veneer	\$ 8756	\$ 8877
	Grade 2 Veneer	\$ 9694	\$ 9815
1 TAP			
HS1060B11	Grade 1 Laminate	\$ 9007	\$ 9128
	Grade 2 Laminate	\$ 9186	\$ 9307
	Grade 1 Veneer	\$10,305	\$10,426
	Grade 2 Veneer	\$11,243	\$11,364
2 TAPS			
HS1060B12	Grade 1 Laminate	\$10,557	\$10,678
	Grade 2 Laminate	\$10,736	\$10,857
	Grade 1 Veneer	\$11,855	\$11,976
	Grade 2 Veneer	\$12,793	\$12,914
3 TAPS			
HS1060B13	Grade 1 Laminate	\$12,106	\$12,227
	Grade 2 Laminate	\$12,285	\$12,406
	Grade 1 Veneer	\$13,404	\$13,525
	Grade 2 Veneer	\$14,342	\$14,463

▶ Specification Information, continued on next page

Host Collection

Boat Shaped Tables with Two Bases *continued*
 DESIGN F/P DESIGN AND VECTA DESIGN TEAM

SIN 711.11

Tip: Prices shown include top, TAP(s), and slim bases.
 ▶ See base options for flared bases, page 256

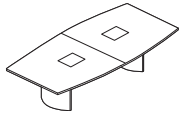
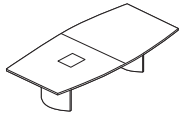
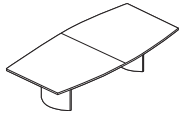

Tip: Last digit of style number indicates number of TAP(s).

Tip: For tech corridor, 10'L tables have four long doors and four short doors.



▶ Specification Information, continued from previous page

Specification Information

Style Number	Finish	Base Prices	
			
		Flat Wood Edge:	Bullnose Wood Edge:

10'L, 60"W Center, 48"W End Two Piece Top

0 TAP

HS1060B20	Grade 1 Laminate	\$ 7830	\$ 7951
	Grade 2 Laminate	\$ 8009	\$ 8130
	Grade 1 Veneer	\$ 9128	\$ 9249
	Grade 2 Veneer	\$10,066	\$10,187

1 TAP

HS1060B21	Grade 1 Laminate	\$ 9379	\$ 9500
	Grade 2 Laminate	\$ 9558	\$ 9679
	Grade 1 Veneer	\$10,677	\$10,798
	Grade 2 Veneer	\$11,615	\$11,736

2 TAPS

HS1060B22	Grade 1 Laminate	\$10,926	\$11,047
	Grade 2 Laminate	\$11,105	\$11,226
	Grade 1 Veneer	\$12,224	\$12,345
	Grade 2 Veneer	\$13,162	\$13,283

▶ Specification Information, continued on next page

Host Collection

Boat Shaped Tables with Two Bases
DESIGN F/P DESIGN AND VECTA DESIGN TEAM

SIN 711.11

Tip: Prices shown include top, TAP(s), and slim bases.
▶ See base options for flared bases, page 256

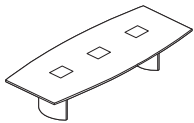
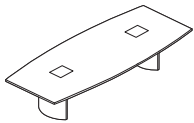
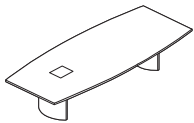
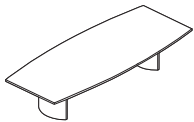

Tip: Last digit of style number indicates number of TAP(s).

Tip: For tech corridor, 12'L tables have four long doors and four short doors.



▶ Specification Information, continued from previous page

Specification Information

Style Number	Finish	Base Prices	
			
		Flat Wood Edge:	Bullnose Wood Edge:

12'L, 60"W Center, 48"W End One Piece Top

0 TAP

HS1260B10	Grade 1 Laminate	\$ 8003	\$ 8138
	Grade 2 Laminate	\$ 8219	\$ 8354
	Grade 1 Veneer	\$ 9579	\$ 9714
	Grade 2 Veneer	\$10,706	\$10,841

1 TAP

HS1260B11	Grade 1 Laminate	\$ 9552	\$ 9687
	Grade 2 Laminate	\$ 9768	\$ 9903
	Grade 1 Veneer	\$11,128	\$11,263
	Grade 2 Veneer	\$12,255	\$12,390

2 TAPS

HS1260B12	Grade 1 Laminate	\$11,099	\$11,234
	Grade 2 Laminate	\$11,315	\$11,450
	Grade 1 Veneer	\$12,675	\$12,810
	Grade 2 Veneer	\$13,802	\$13,937

3 TAPS

HS1260B13	Grade 1 Laminate	\$12,648	\$12,783
	Grade 2 Laminate	\$12,864	\$12,999
	Grade 1 Veneer	\$14,224	\$14,359
	Grade 2 Veneer	\$15,351	\$15,486

▶ Specification Information, continued on next page

Host Collection

Boat Shaped Tables with Two Bases *continued*
 DESIGN F/P DESIGN AND VECTA DESIGN TEAM

SIN 711.11

Tip: Prices shown include top, TAP(s), and slim bases.
 ▶ See base options for flared bases, page 256

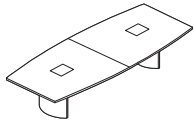
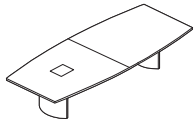
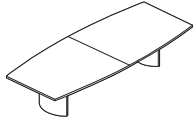

Tip: Last digit of style number indicates number of TAP(s).

Tip: For tech corridor, 12'L tables have four long doors and four short doors.



▶ Specification Information, continued from previous page

Specification Information

Style Number	Finish	Base Prices	
			
		Flat Wood Edge:	Bullnose Wood Edge:

12'L, 60"W Center, 48"W End Two Piece Top

0 TAP

HS1260B20	Grade 1 Laminate	\$ 8374	\$ 8509
	Grade 2 Laminate	\$ 8590	\$ 8725
	Grade 1 Veneer	\$ 9950	\$10,085
	Grade 2 Veneer	\$11,077	\$11,212

1 TAP

HS1260B21	Grade 1 Laminate	\$ 9922	\$10,057
	Grade 2 Laminate	\$10,138	\$10,273
	Grade 1 Veneer	\$11,498	\$11,633
	Grade 2 Veneer	\$12,625	\$12,760

2 TAPS

HS1260B22	Grade 1 Laminate	\$11,470	\$11,605
	Grade 2 Laminate	\$11,686	\$11,821
	Grade 1 Veneer	\$13,046	\$13,181
	Grade 2 Veneer	\$14,173	\$14,308

Coalesse

Host Collection

Boat Shaped Tables with Two Bases
DESIGN F/P DESIGN AND VECTA DESIGN TEAM

SIN 711.11

Host Collection

Boat Shaped Tables with Three Bases
 DESIGN F/P DESIGN AND VECTA DESIGN TEAM

SIN 711.11

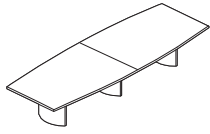

Tip: Shipped knocked down.

Tip: Grain direction for wood-grain laminate runs the length of the table.

Tip: Clips are provided with table: One clip per foot of table length.

Tip: The wood edge on a table top with woodgrain laminate may not match the top.

Tip: You must send a sample of reasonable size for Stain-to-Match.

Standard Includes		Required to Specify
<ul style="list-style-type: none"> ▶ Need help? Product details, see <i>Coalesse Tables, Storage, and Accessories Specification Guide</i> 	<ul style="list-style-type: none"> • Top: 1¼" particle board core with laminate • Flat wood edge • TAP(s), if selected: 10"W x 12"L opening(s) trimmed with a flat solid wood profile and with brushed anodized aluminum TAP doors • Tech corridor: four aluminum beams for top support provide tracks for hinged aluminum doors that clip shut: satin anodized finish • Universal clip: black plastic • Three 27"W bases: wood veneer on MDF with aluminum universal bracket • Concealed leveling glides: non-marring, black plastic 	<ol style="list-style-type: none"> 1 Style number 2 Base selection 3 Laminate color number for table top, if selected 4 Wood color number for wood edge <p>▶ See <i>Veneer Matrix</i>, page 365</p> <ol style="list-style-type: none"> 5 Laminate color number for table top 6 Door color number for storage tray or TAP door, if selected: <ul style="list-style-type: none"> - 8044 Black - 8047 Silver 7 Options, if selected (see below) <p>▶ See <i>Surface Materials</i>, page 350.</p>

Options	Price	Required to Specify
Surface Materials <ul style="list-style-type: none"> • Top • Grade 2 laminate • Grade 1 wood veneer • Grade 2 wood veneer • Stain-to-Match 	<ul style="list-style-type: none"> Prices at right Prices at right Prices at right No cost 	<ul style="list-style-type: none"> Specify with <i>Grade 2 laminate</i> and select color number. Specify with <i>Grade 1 wood veneer</i> and select color number. Specify with <i>Grade 2 wood veneer</i> and select color number. Specify with <i>Stain-to-Match</i>. <p>▶ Page 383</p>

Edges	Wood	Price	Required to Specify
	<ul style="list-style-type: none"> • Bullnose wood edge 	Prices at right	Specify with <i>bullnose wood edge</i> .

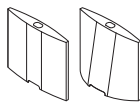
Bases	Price	Required to Specify
 <ul style="list-style-type: none"> • Three slim bases • Two slim and one flared bases • One slim and two flared bases • Three flared bases 	<ul style="list-style-type: none"> No cost +\$ 807 +\$1615 +\$2421 	<ul style="list-style-type: none"> Specify with <i>three slim bases</i>. Specify with <i>two slim</i> and one flared bases. Specify with <i>one slim</i> and two flared bases. Specify with <i>three flared bases</i>.

Tip: 14'L and 16'L tables available with zero, one, two, or four TAP(s). 18'L and 20'L tables available with zero, one, two, four, or six TAP(s).

Tip: In addition to the data and audio/video AAPs available from Coalesse, other styles of AAPs are available through Extron Electronics. For an Extron dealer, call 1.800.633.9876.

Tip: See TAP options for electrical systems and faceplate list.

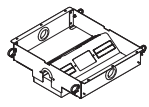
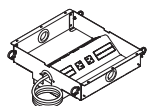
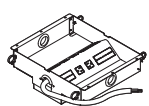
TAP Electrical System with Faceplate Options	Price	Required to Specify
 <ul style="list-style-type: none"> • Field-wired tray (no electrical) - PAFW field-wired tray (no electrical) with blank AAPs - PDFW field-wired tray (no electrical) with two data AAPs - PVFW field-wired tray (no electrical) with two of each video/audio and data AAPs 	No cost	Specify with <i>power data</i> , and select TAP type and TAP door color number.
 <ul style="list-style-type: none"> • Cord and plug tray (10' cord) - PACP cord and plug tray with outlets and blank AAPs - PDCP cord and plug tray with outlets and two data AAPs - PAVC cord and plug tray with outlets and two of each video/audio and data AAPs 	No cost	Specify with <i>power data</i> , and select TAP type and TAP door color number.
 <ul style="list-style-type: none"> • Hard-wired tray (6' conduit) - PAHW hard-wired tray with outlets and blank AAPs - PDHW hard-wired tray with outlets and two data AAPs - PAVH hard-wired tray with outlets and two of each video/audio and data AAPs 	No cost	Specify with <i>power data</i> , and select TAP type and TAP door color number.

▶ Options, continued on next page

Host Collection

Boat Shaped Tables with Three Bases
DESIGN F/P DESIGN AND VECTA DESIGN TEAM

SIN 711.11

Tip: For single TAP style numbers, the modular system tray is not available. Specify the hard-wired tray option.

Tip: If the specified table has multiple TAP(s), any one TAP can be replaced with a storage tray.

Tip: Wood veneer doors for storage tray or TAP will always be cross grain.

Tip: Connectrac must be the same wiring schematic as the table.

► Options, continued from previous page

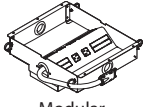
Options	Price	Required to Specify
TAP Electrical System with Faceplate Options  Modular	<ul style="list-style-type: none"> Modular system tray (hardwire base power infeed) <ul style="list-style-type: none"> - PAMH modular system tray with outlets and blank AAPs - PDMH modular system tray with outlets and two data AAPs - PVMH modular system tray with outlets and two of each video/audio and data AAPs +\$138 each tray	Specify with <i>modular power data</i> , and select TAP type and TAP door color number.
Storage Tray	<ul style="list-style-type: none"> Storage tray -\$579	Specify with <i>storage tray</i> and select door color number.
Doors	<ul style="list-style-type: none"> Storage tray wood veneer doors TAP wood veneer doors +\$291 per door +\$291 per door	Specify with <i>wood doors</i> . Specify with <i>wood doors</i> .
Related Products	<ul style="list-style-type: none"> Floor kit: Connectrac Corridor shelf 	► Page 283 ► Page 283

TAP Locations

14'L, 60"W Center, 48"W End TAP Locations—Two piece top

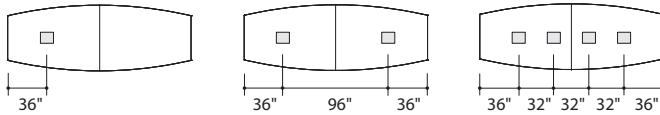

14'L, 60"W Center, 48"W End TAP Locations—Three piece top

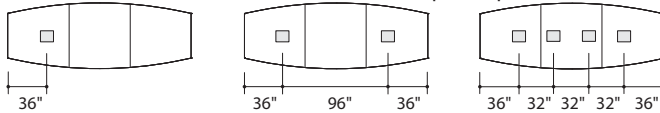

16'L, 60"W Center, 48"W End TAP Locations—Two piece top

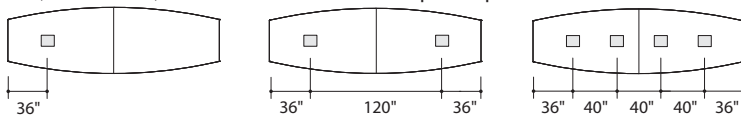

16'L, 60"W Center, 48"W End TAP Locations—Three piece top

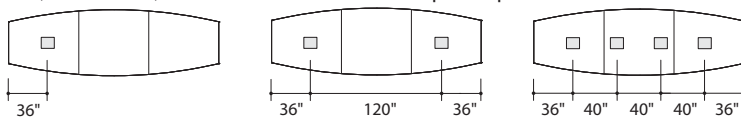

► Options, continued on next page

Host Collection

Boat Shaped Tables with Three Bases *continued*
DESIGN F/P DESIGN AND VECTA DESIGN TEAM

SIN 711.11

► Options, continued from previous page

TAP Locations

18'L, 60"W Center, 48"W End TAP Locations—Two piece top

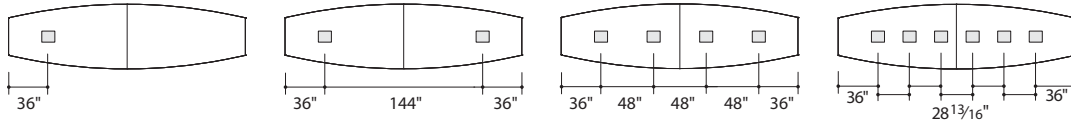

18'L, 60"W Center, 48"W End TAP Locations—Three piece top

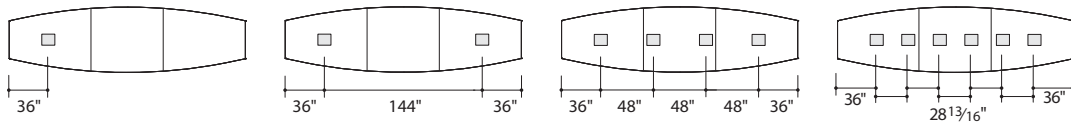

20'L, 60"W Center, 48"W End TAP Locations—Two piece top

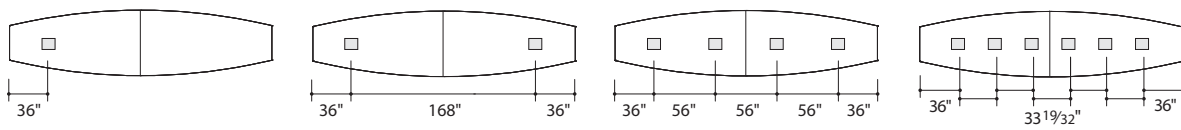

20'L, 60"W Center, 48"W End TAP Locations—Three piece top

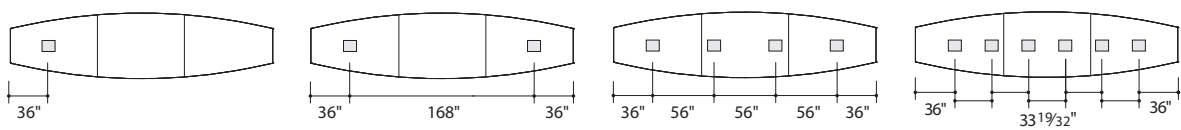

Host Collection

Boat Shaped Tables with Three Bases
DESIGN F/P DESIGN AND VECTA DESIGN TEAM

SIN 711.11



Tip: Prices shown include top, TAP(s), and slim bases.
► See base options for flared bases, page 264

Tip: Last digit of style number indicates number of TAP(s).

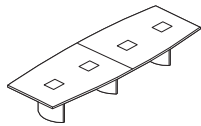
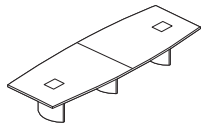
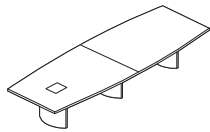
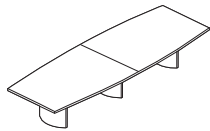
Tip: For tech corridor, 14'L tables have four long doors and four short doors.



Specification Information

Style Number	Finish	Base Prices	
			
		Flat Wood Edge:	Bullnose Wood Edge:

14'L, 60"W Center, 48"W End Two Piece Top

0 TAP

HS1460B20	Grade 1 Laminate	\$11,030	\$11,182
	Grade 2 Laminate	\$11,284	\$11,436
	Grade 1 Veneer	\$13,397	\$13,549
	Grade 2 Veneer	\$14,726	\$14,878

1 TAP

HS1460B21	Grade 1 Laminate	\$12,580	\$12,732
	Grade 2 Laminate	\$12,834	\$12,986
	Grade 1 Veneer	\$14,947	\$15,099
	Grade 2 Veneer	\$16,276	\$16,428

2 TAPS

HS1460B22	Grade 1 Laminate	\$14,128	\$14,280
	Grade 2 Laminate	\$14,382	\$14,534
	Grade 1 Veneer	\$16,495	\$16,647
	Grade 2 Veneer	\$17,824	\$17,976

4 TAPS

HS1460B24	Grade 1 Laminate	\$17,224	\$17,376
	Grade 2 Laminate	\$17,478	\$17,630
	Grade 1 Veneer	\$19,591	\$19,743
	Grade 2 Veneer	\$20,920	\$21,072

► Specification Information, continued on next page

Host Collection

Boat Shaped Tables with Three Bases *continued*
 DESIGN F/P DESIGN AND VECTA DESIGN TEAM

SIN 711.11

Tip: Prices shown include top, TAP(s), and slim bases.
 ▶ See base options for flared bases, page 264

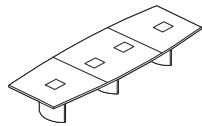
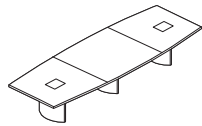
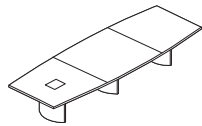
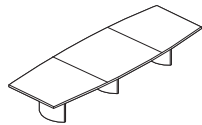

Tip: Last digit of style number indicates number of TAP(s).

Tip: For tech corridor, 14'L tables have four long doors and four short doors.



▶ Specification Information, continued from previous page

Specification Information

Style Number	Finish	Base Prices	
			
		Flat Wood Edge:	Bullnose Wood Edge:

14'L, 60"W Center, 48"W End Three Piece Top

0 TAP

HS1460B30	Grade 1 Laminate	\$11,402	\$11,554
	Grade 2 Laminate	\$11,656	\$11,808
	Grade 1 Veneer	\$13,769	\$13,921
	Grade 2 Veneer	\$15,098	\$15,250

1 TAP

HS1460B31	Grade 1 Laminate	\$12,949	\$13,101
	Grade 2 Laminate	\$13,203	\$13,355
	Grade 1 Veneer	\$15,316	\$15,468
	Grade 2 Veneer	\$16,645	\$16,797

2 TAPS

HS1460B32	Grade 1 Laminate	\$14,498	\$14,650
	Grade 2 Laminate	\$14,752	\$14,904
	Grade 1 Veneer	\$16,865	\$17,017
	Grade 2 Veneer	\$18,194	\$18,346

4 TAPS

HS1460B34	Grade 1 Laminate	\$17,596	\$17,748
	Grade 2 Laminate	\$17,850	\$18,002
	Grade 1 Veneer	\$19,963	\$20,115
	Grade 2 Veneer	\$21,292	\$21,444

▶ Specification Information, continued on next page

Host Collection

Boat Shaped Tables with Three Bases
DESIGN F/P DESIGN AND VECTA DESIGN TEAM

SIN 711.11

Tip: Prices shown include top, TAP(s), and slim bases.
▶ See base options for flared bases, page 264

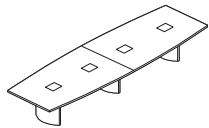
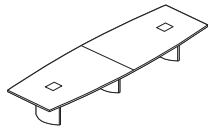
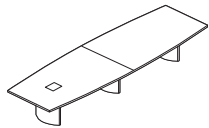
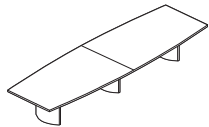

Tip: Last digit of style number indicates number of TAP(s).

Tip: For tech corridor, 16'L tables have eight long doors and four short doors.



▶ Specification Information, continued from previous page

Specification Information

Style Number	Finish	Base Prices	
		Flat Wood Edge:	Bullnose Wood Edge:
			

16'L, 60"W Center, 48"W End Two Piece Top

0 TAP			
HS1660B20	Grade 1 Laminate	\$11,520	\$11,688
	Grade 2 Laminate	\$11,808	\$11,976
	Grade 1 Veneer	\$13,917	\$14,085
	Grade 2 Veneer	\$15,429	\$15,597
1 TAP			
HS1660B21	Grade 1 Laminate	\$13,068	\$13,236
	Grade 2 Laminate	\$13,356	\$13,524
	Grade 1 Veneer	\$15,465	\$15,633
	Grade 2 Veneer	\$16,977	\$17,145
2 TAPS			
HS1660B22	Grade 1 Laminate	\$14,616	\$14,784
	Grade 2 Laminate	\$14,904	\$15,072
	Grade 1 Veneer	\$17,013	\$17,181
	Grade 2 Veneer	\$18,525	\$18,693
4 TAPS			
HS1660B24	Grade 1 Laminate	\$17,714	\$17,882
	Grade 2 Laminate	\$18,002	\$18,170
	Grade 1 Veneer	\$20,111	\$20,279
	Grade 2 Veneer	\$21,623	\$21,791

▶ Specification Information, continued on next page

Host Collection Boat Shaped Tables with Three Bases *continued*

DESIGN F/P DESIGN AND VECTA DESIGN TEAM

SIN 711.11

Tip: Prices shown include top, TAP(s), and slim bases.
 ▶ See base options for flared bases, page 264

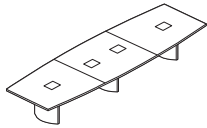
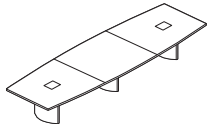
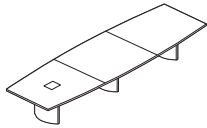
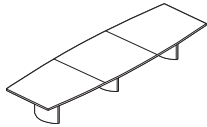

Tip: Last digit of style number indicates number of TAP(s).

Tip: For tech corridor, 16'L tables have eight long doors and four short doors.



▶ Specification Information, continued from previous page

Specification Information

Style Number	Finish	Base Prices	
			
		Flat Wood Edge:	Bullnose Wood Edge:

16'L, 60"W Center, 48"W End Three Piece Top

0 TAP

HS1660B30	Grade 1 Laminate	\$11,890	\$12,058
	Grade 2 Laminate	\$12,178	\$12,346
	Grade 1 Veneer	\$14,287	\$14,455
	Grade 2 Veneer	\$15,799	\$15,967

1 TAP

HS1660B31	Grade 1 Laminate	\$13,439	\$13,607
	Grade 2 Laminate	\$13,727	\$13,895
	Grade 1 Veneer	\$15,836	\$16,004
	Grade 2 Veneer	\$17,348	\$17,516

2 TAPS

HS1660B32	Grade 1 Laminate	\$14,988	\$15,156
	Grade 2 Laminate	\$15,276	\$15,444
	Grade 1 Veneer	\$17,385	\$17,553
	Grade 2 Veneer	\$18,897	\$19,065

4 TAPS

HS1660B34	Grade 1 Laminate	\$18,086	\$18,254
	Grade 2 Laminate	\$18,374	\$18,542
	Grade 1 Veneer	\$20,483	\$20,651
	Grade 2 Veneer	\$21,995	\$22,163

▶ Specification Information, continued on next page

Host Collection

Boat Shaped Tables with Three Bases
DESIGN F/P DESIGN AND VECTA DESIGN TEAM

SIN 711.11

Tip: Prices shown include top, TAP(s), and slim bases.
▶ See base options for flared bases, page 264

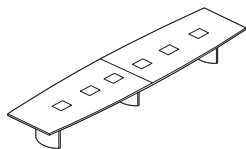
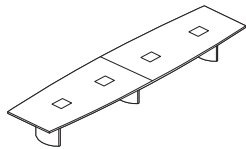
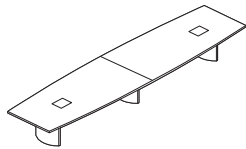
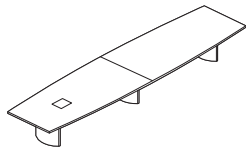
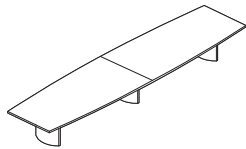

Tip: Last digit of style number indicates number of TAP(s).

Tip: For tech corridor, 18'L tables have eight long doors and four short doors.



▶ Specification Information, continued from previous page

Specification Information

Style Number	Finish	Base Prices	
			
		Flat Wood Edge:	Bullnose Wood Edge:

18'L, 60"W Center, 48"W End Two Piece Top

0 TAP			
HS1860B20	Grade 1 Laminate	\$12,044	\$12,225
	Grade 2 Laminate	\$12,369	\$12,550
	Grade 1 Veneer	\$15,172	\$15,353
	Grade 2 Veneer	\$16,884	\$17,065
1 TAP			
HS1860B21	Grade 1 Laminate	\$13,594	\$13,775
	Grade 2 Laminate	\$13,919	\$14,100
	Grade 1 Veneer	\$16,722	\$16,903
	Grade 2 Veneer	\$18,434	\$18,615
2 TAPS			
HS1860B22	Grade 1 Laminate	\$15,142	\$15,323
	Grade 2 Laminate	\$15,467	\$15,648
	Grade 1 Veneer	\$18,270	\$18,451
	Grade 2 Veneer	\$19,982	\$20,163
4 TAPS			
HS1860B24	Grade 1 Laminate	\$18,238	\$18,419
	Grade 2 Laminate	\$18,563	\$18,744
	Grade 1 Veneer	\$21,366	\$21,547
	Grade 2 Veneer	\$23,078	\$23,259
6 TAPS			
HS1860B26	Grade 1 Laminate	\$21,336	\$21,517
	Grade 2 Laminate	\$21,661	\$21,842
	Grade 1 Veneer	\$24,464	\$24,645
	Grade 2 Veneer	\$26,176	\$26,357

▶ Specification Information, continued on next page

Host Collection Boat Shaped Tables with Three Bases *continued*

DESIGN F/P DESIGN AND VECTA DESIGN TEAM

SIN 711.11

Tip: Prices shown include top, TAP(s), and slim bases.
 ▶ See base options for flared bases, page 264

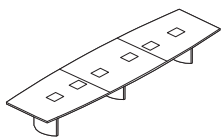
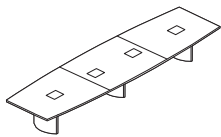
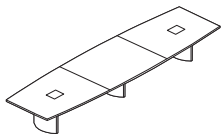
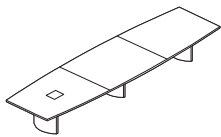
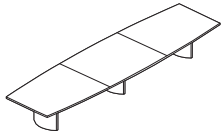

Tip: Last digit of style number indicates number of TAP(s).

Tip: For tech corridor, 18'L tables have eight long doors and four short doors.



▶ Specification Information, continued from previous page

Specification Information

Style Number	Finish	Base Prices	
			
		Flat Wood Edge:	Bullnose Wood Edge:

18'L, 60"W Center, 48"W End Three Piece Top

0 TAP

HS1860B30	Grade 1 Laminate	\$12,416	\$12,597
	Grade 2 Laminate	\$12,741	\$12,922
	Grade 1 Veneer	\$15,544	\$15,725
	Grade 2 Veneer	\$17,256	\$17,437

1 TAP

HS1860B31	Grade 1 Laminate	\$13,964	\$14,145
	Grade 2 Laminate	\$14,289	\$14,470
	Grade 1 Veneer	\$17,092	\$17,273
	Grade 2 Veneer	\$18,804	\$18,985

2 TAPS

HS1860B32	Grade 1 Laminate	\$15,513	\$15,694
	Grade 2 Laminate	\$15,838	\$16,019
	Grade 1 Veneer	\$18,641	\$18,822
	Grade 2 Veneer	\$20,353	\$20,534

4 TAPS

HS1860B34	Grade 1 Laminate	\$18,610	\$18,791
	Grade 2 Laminate	\$18,935	\$19,116
	Grade 1 Veneer	\$21,738	\$21,919
	Grade 2 Veneer	\$23,450	\$23,631

6 TAPS

HS1860B36	Grade 1 Laminate	\$21,707	\$21,888
	Grade 2 Laminate	\$22,032	\$22,213
	Grade 1 Veneer	\$24,835	\$25,016
	Grade 2 Veneer	\$26,547	\$26,728

▶ Specification Information, continued on next page

Host Collection

Boat Shaped Tables with Three Bases
DESIGN F/P DESIGN AND VECTA DESIGN TEAM

SIN 711.11

Tip: Prices shown include top, TAP(s), and slim bases.
▶ See base options for flared bases, page 264

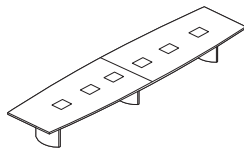
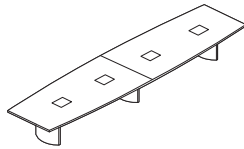
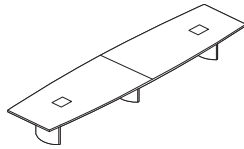
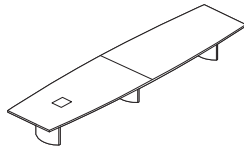
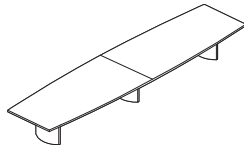

Tip: Last digit of style number indicates number of TAP(s).

Tip: For tech corridor, 20'L tables have eight long doors and four short doors.



▶ Specification Information, continued from previous page

Specification Information

Style Number	Finish	Base Prices	
			
		Flat Wood Edge:	Bullnose Wood Edge:

20'L, 60"W Center, 48"W End Two Piece Top

0 TAP			
HS2060B20	Grade 1 Laminate	\$12,534	\$12,733
	Grade 2 Laminate	\$12,895	\$13,094
	Grade 1 Veneer	\$15,696	\$15,895
	Grade 2 Veneer	\$17,588	\$17,787
1 TAP			
HS2060B21	Grade 1 Laminate	\$14,083	\$14,282
	Grade 2 Laminate	\$14,444	\$14,643
	Grade 1 Veneer	\$17,245	\$17,444
	Grade 2 Veneer	\$19,137	\$19,336
2 TAPS			
HS2060B22	Grade 1 Laminate	\$15,632	\$15,831
	Grade 2 Laminate	\$15,993	\$16,192
	Grade 1 Veneer	\$18,794	\$18,993
	Grade 2 Veneer	\$20,686	\$20,885
4 TAPS			
HS2060B24	Grade 1 Laminate	\$18,730	\$18,929
	Grade 2 Laminate	\$19,091	\$19,290
	Grade 1 Veneer	\$21,892	\$22,091
	Grade 2 Veneer	\$23,784	\$23,983
6 TAPS			
HS2060B26	Grade 1 Laminate	\$21,826	\$22,025
	Grade 2 Laminate	\$22,187	\$22,386
	Grade 1 Veneer	\$24,988	\$25,187
	Grade 2 Veneer	\$26,880	\$27,079

▶ Specification Information, continued on next page

Host Collection Boat Shaped Tables with Three Bases *continued*

DESIGN F/P DESIGN AND VECTA DESIGN TEAM

SIN 711.11



Tip: Prices shown include top, TAP(s), and slim bases.
 ▶ See base options for flared bases, page 264

Tip: Last digit of style number indicates number of TAP(s).

Tip: For tech corridor, 20'L tables have eight long doors and four short doors.

▶ Specification Information, continued from previous page

Specification Information

Style Number	Finish	Base Prices	
			
		Flat Wood Edge:	Bullnose Wood Edge:

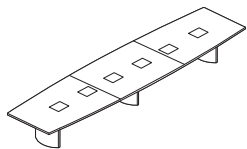
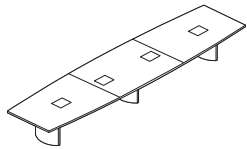
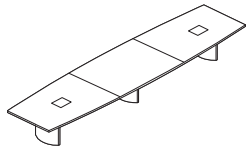
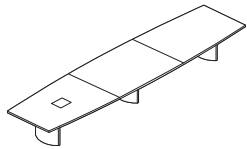
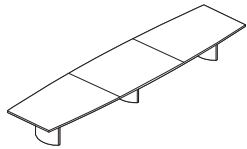

20'L, 60"W Center, 48"W End Three Piece Top

0 TAP			
HS2060B30	Grade 1 Laminate	\$12,906	\$13,105
	Grade 2 Laminate	\$13,267	\$13,466
	Grade 1 Veneer	\$16,068	\$16,267
	Grade 2 Veneer	\$17,960	\$18,159
1 TAP			
HS2060B31	Grade 1 Laminate	\$14,453	\$14,652
	Grade 2 Laminate	\$14,814	\$15,013
	Grade 1 Veneer	\$17,615	\$17,814
	Grade 2 Veneer	\$19,507	\$19,706
2 TAPS			
HS2060B32	Grade 1 Laminate	\$16,003	\$16,202
	Grade 2 Laminate	\$16,364	\$16,563
	Grade 1 Veneer	\$19,165	\$19,364
	Grade 2 Veneer	\$21,057	\$21,256
4 TAPS			
HS2060B34	Grade 1 Laminate	\$19,099	\$19,298
	Grade 2 Laminate	\$19,460	\$19,659
	Grade 1 Veneer	\$22,261	\$22,460
	Grade 2 Veneer	\$24,153	\$24,352
6 TAPS			
HS2060B36	Grade 1 Laminate	\$22,196	\$22,395
	Grade 2 Laminate	\$22,557	\$22,756
	Grade 1 Veneer	\$25,358	\$25,557
	Grade 2 Veneer	\$27,250	\$27,449

Coalesse

Host Collection

Boat Shaped Tables with Three Bases
DESIGN F/P DESIGN AND VECTA DESIGN TEAM

SIN 711.11

Host Collection Trapezoid Tables with Two Bases

DESIGN F/P DESIGN AND VECTA DESIGN TEAM

SIN 711.11

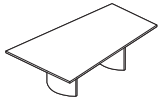

Tip: Shipped knocked down.

Tip: Grain direction for wood-grain laminate runs the length of the table.

Tip: See TAP options for electrical systems and faceplate list.

Tip: Clips are provided with table. One clip per foot of table length.

Tip: The wood edge on a table top with woodgrain laminate may not match the top.

Tip: You must send a sample of reasonable size for Stain-to-Match.

Standard Includes		Required to Specify
<ul style="list-style-type: none"> ▶ Need help? Product details, see <i>Coalesse Tables, Storage, and Accessories Specification Guide</i> 	<ul style="list-style-type: none"> • Top: 1¼" particle board core with laminate • Flat wood edge • TAP(s), if selected: 10"W x 12"L opening(s) trimmed with a flat solid wood profile and with brushed anodized aluminum TAP doors: • Tech corridor: two aluminum beams for top support provide tracks for hinged aluminum doors that clip shut: satin anodized finish • Universal clip: black plastic • Two 27"W bases: wood veneer on MDF with aluminum universal bracket • Concealed leveling glides: non-marring, black plastic 	<ol style="list-style-type: none"> 1 Style number 2 Base selection (see below) and wood color number for base 3 Laminate color number for table top, if selected 4 Wood color number for wood edge <p>▶ See <i>Veneer Matrix</i>, page 365</p> <ol style="list-style-type: none"> 5 Door color number for storage tray or TAP door, if selected: <ul style="list-style-type: none"> - 8044 Black - 8047 Silver 6 Options, if selected (see below) <p>▶ See <i>Surface Materials</i>, page 350.</p>

Options	Price	Required to Specify
Surface Materials Top <ul style="list-style-type: none"> • Grade 2 laminate • Grade 1 Wood veneer • Grade 2 wood veneer • Stain-to-Match 	<ul style="list-style-type: none"> Prices at right Prices at right Prices at right No cost 	<ul style="list-style-type: none"> Specify with <i>Grade 2 laminate</i> and select color number. Specify with <i>Grade 1 wood veneer</i> and select color number. Specify with <i>Grade 2 wood veneer</i> and select color number. Specify with <i>Stain-to-Match</i>. <p>▶ Page 383</p>

Edges	Wood <ul style="list-style-type: none"> • Bullnose wood edge • Horizon wood edge 	<ul style="list-style-type: none"> Prices at right Prices at right 	<ul style="list-style-type: none"> Specify with <i>bullnose wood edge</i>. Specify with <i>horizon wood edge</i>.
--------------	---	--	---

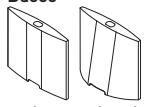
Bases  Slim Flared	<ul style="list-style-type: none"> • Two slim bases • One slim and one flared base • Two flared bases 	<ul style="list-style-type: none"> No cost +\$ 807 +\$1615 	<ul style="list-style-type: none"> Specify with <i>two slim bases</i>. Specify with <i>one slim base</i> and one flared base. Specify with <i>two flared bases</i>.
---	--	---	--

Tip: 96"L tables available with zero, one, or two TAP(s). 10'L and 12'L tables available with zero, one, two, or three TAP(s).

Tip: In addition to the data and audio/video AAPs available from Coalesse, other styles of AAPs are available through Extron Electronics. For an Extron dealer, call 1-800-633-9876.

Tip: See TAP options for electrical systems and faceplate list.

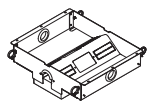
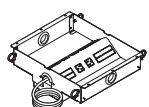
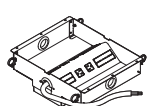
TAP Electrical System with Faceplate Options  Field Wired  Cord and Plug  Hardwired	<ul style="list-style-type: none"> • Field-wired tray (no electrical) <ul style="list-style-type: none"> - PAFW field-wired tray (no electrical) with blank AAPs - PDFW field-wired tray (no electrical) with two data AAPs - PVFW field-wired tray (no electrical) with two of each video/audio and data AAPs • Cord and plug tray (10' cord) <ul style="list-style-type: none"> - PACP cord and plug tray with outlets and blank AAPs - PDCP cord and plug tray with outlets and two data AAPs - PAVC cord and plug tray with outlets and two of each video/audio and data AAPs • Hard-wired tray (6' conduit) <ul style="list-style-type: none"> - PAHW hard-wired tray with outlets and blank AAPs - PDHW hard-wired tray with outlets and two data AAPs - PAVH hard-wired tray with outlets and two of each video/audio and data AAPs 	<ul style="list-style-type: none"> No cost No cost No cost 	<ul style="list-style-type: none"> Specify with <i>power data</i>, and select TAP type and TAP door color number. Specify with <i>power data</i>, and select TAP type and TAP door color number. Specify with <i>power data</i>, and select TAP type and TAP door color number.
---	---	---	--

▶ Options, continued on next page

Host Collection

Trapezoid Tables with Two Bases
DESIGN F/P DESIGN AND VECTA DESIGN TEAM

SIN 711.11

► Options, continued from previous page

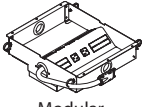
Options	Price	Required to Specify
TAP Electrical System with Faceplate Options  Modular	<ul style="list-style-type: none"> Modular system tray (hardwire base power infeed) <ul style="list-style-type: none"> - PAMH modular system tray with outlets and blank AAPs - PDMH modular system tray with outlets and two data AAPs - PVMH modular system tray with outlets and two of each video/audio and data AAPs +\$138 each tray	Specify with <i>modular power data</i> , and select TAP type and TAP door color number.
Storage Tray	<ul style="list-style-type: none"> Storage tray -\$579	Specify with <i>storage tray</i> and select door color number.
Doors	<ul style="list-style-type: none"> Storage tray wood veneer doors TAP wood veneer doors +\$291 per door +\$291 per door	Specify with <i>wood doors</i> . Specify with <i>wood doors</i> .
Related Products	<ul style="list-style-type: none"> Floor kit: Connectrac Corridor shelf 	► Page 283 ► Page 283

Tip: If the specified table has multiple TAP(s), any one TAP can be replaced with a storage tray.

Tip: Wood veneer doors for storage tray or TAP will always be cross grain.

Tip: Connectrac must be the same wiring schematic as the table.

TAP Locations

96"L x 42"W x 60"W TAP Locations—One piece top

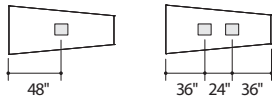

10'L x 42"W x 60"W TAP Locations—One piece top

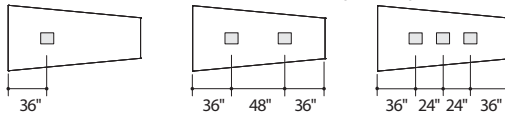

10'L x 42"W x 60"W TAP Locations—Two piece top

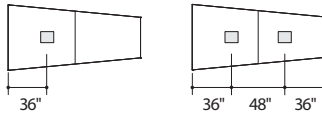

12'L x 42"W x 60"W TAP Locations—One piece top

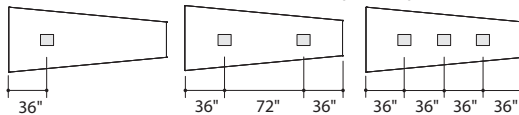

12'L x 42"W x 60"W TAP Locations—Two piece top

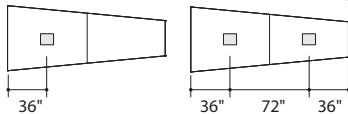

► Specification Information, on next page

Host Collection Trapezoid Tables with Two Bases *continued*

DESIGN F/P DESIGN AND VECTA DESIGN TEAM

SIN 711.11

Tip: Prices shown include top, TAP(s), and slim bases.
 ▶ See base options for flared bases, page 276

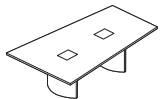
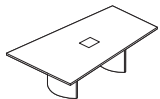
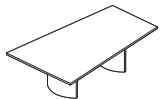

Tip: Last digit of style number indicates number of TAP(s).

Tip: For tech corridor, 96"L tables have two long doors and four short doors.



▶ Options, on previous page

Specification Information

Style Number	Finish	Base Prices		
				
		Flat Wood Edge:	Bullnose Wood Edge:	Horizon Wood Edge:

96"L x 42"W x 60"W One Piece Top

0 TAP

Style Number	Finish	Flat Wood Edge	Bullnose Wood Edge	Horizon Wood Edge
HS9660T10	Grade 1 Laminate	\$ 6743	\$ 6841	\$ 8106
	Grade 2 Laminate	\$ 6889	\$ 6987	\$ 8252
	Grade 1 Veneer	\$ 7426	\$ 7524	\$ 8789
	Grade 2 Veneer	\$ 8166	\$ 8264	\$ 9529

1 TAP

Style Number	Finish	Flat Wood Edge	Bullnose Wood Edge	Horizon Wood Edge
HS9660T11	Grade 1 Laminate	\$ 8291	\$ 8389	\$ 9654
	Grade 2 Laminate	\$ 8437	\$ 8535	\$ 9800
	Grade 1 Veneer	\$ 8974	\$ 9072	\$10,337
	Grade 2 Veneer	\$ 9714	\$ 9812	\$11,077

2 TAPS

Style Number	Finish	Flat Wood Edge	Bullnose Wood Edge	Horizon Wood Edge
HS9660T12	Grade 1 Laminate	\$ 9840	\$ 9938	\$11,203
	Grade 2 Laminate	\$ 9986	\$10,084	\$11,349
	Grade 1 Veneer	\$10,523	\$10,621	\$11,886
	Grade 2 Veneer	\$11,263	\$11,361	\$12,626

▶ Specification Information, continued on next page

Host Collection

Trapezoid Tables with Two Bases
DESIGN F/P DESIGN AND VECTA DESIGN TEAM

SIN 711.11

Tip: Prices shown include top, TAP(s), and slim bases.
▶ See base options for flared bases, page 276

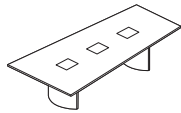
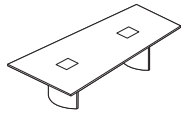
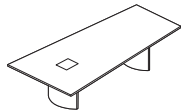
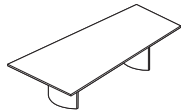

Tip: Last digit of style number indicates number of TAP(s).

Tip: For tech corridor, 10'L tables have four long doors and four short doors.



▶ Specification Information, continued from previous page

Specification Information

Style Number	Finish	Base Prices		
				
		Flat Wood Edge:	Bullnose Wood Edge:	Horizon Wood Edge:

10'L x 42"W x 60"W One Piece Top

0 TAP				
HS1060T10	Grade 1 Laminate	\$ 7197	\$ 7318	\$ 8599
	Grade 2 Laminate	\$ 7376	\$ 7497	\$ 8778
	Grade 1 Veneer	\$ 8022	\$ 8143	\$ 9424
	Grade 2 Veneer	\$ 8946	\$ 9067	\$10,348
1 TAP				
HS1060T11	Grade 1 Laminate	\$ 8743	\$ 8864	\$10,145
	Grade 2 Laminate	\$ 8922	\$ 9043	\$10,324
	Grade 1 Veneer	\$ 9568	\$ 9689	\$10,970
	Grade 2 Veneer	\$10,492	\$10,613	\$11,894
2 TAPS				
HS1060T12	Grade 1 Laminate	\$10,292	\$10,413	\$11,694
	Grade 2 Laminate	\$10,471	\$10,592	\$11,873
	Grade 1 Veneer	\$11,117	\$11,238	\$12,519
	Grade 2 Veneer	\$12,041	\$12,162	\$13,443
3 TAPS				
HS1060T13	Grade 1 Laminate	\$11,841	\$11,962	\$13,243
	Grade 2 Laminate	\$12,020	\$12,141	\$13,422
	Grade 1 Veneer	\$12,666	\$12,787	\$14,068
	Grade 2 Veneer	\$13,590	\$13,711	\$14,992

▶ Specification Information, continued on next page

Host Collection Trapezoid Tables with Two Bases *continued*

DESIGN F/P DESIGN AND VECTA DESIGN TEAM

SIN 711.11

Tip: Prices shown include top, TAP(s), and slim bases.
 ▶ See base options for flared bases, page 276

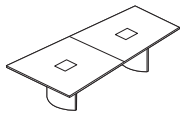
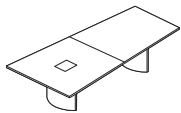
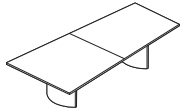

Tip: Last digit of style number indicates number of TAP(s).

Tip: For tech corridor, 10'L tables have four long doors and four short doors.



▶ Specification Information, continued from previous page

Specification Information

Style Number	Finish	Base Prices		
				
		Flat Wood Edge:	Bullnose Wood Edge:	Horizon Wood Edge:

10'L x 42"W x 60"W Two Piece Top

0 TAP

HS1060T20	Grade 1 Laminate	\$ 7564	\$ 7685	\$ 8966
	Grade 2 Laminate	\$ 7743	\$ 7864	\$ 9145
	Grade 1 Veneer	\$ 8389	\$ 8510	\$ 9791
	Grade 2 Veneer	\$ 9313	\$ 9434	\$10,715

1 TAP

HS1060T21	Grade 1 Laminate	\$ 9115	\$ 9236	\$10,517
	Grade 2 Laminate	\$ 9294	\$ 9415	\$10,696
	Grade 1 Veneer	\$ 9940	\$10,061	\$11,342
	Grade 2 Veneer	\$10,864	\$10,985	\$12,266

2 TAPS

HS1060T22	Grade 1 Laminate	\$10,663	\$10,784	\$12,065
	Grade 2 Laminate	\$10,842	\$10,963	\$12,244
	Grade 1 Veneer	\$11,488	\$11,609	\$12,890
	Grade 2 Veneer	\$12,412	\$12,533	\$13,814

▶ Specification Information, continued on next page

Host Collection Trapezoid Tables with Two Bases

DESIGN F/P DESIGN AND VECTA DESIGN TEAM

SIN 711.11

Tip: Prices shown include top, TAP(s), and slim bases.
 ▶ See base options for flared bases, page 276

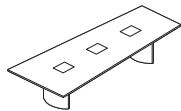
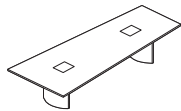
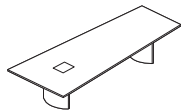
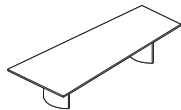

Tip: Last digit of style number indicates number of TAP(s).

Tip: For tech corridor, 12'L tables have four long doors and four short doors.



▶ Specification Information, continued from previous page

Specification Information

Style Number	Finish	Base Prices		
				
		Flat Wood Edge:	Bullnose Wood Edge:	Horizon Wood Edge:

12'L x 42"W x 60"W One Piece Top

0 TAP				
HS1260T10	Grade 1 Laminate	\$ 7666	\$ 7801	\$ 9106
	Grade 2 Laminate	\$ 7882	\$ 8017	\$ 9322
	Grade 1 Veneer	\$ 8964	\$ 9099	\$10,404
	Grade 2 Veneer	\$10,081	\$10,216	\$11,521
1 TAP				
HS1260T11	Grade 1 Laminate	\$ 9216	\$ 9351	\$10,656
	Grade 2 Laminate	\$ 9432	\$ 9567	\$10,872
	Grade 1 Veneer	\$10,514	\$10,649	\$11,954
	Grade 2 Veneer	\$11,631	\$11,766	\$13,071
2 TAPS				
HS1260T12	Grade 1 Laminate	\$10,765	\$10,900	\$12,205
	Grade 2 Laminate	\$10,981	\$11,116	\$12,421
	Grade 1 Veneer	\$12,063	\$12,198	\$13,503
	Grade 2 Veneer	\$13,180	\$13,315	\$14,620
3 TAPS				
HS1260T13	Grade 1 Laminate	\$12,312	\$12,447	\$13,752
	Grade 2 Laminate	\$12,528	\$12,663	\$13,968
	Grade 1 Veneer	\$13,610	\$13,745	\$15,050
	Grade 2 Veneer	\$14,727	\$14,862	\$16,167

▶ Specification Information, continued on next page

Host Collection Trapezoid Tables with Two Bases *continued*

DESIGN F/P DESIGN AND VECTA DESIGN TEAM

SIN 711.11

Tip: Prices shown include top, TAP(s), and slim bases.
 ▶ See base options for flared bases, page 276

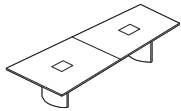
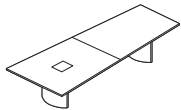
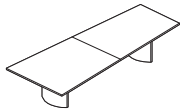

Tip: Last digit of style number indicates number of TAP(s).

Tip: For tech corridor, 12'L tables have four long doors and four short doors.



▶ Specification Information, continued from previous page

Specification Information

Style Number	Finish	Base Prices		
				
		Flat Wood Edge:	Bullnose Wood Edge:	Horizon Wood Edge:

12'L x 42"W x 60"W Two Piece Top

0 TAP

HS1260T20	Grade 1 Laminate	\$ 8038	\$ 8173	\$ 9478
	Grade 2 Laminate	\$ 8254	\$ 8389	\$ 9694
	Grade 1 Veneer	\$ 9336	\$ 9471	\$10,776
	Grade 2 Veneer	\$10,453	\$10,588	\$11,893

1 TAP

HS1260T21	Grade 1 Laminate	\$ 9585	\$ 9720	\$11,025
	Grade 2 Laminate	\$ 9801	\$ 9936	\$11,241
	Grade 1 Veneer	\$10,883	\$11,018	\$12,323
	Grade 2 Veneer	\$12,000	\$12,135	\$13,440

2 TAPS

HS1260T22	Grade 1 Laminate	\$11,135	\$11,270	\$12,575
	Grade 2 Laminate	\$11,351	\$11,486	\$12,791
	Grade 1 Veneer	\$12,433	\$12,568	\$13,873
	Grade 2 Veneer	\$13,550	\$13,685	\$14,990

Floor Kit: Connectrac

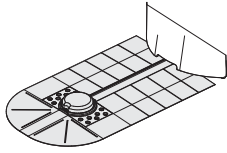

Tip: Shipped knocked down.

Standard Includes	Required to Specify
<ul style="list-style-type: none"> • Dome to cover floor monument (maximum size 5⁹/₁₆" W X 5⁹/₁₆" L X 3"H): black plastic • Low profile aluminum/PVC raceway to conceal wires from the dome to the table base <ul style="list-style-type: none"> - Aluminum bottom track and removable black powder-coated aluminum top cap for carpet strip: natural - Moisture-resistant MDF transition ramps run along both sides of raceway - Standard 4 foot length - Raceway can be field-cut to desired length • ADA compliant 	Style number

Specification Information	
Style Number	Price
HSFCONPT	\$567

Corridor Shelf

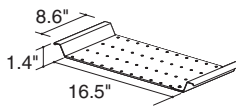

Standard Includes	Required to Specify
<ul style="list-style-type: none"> • Perforated steel shelf in silver power coat • Hangs from the lower rail on the beams to hold routers, hubs, line drivers, scalers and other technical equipment • 1/2" rack units of space, 2³/₄" H • Shipped assembled with adjustment screws 	Style number

Specification Information	
Style Number	Price
HSFSHLF	\$97

Host Collection Accessories *continued*
 DESIGN F/P DESIGN AND VECTA DESIGN TEAM

SIN 711.11

Six Outlet Plug Strip

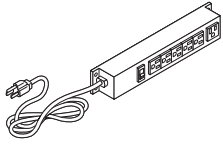

Standard Includes	Required to Specify
<ul style="list-style-type: none"> • Power strip with 15' cord and three-prong plug: black • Six power outlets • On-off switch • Surge suppressor • Dual lock adhesive strips for tech corridor installation 	Style number

Specification Information	
Style Number	Price
793330	\$250

Corridor Power Kit, Modular

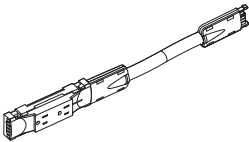

Tip: Corridor power kit can only be used when modular TAPs are specified.

Standard Includes	Required to Specify
<ul style="list-style-type: none"> • Modular duplex receptacle • Dual lock adhesive strip 	Style number

Specification Information	
Style Number	Price
HS4WXFRM	\$101

Reunion Collection

Rectangular Seminar Tables with Removable Snap Legs (SIN 711.11)	286
Rectangular Seminar Tables with Fixed Snap Legs (SIN 711.11)	290
Square Seminar Tables with Removable Snap Legs (SIN 711.11)	294
Square Seminar Tables with Fixed Snap Legs (SIN 711.11)	296
60° Trapezoid Seminar Tables with Removable Snap Legs (SIN 711.11)	298
60° Trapezoid Seminar Tables with Fixed Snap Legs (SIN 711.11)	299
Half Round Seminar Tables with Removable Snap Legs (SIN 711.11)	300
Half Round Seminar Tables with Fixed Snap Legs (SIN 711.11)	301
90° Connecting Tops for Seminar Tables (SIN 711.11)	302
Accessories (SIN 711.11)	303

Reunion Seminar Rectangular Seminar Tables with Removable Snap Legs

DESIGN FM DESIGN

SIN 711.11

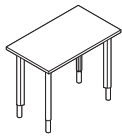

Tip: Shipped knocked down.

Standard Includes	Required to Specify
<ul style="list-style-type: none"> ▶ Need help? Product details, see <i>Coalesse Tables, Storage, and Accessories Specification Guide</i> • Top: 1¼" particle board core with laminate • Reunion vinyl edge: black • Four 2½" x 1¾" removable snap legs: extruded aluminum and die-cast aluminum head with single powder coat and black tubular steel foot • Integral wire manager in leg to accommodate up to two ¾" diameter cords • Leveling glides with adjustability range of ½"H: black plastic 	<ol style="list-style-type: none"> 1 Style number 2 Powder coat color number for legs 3 Laminate color number for top 4 Options, if selected (see below) <p>▶ See <i>Surface Materials</i>, page 350.</p>

Tip: You must send a sample of reasonable size for *Stain-to-Match*.

Tip: If you specify a wood edge on a top with woodgrain laminate, the edge and top may not match.

Tip: For grain matching always include a drawing or sketch along with your specification showing the arrangement of tables you plan so that we can ensure proper grain matching.

Tip: When the factory-installed flex ganger option is specified, the flex gangers will be installed in the end-to-end ganging configuration. If side-to-side or end-and-side ganging is required, change the position of the flex gangers at time of installation. All flex ganger locations are pre-drilled for simple re-location when desired.

Tip: When three grommets are specified, grommets will be located left, right, and center.

Tip: For sphere location availability.

Tip: If couplers are needed on PCS or CSP they must be ordered separately.

Tip: For installation of grommets, spheres, Interport, Mini-Port, Interact, Axil Z, or Ellora submit a drawing indicating the desired location for a factory installed cutout(s). Field installation is also available. All require the grommet(s), sphere(s), Interport, Mini-Port, Interact, Axil Z, or Ellora to be ordered as a separate item.

Tip: Table height adjustment range changes to 28½"H to 34½"H when casters are specified.

Options	Price	Required to Specify
Surface Materials <ul style="list-style-type: none"> • Grade 2 laminate • Grade 1 wood veneer • Grade 2 wood veneer • Stain-to-Match 	<ul style="list-style-type: none"> Prices at right Prices at right Prices at right No cost 	<ul style="list-style-type: none"> Specify with <i>Grade 2 laminate</i> and select color number. Specify with <i>Grade 1 wood veneer</i> and select color number. Specify with <i>Grade 2 wood veneer</i> and select color number. Specify with <i>Stain-to-Match</i>. <p>▶ Page 383</p>
Edge <ul style="list-style-type: none"> • Flat wood edge 	<ul style="list-style-type: none"> Prices at right 	<ul style="list-style-type: none"> Specify with <i>flat wood edge</i>.
Flex ganger package (Not to be used with wood edge) <ul style="list-style-type: none"> • End-to-end 	<ul style="list-style-type: none"> +\$ 78 	<ul style="list-style-type: none"> Specify with <i>end-to-end flex gangers</i>.
Modesty Panel ▶ Page 304 <ul style="list-style-type: none"> • 42"L • 48"L • 60"L • 72"L 	<ul style="list-style-type: none"> +\$221 +\$236 +\$251 +\$268 	<ul style="list-style-type: none"> Specify with <i>modesty panel</i> and select powder coat color number. Specify with <i>modesty panel</i> and select powder coat color number. Specify with <i>modesty panel</i> and select powder coat color number. Specify with <i>modesty panel</i> and select powder coat color number.
Grommets <ul style="list-style-type: none"> • One grommet: black plastic • Two grommets: black plastic • Three grommets: black plastic 	<ul style="list-style-type: none"> +\$ 68 +\$136 +\$204 	<ul style="list-style-type: none"> Specify with <i>grommet</i> and select location of left, right, or center. Specify with <i>two grommets</i> and select location of left/center, right/center, or right/left. Specify with <i>three grommets</i>.
Spheres <ul style="list-style-type: none"> • Factory-installed opening and sphere to be installed on site: black plastic only • CSP = Four data jack locations • PCS = Two simplex power outlets and two data jack locations • PSP = Four simplex power 	<ul style="list-style-type: none"> +\$172 each +\$262 each +\$380 each 	<ul style="list-style-type: none"> Specify with <i>CSP sphere</i> and select location of left, right, or center. Specify with <i>PCS sphere</i> and select location of left, right, or center. Specify with <i>PSP sphere</i> and select location of left, right, or center.
Casters <ul style="list-style-type: none"> • 3" diameter, locking, single-wheel casters: black plastic 	<ul style="list-style-type: none"> +\$157 	<ul style="list-style-type: none"> Add suffix C to the style number.

Veneer direction



Reunion Seminar

Rectangular Seminar Tables with Removable Snap Legs

DESIGN FM DESIGN

SIN 711.11

Specification Information

Dimensions			Style Number	Finish	Base Prices	
L	W	H			Flat Vinyl Edge:	Flat Wood Edge:



Flat Vinyl Edge:



Flat Wood Edge:

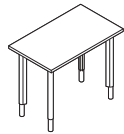

24"W Rectangular Seminar Tables with Removable Snap Legs

Dimensions (L x W x H)	Style Number	Grade 1 Price	Grade 2 Price
42" x 24" x 26 1/2" - 32 1/2"	50611625	Grade 1 Laminate	\$1661
		Grade 2 Laminate	\$1694
		Grade 1 Wood Veneer	\$2192
		Grade 2 Wood Veneer	\$2331
48" x 24" x 26 1/2" - 32 1/2"	50621625	Grade 1 Laminate	\$1668
		Grade 2 Laminate	\$1705
		Grade 1 Wood Veneer	\$2199
		Grade 2 Wood Veneer	\$2343
60" x 24" x 26 1/2" - 32 1/2"	50631625	Grade 1 Laminate	\$1711
		Grade 2 Laminate	\$1756
		Grade 1 Wood Veneer	\$2244
		Grade 2 Wood Veneer	\$2425
72" x 24" x 26 1/2" - 32 1/2"	50641625	Grade 1 Laminate	\$1735
		Grade 2 Laminate	\$1789
		Grade 1 Wood Veneer	\$2268
		Grade 2 Wood Veneer	\$2485

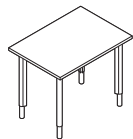

30"W Rectangular Seminar Tables with Removable Snap Legs

Dimensions (L x W x H)	Style Number	Grade 1 Price	Grade 2 Price
42" x 30" x 26 1/2" - 32 1/2"	50612625	Grade 1 Laminate	\$1861
		Grade 2 Laminate	\$1901
		Grade 1 Wood Veneer	\$2597
		Grade 2 Wood Veneer	\$2750
48" x 30" x 26 1/2" - 32 1/2"	50622625	Grade 1 Laminate	\$1893
		Grade 2 Laminate	\$1938
		Grade 1 Wood Veneer	\$2629
		Grade 2 Wood Veneer	\$2812
60" x 30" x 26 1/2" - 32 1/2"	50632625	Grade 1 Laminate	\$1942
		Grade 2 Laminate	\$1998
		Grade 1 Wood Veneer	\$2678
		Grade 2 Wood Veneer	\$2907
72" x 30" x 26 1/2" - 32 1/2"	50642625	Grade 1 Laminate	\$1977
		Grade 2 Laminate	\$2044
		Grade 1 Wood Veneer	\$2713
		Grade 2 Wood Veneer	\$2987

► Specification Information, continued on next page

► Specification Information, continued from previous page

Specification Information						
Dimensions			Style Number	Finish	Base Prices	
L	W	H			Flat Vinyl Edge:	Flat Wood Edge:

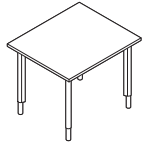

36"W Rectangular Seminar Tables with Removable Snap Legs

42"	36"	26½"-32½"	50613625	Grade 1 Laminate	\$2039	\$2745
				Grade 2 Laminate	\$2087	\$2793
				Grade 1 Wood Veneer	\$2848	\$3554
				Grade 2 Wood Veneer	\$3010	\$3716
48"	36"	26½"-32½"	50623625	Grade 1 Laminate	\$2088	\$2794
				Grade 2 Laminate	\$2142	\$2848
				Grade 1 Wood Veneer	\$2897	\$3603
				Grade 2 Wood Veneer	\$3114	\$3820
60"	36"	26½"-32½"	50633625	Grade 1 Laminate	\$2169	\$2875
				Grade 2 Laminate	\$2236	\$2942
				Grade 1 Wood Veneer	\$2978	\$3684
				Grade 2 Wood Veneer	\$3249	\$3955
72"	36"	26½"-32½"	50643625	Grade 1 Laminate	\$2254	\$2960
				Grade 2 Laminate	\$2335	\$3041
				Grade 1 Wood Veneer	\$3063	\$3769
				Grade 2 Wood Veneer	\$3390	\$4096

Coalesse

Reunion Seminar

DESIGN FM DESIGN

Rectangular Seminar Tables with Removable Snap Legs

SIN 711.11

Reunion Seminar Rectangular Seminar Tables with Fixed Snap Legs

DESIGN FM DESIGN

SIN 711.11

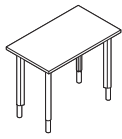

Tip: Shipped knocked down.

Tip: Reunion Seminar tables 24"W with fixed snap legs cannot be used with corner connecting tops.

Tip: You must send a sample of reasonable size for Stain-to-Match.

Tip: If you specify a wood edge on a top with woodgrain laminate, the edge and top may not match.

Tip: For grain matching always include a drawing or sketch along with your specification showing the arrangement of tables you plan so that we can ensure proper grain matching.

Tip: When the factory-installed flex ganger option is specified, the flex gangers will be installed in the end-to-end ganging configuration. If side-to-side or end-and-side ganging is required, change the position of the flex gangers at time of installation. All flex ganger locations are pre-drilled for simple re-location when desired.

Tip: When three grommets are specified, grommets will be located left, right, and center.

Tip: For sphere location availability.

Tip: If couplers are needed on PCS or CSP they must be ordered separately.

Tip: For installation of grommets, spheres, Interport, Mini-Port, Interact, Axil Z, or Ellora submit a drawing indicating the desired location for a factory installed cutout(s). Field installation is also available. All require the grommet(s), sphere(s), Interport, Mini-Port, Interact, Axil Z, or Ellora to be ordered as a separate item.

Tip: Table height adjustment range changes to 28½"H to 34½"H when casters are specified.

Standard Includes		Required to Specify
<ul style="list-style-type: none"> ▶ Need help? Product details, see <i>Coalesse Tables, Storage, and Accessories Specification Guide</i> 	<ul style="list-style-type: none"> • Top: 1¼" particle board core with laminate • Reunion vinyl edge: black • Four 2½" x 1¾" fixed snap legs: extruded aluminum and die-cast aluminum head with single powder coat and black tubular steel foot • Integral wire manager in leg to accommodate up to two ¾" diameter cords • Leveling glides with adjustability range of ½"H: black plastic 	<ol style="list-style-type: none"> 1 Style number 2 Powder coat color number for legs 3 Laminate color number for top 4 Options, if selected (see below) <p>▶ See <i>Surface Materials</i>, page 350.</p>

Options	Price	Required to Specify
Surface Materials <ul style="list-style-type: none"> • Grade 2 laminate • Grade 1 wood veneer • Grade 2 wood veneer • Stain-to-Match 	<ul style="list-style-type: none"> Prices at right Prices at right Prices at right No cost 	<ul style="list-style-type: none"> Specify with <i>Grade 2 laminate</i> and select color number. Specify with <i>Grade 1 wood veneer</i> and select color number. Specify with <i>Grade 2 wood veneer</i> and select color number. Specify with <i>Stain-to-Match</i>. <p>▶ Page 383</p>
Edge <ul style="list-style-type: none"> • Wood • Flat wood edge 	<ul style="list-style-type: none"> Prices at right 	<ul style="list-style-type: none"> Specify with <i>flat wood edge</i>.
Flex ganger package (Not to be used with wood edge) <ul style="list-style-type: none"> • End-to-end 	<ul style="list-style-type: none"> +\$ 78 	<ul style="list-style-type: none"> Specify with <i>end-to-end flex gangers</i>.
Modesty Panel <ul style="list-style-type: none"> ▶ Page 304 • 42"L • 48"L • 60"L • 72"L 	<ul style="list-style-type: none"> +\$221 +\$236 +\$251 +\$268 	<ul style="list-style-type: none"> Specify with <i>modesty panel</i> and select powder coat color number. Specify with <i>modesty panel</i> and select powder coat color number. Specify with <i>modesty panel</i> and select powder coat color number. Specify with <i>modesty panel</i> and select powder coat color number.
Grommets <ul style="list-style-type: none"> • One grommet: black plastic • Two grommets: black plastic • Three grommets: black plastic 	<ul style="list-style-type: none"> +\$ 68 +\$136 +\$204 	<ul style="list-style-type: none"> Specify with <i>grommet</i> and select location of left, right, or center. Specify with <i>two grommets</i> and select location of left/center, right/center, or right/left. Specify with <i>three grommets</i>.
Spheres <ul style="list-style-type: none"> • Factory-installed opening and sphere to be installed on site: black plastic only • CSP = Four data jack locations • PCS = Two simplex power outlets and two data jack locations • PSP = Four simplex power 	<ul style="list-style-type: none"> +\$172 each +\$262 each +\$380 each 	<ul style="list-style-type: none"> Specify with <i>CSP sphere</i> and select location of left, right, or center. Specify with <i>PCS sphere</i> and select location of left, right, or center. Specify with <i>PSP sphere</i> and select location of left, right, or center.
Casters <ul style="list-style-type: none"> • 3" diameter, locking, single-wheel casters: black plastic 	<ul style="list-style-type: none"> +\$157 	<ul style="list-style-type: none"> Add suffix C to the style number.

Veneer direction



Reunion Seminar

Rectangular Seminar Tables with Fixed Snap Legs

DESIGN FM DESIGN

SIN 711.11

Specification Information

Dimensions			Style Number	Finish	Base Prices	
L	W	H			Flat Vinyl Edge:	Flat Wood Edge:



Flat Vinyl Edge:



Flat Wood Edge:

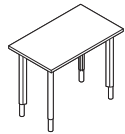

24"W Rectangular Seminar Tables with Fixed Snap Legs

Dimensions (L x W x H)	Style Number	Grade 1 Price	Grade 2 Price	
42" x 24" x 26 1/2"-32 1/2"	50611655	Grade 1 Laminate	\$1529	\$2157
		Grade 2 Laminate	\$1562	\$2190
		Grade 1 Wood Veneer	\$2060	\$2688
		Grade 2 Wood Veneer	\$2199	\$2827
48" x 24" x 26 1/2"-32 1/2"	50621655	Grade 1 Laminate	\$1539	\$2167
		Grade 2 Laminate	\$1576	\$2204
		Grade 1 Wood Veneer	\$2070	\$2698
		Grade 2 Wood Veneer	\$2214	\$2842
60" x 24" x 26 1/2"-32 1/2"	50631655	Grade 1 Laminate	\$1579	\$2207
		Grade 2 Laminate	\$1624	\$2252
		Grade 1 Wood Veneer	\$2112	\$2740
		Grade 2 Wood Veneer	\$2293	\$2921
72" x 24" x 26 1/2"-32 1/2"	50641655	Grade 1 Laminate	\$1603	\$2231
		Grade 2 Laminate	\$1657	\$2285
		Grade 1 Wood Veneer	\$2136	\$2764
		Grade 2 Wood Veneer	\$2353	\$2981

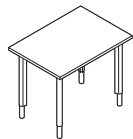

30"W Rectangular Seminar Tables with Fixed Snap Legs

Dimensions (L x W x H)	Style Number	Grade 1 Price	Grade 2 Price	
42" x 30" x 26 1/2"-32 1/2"	50612655	Grade 1 Laminate	\$1727	\$2433
		Grade 2 Laminate	\$1767	\$2473
		Grade 1 Wood Veneer	\$2463	\$3169
		Grade 2 Wood Veneer	\$2616	\$3322
48" x 30" x 26 1/2"-32 1/2"	50622655	Grade 1 Laminate	\$1760	\$2466
		Grade 2 Laminate	\$1805	\$2511
		Grade 1 Wood Veneer	\$2496	\$3202
		Grade 2 Wood Veneer	\$2679	\$3385
60" x 30" x 26 1/2"-32 1/2"	50632655	Grade 1 Laminate	\$1812	\$2518
		Grade 2 Laminate	\$1868	\$2574
		Grade 1 Wood Veneer	\$2548	\$3254
		Grade 2 Wood Veneer	\$2777	\$3483
72" x 30" x 26 1/2"-32 1/2"	50642655	Grade 1 Laminate	\$1844	\$2550
		Grade 2 Laminate	\$1911	\$2617
		Grade 1 Wood Veneer	\$2580	\$3286
		Grade 2 Wood Veneer	\$2854	\$3560

► Specification Information, continued on next page

Reunion Seminar

Rectangular Seminar Tables with Fixed Snap Legs *continued*

DESIGN FM DESIGN

SIN 711.11

► Specification Information, continued from previous page

Specification Information

Dimensions			Style Number	Finish	Base Prices	
L	W	H			Flat Vinyl Edge:	Flat Wood Edge:



Flat Vinyl Edge:



Flat Wood Edge:

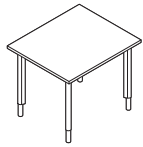

36"W Rectangular Seminar Tables with Fixed Snap Legs

Dimensions L	Dimensions W	Dimensions H	Style Number	Finish	Flat Vinyl Edge	Flat Wood Edge
42"	36"	26½"-32½"	50613655	Grade 1 Laminate	\$1906	\$2612
				Grade 2 Laminate	\$1954	\$2660
				Grade 1 Wood Veneer	\$2715	\$3421
				Grade 2 Wood Veneer	\$2877	\$3583
48"	36"	26½"-32½"	50623655	Grade 1 Laminate	\$1957	\$2663
				Grade 2 Laminate	\$2011	\$2717
				Grade 1 Wood Veneer	\$2766	\$3472
				Grade 2 Wood Veneer	\$2983	\$3689
60"	36"	26½"-32½"	50633655	Grade 1 Laminate	\$2039	\$2745
				Grade 2 Laminate	\$2106	\$2812
				Grade 1 Wood Veneer	\$2848	\$3554
				Grade 2 Wood Veneer	\$3119	\$3825
72"	36"	26½"-32½"	50643655	Grade 1 Laminate	\$2121	\$2827
				Grade 2 Laminate	\$2202	\$2908
				Grade 1 Wood Veneer	\$2930	\$3636
				Grade 2 Wood Veneer	\$3257	\$3963

Coalesse

Reunion Seminar

DESIGN FM DESIGN

Rectangular Seminar Tables with Fixed Snap Legs

SIN 711.11

Reunion Seminar Square Seminar Tables with Removable Snap Legs

DESIGN FM DESIGN

SIN 711.11

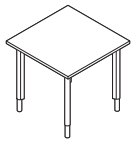

Tip: Shipped knocked down.

Tip: You must send a sample of reasonable size for Stain-to-Match.

Tip: If you specify a wood edge on a top with woodgrain laminate, the edge and top may not match.

Tip: For grain matching always include a drawing or sketch along with your specification showing the arrangement of tables you plan so that we can ensure proper grain matching.

Tip: When the factory-installed flex ganger option is specified, the flex gangers will be installed in the end-to-end ganging configuration. If side-to-side or end-and-side ganging is required, change the position of the flex gangers at time of installation. All flex ganger locations are pre-drilled for simple re-location when desired.

Tip: Table height adjustment range changes to 28½"H to 34½"H when casters are specified.

Standard Includes		Required to Specify
<ul style="list-style-type: none"> ▶ Need help? Product details, see <i>Coalesse Tables, Storage, and Accessories Specification Guide</i> 	<ul style="list-style-type: none"> • Top: 1¼" particle board core with laminate • Reunion vinyl edge: black • Four 2½" x 1¾" removable snap legs: extruded aluminum and die-cast aluminum head with single powder coat and black tubular steel foot • Integral wire manager in leg to accommodate up to two ¾" diameter cords • Leveling glides with adjustability range of ½"H: black plastic 	<ol style="list-style-type: none"> 1 Style number 2 Powder coat color number for legs 3 Laminate color number for top 4 Options, if selected (see below) <ul style="list-style-type: none"> ▶ See <i>Surface Materials</i>, page 350.

Options	Price	Required to Specify
Surface Materials <ul style="list-style-type: none"> • Top • Grade 2 laminate • Grade 1 wood veneer • Grade 2 wood veneer • Stain-to-Match 	<ul style="list-style-type: none"> Prices at right Prices at right Prices at right No cost 	<ul style="list-style-type: none"> Specify with <i>Grade 2 laminate</i> and select color number. Specify with <i>Grade 1 wood veneer</i> and select color number. Specify with <i>Grade 2 wood veneer</i> and select color number. Specify with <i>Stain-to-Match</i>. ▶ Page 383
Edge <ul style="list-style-type: none"> • Wood • Flat wood edge 	<ul style="list-style-type: none"> Prices at right 	<ul style="list-style-type: none"> Specify with <i>flat wood edge</i>.
Flex ganger package (Not to be used with wood edge) <ul style="list-style-type: none"> • End-to-end 	<ul style="list-style-type: none"> +\$ 78 	<ul style="list-style-type: none"> Specify with <i>end-to-end flex gangers</i>.
Modesty Panel <ul style="list-style-type: none"> ▶ Page 304 • 42"L • 48"L • 60"L 	<ul style="list-style-type: none"> +\$244 +\$261 +\$282 	<ul style="list-style-type: none"> Specify with <i>modesty panel</i> and select powder coat color number. Specify with <i>modesty panel</i> and select powder coat color number. Specify with <i>modesty panel</i> and select powder coat color number.
Casters <ul style="list-style-type: none"> • 3" diameter, locking, single-wheel casters: black plastic 	<ul style="list-style-type: none"> +\$157 	<ul style="list-style-type: none"> Add suffix C to the style number.

Veneer direction



Reunion Seminar

DESIGN FM DESIGN

Square Seminar Tables with Removable Snap Legs

SIN 711.11

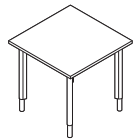

Specification Information						
Dimensions			Style Number	Finish	Base Prices	
L	W	H			Flat Vinyl Edge:	Flat Wood Edge:
36"	36"	26½"-32½"	50436625	Grade 1 Laminate	\$1788	\$2455
				Grade 2 Laminate	\$1829	\$2496
				Grade 1 Wood Veneer	\$2597	\$3264
				Grade 2 Wood Veneer	\$2759	\$3426
42"	42"	26½"-32½"	50442625	Grade 1 Laminate	\$1822	\$2489
				Grade 2 Laminate	\$1877	\$2544
				Grade 1 Wood Veneer	\$2631	\$3298
				Grade 2 Wood Veneer	\$2858	\$3525
48"	48"	26½"-32½"	50448625	Grade 1 Laminate	\$1904	\$2571
				Grade 2 Laminate	\$1974	\$2641
				Grade 1 Wood Veneer	\$2713	\$3380
				Grade 2 Wood Veneer	\$2958	\$3625
60"	60"	26½"-32½"	50460625	Grade 1 Laminate	\$2055	\$2722
				Grade 2 Laminate	\$2167	\$2834
				Grade 1 Wood Veneer	\$2864	\$3531
				Grade 2 Wood Veneer	\$3245	\$3912

Reunion Seminar Square Seminar Tables with Fixed Snap Legs

DESIGN FM DESIGN

SIN 711.11



Tip: Shipped knocked down.

Standard Includes	Required to Specify
<ul style="list-style-type: none"> ▶ Need help? Product details, see <i>Coalesse Tables, Storage, and Accessories Specification Guide</i> • Top: 1/4" particle board core with laminate • Reunion vinyl edge: black • Four 2 1/2" x 1 3/4" fixed snap legs: extruded aluminum and die-cast aluminum head with single powder coat and black tubular steel foot • Integral wire manager in leg to accommodate up to two 3/8" diameter cords • Leveling glides with adjustability range of 1/2"H: black plastic 	<ol style="list-style-type: none"> 1 Style number 2 Powder coat color number for legs 3 Laminate color number for top 4 Options, if selected (see below) <p>▶ See <i>Surface Materials</i>, page 350.</p>

Options	Price	Required to Specify
Surface Materials <ul style="list-style-type: none"> • Top • Grade 2 laminate • Grade 1 wood veneer • Grade 2 wood veneer • Stain-to-Match 	<p>Prices at right</p> <p>Prices at right</p> <p>Prices at right</p> <p>No cost</p>	<p>Specify with <i>Grade 2 laminate</i> and select color number.</p> <p>Specify with <i>Grade 1 wood veneer</i> and select color number.</p> <p>Specify with <i>Grade 2 wood veneer</i> and select color number.</p> <p>Specify with <i>Stain-to-Match</i>.</p> <p>▶ Page 383</p>
Edge <ul style="list-style-type: none"> • Wood • Flat wood edge 	<p>Prices at right</p>	<p>Specify with <i>flat wood edge</i>.</p>
Flex ganger package (Not to be used with wood edge) <ul style="list-style-type: none"> • End-to-end 	<p>+\$ 78</p>	<p>Specify with <i>end-to-end flex gangers</i>.</p>
Modesty Panel <ul style="list-style-type: none"> • 42"L • 48"L • 60"L <p>▶ Page 304</p>	<p>+\$244</p> <p>+\$261</p> <p>+\$282</p>	<p>Specify with <i>modesty panel</i> and select powder coat color number.</p> <p>Specify with <i>modesty panel</i> and select powder coat color number.</p> <p>Specify with <i>modesty panel</i> and select powder coat color number.</p>
Castors <ul style="list-style-type: none"> • 3" diameter, locking, single-wheel casters: black plastic 	<p>+\$157</p>	<p>Add suffix C to the style number.</p>

Tip: You must send a sample of reasonable size for *Stain-to-Match*.

Tip: If you specify a wood edge on a top with woodgrain laminate, the edge and top may not match.

Tip: For grain matching always include a drawing or sketch along with your specification showing the arrangement of tables you plan so that we can ensure proper grain matching.

Tip: When the factory-installed flex ganger option is specified, the flex gangers will be installed in the end-to-end ganging configuration. If side-to-side or end-and-side ganging is required, change the position of the flex gangers at time of installation. All flex ganger locations are pre-drilled for simple re-location when desired.

Tip: Table height adjustment range changes to 28 1/2"H to 34 1/2"H when casters are specified.

Veneer direction



Reunion Seminar

DESIGN FM DESIGN

Square Seminar Tables with Fixed Snap Legs

SIN 711.11

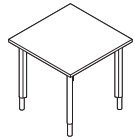

Specification Information							
Dimensions			Style Number	Finish	Base Prices		
L	W	H			Flat Vinyl Edge:	Flat Wood Edge:	
36"	36"	26½"-32½"	50436655	Grade 1 Laminate	\$1659	\$2326	
				Grade 2 Laminate	\$1700	\$2367	
				Grade 1 Wood Veneer	\$2468	\$3135	
				Grade 2 Wood Veneer	\$2630	\$3297	
42"	42"	26½"-32½"	50442655	Grade 1 Laminate	\$1691	\$2358	
				Grade 2 Laminate	\$1746	\$2413	
				Grade 1 Wood Veneer	\$2500	\$3167	
				Grade 2 Wood Veneer	\$2727	\$3394	
48"	48"	26½"-32½"	50448655	Grade 1 Laminate	\$1778	\$2445	
				Grade 2 Laminate	\$1848	\$2515	
				Grade 1 Wood Veneer	\$2587	\$3254	
				Grade 2 Wood Veneer	\$2832	\$3499	
60"	60"	26½"-32½"	50460655	Grade 1 Laminate	\$1924	\$2591	
				Grade 2 Laminate	\$2036	\$2703	
				Grade 1 Wood Veneer	\$2733	\$3400	
				Grade 2 Wood Veneer	\$3114	\$3781	

Reunion Seminar 60° Trapezoid Seminar Tables with Removable Snap Legs

DESIGN FM DESIGN

SIN 711.11



Tip: Shipped knocked down.

Tip: You must send a sample of reasonable size for Stain-to-Match.

Tip: If you specify a wood edge on a top with woodgrain laminate, the edge and top may not match.

Tip: For grain matching always include a drawing or sketch along with your specification showing the arrangement of tables you plan so that we can ensure proper grain matching.

Tip: When the factory-installed flex ganger option is specified, the flex gangers will be installed in the end-to-end ganging configuration. If side-to-side or end-and-side ganging is required, change the position of the flex gangers at time of installation. All flex ganger locations are pre-drilled for simple re-location when desired.

Tip: Table height adjustment range changes to 28½"H to 34½"H when casters are specified.

Standard Includes		Required to Specify
<ul style="list-style-type: none"> ▶ Need help? Product details, see <i>Coalesse Tables, Storage, and Accessories Specification Guide</i> 	<ul style="list-style-type: none"> • Top: 1¼" particle board core with laminate • Reunion vinyl edge: black • Four 2½" x 1¾" removable snap legs: extruded aluminum and die-cast aluminum head with single powder coat and black tubular steel foot • Integral wire manager in leg to accommodate up to two ¾" diameter cords • Leveling glides with adjustability range of ½"H: black plastic 	<ol style="list-style-type: none"> 1 Style number 2 Powder coat color number for legs 3 Laminate color number for top 4 Options, if selected (see below) <p>▶ See <i>Surface Materials</i>, page 350.</p>

Options	Price	Required to Specify
Surface Materials Top <ul style="list-style-type: none"> • Grade 2 laminate • Grade 1 wood veneer • Grade 2 wood veneer • Stain-to-Match 	<ul style="list-style-type: none"> Prices below Prices below Prices below No cost 	<ul style="list-style-type: none"> Specify with <i>Grade 2 laminate</i> and select color number. Specify with <i>Grade 1 wood veneer</i> and select color number. Specify with <i>Grade 2 wood veneer</i> and select color number. Specify with <i>Stain-to-Match</i>. <p>▶ Page 383</p>
Edge Wood <ul style="list-style-type: none"> • Flat wood edge 	<ul style="list-style-type: none"> Prices below 	<ul style="list-style-type: none"> Specify with <i>flat wood edge</i>.
Flex ganger package (Not to be used with wood edge) <ul style="list-style-type: none"> • End-to-end 	<ul style="list-style-type: none"> +\$ 78 	<ul style="list-style-type: none"> Specify with <i>end-to-end flex gangers</i>.
Casters <ul style="list-style-type: none"> • 3" diameter, locking, single-wheel casters: black plastic 	<ul style="list-style-type: none"> +\$157 	<ul style="list-style-type: none"> Add suffix C to the style number.

Specification Information							
Dimensions			Style Number	Finish	Base Prices		
L	W	H			Flat Vinyl Edge:	Flat Wood Edge:	
48"	24"	26½"–32½"	51421625		Grade 1 Laminate	\$1773	\$2479
					Grade 2 Laminate	\$1810	\$2516
					Grade 1 Wood Veneer	\$2306	\$3012
					Grade 2 Wood Veneer	\$2450	\$3156
60"	30"	26½"–32½"	51432625		Grade 1 Laminate	\$1938	\$2644
					Grade 2 Laminate	\$1994	\$2700
					Grade 1 Wood Veneer	\$2674	\$3380
					Grade 2 Wood Veneer	\$2903	\$3609

Veneer direction



Reunion Seminar 60° Trapezoid Seminar Tables with Fixed Snap Legs

DESIGN FM DESIGN

SIN 711.11



Tip: Shipped knocked down.

Tip: You must send a sample of reasonable size for Stain-to-Match.

Tip: If you specify a wood edge on a top with woodgrain laminate, the edge and top may not match.

Tip: For grain matching always include a drawing or sketch along with your specification showing the arrangement of tables you plan so that we can ensure proper grain matching.

Tip: When the factory-installed flex ganger option is specified, the flex gangers will be installed in the end-to-end ganging configuration. If side-to-side or end-and-side ganging is required, change the position of the flex gangers at time of installation. All flex ganger locations are pre-drilled for simple re-location when desired.

Tip: Table height adjustment range changes to 28½"H to 34½"H when casters are specified.

Standard Includes	Required to Specify
<ul style="list-style-type: none"> ▶ Need help? Product details, see <i>Coalesse Tables, Storage, and Accessories Specification Guide</i> • Top: 1¼" particle board core with laminate • Reunion vinyl edge: black • Four 2½" x 1¾" fixed snap legs: extruded aluminum and die-cast aluminum head with single powder coat and black tubular steel foot • Integral wire manager in leg to accommodate up to two ¾" diameter cords • Leveling glides with adjustability range of ½"H: black plastic 	<ol style="list-style-type: none"> 1 Style number 2 Powder coat color number for legs 3 Laminate color number for top 4 Options, if selected (see below) <p>▶ See <i>Surface Materials</i>, page 350.</p>

Options	Price	Required to Specify
Surface Materials <ul style="list-style-type: none"> • Top • Grade 2 laminate • Grade 1 wood veneer • Grade 2 wood veneer • Stain-to-Match 	<ul style="list-style-type: none"> Prices below Prices below Prices below No cost 	<ul style="list-style-type: none"> Specify with <i>Grade 2 laminate</i> and select color number. Specify with <i>Grade 1 wood veneer</i> and select color number. Specify with <i>Grade 2 wood veneer</i> and select color number. Specify with <i>Stain-to-Match</i>. <p>▶ Page 383</p>
Edge <ul style="list-style-type: none"> • Wood • Flat wood edge 	<ul style="list-style-type: none"> Prices below 	<ul style="list-style-type: none"> Specify with <i>flat wood edge</i>.
Flex ganger package (Not to be used with wood edge) <ul style="list-style-type: none"> • End-to-end 	<ul style="list-style-type: none"> +\$ 78 	<ul style="list-style-type: none"> Specify with <i>end-to-end flex gangers</i>.
Casters <ul style="list-style-type: none"> • 3" diameter, locking, single-wheel casters: black plastic 	<ul style="list-style-type: none"> +\$157 	<ul style="list-style-type: none"> Add suffix C to the style number.

Specification Information							
Dimensions			Style Number	Finish	Base Prices		
L	W	H			Flat Vinyl Edge:	Flat Wood Edge:	
48"	24"	26½"-32½"	51421655	Grade 1 Laminate	\$1643	\$2349	
					Grade 2 Laminate	\$1680	\$2386
					Grade 1 Wood Veneer	\$2176	\$2882
					Grade 2 Wood Veneer	\$2320	\$3026
60"	30"	26½"-32½"	51432655	Grade 1 Laminate	\$1807	\$2513	
					Grade 2 Laminate	\$1863	\$2569
					Grade 1 Wood Veneer	\$2543	\$3249
					Grade 2 Wood Veneer	\$2772	\$3478

Veneer direction



Reunion Seminar Half Round Seminar Tables with Removable Snap Legs

DESIGN FM DESIGN

SIN 711.11

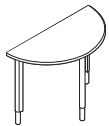

Tip: Shipped knocked down.

Tip: You must send a sample of reasonable size for Stain-to-Match.

Tip: If you specify a wood edge on a top with woodgrain laminate, the edge and top may not match.

Tip: For grain matching always include a drawing or sketch along with your specification showing the arrangement of tables you plan so that we can ensure proper grain matching.

Tip: When the factory-installed flex ganger option is specified, the flex gangers will be installed in the end-to-end ganging configuration. If side-to-side or end-and-side ganging is required, change the position of the flex gangers at time of installation. All flex ganger locations are pre-drilled for simple re-location when desired.

Tip: Table height adjustment range changes to 28½"H to 34½"H when casters are specified.

Veneer direction



Standard Includes		Required to Specify
<ul style="list-style-type: none"> ▶ Need help? Product details, see <i>Coalesse Tables, Storage, and Accessories Specification Guide</i> 	<ul style="list-style-type: none"> • Top: 1¼" particle board core with laminate • Reunion vinyl edge: black • Three 2½" x 1¾" snap legs: extruded aluminum and die-cast aluminum head with single powder coat and black tubular steel foot • Integral wire manager in leg to accommodate up to two ¾" diameter cords • Leveling glides with adjustability range of ½"H: black plastic 	<ol style="list-style-type: none"> 1 Style number 2 Powder coat color number for legs 3 Laminate color number for top 4 Options, if selected (see below) <p>▶ See <i>Surface Materials</i>, page 350.</p>

Options	Price	Required to Specify
Surface Materials Top <ul style="list-style-type: none"> • Grade 2 laminate • Grade 1 wood veneer • Grade 2 wood veneer • Stain-to-Match 	<ul style="list-style-type: none"> Prices below Prices below Prices below No cost 	<ul style="list-style-type: none"> Specify with <i>Grade 2 laminate</i> and select color number. Specify with <i>Grade 1 wood veneer</i> and select color number. Specify with <i>Grade 2 wood veneer</i> and select color number. Specify with <i>Stain-to-Match</i>. <p>▶ Page 383</p>
Edge Wood <ul style="list-style-type: none"> • Flat wood edge 	<ul style="list-style-type: none"> Prices below 	<ul style="list-style-type: none"> Specify with <i>flat wood edge</i>.
Flex ganger package (Not to be used with wood edge) <ul style="list-style-type: none"> • Factory-installed flex gangers to join adjacent tables: black plastic 	<ul style="list-style-type: none"> +\$ 78 	<ul style="list-style-type: none"> Specify with <i>flex gangers</i>.
Casters <ul style="list-style-type: none"> • 3" diameter, locking, single-wheel casters: black plastic 	<ul style="list-style-type: none"> +\$119 	<ul style="list-style-type: none"> Add suffix C to the style number.

Specification Information						
Dimensions			Style Number	Finish	Base Prices	
L	W	H			Flat Vinyl Edge:	Flat Wood Edge:
48"	24"	26½"-32½"	50348625			
60"	30"	26½"-32½"	50360625			
72"	36"	26½"-32½"	50372625			

With Removable Snap Legs						
Dimensions	Style Number	Grade 1 Laminate	Grade 2 Laminate	Grade 1 Wood Veneer	Grade 2 Wood Veneer	
48" 24" 26½"-32½"	50348625	Grade 1 Laminate	\$1563	\$2147		
		Grade 2 Laminate	\$1600	\$2184		
		Grade 1 Wood Veneer	\$2096	\$2680		
		Grade 2 Wood Veneer	\$2240	\$2824		
60" 30" 26½"-32½"	50360625	Grade 1 Laminate	\$1726	\$2386		
		Grade 2 Laminate	\$1782	\$2442		
		Grade 1 Wood Veneer	\$2462	\$3122		
		Grade 2 Wood Veneer	\$2691	\$3351		
72" 36" 26½"-32½"	50372625	Grade 1 Laminate	\$2099	\$2759		
		Grade 2 Laminate	\$2180	\$2840		
		Grade 1 Wood Veneer	\$2908	\$3568		
		Grade 2 Wood Veneer	\$3235	\$3895		

Reunion Seminar Half Round Seminar Tables with Fixed Snap Legs

DESIGN FM DESIGN

SIN 711.11

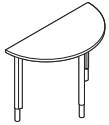

Tip: Shipped knocked down.

Tip: You must send a sample of reasonable size for Stain-to-Match.



Tip: If you specify a wood edge on a top with woodgrain laminate, the edge and top may not match.

Tip: For grain matching always include a drawing or sketch along with your specification showing the arrangement of tables you plan so that we can ensure proper grain matching.

Tip: Table height adjustment range changes to 28 1/2" H to 34 1/2" H when casters are specified.

Standard Includes	Required to Specify
<ul style="list-style-type: none"> ▶ Need help? Product details, see <i>Coalesse Tables, Storage, and Accessories Specification Guide</i> • Top: 1/4" particle board core with laminate • Reunion vinyl edge: black • Three 2 1/2" x 1 3/4" snap legs: extruded aluminum and die-cast aluminum head with single powder coat and black tubular steel foot • Integral wire manager in leg to accommodate up to two 3/8" diameter cords • Leveling glides with adjustability range of 1/2"H: black plastic 	<ol style="list-style-type: none"> 1 Style number 2 Powder coat color number for legs 3 Laminate color number for top 4 Options, if selected (see below) <p>▶ See <i>Surface Materials</i>, page 350.</p>

Options	Price	Required to Specify
Surface Materials <ul style="list-style-type: none"> • Top • Grade 2 laminate • Grade 1 wood veneer • Grade 2 wood veneer • Stain-to-Match 	<ul style="list-style-type: none"> Prices below Prices below Prices below No cost 	<ul style="list-style-type: none"> Specify with <i>Grade 2 laminate</i> and select color number. Specify with <i>Grade 1 wood veneer</i> and select color number. Specify with <i>Grade 2 wood veneer</i> and select color number. Specify with <i>Stain-to-Match</i>. <p>▶ Page 383</p>
Edge <ul style="list-style-type: none"> • Wood • Flat wood edge 	<ul style="list-style-type: none"> Prices below 	<ul style="list-style-type: none"> Specify with <i>flat wood edge</i>.
Flex ganger package (Not to be used with wood edge) <ul style="list-style-type: none"> • Factory-installed flex gangers to join adjacent tables: black plastic 	<ul style="list-style-type: none"> +\$ 78 	<ul style="list-style-type: none"> Specify with <i>flex gangers</i>.
Casters <ul style="list-style-type: none"> • 3" diameter, locking, single-wheel casters: black plastic 	<ul style="list-style-type: none"> +\$119 	<ul style="list-style-type: none"> Add suffix C to the style number.

Specification Information			
Dimensions	Style Number	Finish	Base Prices
L W H			
			 Flat Vinyl Edge:
			 Flat Wood Edge:

With Fixed Snap Legs

Dimensions	Style Number	Grade 1 Laminate	Grade 2 Laminate	Grade 1 Wood Veneer	Grade 2 Wood Veneer
48" 24" 26 1/2"-32 1/2"	50348655	\$1463	\$1500	\$1996	\$2140
		\$2047	\$2084	\$2580	\$2724
60" 30" 26 1/2"-32 1/2"	50360655	\$1627	\$1683	\$2363	\$2592
		\$2287	\$2343	\$3023	\$3252
72" 36" 26 1/2"-32 1/2"	50372655	\$1995	\$2076	\$2804	\$3131
		\$2655	\$2736	\$3464	\$3791

Reunion Seminar 90° Connecting Tops for Seminar Tables

DESIGN FM DESIGN

SIN 711.11



Tip: Shipped knocked down.

Tip: Corner connecting tops cannot be used with Reunion Seminar tables 24"W with fixed snap legs.

Tip: You must send a sample of reasonable size for Stain-to-Match.

Tip: If you specify a wood edge on a top with woodgrain laminate, the edge and top may not match.

Tip: For grain matching always include a drawing or sketch along with your specification showing the arrangement of tables you plan so that we can ensure proper grain matching.

Standard Includes

- ▶ Need help? Product details, see *Coalesse Tables, Storage, and Accessories Specification Guide*
- Top: 1/4" particle board core with laminate
- Reunion vinyl edge: black
- Connecting hardware

Required to Specify

- 1 Style number
 - 2 Laminate color number for top
 - 3 Options, if selected (see below)
- ▶ See *Surface Materials*, page 350.

Options

Surface Materials	Top	Price	Required to Specify
	• Grade 2 laminate	Prices below	Specify with <i>Grade 2 laminate</i> and select color number.
	• Grade 1 wood veneer	Prices below	Specify with <i>Grade 1 wood veneer</i> and select color number.
	• Grade 2 wood veneer	Prices below	Specify with <i>Grade 2 wood veneer</i> and select color number.
	• Stain-to-Match	No cost	Specify with <i>Stain-to-Match</i> . ▶ Page 383

Edge	Wood	Price	Required to Specify
	• Flat wood edge	Prices below	Specify with <i>flat wood edge</i> .

Specification Information

Dimensions W	Style Number	Finish	Prices	
			Flat Vinyl Edge:	Flat Wood Edge:
24"	51091000	Grade 1 Laminate	\$ 382	\$1010
		Grade 2 Laminate	\$ 399	\$1027
		Grade 1 Wood Veneer	\$ 915	\$1543
		Grade 2 Wood Veneer	\$ 987	\$1615
30"	51092000	Grade 1 Laminate	\$ 418	\$1124
		Grade 2 Laminate	\$ 448	\$1154
		Grade 1 Wood Veneer	\$ 951	\$1657
		Grade 2 Wood Veneer	\$1065	\$1771
36"	51093000	Grade 1 Laminate	\$ 461	\$1167
		Grade 2 Laminate	\$ 502	\$1208
		Grade 1 Wood Veneer	\$ 994	\$1700
		Grade 2 Wood Veneer	\$1156	\$1862

Veneer direction



Flex Ganger Package

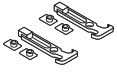

Tip: Order one ganger package for each table-to-table combination.

	Standard Includes	Required to Specify
▶ Need help? Product details, see <i>Coalesse Tables, Storage, and Accessories Specification Guide</i>	<ul style="list-style-type: none"> Two field-installed flexible ganger loops and four hooks: black plastic only Installation instructions 	Style number

Specification Information		
Style Number		Price
793365		\$78

Bar Ganger Package

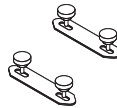

	Standard Includes	Required to Specify
▶ Need help? Product details, see <i>Coalesse Tables, Storage, and Accessories Specification Guide</i>	<ul style="list-style-type: none"> Two field-installed steel bars and four threaded hand knobs: black steel only 	Style number

Specification Information		
Style Number		Price
793335		\$55

Field-Installed Horizontal Wire Manager for Reunion Seminar



	Standard Includes	Required to Specify
▶ Need help? Product details, see <i>Coalesse Tables, Storage, and Accessories Specification Guide</i>	<ul style="list-style-type: none"> Horizontal wire manager: black plastic Attachment velcro Installation instructions 	Style number

Specification Information		
Length	Style Number	Price
42"	793442	\$ 87
48"	793448	\$100
60"	793460	\$113
72"	793472	\$129

Field-Installed Modesty Panel for Reunion Seminar

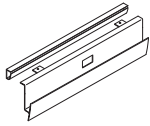

Standard Includes		Required to Specify
<ul style="list-style-type: none"> ▶ Need help? Product details, see <i>Coalesse Tables, Storage, and Accessories Specification Guide</i> 	<ul style="list-style-type: none"> • Modesty panel with integral horizontal wire manager: extruded aluminum with powder coat • Attachment hardware • Installation instructions 	<ol style="list-style-type: none"> 1 Style number 2 Powder coat color number for modesty panel

Specification Information		
Length	Style Number	Price
42"	793742	\$248
48"	793748	\$262
60"	793760	\$281
72"	793772	\$299

Mobile Storage Cart

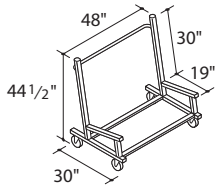

Tip: Shipped knocked down.

Tip: Mobile storage cart accommodates folding Reunion tables of lengths from 48"-72" and widths up to 42". Folded height is 3⁵/₈".

Standard Includes		Required to Specify
<ul style="list-style-type: none"> ▶ Need help? Product details, see <i>Coalesse Tables, Storage, and Accessories Specification Guide</i> 	<ul style="list-style-type: none"> • Cart to accommodate up to 12 folding Reunion table tops and up to 16 Reunion legs: black only • Bumpers: black 	Style number

Specification Information	
Style Number	Price
Accommodates 48"L, 60"L, or 72"L Tables up to 42"W	
793333	\$2143

SW_1

Specifying

Low Collaborative Conference Tables (SIN 711.11)	306
Conference Tables (SIN 711.11)	310
Round, Square, and Super-Square Tables (SIN 711.11)	314
Occasional Tables (SIN 711.11)	316
Work Tables (SIN 711.11)	318
Accessories (SIN 711.11)	319

SW_1 Low Collaborative Conference Tables

DESIGN SCOTT WILSON & MINIMAL

SIN 711.11



Tip: Your specification is not complete until you add the fifth letter to the style number to define top surface.

- L - Laminate top
- V - Wood veneer top
- C - Corian top
- G - Glass top

Tip: Glass tops are not secured to the substructure. Glass tops are placed on rubber pads that are adhered to the substructure. If the glass tables need to be moved, remove the glass top prior to moving the table.

Tip: Standard grain direction runs the width of the table (front-to back).

Tip: If grommet with wire manager is selected, the finish is not selectable, it will be the same as the substructure finish choice.

Tip: Tablets are an optional pick for the 42" and 84" square and 84"L and 120"L rectangular tables only. Tablets are available in black or milk finish.

Veneer direction



Standard Includes	Required to Specify
-------------------	---------------------

- | | | |
|---|--|---|
| <ul style="list-style-type: none"> ▶ Need help? Product details, see <i>Coalesse Tables, Storage, and Accessories Specification Guide</i> | <ul style="list-style-type: none"> • 1/2" thick top surface: <ul style="list-style-type: none"> - Laminate (Grade 1) with 3 mm edge band, if selected - Wood veneer (Grade 1) with matching 3 mm edge band, if selected - Corian, if selected: white only - Glass, if selected • 1/4" thick bottom substructure: black or milk • Base, column, and cone: 8040 Polished Matte Aluminum • Glides • Ships ready-to-assemble | <ol style="list-style-type: none"> 1 Style number with appropriate top series letter indicated in the space provided. (For example: COWX_Q42 becomes COWXLQ42 for a laminate top surface): <ul style="list-style-type: none"> L - Laminate top V - Wood veneer top C - Corian top G - Glass top 2 Laminate, wood, or glass color number for top, if selected 3 Plastic color for edge band of laminate top, if selected 4 Bottom substructure: <ul style="list-style-type: none"> 6000 Black 6052 Milk 5 Options, if selected (see below) <ul style="list-style-type: none"> ▶ See <i>Surface Materials</i>, page 350. |
|---|--|---|

Options	Price	Required to Specify
---------	-------	---------------------

Surface Materials	Laminate <ul style="list-style-type: none"> • Grade 2 laminate Wood <ul style="list-style-type: none"> • Grade 2 wood veneer • Stain-to-Match 	Prices at right Prices at right No cost	Specify with <i>Grade 2 laminate</i> and select color number. Specify with <i>Grade 2 wood veneer</i> and select color number. Specify with <i>Stain-to-Match</i> . ▶ See <i>Coalesse Surface Materials Reference Guide</i> .
Wood Veneer Grain Direction	<ul style="list-style-type: none"> • Lengthwise grain direction for tops up to 96"L 	No cost	Specify with <i>lengthwise grain direction</i> .
Grommet with Wire Management	42" square and 120"L tables (center only) <ul style="list-style-type: none"> • One grommet 60" and 72" large round and square tables <ul style="list-style-type: none"> • One grommet • Two grommets 84" and 96" large round and square tables <ul style="list-style-type: none"> • Two grommets • Four grommets 72"L, 84"L, and 96"L tables (end (V-leg) location only) <ul style="list-style-type: none"> • One grommet 72"L, 84"L, 96"L, and 120"L tables (outer ends (V-legs) location only) <ul style="list-style-type: none"> • Two grommets 	+\$ 196 +\$ 196 +\$ 392 +\$ 392 +\$ 784 +\$ 196 +\$ 392	Specify with <i>one grommet with wire manager</i> . Specify with <i>one grommet with wire manager</i> . Specify with <i>two grommets with wire manager</i> . Specify with <i>two grommets with wire manager</i> . Specify with <i>four grommets with wire manager</i> . Specify with <i>one grommet with wire manager</i> . Specify with <i>two grommets with wire manager</i> .
Tablets	42" square tables <ul style="list-style-type: none"> • Two tablets: black or milk plastic • Four tablets: black or milk plastic 84"L rectangular tables <ul style="list-style-type: none"> • Six tablets: black or milk plastic 84" square table and 120"L rectangular tables <ul style="list-style-type: none"> • Eight tablets: black or milk plastic 	+\$ 934 +\$1868 +\$2802 +\$3736	Specify with <i>two tablets</i> and select plastic color number. Specify with <i>four tablets</i> and select plastic color number. Specify with <i>six tablets</i> and select plastic color number. Specify with <i>eight tablets</i> and select plastic color number.
Related Products	<ul style="list-style-type: none"> • SW_1 seating 		▶ See <i>GSA Volume 5a Specification Guide</i> .

SW_1 Low Collaborative Conference Tables

DESIGN SCOTT WILSON & MINIMAL

SIN 711.11

Tip: Your specification is not complete until you add the fifth letter to the style number to define top surface.

- L - Laminate top
- V - Wood veneer top
- C - Corian top
- G - Glass top

Tip: Glass tops are not secured to the substructure. Glass tops are placed on rubber pads that are adhered to the substructure. If the glass tables need to be moved, remove the glass top prior to moving the table.

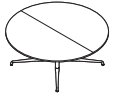

Tip: 60" and 72" round and square table base consists of four single legs. The 84" and 96" round and square table base consists of four v-legs.



Tip: Tablets are an optional pick for the 42" square tables only.

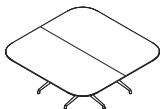

Veneer direction



Specification Information

Dimensions			Style Number	# of (optional) Tablets	Base Prices							
L	W	H			Laminate		Veneer		Wedge Veneer Layup		Corian	Glass
					Grade 1	Grade 2	Grade 1	Grade 2	Grade 1	Grade 2		

Large Round Tables

One-Piece Top

60" dia	26"	COWX_RND60	N.A.	\$3072	\$3179	\$4306	\$4688	\$ 7276	\$ 7634	\$ 6454	\$ 7694
---------	-----	------------	------	--------	--------	--------	--------	---------	---------	---------	---------

Two-Piece Top

72" dia	26"	COWX_RND72	N.A.	\$3936	\$4071	\$5661	\$6162	\$ 9565	\$10,035	\$ 8267	\$ 9843
---------	-----	------------	------	--------	--------	--------	--------	---------	----------	---------	---------

84" dia	26"	COWX_RND84	N.A.	\$4904	\$5073	\$7151	\$7787	\$12,084	\$12,694	\$11,768	\$13,487
---------	-----	------------	------	--------	--------	--------	--------	----------	----------	----------	----------

96" dia	26"	COWX_RND96	N.A.	\$6143	\$6355	\$9055	\$9859	\$15,301	\$16,051	\$12,902	\$15,359
---------	-----	------------	------	--------	--------	--------	--------	----------	----------	----------	----------

Square Table

42"	42"	26"	COWX_Q42	2 or 4	\$1980	\$2038	\$2831	\$3064	N.A.	N.A.	\$ 2948	\$ 4012
-----	-----	-----	----------	--------	--------	--------	--------	--------	------	------	---------	---------

Large Square Tables

One-Piece Top

60"	60"	26"	COWX_SQ60	N.A.	\$3162	\$3271	\$4425	\$4818	N.A.	N.A.	\$ 6633	\$ 8053
-----	-----	-----	-----------	------	--------	--------	--------	--------	------	------	---------	---------

Two-Piece Top

72"	72"	26"	COWX_SQ72	N.A.	\$4026	\$4166	\$5780	\$6293	N.A.	N.A.	\$ 8447	\$10,199
-----	-----	-----	-----------	------	--------	--------	--------	--------	------	------	---------	----------

84"	84"	26"	COWX_SQ84	8	\$4993	\$5165	\$7272	\$7917	N.A.	N.A.	\$11,948	\$13,844
-----	-----	-----	-----------	---	--------	--------	--------	--------	------	------	----------	----------

96"	96"	26"	COWX_SQ96	N.A.	\$6233	\$6448	\$9174	\$9988	N.A.	N.A.	\$13,081	\$15,716
-----	-----	-----	-----------	------	--------	--------	--------	--------	------	------	----------	----------

► Specification Information, continued on next page

SW_1

SW_1 Low Collaborative Conference Tables *continued*
 DESIGN SCOTT WILSON & MINIMAL

SIN 711.11

► Specification Information, continued from previous page

Tip: Your specification is not complete until you add the fifth letter to the style number to define top surface.

- L - Laminate top
- V - Wood veneer top
- C - Corian top
- G - Glass top

Tip: Glass tops are not secured to the substructure. Glass tops are placed on rubber pads that are adhered to the substructure. If the glass tables need to be moved, remove the glass top prior to moving the table.

Specification Information

Dimensions			Style Number	# of (optional) Tablets	Base Prices		Veneer		Corian	Glass
L	W	H			Laminate Grade 1	Grade 2	Grade 1	Grade 2		

Rectangular Tables

84"	42"	26"	COWX_R4284	6	\$2864	\$2980	\$3953	\$4390	\$ 6682	\$ 7862
-----	-----	-----	------------	---	--------	--------	--------	--------	---------	---------

120"	42"	26"	COWX_R4120	8	\$3988	\$4152	\$6374	\$7015	\$11,220	\$13,818
------	-----	-----	------------	---	--------	--------	--------	--------	----------	----------

Super Elliptical Tables

One-Piece Top

72"	40"	26"	COWX_SE4072	N.A.	\$2274	\$2367	\$3361	\$3715	\$ 6505	\$ 7686
84"	40"	26"	COWX_SE4084	N.A.	\$2924	\$3040	\$4012	\$4449	\$ 6859	\$ 8040
96"	40"	26"	COWX_SE4096	N.A.	\$3338	\$3465	\$4425	\$4949	\$ 7213	\$ 8631
120"	44"	26"	COWX_SE4120	N.A.	\$4106	\$4285	\$6493	\$7191	\$11,457	\$14,055

*Tablets are only available as an option on square tables.

Two-Piece Top

120"	44"	26"	COWX_SE4122	N.A.	\$4461	\$4640	\$6848	\$7546	\$11,810	\$14,410
------	-----	-----	-------------	------	--------	--------	--------	--------	----------	----------



Tip: 96"L corian and glass tables require a center in-line leg as standard. The 96"L laminate and veneer tables do not require a center in-line leg for support.

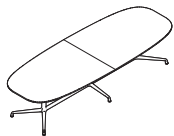

Coalesce

SW_1 Low Collaborative Conference Tables

DESIGN SCOTT WILSON & MINIMAL

SIN 711.11

SW_1

SW_1 Conference Tables

DESIGN SCOTT WILSON & MINIMAL

SIN 711.11



Tip: Your specification is not complete until you add the fifth letter to the style number to define top surface.

- L - Laminate top
- V - Wood veneer top
- C - Corian top
- G - Glass top

Tip: Glass tops are not secured to the substructure. Glass tops are placed on rubber pads that are adhered to the substructure. If the glass tables need to be moved, remove the glass top prior to moving the table.

Tip: You must send a sample of reasonable size for Stain-to-Match.

Tip: Standard grain direction runs the width of the table (front-to back)

Tip: If grommet with wire manager is selected, the finish is not selectable, it will be the same as the substructure finish choice.

Standard Includes	Required to Specify
-------------------	---------------------

- ▶ Need help? Product details, see *Coalesse Tables, Storage, and Accessories Specification Guide*
- 1/2" thick top surface:
 - Laminate (Grade 1) with 3 mm edge band, if selected
 - Wood veneer (Grade 1) with matching 3 mm edge band, if selected
 - Corian, if selected: white only
 - Glass, if selected
- 1/4" thick bottom substructure: black or milk
- Base, column and cone: 8040 Polished Matte Aluminum
- Glides
- Ships ready-to-assemble

- 1 Style number with appropriate top series letter indicated in the space provided. (For example: COW_RC4284 becomes COWLRC4284 for a laminate top surface):
 - L - Laminate top
 - V - Wood veneer top
 - C - Corian top
 - G - Glass top
- 2 Laminate, wood, or glass color number for top, if selected
- 3 Plastic color for edge band of laminate top, if selected
- 4 Bottom substructure:
 - 6000 Black
 - 6052 Milk
- 5 Options, if selected (see below)
 - ▶ See *Surface Materials*, page 350.

Options	Price	Required to Specify
---------	-------	---------------------

Surface Materials	Laminate	Prices at right	Specify with <i>Grade 2 laminate</i> and select color number.
	Wood	Prices at right	Specify with <i>Grade 2 wood veneer</i> and select color number.
	• Stain-to-Match	No cost	Specify with <i>Stain-to-Match</i> . ▶ Page 383
Wood Veneer Grain Direction	• Lengthwise grain direction for tops up to 96"L	No cost	Specify with <i>lengthwise grain direction</i> .
Grommet with Wire Management	60" and 72" large round and square tables		
	• One grommet	+\$196	Specify with <i>one grommet with wire manager</i> .
	• Two grommets	+\$392	Specify with <i>two grommets with wire manager</i> .
	84" and 96" large round and square tables		
	• Two grommets	+\$392	Specify with <i>two grommets with wire manager</i> .
	• Four grommets	+\$784	Specify with <i>four grommets with wire manager</i> .
	96"L (corian and glass), 120"L, 144"L (laminate and veneer), tables (center only)		
	• One grommet	+\$196	Specify with <i>one grommet with wire manager</i> .
	84"L and 96"L (laminate and veneer) tables (end (V-leg) location only)		
	• One grommet	+\$196	Specify with <i>one grommet with wire manager</i> .
84"L, 96"L, 120"L, 144"L, 168"L, 192"L, 216"L, and 240"L tables (outer ends V-legs) location only)			
• Two grommets	+\$392	Specify with <i>two grommets with wire manager</i> .	
144"L (corian and glass), 168"L, 192"L, 216"L, and 240"L tables (inner in-line leg locations only)			
• Two grommets	+\$392	Specify with <i>two grommets with wire manager</i> .	
216"L and 240"L tables (center and outer ends (V-legs) location only)			
• Three grommets	+\$588	Specify with <i>three grommets with wire manager</i> .	

Related Products • SW_1 seating ▶ See *GSA Volume 5a Specification Guide*.

Veneer direction



SW_1 Conference Tables

DESIGN SCOTT WILSON & MINIMAL

SIN 711.11

Tip: Your specification is not complete until you add the fifth letter to the style number to define top surface.

- L - Laminate top
- V - Wood veneer top
- C - Corian top
- G - Glass top

Tip: Glass tops are not secured to the substructure. Glass tops are placed on rubber pads that are adhered to the substructure. If the glass tables need to be moved, remove the glass top prior to moving the table.

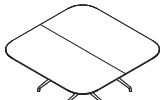
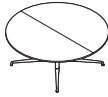

Tip: 60" and 72" round and square table base consists of four single legs. The 84" and 96" round and square table base consists of four v-legs.

Specification Information

Dimensions			Style Number	Base Prices							
L	W	H		Laminate		Veneer		Wedge Veneer Layup		Corian	Glass
				Grade 1	Grade 2	Grade 1	Grade 2	Grade 1	Grade 2		

Large Round Tables

One-Piece Top

60" diameter	28½"	COW_RND60	\$3072	\$3179	\$4306	\$4688	\$ 7276	\$ 7634	\$ 6454	\$ 7694
--------------	------	------------------	--------	--------	--------	--------	---------	---------	---------	---------

Two-Piece Top

72" diameter	28½"	COW_RND72	\$3936	\$4071	\$5661	\$6162	\$ 9565	\$10,035	\$ 8267	\$ 9843
--------------	------	------------------	--------	--------	--------	--------	---------	----------	---------	---------

84" diameter	28½"	COW_RND84	\$4904	\$5073	\$7151	\$7787	\$12,084	\$12,694	\$11,768	\$13,487
--------------	------	------------------	--------	--------	--------	--------	----------	----------	----------	----------

96" diameter	28½"	COW_RND96	\$6143	\$6355	\$9055	\$9859	\$15,301	\$16,051	\$12,902	\$15,359
--------------	------	------------------	--------	--------	--------	--------	----------	----------	----------	----------

Large Square Tables

One-Piece Top

60"	60"	28½"	COW_SQ60	\$3162	\$3271	\$4425	\$4818	N.A.	N.A.	\$ 6633	\$ 8053
-----	-----	------	-----------------	--------	--------	--------	--------	------	------	---------	---------

Two-Piece Top

72"	72"	28½"	COW_SQ72	\$4026	\$4166	\$5780	\$6293	N.A.	N.A.	\$ 8447	\$10,199
-----	-----	------	-----------------	--------	--------	--------	--------	------	------	---------	----------

84"	84"	28½"	COW_SQ84	\$4993	\$5165	\$7272	\$7917	N.A.	N.A.	\$11,948	\$13,844
-----	-----	------	-----------------	--------	--------	--------	--------	------	------	----------	----------

96"	96"	28½"	COW_SQ96	\$6233	\$6448	\$9174	\$9988	N.A.	N.A.	\$13,081	\$15,716
-----	-----	------	-----------------	--------	--------	--------	--------	------	------	----------	----------

► Specification Information, continued on next page

SW_1 Conference Tables *continued*
 DESIGN SCOTT WILSON & MINIMAL

SIN 711.11

► Specification Information, continued from previous page

Tip: Your specification is not complete until you add the fifth letter to the style number to define top surface.

- L - Laminate top
- V - Wood veneer top
- C - Corian top
- G - Glass top

Tip: Glass tops are not secured to the substructure. Glass tops are placed on rubber pads that are adhered to the substructure. If the glass tables need to be moved, remove the glass top prior to moving the table.

Specification Information

Dimensions			Style Number	Base Prices				Corian	Glass
L	W	H		Laminate		Veneer			
				Grade 1	Grade 2	Grade 1	Grade 2		

Rectangular Tables

One-Piece Top

84"	42"	28½"	COW_RC4284	\$2864	\$2980	\$3953	\$4390	\$ 6682	\$ 7862
96"	48"	28½"	COW_RC4896	\$3279	\$3426	\$4366	\$4948	\$ 7036	\$ 8454
120"	48"	28½"	COW_RC48120	\$3988	\$4152	\$6374	\$7015	\$11,220	\$13,818



Tip: 96"L corian and glass tables require a center in-line leg as standard. The 96"L laminate and veneer tables do not require a center in-line leg for support. Refer to base matrix in the Coalesse Conferencing and Storage specification guide.

Two-Piece Top

120"	48"	28½"	COW_RC48122	\$4342	\$4521	\$6729	\$7427	\$11,574	\$14,174
144"	48"	28½"	COW_RC48144	\$4697	\$4918	\$8029	\$8903	\$12,401	\$15,000

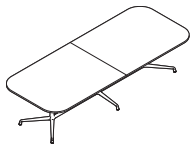

Tip: 144"L and longer are two-piece tops, all three piece tops are noted.

Tip: 144"L corian and glass tables require a center in-line leg as standard. The 144"L laminate and veneer tables do not require a center in-line leg for support. Refer to base matrix in the Coalesse Conferencing and Storage specification guide.

► Specification Information, continued on next page

SW_1 Conference Tables

DESIGN SCOTT WILSON & MINIMAL

SIN 711.11

► Specification Information, continued from previous page

Tip: Glass tops are not secured to the substructure. Glass tops are placed on rubber pads that are adhered to the substructure. If the glass tables need to be moved, remove the glass top prior to moving the table.

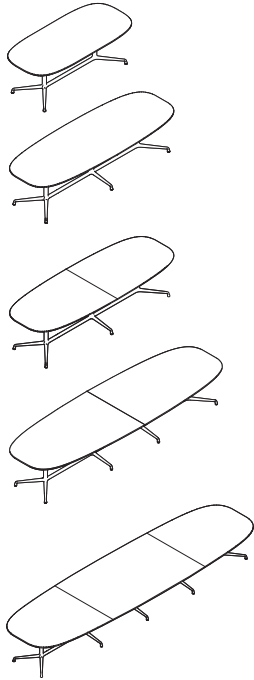

Specification Information

Dimensions			Style Number	Base Prices				Corian	Glass
L	W	H		Laminate		Veneer			
				Grade 1	Grade 2	Grade 1	Grade 2		

Super Elliptical Tables

One-Piece Top

84"	40"	28½"	COW_SEC84	\$2924	\$3040	\$ 4012	\$ 4449	\$ 6859	\$ 8040
96"	40"	28½"	COW_SEC96	\$3338	\$3465	\$ 4425	\$ 4949	\$ 7213	\$ 8631
120"	44"	28½"	COW_SEC120	\$4106	\$4285	\$ 6493	\$ 7191	\$11,457	\$14,055

Two-Piece Top

120"	44"	28½"	COW_SEC122	\$4461	\$4640	\$ 6848	\$ 7546	\$11,810	\$14,410
144"	48"	28½"	COW_SEC144	\$4814	\$5035	\$ 8146	\$ 9020	\$12,637	\$15,237
168"	52"	28½"	COW_SEC168	\$5523	\$5803	\$10,043	\$11,371	N.A.	N.A.
192"	56"	28½"	COW_SEC192	\$6292	\$6630	\$12,289	\$13,803	N.A.	N.A.
216"	60"	28½"	COW_SEC216	\$7119	\$7526	\$13,588	\$15,301	N.A.	N.A.
240"	60"	28½"	COW_SEC240	\$8006	\$8484	\$14,888	\$16,780	N.A.	N.A.

Three-Piece Top

216"	60"	28½"	COW_SEC213	\$7473	\$7880	\$13,941	\$15,654	N.A.	N.A.
240"	60"	28½"	COW_SEC243	\$8360	\$8838	\$15,242	\$17,134	N.A.	N.A.

SW_1 Round, Square, and Super-Square Tables

DESIGN SCOTT WILSON & MINIMAL

SIN 711.11

Tip: Your specification is not complete until you add the fifth letter to the style number to define top surface.

- L - Laminate top
- V - Wood veneer top
- C - Corian top
- G - Glass top

Tip: Glass tops are not secured to the substructure. Glass tops are placed on rubber pads that are adhered to the substructure. If the glass tables need to be moved, remove the glass top prior to moving the table.

Standard Includes

- ▶ Need help? Product details, see *Coalesse Tables, Storage, and Accessories Specification Guide*
- 1/2" thick top surface:
 - Laminate (Grade 1) with 3 mm edge band, if selected
 - Wood veneer (Grade 1) with matching 3 mm edge band, if selected
 - Corian, if selected: white only
 - Glass, if selected
- 1/4" thick bottom substructure: black or milk
- Base, column, and cone: 8040 Polished Matte Aluminum
- Glides
- Ships ready-to-assemble

Required to Specify

- 1 Style number with appropriate top series letter indicated in the space provided. (For example: COW_RND30 becomes COWLRND30 for a laminate top surface):
 - L - Laminate top
 - V - Wood veneer top
 - C - Corian top
 - G - Glass top
- 2 Laminate, wood, or glass color number for top, if selected
- 3 Plastic color for edge band of laminate top, if selected
- 4 Bottom substructure:
 - 6000 Black
 - 6052 Milk
- 5 Options, if selected (see below)
 - ▶ See *Surface Materials*, page 350.

Options

Options	Price	Required to Specify
Surface Materials		
Laminate		
• Grade 2 laminate	Prices below	Specify with <i>Grade 2 laminate</i> and select color number.
Wood		
• Grade 2 wood veneer	Prices below	Specify with <i>Grade 2 wood veneer</i> and select color number.
• Grade 1 wedge layup veneer	Prices below	Specify with <i>Grade 1 wedge veneer layup</i> and select color number.
• Grade 2 wedge layup veneer	Prices below	Specify with <i>Grade 2 wedge veneer layup</i> and select color number.
• Stain-to-Match	No cost	Specify with <i>Stain-to-Match</i> . ▶ Page 383

Veneer direction



Tip: If grommet with wire manager is selected, the finish is not selectable, it will be the same as the substructure finish choice.

Grommet with Wire Management	42" and 48" round, 42" square, and 45 1/2" super-square tables (center only)		
	• One grommet	+ \$196	Specify with <i>one grommet with wire manager</i> .

Specification Information

Dimensions L W H	Style Number	Base Prices								Corian	Glass
		Laminate		Veneer		Wedge Veneer Layup		Grade 1	Grade 2		
		Grade 1	Grade 2	Grade 1	Grade 2	Grade 1	Grade 2				

Round Tables

30 diameter	28 1/2"	COW_RND30	\$1802	\$1832	\$2499	\$2615	N.A.	N.A.	\$2654	\$3184
36 diameter	28 1/2"	COW_RND36	\$1861	\$1902	\$2580	\$2754	\$3977	\$4152	\$2772	\$3479
42 diameter	28 1/2"	COW_RND42	\$1920	\$1978	\$2664	\$2897	\$4469	\$4702	\$2889	\$3775
48 diameter	28 1/2"	COW_RND48	\$2038	\$2114	\$2831	\$3093	\$4810	\$5073	\$3008	\$4071

Square Tables

30"	30"	28 1/2"	COW_SQ30	\$1861	\$1891	\$2580	\$2696	N.A.	N.A.	\$2772	\$3479
36"	36"	28 1/2"	COW_SQ36	\$1920	\$1961	\$2664	\$2838	N.A.	N.A.	\$2889	\$3775
42"	42"	28 1/2"	COW_SQ42	\$2038	\$2096	\$2831	\$3064	N.A.	N.A.	\$3008	\$4071

Super-Square Table

45 1/2"	45 1/2"	28 1/2"	COW_SSQ45	\$2126	\$2202	\$2948	\$3210	\$4927	\$5172	\$3184	\$4366
---------	---------	---------	-----------	--------	--------	--------	--------	--------	--------	--------	--------



Coalesce

SW_1 Round, Square, and Super-Square Tables

DESIGN SCOTT WILSON & MINIMAL

SIN 711.11

SW_1

SW_1 Occasional Tables
DESIGN SCOTT WILSON & MINIMAL

SIN 711.11



Standard Includes	Required to Specify
<ul style="list-style-type: none"> ▶ Need help? Product details, see <i>Coalesse Tables, Storage, and Accessories Specification Guide</i> • 1/2" thick top surface: <ul style="list-style-type: none"> - Laminate (Grade 1) with 3 mm edge band, if selected - Wood veneer (Grade 1) with matching 3 mm edge band, if selected - Corian, if selected: white only - Glass, if selected • 1/4" thick bottom substructure: black or milk • Base, column, and cone: 8040 Aluminum Matte Polished • Glides • Ships ready-to assemble 	<ol style="list-style-type: none"> 1 Style number with appropriate top series letter indicated in the space provided. (For example: COWO_RND30 becomes COWOLRND30 for a laminate top surface): <ul style="list-style-type: none"> L - Laminate top V - Wood veneer top C - Corian top G - Glass top 2 Laminate, wood, or glass color number for top, if selected 3 Plastic color for edge band of laminate top, if selected 4 Bottom substructure: <ul style="list-style-type: none"> 6000 Black 6052 Milk 5 Options, if selected (see below) <p>▶ See <i>Surface Materials</i>, page 350.</p>

Options	Price	Required to Specify
Surface Materials Laminate <ul style="list-style-type: none"> • Grade 2 laminate Wood <ul style="list-style-type: none"> • Grade 2 wood veneer • Grade 1 wedge layup veneer • Grade 2 wedge layup veneer • Stain-to-Match 	<p>Prices at right</p> <p>Prices at right</p> <p>Prices at right</p> <p>Prices at right</p> <p>No cost</p>	<p>Specify with <i>Grade 2 laminate</i> and select color number.</p> <p>Specify with <i>Grade 2 wood veneer</i> and select color number.</p> <p>Specify with <i>Grade 1 wedge veneer layup</i> and select color number.</p> <p>Specify with <i>Grade 2 wedge veneer layup</i> and select color number.</p> <p>Specify with <i>Stain-to-Match</i>.</p> <p>▶ Page 383</p>

Veneer direction



Tip: If grommet with wire manager is selected, the finish is not selectable, it will be the same as the substructure finish choice.

Tip: Your specification is not complete until you add the fifth letter to the style number to define top surface.

- L - Laminate top
- V - Wood veneer top
- C - Corian top
- G - Glass top

Grommet <ul style="list-style-type: none"> • One grommet (center only) • One grommet • Two grommets 	<p>42" and 48" round, 42" square and 45 1/2" super-square tables</p> <p>+\$118</p> <p>60" round and square tables</p> <p>+\$118</p> <p>60" large round and large square tables</p> <p>+\$236</p>	<p>Specify with <i>one grommet</i>.</p> <p>Specify with <i>one grommet</i>.</p> <p>Specify with <i>two grommets</i>.</p>
Related Products <ul style="list-style-type: none"> • SW_1 seating 		<p>▶ See <i>GSA Volume 5a Specification Guide</i>.</p>

SW_1 Occasional Tables

DESIGN SCOTT WILSON & MINIMAL

SIN 711.11

Tip: Glass tops are not secured to the substructure. Glass tops are placed on rubber pads that are adhered to the substructure. If the glass tables need to be moved, remove the glass top prior to moving the table.



Specification Information

Dimensions			Style Number	Base Prices				Wedge Veneer Layup		Corian	Glass
L	W	H		Laminate Grade 1	Laminate Grade 2	Veneer Grade 1	Veneer Grade 2	Grade 1	Grade 2		

Round Tables

30 diameter	15"		COWO_RND30	\$1743	\$1773	\$2441	\$2557	N.A.	N.A.	\$2595	\$3125
36 diameter	15"		COWO_RND36	\$1802	\$1843	\$2521	\$2695	\$3918	\$4093	\$2712	\$3421
42 diameter	15"		COWO_RND42	\$1861	\$1919	\$2605	\$2838	\$4410	\$4643	\$2831	\$3716
48 diameter	15"		COWO_RND48	\$1980	\$2056	\$2772	\$3034	\$4751	\$5014	\$2948	\$4012

Large Round Table

60" diameter	15"		COWO_RND60	\$3013	\$3120	\$4246	\$4628	\$7216	\$7574	\$6395	\$7636
--------------	-----	--	------------	--------	--------	--------	--------	--------	--------	--------	--------

Square Tables

30"	30"	15"	COWO_SQ30	\$1802	\$1832	\$2521	\$2637	N.A.	N.A.	\$2712	\$3421
36"	36"	15"	COWO_SQ36	\$1861	\$1902	\$2605	\$2779	N.A.	N.A.	\$2831	\$3716
42"	42"	15"	COWO_SQ42	\$1980	\$2038	\$2772	\$3005	N.A.	N.A.	\$2948	\$4012

Large Square Table

60"	60"	15"	COWO_SQ60	\$3102	\$3211	\$4366	\$4759	N.A.	N.A.	\$6574	\$7993
-----	-----	-----	-----------	--------	--------	--------	--------	------	------	--------	--------

Super-Square Table

45½"	45½"	15"	COWO_SSQ45	\$2068	\$2144	\$2889	\$3151	\$4868	\$5113	\$3125	\$4307
------	------	-----	------------	--------	--------	--------	--------	--------	--------	--------	--------

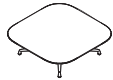

SW_1

SW_1 Work Tables

DESIGN SCOTT WILSON & MINIMAL

SIN 711.11

Standard Includes	Required to Specify
<ul style="list-style-type: none"> ▶ Need help? Product details, see <i>Coalesse Tables, Storage, and Accessories Specification Guide</i> • 1/2" thick top surface: <ul style="list-style-type: none"> - Laminate (Grade 1) with 3 mm edge band, if selected - Wood veneer (Grade 1) with matching 3 mm edge band, if selected - Corian, if selected: white only - Glass, if selected • 1/4" thick bottom substructure: black or milk • Base, column, and cone: 8040 Polished Matte Aluminum • Glides • Ships ready-to assemble 	<ol style="list-style-type: none"> 1 Style number with appropriate top series letter indicated in the space provided. (For example: COW_RT3060 becomes COWLRT3060 for a laminate top surface): <ul style="list-style-type: none"> L - Laminate top V - Wood veneer top C - Corian top G - Glass top 2 Laminate, wood, or glass color number for top, if selected 3 Plastic color for edge band of laminate top, if selected 4 Bottom substructure: <ul style="list-style-type: none"> 6000 Black 6052 Milk 5 Options, if selected (see below) <ul style="list-style-type: none"> ▶ See <i>Surface Materials</i>, page 350.

Tip: Standard grain direction runs the width of the table (front-to back).

Tip: Your specification is not complete until you add the fifth letter to the style number to define top surface.

- L - Laminate top
- V - Wood veneer top
- C - Corian top
- G - Glass top

Tip: Glass tops are not secured to the substructure. Glass tops are placed on rubber pads that are adhered to the substructure. If the glass tables need to be moved, remove the glass top prior to moving the table.

Options	Price	Required to Specify
Surface Materials <ul style="list-style-type: none"> • Laminate <ul style="list-style-type: none"> • Grade 2 laminate • Wood <ul style="list-style-type: none"> • Grade 2 wood veneer • Stain-to-Match 	<ul style="list-style-type: none"> Prices below Prices below No cost 	<ul style="list-style-type: none"> Specify with <i>Grade 2 laminate</i> and select color number. Specify with <i>Grade 2 wood veneer</i> and select color number. Specify with <i>Stain-to-Match</i>. ▶ Page 383
Wood Veneer Grain Direction <ul style="list-style-type: none"> • Lengthwise grain direction for tops up to 96"L 	No cost	Specify with <i>lengthwise grain direction</i> .
Related Products <ul style="list-style-type: none"> • SW_1 seating 		▶ See <i>GSA Volume 5a Specification Guide</i> .

Specification Information

Dimensions L W H	Style Number	Prices				Corian	Glass
		Laminate		Veneer			
		Grade 1	Grade 2	Grade 1	Grade 2		

Rectangular Tables

60"	30"	28½"	COW_RT3060	\$1861	\$1919	\$2948	\$3181	\$5795	\$6741
72"	30"	28½"	COW_RT3072	\$1980	\$2049	\$3066	\$3340	\$6031	\$6976
60"	36"	28½"	COW_RT3660	\$1980	\$2049	\$3066	\$3340	\$6031	\$6976
72"	36"	28½"	COW_RT3672	\$2098	\$2179	\$3184	\$3500	\$6268	\$7213

Super-Elliptical Tables

60"	40"	28½"	COW_SE4060	\$2038	\$2119	\$3125	\$3441	\$6386	\$7332
72"	40"	28½"	COW_SE4072	\$2274	\$2367	\$3361	\$3715	\$6505	\$7686



Veneer direction



Standard Includes **Required to Specify**

- Vertical wire managers: milk or black plastic
- Horizontal wire manager, 6-pack: velcro and attachment hardware
- Manages small amounts of cords and wires

- 1 Style number for vertical wire manager, if selected
6000 Black
6052 Milk
- 2 Style number for horizontal wire manager, if selected
▶ See *Coalesse Surface Materials Reference Guide*.

Related Products

- SW_1 tables

Specification Information

Dimensions			Style	Price
L	W	H	Number	

Vertical Wire Manager For Use with Low Conference Tables

N.A.	N.A.	26"	COWVWM26	\$118
------	------	-----	----------	-------

Vertical Wire Manager For Use with Standard Height Tables

N.A.	N.A.	28½"	COWVWM28	\$118
------	------	------	----------	-------

Horizontal Wire Manager Clips (Package of 6)

½"	8"	½"	COWHWM	\$ 48
----	----	----	--------	-------



Tip: Horizontal wire manager clips attach under the work surface with screws.

Storage/Ancillary



Statement of Line 322



Exponents 325

Storage/Ancillary

Statement of Line

Exponents

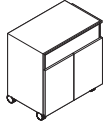

Specifying
▶ Page 328

Exponents Mobile Cart

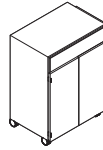

Specifying
▶ Page 326

Exponents Moby

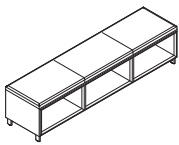

Open

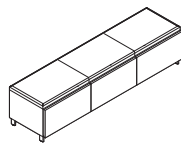

Closed

Specifying
▶ Page 330

Exponents Benches

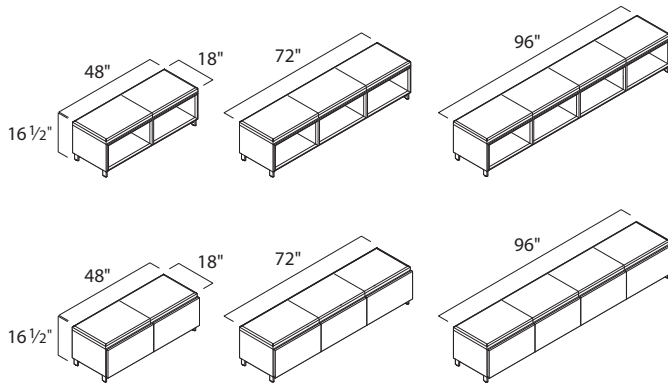

In-line



End-of-Run

Specifying
▶ Page 333

Exponents Bench Bridges

Statement of Line

Exponents

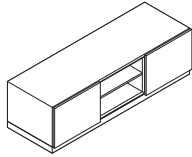

Partial - Open

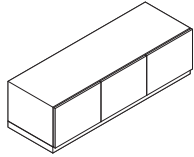

Closed

Specifying
▶ Page 334-340

Exponents Credenzas

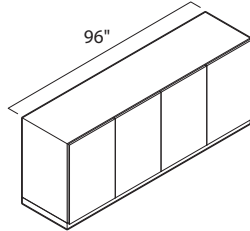
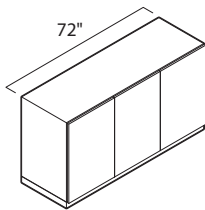
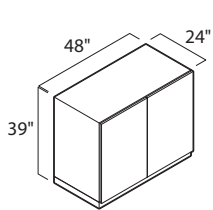
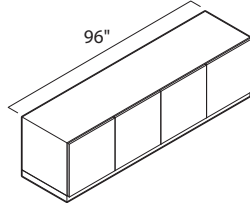
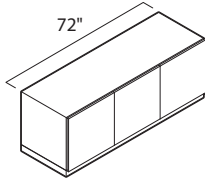
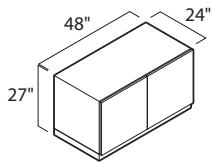
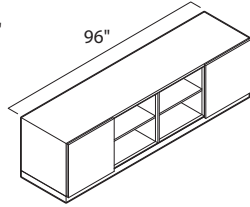
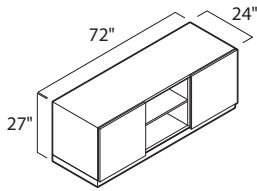

Storage/Ancillary

Statement of Line *continued*

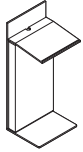

Specifying
▶ Page 343

Exponents Lectern



Specifying
▶ Page 344

Exponents Mobile Whiteboard Display

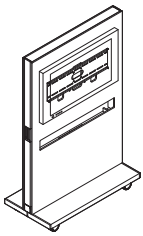

Specifying
▶ Page 345

Exponents Mobile Mediaboard Display

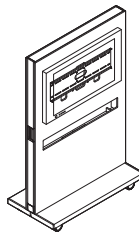

Specifying
▶ Page 346

Exponents Mobile Mediaboard Display with Steelcase media:scape Technology



Specifying
▶ Page 347

Exponents Mediaboard Shelf

Exponents

Carts (SIN 711.2)	326
Benches (SIN 711.2)	331
Bench Bridges (SIN 711.2)	333
Credenzas (SIN 711.2)	334
Accessories (SIN 711.2)	343

Exponents Mobile Cart

DESIGN COALESSE DESIGN GROUP

SIN 711.2

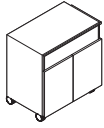

Tip: The handle finish is recommended to match the ribbon finish.

Standard Includes	Required to Specify
<ul style="list-style-type: none"> ▶ Need help? Product details, see <i>Coalesse Tables, Storage, and Accessories Specification Guide</i> • Case with top opening: painted MDF • Door fronts with 110° soft close hinges: painted MDF • Handle: paint • Accent ribbon: paint • One adjustable shelf behind doors: matches case finish • Wire management entry and exit points at bottom • Casters: 6009 Arctic White plastic for V145 Milk painted MDF case or 6000 Black plastic for all other finish choices • Ships assembled, casters require installation • Additional adjustable shelf(s), if selected: painted MDF 	<ol style="list-style-type: none"> 1 Style number 2 Painted MDF color number for case: V145 Milk V197 Black 3 Painted MDF color number for door fronts: V145 Milk V197 Black 4 Paint color number for handle: 4135 Black Matte 4141 Platinum Matte 5 Paint color number for accent ribbon: 4135 Black Matte 4141 Platinum Matte 6 Painted MDF color number for additional adjustable shelf(s), if selected: V145 Milk V197 Black 7 Options, if selected (see below) <p>▶ See <i>Surface Materials</i>, page 350.</p>

Options	Price	Required to Specify
Surface Materials <ul style="list-style-type: none"> • Case and Door Fronts • Grade 1 wood veneer • Grade 2 wood veneer • Stain-to-Match 	<ul style="list-style-type: none"> Prices at right Prices at right No cost 	<ul style="list-style-type: none"> Specify with <i>Grade 1 wood veneer</i> and select color number. Specify with <i>Grade 2 wood veneer</i> and select color number. Specify with <i>Stain-to-Match</i>. <p>▶ See <i>Coalesse Surface Materials Reference Guide</i>.</p>
<ul style="list-style-type: none"> • Accent Ribbon • Grade 1 wood veneer • Grade 2 wood veneer • Stain-to-Match 	<ul style="list-style-type: none"> +\$ 58 +\$ 60 No cost 	<ul style="list-style-type: none"> Specify with <i>Grade 1 wood veneer</i> and select color number. Specify with <i>Grade 2 wood veneer</i> and select color number. Specify with <i>Stain-to-Match</i>. <p>▶ See <i>Coalesse Surface Materials Reference Guide</i>.</p>
Power <ul style="list-style-type: none"> • 3 power receptacles 	<ul style="list-style-type: none"> +\$284 	<ul style="list-style-type: none"> Specify with <i>power</i>.
Service Tray <ul style="list-style-type: none"> • Painted MDF • Painted MDF: V145 Milk or V197 Black 	<ul style="list-style-type: none"> +\$738 	<ul style="list-style-type: none"> Specify with <i>painted MDF</i> and select color number.
<ul style="list-style-type: none"> • Wood • Grade 1 wood veneer • Grade 2 wood veneer • Stain-to-Match 	<ul style="list-style-type: none"> +\$885 +\$917 No cost 	<ul style="list-style-type: none"> Specify with <i>Grade 1 wood veneer</i> and select color number. Specify with <i>Grade 2 wood veneer</i> and select color number. Specify with <i>Stain-to-Match</i>. <p>▶ See <i>Coalesse Surface Materials Reference Guide</i>.</p>
Pull-out Shelf <ul style="list-style-type: none"> • Painted MDF • Painted MDF: V145 Milk or V197 Black 	<ul style="list-style-type: none"> +\$679 	<ul style="list-style-type: none"> Specify with <i>painted MDF</i> and select color number.
<ul style="list-style-type: none"> • Wood • Grade 1 wood veneer • Grade 2 wood veneer • Stain-to-Match 	<ul style="list-style-type: none"> +\$826 +\$856 No cost 	<ul style="list-style-type: none"> Specify with <i>Grade 1 wood veneer</i> and select color number. Specify with <i>Grade 2 wood veneer</i> and select color number. Specify with <i>Stain-to-Match</i>. <p>▶ See <i>Coalesse Surface Materials Reference Guide</i>.</p>

▶ Options, continued on next page

Tip: When wood veneer is specified on the case and wood veneer is specified for the ribbon, it is recommended the ribbon finish match the wood veneer case selection.

Tip: The power device finish is non-specifiable. If V145 Milk painted MDF is specified, the power device will be white gloss. For all other finish specifications, the power device will be black gloss.

Tip: Power device attaches to the wire management gap at the back of the adjustable shelf.

Tip: Service tray can fit in pull-out shelf, sit in top opening or sit, on top of cart.

Tip: Pull-out shelf is available for the top opening only.

Exponents Mobile Cart

DESIGN COALESSE DESIGN GROUP

SIN 711.2

► Options, continued from previous page

Options		Price	Required to Specify
Lock and Keying	Lock		
	<ul style="list-style-type: none"> Nickel +\$141 Ember Chrome +\$141 		Specify with 9211 Nickel lock. Specify with 9250 Ember Chrome lock.
Keying			
<ul style="list-style-type: none"> Factory- and field-installed keying units 			► See GSA Volume 5a Specification Guide.

Specification Information

Dimensions			Style	Case	Base Prices		
D	W	H	Number		Door Fronts		
					Painted	Grade 1	Grade 2
					MDF	Veneer	Veneer

Mobile Cart

Dimensions	Style	Case	Painted MDF	Grade 1 Veneer	Grade 2 Veneer
19 3/4" 30" 32"	COCCD303219		\$3250	\$3366	\$3396
			\$3832	\$3948	\$3978
			\$3960	\$4076	\$4106

Specification Information

Dimensions			Style	Base Prices		
D	W	H	Number	Painted	Grade 1	Grade 2
				MDF	Veneer	Veneer

Adjustable Shelf

Dimensions	Style	Case	Painted	Grade 1	Grade 2
16 1/2" 28 1/4" 3 1/4"	COCCMAS30		\$196	\$232	\$240

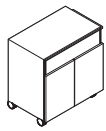

Tip: Adjustable shelf is in addition to the adjustable shelf that is standard on the mobile cart.

Exponents Moby

DESIGN COALESSE DESIGN GROUP

SIN 711.2

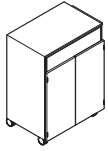

Tip: The handle finish is recommended to match the ribbon finish.

Standard Includes		Required to Specify
<ul style="list-style-type: none"> ▶ Need help? Product details, see <i>Coalesse Tables, Storage, and Accessories Specification Guide</i> 	<ul style="list-style-type: none"> • Case with top opening: painted MDF • Door fronts with 270° hinges: painted MDF • Handle: paint • Accent ribbon: paint • Two adjustable shelves behind doors: matches case finish • Wire management entry and exit points at bottom • Casters: 6009 Arctic White plastic for V145 Milk painted MDF case or 6000 Black plastic for all other finish choices • Ships assembled, casters require installation • Additional adjustable shelf(s), if selected: painted MDF 	<ol style="list-style-type: none"> 1 Style number 2 Painted MDF color number for case: V145 Milk V197 Black 3 Painted MDF color number for door fronts: V145 Milk V197 Black 4 Paint color number for handle: 4135 Black Matte 4141 Platinum Matte 5 Paint color number for accent ribbon: 4135 Black Matte 4141 Platinum Matte 6 Painted MDF color number for additional adjustable shelf(s), if selected: V145 Milk V197 Black 7 Options, if selected (see below) <p>▶ See <i>Surface Materials</i>, page 350.</p>

	Options	Price	Required to Specify
Surface Materials	Case and Door Fronts		
	• Grade 1 wood veneer	Prices at right	Specify with <i>Grade 1 wood veneer</i> and select color number.
	• Grade 2 wood veneer	Prices at right	Specify with <i>Grade 2 wood veneer</i> and select color number.
	• Stain-to-Match	No cost	Specify with <i>Stain-to-Match</i> . ▶ See <i>Coalesse Surface Materials Reference Guide</i> .
	Accent Ribbon		
	• Grade 1 wood veneer	+\$ 88	Specify with <i>Grade 1 wood veneer</i> and select color number.
	• Grade 2 wood veneer	+\$ 91	Specify with <i>Grade 2 wood veneer</i> and select color number.
	• Stain-to-Match	No cost	Specify with <i>Stain-to-Match</i> . ▶ See <i>Coalesse Surface Materials Reference Guide</i> .
Power	• 3 power receptacles	+\$284	Specify with <i>power</i> .
Interior Configurations	• Personal drawer and adjustable shelf interior to match case	+\$233	Specify with <i>personal drawer and adjustable shelf interior</i> .
	• Fixed shelf, personal drawer and file drawer interior to match case	+\$557	Specify with <i>fixed shelf, personal drawer, and file drawer interior</i> .
Lock and Keying	Lock		
	• Nickel	+\$141	Specify with <i>9211 Nickel lock</i> .
	• Ember Chrome	+\$141	Specify with <i>9250 Ember Chrome lock</i> .
	Keying		
	• Factory- and field-installed keying units		▶ See <i>GSA Volume 5a Specification Guide</i> .

Tip: When wood veneer is specified on the case and wood veneer is specified for the ribbon, it is recommended the ribbon finish match the wood veneer case selection.

Tip: The power device finish is non-specifiable. If V145 Milk painted MDF is specified, the power device will be white gloss. For all other finish specifications, the power device will be black gloss.

Tip: Interior configurations match the case selection finish.

Exponents Moby

DESIGN COALESSE DESIGN GROUP

SIN 711.2

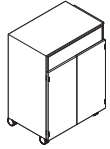

Specification Information

Dimensions			Style	Case	Base Prices		
D	W	H	Number		Door Fronts		
					Painted	Grade 1	Grade 2
					MDF	Veneer	Veneer

Moby

19 ³ / ₄ "	30"	42"	COCMD304219	Painted MDF	\$3693	\$3809	\$3841
				Grade 1 Veneer	\$4334	\$4450	\$4482
				Grade 2 Veneer	\$4479	\$4595	\$4627

Specification Information

Dimensions			Style	Base Prices		
D	W	H	Number	Painted	Grade 1	Grade 2
				MDF	Veneer	Veneer

Adjustable Shelf

16 ¹ / ₂ "	28 ¹ / ₄ "	3 ³ / ₄ "	COCCMAS30	\$196	\$232	\$240
----------------------------------	----------------------------------	---------------------------------	-----------	-------	-------	-------



Tip: Adjustable shelf is in addition to the adjustable shelf that is standard on the mobile cart.

Exponents Benches

DESIGN COALESSE DESIGN GROUP

SIN 711.2

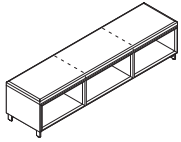

► Need help?
Product details, see *Coalesse Tables, Storage, and Accessories Specification Guide*

Standard Includes

- Case: painted MDF
- Unfinished outside back: black backer
- Door fronts with pull down self opening door with soft close catch, if selected: painted MDF
- Accent ribbon: paint
- Metal base: paint
- Ships assembled, seat cushion requires installation

Required to Specify

- 1 Style number
- 2 Painted MDF color number for case:
V145 Milk
V197 Black
- 3 Paint color number for metal base:
4135 Black Matte
4141 Platinum Matte
- 4 Painted MDF color number for door fronts, if selected:
V145 Milk
V197 Black
- 5 Paint color number for accent ribbon:
4135 Black Matte
4141 Platinum Matte
- 6 Seat cushion finish number:
- Fabric
- Leather
- 7 Options, if selected (see below)
► See *Surface Materials*, page 350.

Tip: Specification is not complete until a fabric selection is specified.

Required Selections	Price	Required to Specify
Upholstery for 48"W and 72"W benches		
• Fabric price group 6	+\$ 46	Specify <i>with upholstery</i> and select fabric color number.
• Fabric price group 7	+\$ 70	Specify <i>with upholstery</i> and select fabric color number.
• Fabric price group 8	+\$ 92	Specify <i>with upholstery</i> and select fabric color number.
• Fabric price group 9	+\$141	Specify <i>with upholstery</i> and select fabric color number.
• Fabric price group 10	+\$176	Specify <i>with upholstery</i> and select fabric color number.
• Fabric price group 11	+\$202	Specify <i>with upholstery</i> and select fabric color number.
• Fabric price group 12	+\$218	Specify <i>with upholstery</i> and select fabric color number.
• Fabric price group 13	+\$299	Specify <i>with upholstery</i> and select fabric color number.
• Fabric price group 14	+\$409	Specify <i>with upholstery</i> and select fabric color number.
• COM	+\$ 68	Specify <i>with upholstery</i> and select fabric color number.
• COL	+\$274	Specify <i>with upholstery</i> and select fabric color number.
• Leather price group C for 48"W only	+\$569	Specify <i>with upholstery</i> and select fabric color number.
• Leather price group E for 48"W only	+\$628	Specify <i>with upholstery</i> and select fabric color number.
• Leather price group C for 72"W only	+\$654	Specify <i>with upholstery</i> and select fabric color number.
• Leather price group E for 72"W only	+\$724	Specify <i>with upholstery</i> and select fabric color number.
Upholstery for 96"W benches		
• Fabric price group 6	+\$ 65	Specify <i>with upholstery</i> and select fabric color number.
• Fabric price group 7	+\$101	Specify <i>with upholstery</i> and select fabric color number.
• Fabric price group 8	+\$130	Specify <i>with upholstery</i> and select fabric color number.
• Fabric price group 9	+\$201	Specify <i>with upholstery</i> and select fabric color number.
• Fabric price group 10	+\$254	Specify <i>with upholstery</i> and select fabric color number.
• Fabric price group 11	+\$287	Specify <i>with upholstery</i> and select fabric color number.

► Required Selections, continued on next page

Exponents Benches

DESIGN COALESSE DESIGN GROUP

SIN 711.2

► Required Selections, continued from previous page

Tip: Specification is not complete until a fabric selection is specified.

Required Selections	Price	Required to Specify
Upholstery for 96"W benches, continued		
• Fabric price group 12	+\$314	Specify with <i>upholstery</i> and select fabric color number.
• Fabric price group 13	+\$428	Specify with <i>upholstery</i> and select fabric color number.
• Fabric price group 14	+\$585	Specify with <i>upholstery</i> and select fabric color number.
• COM	+\$ 96	Specify with <i>upholstery</i> and select fabric color number.
• COL	+\$274	Specify with <i>upholstery</i> and select fabric color number.
• Leather price group C for 96"W only	+\$860	Specify with <i>upholstery</i> and select fabric color number.
• Leather price group E for 96"W only	+\$951	Specify with <i>upholstery</i> and select fabric color number.

Tip: When wood veneer is specified on the case and wood veneer is specified for the ribbon, it is recommended the ribbon finish match the wood veneer case selection.

Options	Price	Required to Specify
Surface Materials		
Acrylic backer for seat cushion		
• Backer for 48"W and 72"W benches	+\$ 17	Specify with <i>acrylic backer</i> .
• Backer for 96"W benches	+\$ 22	Specify with <i>acrylic backer</i> .
Case and door fronts		
• Grade 1 wood veneer	Prices at right	Specify with <i>Grade 1 wood veneer</i> and select color number.
• Grade 2 wood veneer	Prices at right	Specify with <i>Grade 2 wood veneer</i> and select color number.
• Stain-to-Match	No cost	Specify with <i>Stain-to-Match</i> . ► See <i>Coalesse Surface Materials Reference Guide</i> .
Accent ribbon		
• 48"W bench with Grade 1 wood veneer	+\$ 58	Specify with <i>Grade 1 wood veneer</i> accent and select color number.
• 48"W bench with Grade 2 wood veneer	+\$ 60	Specify with <i>Grade 2 wood veneer</i> accent and select color number.
• 72"W bench with Grade 1 wood veneer	+\$ 88	Specify with <i>Grade 1 wood veneer</i> accent and select color number.
• 72"W bench with Grade 2 wood veneer	+\$ 91	Specify with <i>Grade 2 wood veneer</i> accent and select color number.
• 96"W bench with Grade 1 wood veneer	+\$116	Specify with <i>Grade 1 wood veneer</i> accent and select color number.
• 96"W bench with Grade 2 wood veneer	+\$121	Specify with <i>Grade 2 wood veneer</i> accent and select color number.
• Stain-to-Match	No cost	Specify with <i>Stain-to-Match</i> . ► See <i>Coalesse Surface Materials Reference Guide</i> .
Finished back panel		
• 48"W credenza	+\$165	Specify with <i>finished back panel</i> .
• 72"W credenza	+\$227	Specify with <i>finished back panel</i> .
• 96"W credenza	+\$279	Specify with <i>finished back panel</i> .
Lock and Keying		
Locks		
• 48"W bench	+\$220	Specify with <i>9211 Nickel locks</i> or with <i>9250 Ember Chrome locks</i> .
• 72"W bench	+\$330	Specify with <i>9211 Nickel locks</i> or with <i>9250 Ember Chrome locks</i> .
• 96"W bench	+\$440	Specify with <i>9211 Nickel locks</i> or with <i>9250 Ember Chrome locks</i> .
Keying		
• Factory- and field-installed keying units		► See <i>GSA Volume 5a Specification Guide</i> .

Tip: When finished back panel is specified, the finish will match the case finish.

► Specification Information, on next page

Exponents Benches *continued*

DESIGN COALESSE DESIGN GROUP

SIN 711.2

► Options, on previous page

Specification Information

Dimensions			Style Number	Base Prices		
D	W	H		Painted MDF	Grade 1 Veneer	Grade 2 Veneer

Open Benches

48"W

18"	48"	16½"	COCZBOC184815	\$2245	\$2594	\$2683
COM/yds = 1¾, COL/sq ft = 33						

72"W

18"	72"	16½"	COCZBOC187215	\$2687	\$3066	\$3169
COM/yds = 1¾, COL/sq ft = 33						

96"W

18"	96"	16½"	COCZBOC189615	\$3161	\$3540	\$3656
COM/yds = 2½, COL/sq ft = 50						

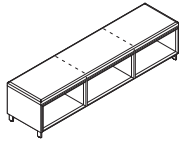

Specification Information

Dimensions			Style Number	Case	Base Prices		
D	W	H			Door Fronts		
					Painted MDF	Grade 1 Veneer	Grade 2 Veneer

Benches with Doors

48"W

18¾"	48"	16½"	COCZBDC184815	Painted MDF	\$3132	\$3306	\$3348
				Grade 1 Veneer	\$3481	\$3655	\$3697
				Grade 2 Veneer	\$3570	\$3744	\$3786
COM/yds = 1¾, COL/sq ft = 33							

72"W

18¾"	72"	16½"	COCZBDC187215	Painted MDF	\$3821	\$4049	\$4102
				Grade 1 Veneer	\$4200	\$4428	\$4481
				Grade 2 Veneer	\$4303	\$4531	\$4584
COM/yds = 1¾, COL/sq ft = 33							

96"W

18¾"	96"	16½"	COCZBDC189615	Painted MDF	\$4532	\$4812	\$4876
				Grade 1 Veneer	\$4911	\$5191	\$5255
				Grade 2 Veneer	\$5027	\$5307	\$5371
COM/yds = 2½, COL/sq ft = 50							

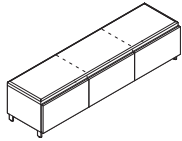

Exponents Bench Bridges

DESIGN COALESSE DESIGN GROUP

SIN 711.2

Standard Includes		Required to Specify
<ul style="list-style-type: none"> Need help? Product details, see <i>Coalesse Tables, Storage, and Accessories Specification Guide</i> 	<ul style="list-style-type: none"> Case: painted MDF In-line bridges: unfinished sides, black backer Metal base, end-of-run bridge only: paint Brackets with connecting hardware: black matte paint only Corner bridge back corner leg: black matte paint only Ships assembled 	<ol style="list-style-type: none"> Style number Painted MDF color number for case: V145 Milk V197 Black Paint color number for end-of-run base, if selected: 4135 Black Matte 4141 Platinum Matte Options, if selected (see below) <p>▶ See <i>Surface Materials</i>, page 350.</p>

	Options	Price	Required to Specify
Surface Materials	Case <ul style="list-style-type: none"> Grade 1 wood veneer Grade 2 wood veneer Stain-to-Match 	<ul style="list-style-type: none"> Prices below Prices below No cost 	<ul style="list-style-type: none"> Specify with <i>Grade 1 wood veneer</i> and select color number. Specify with <i>Grade 2 wood veneer</i> and select color number. Specify with <i>Stain-to-Match</i>. <p>▶ See <i>Coalesse Surface Materials Reference Guide</i>.</p>
Power	<ul style="list-style-type: none"> 3 power receptacles 	+\$284	Specify with <i>power</i> .
Grommet	<ul style="list-style-type: none"> 1 grommet for corner bridge only: 4135 Black Matte or 4141 Platinum Matte 	+\$ 59	Specify with <i>grommet</i> and select color number.

Tip: The power device finish is non-specifiable. If V145 Milk painted MDF is specified, the power device will be white gloss. For all other finish specifications, the power device will be black gloss.

Specification Information						
Dimensions			Style Number	Base Prices		
D	W	H		Painted MDF	Grade 1 Veneer	Grade 2 Veneer

In-Line Bridge						
18"	24"	15"	COCZBI182415	\$1309	\$1503	\$1563

End-of-Run Bridge						
18"	24"	15"	COCZBE182415	\$1536	\$1764	\$1832



Exponents Credenzas 27"H

DESIGN COALESSE DESIGN GROUP

SIN 711.2

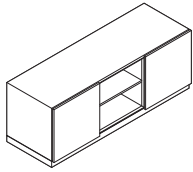

► Need help?
Product details, see *Coalesse Tables, Storage, and Accessories Specification Guide*

Standard Includes

- Case: painted MDF
- Unfinished outside back: black backer
- Door fronts with 110° soft close hinges, if selected: painted MDF
- Accent ribbon: paint
- Plinth base: matches case finish
- One adjustable shelf per opening, behind doors: matches case
- One adjustable shelf per opening, without doors (for open or partial open credenzas): painted MDF
- Ships assembled
- Additional adjustable shelf(s), if selected: painted MDF

Required to Specify

- 1 Style number
- 2 Painted MDF color number for case:
V145 Milk
V197 Black
- 3 Painted MDF color number for door fronts, if selected:
V145 Milk
V197 Black
- 4 Paint color number for accent ribbon:
4135 Black Matte
4141 Platinum Matte
- 5 Painted MDF color number for additional adjustable shelf(s), if selected:
V145 Milk MDF
V197 Black MDF
- 6 Options, if selected (see below)
► See *Surface Materials*, page 350.

Tip: When wood veneer is specified on the case and wood veneer is specified for the ribbon, it is recommended the ribbon finish match the wood veneer case selection.

	Options	Price	Required to Specify
Surface Materials	Case and door fronts		
	• Grade 1 wood veneer	Prices at right	Specify with <i>Grade 1 wood veneer</i> and select color number.
	• Grade 2 wood veneer	Prices at right	Specify with <i>Grade 2 wood veneer</i> and select color number.
	• Stain-to-Match	No cost	Specify with <i>Stain-to-Match</i> . ► See <i>Coalesse Surface Materials Reference Guide</i> .
	Accent ribbon		
	• 48"W credenza with Grade 1 wood veneer	+\$116	Specify with <i>Grade 1 wood veneer</i> accent and select color number.
	• 48"W credenza with Grade 2 wood veneer	+\$121	Specify with <i>Grade 2 wood veneer</i> accent and select color number.
	• 72"W credenza with Grade 1 wood veneer	+\$147	Specify with <i>Grade 1 wood veneer</i> accent and select color number.
	• 72"W credenza with Grade 2 wood veneer	+\$152	Specify with <i>Grade 2 wood veneer</i> accent and select color number.
	• 96"W credenza with Grade 1 wood veneer	+\$174	Specify with <i>Grade 1 wood veneer</i> accent and select color number.
	• 96"W credenza with Grade 2 wood veneer	+\$180	Specify with <i>Grade 2 wood veneer</i> accent and select color number.
	• Stain-to-Match	No cost	Specify with <i>Stain-to-Match</i> . ► See <i>Coalesse Surface Materials Reference Guide</i> .
	Finished back panel		
	• 48"W credenza	+\$227	Specify with <i>finished back panel</i> .
	• 72"W credenza	+\$284	Specify with <i>finished back panel</i> .
	• 96"W credenza	+\$330	Specify with <i>finished back panel</i> .
	Adjustable shelf		
	• 1 Adjustable shelf		
	- With Grade 1 wood veneer	+\$ 30	Specify with <i>one open adjustable shelf</i> and select color number, if required.
	- With Grade 2 wood veneer	+\$ 37	Specify with <i>one open adjustable shelf</i> and select color number, if required.
	- With Stain-to-Match	No cost	Specify with <i>Stain-to-Match</i> . ► See <i>Coalesse Surface Materials Reference Guide</i> .
	• 2 Adjustable shelves		
	- With Grade 1 wood veneer	+\$ 60	Specify with <i>two open adjustable shelves</i> and select color number, if required.
	- With Grade 2 wood veneer	+\$ 74	Specify with <i>two open adjustable shelves</i> and select color number, if required.
	- With Stain-to-Match	No cost	Specify with <i>Stain-to-Match</i> . ► See <i>Coalesse Surface Materials Reference Guide</i> .

► Options, continued on next page

Tip: When finished back panel is specified, the finish will match the case finish.

Tip: For the adjustable shelf without doors, open or partial open credenzas, a contrasting finish can be specified. The adjustable shelves behind the doors are not specifiable and will match the case specification.

Exponents Credenzas 27"H

DESIGN COALESSE DESIGN GROUP

SIN 711.2

► Options, continued from previous page

	Options	Price	Required to Specify
Metal Legs	• Black matte or platinum matte - 48"W credenza	+\$ 266	Specify <i>with metal legs</i> and select paint color number.
	- 72"W credenza	+\$ 326	Specify <i>with metal legs</i> and select paint color number.
	- 96"W credenza	+\$ 385	Specify <i>with metal legs</i> and select paint color number.

Tip: Pull-out shelf is available for the middle open section(s) only. For a 72"W credenza, the pull-out shelf is available in the middle open section only. For a 96"W credenza, the pull-out shelf is available in the middle two open sections only.

Tip: The pull-out shelf does not replace the adjustable shelf.

Pull-out Shelf for 72"W and 96"W Credenzas only	72"W (center/middle location only)		
	• With painted MDF	+\$ 679	Specify <i>with one pull-out shelf</i> and select color number.
	• With Grade 1 wood veneer	+\$ 826	Specify <i>with one pull-out shelf</i> and select color number.
	• With Grade 2 wood veneer	+\$ 856	Specify <i>with one pull-out shelf</i> and select color number.
	• Stain-to-Match	No cost	Specify <i>with Stain-to-Match</i> . ► See <i>Coalesse Surface Materials Reference Guide</i> .

	96"W (two center/middle locations only)		
	Left center location only		
	• With painted MDF	+\$ 679	Specify <i>with one pull-out shelf</i> , left center location and select color number.
	• With Grade 1 wood veneer	+\$ 826	Specify <i>with one pull-out shelf</i> , left center location and select color number.
	• With Grade 2 wood veneer	+\$ 856	Specify <i>with one pull-out shelf</i> , left center location and select color number.
	• Stain-to-Match	No cost	Specify <i>with Stain-to-Match</i> . ► See <i>Coalesse Surface Materials Reference Guide</i> .

	Right center location only		
	• With painted MDF	+\$ 679	Specify <i>with one pull-out shelf</i> , right center location and select color number.
	• With Grade 1 wood veneer	+\$ 826	Specify <i>with one pull-out shelf</i> , right center location and select color number.
	• With Grade 2 wood veneer	+\$ 856	Specify <i>with one pull-out shelf</i> , right center location and select color number.
	• Stain-to-Match	No cost	Specify <i>with Stain-to-Match</i> . ► See <i>Coalesse Surface Materials Reference Guide</i> .

	Left and right center locations		
	• With painted MDF	+\$1358	Specify <i>with two pull-out shelves</i> , left center and right center location and select color number.
	• With Grade 1 wood veneer	+\$1649	Specify <i>with two pull-out shelves</i> , left center and right center location and select color number.
	• With Grade 2 wood veneer	+\$1714	Specify <i>with two pull-out shelves</i> , left center and right center location and select color number.
	• Stain-to-Match	No cost	Specify <i>with Stain-to-Match</i> . ► See <i>Coalesse Surface Materials Reference Guide</i> .

Tip: Painted MDF accent top should be specified with a veneer case. Wood veneer accent top should be specified with a painted MDF case. Corian and glass accent tops can be specified with a wood veneer or painted MDF case.

Accent Top	Painted MDF for wood veneer cases		
	• 48"W credenza	+\$ 591	Specify <i>with painted MDF accent top</i> and select color number.
	• 72"W credenza	+\$ 743	Specify <i>with painted MDF accent top</i> and select color number.
	• 96"W credenza	+\$ 976	Specify <i>with painted MDF accent top</i> and select color number.

	Grade 1 wood veneer for painted MDF cases		
	• 48"W credenza	+\$ 708	Specify <i>with Grade 1 wood veneer accent top</i> and select color number.
	• 72"W credenza	+\$ 892	Specify <i>with Grade 1 wood veneer accent top</i> and select color number.
	• 96"W credenza	+\$1171	Specify <i>with Grade 1 wood veneer accent top</i> and select color number.
	• Stain-to-Match	No cost	Specify <i>with Stain-to-Match</i> . ► See <i>Coalesse Surface Materials Reference Guide</i> .

► Options, continued on next page

Exponents Credenzas 27"H *continued*

DESIGN COALESSE DESIGN GROUP

SIN 711.2

►Options, continued from previous page

	Options	Price	Required to Specify			
Accent Top	Grade 2 wood veneer for painted MDF cases					
	• 48"W credenza	+\$ 708	Specify with <i>Grade 2 wood veneer accent top</i> and select color number.			
	• 72"W credenza	+\$ 892	Specify with <i>Grade 2 wood veneer accent top</i> and select color number.			
	• 96"W credenza	+\$1171	Specify with <i>Grade 2 wood veneer accent top</i> and select color number.			
	• Stain-to-Match	No cost	Specify with <i>Stain-to-Match</i> . ► See <i>Coalesse Surface Materials Reference Guide</i> .			
	Corian: glacier white only					
	• 48"W credenza	+\$1205	Specify with <i>Corian accent top</i> .			
	• 72"W credenza	+\$1516	Specify with <i>Corian accent top</i> .			
	• 96"W credenza	+\$1988	Specify with <i>Corian accent top</i> .			
	Glass					
• 48"W credenza	+\$1418	Specify with <i>glass accent top</i> and select color number.				
• 72"W credenza	+\$1784	Specify with <i>glass accent top</i> and select color number.				
• 96"W credenza	+\$2339	Specify with <i>glass accent top</i> and select color number.				
Grommets: black matte or platinum matte	48"W credenza		No Accent Top, Painted MDF Accent Top or Wood Veneer Accent Top	Corian Accent Top	Glass Accent Top	
	• Grommet, left	+\$ 58	+\$89	+\$118	Specify with <i>grommet left</i> and select color number.	
	• Grommet, right	+\$ 58	+\$89	+\$118	Specify with <i>grommet right</i> and select color number.	
	72"W credenza					
	• Grommet, left	+\$ 58	+\$89	+\$118	Specify with <i>grommet left center</i> and select color number.	
	• Grommet, center	+\$ 58	+\$89	+\$118	Specify with <i>grommet center</i> and select color number.	
	• Grommet, right	+\$ 58	+\$89	+\$118	Specify with <i>grommet right</i> and select color number.	
	96"W credenza					
	• Grommet, left	+\$ 58	+\$89	+\$118	Specify with <i>grommet left</i> and select color number.	
	• Grommet, left center	+\$ 58	+\$89	+\$118	Specify with <i>grommet left center</i> and select color number.	
	• Grommet, right center	+\$ 58	+\$89	+\$118	Specify with <i>grommet right center</i> and select color number.	
	• Grommet, right	+\$ 58	+\$89	+\$118	Specify with <i>grommet right</i> and select color number.	
	Lock and Keying	Lock				
		• 2 doors	+\$ 220	Specify with <i>9211 Nickel locks</i> or with <i>9250 Ember Chrome locks</i> .		
		• 3 doors	+\$ 330	Specify with <i>9211 Nickel locks</i> or with <i>9250 Ember Chrome locks</i> .		
		• 4 doors	+\$ 440	Specify with <i>9211 Nickel locks</i> or with <i>9250 Ember Chrome locks</i> .		
Keying						
• Factory- and field-installed keying units		► See <i>GSA Volume 5a Specification Guide</i> .				

Tip: Multiple grommet locations can be specified on any given credenza. For a 48"W credenza, a maximum of two grommets can be specified. For a 72"W credenza, a maximum of three grommets can be specified. For a 96"W credenza, a maximum of four grommets can be specified.

Tip: Grommets can be specified on credenzas with and without accent tops.

►Options, continued on next page

Exponents Credenzas 27"H

DESIGN COALESSE DESIGN GROUP

SIN 711.2

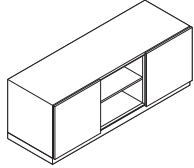

Specification Information

Dimensions			Style Number	Case	Base Prices		
D	W	H			Door Fronts		
					Painted MDF	Grade 1 Veneer	Grade 2 Veneer

Partial Open Credenzas

72"W

24 ³ / ₄ "	72"	27"	COCZD0257227	Painted MDF	\$4982	\$5168	\$5215
				Grade 1 Veneer	\$5680	\$5866	\$5913
				Grade 2 Veneer	\$5848	\$6034	\$6081

96"W

24 ³ / ₄ "	96"	27"	COCZD0259627	Painted MDF	\$5662	\$5848	\$5895
				Grade 1 Veneer	\$6419	\$6605	\$6652
				Grade 2 Veneer	\$6610	\$6796	\$6843

Credenzas with Doors

48"W

24 ³ / ₄ "	48"	27"	COCZD254827	Painted MDF	\$4478	\$4664	\$4711
				Grade 1 Veneer	\$5060	\$5246	\$5293
				Grade 2 Veneer	\$5209	\$5395	\$5442

72"W

24 ³ / ₄ "	72"	27"	COCZD257227	Painted MDF	\$5435	\$5697	\$5760
				Grade 1 Veneer	\$6133	\$6395	\$6458
				Grade 2 Veneer	\$6307	\$6569	\$6632

96"W

24 ³ / ₄ "	96"	27"	COCZD259627	Painted MDF	\$6405	\$6731	\$6810
				Grade 1 Veneer	\$7221	\$7547	\$7626
				Grade 2 Veneer	\$7416	\$7742	\$7821

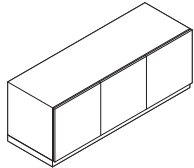

Tip: Adjustable shelf is in addition to the adjustable shelves that are standard on the credenza.

Specification Information

Dimensions			Style Number	Base Prices		
D	W	H		Painted MDF	Grade 1 Veneer	Grade 2 Veneer

Adjustable Shelf for 48"W Credenzas

22 ¹ / ₄ "	22 ⁷ / ₈ "	3/4"	COCZAS48	\$196	\$232	\$240
----------------------------------	----------------------------------	------	----------	-------	-------	-------

Adjustable Shelf for 72"W Credenzas, End Compartments

22 ¹ / ₄ "	22 ¹ / ₂ "	3/4"	COCZASEND72	\$196	\$232	\$240
----------------------------------	----------------------------------	------	-------------	-------	-------	-------

Adjustable Shelf for 72"W Credenzas, Middle Compartments

22 ¹ / ₄ "	24"	3/4"	COCZASMID72	\$196	\$232	\$240
----------------------------------	-----	------	-------------	-------	-------	-------

► Specification Information, continued on next page

Exponents Credenzas 27"H *continued*

DESIGN COALESSE DESIGN GROUP

SIN 711.2

► Specification Information, continued from previous page

Specification Information

Dimensions			Style Number	Base Prices		
D	W	H		Painted MDF	Grade 1 Veneer	Grade 2 Veneer

Adjustable Shelf for 96"W Credenzas, End Compartments

22¼"	22½"	¾"	COCZASND96	\$196	\$232	\$240
------	------	----	------------	-------	-------	-------

Adjustable Shelf for 96"W Credenzas, Middle Compartments

22¼"	23⅝"	¾"	COCZASMD96	\$196	\$232	\$240
------	------	----	------------	-------	-------	-------



Tip: Adjustable shelf is in addition to the adjustable shelves that are standard on the credenza.

Coalesse

Exponents Credenzas 27"H

DESIGN COALESSE DESIGN GROUP

SIN 711.2

Exponents Credenzas 39"H

DESIGN COALESSE DESIGN GROUP

SIN 711.2

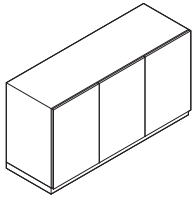

Standard Includes	Required to Specify
<ul style="list-style-type: none"> ▶ Need help? Product details, see <i>Coalesse Tables, Storage, and Accessories Specification Guide</i> Case: painted MDF Unfinished outside back: black backer Door fronts with 110° soft close hinges, if selected: painted MDF Accent ribbon: paint Plinth base: matches case finish Two adjustable shelves per opening, behind doors: matches case Ships assembled Additional adjustable shelf(s), if selected: painted MDF 	<ol style="list-style-type: none"> Style number Painted MDF color number for case: V145 Milk V197 Black Painted MDF color number for door fronts, if selected: V145 Milk V197 Black Paint color number for accent ribbon: 4135 Black Matte 4141 Platinum Matte Painted MDF color number for additional adjustable shelf(s), if selected: V145 Milk MDF V197 Black MDF Options, if selected (see below) <p>▶ See <i>Surface Materials</i>, page 350.</p>

Tip: When wood veneer is specified on the case and wood veneer is specified for the ribbon, it is recommended the ribbon finish match the wood veneer case selection.

Options	Price	Required to Specify
Surface Materials <ul style="list-style-type: none"> Case and door fronts Grade 1 wood veneer Grade 2 wood veneer Stain-to-Match 	<ul style="list-style-type: none"> Prices at right Prices at right No cost 	<ul style="list-style-type: none"> Specify with <i>Grade 1 wood veneer</i> and select color number. Specify with <i>Grade 2 wood veneer</i> and select color number. Specify with <i>Stain-to-Match</i>. <p>▶ See <i>Coalesse Surface Materials Reference Guide</i>.</p>
<ul style="list-style-type: none"> Accent ribbon 48"W credenza with Grade 1 wood veneer 48"W credenza with Grade 2 wood veneer 72"W credenza with Grade 1 wood veneer 72"W credenza with Grade 2 wood veneer 96"W credenza with Grade 1 wood veneer 96"W credenza with Grade 2 wood veneer Stain-to-Match 	<ul style="list-style-type: none"> +\$147 +\$152 +\$174 +\$180 +\$205 +\$212 No cost 	<ul style="list-style-type: none"> Specify with <i>Grade 1 wood veneer</i> accent and select color number. Specify with <i>Grade 2 wood veneer</i> accent and select color number. Specify with <i>Grade 1 wood veneer</i> accent and select color number. Specify with <i>Grade 2 wood veneer</i> accent and select color number. Specify with <i>Grade 1 wood veneer</i> accent and select color number. Specify with <i>Grade 2 wood veneer</i> accent and select color number. Specify with <i>Stain-to-Match</i>. <p>▶ See <i>Coalesse Surface Materials Reference Guide</i>.</p>
<ul style="list-style-type: none"> Finished back panel 48"W credenza 72"W credenza 96"W credenza 	<ul style="list-style-type: none"> +\$284 +\$330 +\$392 	<ul style="list-style-type: none"> Specify with <i>finished back panel</i>. Specify with <i>finished back panel</i>. Specify with <i>finished back panel</i>.
Metal Legs <ul style="list-style-type: none"> Black matte or platinum matte - 48"W credenza - 72"W credenza - 96"W credenza 	<ul style="list-style-type: none"> +\$266 +\$326 +\$385 	<ul style="list-style-type: none"> Specify with <i>metal legs</i> and select paint color number. Specify with <i>metal legs</i> and select paint color number. Specify with <i>metal legs</i> and select paint color number.
Accent Top <ul style="list-style-type: none"> Painted MDF for wood veneer cases 48"W credenza 72"W credenza 96"W credenza 	<ul style="list-style-type: none"> +\$591 +\$743 +\$976 	<ul style="list-style-type: none"> Specify with <i>painted MDF accent top</i> and select color number. Specify with <i>painted MDF accent top</i> and select color number. Specify with <i>painted MDF accent top</i> and select color number.

Tip: When finished back panel is specified, the finish will match the case finish.

Tip: Painted MDF accent top should be specified with a veneer case. Wood veneer accent top should be specified with a painted MDF case. Corian and glass accent tops can be specified with a wood veneer or painted MDF case.

▶ Options, continued on next page

Exponents Credenzas 39"H

DESIGN COALESSE DESIGN GROUP

SIN 711.2

► Options, continued from previous page

Options	Price	Required to Specify
Accent Top		
Grade 1 wood veneer for painted MDF cases		
• 48"W credenza	+\$ 708	Specify with <i>Grade 1 wood veneer accent top</i> and select color number. Specify with <i>Grade 1 wood veneer accent top</i> and select color number. Specify with <i>Grade 1 wood veneer accent top</i> and select color number. Specify with <i>Stain-to-Match</i> . ► See <i>Coalesse Surface Materials Reference Guide</i> .
• 72"W credenza	+\$ 892	
• 96"W credenza	+\$1171	
• Stain-to-Match	No cost	
Grade 2 wood veneer for painted MDF cases		
• 48"W credenza	+\$ 708	Specify with <i>Grade 2 wood veneer accent top</i> and select color number. Specify with <i>Grade 2 wood veneer accent top</i> and select color number. Specify with <i>Grade 2 wood veneer accent top</i> and select color number. Specify with <i>Stain-to-Match</i> . ► See <i>Coalesse Surface Materials Reference Guide</i> .
• 72"W credenza	+\$ 892	
• 96"W credenza	+\$1171	
• Stain-to-Match	No cost	
Corian: glacier white only		
• 48"W credenza	+\$1205	Specify with <i>Corian accent top</i> . Specify with <i>Corian accent top</i> . Specify with <i>Corian accent top</i> .
• 72"W credenza	+\$1516	
• 96"W credenza	+\$1988	
Glass		
• 48"W credenza	+\$1418	Specify with <i>glass accent top</i> and select color number. Specify with <i>glass accent top</i> and select color number. Specify with <i>glass accent top</i> and select color number.
• 72"W credenza	+\$1784	
• 96"W credenza	+\$2339	

Tip: Multiple grommet locations can be specified on any given credenza. For a 48"W credenza, a maximum of two grommets can be specified, For a 72"W credenza, a maximum of three grommets can be specified. For a 96"W credenza, a maximum of four grommets can be specified.

Tip: Grommets can be specified on credenzas with and without accent tops.

Grommets: black matte or platinum matte	No Accent Top, Painted MDF Accent Top or Wood Veneer Accent Top	Corian Accent Top	Glass Accent Top	
48"W credenza				
• Grommet, left	+\$ 59	+\$89	+\$118	Specify with <i>grommet left</i> and select color number.
• Grommet, right	+\$ 59	+\$89	+\$118	Specify with <i>grommet right</i> and select color number.
72"W credenza				
• Grommet, left	+\$ 59	+\$89	+\$118	Specify with <i>grommet left center</i> and select color number.
• Grommet, center	+\$ 59	+\$89	+\$118	Specify with <i>grommet center</i> and select color number.
• Grommet, right	+\$ 59	+\$89	+\$118	Specify with <i>grommet right</i> and select color number.
96"W credenza				
• Grommet, left	+\$ 59	+\$89	+\$118	Specify with <i>grommet left</i> and select color number.
• Grommet, left center	+\$ 59	+\$89	+\$118	Specify with <i>grommet left center</i> and select color number.
• Grommet, right center	+\$ 59	+\$89	+\$118	Specify with <i>grommet right center</i> and select color number.
• Grommet, right	+\$ 59	+\$89	+\$118	Specify with <i>grommet right</i> and select color number.

Lock and Keying				
Lock				
• 2 doors	+\$ 220	Specify with <i>9211 Nickel locks</i> or with <i>9250 Ember Chrome locks</i> . Specify with <i>9211 Nickel locks</i> or with <i>9250 Ember Chrome locks</i> . Specify with <i>9211 Nickel locks</i> or with <i>9250 Ember Chrome locks</i> .		
• 3 doors	+\$ 330			
• 4 doors	+\$ 440			
Keying				
• Factory- and field-installed keying units		► See <i>GSA Volume 5a Specification Guide</i> .		

► Specification Information, on next page

Exponents Credenzas 39"H *continued*

DESIGN COALESSE DESIGN GROUP

SIN 711.2

► Options, on previous page

Specification Information

Dimensions			Style Number	Case	Base Prices		
D	W	H			Painted MDF	Grade 1 Veneer	Grade 2 Veneer

Credenzas with Doors

48"W

24 ³ / ₄ "	48"	39"	COCZUD254839	Painted MDF	\$5082	\$5315	\$5366
				Grade 1 Veneer	\$5664	\$5897	\$5948
				Grade 2 Veneer	\$5821	\$6054	\$6105

72"W

24 ³ / ₄ "	72"	39"	COCZUD257239	Painted MDF	\$6273	\$6553	\$6622
				Grade 1 Veneer	\$6971	\$7251	\$7320
				Grade 2 Veneer	\$7153	\$7433	\$7502

96"W

24 ³ / ₄ "	96"	39"	COCZUD259639	Painted MDF	\$7445	\$7794	\$7883
				Grade 1 Veneer	\$8261	\$8610	\$8699
				Grade 2 Veneer	\$8465	\$8814	\$8903

Specification Information

Dimensions			Style Number	Base Prices		
D	W	H		Painted MDF	Grade 1 Veneer	Grade 2 Veneer

Adjustable Shelf for 48"W Credenzas

22 ¹ / ₄ "	22 ⁷ / ₈ "	3/4"	COCZAS48	\$196	\$232	\$240
----------------------------------	----------------------------------	------	----------	-------	-------	-------

Adjustable Shelf for 72"W Credenzas, End Compartments

22 ¹ / ₄ "	22 ¹ / ₂ "	3/4"	COCZASEND72	\$196	\$232	\$240
----------------------------------	----------------------------------	------	-------------	-------	-------	-------

Adjustable Shelf for 72"W Credenzas, Middle Compartments

22 ¹ / ₄ "	24"	3/4"	COCZASMID72	\$196	\$232	\$240
----------------------------------	-----	------	-------------	-------	-------	-------

Adjustable Shelf for 96"W Credenzas, End Compartments

22 ¹ / ₄ "	22 ¹ / ₂ "	3/4"	COCZASEND96	\$196	\$232	\$240
----------------------------------	----------------------------------	------	-------------	-------	-------	-------

Adjustable Shelf for 96"W Credenzas, Middle Compartments

22 ¹ / ₄ "	23 ⁵ / ₈ "	3/4"	COCZASMID96	\$196	\$232	\$240
----------------------------------	----------------------------------	------	-------------	-------	-------	-------

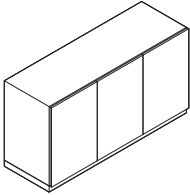

Tip: Adjustable shelf is in addition to the adjustable shelves that are standard on the credenza.

Exponents Lectern

DESIGN COALESSE DESIGN GROUP

SIN 711.2

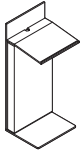

Standard Includes		Required to Specify
<ul style="list-style-type: none"> ▶ Need help? Product details, see <i>Coalesse Tables, Storage, and Accessories Specification Guide</i> 	<ul style="list-style-type: none"> • Case: painted MDF • Removable back panel for easy access to wire management: painted MDF • Metal base: paint • Accent ribbon: paint • Integrated 160° hinged cover for power and data or storage • Wire management entry and exit points at bottom • Glides: nylon non-marring • Ships assembled 	<ol style="list-style-type: none"> 1 Style number 2 Painted MDF color number for case: V145 Milk V197 Black 3 Painted MDF color number for back panel: V145 Milk V197 Black 4 Paint color number for base: 4135 Black Matte 4141 Platinum Matte 5 Paint color number for accent ribbon: 4135 Black Matte 4141 Platinum Matte 6 Options, if selected (see below) <p>▶ See <i>Surface Materials</i>, page 350.</p>

Options	Price	Required to Specify
Surface Materials <ul style="list-style-type: none"> • Case and back panel • Grade 1 wood veneer • Grade 2 wood veneer • Stain-to-Match 	<ul style="list-style-type: none"> Prices below Prices below No cost 	<ul style="list-style-type: none"> Specify with <i>Grade 1 wood veneer</i> and select color number. Specify with <i>Grade 2 wood veneer</i> and select color number. Specify with <i>Stain-to-Match</i>. <p>▶ See <i>Coalesse Surface Materials Reference Guide</i>.</p>
<ul style="list-style-type: none"> • Accent ribbon • Grade 1 wood veneer • Grade 2 wood veneer • Stain-to-Match 	<ul style="list-style-type: none"> +\$ 58 +\$ 60 No cost 	<ul style="list-style-type: none"> Specify with <i>Grade 1 wood veneer</i> and select color number. Specify with <i>Grade 2 wood veneer</i> and select color number. Specify with <i>Stain-to-Match</i>. <p>▶ See <i>Coalesse Surface Materials Reference Guide</i>.</p>
Power and Data	<ul style="list-style-type: none"> • 2 power receptacles, 2 data, and 1 VGA with audio: black gloss only 	<ul style="list-style-type: none"> +\$397 <p>Specify with <i>PVD</i>.</p>

Tip: When wood veneer is specified on the case and wood veneer is specified for the ribbon, it is recommended the ribbon finish match the wood veneer case selection.

Specification Information							
Dimensions			Style Number	Case	Base Prices		
D	W	H			Painted MDF	Grade 1 Veneer	Grade 2 Veneer
18 ³ / ₄ "	23 ¹ / ₂ "	48"	COCL42	Painted MDF	\$3132	\$3248	\$3280
				Grade 1 Veneer	\$3597	\$3713	\$3745
				Grade 2 Veneer	\$3714	\$3830	\$3862

Tip: The height of the lectern includes the back panel.

Exponents Mobile Whiteboard Display

DESIGN COALESSE DESIGN GROUP

SIN 711.2

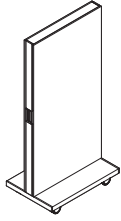

Tip: The e³ CeramicSteel markerboard surface is magnetic.

Tip: See CeramicSteel Care and Maintenance for additional information.

► Page 384

Standard Includes

- Need help? Product details, see *Coalesse Tables, Storage, and Accessories Specification Guide*
- One removable and one fixed whiteboard panel: 7655 e³ CeramicSteel markerboard surface with 4145 Milk Gloss painted aluminum trim
- Base, handle, and inner frame: paint
- Base bumper: plastic to complement paint on base
- Outer frame trim: painted MDF
- Two directional and two locking swivel 4" casters: 6009 Arctic White plastic for 4145 Milk Gloss paint selection or 6000 Black plastic for 4135 Black Matte paint selection
- Ships assembled

Required to Specify

- 1 Style number
- 2 Paint color number for base, handle, and inner frame:
 - 4135 Black Matte
 - 4145 Milk Gloss
- 3 Painted MDF color number for trim panels:
 - V145 Milk
 - V197 Black
- 4 Options, if selected (see below)
 - See *Surface Materials*, page 350.

Options

Options	Price	Required to Specify
Surface Materials	Wood trim panels	
• Grade 1 wood veneer	+\$134	Specify with <i>Grade 1 wood veneer trim panels</i> and select color number.
• Grade 2 wood veneer	+\$141	Specify with <i>Grade 2 wood veneer trim panels</i> and select color number.
• Stain-to-Match	No cost	Specify with <i>Stain-to-Match</i> .
		► See <i>Coalesse Surface Materials Reference Guide</i> .

Specification Information

Dimensions			Style Number	Base Price
D	W	H		
24½"	36"	75⅞"	COCWBN	\$3325
24½"	48"	75⅞"	COCWBW	\$4035

Exponents Mobile Mediaboard Display

DESIGN COALESSE DESIGN GROUP

SIN 711.2

Tip: The e³ CeramicSteel markerboard surface is magnetic.

► Need help? Product details, see *Coalesse Tables, Storage, and Accessories Specification Guide*

Standard Includes	Required to Specify
-------------------	---------------------

- One removable back panel and one front fixed whiteboard panel: 7655 e³ CeramicSteel markerboard surface with 4145 Milk Gloss painted aluminum trim
- Base, handle, and inner frame: paint
- Base bumper: plastic to complement paint on base
- Outer frame trim: painted MDF
- Mediaboard well for power and display module: black
- Power and display module: five white waterproof simplex power outlets, one VGA jack, and one audio jack with cable connection to monitor, faceplate is black gloss paint
- Monitor mount bracket kit: black paint
- Wire management grommet for plug: black plastic
- Two directional and two locking swivel 4" casters: 6009 Arctic White plastic for 4145 Milk Gloss paint selection or 6000 Black plastic for 4135 Black Matte paint selection
- Shelf: paint
- Ships assembled except for monitor mount

- 1 Style number
- 2 Paint color number for base, handle, and inner frame:
4135 Black Matte
4145 Milk Gloss
- 3 Painted MDF color number for trim panels:
V145 Milk
V197 Black
- 4 Paint color number for shelf, if selected:
4135 Black Matte
4145 Milk Gloss
- 5 Options, if selected (see below)
► See *Surface Materials*, page 350.

Tip: See CeramicSteel Care and Maintenance for additional information.
► Page 384

Options	Price	Required to Specify
---------	-------	---------------------

Surface Materials	Wood trim panels <ul style="list-style-type: none"> • Grade 1 wood veneer • Grade 2 wood veneer • Stain-to-Match 	+\$134 +\$141 No cost	Specify with <i>Grade 1 wood veneer trim panels</i> and select color number. Specify with <i>Grade 2 wood veneer trim panels</i> and select color number. Specify with <i>Stain-to-Match</i> . ► See <i>Coalesse Surface Materials Reference Guide</i> .
Power and Data	<ul style="list-style-type: none"> • Five power outlets, one HDMI, and one blank 	No cost	Specify with <i>five power and HDMI</i> .

Specification Information

Dimensions			Style	Base
D	W	H	Number	Price

Mobile Mediaboard Display

24 ¹ / ₈ "	48"	75 ⁷ / ₈ "	COCMBW	\$5428
----------------------------------	-----	----------------------------------	--------	--------

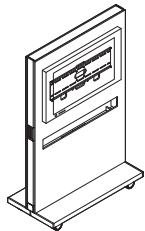

Shelf

9 ¹³ / ₁₆ "	15"	4 ³ / ₁₆ "	COCMBSHLF	\$ 217
-----------------------------------	-----	----------------------------------	-----------	--------

Exponents Mobile Mediaboard Display with Steelcase media:scape Technology

DESIGN COALESSE DESIGN GROUP

SIN 711.2

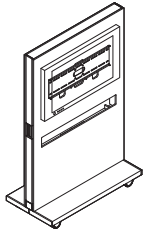

Tip: The e³ CeramicSteel marker-board surface is magnetic.

	Standard Includes	Required to Specify
<p>► Need help? Product details, see <i>Coalesse Tables, Storage, and Accessories Specification Guide</i></p>	<ul style="list-style-type: none"> One removable back panel and one front fixed whiteboard panel: 7655 e³ CeramicSteel markerboard surface with 4145 Milk Gloss painted aluminum trim Base, handle, and inner frame: paint Base bumper: plastic to complement paint on base Outer frame trim: painted MDF Mediaboard well for power module: black Wire management: five white waterproof simplex power outlets, faceplate is black gloss paint Integrated media:scape componentry, includes four PUCKs Monitor mount bracket kit: black paint Wire management grommet for plug: black plastic Two directional and two locking swivel 4" casters: 6009 Arctic White plastic for 4145 Milk Gloss paint selection or 6000 Black plastic for 4135 Black Matte paint selection Shelf: paint Ships assembled, except for monitor mount and media:scape components 	<ol style="list-style-type: none"> Style number Paint color number for base, handle, and inner frame: 4135 Black Matte 4145 Milk Gloss Painted MDF color number for trim panels: V145 Milk V197 Black Paint color number for shelf, if selected: 4135 Black Matte 4145 Milk Gloss Maintenance agreement (see below under Required Selections) PUCKs (see below under Required Selections) Options, if selected (see below) <p>► See <i>Surface Materials</i>, page 350.</p>

Tip: See *CeramicSteel Care and Maintenance* for additional information.
► Page 384

	Required Selections	Price	Required to Specify
Maintenance Agreement	<ul style="list-style-type: none"> One year Two years Three years Four years 	<ul style="list-style-type: none"> +\$ 700 +\$1260 +\$1785 +\$1960 	<p>Specify with <i>one year maintenance agreement</i>.</p> <p>Specify with <i>two year maintenance agreement</i>.</p> <p>Specify with <i>three year maintenance agreement</i>.</p> <p>Specify with <i>four year maintenance agreement</i>.</p>

PUCKs	All PUCKs same type	Price	Required to Specify
	<ul style="list-style-type: none"> VGA HDMI DisplayPort Mini DisplayPort 	<ul style="list-style-type: none"> No cost No cost No cost No cost 	<p>Specify with <i>VGA PUCKs</i>.</p> <p>Specify with <i>HDMI PUCKs</i>.</p> <p>Specify with <i>DisplayPort PUCKs</i>.</p> <p>Specify with <i>Mini DisplayPort PUCKs</i>.</p>
	Mixed PUCK types		
	<ul style="list-style-type: none"> PUCK 1 <ul style="list-style-type: none"> - VGA - HDMI - DisplayPort - Mini DisplayPort PUCK 2 <ul style="list-style-type: none"> - VGA - HDMI - DisplayPort - Mini DisplayPort PUCK 3 <ul style="list-style-type: none"> - VGA - HDMI - DisplayPort - Mini DisplayPort PUCK 4 <ul style="list-style-type: none"> - VGA - HDMI - DisplayPort 	<ul style="list-style-type: none"> No cost No cost No cost No cost No cost No cost No cost No cost No cost No cost No cost No cost No cost No cost 	<p>Specify with <i>VGA PUCK</i>.</p> <p>Specify with <i>HDMI PUCK</i>.</p> <p>Specify with <i>DisplayPort PUCK</i>.</p> <p>Specify with <i>Mini DisplayPort PUCK</i>.</p> <p>Specify with <i>VGA PUCK</i>.</p> <p>Specify with <i>HDMI PUCK</i>.</p> <p>Specify with <i>DisplayPort PUCK</i>.</p> <p>Specify with <i>Mini DisplayPort PUCK</i>.</p> <p>Specify with <i>VGA PUCK</i>.</p> <p>Specify with <i>HDMI PUCK</i>.</p> <p>Specify with <i>DisplayPort PUCK</i>.</p> <p>Specify with <i>Mini DisplayPort PUCK</i>.</p> <p>Specify with <i>VGA PUCK</i>.</p> <p>Specify with <i>HDMI PUCK</i>.</p> <p>Specify with <i>DisplayPort PUCK</i>.</p>

	Options	Price	Required to Specify
Surface Materials	Wood Trim Panels		
	<ul style="list-style-type: none"> Grade 1 wood veneer Grade 2 wood veneer Stain-to-Match 	<ul style="list-style-type: none"> +\$ 134 +\$ 141 No cost 	<p>Specify with <i>Grade 1 wood veneer trim panels</i> and select color number.</p> <p>Specify with <i>Grade 2 wood veneer trim panels</i> and select color number.</p> <p>Specify with <i>Stain-to-Match</i>.</p> <p>► See <i>Coalesse Surface Materials Reference Guide</i>.</p>

Exponents Mobile Mediaboard Display with Steelcase media:scape Technology

DESIGN COALESSE DESIGN GROUP

SIN 711.2

Specification Information

Dimensions			Style	Base
D	W	H	Number	Price

Mobile Mediaboard Display with Steelcase media:scape Technology

24 ¹ / ₈ "	48"	75 ⁷ / ₈ "	COC1MBWMS	\$16,401
----------------------------------	-----	----------------------------------	-----------	----------

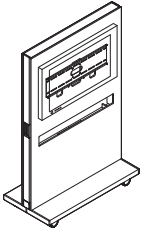

Shelf

9 ¹³ / ₁₆ "	15"	4 ³ / ₁₆ "	COCMBSHLF	\$ 217
-----------------------------------	-----	----------------------------------	-----------	--------

Surface Materials

► For more detailed Coalesse surface material information, see the *Coalesse Surface Materials Reference Guide* or consult your Steelcase dealer.

Surface Materials-Upholstery	350
Customer's Own Material	352
Flammability Information	354
Upholstery Matrix	355
Surface Materials-Leather/Faux	358
Cut Yardage Net Price List	360
Leather and Faux Leather Matrix	361
Surface Materials-Wood	362
Hardwood Matrix	364
Veneer Matrix	365
Surface Materials-Laminate	366
High-Pressure Laminate Matrix	368
Laminate Edge Band Matrix	372
Surface Materials-Glass	374
Glass Matrix	375
Surface Materials-Metal/Paint	376
Metal/Paint Matrix	378
Emu Advanced Collection Paint Matrix	380
Surface Materials-Miscellaneous	383
Ordering	384
Care and Maintenance	386

Surface Materials - Upholstery

Upholstery

All Coalesse textiles are priced by grades. Some Coalesse fabrics can be treated for flame retardancy, contact Customer Service. All Coalesse products are handcrafted making each unique. Certain fabrics and leathers will appear loose and may differ from like products due to comfort wrinkles when upholstered.

A contrasting welt is available on some products. Consult Customer Service for yardage or square feet requirements and prices. All stripes will be applied vertically unless customer specifies otherwise. Loose cushions on Coalesse products are not fully upholstered (not reversible).

Designtex, Maharam, Steelcase, and select Luna fabrics are graded in our pricing. Simply order Coalesse products with Designtex, Maharam, Steelcase, and select Luna specified. Designtex, Maharam, Steelcase, and select Luna fabrics are graded in on Coalesse products; however, Coalesse does not stock fabrics and can only respond based on Designtex, Maharam, Steelcase, and select Luna fabrics lead times. For current grades, refer to Coalesse website: www.Coalesse.com.

Special Fabric Applications

Backing

- Backing information is found on each product page. Select this option when ordering your product to have backing applied. Price varies by product according to yardage it requires.

Tip: Prices subject to change without notice and an additional 2 week lead time will apply for 54" wide fabrics. Wider fabrics will require 4 week additional lead time. Check fabric database to determine if backing is required at www.Coalesse.com.

Seating Upholstery

Coalesse fabrics are priced by grades from 6 through 14 and leathers C and E. Fabrics and leathers may be purchased separately as cut yardage, see page 360. All products are handcrafted, making each unique. Certain fabrics and leathers will appear loose and may differ from like products due to wrinkles when upholstered. A contrasting welt is available on some products. Consult Customer Service for yardage or square feet requirements for pricing.

All stripes will be applied vertically unless customer specifies otherwise. Loose cushions on Coalesse products are not fully upholstered (not reversible). Any graded-in or COM textile should be reviewed with supplier to verify availability. In some cases a textile supplier may require minimums that exceed your furniture order requirements. In these situations, you will be contacted with an option to select a different textile or continue with your original textile selection as a COM-DTP. If you choose to continue with your textile selection as COM-DTP to allow you to order the minimum required, please ship only the textile needed to Coalesse for your furniture order.

Emu Upholstery

Applies to: Emu Advanced Collection Outdura Collection

Fabric Grade 6

5G30	Natural White
5G31	Kona
5G32	Sandstone
5G33	Cadet Grey
5G34	Stone
5G35	China Red
5G36	Cardinal Red
5G37	Solid Aquamarine
5G38	Canary
5G39	Pesto
5G41	Island Blue

SW_1 Knit

Applies to: SW_1 Collection

5KG0	Stone
5KG1	Grey
5KG2	Brown
5KG3	Black
5KG4	Ivory
5KG5	Coal
5KG6	Garnet
5KG7	Golden
5KG8	Royal

Lagunitas Knit

Applies to: Lagunitas focus nook and lounge system

Grade 1

5K50	Stone
5K51	Grey
5K54	Black
5K58	Ivory
5K59	Coal

Grade 2

5K52	Cement
5K53	Brown
5K55	Garnet
5K56	Golden
5K57	Royal
5K60	Glacier
5K61	Cadet
5K62	Grass
5K63	Forest
5K64	Amber
5K65	Terracotta
5K66	Crimson
5K67	Berry
5K68	Violet
5K69	Khaki

Hexa Upholstery

Applies to: Hosu

Fabric Grade 10

CL50	Dark Grey
CL51	Light Grey
CL52	Blue
CL53	Green
CL54	Red
CL55	Yellow

Fusion Upholstery

Applies to: Hosu lounge and Lagunitas personal table

Fabric Grade 11

CL60	Caviar
CL61	Portobello
CL62	Graphite
CL63	Java
CL64	Steam*

* Not available on Hosu

Surface Materials - Steelcase Upholstery

Steelcase Upholstery

Coalesse offers a select palette of Steelcase fabrics as standard. This provides the convenience of an integrated finish offering and ease of specification. See the Steelcase Standard Fabric Matrix for availability by product line. For a visual reference, please refer to the Steelcase Finish Library.

Grade 6

Cogent: Connect

- 5S15 Coconut
- 5S16 Turmeric/Honey
- 5S17 Tangerine
- 5S18 Scarlet
- 5S19 Concord
- 5S20 Maya Blue
- 5S21 Blue Jay
- 5S23 Wasabi
- 5S24 Nickel
- 5S25 Graphite
- 5S26 Licorice
- 5S27 Malt
- 5S28 Root Beer
- 5S93 Blueprint
- 5S94 Lizard/Jungle
- 5S95 Sailor
- 5S96 Quicksilver
- 5S98 Canary
- 5S99 Lipstick/Merlot
- 5SD0 Royal Blue

Jacks

- 5B61 Taupe
- 5B62 Camel
- 5B64 Pewter
- 5B70 Midnight

Seating Vinyl

- 5801 Topaz
- 5805 Foggy Night
- 5809 Black
- 5810 Forest
- 5812 Navy
- 5813 Currant
- 5814 Leaf
- 5815 Seaside
- 5817 Pebble
- 5818 Spice
- 5819 Thistle
- 5820 Coffee
- 5822 Iris

Spyder

- 5B01 Foggy Night
- 5B04 Peri

Nitelights

- 5F58 Hazelnut
- 5F61 Earth
- 5F62 Shore
- 5F63 Moss
- 5F65 Regal Blue
- 5F66 Stone
- 5F67 Moon

Link

- 5A20 Burgundy
- 5A23 Green
- 5A24 Blue
- 5A25 Navy
- 5A26 Purple
- 5A27 Black
- 5A28 Ocean
- 5A30 Chamois

Grade 7

Stand In

- 5621 Sleet
- 5622 Lunar
- 5623 Cyclone
- 5624 Eclipse
- 5625 Powder
- 5626 Chardonnay
- 5627 Graham
- 5628 Sediment
- 5629 Allspice
- 5630 Apple
- 5631 Lava
- 5632 Cayenne
- 5633 Plantain
- 5634 Parsley
- 5635 Scallion
- 5636 Atlantis
- 5691 Orca
- 5740 Burlap
- 5741 Porter
- 5742 Tusk
- 5743 Putty
- 5744 Blueberry
- 5745 Charteuse
- 5746 Mango
- 5747 Sedona
- 5748 Juniper
- 5749 Peanut

Cogent: Trails

- 5S29 Bronzite
- 5S85 Agate
- 5S86 Lapis
- 5S87 Malachite
- 5S88 Quartz
- 5S90 Tiger Eye
- 5S91 Travertine
- 5S92 Topaz

New Black

- 5J08 Jack
- 5J09 James
- 5J12 Harley

Imperma

- TM01 Toffee
- TM02 Pigeon
- TM03 Fossil
- TM04 Poppyseed
- TM05 Auburn
- TM06 Cumin
- TM07 Marble
- TM08 Cliff
- TM09 Tarragon
- TM10 Pesto
- TM11 Wave
- TM12 Niagara
- TM13 Tuscan
- TM14 Peppercorn

Grade 8

Billiard Multi-Use by Designtex

- 5H10 Bone
- 5H11 Poppy
- 5H12 Tangelo
- 5H13 Citron
- 5H14 Avocado
- 5H15 Hunter
- 5H16 Indigo
- 5H17 Mallard
- 5H18 Teak
- 5H19 Cumulus
- 5H20 Pewter
- 5H21 Gunmetal
- 5H22 Ink

Texel

- TM20 Angora
- TM21 Grist
- TM22 Galaxy
- TM23 Terracotta
- TM24 Nude
- TM25 Field
- TM26 Haze

Grade 9

Remix

- RE01 Rust
- RE02 Pumpkin
- RE03 Pebble
- RE04 Dark Chocolate
- RE05 Beige
- RE06 Linen Beige
- RE07 Hazelnut
- RE08 Concrete
- RE09 Sky Blue
- RE10 Blue Jean
- RE11 Ivy Green
- RE12 Primavera Yellow
- RE13 Night Blue

Bo Peep

- 5G66 Pita
- 5G67 Bone
- 5G68 Safari
- 5G69 Brown Sugar
- 5G70 Chocolate
- 5G71 Candlelight
- 5G72 Honey Mustard
- 5G73 Marmalade
- 5G74 Picnic
- 5G75 Pinot
- 5G76 Bloom
- 5G77 Grapevine
- 5G78 Firefly
- 5G79 Artichoke
- 5G80 Serpent
- 5G81 Carolina
- 5G82 Blue Bonnet
- 5G83 Nautical
- 5G84 Gravel
- 5G85 Sharkskin
- 5G86 Kohl

Customer's Own Material

CUSTOMER'S OWN MATERIAL

Coalesse is pleased to cooperate with COM/COL selections. Prior to order placement for exact yardage requirements, a sample cutting of actual COM/COL must be submitted to Coalesse for approval only if fabric approval is not found in Coalesse fabric database. Identify the name and number of units on which the fabric/leather is to be applied. If COM has a repeat the sample should be large enough to show the entire repeat. Coalesse will not accept nor use any painted leathers. A painted leather is described as any suede or leather which is not aniline dyed with the same color throughout the thickness of the hide.

Even after preliminary approval, Coalesse reserves the right to reject COM/COL if necessary when the quality is not satisfactory for the item it is intended to be used on. Once COM/COL is accepted Coalesse assumes no responsibility for its overall appearance, flammability, normal durability, colorfastness, or any other quality, after upholstered on a Coalesse product.

COALESSE STANDARD TO BUY PROGRAM

The Customer's Own Material (COM) Program offers the opportunity for customers to select fabrics that are not offered through the standard Coalesse surface materials program for use on our products. Through the COM program, Coalesse will test your materials for application on Coalesse products. Once approved, you can place your order. Coalesse will facilitate the entire ordering process and give you a production schedule. Coalesse will order the COM fabric directly from the textile manufacturer. For up-to-date information regarding fabric test results for all COM fabrics and details regarding yardage requirements for most Seating lines, visit the fabric database at www.coalesse.com.

CUSTOMERS TO BUY SCHEDULING POLICY/COM/COL POLICY

COM/COL must be received at manufacturing location no later than 20 working days prior to the order scheduled delivery date. If COM/COL is not received in this time frame, scheduling will move the order's delivery date out to the best available ship date. Customer Service will notify the dealer via e-mail of the order's new scheduled delivery date. Project size order shipment may be affected due to size of order. If the COM/COL is received and the COM/COL requires backing, scheduling will move order out to best available ship date. Backing charges will apply. If COM/COL is received defective or short yardage/sq. ft., the replacement COM/COL order must be received within 3 days to maintain scheduled delivery date on order. It is the responsibility of the dealer to advise Coalesse on what to do with defective materials. In addition, customers may request Coalesse to order for COM/COL materials.

SQUARE FOOTAGE/ YARDAGE REQUIREMENTS

COM and COL price includes application of Customer's Own Material or Leather to frames. All COM and COL should be shipped freight prepaid to designated manufacturing location. Labels will be provided by your Customer Service representative to ensure clear textile identification.

Please have customers send COM/COL and add TAG: COM/COL.

COM and COL must be identified as follows to prevent order delays:

1. Name and address (Should match purchase order)
2. Your furniture purchase order number/sales order
3. Style number to which fabric is to be applied
4. Supplier name and fabric name, number, and color

COL hides must be rolled for shipment to manufacturing location in a neat manner, avoiding creases and excessive roll marks. All leathers will be rejected if sent in a folded manner.

To determine COL square footage, see COL requirements for each product. Square footage requirements are based on an average hide size of 45-50 square feet of clean, usable leather. If the COL has a smaller average hide size, please consult Customer Service for quotation. Please note, leather is a natural product and all square footage requirements are estimations. The shape of the COL hides supplied and the usable, clean square footage may make it necessary for us to request more leather after COL is received.

Yardage requirements shown are based on 54" width plain material. If fabric design requires vertical/top out, Customer Service should be consulted for additional yards required. If fabric is under 54", refer to fabric database at www.coalesse.com.

EXCESS COM/COL POLICY

All excess COM/COL will be disposed of after order is completed unless prior arrangements have been made with Coalesse Customer Service. Fedex account number and address to ship to must be referenced. Excess WILL NOT be returned with shipment of furniture.

Customer's Own Material

Cutting Direction Guidelines

Cutting direction is based on the fabric width and the way the fabric is cut from the roll and applied to Coalesse products. There are two cutting directions: railroaded or horizontal.

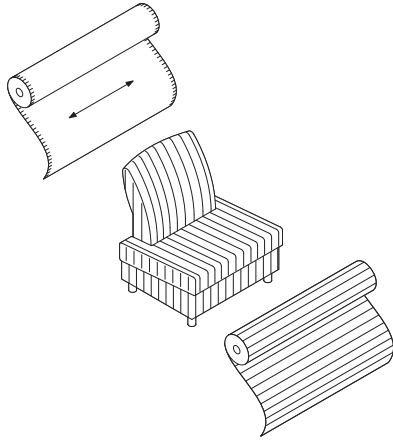

Horizontal or railroaded (across roll, warp horizontal) means fabric is cut across the roll; selvages are on the top and bottom.

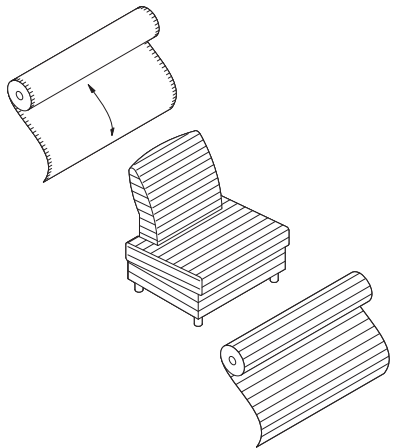

Vertical or top out (down roll, warp vertical) means fabric is cut in the same direction it is woven; selvages are on the left and right sides.

Flammability Information

California Technical Bulletin 133

Definition: California Technical Bulletin 133 (CAL 133) is a flammability test procedure for seating furniture specified in public occupancies. Specifications, test procedures and requirements pertaining to flammability regulations are changing rapidly. Coalesse will make every effort to keep our information and services pertaining to flammability specifications up-to-date.

Coalesse reserves the right to make deletions and additions and cannot guarantee fabric manufacturer materials nor its specifications will not change. A new evaluation will be necessary if materials are altered by manufacturer. This approval information on our website is subject to change without notice. Coalesse is not responsible for textile manufacturer's changes. Contact fabric manufacturer for availability.

For fabrics not pre-approved, please submit the fabric supplier name, fabric name, style number, content, weight, Coalesse product number, and fabric name to be applied to Customer Service at 1.800.627.6770 or fax to 888.413.5161. Our Customer Service representative will contact you within 48 hours of your request with information on the fabric's CAL 133 compliance. Actual fabric sample may be required. **If not approved, a burn test may be required at a fee. Contact Customer Service for a quote.**

UFAC – All upholstered seating is constructed to conform to UFAC (Upholstered Furniture Action Council) specifications. This is comparable to NFPA 260. All Coalesse fabrics and leathers meet UFAC specifications and NFPA 260 requirements.

California Bureau of Home Furnishings Technical Bulletin 117

All Coalesse upholstered seating, fabrics, and leathers meet California Technical Bulletin 117. All products manufactured after May 1, 1993 have CAL 117 label attached.

California Bureau of Home Furnishings Technical Bulletin 133

On March 1, 1992 Technical Bulletin 133 (TB 133), a fire test for seating furniture in public buildings, became law in California. On and after March 1, 1992 all seating furniture sold in California for use in the public buildings specified in the regulations, must be in compliance with the requirements of TB 133, and each product must be labeled stating that the furniture meets TB 133. If a building is fully sprinklered, compliance with TB 133 becomes discretionary, however, even in sprinklered buildings all furniture must meet the minimum fire standards of the bureau's Technical Bulletin 117.

California Technical Bulletin 133 requires special construction procedures and is based on fabric and product design. For applicable CAL 133 upcharge, refer to up-charge, refer to individual product pages in the specification guide or the fabric database at www.coalesse.com.

Pre-Approved Fabrics – www.coalesse.com If a model or fabric is not listed, consult Customer Service for details at 800.627.6770.

***Note** – California Technical Bulletin 133 is a unit test and requires specific product testing of unit for certification. If certification is required the test of a unit constructed exactly as the unit(s) to be specified in the installation, the cost of the test unit plus the cost of testing (\$500 net per test) must be added to obtain certification. Coalesse is not responsible for any charges for COM/COL purchased prior to evaluation if unit fails. Textile and unit cannot be returned.

Please consult Customer Service at 1.800.627.6770 or Fax 888.413.5161 for suggested fabrics/leathers, upcharges and minimums required for meeting California Technical Bulletin 133.

General Information

-Specifications, test procedures and requirements pertaining to flammability regulations are changing rapidly. Coalesse will make every effort to keep our information and services pertaining to flame specifications up-to-date. However, we do reserve the right to alter the products, fabrics/leathers or upcharges associated with any of the above or any other flame specifications.

When COM or COL is specified for use on Coalesse seating that is to meet the New York Port Authority Code, the COM or COL must be treated to meet this code prior to receipt by Coalesse. Coalesse is not responsible for the flammability treatment or certification of any COM or COL. All upcharges indicated are to be added to list prices. ▶ See specific product pages for CAL 133 approval, option, and pricing.

Upholstery Matrix

Note: Coalesse reserves the right to reject fabrics when necessary if the quality or construction is not satisfactory for intended use. For most up to date information on fabric usage, please check the fabric database on www.coalesse.com.

Legend

- = Not available
- = Available
- = Available but requires backer
- ⊙ = Available but requires contrasting fabric
- = Available but requires backer and contrasting fabric
- ▶ See specification pages for details.

	Chance Grade 12	Connoisseur 3 Grade 13	Conservation Grade 10	Divina Melange Grade 14/2CH	Frolic Grade 14	Hallingdal Grade 14/2CH	Link Grade 6	Pigment Grade 13	React Grade 10	Remix Grade 12	Restore Grade 10	Rocket Grade 9	Salon Grade 9	Samba Grade 12	Sequence Grade 12	Souvenir Grade 10	Square Grade 12	Steady Grade 11	Steelcut Grade 13	Sustain Grade 10	Swayed All Over Grade COM	Tempera Grade 14	Whimsy Grade 11
Bindu	■	□	•	□	■	□	■	□	•	■	•	□	•	■	•	•	•	•	■	■	■	□	•
Bix	■	□	⊙	□	■	□	■	□	□	■	□	□	□	■	■	•	⊙	•	■	■	■	□	⊙
Chord	■	□	■	□	■	□	■	□	■	■	■	□	□	■	■	•	■	•	■	■	■	□	■
Circa	■	□	•	□	■	□	■	□	•	■	•	□	•	■	•	•	•	•	■	■	■	□	•
Coupe	■	□	■	□	■	□	■	□	■	■	■	□	□	■	■	■	■	•	■	■	■	□	■
Enea	■	□	■	□	■	□	■	□	■	■	■	□	□	■	■	■	■	•	■	■	■	□	■
Kathryn	■	□	■	□	■	□	■	□	■	■	■	□	□	■	■	■	■	•	■	■	■	□	■
Ripple	■	□	•	□	■	□	■	□	•	■	•	□	•	■	•	•	•	•	■	■	■	□	•
Swathmore	■	□	■	□	■	□	■	□	■	■	■	□	□	■	■	■	■	•	■	■	■	□	■
Swathmore Grande	■	□	■	□	■	□	■	□	■	■	■	□	□	■	■	■	■	•	■	■	■	□	■

Disclaimer: Coalesse is pleased to provide this information. However, even after preliminary approval, Coalesse reserves the right to reject fabrics/leathers when necessary if the quality or construction is not satisfactory for the item it is intended for use on. Coalesse reserves the right to evaluate data daily and make any necessary changes or improvements to the information provided. Textile recommendations do not imply a warranty for the textiles. The textile manufacturer provides all warranties for textiles. All trademarks and trade names are the property of the different manufacturers. All pricing quotes for product should be obtained from your local Sales Representative or a Coalesse Customer Service Representative. Recommendations such as latex backing, Gore SP and CAL 133 will require additional cost and may require additional lead-time. All specifications are subject to change without notice.

Steelcase Upholstery Matrix

Note: Coalesse reserves the right to reject fabrics when necessary if the quality or construction is not satisfactory for intended use. For most up to date information on fabric usage please check the fabric database on www.coalesse.com.

Legend

- = Not available
- = Available
- ▶ See specification pages in the *Coalesse Specification Guides* for details.

	Steelcase Fabrics													
	Cogent: Connect Grade 06	Jacks Grade 06	Seating Vinyl Grade 06	Spyder Grade 06	Nitelights Grade 06	Link Grade 06	Stand In Grade 07	Cogent: Trails Grade 07	New Black Grade 07	Imperma Grade 07	Billiard Multi-Use by Designtex Grade 08	Texel Grade 08	Remix Grade 09	Bo Peep Grade 10
Await	•	■	■	■	■	■	■	■	■	■	■	■	■	■
Bindu	■	■	■	■	■	■	■	■	■	■	■	■	■	■
Bix Cushions	■	■	■	■	■	■	■	■	■	■	■	■	■	■
Bix Screen	■	■	•	■	•	■	■	■	■	■	■	■	■	■
Bob	■	■	■	■	■	■	■	■	■	■	■	■	■	■
Capa	■	■	■	■	■	■	■	■	■	■	■	■	■	■
Chord	■	■	■	■	■	■	■	■	■	■	■	■	■	■
Circa	•	■	■	■	■	■	■	■	■	■	■	■	■	■
Coupe	■	■	■	■	■	■	■	■	■	■	■	■	■	■
Davos	■	■	■	■	■	■	■	■	■	■	■	■	■	■
Elbow Chair CH20	•	•	•	•	•	•	•	•	•	•	•	•	•	•
Emu Outdoor Cushion	•	•	•	•	•	•	•	•	•	•	•	•	•	•
Emu Indoor Cushion	■	■	■	■	■	■	■	■	■	■	■	■	■	■
Emu Terramare	•	•	•	•	•	•	•	•	•	•	•	•	•	•
Enea	■	■	■	■	■	■	■	■	■	■	■	■	■	■
Enea Lottus	■	■	■	■	■	■	■	■	■	■	■	■	■	■
Exponents, Benches	■	■	■	■	■	■	■	■	■	■	■	■	■	■
Hosu	■	■	■	■	■	■	■	■	■	■	■	■	■	■
Joel	■	■	■	■	■	■	■	■	■	■	■	■	■	■
Kathryn	■	■	■	■	■	■	■	■	■	■	■	■	■	■
Last Minute	■	■	■	■	■	■	■	■	■	■	■	■	■	■
Lounge Seating CH100 Series	•	•	•	•	•	•	•	•	•	•	•	•	•	•
Millbrae Contract	■	■	■	■	■	■	■	■	■	■	■	■	■	■
Millbrae Lifestyle	•	■	■	■	■	■	■	■	■	■	•	■	•	■

▶ Continued on next page

The above Steelcase fabrics are available as standard without a backer on select Coalesse product lines. For those product lines that are noted as unavailable, it may be specifiable with a backer as a Graded-In fabric. Additional Steelcase fabrics are available through the Graded-In program. Please consult the Coalesse Fabric Database for availability. Disclaimer: Coalesse is pleased to provide this information. However, even after preliminary approval, Coalesse reserves the right to reject fabrics/leathers when necessary if the quality or construction is not satisfactory for the item it is intended for use on. Coalesse reserves the right to evaluate data daily and make any necessary changes or improvements to the information provided. Textile recommendations do not imply a warranty for the textiles. The textile manufacturer provides all warranties for textiles. All trademarks and trade names are the property of the different manufacturers. All pricing quotes for product should be obtained from your local Sales Representative or a Coalesse Customer Service Representative. Recommendations such as backing and CAL 133 will require additional cost and may require additional lead-time. All specifications are subject to change without notice.

Steelcase Upholstery Matrix

Note: Coalesse reserves the right to reject fabrics when necessary if the quality or construction is not satisfactory for intended use. For most up to date information on fabric usage please check the fabric database on www.coalesse.com.

► Continued, from previous page

Legend

- = Not available
- = Available
- See specification pages in the *Coalesse Specification Guides* for details.

	Steelcase Fabrics													
	Cogent: Connect Grade 06	Jacks Grade 06	Seating Vinyl Grade 06	Spyder Grade 06	Nitelights Grade 06	Link Grade 06	Stand In Grade 07	Cogent: Trails Grade 07	New Black Grade 07	Imperma Grade 07	Billiard Multi-Use by DesignTex Grade 08	Texel Grade 08	Remix Grade 09	Bo Peep Grade 10
Lagunitas Cushion	■	■	■	■	■	■	■	■	■	■	■	■	■	■
Lox	•	■	■	■	■	■	■	■	■	■	•	■	•	■
Montara650	■	■	■	■	■	■	■	■	■	■	■	■	■	■
Passerelle	■	■	■	■	■	■	■	■	■	■	■	■	■	■
Ripple	•	■	■	■	■	■	■	■	■	■	■	■	■	■
Sidewalk	■	■	■	■	■	■	■	■	■	■	■	■	■	■
SW_1	■	■	■	■	■	■	•	•	■	■	■	■	■	■
Swathmore	■	■	■	■	■	■	■	■	■	■	■	■	■	■
Swathmore Grande	■	■	■	■	■	■	■	■	■	■	■	■	■	■
Switch	■	■	■	■	■	■	■	■	■	■	■	■	■	■
Together	■	■	■	■	■	■	■	■	■	■	■	■	■	■
Topo Lounge	■	■	■	■	■	■	■	■	■	■	■	■	■	■
Topo Mobile Lounge	■	■	■	■	■	■	■	■	■	■	■	■	■	■
Visalia	■	■	■	■	■	■	■	■	■	■	■	■	■	■
Wrapp	•	■	■	■	■	■	■	■	■	■	•	■	•	■

The above Steelcase fabrics are available as standard without a backer on select Coalesse product lines. For those product lines that are noted as unavailable, it may be specifiable with a backer as a Graded-In fabric. Additional Steelcase fabrics are available through the Graded-In program. Please consult the Coalesse Fabric Database for availability. Disclaimer: Coalesse is pleased to provide this information. However, even after preliminary approval, Coalesse reserves the right to reject fabrics/leathers when necessary if the quality or construction is not satisfactory for the item it is intended for use on. Coalesse reserves the right to evaluate data daily and make any necessary changes or improvements to the information provided. Textile recommendations do not imply a warranty for the textiles. The textile manufacturer provides all warranties for textiles. All trademarks and trade names are the property of the different manufacturers. All pricing quotes for product should be obtained from your local Sales Representative or a Coalesse Customer Service Representative. Recommendations such as backing and CAL 133 will require additional cost and may require additional lead-time. All specifications are subject to change without notice.

Surface Materials - Leather/Faux

Leather

ELMOSOFT, ELMORUSTICAL LEATHER CARE

Only the finest hides are used for Elmo leather. Expect some color variations from hide to hide due to the aniline state of the product. Color fading may occur if leather is exposed to direct or intense light. Care is required to allow this product to achieve the rich natural patina that beautiful natural leather develops. The hallmarks of this leather include some naturally occurring markings, such as healed scars, insect bites, stretch marks, and fat wrinkles. Elmorustical's leather treatment is very natural with little protection from spills or body oils. This rich leather will exhibit stains and oils through normal use. Coalesse is not responsible for discoloration, spotting, or staining on this leather.

Special Color Match Leather

Coalesse can provide a special color match in its leather to any supplier's leather color, paint color, carpet color, wallpaper color, etc. Sample to match must be submitted to Coalesse with purchase order. Sample for approval can be supplied if requested.

Note: Minimum order 2,500 sq. ft.

Special Fabric Applications

Backing

- Backing information is found on each product page. Select this option when ordering your product to have backing applied. Price varies by product according to yardage it requires.

Tip: Prices subject to change without notice and an additional 2 week lead time will apply for 54" wide fabrics. Wider fabrics will require 4 week additional lead time.

Elmo Leather

Coalesse uses leathers that are provided by Elmo of Sweden. Elmosoft is a full grain, aniline dyed, semi-aniline finish. With Elmosoft leather, now recyclable and chromium-free, you have the opportunity to bid on green projects when requested. Elmosoft leathers are never corrected, buffed, or altered in any way. Coalesse purchases only original full grain leathers. The quality of this genuine leather can be felt in the hand immediately. Other leathers are often stiff because of the amount of pigment needed to cover the imperfections of an inferior hide. Using leather of low quality affects the overall quality of the furniture it is upholstered on. You can feel confident in leather purchased from Coalesse.

Elmosoft

Grade C

Elmosoft

- L110 Maritime Blue
- L111 Midnight Blue
- L112 Ebony
- L113 Gunmetal
- L114 Mica
- L115 Dove Grey
- L116 Plum Pleasure
- L122 Truffle
- L128 Red Birch
- L132 Violet
- L133 Espresso
- L134 Ruby
- L135 Scarlet
- L138 Bourbon
- L139 Cinder
- L140 Garnet
- L143 Pecan
- L144 Chamois
- L146 Russet
- L147 Saddle
- L151 White
- L709 Sugar
- L711 Parchment
- L712 Buff
- L716 Khaki
- L717 Cameo
- L721 Rock
- L722 Desert
- L723 Storm
- L725 Teal
- L727 Egyptian Blue
- L728 Bright Blue
- L730 Hunter
- L736 Lemon
- L737 Sunshine
- L738 Drama
- L740 Dazzle
- L743 Forest Green
- L744 Turtle
- L745 Grass
- L746 Envy
- L747 Cigar
- L748 Light Chocolate
- L749 Beaver
- L750 Bluffstone
- L751 Sienna
- L752 Oxblood
- L753 Dough
- L754 Acorn
- L755 Peanut Butter
- L756 Quinoa
- L757 Dark Sand
- L758 Mustard
- L759 Amber Orange
- L760 Bengal
- L761 Periwinkle
- L762 Canvas
- L763 Macadamia
- L764 True Blue
- L765 Storm Blue
- L766 Powder Blue
- L767 Blush
- L768 Tropical
- L769 Mauve
- L770 Cadet
- L771 Powder Mint
- L772 Timberwolf
- L773 Chalice
- L774 Oil
- L775 Coyote

Elmorustical Leather and Elmotique

Elmorustical and Elmotique is a full top grain, aniline dyed leather.

Elmorustical has a grain which varies in structure and offers outstanding comfort. It is an aniline leather with all the distinct features of the natural hide.

Elmotique is a thinner aniline leather with a batique-effect and displays all the features possessed by the original hide.

Only the finest hides are used for Elmorustical and Elmotique leathers. Expect some color variations from hide to hide due to the aniline state of the product. Color fading may occur if leather is exposed to direct or intense light. Care is required to allow this product to achieve the rich natural patina that beautiful leather develops. The hallmarks of this leather include some naturally occurring markings such as healed scars, insect bites, stretch marks, and fat wrinkles. Elmorustical and Elmotique's leather treatment is very natural with little protection from spills or body oils. This rich leather will exhibit stains and oils through normal use. Coalesse is not responsible for discoloration, spotting, or staining on this leather.

Grade E

Elmorustical

- L318 Loam
- L319 Ebony
- L321 Beige
- L323 Buff
- L325 Camel
- L326 Charbrown
- L330 Flame
- L332 Honey
- L334 Mist Green
- L337 Russet
- L338 Rust
- L363 Tendril
- L364 Fog
- L365 Sunflower
- L366 Terra Cotta
- L367 Cadet
- L368 Marine
- L369 Mallard
- L370 Smoke
- L371 Merlot
- LD54 Twilight

Elmotique

- L310 Sage Brush
- L311 Flaxen
- L312 Earth
- L313 Clay
- L314 Blue Mountain
- L315 Juniper

Faux Leather

Coalesse offers a variety of faux leathers. Not all faux leathers are available on all products, check seating matrix to determine availability. ▶Page 361

Grade 10

Brisa
(For a visual palette, please refer to the Steelcase Finish Library)

- BR01 Black Onyx
- BR04 Truffle
- BR06 Ash
- BR07 Sage
- BR08 Celery
- BR09 Sterling Blue
- BR10 Night Navy
- BR11 Cambridge Blue
- BR12 Abyss
- BR13 Canyon
- BR14 Pompeia
- BR15 Salsa
- BR16 Cinnabar
- BR17 Aztec
- BR18 New Sand
- BR19 Cream
- BR20 White
- BR21 Moccasin
- BR22 Buckskin
- BR23 Praire
- BR24 Mineral
- BR25 Skyway
- BR26 Iron
- BR27 Stormy
- BR28 Esmeralda
- BR29 Seaweed
- BR30 Bone
- BR31 Caramel
- BR32 Bridle
- BR33 Moon

Surface Materials - Leather/Faux

Grade 11

Destiny

DY01	Black
DY02	Raisin
DY03	Blueberry
DY04	Chestnut
DY05	Cedar
DY06	Black Rose
DY07	Wine
DY09	Dune
DY10	Truffle
DY11	Oak
DY12	Newport
DY13	Evergreen
DY14	Storm
DY15	Juniper
DY16	Olive
DY17	Mocha
DY18	Ash
DY21	Butter
DY23	Deep Red
DY24	Eggshell
DY26	Parchment
DY27	Periwinkle
DY30	Royal Purple
DY31	Saddle
DY32	Cactus Green
DY33	Cypress
DY34	Mink
DY35	Football
DY36	Root

Finesse

AM00	White Cloud
AM01	Gelato
AM02	Winter White
AM04	Mushroom
AM06	Charbrown
AM08	Iceberg
AM09	Gravel
AM10	Colonial Blue
AM24	Rye
AM25	Barley
AM26	Stucco
AM27	Beaver
AM28	Otter
AM65	Bordeaux
AM66	Navy
AM67	Cinder
AM80	Cameo
AM81	Oyster Grey
AM83	Taupe
AM85	Chestnut
AM87	Indigo
AM88	Bone
AM89	Jet Black
AM92	Burgundy
AM93	Hunter Green
AM98	Oxford Brown

Ovation

O500	Dark Brown
O501	Light Grey
O502	Sage
O503	Indigo
O504	Lilac
O505	Terra
O506	Moss
O507	Teal
O508	Stone
O509	Cappuccino

Panache

P800	Ebony
P801	Cactus
P802	Sherwood
P803	Teal Blue
P804	Sweet Sage
P805	Coffee
P806	True Taupe
P807	Cashew
P808	Acorn
P809	Redwood
P810	Exotic Orchid
P811	Maize
P812	Chartreuse
P813	Regal Blue

Prestige

AFA1	Onyx
AFB2	Soft White
AFC3	Saxe Blue
AFD3	Buff
AFDG	Antique White
AFE1	Sandstone
AFH1	Pecan
AFH2	Buttercreme
AFI1	Havana
AFI2	Brick
AFK1	Parchment
AFL8	French Grey
AFP1	Willow
AFP2	Boxwood Green
AFPA	Tree Moss
AFPC	Celadon
AFS3	Wild Plum

Grade 12

Elegance

EL01	Ivory
EL02	Cream
EL03	Char
EL04	Saddle
EL05	Dune
EL06	Camel
EL07	Sage
EL08	Gray
EL09	Walnut
EL10	Burgundy
EL11	Green
EL12	Navy
EL13	Black

Grade 13

Destiny Perforated

DP01	Black
DP02	Raisin
DP03	Blueberry
DP04	Chestnut
DP05	Cedar
DP06	Black Rose
DP07	Wine
DP09	Dune
DP10	Truffle
DP11	Oak
DP12	Newport
DP13	Evergreen
DP14	Storm
DP15	Juniper
DP16	Olive
DP17	Mocha
DP21	Butter
DP23	Deep Red
DP24	Eggshell
DP26	Parchment
DP27	Periwinkle
DP30	Royal Purple
DP31	Saddle
DP32	Cactus Green
DP33	Cypress
DP34	Mink
DP35	Football
DP36	Root

Finesse Perforated

AP00	White Cloud
AP01	Gelato
AP02	Winter White
AP04	Mushroom
AP06	Charbrown
AP08	Iceberg
AP09	Gravel
AP10	Colonial Blue
AP24	Rye
AP25	Barley
AP26	Stucco
AP27	Beaver
AP28	Otter
AP65	Bordeaux
AP66	Navy
AP67	Cinder
AP80	Cameo
AP81	Oyster Grey
AP83	Taupe
AP85	Chestnut
AP87	Indigo
AP88	Bone
AP89	Jet Black
AP92	Burgundy
AP93	Hunter Green
AP98	Oxford Brown

Panache Perforated

PR00	Ebony
PR01	Cactus
PR02	Sherwood
PR03	Teal Blue
PR04	Sweet Sage
PR05	Coffee
PR06	True Taupe
PR07	Cashew
PR08	Acorn
PR09	Redwood
PR10	Exotic Orchid
PR11	Maize
PR12	Chartreuse
PR13	Regal Blue

Prestige Perforated

APA1	Onyx
APB2	Soft White
APC3	Saxe Blue
APD3	Buff
APDG	Antique White
APE1	Sandstone
APH1	Pecan
APH2	Buttercream
API1	Havana
API2	Brick
APK1	Parchment
APL8	French Grey
APP1	Willow
APP2	Boxwood Green
APPA	Tree Moss
APPC	Celadon
APSP	Wild Plum

Cut Yardage Net Price List

FABRIC NAME	Under 60 Yards	60 Yards & Over
Elegance®	\$84.00/yd.	\$80.00/yd.
Finesse®	\$51.00/yd.	\$50.00/yd.
Finesse® Perforated (min. 5 yds)	\$61.00/yd.	\$60.00/yd.
Prestige®	\$56.00/yd.	\$53.00/yd.
Prestige® Perforated (min. 5 yds)	\$66.00/yd.	\$63.00/yd.
Destiny®	\$57.00/yd.	\$55.00/yd.
Destiny® Perforated (min. 5 yds)	\$67.00/yd.	\$64.00/yd.
Ovation	\$57.00/yd.	\$53.00/yd.
Panache	\$57.00/yd.	\$55.00/yd.

LEATHER NAME	Under 500 sq. ft.	500-1000 sq. ft.	Over 1000 sq. ft.
Elmosoft	\$9.00/sq. ft.	\$8.00/sq. ft.	\$7.50/sq. ft.
Elmorustical*	\$11.00/sq. ft.	\$9.00/sq. ft.	\$8.50/sq. ft.

ORDERING INFORMATION

- Minimum Order Requirements
 - Fabric: 1 yd. - 1/8 yd. increments.
 - Leather: 1 full hide (avg. sq. ft./hide - 50).
 - All orders will be filled in full hides only.
 - Overage will be invoiced accordingly.
- Special match leather: 2,500 sq. ft. minimum (Check delivery date)
- The embossing techniques used on Novasuede Perforated to achieve these looks involve very high temperatures. Color and shade may vary slightly based on the fiber density being embossed.
- Cancelled textile orders are subject to a 30% restocking fee. Order must be cancelled 5 days before ship date.
- Due to the natural processes of dyeing, sanding and embossing necessary to achieve these special looks, actual production may vary slightly in appearance from the swatches shown.

COALESSE TEXTILE WARRANTY

Coalesse textile merchandise is produced in accordance with Coalesse high standards. Coalesse does not guarantee, warrant or accept any responsibility whatsoever by reason of its fabrics or leathers fading, wearing, cracking, shrinking, stretching, tearing, seam slippage, alteration in color due to any finish treatment (flameproofing, stain repellent, etc.) or discoloration from liquid contact. Printed textiles are not warranted against irregularity in register. Coalesse is not responsible for dye lot differences or discrepancies in widths of fabrics. Coalesse does not guarantee, warrant or represent an exact color match to cuttings, tabs, memos or sample cards. Coalesse does not warrant exact matching of color or grain of leather. Leather hides may contain certain natural marks, scars, scratches, wrinkles and shade variations within hides, etc., considered by leather tanneries and Coalesse to be inherent characteristics part of the natural beauty of leather and the size or location of such markings cannot be controlled. In any event, upon inspection, Coalesse's responsibility shall be limited to either replacement of merchandise or refund of purchase price at Coalesse's option. The foregoing constitutes the sole and exclusive remedy of the customer. Coalesse is not responsible for the application or installation of our products. In no event shall Coalesse be responsible for any consequential damages or any charges, costs, expenses, or obligations other than as expressly herein set forth. Coalesse makes no other warranties, expressed or implied, as to any product sold by Coalesse. All other warranties (including any warranty of merchantability or fitness for any particular purpose) are hereby excluded.

Leather and Faux Leather Matrix

Note: Coalesse reserves the right to reject fabrics when necessary if the quality or construction is not satisfactory for intended use. For most up to date information on fabric usage, please check the fabric database on www.coalesse.com.

Legend

- = Not available
- = Available
- ☐ = Must be ordered as COM or COL
- ▣ = Available but will puddle
- ▶ See specification pages for details.

	Elmosoft Grade C	Elmoique Grade E	Elmorustical Grade E	Loke Leather	Brisa Grade 10	Destiny Grade 11	Destiny Perforated Grade 13	Prestige Grade 11	Prestige Perforated Grade 13	Finesse Grade 11	Finesse Perforated Grade 13	Elegance Grade 12	Panache Grade 11	Panache Perforated Grade 13	Ovation Grade 11
Await	■	•	■	☐	■	■	■	■	■	■	■	■	■	■	■
Bindu	■	•	■	☐	■	■	■	■	■	■	■	■	■	■	■
Bix	■	•	■	•	■	■	•	■	•	■	•	■	■	•	■
Bob	■	•	■	•	■	■	•	■	•	■	•	■	■	■	■
Capa	■	•	■	☐	■	■	■	■	■	■	■	■	■	■	■
Chord	■	•	■	☐	■	■	■	■	■	■	■	■	■	■	■
Circa	■	•	■	☐	■	■	■	■	■	■	■	■	■	■	■
Coupe	■	•	■	☐	■	■	■	■	■	■	■	■	■	■	■
Davos	■	•	■	•	■	■	•	■	•	■	•	■	■	•	■
Emu Indoor Cushion	■	■	■	•	■	■	■	■	■	■	■	■	■	•	■
Enea	■	•	■	☐	■	■	■	■	■	■	■	■	■	■	■
Enea Lottus	■	■	■	•	■	■	•	■	•	■	•	■	■	•	■
Exponents (Benches)	■	•	■	•	■	■	•	■	•	■	•	■	■	•	■
Joel	■	•	■	•	■	■	•	■	•	■	•	■	■	•	■
Kathryn	■	■	■	☐	■	■	■	■	■	■	■	■	■	■	■
Lagunitas	■	•	■	•	■	■	■	■	■	■	■	■	■	■	■
Lox	■	■	■	•	■	■	•	■	•	■	•	■	■	•	■
Millbrae Contract	■	•	■	☐	■	■	■	■	■	■	■	■	■	■	■
Millbrae Lifestyle	■	■	■	☐	■	■	■	■	■	■	■	■	■	■	■
Montara650	■	•	■	•	■	■	•	■	•	■	•	■	■	■	■
Passerelle	■	•	■	☐	■	■	■	■	■	■	■	■	■	■	■
Ripple	■	•	■	☐	■	■	■	■	■	■	■	■	■	■	■
SW_1	■	•	■	•	■	■	•	■	•	■	•	■	■	•	■
Swathmore	■	•	■	☐	■	■	■	■	■	■	■	■	■	■	■
Swathmore Grande	■	•	■	☐	■	■	■	■	■	■	■	■	■	■	■
Switch	■	•	■	☐	■	■	■	■	■	■	■	■	■	■	■
Together	▣	•	▣	•	▣	▣	•	▣	•	▣	•	▣	▣	•	■
Topo	■	•	■	•	■	■	•	■	•	■	•	■	■	•	■
Visalia	■	•	■	☐	■	■	■	■	■	■	■	■	■	■	■
Wrapp	■	•	■	•	■	■	■	■	■	■	■	■	■	■	■

Disclaimer: Coalesse is pleased to provide this information. However, even after preliminary approval, Coalesse reserves the right to reject fabrics/leathers when necessary if the quality or construction is not satisfactory for the item it is intended for use on. Coalesse reserves the right to evaluate data daily and make any necessary changes or improvements to the information provided. Textile recommendations do not imply a warranty for the textiles. The textile manufacturer provides all warranties for textiles. All trademarks and trade names are the property of the different manufacturers. All pricing quotes for product should be obtained from your local Sales Representative or a Coalesse Customer Service Representative. Recommendations such as latex backing, Gore SP and CAL 133 will require additional cost and may require additional lead-time. All specifications are subject to change without notice.

Surface Materials - Wood

Wood

Standard Wood Finishes

Coalesse's primary wood finish, Clarity, is a water-borne UV topcoat, which protects the environment while providing exceptional durability and resistance to water and chemical stains. Contoured products, such as wood guest chairs and occasional tables, are finished with post-catalyzed vinyl, which provides similar properties and matches the sheen and color of Clarity. Due to natural variations in wood, finished products may vary from samples in color, texture, and grain.

Wood will develop a deep, rich patina over time as the wood ages. Mineral streaks, gum pockets, and pin knots are some of the unique characteristics that are visible in veneers and solids.

All wood products will darken with age and exposure to ultraviolet light. This is especially apparent with cherry and maple veneer.

When storing your wood furniture, please follow the following guidelines:

- Do not store products in trailers
- Store products in areas that simulate office temperatures (60°F to 90°F)
- Store products in areas that maintain constant, office-like humidity levels
- Keep product away from light. Cover products to make sure they are not exposed to light.

Samples contact Customer Service at 1.800.627.6770

Steelcase Wood Finishes

Coalesse will match current Steelcase wood finishes at no upcharge. Finish matches are for color only and do not match the Steelcase finish in sheen. Samples will be provided upon request from Customer Service at 1.800.627.6770 and will be produced within 10 working days.

Stain-To-Match Wood Finish on cherry, maple, walnut, or oak

Coalesse will Stain-To-Match any wood finish at no upcharge. Samples submitted for matching must be at least 12" x 12" in surface dimension. Customers must specify cherry, maple, oak, or walnut species. Coalesse will produce a strike-off within 5 working days following acknowledgement of the order. Coalesse will not schedule the order for production until the strike-off has been approved and received by Coalesse.

Tip: For a visual palette, please refer to the Steelcase Finish Library.

Painted MDF

The painted medium density fiberboard (MDF) is utilizing molding grade MDF, therefore, the 45 lb density is consistent throughout the entire thickness of the board. This allows for a smooth edge when painted. Three coats of water reducible finish is applied to the board in a milk or black. The painted MDF has durability and care properties like a wood veneer, thus, must be treated as such.

Veneer Specifications

Cherry

- American Black Cherry
- Flat cut, plain sliced/book matched
- Quarter cut/book matched
- Narrow cathedrals, mild grain, minimal pitch
- 5-10" wide leaves of 1/42" thick veneer, balanced on panel
- No gaps between leaves
- PB (particle board) core
- Low sheen 15 or high sheen 35

Maple

- Eastern Hard White Maple
- Flat cut, plain sliced/slip matched
- Quarter cut/book matched
- Narrow cathedrals, mild grain, minimal pitch
- 5-10" wide leaves of 1/42" thick veneer, balanced on panel
- No gaps between leaves
- PB (particle board) core
- Low sheen 15 or high sheen 35

Oak

- White Oak
- Rift cut
- Slip match
- Mild grain
- 4-8" wide leaves of 1/42" thick veneer, balanced on panel
- No gaps between leaves
- PB (particle board) core
- Low sheen 15 or high sheen 35

Walnut

- American Black Walnut
- Flat cut, plain sliced/book matched
- Quarter cut/book matched
- Narrow cathedrals, mild grain
- 5-10" wide leaves of 1/42" thick veneer, balanced on panel
- No gaps between leaves
- PB (particle board) core
- Low sheen 15 or high sheen 35

Exclusive (by product)

Teak

- Quarter cut/book match
- 15 sheen

Ash (Grey)

- Quarter cut/book match
- 15 sheen

Flat-cut – High Sheen

Grade 1

- V10C FC/HS Natural Cherry
- V11C FC/HS Clear Cherry
- V12C FC/HS Medium Amber Cherry
- V13C FC/HS Dark Cherry
- V10M FC/HS Clear Maple
- V11M FC/HS Natural Beech on Maple
- V12M FC/HS Medium Maple
- V10W FC/HS Natural Walnut
- V11W FC/HS Clear Walnut
- V12W FC/HS Medium Walnut
- V13W FC/HS Black Walnut
- V14W FC/HS Dark Walnut

Flat-cut – Low Sheen

Grade 1

- V1AC FC/LS Natural Cherry
- V1BC FC/LS Clear Cherry
- V1CC FC/LS Medium Amber Cherry
- V1DC FC/LS Dark Cherry
- V1AM FC/LS Clear Maple
- V1BM FC/LS Natural Beech on Maple
- V1CM FC/LS Medium Maple
- V1AW FC/LS Natural Walnut
- V1BW FC/LS Clear Walnut
- V1CW FC/LS Medium Walnut
- V1EW FC/LS Dark Walnut

Rift-cut – High Sheen

Grade 1

- V30K RC/HS Natural Oak
- V31K RC/HS Desert Oak
- V32K RC/HS Medium Brown Oak
- V33K RC/HS Medium Gray Oak
- V34K RC/HS Black Brown Oak

Rift-cut – Low Sheen

Grade 1

- V3AK RC/LS Natural Oak
- V3BK RC/LS Desert Oak
- V3CK RC/LS Medium Brown Oak
- V3DK RC/LS Medium Gray Oak
- V3EK RC/LS Black Brown Oak

Quarter-cut – High Sheen

Grade 2

- V20C QC/HS Natural Cherry
- V21C QC/HS Clear Cherry
- V22C QC/HS Medium Amber Cherry
- V23C QC/HS Dark Cherry
- V20M QC/HS Clear Maple
- V21M QC/HS Natural Beech on Maple
- V22M QC/HS Medium Maple
- V20W QC/HS Natural Walnut
- V21W QC/HS Clear Walnut
- V22W QC/HS Medium Walnut
- V23W QC/HS Black Walnut
- V24W QC/HS Dark Walnut

FC=Flat Cut
RC=Rift Cut
QC=Quarter Cut
WL=Wedge Lay-up
HS=High Sheen
LS=Low Sheen

Surface Materials - Wood

Quarter-cut – Low Sheen

Grade 2

V2AA	QC/LS Ash Natural FSC
V2AC	QC/LS Natural Cherry
V2BC	QC/LS Clear Cherry
V2CC	QC/LS Medium Amber Cherry
V2DC	QC/LS Dark Cherry
V2AM	QC/LS Clear Maple
V2BM	QC/LS Natural Beech on Maple
V2CM	QC/LS Medium Maple
V2AW	QC/LS Natural Walnut
V2BW	QC/LS Clear Walnut
V2CW	QC/LS Medium Walnut
V2EW	QC/LS Dark Walnut
V2AT	QC/LS Teak Natural Raw FSC

Wedge Lay-up* – Flat cut – High Sheen

Grade 1

W10C	WC/FC/HS Natural (Raw) Cherry
W11C	WC/FC/HS Clear Cherry
W12C	WC/FC/HS Medium Amber Cherry
W13C	WC/FC/HS Dark Cherry
W10M	WC/FC/HS Clear Maple
W11M	WC/FC/HS Natural Beech on Maple
W12M	WC/FC/HS Medium Maple
W10W	WC/FC/HS Natural (Raw) Walnut
W11W	WC/FC/HS Clear Walnut
W12W	WC/FC/HS Medium Walnut
W13W	WC/FC/HS Black Walnut
W14W	WC/FC/HS Dark Walnut

Wedge Lay-up* – Flat cut – Low Sheen

Grade 1

W1AC	WC/FC/LS Natural (Raw) Cherry
W1BC	WC/FC/LS Clear Cherry
W1CC	WC/FC/LS Medium Amber Cherry
W1DC	WC/FC/LS Dark Cherry
W1AM	WC/FC/LS Clear Maple
W1BM	WC/FC/LS Natural Beech on Maple
W1CM	WC/FC/LS Medium Maple
W1AW	WC/FC/LS Natural (Raw) Walnut
W1BW	WC/FC/LS Clear Walnut
W1CW	WC/FC/LS Medium Walnut
W1EW	WC/FC/LS Dark Walnut

Wedge Lay-up* – Rift cut – High Sheen

Grade 1

W30K	WC/RC/HS Natural (Raw) Oak
W31K	WC/RC/HS Desert Oak
W32K	WC/RC/HS Medium Brown Oak
W33K	WC/RC/HS Medium Gray Oak
W34K	WC/RC/HS Black Brown Oak

Wedge Lay-up* – Rift cut – Low Sheen

Grade 1

W3AK	WC/RC/LS Natural (Raw) Oak
W3BK	WC/RC/LS Desert Oak
W3CK	WC/RC/LS Medium Brown Oak
W3DK	WC/RC/LS Medium Gray Oak
W3EK	WC/RC/LS Black Brown Oak

FC=Flat Cut
RC=Rift Cut
QC=Quarter Cut
WL=Wedge Lay-up
HS=High Sheen
LS=Low Sheen
OP=Open Pore

Wedge Lay-up* – Quarter cut – High Sheen

Grade 2

W20C	WC/QC/HS Natural (Raw) Cherry
W21C	WC/QC/HS Clear Cherry
W22C	WC/QC/HS Medium Amber Cherry
W23C	WC/QC/HS Dark Cherry
W20M	WC/QC/HS Clear Maple
W21M	WC/QC/HS Natural Beech on Maple
W22M	WC/QC/HS Medium Maple
W20W	WC/QC/HS Natural (Raw) Walnut
W21W	WC/QC/HS Clear Walnut
W22W	WC/QC/HS Medium Walnut
W23W	WC/QC/HS Black Walnut
W24W	WC/QC/HS Dark Walnut

Wedge Lay-up* – Quarter cut – Low Sheen

Grade 2

W2AC	WC/QC/LS Natural (Raw) Cherry
W2BC	WC/QC/LS Clear Cherry
W2CC	WC/QC/LS Medium Amber Cherry
W2DC	WC/QC/LS Dark Cherry
W2AM	WC/QC/LS Clear Maple
W2BM	WC/QC/LS Natural Beech on Maple
W2CM	WC/QC/LS Medium Maple
W2AW	WC/QC/LS Natural (Raw) Walnut
W2BW	WC/QC/LS Clear Walnut
W2CW	WC/QC/LS Medium Walnut
W2EW	WC/QC/LS Dark Walnut

*Available on select tables, refer to pricing pages for availability.

Steelcase Veneers, Open Pore Only

Cherry, Flat Cut

Grade 1

3402	FC/OP Clear Cherry
3412	FC/OP Natural Cherry
3422	FC/OP Medium Cherry

Maple, Flat Cut

Grade 1

3522	FC/OP Clear Maple
3572	FC/OP Amber on Maple
3582	FC/OP Winter on Maple
3592	FC/OP Blonde on Maple

Maple, Quarter Cut

Grade 1

3222	QC/OP Clear Maple
3272	QC/OP Amber on Maple
3292	QC/OP Blonde on Maple

Walnut, Flat Cut

Grade 1

3062	FC/OP Graphite Walnut
3702	FC/OP Clear Walnut
3712	FC/OP Natural Walnut
3722	FC/OP Dark Mahogany on Walnut
3752	FC/OP Medium Walnut
3762	FC/OP Dark Walnut
3772	FC/OP Medium Mahogany on Walnut

Walnut, Quarter Cut

Grade 1

3302	QC/OP Clear Walnut
3312	QC/OP Natural Walnut
3322	QC/OP Dark Mahogany on Walnut
3352	QC/OP Medium Walnut
3362	QC/OP Dark Walnut
3372	QC/OP Medium Mahogany on Walnut
3382	QC/OP Graphite Walnut

Oak, Rift Cut

Grade 1

3602	RC/OP Desert Oak
3612	RC/OP Warm Oak
3692	RC/OP Espresso Oak

Natural Veneer

Grade 1

32A2	QC/OP Blanch Maple
33A2	QC/OP Thunder Walnut
3342	FC/OP Black Walnut
35A2	FC/OP Blanch Maple
36A2	RC/OP Volcanic Oak
37A2	FC/OP Thunder Walnut

Grade 2

3082	FC/OP Washed Walnut
3392	QC/OP Black Walnut

Planked Veneer

3P41	OP Planked Cherry
3P51	OP Planked Maple
3P61	OP Planked Oak
3P71	OP Planked Walnut

Painted MDF

Applies to: Exponents

V145	Milk
V197	Black

Hardwood Matrix

For Collaboration Chair Bases, Guest Chairs, Occasional Tables, and Lounge Chairs

Legend

- = Not available
- = Available
- M = Stain color only on maple
- B = Stain color only on beach
- ▶ See specification pages for details.

	Maple Flat Cut – High Sheen	Maple Flat Cut – Low Sheen	Maple Quarter Cut – High Sheen	Maple Quarter Cut – Low Sheen	Cherry Flat Cut – High Sheen	Cherry Flat Cut – Low Sheen	Cherry Quarter Cut – High Sheen	Cherry Quarter Cut – Low Sheen	Oak Rift Cut – High Sheen	Oak Rift Cut – Low Sheen	Walnut Flat Cut – High Sheen	Walnut Flat Cut – Low Sheen	Walnut Quarter Cut – High Sheen	Walnut Quarter Cut – Low Sheen	Teak Quarter Cut – High Sheen	Teak Quarter Cut – Low Sheen	Grey Ash – High Sheen	Grey Ash – Low Sheen	Exclusive Finishes for Trees	Carl Hansen Exclusive Wood Finishes
Seating																				
Circa	■	■	•	•	M	M	•	•	M	M	■	■	•	•	•	•	•	•	•	
Coupe	■	■	•	•	M	M	•	•	M	M	■	■	•	•	•	•	•	•	•	
Detour Tablet	■	■	•	•	M	M	•	•	M	M	M	M	•	•	•	•	•	•	•	
Enea	■	■	•	•	M	M	•	•	M	M	M	M	•	•	•	•	•	•	•	
Kathryn	B	B	•	•	B	B	•	•	B	B	B	B	•	•	•	•	•	•	•	
Passerelle	■	■	•	•	M	M	•	•	M	M	M	M	•	•	•	•	•	•	•	
Swathmore	■	■	•	•	M	M	•	•	M	M	M	M	•	•	•	•	•	•	•	
Swathmore Grande	■	■	•	•	M	M	•	•	M	M	M	M	•	•	•	•	•	•	•	
Occasional Tables																				
Bix Tables	■	■	•	•	■	■	•	•	■	■	■	■	•	•	•	•	•	•	•	
Circa	■	■	•	•	M	M	•	•	M	M	■	■	•	•	•	•	•	•	•	
Diekman	■	■	•	•	M	M	•	•	M	M	M	M	•	•	•	•	•	•	•	
Enea	■	■	•	•	M	M	•	•	M	M	M	M	•	•	•	•	•	•	•	
Passerelle	■	■	•	•	M	M	•	•	M	M	M	M	•	•	•	•	•	•	•	
Sidewalk	■	■	•	•	M	M	•	•	M	M	M	M	•	•	•	•	•	•	•	
Trees	•	•	•	•	•	•	•	•	•	•	•	•	•	•	•	•	•	■	•	

Surface Materials - Laminate

Laminate

Coalesse's graded laminate program includes our standard laminates, Steelcase High-Pressure Laminates, and standard High-Pressure Laminates from Nevamar, Wilsonart, Formica, and Pionite.

Coalesse Standard Laminate

Grade 1

Coalesse High-Pressure Laminates are priced as Grade 1.

High-Pressure Laminates listed below are not available on all products, check laminate matrix for availability.

- 2730 Arctic White
- 2746 Black
- 2826 White Nebula
- 2829 Poppysseed
- 2830 Charcoal
- 2884 Milk
- 2886 Maple
- 2887 Amber Cherry
- 2890 Folkstone BMW
- 2891 Ingot
- 2892 Ash
- 2894 Natural Cork
- 2895 Natural Walnut
- 2896 Dark Cork
- 2897 Desert Oak
- 2898 Satin Stainless

Steelcase Standard Laminate

Grade 1

Steelcase High-Pressure Laminates are priced as Grade 1. All Steelcase High-Pressure Laminates may be specified on Coalesse products with exception (must be ordered as Special): Awaiting tables, Enea tables, Enea Lottus tables, and Sidewalk tables. The use of Steelcase High-Pressure Laminate may be subject to extended lead times.

Tip: For a visual palette, please refer to the Steelcase Finish Library.

Fiber Laminate

- 2850 Vanadium Fiber
- 2851 Rhyme Fiber
- 2852 Tungsten Fiber
- 2854 Vellum Fiber
- 2859 Novell Fiber
- 2860 Granite Fiber
- 2861 Coconut Fiber
- 2862 Stucco Fiber

Micro Laminate

- 2920 Marl Micro
- 2921 Gypsum Micro
- 2922 Clay Micro
- 2923 Shadow Micro

Patina Laminate

- 2870 Blonde Bronze Patina
- 2871 Balckened Bronze Patina
- 2873 Instant Iron Patina

Solid Laminate

- 2722 Cream
- 2730 Arctic White
- 2746 Black
- 2759 Warm White
- 2811 Mist
- 2883 Seagull
- 2884 Milk
- 2885 Dune
- 2HMG Merle

Speckle Laminate

- 2820 Coffee Speckle
- 2822 Woodrose Speckle
- 2823 Driftwood Speckle
- 2824 Smoke Speckle
- 2825 Vanadium Speckle

Woodgrain Laminate

- 2406 Clear Cherry
- 2409 Clear Maple
- 2410 Graphite Walnut
- 2412 Natural Cherry
- 2422 Medium Cherry
- 2511 Winter on Maple
- 2538 Clear Walnut
- 2539 Warm Oak
- 2592 Blonde on Maple
- 2714 Natural Walnut
- 2772 Medium Mahogany on Walnut
- 2HAK Clear Oak
- 2HAN Ash Noce
- 2HAT Acacia
- 2HAW Ash Wenge
- 2HBN Bisque Noce
- 2HBW Bisque Wenge
- 2HCN Clay Noce
- 2HCW Clay Wenge
- 2HSN Storm Noce
- 2HSW Storm Wenge

turnstone Laminate Collection

A selection of laminates and edgebands are available on some Coalesse brand products. This collection is stocked and available with standard lead times and supported like standard laminates to help make ordering easy.

Tip: For a visual palette, please refer to the Steelcase Finish Library.

- 2535 Virginia Walnut
- 2536 Blackwood
- 2612 Marbled Maple
- 2614 Chocolate Walnut
- 2615 Marbled Cherry

Steelcase Select Surfaces Laminate

Grade 2

Textured Woodgrain Laminate

- 2TH2 Fawn Cypress
- 2TH3 Weathered Char
- 2TH4 Saddle Oak
- 2TH5 Veranda Teak
- 2TH6 Persian Cherry
- 2TH7 Walnut Heights

Tip: Because these finishes are part of Steelcase Select Surfaces, they may have additional lead times.

Textured Industrial Laminate

- 2UH1 Reclaimed Aggregate
- 2UH2 Reclaimed Gravel
- 2UH4 Cement*
- 2UH6 Sheetrock

Tip: Because these finishes are part of Steelcase Select Surfaces, they may have additional lead times.

*2UH4 Cement is only available on select table sizes.

Open Line Laminates

Customers can select laminates that are not offered as standard from select suppliers. Standard grade High-Pressure Laminates can be specified in Grade 1 (290A) or Grade 2 (290B) as indicated below (subject to availability). Grade 2 laminates will have extended lead time. Select from any Coalesse or Steelcase standard edge band finishes.

Contact Customer Service at 1.800.627.6770 to verify that your laminate selection falls within the categories noted below.

Directional patterns and woodgrains may be used on freestanding systems products, but will not be patterned matched.

Some standard High-Pressure Laminates, may not be available in the appropriate size to produce large products.

Wilsonart (Grade 1)
Standards (matte finish)
*Exceptions: High definition which must be quoted as a special.
Marker board which is grade 2.*

Nevamar (Grade 2)
Solids (textured finish)
Patterns (textured finish)

Formica (Grade 2)
Color portfolio (matte finish)
Patterns (matte finish)
Formations (matte finish)

Pionite (Grade 2)
Decorative surfaces (suede finish)

Non-Standard Laminates

Coalesse can supply additional laminates for an upcharge. Contact your Coalesse sales consultant for a custom quotation. Custom upcharges will vary based upon the cost of the material specified and additional labor required to manufacture the products. Some non-standard laminates will not be available in the appropriate size to produce large Coalesse products. A sample of the laminate may be requested for approval. Some non-standard laminates may be subject to extended lead times.

Coalesse does not use the following types of laminate materials on Topo:

- Formica solid surfacing – Surell Solids, Surell Granites
- Nevamar – Fountainhead
- Dupont – Corian
- Metal Laminates – textured, brushed or polished

Coalesse

Surface Materials - Laminate

High-Pressure Laminate Matrix

Legend

- = Not available
- = Available
- ▶ See specification pages for details.

Seating

Await	■	■	•	•	•	•	•	•	•	•	•	•	•	•	•	•	■
Bix Podium Drawer Front	■	■	■	■	■	■	■	■	■	■	■	■	■	■	■	■	•
Coupe	■	■	•	•	•	■	•	•	■	■	■	■	■	■	■	■	•
Sidewalk Tablet	■	■	•	•	•	■	•	•	■	■	■	■	■	■	■	■	•
Swathmore Grande	■	■	•	•	•	■	•	•	■	■	■	■	■	■	■	■	•

Occasional Tables

Await	■	■	•	•	•	•	•	•	•	•	•	•	•	•	•	•	■
Bix Tables	■	■	■	■	■	■	■	■	■	■	■	■	■	■	■	■	•
Bob Tables	■	■	■	■	■	■	■	■	■	■	■	■	■	■	■	■	•
Circa Tables	■	■	■	■	■	■	■	■	■	■	■	■	■	■	■	■	•
Enea	■	■	■	■	■	■	■	■	■	■	■	■	■	■	■	■	•
Enea Lottus	■	■	■	■	■	■	■	■	■	■	■	■	■	■	■	■	•
Lagunitas Tables	■	■	■	■	■	■	■	■	■	■	■	■	■	■	■	■	•
Lagunitas Focus Nook	■	■	■	■	■	■	■	■	■	■	■	■	■	■	■	■	•
Montara650	■	■	■	■	■	■	■	■	■	■	■	■	■	■	■	■	•
Sidewalk	■	■	■	■	■	■	■	■	■	■	■	■	■	■	■	■	•
SW_1	■	■	■	■	■	■	■	■	■	■	■	■	■	■	■	■	•

Tables and Casegoods

Au Lait	■	■	■	■	■	■	■	■	■	■	■	■	■	■	■	■	•
Ballet	■	■	■	■	■	■	■	■	■	■	■	■	■	■	■	■	•
E-Table 2 Top	■	■	■	■	■	■	■	■	■	■	■	■	■	■	■	■	•
E-Table 2 Laminate Base	■	■	•	•	•	■	•	•	■	■	■	■	■	■	■	■	•
Enea	■	■	■	■	■	■	■	■	■	■	■	■	■	■	■	■	•
Enea Lottus	■	■	■	■	■	■	■	■	■	■	■	■	■	■	■	■	•
Host Collection	■	■	■	■	■	■	■	■	■	■	■	■	■	■	■	■	•
Montara650	■	■	■	■	■	■	■	■	■	■	■	■	■	■	■	■	•
Reunion Collection	■	■	■	■	■	■	■	■	■	■	■	■	■	■	■	■	•
SW_1	■	■	■	■	■	■	■	■	■	■	■	■	■	■	■	■	•
Train	■	■	■	■	■	■	■	■	■	■	■	■	■	■	■	■	•

	Standard Coalesse High-Pressure Laminate																Standard Steelcase High-Pressure Laminate																								
	2730 Arctic White	2746 Black	2826 White Nebula	2829 Poppyseed	2830 Charcoal	2884 Milk	2886 Maple	2887 Amber Cherry	2890 Folkstone	2891 Ingot	2892 Ash	2894 Natural Cork	2895 Natural Walnut	2896 Dark Cork	2897 Desert Oak	2898 Satin Stainless	290N North Sea	2406 Clear Cherry	2409 Clear Maple	2410 Graphite Walnut	2412 Natural Cherry	2422 Medium Cherry	2503 Brushed Silver	2511 Winter on Maple	2535 Virginia Walnut	2536 Blackwood	2538 Clear Walnut														
Seating																																									
Await	■	■	•	•	•	•	•	•	•	•	•	•	•	•	•	•	•	■	•	•	•	•	•	•	•	•	•	•	•	•	•	•	•	•	•	•					
Bix Podium Drawer Front	■	■	■	■	■	■	■	■	■	■	■	■	■	■	■	■	■	■	■	■	■	■	■	■	■	■	■	■	■	■	■	■	■	■	■	■	■	■			
Coupe	■	■	•	•	•	■	•	•	■	■	■	■	■	■	■	■	■	■	■	■	■	■	■	■	■	■	■	■	■	■	■	■	■	■	■	■	■	■			
Sidewalk Tablet	■	■	•	•	•	■	•	•	■	■	■	■	■	■	■	■	■	■	■	■	■	■	■	■	■	■	■	■	■	■	■	■	■	■	■	■	■	■			
Swathmore Grande	■	■	•	•	•	■	•	•	■	■	■	■	■	■	■	■	■	■	■	■	■	■	■	■	■	■	■	■	■	■	■	■	■	■	■	■	■	■	■		
Occasional Tables																																									
Await	■	■	•	•	•	•	•	•	•	•	•	•	•	•	•	•	•	■	•	•	•	•	•	•	•	•	•	•	•	•	•	•	•	•	•	•	•				
Bix Tables	■	■	■	■	■	■	■	■	■	■	■	■	■	■	■	■	■	■	■	■	■	■	■	■	■	■	■	■	■	■	■	■	■	■	■	■	■	■	■		
Bob Tables	■	■	■	■	■	■	■	■	■	■	■	■	■	■	■	■	■	■	■	■	■	■	■	■	■	■	■	■	■	■	■	■	■	■	■	■	■	■	■		
Circa Tables	■	■	■	■	■	■	■	■	■	■	■	■	■	■	■	■	■	■	■	■	■	■	■	■	■	■	■	■	■	■	■	■	■	■	■	■	■	■	■		
Enea	■	■	■	■	■	■	■	■	■	■	■	■	■	■	■	■	■	■	■	■	■	■	■	■	■	■	■	■	■	■	■	■	■	■	■	■	■	■	■		
Enea Lottus	■	■	■	■	■	■	■	■	■	■	■	■	■	■	■	■	■	■	■	■	■	■	■	■	■	■	■	■	■	■	■	■	■	■	■	■	■	■	■		
Lagunitas Tables	■	■	■	■	■	■	■	■	■	■	■	■	■	■	■	■	■	■	■	■	■	■	■	■	■	■	■	■	■	■	■	■	■	■	■	■	■	■	■	■	
Lagunitas Focus Nook	■	■	■	■	■	■	■	■	■	■	■	■	■	■	■	■	■	■	■	■	■	■	■	■	■	■	■	■	■	■	■	■	■	■	■	■	■	■	■	■	
Montara650	■	■	■	■	■	■	■	■	■	■	■	■	■	■	■	■	■	■	■	■	■	■	■	■	■	■	■	■	■	■	■	■	■	■	■	■	■	■	■	■	
Sidewalk	■	■	■	■	■	■	■	■	■	■	■	■	■	■	■	■	■	■	■	■	■	■	■	■	■	■	■	■	■	■	■	■	■	■	■	■	■	■	■	■	
SW_1	■	■	■	■	■	■	■	■	■	■	■	■	■	■	■	■	■	■	■	■	■	■	■	■	■	■	■	■	■	■	■	■	■	■	■	■	■	■	■	■	
Tables and Casegoods																																									
Au Lait	■	■	■	■	■	■	■	■	■	■	■	■	■	■	■	■	■	■	■	■	■	■	■	■	■	■	■	■	■	■	■	■	■	■	■	■	■	■	■	■	
Ballet	■	■	■	■	■	■	■	■	■	■	■	■	■	■	■	■	■	■	■	■	■	■	■	■	■	■	■	■	■	■	■	■	■	■	■	■	■	■	■	■	■
E-Table 2 Top	■	■	■	■	■	■	■	■	■	■	■	■	■	■	■	■	■	■	■	■	■	■	■	■	■	■	■	■	■	■	■	■	■	■	■	■	■	■	■	■	■
E-Table 2 Laminate Base	■	■	•	•	•	■	•	•	■	■	■	■	■	■	■	■	■	■	■	■	■	■	■	■	■	■	■	■	■	■	■	■	■	■	■	■	■	■	■	■	■
Enea	■	■	■	■	■	■	■	■	■	■	■	■	■	■	■	■	■	■	■	■	■	■	■	■	■	■	■	■	■	■	■	■	■	■	■	■	■	■	■	■	■
Enea Lottus	■	■	■	■	■	■	■	■	■	■	■	■	■	■	■	■	■	■	■	■	■	■	■	■	■	■	■	■	■	■	■	■	■	■	■	■	■	■	■	■	■
Host Collection	■	■	■	■	■	■	■	■	■	■	■	■	■	■	■	■	■	■	■	■	■	■	■	■	■	■	■	■	■	■	■	■	■	■	■	■	■	■	■	■	■
Montara650	■	■	■	■	■	■	■	■	■	■	■	■	■	■	■	■	■	■	■	■	■	■	■	■	■	■	■	■	■	■	■	■	■	■	■	■	■	■	■	■	■
Reunion Collection	■	■	■	■	■	■	■	■	■	■	■	■	■	■	■	■	■	■	■	■	■	■	■	■	■	■	■	■	■	■	■	■	■	■	■	■	■	■	■	■	■
SW_1	■	■	■	■	■	■	■	■	■	■	■	■	■	■	■	■	■	■	■	■	■	■	■	■	■	■	■	■	■	■	■	■	■	■	■	■	■	■	■	■	■
Train	■	■	■	■	■	■	■	■	■	■	■	■	■	■	■	■	■	■	■	■	■	■	■	■	■	■	■	■	■	■	■	■	■	■	■	■	■	■	■	■	■

High-Pressure Laminate Matrix *continued*

Legend

- = Not available
- = Available
- ▶ See specification pages for details.

	2HBW Bisque Wenge	2HCN Clay Noce	2HCW Clay Wenge	2HMG Merle	2HSN Storm Noce	2HSW Storm Wenge	Select Surfaces Steelcase High-Pressure Laminate*									
							2TH2 Fawn Cypress	2TH3 Weathered Char	2TH4 Saddle Oak	2TH5 Veranda Teak	2TH6 Persian Cherry	2TH7 Walnut Heights	2UH1 Reclaimed Aggregate	2UH2 Reclaimed Gravel	2UH4 Cement	2UH6 Sheetrock
Seating																
Await	•	•	•	•	•	•	•	•	•	•	•	•	•	•	•	•
Bix Podium Drawer Front	■	■	■	■	■	■	■	■	■	■	■	■	■	■	■	■
Coupe	•	•	•	•	•	•	•	•	•	•	•	•	•	•	•	•
Sidewalk Tablet	•	•	•	■	•	•	■	■	■	■	■	■	■	■	■	■
Swathmore Grande	•	•	•	•	•	•	•	•	•	•	•	•	•	•	•	•
Occasional Tables																
Await	•	•	•	•	•	•	•	•	•	•	•	•	•	•	•	•
Bix Tables	■	■	■	■	■	■	■	■	■	■	■	■	■	■	■	■
Bob Tables	■	■	■	■	■	■	■	■	■	■	■	■	■	■	■	■
Circa Tables	■	■	■	■	■	■	■	■	■	■	■	■	■	■	■	■
Enea	■	■	■	■	■	■	■	■	■	■	■	■	■	■	■	■
Enea Lottus	■	■	■	■	■	■	•	•	•	•	•	•	•	•	•	•
Lagunitas Tables	■	■	■	■	■	■	■	■	■	■	■	■	■	■	■	■
Lagunitas Focus Nook	■	■	■	■	■	■	■	■	■	■	■	■	■	■	■	■
Montara650	■	■	■	■	■	■	■	■	■	■	■	■	■	■	■	■
Sidewalk	■	■	■	■	■	■	■	■	■	■	■	■	■	■	■	■
SW_1	■	■	■	■	■	■	■	■	■	■	■	■	■	■	■	■
Tables and Casegoods																
Au Lait	■	■	■	■	■	■	■	■	■	■	■	■	■	■	■	■
Ballet	■	■	■	■	■	■	■	■	■	■	■	■	■	■	■	■
Bob	■	■	■	■	■	■	■	■	■	■	■	■	■	■	■	■
E-Table 2 Top	■	■	■	■	■	■	■	■	■	■	■	■	■	•	■	■
E-Table 2 Laminate Base	■	•	•	•	•	•	•	•	•	•	•	•	•	•	•	•
Enea	■	■	■	■	■	■	■	■	■	■	■	■	■	■	■	■
Enea Lottus	■	■	■	■	■	■	•	•	•	•	•	•	•	•	•	•
Host Collection	■	■	■	■	■	■	■	■	■	■	■	■	■	■	•	■
Montara650	■	■	■	■	■	■	■	■	■	■	■	■	■	■	■	■
Reunion Collection	■	■	■	■	■	■	■	■	■	■	■	■	■	■	■	■
SW_1	■	■	■	■	■	■	■	■	■	■	■	■	■	■	■	■
Train	■	■	■	■	■	■	■	■	■	■	■	■	■	■	■	■

* Because these finishes are part of Steelcase Select Surfaces, they may have additional lead times.

High-Pressure Laminate Matrix

Laminate Edge Band Matrix

Legend

- = Not available
- = Available
- ▶ See specification pages for details.

6000 Black	6001 Coffee	6009 Artic White	6011 Ash	6012 Ingot	6034 Natural Cherry	6036 Medium Cherry	6037 Winter on Maple	6038 Blonde on Maple	6041 Natural Walnut	6045 Medium Mahogany on Walnut	6052 Milk	6053 Seagull	6086 Folkstone	6090 Amber Cherry	6091 Fusion Maple	6093 Dove Grey	6125 Graystone	6126 Greige	6127 Stonedust	6128 Taupe	6130 Dark Gray	6134 North Sea	6213 Acacia	6219 Clear Oak	6231 Graphite Walnut	6234 Clear Cherry	6237 Clear Maple	6242 Virginia Walnut	6243 Blackwood	6245 Clear Walnut	6246 Warm Oak	6249 Platinum Solid
------------	-------------	------------------	----------	------------	---------------------	--------------------	----------------------	----------------------	---------------------	--------------------------------	-----------	--------------	----------------	-------------------	-------------------	----------------	----------------	-------------	----------------	------------	----------------	----------------	-------------	----------------	----------------------	-------------------	------------------	----------------------	----------------	-------------------	---------------	---------------------

Seating

Swathmore Grande Mobile Tablet Self Edge	■	•	•	•	•	•	•	•	•	•	•	•	•	•	•	•	•	•	•	•	•	•	•	•	•	•	•	•	•	•	•	•	•
--	---	---	---	---	---	---	---	---	---	---	---	---	---	---	---	---	---	---	---	---	---	---	---	---	---	---	---	---	---	---	---	---	---

Occasional Tables

Await Table 3 mm Edge	■	•	■	•	•	•	•	•	•	•	•	•	•	•	•	•	•	•	•	•	•	•	■	•	•	•	•	•	•	•	•	•	•		
Bix Edge	■	■	■	■	■	■	■	■	■	■	■	■	■	■	■	■	■	■	■	■	■	■	■	■	■	■	■	■	■	■	■	■	■	■	
Enea T-Mold Edge	■	•	•	•	•	•	•	•	•	•	•	•	•	•	•	•	•	•	•	•	•	•	•	•	•	•	•	•	•	•	•	•	•	•	
Enea Lottus	■	•	•	•	•	•	•	•	•	•	•	•	•	•	•	•	•	•	•	•	•	•	•	•	•	•	•	•	•	•	•	•	•	•	
Montara650	■	■	■	■	■	■	■	■	■	■	■	■	■	■	■	■	■	■	■	■	■	■	■	■	■	■	■	■	■	■	■	■	■	■	■

Tables and Casegoods

Au Lait Convex Vinyl Edge	■	•	•	•	•	•	•	•	•	•	•	•	•	•	•	•	•	•	•	•	•	•	•	•	•	•	•	•	•	•	•	•	•	•			
Au Lait Cast Urethane Edge	■	•	•	•	•	•	•	•	•	•	•	•	•	•	•	•	•	•	•	•	•	•	•	•	•	•	•	•	•	•	•	•	•	•	•		
Await Table 3 mm Edge	■	•	■	•	•	•	•	•	•	•	•	•	•	•	•	•	•	•	•	•	•	•	■	•	•	•	•	•	•	•	•	•	•	•	•		
Ballet Ribbed Vinyl Edge	■	•	•	•	•	•	•	•	•	•	•	•	•	•	•	•	•	•	•	•	•	•	•	•	•	•	•	•	•	•	•	•	•	•	•		
Bix Edge (Bridge, work booth tables)	■	■	■	■	■	■	■	■	■	■	■	■	■	■	■	■	■	■	■	■	■	■	■	■	■	■	■	■	■	■	■	■	■	■	■	■	
Bob Tables	■	■	■	■	■	■	■	■	■	■	■	■	■	■	■	■	■	■	■	■	■	■	■	■	■	■	■	■	■	■	■	■	■	■	■	■	
E-Table 2 Convex Vinyl Edge	■	•	•	•	•	•	•	•	•	•	•	•	•	•	•	•	•	•	•	•	•	•	•	•	•	•	•	•	•	•	•	•	•	•	•		
E-Table 2 3 mm Edge	■	■	■	■	■	■	■	■	■	■	■	■	■	■	■	■	■	■	■	■	■	■	■	■	■	■	■	■	■	■	■	■	■	■	■	■	
Enea T-mold edge	■	•	•	•	•	•	•	•	•	•	•	•	•	•	•	•	•	•	•	•	•	•	•	•	•	•	•	•	•	•	•	•	•	•	•		
Enea Lottus Phenolic Edge	■	•	•	•	•	•	•	•	•	•	•	•	•	•	•	•	•	•	•	•	•	•	•	•	•	•	•	•	•	•	•	•	•	•	•		
Host Collection	•	•	•	•	•	•	•	•	•	•	•	•	•	•	•	•	•	•	•	•	•	•	•	•	•	•	•	•	•	•	•	•	•	•	•	•	
Lagunitas Table 3 mm Edge	■	■	■	■	■	■	■	■	■	■	■	■	■	■	■	■	■	■	■	■	■	■	■	■	■	■	■	■	■	■	■	■	■	■	■	■	■
Lagunitas Focus Nook	■	■	■	■	■	■	■	■	■	■	■	■	■	■	■	■	■	■	■	■	■	■	■	■	■	■	■	■	■	■	■	■	■	■	■	■	■
Montara650	■	■	■	■	■	■	■	■	■	■	■	■	■	■	■	■	■	■	■	■	■	■	■	■	■	■	■	■	■	■	■	■	■	■	■	■	■
Reunion Collection Bullnose Vinyl Edge	■	•	•	•	•	•	•	•	•	•	•	•	•	•	•	•	•	•	•	•	•	•	•	•	•	•	•	•	•	•	•	•	•	•	•	•	
Reunion Seminar Flat Vinyl Edge	■	•	•	•	•	•	•	•	•	•	•	•	•	•	•	•	•	•	•	•	•	•	•	•	•	•	•	•	•	•	•	•	•	•	•	•	
SW_1	■	■	■	■	■	■	■	■	■	■	■	■	■	■	■	■	■	■	■	■	■	■	■	■	■	■	■	■	■	■	■	■	■	■	■	■	■
Train Signature Edge	■	•	•	•	•	•	•	•	•	•	•	•	•	•	•	•	•	•	•	•	•	•	•	•	•	•	•	•	•	•	•	•	•	•	•	•	

Laminate Edge Band Matrix

6271 Plywood	6527 Merle	6607 Woodrose	6609 Smoke	6615 Grey V5	6619 Ice	6631 Cream	6635 Dawn	6636 Mist	6654 Sand	6655 Warm White	6676 Marbled Maple	6677 Chocolate Walnut	6678 Marbled Cherry	6694 Slate	6695 Midnight	6697 Fog	6698 Fieldstone	6703 Ash Wenge	6704 Storm Wenge	6705 Bisque Wenge	6706 Clay Wenge	6707 Ash Noce	6708 Bisque Noce	6709 Clay Noce	6710 Storm Noce	6D10 Silver Metallic	6D11 Black	6D12 White	6T02 Fawn Cypress*	6T03 Weathered Char*	6T04 Saddle Oak*	6T05 Veranda Teak*	6T06 Persian Cherry*	6T07 Walnut Heights*	2UH1 Reclaimed Aggregate*	2UH2 Reclaimed Gravel*	2UH4 Cement*	2UH6 Sheetrock*				
•	•	•	•	•	•	•	•	•	•	•	•	•	•	•	•	•	•	•	•	•	•	•	•	•	•	•	•	•	•	•	•	•	•	•	•	•	•	•	•	•	•	
■	■	•	•	■	■	■	■	■	■	■	■	■	■	■	■	■	■	■	■	■	■	■	■	■	■	■	■	■	■	■	■	■	■	■	■	■	■	■	■	■	■	
•	•	•	•	•	•	•	•	•	•	•	•	•	•	•	•	•	•	•	•	•	•	•	•	•	•	•	•	•	•	•	•	•	•	•	•	•	•	•	•	•	•	
■	■	•	•	■	■	■	■	■	■	■	■	■	■	■	■	■	■	■	■	■	■	■	■	■	■	■	■	■	■	■	■	■	■	■	■	■	■	■	■	■	■	■
•	•	■	■	•	•	•	•	•	•	•	•	•	•	•	•	•	•	•	•	•	•	•	•	•	•	•	•	•	•	•	•	•	•	•	•	•	•	•	•	•	•	
■	■	•	•	■	■	■	■	■	■	■	■	■	■	■	■	■	■	■	■	■	■	■	■	■	■	■	■	■	■	■	■	■	■	■	■	■	■	■	■	■	■	■
•	•	•	•	•	•	•	•	•	•	•	•	•	•	•	•	•	•	•	•	•	•	•	•	•	•	•	•	•	•	•	•	•	•	•	•	•	•	•	•	•	•	
■	■	•	•	■	■	■	■	■	■	■	■	■	■	■	■	■	■	■	■	■	■	■	■	■	■	■	■	■	■	■	■	■	■	■	■	■	■	■	■	■	■	■
•	•	•	•	•	•	•	•	•	•	•	•	•	•	•	•	•	•	•	•	•	•	•	•	•	•	•	•	•	•	•	•	•	•	•	•	•	•	•	•	•	•	
■	■	•	•	■	■	■	■	■	■	■	■	■	■	■	■	■	■	■	■	■	■	■	■	■	■	■	■	■	■	■	■	■	■	■	■	■	■	■	■	■	■	■

* Because these finishes are part of Steelcase Select Surfaces, they may have additional lead times.

Surface Materials - Glass

Glass

Not all glass selections are available on every product. Refer to glass matrix for availability by product.

Back-Painted Glass

6720	Sand
6721	Pewter
6722	Mojave
6723	Terra
6724	Jade
6725	Ocean
ACM	Absolute Clear with Moonlight
ACS	Absolute Clear with Sage
ACP	Absolute Clear with Poppy
ACG	Absolute Clear with Goldenrod
ACB	Absolute Clear with Black
ACC	Absolute Clear with Crystal Spring

Glass

6511	Acid Etched
AC	Absolute Clear
ACF	Absolute Clear Frosted
CG	Clear Green
CGF	Clear Green Laminated/Frosted Appearance

Exclusive to Emu products:

6547	Transparent
6548	Smoke Grey

Surface Materials - Metal/Paint

Metal/Paint

Coalesse powder coats all painted metal components for an exceptionally durable, environmentally responsible finish — eliminating VOC's (volatile organic compounds) from being released into the environment. Electrostatically charged powder coat material is applied to an exacting thickness and then temperature baked, resulting in a smooth, flawless finish that is abrasion and impact resistant. The following Coalesse metal finishes are available:

Paint

Coalesse Standard Paint—Neutrals

Grade 1

Standard Coat Paint

- 4138 Graphite Gloss
- 4140 Arctic White Gloss
- 4141 Platinum Matte
- 4142 Platinum Gloss
- 4144 Black Gloss (formerly anthracite gloss)
- 4145 Milk Gloss
- 4146 Champagne Matte
- 4147 Champagne Gloss
- 4148 Midnight Brown Gloss
- 4180 Graphite Matte
- 4193 Midnight Brown Matte
- 4242 Milk Matte
- 4710 Low Gloss Black
- 7196 Midnight Brown Textured
- 7197 Anthracite Textured

Coalesse Standard Paint—Colors

Grade 1

- 4065 Blue Ink Textured
- 4066 Ocean Textured
- 4067 Ice Textured
- 4068 Olive Textured
- 4069 Honey Textured
- 4070 Currant Textured
- 4071 Saffron Textured

Steelcase Select Surfaces Paint

Accent Paints

Grade 3

Allow customers to add trend-driven color to painted surfaces. We evolve this collection often, to ensure that fresh new colors are always available.

- 4AQB Wasabi
- 4AQ9 Scarlet
- 4AV3 Blue Jay
- 4AV4 Baltic
- 4AX0 Flash
- 4AX1 Citron
- 4AY2 Chili
- 4AZ5 Marlin
- 4BH7 Canary
- 4BQ7 Fuschia
- 4CZ1 Aubergine
- 4CZ2 Peacock
- 4CZ3 Jungle
- 4CZ4 Merlot
- 4CZ5 Honey
- 4CZ6 Lagoon
- 4CZ7 Saffron
- 4CZ8 Light Peacock

Lux Coatings

Grade 3

Introduces a softer, more human-centered aesthetic to the workplace. These powder coat paints provide tasteful accent for your spaces.

- 4B20 Obsidian
- 4B22 Matte Brass
- 4B23 Burnished Bronze
- 4B24 Night Bronze
- 4B25 Matte Copper
- 4B26 Smoked Mica
- 4B27 Blue Steel
- 4B28 Silver Lilac
- 4B29 Cast Iron
- 4B30 Bright Gold

Applies to: Emu Advanced Collection*

- 4251 Emu Indian Brown
- 4256 Aluminum
- 4257 Antique Iron
- 7234 Emu Black
- 7271 Emu White
- 7272 Blue
- 7273 Green
- 7294 Emu Grey/Green
- 7296 Emu Taupe
- 7297 Emu Corten
- 7298 Emu Copper
- 7391 Emu Poppy

*Not all colors available on all products as standard, consult Emu advanced paint matrix.

Applies to: Enea

- 4018 Silver Metallic
- 4016 White Gloss
- 4017 Black Gloss

Applies to: Enea Lottus

- 4062 Anthracite Grey Textured
 - 4063 Cool Grey Textured
 - 4064 Sand Textured
 - 4216 Red*
 - 4217 Brown
 - 4218 Platinum Silver
 - 7207 Black Textured
 - 7241 Arctic White Textured
- *Not available on Enea Lottus tables.

Applies to: Exponents (Base, Accent Ribbon, Handle, and Grommet)

- 4135 Black Matte
- 4141 Platinum Matte

Applies to: Exponents mobile displays (Base, Handle, and Inner Frame)

- 4135 Black Matte
- 4145 Milk Gloss

Metal

Anodized Aluminum

Applies to: Rod or disc pulls
5200 Satin Aluminum

Brushed Aluminum

Applies to: Lox stool
9251 Brushed Aluminum

Polished Aluminum

Applies to: Lox chair, Potrero415, and Bindu conference bases
8046 Polished Aluminum

Applies to: Bob and SW_1

8040 Aluminum Matte Polished

Chrome

- 9201 Chrome
- 9207 Polished trivalent chrome
- 9208 Etched trivalent chrome

Brushed Nickel

Applies to: Millbrae seating and tables
9238 Brushed Nickel

Coalesce

Surface Materials - Metal/Paint

Metal/Paint Matrix

Legend

- = Not available
- = Available
- ▶ See specification pages for details.

Seating

Bindu Conference
Bindu Guest
Bix
Bob
Capa
Chord
Circa
Coupe
Enea
Enea Lottus
Lagunitas
Last Minute
Lox Stool
Millbrae
Montara650
SW_1
Switch
Topo Lounge
Visalia
Wrapp

Occasional Tables

Bix (vinyl version)
Bob
Circa
Enea
Enea Lottus
Lagunitas
Lagunitas Focus Nook
Millbrae
Montara650
Switch
SW_1

Coalesse Standard Paint—Neutrals										Coalesse Standard Paint—Colors										Product Line Exclusives								
4135 Black Matte	4138 Graphite Gloss	4140 Arctic White Gloss	4141 Platinum Matte	4142 Platinum Gloss	4144 Black Gloss	4145 Milk Gloss	4146 Champagne Matte	4147 Champagne Gloss	4148 Midnight Brown Gloss	4180 Graphite Matte	4193 Midnight Brown Matte	4242 Milk Matte	4710 Low Gloss Black	7196 Midnight Brown Textured	7197 Anthracite Textured	4065 Blue Ink Textured	4066 Ocean Textured	4067 Ice Textured	4068 Olive Textured	4069 Honey Textured	4070 Currant Textured	4071 Saffron Textured	LessThanFive	LessThanFive Essential	Enea Exclusive Finishes	Enea Café Wood Exclusive Finishes	Enea Lottus Exclusive Finishes	
Bindu Conference	•	•	•	•	•	•	•	•	•	•	•	•	•	•	•	•	•	•	•	•	•	•	•	•	•	•	•	•
Bindu Guest	•	•	•	•	•	•	•	•	•	•	•	•	•	•	•	•	•	•	•	•	•	•	•	•	•	•	•	•
Bix	•	■	■	■	■	■	■	■	■	•	•	•	•	•	•	•	•	•	•	•	•	•	•	•	•	•	•	•
Bob	•	■	•	■	■	■	■	■	■	■	■	■	■	■	■	■	■	■	■	■	■	■	■	•	•	•	•	•
Capa	•	•	•	•	•	•	•	•	•	•	•	•	•	•	•	•	•	•	•	•	•	•	•	•	•	•	•	•
Chord	•	•	•	•	•	•	•	•	•	•	•	•	•	•	•	•	•	•	•	•	•	•	•	•	•	•	•	•
Circa	•	■	■	■	■	■	■	■	■	■	■	■	■	■	■	■	■	■	■	■	■	■	■	•	•	•	•	•
Coupe	•	■	■	•	■	■	•	•	■	•	•	•	•	•	•	•	•	•	•	•	•	•	•	•	•	•	•	•
Enea	•	•	•	•	•	•	•	•	•	•	•	•	•	•	•	•	•	•	•	•	•	•	•	•	■	•	•	•
Enea Lottus	•	•	■	•	■	■	■	■	■	•	•	•	•	•	•	■	■	■	■	■	■	■	■	•	•	•	■	•
Lagunitas	•	•	•	■	•	•	•	•	•	•	•	•	•	■	•	•	•	•	•	•	•	•	•	•	•	•	•	•
Last Minute	•	•	•	•	•	•	•	•	•	•	•	•	•	•	•	•	•	•	•	•	•	•	•	•	•	•	•	•
Lox Stool	•	•	•	•	•	•	•	•	•	•	•	•	•	•	•	•	•	•	•	•	•	•	•	•	•	•	•	•
Millbrae	•	■	•	■	•	■	■	•	•	■	■	■	■	■	■	■	■	■	■	■	■	■	■	•	•	•	•	•
Montara650	•	■	•	■	•	■	■	•	•	■	■	■	■	■	■	■	■	■	■	■	■	■	■	•	•	•	•	•
SW_1	•	•	•	•	•	•	•	•	•	•	•	•	•	•	•	•	•	•	•	•	•	•	•	•	•	•	•	•
Switch	•	•	•	•	•	•	•	•	•	•	•	•	•	•	•	•	•	•	•	•	•	•	•	•	•	•	•	•
Topo Lounge	•	■	■	■	■	■	■	■	■	■	■	■	■	■	■	■	■	■	■	■	■	■	■	•	•	•	•	•
Visalia	•	■	•	■	•	■	■	•	•	■	■	■	■	■	■	■	■	■	■	■	■	■	■	•	•	•	•	•
Wrapp	•	•	•	•	•	•	•	•	•	•	•	•	•	•	•	•	•	•	•	•	•	•	•	•	•	•	•	•
Bix (vinyl version)	•	■	■	■	■	■	■	■	■	•	•	•	•	•	■	■	■	■	■	■	■	■	•	•	•	•	•	•
Bob	•	■	•	■	■	■	■	■	■	■	■	■	■	■	■	■	■	■	■	■	■	■	■	•	•	•	•	•
Circa	•	■	■	■	■	■	■	■	■	■	■	■	■	■	■	■	■	■	■	■	■	■	■	•	•	•	•	•
Enea	•	•	•	•	•	•	•	•	•	•	•	•	•	•	•	•	•	•	•	•	•	•	•	•	■	•	•	•
Enea Lottus	•	•	■	•	■	■	■	■	■	•	•	•	•	•	■	■	■	■	■	■	■	■	■	•	•	•	■	•
Lagunitas	•	■	■	■	■	■	■	■	■	■	■	■	■	■	■	■	■	■	■	■	■	■	■	•	•	•	•	•
Lagunitas Focus Nook	•	■	■	■	■	■	■	■	■	■	■	■	■	■	■	■	■	■	■	■	■	■	■	•	•	•	•	•
Millbrae	•	■	•	■	•	■	■	•	•	■	■	■	■	■	■	■	■	■	■	■	■	■	■	•	•	•	•	•
Montara650	•	■	•	■	•	■	■	•	•	■	■	■	■	■	■	■	■	■	■	■	■	■	■	•	•	•	•	•
Switch	•	•	•	•	•	•	•	•	•	•	•	•	•	•	•	•	•	•	•	•	•	•	•	•	•	•	•	•
SW_1	•	•	•	•	•	•	•	•	•	•	•	•	•	•	•	•	•	•	•	•	•	•	•	•	•	•	•	•

Metal/Paint Matrix

Coalesse Metals																							
8040 Aluminum Matte Polished	•	•	•	•	•	•	•	•	•	•	•	•	•	•	•	•	•	•	•	•	•	•	
8046 Polished Aluminum	•	•	•	•	•	•	•	•	•	•	•	•	•	•	•	•	•	•	•	•	•	•	
9201 Chrome	•	•	•	•	•	•	•	•	•	•	•	•	•	•	•	•	•	•	•	•	•	•	
9207 Polished Trivalent Chrome	•	•	•	•	•	•	•	•	•	•	•	•	•	•	•	•	•	•	•	•	•	•	
9208 Etched Trivalent Chrome	•	•	•	•	•	•	•	•	•	•	•	•	•	•	•	•	•	•	•	•	•	•	
9238 Brushed Nickel	•	•	•	•	•	•	•	•	•	•	•	•	•	•	•	•	•	•	•	•	•	•	
9251 Brushed Aluminum	•	•	•	•	•	•	•	•	•	•	•	•	•	•	•	•	•	•	•	•	•	•	
9260 Black Chrome	•	•	•	•	•	•	•	•	•	•	•	•	•	•	•	•	•	•	•	•	•	•	
9261 Copper	•	•	•	•	•	•	•	•	•	•	•	•	•	•	•	•	•	•	•	•	•	•	
Potrero415 Exclusives	•	•	•	•	•	•	•	•	•	•	•	•	•	•	•	•	•	•	•	•	•	•	
Custom Paint																							
Coalesse Color	•	•	•	•	•	•	•	•	•	•	•	•	•	•	•	•	•	•	•	•	•	•	
Steelcase Select Surfaces																							
Accent Paints	•	•	•	•	•	•	•	•	•	•	•	•	•	•	•	•	•	•	•	•	•	•	
Lux Coatings*	•	•	•	•	•	•	•	•	•	•	•	•	•	•	•	•	•	•	•	•	•	•	

* Lux Coatings are not available on Montara650 54" or 60" round work-height tables.

Emu Advanced Collection Paint Matrix

Legend

- = Not available
- = Available
- ▶ See specification pages for details.

	4251 Emu Indian Brown	4256 Aluminum	4257 Antique Iron	7234 Emu Black	7271 Emu White	7272 Blue	7273 Green	7294 Emu Grey/Green	7296 Emu Taupe	7297 Emu Corten	7298 Emu Copper	7391 Emu Poppy
Heaven Seating, Tables, and Pouf	•	■	•	■	■	•	•	•	•	•	•	•
Heaven Vases	•	•	•	•	■	•	•	•	•	•	•	•
Ivy Collection	•	•	•	•	■	•	•	•	•	•	•	•
Pattern Collection	•	•	•	■	■	■	■	•	•	•	•	■
Retrouvé Collection	•	•	•	•	■	•	•	•	•	•	•	•
Round Collection	■	•	■	■	■	•	•	•	•	•	•	•

Tip: Select product lines allow for other Emu paint finishes (those shown as not available on the matrix) as an available option. Consult the Coalesse Seating and Outdoor Specification Guide for details.

Surface Materials - Miscellaneous

Convex Vinyl Edge Band

Applies to:

- Au Lait (includes cast urethane) and E-Table:

6000 Black
6607 Woodrose
6609 Smoke
6655 Warm White

Cast Urethane Edge

Applies to:

- Au Lait

6000 Black
6607 Woodrose
6609 Smoke
6655 Warm White

Plastic

Applies to:

- Enea

003 White
0013 Sunset Orange
0014 Clover Green
0015 Sand
0016 Walnut Brown
0017 Cool Grey
0400 Black
0405 Periwinkle
0406 Alabaster
0409 Red
0414 Anthracite Grey
0421 Blue

Applies to:

- Enea Lottus

003 White
0013 Sunset Orange
0014 Clover Green
0015 Sand
0016 Walnut Brown
0017 Cool Grey
0400 Black
0409 Red
0414 Anthracite Grey
0421 Blue
0422 Blue Ink
0423 Ocean
0424 Ice
0425 Olive
0426 Honey
0427 Currant
0428 Saffron

Tip: Not all colors available on all products. Consult the Enea plastic matrix for product line availability.

Applies to:

- Exponents mobile cart, moby, and mobile display casters

6000 Black
6009 Arctic White

Applies to:

- Lox stools
- 6347 Black Gloss
6348 White Gloss

Applies to:

- SW_1 tablets, grommet, barrier, wire manager, sub-structure, lounge tablet, Sebastopol grommet

6000 Black
6052 Milk

Applies to:

- Grommet, spheres, flex-gangers, Mini-Port, Interport, casters, horizontal wire manager, and vertical wire manager

Black plastic

Applies to:

- Lagunitas focus nook

6000 Black
6052 Milk
6D03 Graphite

TAP Power Module Door Finishes**Brushed Anodized Aluminum**

Applies to:

- Host
- 8043 Silver
8044 Black

Utility Bay

Applies to:

- E-Table 2

4137 Matte Black
4745 Nickel Mica
4746 Silver Mica
4747 Charcoal Mica

Glass Doors

Applies to:

- Host credenzas
- Frosted glass

Locks

Applies to:

- Denizen and Exponents
- 9211 Nickel
9250 Ember Chrome

Interior and Plinth

Applies to:

- Host credenzas

Black Melamine

Solid

Applies to:

- Exponents and SW_1 tables
- 2801 Glacier White

Grommet

Applies to:

- Exponents
- 4135 Black Matte
4141 Platinum Black

Power, Voice Data Modules

Applies to:

- Exponents
- 4140 Arctic White Gloss
4141 Black Gloss

Glossy Laminate

Applies to:

- Sebastopol

2001 Smoky White Glossy
2002 Studio Grey Glossy
2003 Wrought Iron Glossy
2004 Black Pearl Glossy
2005 Liberty Red Glossy

Ordering

How to Order

Coalesse furniture is available through authorized dealers and retailers. Select products are available for order from our web site. The authorized dealer can help you with everything from surface material selection and order placement, to specialized services, such as space planning and design, delivery and installation. Best of all, they are part of your local community, providing expert advice with a thorough understanding of local needs. For more information and a listing of dealers and retailers, visit www.coalesse.com or call 1.800.627.6770.

Coalesse reserves the right to limit distribution of any or all models.

Credit, Prices, and Terms

Credit may be established upon acceptance of satisfactory references. For payment terms, contact Coalesse's Credit Department. Coalesse may cancel or change credit terms at its discretion and may request advance payment at any time.

The order confirmation will be deemed by the customer and by Coalesse, as the final expression of agreement and will be deemed the exclusive statement of terms. The order confirmation supersedes all prior writings and may not be modified or rescinded, except by a revised Coalesse order confirmation signed by the customer. No changes are binding on Coalesse until delivery of the order confirmation.

Any storage charges and applicable sales taxes are in addition to the prices shown for merchandise. Inside delivery, uncartoning and installation are customer's responsibility unless separately quoted. All list pricing shown includes freight prepaid to one destination for delivery in the 48 contiguous United States. Hawaii and Alaska are not included. We reserve the right to increase prices without notice due to increases in labor and material costs. If timely payment is not made, customer is liable for reasonable collection costs, including attorney's fees.

Shipping and Storage

Coalesse reserves the right to select carrier and packaging method. Partial shipments may be delivered. Coalesse is not liable for delays or delivery failure due to strikes, lockouts, labor, or transportation difficulties, failure or delay of supply sources, accidents, fire, acts of God, or any other cause of like or unlike nature beyond Coalesse's control. Coalesse may transfer merchandise to storage if not accepted when shipment scheduled. Transfer and storage charges will be the customer's expense. Coalesse's invoice is payable upon transfer. If transfer is made prior to confirmed shipping date, storage expenses will be borne by customer.

Shipping charges MAY be calculated per order. Lead-times vary by product. Coalesse reserves the right to select carrier. Partial shipments may be delivered. Coalesse will make every effort to provide current and accurate lead-time information, however, Coalesse is not liable for delays or delivery failure due to strikes, lockouts, labor, or transportation difficulties, failure or delay of supply sources, accidents, fire, acts of God, or any other cause of like or unlike nature beyond Coalesse's control.

Freight is included on domestically manufactured products within the 48 contiguous states of the United States and standard freight service of Carl Hansen & Søn and Emu.

Claims

Merchandise shipped from Coalesse is thoroughly inspected and properly packed before leaving the factory. Responsibility of its safe delivery is assumed by the carrier at the time of shipment. Customer must match the freight delivered with the bill of lading. Customer must examine packaging material upon delivery and note any damage on the carrier bill of lading. If there is damage to the packaging material, inspect the furniture immediately. If concealed damage is found, contact the carrier within 10 days of delivery date. Save all packaging materials until after inspection.

Freight damage and claims must be reported by the purchaser to the carrier. Coalesse is not responsible for freight claims. Claims for loss or damage must not be deducted from our invoice, nor payment withheld awaiting adjustment of such claims. Do not return any merchandise to Coalesse without a Return Authorization number. By following these procedures carefully, Coalesse guarantees our full support of your claims to protect you against loss or damages. All claims against Coalesse for defects, errors or shortages must be made by customer in writing within ten (10) days after delivery. Failure to make claims within ten (10) days constitutes acceptance of merchandise and waives claims. Cutting of textiles deems acceptance of yardage and waives all defects, errors, and shortages. Coalesse is not liable for subsequent damages.

Special/Custom Products

Coalesse prides itself on being responsive to our customer's needs. Contact our Customer Service team at 1.800.627.6770 to discuss a special opportunity. Due to product modifications and engineering time, special orders may not be cancelled. Charges will apply.

FOR MORE INFORMATION (on ordering our products) Please contact Coalesse Customer Service at: 1.800.627.6770 .

Order Cancellations/Changes

All order change/cancellation requests must be submitted using the Coalesse order change/cancellation request form. Late changes could jeopardize the committed delivery of an order.

Rapid10 program, no change or cancellations allowed.

Coalesse Products:

- No charges will be assessed for change or cancellation 14 or more calendar days prior to the manufacturing completion date (excludes holidays and/or large quantity project size orders). For import products, charges may apply.

- No manufacturing changes are allowed 0-13 calendar days prior to the manufacturing completion date. Simple changes including shipping address changes are subject to approval but will be accommodated when possible.

- No cancellations or product changes will be accepted for quick ship or special/custom product orders including special laminates. A cancellation fee will be applicable for any custom product and/or change may jeopardize lead time.

- If COM/COL has been received at time of change or cancellation, it is the dealer's responsibility to advise disposition or return of materials. Coalesse will not store materials after 30 days.

Additional Charges

- Changes or cancellations that involve any of the following may be subject to a charge earlier and/or greater than shown above: Special engineering product, CSM, pre-ordered components, materials with extended lead times (e.g., veneers, special paint, etc.) or large quantities of standard materials.

- Use our Order Change/Cancellation Request Form for all order changes. It is Coalesse responsibility to accurately process change order requests. It is the dealer's responsibility to verify that we have accurately interpreted your change requests by checking the acknowledgement after the change has been made. If you do not use the web-based change order form process and an error occurs during our translation which cannot be corrected prior to ship, all costs will be shared on a 50/50 basis. Changing ship dates or adding product to your order is subject to the availability of manufacturing capacity.

- Cartoning changes and shipping address changes are subject to approval and to a change charge. Please consult your Customer Service for specific information pertaining to your order.

Reserved Fabric Policy

Prior to order receipt, reserving textiles (COM/COL, Maharam, Designtex, and select Luna Graded-In) is the responsibility of the dealer. Coalesse cannot reserve textiles based on projected orders. Coalesse cannot guarantee Maharam or Designtex fabric availability. If dealer reserves Maharam or Designtex textiles, Coalesse will require the reserve number and zip code for locating purposes when ordering.

Schedule Enhancements

Coalesse will entertain schedule enhancements on a case-by-case basis; however, please understand that we must receive complete information such as installation date, opening date, etc., to make informed scheduling decisions.

No order move-ups or move-outs are allowed on any order that falls within the 15-working day period of its manufacturing completion date. If it is within the 15-working day period, Coalesse will invoice at shipment but may offer storage options at a charge for manufactured product.

Ordering

Surface Materials

ELMO SOFT, ELMORUSTICAL LEATHER CARE

Only the finest hides are used for Elmo leather. Expect some color variations from hide to hide due to the aniline state of the product. Color fading may occur if leather is exposed to direct or intense light. Care is required to allow this product to achieve the rich natural patina that beautiful natural leather develops. The hallmarks of this leather include some naturally occurring markings, such as healed scars, insect bites, stretch marks, and fat wrinkles. Elmorustical's leather treatment is very natural with little protection from spills or body oils. This rich leather will exhibit stains and oils through normal use. Coalesse is not responsible for discoloration, spotting, or staining on this leather.

Special Color Match Leather

Coalesse can provide a special color match in its leather to any supplier's leather color, paint color, carpet color, wall-paper color, etc. Sample to match must be submitted to Coalesse with purchase order. Sample for approval can be supplied if requested.

Note: Minimum order 2,500 sq. ft.

Special Fabric Applications

(available on GradedIn or Coalesse to purchase orders)

Teflon protection

- Minimum charge:
- 1-30 yards \$125 list
 - 31+ yards \$2.50 list/per yard

Latex backing

- 1-50 yards \$260 list minimum charge
- 50+ yards \$8.00 list/per yard

Tip: Prices subject to change without notice and an additional 2 week lead time will apply for 54" wide fabrics. Wider fabrics will require 4 week additional lead time. Multiple rolls will incur additional charges per roll.

Upholstery

All Coalesse textiles are priced by grades. Some Coalesse fabrics can be treated for flame retardancy, contact Customer Service. All Coalesse products are handcrafted making each unique. Certain fabrics and leathers will appear loose and may differ from like products due to comfort wrinkles when upholstered.

A contrasting welt is available on some products. Consult Customer Service for yardage or square feet requirements and prices. All stripes will be applied vertically unless customer specifies otherwise. Loose cushions on Coalesse products are not fully upholstered (not reversible).

Designtex, Maharam, and select Luna fabrics are graded in our pricing. Simply order Coalesse products with Designtex, Maharam, and select Luna specified. Designtex and Maharam fabrics are graded in on Coalesse products; however, Coalesse does not stock fabrics and can only respond based on Designtex and Maharam lead times. For current grades, refer to Coalesse website: www.Coalesse.com.

Pre-approved CAL 133 Textiles Designtex and Maharam textiles have been graded into our pricing; however, not all textiles are recommended on all seating. For current grade and approval information, please visit our website and click on FABRICEVALUATIONS to obtain grade pricing for a specific pattern.

Wood and Finish Specifications

Solid hardwood is a renewable natural resource, and each section of a tree is unique. The color and grain pattern will vary emphasizing the natural beauty of each product built. Wood is a natural material and will accept stain differently. Coalesse cannot guarantee finished products to be an exact match to finish samples due to the natural characteristics of wood. Light finishes will exhibit some mineral streaks and dark graining due to the natural wood.

The finish used by Coalesse on hardwood frames and occasional tables is pre-catalyzed lacquer which can be easily repaired in the field if damage occurs. Veneer is sanded prior to finish application, and sanded between coats. The lacquer top coat is then polished after final application with wool wax. 4 to 6 layers of finish are applied during the process. The CH process varies from our internal processes.

Coalesse Tables and Casegoods

Coalesse's primary wood finish, Clarity, is a water-borne UV topcoat, which protects the environment while providing exceptional durability and resistance to water and chemical stains. contoured products, such as wood guest chairs & occasional tables, are finished with post-catalyzed vinyl, which provides similar properties and matches the sheen and color of Clarity, due to natural variations in wood, finished products may vary from samples in color, texture, and grain.

Stain-To-Match Program

Coalesse will offer a stain to match program at no additional upcharge for all products with wood finish options.

Customer must supply Coalesse Customer Service with sample to be matched. (internal note - CSR's will have samples of bare wood to compare and define species when applicable that will be used to accomplish the closest stain to match).

Coalesse high sheen will be standard unless specified by customer.

Sheen to match is available as part of the stain/sheen to match program at no upcharge.

Species to match is considered a special and requires to special request to Coalesse Customer Service. Species to match may require an upcharge.

Care and Maintenance

Chrome

Use commercial cleanser and polish, according to manufacturer's directions.

Fabric

Under normal use, clean with soft cloth dampened with water. For spots and spills, we recommend professional cleaning. For COM, refer to the specific cleaning instructions recommended by the fabric supplier.

Emu Outdoor Fabric:

Remove loose dirt with soft bristle brush or hose down with cold water. Clean with mixture of water and mild soap. Rub in mixture with soft brush and allow to thoroughly soak into fabric. Rinse thoroughly with cold water and air dry. Never use water over 100 degrees Fahrenheit. Do not machine dry. For light cleaning, avoid using detergents.

For stubborn stains use mixture of one gallon cold water, 1/2 cup bleach and 1/4 cup mild soap for one hour.

Detergents can be used without harm, though they may remove some of the water and stain resistant properties in the fabric.

SW_1 Knit:

Clean with warm water and soap. Wet sponge and wipe fabric. Household cleaners such as Windex™ may be used. Do NOT use cleaners containing bleach.

Laminate and solid phenolic should be cleaned with soap and water. For stubborn stains, use a non-abrasive household cleaner.

SW_1 Tablet surfaces clean with soft cloth dampened with water and soap, if needed. The use of general purpose cleaners are acceptable but must be void of citric content that has z-butoxyethanol in the formulation listing.

Cleaning Laminate

Markerboard Surface

Use dry erase markers only. Remove dry-erase markings with a markerboard eraser or soft cloth as often as possible. Change erasers, as they become dirty. Dirty erasers will leave ink residue on the surface.

For daily cleaning, or as needed, use a dry erase cleaner, or a non-abrasive household cleaner, such as glass cleaner. This may be done with a soft cloth or sponge. Dry the surface with a soft cloth prior to writing. All markings should be removed weekly.

Caution:

- Do not use permanent markers on markerboard surfaces. In the event a permanent marker is used, removal of markings may be attempted by using dry erase cleaner, or by writing over the marking with a dry erase marker and erasing with a markerboard eraser or soft cloth.
- Do not use abrasive cleaners or solvent type cleaning solutions, such as Ketones (Acetone, MEK, etc.) lacquer thinner, nail polish remover, etc. because they may remove the finish from the markerboard surface.

Cleaning CeramicSteel

Markerboard Surface

- Care and maintenance applies to both a³ CeramicSteel and e³ CeramicSteel.
- Wipe board with a clean cloth moistened by a liquid markerboard cleaner or a solution of 50% water and 50% isopropyl alcohol.
- Rinse with clear water.
- Wipe dry with a clean cloth. If your board is used daily, the cleaning should be performed at least 2-3 times a week.

More thorough cleaning may be required if writing is left on the board for more than two days.

Markers

Use any high-quality dry erase marker.

CAUTION! The use of Low Odor markers may cause ghosting to occur. If Low Odor markers have been used, the surface can be completely cleaned by following the cleaning instructions above. Remember to discard eraser if used with Low Odor markers.

Removing Permanent Marker

Option 1:

- Write over the top of the permanent marker ink with a dry-erase marker
- Simply erase

Option 2:

- Moisten a clean, dry cloth with isopropyl alcohol
- Wipe the board in a circular motion to loosen marker residue
- Rinse with clear water
- Dry the board with a clean cloth
- Repeat these steps as necessary

Installer's Instructions for Initial Cleaning at Time of Installation

NOTE: These initial cleaning instructions are shipped with every board.

- For initial cleaning, wipe your board with a clean cloth moistened by a mild, alcohol-based cleaner.
- Rinse with clear water. This step is simple, but very important.
- Wipe dry with a clean cloth.

Leather

Under normal use, regular dusting and vacuum cleaning are all that is necessary. For spots and spills, wipe excess liquid immediately. If necessary, use lukewarm water cleaning the entire area where spot occurred and air dry. For stubborn spots or stains, use a solution of mild non-detergent soap and air dry. For butter, oil, or grease, wipe excess with dry cloth and then leave alone. The spot will dissipate into the leather. Do not apply water.

Faux Leather

Under normal use, clean with soft cloth dampened with water. For spots and stains, use the recommended mixture of Woolite and water. Rinse with clean water and air dry.

Granite/Glass

Under normal use, clean with Windex and soft cotton cloth.

Powder coat finishes on chairs and table bases

should be cleaned with a liquid detergent and water. Remove stubborn stains with liquid cleanser, such as Formula 409.

Emu Outdoor Paint:

Store in an enclosed and dry area during winter to avoid condensation. Before winter and regularly every quarter, clean the metal surfaces with a cloth dipped in water or detergent and protect them with vasoline oil or car polish. Do not use ethyl alcohol or detergents that contain even in small quantities acetone, trichloroethylene, or ammonia (or solvents in general). When storing tables, do not stack them or put the table tops in direct contact with each other. Handle the seats with care when stacking them to avoid damaging the varnished surfaces.

Polished Aluminum finishes

on table bases should be cleaned with a commercial powder, liquid, or paste metal cleaner and polish. Follow the manufacturer's directions.

Veneers and painted MDF

should be cleaned regularly with mild soap and water and dried with a soft cloth. *Tip: Never use ammonia-based cleaners or wax on wood surfaces.*

Veneers should be cleaned regularly with mild soap and water and dried with a soft cloth.

Tip: Never use ammonia-based cleaners or wax on wood surfaces.

Protecting Wood Surfaces

Use desk pads and coasters to help protect the finish against dents, scratches, moisture and hot and cold liquids. Do not use desk pads that have plastic backing. Use felt or leather pads on the bottoms of office equipments and accessories.

Periodically move desk accessories and other objects kept on the worksurface to ensure even aging.

Lift objects when you move them, instead of pulling or pushing them across the surface, to avoid scratching the surface. Avoid leaving vinyl binders on worksurface for long periods.

If you use a protective glass top, insert felt pads between the glass and the worksurface to create an air space and allow the wood to breathe.

Keep your furniture away from direct sunlight. Avoid extreme temperatures and humidity. Maintain temperatures between 60 and 80 degrees Fahrenheit and humidity levels between 30 and 50 percent.

Cleaning Wood Surfaces

Keep a supply of soft, clean, absorbent cloths handy for wiping up spills and regular dusting.

To dust, wipe with a slightly damp, soft cloth, using another soft cloth to dry. Always wipe the surface in the direction of the woodgrain.

Use a quality cleaner or flax soap formulated especially for use on wood surfaces. Do not use oils or ammonia. Dilute the cleaner as directed by the manufacturer. Dampen but do not saturate a soft cloth with the diluted cleaning solution. Wipe the surface in the direction of the woodgrain to remove dirt and fingerprints. Wipe the surface clean with a soft, dry cloth.

Care and Maintenance

Vinyl

Under normal use, clean with soft cloth dampened with mild soap solution. For stubborn stains and spills, a sponge or soft brush may be used with mild non-abrasive cleaner.

Transolid/Corian:

Clean regularly with mild soap and water. Dry with a soft cloth.

Tables should be inspected and maintained regularly by tightening screws and bolts, inspecting casters and glides for damage, and inspecting all moving parts for damage and wear.

Resources

Style Number Index

390

Style Number Index

Style Number	Page	Description	Style Number	Page	Description
100-T1	70	Bob Round Occasional Table	50632625	287	Reunion 30"W Rect Seminar
100-T2	70	Bob Round Occasional Table	50632655	291	Reunion 30"W Rect Seminar
100-T3	71	Bob Round Occasional Table	50633625	288	Reunion 36"W Rect Seminar
100-T4	71	Bob Round Occasional Table	50633655	292	Reunion 36"W Rect Seminar
105-T1	71	Bob Round Conference Dining Table	50641625	287	Reunion 24"W Rect Seminar
105-T2	71	Bob Round Conference Dining Table	50641655	291	Reunion 24"W Rect Seminar
105-T3	72	Bob Round Conference Dining Table	50642625	287	Reunion 30"W Rect Seminar
105-T4	72	Bob Round Conference Dining Table	50642655	291	Reunion 30"W Rect Seminar
321891	101	Train Receptacle, Circuit 1	50643625	288	Reunion 36"W Rect Seminar
321892	101	Train Receptacle, Circuit 2	50643655	292	Reunion 36"W Rect Seminar
321893	101	Train Receptacle, Circuit 3	51091000	302	Reunion 90° Connect Top
321894	101	Train Receptacle, Circuit 4	51092000	302	Reunion 90° Connect Top
321899	108	Wall Jack/Faceplate	51093000	302	Reunion 90° Connect Top
39-2424	85	Switch Square	51421625	298	Reunion 60° Trapezoid Seminar
39-2442	85	Switch Rectangle	51421655	299	Reunion 60° Trapezoid Seminar
39-3636	85	Switch Square	51432625	298	Reunion 60° Trapezoid Seminar
44-T164830	84	Passerelle Occasional Table	51432655	299	Reunion 60° Trapezoid Seminar
44-T242417	84	Passerelle Occasional Table	793215	20	Grommet
44-T242421	84	Passerelle Occasional Table	793330	29, 68, 110, 284	Power Strip
47-T1326C	73	Diekman Wood Table	793332	68	Ballet Vertical Wire Mgr
47-T1623A	73	Diekman Wood Table	793333	69, 304	Ballet Mobile Strg Cart
47-T1623B	73	Diekman Wood Table	793335	68, 303	Bar Ganger Package
47-T17ELG	73	Diekman Wood Table	793365	303	Flex Ganger Package
47-T17RG1	73	Diekman Wood Table	793369	161	Floor Monument Kit
47-T2217E	73	Diekman	793442	30, 303	Horizontal Wire Mngr
47-T23EL	73	Diekman	793448	30, 303	Horizontal Wire Mngr
47-T2617D	73	Diekman	793460	30, 303	Horizontal Wire Mngr
50348625	300	Reunion Half Round Seminar	793472	30, 303	Horizontal Wire Mngr
50348655	301	Reunion Half Round Seminar	793742	304	Reunion Seminar Modsty Pnl
50360625	300	Reunion Half Round Seminar	793748	304	Reunion Seminar Modsty Pnl
50360655	301	Reunion Half Round Seminar	793760	304	Reunion Seminar Modsty Pnl
50372625	300	Reunion Half Round Seminar	793772	304	Reunion Seminar Modsty Pnl
50372655	301	Reunion Half Round Seminar	793893	30, 48	Vertical Wire Manager
50436625	295	Reunion Square Seminar	802511	61	Ballet Folding K-Base
50436655	297	Reunion Square Seminar	802561	61	Ballet Folding K-Base
50442625	295	Reunion Square Seminar	803512	61	Ballet Folding K-Base
50442655	297	Reunion Square Seminar	803562	61	Ballet Folding K-Base
50448625	295	Reunion Square Seminar	804513	61	Ballet Folding K-Base
50448655	297	Reunion Square Seminar	804563	61	Ballet Folding K-Base
50460625	295	Reunion Square Seminar	809000	67	Ballet Connecting Top
50460655	297	Reunion Square Seminar	814412	57	Ballet Folding X-Base
50611625	287	Reunion 24"W Rect Seminar	814462	57	Ballet Folding X-Base
50611655	291	Reunion 24"W Rect Seminar	815413	57	Ballet Folding X-Base
50612625	287	Reunion 24"W Rect Seminar	815463	57	Ballet Folding X-Base
50612655	291	Reunion 24"W Rect Seminar	816414	57	Ballet Folding X-Base
50613625	288	Reunion 36"W Rect Seminar	816464	57	Ballet Folding X-Base
50613655	292	Reunion 36"W Rect Seminar	823411	57	Ballet Folding X-Base
50621625	287	Reunion 30"W Rect Seminar	823461	57	Ballet Folding X-Base
50621655	291	Reunion 30"W Rect Seminar	824412	57	Ballet Folding X-Base
50622625	287	Reunion 30"W Rect Seminar	824462	57	Ballet Folding X-Base
50622655	291	Reunion 30"W Rect Seminar	825413	57	Ballet Folding X-Base
50623625	288	Reunion 36"W Rect Seminar	825463	57	Ballet Folding X-Base
50623655	292	Reunion 36"W Rect Seminar	826414	57	Ballet Folding X-Base
50631625	287	Reunion 24"W Rect Seminar	826464	57	Ballet Folding X-Base
50631655	291	Reunion 24"W Rect Seminar	834402	59	Ballet Non-Folding X-Base

Style Number Index

Style Number	Page	Description	Style Number	Page	Description
834452	59	Ballet Non-Folding X-Base	912501	66	Ballet Non-Folding K-Base
835403	59	Ballet Non-Folding X-Base	912551	66	Ballet Non-Folding K-Base
835453	59	Ballet Non-Folding X-Base	913502	66	Ballet Non-Folding K-Base
836404	59	Ballet Non-Folding X-Base	913552	66	Ballet Non-Folding K-Base
836454	59	Ballet Non-Folding X-Base	914503	66	Ballet Non-Folding K-Base
842511	61	Ballet Folding K-Base	914553	66	Ballet Non-Folding K-Base
842561	61	Ballet Folding K-Base	915405	51	Ballet Arc
843512	61	Ballet Folding K-Base	915415	51	Ballet Arc
843562	61	Ballet Folding K-Base	916406	51	Ballet Arc
844513	61	Ballet Folding K-Base	916416	51	Ballet Arc
844563	61	Ballet Folding K-Base	919423C	52	Ballet Non-Folding Side
849000	67	Ballet Connecting Top	920424C	52	Ballet Non-Folding Side
853411	56	Ballet Folding X-Base	926421	54	Ballet Sqr Pedestal Base
853461	56	Ballet Folding X-Base	927422	54	Ballet Pedestal
854412	56	Ballet Folding X-Base	933421	53	Ballet Rnd Pedestal Base
854462	56	Ballet Folding X-Base	933421T	50	Ballet Round Café
855413	56	Ballet Folding X-Base	934421	53	Ballet Rnd Pedestal Base
855463	56	Ballet Folding X-Base	934422T	50	Ballet Round Café
856414	56	Ballet Folding X-Base	AL2424SC	44	Au Lait Square Table Solid Core Top
856464	56	Ballet Folding X-Base	AL2424USC	44	Au Lait Square Table Solid Core Top
862501	65	Ballet Non-Folding K-Base	AL2430SC	46	Au Lait Rect Solid Core Top
862551	65	Ballet Non-Folding K-Base	AL2430USC	46	Au Lait Rect Solid Core Top
863502	65	Ballet Non-Folding K-Base	AL2436SC	46	Au Lait Rect Solid Core Top
863552	65	Ballet Non-Folding K-Base	AL2436USC	46	Au Lait Rect Solid Core Top
864503	65	Ballet Non-Folding K-Base	AL3000SC	42	Au Lait Round Table Solid Core Top
864553	65	Ballet Non-Folding K-Base	AL3000USC	42	Au Lait Round Table Solid Core Top
873401	58	Ballet Non-Folding X-Base	AL3030SC	44	Au Lait Square Table Solid Core Top
873451	58	Ballet Non-Folding X-Base	AL3030USC	44	Au Lait Square Table Solid Core Top
874402	58	Ballet Non-Folding X-Base	AL3036SC	46	Au Lait Rect Solid Core Top
874452	58	Ballet Non-Folding X-Base	AL3036USC	47	Au Lait Rect Solid Core Top
875403	58	Ballet Non-Folding X-Base	AL3042MC	47	Au Lait Rect Solid Core Top
875453	58	Ballet Non-Folding X-Base	AL3042UMC	47	Au Lait Rect Solid Core Top
876404	58	Ballet Non-Folding X-Base	AL3600SC	43	Au Lait Round Table Solid Core Top
876454	58	Ballet Non-Folding X-Base	AL3600USC	43	Au Lait Round Table Solid Core Top
883401	59	Ballet Non-Folding X-Base	AL3636MC	45	Au Lait Square Table Solid Core Top
883451	59	Ballet Non-Folding X-Base	AL3636UMC	45	Au Lait Square Table Solid Core Top
884402	59	Ballet Non-Folding X-Base	AL4200MC	43	Au Lait Round Table Solid Core Top
884452	59	Ballet Non-Folding X-Base	AL4200UMC	43	Au Lait Round Table Solid Core Top
885403	59	Ballet Non-Folding X-Base	ALB2424SC	44	Au Lait Square Table Solid Core Top
885453	59	Ballet Non-Folding X-Base	ALB2424USC	44	Au Lait Square Table Solid Core Top
886404	59	Ballet Non-Folding X-Base	ALB3000SC	43	Au Lait Round Table Solid Core Top
886454	59	Ballet Non-Folding X-Base	ALB3000USC	43	Au Lait Round Table Solid Core Top
892501	65	Ballet Non-Folding K-Base	ALB3030MC	45	Au Lait Square Table Solid Core Top
892551	65	Ballet Non-Folding K-Base	ALB3030USC	45	Au Lait Square Table Solid Core Top
893502	65	Ballet Non-Folding K-Base	ALB3600MC	43	Au Lait Round Table Solid Core Top
893552	65	Ballet Non-Folding K-Base	ALB3600UMC	43	Au Lait Round Table Solid Core Top
894503	65	Ballet Non-Folding K-Base	ALB3636MC	45	Au Lait Square Table Solid Core Top
894553	65	Ballet Non-Folding K-Base	ALB3636UMC	45	Au Lait Square Table Solid Core Top
902511	62	Ballet Folding K-Base	ALCASTER	48	Au Lait Caster
902561	62	Ballet Folding K-Base	ALGLIDE	48	Au Lait Glide
903512	62	Ballet Folding K-Base	ALW2424SC	44	Au Lait Square Table Solid Core Top
903562	62	Ballet Folding K-Base	ALW2424USC	44	Au Lait Square Table Solid Core Top
904513	62	Ballet Folding K-Base	ALW2430SC	46	Au Lait Rect Solid Core Top
904563	62	Ballet Folding K-Base	ALW2430USC	46	Au Lait Rect Solid Core Top
909000	67	Ballet Connecting Top	ALW2436SC	46	Au Lait Rect Solid Core Top

Style Number Index *continued*

Style Number	Page	Description	Style Number	Page	Description
ALW2436USC	46	Au Lait Rect Solid Core Top	COMOTL2020	83	Millbrae Side Table
ALW3000SC	42	Au Lait Round Table Solid Core Top	COMOTL2054	83	Millbrae Rectangular Table
ALW3000USC	42	Au Lait Round Table Solid Core Top	COMOTL3030	83	Millbrae Square Table
ALW3030SC	45	Au Lait Square Table Solid Core Top	COMOTL3060	83	Millbrae Rectangular Table
ALW3030USC	45	Au Lait Square Table Solid Core Top	COMOTL3636	83	Millbrae Square Table
ALW3036SC	47	Au Lait Rect Solid Core Top	COMOTL4848	83	Millbrae Square Table
ALW3036USC	47	Au Lait Rect Solid Core Top	COSFZCTRD	91	Montara650 Café-Height Table
ALW3042MC	47	Au Lait Rect Solid Core Top	COSFZCTSQ	91	Montara650 Café-Height Table
ALW3042UMC	47	Au Lait Rect Solid Core Top	COSFZOTRD	92	Montara650 Occasional Table
ALW3600SC	43	Au Lait Round Table Solid Core Top	COSFZOTSQ	92	Montara650 Occasional Table
ALW3600USC	43	Au Lait Round Table Solid Core Top	COSFZWTRD	89	Montara650 Work-Height Table
ALW3636MC	45	Au Lait Square Table Solid Core Top	COSFZWTSQ	89	Montara650 Work-Height Table
ALW3636UMC	45	Au Lait Square Table Solid Core Top	COW_RC4284	312	SW_1 Rectangular Conference Table
ALW4200MC	43	Au Lait Round Table Solid Core Top	COW_RC48120	312	SW_1 Rectangular Conference Table
ALW4200UMC	43	Au Lait Round Table Solid Core Top	COW_RC48122	312	SW_1 Rectangular Conference Table
COBPIFMH	28, 109	Two-Circuit Hdwr Base Pwr Infeed	COW_RC48144	312	SW_1 Rectangular Conference Table
COBPIFMP20	28, 109	Single-Circuit 20-Amp Plug Base Pwr Infeed	COW_RC4896	312	SW_1 Rectangular Conference Table
COC1MBWMS	347	Mobile Mediaboard Dsp. w/SC media:scape Tech.	COW_RND30	314	SW_1 Round Table
COCCD303219	327	Exponents Mobile Cart	COW_RND36	314	SW_1 Round Table
COCCMAS30	327, 329	Exponents Adjustable Shelf	COW_RND42	314	SW_1 Round Table
COCL42	343	Exponents Lectern	COW_RND48	314	SW_1 Round Table
COCMBSHLF	345, 347	Eponents Shelf	COW_RND60	311	SW_1 Conference Table
COCMBW	345	Mobile Mediaboard Display	COW_RND72	311	SW_1 Conference Table
COCMD304219	329	Exponents Moby	COW_RND84	311	SW_1 Conference Table
COCWBN	344	Mobile Whiteboard Display	COW_RND96	311	SW_1 Conference Table
COCWBW	344	Mobile Whiteboard Display	COW_RT3060	318	SW_1 Rectangular Work Table
COCZAS48	337, 342	Adjustable Shelf for 48"W Credenza	COW_RT3072	318	SW_1 Rectangular Work Table
COCZASEND72	337, 342	Adjustable Shelf for 72"W Credenza, End	COW_RT3660	318	SW_1 Rectangular Work Table
COCZASEND96	338, 342	Adjustable Shelf for 96"W Credenza, End	COW_RT3672	318	SW_1 Rectangular Work Table
COCZASMD72	337, 342	Adjustable Shelf for 72"W Credenza, Middle	COW_SE4060	318	SW_1 Super-Elliptical Work Table
COCZASMD96	338, 342	Adjustable Shelf for 96"W Credenza, Middle	COW_SE4072	318	SW_1 Super-Elliptical Work Table
COCZBDC184815	332	Exponents Bench with Doors	COW_SEC120	313	SW_1 Super Elliptical Conference Table
COCZBDC187215	332	Exponents Bench with Doors	COW_SEC122	313	SW_1 Super Elliptical Conference Table
COCZBDC189615	332	Exponents Bench with Doors	COW_SEC144	313	SW_1 Super Elliptical Conference Table
COCZBE182415	333	Exponents End-of-Run Bench Bridge	COW_SEC168	313	SW_1 Super Elliptical Conference Table
COCZBI182415	333	Exponents In-Line Bench Bridge	COW_SEC192	313	SW_1 Super Elliptical Conference Table
COCZBOC184815	332	Exponents Open Bench	COW_SEC213	313	SW_1 Super Elliptical Conference Table
COCZBOC187215	332	Exponents Open Bench	COW_SEC216	313	SW_1 Super Elliptical Conference Table
COCZBOC189615	332	Exponents Open Bench	COW_SEC240	313	SW_1 Super Elliptical Conference Table
COCZD254827	337	Exponents Credenza 27"H	COW_SEC243	313	SW_1 Super Elliptical Conference Table
COCZD257227	337	Exponents Credenza 27"H	COW_SEC84	313	SW_1 Super Elliptical Conference Table
COCZD259627	337	Exponents Credenza 27"H	COW_SEC96	313	SW_1 Super Elliptical Conference Table
COCZDO257227	337	Exponents Credenza 27"H	COW_SQ30	314	SW_1 Square Table
COCZDO259627	337	Exponents Credenza 27"H	COW_SQ36	314	SW_1 Square Table
COCZUD254839	342	Exponents Credenza 39"H	COW_SQ42	314	SW_1 Square Table
COCZUD257239	342	Exponents Credenza 39"H	COW_SQ60	311	SW_1 Conference Table
COCZUD259639	342	Exponents Credenza 39"H	COW_SQ72	311	SW_1 Conference Table
CODHA4	25, 104	Axil Z, Hardwire	COW_SQ84	311	SW_1 Conference Table
CODHE4	27, 106	Ellora, Hardwire	COW_SQ96	311	SW_1 Conference Table
CODPA4	24, 103	Axil Z, Hardwire	COW_SSQ45	314	SW_1 Super-Square Table
CODPE4	26, 105	Ellora, Hardwire	COWHWM	319	SW_1 Horizontal Wire Manager Clips
COLAGTO	81	Lagunitas Occasional Table	COWO_RND30	317	SW_1 Round Occasional Table
COLAGTP	82	Lagunitas Personal Table	COWO_RND36	317	SW_1 Round Occasional Table
COLAGTRECT	80	Lagunitas Work Table	COWO_RND42	317	SW_1 Round Occasional Table
COLAGTW	80	Work Tables	COWO_RND48	317	SW_1 Round Occasional Table

Style Number Index

Style Number	Page	Description	Style Number	Page	Description
COWO_RND60	317	SW_1 Occasional Table	E2C9636A	132	E-Table 2 Racetrack
COWO_SQ30	317	SW_1 Square Occasional Table	E2C9642A	132	E-Table 2 Racetrack
COWO_SQ36	317	SW_1 Square Occasional Table	E2C9648L	137	E-Table 2 Racetrack
COWO_SQ42	317	SW_1 Square Occasional Table	E2C9654L	137	E-Table 2 Racetrack
COWO_SQ60	317	SW_1 Occasional Table	E2C9660L	137	E-Table 2 Racetrack
COWO_SSQ45	317	SW_1 Super-Square Occasional Table	E2F1048L	139	E-Table 2 Faceted
COWVWM26	319	SW_1 Vertical Wire Manager	E2F1054L	139	E-Table 2 Faceted
COWVWM28	319	SW_1 Vertical Wire Manager	E2F1060L	139	E-Table 2 Faceted
COWX_Q42	307	SW_1 Square Low Coll Conf Tbl	E2F1248L	139	E-Table 2 Faceted
COWX_R4120	308	SW_1 Rectangular Low Coll Conf Tbl	E2F1254L	139	E-Table 2 Faceted
COWX_R4284	308	SW_1 Rectangular Low Coll Conf Tbl	E2F1260L	139	E-Table 2 Faceted
COWX_RND60	307	SW_1 Low Collaborative Conference Table	E2F1448L	145	E-Table 2 Faceted
COWX_RND72	307	SW_1 Low Collaborative Conference Table	E2F1454L	145	E-Table 2 Faceted
COWX_RND84	307	SW_1 Low Collaborative Conference Table	E2F1460L	145	E-Table 2 Faceted
COWX_RND96	307	SW_1 Low Collaborative Conference Table	E2F1648L	145	E-Table 2 Faceted
COWX_SE4072	308	SW_1 Super Elliptical Low Coll Conf Tbl	E2F1654L	146	E-Table 2 Faceted
COWX_SE4084	308	SW_1 Super Elliptical Low Coll Conf Tbl	E2F1660L	146	E-Table 2 Faceted
COWX_SE4096	308	SW_1 Super Elliptical Low Coll Conf Tbl	E2F1848L	146	E-Table 2 Faceted
COWX_SE4120	308	SW_1 Super Elliptical Low Coll Conf Tbl	E2F1854L	146	E-Table 2 Faceted
COWX_SE4122	308	SW_1 Super Elliptical Low Coll Conf Tbl	E2F1860L	146	E-Table 2 Faceted
COWX_SQ60	307	SW_1 Low Collaborative Conference Table	E2F2048L	146	E-Table 2 Faceted
COWX_SQ72	307	SW_1 Low Collaborative Conference Table	E2F2054L	146	E-Table 2 Faceted
COWX_SQ84	307	SW_1 Low Collaborative Conference Table	E2F2060L	146	E-Table 2 Faceted
COWX_SQ96	307	SW_1 Low Collaborative Conference Table	E2F2248L	152	E-Table 2 Faceted
CSP	21	Communications Sphere	E2F2254L	152	E-Table 2 Faceted
E2C1048L	137	E-Table 2 Racetrack	E2F2260L	152	E-Table 2 Faceted
E2C1054L	137	E-Table 2 Racetrack	E2F2448L	153	E-Table 2 Faceted
E2C1060L	137	E-Table 2 Racetrack	E2F2454L	153	E-Table 2 Faceted
E2C1248L	138	E-Table 2 Racetrack	E2F2460L	153	E-Table 2 Faceted
E2C1254L	138	E-Table 2 Racetrack	E2F7236A	132	E-Table 2 Faceted
E2C1260L	138	E-Table 2 Racetrack	E2F7242A	132	E-Table 2 Faceted
E2C1448L	143	E-Table 2 Racetrack	E2F7248A	132	E-Table 2 Faceted
E2C1454L	143	E-Table 2 Racetrack	E2F8436A	132	E-Table 2 Faceted
E2C1460L	143	E-Table 2 Racetrack	E2F8442A	132	E-Table 2 Faceted
E2C1648L	144	E-Table 2 Racetrack	E2F8448A	132	E-Table 2 Faceted
E2C1654L	144	E-Table 2 Racetrack	E2F9636A	133	E-Table 2 Faceted
E2C1660L	144	E-Table 2 Racetrack	E2F9642A	133	E-Table 2 Faceted
E2C1848L	144	E-Table 2 Racetrack	E2F9648L	138	E-Table 2 Faceted
E2C1854L	144	E-Table 2 Racetrack	E2F9654L	138	E-Table 2 Faceted
E2C1860L	144	E-Table 2 Racetrack	E2F9660L	138	E-Table 2 Faceted
E2C2048L	145	E-Table 2 Racetrack	E2R1048L	140	E-Table 2 Rectangle
E2C2054L	145	E-Table 2 Racetrack	E2R1054L	140	E-Table 2 Rectangle
E2C2060L	145	E-Table 2 Racetrack	E2R1060L	140	E-Table 2 Rectangle
E2C2248L	151	E-Table 2 Racetrack	E2R1248L	140	E-Table 2 Rectangle
E2C2254L	151	E-Table 2 Racetrack	E2R1254L	140	E-Table 2 Rectangle
E2C2260L	151	E-Table 2 Racetrack	E2R1260L	140	E-Table 2 Rectangle
E2C2448L	152	E-Table 2 Racetrack	E2R1448L	147	E-Table 2 Rectangle
E2C2454L	152	E-Table 2 Racetrack	E2R1454L	147	E-Table 2 Rectangle
E2C2460L	152	E-Table 2 Racetrack	E2R1460L	147	E-Table 2 Rectangle
E2C7236A	131	E-Table 2 Racetrack	E2R1648L	147	E-Table 2 Rectangle
E2C7242A	131	E-Table 2 Racetrack	E2R1654L	147	E-Table 2 Rectangle
E2C7248A	131	E-Table 2 Racetrack	E2R1660L	147	E-Table 2 Rectangle
E2C8436A	131	E-Table 2 Racetrack	E2R1848L	147	E-Table 2 Rectangle
E2C8442A	131	E-Table 2 Racetrack	E2R1854L	147	E-Table 2 Rectangle
E2C8448A	131	E-Table 2 Racetrack	E2R1860L	148	E-Table 2 Rectangle

Style Number Index *continued*

Style Number	Page	Description	Style Number	Page	Description
E2R2048L	148	E-Table 2 Rectangle	E2S9648L	141	E-Table 2 Soft Radius End
E2R2054L	148	E-Table 2 Rectangle	E2S9654L	141	E-Table 2 Soft Radius End
E2R2060L	148	E-Table 2 Rectangle	E2S9660L	141	E-Table 2 Soft Radius End
E2R2248L	153	E-Table 2 Rectangle	E2T1036A	157	E-Table 2 Trapezoid
E2R2254L	153	E-Table 2 Rectangle	E2T1048L	160	E-Table 2 Trapezoid
E2R2260L	153	E-Table 2 Rectangle	E2T1236A	157	E-Table 2 Trapezoid
E2R2448L	153	E-Table 2 Rectangle	E2T1248L	160	E-Table 2 Trapezoid
E2R2454L	154	E-Table 2 Rectangle	E2T1436A	157	E-Table 2 Trapezoid
E2R2460L	154	E-Table 2 Rectangle	E2T1448L	160	E-Table 2 Trapezoid
E2R7236A	133	E-Table 2 Rectangle	E2T9636A	157	E-Table 2 Trapezoid
E2R7242A	133	E-Table 2 Rectangle	E2T9648L	160	E-Table 2 Trapezoid
E2R7248A	133	E-Table 2 Rectangle	E2TK	161	E-Table 2 Transformer Kit
E2R8436A	133	E-Table 2 Rectangle	H35-T2436L	77	Enea Table Single Base
E2R8442A	133	E-Table 2 Rectangle	H35-T2436W	77	Enea Table Single Base
E2R8448A	133	E-Table 2 Rectangle	H35-T2442L	77	Enea Table Single Base
E2R9636A	134	E-Table 2 Rectangle	H35-T2442W	77	Enea Table Single Base
E2R9642A	134	E-Table 2 Rectangle	H35-T3030L	76	Enea Table Single Base
E2R9648L	139	E-Table 2 Rectangle	H35-T3030W	76	Enea Table Single Base
E2R9654L	140	E-Table 2 Rectangle	H35-T3036L	77	Enea Table Single Base
E2R9660L	140	E-Table 2 Rectangle	H35-T3036W	77	Enea Table Single Base
E2RND48L	129	E-Table 2 48" Dia Round Table	H35-T3042L	77	Enea Table Single Base
E2RND54L	129	E-Table 2 54" Dia Round Table	H35-T3042W	77	Enea Table Single Base
E2RND60L	129	E-Table 2 60" Dia Round Table	H35-T307230GL	78	Enea Table Twin Base
E2S1048L	141	E-Table 2 Soft Radius End	H35-T307230GW	78	Enea Table Twin Base
E2S1054L	141	E-Table 2 Soft Radius End	H35-T307230KL	79	Enea Table Twin Base
E2S1060L	141	E-Table 2 Soft Radius End	H35-T307230KW	79	Enea Table Twin Base
E2S1248L	141	E-Table 2 Soft Radius End	H35-T307230VL	79	Enea Table Twin Base
E2S1254L	141	E-Table 2 Soft Radius End	H35-T307230VW	79	Enea Table Twin Base
E2S1260L	141	E-Table 2 Soft Radius End	H35-T307236GL	78	Enea Table Twin Base
E2S1448L	148	E-Table 2 Soft Radius End	H35-T307236GW	78	Enea Table Twin Base
E2S1454L	148	E-Table 2 Soft Radius End	H35-T307236KL	79	Enea Table Twin Base
E2S1460L	148	E-Table 2 Soft Radius End	H35-T307236KW	79	Enea Table Twin Base
E2S1648L	148	E-Table 2 Soft Radius End	H35-T307236VL	79	Enea Table Twin Base
E2S1654L	149	E-Table 2 Soft Radius End	H35-T307236VW	79	Enea Table Twin Base
E2S1660L	149	E-Table 2 Soft Radius End	H35-T307242GL	78	Enea Table Twin Base
E2S1848L	149	E-Table 2 Soft Radius End	H35-T307242GW	78	Enea Table Twin Base
E2S1854L	149	E-Table 2 Soft Radius End	H35-T307242KL	79	Enea Table Twin Base
E2S1860L	149	E-Table 2 Soft Radius End	H35-T307242KW	79	Enea Table Twin Base
E2S2048L	149	E-Table 2 Soft Radius End	H35-T307242VL	79	Enea Table Twin Base
E2S2054L	149	E-Table 2 Soft Radius End	H35-T307242VW	79	Enea Table Twin Base
E2S2060L	149	E-Table 2 Soft Radius End	H35-T3618L	76	Enea Table Single Base
E2S2248L	154	E-Table 2 Soft Radius End	H35-T3618W	76	Enea Table Single Base
E2S2254L	154	E-Table 2 Soft Radius End	H35-T3630L	76	Enea Table Single Base
E2S2260L	154	E-Table 2 Soft Radius End	H35-T3630W	76	Enea Table Single Base
E2S2448L	154	E-Table 2 Soft Radius End	H35-T3636L	77	Enea Table Single Base
E2S2454L	154	E-Table 2 Soft Radius End	H35-T3636W	77	Enea Table Single Base
E2S2460L	154	E-Table 2 Soft Radius End	H35-T3642L	77	Enea Table Single Base
E2S7236A	134	E-Table 2 Soft Radius End	H35-T3642W	77	Enea Table Single Base
E2S7242A	134	E-Table 2 Soft Radius End	H35-T4218L	76	Enea Table Single Base
E2S7248A	134	E-Table 2 Soft Radius End	H35-T4218W	76	Enea Table Single Base
E2S8436A	134	E-Table 2 Soft Radius End	H35-T4230L	76	Enea Table Single Base
E2S8442A	134	E-Table 2 Soft Radius End	H35-T4230W	76	Enea Table Single Base
E2S8448A	134	E-Table 2 Soft Radius End	H35-T4236L	77	Enea Table Single Base
E2S9636A	135	E-Table 2 Soft Radius End	H35-T4236W	77	Enea Table Single Base
E2S9642A	135	E-Table 2 Soft Radius End	HS1048C10	227	Host Racetrack

Style Number Index

Style Number	Page	Description	Style Number	Page	Description
HS1048C11	227	Host Racetrack	HS1248C10	231	Host Racetrack
HS1048C12	227	Host Racetrack	HS1248C11	231	Host Racetrack
HS1048C13	227	Host Racetrack	HS1248C12	231	Host Racetrack
HS1048C20	228	Host Racetrack	HS1248C13	231	Host Racetrack
HS1048C21	228	Host Racetrack	HS1248C20	232	Host Racetrack
HS1048C22	228	Host Racetrack	HS1248C21	232	Host Racetrack
HS1048R10	168	Host Rectangular	HS1248C22	232	Host Racetrack
HS1048R11	168	Host Rectangular	HS1248R10	171	Host Rectangular
HS1048R12	168	Host Rectangular	HS1248R11	171	Host Rectangular
HS1048R13	169	Host Rectangular	HS1248R12	171	Host Rectangular
HS1048R20	169	Host Rectangular	HS1248R13	171	Host Rectangular
HS1048R21	169	Host Rectangular	HS1248R20	172	Host Rectangular
HS1048R22	169	Host Rectangular	HS1248R21	172	Host Rectangular
HS1048S10	197	Host Soft Radiused	HS1248R22	172	Host Rectangular
HS1048S11	197	Host Soft Radiused	HS1248S10	199	Host Soft Radiused
HS1048S12	197	Host Soft Radiused	HS1248S11	199	Host Soft Radiused
HS1048S13	197	Host Soft Radiused	HS1248S12	200	Host Soft Radiused
HS1048S20	198	Host Soft Radiused	HS1248S13	200	Host Soft Radiused
HS1048S21	198	Host Soft Radiused	HS1248S20	200	Host Soft Radiused
HS1048S22	198	Host Soft Radiused	HS1248S21	200	Host Soft Radiused
HS1060B10	259	Host Boat	HS1248S22	200	Host Soft Radiused
HS1060B11	259	Host Boat	HS1260B10	261	Host Boat
HS1060B12	259	Host Boat	HS1260B11	261	Host Boat
HS1060B13	259	Host Boat	HS1260B12	261	Host Boat
HS1060B20	260	Host Boat	HS1260B13	261	Host Boat
HS1060B21	260	Host Boat	HS1260B20	262	Host Boat
HS1060B22	260	Host Boat	HS1260B21	262	Host Boat
HS1060C10	229	Host Racetrack	HS1260B22	262	Host Boat
HS1060C11	229	Host Racetrack	HS1260C10	233	Host Racetrack
HS1060C12	229	Host Racetrack	HS1260C11	233	Host Racetrack
HS1060C13	229	Host Racetrack	HS1260C12	233	Host Racetrack
HS1060C20	230	Host Racetrack	HS1260C13	233	Host Racetrack
HS1060C21	230	Host Racetrack	HS1260C20	234	Host Racetrack
HS1060C22	230	Host Racetrack	HS1260C21	234	Host Racetrack
HS1060R10	169	Host Rectangular	HS1260C22	234	Host Racetrack
HS1060R11	169	Host Rectangular	HS1260R10	172	Host Rectangular
HS1060R12	170	Host Rectangular	HS1260R11	172	Host Rectangular
HS1060R13	170	Host Rectangular	HS1260R12	172	Host Rectangular
HS1060R20	170	Host Rectangular	HS1260R13	173	Host Rectangular
HS1060R21	170	Host Rectangular	HS1260R20	173	Host Rectangular
HS1060R22	170	Host Rectangular	HS1260R21	173	Host Rectangular
HS1060S10	198	Host Soft Radiused	HS1260R22	173	Host Rectangular
HS1060S11	198	Host Soft Radiused	HS1260S10	201	Host Soft Radiused
HS1060S12	198	Host Soft Radiused	HS1260S11	201	Host Soft Radiused
HS1060S13	199	Host Soft Radiused	HS1260S12	201	Host Soft Radiused
HS1060S20	199	Host Soft Radiused	HS1260S13	201	Host Soft Radiused
HS1060S21	199	Host Soft Radiused	HS1260S20	202	Host Soft Radiused
HS1060S22	199	Host Soft Radiused	HS1260S21	202	Host Soft Radiused
HS1060T10	279	Host Trapezoid Table	HS1260S22	202	Host Soft Radiused
HS1060T11	279	Host Trapezoid Table	HS1260T10	281	Host Trapezoid Table
HS1060T12	279	Host Trapezoid Table	HS1260T11	281	Host Trapezoid Table
HS1060T13	279	Host Trapezoid Table	HS1260T12	281	Host Trapezoid Table
HS1060T20	280	Host Trapezoid Table	HS1260T13	281	Host Trapezoid Table
HS1060T21	280	Host Trapezoid Table	HS1260T20	282	Host Trapezoid Table
HS1060T22	280	Host Trapezoid Table	HS1260T21	282	Host Trapezoid Table

Style Number Index continued

Style Number	Page	Description	Style Number	Page	Description
HS1260T22	282	Host Trapezoid Table	HS1460S32	210	Host Soft Radiused
HS1448C20	240	Host Racetrack	HS1460S34	210	Host Soft Radiused
HS1448C21	240	Host Racetrack	HS1648C20	244	Host Racetrack
HS1448C22	240	Host Racetrack	HS1648C21	244	Host Racetrack
HS1448C24	240	Host Racetrack	HS1648C22	244	Host Racetrack
HS1448C30	241	Host Racetrack	HS1648C24	244	Host Racetrack
HS1448C31	241	Host Racetrack	HS1648C30	245	Host Racetrack
HS1448C32	241	Host Racetrack	HS1648C31	245	Host Racetrack
HS1448C34	241	Host Racetrack	HS1648C32	245	Host Racetrack
HS1448R20	178	Host Rectangular	HS1648C34	245	Host Racetrack
HS1448R21	178	Host Rectangular	HS1648R20	182	Host Rectangular
HS1448R22	178	Host Rectangular	HS1648R21	182	Host Rectangular
HS1448R24	178	Host Rectangular	HS1648R22	182	Host Rectangular
HS1448R30	179	Host Rectangular	HS1648R24	182	Host Rectangular
HS1448R31	179	Host Rectangular	HS1648R30	183	Host Rectangular
HS1448R32	179	Host Rectangular	HS1648R31	183	Host Rectangular
HS1448R34	179	Host Rectangular	HS1648R32	183	Host Rectangular
HS1448S20	207	Host Soft Radiused	HS1648R34	183	Host Rectangular
HS1448S21	207	Host Soft Radiused	HS1648S20	211	Host Soft Radiused
HS1448S22	207	Host Soft Radiused	HS1648S21	211	Host Soft Radiused
HS1448S24	207	Host Soft Radiused	HS1648S22	211	Host Soft Radiused
HS1448S30	208	Host Soft Radiused	HS1648S24	211	Host Soft Radiused
HS1448S31	208	Host Soft Radiused	HS1648S30	212	Host Soft Radiused
HS1448S32	208	Host Soft Radiused	HS1648S31	212	Host Soft Radiused
HS1448S34	208	Host Soft Radiused	HS1648S32	212	Host Soft Radiused
HS1460B20	267	Host Boat	HS1648S34	212	Host Soft Radiused
HS1460B21	267	Host Boat	HS1660B20	269	Host Boat
HS1460B22	267	Host Boat	HS1660B21	269	Host Boat
HS1460B24	267	Host Boat	HS1660B22	269	Host Boat
HS1460B30	268	Host Boat	HS1660B24	269	Host Boat
HS1460B31	268	Host Boat	HS1660B30	270	Host Boat
HS1460B32	268	Host Boat	HS1660B31	270	Host Boat
HS1460B34	268	Host Boat	HS1660B32	270	Host Boat
HS1460C20	242	Host Racetrack	HS1660B34	270	Host Boat
HS1460C21	242	Host Racetrack	HS1660C20	246	Host Racetrack
HS1460C22	242	Host Racetrack	HS1660C21	246	Host Racetrack
HS1460C24	242	Host Racetrack	HS1660C22	246	Host Racetrack
HS1460C30	243	Host Racetrack	HS1660C24	246	Host Racetrack
HS1460C31	243	Host Racetrack	HS1660C30	247	Host Racetrack
HS1460C32	243	Host Racetrack	HS1660C31	247	Host Racetrack
HS1460C34	243	Host Racetrack	HS1660C32	247	Host Racetrack
HS1460R20	180	Host Rectangular	HS1660C34	247	Host Racetrack
HS1460R21	180	Host Rectangular	HS1660R20	184	Host Rectangular
HS1460R22	180	Host Rectangular	HS1660R21	184	Host Rectangular
HS1460R24	180	Host Rectangular	HS1660R22	184	Host Rectangular
HS1460R30	181	Host Rectangular	HS1660R24	184	Host Rectangular
HS1460R31	181	Host Rectangular	HS1660R30	185	Host Rectangular
HS1460R32	181	Host Rectangular	HS1660R31	185	Host Rectangular
HS1460R34	181	Host Rectangular	HS1660R32	185	Host Rectangular
HS1460S20	209	Host Soft Radiused	HS1660R34	185	Host Rectangular
HS1460S21	209	Host Soft Radiused	HS1660S20	213	Host Soft Radiused
HS1460S22	209	Host Soft Radiused	HS1660S21	213	Host Soft Radiused
HS1460S24	209	Host Soft Radiused	HS1660S22	213	Host Soft Radiused
HS1460S30	210	Host Soft Radiused	HS1660S24	213	Host Soft Radiused
HS1460S31	210	Host Soft Radiused	HS1660S30	214	Host Soft Radiused

Style Number Index

Style Number	Page	Description	Style Number	Page	Description
HS1660S31	214	Host Soft Radiused	HS1860R22	188	Host Rectangular
HS1660S32	214	Host Soft Radiused	HS1860R24	188	Host Rectangular
HS1660S34	214	Host Soft Radiused	HS1860R26	188	Host Rectangular
HS1848C20	248	Host Racetrack	HS1860R30	189	Host Rectangular
HS1848C21	248	Host Racetrack	HS1860R31	189	Host Rectangular
HS1848C22	248	Host Racetrack	HS1860R32	189	Host Rectangular
HS1848C24	248	Host Racetrack	HS1860R34	189	Host Rectangular
HS1848C26	248	Host Racetrack	HS1860R36	189	Host Rectangular
HS1848C30	249	Host Racetrack	HS1860S20	217	Host Soft Radiused
HS1848C31	249	Host Racetrack	HS1860S21	217	Host Soft Radiused
HS1848C32	249	Host Racetrack	HS1860S22	217	Host Soft Radiused
HS1848C34	249	Host Racetrack	HS1860S24	217	Host Soft Radiused
HS1848C36	249	Host Racetrack	HS1860S26	217	Host Soft Radiused
HS1848R20	186	Host Rectangular	HS1860S30	218	Host Soft Radiused
HS1848R21	186	Host Rectangular	HS1860S31	218	Host Soft Radiused
HS1848R22	186	Host Rectangular	HS1860S32	218	Host Soft Radiused
HS1848R24	186	Host Rectangular	HS1860S34	218	Host Soft Radiused
HS1848R26	186	Host Rectangular	HS1860S36	218	Host Soft Radiused
HS1848R30	187	Host Rectangular	HS2048C20	252	Host Racetrack
HS1848R31	187	Host Rectangular	HS2048C21	252	Host Racetrack
HS1848R32	187	Host Rectangular	HS2048C22	252	Host Racetrack
HS1848R34	187	Host Rectangular	HS2048C24	252	Host Racetrack
HS1848R36	187	Host Rectangular	HS2048C26	252	Host Racetrack
HS1848S20	215	Host Soft Radiused	HS2048C30	253	Host Racetrack
HS1848S21	215	Host Soft Radiused	HS2048C31	253	Host Racetrack
HS1848S22	215	Host Soft Radiused	HS2048C32	253	Host Racetrack
HS1848S24	215	Host Soft Radiused	HS2048C34	253	Host Racetrack
HS1848S26	215	Host Soft Radiused	HS2048C36	253	Host Racetrack
HS1848S30	216	Host Soft Radiused	HS2048R20	190	Host Rectangular
HS1848S31	216	Host Soft Radiused	HS2048R21	190	Host Rectangular
HS1848S32	216	Host Soft Radiused	HS2048R22	190	Host Rectangular
HS1848S34	216	Host Soft Radiused	HS2048R24	190	Host Rectangular
HS1848S36	216	Host Soft Radiused	HS2048R26	190	Host Rectangular
HS1860B20	271	Host Boat	HS2048R30	191	Host Rectangular
HS1860B21	271	Host Boat	HS2048R31	191	Host Rectangular
HS1860B22	271	Host Boat	HS2048R32	191	Host Rectangular
HS1860B24	271	Host Boat	HS2048R34	191	Host Rectangular
HS1860B26	271	Host Boat	HS2048R36	191	Host Rectangular
HS1860B30	272	Host Boat	HS2048S20	219	Host Soft Radiused
HS1860B31	272	Host Boat	HS2048S21	219	Host Soft Radiused
HS1860B32	272	Host Boat	HS2048S22	219	Host Soft Radiused
HS1860B34	272	Host Boat	HS2048S24	219	Host Soft Radiused
HS1860B36	272	Host Boat	HS2048S26	219	Host Soft Radiused
HS1860C20	250	Host Racetrack	HS2048S30	220	Host Soft Radiused
HS1860C21	250	Host Racetrack	HS2048S31	220	Host Soft Radiused
HS1860C22	250	Host Racetrack	HS2048S32	220	Host Soft Radiused
HS1860C24	250	Host Racetrack	HS2048S34	220	Host Soft Radiused
HS1860C26	250	Host Racetrack	HS2048S36	220	Host Soft Radiused
HS1860C30	251	Host Racetrack	HS2060B20	273	Host Boat
HS1860C31	251	Host Racetrack	HS2060B21	273	Host Boat
HS1860C32	251	Host Racetrack	HS2060B22	273	Host Boat
HS1860C34	251	Host Racetrack	HS2060B24	273	Host Boat
HS1860C36	251	Host Racetrack	HS2060B26	273	Host Boat
HS1860R20	188	Host Rectangular	HS2060B30	274	Host Boat
HS1860R21	188	Host Rectangular	HS2060B31	274	Host Boat

Style Number Index continued

Style Number	Page	Description	Style Number	Page	Description
HS2060B32	274	Host Boat	INTHW	23	Interact, Hardwire
HS2060B34	274	Host Boat	INTSC	23	Interact, 6' Cord
HS2060B36	274	Host Boat	PCS	21	Power/Comm Sphere
HS2060C20	254	Host Racetrack	PODHW	102	Train POD
HS2060C21	254	Host Racetrack	PODMD1	102	3' Conduit with Modular Connector
HS2060C22	254	Host Racetrack	PODMD2	102	3' Conduit with Modular Connector
HS2060C24	254	Host Racetrack	PODMD3	102	3' Conduit with Modular Connector
HS2060C26	254	Host Racetrack	PODMD4	102	3' Conduit with Modular Connector
HS2060C30	255	Host Racetrack	PODPL	102	Train POD
HS2060C31	255	Host Racetrack	PSP	21	Power Sphere
HS2060C32	255	Host Racetrack	RJ11	22	Coupler
HS2060C34	255	Host Racetrack	RJ45	22	Coupler
HS2060C36	255	Host Racetrack	TN4824C	99	Train 24"W Rectangular
HS2060R20	192	Host Rectangular	TN4830C	99	Train 30"W Rectangular
HS2060R21	192	Host Rectangular	TN6024C	99	Train 24"W Rectangular
HS2060R22	192	Host Rectangular	TN6030C	99	Train 30"W Rectangular
HS2060R24	192	Host Rectangular	TN7224C	99	Train 24"W Rectangular
HS2060R26	192	Host Rectangular	TN7230C	99	Train 30"W Rectangular
HS2060R30	193	Host Rectangular	TN90D24	100	Train Corner Top
HS2060R31	193	Host Rectangular	TN90D30	100	Train Corner Top
HS2060R32	193	Host Rectangular	TNBPIHW	107	Train Power Infeed
HS2060R34	193	Host Rectangular	TNBPIMD	108	Train Power Infeed
HS2060R36	193	Host Rectangular	TNBPINY	107	Train Power Infeed
HS2060S20	221	Host Soft Radiused	TNGL	101	Train Glides
HS2060S21	221	Host Soft Radiused			
HS2060S22	221	Host Soft Radiused			
HS2060S24	221	Host Soft Radiused			
HS2060S26	221	Host Soft Radiused			
HS2060S30	222	Host Soft Radiused			
HS2060S31	222	Host Soft Radiused			
HS2060S32	222	Host Soft Radiused			
HS2060S34	222	Host Soft Radiused			
HS2060S36	222	Host Soft Radiused			
HS4800D10	165	Host Round			
HS4800D11	165	Host Round			
HS4WXFRM	284	Host Corridor Power Kit, Modular			
HS6000D10	165	Host Round			
HS6000D11	165	Host Round			
HS9648C10	226	Host Racetrack			
HS9648C11	226	Host Racetrack			
HS9648C12	226	Host Racetrack			
HS9648R10	168	Host Rectangular			
HS9648R11	168	Host Rectangular			
HS9648R12	168	Host Rectangular			
HS9648S10	196	Host Soft Radiused			
HS9648S11	196	Host Soft Radiused			
HS9648S12	196	Host Soft Radiused			
HS9654B10	258	Host Boat			
HS9654B11	258	Host Boat			
HS9654B12	258	Host Boat			
HS9660T10	278	Host Trapezoid Table			
HS9660T11	278	Host Trapezoid Table			
HS9660T12	278	Host Trapezoid Table			
HSFCONPT	283	Host Floor Kit: Connectrac			
HSFSHLF	283	Host Corridor Shelf			

Style Number Index

Trademark List

- ® The following are registered trademarks for products of Steelcase Inc. or one of its related corporate entities: 4 o'clock, 900 Series, à la carte, Airtouch, Ally, Amia, Answer, Archipelago, Avenir, Ballet, Bix, Brayton International, Cachet, Canopy, Canto, Chancellor, Coalesse, Confidante, Context, Convene, CopyCam, Criterion, Crushed Can, Currency, dash, Designtex, Details, Detour, Drive, Elective Elements, Ellipse, Ember Chrome, Emerge, E-Table 2, FYI, Garland, Gentry, Ginkgo Biloba, Groupwork, Ideo, Jacket, Jenny, Jersey, Kart, Kick, LaCosta, Leap, Let's B, LiveBack, Max-Stacker, media:scape, Metro, Migrations, Mitra, Montage, Nurture, Oriana, Parade, Pathways, PCT, Permiso, Player, Portal, Power Pincher, Progeny, Protégé, R2, Rally, Relevant, Reply, Rizzi Arc, Sensor, Series 9000, Siento, Sieste, Sine, Softcare, Springboard, Steelcase, Steelcase Design Partnership, Stella, Stow Davis, Swathmore, Sylvi, TeamWork, Technique, Texpress, Think, Thunder, Topo, Train, turnstone, Underline, Unison, Vecta, Viridian, Walden, Wernld, and X-Stack.
- ® The following registered trademarks are under license from AWI Licensing Company, Dover, DE: SoundScapes, DuraBrite, BioBlock, and Armstrong.
- ® The following registered trademarks are under license from Byrne Electrical, Rockford, MI: Interport, Mini-Port, Axil Z, and Ellora.
- ® The following is a registered trademark of DuPont, Wilmington, DE: Corian.
- ® The following is a registered trademark of Genlyte Thomas Company, Louisville, KY: Lightolier.
- ® The following is a registered trademark of Hilti Corporation, FL-9494 Schaan, Principality of Liechtenstein: Hilti.
- ® The following is a registered trademark of Leviton Manufacturing Company, Little Neck, NY: Decora.
- ® The following is a registered trademark of Mechanical Plastics Corp, Elmsford, NY: Toggler.
- ® The following is a registered trademark of Microsoft Corporation, Redmond, WA: Microsoft.
- ® The following is a registered trademark of Panduit Corporation, Lockport, IL: Panduit.
- ® The following is a registered trademark of Trav (Press), Cuneo, Italy: Assisa.
- ® The following is a registered trademark of Virtual Ink, Boston, MA: mimioActive.
- ® The following registered trademarks are under license from Wilkhahn Furniture Products: Avera, Senzo, Versal, and Wilkhahn FS.

- ® The following is a registered trademark of Wilsonart International, Temple, TX: Chemsurf.
- ® The following is a registered trademark of Wiremold, West Hartford, CT: Wiremold.
- ® The following is a registered trademark of EMU Group S.P.A., Perugia, Italy: Emu.
- ® The following is a registered trademark of Security People, Inc.: Digilock.
- ™ The following are trademarks for products of Steelcase Inc. or one of its related corporate entities: Access, Active/Passive Shelf, Ainsley, Akira, Alcove, Alerion, Alight, Amaris, American Elect, American Tradition, ap40, Arbor, Arriva, Asana, Ascot, Aspekt, Astor, Await, Bassline, B-Free, Bira, Bivi, Bixby, Bottomline, Brody, Brook, Buoy, Burton, c:scape, Calla, Calm, Camber, Campfire, Capa, Cappuccino, Cesar, Chester, Chord, Circa, Clarendon, Classic Rectangular, Clipper, cobì, Collaboration, Community, Company, Convey, Cortex, Coupe, Crea, Crew, Cura, Cypress, Davenport, Dearborn, Deck, Déjà, Denizen, Denska, Derby, Divisio, Donovan, Dune, Duo, Echo, Edge, Elsna, Empath, Empress, Enea, ēno, EnSync, Enviro, Escapade, Exchange, Exponents, Field, Flat Top, FlexFrame, Flip Top, Flute, Folio, FrameOne, FreeFlow, Frontier, Galliei, Gesture, Ginger, Ginkgo, Go Wall, Grip, Groove, Hatchback, Hawthorne, Hitch, Host Collection, Hosu, Huddleboard, i2i, Impact, Indy, InfoLink, IOS, I-Solve, Jack, Jarrah, Jetty, Juice, Kami, Kast, Kathryn, Lagunitas, Lark, L'Attitude, LearnLab, Leela, LessThanFive, Lincoln, Linden, LiveSeat, Loria, Lyric, Malibu, Malibu Too, Mansfield, Marathon, Martini, Mason, Masque, Migration, Millbrae, Mineral, Mingle, Mystic, Mystic Metal, Mystic Wood, Montara650, Montreal, Move, Nadia, Neighbor, nesso, Nickel, Nikko, Nod, Node, Norfolk, Ology, Ontrak, Oom, Opus, Orchid, Outlook Collection, Ovation, Paloma, Paperflo, Parliament, Pasio, Passerelle, Patriarch, Payback, Peek, Pile File, Pisa, Pool, Potrero415, PUCK, QiVi, Quba, Rave, Reed, Regard, Relay, Reunion, Ripple, Riser, Roam, Rocco, Rocky, RoomWizard, Runner, Satellite, Sawyer, ScapeSeries, Senti, Sentinel, Senza, Sequoia, Session, ShareLink, Shield, Shortcut, Sidewalk, SILQ, Skylar, Slumber, Smoke, Snug, Soft Leaf, Sonata, Sorrel, SOTO, Southside, Stationkits, Steelcase Series, Stiletto, Surprise!, Surround, Switch, Symphony, Sync, TagWizard, Tava, TeamStudio, TeamTheater, Tenaro, Terrazzo, Theorem, Thread, Topaz, Touchdown, Tour, Tower Too, Trees, Trillium, Trolley, tX2, U-Free, Umami, Underscore, Uno, V.I.A., Verb, Verge, Verlay, Victor2, Visalia, Waldorf, Woodruff, Workspring, and X-tenz.
- ™ The following is a trademark of Microsoft Corporation, Redmond, WA: Windows.
- ™ The following is a trademark of Rodman Industries, Inc., Oconomowoc, WI: ResinCore1.
- ™ The following is a trademark of Ultrafabrics, LLC, Elmsford, NY: Ultraleather.

- ™ The following trademarks are under license from Wilkhahn Furniture products: Cana, Linus, Logon, Picto, Range, Stitz, Thema, Timetable, and Tubis.
- ™ The following trademark is used under license from Cradle to Cradle Products Innovation Institute, Oakland, CA: Cradle to Cradle Certified.
- ™ The following trademarks are under license from Walter Knoll: Andoo, Bob, Lazlo, Lox, Ribbon, and Together.
- ™ The following trademarks are under license from PP Møbler: Bar and Flag Halyard.
- ™ The following trademarks are under license from Viccarbe: Davos, Holy Day, Last Minute, RS, Sistema, and Wrapp.
- ™ The following trademarks are under license from Carl Hansen: Elbow, Paddle, Shell, Wing, and Wishbone.
- ™ The following trademarks are under license from Cambridge Sound Management, LLC, Cambridge, MA: QtPro Soundmasking, Qt Quiet Technology, and Sonet Qt.
- ™ The following is a trademark of Electri-Cable Assemblies, Shelton, CT: Interact.
- ™ The following is a trademark of Clestra Hauserman: IRYS.
- ™ The following is a trademark of Wiesner-Hager Möbel GmbH: Nooi.
- ™ The following are trademarks of PolyVision: a³, e³, Flow, Motif, PolyVision, Sans, and Serif.
- ™ The following is a trademark of Bostock Company, Inc: SnapCab.
- ™ The following is a trademark of Williams-Sonoma, Inc: West Elm.
- ™ The following is a trademark of Elena Marquina Testor: nanimarquina.

Trademarks used here in are the property of Steelcase, Inc. or of their respective owners.