

Architectural Solutions Specification Guide



Availability

Electronic price list updated with release 188.D (U.S.) and 150.D (Canada), dated December 17, 2018.

Spec News is available on village.steelcase.com. Search Steelcase Marketing Resources (Adstock) and download the current release's Spec News.

Tip: Steelcase Marketing Resources is a new global platform for ordering Steelcase marketing materials that replaces Adstock.

View or download Steelcase Specification Guides at [https://www.steelcase.com/resources/documents?tax-\[doctype\]=spec-guide](https://www.steelcase.com/resources/documents?tax-[doctype]=spec-guide).

Transitional products in this specification guide are **maintained for existing customers only** and are likely to be phased out over time. These products are indicated with a . Products that are scheduled to be culled are indicated with an , followed by the last order entry date.

Surface Materials

The surface materials team has announced the launch of the Finish Library, found at <http://finishlibrary.steelcase.com>.

► For a list of all trademarks, refer to the last page of this specification guide.

© 2018 Steelcase Inc.



For Canadian Pricing

Canadian factor can be found at steelcase.com/CADpricing.

Calculate in the following order to avoid rounding errors:

- Multiply the base price and each option by the Canadian factor.
- Round each to the nearest dollar.
- Add base and options for total list price.

Working With This Specification Guide

Ten Tips: How to Get the Most Out of This Book	2
Additional Resources	4

Understanding

Privacy Wall	5
Thread	305
Underscore Floor	325
Modular Power	343
QtPro Soundmasking	369
IRYS Pod	399

Specifying

Privacy Wall	115
Thread	313
Underscore Floor	335
Modular Power	351
QtPro Soundmasking	381
IRYS Pod	405

Surface Materials

Resources

Wiring Schematics	418
Locations with Special Requirements	419
How to Calculate Power Needs	420
Style Number Index	422

Ten Tips: How to Get the Most Out of This Book

Tip 1

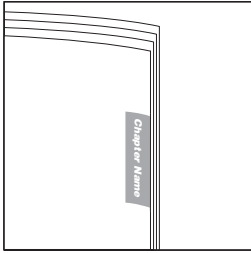

Watch the tabs on the right-hand edges of the pages. They'll always indicate which chapter you are in.

Tip 2

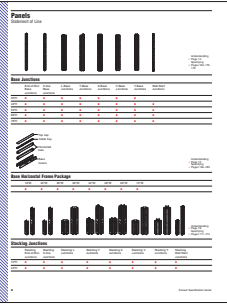

Use the Statement of Line pages for an overview of the available components, their sizes, and page references for additional information. Each *Understanding* chapter includes a statement of line after the table of contents.

Tip 3



Find cross references by looking for page numbers flagged with an arrow.

Tip 4

Study the product detail pages in the *Understanding* section to learn everything an expert knows about specific products. Each product detail page in this section contains the following features, where applicable:

- Product Drawing
- Actual Dimensions
- Product Details
- Connections
- Wiring and Cabling
- Surface Materials
- Application Topics

Product Drawing shows you what the product looks like and points out important features.

Product Details gives specific information on the product and how it is used.

Connections describes how the product is assembled or how it attaches to another product.

Actual Dimensions table lists the dimensions of the product.

Wiring and Cabling details the power and cable-management and cable routing capabilities of the product.

Surface Materials lists what material is used for each part of the product.

Tip 5

Refer to the specifying pages for all the information needed to order a product. Each product specifying page contains a variety of elements to help you complete a specification:

- Product Drawing
- Standard Includes
- Required to Specify
- Options
- Related Products
- Specification Information
 - Dimensions
 - Style Number
 - Price

Product Drawing shows you what the product looks like.

Standard Includes (under the red or dark grey band) provides a list of what comes standard with the product.

Required to Specify (under the red or dark grey band) itemizes the information that you must provide to order the standard product and the preferred sequence for specification.

Specification Information (under the teal or light grey band) provides product dimensions, style numbers, and prices for the standard product and any surface material choices that are available.

Standard Includes

- Standard length and width (18" x 24" glass opening)
- Standard finish (see page 18)
- Base trim with no backcoat (see 19" panel piece)
- Standard glass (see page 19)
- Standard hardware (see page 19)

Required to Specify

- Style Number
- Finish (see page 18)
- Panel Piece
- Mounting Hardware (see page 19)

Options

Options	Unit Price	Required to Specify
Panel piece group 1	10.00	Specify panel piece number
Panel piece group 2	10.00	Specify panel piece number
Panel piece group 3	10.00	Specify panel piece number
Panel piece group 4	10.00	Specify panel piece number

Specification Information

Style Number	Unit Price	Option
18" x 24" TS7042BL	10.00	None
18" x 24" TS7042S	10.00	None
18" x 24" TS7048BL	10.00	None
18" x 24" TS7048S	10.00	None
18" x 24" TS7060BL	10.00	None
18" x 24" TS7060S	10.00	None
18" x 24" TS7072BL	10.00	None

Options (under the black band) lists all the options that apply to the product, their price, and what is required to specify.

Related Products provide specification information for products that are directly related.

Tip 6

Required to Specify

Specify with *Customiz Stain*

Italic typeface on specifying pages usually identifies wording that you should use in your order.

Tip 7

To determine how many skins are needed to complete a panel, consult the table at the right.

Tip: Remember to order skins for both sides of the panel buildup.

Watch for tips throughout the text that give you explanations and helpful instructions.

Tip 8

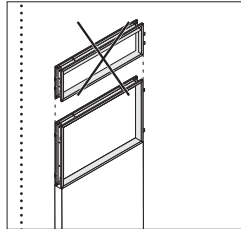

Learn what you cannot do by looking for drawings crossed out with an "X."

Tip 9

Use the surface materials listings in the Surface Materials section of this book to find surface material color numbers.

Tip 10

Style Number	Page
TS7042BL	131
TS7042S	130
TS7048BL	131
TS7048S	130
TS7060BL	131
TS7060S	130
TS7072BL	131

Refer to the style number index when you know a style number and you need to find the page that has more details about the product.

Additional Resources

Architectural Solutions

are supported with informational materials, tools, and software to help you plan, specify, and order an installation efficiently.

Product brochures and planning tools can be ordered through your Steelcase area office by calling 1.800.784.0358 or through the Marketing Resources web site at village.steelcase.com.

Printed Materials

Surface Materials Reference Manual

This publication provides:

- An explanation of the surface materials
- “Available on” matrices
- Vertical surface fabric and seating upholstery selection listing
- Technical data for surface materials
- Surface material care and cleaning instructions

Computer Tools

Electronic Catalog

Accurate sales quotations and purchase orders for Steelcase products are created with specification software that uses Steelcase Electronic Catalog data. Use the data to specify and price style numbers and options for every Steelcase product. The data is updated bimonthly by Steelcase and provided to software programs including: the Hedberg Business System, SmartTools—Steelcase’s design and specification software (for more information on SmartTools, please email SmartTools@steelcase.com), the ProjectMatrix ProjectSymbols libraries, as well as 20-20 CAP Studio.

Furniture Symbol Graphic Data

Steelcase creates 2D and 3D furniture symbols (with attributes) for planning and initially specifying Steelcase products. This data is incorporated into several add-on software packages that work in either a Microstation or an AutoCAD drafting environment.

For more information about these and other software tools to help you plan effective work environments, please email fsl@steelcase.com.

Digital Publications

You can access these digital publications at www.steelcase.com or village.steelcase.com.

Architectural Solutions Product Training

Basic training for the products included in the Architectural Solutions product portfolio is available as part of the Building Product Muscle (BPM) curriculum on the Steelcase University Web site at village.steelcase.com.

The four BPM modules are Web-based, interactive courses filled with pictures, detailed positioning, statement of line, and feature benefit information, as well as practice exercises designed to build salespeople’s knowledge of the products. The BPMs also provide printable job aids of all content covered in the courses to serve as ongoing performance support. The available courses are:

- Privacy Wall—SAL271
- Architectural Solutions Low-Profile Floor—SAL243
- Architectural Solutions Modular Power—SAL245

Additionally, there are two courses available to help improve your understanding of how to position the advantages of an Architectural Solution with potential clients: Architectural Solutions—SAL242 and The AS Value Proposition—SAL258.

Support

Steelcase Capabilities

Steelcase products are distributed, installed, and serviced through a network of more than 600 dealers worldwide. Steelcase is also represented with offices and corporate showrooms in 26 U.S. cities, 4 Canadian cities, and in France, Germany, Great Britain, and Japan. Every Steelcase product meets our exceptionally high standards of quality and durability and comes with the Steelcase assurance of excellence in service.

For assistance, please call your local dealer, the Steelcase Solutions Resource Team, or the Steelcase Solutions Fulfillment Team at 1.888.STEELCASE (1.888.783.3522) or send an e-mail to lineone@steelcase.com.

Call the Steelcase Solutions Resource Team prior to placing an order, when working on a bid, or when you need information about product applications and specifications.

Call the Steelcase Solutions Fulfillment Team if you have submitted an order to Steelcase and you need to speak to your Solutions Fulfillment Team Representative about the order. Also call if you have any post-shipment quality concerns or service parts questions.

For warranty information, please go to <http://www.steelcase.com/warranty/>.

Outside the U.S.A., Canada, Mexico, Puerto Rico, and the U.S. Virgin Islands, call 1.616.247.2500.

For information about Steelcase, the name of your nearest Steelcase dealer, or for product literature, call 1.800.333.9939, or visit our Web site: www.steelcase.com.

Understanding Privacy Wall



Statement of Line

6

Product Details

Solid Wall Panels	18
Glass Wall Panels	24
Butt-Hinged Frames and Door Leaves	34
Pivot-Hinged Frames and Door Leaves	40
Door Swing Orientation Choices	46
Privacy Wall Slider Doors	48
Glass Selections Polished Edge Slider Doors	54
Ceiling Tracks	60
Cornice Track	64
Ceiling Clip Application	66
Mini Ends	68
Wall Channels	72
Wall Channel Flexibility	75
Cut Panels	76
Adapters	78
Posts	82
Feature Strip Application	86
Lite Scale Glazing	88

Application Topics

Centerline Versus Interior Dimension Planning	96
Base Trim Details	98
How to Connect Privacy Wall to I-Line Moveable Walls	102
Etched and Pattern Glass Planning	104

Wiring and Cabling

How to Power a Panel	106
Overview of Powered Panels	110
Wiring Schematics	112
How to Calculate Power Needs	113
Field-Installed Modular Harness Length Guidelines	114

Statement of Line

Privacy Wall

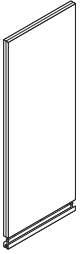

Solid Wall Panels

Heights 8'0" to 10'0"
in one-inch increments

6"W	●
8"W	● M
18"W	● M
20"W	● M
24"W	● M
30"W	● M
36"W	● M
40"W	● M
42"W	● M
48"W	● M
60"W	● M

- ▶ Understanding, page 18
- ▶ Specifying, page 116

All-Glass Wall Panels

Heights 8'0" to 10'0"
in one-inch increments

6"W	●
8"W	● M
18"W	● M
20"W	● M
24"W	● M
30"W	● M
36"W	● M
40"W	● M
42"W	● M
48"W	● M
60"W	● M

- ▶ Understanding, page 24
- ▶ Specifying, page 122

M = Available in modular widths

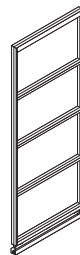
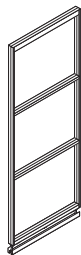

Glass Wall Panels with Three Equal Divided Lites

Heights 8'0" to 10'0"
in one-inch increments

6"W	●
8"W	● M
18"W	● M
20"W	● M
24"W	● M
30"W	● M
36"W	● M
40"W	● M
42"W	● M
48"W	● M
60"W	● M

- ▶ Understanding, page 24
- ▶ Specifying, page 126

Glass Wall Panels with Four Equal Divided Lites

Heights 8'0" to 10'0"
in one-inch increments

6"W	●
8"W	● M
18"W	● M
20"W	● M
24"W	● M
30"W	● M
36"W	● M
40"W	● M
42"W	● M
48"W	● M
60"W	● M

- ▶ Understanding, page 24
- ▶ Specifying, page 130

M = Available in modular widths

Statement of Line Privacy Wall, continued

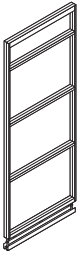

Glass Wall Panels with Four Divided Lites*

	Heights 8'0" to 10'0" in one-inch increments
6"W	●
8"W	● M
18"W	● M
20"W	● M
24"W	● M
30"W	● M
36"W	● M
40"W	● M
42"W	● M
48"W	● M
60"W	● M

*Transom-aligned top lite
 ▶ Understanding, page 24
 ▶ Specifying, page 134

Glass Wall Panels with Two Divided Lites*

	Heights 8'0" to 10'0" in one-inch increments
6"W	●
8"W	● M
18"W	● M
20"W	● M
24"W	● M
30"W	● M
36"W	● M
40"W	● M
42"W	● M
48"W	● M
60"W	● M

*Transom-aligned top lite
 ▶ Understanding, page 24
 ▶ Specifying, page 138

M = Available in modular widths



Clerestory Wall Panels*

Heights 8'0" to 10'0"
in one-inch increments

18"W	● M
20"W	● M
24"W	● M
30"W	● M
36"W	● M
40"W	● M
42"W	● M
48"W	● M
60"W	● M

*Transom-aligned top lite
▶ Understanding, page 24
▶ Specifying, page 142

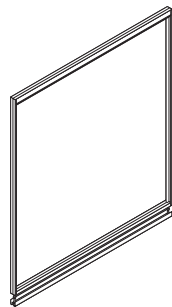

Glass Selections All-Glass Frame Kits

Heights 8'0" to 10'0"
in one-inch increments

72"W	● M
80"W	● M
84"W	● M
96"W	● M
108"W	● M
120"W	● M
144"W	● M

▶ Understanding, page 24
▶ Specifying, page 198

M = Available in modular widths



Glass Selections All-Glass Wall Panels

Heights 8'0" to 10'0"
in one-inch increments

6"W	●
8"W	● M
18"W	● M
20"W	● M
24"W	● M
30"W	● M
36"W	● M
40"W	● M
42"W	● M
48"W	● M
60"W	● M

▶ Understanding, page 24
▶ Specifying, page 196

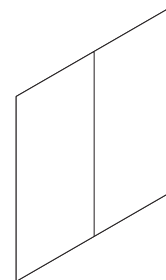

Glass Selections All-Glass Glass Kits

Heights 8'0" to 10'0"
in one-inch increments

72"W	● M
80"W	● M
84"W	● M
96"W	● M
108"W	● M
120"W	● M
144"W	● M

▶ Understanding, page 24
▶ Specifying, page 200

Statement of Line Privacy Wall, continued

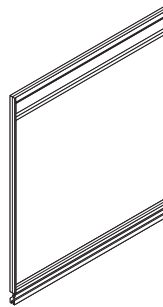

Glass Selections Wall Panels with Two Divided Lites*

Heights 8'0" to 10'0" in one-inch increments	
6"W	●
8"W	● M
18"W	● M
20"W	● M
24"W	● M
30"W	● M
36"W	● M
40"W	● M
42"W	● M
48"W	● M
60"W	● M

*Transom-aligned top lite
 ▶ Understanding, page 24
 ▶ Specifying, page 202

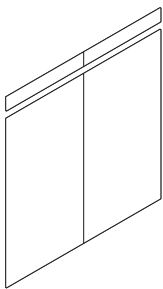

Glass Selections Two Divided Lite Glass Kits*

Heights 8'0" to 10'0" in one-inch increments	
72"W	● M
80"W	● M
84"W	● M
96"W	● M
108"W	● M
120"W	● M
144"W	● M

*Transom-aligned top lite
 ▶ Understanding, page 24
 ▶ Specifying, page 208

M = Available in modular widths

Glass Selections Two Divided Lite Frame Kits*

Heights 8'0" to 10'0" in one-inch increments	
72"W	● M
80"W	● M
84"W	● M
96"W	● M
108"W	● M
120"W	● M
144"W	● M

*Transom-aligned top lite
 ▶ Understanding, page 24
 ▶ Specifying, page 206



Glass Selections Clerestory Wall Panels*

Heights 8'0" to 10'0" in one-inch increments	
18"W	● M
20"W	● M
24"W	● M
30"W	● M
36"W	● M
40"W	● M
42"W	● M
48"W	● M
60"W	● M

*Transom-aligned top lite
 ▶ Understanding, page 24
 ▶ Specifying, page 210

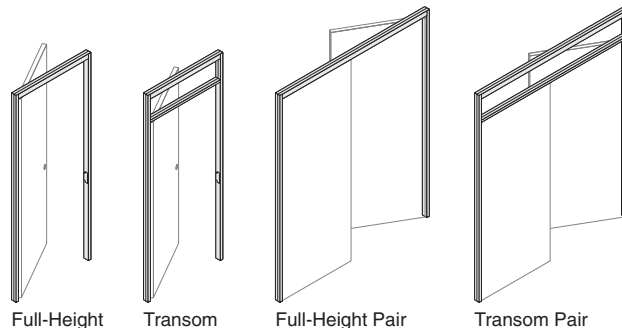
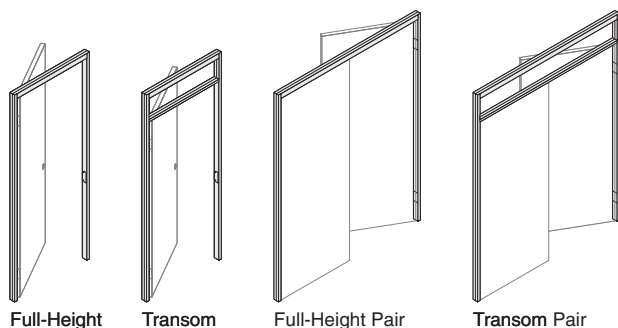

Butt-Hinged Door Frames

Heights 8'0" to 10'0"
in one-inch increments

- 40"W single ●
- 76"W pair ●

- ▶ Understanding, page 34
- ▶ Specifying, page 148

Tip: Butt-hinged door frames are not available in anodized aluminum and are not recommended for use with Glass Selections panels.
Tip: Butt-hinged door frames are available in lite scale glazing.

Pivot-Hinged Door Frames

Heights 8'0" to 10'0"
in one-inch increments

- 40"W without switch cutout ●
- 42"W with switch cutout ●
- 80"W without switch cutout ●

- ▶ Understanding, page 40
- ▶ Specifying, page 150

Tip: Pivot-hinged door frames are available in lite scale glazing.

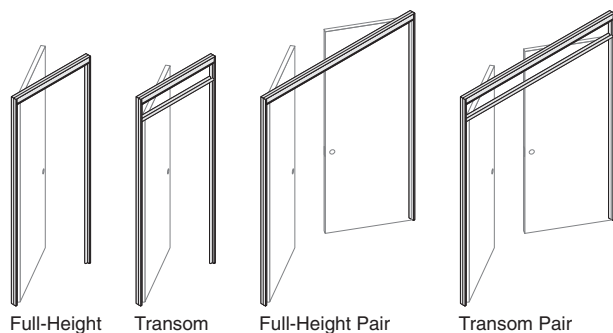

Glass Selections Pivot-Hinged Door Frames

Heights 8'0" to 10'0"
in one-inch increments

- 40"W without switch cutout ●
- 42"W with switch cutout ●
- 80"W without switch cutout ●

- ▶ Understanding, page 40
- ▶ Specifying, page 214

Tip: Glass Selections door leaves must be used in conjunction with Glass Selections door frames.
Tip: Glass Selections door frames are available in lite scale glazing.

Statement of Line Privacy Wall, continued

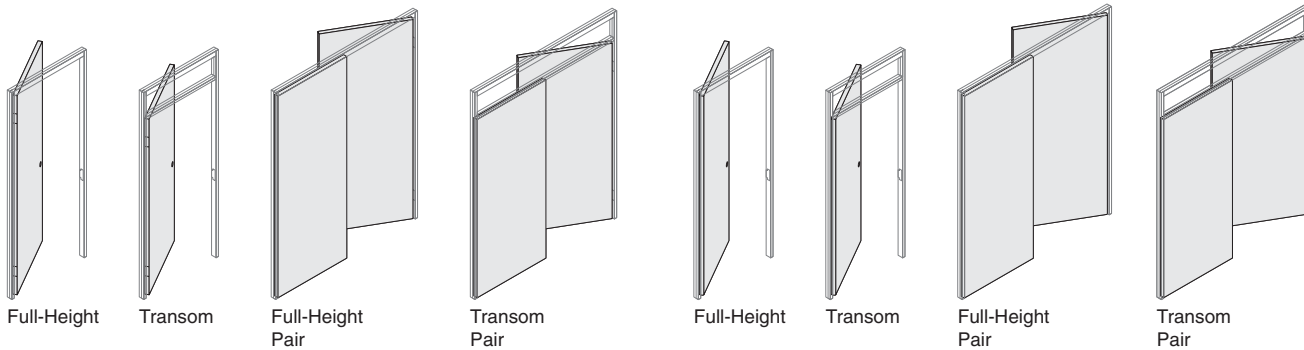

Butt-Hinged Door Leaves

	Height
40"W (35 ¹³ / ₁₆ " actual) solid single	8'0" to 10'0" in one-inch increments for full-height door frame 7'0" for transom door frame
40"W (35 ¹³ / ₁₆ " actual) glass single	8'0" to 9'0" in one-inch increments for full-height door frame 7'0" for transom door frame
76"W (71 ⁵ / ₈ " actual) solid pair	8'0" to 10'0" in one-inch increments for full-height door frame 7'0" for transom door frame

- ▶ Understanding, page 34
- ▶ Specifying, page 156

Tip: Butt-hinged door leaves are not available in anodized aluminum and are not recommended for use with Glass Selections panels.

Pivot-Hinged Door Leaves

	Height
40"W (37 ³ / ₁₆ " actual*) solid single	8'0" to 10'0" in one-inch increments for full-height door frame 7'0" for transom door frame
40"W (37 ³ / ₁₆ " actual*) glass single	8'0" to 9'0" in one-inch increments for full-height door frame 7'0" for transom door frame
42"W (36 ³ / ₈ " actual) solid single	8'0" to 10'0" in one-inch increments for full-height door frame 7'0" for transom door frame
42"W (36 ³ / ₈ " actual) glass single	8'0" to 9'0" in one-inch increments for full-height door frame 7'0" for transom door frame
80"W (77 ¹ / ₂ " actual) solid pair	8'0" to 10'0" in one-inch increments for full-height door frame 7'0" for transom door frame

Tip: For pivot-hinged pair of doors, the active leaf will always be 37³/₁₆"W. Width of inactive door leaf will be 39¹³/₁₆".

- *36³/₈" with switch in frame
- ▶ Understanding, page 40
- ▶ Specifying, page 160

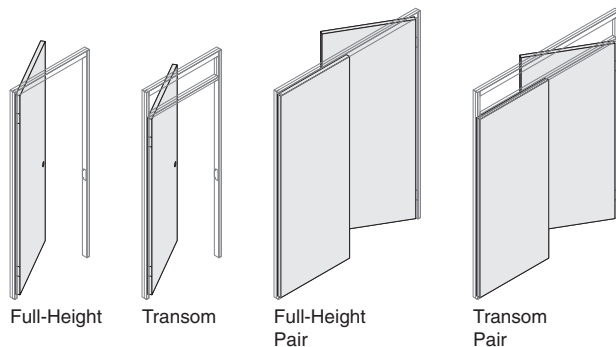

Glass Selections Pivot-Hinged Door Leaves

	Height
40"W (37 ³ / ₁₆ " actual*) solid single	8'0" to 10'0" in one-inch increments for full-height door frame 7'0" for transom door frame
40"W (37 ³ / ₁₆ " actual*) glass single	8'0" to 9'0" in one-inch increments for full-height door frame 7'0" for transom door frame
42"W (36 ³ / ₈ " actual) solid single	8'0" to 10'0" in one-inch increments for full-height door frame 7'0" for transom door frame
42"W (36 ³ / ₈ " actual) glass single	8'0" to 9'0" in one-inch increments for full-height door frame 7'0" for transom door frame
80"W (77 ¹ / ₂ " actual) solid pair	8'0" to 10'0" in one-inch increments for full-height door frame 7'0" for transom door frame

Tip: For pivot-hinged pair of doors, the active leaf will always be 37³/₁₆"W. Width of inactive door leaf will be 39¹³/₁₆".

Tip: Glass Selections door leaves must be used in conjunction with Glass Selections door frames.

*36³/₈" with switch in frame

► Understanding, page 40

► Specifying, page 216

Privacy Wall

Statement of Line Privacy Wall, continued

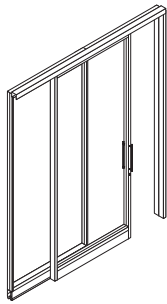

Full Glass

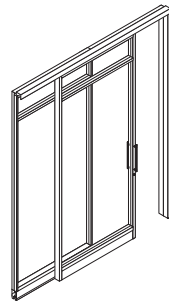

Two transom-aligned lites

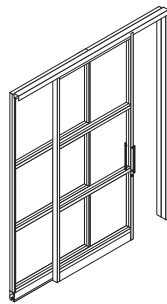

Three equal divided lites

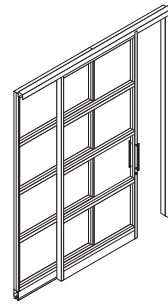

Four equal divided lites

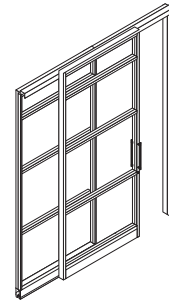

Four transom-aligned lites

Slider Doors

Heights 8'0" to 10'0"
in one-inch increments

	Full Glass	Two Transom-Aligned Lites	Three Equal Divided Lites	Four Equal Divided Lites	Four Transom-Aligned Lites
80"W	●	●	●	●	●
96"W	●	●	●	●	●

- ▶ Understanding, page 48
- ▶ Specifying, page 174

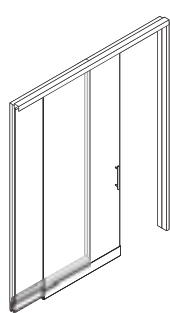

Full-height

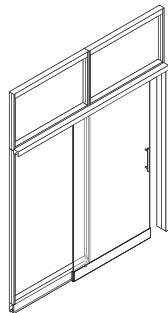

Transom-height

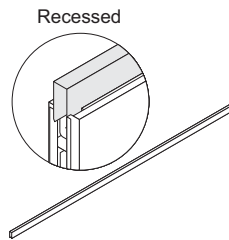

Recessed

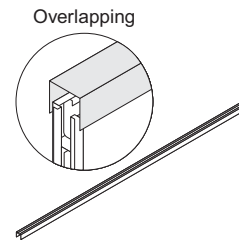

Overlapping

Glass Selections Polished Edge Slider Doors

Heights 8'0" to 10'0"
in one-inch increments

	Full-Height	Transom-Height
80"W single	●	●
84"W single	●	●
96"W single	●	●

- ▶ Understanding, page 54
- ▶ Specifying, page 224

Ceiling Tracks*

Length

120" to cut on site

*Finished end, L, and V ceiling tracks are also available.

- ▶ Understanding, page 60
- ▶ Specifying, page 238

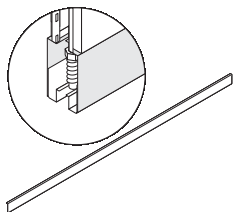

Continuous Base Trim

Length	5"H
120" to cut on site	●

- ▶ Understanding, page 19
- ▶ Specifying, page 244

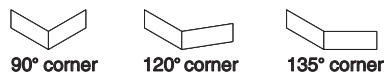

Corner Base Trim

	5"H
90°	●
120°	●
135°	●

- ▶ Understanding, page 82
- ▶ Specifying, page 245

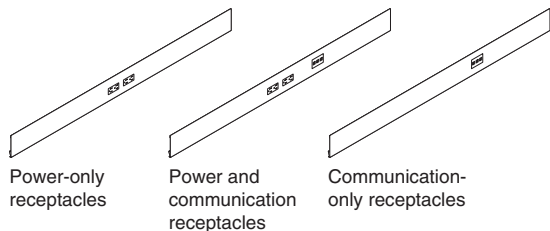

Power and Communication Base Trim

	24"W
Power only	●
Power and communication	●
Communication only	●

- Tip: Chicago base trim is also available.*
- ▶ Understanding, page 21
 - ▶ Specifying, page 246



Feature Strips

	Heights 8'0" to 10'0" in one-inch increments
In-line	●
Half	●

- ▶ Understanding, page 19
- ▶ Specifying, page 248

Statement of Line Privacy Wall, continued



Furniture Reveal Strips

Length

34" to cut on site

- ▶ Understanding, page 19
- ▶ Specifying, page 251

Mini Ends

Heights 8'0" to 10'0"
in one-inch increments

1½"W to 2½"W ●

2½"W to 3½"W ●

3½"W to 6"W ●

- ▶ Understanding, page 68
- ▶ Specifying, pages 185 and 229

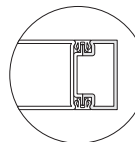

Finished-end

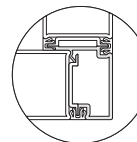

Two-way L

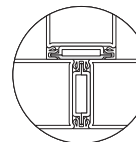

Three-way T

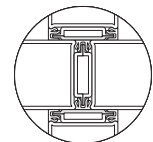

Four-way X

Wall Channels

120"

1" ●

2¼" ●

4" ●

- ▶ Understanding, page 72
- ▶ Specifying, page 187

Tip: Wall channels are not available in anodized aluminum and are not recommended for use with Glass Selections panels.

Adapters

Heights 8'0" to 10'0"
in one-inch increments

L ●

T ●

X ●

Finished-end 120"

- ▶ Understanding, page 78
- ▶ Specifying, pages 190 and 230

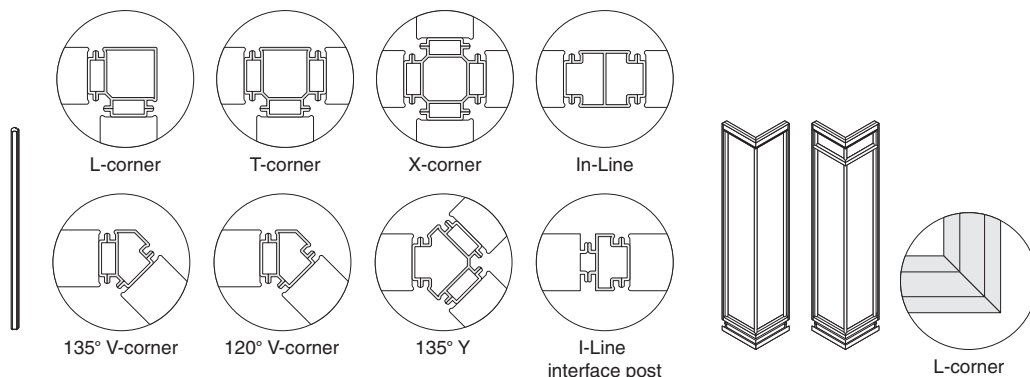

Posts

Heights 8'0" to 10'0"
in one-inch increments

L	•
T	•
X	•
In-line	•
120° V	•
135° V	•
135° Y	•
I-Line interface post	120"

Tip: I-Line Interface post is cut to length in the field.

- ▶ Understanding, pages 20 and 82
- ▶ Specifying, pages 192 and 231

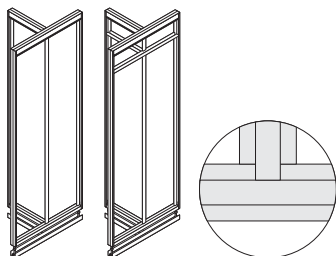

T-corner

Glass Selections T-Corner Unit All-Glass Frame Kits

Heights 8'0" to 10'0"
in one-inch increments

18"W x 18"W x 18"W • **M**

- ▶ Understanding, page 26
- ▶ Specifying, page 234

Glass Selections L-Corner Units

Heights 8'0" to 10'0"
in one-inch increments

18"W x 18"W • **M**

- ▶ Understanding, page 26
- ▶ Specifying, page 232

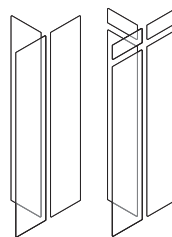

Glass Selections T-Corner Unit All-Glass Kits

Heights 8'0" to 10'0"
in one-inch increments

18"W x 18"W x 18"W • **M**

- ▶ Understanding, page 26
- ▶ Specifying, page 235

M = Available in modular widths

Solid Wall Panels

Note: All planning and application guidelines contained in this section of the specification guide are based on the requirement that ceiling track is connected to a ceiling in order to properly support the wall components as shown.

Privacy Wall solid wall panels create floor-to-ceiling walls, prefabricated to the height and width dimensions you specify. These panels, which offer power and communication capability, can be relocated to respond to changing needs.
 ▶ Specifying, page 116

Hollow core panel enables wiring and cabling to be routed within the panel.

Enhanced core panel has an insulated core to afford greatest acoustical performance. Use with overlapping ceiling track to realize maximum results.

Integral slotted verticals allow for panel-supported furniture. Integral slotted verticals start above the base and run to a height of 84". Slotting will support components that are designed to hang on Answer and Kick, including Universal Storage and Worksurfaces.

Adjustable levelers allow panels to be installed on uneven floors.

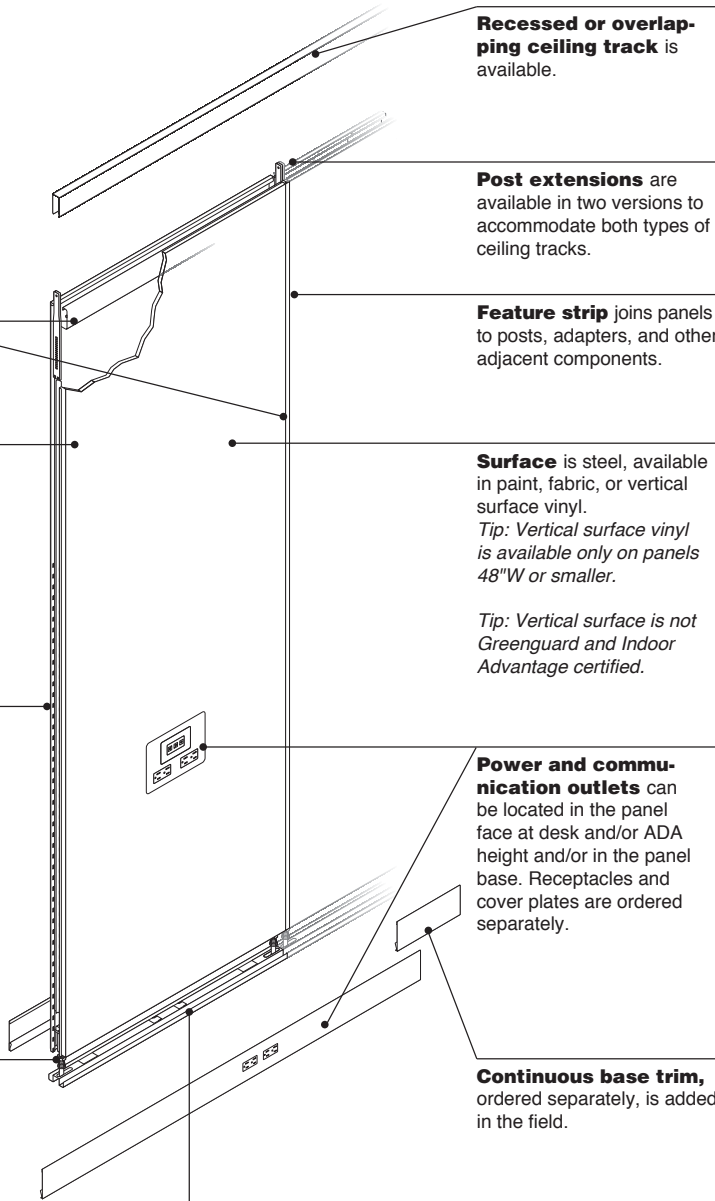

Recessed or overlapping ceiling track is available.

Post extensions are available in two versions to accommodate both types of ceiling tracks.

Feature strip joins panels to posts, adapters, and other adjacent components.

Surface is steel, available in paint, fabric, or vertical surface vinyl.
Tip: Vertical surface vinyl is available only on panels 48\"W or smaller.

Tip: Vertical surface is not Greenguard and Indoor Advantage certified.

Power and communication outlets can be located in the panel face at desk and/or ADA height and/or in the panel base. Receptacles and cover plates are ordered separately.

Continuous base trim, ordered separately, is added in the field.

Floor track anchors base of panel to carpeted floor, without fasteners.
Tip: For information about hard surface floors and Low-Profile Floor.
 ▶ Page 328

Product Details

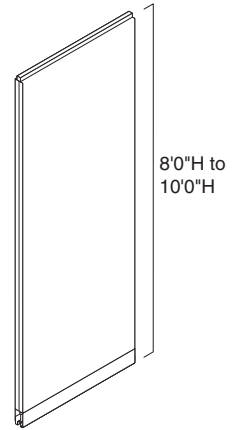

Panel height can be specified from 8'0\"H to 10'0\"H, in one-inch increments, to accommodate different ceiling heights.
Tip: Specify ceiling height of your installation and component will be fabricated to allow for ceiling track.

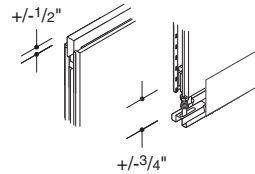

Ceiling track allows 1/2\" of vertical adjustment at ceiling to accommodate variations in field conditions. Floor track allows 3/4\" of vertical adjustment to accommodate variations at base.

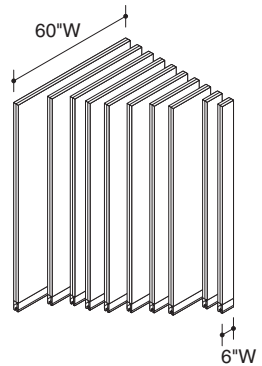

Panel widths range from 6\"W to 60\"W.



Width of panel is measured to center of joint between two panels.

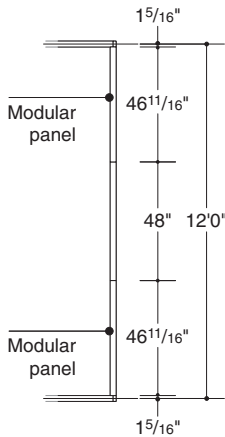

Modular panels used with adapters allow centerline planning. In the example above, two modular panels allow the distance between the centerline of the two parallel walls to remain at 12'0".

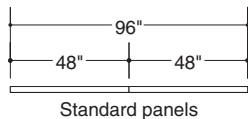

Standard panels

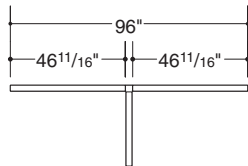

Modular panels

Modular panel widths are slightly smaller ($1\frac{15}{16}$ " less) than regular panel widths so that when a corner condition is created, the overall dimension remains unchanged. All other features of modular panels are the same as standard panels.

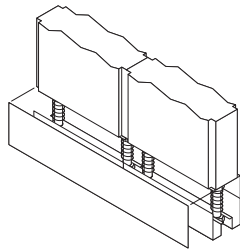

Continuous base trim, ordered separately, is 5"H and available in 10' lengths. It runs along multiple panels to create a uniform look. For longer runs, multiple base trim segments can be used adjacent to each other.

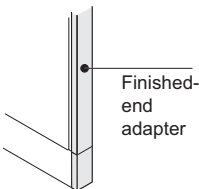

Finished-end adapter is available to finish the exposed end of a run of panels. Adapter adds approximately $1\frac{3}{16}$ " to the length of the wall.

Solid panels, as tested per ASTM E90, achieve STC ratings as follows:

- STC 41 for hollow core panels with recessed ceiling track
- STC 42 for hollow core panels with overlapping ceiling track
- STC 45 for enhanced core panels with overlapping ceiling track

Tip: Use of hang-on components or receptacles in panels may reduce acoustic effectiveness.

Panel-end trim piece

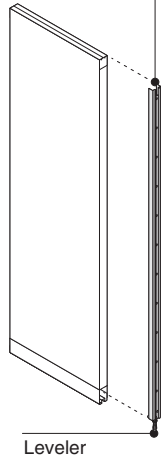

Panel end cut kit connects a cut panel to another panel in line. It restores leveler and housing that is removed when panel is cut on site. Kit includes trim piece to finish the cut side of the panel and to enable feature strip connection to an adjacent panel.

Tip: Hang-on components are not allowed on cut panels.

▶ Page 188

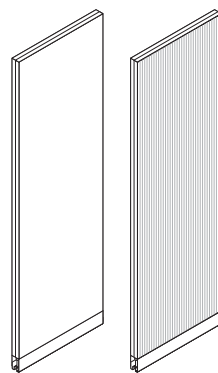

Different surface materials can be applied to opposite sides of the panel. For example, you can have vinyl applied to side 1 and fabric applied to side 2.

Vinyl is available on panels that are 48"W or smaller.

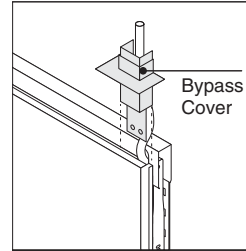

Ceiling track bypass cover is available to conceal cable or conduit routed next to a recessed ceiling track as the conduit travels from the ceiling into a wall panel.

▶ Page 242

Acoustic packing is available to improve the acoustical performance at mini ends and wall channels. Each 120" length of acoustic packing provides enough material for three mini ends at 10' ceiling height.

▶ Page 252

Connections

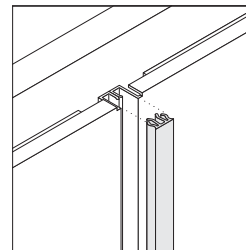

Recessed

Feature strips, ordered separately, join panels together. Strip prevents light and sound leaks and can be cut to allow access to the integral slotted verticals. To rearrange panels, feature strips can be removed and reused.

▶ Page 248

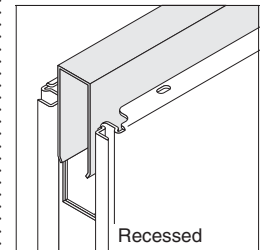

Overlapping

Ceiling track, ordered separately, joins the top of wall panels to the ceiling. Ceiling track is available recessed or overlapping.

▶ Page 60

Solid Wall Panels, continued

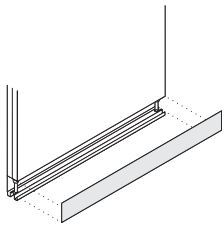

Base trim fits into position at the bottom of panel surface above the floor track.

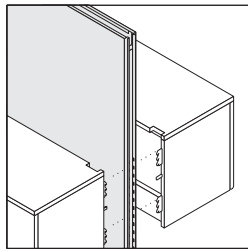

Integral slotted verticals accommodate any hang-on component that will hang on Answer or Kick panels, at any height in 1" increments up to 85".

▶ See page 86 for more information about hanging components.
▶ See *Storage Specification Guide*.

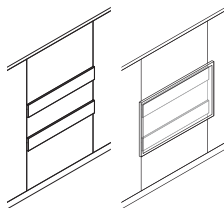

In some cases it may be desirable to hang components from the face of a solid panel, rather than connecting to the slots in the vertical edges of the panels. The solid panel construction is not adequate for fastening directly to the face of the panel. In the cases where a surface mounting solution is desired, load bars can be specified to provide additional support at the panel face. Mounting hardware can be screwed to the load bar without any damage to the panel surface.

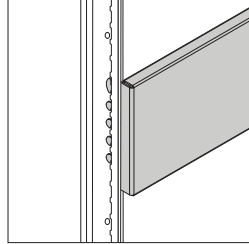

Load bars engage with panel slots and can be mounted at 1" increments. They are specifiable in widths from 18" to 60", in 1/16" increments. Load bars should be specified in widths to match the panel(s) from which they are hanging. Load bars can be specified in standard or modular sizes to match their corresponding panels. Load bars can be used with solid or clerestory panels.

▶ See page 116

Tip: Use of hang-on components with solid panels may reduce acoustic effectiveness.

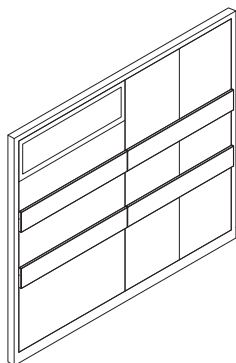

A single load bar can span multiple panels and can also be mounted side by side.

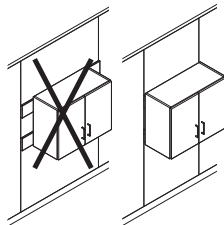

It is recommended that load bars and panels be planned in a narrow enough width to keep them concealed once the components are mounted.

Tip: Load bars are equal or less than the width of the mounted component.

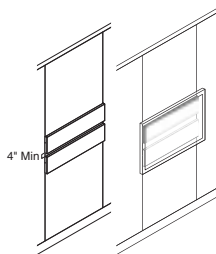

Load bars are used in sets of two and can be spaced apart as needed to accommodate the equipment to be mounted to them. For smaller monitor mounting brackets, load bars can be spaced 1" apart.

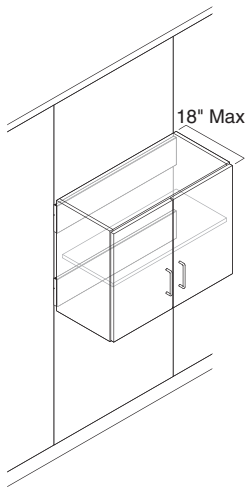

When hanging a larger conventional casegood cabinet that is designed to mount with cleats, load bars can be used. In these applications, the load bars would be positioned to align with the cleat hardware that is included as part of the cabinet design. Load bars are not designed to support cabinets that are deeper than 18".

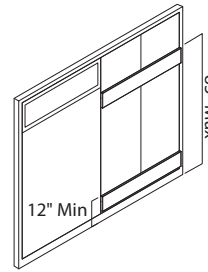

Load bars can be mounted at a maximum height of 85" AFF (Above Finished Floor) and a minimum height of 12" AFF (Above Finished Floor). Two load bars can support a maximum of 650 pounds. When a single load bar is installed at a feature strip, a furniture reveal strip should be installed adjacent to the load bar.

▶ See page 253

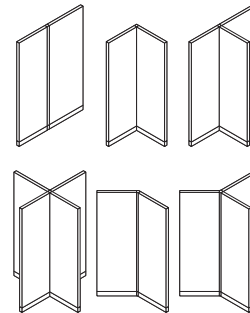

Posts join panels in in-line, L-, T-, X-, V-, and Y-configurations without blocking access to integral slotted verticals.

▶ Page 82

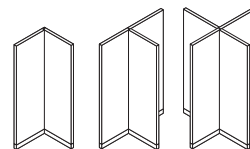

Adapters connect panels in L-, T-, and X-configurations without adding extra creep to panel dimension.

Tip: Adapter blocks slotted verticals in panel edge of some panels.

▶ Page 78

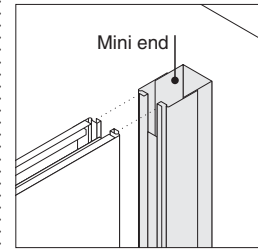

Mini end connects a panel or panel run to a perpendicular building wall. Elements of the mini end telescope allow a limited range of dimensional adjustability.

▶ Page 68

Edge Premium Markerboard products can be surface mounted to Privacy Wall by clipping into panel slots. All mounting brackets and hardware are included with each board. In addition to bracket mounted boards, Senti markerboards can be magnetically mounted to painted panel surfaces. The maximum size markerboard for magnetic mounting is 48" x 48". Application rules, magnetic mounting guidelines, and specification information can be found in the *Meeting Spaces Specification Guide*.

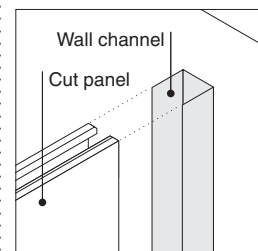

Wall channel connects an uncut panel to a perpendicular building wall.

▶ Page 72

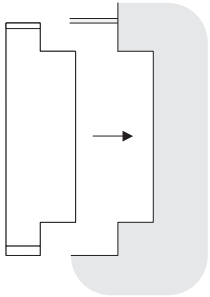

Solid panels can be cut on site to conform to building walls and ceiling details including sills and bulkheads.

Specify an end filler cut kit when cutting a panel into a wall channel. The end filler cut kit includes a wall channel and a spreader.

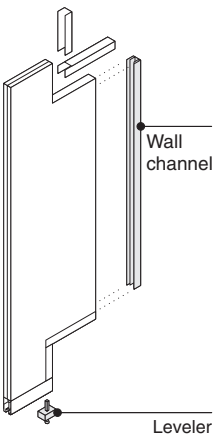

Cut edges of cut panel can be finished with field-cut wall channel.

End filler cut kit combines a wall channel and spreader into one assembly. Kit is used when cutting a panel at a perpendicular building wall.
▶ Page 189

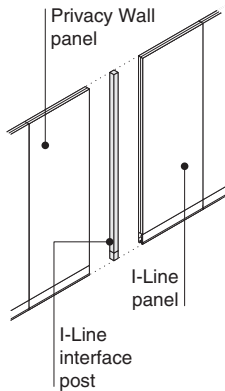

I-Line interface post allows a Privacy Wall panel to connect to an existing I-Line panel in line.
▶ Page 194

Tip: Two I-Line feature strips are needed for the I-Line side of the connection. Two Privacy Wall feature strips are needed for the Privacy Wall side of the connection.
▶ See *How to Connect Privacy Wall to I-Line Moveable Walls*, page 102.

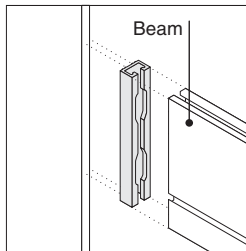

Post and Beam attachment kit is available to connect Privacy Wall panels to Post and Beam at a feature strip. The Post and Beam kit cannot be used off-module. It is designed for use in overhead applications only. It should not be used in fence application.
▶ Page 254

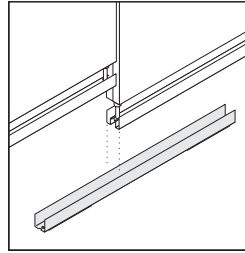

Universal floor grippers are designed for use with Privacy Wall panels that are placed on top of Low-Profile Floor. The universal floor gripper fits underneath the panel floor channel and glides to evenly distribute weight on the floor. When used with double-sided adhesive tape, the universal floor gripper will also prevent movement on hard surface floors like tile, wood, or terrazzo.
Tip: Universal floor grippers must be specified when installing in accordance with ICC Compliance Report.

Panels which are configured for low profile base trim are not compatible with the universal floor gripper. Panels that are required to be secured to the floor must be directly anchored to the floor with conventional fasteners.

Edge, Access, and Session, Premium Markerboard and Tackboard products, can be surface mounted to Privacy Wall by clipping into panel slots. All mounting brackets and hardware are included with each board. In addition to bracket mounted boards, Senti markerboards can be magnetically mounted to painted panel surfaces. The maximum size markerboard for magnetic mounting is 48"x48". Application rules, magnetic mounting guidelines, and specification information can be found in the *Meeting Spaces Specification Guide*.

Panels that are wider than 48" may not be suitable for application in certain areas where local building codes have specific provisions for seismic activity.

Wiring & Cabling

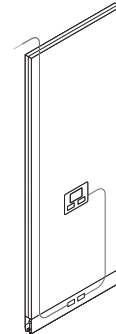

Hollow core in panel enables both vertical and horizontal cable routing within panel.

Panels with enhanced core do not allow for vertical cable routing. Cable can be routed laterally at the base.

Solid hollow core Privacy Wall panels can be specified with factory-installed powerkits. Powerkits include a power block and an installation cage. Field-installed powerkits are also available.

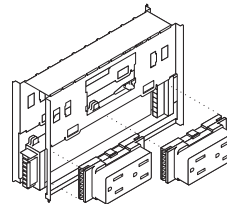

Desk- and ADA-height power blocks will be factory installed in center of panel to accommodate either power receptacles only or power and communication receptacles. A single power block can be specified to allow receptacles on one side or both sides of the panel.

Power receptacles

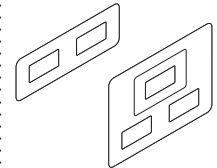

Power and communication receptacles

Cover plates, ordered separately, accommodate power receptacles and communication faceplates. Cover plates are used in panel face only.
▶ Page 258

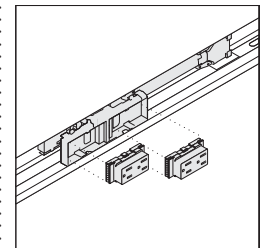

Base-height power block will be factory installed in center of panel. A single power block can be specified to allow receptacles in one side or both sides of panel. Base-height power is available in both hollow core and enhanced core panels.

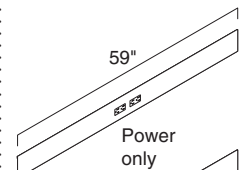

59"
Power only

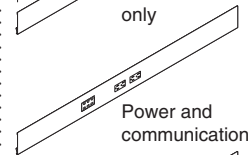

59"
Power and communication

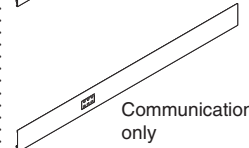

59"
Communication only

Base trim, ordered separately, is 59"W and available in three versions— power only, power and communication, and communication only.

Solid Wall Panels, continued

Width of panel must be adequate to accommodate cutouts. See table below for minimum widths.

Power and Communication

- 30"W–60"W Standard panel
- 30"W–60"W Modular panel

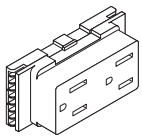

Power receptacles are ordered separately and installed on site. They are coded to indicate which circuit and type of ground they engage.

▶ Page 256

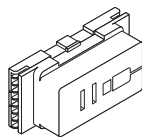

USB receptacles are ordered separately and installed on site. They are available in three wiring schematics with multiple line options. USB receptacles offer easy access to two charging ports. Each port provides 1 ampere of output. USB receptacles conveniently charge a wide range of electronic devices. Some devices may not be compatible.

Communication receptacles are provided by others and installed on site. They can accommodate single-gang NEMA-style faceplate, snap-in modular furniture-style faceplate, or Decora mounting strap style.

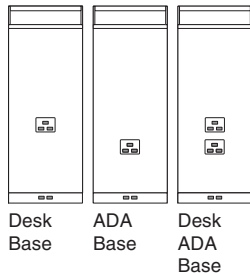
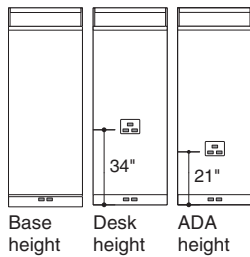

Receptacles in hollow core panels can be specified in any combination of base height, desk height, or ADA height, or on Clerestory panels.

Utilities can be specified on either side of the panel or on both sides. Receptacles can be installed on either side of the panel or on both sides. Fillers can be installed in any unused cutouts.

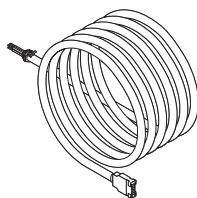

Infeeds can connect power blocks to building power in the ceiling or floor. Factory-installed infeeds extend a minimum of 12' from the panel.

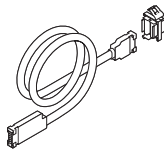

Modular harnesses and harness-to-harness connectors can be used to extend power to a power block from another power block in an adjacent panel.

Wiring schematics are available to accommodate a wide range of building types and power needs. 15-amp and 20-amp systems are available in 4-circuit, 3+1; 4-circuit, 2+2; and 3-circuit with separate neutrals. All of these choices are supported with a system ground and isolated ground.

Local electrical codes vary. Consult a qualified electrical contractor or engineer for the proper installation of electrical components.

Chicago and New York City require that all power be hardwired in the field. Modular power systems are not permitted. All Privacy Wall panels can be hardwired on site using conventional electrical components.

New York City/Chicago power prep option can be selected to provide panel cutouts and internal hardware to receive hardwired components.

New York City/Chicago power prep option requires use of Privacy Wall cover plate, ordered separately.

▶ Page 258

Surface Materials

- Panels**
- Paint
 - Fabric

Tip: Different surface materials can be applied to opposite sides of the panel.

Tip: Remember to designate side 1 and side 2 as appropriate to correspond to power and communication locations.

- Ceiling track**
- Paint

- Base trim**
- Paint

- Feature strip**
- Paint
 - Fabric
 - Vinyl

- Cover plate**
- Plastic

- Receptacle**
- Plastic

Application Topics

Feature Strip Application

▶ Page 86

Centerline Versus Interior Dimension Planning

▶ Page 96

How to Power a Panel

▶ Page 106

Overview of Powered Panels

▶ Page 110

Power Options

▶ Page 146

Solid Wall Panels — SmartTools Options

Note: All planning and application guidelines contained in this section of the specification guide are based on the requirement that ceiling track is connected to a ceiling in order to properly support the wall components as shown.

Product Details for SmartTools Options

SmartTools Options are available and easily ordered when using SmartTools software. If you do not have access to SmartTools software, these options can also be ordered using the normal Specials RFQ (Request for Quote) process.

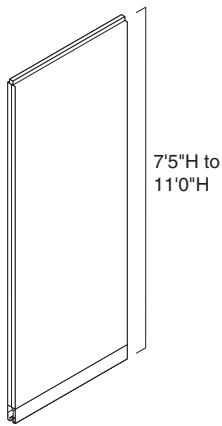

Panel height can be specified from 75"H to 11'0"H, in one-inch increments, to accommodate different ceiling heights.

Tip: Specify ceiling height of your installation and component will be fabricated to allow for ceiling track.

Tip: Panels that are greater than 10'0"H cannot exceed 48" in width.

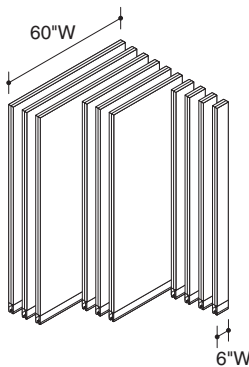

Solid panel widths range from 6"W to 60"W in even 1" increments.

Tip: Panels with enhanced core do not exceed 48" in width.

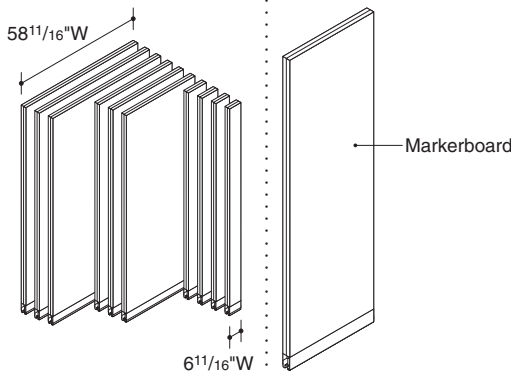

Modular solid panel widths range from 6¹/₁₆"W to 58¹/₁₆"W in 1" increments.
Tip: Panels with enhanced core do not exceed 46¹/₁₆" in width.

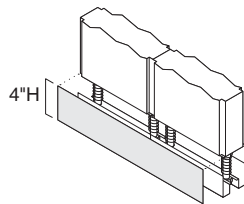

4" high continuous base trim, ordered separately, can also be specified and is available in 10' lengths. It runs along multiple panels to create a uniform look. For longer runs, multiple base trim segments can be used adjacent to each other. When using 4"H base, panels and other vertical components must be specified with a modified height to accept 4"H base trim and to ensure that the correct overall ceiling height is achieved.

Tip: Other modified components that must be specified to accept 4"H base:

- Panels*
- Posts and adapters*
- Feature strips*
- Door frames*
- Slider doors*
- Mini ends*
- Wall channels and cut kits*

Tip: 4" high base cannot be used with base-located power.

Panel surfaces can be specified with a markerboard surface for use with dry erase markers.

Tip: When using adjacent markerboard panels, specify the shared feature strip in a black painted or anodized finish. Black painted strips will conceal marks on surface. Anodized surface will allow markers to be cleaned from surface.

Tip: Markerboard surface is available in a maximum ceiling height of 120" and a maximum width of 48".

Glass Wall Panels

Including Glass Selections Wall Panels

Note: All planning and application guidelines contained in this section of the specification guide are based on the requirement that ceiling track is connected to a ceiling in order to properly support the wall components as shown.

Privacy Wall glass wall panels and Glass Selections wall panels create floor-to-ceiling walls, prefabricated to the height and width dimensions you specify. These panels, which offer power and communication capability, can be relocated to respond to changing needs.
▶ Specifying, pages 122–142, 196–210, 232–236

Feature strip joins panels.

Factory-installed lites can be specified in a variety of glass types.
Tip: For information regarding Etched and Pattern Glass Planning.
▶ Page 104.

Muntins divide glass into separate lites.

Adjustable levelers allow panels to be installed on uneven floors.

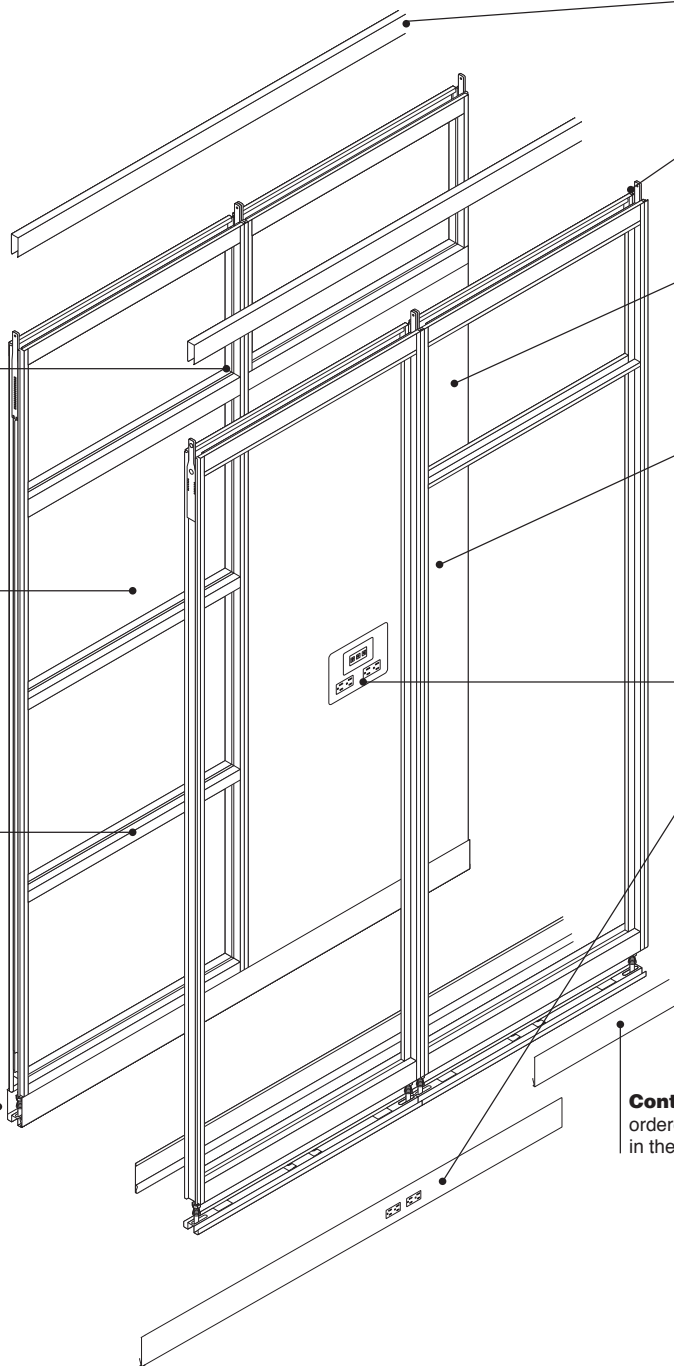

Recessed or overlapping ceiling track is available.

Post extensions are available in two versions to accommodate both types of ceiling tracks.

Integral slotted verticals above the base run to a height of 84".
Tip: Integral slotted verticals are available only on Clerestory and solid panels.

Surface of Clerestory panels is steel, available in paint, fabric, or vertical surface vinyl.
Tip: Vertical surface vinyl is available only on panels 48"W or smaller.

Tip: Vertical surface vinyl is not Greenguard and Indoor Advantage certified.

Power and communication outlets can be located in the panel face at desk and/or ADA height and/or in the base of a Clerestory panel. Outlets can be located in the base of full-glass panel or divided lite panel. Receptacles and cover plates are ordered separately.

Continuous base trim, ordered separately, is added in the field.

Product Details

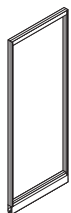

Glass wall panel

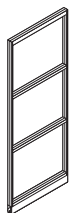

Three equal divided lites

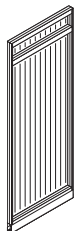

Some pattern glass types have a linear pattern. These linear patterns are oriented vertically as shown. ▶ See page 104 to identify vertical pattern glass.

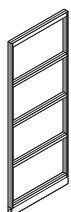

Four equal divided lites

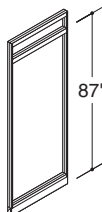

Two divided lites, transom-aligned top lite

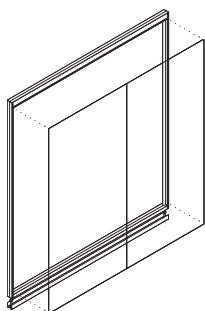

Glass Selections frame and glass kits are assembled in the field. Butt joints must be sealed glazed with glazing tape or silicone sealant to be codecompliant. *Tip: COM glass for frame and glass kits must be 3/8" thick for structural integrity.*

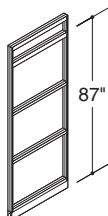

Four divided lites, transom-aligned top lite

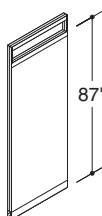

Clerestory

Glass wall panels are available in the following types: one lite, three equal divided lites, four equal divided lites, two divided lites with transom-aligned top lite, four divided lites with transom-aligned top lite, and solid with glass Clerestory.

Tip: Standard glass thickness must be between 0.312" and 0.417" thick.

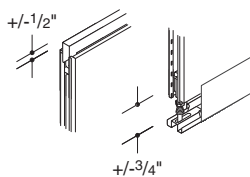

Ceiling track allows 1/2" of vertical adjustment at ceiling to accommodate variations in field conditions. Floor track allows 3/4" of vertical adjustment to accommodate variations at base.

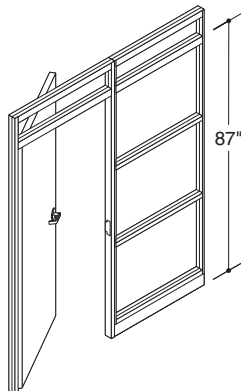

Glass wall panels with transom-aligned top lite correspond to transom-height doors. *Tip: Top muntin is 2/4"H; other muntins are 1/2"H. Glass Selections muntins are 2 1/2"H.*

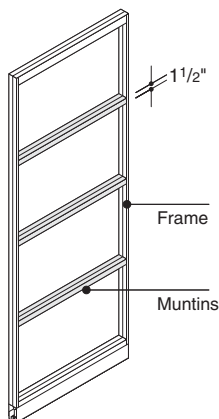

Muntins are factory installed horizontal framing elements that physically divide glass lites. Muntins match frame color specified. Glass Selections is available in clear anodized aluminum only. *Tip: All muntins in glass wall panels with four equal divided lites are 1 1/2"H. Glass Selections muntins are 2 1/2"H.*

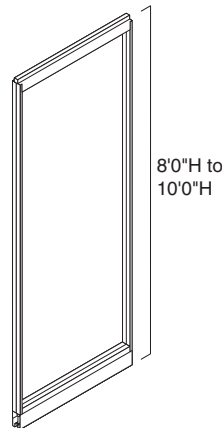

Panel height can be specified from 8'0"H to 10'0"H, in one-inch increments, to accommodate different ceiling heights. *Tip: Specify ceiling height of your installation and component will be fabricated to allow for ceiling track.*

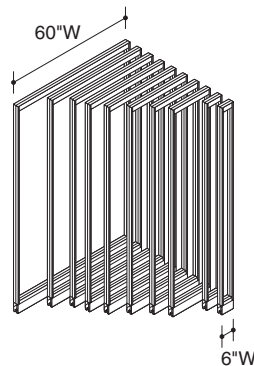

Panel widths range from 6"W to 60"W. *Exception: Clerestory and Glass Selections Clerestory wall panels range from 18"W to 60".*

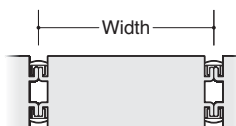

Width of panel is measured to center of joint between two panels.

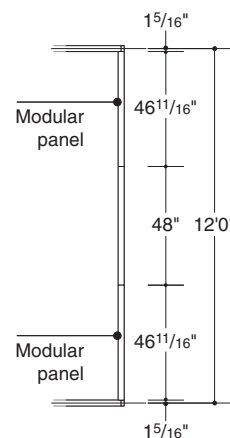

Modular panels used with adapters allow centerline planning. In the example above, two modular panels allow the distance between the centerline of the two parallel walls to remain at 12'0".

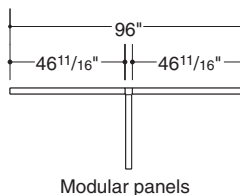
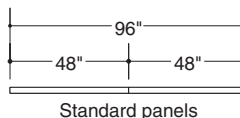

Modular panel widths are slightly smaller (1 5/16" less) than regular panel widths so that when a corner condition is created, the overall dimension remains unchanged.

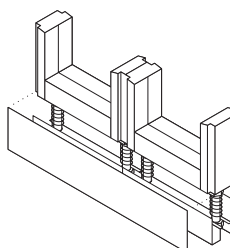

Continuous base trim, ordered separately, is 5"H and available in 10' lengths. It runs along multiple panels to create a uniform look. For longer runs, multiple base trim segments can be used adjacent to each other.

Glass Wall Panels, Including Glass Selections Wall Panels, continued

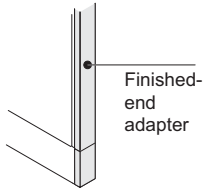

Finished-end adapter is available to finish the exposed end of a run of panels. Adapter adds approximately 1³/₁₆" to the length of the wall.

Vinyl is available on Clerestory panels that are 48"W or smaller.

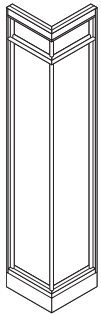

Glass Selections L-corner units, ordered separately, join Glass Selections panels in L-configuration. Butt joints are field-glazed (glazing tape or silicone sealant) on site during installation. ▶ Page 232

Full-size panel for interior dimension planning
Modular-size panel for centerline planning

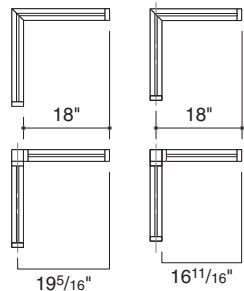

Glass Selections L-corner units plan dimensionally in the same manner as individual panels that are joined by a post.

Full-size panel for interior dimension planning

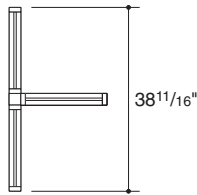
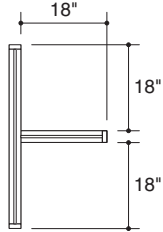

Modular-size panel for centerline planning

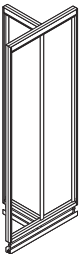
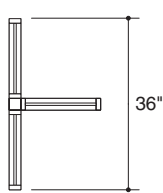
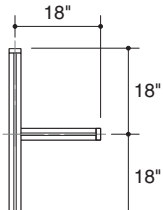

Glass Selections T-corner frame kits join Glass Selection panels in a T-configuration. Frame kits are assembled in the field. Glass kits include three pieces of glass. Butt joints must be glazed with glazing tape or silicone sealant to be code-compliant.

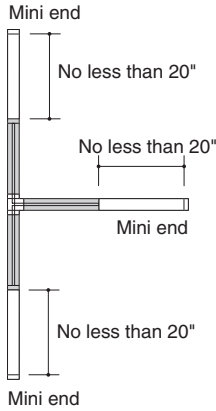

Due to the process steps involved in installation of glass, T-corner frame kits can be placed no closer than 20" to a single mini end or wall channel.

Connections

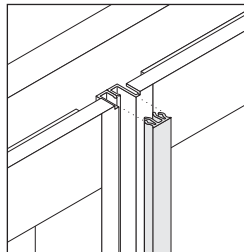

Feature strips, ordered separately, join panels together. Strip prevents light and sound leaks and can be cut to allow access to the integral slotted verticals in the Clerestory panels. To rearrange panels, feature strips can be removed and reused. ▶ Page 249

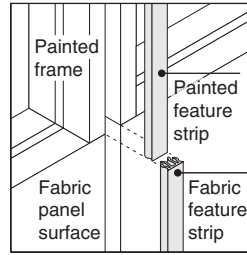

For Clerestory panels, you can specify two different feature strips when the solid-panel finish is different from the upper-glass frame finish.

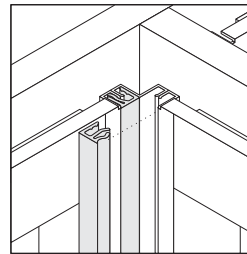

Half feature strips are used in combination with inline feature strips for inside corner applications.

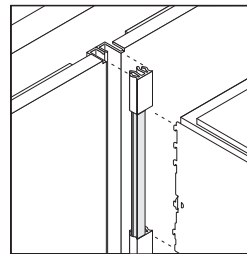

Furniture reveal strips, ordered separately, are positioned between two sections of in-line feature strip to allow access to one set of panel slots when a single component is mounted on a Privacy Wall panel. When components are mounted side-by-side, both sets of slots are left exposed, and there is no need for a furniture reveal strip. Furniture reveal strips are painted to match the adjacent wall panel or to match the component bracket. ▶ Page 251

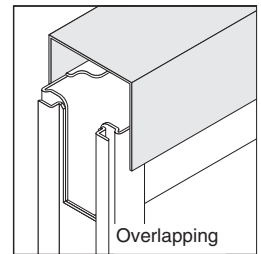
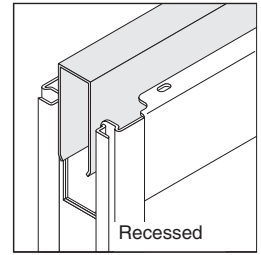

Ceiling track, ordered separately, joins the top of wall panels to the ceiling. Ceiling track is available recessed or overlapping. ▶ Page 60

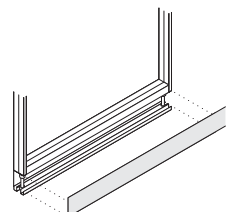

Base trim fits into position at the bottom of panel surface above the floor track.

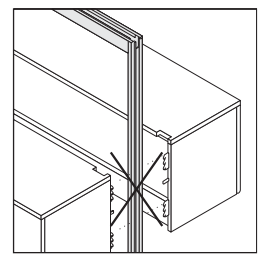

Panel-supported storage and work surface components cannot be attached to glass wall panels. Use solid wall or Clerestory panels instead. ▶ See page 87 for more information about hanging components.

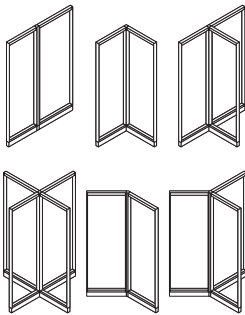

Posts join panels in in-line, L-, T-, X-, V-, and Y-configurations without blocking access to integral slotted verticals.

▶ Page 82

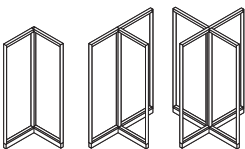

Adapters connect panels in L-, T-, and X-configurations without adding extra creep to panel dimension.

▶ Page 78

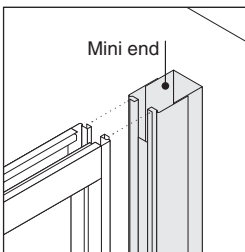

Mini end connects a panel or panel run to a perpendicular building wall.

▶ Page 68.

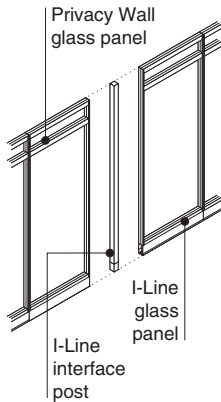

I-Line interface post allows a Privacy Wall panel to connect to an existing I-Line panel in line.

▶ Page 194

Tip: Two I-Line feature strips are needed for the I-Line side of the connection. Two Privacy Wall feature strips are needed for the Privacy Wall side of the connection.

▶ See *How to Connect Privacy Wall to I-Line Moveable Walls*, page 102.

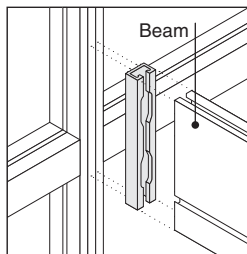

Post and Beam attachment kit is available to connect Privacy Wall panels to Post and Beam at a feature strip. The Post and Beam kit cannot be used off-module. It is designed for use in overhead applications only. It should not be used in fence application.

▶ Page 254

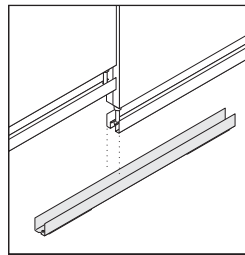

Universal floor grippers are designed for use with Privacy Wall panels that are placed on top of Low-Profile Floor. The universal floor gripper fits underneath the panel floor channel and glides to evenly distribute weight on the floor. When used with double-sided adhesive tape, the universal floor gripper will also prevent movement on hard surface floors like tile, wood, or terrazzo.

Panels which are configured for low profile base trim are not compatible with the universal floor gripper. Panels that are required to be secured to the floor must be directly anchored to the floor with conventional fasteners.

Panels that are wider than 48" may not be suitable for application in certain areas where local building codes have specific provisions for seismic activity.

Wiring & Cabling

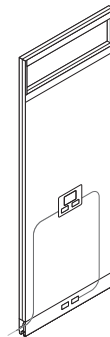

Hollow core in Clerestory panel enables both vertical and horizontal cable routing within panel.

Glass Privacy Wall panels can be specified with factory-installed powerkits. Power kits include a power block. Field-installed powerkits are also available.

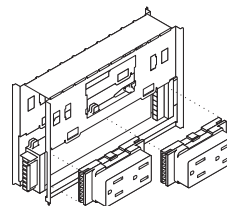

Desk- and ADA-height power blocks or Clerestory panel will be factory installed in center of panel to accommodate either power receptacles only or power and communication receptacles. A single power block can be specified to allow receptacles on one side or both sides of the panel. Both sides must be specified with the same configuration (power receptacles only or power and communications receptacles). Both sides must be specified with the same configuration (power receptacles only or power and communication receptacles).

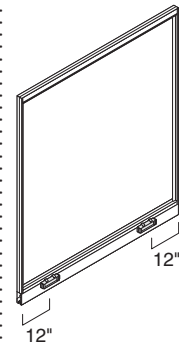

Power is located in the center of a panel except in Glass Selections frame kits, where the center of the power is located 12" from the panel edge.

Power receptacles

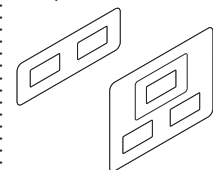

Power and communication receptacles

Cover plates, ordered separately, accommodate power receptacles and communication faceplates. Cover plates are used in panel face only.

▶ Page 258

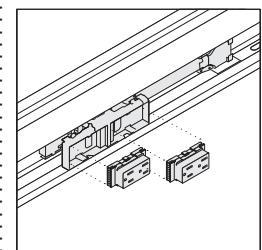

Base-height power block will be factory installed in center of panel. A single power block can accommodate receptacles in one side or both sides of panel.

Glass Wall Panels, Including Glass Selections Wall Panels, continued

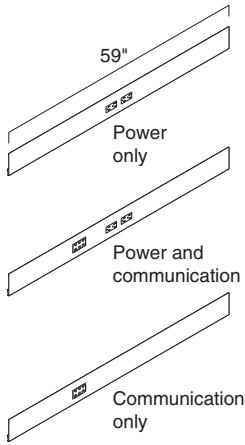

Base trim, ordered separately, is 59"W and available in three versions— power only, power and communication, and communication only.

Width of panel must be adequate to accommodate cutouts. See table below for minimum widths.

Power and Communication

- 30"W standard panel
- 30"W (nominal) modular panel

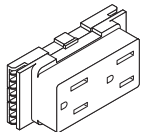

Power receptacles are ordered separately and installed on site. They are coded to indicate which circuit and type of ground they engage. ▶ Page 256

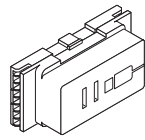

USB receptacles are ordered separately and installed on site. They are available in three wiring schematics with multiple line options. USB receptacles offer easy access to two charging ports. Each port provides 1 ampere of output. USB receptacles conveniently charge a wide range of electronic devices. Some devices may not be compatible.

Communication receptacles are provided by others and installed on site. They can accommodate single-gang NEMA-style faceplate, snap-in modular furniture-style faceplate, or Decora mounting strap style.

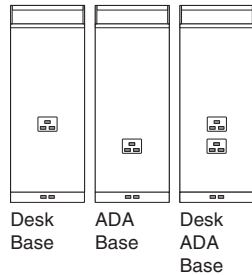
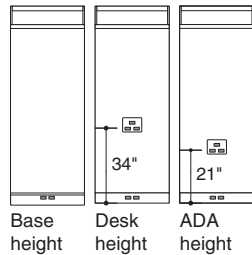

Receptacles can be specified in any combination of base height, desk height, or ADA height, on Clerestory panels.

Utilities can be specified on either side of the panel or on both sides. Receptacles can be installed on either side of the panel or on both sides. Fillers can be installed in any unused cutouts.

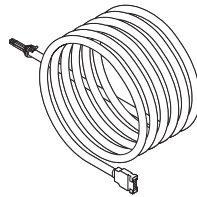

Infeeds can connect power blocks to building power in the ceiling or floor. Because glass panels cannot accommodate vertical routing of harnesses through the glass portion of the panel, use adjacent solid panels, mini ends, or door frames to bring power from the ceiling to a power block in a glass panel. Clerestory can route in panel from bottom.

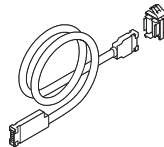

Modular harnesses and harness-to-harness connectors can be used to extend power to a power block from another power block in an adjacent panel.

Wiring schematics are available to accommodate a wide range of building types and power needs. 15-amp and 20-amp systems are available in 4-circuit, 3+1; 4-circuit, 2+2; and 3-circuit with separate neutrals. All of these choices are supported with a system ground and isolated ground.

Local electrical codes vary. Consult a qualified electrical contractor or engineer for the proper installation of electrical components.

Chicago and New York City require that all power be hardwired in the field. Modular power systems are not permitted. All Privacy Wall panels can be hardwired on site using conventional electrical components.

New York City/Chicago power prep option can be selected to provide panel cutouts and internal hardware to receive hardwired components.

New York City/Chicago power prep option requires use of Privacy Wall cover plate, ordered separately. ▶ Page 258

Surface Materials

Panel frame and muntins

- Paint

Glass Selections panel frame and muntins

- Paint
- Clear anodized aluminum

Clerestory panel

- Paint
- Fabric
- Vertical surface vinyl

Lite

- Glass
- Customer-specified glass also available

Ceiling track

- Paint

Base trim

- Paint

Feature strip

- Paint
- Fabric
- Vinyl
- Anodized aluminum

Cover plate

- Plastic

Receptacle

- Plastic

Application Topics

Feature Strip Application

▶ Page 86

Centerline Versus Interior Dimension Planning

▶ Page 96

How to Power a Panel

▶ Page 106

Overview of Powered Panels

▶ Page 110

Power Options

▶ Page 146

Glass Wall Panels — SmartTools Options

Note: All planning and application guidelines contained in this section of the specification guide are based on the requirement that ceiling track is connected to a ceiling in order to properly support the wall components as shown.

Product Details for SmartTools Options

SmartTools Options are available and easily ordered when using SmartTools software. If you do not have access to SmartTools software, these options can also be ordered using the normal Specials RFQ (Request for Quote) process.

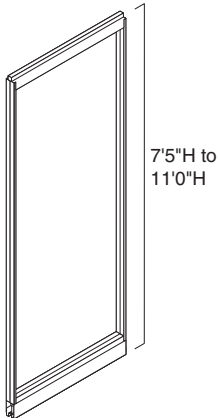

Panel height can be specified from 7'5"H to 11'0"H, in one-inch increments, to accommodate different ceiling heights.
Tip: Specify ceiling height of your installation and component will be fabricated to allow for ceiling track.

Tip: Panels that are greater than 10'0"H cannot exceed 48" in width.
Exception: Clerestory panels can be specified with a minimum ceiling height of 7'11".

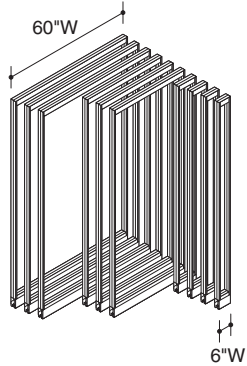

Glass panel widths range from 6"W to 60"W in even 1" increments.
Exception: Clerestory wall panels have a minimum width of 18"W, and maximum width of 60"W.

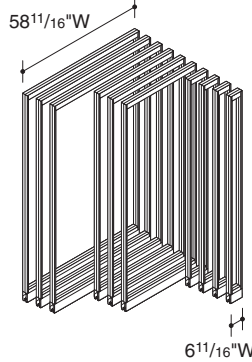

Modular glass panel widths range from 6 11/16"W to 58 11/16"W in 1" increments.
Exception: Clerestory wall panels have a minimum width of 16 11/16"W, and maximum of 58 11/16"W.

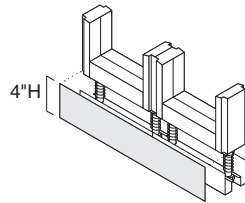

4" high continuous base trim, ordered separately, can also be specified and is available in 10' lengths. It runs along multiple panels to create a uniform look. For longer runs, multiple base trim segments can be used adjacent to each other. When using 4" high base, panels and other vertical components must be specified with modified height to accept 4" base trim and to ensure that the correct overall ceiling height is achieved.

Tip: Other special components that must be specified to accept 4"H base:
Panels
Posts and adapters
Feature strips
Door frames
Slider doors
Mini ends
Wall channels and cut kits

Tip: 4" high base cannot be used with base-located power.

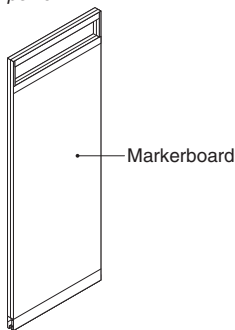

Clerestory panel surfaces can be specified with a markerboard surface for use with dry erase markers.
Tip: When using adjacent markerboard panels, specify the shared feature strip in a black painted or anodized finish. Black painted strips will conceal marks on surface. Anodized surface will allow markers to be cleaned from surface.

Tip: Markerboard surface is available in a minimum of 18"W and a maximum of 48"W.

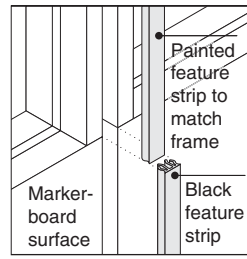

For Clerestory panels, you can specify two different feature strips when the solid panel finish is markerboard.

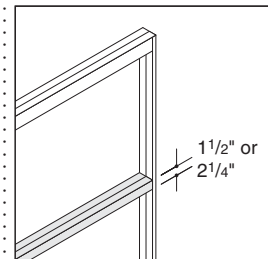

Muntin size can be specified as 1 1/2" or 2 1/4".

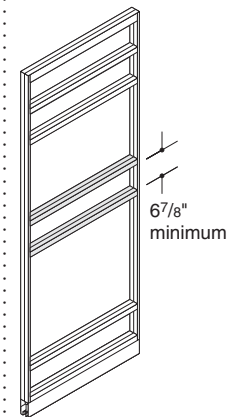
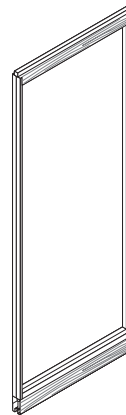

Additional muntins can be added to a four divided lite panel to make up to six lites. Muntins and glass horizontals can be no closer than 6 7/8".

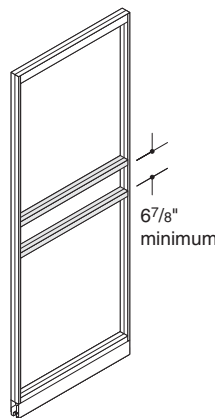

Any or all of the standard muntin positions can be moved. Muntins and glass horizontals can be no closer than 6 7/8".

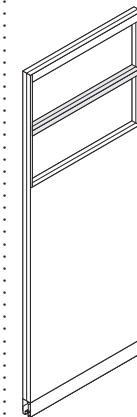

A single muntin can be added to a Clerestory panel to create two lites. Muntins and glass horizontals can be no closer than 6 7/8".

Glass Selections — SmartTools Options

Note: All planning and application guidelines contained in this section of the specification guide are based on the requirement that ceiling track is connected to a ceiling in order to properly support the wall components as shown.

Product Details for SmartTools Options

SmartTools Options are available and easily ordered when using SmartTools software. If you do not have access to SmartTools software, these options can also be ordered using the normal Specials RFQ (Request for Quote) process.

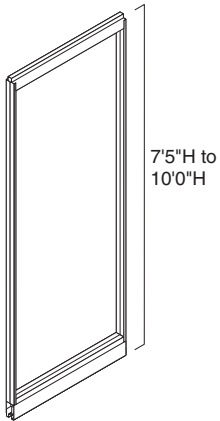

The height for wall panels, frame kits, glass kits, L- and T-corners

can be specified from 7'5"H to 10'H in one-inch increments to accommodate different ceiling heights.
Tip: Specify ceiling height of your installation and component will be fabricated to allow for ceiling track.
Exception: Clerestory panels can be specified with a minimum ceiling height of 7'11\".

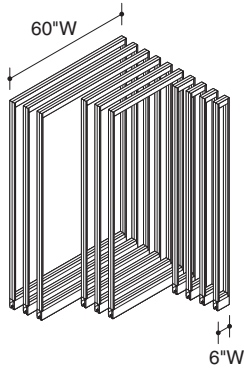

Panel widths range from 6"W to 60"W in even 1" increments.

Exception: Clerestory wall panels have a minimum width of 18"W and maximum of 60"W.

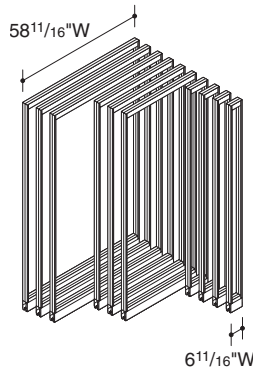

Modular glass panel widths range from 6¹¹/₁₆"W to 58¹¹/₁₆"W in 1" increments.

Exception: Clerestory wall panels have a minimum width of 16¹¹/₁₆"W, and maximum of 58¹¹/₁₆"W.

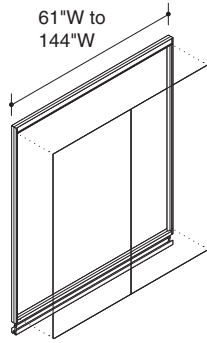

Frame kits and glass kits can range in widths from 61"W to 144"W in even 1" increments.

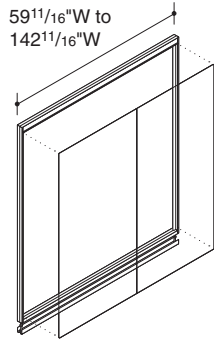

For modular frame kits and glass kits, sizes can range from 59¹¹/₁₆"W to 142¹¹/₁₆"W.

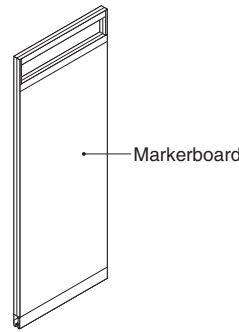

Glass Selections Clerestory panel surfaces

can be specified with a markerboard surface for use with dry erase markers.
Tip: When using adjacent markerboard panels, specify the shared feature strip in a black painted or anodized finish. Black painted strips will conceal marks on surface. Anodized surface will allow markers to be cleaned from surface.

Tip: Markerboard surface is available in a minimum width of 18"W and a maximum of 48"W.

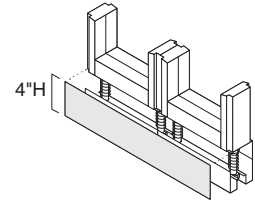

4" high continuous base trim

, ordered separately, can also be specified and is available in 10' lengths. It runs along multiple panels to create a uniform look. For longer runs, multiple base trim segments can be used adjacent to each other. When using 4" high base, panels and other vertical components must be specified with modified height to accept 4" base trim and to ensure that the correct overall ceiling height is achieved.

Tip: Other components that must be specified with 4" base:

- Panels
- Frame kits and glass kits
- Posts and adapters
- Feature strips
- Door frames
- Slider doors
- Mini ends
- Wall channels and cut kits

Tip: 4" high base cannot be used with base-located power.

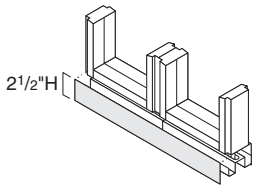

Low profile base trim,

ordered separately, can be specified on Glass Selections panels (including Clerestory) and frame kits. The base height is 2 1/2"H and is available in 10' lengths. It runs along multiple panels to create a uniform look. For longer runs, multiple base trim segments can be used adjacent to each other. When using low profile base, specify panels with base trim height to match. Components must be specified with a modified height to ensure that correct overall ceiling height is achieved. Other components must also be specified with a modified height to ensure that correct overall ceiling height is achieved.

Tip: Other special components that must be specified with low profile base:

- Panels*
- Frame kits and glass kits*
- L- and T-corner units*
- Feature strips*
- Posts*
- Door frames*
- Slider doors*
- Mini ends*

Panels with low profile base have reduced vertical adjustment at the floor (plus/minus 3/8").

Base trim for low profile base is provided with a clear anodized finish.

Panels which are configured for low profile base trim are not compatible with the universal floor gripper. Panels that are required to be secured to the floor must be directly anchored to the floor with conventional fasteners.

Butt-Hinged Frames and Door Leaves

Note: All planning and application guidelines contained in this section of the specification guide are based on the requirement that ceiling track is connected to a ceiling in order to properly support the wall components as shown.

Privacy Wall doors can be used with Privacy Wall panels. Door frames and leaves must be ordered separately.

► Specifying, pages 148 and 156

Tip: Glass Selections panels are compatible with pivot-hinged frames and leaves only.

Recessed or overlapping ceiling track is available.

Pair leaves can be painted or specified with wood veneer.

Inactive door leaf is secured with flush bolts that are included with hinge kit for pair doors (ordered separately).

Door frame is factory prepped for butt hinges. Door hardware is ordered separately.

► Page 168

Tip: Butt-hinged door frames are not available for Glass Selections panels.

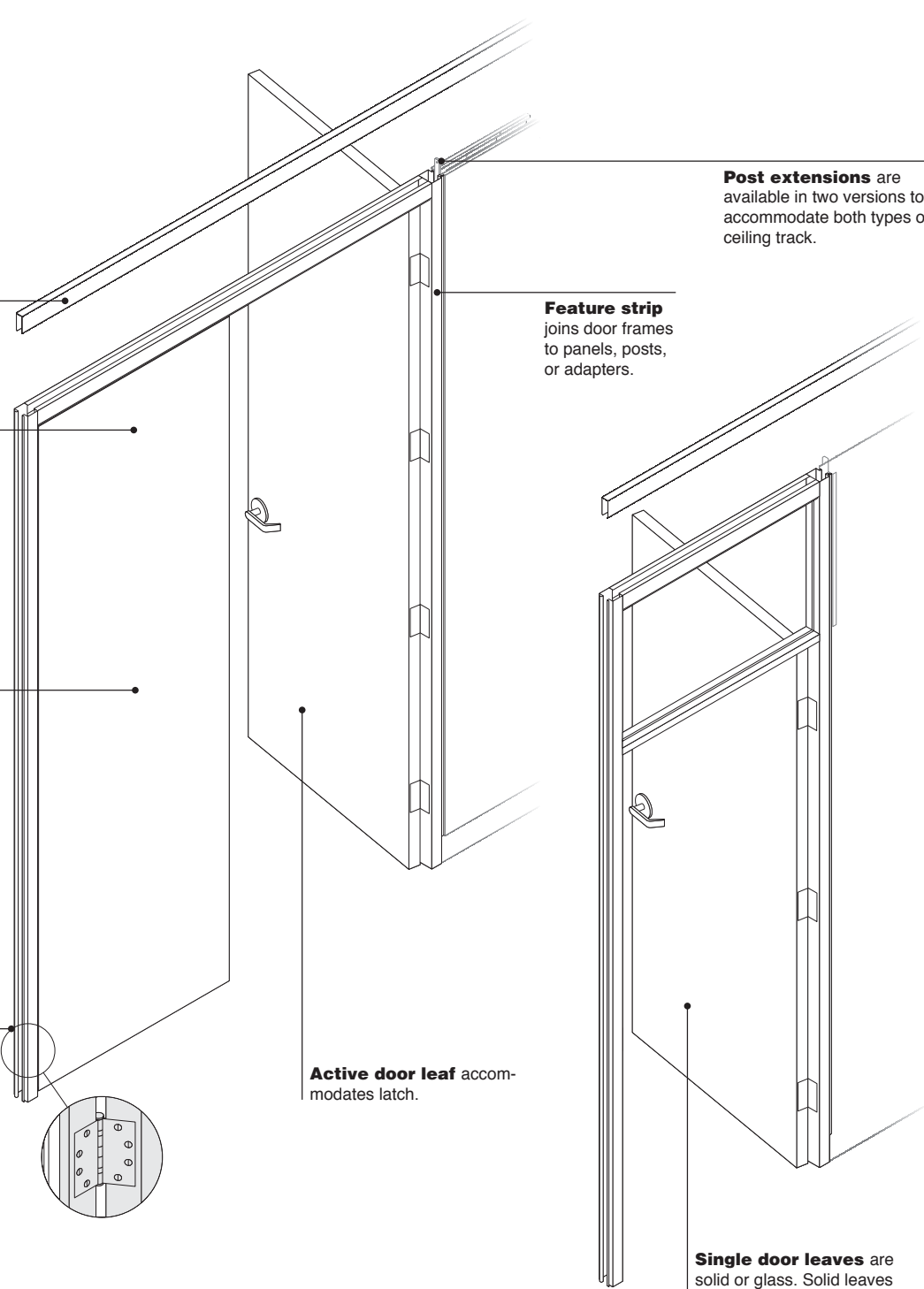

Post extensions are available in two versions to accommodate both types of ceiling track.

Feature strip joins door frames to panels, posts, or adapters.

Active door leaf accommodates latch.

Single door leaves are solid or glass. Solid leaves can be painted or specified with wood veneer.

Product Details

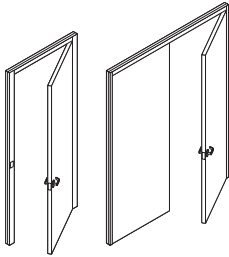

Single and pair versions of doors and door frames are available.

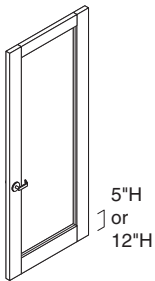

Glass doors can be ordered with a bottom rail height dimension of 5"H or 12"H. The 5" rail height will align closely with the bottom horizontal of a glass panel. In some areas of the country (such as California), a 12"H minimum bottom rail is required for code compliance in some applications.

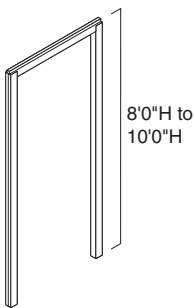

Door frames can be specified from 8'0"H to 10'0"H, in one-inch increments, to accommodate different ceiling heights. *Tip: Specify ceiling height of your installation and component will be fabricated to allow for ceiling track.*

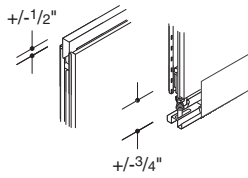

Ceiling track allows 1/2" of vertical adjustment to accommodate variations in field conditions. Floor track allows 3/4" of vertical adjustment.

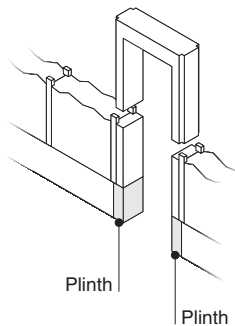

Plinths are included to finish the bottom of both sides of a door frame.

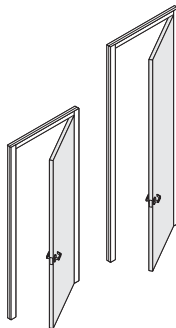

Full-height doors increase in height as the door frame increases. *Tip: Maximum ceiling height of glass doors is 9'0"H.*

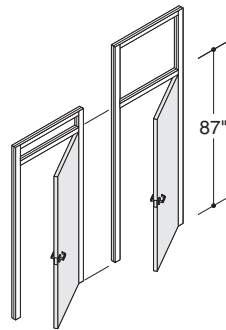

Transom-height door leaves are 7'0"H. Transom increases in height as the door frame increases.

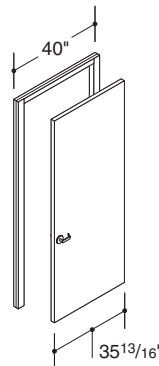

Width of single door frame is 40"W and accommodates a 35 13/16"W door.

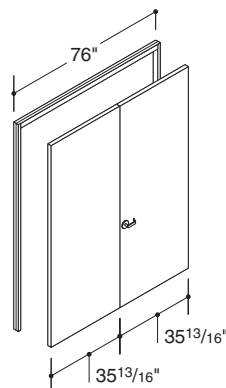

Width of pair frame is 76"W and accommodates two 35 13/16"W door leaves.

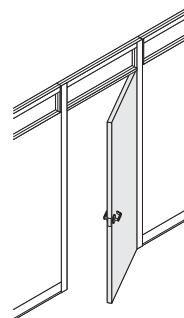

Transom-height doors correspond to Clerestory or glass wall panels with transom-aligned top lite. *Tip: For information regarding Etched and Pattern Glass Planning.* ▶ Page 104.

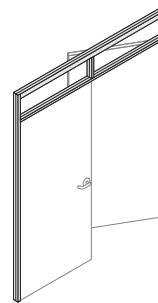

Transom-height frames for pair of doors with vertical directional, patterned glass will have a vertical muntin installed in the center of the transom. ▶ See *Glass Availability Matrix* for directional glass options, page 414.

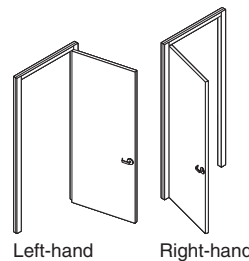

Left- and right-hand versions of butt-hinged doors and door frames are available. Swing orientation cannot be altered.

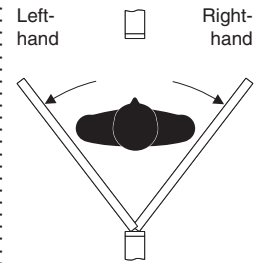

To determine whether a door is left or right hand, imagine yourself standing in the door's frame with your back against the side of the frame where the door's hinges will be attached. If the door will swing to your left, it is a left-hand door (and frame). If it will swing to your right, it is a right-hand door (and frame).

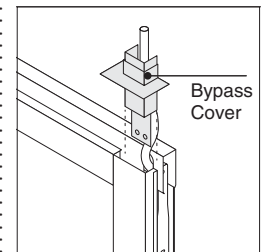

Ceiling track bypass cover is available to conceal switch conduit routed next to a recessed ceiling track as the conduit travels from the ceiling into a door frame. ▶ Page 242

Butt-Hinged Frames and Door Leaves, continued

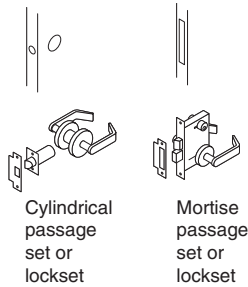

Cylindrical passage set or lockset
Mortise passage set or lockset

Cutout for cylindrical passage set or lockset is standard in butt-hinged door leaves. Cutout for mortise passage set or lockset is available as an option. Order passage sets and locksets separately.

▶ Page 168
Tip: Cutout and hardware must be the same for door and door frames.

Tip: Locksets and passage sets ordered from another manufacturer must have a 1³/₈" curved strike plate.

Tip: Doors that are specified with hardware prep for mortise locks will not have faces drilled for levers, cylinders, etc. All necessary holes in the face of the door must be drilled by the installer.



Magnetic wall stop



Dome-style floor stop



Screw-in base stop

Door stops can be ordered for use with doors. Magnetic wall stop, dome-style floor stop, and screw-in base stop are available. Magnetic wall stop is for use with painted solid or Clerestory panels only.

▶ Page 170

All door openings meet ADA requirements.

Connections

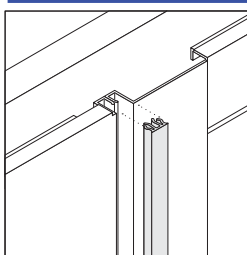

Feature strips, ordered separately, join door frames to panels, posts, adapters, and other components while preventing light and sound leaks. To rearrange doors, feature strips can be removed and reused.

▶ Page 248

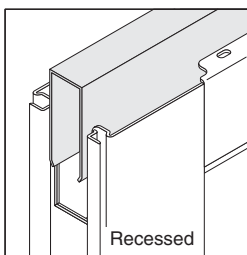

Recessed

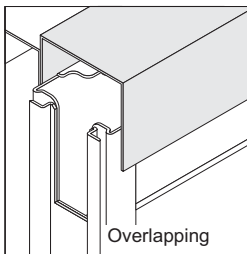

Overlapping

Ceiling track, ordered separately, joins the top of door frames to the ceiling. Ceiling track is available recessed or overlapping.

▶ Page 60

Panel-supported storage and worksurface components cannot be attached to door frames. Use solid wall or Clerestory panels instead.

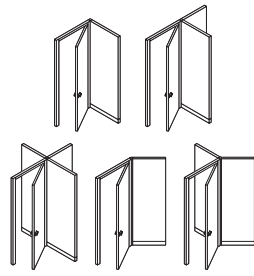

Posts join a door frame to a panel in an L-, T-, X-, V-, or Y-configuration. A T-, X-, or in-line post can also be used between two in-line door frames.

▶ Page 82

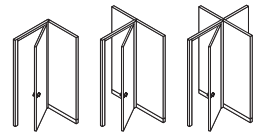

Adapters connect a door frame to a panel in an L-, T-, or X-configuration. A T-adapter can also be used between two in-line door frames.

▶ Page 78

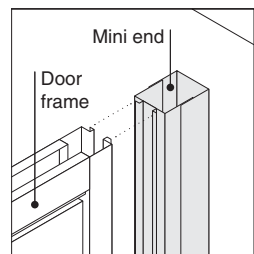

Mini end connects a door frame to a perpendicular building wall.

▶ Page 68

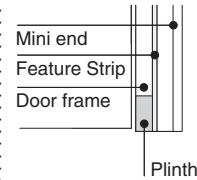

When positioned next to a door frame, the mini end should be specified "to floor," and will be field-cut by the installer to final length.

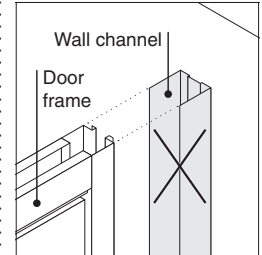

Do not use a wall channel to connect a door frame to a perpendicular wall.

▶ See *Wall Channel Flexibility*, page 75.

Panels that are wider than 48" may not be suitable for application in certain areas where local building codes have specific provisions for seismic activity.

Wiring & Cabling

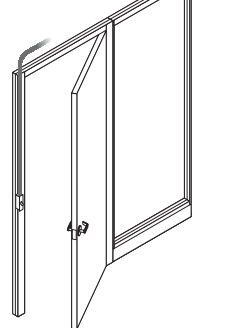
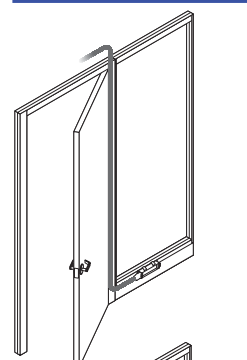

Installation of a switch in a door frame will limit the ability to route a power infeed through the frame. If the door frame has no switch, you can route power to the base of an adjacent glass panel.

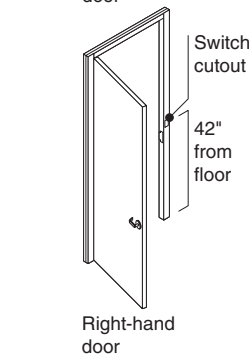
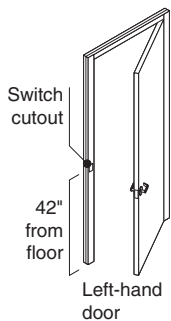

Switch cutout, available as an option on single door frames, will be factory-cut in the strike jamb of the frame, on the side that matches the direction in which the door swings. Switch cutout is located 42" from floor.

Wiring is routed from the ceiling or floor through the door jamb.

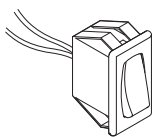

Low-voltage switches are available on all door frame types except pairs of doors.

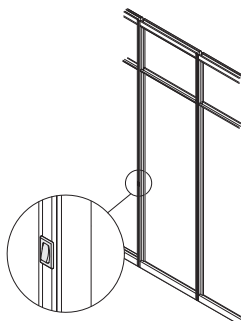

Low-voltage switches can be positioned on an in-line feature strip between two panels (solid or glass) or between a panel and a door frame. The feature strip is cut and notched during installation to accommodate the switch.

Low-voltage switch kits include:

- Switch device
- Cover trim
- Transformer
- Low-voltage (18-gauge) wire x 30'



High-voltage switches are rated for 120V and 277V applications, and are available on all door frame types except Privacy Wall slider doors, Glass Selections slider doors, and pairs of doors. You must specify door frame for use with switch cutout.

High-voltage switch kits include:

- Electrical box and strap
- Switch device
- Cover plate

Wiring and conduit are not included.

Surface Materials

Door frame

- Paint

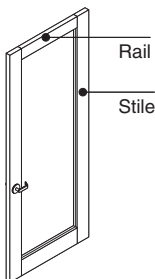

Aluminum rails and stiles on glass door leaf

- Paint

Solid door leaf

- Paint
- Wood veneer

Transom, glass door leaf

- Glass

Strike plate, door stops, and butt hinges

- 9200 Satin Chrome
- 9201 Polished Chrome

Switch plate

- Paint

Feature strip

- Paint
- Fabric
- Vinyl

Application Topics

Door Swing Orientation Choices

- ▶ Page 46

Feature Strip Application

- ▶ Page 86

Butt-Hinged Frames and Door Leaves — SmartTools Options

Note: All planning and application guidelines contained in this section of the specification guide are based on the requirement that ceiling track is connected to a ceiling in order to properly support the wall components as shown.

Product Details for SmartTools Options

SmartTools Options are available and easily ordered when using SmartTools software. If you do not have access to SmartTools software, these options can also be ordered using the normal Specials RFQ (Request for Quote) process.

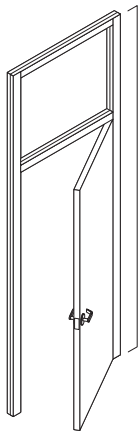

8'0"H to 11'0"H

Door frames with transom can be specified from 8'H to 11'H, in one-inch increments, to accommodate different ceiling heights.

Tip: Specify ceiling height of your installation and component will be fabricated to allow for ceiling track.

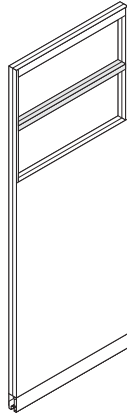

A single muntin can be added to a transom height door frame to create two lites. Muntins and glass horizontals can be no closer than 6⁷/₈".

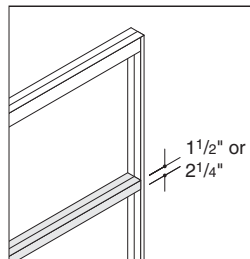

Muntin size can be specified as 1¹/₂" or 2¹/₄".

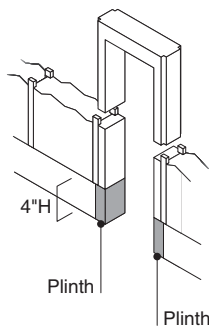

When planning with 4" high base, specify door frames to accept 4"H base and to receive special height plinths to match base trim.

Pivot-Hinged Frames and Door Leaves

Including Glass Selections Pivot-Hinged Frames and Door Leaves

Note: All planning and application guidelines contained in this section of the specification guide are based on the requirement that ceiling track is connected to a ceiling in order to properly support the wall components as shown.

Privacy Wall doors can be used with Privacy Wall panels. Door frames and leaves must be ordered separately.
 ▶ Specifying, pages 150–154, 160–167, and 214–223
Tip: Glass Selections panels are compatible with pivot-hinged frames and leaves only.

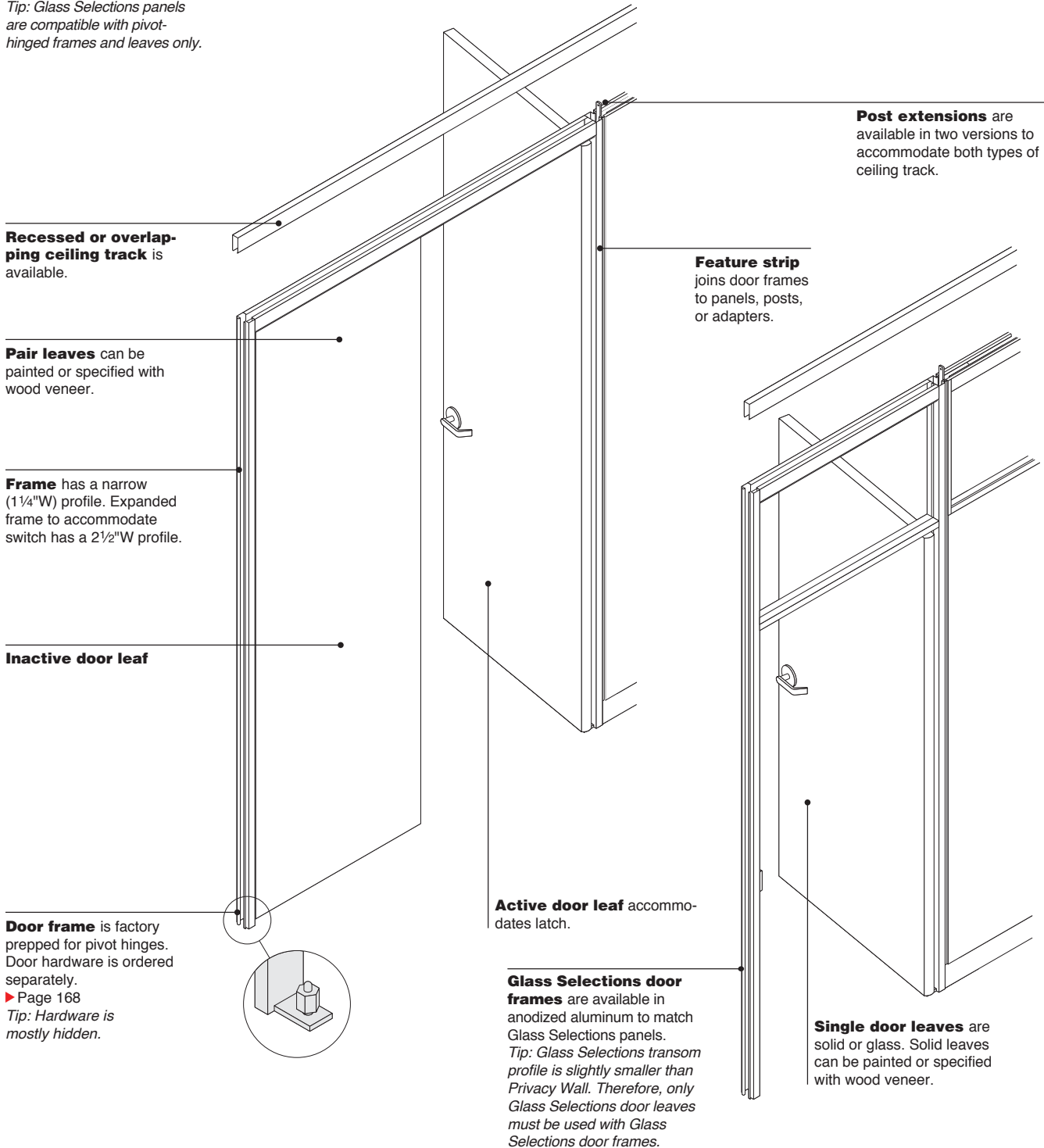

Product Details

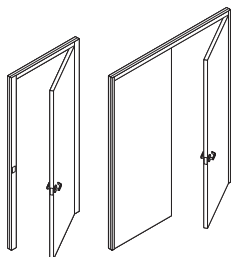

Single and pair versions of doors and door frames are available.

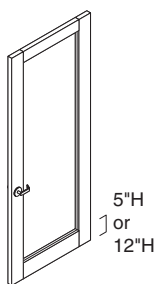

5"H or 12"H

Glass doors can be ordered with a bottom rail height dimension of 5"H or 12"H. The 5" rail height will align closely with the bottom horizontal of a glass panel. In some areas of the country (such as California), a 12"H minimum bottom rail is required for code compliance in some applications.

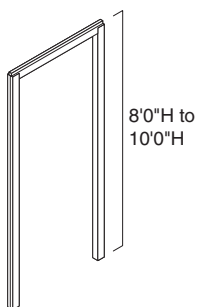

8'0"H to 10'0"H

Door frames can be specified from 8'0"H to 10'0"H, in one-inch increments, to accommodate different ceiling heights.

Tip: Specify ceiling height of your installation and component will be fabricated to allow for ceiling track.

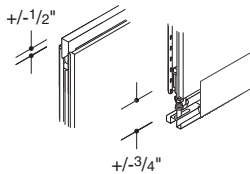

Ceiling track allows 1/2" of vertical adjustment to accommodate variations in field conditions. Floor track allows 3/4" of vertical adjustment.

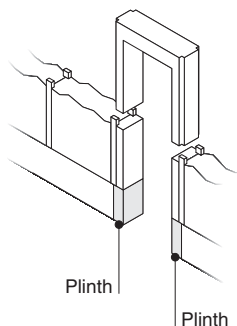

Plinths are included to finish the bottom of both sides of a door frame.

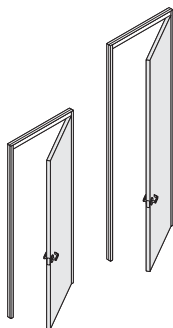

Full-height doors increase in height as the door frame increases. *Tip: Maximum ceiling height of glass doors is 9'0"H.*

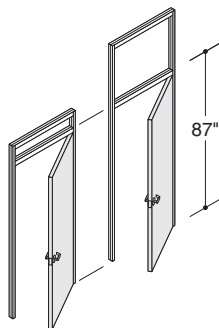

Transom-height door leaves are 7'0"H. Transom increases in height as the door frame increases.

Tip: For information regarding Etched and Pattern Glass Planning.

▶ Page 104.

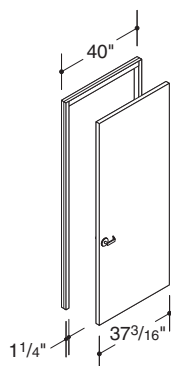

Width of single door frame without switch cutout is 40"W and accommodates a 37 3/16"W door.

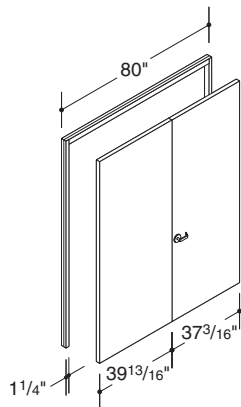

Width of pair frame is 80"W.

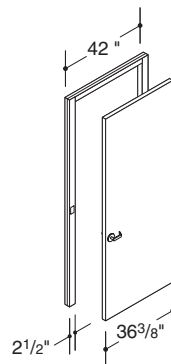

Width of single door frame with switch cutout is 42"W and accommodates a 36 3/8"W door.

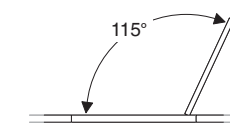

Maximum swing of door is 115°.

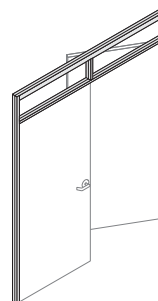

Transom-height frames for pair of doors with vertical directional, patterned glass will have a vertical muntin installed in the center of the transom.

▶ See *Glass Availability Matrix* for directional glass options, page 414.

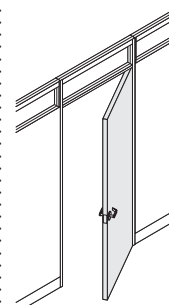

Transom-height doors correspond to Clerestory or glass wall panels with transom-aligned top lite.

Tip: For information regarding Etched and Pattern Glass Planning.

▶ Page 104.

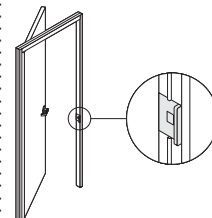

Left-hand pivot door

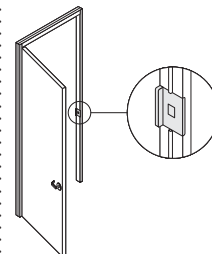

Right-hand pivot door

Solid pivot-hinged doors and door frames are non-handed. By removing and reinstalling the strike plate, you can convert a left-hand pivot door into a right-hand pivot door.

Tip: Glass pivot doors are handed to ensure that glass is properly oriented.

▶ Page 104

Pivot-Hinged Frames and Door Leaves, Including Glass Selections Pivot-Hinged Frames and Door Leaves, continued

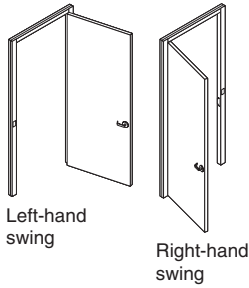

Pivot-hinged door frames with switch cutout are handed. The switch cutout is on the side of the frame opposite the pivots. You cannot change the swing orientation of the door frame in the field, although you can change the swing of the door.

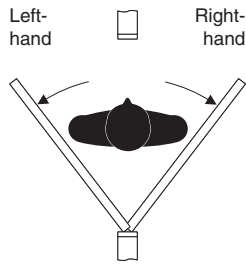

To determine whether a door is left or right hand, imagine yourself standing in the door's frame with your back against the side of the frame where the door's hinges will be attached. If the door will swing to your left, it is a left-hand door (and frame). If it will swing to your right, it is a right-hand door (and frame).

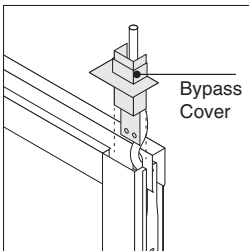

Ceiling track bypass cover is available to conceal switch conduit routed next to a recessed ceiling track as the conduit travels from the ceiling into a door frame. ▶ Page 242

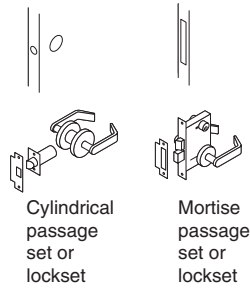

Cutout for cylindrical passage set or lockset is standard in pivot-hinged door leaves. Cutout and strike plate for mortise passage set or lockset is available as an option. Order passage sets and locksets separately.

▶ Page 168

Tip: Cutout and hardware must be the same for door and door frames.

Tip: Mortise locksets and passage sets ordered from another manufacturer must have a 1 1/8" flat strike plate.

Tip: Doors that are specified with hardware prep for mortise locks will not have faces drilled for levers, cylinders, etc. All necessary holes in the face of the door must be drilled by the installer.



Dome-style floor stop



Door stops can be ordered for use with doors. Magnetic wall stop, dome-style floor stop, and screw-in base stop are available. Magnetic wall stop is for use with painted solid or Clerestory panels only. ▶ Page 170

All door openings meet ADA requirements.

Connections

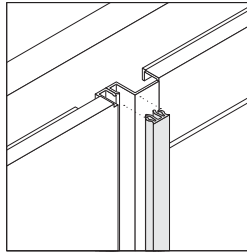

Feature strips, ordered separately, join door frames to panels, posts, adapters, and other components while preventing light and sound leaks. To rearrange doors, feature strips can be removed and reused. ▶ Page 248

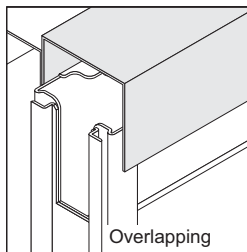
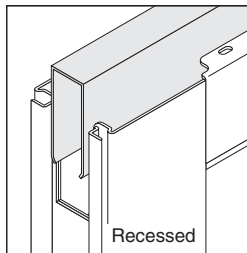

Ceiling track, ordered separately, joins the top of door frames to the ceiling. Ceiling track is available recessed or overlapping. ▶ Page 60

Panel-supported storage and worksurface components cannot be attached to door frames. Use solid wall or Clerestory panels instead.

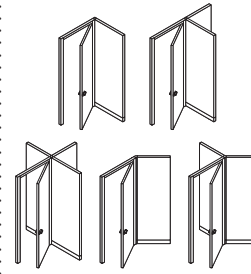

Posts join a door frame to a panel in an L-, T-, X-, V-, or Y-configuration. A T-, X-, or in-line post can also be used between two in-line door frames. ▶ Page 82

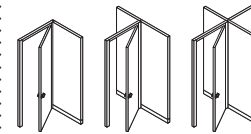

Adapters connect a door frame to a panel in an L-, T- or X-configuration. A T-adapter can also be used between two in-line door frames. ▶ Page 78

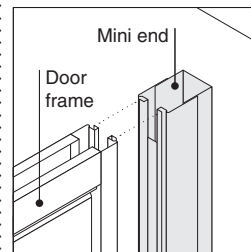

Mini end connects a door frame to a perpendicular building wall. ▶ Page 68

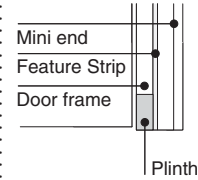

When positioned next to a door frame, the mini end should be specified "to floor" and will be field-cut by the installer to final length.

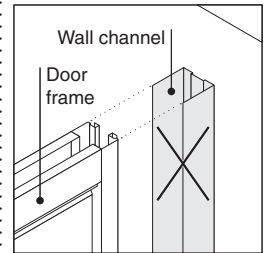

Do not use a wall channel to connect a door frame to a perpendicular wall.

▶ See *Wall Channel Flexibility*, page 75.

Panels that are wider than 48" may not be suitable for application in certain areas where local building codes have specific provisions for seismic activity.

Wiring & Cabling

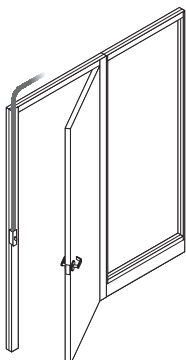

Pivot door with switch

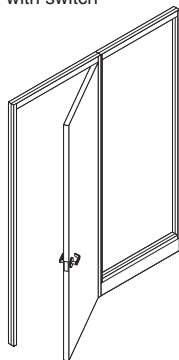

Pivot door without switch

Installation of a switch

in a door frame will limit the ability to route a power infeed through the frame. If the door frame has no switch, you can route power to the base of an adjacent glass panel.

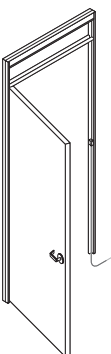

In door frame with glass transom, switch wiring must run down through the floor. Wiring cannot be run up to the ceiling.

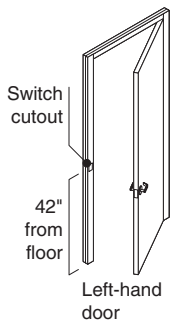

Switch cutout
42" from floor
Left-hand door

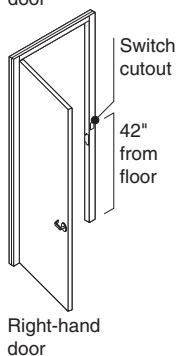

Switch cutout
42" from floor
Right-hand door

Switch cutout in pivot-hinged door frames

is always on the strike jamb of the frame. Cutout is standard on the side that matches the direction in which the door swings. Switch cutout is located 42" from floor.

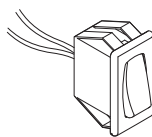

Low-voltage switches are available on all door frame types except pairs of doors.

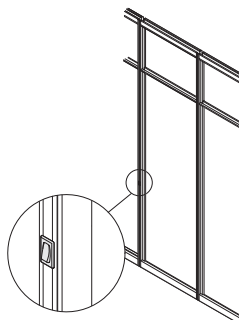

Low-voltage switches can be positioned on an in-line feature strip between two panels (solid or glass) or between a panel and a door frame. The feature strip is cut and notched during installation to accommodate the switch.

Pivot-hinged door frames can remain non-handed by installing low-voltage switches in the feature strip rather than positioning them in the door frame.



High-voltage switches are available on all door frame types except Privacy Wall slider doors, Glass Selections slider doors, and pairs of doors. You must specify door frame for use with switch cutout.

Surface Materials

Door frame

- Paint

Glass Selections door frame

- Paint
- Clear anodized aluminum

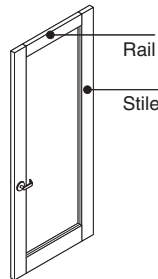

Aluminum rails and stiles on glass door leaf

- Paint
- Clear anodized aluminum (Glass Selections only)

Solid door leaf

- Paint
- Wood veneer

Transom, glass door leaf

- Glass

Strike plate and door stops

- 9200 Satin Chrome
- 9201 Polished Chrome

Pivot hinges

- 9200 Satin Chrome

Switch plate

- Paint

Feature strip

- Paint
- Fabric
- Vinyl
- Anodized aluminum

Application Topics

Door Swing Orientation Choices

▶ Page 46

Feature Strip Application

▶ Page 86

Pivot-Hinged Frames and Door Leaves — SmartTools Options

Note: All planning and application guidelines contained in this section of the specification guide are based on the requirement that ceiling track is connected to a ceiling in order to properly support the wall components as shown.

Product Details for SmartTools Options

SmartTools Options are available and easily ordered when using SmartTools software. If you do not have access to SmartTools software, these options can also be ordered using the normal Specials RFQ (Request for Quote) process.

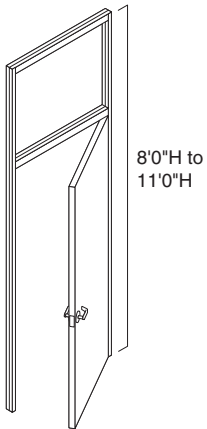

Privacy Wall door frames with transom can be specified from 8' 0"H to 11' 0"H, in one-inch increments, to accommodate different ceiling heights.

Exception: Glass Selections door frames are available in a maximum of 10'0".

Tip: Specify ceiling height of your installation and component will be fabricated to allow for ceiling track.

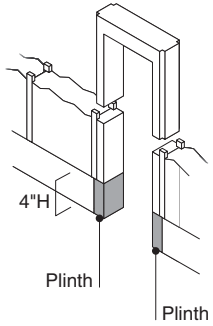

When planning with 4" high base, or low profile base, specify door frames to accept 4"H or 2 1/2"H base and receive special height plinths to match base trim.

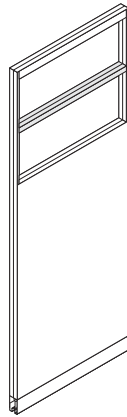
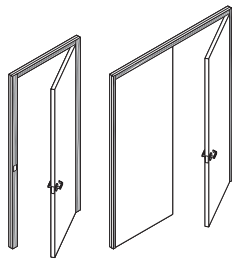

A single muntin can be added to a Privacy Wall transom height door frame to create two lites. Muntins and glass horizontals can be no closer than 6 7/8".

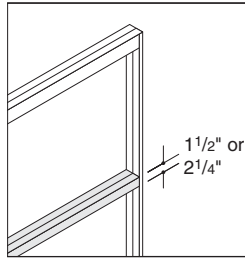

Muntin size can be specified as 1 1/2" or 2 1/4".

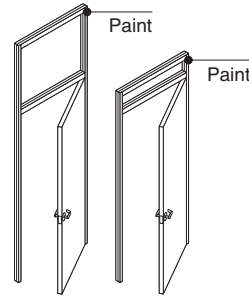

Glass Selections door frames can be specified with painted surfaces as an alternative to anodized aluminum.

Door Swing Orientation Choices

Note: All planning and application guidelines contained in this section of the specification guide are based on the requirement that ceiling track is connected to a ceiling in order to properly support the wall components as shown.

Butt-Hinged Door Frames

Butt-Hinged Door Frames with Switch Cutout

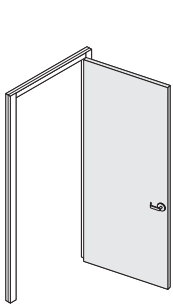

Left-hand swing orientation

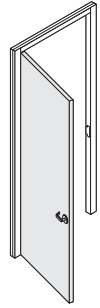

Right-hand swing orientation

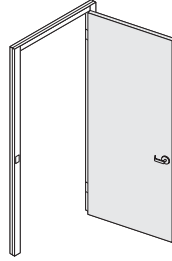

Left-hand swing orientation plus switch cutout

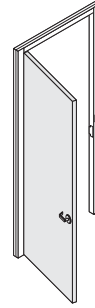

Right-hand swing orientation plus switch cutout

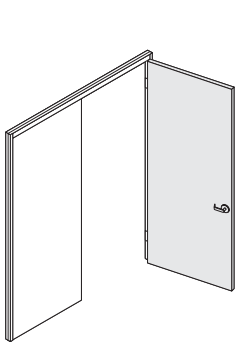

Left-hand active swing orientation on active leaf

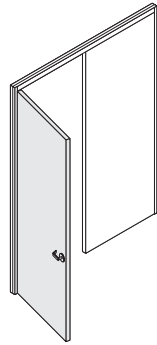

Right-hand active swing orientation on active leaf

Tip: Transom-height door frames are also available.

Pivot-Hinged Door Frames

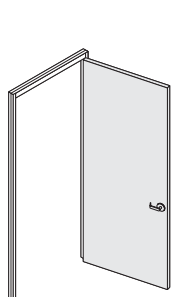

Left-hand swing orientation

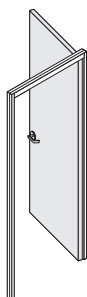

Reverse swing orientation on site at the time of installation

Pivot-Hinged Door Frames with Switch Cutout

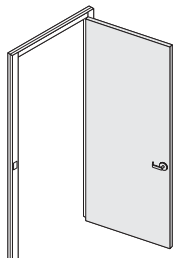

Left-hand swing orientation on door frame with switch cutout

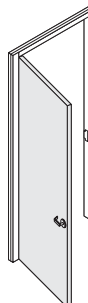

Right hand swing orientation on door frame with switch cutout

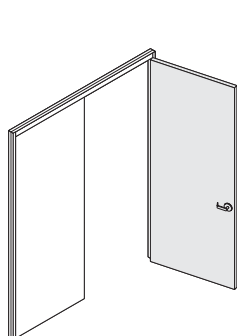

Left-hand active swing orientation on active leaf

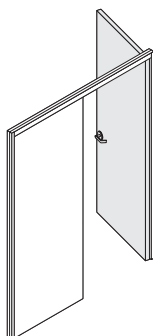

Reverse swing orientation on site at the time on installation

Tip: Glass pivot doors are handed to ensure that glass is properly oriented.
▶ Page 104

Tip: Transom-height door frames are also available.

Privacy Wall Slider Doors

Note: All planning and application guidelines contained in this section of the specification guide are based on the requirement that ceiling track is connected to a ceiling in order to properly support the wall components as shown.

Privacy Wall slider doors include door frame, slider door, fixed panel, and hardware.

► Specifying, page 174

Post extensions are available in two versions to accommodate both types of ceiling track.

Feature strip joins slider door to panels, posts, or adapters.

Recessed or overlapping ceiling track is available.

Fascia conceals track and ceiling mechanism and projects beyond the face of the wall.

Knockout for low-voltage switch is located on fixed panel 42" from floor.

Fixed panel does not move. It provides space for the overlapping door when it is in the open position.

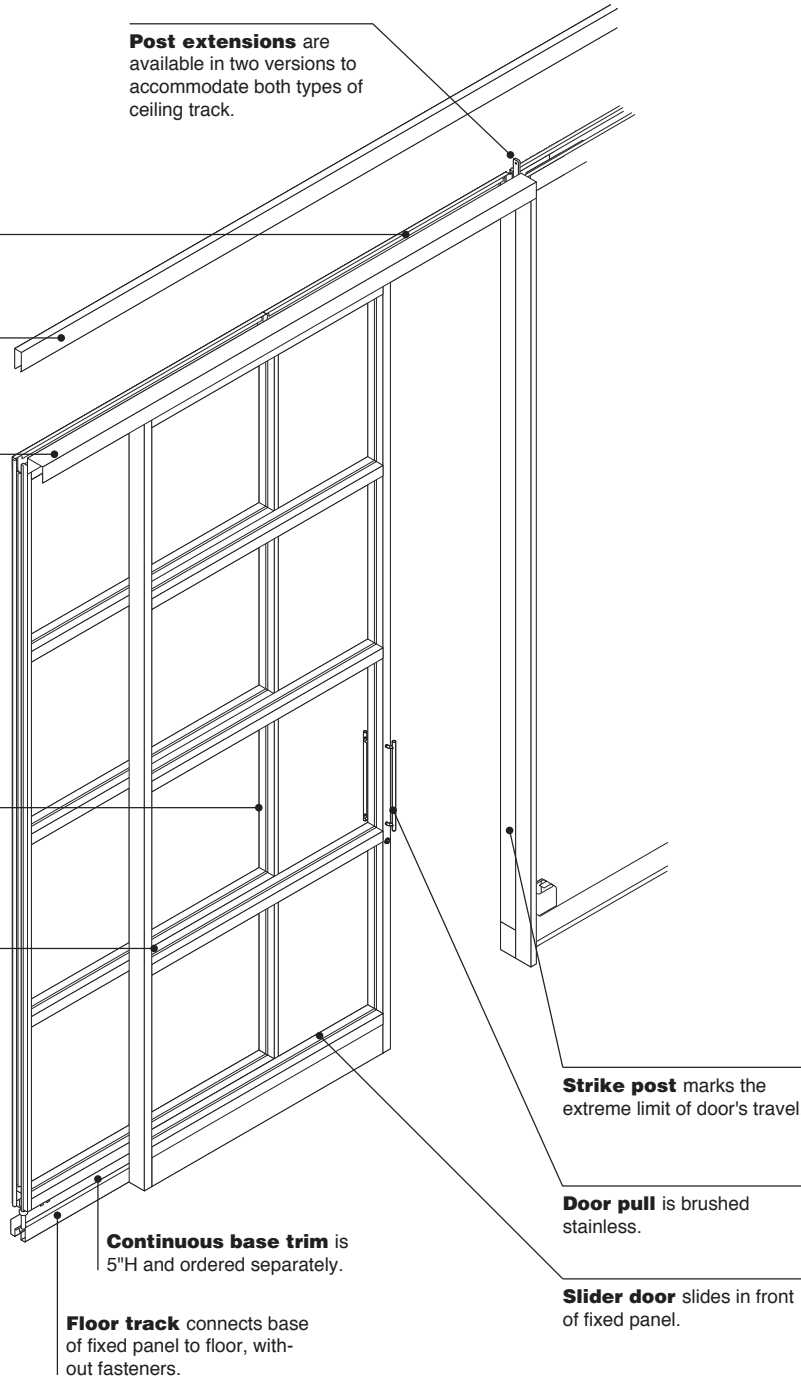

Continuous base trim is 5"H and ordered separately.

Floor track connects base of fixed panel to floor, without fasteners.

Strike post marks the extreme limit of door's travel.

Door pull is brushed stainless.

Slider door slides in front of fixed panel.

Product Details

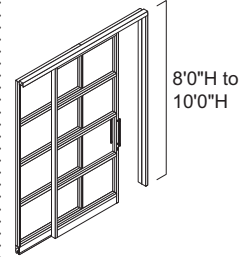

Slider doors can be specified from 8'0"H to 10'0"H, in one-inch increments, to accommodate different ceiling heights.

Tip: Specify ceiling height of your installation and component will be fabricated to allow for ceiling track.

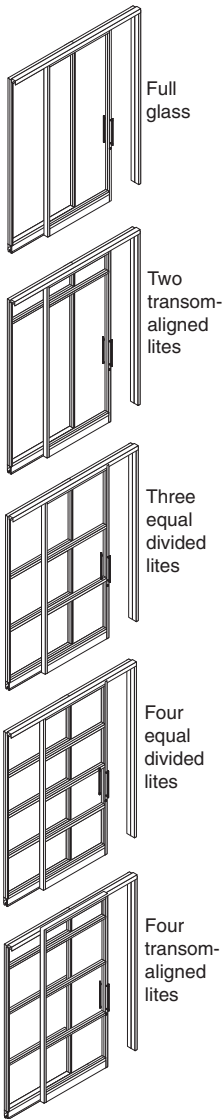

Slider door units are available with five different glass configurations.

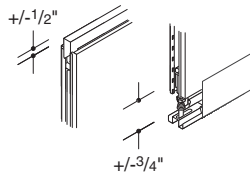

Ceiling track allows 1/2" of vertical adjustment at ceiling to accommodate variations in field conditions. Floor track allows 3/4" of vertical adjustment to accommodate variations at base.

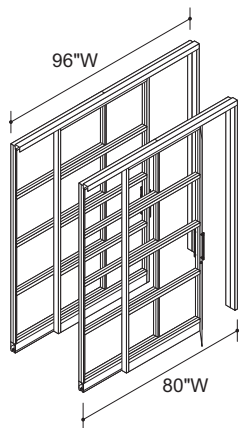

Width of slider door is 80"W or 96"W. Full opening is slightly less than half of the total width of sliding door assembly.

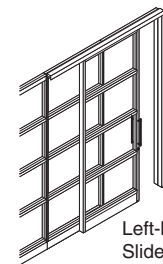

Left-hand Slider door

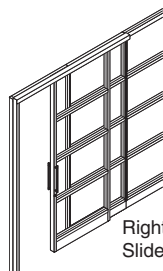

Right-hand Slider door

Slider door is available left hand and right hand when viewed from slider door side.

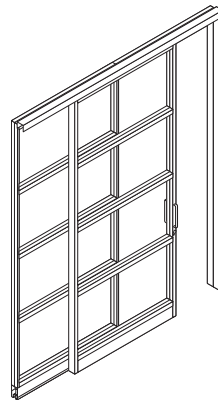

Glass lite types can be specified individually per row. See *Surface Materials*, page 408. Tip: For information regarding Etched and Pattern Glass Planning. Page 104.

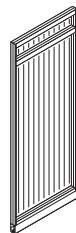

Some pattern glass types have a linear pattern. These linear patterns are oriented vertically as shown. See page 104 to identify vertical pattern glass.

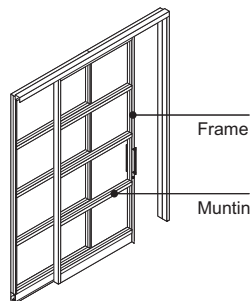

Frame
Muntin

Muntins are factory-installed horizontal framing elements that physically divide glass lites. Muntins match frame color specified. Tip: All muntins in slider doors with four equal divided lites are 1 1/2"H.

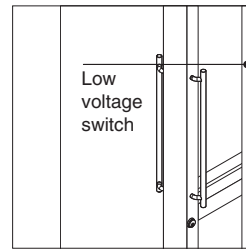

Low voltage switch cutout is located in the side face of the finished opening frame.

Tip: If slider door is oriented to the outside of the room, the switch cutout will be positioned on the inside of the room. If slider door is oriented to the inside of the room, the switch cutout will be positioned on the outside of the room.

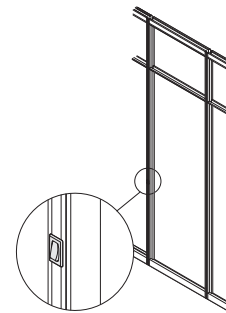

Low-voltage switches can be positioned on an in-line feature strip between two panels (solid or glass) or between a panel and a door frame. The feature strip is cut and notched during installation to accommodate the switch.

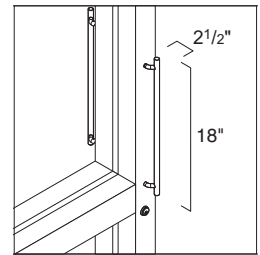

Door lock with interior thumb latch is available as an option. Locks are keyed randomly.

If using an alternate pull, sliders can be specified to be provided without a pull and without mounting holes in the door. Care should be taken to use an offset pull, and to avoid interference with the lock mechanism.

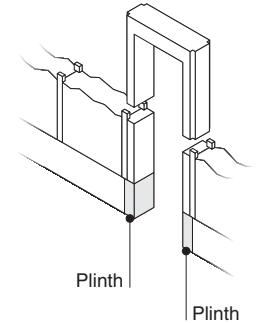

Plinths are included to finish the bottom of both sides of a door frame.

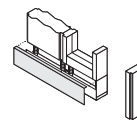

Continuous base trim, ordered separately, is 5"H and available in 10' lengths. It runs along multiple panels and slider doors to create a uniform look. For longer runs, multiple base trim segments can be used adjacent to each other.

Privacy Wall Slider Doors, continued

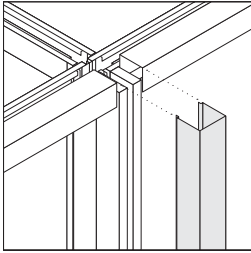

Back-to-back slider cover is available to trim the gap produced when two slider doors are installed side by side.

▶ Page 184

Tip: Back-to-back slider cover is used in a strike-to-strike centerline planning application only.

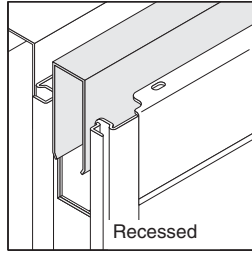

Recessed

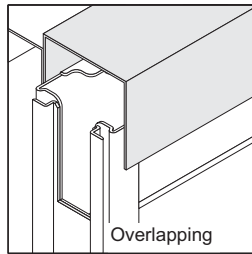

Overlapping

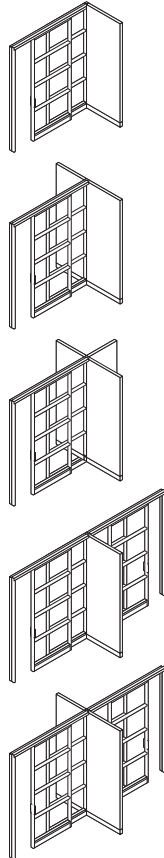

Posts join a slider door to a panel in an L-, T-, X-, or in-line configuration. A T-, X-, or in-line post can also be used between two slider doors.

▶ Page 82

Connections

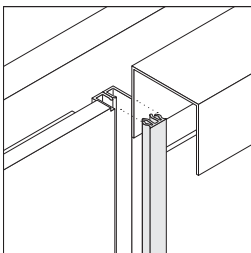

Feature strips, ordered separately, join slider doors to panels, posts, adapters, and other components while preventing light and sound leaks. To rearrange doors, feature strips can be removed and reused.

▶ Page 248

Ceiling track, ordered separately, joins the top of doors to the ceiling. Ceiling track is available recessed or overlapping.

▶ Page 60

Panel-supported storage and worksurface components cannot be attached to slider doors. Use solid wall or Clerestory panels instead.

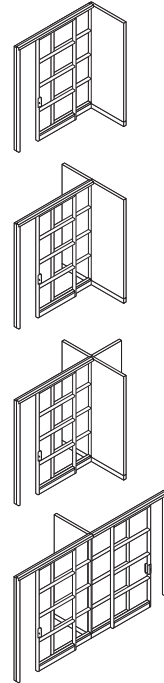

Adapters connect a slider door to a panel in an L-, T-, or X-configuration. A T-adapter can also be used with two slider door strikes back to back.

▶ Page 78

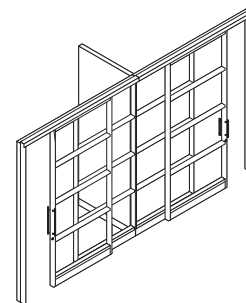

Back-to-back slider doors will work at all adapters and posts when slider doors are on the outside of an office.

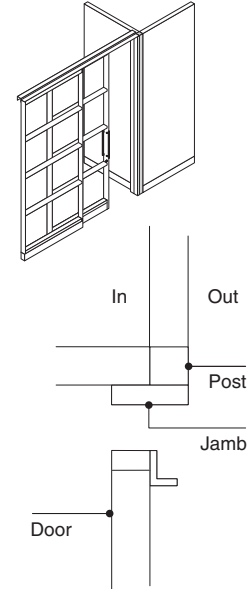

Plan view of T-post

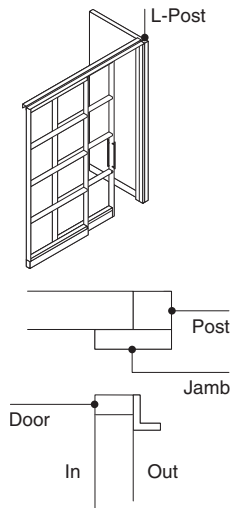

Plan view of L-post

Slider doors will not work with an L- or T-adapter when slider doors are on the inside of an office. Use a post when positioning slide doors to the inside of an office.

Tip: Slider door handing is oriented to the door side of the unit. Be sure to consider door position when determining handing.

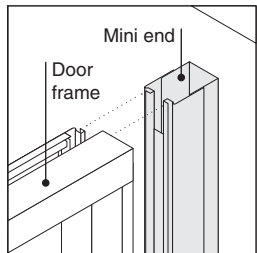

Mini end connects a slider door unit to a perpendicular building wall.

▶ Page 68

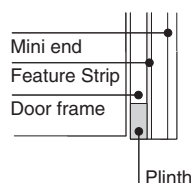

When positioned next to a door frame, the mini end should be specified "to floor" and will be field-cut by the installer to final length.

Panels that are wider than 48" may not be suitable for application in certain areas where local building codes have specific provisions for seismic activity.

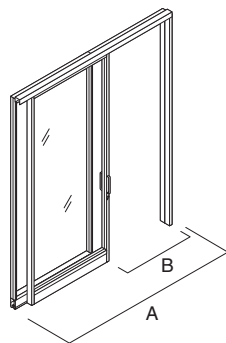

Slider doors are compliant with ADA guidelines for door openings, door hardware, and pull force.

Clear opening width when door is open is as follows:

Dimensions	
A	B
80"	34 ¹ / ₄ "
96"	42 ¹ / ₄ "

Wiring & Cabling

Slider door does not accommodate vertical wire and cable routing.

Knockout is available on Privacy Wall slider doors for low-voltage switches.

Surface Materials

Door frame and muntins

- Paint

Lite

- Glass

Floor track

- Paint

Base trim

- Paint

Feature strip

- Plastic
- Fabric
- Vinyl

Door pull

- Satin Chrome

Application Topics

Feature Strip Application

▶ Page 86

Privacy Wall Slider Doors — SmartTools Options

Note: All planning and application guidelines contained in this section of the specification guide are based on the requirement that ceiling track is connected to a ceiling in order to properly support the wall components as shown.

Product Details for SmartTools Options

SmartTools Options are available and easily ordered when using SmartTools software. If you do not have access to SmartTools software, these options can also be ordered using the normal Specials RFQ (Request for Quote) process.

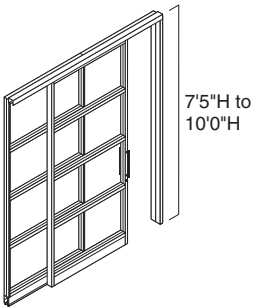

Slider doors can be specified from 7' 5"H to 10' 0"H, in one-inch increments, to accommodate different ceiling heights.

Tip: Specify ceiling height of your installation and component will be fabricated to allow for ceiling track.

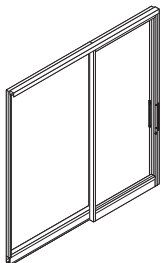

Variable widths – side panel only: variable slider door assembly widths can be achieved by varying the width of the side panel while the door and frame remain unchanged.

80"W: 80" min – 103" max
96"W: 96" min – 111" max

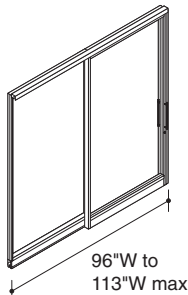
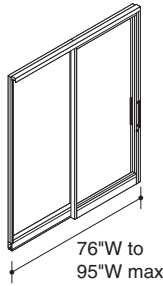

Variable widths – door and side panel: variable slider door assembly widths can be achieved by varying the size of both the side panel and the door, keeping both symmetrical in width.

80"W: 76" min – 95" max
96"W: 96" min – 113" max

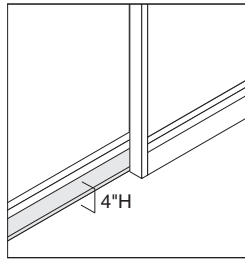

4" high continuous base trim, ordered separately, can also be specified and is available in 10' lengths. When using 4" high base, panels and other vertical components must be specified with a modified height to accept 4" base trim and to ensure that the correct overall ceiling height is achieved.

Tip: Other modified components that must be specified to accept 4" H base:

- Panels
- Posts and adapters
- Feature strips
- Door frame
- Mini end
- Wall channels and cut kits
- Base trim

Tip: 4" high base cannot be used with base-located power.

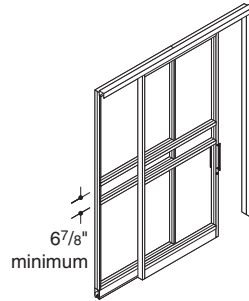

Any or all of the standard muntin positions can be moved. Muntins and glass horizontals can be no closer than 6 7/8".

Muntin locations apply to both the slider door and side panel.

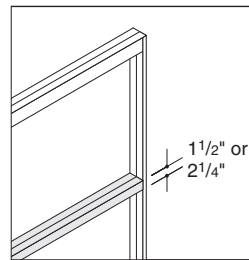

Muntin sizes can be specified as 1 1/2" or 2 1/4".

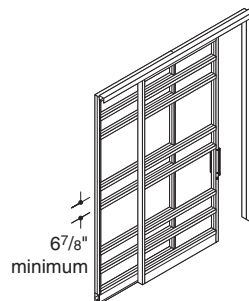

Additional muntins can be added to a four divided lite slider to make up to six lites. Muntins and glass horizontals can be no closer than 6 7/8".

Glass Selections Polished Edge Slider Doors

Note: All planning and application guidelines contained in this section of the specification guide are based on the requirement that ceiling track is connected to a ceiling in order to properly support the wall components as shown.

Glass Selections slider doors include door frame, slider door, fixed panel, and hardware.

► Specifying, page 224

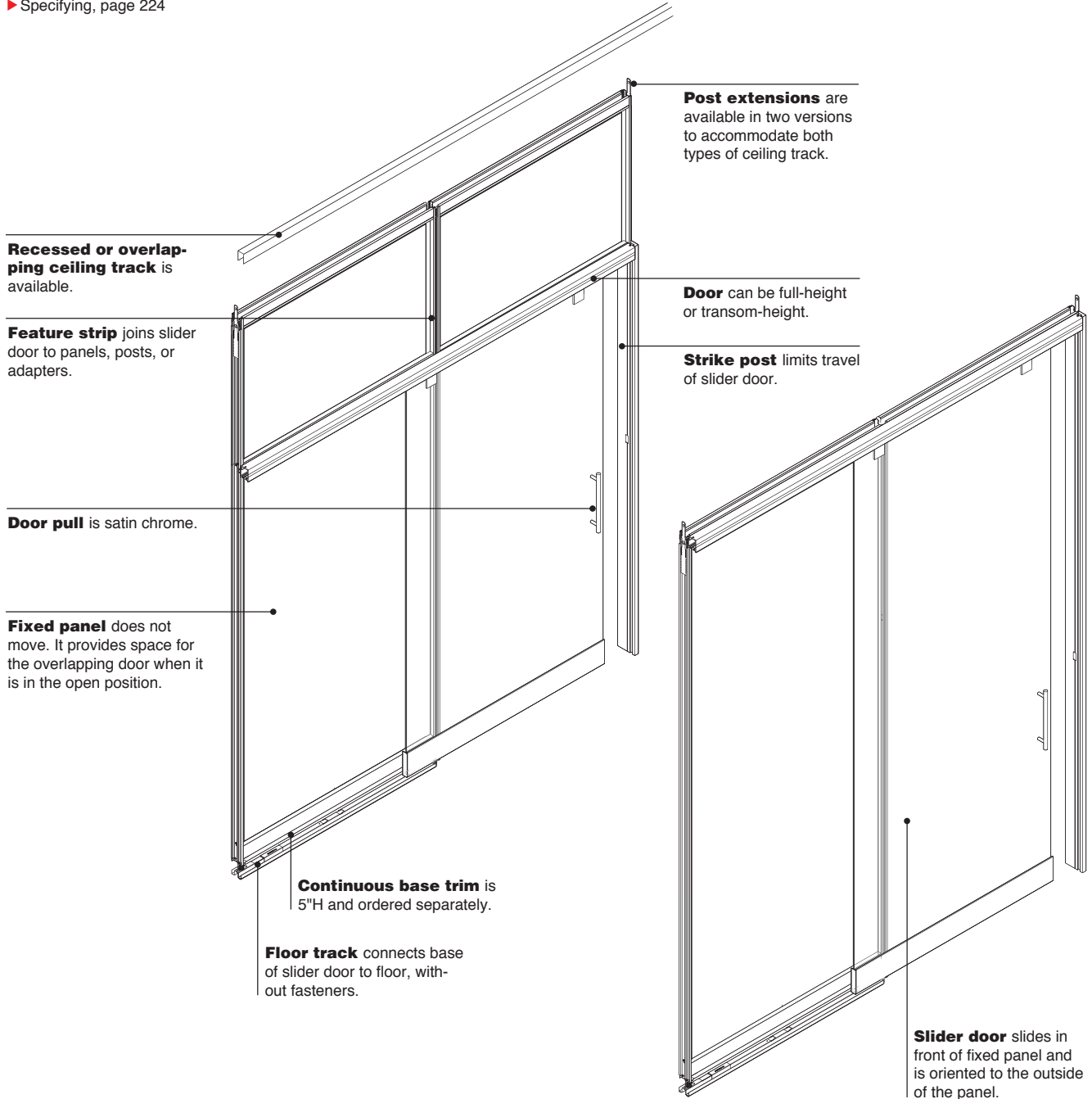

Product Details

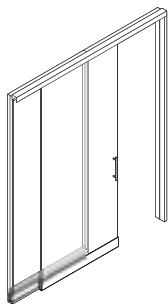

Full-height slider doors can be specified from 8'0"H to 10'0"H, in one-inch increments, to accommodate different ceiling heights.
Tip: Specify ceiling height of your installation and component will be fabricated to allow for ceiling track.

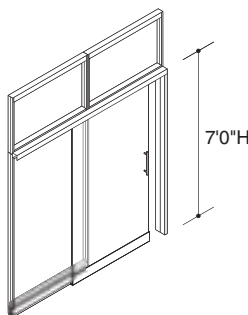

Transom-height slider doors can be specified from 8'0"H to 10'0"H, in one-inch increments. Door height is always 7'. Transom-height varies depending on ceiling height.

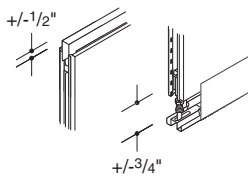

Ceiling track allows 1/2" of vertical adjustment at ceiling to accommodate variations in field conditions. **Floor track** allows 3/4" of vertical adjustment to accommodate variations at base.

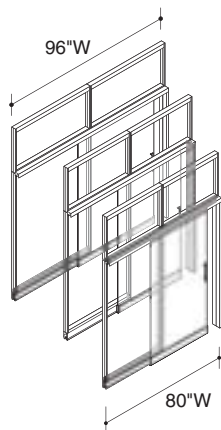

Width of slider door is 80"W, 84"W, or 96"W. Full opening is slightly less than half of the total width of sliding door assembly.

The glass selections slider door is available with a close-assist feature. The close-assist mechanism offers the convenience of controlling the door through its final closing motion and provides an additional safety measure by slowing the door as it contacts the door frame. The glass selections slider door can be specified in the following configurations: close-assist on the leading edge of the door or close-assist on both edges.

It is not recommended to use the close-assist mechanism on doors that exceed 32 square feet in size, as the weight of the door may diminish the performance of the close-assist functionality to the point where it may not meet customer expectations. If specifying a full height door that is greater than 9' ceiling height, it is recommended to specify the overall slider assembly width at 80" or less (using a nominal 40" wide door).

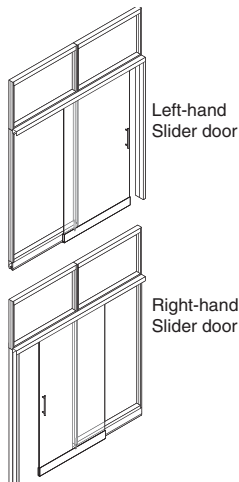

Slider door is available left-hand and right-hand.
Tip: Slider door handing is oriented to the door side of the unit. Be sure to consider door position when determining handing.

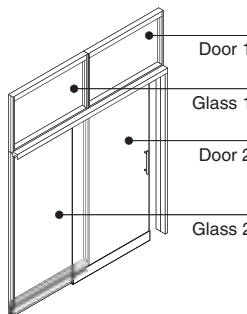

Glass lite types can be specified individually per section.
 ▶ See *Surface Materials*, page 408.

Tip: For information regarding Etched and Pattern Glass Planning.
 ▶ Page 104.



Some pattern glass types have a linear pattern. These linear patterns are oriented vertically as shown.
 ▶ See page 104 to identify vertical pattern glass.

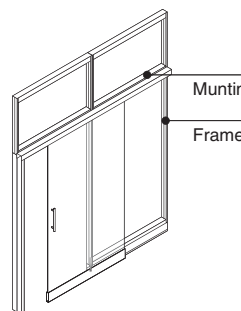

Muntins are factory-installed horizontal framing elements that physically divide glass lites. Muntins are anodized aluminum.
Tip: Glass Selections muntins are 2 1/2"H.

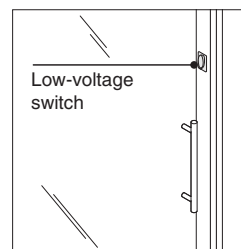

Low-voltage switch cutout is located in the side face of the finished opening frame.

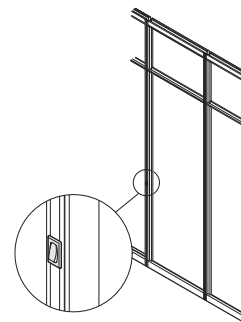

Low-voltage switches can be positioned on an in-line feature strip between two panels (solid or glass) or between a panel and a door frame. The feature strip is cut and notched during installation to accommodate the switch.

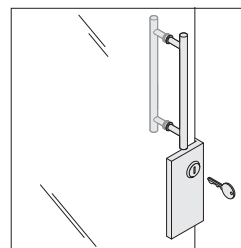

Door lock with interior thumb latch is available as an option. Locks are keyed randomly on single slider door only.

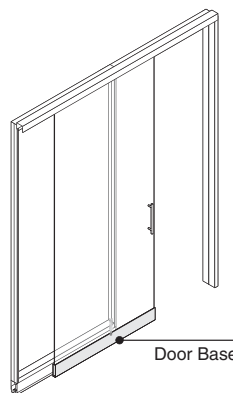

Door base is painted to match adjacent base trim. Base trim for the adjacent fixed panel is ordered separately.

Glass Selections Polished Edge Slider Doors, continued

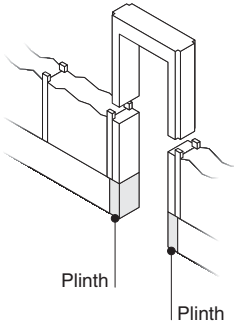

Plinths are included to finish the bottom of both sides of a door frame.

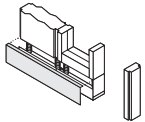

Continuous base trim, ordered separately, is 5"H and available in 10' lengths. It runs along multiple panels and slider doors to create a uniform look. For longer runs, multiple base trim segments can be used adjacent to each other.

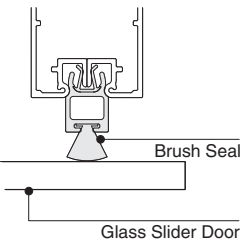

A vertical seal can be specified and installed between the door frame and side panel to engage the trailing edge of the door when closed.

Connections

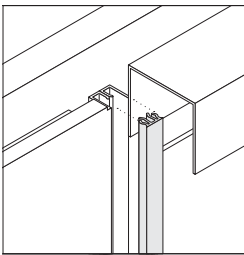

Feature strips, ordered separately, join slider doors to panels, posts, adapters, and other components while preventing light and sound leaks. To rearrange doors, feature strips can be removed and reused.

▶ Page 248

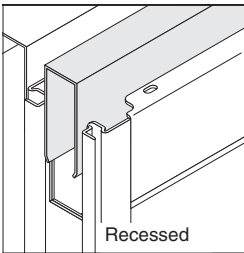

Recessed

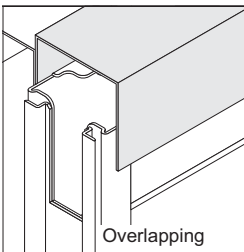

Overlapping

Ceiling track, ordered separately, joins the top of doors to the ceiling. Ceiling track is available recessed or overlapping.

▶ Page 60

Panel-supported storage and worksurface components cannot be attached to slider doors. Use solid wall or Clerestory panels instead.

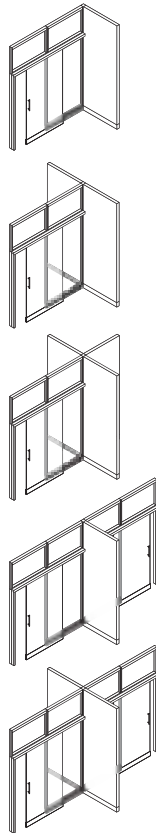

Posts join a slider door to a panel in an L-, T-, X-, or in-line configuration. A T-, X-, or in-line post can also be used between two slider doors.

▶ Page 82

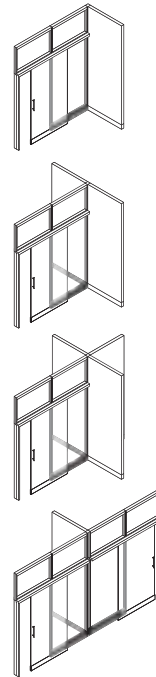

Adapters connect a slider door to a panel in an L-, T-, or X-configuration. A T-adapter can also be used with two slider door strikes back to back.

▶ Page 78

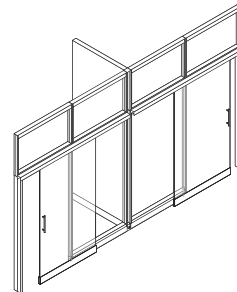

Back-to-back slider doors will work with all adapters and posts when slider doors are on the outside of an office.

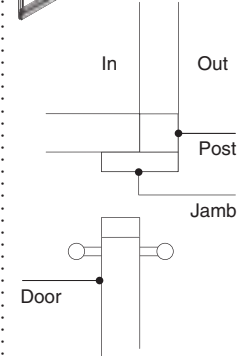
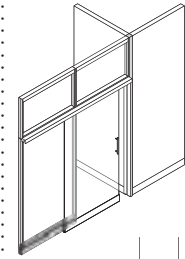

Plan view of T-post

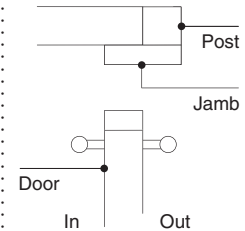
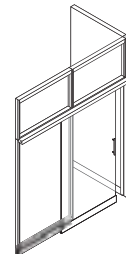

Plan view of L-post

Slider doors will not work with an L- or T-adapter when slider doors are on the inside of an office. Use a post when positioning slide doors to the inside of an office.

Tip: Slider door handing is oriented to the door side of the unit. Be sure to consider door position when determining handing.

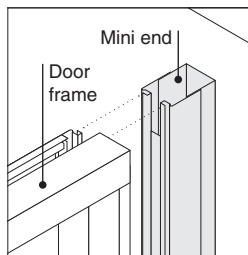

Mini end connects a slider door unit to a perpendicular building wall.

▶ Page 68

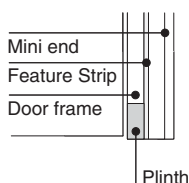

When positioned next to a door frame, the mini end should be specified "to floor," and will be field-cut by the installer to final length.

Panels that are wider than 48" may not be suitable for application in certain areas where local building codes have specific provisions for seismic activity.

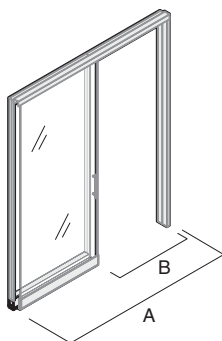

Slider doors are compliant with ADA guidelines for door openings, door hardware, and pull force.

Clear opening width when door is open is as follows:

Dimensions

A	B
80"	33 ⁵ / ₁₆ "
84"	35 ⁵ / ₁₆ "
96"	41 ⁵ / ₁₆ "

Wiring & Cabling

Slider door does not accommodate vertical wire and cable routing.

Low-voltage switches are available for Glass Selections slider doors.

Surface Materials

Door frame and muntins

- Clear anodized aluminum
- Paint

Lite

- Glass

Door base

- Paint

Base trim

- Paint

Feature strip

- Plastic
- Fabric
- Vinyl
- Anodized aluminum

Application Topics

Feature Strip Application

▶ Page 86

Glass Selections Polished Edge Slider Doors — SmartTools Options

Note: All planning and application guidelines contained in this section of the specification guide are based on the requirement that ceiling track is connected to a ceiling in order to properly support the wall components as shown.

Product Details for SmartTools Options

SmartTools Options are available and easily ordered when using SmartTools software. If you do not have access to SmartTools software, these options can also be ordered using the normal Specials RFQ (Request for Quote) process.

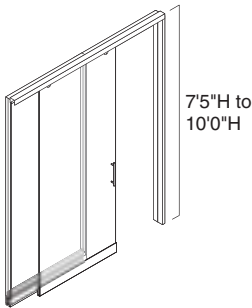

Full-height slider doors can be specified from 7'5"H to 10'0"H, in one-inch increments, to accommodate different ceiling heights.

Tip: Specify ceiling height of your installation and component will be fabricated to allow for ceiling track.

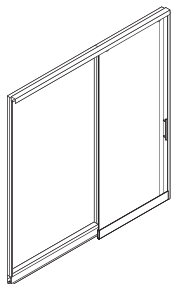

Special widths – side panel only: special slider door assembly widths can be achieved by varying the width of the side panel while the door and frame remain unchanged.

80"W: 80" min – 100" max
84"W: 84" min – 102" max
96"W: 96" min – 108" max

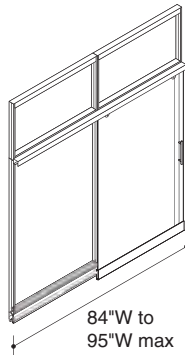
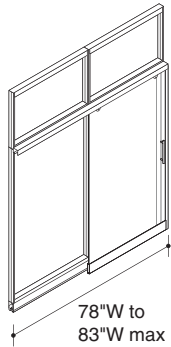

Special widths – door and side panel: special slider door assembly widths can be achieved by varying the size of both the side panel and the door, keeping both symmetrical in width.

80"W: 78" min – 83" max
84"W: 84" min – 95" max
96"W: 96" is maximum width

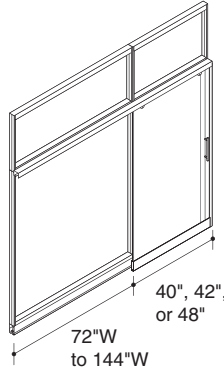
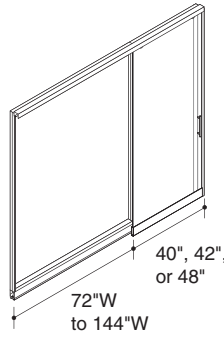

Slider doors with frame kit as side panel: slider door frames and doors can be combined with frame kits and glass kits in variable widths.

40" door frame: 112" min – 184" max
42" door frame: 114" min – 186" max
48" door frame: 120" min – 192" max

Glass kit must be ordered separately for slider with frame kit as a side panel.

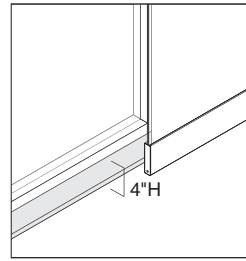

4" high continuous base trim, ordered separately, can also be specified and is available in 10' lengths. When using 4"H base, slider door units and other vertical components must be specified with a modified height to accept 4"H base trim and to ensure that the correct overall ceiling height is achieved.

Other modified components that must be specified to accept 4"H base:

- Panels
 - Posts and adapters
 - Feature strips
 - Door frame
 - Mini end
 - Wall channels and cut kits
 - Base trim
- Tip: 4" high base cannot be used with base-located power.*

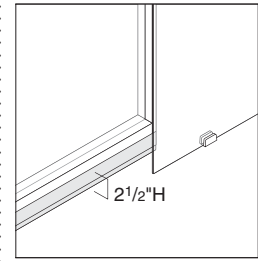

Low profile base trim, ordered separately, can be specified on Glass Selections slider units. The base height is 2½"H and is available in 10' lengths. It runs along multiple panels to create a uniform look. For longer runs, multiple base trim segments can be used adjacent to each other. When using low profile base, slider door units and other vertical components must be specified with a modified height to accept 2½" base trim and to ensure that the correct overall ceiling height is achieved.

Other modified components that must be specified to accept profile base:

- Panels
 - Frame kits and glass kits
 - Feature strips
 - Posts
 - Door frame
 - Mini end
- Tip: Low profile base cannot be used with power.*

Glass Selections slider doors, when used with low profile base trim, have no bottom trim.

Panels with low profile base have reduced vertical adjustment at the floor (plus/minus ⅜").

Glass Selections Polished
Edge Slider Doors –
SmartTools Options

Ceiling Tracks

Note: All planning and application guidelines contained in this section of the specification guide are based on the requirement that ceiling track is connected to a ceiling in order to properly support the wall components as shown.

Ceiling track attaches the top of Privacy Wall panels, door frames, and other components to the ceiling. Ceiling track is available in recessed or overlapping versions.

► Specifying, page 238

Recessed ceiling track is set back from the surface of the panel on both sides.

Factory-formed corner pieces are available to form L- and V-configurations.

Tip: Use overlapping ceiling track with enhanced core panel to achieve greatest acoustical performance.

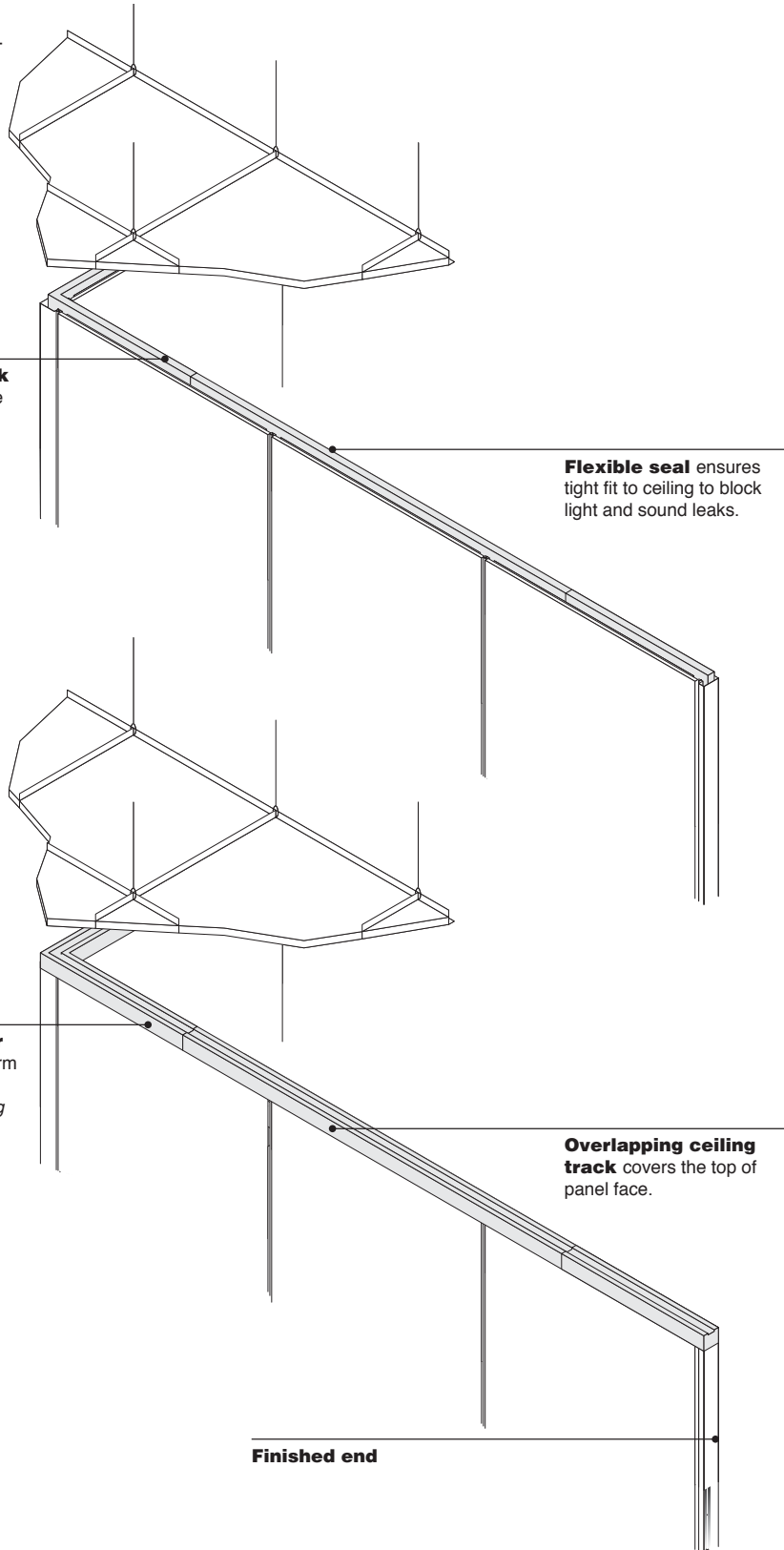

Flexible seal ensures tight fit to ceiling to block light and sound leaks.

Overlapping ceiling track covers the top of panel face.

Finished end

Product Details

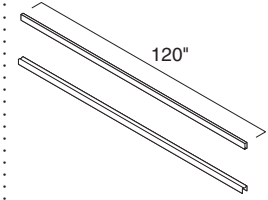

Straight ceiling track is available in 120" lengths. It can be cut on site to accommodate any condition. Multiple straight lengths can be joined in line.

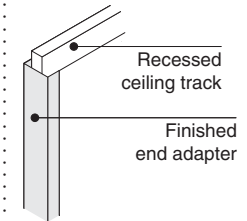

Recessed ceiling track

Finished end adapter

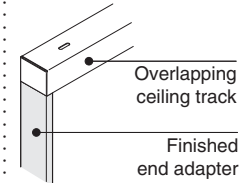

Overlapping ceiling track

Finished end adapter

Finished-end ceiling track is available to finish the exposed end of a straight run of overlapping or recessed ceiling track.

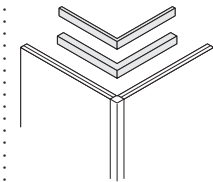

L corner pieces are available recessed or overlapping to form 90° corners.

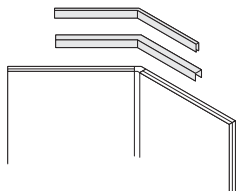

V corner pieces are available recessed or overlapping to form 120° or 135° corners.

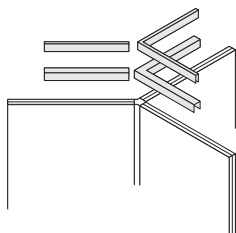

To join panels in a Y-configuration, use straight ceiling track with an L corner piece.

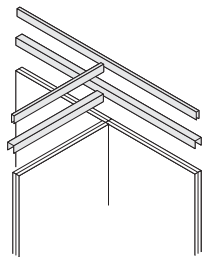

For panels joined in a T-configuration, use two straight lengths of ceiling track, placed perpendicular to each other.

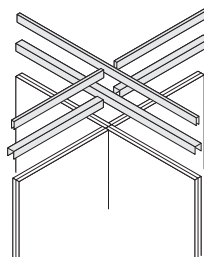

For panels joined in an X-configuration, use multiple straight lengths of ceiling track placed perpendicular to each other.

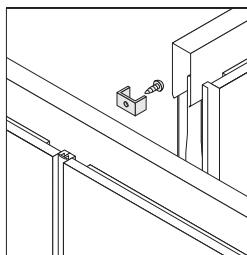

T-clip can be used for panels joined in a T-configuration to improve track alignment. Use two T-clips for panels joined in an X-configuration.
▶ Page 242

Connections

Ceiling track can be removed and repositioned using optional hardware, without damaging ceiling grid or tile.

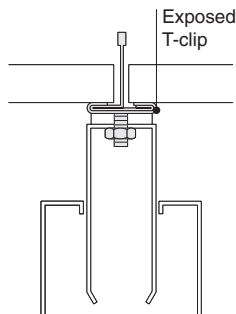

Attachment hardware is available in a variety of types to accommodate most standard ceiling types and other field conditions. To discuss unusual field conditions, call the Steelcase Solutions Resource Team at 1.888.STEELCASE (1.888.783.3522) or send an e-mail to lineone@steelcase.com.
▶ Page 238

Ceiling clip attachment hardware is included with ceiling track. Additional ceiling clips can be ordered separately for inventory or changes.
▶ Page 240

Panels that are wider than 48" may not be suitable for application in certain areas where local building codes have specific provisions for seismic activity. When required by the local seismic design criteria, additional ceiling fasteners and/or structural bracing may be required. For more information regarding seismic applications, visit the Architectural Solutions web site at village.steelcase.com.

Wiring & Cabling

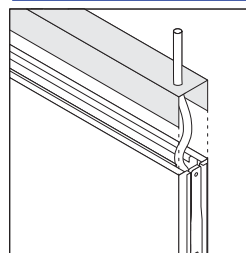

Overlapping ceiling track conceals power harnesses and cables routed vertically from the ceiling into a run of panels.

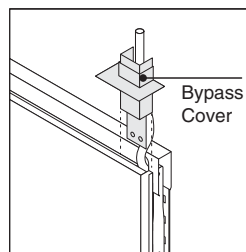

Bypass cover is available to conceal power harnesses and cables routed next to a recessed ceiling track as the conduit travels from the ceiling into a run of panels or a door frame.
Tip: Bypass cover must be used to conceal a ceiling infeed when the ceiling track is directly under a T-runner and when a modular infeed is being used.
▶ Page 242

Surface Materials

Ceiling track
• Paint

Ceiling Tracks — SmartTools Options

Note: All planning and application guidelines contained in this section of the specification guide are based on the requirement that ceiling track is connected to a ceiling in order to properly support the wall components as shown.

Product Details for SmartTools Options

SmartTools Options are available and easily ordered when using SmartTools software. If you do not have access to SmartTools software, these options can also be ordered using the normal Specials RFQ (Request for Quote) process.

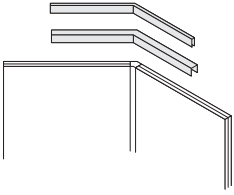

V corner ceiling track sections, 24" x 24" are available recessed or overlapping, in 5° increments, from 70° minimum to 175° maximum.

Cornice Track

Privacy Wall is designed and intended for use with ceiling track that is connected to a suspended ceiling grid. In some cases, it may be desirable to install Privacy Wall in an application where there is no ceiling. In these cases, in order to provide an acceptable level of stability, it is necessary to follow the panel stability guidelines for cornice application. Also, cornice track is inserted into the top of the walls and fastened in place. Ceiling track is not used.

► Specifying, page 243

Glass Selections is not approved for applications with cornice track.

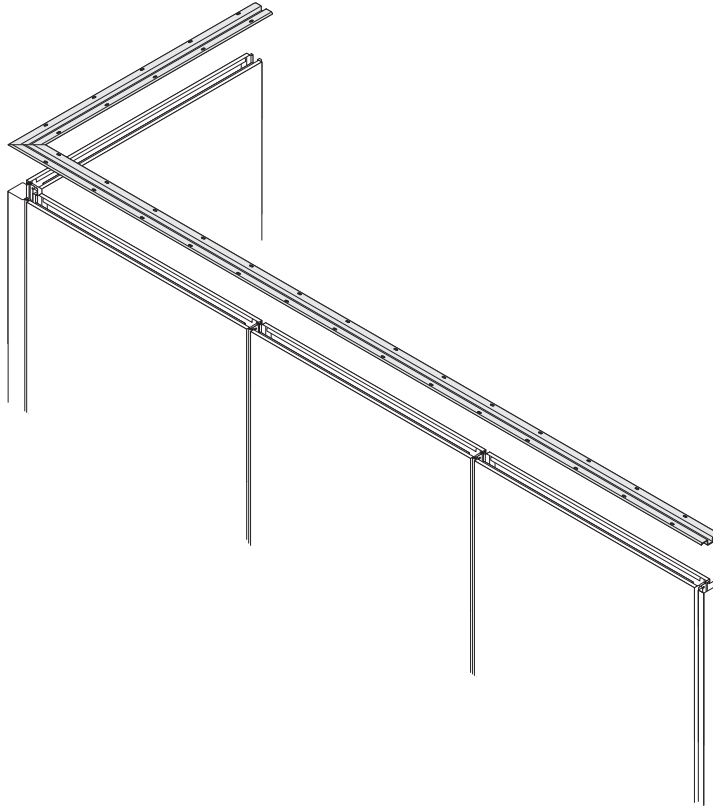

Product Details

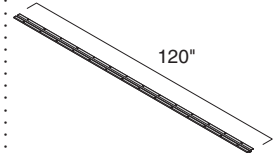

Cornice track is available in 120" lengths. It can be cut on site to accommodate any condition. Multiple straight lengths can be joined in line.

When ordering panels and door frames, specify the recessed option for ceiling track.

Glass Selections is not approved for applications with cornice track.

Cornice-supported walls cannot support panel-hung furniture components.

Connections

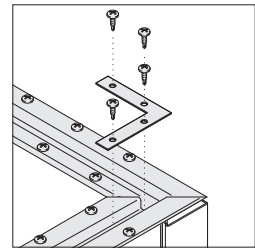

For panels joined in an L-configuration, use two straight lengths of ceiling track, placed perpendicular to each other using a cornice track L bracket.

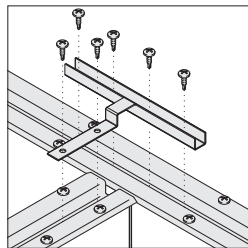

For panels joined in a T-configuration, use two straight lengths of ceiling track, placed perpendicular to each other using a cornice track T bracket.

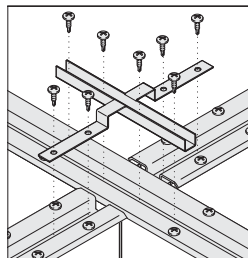

For panels joined in a X-configuration, use three straight lengths of ceiling track, placed perpendicular to each other using a cornice track X bracket.

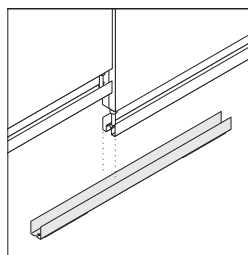

When installing on hard surface floors, it is recommended to use the universal floor grippers (GPUFG) at each in-line panel joint.

Termination at wall channels or mini ends requires a mechanical fastening to the foreign wall. Either plastic anchors or toggle bolts at drywall, or tapcons at concrete or masonry.

When ordering panels and door frames, specify recessed option for ceiling track.

Glass Selections is not approved for applications with cornice track.

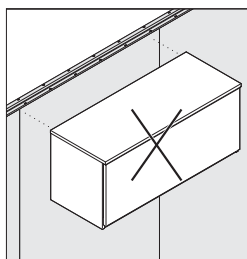

Cornice supported walls cannot support panel hung furniture components.

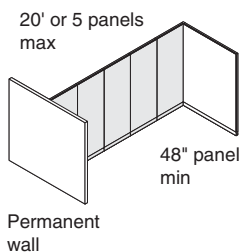

Maximum runs for solid panels are 20 feet or 5 panels and both ends must terminate at an intersection or properly anchored termination. An intersecting wall must be at least 48" long.

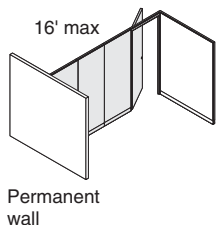

Maximum runs for solid panels including a door unit is 16 feet, and both ends must terminate at an intersection or properly anchored termination.

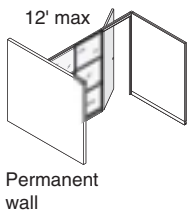
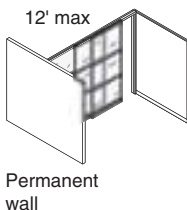
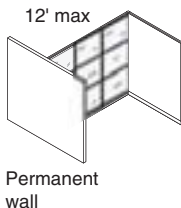

A maximum run for all glass fronts or all glass with a door unit is 12 feet and both ends must terminate at an intersection or properly anchored termination.

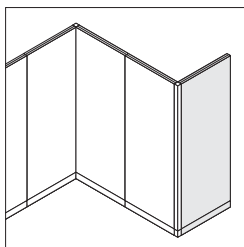

If intersecting wall includes two panels or more, another intersecting panel is required at the end.

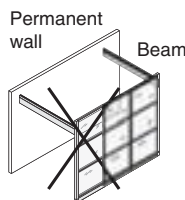
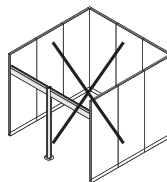
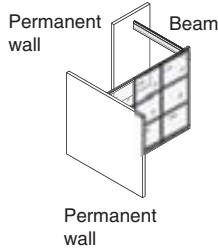
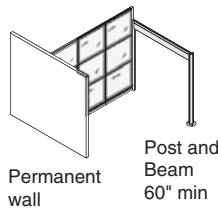

Post and Beam, with a minimum beam length of 60", can be used for support in place of an intersection or termination, but only at one end of the wall. One end of the beam must be anchored to the floor or some permanent part of the structure. Only overhead beams should be used with Privacy Wall.

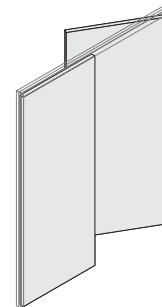

Pair of doors are not recommended for use in cornice height applications.

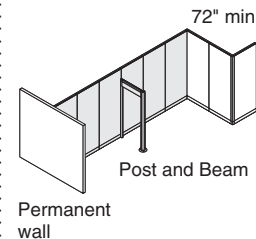
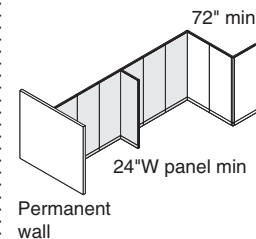

When a single wall exceeds the maximum length as defined above, an intermediate intersecting panel or Post and Beam can be inserted to stabilize the wall. If both ends of the wall intersect with either a fixed wall or a connecting wall that is 72" in length, then the intermediate panel can be as small as 24" wide.

When required by the local seismic design criteria, structural bracing may be required. For more information regarding seismic applications, visit the Architectural Solutions web site at village.steelcase.com.

Ceiling Clip Application

Note: All planning and application guidelines contained in this section of the specification guide are based on the requirement that ceiling track is connected to a ceiling in order to properly support the wall components as shown.

Exposed Tee Grids – Privacy Wall Fastener Kits

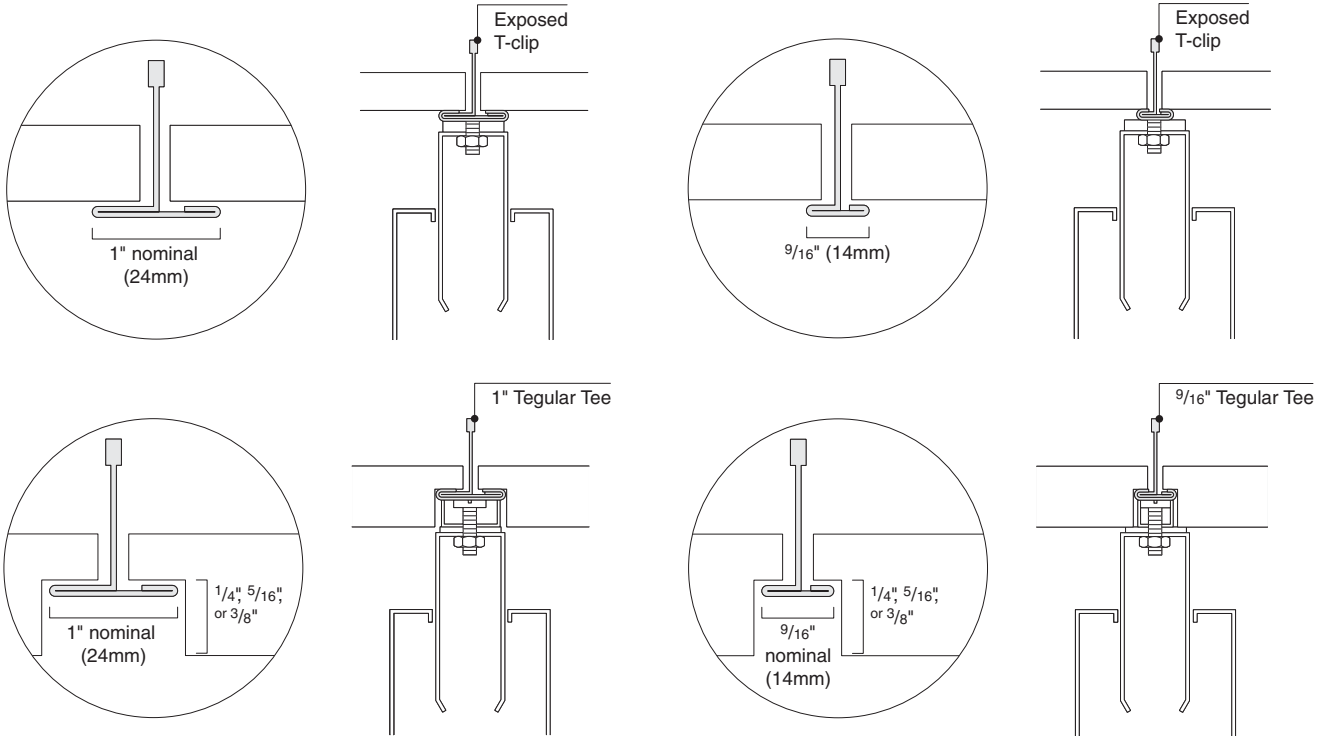

Ceiling clips support the most common types of ceiling systems.

Bolt and Screw Grids – Privacy Wall Fastener Kits

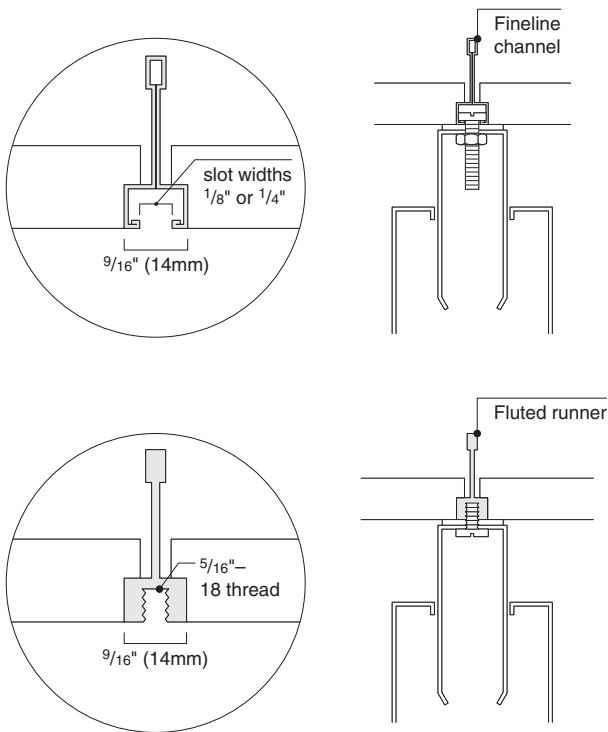

Concealed Grids – Field-Purchased Generic Fasteners

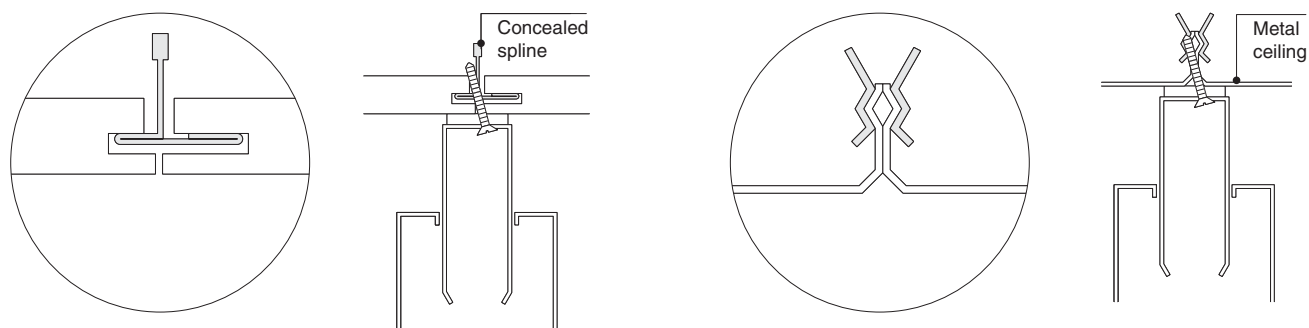

For these and other types of ceilings, the following fasteners can be sourced locally by the installer:

Concealed spline	#7 – 17 x 1 5/8" Bugle Head Self-Drilling Screws
Drywall	#14 – 1" Phillips Head SMS with plastic anchor
Plaster	1/4 – 20 Toggle Bolt
Concrete	Tapcon Anchor x 2"
Metal pan	#7 – 17 x 1" Bugle Head Self-Drilling Screws

Mini Ends

Note: All planning and application guidelines contained in this section of the specification guide are based on the requirement that ceiling track is connected to a ceiling in order to properly support the wall components as shown.

Mini ends connect a panel to another panel or to a perpendicular building wall or column.

► Specifying, pages 185 and 229

Verticals on inner channel allows the mini end to connect to adjacent panel using feature strips. Panel slots remain accessible to support panel-supported furniture. The mini end has no slots and cannot support components.

Neoprene seals provide light and sound seal between the mini end and the building wall.

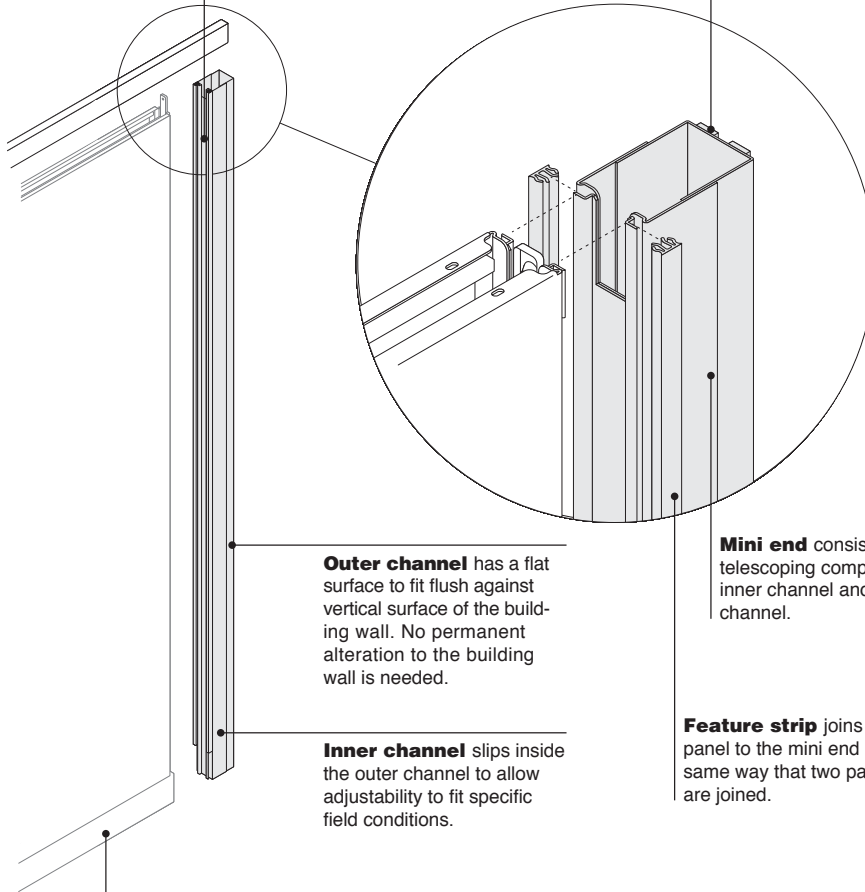

Outer channel has a flat surface to fit flush against vertical surface of the building wall. No permanent alteration to the building wall is needed.

Inner channel slips inside the outer channel to allow adjustability to fit specific field conditions.

Mini end consists of two telescoping components—inner channel and outer channel.

Feature strip joins the panel to the mini end in the same way that two panels are joined.

Continuous base trim, ordered separately, is added in the field. Mini end extends into the base cavity and is covered by base trim.

Product Details

Height of mini end must be the same as the adjacent panel. Mini ends are available in all the same heights as panels. Indicate height when you order by specifying the ceiling height of the installation.

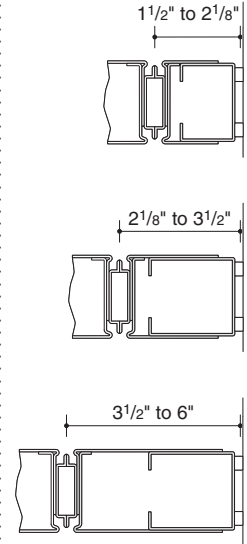

Three sizes of mini ends are available. Each telescopes to accommodate a different range of dimensions. For installations that require a dimension smaller than 1 1/2", use a wall channel.

► Page 72

For installations that require a dimension larger than 6", consider using a larger panel somewhere in the run or use a panel end cut kit.

► Page 76

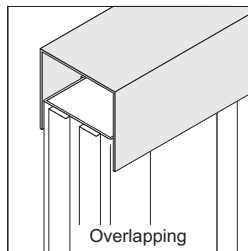
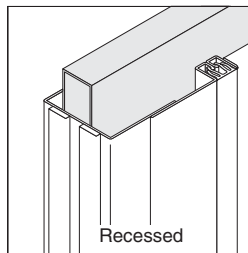

Both recessed and overlapping ceiling tracks can be used with mini ends.

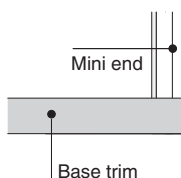

Base of mini end is finished with continuous base trim, ordered separately, like any panel.

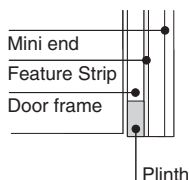

When positioned next to a door frame, the mini end should be specified "to floor," and will be field-cut by the installer to final length.

Connections

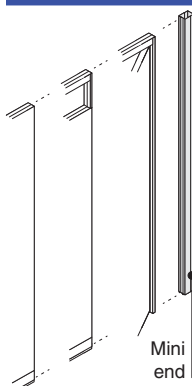

All panel types and door frames can connect to a mini end.

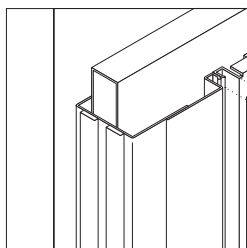

Adjacent panels connect to a mini end in the same way all panels connect. Feature strip on both sides of the panel form a continuous link to the mini end by engaging the verticals of the mini end and the adjacent panel.

Acoustic packing, when used with mini ends, may help to improve acoustical performance.

Physical connection to the building is not needed. Mini end fits tightly against the building wall, and the contact points are sealed with continuous neoprene strips to form a light and sound seal.

Panel-supported components cannot be attached to a mini end. Use the adjacent panel to support storage and worksurface components.

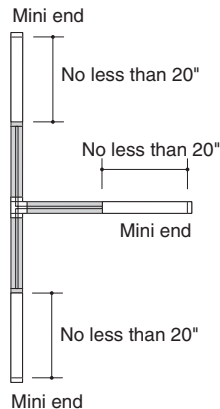

Due to the process steps involved in installation of glass, T-corner frame kits can be placed no closer than 20" to a single mini-end or wall channel.

Wiring & Cabling

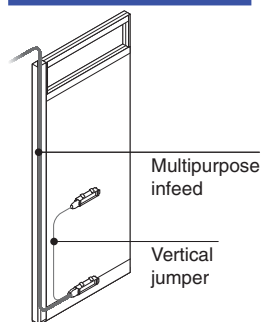

Wire and cable routing vertically through a mini end is possible. Mini ends are often used to route power to a run of glass panels which don't have sufficient space to accommodate vertical power and cable routing.

Surface Materials

Surfaces of mini ends can be paint, fabric, vinyl, or anodized aluminum for Glass Selections. Both sides must be the same material and color.

Mini end

- Paint
- Fabric
- Anodized aluminum (Glass Selections only)

Mini Ends — SmartTools Options

Note: All planning and application guidelines contained in this section of the specification guide are based on the requirement that ceiling track is connected to a ceiling in order to properly support the wall components as shown.

Product Details for SmartTools Options

SmartTools Options are available and easily ordered when using SmartTools software. If you do not have access to SmartTools software, these options can also be ordered using the normal Specials RFQ (Request for Quote) process.

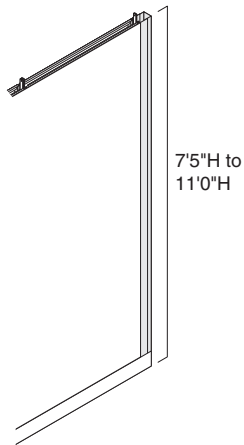

Privacy Wall mini ends can be specified from 7' 5"H to 11' 0"H, in one-inch increments, to accommodate different ceiling heights.
Tip: Specify ceiling height of your installation and component will be fabricated to allow for ceiling track.

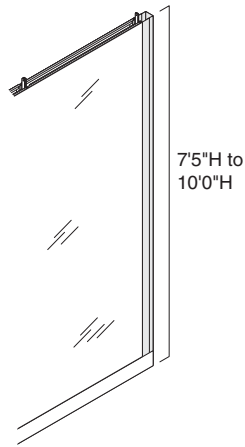

Glass Selections mini ends can be specified from 7' 5"H to 10' 0"H, in one-inch increments, to accommodate different ceiling heights.
Tip: Specify ceiling height of your installation and component will be fabricated to allow for ceiling track.

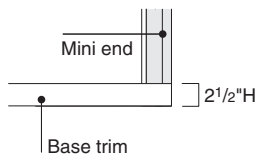
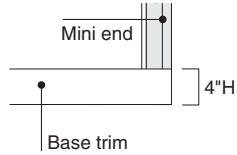

When planning with 4" high base, or low profile base, specify mini ends with modified height to accept 4" base trim and to ensure that the correct overall ceiling height is achieved.
Tip: Mini ends to the floor do not need to be modified for use with 4" base or low profile base.

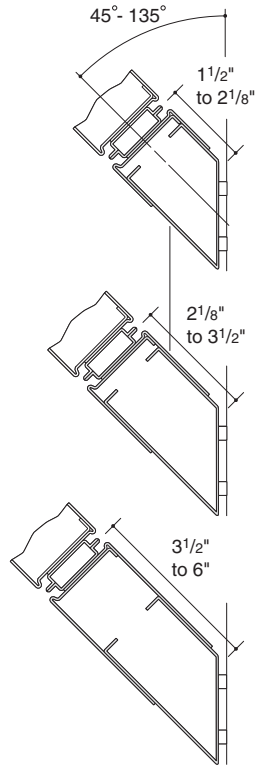

Mini ends can be specified with an angled interface for end conditions that are not perpendicular to fixed surfaces. Angles are available in 5° increments ranging from 45° to 135°.
Tip: Mini ends can be adjusted during installation by as much as 3°.

Wall Channels

Note: All planning and application guidelines contained in this section of the specification guide are based on the requirement that ceiling track is connected to a ceiling in order to properly support the wall components as shown.

Wall channels connect panels with uncut edges to a perpendicular building wall or column.

► Specifying, page 187

Neoprene seals provide light and sound seal between the wall channel and the building wall.

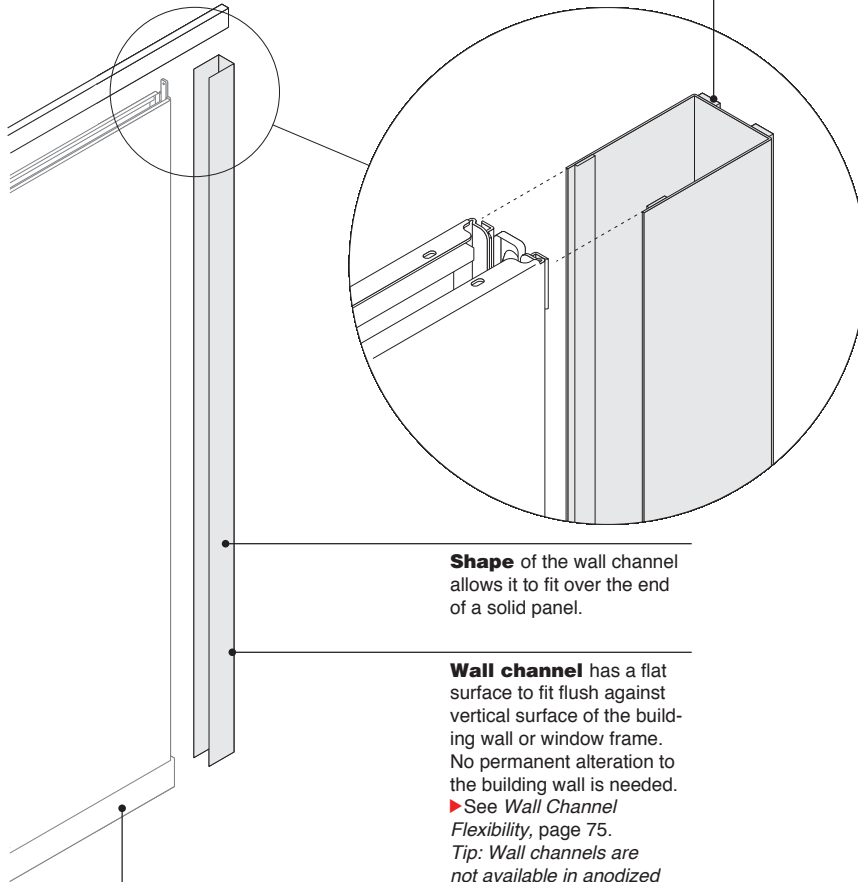

Shape of the wall channel allows it to fit over the end of a solid panel.

Wall channel has a flat surface to fit flush against vertical surface of the building wall or window frame. No permanent alteration to the building wall is needed.

► See *Wall Channel Flexibility*, page 75.

Tip: Wall channels are not available in anodized aluminum. Dimensions of wall channel do not allow for use with Glass Selections panels.

Continuous base trim, ordered separately, is added in the field. Wall channel extends into the base cavity and is covered by base trim.

Product Details

Height of wall channel must be the same as the adjacent panel. Wall channels are available in all the same heights as panels. Wall channel ships in 10' lengths and is cut to size in the field.

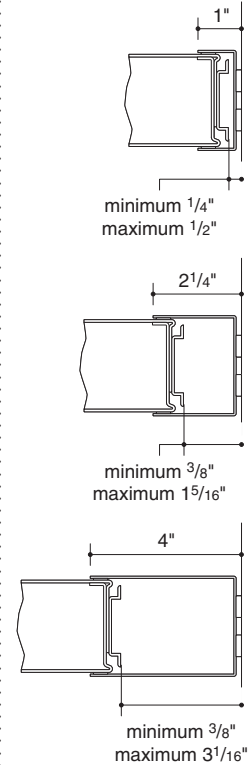

Three sizes of wall channels are available. Each accommodates a range of different dimensions.

► For the dimensions of glass panels and doors, see *Wall Channel Flexibility*, page 75.

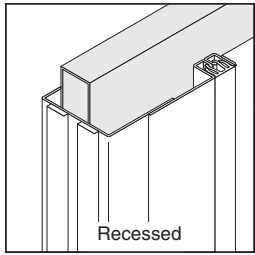

Recessed

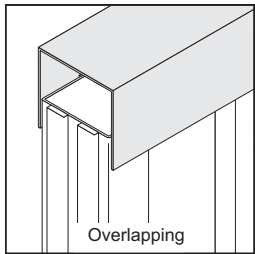

Overlapping

Both recessed and overlapping ceiling tracks can be used with wall channels.

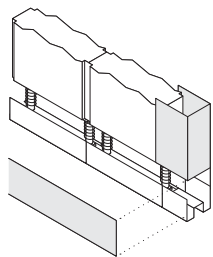

Wall channel is cut to the top of the base trim and covered by the base trim.

Solid panels can be inserted to make use of full dimension of the wall channel.

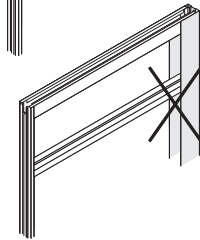
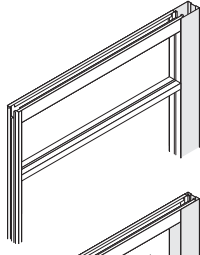

Glass panels should not be inserted too deeply into the wall channel because the wall channel will overlap the glass.

► See *Wall Channel Flexibility*, page 75.

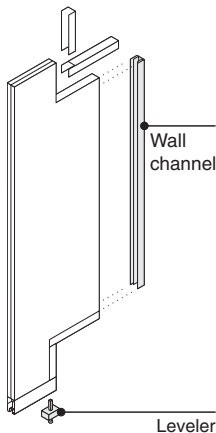

Wall channel

Leveler

Specify an end filler cut kit when cutting a panel into a wall channel. The end filler cut kit includes a wall channel and spreader.

Connections

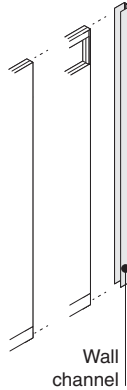

Wall channel

All panel types can be used with a wall channel. Adjacent panel is inserted inside the wall channel.

Acoustic packing, when used with wall channels, may help improve acoustical performance.

Physical connection to the building is not needed. Wall channel fits tightly against the building wall, and the contact points are sealed with continuous neoprene strips to form a light and sound seal.

Slotted edges of the adjacent panel are blocked by wall channel. Use mini ends if planning with panel-supported furniture.

► For installations with cut panels, see *Cut Panels*, page 76.

Wiring & Cabling

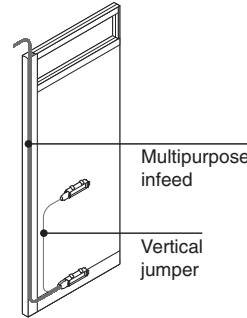

Multipurpose infeed

Vertical jumper

Wire and cable routing vertically through a wall channel is possible. Wall channels can be used to route power to a run of glass panels which don't have sufficient space to accommodate vertical power and cable routing.

Surface Materials

Surfaces of wall channels can be paint, fabric, or vinyl. Both sides must be the same material and color.

Wall channel

- Paint
- Fabric

Application Topics

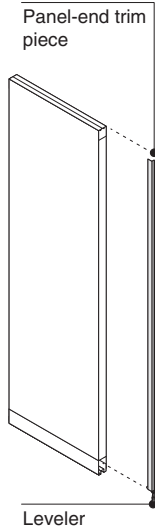

Panel-end trim piece

Leveler

Panel end cut kit connects a cut panel to another panel in line. It restores leveler and housing that is removed when panel is cut on site. Kit includes trim piece to finish the cut side of the panel and to enable feature strip connection to an adjacent panel.

► Page 188

Tip: Hang-on components are not allowed on cut panels.

Wall Channels — SmartTools Options

Note: All planning and application guidelines contained in this section of the specification guide are based on the requirement that ceiling track is connected to a ceiling in order to properly support the wall components as shown.

Product Details for SmartTools Options

SmartTools Options are available and easily ordered when using SmartTools software. If you do not have access to SmartTools software, these options can also be ordered using the normal Specials RFQ (Request for Quote) process.

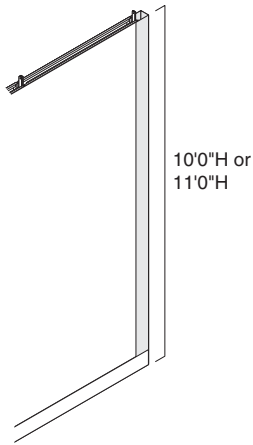

Wall channels can be specified as 10'0"H or 11'0"H.
Tip: Specify ceiling height of your installation and component will be fabricated to allow for ceiling track.

Wall Channel Flexibility

Note: All planning and application guidelines contained in this section of the specification guide are based on the requirement that ceiling track is connected to a ceiling in order to properly support the wall components as shown.

Wall channels allow panels to telescope inside. The amount of flexibility varies depending on the size of the wall channel and what type of panel it is or whether it is a door frame.

Tip: Wall channels are not recommended for use with Glass Selections.

Tip: Order an end filler cut kit when positioning a cut panel at a wall channel.

Tip: 1" wall channel is recommended for use with glass panels. The 2 1/4" and 4" wall channels may overlap a portion of the glass area.

Solid Panels

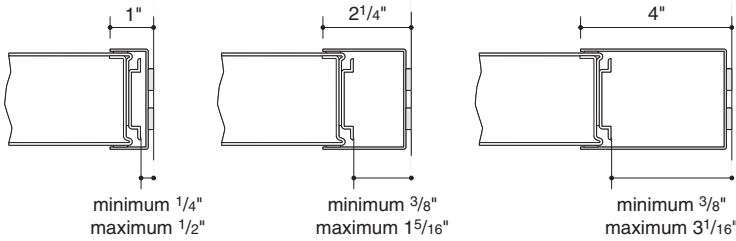

Glass Panels

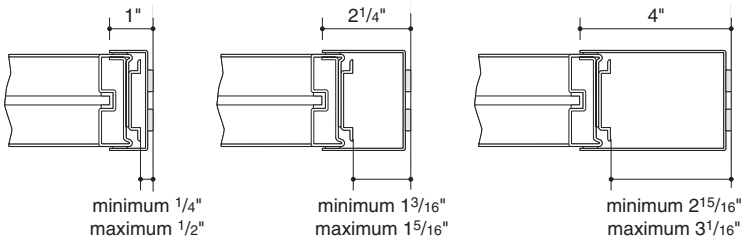

Door Frames

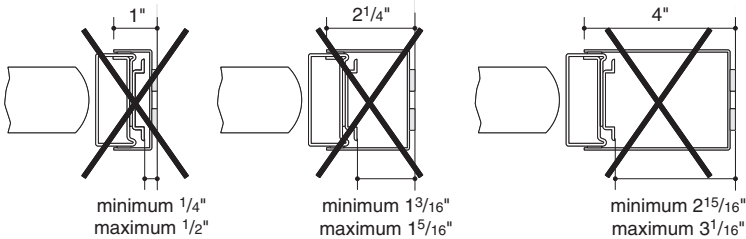

Door frames must be joined to a perpendicular building wall with a mini end, not a wall channel.

Cut Panels

Note: All planning and application guidelines contained in this section of the specification guide are based on the requirement that ceiling track is connected to a ceiling in order to properly support the wall components as shown.

Cut panels are typically positioned at the end of a run, adjacent to a wall channel. Cut panels can also be positioned in the middle of a run. All cut panels require an end filler cut kit.
 ▶ Page 189

Solid panels can be cut on site to allow walls to fit with existing building conditions. Glass panels cannot be cut.

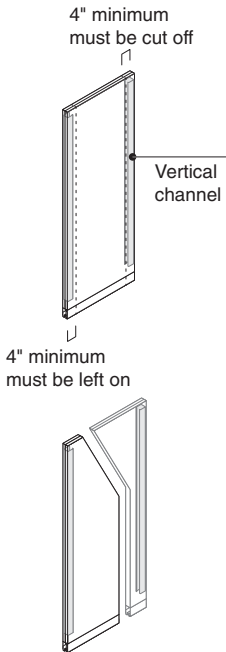

Plan your cuts so that at least 4" of panel width is removed and at least 4" of panel remains. Angled cuts are possible if they conform to these guidelines.
Tip: When you need multiple cut panels, you may be able to specify a larger panel and cut it to produce two smaller cut panels.

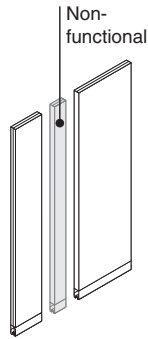

Cut section of panel must have at least one vertical edge intact to be functional.

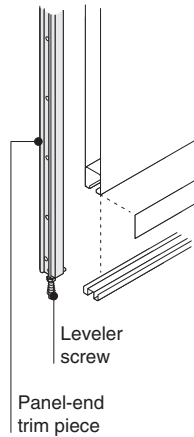

Panel end cut kit is available to restore leveler and housing that is removed when panel is cut on site. Kit includes trim piece to finish the cut side of the panel and to enable feature strip connection to an adjacent panel.
 ▶ Page 188
Tip: Hang-on components are not allowed on cut panels.

An end filler cut kit is used when a cut panel is positioned adjacent to a fixed wall.

A panel end cut kit is used when a cut panel is positioned in the middle of a run or adjacent to a corner.

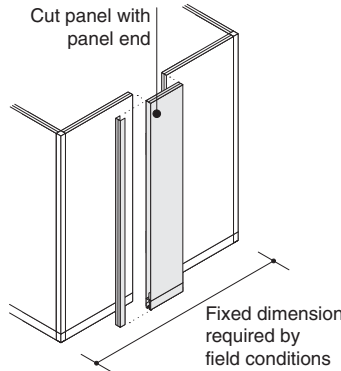

Panel end finishes the edge of a cut panel installed in line with other panels to produce a wall of a specific length. A panel end is typically used to achieve a specific length in a wall that has no wall channel. Panel end trim piece is included in the panel end cut kit.

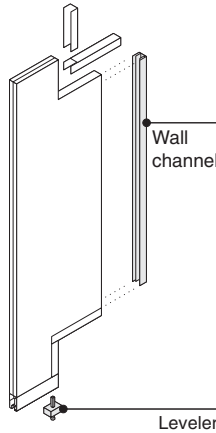

End filler cut kits can be used to finish the edge of a panel that has been cut to conform to the specific shape of a perpendicular building wall, or when a panel is next to an architectural element such as a drywall partition. In this case, you will need to apply an end filler cut kit, which includes a wall channel, spreaders, and a leveler.
 ▶ Page 189

Surface materials don't affect cutting. Painted, fabric, and vinyl surfaces can all be cut on site.

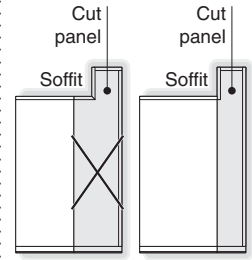

Plan your cuts with installation in mind to make sure that it will be possible to fit behind any soffits. Aligning cuts with boundaries may simplify installation.

Adapters

Note: All planning and application guidelines contained in this section of the specification guide are based on the requirement that ceiling track is connected to a ceiling in order to properly support the wall components as shown.

Adapters engage the verticals on the edge of a panel to allow perpendicular panels to connect.
 ▶ Specifying, pages 190 and 230

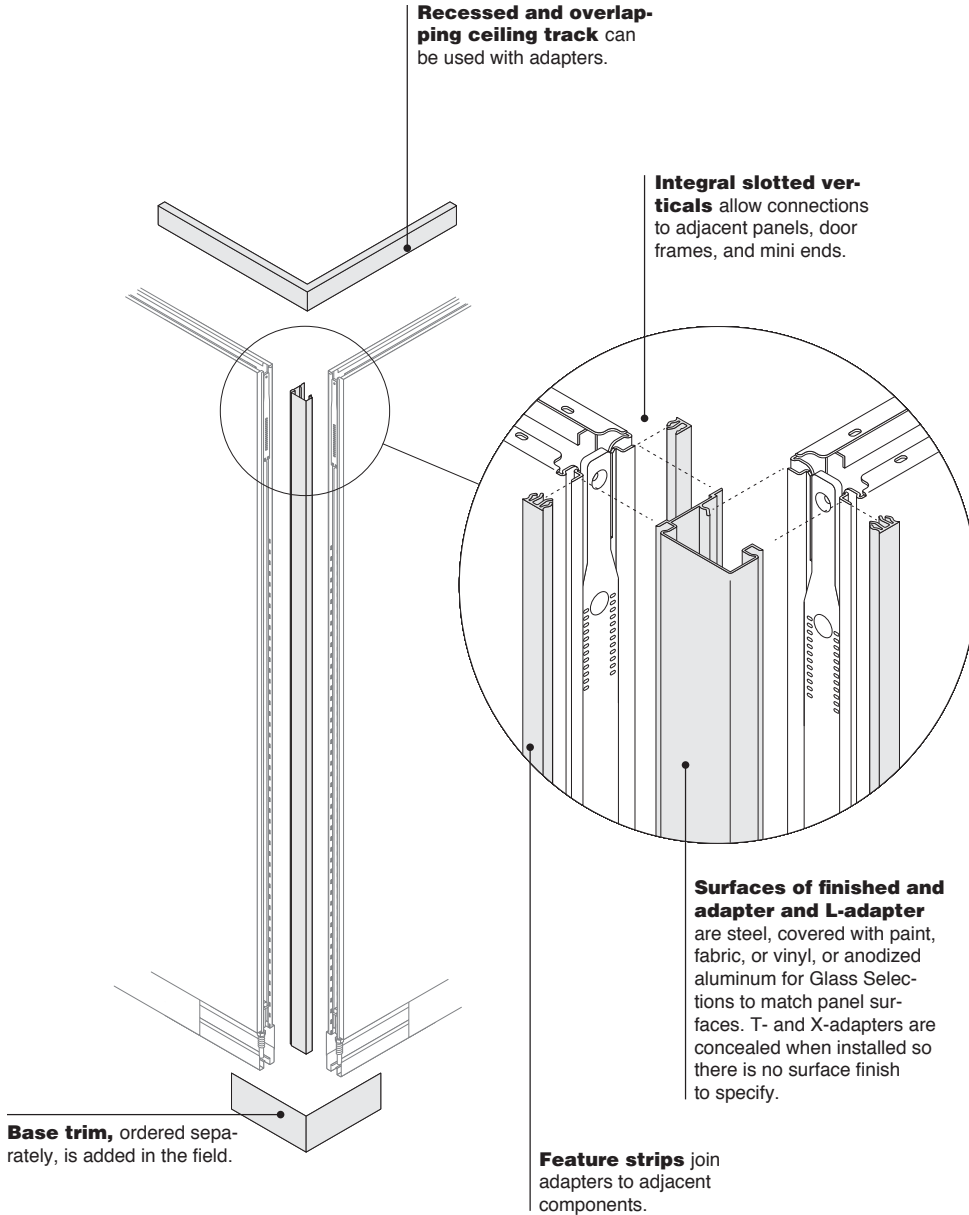

Product Details

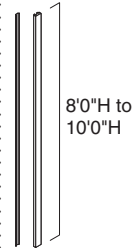

Height can be specified from 8'0" to 10'0", in one-inch increments, to accommodate different ceiling heights.

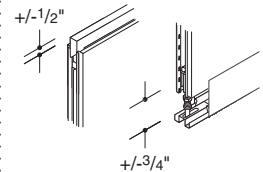

Ceiling track allows 1/2" of vertical adjustment to accommodate variations in field conditions. Floor track allows 3/4" of vertical adjustment to accommodate variations at base.

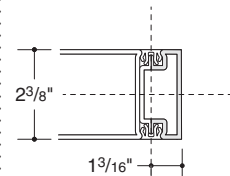

Finished-end adapter caps the exposed vertical edge of the last panel in a run. Surface of the adapter is steel, covered in paint, fabric, or vinyl, or anodized aluminum for Glass Selections. The plinth, which is included in the finished end assembly, is painted to match the adjacent base trim. Finished-end adapter adds approximately 1 3/16" to the length of the wall.

▶ See *Feature Strip Application*, page 86.

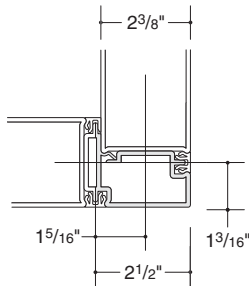

L-adapter allows a perpendicular panel to attach at the end of a panel. Surface of the adapter is steel, covered in paint, fabric, or vinyl, or anodized aluminum for Glass Selections.
 ▶ See *Feature Strip Application*, page 86.

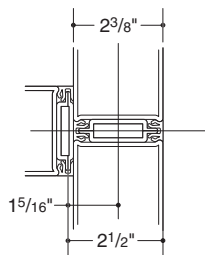

T-adapter allows a perpendicular panel to attach on the centerline between two panels joined in line.
 ▶ See *Feature Strip Application*, page 86.

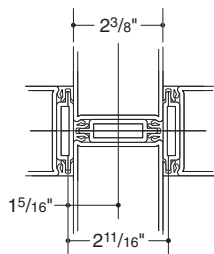

X-adapter allows two perpendicular panels to attach on opposite sides of the centerline between two panels joined in line.
Tip: Base trim projects 1/16" from the face of the panel.
 ▶ See *Feature Strip Application*, page 86.

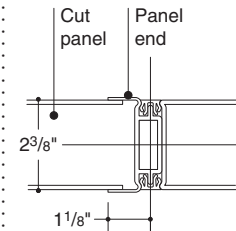

Panel end cut kit can be used to finish the end of a cut panel so that it functions like a conventional panel and can make connections to an adjacent panel, door frame, or mini end. Surface of the adapter is painted steel.
 ▶ Page 188
Tip: Panel end is included in panel end cut kit.

Connections

Any panel, door frame, or mini end can be connected to an adapter.

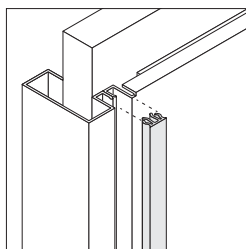

Feature strips, ordered separately, join panels and other components to adapters and prevent light and sound leaks. Feature strip can be cut on site to provide access to the integral slotted verticals so that panel-supported components can be attached. To rearrange panels, feature strips can be removed and reused.
 ▶ Page 248

Tip: Anodized feature strips are designed for use with Glass Selection anodized door and glass frames. They are not compatible with upholstered panels.

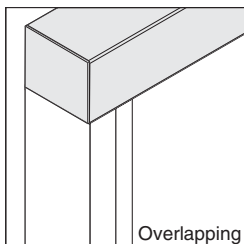
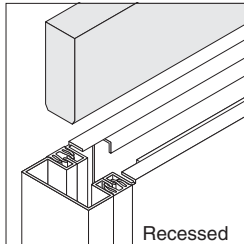

Overlapping or recessed finished-end ceiling track is available for use with finished end adapter. This ceiling track component finishes the end of the ceiling track in the same way that the finished end adapter completes the exposed vertical edge of the last panel.
 ▶ Page 238

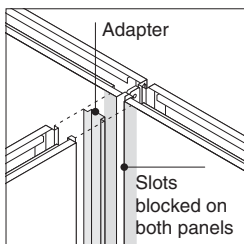

Blocked slots occur on the edges of some panels in configurations with adapters. This makes it impractical to attach panel-supported components at these points.
 ▶ For an overview of the planning choices, see *Centerline Versus Interior Dimension Planning*, page 96.

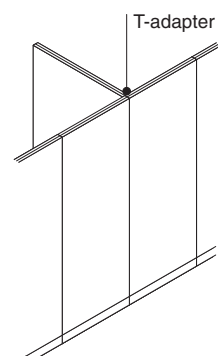
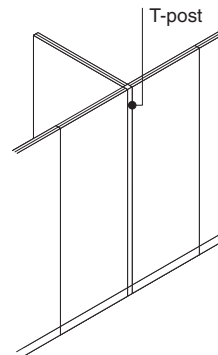

T-adapters, unlike T-posts, produce a simpler, cleaner visual by presenting one joint instead of two.

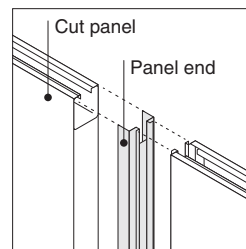

Exact fit between fixed elements, such as building columns, is possible by using a panel end cut kit. The cut panel behaves exactly like a conventional panel but its width dimension can be modified on site to match field conditions.
Tip: You cannot hang furniture on a cut panel.
 ▶ See *Cut Panels*, page 76.

Wiring & Cabling

Adapters do not accommodate vertical wire and cable routing.

Surface Materials

Finished-end adapter and L-adapter

- Paint
- Fabric
- Anodized aluminum

Application Topics

Feature Strip Application
 ▶ Page 86

Centerline Versus Interior Dimension Planning
 ▶ Page 96

Base Trim Details
 ▶ Page 98

Adapters — SmartTools Options

Note: All planning and application guidelines contained in this section of the specification guide are based on the requirement that ceiling track is connected to a ceiling in order to properly support the wall components as shown.

Product Details for SmartTools Options

SmartTools Options are available and easily ordered when using SmartTools software. If you do not have access to SmartTools software, these options can also be ordered using the normal Specials RFQ (Request for Quote) process.

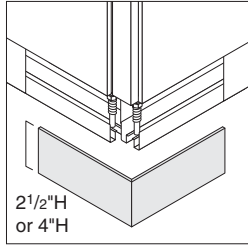

When planning with 4" high base or low profile base, specify adapters with modified height to accept 4"H or 2 1/2"H base trim and to ensure that the correct overall ceiling height is achieved.
Tip: Base trim is ordered separately.



7'5"H to
11'0"H

Privacy Wall adapters can be specified from 7'5"H to 11'0"H, in one-inch increments, to accommodate different ceiling heights.

Tip: Specify ceiling height of your installation and component will be fabricated to allow for ceiling track.



7'5"H to
10'0"H

Glass Selections adapters can be specified from 7'5"H to 10'0"H, in one-inch increments, to accommodate different ceiling heights.

Tip: Specify ceiling height of your installation and component will be fabricated to allow for ceiling track.

Posts

Note: All planning and application guidelines contained in this section of the specification guide are based on the requirement that ceiling track is connected to a ceiling in order to properly support the wall components as shown.

Posts join panels in a variety of configurations.
 ▶ Specifying, pages 192 and 231

Product Details

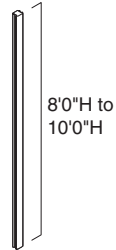
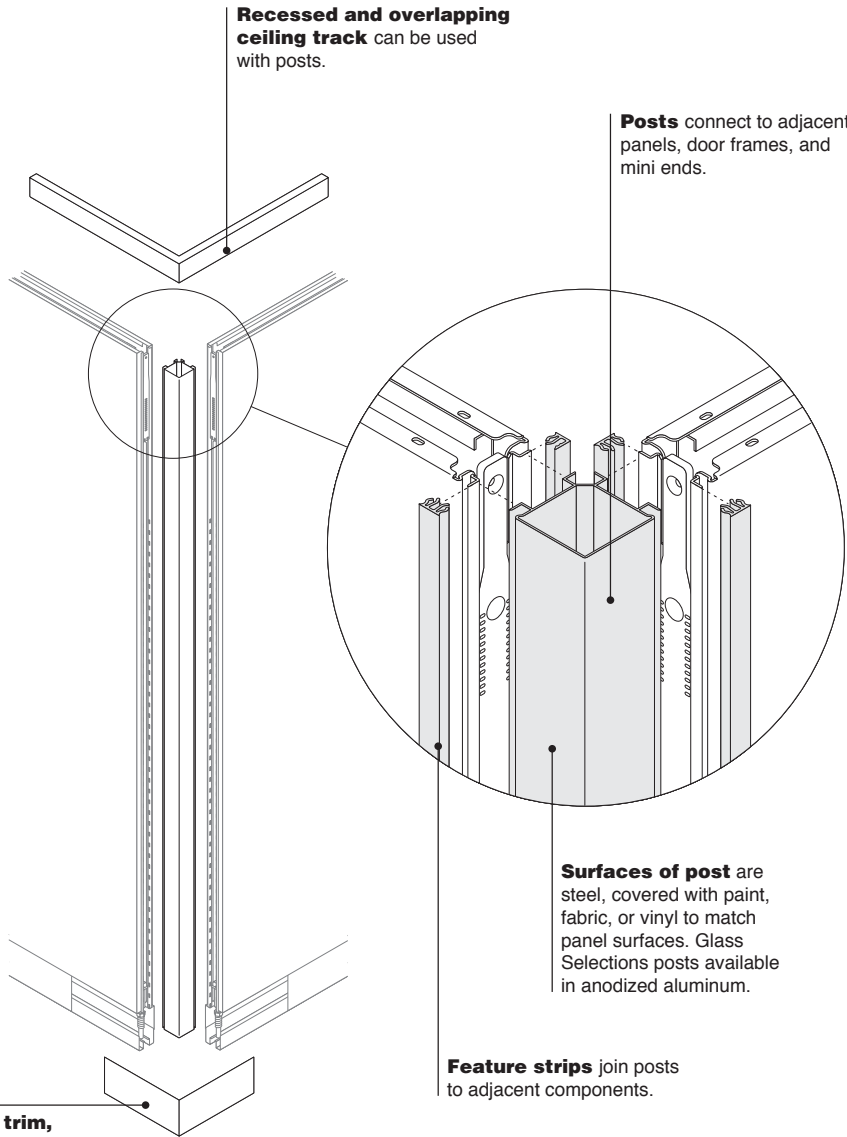

Height can be specified from 8'0" to 10'0", in one-inch increments, to accommodate different ceiling heights.

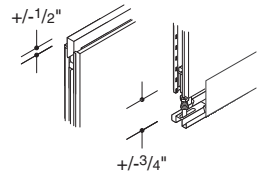

Ceiling track allows 1/2" of vertical adjustment to accommodate variations in field conditions. Floor track allows 3/4" of vertical adjustment to accommodate variations at base.

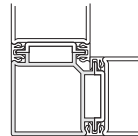
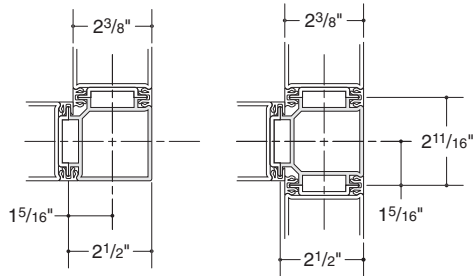

L-post

L-post has a square profile.

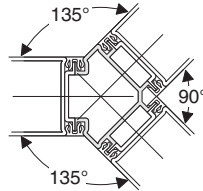

V-post is made up of a 90° corner and two 135° angles.

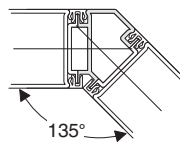
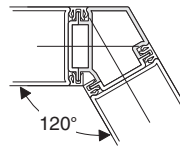

V-post is available either 120° or 135°.

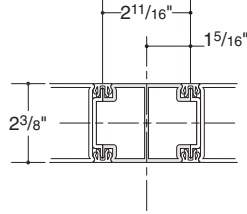
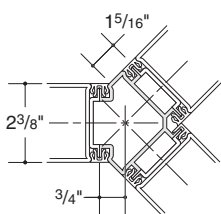
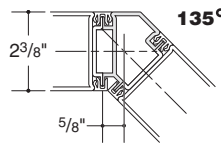
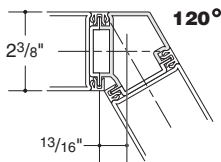
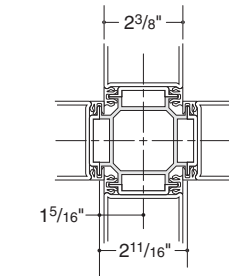

Configurations for posts include in-line, L, T, X, V, Y, and I-Line interface.

Tip: Base trim projects 1/16" from the face of the panel.

Connections

Any panel, door frame, or mini end can be connected to a post.

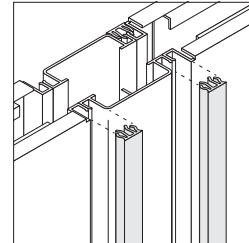

Feature strips, ordered separately, join panels and other components to posts and prevent light and sound leaks. Feature strip can be cut on site to provide access to the integral slotted verticals so that panel-supported components can be attached. To rearrange panels, feature strips can be removed and reused.

Posts are often more appropriate when planning with interior room dimensions. *Tip: Remember to allow for post dimensions when calculating the overall length of a wall.*

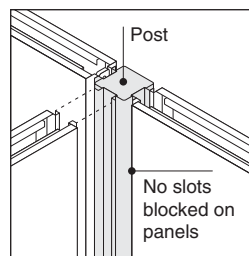

Slotted verticals are available when using posts. For an overview of the planning choices, see *Centerline Versus Interior Dimension Planning*, page 96.

Wiring & Cabling

Posts can be used to vertically route power and cable infeeds down from the ceiling or up from the floor.

Post

- Paint
- Fabric
- Vinyl
- Anodized aluminum

Base trim

- Paint

Feature strip

- Paint
- Fabric
- Anodized aluminum

Application Topics

Feature Strip Application

▶ Page 86

Centerline Versus Interior Dimension Planning

▶ Page 96

Posts — SmartTools Options

Note: All planning and application guidelines contained in this section of the specification guide are based on the requirement that ceiling track is connected to a ceiling in order to properly support the wall components as shown.

Product Details for SmartTools Options

SmartTools Options are available and easily ordered when using SmartTools software. If you do not have access to SmartTools software, these options can also be ordered using the normal Specials RFQ (Request for Quote) process.

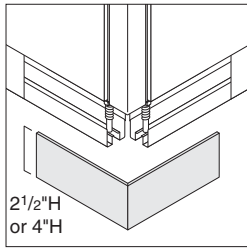

When planning with 4\"/>

Tip: Base trim is ordered separately.

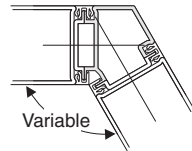

V-post can be specified at different angles in 5° increments, from 70° minimum to 175° maximum.

Tip: Base trim and ceiling track can also be ordered in corresponding angled configurations.

Tip: Each angled post has different dimensions. Exact dimensions should be requested through the quote process.

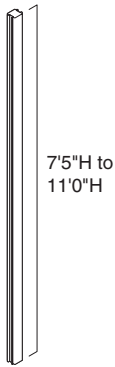

Privacy Wall posts can be specified from 7'5\"/>

Tip: Specify ceiling height of your installation and component will be fabricated to allow for ceiling track.

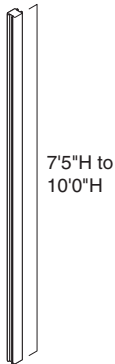

Glass Selections posts can be specified from 7'5\"/>

Tip: Specify ceiling height of your installation and component will be fabricated to allow for ceiling track.

Feature Strip Application

Use the table at right to determine the quantity of individual feature strips you need in specific applications.

Tip: For correct fit of feature strips, you must specify type of components that will be used in conjunction with feature strips. Example: One painted component and one upholstered component.

▶ See page 248 to order feature strips.

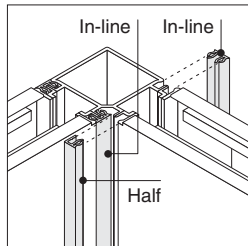

Two kinds of feature strips are available. They are available individually (style numbers GPFS1, GPFSH1, GPFS1A, or GPFSH1A available in 10' only) or in packages of 25 (style numbers GPFS, GPFSH, GPFS1A, or GPFSH1A ordered by 1" increments).

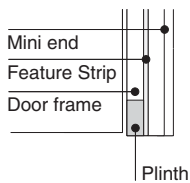

When positioned next to a door frame, the mini end should be specified "to floor," and will be field-cut by the installer to final length.

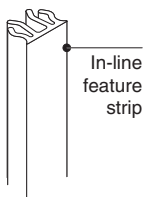

In-line feature strips are used when joining two surfaces on the same plane. They can be specified to correspond to the installation height, or 120"-long feature strips are available to be field-cut.

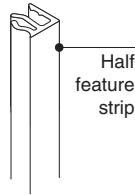

Half feature strips are used in combination with in-line feature strips for inside corner applications.

Tip: To ensure best fit for feature strips, specify a wall application option.

▶ Page 248

Specify both a painted and fabric half feature strip for Clerestory panels with one painted and one upholstered component.

When ordering painted feature strips, specify the type of wall application for the adjoining components.

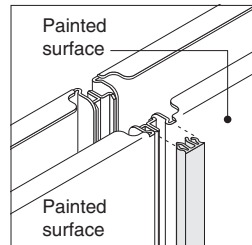

For use with two painted components.

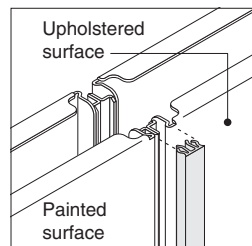

For use with one painted and one upholstered component.

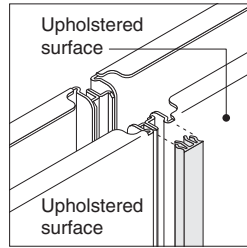

For use with two upholstered components.

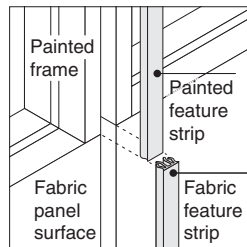

For Clerestory panels, you can specify two different feature strips when the solid-panel finish is different from the upper-glass frame finish.

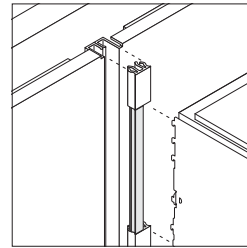

Furniture reveal strips, ordered separately, are positioned between two sections of in-line feature strip to allow access to one set of panel slots when a single component is mounted on a Privacy Wall panel. When components are mounted side by side, both sets of slots are left exposed, and there is no need for a furniture reveal strip. Furniture reveal strips are painted to match the adjacent wall panel or to match the component bracket.

Tip: Use of hang-on components with enhanced core panels may reduce acoustic effectiveness.

▶ Page 251

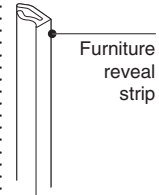

Furniture reveal strips are used when hanging components on Privacy Wall panels. The furniture reveal strip finishes off one half of an in-line panel joint, while allowing access to panel slots. They are cut to size from a 34" length as part of the installation process. Typically, one 34" strip is adequate to trim out both edges of a worksurface or storage cabinet.

▶ Page 251

Privacy Wall uses the same furniture interface as Answer. When specifying overhead storage and worksurfaces to be mounted on Privacy Wall, select the Answer bracket option.

Product	Number of in-line feature strips GPFS, GPFSH1, GPFS1A, or GPFS1A	Number of half feature strips GPFSH, GPFSH1, GPFSHA, or GPFSH1A
Panel	2	0
Hinged door frame	2	0
Slider door unit	4	0
Mini end	2	0
Panel end cut kit	2	0
Finished-end adapter	2	0
L-adapter	1	1
T-adapter	0	2
X-adapter	0	4
L-post	1	1
T-post	2	2
X-post	0	4
In-line post	2	0
V-post	0	2
Y-post	1	1
I-Line interface post	2	0

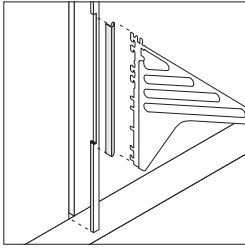

When hanging furniture on panels, optional acoustic seals can be field-applied to the cantilever or shelf brackets to minimize sound transmission through the wall.

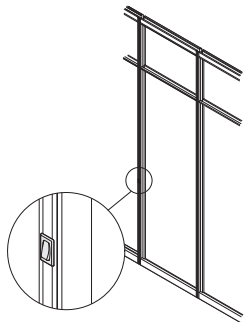

Low-voltage switches can be positioned on an in-line feature strip between two panels (solid or glass) or between a panel and a door frame. The feature strip is cut and notched during installation to accommodate the switch.

Lite Scale Glazing

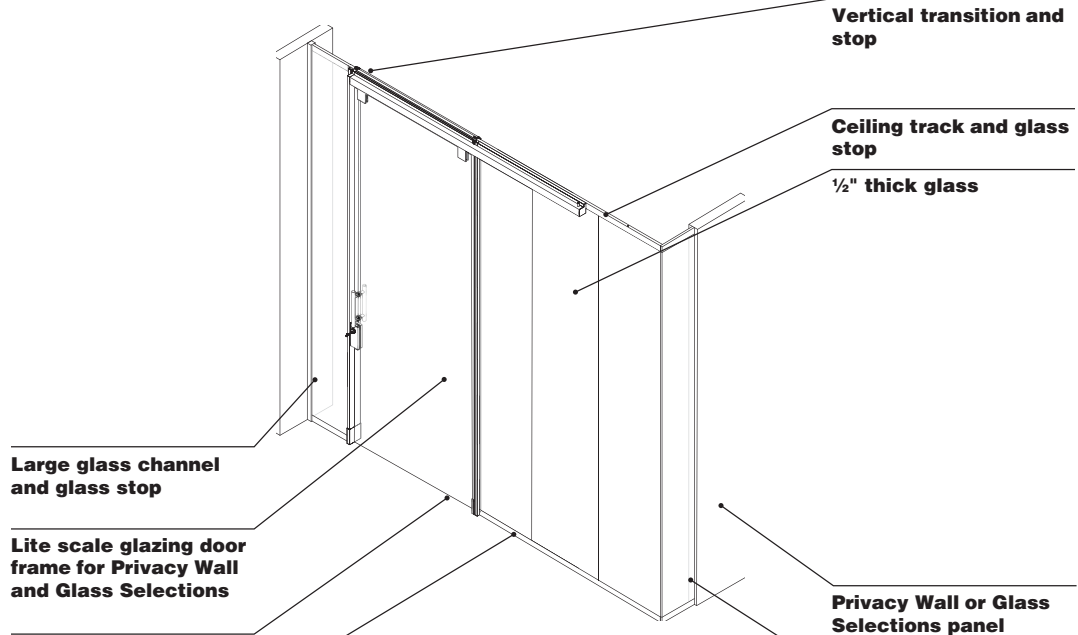
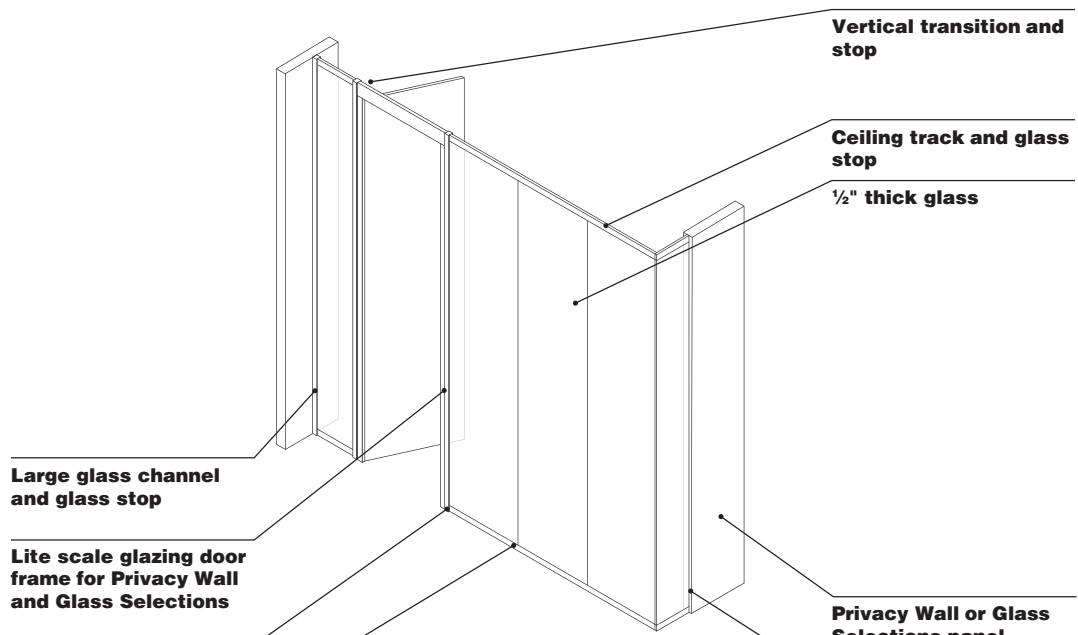

Product Details

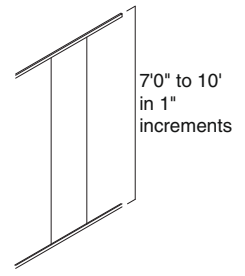

Ceiling height can be specified from 7'0" to 10'0" in 1" increments.

Tip: Specify ceiling height of your installation. Glass and door components will be fabricated to allow for ceiling track.

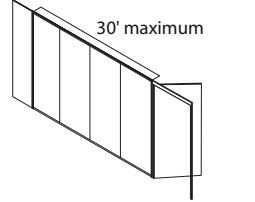

The maximum length of the lite scale glass wall is 30'0". At this length, a vertical component (post, door frame, mini-end, or glass channel) must be positioned at both ends of the wall.

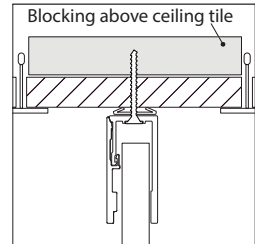

When installed under a suspended ceiling grid, blocking is required above ceiling tiles for structural support. Blocking materials and fasteners are provided by the installer.

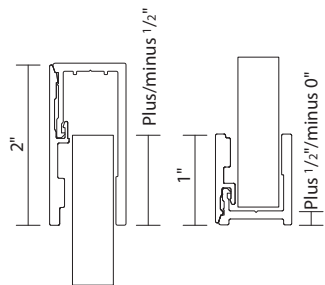

Ceiling track allows for 1/2" of adjustment in each direction. The small track at the base allows for an increase of 1/2" .

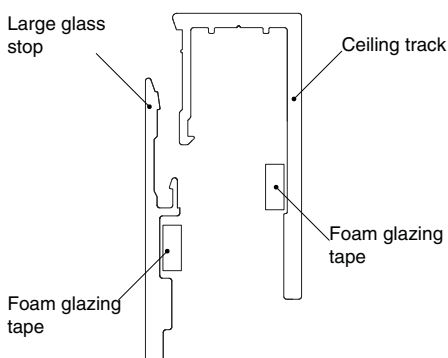

Ceiling track and large glass stops are combined during installation. Parts are provided in 122" lengths and cut to size on site as necessary.
Tip: Foam glazing tape is ordered separately and applied during installation.

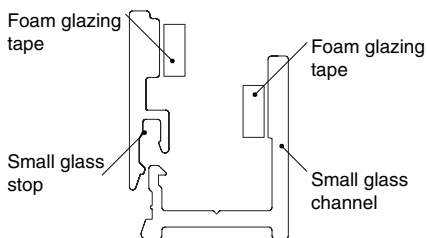

Small glass channels and small glass stops are combined during installation for use as floor track and base trim. Parts are provided in the 122" lengths and cut to size on site as necessary.
Tip: Foam glazing tape is ordered separately and applied during installation.

Tip: Shims used for leveling glass are provided by installer.

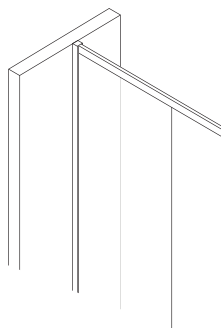

Lite scale glass walls can intersect with conventional walls using vertical channels and stops.

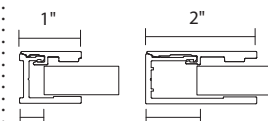

Plus/minus 1/4" Plus/minus 1/2"

Large track allows for 1/2" of adjustment in each direction. The small track allows for 1/4" of adjustment.

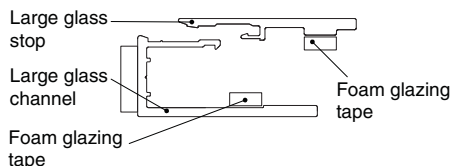
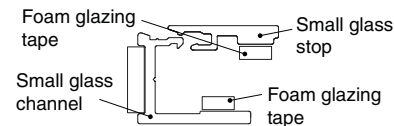

Small and large glass channels can be used at terminations against conventional walls. Parts are provided in 122" lengths and are cut to size on site as necessary.
Tip: Foam glazing tape is ordered separately and applied during installation.

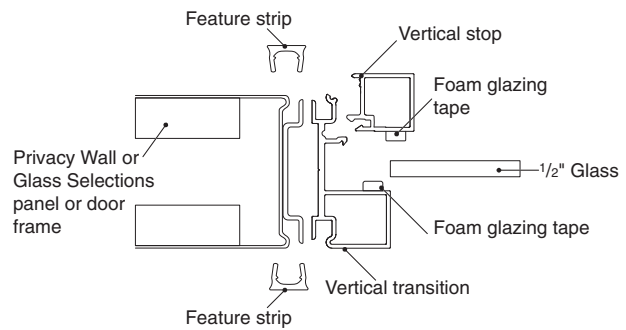
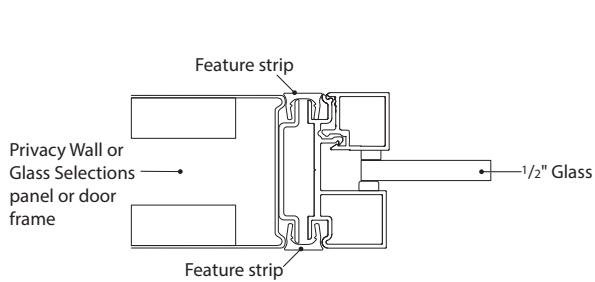
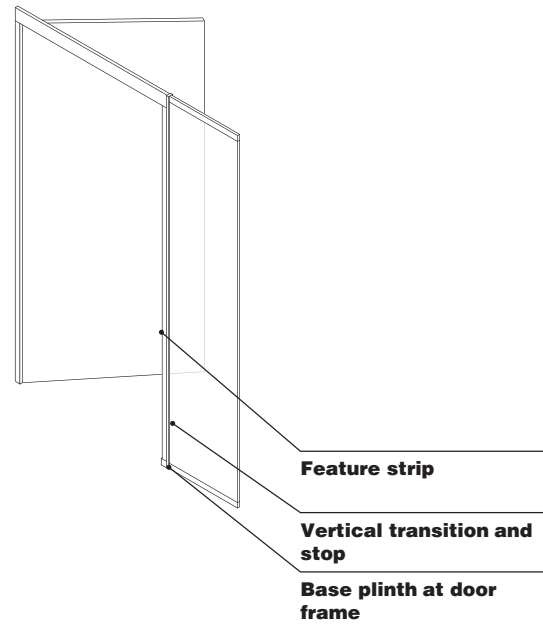
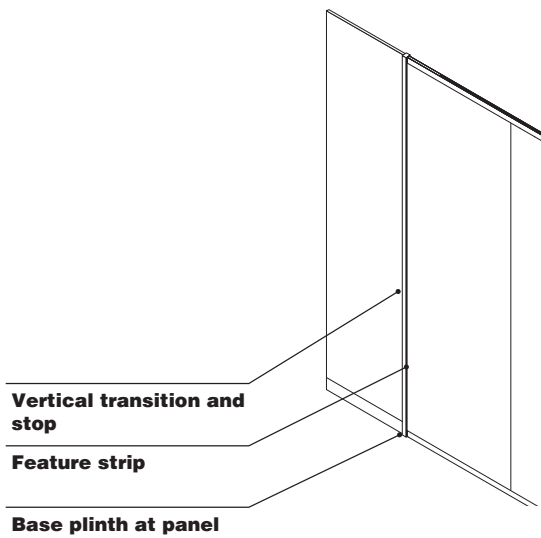

Vertical transition, vertical stop, and feature strips are combined during installation when positioning Privacy Wall panels and door frames adjacent to lite scale glazing. Parts are provided in 122" lengths and cut to size on site as necessary.
Tip: Foam glazing tape is ordered separately and applied during installation.

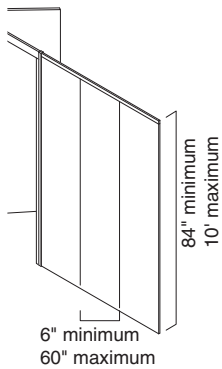

Glass thickness is 1/2". Glass lites can be specified in widths from 6" to 60" wide. Ceiling heights can be specified from 84" to 120".
Tip: Lite scale glass widths of 40" or less are recommended to simplify handling and installation. Overall glass size should not exceed 40 square feet.

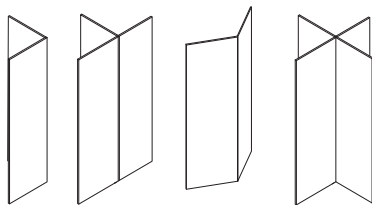

Various intersections can be created with lite scale glazing components. Framing components are shipped as straight lengths 122" long and are cut and mitered to the appropriate angle as part of the installation process.

90 degree angles use black glazing tape to join individual pieces of glass. Other angles can be joined using silicone or flexible bulb seals similar to CRL seal S1LB.
 ▶ See page 270 for black glazing tape.

Glazing tape for in-line glass joints is provided by dealer for installer similar to 3M 4918F clear VHB - 6 mil wide x 80 mil thick.

Tempered glass for lite scale glazing can be provided through Steelcase or sourced through local suppliers. Glass sizes can be specified in 1/16" increments.

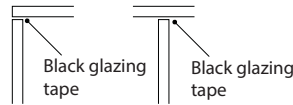

Black glazing tape is provided for perpendicular intersections.

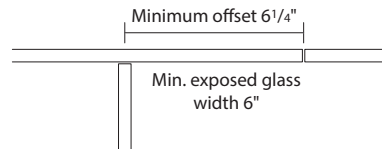

An in-line glass joint can be no longer than 6 1/4" to the centerline of an L or T butt glass intersection.

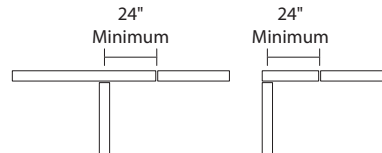

In order to minimize the visual impact of vertical glass joints, it is recommended that an in-line joint be positioned no closer than 24" from an intersection.

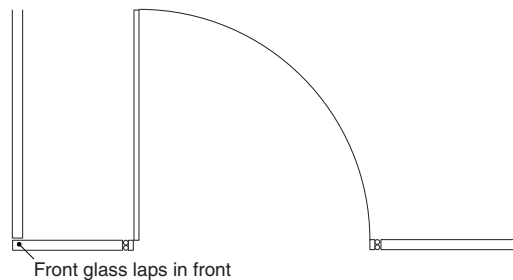

At L corners, the lap joint at the glass will typically be oriented to the glass in the front wall (as defined by the door opening placement) to extend through the corner.

Lite Scale Glazing, continued

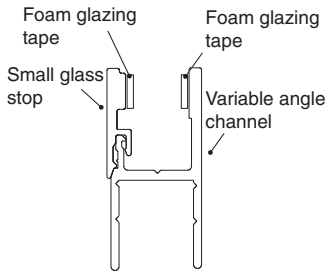

Displayed above is the variable angle end condition.

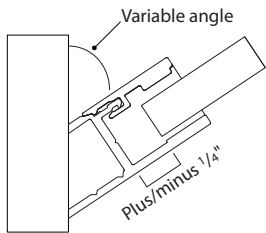

A variable angle glass channel with a small glass stop is used to create angels other than 90 degrees at a termination at a conventional wall. The channel is cut to the proper angle by the installer. The minimum angle is 30° degrees. Parts are provided in 122" lengths and cut to size on site as necessary.

Tip: Foam glazing tape is ordered separately and applied during installation.

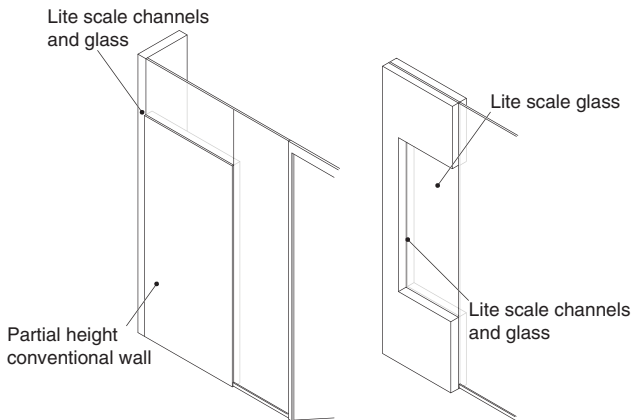

Glass channel (large or small) can be field cut and mitered to fit a perimeter sill and soft conditions. Glass can also be set above partial height conventional walls in a knee-wall or clerestory application.

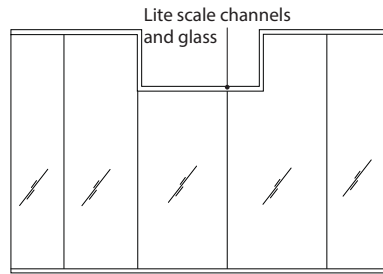

Glass ceiling track can be field cut and mitered to fit at soffit conditions or a change in ceiling height.

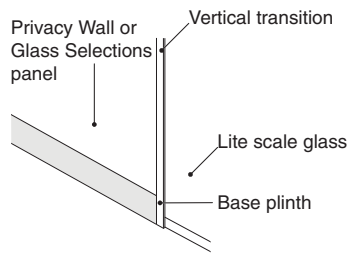

Base plinths cap the end of the Privacy Wall base trim at transitions from lite scale glass to Privacy Wall panels.

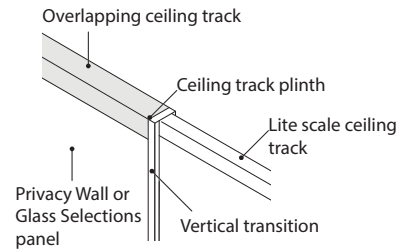

When using Privacy Wall panels with overlapping ceiling track, ceiling track plinths cap the end of the ceiling track at transitions from lite scale glass to Privacy Wall panels or door frames.

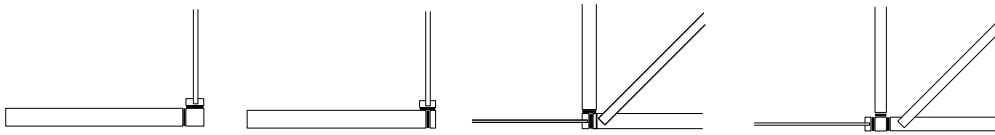

Transition verticals can be used at in-line connection at panels, door frames, as well as posts and adapters to join lite scale glass to Privacy Wall or Glass Selections.

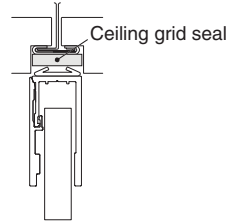
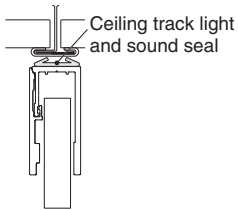

When installed under a suspended ceiling grid, a light and sound seal is added to the ceiling track during installation.
Tip: This seal is not required at drywall soffit or ceilings.

When installed under a suspended ceiling grid with recessed grid or tegular tiles, ceiling grid seal is specified to fill the voids at the ceiling track.

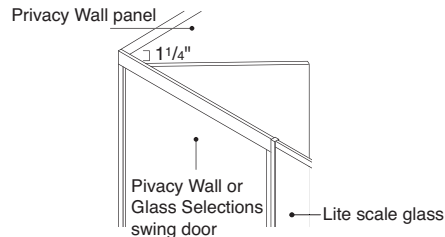
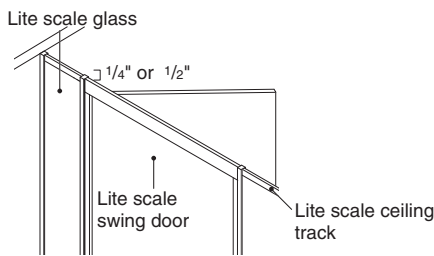
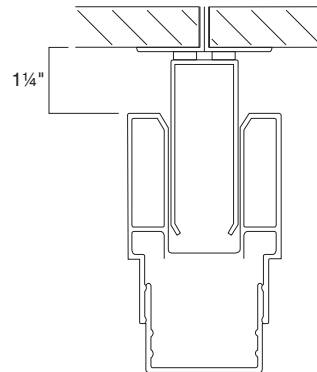
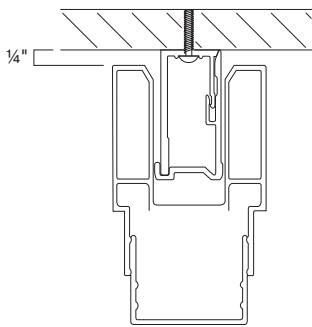

When lite scale glazing is applied in a front only application (i.e. without a connection to Privacy Wall), lite scale swing door frames and door leaves are specified. Lite scale door frames are designed with a smaller reveal (nominal 1/4" or 1/2") at the ceiling track.

When lite scale glazing is blended with Privacy Wall panels, and door frames are connected to Privacy Wall or Glass Selections, Privacy Wall or Glass Selections swing door frames and door leaves are specified. Privacy Wall and Glass Selections swing door frames are designed with a 1 1/4" reveal at the ceiling track to align with Privacy Wall panels.

Lite Scale Glazing, continued

Lite scale door units are the same design as Glass Selection and Privacy Wall door frames and door leaves. The relative height of the door frames is taller, as noted below.

- ▶ See page 290 for butt hinged door frames
- ▶ See page 292 for pivot hinged door units
- ▶ See page 300 for Glass Selections polished edge slider frame

Lite scale door frames and doors configure to position the top horizontal to within 1/4" from the ceiling of:

- All transom height doors
- Glass Selections full height pivot hinge doors
- Privacy Wall butt hinge doors
- Glass Selections slider door frames

To within 1/2" of the ceiling of:

- Privacy Wall pivot hinged doors

All other specification and application guidelines for lite scale door components are the same as Privacy Wall and Glass Selections. Refer to those sections for additional information.

Ceiling track spacer

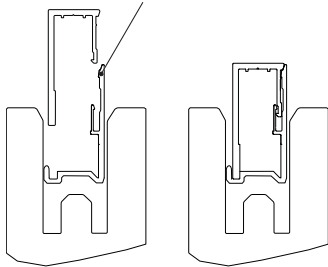

Ceiling track spacer is specified when positioning a lite scale door frame beneath a lite scale ceiling track. It properly aligns the top door jamb to the lite scale ceiling track.

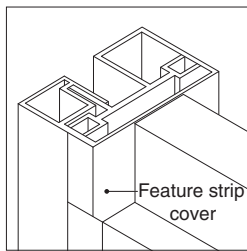

When transitioning from Privacy Wall or Glass Selections door frames to lite scale ceiling track, the transition vertical and feature strip are extended and trimmed with a feature strip cover at the top of the feature strip.

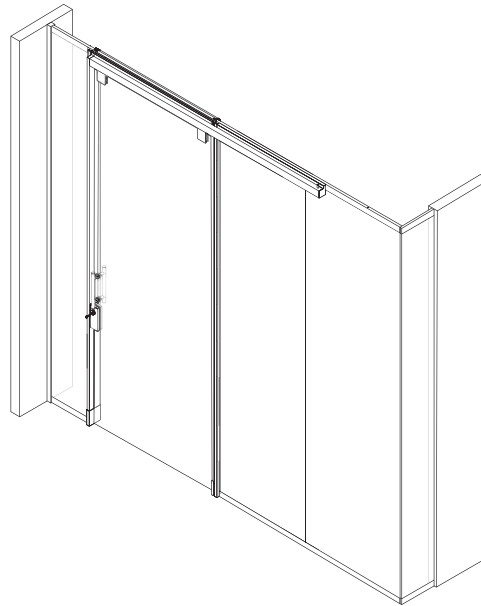

Lite scale slider door assemblies are applied by specifying door frame, door leaf, track, and hanger. Lite scale sliders are available as full height only. Lite scale door frames and doors are available in widths of 40"W, 42"W, or 48"W. Additional widths are available in 1" increments.

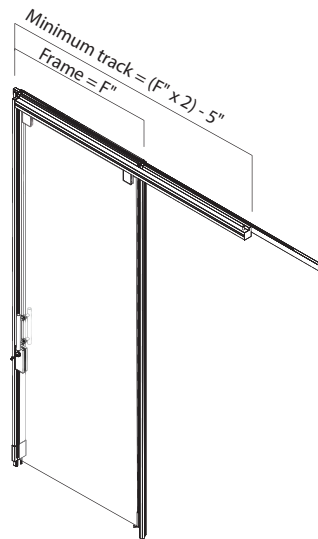

Slider door track is available in widths from 71"W to 144"W. The minimum width slider track = (door frame width x 2) minus 5".

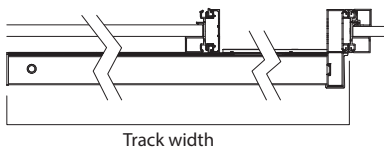

Slider door track width is measured from the centerline of the strike side feature strip to the end of the track.

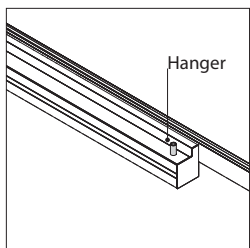

Slider door track hanger conceals the fastener that attaches the slider door track to the support structure above the ceiling. Hanger is shipped in 24" lengths and cut to length by the installer. One length will accommodate ten doors.

Customer or GC to provide structure above the ceiling or soffit as required to support a 150 pound vertical load at the trailing edge of the slider track.

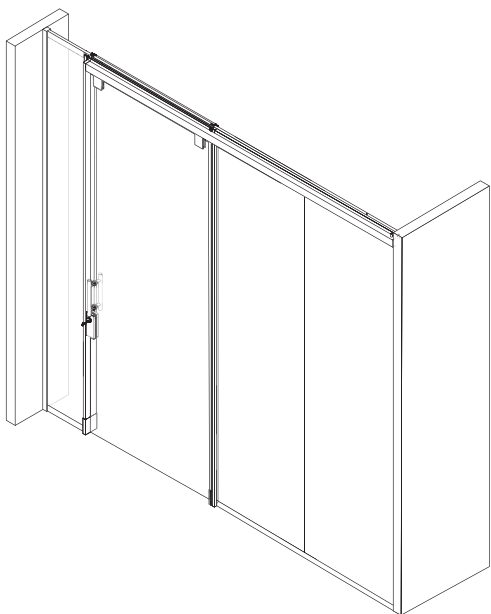

The slider track can span across a glass front by ordering an oversized width of track (120"W or 144"W) and having the installer cut to size.

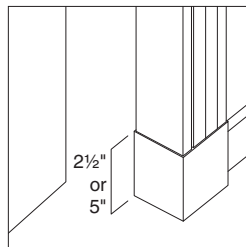

Door frames can be specified with 2 1/2" high plinths or 5" high plinths when blended with Privacy Wall panels.

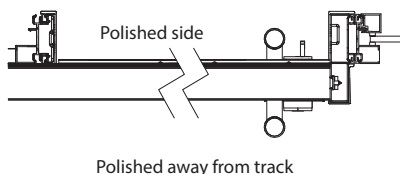
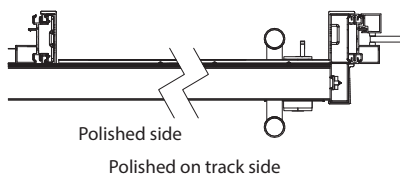

When using etched and/or patterned glass on the slider doors, the glass can be oriented to either face of the wall.

▶ Refer to page 96 for more information regarding etched and pattern glass.

Centerline Versus Interior Dimension Planning

Planning Choices

Architects and designers typically use either centerline planning or inside-dimension planning when laying out walls. Privacy Wall supports either approach or a combination. Your decision about which strategy to use will depend on your building and integration and interface issues. Each approach offers its own advantages and disadvantages.

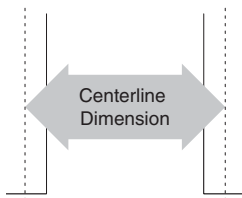

Centerline planning concerns the distance between the centerline of walls; the thickness of the walls is a secondary consideration. For example, two parallel walls that are $2\frac{3}{8}$ " thick and with centerlines that are 96" apart will produce an interior space that is $93\frac{5}{8}$ "W.

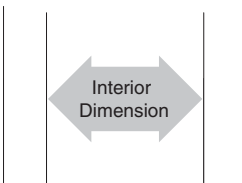

Interior planning concerns the physical dimensions of the room created by walls. For example, to create an interior space that is 96"W, two parallel walls that are $2\frac{3}{8}$ " thick would have a centerline dimension of $98\frac{9}{16}$ ".

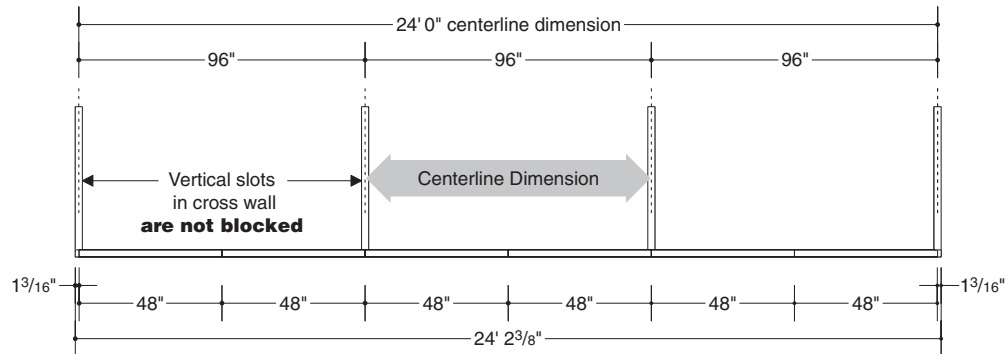

Using Adapters

Advantages

- Allows centerline planning.
- No creep added to the dimensions of the run of panels in one axis.
- Lower cost than using posts at T- and X-corners.
- Clean visuals. No double feature strips visible when the back side of the wall doesn't have perpendicular panels.

Disadvantages

- Vertical slots in some panels will be blocked by overlapping panels and therefore cannot accommodate panel-supported storage or worksurface components.

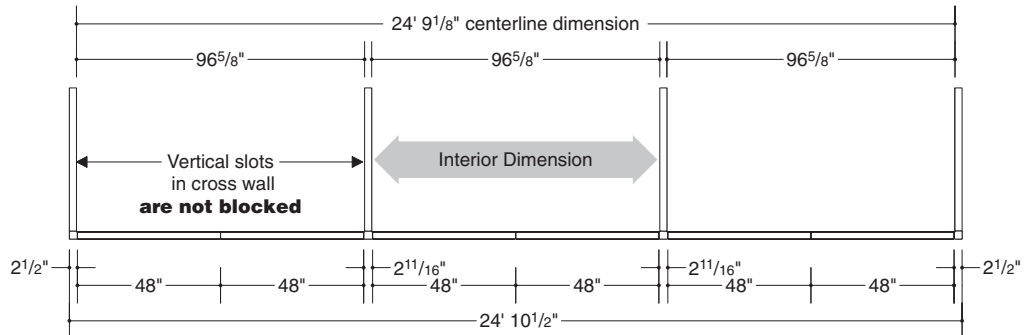

Using Posts

Advantages

- Ideal for interior dimension planning because the inside dimensions of the room will always match the dimensions of the panels that make up the wall.
- Vertical slots will never be blocked, so adding panel-supported storage or worksurfaces is never a problem.

Disadvantages

- Must allow the $2\frac{11}{16}$ " increment that each L-post adds and $2\frac{11}{16}$ " increment that each T-post adds to the length of the run of panels.

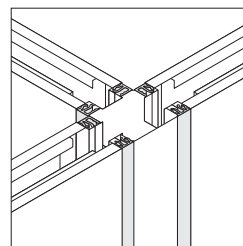

- Posts and two feature strips will be visible on the opposite side of the wall if no panels are joined at those points.
- More expensive than using adapters at T- and X-corners.

Combining Techniques

In some applications it is desirable to combine centerline planning with inside-dimension planning. For example, you might want a front wall that produces alignment in a building that has columns or window elements on centerlines that are spaced 96" apart. But along the cross walls, you may want to use inside-dimension planning to ensure that standard-sized furniture components, such as workspaces and bins, will match panel dimensions.

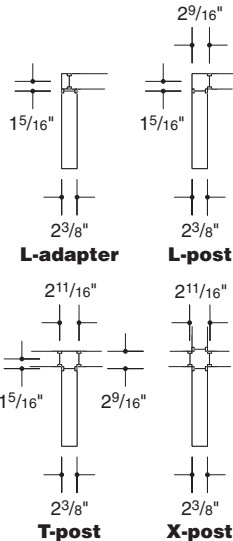
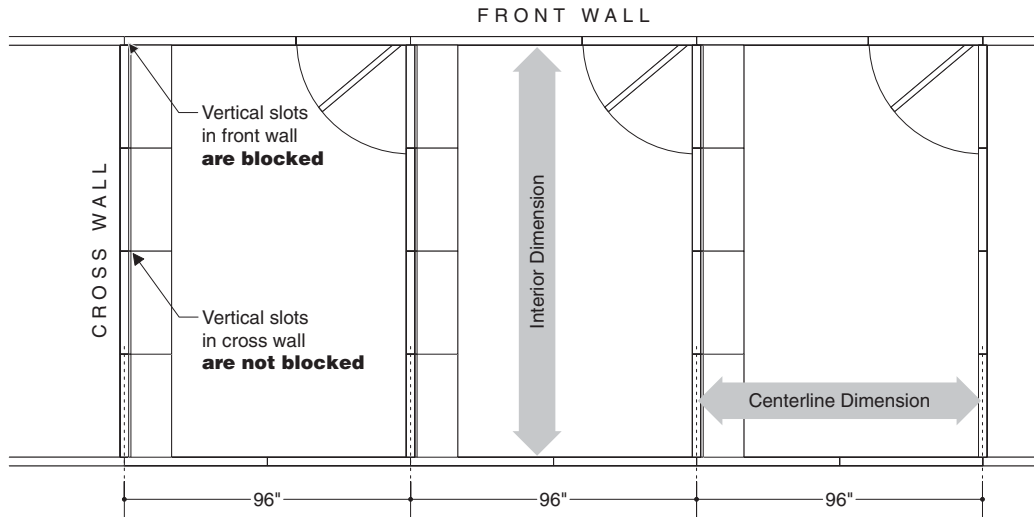

Adapters and posts add different dimensions to a run of panel depending on the configuration.

Interior dimension planning along cross walls means that vertical slots will be available to attach storage components and workspaces to cross wall panels.

Centerline planning along front wall allows fin walls to match centerlines of building elements such as columns, window frames, and ceiling grid.

Base Trim Details

Panels

In-line

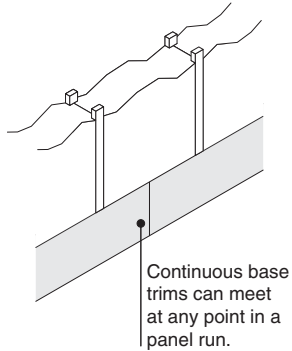

Inside corner

Continuous base trims meet at an inside corner regardless of angle.

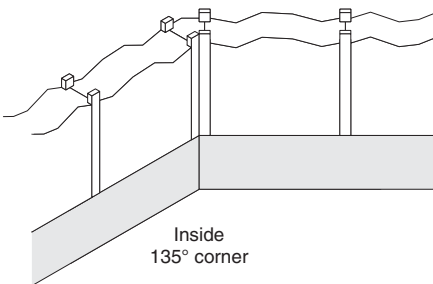
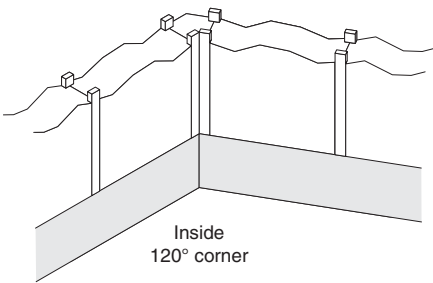
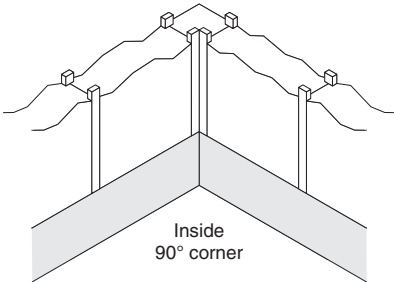

Outside corner

One-piece outside corner base trim must be specified to trim outside panel corners regardless of angle.

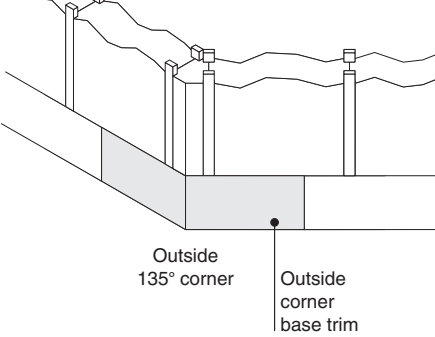
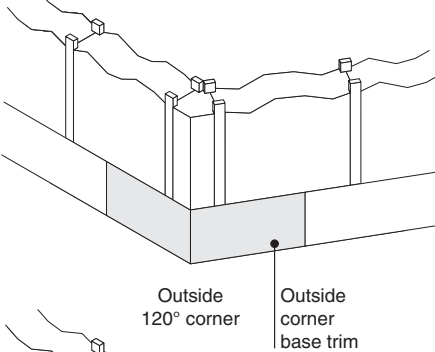
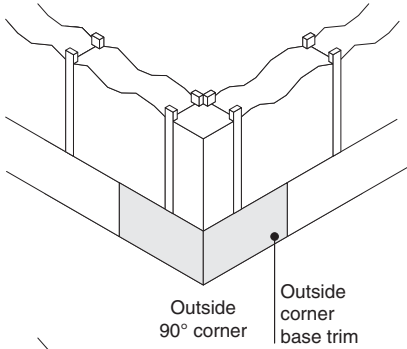

Doors

Inside corner

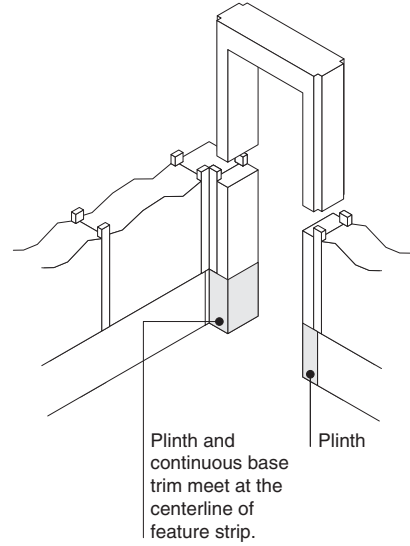

Outside corner

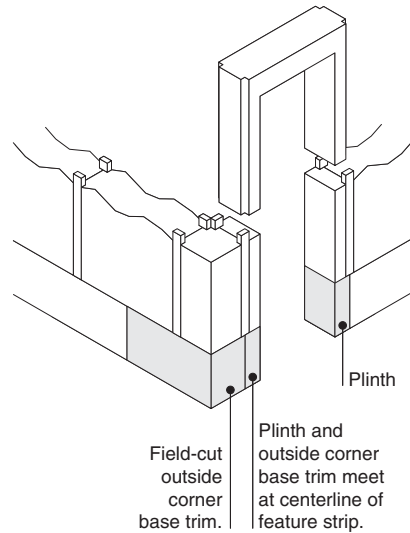

Back-to-back

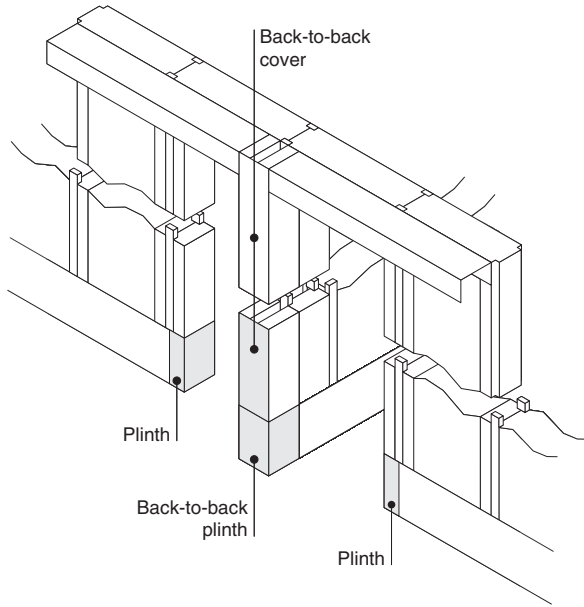

Inside slider door

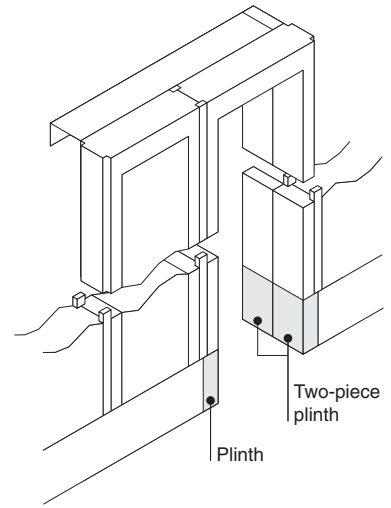

Two doors separated by a post

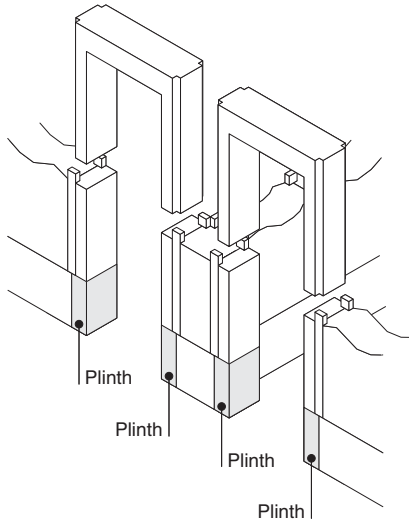

Outside slider door

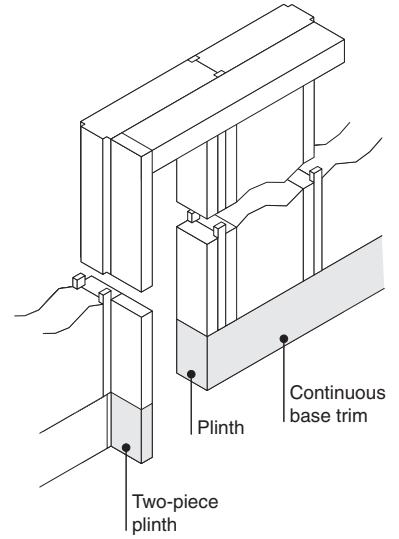

Base Trim Details, continued

Product Details for SmartTools Options

SmartTools Options are available and easily ordered when using SmartTools software. If you do not have access to SmartTools software, these options can also be ordered using the normal Specials RFQ (Request for Quote) process.

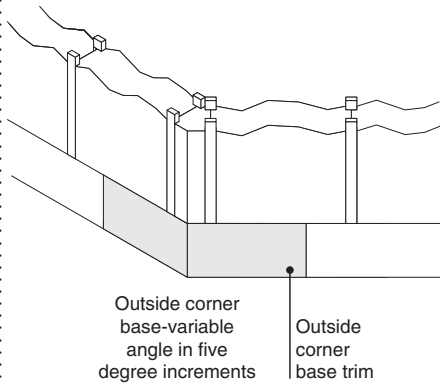

How to Connect Privacy Wall to I-Line Moveable Walls

I-Line interface posts connect Privacy Wall to its predecessor, I-Line Moveable Walls.

Two I-Line feature strips are required for the I-Line side of the connection.

Two Privacy Wall feature strips are required for the Privacy Wall side of the connection.

I-Line interface post can be cut in the field.

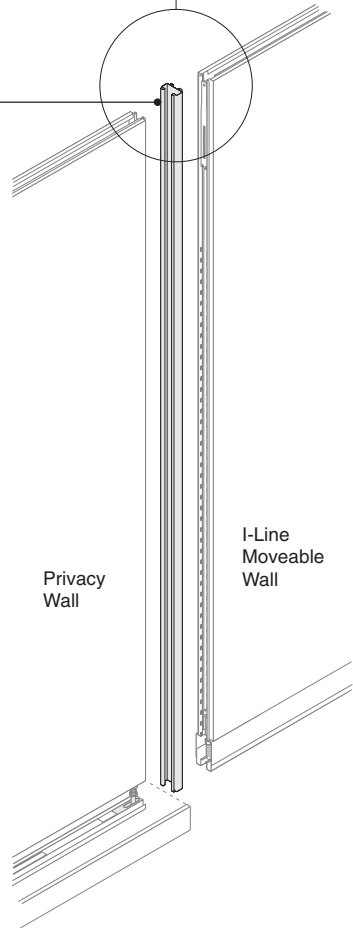
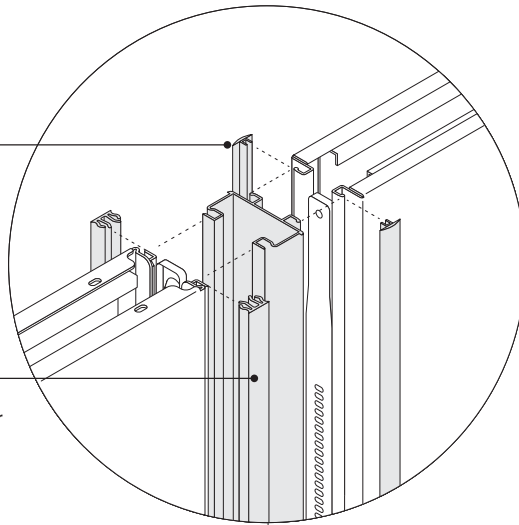

Product Details

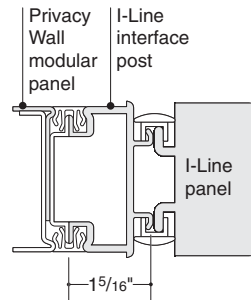

Width of I-Line interface post adds $1\frac{1}{4}$ " to the width of any panel it is attached to. Because a Privacy Wall modular panel is $1\frac{1}{4}$ " less wide than a standard panel, using an I-Line interface post with a Privacy Wall modular panel will retain the overall dimension of a regular panel.

Ceiling track, ordered separately, continues uninterrupted from the I-Line panel to the Privacy Wall panel. Ceiling track is available recessed or overlapping.

Continuous base trim on Privacy Wall panels extends over the I-Line interface post. I-Line panels have their own base trim. Height of both I-Line and Privacy Wall base trims may vary slightly.

Connections

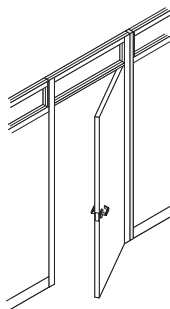
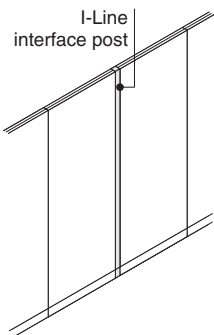

Any Privacy Wall panel or door frame can connect to I-Line using an I-Line interface post.

In-line connections are possible by adding an I-Line interface post between Privacy Wall and I-Line panels.

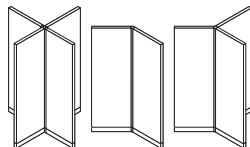
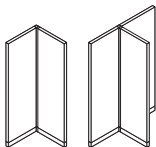

I-Line interface posts attach to adjacent posts in L-, T-, X-, V-, and Y-configurations.

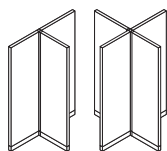

T- and X-adapters can be used to connect Privacy Wall to I-Line Moveable Walls.

Wiring & Cabling

Power cannot be routed vertically inside an I-Line interface post. The post allows horizontal cable routing at the base.

Surface Materials

- I-Line interface post**
 - Paint
 - Tip: Not all Privacy Wall paint colors match classic I-Line paint colors.*
 - Fabric
 - Vinyl

Etched and Pattern Glass Planning

Planning Guidelines

You should consider the orientation of the faces of etched and pattern glass in relation to the insides and outsides of rooms.

Etched glass should be installed with the rough side facing the inside of the room and the smooth side facing the corridor. This placement allows for easier cleaning of the more heavily traveled corridor.

Pattern glass should be installed with the rough side facing the corridor and the smooth side facing the inside of the room. This placement allows more people to appreciate the visually interesting and attractive side of the glass.

When using etched and/or pattern glass on the slider doors, the glass will be oriented as outlined above when the door is positioned on the outside of the room. If slider doors are to be positioned on the inside of the room and glass surfaces are desired to be oriented outlined above, the slider door units must be ordered through specials.

Clerestory panels that are ordered with split finish surfaces or single sided electricals will be oriented to side one and side two. When determining how to order these, keep in mind that glass surfaces are always oriented as follows: for etched glass, the rough side will be oriented to side two; for pattern glass, the rough side will be oriented to side one.

Etched glass

Satin

Pattern glass

Bamboo
Harp
Mirage

All other glass types

are either rough on both faces or smooth on both faces.

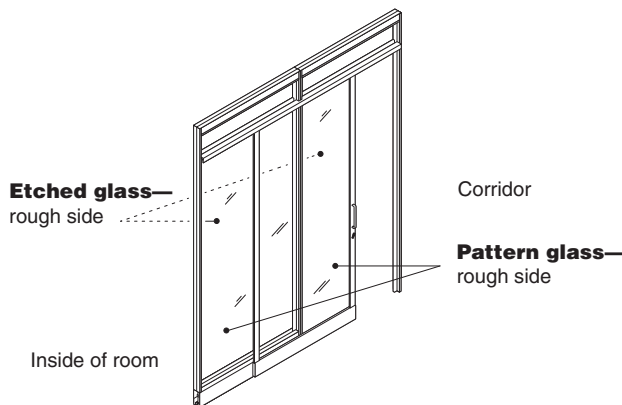
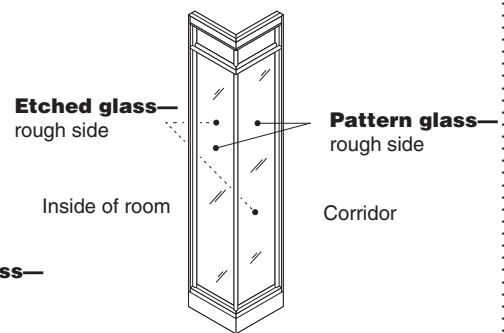
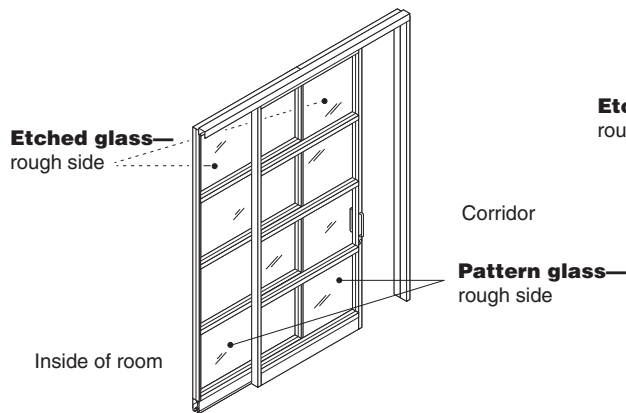
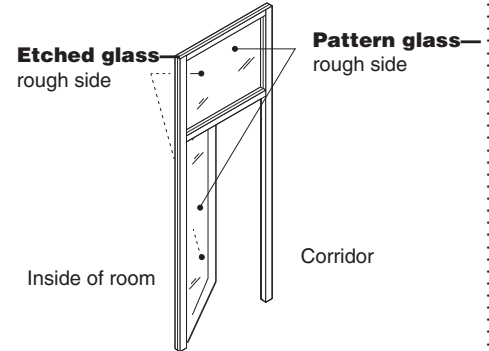
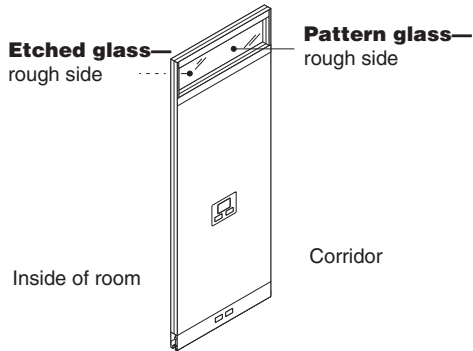

How to Power a Panel

Factory-installed components are available to power panels with receptacles at desk height, ADA height, or at the base of the panel. Power infeeds can feed through the ceiling or the floor.

Tip: Bypass cover may be required when specifying recessed ceiling track.
▶ Page 242

Ceiling infeed can be factory installed in panel to ADA or desk height, or field installed at base height.

Communication cable, field installed.

Power and communication receptacles are factory installed at ADA height, desk height, or base height.

Floor infeed can be factory installed in panel at ADA or desk height, or field installed at base height.

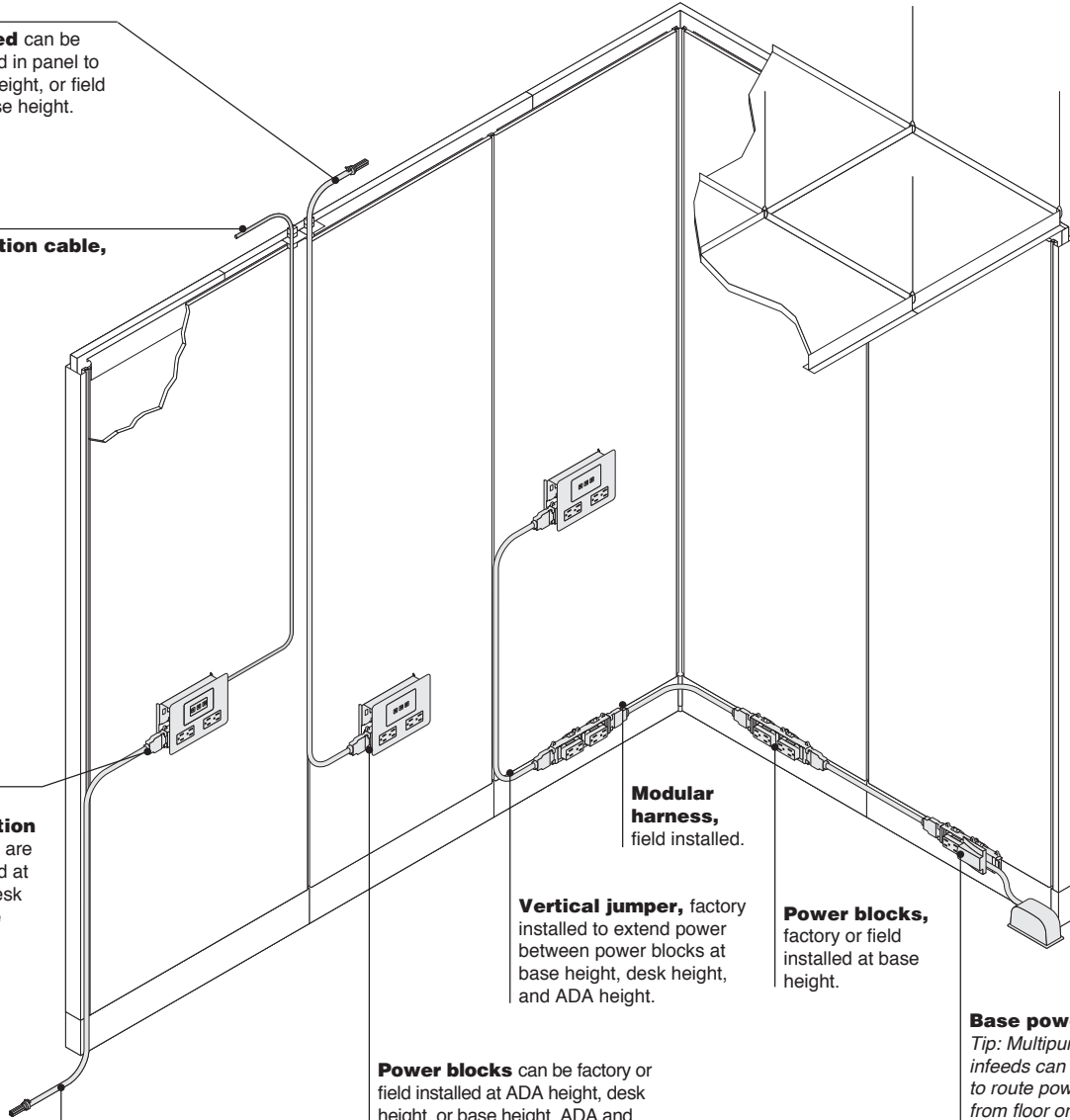

Vertical jumper, factory installed to extend power between power blocks at base height, desk height, and ADA height.

Power blocks, factory or field installed at base height.

Power blocks can be factory or field installed at ADA height, desk height, or base height. ADA and desk-height power blocks are available in hollow core panels only.
Tip: For power installation at ADA or desk height in the field, you must use a power and communication powerkit and cover plate. Powerkits with power blocks and communication openings can only be installed in the field at ADA- or desk-height locations.

Base power infeed
Tip: Multipurpose infeeds can be installed to route power to base from floor or ceiling.

Powering a Privacy Wall panel requires five things—power blocks, receptacles, cutouts in the surface of the panel to access the receptacles, a harness or infeed to bring power to the power block, and a cover plate or power and communication base trim to trim the opening.

Power Blocks

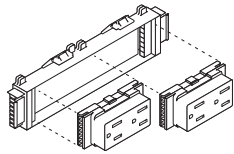

Power blocks must be installed in a panel in order to accommodate power receptacles. Power blocks can accommodate receptacles on one side or both sides of a panel.

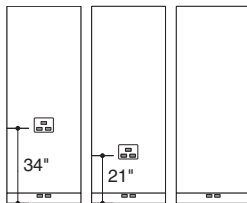

Desk height
ADA height
Base height

Three different heights are possible for power blocks—desk height, ADA height, and base height. Any combination of these heights is possible. ADA and desk-height power blocks are available in hollow core panels only.
Tip: When placing furniture on or in front of a powered panel, review the furniture type and position to avoid obstructing the power or communication termination.

Utilities can be specified on either side of the panel or on both sides. Receptacles can be installed on either side of the panel or on both sides. Fillers can be installed in any unused cutouts.

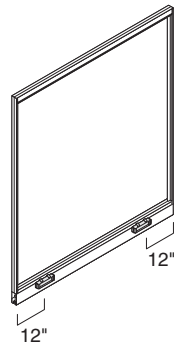

Power is located in the center of a panel except in Glass Selections frame kits, where power is located 12" from the panel edge.
Tip: If using base trim with power and communication cutout, plan on placing cutouts at right edge of panel.

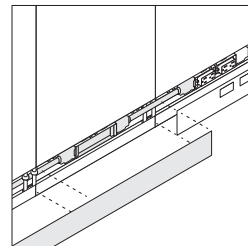

Power blocks can be located in the base without cutouts to continue distribution of power between panels.

Panel type determines which receptacle locations are available. For example, solid wall panels can have receptacles in any position, but glass wall panels can have receptacles in the base only.

Panel Type	Desk-height	ADA-height	Base
Solid	●	●	●
Glass	N.A.	N.A.	●
Clerestory	●	●	●

Field-installed power-kits, infeeds, and jumpers can be ordered separately and added on site. For installations at desk or ADA height, solid panel surface must be cut carefully to position power block correctly and to accommodate cover plate. Power and communication is available in panel face only.

Receptacles

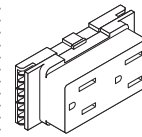

Receptacles are ordered separately and field installed in power blocks. Separate duplex receptacles are available to engage each of the different circuits that are possible in the electrical system. Receptacles are coded to indicate which circuit and type of ground they engage.
▶ Page 256

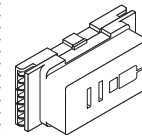

USB receptacles are ordered separately and installed on site. They are available in three wiring schematics with multiple line options. USB receptacles offer easy access to two charging ports. Each port provides 1 ampere of output. USB receptacles conveniently charge a wide range of electronic devices. Some devices may not be compatible.

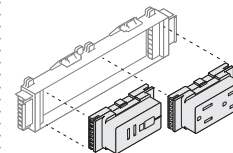

Installation is done on site. Receptacles snap into power block. Tools are not required for installation.

Cutouts

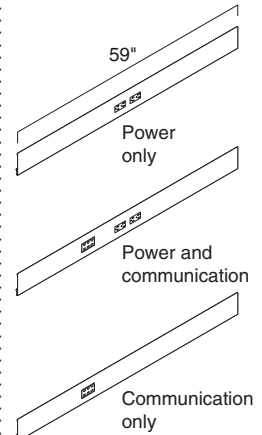

Power and communication base trim, ordered separately, are factory punched for modular power receptacles and communication outlets. Three kinds are available—power only, power and communication, and communication only.
Tip: Base communication cutouts are designed to accommodate only NEMA faceplates. Cutout is 3"W x 2"H.

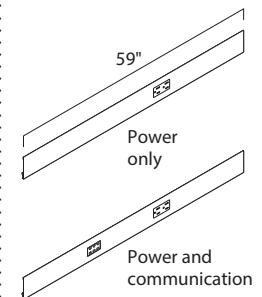

Power and communication base trim for Chicago and New York City power, ordered separately, are factory punched for hardwired power receptacles (not by Steelcase) and communication outlets. Two kinds are available - power only, and power communication.
Tip: Base communication cutouts are designed to accommodate only NEMA faceplates. Cutout is 3"W x 2"H.
Tip: Power cutouts are 4 1/8"W x 2 1/4"H.

How to Power a Panel, continued

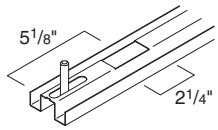

The floor track is factory cut at both ends to provide access for multipurpose infeeds that are routed up from the floor.



Power-only



Power and communication

Plastic cover plate, ordered separately, frames receptacles and communication outlets in the panel face. Two kinds of cover plates are available—power only and power and communication. They are required for utilities in the panel surface.

▶ Page 258

Width of panel must be adequate to accommodate cutouts.

- Panels that are 30"W (standard or modular) can accommodate power and/or communication in any position or configuration.
- Panels that are smaller than 30"W cannot accommodate power or communication in any configuration.

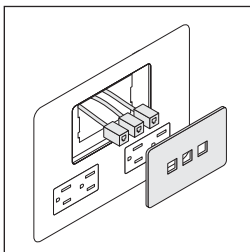

Communication opening is sized to accommodate a standard NEMA-size faceplate, modular furniture faceplate, or Decora mounting strap style outlet supplied by the electrician.

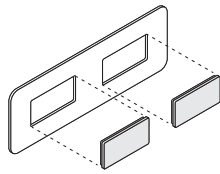

Fillers, ordered separately, fill empty receptacle and communication openings.

Tip: Power and communication filler is not designed for use with the base communication cutout. Fillers for this NEMA-size cutout should be sourced locally.

Infeeds

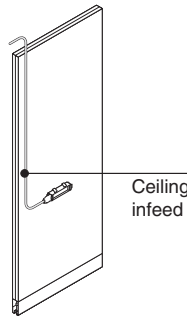

Ceiling infeed

Ceiling infeeds are factory installed to bring power to a power block installed at desk height or ADA height. Harness orientation is standard on the left side when facing side 1.

Tip: Panels that are less than 24"W are not factory punched for infeeds.

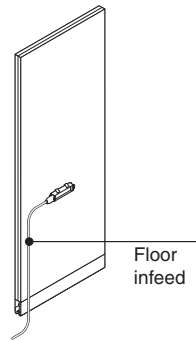

Floor infeed

Floor infeeds, for use with raised floor systems, are factory installed to bring power to a power block installed at desk height or ADA height. Harness orientation is standard on the left side when facing side 1. Factory-installed infeeds extend a minimum of 12' from the panel.

Tip: Panels that are less than 24"W are not factory punched for infeeds.

Base power blocks

always receive their power from field-installed harnesses or factory-installed jumper harnesses.

▶ Page 110

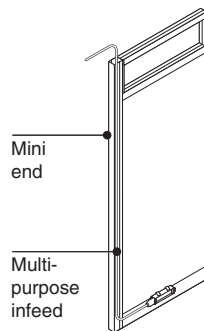

Mini end

Multi-purpose infeed

Field-installed multi-purpose infeed can be used to bring power from the ceiling or floor by routing it through an adjacent component such as a mini end or post.

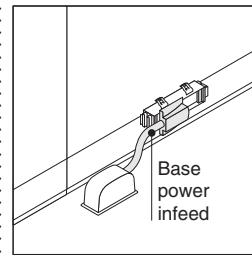

Base power infeed

Field-installed base power infeed can bring power from a floor monument to a power block in the base of a panel. Floor infeed harness at the base occupies one receptacle location in the base power block.

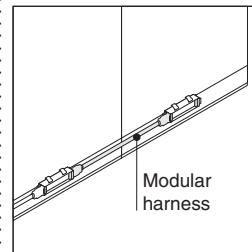

Modular harness

Field-installed modular harness can bring power from a power block installed in the base of an adjacent panel.

▶ To calculate harness length, see page 114.

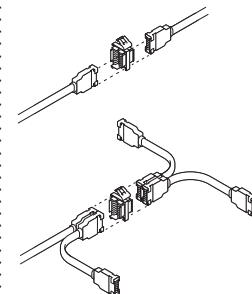

Harness-to-harness connector or branching harness-to-harness connector, ordered separately, links harnesses. Harness-to-harness connector allows multiple harnesses to connect to allow power networks to branch.

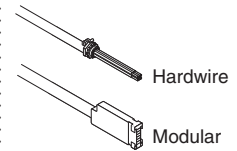

Hardwire

Modular

End of the power infeed can be hardwire or modular. Hardwire allows the electrician to make a conventional connection to the building's power inside a junction box. Modular allows the infeed to connect to any corresponding modular connector or harness using a harness-to-harness connector. This is the same modular connector used by Answer, Montage, and Architectural Solutions Modular Power System.

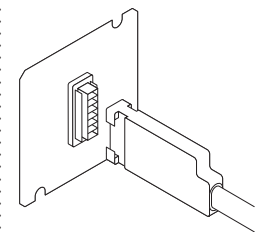

Modular infeed cover is included with modular multi-purpose infeed to hardwire to a junction box. It allows modular connector to snap into position. This allows walls to be disconnected, moved, and reconnected later.

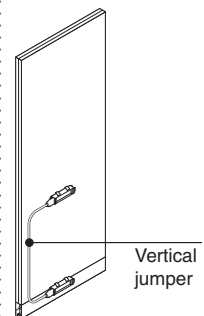

Vertical jumper

Vertical jumper is factory installed to extend power between power blocks at base height, desk height, and ADA height. Jumper can also be field installed to achieve same configuration.

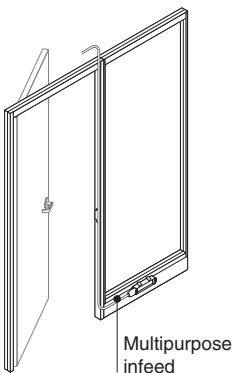
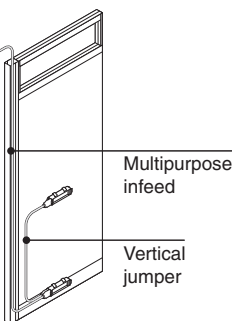
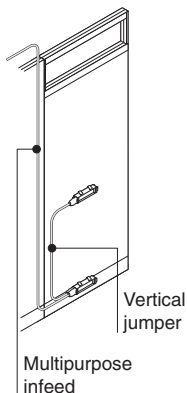

Glass panels cannot accommodate vertical routing of power harnesses through the glass portion of the panel. Use adjacent panels, mini ends, or door frames to accommodate a field-installed multipurpose infeed.

Tip: A power switch installed in a door frame will block the path of a multipurpose infeed.

Chicago and New York City electrical code

requires that all power be hardwired in the field. Modular power systems are not permitted. All panels can be hardwired on site using conventional electrical components.

Desk or ADA power and communication in Chicago and New York City can be accommodated in two ways.

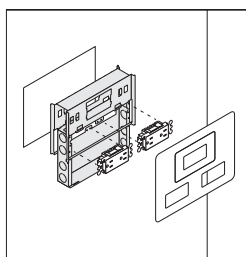

Specify the Chicago/New York City hardwire power prep option

and the factory will cut the panel at desk and/or ADA height on one side of the panel. This allows the electrician to install a Chicago/New York City junction box and hardwire standard Decora-style receptacle(s) in the field. Order power/communication Chicago/New York City junction box and cover plate separately. Only power/communication is available with this option.

Tip: Hardwire power boxes cannot be double sided.

New York City/Chicago prep option requires use of Privacy Wall cover plate, ordered separately.
▶ Page 258

San Francisco electrical code requires that base power infeeds be encased in metallic liquid-tight conduit.

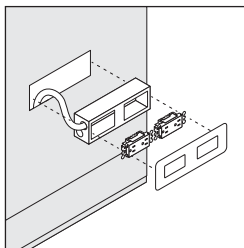

Electrician can cut solid or Clerestory panels in the field and install conventional components (junction box, receptacle, outlet cover, and conduit) as in typical drywall construction.

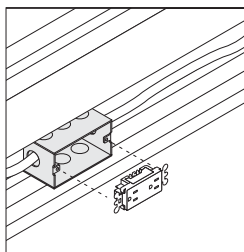

Base power for panels installed in Chicago or New York City is hardwired in the field using conventional components (Decora-style receptacle, junction box, conduit) supplied by the electrician.

Tip: Order Chicago/New York City base trim.

All Privacy Wall electrical components are listed by Underwriters Laboratory (UL) and certified by the Canadian Standards Association (CSA).

All Steelcase electrical systems are designed in compliance with the National Electrical Code (NEC) and Canadian Electrical Code (CEC) to function as a multi-wire branch circuit. Installations should be made in accordance with the NEC or CEC provisions for multi-wire branch circuits.

Local electrical codes vary. Consult a qualified electrical contractor or engineer for the proper installation of electrical equipment.

Specifying

For guidelines about the steps to specify power components for a panel, see *Power Options*.
▶ Page 146

Overview of Powered Panels

Power in Base

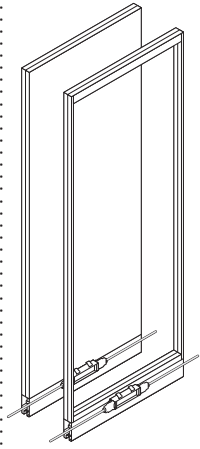

Power in the base of a solid or glass panel can be energized using field-installed harnesses or infeeds.

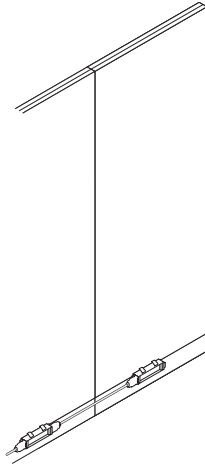

Power source A: Field-installed harness from adjacent panel with power in base.
▶ Page 146

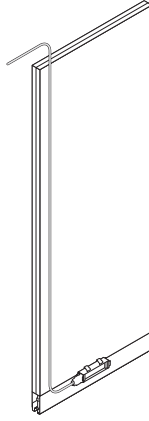

Power source B: Field-installed multipurpose infeed from ceiling through hollow core in solid panel.
▶ Page 146

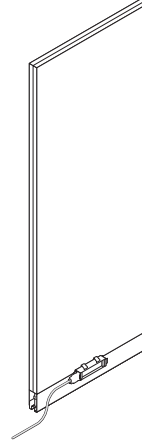

Power source C: Field-installed multipurpose infeed from floor.
▶ Page 146

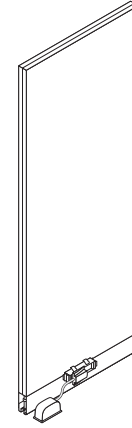

Power source D: Field-installed base power infeed from floor monument or adjacent wall. Occupies one receptacle location.
▶ Page 146

Power at Desk Height or ADA Height

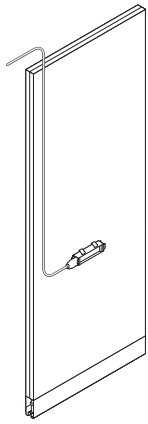

Power source E: Factory-installed ceiling infeed.
▶ Page 146

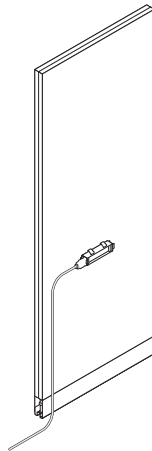

Power source F: Factory-installed floor infeed.
▶ Page 146

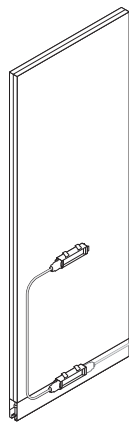

Power source G: Factory-installed vertical jumper. Base must receive power using one of the approaches shown at the top of the page. When base/ADA/desk combinations are specified, a jumper will be factory installed.
▶ Page 146

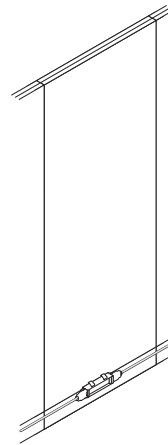

Power blocks can be located in the base without cutouts to allow for distribution of power or to bring power from floor or ceiling.



Power in Panels with Glass

Power cannot be routed vertically through the glass portion of a Clerestory panel so desk-height and ADA-height receptacles in glass panels always receive power from below.

Tip: Power block in base doesn't have to be expressed. You may choose to use it only as a connection point for an infeed and not install base trim with receptacle openings.

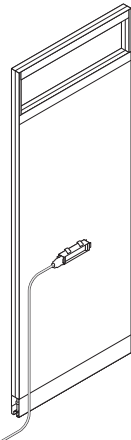

Power source F:
Factory-installed floor infeed.
▶ Page 146

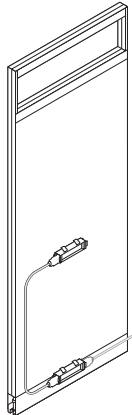

Power source G:
Factory-installed vertical jumper. Base must receive power using one of the approaches shown on previous page.
▶ Page 146
Tip: When base/ADA/desk combinations are specified, a jumper will be factory installed.

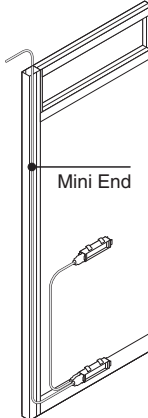

Adjacent mini end can be used to route a field-installed multipurpose infeed. Factory-installed vertical jumper can extend power to desk height or ADA height.
Tip: When base/ADA/desk combinations are specified, a jumper will be factory installed.

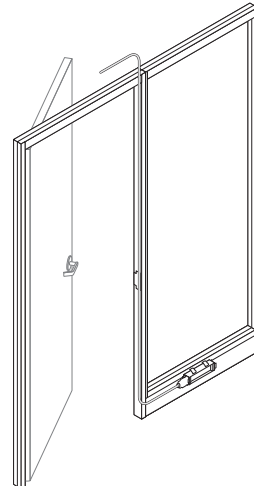

Adjacent door frame can be used to route a field-installed multipurpose infeed.
Exception: Switch installed in routing side of door frame will block harness.

Wiring Schematics

Details for the Electrician

Privacy Wall modular power components are offered in three different wiring schematics to allow you to match your specific wiring strategy to any typical building wiring plan.

Tip: All the components in an electrical system must use the same wiring schematic. The components are color coded and keyed to make it impossible to connect mismatched parts.

Black = Four-circuit, 3+1

Brown = Four-circuit, 2+2

Rust = Three-circuit, separate neutrals

Shared neutral conductors = 10 gauge

Separate neutral conductors = 12 gauge

Hot conductors = 12 gauge

Grounding conductors = 12 gauge

Four-Circuit, 3+1

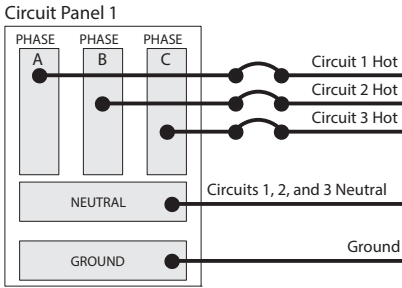

In the four-circuit 3+1 schematic, circuits 1, 2, and 3 are distributed from the first circuit panel and are supported with one shared neutral and one shared ground. Circuit 4 is distributed from a second circuit panel and is supported with a separate neutral and ground.

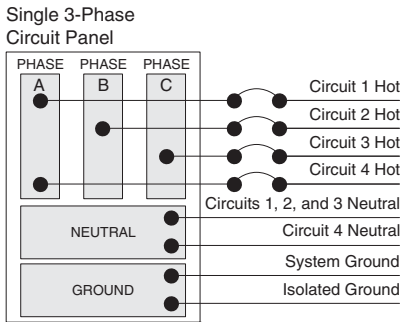

On a single 3-phase circuit panel, all four circuits are distributed as shown.

Four-Circuit, 2+2

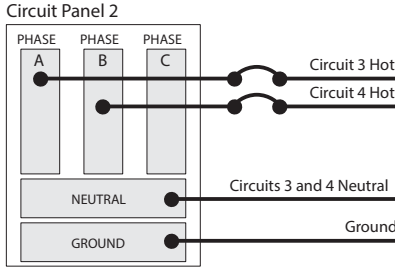
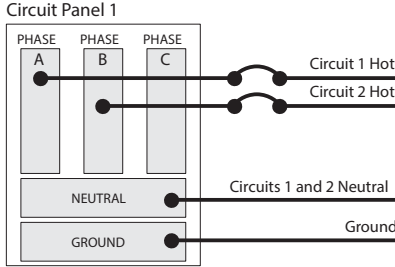

In the four-circuit 2+2 schematic, circuits 1 and 2 are distributed from two different phases from the first circuit panel and are supported with one shared neutral and one shared ground. Circuits 3 and 4 are distributed from a second circuit panel and supported by their own shared neutral and ground.

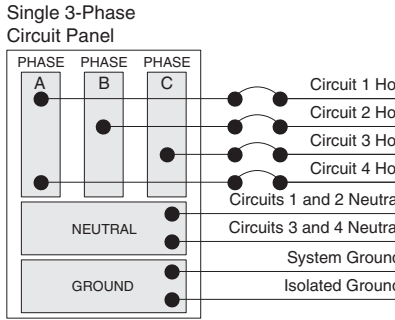

On a single 3-phase circuit panel, all four circuits are distributed as shown.

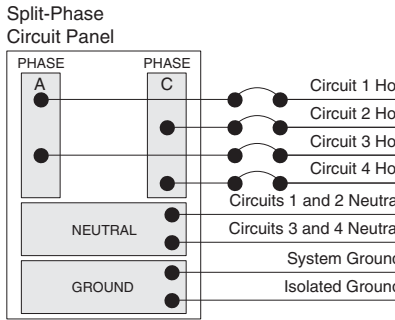

On a split-phase circuit panel, all four circuits are distributed as shown.

Three-Circuit, Separate Neutrals

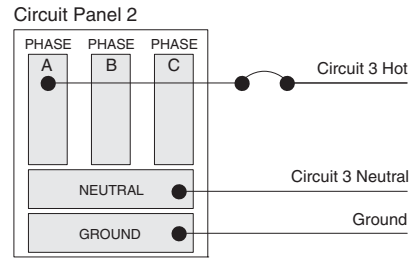
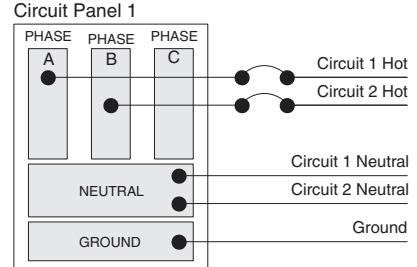

In the three-circuit, separate neutral schematic, circuits 1 and 2 are distributed from two different phases from the first circuit panel. Each circuit is supported with its own neutral and a common ground. Circuit 3 is distributed from the second circuit panel and is supported by its own neutral and ground.

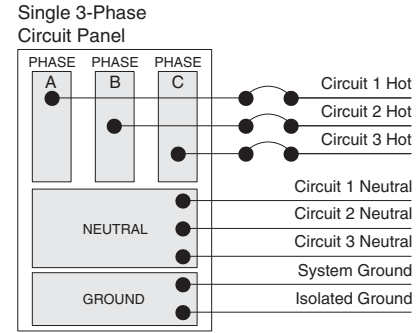

On a single 3-phase circuit panel, three circuits are distributed as shown.

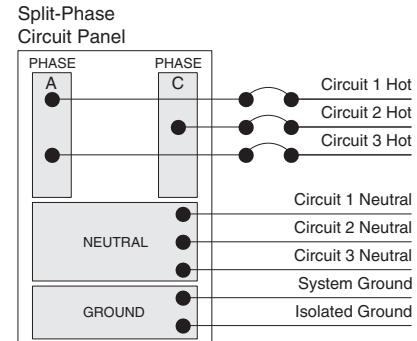

On a split-phase circuit panel, three circuits are distributed as shown.

How to Calculate Power Needs

Use This to Determine How Many Power-Ins You'll Need

When planning a power network, you must calculate the amperage requirements of all your electrical components so you can provide sufficient electricity to power them.

If your usage is not known in advance: The National Electrical Code (NEC) allows a maximum of 13 receptacles on each 20-amp circuit. This provides up to 30 receptacles for each 3-circuit power-in and 40 receptacles for each 4-circuit power-in.

If your usage is known in advance: Add up the amperage used by each piece of equipment in the workstation. Whenever you reach 60 amps (20 amps times 3 circuits) or 80 amps (20 amps times 4 circuits) from items that are likely to be used at the same time, you have reached the limit for a single power-in. Specify another power-in and continue until all equipment is powered.

If the circuits will normally be subject to a continuous load (three or more hours of continuous use, such as lights or computers), the NEC requires that circuit capacity be "de-rated" by 20 percent. Therefore, treat circuits used for continuous loads as if they were rated at 16 amps instead of the regular 20 amps.

Try to anticipate future increases in power requirements and build some excess capacity into your plan.

▶ See table at right for typical and actual amperage usages for components.

To calculate amperage when the wattage of a device is known, divide watts by 120.

Some appliances, such as large copiers, coffee makers, or space heaters require most of the current available on a 20-amp circuit. It is recommended that such devices be supplied with their own receptacle/circuit, directly from the building. This leaves the capacity of the furniture circuits available for the more dynamic requirements of the office equipment.

Local electrical codes vary. Consult a qualified electrical contractor or engineer for the proper planning of electrical circuits in your locale.

Approximate power consumption for common devices

• Device	• Wattage	• Amperage	• Voltage	• Number of Devices Supported on Single 20 Amp Circuit*
Laptop	90	0.8	110	20
CPU/Desktop Computer	120	1.1	110	15
Monitor	60	0.5	110	29
Phone	5	0.0	110	352
High Power Tablet (e.g. Surface Pro)	40	0.4	110	44
Low Power Tablet (e.g. iPad Air)	15	0.1	110	117
Desktop Printer	40	0.4	110	44
42" LCD Screen	210	1.9	110	8
DVD Player	25	0.2	110	70
Projector	175	1.6	110	10
Desktop Lamp	19	0.2	110	93
Large Printer/Copier (high)	1900	17.3	110	1
Large Printer/Copier (low)	850	7.7	110	2
Paper Shredder	360	3.3	110	5
Desktop Fan	20	0.2	110	88
Standing Fan	180	1.6	110	10
Coffee Maker (high)	1200	10.9	110	1
Coffee Maker (low)	600	5.5	110	3
Microwave (high)	400	13.6	110	1
Microwave (low)	150	5.5	110	3
Refrigerator (high)	1500	3.6	110	4
Refrigerator (low)	200	1.4	110	12
Vacuum (high)	1500	13.6	110	1
Vacuum (low)	200	1.8	110	9
Space Heater (high)	1500	13.6	110	1
Space Heater (low)	750	6.8	110	2

Tip: These calculations are estimations and are meant solely for informational purposes. It is important to conduct proper power planning for each installation to prevent overloading a circuit.

Field-Installed Modular Harness Length Guidelines

Modular harnesses allow power to be extended from one power block to another. Use the guidelines on this page to determine harness length.
▶ Page 261

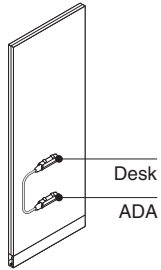

Tip: For field-installed ADA-to-desk connections, order desk-height to ADA-height jumper.

Tip: Harnesses stretch 3". For example, a 33" harness will allow for a 33" to 36" connection.

Tip: When two powered panels are separated by a third panel, calculate the harness length by adding the result of these tables plus the width of the third (middle) panel.

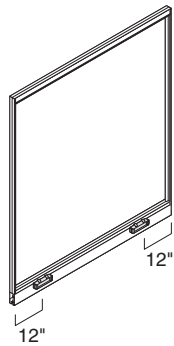

Tip: Power is located in the center of a panel except in Glass Selections frame kits, where the center of the power is located 12" from the panel edge. All GS frame kits connect with the same size harnesses, regardless of width.

GS = Glass Selections

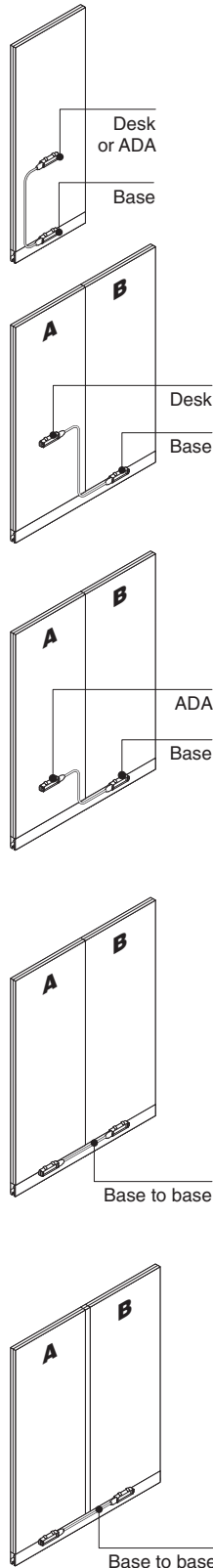

Desk or ADA to Base within Same Panel

Panel 24"W	30"W	36"W	40"W	42"W	48"W	60"W
N.A.	62"	62"	76"	74"	74"	86"

Desk to Base for Two Adjacent Panels

Panel B	Panel A 24"W	30"W	36"W	40"W	42"W	48"W	60"W
GS Frame Kit	N.A.	62"	62"	74"	74"	74"	86"
30"W	N.A.	62"	62"	74"	74"	74"	86"
36"W	N.A.	62"	62"	74"	74"	74"	86"
40"W	N.A.	62"	62"	74"	74"	74"	86"
42"W	N.A.	62"	62"	74"	74"	74"	86"
48"W	N.A.	62"	62"	74"	74"	86"	86"
60"W	N.A.	62"	62"	74"	74"	86"	86"

ADA to Base for Two Adjacent Panels

Panel B	Panel A 24"W	30"W	36"W	40"W	42"W	48"W	60"W
GS Frame Kit	N.A.	62"	62"	74"	74"	74"	86"
30"W	N.A.	62"	62"	74"	74"	74"	86"
36"W	N.A.	62"	62"	74"	74"	74"	86"
40"W	N.A.	62"	62"	74"	74"	74"	86"
42"W	N.A.	62"	62"	74"	74"	74"	86"
48"W	N.A.	62"	62"	74"	74"	86"	86"
60"W	N.A.	62"	62"	74"	74"	86"	86"

Base to Base for Two Adjacent Panels

Panel B	Panel A GS Frame Kit	30"W	36"W	40"W	42"W	48"W	60"W
GS Frame Kit	16"	21"	21"	25"	25"	29"	33"
30"W	21"	21"	25"	29"	29"	33"	37"
36"W	21"	25"	29"	29"	33"	33"	41"
40"W	25"	29"	29"	33"	33"	37"	41"
42"W	25"	29"	33"	33"	33"	37"	46"
48"W	29"	33"	33"	37"	37"	41"	46"
60"W	33"	37"	41"	41"	46"	46"	54"

Base to Base for Two Adjacent Panels Separated by a Post

Panel B	Panel A GS Frame Kit	30"W	36"W	40"W	42"W	48"W	60"W
GS Frame Kit	21"	21"	25"	29"	29"	33"	37"
30"W	21"	25"	29"	29"	33"	33"	41"
36"W	25"	29"	33"	33"	33"	37"	46"
40"W	29"	29"	33"	37"	37"	41"	46"
42"W	29"	33"	33"	37"	37"	41"	46"
48"W	33"	33"	37"	41"	41"	46"	50"
60"W	37"	41"	46"	46"	46"	50"	54"

Specifying Privacy Wall

Specifying

Solid Wall Panels with Hollow Core	116
All-Glass Wall Panels	122
Glass Wall Panels with Three Equal Divided Lites	126
Glass Wall Panels with Four Equal Divided Lites	130
Glass Wall Panels with Four Divided Lites	134
Glass Wall Panels with Two Divided Lites	138
Clerestory Wall Panels	142
Power Options	146
Butt-Hinged Door Frames	148
Pivot-Hinged Door Frames	150
Pivot-Hinged Door Frames with Switch Cutout	154
Full-Height Butt-Hinged Door Leaves	156
Transom-Height Butt-Hinged Door Leaves	158
Full-Height Pivot-Hinged Door Leaves	160
Transom-Height Pivot-Hinged Door Leaves	162
Full-Height Pivot-Hinged Door Leaves for Use with Switch Cutout	164
Transom-Height Pivot-Hinged Door Leaves for Use with Switch Cutout	166
Hardware and Accessories for Swing Doors	168
Privacy Wall Slider Doors with Tubular Pull	174
Back-to-Back Cover	184
Mini Ends, Wall Channels, Adapters and Posts	185
I-Line Interface Post	194
Glass Selections All-Glass Wall Panels	196
Glass Selections All-Glass Frame Kits	198
Glass Selections All-Glass Glass Kits	200
Glass Selections Wall Panels with Two Divided Lites	202
Glass Selections Two Divided Lite Frame Kits	206
Glass Selections Two Divided Lite Glass Kits	208
Glass Selections Clerestory Wall Panels	210
Glass Selections Pivot-Hinged Door Frames	214
Glass Selections Full-Height Pivot-Hinged Door Leaves	216

Specifying, continued

Glass Selections Transom-Height Pivot-Hinged Door Leaves	218
Glass Selections Full-Height Pivot-Hinged Door Leaves for Use with Switch Cutout	220
Glass Selections Transom-Height Pivot-Hinged Door Leaves for Use with Switch Cutout	222
Glass Selections Full-Height Polished Edge Slider Doors with Close-Assist	224
Glass Selections Transom-Height Polished Edge Slider Doors with Close-Assist	226
Glass Selections Polished Edge Slider Door Vertical Seal	228
Glass Selections Mini Ends	229
Glass Selections Adapters	230
Glass Selections Posts	231
Glass Selections Transitions	232
Ceiling Tracks	238
Cornice Track and Brackets	243
Trim and Accessories	244
Load Bar	253
Post and Beam Attachment Kit	254
Accessories	255
Wiring and Cabling	256
Glass Channels and Stops – Lite Scale Glazing	265
Vertical Transition and Stop – Lite Scale Glazing	266
Glass Lite Butt Glazed – Lite Scale Glazing	267
Feature Strip Cover – Lite Scale Glazing	268
Door Frames – Lite Scale Glazing	272
Door Leaves – Lite Scale Glazing	278
Glass Selections Door Frames – Lite Scale Glazing	290
Glass Selections Door Leaves – Lite Scale Glazing	292
Glass Selections Slider Track – Lite Scale Glazing	300
Glass Selections Slider Door Leaves – Lite Scale Glazing	301
Glass Selections Slider Frame – Lite Scale Glazing	302
Glass Selections Slider Hanger – Lite Scale Glazing	303

Solid Wall Panels with Hollow Core

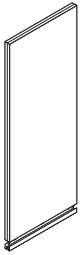

Tip: Order ceiling track, feature strip, and continuous base trim separately.

Tip: Paint price group 2 is only available on panels 36"W or smaller.

Tip: Panels that are wider than 48" may not be suitable for application in certain areas where local building codes have specific provisions for seismic activity.

Standard Includes		Required to Specify
<ul style="list-style-type: none"> ▶ Need help? Product details, page 18 	<ul style="list-style-type: none"> • Ceiling height from 8'0"H to 10'0"H, in one-inch increments • 2³/₈"-thick panel with steel surfaces: paint • Integral slotted verticals • Hollow core panel for cable and power routing • Floor track with adjustable levelers to accommodate continuous 5"H base trim (ordered separately) 	<ol style="list-style-type: none"> 1 Style number 2 Ceiling height 3 Paint color number for side 1 4 Paint color number for side 2 5 Post extension 6 Options, if selected (see below) <p>▶ See <i>Surface Materials</i>, page 408.</p>

Options	U.S. Price	Required to Specify
Surface Materials		
Panel surfaces 8'0"H through 10'0"H (per side) 6"W to 30"W		
• Paint price group 1	No cost	Specify paint color number for side 1 and/or side 2.
• Paint price group 2	+\$ 18	Specify paint color number for side 1 and/or side 2.
• Paint price group 3	+\$ 31	Specify paint color number for side 1 and/or side 2.
• Fabric price group 1	+\$174	Specify fabric color number for side 1 and/or side 2.
• Fabric price group 2	+\$236	Specify fabric color number for side 1 and/or side 2.
• Fabric price group 3	+\$299	Specify fabric color number for side 1 and/or side 2.
• Fabric price group 5	+\$369	Specify fabric color number for side 1 and/or side 2.
• Customer's Own Material/ Vinyl (COM)	+\$170	▶ See <i>Surface Materials Reference Manual</i> .
Panel surfaces 8'0"H through 10'0"H (per side) 36"W to 60"W		
• Paint price group 1	No cost	Specify paint color number for side 1 and/or side 2.
• Paint price group 2	+\$ 31	Specify paint color number for side 1 and/or side 2.
• Paint price group 3	+\$ 46	Specify paint color number for side 1 and/or side 2.
• Fabric price group 1	+\$234	Specify fabric color number for side 1 and/or side 2.
• Fabric price group 2	+\$344	Specify fabric color number for side 1 and/or side 2.
• Fabric price group 3	+\$504	Specify fabric color number for side 1 and/or side 2.
• Fabric price group 5	+\$643	Specify fabric color number for side 1 and/or side 2.
• Customer's Own Material/ Vinyl (COM)	+\$219	▶ See <i>Surface Materials Reference Manual</i> .
Post Extension		
• Post extensions modified to accommodate recessed ceiling track (ordered separately)	No cost	Specify with <i>post extensions for recessed ceiling track interface</i> .
• Post extensions modified to accommodate overlapping ceiling track (ordered separately)	No cost	Specify with <i>post extensions for overlapping ceiling track interface</i> .
Ceiling Height		
• 8'0" through 9'0"	No cost	Specify ceiling height in 1" increments.
• 9'1" through 10'0"	+\$ 96	Specify ceiling height in 1" increments.

▶ Options, continued on next page



For Canadian Pricing
 Multiply U.S. Price by the Canadian price factor.
 ▶ See page 1 for details.

► Options, continued from previous page

Options	U.S. Price	Required to Specify
Electrical Power (for panels 30"W through 60"W)	Power block locations	
	• Base +\$207	Specify with power block location at base.
	• ADA height +\$755	Specify with power block location at ADA height.
	• Desk height +\$755	Specify with power block location at desk height.
	New York City/Chicago Power Prep	
	• NYC/CHI side 1 +\$ 26	Specify with NYC/CHI side 1.
	• NYC/CHI side 2 +\$ 26	Specify with NYC/CHI side 2.
	• NYC/CHI sides 1 and 2 +\$ 52	Specify with NYC/CHI sides 1 and 2.
	Receptacle cutouts	
	• Power side 1 No cost	Specify with power side 1.
	• Power side 2 No cost	Specify with power side 2.
	• Power sides 1 and 2 +\$ 26	Specify with power sides 1 and 2.
	• Power/comm side 1 No cost	Specify with power/comm side 1.
	• Power/comm side 2 No cost	Specify with power/comm side 2.
	• Power/comm sides 1 and 2 +\$ 26	Specify with power/comm sides 1 and 2.
	Power schematic	
	• 3+1 No cost	Specify with 3+1 power.
	• 2+2 No cost	Specify with 2+2 power.
	• 3SN No cost	Specify with 3SN power.
	Ceiling infeeds	
	• Top left hardwire No cost	Specify with top left hardwire.
	• Top left modular +\$ 96	Specify with top left modular.
	Floor infeeds	
	• Bottom left hardwire No cost	Specify with bottom left hardwire.
	• Bottom left modular +\$ 96	Specify with bottom left modular.

Related Products	
• Ceiling tracks	► Page 238
• Continuous base trim	► Page 244
• Feature strips	► Page 248
• Power receptacles	► Page 256
• Power and communication cover plates	► Page 258
• Infeeds	► Page 259
• Modular harnesses	► Page 261
• Field-installed powerkits	► Page 239
• Cornice track	► Page 243

Tip: To price power in two locations, add the upcharges together.

Tip: Infeed is included in price of ADA- or desk-height receptacle power location option. Base power block location does not include infeed. It must be ordered separately, if needed.

Tip: NYC/CHI prices replace the receptacle power location option prices when selected.

Tip: Order power and communication and power-only cover plates separately.

Tip: Panels that are less than 24"W are not factory punched for infeeds.

Tip: SmartTools options are available and easily ordered when using SmartTools software. If you do not have access to SmartTools software, these options can also be ordered using the normal Specials RFQ (Request For Quote) process.

Tip: Markerboard surface cannot exceed 48"W or 120" in height.

Tip: Standard Privacy Wall ceiling heights are 8'0" through 10'0".

Tip: Panels for ceiling height of 10'1" to 11'0" are available in width up to 48"W only.

SmartTools Options	U.S. Price	Required to Specify
7610 White Markerboard Surface	• 6"W through 24"W +\$487	Specify with markerboard.
	• 25"W through 36"W +\$523	Specify with markerboard.
	• 37"W through 48"W +\$559	Specify with markerboard.
Parametric Ceiling Height (Available in 1" increments)	• 7'5" through 7'11" No cost	Specify ceiling height in 1" increments.
	• 10'1" through 11'0" +\$163	Specify ceiling height in 1" increments.
Parametric Panel Widths (Available in 1" increments)	• Non standard widths No cost	Specify panel widths in 1" increments.
	• Non standard modular widths No cost	Specify panel widths in 1" increments.
Base	• 4"H base +\$ 63	Specify to accept 4"H base.

► Specification Information, on next page

Solid Wall Panels with Hollow Core, continued

► Options, on previous page

Specification Information

Width	Style Number	U.S. Base Price	Nominal Width	Modular Width	Style Number	U.S. Base Price
Solid Wall Panels						
6"	GPSS06	\$ 918				
8"	GPSS08	\$ 918				
18"	GPSS18	\$ 986				
20"	GPSS20	\$ 986				
24"	GPSS24	\$1050				
30"	GPSS30	\$1101				
36"	GPSS36	\$1133				
40"	GPSS40	\$1177				
42"	GPSS42	\$1177				
48"	GPSS48	\$1215				
60"	GPSS60	\$1577				
:	:	:	:	:	:	:
Modular Solid Wall Panels						
			8"	6 ¹¹ / ₁₆ "	GPSM08	\$ 918
			18"	16 ¹¹ / ₁₆ "	GPSM18	\$ 986
			20"	18 ¹¹ / ₁₆ "	GPSM20	\$ 986
			24"	22 ¹¹ / ₁₆ "	GPSM24	\$1050
			30"	28 ¹¹ / ₁₆ "	GPSM30	\$1101
			36"	34 ¹¹ / ₁₆ "	GPSM36	\$1133
			40"	38 ¹¹ / ₁₆ "	GPSM40	\$1177
			42"	40 ¹¹ / ₁₆ "	GPSM42	\$1177
			48"	46 ¹¹ / ₁₆ "	GPSM48	\$1215
			60"	58 ¹¹ / ₁₆ "	GPSM60	\$1577
:	:	:	:	:	:	:

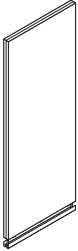

 **For Canadian Pricing**
 Multiply U.S. Price by the
 Canadian price factor.
 ► See page 1 for details.

Solid Wall Panels with Enhanced Core

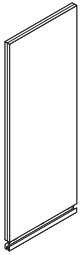

Tip: Order ceiling track, feature strip, and continuous base trim separately.

Tip: Paint price group 2 is only available on panels 36"W or smaller.

Tip: Enhanced core panels are intended for use with overlapping ceiling track in order to maximize their acoustical properties.

Tip: Multipurpose infeeds are ordered separately, and route through the floor, adjacent posts, mini ends, or door frames.



For Canadian Pricing
Multiply U.S. Price by the Canadian price factor.

▶ See page 1 for details.

Standard Includes	Required to Specify
<ul style="list-style-type: none"> ▶ Need help? Product details, page 18 • Ceiling height from 8'0"H to 10'0"H, in one-inch increments • 2³/₈"-thick panel with steel surfaces: paint • Integral slotted verticals • Insulated core for improved acoustical performance • Floor track with adjustable levelers to accommodate continuous 5"H base trim (ordered separately) • Post extension for overlapping ceiling track 	<ol style="list-style-type: none"> 1 Style number 2 Ceiling height 3 Paint color number for side 1 4 Paint color number for side 2 5 Options, if selected (see below) <p>▶ See <i>Surface Materials</i>, page 408.</p>

Options	U.S. Price	Required to Specify
Surface Materials		
Panel surfaces 8'0"H through 10'0"H (per side) 6"W to 30"W		
• Paint price group 1	No cost	Specify paint color number for side 1 and/or side 2.
• Paint price group 2	+\$ 18	Specify paint color number for side 1 and/or side 2.
• Paint price group 3	+\$ 31	Specify paint color number for side 1 and/or side 2.
• Fabric price group 1	+\$174	Specify fabric color number for side 1 and/or side 2.
• Fabric price group 2	+\$236	Specify fabric color number for side 1 and/or side 2.
• Fabric price group 3	+\$299	Specify fabric color number for side 1 and/or side 2.
• Fabric price group 5	+\$369	Specify fabric color number for side 1 and/or side 2.
• Customer's Own Material/ Vinyl (COM)	+\$170	▶ See <i>Surface Materials Reference Manual</i> .
Panel surfaces 8'0"H through 10'0"H (per side) 36"W to 48"W		
• Paint price group 1	No cost	Specify paint color number for side 1 and/or side 2.
• Paint price group 2	+\$ 31	Specify paint color number for side 1 and/or side 2.
• Paint price group 3	+\$ 46	Specify paint color number for side 1 and/or side 2.
• Fabric price group 1	+\$234	Specify fabric color number for side 1 and/or side 2.
• Fabric price group 2	+\$344	Specify fabric color number for side 1 and/or side 2.
• Fabric price group 3	+\$504	Specify fabric color number for side 1 and/or side 2.
• Fabric price group 5	+\$643	Specify fabric color number for side 1 and/or side 2.
• Customer's Own Material/ Vinyl (COM)	+\$219	▶ See <i>Surface Materials Reference Manual</i> .
Ceiling Height		
• 8'0" through 9'0"	No cost	Specify ceiling height in 1" increments.
• 9'1" through 10'0"	+\$ 96	Specify ceiling height in 1" increments.
Electrical Power (for panels 30"W through 60"W)		
Power block locations		
• Base	+\$207	Specify with power block location at base.
Power schematic		
• 3+1	No cost	Specify with 3+1 power.
• 2+2	No cost	Specify with 2+2 power.
• 3SN	No cost	Specify with 3SN power.
Related Products		
• Ceiling tracks		▶ Page 238
• Continuous base trim		▶ Page 244
• Feature strips		▶ Page 248
• Power receptacles		▶ Page 256
• Infeeds		▶ Page 259
• Modular harnesses		▶ Page 261
• Field-installed powerkits		▶ Page 239
• Cornice track		▶ Page 243

▶ Options, continued on next page

► Options, continued from previous page

Tip: SmartTools options are available and easily ordered when using SmartTools software. If you do not have access to SmartTools software, these options can also be ordered using the normal Specials RFQ (Request For Quote) process.

Tip: Markerboard surface cannot exceed 48"W or 120" in height.

Tip: Standard Privacy Wall ceiling heights are 8'0" through 10'0".

Tip: Panels for ceiling height of 10'1" to 11'0" are available in width up to 48"W only.

SmartTools Options	U.S. Price	Required to Specify
7610 White Markerboard Surface	<ul style="list-style-type: none"> • 6"W through 24"W +\$487 • 25"W through 36"W +\$523 • 37"W through 48"W +\$559 	Specify with markerboard. Specify with markerboard. Specify with markerboard.
Parametric Ceiling Height (Available in 1" increments)	<ul style="list-style-type: none"> • 7'5" through 7'11" No cost • 10'1" through 11'0" +\$163 	Specify ceiling height in 1" increments. Specify ceiling height in 1" increments.
Parametric Panel Widths (Available in 1" increments)	<ul style="list-style-type: none"> • Non standard widths No cost • Non standard modular widths No cost 	Specify panel widths in 1" increments. Specify panel widths in 1" increments.
Base	• 4"H base +\$ 63	Specify to accept 4"H base.

Specification Information

Width	Style Number	U.S. Base Price	Nominal Width	Modular Width	Style Number	U.S. Base Price
-------	--------------	-----------------	---------------	---------------	--------------	-----------------

Solid Wall Panels with Enhanced Core

6"	GPSAS06	\$ 951
8"	GPSAS08	\$ 951
18"	GPSAS18	\$1020
20"	GPSAS20	\$1085
24"	GPSAS24	\$1085
30"	GPSAS30	\$1138
36"	GPSAS36	\$1174
40"	GPSAS40	\$1218
42"	GPSAS42	\$1218
48"	GPSAS48	\$1258

Modular Solid Wall Panels with Enhanced Core

8"	6 ¹¹ / ₁₆ "	GPSAM08	\$ 951
18"	16 ¹¹ / ₁₆ "	GPSAM18	\$1020
20"	18 ¹¹ / ₁₆ "	GPSAM20	\$1085
24"	22 ¹¹ / ₁₆ "	GPSAM24	\$1085
30"	28 ¹¹ / ₁₆ "	GPSAM30	\$1138
36"	34 ¹¹ / ₁₆ "	GPSAM36	\$1174
40"	38 ¹¹ / ₁₆ "	GPSAM40	\$1218
42"	40 ¹¹ / ₁₆ "	GPSAM42	\$1218
48"	46 ¹¹ / ₁₆ "	GPSAM48	\$1258

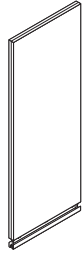

For Canadian Pricing
Multiply U.S. Price by the Canadian price factor.
► See page 1 for details.

All-Glass Wall Panels

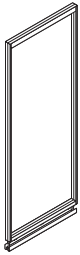

Tip: Order ceiling track, feature strip, and continuous base trim separately.

Standard Includes		Required to Specify
<ul style="list-style-type: none"> ▶ Need help? Product details, page 24 	<ul style="list-style-type: none"> Ceiling height from 8'0"H to 10'0"H, in one-inch increments 2³/₈"-thick panel with steel frame: paint 1/4"-thick factory-installed lite: glass Floor track with adjustable levelers to accommodate continuous 5"H base trim (ordered separately) 	<ol style="list-style-type: none"> Style number Ceiling height Paint color number for frame Glass number for lite Post extension Options, if selected (see below) <p>▶ See <i>Surface Materials</i>, page 408.</p>

Surface Materials	Options	U.S. Price	Required to Specify
	Glass frame surface		
	• Paint price group 1	No cost	Specify paint color number.
	• Paint price group 2	+\$ 29	Specify paint color number.
	• Paint price group 3	+\$ 48	Specify paint color number.
	Panel surfaces 8'0"H through 10'0"H (per lite), 6"W to 8"W		
	• Glass price group 1	No cost	Specify glass number for lite.
	• Glass price group 2	+\$ 103	Specify glass number for lite.
	• Glass price group 3	+\$ 126	Specify glass number for lite.
	• Glass price group 4	+\$ 201	Specify glass number for lite.
	• Glass price group 5	N.A.	Specify glass number for lite.
• Glass price group 6	+\$ 392	Specify glass number for lite.	
			▶ See <i>Surface Materials Reference Manual</i> .
Panel surfaces 8'0"H through 10'0"H (per lite), 18"W to 24"W			
• Glass price group 1	No cost	Specify glass number for lite.	
• Glass price group 2	+\$ 312	Specify glass number for lite.	
• Glass price group 3	+\$ 373	Specify glass number for lite.	
• Glass price group 4	+\$ 597	Specify glass number for lite.	
• Glass price group 5	N.A.	Specify glass number for lite.	
• Glass price group 6	+\$1175	Specify glass number for lite.	
			▶ See <i>Surface Materials Reference Manual</i> .
Panel surfaces 8'0"H through 10'0"H (per lite), 30"W to 36"W			
• Glass price group 1	No cost	Specify glass number for lite.	
• Glass price group 2	+\$ 468	Specify glass number for lite.	
• Glass price group 3	+\$ 557	Specify glass number for lite.	
• Glass price group 4	+\$ 893	Specify glass number for lite.	
• Glass price group 5	N.A.	Specify glass number for lite.	
• Glass price group 6	+\$1761	Specify glass number for lite.	
			▶ See <i>Surface Materials Reference Manual</i> .
Panel surfaces 8'0"H through 10'0"H (per lite), 40"W to 48"W			
• Glass price group 1	No cost	Specify glass number for lite.	
• Glass price group 2	+\$ 624	Specify glass number for lite.	
• Glass price group 3	+\$ 742	Specify glass number for lite.	
• Glass price group 4	+\$1193	Specify glass number for lite.	
• Glass price group 5	N.A.	Specify glass number for lite.	
• Glass price group 6	+\$2349	Specify glass number for lite.	
			▶ See <i>Surface Materials Reference Manual</i> .
Panel surfaces 8'0"H through 10'0"H (per lite), 60"W			
• Glass price group 1	No cost	Specify glass number for lite.	
• Glass price group 2	+\$ 780	Specify glass number for lite.	
• Glass price group 3	+\$ 927	Specify glass number for lite.	
• Glass price group 4	+\$1487	Specify glass number for lite.	
• Glass price group 5	N.A.	Specify glass number for lite.	
• Glass price group 6	+\$2937	Specify glass number for lite.	
			▶ See <i>Surface Materials Reference Manual</i> .

Post Extension	• Post extensions modified to accommodate recessed ceiling track (ordered separately)	No cost	Specify with post extensions for recessed ceiling track interface.
	• Post extensions modified to accommodate overlapping ceiling track (ordered separately)	No cost	Specify with post extensions for overlapping ceiling track interface.

▶ Options, continued on next page

 **For Canadian Pricing**
Multiply U.S. Price by the Canadian price factor.
▶ See page 1 for details.

► Options, continued from previous page

Options	U.S. Price	Required to Specify	
Ceiling Height	<ul style="list-style-type: none"> • 8'0" through 9'0" • 9'1" through 10'0" 	<ul style="list-style-type: none"> No cost +\$ 96 	<ul style="list-style-type: none"> Specify ceiling height in 1" increments. Specify ceiling height in 1" increments.
Electrical Power (For panels 30"W through 60"W)	<ul style="list-style-type: none"> • 3+1 • 2+2 • 3SN 	<ul style="list-style-type: none"> Base power block power schematic +\$ 207 +\$ 207 +\$ 207 	<ul style="list-style-type: none"> Specify with 3+1 power. Specify with 2+2 power. Specify with 3SN power.
Related Products	<ul style="list-style-type: none"> • Ceiling tracks • Continuous base trim • Feature strips • Power receptacles • Power and communication cover plates • Infeeds • Modular harnesses • Field-installed powerkits • Cornice track 		<ul style="list-style-type: none"> ► Page 238 ► Page 244 ► Page 248 ► Page 256 ► Page 258 ► Page 259 ► Page 261 ► Page 239 ► Page 243

Tip: Base power block location does not include infeed. It must be ordered separately, if needed.

SmartTools Options	U.S. Price	Required to Specify	
Parametric Ceiling Height (Available in 1" increments)	<ul style="list-style-type: none"> • 7'5" through 7'11" • 10'1" through 11'0" 	<ul style="list-style-type: none"> Use 8'0" price +\$ 163 	<ul style="list-style-type: none"> Specify ceiling height in 1" increments. Specify ceiling height in 1" increments.
Parametric Panel Widths (Available in 1" increments)	<ul style="list-style-type: none"> • Non standard widths • Non standard modular widths 	<ul style="list-style-type: none"> No cost No cost 	<ul style="list-style-type: none"> Specify panel widths in 1" increments. Specify panel widths in 1" increments.
Base	<ul style="list-style-type: none"> • 4"H base 	<ul style="list-style-type: none"> +\$ 228 	<ul style="list-style-type: none"> Specify to accept 4"H base.

Tip: SmartTools options are available and easily ordered when using SmartTools software. If you do not have access to SmartTools software, these options can also be ordered using the normal Specials RFQ (Request For Quote) process.

Tip: Standard Privacy Wall ceiling heights are 8'0" through 10'0".

Tip: Panels for ceiling height of 10'1" to 11'0" are available in width up to 48"W only.

► Specification Information, on next page

 **For Canadian Pricing**
Multiply U.S. Price by the Canadian price factor.
► See page 1 for details.

All-Glass Wall Panels, continued

► Options, on previous page

Specification Information

Width	Style Number	U.S. Base Price	Nominal Width	Modular Width	Style Number	U.S. Base Price
All-Glass Wall Panels						
6"	GPGS06	\$ 626				
8"	GPGS08	\$ 626				
18"	GPGS18	\$ 694				
20"	GPGS20	\$ 694				
24"	GPGS24	\$ 760				
30"	GPGS30	\$ 774				
36"	GPGS36	\$ 873				
40"	GPGS40	\$ 885				
42"	GPGS42	\$ 885				
48"	GPGS48	\$ 988				
60"	GPGS60	\$1269				
Modular All-Glass Wall Panels						
			8"	6 ¹¹ / ₁₆ "	GPGM08	\$ 626
			18"	16 ¹¹ / ₁₆ "	GPGM18	\$ 694
			20"	18 ¹¹ / ₁₆ "	GPGM20	\$ 694
			24"	22 ¹¹ / ₁₆ "	GPGM24	\$ 760
			30"	28 ¹¹ / ₁₆ "	GPGM30	\$ 774
			36"	34 ¹¹ / ₁₆ "	GPGM36	\$ 873
			40"	38 ¹¹ / ₁₆ "	GPGM40	\$ 885
			42"	40 ¹¹ / ₁₆ "	GPGM42	\$ 885
			48"	46 ¹¹ / ₁₆ "	GPGM48	\$ 988
			60"	58 ¹¹ / ₁₆ "	GPGM60	\$1269



 **For Canadian Pricing**
 Multiply U.S. Price by the Canadian price factor.
 ► See page 1 for details.



Glass Wall Panels with Three Equal Divided Lites

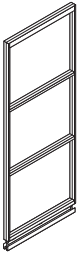

Tip: Order ceiling track, feature strip, and continuous base trim separately.

Standard Includes		Required to Specify
<ul style="list-style-type: none"> ▶ Need help? Product details, page 24 	<ul style="list-style-type: none"> Ceiling height from 8'0"H to 10'0"H, in one-inch increments 2³/₈"-thick panel with steel frame: paint Three, 1/4"-thick factory-installed lites: glass Floor track with adjustable levelers to accommodate continuous 5"H base trim (ordered separately) 	<ol style="list-style-type: none"> Style number Ceiling height Paint color number for frame and muntin Glass number for lite 1 (from top) Glass number for lite 2 Glass number for lite 3 Post extension Options, if selected (see below) <p>▶ See <i>Surface Materials</i>, page 408.</p>

Options	U.S. Price	Required to Specify
Surface Materials	Glass frame surface	
<ul style="list-style-type: none"> Paint price group 1 Paint price group 2 Paint price group 3 	<ul style="list-style-type: none"> No cost +\$ 29 +\$ 48 	<ul style="list-style-type: none"> Specify paint color number. Specify paint color number. Specify paint color number.
Panel surfaces 8'0"H through 10'0"H (per lite), 6"W to 8"W		
<ul style="list-style-type: none"> Glass price group 1 Glass price group 2 Glass price group 3 Glass price group 4 Glass price group 5 Glass price group 6 	<ul style="list-style-type: none"> No cost +\$ 35 +\$ 44 +\$ 67 N.A. +\$133 	<ul style="list-style-type: none"> Specify glass number for lite. Specify glass number for lite. Specify glass number for lite. Specify glass number for lite. Specify glass number for lite. Specify glass number for lite. <p>▶ See <i>Surface Materials Reference Manual</i>.</p>
Panel surfaces 8'0"H through 10'0"H (per lite), 18"W to 24"W		
<ul style="list-style-type: none"> Glass price group 1 Glass price group 2 Glass price group 3 Glass price group 4 Glass price group 5 Glass price group 6 	<ul style="list-style-type: none"> No cost +\$103 +\$126 +\$201 N.A. +\$392 	<ul style="list-style-type: none"> Specify glass number for lite. Specify glass number for lite. Specify glass number for lite. Specify glass number for lite. Specify glass number for lite. Specify glass number for lite. <p>▶ See <i>Surface Materials Reference Manual</i>.</p>
Panel surfaces 8'0"H through 10'0"H (per lite), 30"W to 36"W		
<ul style="list-style-type: none"> Glass price group 1 Glass price group 2 Glass price group 3 Glass price group 4 Glass price group 5 Glass price group 6 	<ul style="list-style-type: none"> No cost +\$157 +\$184 +\$298 N.A. +\$588 	<ul style="list-style-type: none"> Specify glass number for lite. Specify glass number for lite. Specify glass number for lite. Specify glass number for lite. Specify glass number for lite. Specify glass number for lite. <p>▶ See <i>Surface Materials Reference Manual</i>.</p>
Panel surfaces 8'0"H through 10'0"H (per lite), 40"W to 48"W		
<ul style="list-style-type: none"> Glass price group 1 Glass price group 2 Glass price group 3 Glass price group 4 Glass price group 5 Glass price group 6 	<ul style="list-style-type: none"> No cost +\$209 +\$249 +\$397 N.A. +\$783 	<ul style="list-style-type: none"> Specify glass number for lite. Specify glass number for lite. Specify glass number for lite. Specify glass number for lite. Specify glass number for lite. Specify glass number for lite. <p>▶ See <i>Surface Materials Reference Manual</i>.</p>
Panel surfaces 8'0"H through 10'0"H (per lite), 60"W		
<ul style="list-style-type: none"> Glass price group 1 Glass price group 2 Glass price group 3 Glass price group 4 Glass price group 5 Glass price group 6 	<ul style="list-style-type: none"> No cost +\$260 +\$310 +\$495 N.A. +\$979 	<ul style="list-style-type: none"> Specify glass number for lite. Specify glass number for lite. Specify glass number for lite. Specify glass number for lite. Specify glass number for lite. Specify glass number for lite. <p>▶ See <i>Surface Materials Reference Manual</i>.</p>
Post Extension	<ul style="list-style-type: none"> Post extensions modified to accommodate recessed ceiling track (ordered separately) Post extensions modified to accommodate overlapping ceiling track (ordered separately) 	<ul style="list-style-type: none"> No cost No cost <p>Specify with <i>post extensions for recessed ceiling track interface</i>.</p> <p>Specify with <i>post extensions for overlapping ceiling track interface</i>.</p>

▶ Options, continued on next page

 **For Canadian Pricing**
 Multiply U.S. Price by the Canadian price factor.
 ▶ See page 1 for details.

► Options, continued from previous page

	Options	U.S. Price	Required to Specify
Ceiling Height	<ul style="list-style-type: none"> 8'0" through 9'0" 9'1" through 10'0" 	No cost +\$ 96	Specify ceiling height in 1" increments. Specify ceiling height in 1" increments.
Electrical Power (For panels 30"W through 60"W)	Base power block power schematic <ul style="list-style-type: none"> 3+1 2+2 3SN 	+\$ 207 +\$ 207 +\$ 207	Specify with 3+1 power. Specify with 2+2 power. Specify with 3SN power.
Related Products	<ul style="list-style-type: none"> Ceiling tracks Continuous base trim Feature strips Acoustic packing Power receptacles Power and communication cover plates Infeeds Modular harnesses Field-installed powerkits Cornice track 		<ul style="list-style-type: none"> ► Page 238 ► Page 244 ► Page 248 ► Page 252 ► Page 256 ► Page 258 ► Page 259 ► Page 261 ► Page 239 ► Page 243

Tip: Base power block location does not include infeed. It must be ordered separately, if needed.

Tip: SmartTools options are available and easily ordered when using SmartTools software. If you do not have access to SmartTools software, these options can also be ordered using the normal Specials RFQ (Request For Quote) process.

Tip: Standard Privacy Wall ceiling heights are 8'0" through 10'0".

Tip: Panels for ceiling height of 10'1" to 11'0" are available in width up to 48"W only.

	SmartTools Options	U.S. Price	Required to Specify
Muntin	Change muntin size <ul style="list-style-type: none"> Change to 1½"H or 2¼"H 	No cost	Specify muntin size.
	Change muntin location <ul style="list-style-type: none"> Change muntin location 	No cost	Specify muntin location.
Parametric Ceiling Height (Available in 1" increments)	<ul style="list-style-type: none"> 7'5" through 7'11" 10'1" through 11'0" 	Use 8'0" price +\$ 163	Specify ceiling height in 1" increments. Specify ceiling height in 1" increments.
Parametric Panel Widths (Available in 1" increments)	<ul style="list-style-type: none"> Non standard widths Non standard modular widths 	No cost No cost	Specify panel widths in 1" increments. Specify panel widths in 1" increments.
Base	<ul style="list-style-type: none"> 4"H base 	+\$ 228	Specify to accept 4"H base.

► Specification Information, on next page



For Canadian Pricing
Multiply U.S. Price by the Canadian price factor.
► See page 1 for details.

Glass Wall Panels with Three Equal Divided Lites, continued

► Options, on previous page

Specification Information

Width	Style Number	U.S. Base Price	Nominal Width	Modular Width	Style Number	U.S. Base Price
-------	--------------	-----------------	---------------	---------------	--------------	-----------------

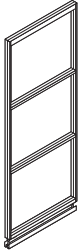

Glass Wall Panels

6"	GPGS3E06	\$ 954
8"	GPGS3E08	\$ 954
18"	GPGS3E18	\$1004
20"	GPGS3E20	\$1004
24"	GPGS3E24	\$1051
30"	GPGS3E30	\$1060
36"	GPGS3E36	\$1128
40"	GPGS3E40	\$1138
42"	GPGS3E42	\$1138
48"	GPGS3E48	\$1208
60"	GPGS3E60	\$1481

Modular Glass Wall Panels

8"	6 ¹¹ / ₁₆ "	GPGM3E08	\$ 954
18"	16 ¹¹ / ₁₆ "	GPGM3E18	\$1004
20"	18 ¹¹ / ₁₆ "	GPGM3E20	\$1004
24"	22 ¹¹ / ₁₆ "	GPGM3E24	\$1051
30"	28 ¹¹ / ₁₆ "	GPGM3E30	\$1060
36"	34 ¹¹ / ₁₆ "	GPGM3E36	\$1128
40"	38 ¹¹ / ₁₆ "	GPGM3E40	\$1138
42"	40 ¹¹ / ₁₆ "	GPGM3E42	\$1138
48"	46 ¹¹ / ₁₆ "	GPGM3E48	\$1208
60"	58 ¹¹ / ₁₆ "	GPGM3E60	\$1481



For Canadian Pricing

Multiply U.S. Price by the Canadian price factor.

► See page 1 for details.

Glass Wall Panels with Four Equal Divided Lites

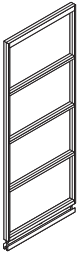

Tip: Order ceiling track, feature strip, and continuous base trim separately.

Standard Includes	Required to Specify
-------------------	---------------------

- | | |
|---|---|
| <ul style="list-style-type: none"> ▶ Need help? Product details, page 24 • Ceiling height from 8'0"H to 10'0"H, in one-inch increments • 2³/₈"-thick panel with steel frame: paint • Four, 1/4"-thick factory-installed lites: glass • Floor track with adjustable levelers to accommodate continuous 5"H base trim (ordered separately) | <ol style="list-style-type: none"> 1 Style number 2 Ceiling height 3 Paint color number for frame and muntin 4 Glass number for lite 1 (from top) 5 Glass number for lite 2 6 Glass number for lite 3 7 Glass number for lite 4 8 Post extension 9 Options, if selected (see below) <p>▶ See <i>Surface Materials</i>, page 408.</p> |
|---|---|

Surface Materials	Options	U.S. Price	Required to Specify
-------------------	---------	------------	---------------------

- | | | | |
|--------------------------|----------------------------|---------|-----------------------------|
| Surface Materials | Glass frame surface | | |
| | • Paint price group 1 | No cost | Specify paint color number. |
| | • Paint price group 2 | +\$ 29 | Specify paint color number. |
| | • Paint price group 3 | +\$ 48 | Specify paint color number. |

Panel surfaces 8'0"H through 10'0"H (per lite), 6"W to 8"W

- | | | |
|-----------------------|---------|--------------------------------|
| • Glass price group 1 | No cost | Specify glass number for lite. |
| • Glass price group 2 | +\$ 26 | Specify glass number for lite. |
| • Glass price group 3 | +\$ 33 | Specify glass number for lite. |
| • Glass price group 4 | +\$ 50 | Specify glass number for lite. |
| • Glass price group 5 | N.A. | Specify glass number for lite. |
| • Glass price group 6 | +\$ 98 | Specify glass number for lite. |
- ▶ See *Surface Materials Reference Manual*.

Panel surfaces 8'0"H through 10'0"H (per lite), 18"W to 24"W

- | | | |
|-----------------------|---------|--------------------------------|
| • Glass price group 1 | No cost | Specify glass number for lite. |
| • Glass price group 2 | +\$ 78 | Specify glass number for lite. |
| • Glass price group 3 | +\$ 94 | Specify glass number for lite. |
| • Glass price group 4 | +\$149 | Specify glass number for lite. |
| • Glass price group 5 | N.A. | Specify glass number for lite. |
| • Glass price group 6 | +\$296 | Specify glass number for lite. |
- ▶ See *Surface Materials Reference Manual*.

Panel surfaces 8'0"H through 10'0"H (per lite), 30"W to 36"W

- | | | |
|-----------------------|---------|--------------------------------|
| • Glass price group 1 | No cost | Specify glass number for lite. |
| • Glass price group 2 | +\$119 | Specify glass number for lite. |
| • Glass price group 3 | +\$140 | Specify glass number for lite. |
| • Glass price group 4 | +\$225 | Specify glass number for lite. |
| • Glass price group 5 | N.A. | Specify glass number for lite. |
| • Glass price group 6 | +\$442 | Specify glass number for lite. |
- ▶ See *Surface Materials Reference Manual*.

Panel surfaces 8'0"H through 10'0"H (per lite), 40"W to 48"W

- | | | |
|-----------------------|---------|--------------------------------|
| • Glass price group 1 | No cost | Specify glass number for lite. |
| • Glass price group 2 | +\$157 | Specify glass number for lite. |
| • Glass price group 3 | +\$184 | Specify glass number for lite. |
| • Glass price group 4 | +\$298 | Specify glass number for lite. |
| • Glass price group 5 | N.A. | Specify glass number for lite. |
| • Glass price group 6 | +\$588 | Specify glass number for lite. |
- ▶ See *Surface Materials Reference Manual*.

Panel surfaces 8'0"H through 10'0"H (per lite), 60"W

- | | | |
|-----------------------|---------|--------------------------------|
| • Glass price group 1 | No cost | Specify glass number for lite. |
| • Glass price group 2 | +\$197 | Specify glass number for lite. |
| • Glass price group 3 | +\$231 | Specify glass number for lite. |
| • Glass price group 4 | +\$375 | Specify glass number for lite. |
| • Glass price group 5 | N.A. | Specify glass number for lite. |
| • Glass price group 6 | +\$734 | Specify glass number for lite. |
- ▶ See *Surface Materials Reference Manual*.

▶ Options, continued on next page



For Canadian Pricing
 Multiply U.S. Price by the Canadian price factor.
 ▶ See page 1 for details.

► Options, continued from previous page

Options	U.S. Price	Required to Specify
Post Extension <ul style="list-style-type: none"> Post extensions modified to accommodate recessed ceiling track (ordered separately) Post extensions modified to accommodate overlapping ceiling track (ordered separately) 	No cost No cost	Specify with post extensions for recessed ceiling track interface. Specify with post extensions for overlapping ceiling track interface.
Ceiling Height <ul style="list-style-type: none"> 8'0" through 9'0" 9'1" through 10'0" 	No cost +\$ 96	Specify ceiling height in 1" increments. Specify ceiling height in 1" increments.
Electrical Power (For panels 30"W through 60"W)	Base power block power schematic <ul style="list-style-type: none"> 3+1 +\$ 207 2+2 +\$ 207 3SN +\$ 207 	Specify with 3+1 power. Specify with 2+2 power. Specify with 3SN power.
Related Products <ul style="list-style-type: none"> Ceiling tracks Continuous base trim Feature strips Power receptacles Power and communication cover plates Infeeds Modular harnesses Field-installed powerkits Cornice track 		► Page 238 ► Page 244 ► Page 248 ► Page 256 ► Page 258 ► Page 259 ► Page 261 ► Page 239 ► Page 243

Tip: Base power block location does not include infeed. It must be ordered separately, if needed.

SmartTools Options	U.S. Price	Required to Specify
Surface Materials <ul style="list-style-type: none"> Glass for 5th and 6th lite opening See standard options for glass price group above 		Specify glass number for lite 5 or 6.
Muntin <ul style="list-style-type: none"> Additional muntin Muntin Change muntin size Change to 1½"H or 2¼"H Change muntin location Change muntin location 	+\$ 177 No cost No cost	Specify with muntin. Specify muntin size. Specify muntin location.
Parametric Ceiling Height (Available in 1" increments)	<ul style="list-style-type: none"> 7'5" through 7'11" Use 8'0" price 10'1" through 11'0" +\$ 163 	Specify ceiling height in 1" increments. Specify ceiling height in 1" increments.
Parametric Panel Widths (Available in 1" increments)	<ul style="list-style-type: none"> Non standard widths No cost Non standard modular widths No cost 	Specify panel widths in 1" increments. Specify panel widths in 1" increments.
Base <ul style="list-style-type: none"> 4"H base 	+\$ 228	Specify to accept 4"H base.

► Specification Information, on next page

Tip: Standard Privacy Wall ceiling heights are 8'0" through 10'0".

Tip: Panels for ceiling height of 10'1" to 11'0" are available in width up to 48"W only.

 **For Canadian Pricing**
 Multiply U.S. Price by the Canadian price factor.
 ► See page 1 for details.

Glass Wall Panels with Four Equal Divided Lites, continued

► Options, on previous page

Specification Information

Width	Style Number	U.S. Base Price	Nominal Width	Modular Width	Style Number	U.S. Base Price
-------	--------------	-----------------	---------------	---------------	--------------	-----------------

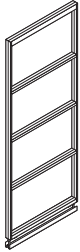

Glass Wall Panels

6"	GPGS4E06	\$1023
8"	GPGS4E08	\$1023
18"	GPGS4E18	\$1075
20"	GPGS4E20	\$1075
24"	GPGS4E24	\$1127
30"	GPGS4E30	\$1137
36"	GPGS4E36	\$1211
40"	GPGS4E40	\$1222
42"	GPGS4E42	\$1222
48"	GPGS4E48	\$1297
60"	GPGS4E60	\$1590
:	:	:

Modular Glass Wall Panels

8"	6 ¹¹ / ₁₆ "	GPGM4E08	\$1023
18"	16 ¹¹ / ₁₆ "	GPGM4E18	\$1075
20"	18 ¹¹ / ₁₆ "	GPGM4E20	\$1075
24"	22 ¹¹ / ₁₆ "	GPGM4E24	\$1127
30"	28 ¹¹ / ₁₆ "	GPGM4E30	\$1137
36"	34 ¹¹ / ₁₆ "	GPGM4E36	\$1211
40"	38 ¹¹ / ₁₆ "	GPGM4E40	\$1222
42"	40 ¹¹ / ₁₆ "	GPGM4E42	\$1222
48"	46 ¹¹ / ₁₆ "	GPGM4E48	\$1297
60"	58 ¹¹ / ₁₆ "	GPGM4E60	\$1590
:	:	:	:



For Canadian Pricing

Multiply U.S. Price by the Canadian price factor.

► See page 1 for details.

Glass Wall Panels with Four Divided Lites

Transom-Aligned Top Lite

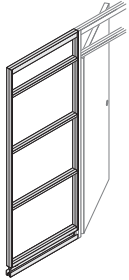

Tip: Order ceiling track, feature strip, and continuous base trim separately.

Standard Includes	Required to Specify
<ul style="list-style-type: none"> ▶ Need help? Product details, page 24 • Ceiling height from 8'0"H to 10'0"H, in one-inch increments • 2³/₈"-thick panel with steel frame: paint • Four, 1/4"-thick factory-installed lites—top lite is transom aligned, bottom three are of equal height: glass • Floor track with adjustable levelers to accommodate continuous 5"H base trim (ordered separately) 	<ol style="list-style-type: none"> 1 Style number 2 Ceiling height 3 Paint color number for frame and muntin 4 Glass number for lite 1 (from top) 5 Glass number for lite 2 6 Glass number for lite 3 7 Glass number for lite 4 8 Post extension 9 Options, if selected (see below) <p>▶ See <i>Surface Materials</i>, page 408.</p>

Options	U.S. Price	Required to Specify
Surface Materials <ul style="list-style-type: none"> • Glass frame surface • Paint price group 1 • Paint price group 2 • Paint price group 3 	<ul style="list-style-type: none"> No cost +\$ 29 +\$ 48 	<ul style="list-style-type: none"> Specify paint color number. Specify paint color number. Specify paint color number.
Top lite glass panel surfaces 8'0"H through 10'0"H (per lite), 6"W to 8"W		
<ul style="list-style-type: none"> • Glass price group 1 • Glass price group 2 • Glass price group 3 • Glass price group 4 • Glass price group 5 • Glass price group 6 	<ul style="list-style-type: none"> No cost +\$ 18 +\$ 24 +\$ 35 N.A. +\$ 71 	<ul style="list-style-type: none"> Specify glass number for lite. Specify glass number for lite. Specify glass number for lite. Specify glass number for lite. Specify glass number for lite. Specify glass number for lite. <p>▶ See <i>Surface Materials Reference Manual</i>.</p>
Lower three lites glass panels surfaces 8'0"H through 10'0"H (per lite), 6"W to 8"W		
<ul style="list-style-type: none"> • Glass price group 1 • Glass price group 2 • Glass price group 3 • Glass price group 4 • Glass price group 5 • Glass price group 6 	<ul style="list-style-type: none"> No cost +\$ 29 +\$ 35 +\$ 55 N.A. +\$106 	<ul style="list-style-type: none"> Specify glass number for lite. Specify glass number for lite. Specify glass number for lite. Specify glass number for lite. Specify glass number for lite. Specify glass number for lite. <p>▶ See <i>Surface Materials Reference Manual</i>.</p>
Top lite glass panel surfaces 8'0"H through 10'0"H (per lite), 18"W to 24"W		
<ul style="list-style-type: none"> • Glass price group 1 • Glass price group 2 • Glass price group 3 • Glass price group 4 • Glass price group 5 • Glass price group 6 	<ul style="list-style-type: none"> No cost +\$ 57 +\$ 67 +\$106 N.A. +\$209 	<ul style="list-style-type: none"> Specify glass number for lite. Specify glass number for lite. Specify glass number for lite. Specify glass number for lite. Specify glass number for lite. Specify glass number for lite. <p>▶ See <i>Surface Materials Reference Manual</i>.</p>
Lower three lites glass panels surfaces 8'0"H through 10'0"H (per lite), 18"W to 24"W		
<ul style="list-style-type: none"> • Glass price group 1 • Glass price group 2 • Glass price group 3 • Glass price group 4 • Glass price group 5 • Glass price group 6 	<ul style="list-style-type: none"> No cost +\$ 85 +\$101 +\$162 N.A. +\$317 	<ul style="list-style-type: none"> Specify glass number for lite. Specify glass number for lite. Specify glass number for lite. Specify glass number for lite. Specify glass number for lite. Specify glass number for lite. <p>▶ See <i>Surface Materials Reference Manual</i>.</p>

▶ Options, continued on next page



For Canadian Pricing

Multiply U.S. Price by the Canadian price factor.

▶ See page 1 for details.

► Options, continued from previous page

Options	U.S. Price	Required to Specify	
Surface Materials	Top lite glass panel surfaces 8'0"H through 10'0"H (per lite), 30"W to 36"W		
	• Glass price group 1	No cost	Specify glass number for lite.
	• Glass price group 2	+\$ 83	Specify glass number for lite.
	• Glass price group 3	+\$ 98	Specify glass number for lite.
	• Glass price group 4	+\$160	Specify glass number for lite.
	• Glass price group 5	N.A.	Specify glass number for lite.
	• Glass price group 6	+\$312	Specify glass number for lite.
	► See <i>Surface Materials Reference Manual</i> .		
	Lower three lites glass panels surfaces 8'0"H through 10'0"H (per lite), 30"W to 36"W		
	• Glass price group 1	No cost	Specify glass number for lite.
	• Glass price group 2	+\$128	Specify glass number for lite.
	• Glass price group 3	+\$152	Specify glass number for lite.
	• Glass price group 4	+\$241	Specify glass number for lite.
	• Glass price group 5	N.A.	Specify glass number for lite.
	• Glass price group 6	+\$476	Specify glass number for lite.
	► See <i>Surface Materials Reference Manual</i> .		
	Top lite glass panel surfaces 8'0"H through 10'0"H (per lite), 40"W to 48"W		
	• Glass price group 1	No cost	Specify glass number for lite.
	• Glass price group 2	+\$111	Specify glass number for lite.
	• Glass price group 3	+\$133	Specify glass number for lite.
• Glass price group 4	+\$211	Specify glass number for lite.	
• Glass price group 5	N.A.	Specify glass number for lite.	
• Glass price group 6	+\$416	Specify glass number for lite.	
► See <i>Surface Materials Reference Manual</i> .			
Lower three lites glass panels surfaces 8'0"H through 10'0"H (per lite), 40"W to 48"W			
• Glass price group 1	No cost	Specify glass number for lite.	
• Glass price group 2	+\$168	Specify glass number for lite.	
• Glass price group 3	+\$203	Specify glass number for lite.	
• Glass price group 4	+\$321	Specify glass number for lite.	
• Glass price group 5	N.A.	Specify glass number for lite.	
• Glass price group 6	+\$633	Specify glass number for lite.	
► See <i>Surface Materials Reference Manual</i> .			
Top lite glass panel surfaces 8'0"H through 10'0"H (per lite), 60"W			
• Glass price group 1	No cost	Specify glass number for lite.	
• Glass price group 2	+\$140	Specify glass number for lite.	
• Glass price group 3	+\$166	Specify glass number for lite.	
• Glass price group 4	+\$262	Specify glass number for lite.	
• Glass price group 5	N.A.	Specify glass number for lite.	
• Glass price group 6	+\$520	Specify glass number for lite.	
► See <i>Surface Materials Reference Manual</i> .			
Lower three lites glass panels surfaces 8'0"H through 10'0"H (per lite), 60"W			
• Glass price group 1	No cost	Specify glass number for lite.	
• Glass price group 2	+\$211	Specify glass number for lite.	
• Glass price group 3	+\$251	Specify glass number for lite.	
• Glass price group 4	+\$402	Specify glass number for lite.	
• Glass price group 5	N.A.	Specify glass number for lite.	
• Glass price group 6	+\$792	Specify glass number for lite.	
► See <i>Surface Materials Reference Manual</i> .			
Post Extension	• Post extensions modified to accommodate recessed ceiling track (ordered separately)	No cost	Specify with post extensions for recessed ceiling track interface.
	• Post extensions modified to accommodate overlapping ceiling track (ordered separately)	No cost	Specify with post extensions for overlapping ceiling track interface.
Ceiling Height	• 8'0" through 9'0"	No cost	Specify ceiling height in 1" increments.
	• 9'1" through 10'0"	+\$ 96	Specify ceiling height in 1" increments.

► Options, continued on next page



For Canadian Pricing

Multiply U.S. Price by the Canadian price factor.

► See page 1 for details.

Glass Wall Panels with Four Divided Lites Transom-Aligned Top Lite, continued

► Options, continued from previous page

Tip: Base power block location does not include infeed. It must be ordered separately, if needed.

Options	U.S. Price	Required to Specify
Electrical Power (For panels 30"W through 60"W)	Base power block power schematic • 3+1 +\$ 207 • 2+2 +\$ 207 • 3SN +\$ 207	Specify with 3+1 power. Specify with 2+2 power. Specify with 3SN power.
Related Products	<ul style="list-style-type: none"> • Ceiling tracks • Continuous base trim • Feature strips • Power receptacles • Power and communication cover plates • Infeeds • Modular harnesses • Field-installed powerkits • Cornice track 	<ul style="list-style-type: none"> ► Page 238 ► Page 244 ► Page 248 ► Page 256 ► Page 258 ► Page 259 ► Page 261 ► Page 239 ► Page 243

Tip: SmartTools options are available and easily ordered when using SmartTools software. If you do not have access to SmartTools software, these options can also be ordered using the normal Specials RFQ (Request For Quote) process.

SmartTools Options	U.S. Price	Required to Specify
Surface Materials	Glass for 5th and 6th lite opening • See standard options for lower three lites glass price group above	Specify glass number for lite 5 or 6.
Muntin	Additional muntin • Muntin +\$ 177 Change muntin size • Change to 1½"H or 2¼"H No cost Change muntin location • Change muntin location No cost	Specify with muntin. Specify muntin size. Specify muntin location.
Parametric Ceiling Height (Available in 1" increments)	• 7'5" through 7'11" Use 8'0" price • 10'1" through 11'0" +\$ 163	Specify ceiling height in 1" increments. Specify ceiling height in 1" increments.
Parametric Panel Widths (Available in 1" increments)	• Non standard widths No cost • Non standard modular widths No cost	Specify panel widths in 1" increments. Specify panel widths in 1" increments.
Base	• 4"H base +\$ 228	Specify to accept 4"H base.

Tip: Specify additional muntin(s) for use in five- or six-lite assembly applications. Maximum of six lites.
 ► See Understanding page 25.

Tip: Standard Privacy Wall ceiling heights are 8'0" through 10'0".

Tip: Panels for ceiling height of 10'1" to 11'0" are available in width up to 48"W only.



For Canadian Pricing
 Multiply U.S. Price by the Canadian price factor.
 ► See page 1 for details.

Specification Information

Width	Style Number	U.S. Base Price	Nominal Width	Modular Width	Style Number	U.S. Base Price
Glass Wall Panels						
6"	GPGS4L06	\$ 963				
8"	GPGS4L08	\$ 963				
18"	GPGS4L18	\$1013				
20"	GPGS4L20	\$1013				
24"	GPGS4L24	\$1061				
30"	GPGS4L30	\$1070				
36"	GPGS4L36	\$1139				
40"	GPGS4L40	\$1149				
42"	GPGS4L42	\$1149				
48"	GPGS4L48	\$1221				
60"	GPGS4L60	\$1497				
Modular Glass Wall Panels						
8"			6 ¹ / ₁₆ "	GPGM4L08	\$ 963	
18"			16 ¹¹ / ₁₆ "	GPGM4L18	\$1013	
20"			18 ¹ / ₁₆ "	GPGM4L20	\$1013	
24"			22 ¹ / ₁₆ "	GPGM4L24	\$1061	
30"			28 ¹ / ₁₆ "	GPGM4L30	\$1070	
36"			34 ¹ / ₁₆ "	GPGM4L36	\$1139	
40"			38 ¹ / ₁₆ "	GPGM4L40	\$1149	
42"			40 ¹ / ₁₆ "	GPGM4L42	\$1149	
48"			46 ¹ / ₁₆ "	GPGM4L48	\$1221	
60"			58 ¹ / ₁₆ "	GPGM4L60	\$1497	

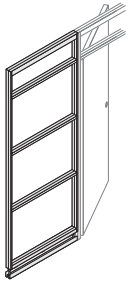

 **For Canadian Pricing**
Multiply U.S. Price by the
Canadian price factor.
▶ See page 1 for details.

Glass Wall Panels with Two Divided Lites

Transom-Aligned Top Lite

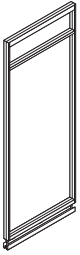

Tip: Order ceiling track, feature strip, and continuous base trim separately.

Standard Includes	Required to Specify
<ul style="list-style-type: none"> ▶ Need help? Product details, page 24 • Ceiling height from 8'0"H to 10'0"H, in one-inch increments • 2³/₈"-thick panel with steel frame: paint • Two, 1/4"-thick factory-installed lites—top lite is transom aligned: glass • Floor track with adjustable levelers to accommodate continuous 5"H base trim (ordered separately) 	<ol style="list-style-type: none"> 1 Style number 2 Ceiling height 3 Paint color number for frame and muntin 4 Glass number for lite 1 (from top) 5 Glass number for lite 2 6 Post extension 7 Options, if selected (see below) <p>▶ See <i>Surface Materials</i>, page 408.</p>

Options	U.S. Price	Required to Specify
Surface Materials <ul style="list-style-type: none"> • Glass frame surface • Paint price group 1 • Paint price group 2 • Paint price group 3 	<ul style="list-style-type: none"> No cost +\$ 29 +\$ 48 	<ul style="list-style-type: none"> Specify paint color number. Specify paint color number. Specify paint color number.
Top lite glass panel surfaces 8'0"H through 10'0"H (per lite), 6"W to 8"W		
<ul style="list-style-type: none"> • Glass price group 1 • Glass price group 2 • Glass price group 3 • Glass price group 4 • Glass price group 5 • Glass price group 6 	<ul style="list-style-type: none"> No cost +\$ 18 +\$ 24 +\$ 35 N.A. +\$ 71 	<ul style="list-style-type: none"> Specify glass number for lite. Specify glass number for lite. Specify glass number for lite. Specify glass number for lite. Specify glass number for lite. Specify glass number for lite. <p>▶ See <i>Surface Materials Reference Manual</i>.</p>
Lower lite glass panel surfaces 8'0"H through 10'0"H (per lite), 6"W to 8"W		
<ul style="list-style-type: none"> • Glass price group 1 • Glass price group 2 • Glass price group 3 • Glass price group 4 • Glass price group 5 • Glass price group 6 	<ul style="list-style-type: none"> No cost +\$ 85 +\$101 +\$162 N.A. +\$317 	<ul style="list-style-type: none"> Specify glass number for lite. Specify glass number for lite. Specify glass number for lite. Specify glass number for lite. Specify glass number for lite. Specify glass number for lite. <p>▶ See <i>Surface Materials Reference Manual</i>.</p>
Top lite glass panel surfaces 8'0"H through 10'0"H (per lite), 18"W to 24"W		
<ul style="list-style-type: none"> • Glass price group 1 • Glass price group 2 • Glass price group 3 • Glass price group 4 • Glass price group 5 • Glass price group 6 	<ul style="list-style-type: none"> No cost +\$ 57 +\$ 67 +\$106 N.A. +\$209 	<ul style="list-style-type: none"> Specify glass number for lite. Specify glass number for lite. Specify glass number for lite. Specify glass number for lite. Specify glass number for lite. Specify glass number for lite. <p>▶ See <i>Surface Materials Reference Manual</i>.</p>
Lower lite glass panel surfaces 8'0"H through 10'0"H (per lite), 18"W to 24"W		
<ul style="list-style-type: none"> • Glass price group 1 • Glass price group 2 • Glass price group 3 • Glass price group 4 • Glass price group 5 • Glass price group 6 	<ul style="list-style-type: none"> No cost +\$253 +\$300 +\$482 N.A. +\$951 	<ul style="list-style-type: none"> Specify glass number for lite. Specify glass number for lite. Specify glass number for lite. Specify glass number for lite. Specify glass number for lite. Specify glass number for lite. <p>▶ See <i>Surface Materials Reference Manual</i>.</p>

▶ Options, continued on next page



For Canadian Pricing

Multiply U.S. Price by the Canadian price factor.

▶ See page 1 for details.

► Options, continued from previous page

	Options	U.S. Price	Required to Specify
Surface Materials	Top lite glass panel surfaces 8'0"H through 10'0"H (per lite), 30"W to 36"W		
	<ul style="list-style-type: none"> • Glass price group 1 • Glass price group 2 • Glass price group 3 • Glass price group 4 • Glass price group 5 • Glass price group 6 	<ul style="list-style-type: none"> No cost +\$ 83 +\$ 98 +\$ 160 N.A. +\$ 312 	<ul style="list-style-type: none"> Specify glass number for lite. Specify glass number for lite. Specify glass number for lite. Specify glass number for lite. Specify glass number for lite. Specify glass number for lite.
	Lower lite glass panel surfaces 8'0"H through 10'0"H (per lite), 30"W to 36"W		
	<ul style="list-style-type: none"> • Glass price group 1 • Glass price group 2 • Glass price group 3 • Glass price group 4 • Glass price group 5 • Glass price group 6 	<ul style="list-style-type: none"> No cost +\$ 379 +\$ 452 +\$ 721 N.A. +\$1424 	<ul style="list-style-type: none"> Specify glass number for lite. Specify glass number for lite. Specify glass number for lite. Specify glass number for lite. Specify glass number for lite. Specify glass number for lite.
	Top lite glass panel surfaces 8'0"H through 10'0"H (per lite), 40"W to 48"W		
	<ul style="list-style-type: none"> • Glass price group 1 • Glass price group 2 • Glass price group 3 • Glass price group 4 • Glass price group 5 • Glass price group 6 	<ul style="list-style-type: none"> No cost +\$ 111 +\$ 133 +\$ 211 N.A. +\$ 416 	<ul style="list-style-type: none"> Specify glass number for lite. Specify glass number for lite. Specify glass number for lite. Specify glass number for lite. Specify glass number for lite. Specify glass number for lite.
	Lower lite glass panel surfaces 8'0"H through 10'0"H (per lite), 40"W to 48"W		
	<ul style="list-style-type: none"> • Glass price group 1 • Glass price group 2 • Glass price group 3 • Glass price group 4 • Glass price group 5 • Glass price group 6 	<ul style="list-style-type: none"> No cost +\$ 504 +\$ 602 +\$ 962 N.A. +\$1898 	<ul style="list-style-type: none"> Specify glass number for lite. Specify glass number for lite. Specify glass number for lite. Specify glass number for lite. Specify glass number for lite. Specify glass number for lite.
	Top lite glass panel surfaces 8'0"H through 10'0"H (per lite), 60"W		
	<ul style="list-style-type: none"> • Glass price group 1 • Glass price group 2 • Glass price group 3 • Glass price group 4 • Glass price group 5 • Glass price group 6 	<ul style="list-style-type: none"> No cost +\$ 140 +\$ 166 +\$ 262 N.A. +\$ 520 	<ul style="list-style-type: none"> Specify glass number for lite. Specify glass number for lite. Specify glass number for lite. Specify glass number for lite. Specify glass number for lite. Specify glass number for lite.
	Lower lite glass panel surfaces 8'0"H through 10'0"H (per lite), 60"W		
	<ul style="list-style-type: none"> • Glass price group 1 • Glass price group 2 • Glass price group 3 • Glass price group 4 • Glass price group 5 • Glass price group 6 	<ul style="list-style-type: none"> No cost +\$ 629 +\$ 751 +\$1204 N.A. +\$2374 	<ul style="list-style-type: none"> Specify glass number for lite. Specify glass number for lite. Specify glass number for lite. Specify glass number for lite. Specify glass number for lite. Specify glass number for lite.
Post Extension	<ul style="list-style-type: none"> • Post extensions modified to accommodate recessed ceiling track (ordered separately) 	No cost	Specify with post extensions for recessed ceiling track interface.
	<ul style="list-style-type: none"> • Post extensions modified to accommodate overlapping ceiling track (ordered separately) 	No cost	Specify with post extensions for overlapping ceiling track interface.
Ceiling Height	• 8'0" through 9'0"	No cost	Specify ceiling height in 1" increments.
	• 9'1" through 10'0"	+\$ 96	Specify ceiling height in 1" increments.

► Options, continued on next page



For Canadian Pricing

Multiply U.S. Price by the Canadian price factor.

► See page 1 for details.

Glass Wall Panels with Two Divided Lites Transom-Aligned Top Lite, continued

► Options, continued from previous page

Tip: Base power block location does not include infeed. It must be ordered separately, if needed.

	Options	U.S. Price	Required to Specify
Electrical Power (For panels 30"W through 60"W)	Base power block power schematic		
	• 3+1	+\$ 207	Specify with 3+1 power.
	• 2+2	+\$ 207	Specify with 2+2 power.
	• 3SN	+\$ 207	Specify with 3SN power.
Related Products	• Ceiling tracks		► Page 238
	• Continuous base trim		► Page 244
	• Feature strips		► Page 248
	• Power receptacles		► Page 256
	• Power and communication cover plates		► Page 258
	• Infeeds		► Page 259
	• Modular harnesses		► Page 261
	• Field-installed powerkits		► Page 239
	• Cornice track		► Page 243

Tip: SmartTools options are available and easily ordered when using SmartTools software. If you do not have access to SmartTools software, these options can also be ordered using the normal Specials RFQ (Request For Quote) process.

Tip: Standard Privacy Wall ceiling heights are 8'0" through 10'0".

Tip: Panels for ceiling height of 10'1" to 11' are available in width up to 48"W only.

	SmartTools Options	U.S. Price	Required to Specify
Muntin	Change muntin size		
	• Change to 1½"H or 2¼"H	No cost	Specify muntin size.
	Change muntin location		
	• Change muntin location	No cost	Specify muntin location.
Parametric Ceiling Height (Available in 1" increments)	• 7'5" through 7'11"	Use 8'0" price	Specify ceiling height in 1" increments.
	• 10'1" through 11'0"	+\$ 163	Specify ceiling height in 1" increments.
Parametric Panel Widths (Available in 1" increments)	• Non standard widths	No cost	Specify panel widths in 1" increments.
	• Non standard modular widths	No cost	Specify panel widths in 1" increments.
Base	• 4"H base	+\$ 228	Specify to accept 4"H base.



For Canadian Pricing

Multiply U.S. Price by the Canadian price factor.

► See page 1 for details.



Specification Information						
Width	Style Number	U.S. Base Price	Nominal Width	Modular Width	Style Number	U.S. Base Price
Glass Wall Panels			Modular Glass Wall Panels			
6"	GPGS2L06	\$ 752				
8"	GPGS2L08	\$ 752	8"	6 ¹ / ₁₆ "	GPGM2L08	\$ 752
18"	GPGS2L18	\$ 811	18"	16 ¹ / ₁₆ "	GPGM2L18	\$ 811
20"	GPGS2L20	\$ 811	20"	18 ¹ / ₁₆ "	GPGM2L20	\$ 811
24"	GPGS2L24	\$ 869	24"	22 ¹ / ₁₆ "	GPGM2L24	\$ 869
30"	GPGS2L30	\$ 885	30"	28 ¹ / ₁₆ "	GPGM2L30	\$ 885
36"	GPGS2L36	\$ 966	36"	34 ¹ / ₁₆ "	GPGM2L36	\$ 966
40"	GPGS2L40	\$ 976	40"	38 ¹ / ₁₆ "	GPGM2L40	\$ 976
42"	GPGS2L42	\$ 976	42"	40 ¹ / ₁₆ "	GPGM2L42	\$ 976
48"	GPGS2L48	\$1063	48"	46 ¹ / ₁₆ "	GPGM2L48	\$1063
60"	GPGS2L60	\$1342	60"	58 ¹ / ₁₆ "	GPGM2L60	\$1342

 **For Canadian Pricing**
Multiply U.S. Price by the
Canadian price factor.
▶ See page 1 for details.

Clerestory Wall Panels

Transom-Aligned Top Lite

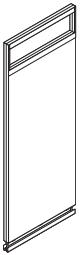

Tip: Order ceiling track, feature strip, and continuous base trim separately.

Tip: Paint price group 2 is only available on panels 36"W or smaller.

Tip: For information regarding Etched and Pattern Glass Planning.
▶ Page 104.

Tip: Customer's Own Glass is available as a special at this time.

Standard Includes	Required to Specify
<ul style="list-style-type: none"> ▶ Need help? Product details, page 24 • Frame: paint • Ceiling height from 8'0"H to 10'0"H, in one-inch increments • 2³/₈"-thick panel with steel surfaces: paint • 1/4"-thick factory-installed Clerestory lite: glass • Integral slotted verticals • Hollow core panel for cable and power routing • Floor track with adjustable levelers to accommodate continuous 5"H base trim (ordered separately) 	<ol style="list-style-type: none"> 1 Style number 2 Paint color number for frame 3 Ceiling height 4 Paint color number for side 1 5 Paint color number for side 2 6 Glass number for Clerestory lite 7 Post extension 8 Options, if selected (see below) <p>▶ See <i>Surface Materials</i>, page 408.</p>

Surface Materials	Options	U.S. Price	Required to Specify
	Glass frame surface		
	• Paint price group 1	No cost	Specify paint color number.
	• Paint price group 2	+\$ 12	Specify paint color number.
	• Paint price group 3	+\$ 24	Specify paint color number.
	Lower panel solid surfaces 8'0"H through 10'0"H (per side), 18"W to 24"W		
	• Paint price group 1	No cost	Specify paint color number.
	• Paint price group 2	+\$ 18	Specify paint color number.
	• Paint price group 3	+\$ 33	Specify paint color number.
	• Fabric price group 1	+\$142	Specify fabric color number for side 1 and/or side 2.
	• Fabric price group 2	+\$201	Specify fabric color number for side 1 and/or side 2.
• Fabric price group 3	+\$264	Specify fabric color number for side 1 and/or side 2.	
• Fabric price group 5	+\$334	Specify fabric color number for side 1 and/or side 2.	
• Customer's Own Material/Vinyl (COM)	+\$137	▶ See <i>Surface Materials Reference Manual</i> .	
Clerestory Lite Glass Panels 8'0"H through 10'0"H			
• Glass price group 1	No cost	Specify glass number for lite.	
• Glass price group 2	+\$ 57	Specify glass number for lite.	
• Glass price group 3	+\$ 67	Specify glass number for lite.	
• Glass price group 4	+\$106	Specify glass number for lite.	
• Glass price group 5	N.A.	Specify glass number for lite.	
• Glass price group 6	+\$209	Specify glass number for lite.	
Lower panel surfaces 8'0"H through 10'0"H (per side), 30"W to 36"W			
• Paint price group 1	No cost	Specify paint color number.	
• Paint price group 2	+\$ 37	Specify paint color number.	
• Paint price group 3	+\$ 57	Specify paint color number.	
• Fabric price group 1	+\$217	Specify fabric color number for side 1 and/or side 2.	
• Fabric price group 2	+\$322	Specify fabric color number for side 1 and/or side 2.	
• Fabric price group 3	+\$477	Specify fabric color number for side 1 and/or side 2.	
• Fabric price group 5	+\$621	Specify fabric color number for side 1 and/or side 2.	
• Customer's Own Material/Vinyl (COM)	+\$201	▶ See <i>Surface Materials Reference Manual</i> .	

▶ Options, continued on next page



For Canadian Pricing

Multiply U.S. Price by the Canadian price factor.

▶ See page 1 for details.

► Options, continued from previous page

Options	U.S. Price	Required to Specify
Surface Materials, continued		
Materials Clerestory Lite Glass Panels 8'0"H through 10'0"H		
• Glass price group 1	No cost	Specify glass number for lite.
• Glass price group 2	+\$ 83	Specify glass number for lite.
• Glass price group 3	+\$ 98	Specify glass number for lite.
• Glass price group 4	+\$160	Specify glass number for lite.
• Glass price group 5	N.A.	Specify glass number for lite.
• Glass price group 6	+\$312	Specify glass number for lite.
Lower panel surfaces 8'0"H through 10'0"H (per side), 40"W to 48"W		
• Paint price group 1	No cost	Specify paint color number.
• Paint price group 3	+\$ 57	Specify paint color number.
• Fabric price group 1	+\$217	Specify fabric color number for side 1 and/or side 2.
• Fabric price group 2	+\$322	Specify fabric color number for side 1 and/or side 2.
• Fabric price group 3	+\$477	Specify fabric color number for side 1 and/or side 2.
• Fabric price group 5	+\$621	Specify fabric color number for side 1 and/or side 2.
• Customer's Own Material/Vinyl (COM)	+\$201	► See <i>Surface Materials Reference Manual</i> .
Clerestory Lite Glass Panels 8'0"H through 10'0"H		
• Glass price group 1	No cost	Specify glass number for lite.
• Glass price group 2	+\$111	Specify glass number for lite.
• Glass price group 3	+\$133	Specify glass number for lite.
• Glass price group 4	+\$211	Specify glass number for lite.
• Glass price group 5	N.A.	Specify glass number for lite.
• Glass price group 6	+\$416	Specify glass number for lite.
Lower panel surfaces 8'0"H through 10'0"H (per side) 60"W		
• Paint price group 1	No cost	Specify paint color number.
• Paint price group 3	+\$ 57	Specify paint color number.
• Fabric price group 1	+\$217	Specify fabric color number for side 1 and/or side 2.
• Fabric price group 2	+\$322	Specify fabric color number for side 1 and/or side 2.
• Fabric price group 3	+\$477	Specify fabric color number for side 1 and/or side 2.
• Fabric price group 5	+\$621	Specify fabric color number for side 1 and/or side 2.
• Customer's Own Material/Vinyl (COM)	+\$201	► See <i>Surface Materials Reference Manual</i> .
Clerestory Lite Glass Panels 8'0"H through 10'0"H		
• Glass price group 1	No cost	Specify glass number for lite.
• Glass price group 2	+\$140	Specify glass number for lite.
• Glass price group 3	+\$166	Specify glass number for lite.
• Glass price group 4	+\$262	Specify glass number for lite.
• Glass price group 5	N.A.	Specify glass number for lite.
• Glass price group 6	+\$520	Specify glass number for lite.

► Options, continued on next page

Tip: Customer's Own Glass is available as a special at this time.

 **For Canadian Pricing**
 Multiply U.S. Price by the Canadian price factor.
 ► See page 1 for details.

Clerestory Wall Panels Transom-Aligned Top Lite, continued

► Options, continued from previous page

	Options	U.S. Price	Required to Specify
Post Extension (For panels 30"W through 60"W)	• Post extensions modified to accommodate recessed ceiling track (ordered separately)	No cost	Specify with post extensions for recessed ceiling track interface.
	• Post extensions modified to accommodate overlapping ceiling track (ordered separately)	No cost	Specify with post extensions for overlapping ceiling track interface.
Ceiling Height	• 8'0" through 9'0"	No cost	Specify ceiling height in 1" increments.
	• 9'1" through 10'0"	+\$ 96	Specify ceiling height in 1" increments.
Electrical Power	Power block location		
	• Base	+\$207	Specify with power block location at base.
	• ADA height	+\$755	Specify with power block location at ADA height.
	• Desk height	+\$755	Specify with power block location at desk height.
	Power schematic		
	• 3+1	No cost	Specify with 3+1 power.
	• 2+2	No cost	Specify with 2+2 power.
	• 3SN	No cost	Specify with 3SN power.
	New York City/Chicago power prep		
	• NYC/CHI at base	N.A.	Specify with NYC/CHI at base.
	• NYC/CHI at ADA or desk height side 1	+\$ 26	Specify with NYC/CHI at ADA or desk height side 1.
	• NYC/CHI at ADA or desk height side 2	+\$ 26	Specify with NYC/CHI at ADA or desk height side 2.
	• NYC/CHI at ADA or desk height sides 1 and 2	+\$ 52	Specify with NYC/CHI at ADA or desk height sides 1 and 2.
	Receptacle cutouts		
	• Power side 1	No cost	Specify with power side 1.
	• Power side 2	No cost	Specify with power side 2.
	• Power sides 1 and 2	+\$ 26	Specify with power sides 1 and 2.
	• Power/comm side 1	No cost	Specify with power/comm side 1.
	• Power/comm side 2	No cost	Specify with power/comm side 2.
	• Power/comm sides 1 and 2	+\$ 26	Specify with power/comm sides 1 and 2.
	Floor infeeds		
	• Bottom left hardwire	No cost	Specify with bottom left hardwire.
	• Bottom left modular	+\$ 96	Specify with bottom left modular.
Related Products	• Ceiling tracks		► Page 238
	• Continuous base trim		► Page 244
	• Feature strips		► Page 248
	• Power receptacles		► Page 256
	• Power and communication cover plates		► Page 258
	• Infeeds		► Page 259
	• Modular harnesses		► Page 261
	• Field-installed powerkits		► Page 239
	• Cornice track		► Page 243

► Options, continued on next page

Tip: To price power in two locations, add the upcharges together.

Tip: Infeed is included in the price of ADA- or desk-height receptacle power location option.

Tip: Base power block location does not include infeed. It must be ordered separately, if needed.

Tip: NYC/CHI prices replace the receptacle power location option prices when selected.

Tip: Order power and communication and power-only cover plates separately.



For Canadian Pricing

Multiply U.S. Price by the Canadian price factor.

► See page 1 for details.

► Options, continued from previous page

Tip: SmartTools options are available and easily ordered when using SmartTools software. If you do not have access to SmartTools software, these options can also be ordered using the normal Specials RFQ (Request For Quote) process.

Tip: Markerboard surface cannot exceed 48"W.

Tip: Maximum of two lites. See Understanding page 30.

Tip: Standard Privacy Wall ceiling heights are 8'0" through 10'0".

Tip: Panels for ceiling height of 10'1" to 11'0" are available in width up to 48"W only.

SmartTools Options	U.S. Price	Required to Specify
7610 White Markerboard Surface	<ul style="list-style-type: none"> • 6"W through 24"W +\$ 487 • 25"W through 36"W +\$ 523 • 37"W through 48"W +\$ 559 	Specify with markerboard. Specify with markerboard. Specify with markerboard.
Muntin	<p>Additional muntin</p> <ul style="list-style-type: none"> • Muntin +\$ 209 <p>Change muntin size</p> <ul style="list-style-type: none"> • Change to 1½"H or 2¼"H No cost <p>Change muntin location</p> <ul style="list-style-type: none"> • Change muntin location No cost 	Specify with muntin. Specify muntin size. Specify muntin location.
Parametric Ceiling Height (Available in 1" increments)	<ul style="list-style-type: none"> • 7'11" Use 8'0" price • 10'1" through 11'0" +\$ 163 	Specify ceiling height in 1" increments. Specify ceiling height in 1" increments.
Parametric Panel Widths (Available in 1" increments)	<ul style="list-style-type: none"> • Non standard widths No cost • Non standard modular widths No cost 	Specify panel widths in 1" increments. Specify panel widths in 1" increments.
Base	<ul style="list-style-type: none"> • 4"H base +\$ 63 	Specify to accept 4"H base.

Specification Information

Width	Style Number	U.S. Base Price	Nominal Width	Modular Width	Style Number	U.S. Base Price
-------	--------------	-----------------	---------------	---------------	--------------	-----------------

Clerestory Panels

18"	GPGSC18	\$1186
20"	GPGSC20	\$1186
24"	GPGSC24	\$1251
30"	GPGSC30	\$1316
36"	GPGSC36	\$1359
40"	GPGSC40	\$1401
42"	GPGSC42	\$1401
48"	GPGSC48	\$1448
60"	GPGSC60	\$1873

Modular Clerestory Panels

18"	16½"16"	GPGMC18	\$1186
20"	18½"16"	GPGMC20	\$1186
24"	22½"16"	GPGMC24	\$1251
30"	28½"16"	GPGMC30	\$1316
36"	34½"16"	GPGMC36	\$1359
40"	38½"16"	GPGMC40	\$1401
42"	40½"16"	GPGMC42	\$1401
48"	46½"16"	GPGMC48	\$1448
60"	58½"16"	GPGMC60	\$1873



 **For Canadian Pricing**
Multiply U.S. Price by the Canadian price factor.
► See page 1 for details.

Power Options

This page guides you through specifying Privacy Wall panels. Use these steps to specify factory-installed power components or communication openings in panels, or to have the factory alter panels to accommodate field-installed power.

Tip: Chicago and New York City electrical code requires field-supplied components to be field installed.

Factory-installed power components are available in all Privacy Wall panels. Use the options on this page to tell the factory how to assemble your panels so they include the power components you want.

Field-installed power components are required in New York City and Chicago. To streamline installation, use the options on this page to tell the factory how to modify the panels so they are ready to accept the power components you must order or supply separately. For details about how power is accommodated in Privacy Wall panels, see:

► *How to Power a Panel*, page 106

► *Overview of Powered Panels*, page 110

Specifying

Panels

1 Choose appropriate panel width to accommodate power and communication receptacles. See the table below for minimum widths.

Power and Communication

Desk height and ADA height

- 30"W standard panel
- 30"W (nominal) modular panel

At base

- 30"W standard panel
- 30"W (nominal) modular panel

2 Power schematic

Specify the power schematic:

- 4-circuit, 3+1
- 4-circuit, 2+2
- 3-circuit, separate neutrals (3SN)
- Chicago and New York City power and communication power prep

3 Power locations

Specify one or more of the following power locations that is available on the panel type you have chosen:

- Desk height
- ADA height
- Base
- Base and desk height
- Base and ADA height
- Desk and ADA
- Desk, ADA, and base

4 Utility choices by locations

Cutouts are only available in the positions you specified for power locations in step 3. See the table below for utility choices and designate side 1, side 2, or both side 1 and side 2.

Tip: For New York City and Chicago power prep options, no specification for utility choice at base height is needed because you add components in the field.

Desk height

- Power only
- Power and communication

ADA height

- Power only
- Power and communication

Base height

- Power only
- Power and communication
- Communication only

5 Remember to specify

receptacles, cover plates, and power and communication base trim to finish your panel.

Tip: For Chicago and New York City installations, electrician must supply conduit, receptacles, and junction boxes for base of panel. Junction box for desk or ADA height is available from Steelcase and is required when using Privacy Wall power and communication cover plates.

► Page 264

Infeeds

6 Power infeeds

Panels with factory-installed power blocks at desk or ADA height can have a factory-installed power infeed harness to supply power from the ceiling or floor. Factory-installed infeeds extend a minimum of 12' from the panel. Specify one of the following:

- Hardwire ceiling infeed
- Modular ceiling infeed
- Hardwire floor infeed
- Modular floor infeed

Tip: If you do not specify one of the above infeeds, a hardwire infeed, located top left in a solid panel and bottom left in a Clerestory panel, will be provided.

When ADA- and/or desk-height power is specified, a factory-installed jumper is included to link the two locations. When ADA-, desk-, ADA- and desk-, and base-height power is specified, a factory-installed jumper is included to link ADA/desk to base.

► Multipurpose power infeeds, page 259

Tip: Infeeds are not required on panels with the Chicago or New York City power prep option.

Example

- One GPSS60
- 9'0" ceiling height
- 4843 Linen side 1
- 4844 Glacier side 2
- 4750 Champagne Metallic floor track
- 2+2 wiring schematic
- Power base height
- Power only side 1 ADA height
- Power and communication side 2 ADA height
- Modular ceiling infeed

Order receptacles, cover plates, and power and communication base trim separately.

Butt-Hinged Door Frames

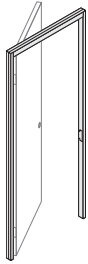

Tip: Glass door is available up to 9'0"H ceiling height.

Tip: For information regarding Etched and Pattern Glass Planning.
▶ Page 104

Tip: Recommended for use with Privacy Wall only. Not for use with Glass Selections.

Tip: Door frame glass option is available on transom door frames only.

Tip: Remember to specify switch cutout option if you want a butt-hinged door frame with a switch.

Tip: Switch cutout is located in strike jamb of single door frame and not available in pair frames. Order switch separately.
▶ Page 172

Tip: Cutout option is not available on pair door frames.

Standard Includes		Required to Specify
▶ Need help? Product details, page 34	<ul style="list-style-type: none"> Ceiling height from 8'0"H to 10'0"H, in one-inch increments Factory prep for butt hinges <i>Tip: Order door hardware separately.</i> Hardware cutout for strike plate Transom, if selected: glass Plinths: paint 	<ol style="list-style-type: none"> Style number Ceiling height Swing orientation Paint color number for frame and plinths Glass number for transom, if selected Post extension Options, if selected (see below) <p>▶ See <i>Surface Materials</i>, page 408.</p>

Options	U.S. Price	Required to Specify
Surface Materials	<ul style="list-style-type: none"> Paint price group 1 No cost Paint price group 2 +\$ 29 Paint price group 3 +\$ 48 	Specify paint color number. Specify paint color number. Specify paint color number.
Single door frames with transom 8'0"H through 10'0"H		
<ul style="list-style-type: none"> Glass price group 1 No cost Glass price group 2 +\$ 92 Glass price group 3 +\$111 Glass price group 4 +\$174 Glass price group 5 N.A. Glass price group 6 +\$346 		Specify glass number for transom. Specify glass number for transom. Specify glass number for transom. Specify glass number for transom. Specify glass number for transom. Specify glass number for transom.
Pair door frames with transom 8'0"H through 10'0"H		
<ul style="list-style-type: none"> Glass price group 1 No cost Glass price group 2 +\$182 Glass price group 3 +\$222 Glass price group 4 +\$348 Glass price group 5 N.A. Glass price group 6 +\$695 		Specify glass number for transom. Specify glass number for transom. Specify glass number for transom. Specify glass number for transom. Specify glass number for transom. Specify glass number for transom.
Post Extension	<ul style="list-style-type: none"> Post extensions modified to accommodate recessed ceiling track (ordered separately) No cost Post extensions modified to accommodate overlapping ceiling track (ordered separately) No cost 	Specify with <i>post extensions for recessed ceiling track interface.</i> Specify with <i>post extensions for overlapping ceiling track interface.</i>
Ceiling Height	<p>Single door frames with transom</p> <ul style="list-style-type: none"> 8'0" through 9'0" No cost 9'1" through 10'0" +\$ 50 <p>Pair door frames with transom</p> <ul style="list-style-type: none"> 8'0" through 9'0" No cost 9'1" through 10'0" +\$ 96 	Specify ceiling height in 1" increments. Specify ceiling height in 1" increments. Specify ceiling height in 1" increments. Specify ceiling height in 1" increments.
Swing Orientation	<ul style="list-style-type: none"> Left-hand door frame No cost Right-hand door frame No cost 	Specify with <i>left-hand door frame.</i> Specify with <i>right-hand door frame.</i>
Switch Cutout	<ul style="list-style-type: none"> Without cutout No cost With low-voltage switch cutout +\$ 37 With high-voltage switch cutout +\$ 37 	Specify <i>without cutout.</i> Specify with <i>low-voltage switch cutout.</i> Specify with <i>high-voltage switch cutout.</i>
Related Products	<ul style="list-style-type: none"> Door leaves Passage sets and locksets Hinges Stops Switches Ceiling tracks Feature strips 	▶ Page 156 ▶ Page 168 ▶ Page 170 ▶ Page 170 ▶ Page 172 ▶ Page 238 ▶ Page 248

▶ Options, continued on next page



For Canadian Pricing
Multiply U.S. Price by the Canadian price factor.
▶ See page 1 for details.

► Options, continued from previous page

Tip: SmartTools options are available and easily ordered when using SmartTools software. If you do not have access to SmartTools software, these options can also be ordered using the normal Specials RFQ (Request For Quote) process.

Tip: Standard Privacy Wall ceiling heights are 8'0" through 10'0".

Tip: Panels for ceiling height of 10'1" to 11'0" are available in width up to 48"W only.

	SmartTools Options	U.S. Price	Required to Specify
Muntin (Transom only)	Additional muntin • Muntin	+\$ 209	Specify with muntin.
	Change muntin size • Change to 1½"H or 2¼"H	No cost	Specify muntin size.
	Change muntin location • Change muntin location	No cost	Specify muntin location.
Parametric Ceiling Height (Transom only)	• 10'1" through 11'0" (Available in 1" increments)	+\$ 163	Specify ceiling height in 1" increments.
Base	• 4"H base	+\$ 63	Specify to accept 4"H base.

Specification Information

Width	Style Number	U.S. Base Price

Single Door Frames

Full-Height

40"	GPDSBF	\$1026
-----	---------------	--------

With Transom

40"	GPDSBT	\$1585
-----	---------------	--------

Pair Frames

Full-Height

76"	GPDPBF	\$1047
-----	---------------	--------

With Transom

76"	GPDPBT	\$1681
-----	---------------	--------

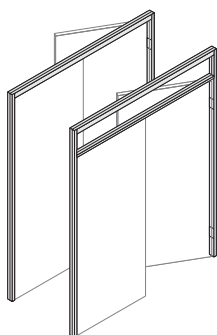
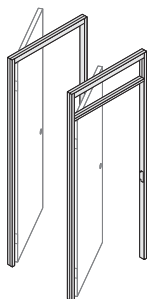

Pivot-Hinged Door Frames



Tip: Glass door is available up to 9'0"H ceiling height.

Tip: Privacy Wall pivot-hinged frames work with Privacy Wall door leaves only.

Tip: Strike plate finish is available on single frames only.

Tip: Door frame glass option is available on transom door frames only.

Tip: For information regarding Etched and Pattern Glass Planning.
▶ Page 104

Tip: Cutout option is not available on pair door frames.

Tip: Swing orientation is available on single pivot-hinged door frame with transom only to properly orient etched and patterned glass.
▶ Page 46



For Canadian Pricing
Multiply U.S. Price by the Canadian price factor.
▶ See page 1 for details.

Standard Includes	Required to Specify
<ul style="list-style-type: none"> ▶ Need help? Product details, page 40 Ceiling height from 8'0"H to 10'0"H, in one-inch increments Reversible, pivot-hinged door frame with plinths: paint Factory prep for pivot hinges <i>Tip: Order door hardware separately.</i> Transom, if selected: glass Strike plate 	<ol style="list-style-type: none"> Style number Ceiling height Swing orientation Paint color number for frame and plinths Glass number for transom, if selected Metal color number for strike plate: <ul style="list-style-type: none"> 9200 Satin Chrome 9201 Polished Chrome Post extension Factory prep for cylindrical or mortise passage set or lockset, if selected Options, if selected (see below) <p>▶ See <i>Surface Materials</i>, page 408.</p>

Options	U.S. Price	Required to Specify
Surface Materials <ul style="list-style-type: none"> Door frame <ul style="list-style-type: none"> Paint price group 1: No cost Paint price group 2: +\$ 29 Paint price group 3: +\$ 48 Strike plate <ul style="list-style-type: none"> Satin chrome: No cost Polished chrome: +\$ 26 		Specify paint color number. Specify paint color number. Specify paint color number.
Single door frames with transom 8'0"H through 10'0"H		
<ul style="list-style-type: none"> Glass price group 1: No cost Glass price group 2: +\$ 92 Glass price group 3: +\$111 Glass price group 4: +\$174 Glass price group 5: N.A. Glass price group 6: +\$346 		Specify glass number for transom. Specify glass number for transom. Specify glass number for transom. Specify glass number for transom. Specify glass number for transom. Specify glass number for transom.
Pair door frames with transom 8'0"H through 10'0"H		
<ul style="list-style-type: none"> Glass price group 1: No cost Glass price group 2: +\$182 Glass price group 3: +\$222 Glass price group 4: +\$348 Glass price group 5: N.A. Glass price group 6: +\$695 		Specify glass number for transom. Specify glass number for transom. Specify glass number for transom. Specify glass number for transom. Specify glass number for transom. Specify glass number for transom.
Post Extension <ul style="list-style-type: none"> Post extensions modified to accommodate recessed ceiling track (ordered separately): No cost Post extensions modified to accommodate overlapping ceiling track (ordered separately): No cost 		Specify with <i>post extensions for recessed ceiling track interface</i> . Specify with <i>post extensions for overlapping ceiling track interface</i> .
Ceiling Height <ul style="list-style-type: none"> Single door frames <ul style="list-style-type: none"> 8'0" through 9'0": No cost 9'1" through 10'0": +\$ 50 Pair door frames <ul style="list-style-type: none"> 8'0" through 9'0": No cost 9'1" through 10'0": +\$ 96 		Specify ceiling height in 1" increments. Specify ceiling height in 1" increments. Specify ceiling height in 1" increments. Specify ceiling height in 1" increments.
Swing Orientation <ul style="list-style-type: none"> For single pivot-hinged door frame with transom <ul style="list-style-type: none"> Left-hand door frame: No cost Right-hand door frame: No cost 		Specify with <i>left-hand door frame</i> . Specify with <i>right-hand door frame</i> .
Lock Prep <ul style="list-style-type: none"> Strike plate and factory prep for cylindrical passage set or lockset: No cost Strike plate and factory prep for mortise passage set or lockset: +\$ 73 		Specify with <i>cylindrical prep</i> . Specify with <i>mortise prep</i> .

▶ Options, continued on next page

► Options, continued from previous page

Related Products

- Door leaves ► Page 160
- Passage sets and locksets ► Page 168
- Hinges ► Page 170
- Stops ► Page 170
- Ceiling tracks ► Page 238
- Feature strips ► Page 248

Tip: SmartTools options are available and easily ordered when using SmartTools software. If you do not have access to SmartTools software, these options can also be ordered using the normal Specials RFQ (Request For Quote) process.

	SmartTools Options	U.S. Price	Required to Specify
Muntin (Transom only)	Additional muntin • Muntin	+\$ 209	Specify with muntin.
	Change muntin size • Change to 1½"H or 2¼"H	No cost	Specify muntin size.
	Change muntin location • Change muntin location	No cost	Specify muntin location.
Parametric Ceiling Height (Transom only)	• 10'1" through 11'0" (Available in 1" increments)	+\$ 163	Specify ceiling height in 1" increments.
Base	• 4"H base	+\$ 63	Specify to accept 4"H base.

Specification Information

Width	Style Number	U.S. Base Price

Tip: Standard Privacy Wall ceiling heights are 8'0" through 10'0".

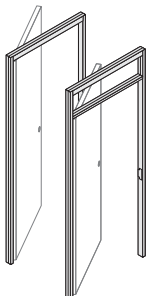

Single Door Frames

Full-Height		
40"	GPDSPF	\$ 649
With Transom		
40"	GPDSPT	\$1296

► Specification Information, continued on next page

For Canadian Pricing
Multiply U.S. Price by the Canadian price factor.
► See page 1 for details.

Pivot-Hinged Door Frames, continued

► Specification Information, continued from previous page

Specification Information

Width	Style Number	U.S. Base Price
-------	--------------	-----------------

Pair Door Frames

Full-Height

80"	GPDPFF	\$ 667
-----	---------------	--------

With Transom

80"	GPDPPT	\$1601
:	:	:

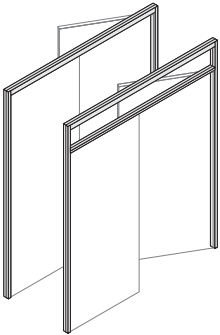

For Canadian Pricing

Multiply U.S. Price by the Canadian price factor.

► See page 1 for details.



Pivot-Hinged Door Frames with Switch Cutout

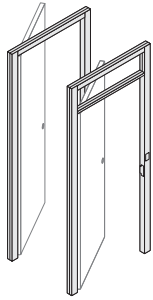

Tip: Glass door is available up to 9'0"H ceiling height.

Tip: Privacy Wall pivot-hinged frames work with Privacy Wall door leaves only.

Tip: For information regarding Etched and Pattern Glass Planning.
▶ Page 104

Tip: Glass surface option for transom door frames only.

Tip: Order switch separately.

Tip: As an alternative to a 42"W frame with switch cutout, you can position a low-voltage switch in an in-line feature strip adjacent to a door frame.
▶ Page 43

Tip: Door frame glass surface option is available on transom door frames only.

Tip: Swing orientation is available on single pivot-hinged door frame with transom only to properly orient etched and patterned glass.



For Canadian Pricing
Multiply U.S. Price by the Canadian price factor.
▶ See page 1 for details.

Standard Includes	Required to Specify
<ul style="list-style-type: none"> ▶ Need help? Product details, page 40 Ceiling height from 8'0"H to 10'0"H, in one-inch increments Left-hand reversible, pivot-hinged door frame with plinths: paint Factory prep for pivot hinges <i>Tip: Order door hardware separately.</i> Transom, if selected: glass Strike plate 	<ol style="list-style-type: none"> Style number Ceiling height Swing orientation Paint color number for frame and plinths Glass number for transom, if selected Metal color number for strike plate: <ul style="list-style-type: none"> 9200 Satin Chrome 9201 Polished Chrome Post extension Factory prep for cylindrical or mortise passage set or lockset, if selected Options, if selected (see below) <p>▶ See <i>Surface Materials</i>, page 408.</p>

Options	U.S. Price	Required to Specify
Surface Materials <ul style="list-style-type: none"> Door frame <ul style="list-style-type: none"> Paint price group 1: No cost Paint price group 2: +\$ 29 Paint price group 3: +\$ 48 Strike plate <ul style="list-style-type: none"> Satin chrome: No cost Polished chrome: +\$ 26 		Specify paint color number. Specify paint color number. Specify paint color number.
Single door frames with transom 8'0"H through 10'0"H		
<ul style="list-style-type: none"> Glass price group 1: No cost Glass price group 2: +\$ 92 Glass price group 3: +\$111 Glass price group 4: +\$174 Glass price group 5: N.A. Glass price group 6: +\$346 		Specify glass number for transom. Specify glass number for transom. Specify glass number for transom. Specify glass number for transom. Specify glass number for transom. Specify glass number for transom.
Post Extension <ul style="list-style-type: none"> Post extensions modified to accommodate recessed ceiling track (ordered separately): No cost Post extensions modified to accommodate overlapping ceiling track (ordered separately): No cost 		Specify with post extensions for recessed ceiling track interface. Specify with post extensions for overlapping ceiling track interface.
Ceiling Height <ul style="list-style-type: none"> Single door frames with transom <ul style="list-style-type: none"> 8'0" through 9'0": No cost 9'1" through 10'0": +\$ 50 		Specify ceiling height in 1" increments. Specify ceiling height in 1" increments.
Swing Orientation <ul style="list-style-type: none"> Left-hand door frame: No cost Right-hand door frame: No cost 		Specify with left-hand door frame. Specify with right-hand door frame.
Switch Cutout <ul style="list-style-type: none"> With low-voltage switch cutout: No cost With high-voltage switch cutout: No cost 		Specify with low-voltage switch cutout. Specify with high-voltage switch cutout.
Lock Prep <ul style="list-style-type: none"> Strike plate and factory prep for cylindrical passage set or lockset: No cost Strike plate and factory prep for mortise passage set or lockset: +\$ 73 		Specify with cylindrical prep. Specify with mortise prep.
Related Products <ul style="list-style-type: none"> Door leaves Passage sets and locksets Hinges Stops Ceiling tracks Feature strips 		▶ Page 160 ▶ Page 168 ▶ Page 170 ▶ Page 170 ▶ Page 238 ▶ Page 248

▶ Options, continued on next page

► Options, continued from previous page

Tip: SmartTools options are available and easily ordered when using SmartTools software. If you do not have access to SmartTools software, these options can also be ordered using the normal Specials RFQ (Request For Quote) process.

	SmartTools Options	U.S. Price	Required to Specify
Muntin (Transom only)	Additional muntin • Muntin	+\$ 209	Specify with muntin.
	Change muntin size • Change to 1½"H or 2¼"H	No cost	Specify muntin size.
	Change muntin location • Change muntin location	No cost	Specify muntin location.
Parametric Ceiling Height (Transom only)	• 10'1" through 11'0" (Available in 1" increments)	+\$ 163	Specify ceiling height in 1" increments.
Base	• 4"H base	+\$ 63	Specify to accept 4"H base.

Tip: Standard Privacy Wall ceiling heights are 8'0" through 10'0".

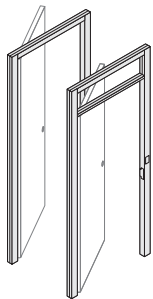

Specification Information		
Width	Style Number	U.S. Base Price

Single Door Frames

Full-Height

42"	GPDSPFS	\$1325
-----	----------------	--------

With Transom

42"	GPDSPTS	\$1798
-----	----------------	--------

 **For Canadian Pricing**
Multiply U.S. Price by the Canadian price factor.
► See page 1 for details.

Full-Height Butt-Hinged Door Leaves



Tip: Glass door is available up to 9'0"H ceiling height.

Tip: For information regarding Etched and Pattern Glass Planning.
▶ Page 104

Standard Includes		Required to Specify
▶ Need help? Product details, page 34	<ul style="list-style-type: none"> Ceiling height from 8'0"H to 10'0"H, in one-inch increments <i>Exception: Maximum ceiling height of glass doors is 9'0"H.</i> Butt-hinged door: paint, glass, or flat-cut veneer Factory prep for butt hinges 	<ol style="list-style-type: none"> Style number Ceiling height Swing orientation Paint color number for door, if solid door selected Glass number for glass door, if glass door selected Paint color number for glass door, if glass door selected Wood veneer color number, if selected Factory prep for cylindrical or mortise passage set or lockset, if selected Options, if selected (see below) <p>▶ See <i>Surface Materials</i>, page 408.</p>

Options	U.S. Price	Required to Specify	
Surface Materials	Glass door surface		
<ul style="list-style-type: none"> Paint price group 1 Paint price group 2 Paint price group 3 	<ul style="list-style-type: none"> No cost +\$ 29 +\$ 48 	<ul style="list-style-type: none"> Specify paint color number. Specify paint color number. Specify paint color number. 	
	36"W solid single door leaves 8'0"H through 10'0"H		
<ul style="list-style-type: none"> Paint price group 1 Paint price group 3 Wood veneer (flat cut) Quarter-cut wood veneer Customiz stain 	<ul style="list-style-type: none"> No cost +\$ 115 No cost +\$ 182 No cost 	<ul style="list-style-type: none"> Specify paint color number. Specify paint color number. Specify wood veneer color number. Specify wood veneer color number. Specify <i>with Customiz stain</i>. 	
	72"W solid pair door leaves 8'0"H through 10'0"H		
<ul style="list-style-type: none"> Paint price group 1 Paint price group 3 Wood veneer (flat cut) Quarter-cut wood veneer Customiz stain 	<ul style="list-style-type: none"> No cost +\$ 227 No cost +\$ 369 No cost 	<ul style="list-style-type: none"> Specify paint color number. Specify paint color number. Specify wood veneer color number. Specify <i>with Quarter-cut open pore veneer</i>. Specify <i>with Customiz stain</i>. 	
	Glass single door 8'0"H through 10'0"H		
<ul style="list-style-type: none"> Glass price group 1 Glass price group 2 Glass price group 3 Glass price group 4 Glass price group 5 Glass price group 6 	<ul style="list-style-type: none"> No cost +\$ 408 +\$ 487 +\$ 783 N.A. +\$1548 	<ul style="list-style-type: none"> Specify glass number for lite. Specify glass number for lite. Specify glass number for lite. Specify glass number for lite. Specify glass number for lite. Specify glass number for lite. 	
Ceiling Height	36"W solid single door leaves butt-hinged 8'0"H through 10'0"H		
	<ul style="list-style-type: none"> 8'0" through 9'0" 9'1" through 10'0" 	<ul style="list-style-type: none"> No cost +\$ 287 	<ul style="list-style-type: none"> Specify ceiling height in 1" increments. Specify ceiling height in 1" increments.
	72"W solid pair door leaves butt-hinged 8'0"H through 10'0"H		
	<ul style="list-style-type: none"> 8'0" through 9'0" 9'1" through 10'0" 	<ul style="list-style-type: none"> No cost +\$ 572 	<ul style="list-style-type: none"> Specify ceiling height in 1" increments. Specify ceiling height in 1" increments.
Swing Orientation	<ul style="list-style-type: none"> Left-hand door frame Right-hand door frame 	<ul style="list-style-type: none"> No cost No cost 	<ul style="list-style-type: none"> Specify <i>with left-hand door frame</i>. Specify <i>with right-hand door frame</i>.
▶ Page 46			
Lock Prep	<ul style="list-style-type: none"> Strike plate and factory prep for cylindrical passage set or lockset Strike plate and factory prep for mortise passage set or lockset 	<ul style="list-style-type: none"> No cost +\$ 46 	<ul style="list-style-type: none"> Specify <i>with cylindrical prep</i>. Specify <i>with mortise prep</i>.
▶ Page 42			

Related Products		
<ul style="list-style-type: none"> Door frames Passage sets and locksets Hinges Stops 		<ul style="list-style-type: none"> ▶ Page 148 ▶ Page 168 ▶ Page 170 ▶ Page 170

 **For Canadian Pricing**
Multiply U.S. Price by the Canadian price factor.
▶ See page 1 for details.

Specification Information

Width	Corresponding Frame Width	Style Number	U.S. Base Price
-------	---------------------------	--------------	-----------------



Solid Single Door

35 ¹³ / ₁₆ "	40"	GPLSSBF40	\$1782
------------------------------------	-----	------------------	--------



Glass Single Door with 5"H Bottom Rail

35 ¹³ / ₁₆ "	40"	GPLGSBF40	\$4581
------------------------------------	-----	------------------	--------

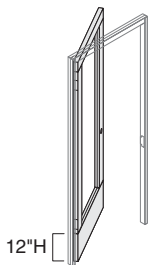

Glass Single Door with 12"H Bottom Rail

35 ¹³ / ₁₆ "	40"	GPLGSBF40B	\$4581
------------------------------------	-----	-------------------	--------

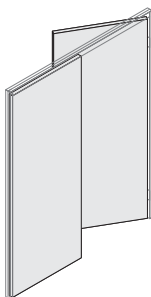

Solid Pair Door

71 ⁵ / ₈ "	76"	GPLSPBF76	\$3640
----------------------------------	-----	------------------	--------

 **For Canadian Pricing**
Multiply U.S. Price by the
Canadian price factor.
▶ See page 1 for details.

Transom-Height Butt-Hinged Door Leaves



Tip: For information regarding Etched and Pattern Glass Planning. ▶ Page 104.

Tip: Door frame glass surface option is available on transom door frames only.

Standard Includes		Required to Specify	
▶ Need help? Product details, page 34	<ul style="list-style-type: none"> • 7'0"H • Butt-hinged door: paint, glass, or flat-cut veneer • Factory prep for butt hinges 	<ol style="list-style-type: none"> 1 Style number 2 Paint color number for door, if solid door selected 3 Swing orientation 4 Glass number for glass door, if glass door selected 5 Paint color number for glass door, if glass door selected 6 Wood veneer color number, if selected 7 Factory prep for cylindrical or mortise passage set or lockset, if selected 8 Options, if selected (see below) 	▶ See <i>Surface Materials</i> , page 408.

Options	U.S. Price	Required to Specify	
Surface Materials	Glass door surface		
	<ul style="list-style-type: none"> • Paint price group 1 No cost • Paint price group 2 +\$ 29 • Paint price group 3 +\$ 48 		Specify paint color number. Specify paint color number. Specify paint color number.
	36"W solid single door leaves 7'0"H		
	<ul style="list-style-type: none"> • Paint price group 1 No cost • Paint price group 3 +\$ 115 • Wood veneer (flat cut) No cost • Quarter-cut wood veneer +\$ 166 		Specify paint color number. Specify paint color number. Specify wood veneer color number. Specify with <i>Quarter-cut open pore veneer</i> . Specify with <i>Customiz stain</i> .
	72"W solid pair door leaves 7'0"H		
	<ul style="list-style-type: none"> • Paint price group 1 No cost • Paint price group 3 +\$ 227 • Wood veneer (flat cut) No cost • Quarter-cut wood veneer +\$ 332 		Specify paint color number. Specify paint color number. Specify wood veneer color number. Specify with <i>Quarter-cut open pore veneer</i> . Specify with <i>Customiz stain</i> .
	Glass single door 7'0"H		
	<ul style="list-style-type: none"> • Glass price group 1 No cost • Glass price group 2 +\$ 408 • Glass price group 3 +\$ 487 • Glass price group 4 +\$ 783 • Glass price group 5 N.A. • Glass price group 6 +\$1548 		Specify glass number for lite. Specify glass number for lite. Specify glass number for lite. Specify glass number for lite. Specify glass number for lite. Specify glass number for lite.
Swing Orientation	<ul style="list-style-type: none"> • Left-hand door frame No cost • Right-hand door frame No cost 		Specify with <i>left-hand door frame</i> . Specify with <i>right-hand door frame</i> .
Lock Prep	<ul style="list-style-type: none"> • Strike plate and factory prep for cylindrical passage set or lockset No cost • Strike plate and factory prep for mortise passage set or lockset +\$ 46 		Specify with <i>cylindrical prep</i> . Specify with <i>mortise prep</i> .
Related Products	<ul style="list-style-type: none"> • Door frames • Passage sets and locksets • Hinges • Stops 		▶ Page 148 ▶ Page 168 ▶ Page 170 ▶ Page 170



For Canadian Pricing
Multiply U.S. Price by the Canadian price factor.
▶ See page 1 for details.

Specification Information

Width	Corresponding Frame Width	Style Number	U.S. Base Price
-------	---------------------------	--------------	-----------------



Solid Single Door

35 ¹³ / ₁₆ "	40"	GPLSSBT40	\$1635
------------------------------------	-----	------------------	--------

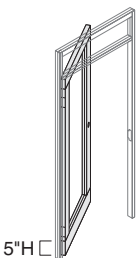

Glass Single Door with 5"H Bottom Rail

35 ¹³ / ₁₆ "	40"	GPLGSBT40	\$4463
------------------------------------	-----	------------------	--------

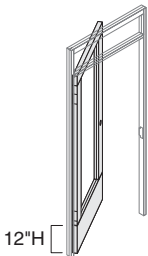

Glass Single Door with 12"H Bottom Rail

35 ¹³ / ₁₆ "	40"	GPLGSBT40B	\$4463
------------------------------------	-----	-------------------	--------

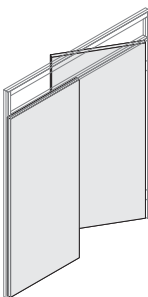

Solid Pair Door

71 ⁵ / ₈ "	76"	GPLSPBT76	\$3350
----------------------------------	-----	------------------	--------

 **For Canadian Pricing**
Multiply U.S. Price by the Canadian price factor.
▶ See page 1 for details.

Full-Height Pivot-Hinged Door Leaves



Tip: Glass door is available up to 9'0"H ceiling height.

Tip: Privacy Wall pivot-hinged door leaves work with Privacy Wall door frames only.

Tip: For information regarding Etched and Pattern Glass Planning.
▶ Page 104.

Tip: Door frame glass surface option is available on transom door frames only.

Tip: Ceiling height option is available on solid door leaves only.

Tip: Swing orientation is available on single pivot-hinged door frame with transom only.

Standard Includes		Required to Specify	
▶ Need help? Product details, page 40	<ul style="list-style-type: none"> Ceiling height from 8'0"H to 10'0"H, in one-inch increments <i>Exception: Maximum ceiling height of glass doors is 9'0"H.</i> Reversible pivot-hinged door: paint, glass, or flat-cut veneer Factory prep for pivot hinges 	<ol style="list-style-type: none"> Style number Ceiling height Paint color number for door, if solid door selected Glass number for glass door, if glass door selected Paint color number for glass door, if glass door selected Wood veneer color number, if selected Factory prep for cylindrical or mortise passage set or lockset, if selected Options, if selected (see below) 	▶ See <i>Surface Materials</i> , page 408.

Options	U.S. Price	Required to Specify	
Surface Materials	Glass door surface		
<ul style="list-style-type: none"> Paint price group 1 Paint price group 2 Paint price group 3 	<ul style="list-style-type: none"> No cost +\$ 29 +\$ 48 	<ul style="list-style-type: none"> Specify paint color number. Specify paint color number. Specify paint color number. 	
37³/₁₆"W solid single door leaf 8'0"H through 10'0"H			
<ul style="list-style-type: none"> Paint price group 1 Paint price group 3 Wood veneer (flat cut) Quarter-cut wood veneer 	<ul style="list-style-type: none"> No cost +\$ 115 No cost +\$ 182 	<ul style="list-style-type: none"> Specify paint color number. Specify paint color number. Specify wood veneer color number. Specify with <i>Quarter-cut open pore veneer</i>. 	
<ul style="list-style-type: none"> Customiz stain 	No cost	Specify with <i>Customiz stain</i> .	
77¹/₂"W solid pair door leaves 8'0"H through 10'0"H			
<ul style="list-style-type: none"> Paint price group 1 Paint price group 3 Wood veneer (flat cut) Quarter-cut wood veneer Customiz stain 	<ul style="list-style-type: none"> No cost +\$ 227 No cost +\$ 369 No cost 	<ul style="list-style-type: none"> Specify paint color number. Specify paint color number. Specify wood veneer color number. Specify wood veneer color number. Specify with <i>Customiz stain</i>. 	
Glass single door 8'0"H through 9'0"H			
<ul style="list-style-type: none"> Glass price group 1 Glass price group 2 Glass price group 3 Glass price group 4 Glass price group 5 Glass price group 6 	<ul style="list-style-type: none"> No cost +\$ 408 +\$ 487 +\$ 783 N.A. +\$1548 	<ul style="list-style-type: none"> Specify glass number for lite. Specify glass number for lite. Specify glass number for lite. Specify glass number for lite. Specify glass number for lite. Specify glass number for lite. 	
Ceiling Height	Solid single door leaves		
	<ul style="list-style-type: none"> 8'0" through 9'0" 9'1" through 10'0" 	<ul style="list-style-type: none"> No cost +\$ 287 	<ul style="list-style-type: none"> Specify ceiling height in 1" increments. Specify ceiling height in 1" increments.
	Solid pair door leaves		
	<ul style="list-style-type: none"> 8'0" through 9'0" 9'1" through 10'0" 	<ul style="list-style-type: none"> No cost +\$ 572 	<ul style="list-style-type: none"> Specify ceiling height in 1" increments. Specify ceiling height in 1" increments.
▶ Lock Prep Page 42	<ul style="list-style-type: none"> Strike plate and factory prep for cylindrical passage set or lockset Strike plate and factory prep for mortise passage set or lockset 	<ul style="list-style-type: none"> No cost +\$ 46 	<ul style="list-style-type: none"> Specify with <i>cylindrical prep</i>. Specify with <i>mortise prep</i>.
Related Products	<ul style="list-style-type: none"> Door frames Passage sets and locksets Hinges Stops 		<ul style="list-style-type: none"> ▶ Page 150 ▶ Page 168 ▶ Page 170 ▶ Page 170



For Canadian Pricing
Multiply U.S. Price by the Canadian price factor.
▶ See page 1 for details.

Specification Information

Width	Corresponding Frame Width	Style Number	U.S. Base Price
-------	---------------------------	--------------	-----------------



Solid Single Door

37 ³ / ₁₆ "	40"	GPLSSPF40	\$2174
-----------------------------------	-----	------------------	--------



Glass Single Door with 5"H Bottom Rail

37 ³ / ₁₆ "	40"	GPLGSPF40	\$4581
-----------------------------------	-----	------------------	--------

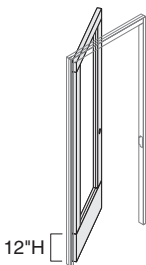

Glass Single Door with 12"H Bottom Rail

37 ³ / ₁₆ "	40"	GPLGSPF40B	\$4581
-----------------------------------	-----	-------------------	--------

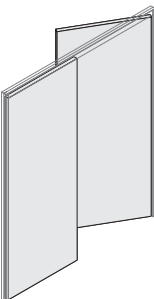

Solid Pair Door

77 ¹ / ₂ "	80"	GPLSPPF80	\$4428
----------------------------------	-----	------------------	--------

 **For Canadian Pricing**
Multiply U.S. Price by the Canadian price factor.
▶ See page 1 for details.

Transom-Height Pivot-Hinged Door Leaves



Tip: Privacy Wall pivot-hinged door leaves work with Privacy Wall door frames only.

Tip: For information regarding Etched and Pattern Glass Planning.
▶ Page 104.

Standard Includes		Required to Specify
▶ Need help? Product details, page 40	<ul style="list-style-type: none"> • 7'0"H • Reversible pivot-hinged door: paint, glass, or flat-cut veneer • Factory prep for pivot hinges 	<ol style="list-style-type: none"> 1 Style number 2 Paint color number for door, if solid door selected 3 Glass number for glass door, if glass door selected 4 Paint color number for glass door, if glass door selected 5 Wood veneer color number, if selected 6 Factory prep for cylindrical or mortise passage set or lockset, if selected 7 Options, if selected (see below) <p>▶ See <i>Surface Materials</i>, page 408.</p>

Options	U.S. Price	Required to Specify
Surface Materials	Transom-height glass door leaves	
<ul style="list-style-type: none"> • Paint price group 1 • Paint price group 2 • Paint price group 3 	<ul style="list-style-type: none"> No cost +\$ 29 +\$ 48 	<ul style="list-style-type: none"> Specify paint color number. Specify paint color number. Specify paint color number.
	37³/₁₆"W solid single door leaves 7'0"H	
<ul style="list-style-type: none"> • Paint price group 1 • Paint price group 3 • Wood veneer (flat cut) • Quarter-cut wood veneer • Customiz stain 	<ul style="list-style-type: none"> No cost +\$ 115 No cost +\$ 166 No cost 	<ul style="list-style-type: none"> Specify paint color number. Specify paint color number. Specify wood veneer color number. Specify wood veneer color number. Specify with <i>Customiz stain</i>.
	77¹/₂"W solid pair door leaves 7'0"H	
<ul style="list-style-type: none"> • Paint price group 1 • Paint price group 3 • Wood veneer (flat cut) • Quarter-cut wood veneer • Customiz stain 	<ul style="list-style-type: none"> No cost +\$ 227 No cost +\$ 332 No cost 	<ul style="list-style-type: none"> Specify paint color number. Specify paint color number. Specify wood veneer color number. Specify wood veneer color number. Specify with <i>Customiz stain</i>.
	Glass single door 7'0"H	
<ul style="list-style-type: none"> • Glass price group 1 • Glass price group 2 • Glass price group 3 • Glass price group 4 • Glass price group 5 • Glass price group 6 	<ul style="list-style-type: none"> No cost +\$ 408 +\$ 487 +\$ 783 N.A. +\$1548 	<ul style="list-style-type: none"> Specify glass number for lite. Specify glass number for lite. Specify glass number for lite. Specify glass number for lite. Specify glass number for lite. Specify glass number for lite.
Lock Prep		
▶ Page 42	<ul style="list-style-type: none"> • Strike plate and factory prep for cylindrical passage set or lockset • Strike plate and factory prep for mortise passage set or lockset 	<ul style="list-style-type: none"> No cost +\$ 46 <p>Specify with <i>cylindrical prep</i>.</p> <p>Specify with <i>mortise prep</i>.</p>
Related Products	<ul style="list-style-type: none"> • Door frames • Passage sets and locksets • Hinges • Stops 	<ul style="list-style-type: none"> ▶ Page 150 ▶ Page 168 ▶ Page 170 ▶ Page 170



For Canadian Pricing
Multiply U.S. Price by the Canadian price factor.
▶ See page 1 for details.

Specification Information

Width	Corresponding Frame Width	Style Number	U.S. Base Price
-------	---------------------------	--------------	-----------------

Solid Single Door

37 ³ / ₁₆ "	40"	GPLSSPT40	\$1992
-----------------------------------	-----	------------------	--------



Glass Single Door with 5"H Bottom Rail

37 ³ / ₁₆ "	40"	GPLGSPT40	\$4463
-----------------------------------	-----	------------------	--------

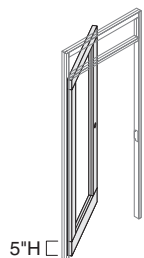

5"H

Glass Single Door with 12"H Bottom Rail

37 ³ / ₁₆ "	40"	GPLGSPT40B	\$4463
-----------------------------------	-----	-------------------	--------



12"H

Solid Pair Door

77 ¹ / ₂ "	80"	GPLSPPT80	\$4066
----------------------------------	-----	------------------	--------

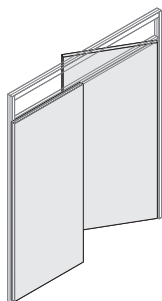

 **For Canadian Pricing**
Multiply U.S. Price by the
Canadian price factor.
▶ See page 1 for details.

Full-Height Pivot-Hinged Door Leaves for Use with Switch Cutout



Tip: Glass door is available up to 9'0"H ceiling height.

Tip: Privacy Wall pivot-hinged door leaves work with Privacy Wall door frames only.

Tip: For information regarding Etched and Pattern Glass Planning. ▶ Page 104.

Tip: Ceiling height option is available on solid door leaves only.

Standard Includes		Required to Specify
▶ Need help? Product details, page 40	<ul style="list-style-type: none"> Ceiling height from 8'0"H to 10'0"H, in one-inch increments <i>Exception: Maximum ceiling height of glass doors is 9'0"H.</i> Reversible pivot-hinged door: paint, glass, or flat-cut veneer Factory prep for pivot hinges 	<ol style="list-style-type: none"> Style number Ceiling height Paint color number for door, if solid door selected Glass number for glass door, if glass door selected Paint color number for glass door, if glass door selected Wood veneer color number, if selected Factory prep for cylindrical or mortise passage set or lockset, if selected Options, if selected (see below) <p>▶ See <i>Surface Materials</i>, page 408.</p>

Options	U.S. Price	Required to Specify	
Surface Materials	Full-height glass door leaves surface options		
<ul style="list-style-type: none"> Paint price group 1 Paint price group 2 Paint price group 3 	<ul style="list-style-type: none"> No cost +\$ 29 +\$ 48 	<ul style="list-style-type: none"> Specify paint color number. Specify paint color number. Specify paint color number. 	
	36³/₈"W solid door leaves 8'0"H through 10'0"H		
<ul style="list-style-type: none"> Paint price group 1 Paint price group 3 Wood veneer (flat cut) Quarter-cut wood veneer Customiz stain 	<ul style="list-style-type: none"> No cost +\$ 115 No cost +\$ 182 No cost 	<ul style="list-style-type: none"> Specify paint color number. Specify paint color number. Specify wood veneer color number. Specify wood veneer color number. Specify with <i>Customiz stain</i>. 	
	Glass single door		
<ul style="list-style-type: none"> Glass price group 1 Glass price group 2 Glass price group 3 Glass price group 4 Glass price group 5 Glass price group 6 	<ul style="list-style-type: none"> No cost +\$ 408 +\$ 487 +\$ 783 N.A. +\$1548 	<ul style="list-style-type: none"> Specify glass number for lite. Specify glass number for lite. Specify glass number for lite. Specify glass number for lite. Specify glass number for lite. Specify glass number for lite. 	
	Ceiling Height		
	Solid single door leaves		
	<ul style="list-style-type: none"> 8'0" through 9'0" 9'1" through 10'0" 	<ul style="list-style-type: none"> No cost +\$ 287 	<ul style="list-style-type: none"> Specify ceiling height in 1" increments. Specify ceiling height in 1" increments.
	Lock Prep		
▶ Page 42	<ul style="list-style-type: none"> Strike plate and factory prep for cylindrical passage set or lockset Strike plate and factory prep for mortise passage set or lockset 	<ul style="list-style-type: none"> No cost +\$ 46 	<ul style="list-style-type: none"> Specify with <i>cylindrical prep</i>. Specify with <i>mortise prep</i>.
	Related Products		
<ul style="list-style-type: none"> Door frames Passage sets and locksets Hinges Stops 		<ul style="list-style-type: none"> ▶ Page 154 ▶ Page 168 ▶ Page 170 ▶ Page 170 	



For Canadian Pricing
Multiply U.S. Price by the Canadian price factor.
▶ See page 1 for details.

Full-Height Pivot-Hinged Door
Leaves for Use with Switch
Cutout

Specification Information

Width	Corresponding Frame Width	Style Number	U.S. Base Price
-------	---------------------------	--------------	-----------------

Solid Single Door

36 $\frac{3}{8}$ "	42"	GPLSSPF42	\$2174
--------------------	-----	------------------	--------



Glass Single Door with 5"H Bottom Rail

36 $\frac{3}{8}$ "	42"	GPLGSPF42	\$4581
--------------------	-----	------------------	--------

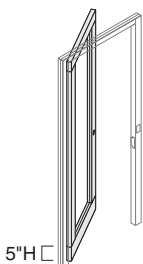

5"H

Glass Single Door with 12"H Bottom Rail

36 $\frac{3}{8}$ "	42"	GPLGSPF42B	\$4581
--------------------	-----	-------------------	--------

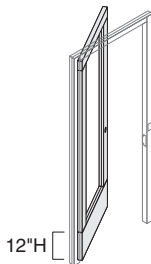

12"H

 **For Canadian Pricing**
Multiply U.S. Price by the
Canadian price factor.
▶ See page 1 for details.

Transom-Height Pivot-Hinged Door Leaves for Use with Switch Cutout



Tip: Privacy Wall pivot-hinged door leaves work with Privacy Wall door frames only.

Tip: For information regarding Etched and Pattern Glass Planning.
▶ Page 104.

Tip: Door frame glass surface option is available on transom door frames only.

Standard Includes	Required to Specify
<ul style="list-style-type: none"> ▶ Need help? Product details, page 40 • 7'0"H • Reversible pivot-hinged door: paint, glass, or flat-cut veneer • Factory prep for pivot hinges 	<ol style="list-style-type: none"> 1 Style number 2 Paint color number for door, if solid door selected 3 Glass number for glass door, if glass door selected 4 Paint color number for glass door, if glass door selected 5 Wood veneer color number, if selected 6 Factory prep for cylindrical or mortise passage set or lockset, if selected 7 Options, if selected (see below) <p>▶ See <i>Surface Materials</i>, page 408.</p>

Options	U.S. Price	Required to Specify
Surface Materials		
Transom-height glass door leaves surface options		
• Paint price group 1	No cost	Specify paint color number.
• Paint price group 2	+\$ 29	Specify paint color number.
• Paint price group 3	+\$ 48	Specify paint color number.
36³/₈"W solid door leaves 8'0"H through 10'0"H		
• Paint price group 1	No cost	Specify paint color number.
• Paint price group 3	+\$ 115	Specify paint color number.
• Wood veneer (flat cut)	No cost	Specify wood veneer color number.
• Quarter-cut wood veneer	+\$ 166	Specify wood veneer color number
• Customiz stain	No cost	Specify with <i>Customiz stain</i> .
Glass single door 7'0"H		
• Glass price group 1	No cost	Specify glass number for lite.
• Glass price group 2	+\$ 408	Specify glass number for lite.
• Glass price group 3	+\$ 487	Specify glass number for lite.
• Glass price group 4	+\$ 783	Specify glass number for lite.
• Glass price group 5	N.A.	Specify glass number for lite.
• Glass price group 6	+\$1548	Specify glass number for lite.
Lock Prep		
▶ Page 42		
• Strike plate and factory prep for cylindrical passage set or lockset	No cost	Specify with <i>cylindrical prep</i> .
• Strike plate and factory prep for mortise passage set or lockset	+\$ 46	Specify with <i>mortise prep</i> .
Related Products		
• Door frames		▶ Page 154
• Passage sets and locksets		▶ Page 168
• Hinges		▶ Page 170
• Stops		▶ Page 170



For Canadian Pricing
Multiply U.S. Price by the Canadian price factor.
▶ See page 1 for details.

Transom-Height Pivot-Hinged
Door Leaves for Use with
Switch Cutout

Specification Information

Width	Corresponding Frame Width	Style Number	U.S. Base Price
-------	---------------------------	--------------	-----------------

Solid Single Door

36 $\frac{3}{8}$ "	42"	GPLSSPT42	\$1992
--------------------	-----	------------------	--------

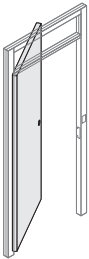

Glass Single Door with 5"H Bottom Rail

36 $\frac{3}{8}$ "	42"	GPLGSPT42	\$4463
--------------------	-----	------------------	--------

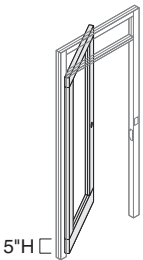

5"H

Glass Single Door with 12"H Bottom Rail

36 $\frac{3}{8}$ "	42"	GPLGSPT42B	\$4463
--------------------	-----	-------------------	--------

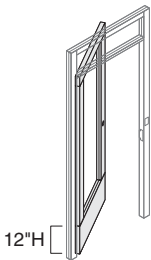

12"H

 **For Canadian Pricing**
Multiply U.S. Price by the
Canadian price factor.
▶ See page 1 for details.

Hardware and Accessories for Swing Doors

Cylindrical Passage Set and Lockset

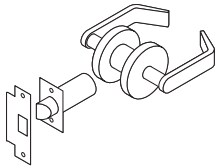

Standard Includes		Required to Specify
<ul style="list-style-type: none"> ▶ Need help? Product details, page 36 	<ul style="list-style-type: none"> • Cylindrical passage set or lockset, keyed randomly • Strike plate 	<ol style="list-style-type: none"> 1 Style number 2 Metal color number for passage set or lockset and strike plate: 9200 Satin Chrome 9201 Polished Chrome 3 Options, if selected (see below)

Options	U.S. Price	Required to Specify
Surface Materials <ul style="list-style-type: none"> • 9200 Satin Chrome • 9201 Polished Chrome 	No cost +\$26	Specify <i>with satin chrome.</i> Specify <i>with polished chrome.</i>

Specification Information	
• Style Number	• U.S. Base Price
.....

Cylindrical Passage Set

GPDCLA	\$ 642
.....

Cylindrical Lockset

GPDCLO	\$ 877
.....

Mortise Passage Set and Lockset

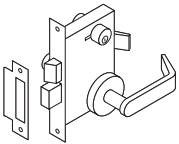

Tip: Door frame glass surface option is available on transom door frames only.

Tip: Ceiling height option is available on solid door leaves only.

Tip: Swing orientation is available on single-pivot-hinged door frame with transom only.

Standard Includes		Required to Specify
<ul style="list-style-type: none"> ▶ Need help? Product details, page 36 	<ul style="list-style-type: none"> • Mortise passage set or lockset, keyed randomly • Strike plate 	<ol style="list-style-type: none"> 1 Style number 2 Metal color number for passage set or lockset and strike plate: 9200 Satin Chrome 9201 Polished Chrome 3 Options, if selected (see below)

Options	U.S. Price	Required to Specify
Surface Materials <ul style="list-style-type: none"> • 9200 Satin Chrome • 9201 Polished Chrome 	No cost +\$37	Specify <i>with satin chrome.</i> Specify <i>with polished chrome.</i>

Specification Information	
• Style Number	• U.S. Base Price
.....

Mortise Passage Set

GPDMLA	\$1086
.....

Mortise Lockset

GPDMLO	\$1297
.....



For Canadian Pricing
Multiply U.S. Price by the Canadian price factor.
▶ See page 1 for details.

Butt Hinge Kits



Standard Includes		Required to Specify
<ul style="list-style-type: none"> ▶ Need help? Product details, page 34 	<ul style="list-style-type: none"> • Set of butt hinges • Hinge kits for pair doors include flush bolts for inactive doors 	<ul style="list-style-type: none"> 1 Style number 2 Metal color number for set of hinges and flush bolts: <ul style="list-style-type: none"> 9200 Satin Chrome 9201 Polished Chrome 3 Options, if selected (see below)

Options	U.S. Price	Required to Specify
Surface Materials Three hinges <ul style="list-style-type: none"> • 9200 Satin Chrome • 9201 Polished Chrome 	No cost +\$35	Specify with <i>satin chrome</i> . Specify with <i>polished chrome</i> .
Four hinges <ul style="list-style-type: none"> • 9200 Satin Chrome • 9201 Polished Chrome 	No cost +\$46	Specify with <i>satin chrome</i> . Specify with <i>polished chrome</i> .
Six or eight hinges <ul style="list-style-type: none"> • 9200 Satin Chrome • 9201 Polished Chrome 	No cost +\$69	Specify with <i>satin chrome</i> . Specify with <i>polished chrome</i> .

Specification Information		
Number of Hinges	Style Number	U.S. Base Price
...

Butt Hinges for Single Doors and Frames

For Use with 84" H Door

3	GPDBH3	\$156
---	---------------	-------

For Use with Full-Height Door

4	GPDBH4	\$207
...

Butt Hinges for Pair Doors and Frames

For Use with 84" H Door

6	GPDBH3P	\$459
---	----------------	-------

For Use with Full-Height Door

8	GPDBH4P	\$512
...



For Canadian Pricing
Multiply U.S. Price by the Canadian price factor.
▶ See page 1 for details.

Hardware and Accessories for Swing Doors, continued

Pivot Hinge Kits

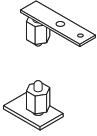

Standard Includes	Required to Specify
<ul style="list-style-type: none"> ▶ Need help? Product details, page 40 • Set of pivot hinges: 9200 Satin Chrome • Hinge kits for pair doors include flush bolts for inactive doors 	<ul style="list-style-type: none"> 1 Style number 2 Metal color number for flush bolts: 9200 Satin Chrome, 9201 Polished Chrome 3 Options, if selected (see below)

Options	U.S. Price	Required to Specify
Surface Materials <ul style="list-style-type: none"> • 9200 Satin Chrome • 9201 Polished Chrome 	No cost +\$33	Specify <i>with satin chrome</i> . Specify <i>with polished chrome</i> .

Specification Information

Style Number	U.S. Base Price

Pivot Hinges for Single Doors and Frames

GPDPHS	\$ 315

Pivot Hinges for Pair Doors and Frames

GPDPHSP	\$1051

Magnetic Wall Stop



Tip: For use with painted solid or Clerestory panels only.

Standard Includes	Required to Specify
<ul style="list-style-type: none"> ▶ Need help? Product details, page 36 • Magnetic wall stop 	<ul style="list-style-type: none"> 1 Style number 2 Metal color number: 9200 Satin Chrome, 9201 Polished Chrome 3 Options, if selected (see below)

Options	U.S. Price	Required to Specify
Surface Materials <ul style="list-style-type: none"> • 9200 Satin Chrome • 9201 Polished Chrome 	No cost +\$26	Specify <i>with satin chrome</i> . Specify <i>with polished chrome</i> .

Specification Information

Style Number	U.S. Base Price

GPDMWS	\$ 42



For Canadian Pricing
Multiply U.S. Price by the Canadian price factor.
▶ See page 1 for details.

Dome-Style Floor Stop



Standard Includes		Required to Specify	
<ul style="list-style-type: none"> Need help? Product details, page 36 	<ul style="list-style-type: none"> Dome-style floor stop 	<ul style="list-style-type: none"> 1 Style number 2 Metal color number: <ul style="list-style-type: none"> 9200 Satin Chrome 9201 Polished Chrome 3 Options, if selected (see below) 	
Options		U.S. Price	Required to Specify
Surface Materials	<ul style="list-style-type: none"> 9200 Satin Chrome 9201 Polished Chrome 	No cost +\$26	Specify with <i>satin chrome</i> . Specify with <i>polished chrome</i> .
Specification Information			
Style Number	U.S. Base Price		
GPDDFS	\$19		

Screw-In Base Stop

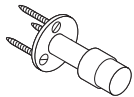

Standard Includes		Required to Specify	
<ul style="list-style-type: none"> Need help? Product details, page 36 	<ul style="list-style-type: none"> Screw-in base stop 	<ul style="list-style-type: none"> 1 Style number 2 Metal color number: <ul style="list-style-type: none"> 9200 Satin Chrome 9201 Polished Chrome 3 Options, if selected (see below) 	
Options		U.S. Price	Required to Specify
Surface Materials	<ul style="list-style-type: none"> 9200 Satin Chrome 9201 Polished Chrome 	No cost +\$26	Specify with <i>satin chrome</i> . Specify with <i>polished chrome</i> .
Specification Information			
Style Number	U.S. Base Price		
GPDSBS	\$70		



For Canadian Pricing
Multiply U.S. Price by the Canadian price factor.
▶ See page 1 for details.

Low-Voltage Switches

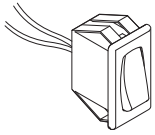

Tip: Switches are UL- and CSA-rated.

Tip: Low-voltage switch assemblies are specified by voltage rating to correspond to the voltage of the lighting system. This ensures that the transformer will be compatible with the lighting system.

Standard Includes	Required to Specify
<ul style="list-style-type: none"> ▶ Need help? Product details, page 37 • Switch: black • 18-gauge wire • Switch plate: black • Transformer 	Style number

Specification Information

Style Number	U.S. Price
--------------	------------

Low-Voltage Switch (24V) with 120V Transformer

GPDS120	\$315
----------------	-------

Low-Voltage Switch (24V) with 277V Transformer

GPDS277	\$327
----------------	-------

Low-Voltage Switch (24V) with 347V Transformer

GPDS347	\$390
----------------	-------

High-Voltage Switches

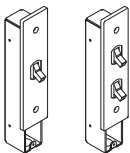

Tip: Switches are UL- and CSA-rated.

Standard Includes	Required to Specify
<ul style="list-style-type: none"> ▶ Need help? Product details, page 37 • Switch: ivory • Electrical box and related hardware • Switch plate: clear anodized satin 	Style number

Specification Information

Style Number	U.S. Price
--------------	------------

Single Pole Single Switch

GPDS1	\$200
--------------	-------

Single Pole Double Switch

GPDS1	\$303
--------------	-------



For Canadian Pricing
 Multiply U.S. Price by the Canadian price factor.
 ▶ See page 1 for details.

Privacy Wall Slider Doors with Tubular Pull

All Glass

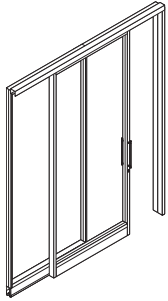

Tip: For information regarding Etched and Pattern Glass Planning.

▶ Page 104.

Tip: Upcharge per lite includes the glass in the door and the side panel.

Standard Includes	Required to Specify
<p>▶ Need help? Product details, page 48</p> <ul style="list-style-type: none"> • Ceiling height from 8'0"H to 10'0"H, in one-inch increments • Slider door: glass • 1/4"-thick clear tempered glass • Door frame: paint • Side panel • Slide hardware • Floor track with adjustable levelers to accommodate continuous 5"H base trim (ordered separately): paint • Low-voltage knockout for door switch 	<ol style="list-style-type: none"> 1 Style number 2 Ceiling height 3 Paint for frame and muntins 4 Glass color number for full glass, if selected 5 Glass color number(s) for three or four equal divided lites, if selected 6 Glass color number(s) for two or four transom-aligned lites, if selected 7 Paint color number for floor track 8 Post extension 9 Slide orientation 10 Options, if selected (see below) <p>▶ See <i>Surface Materials</i>, page 408.</p>

Options	U.S. Price	Required to Specify
<p>Surface Materials</p> <p>Glass frame surface</p> <ul style="list-style-type: none"> • Paint price group 1 No cost • Paint price group 2 +\$ 53 • Paint price group 3 +\$ 96 <hr/> <p>80"W doors 96"H through 120"H</p> <ul style="list-style-type: none"> • Glass price group 1 No cost • Glass price group 2 +\$1040 • Glass price group 3 +\$1239 • Glass price group 4 +\$1986 • Glass price group 5 N.A. • Glass price group 6 +\$3916 <hr/> <p>96"W doors 96"H through 120"H</p> <ul style="list-style-type: none"> • Glass price group 1 No cost • Glass price group 2 +\$1250 • Glass price group 3 +\$1485 • Glass price group 4 +\$2382 • Glass price group 5 N.A. • Glass price group 6 +\$4698 		<p>Specify paint color number.</p> <p>Specify paint color number.</p> <p>Specify paint color number.</p> <hr/> <p>Specify glass number for door.</p> <p>Specify glass number for door.</p> <p>Specify glass number for door.</p> <p>Specify glass number for door.</p> <p>Specify glass number for door.</p> <p>Specify glass number for door.</p> <hr/> <p>Specify glass number for door.</p> <p>Specify glass number for door.</p> <p>Specify glass number for door.</p> <p>Specify glass number for door.</p> <p>Specify glass number for door.</p> <hr/> <p>Specify glass number for door.</p> <p>Specify glass number for door.</p> <p>Specify glass number for door.</p> <p>Specify glass number for door.</p> <p>Specify glass number for door.</p>
<p>Ceiling Height</p> <ul style="list-style-type: none"> • 8'0" through 9'0" No cost • 9'1" through 10'0" +\$ 96 		<p>Specify ceiling height in 1" increments.</p> <p>Specify ceiling height in 1" increments.</p>
<p>Pull</p> <ul style="list-style-type: none"> • No pull and no door prep for pull -\$ 94 		<p>Specify <i>with no pull</i>.</p>
<p>Lock</p> <ul style="list-style-type: none"> • Door lock with interior thumb latch +\$ 452 		<p>Specify <i>with lock</i>.</p>
<p>Slide Orientation</p> <ul style="list-style-type: none"> • Left-hand slider door No cost • Right-hand slider door No cost <p>▶ Page 49</p>		<p>Specify <i>with left-hand slider door</i>.</p> <p>Specify <i>with right-hand slider door</i>.</p>
<p>Post Extension</p> <ul style="list-style-type: none"> • Post extensions modified to accommodate recessed ceiling track (ordered separately) No cost • Post extensions modified to accommodate overlapping ceiling track (ordered separately) No cost 		<p>Specify <i>with post extensions for recessed ceiling track interface</i>.</p> <p>Specify <i>with post extensions for overlapping ceiling track interface</i>.</p>
<p>Related Products</p> <ul style="list-style-type: none"> • Switches • Ceiling tracks • Continuous base trim • Feature strips 		<p>▶ Page 172</p> <p>▶ Page 238</p> <p>▶ Page 244</p> <p>▶ Page 248</p>

▶ Options, continued on next page



For Canadian Pricing

Multiply U.S. Price by the Canadian price factor.

▶ See page 1 for details.

► Options, continued from previous page

Tip: SmartTools options are available and easily ordered when using SmartTools software. If you do not have access to SmartTools software, these options can also be ordered using the normal Specials RFQ (Request For Quote) process.

Tip: Slider door assembly widths are displayed in actual sizes. Relative width of door and side panel may vary.

	SmartTools Options	U.S. Price	Required to Specify
Parametric Ceiling Height (Available in 1" increments)	• 7'5"H through 7'11"H	No cost	Specify ceiling height in 1" increments.
Parametric Width Slider Door Assembly with Equal Width Door and Side Panel	• 76"W through 79"W and 81"W through 95"W • 97"W through 113"W	No cost +\$177	Specify slider door assembly widths in 1" increments. Specify slider door assembly widths in 1" increments.
Parametric Width Slider Door Assembly with Fixed Width Door and Variable Width Side Panel	• 40"W doors: 81"W through 103"W • 48"W doors: 97"W through 111"W	+\$177 +\$177	Specify slider door assembly widths in 1" increments. Specify slider door assembly widths in 1" increments.
Base	• 4"H base	+\$228	Specify to accept 4"H base.

Specification Information

Width	Style Number	U.S. Base Price
80"	GPDSSTF80	\$3670
96"	GPDSSTF96	\$3806

All Glass

80"	GPDSSTF80	\$3670
96"	GPDSSTF96	\$3806

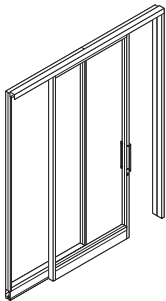

For Canadian Pricing

Multiply U.S. Price by the Canadian price factor.

► See page 1 for details.

Privacy Wall Slider Doors with Tubular Pull

Two Transom-Aligned Lites

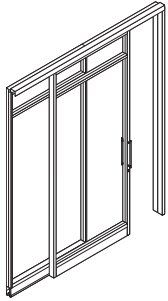

Tip: For information regarding Etched and Pattern Glass Planning, page 48

▶ Page 104.

Tip: Upcharge per lite includes the glass in the door and the side panel.

Standard Includes	Required to Specify
<ul style="list-style-type: none"> ▶ Need help? Product details, page 48 • Ceiling height from 8'0"H to 120"H, in one-inch increments • Slider door: glass • 1/4"-thick clear tempered glass • Door frame: paint • Side panel • Slide hardware • Floor track with adjustable levelers to accommodate continuous 5"H base trim (ordered separately): paint • Tubular door pull: brushed stainless • Low-voltage knockout for door switch 	<ol style="list-style-type: none"> 1 Style number 2 Ceiling height 3 Paint for frame and muntins 4 Glass color number for full glass, if selected 5 Glass color number(s) for three or four equal divided lites, if selected 6 Glass color number(s) for two or four transom-aligned lites, if selected 7 Paint color number for floor track 8 Post extension 9 Slide orientation 10 Options, if selected (see below) <p>▶ See <i>Surface Materials</i>, page 408.</p>

Options	U.S. Price	Required to Specify
Surface Materials <ul style="list-style-type: none"> • Glass frame surface • Paint price group 1 • Paint price group 2 • Paint price group 3 	<ul style="list-style-type: none"> No cost +\$ 53 -\$ 96 	<ul style="list-style-type: none"> Specify paint color number. Specify paint color number. Specify paint color number.
80"W doors 96"H through 120"H (per top lite row of glass)		
<ul style="list-style-type: none"> • Glass price group 1 • Glass price group 2 • Glass price group 3 • Glass price group 4 • Glass price group 5 • Glass price group 6 	<ul style="list-style-type: none"> No cost +\$ 194 +\$ 231 +\$ 371 N.A. +\$ 727 	<ul style="list-style-type: none"> Specify glass number for door. Specify glass number for door. Specify glass number for door. Specify glass number for door. Specify glass number for door. Specify glass number for door.
80"W doors 96"H through 120"H (per lower lite row of glass)		
<ul style="list-style-type: none"> • Glass price group 1 • Glass price group 2 • Glass price group 3 • Glass price group 4 • Glass price group 5 • Glass price group 6 	<ul style="list-style-type: none"> No cost +\$ 884 +\$1050 +\$1684 N.A. +\$3325 	<ul style="list-style-type: none"> Specify glass number for door. Specify glass number for door. Specify glass number for door. Specify glass number for door. Specify glass number for door. Specify glass number for door.
96"W doors 96"H through 120"H (per top lite row of glass)		
<ul style="list-style-type: none"> • Glass price group 1 • Glass price group 2 • Glass price group 3 • Glass price group 4 • Glass price group 5 • Glass price group 6 	<ul style="list-style-type: none"> No cost +\$ 222 +\$ 264 +\$ 421 N.A. +\$ 833 	<ul style="list-style-type: none"> Specify glass number for door. Specify glass number for door. Specify glass number for door. Specify glass number for door. Specify glass number for door. Specify glass number for door.
96"W doors 96"H through 120"H (per lower lite row of glass)		
<ul style="list-style-type: none"> • Glass price group 1 • Glass price group 2 • Glass price group 3 • Glass price group 4 • Glass price group 5 • Glass price group 6 	<ul style="list-style-type: none"> No cost +\$1007 +\$1201 +\$1924 N.A. +\$3798 	<ul style="list-style-type: none"> Specify glass number for door. Specify glass number for door. Specify glass number for door. Specify glass number for door. Specify glass number for door. Specify glass number for door.
Ceiling Height <ul style="list-style-type: none"> • 8'0" through 9'0" • 9'1" through 10'0" 	<ul style="list-style-type: none"> No cost +\$ 96 	<ul style="list-style-type: none"> Specify ceiling height in 1" increments. Specify ceiling height in 1" increments.
Pull <ul style="list-style-type: none"> • No pull and no door prep for pull 	<ul style="list-style-type: none"> -\$ 94 	<ul style="list-style-type: none"> Specify <i>with no pull</i>.
Lock <ul style="list-style-type: none"> • Door lock with interior thumb latch 	<ul style="list-style-type: none"> +\$ 452 	<ul style="list-style-type: none"> Specify <i>with lock</i>.
Slide Orientation <ul style="list-style-type: none"> • Left-hand slider door • Right-hand slider door 	<ul style="list-style-type: none"> No cost No cost 	<ul style="list-style-type: none"> Specify <i>with left-hand slider door</i>. Specify <i>with right-hand slider door</i>.

▶ Page 49

▶ Options, continued on next page

 **For Canadian Pricing**
 Multiply U.S. Price by the Canadian price factor.
 ▶ See page 1 for details.

► Options, continued from previous page

Options	U.S. Price	Required to Specify
Post Extension	<ul style="list-style-type: none"> • Post extensions modified to accommodate recessed ceiling track (ordered separately) • Post extensions modified to accommodate overlapping ceiling track (ordered separately) 	<p>No cost</p> <p>No cost</p> <p>Specify with post extensions for recessed ceiling track interface.</p> <p>Specify with post extensions for overlapping ceiling track interface.</p>
Related Products	<ul style="list-style-type: none"> • Switches • Ceiling tracks • Continuous base trim • Feature strips 	<ul style="list-style-type: none"> ► Page 172 ► Page 238 ► Page 244 ► Page 248

Tip: SmartTools options are available and easily ordered when using SmartTools software. If you do not have access to SmartTools software, these options can also be ordered using the normal Specials RFQ (Request For Quote) process.

Tip: Slider door assembly widths are displayed in actual sizes. Relative width of door and side panel may vary.

SmartTools Options	U.S. Price	Required to Specify
Muntin	<ul style="list-style-type: none"> • Change to 1½"H or 2¼"H • Change muntin location 	<p>No cost</p> <p>No cost</p> <p>Specify change muntin size.</p> <p>Specify change muntin location.</p>
Parametric Width Slider Door Assembly with Equal Width Door and Side Panel	<ul style="list-style-type: none"> • 76"W through 79"W and 81"W through 95"W • 97"W through 113"W 	<p>No cost</p> <p>+\$177</p> <p>Specify slider door assembly widths in 1" increments.</p> <p>Specify slider door assembly widths in 1" increments.</p>
Parametric Width Slider Door Assembly with Fixed Width Door and Variable Width Side Panel	<ul style="list-style-type: none"> • 40"W doors: 81"W through 103"W • 48"W doors: 97"W through 111"W 	<p>+\$177</p> <p>+\$177</p> <p>Specify slider door assembly widths in 1" increments.</p> <p>Specify slider door assembly widths in 1" increments.</p>
Base	<ul style="list-style-type: none"> • 4"H base 	<p>+\$228</p> <p>Specify to accept 4"H base.</p>

Specification Information

Width	Style Number	U.S. Base Price
-------	--------------	-----------------

Two Transom-Aligned Lites

80"	GPDSST2L80	\$3719
96"	GPDSST2L96	\$3882

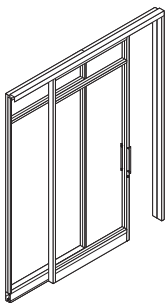

For Canadian Pricing
Multiply U.S. Price by the Canadian price factor.
► See page 1 for details.

Privacy Wall Slider Doors with Tubular Pull

Three Equal Divided Lites

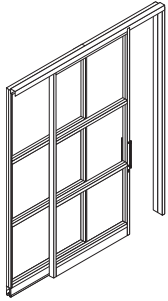

Tip: For information regarding Etched and Pattern Glass Planning.

▶ Page 104.

Tip: Upcharge per lite includes the glass in the door and the side panel.

Standard Includes		Required to Specify
▶ Need help? Product details, page 48	<ul style="list-style-type: none"> Ceiling height from 8'0"H to 120"H, in one-inch increments Slider door: glass 1/4"-thick clear tempered glass Door frame: paint Side panel Slide hardware Floor track with adjustable levelers to accommodate continuous 5"H base trim (ordered separately): paint Tubular door pull: brushed stainless Low-voltage knockout for door switch 	<ol style="list-style-type: none"> Style number Ceiling height Paint for frame and muntins Glass color number for full glass, if selected Glass color number(s) for three or four equal divided lites, if selected Glass color number(s) for two or four transom-aligned lites, if selected Paint color number for floor track Post extension Slide orientation Options, if selected (see below) <p>▶ See <i>Surface Materials</i>, page 408.</p>

Options	U.S. Price	Required to Specify
Surface Materials	Glass frame surface <ul style="list-style-type: none"> Paint price group 1: No cost Paint price group 2: +\$ 53 Paint price group 3: +\$ 96 	Specify paint color number. Specify paint color number. Specify paint color number.
80"W doors 8'0"H through 10'0"H (per row of glass)		
<ul style="list-style-type: none"> Glass price group 1: No cost Glass price group 2: +\$ 346 Glass price group 3: +\$ 413 Glass price group 4: +\$ 661 Glass price group 5: N.A. Glass price group 6: +\$1304 		Specify glass number for lite. Specify glass number for lite. Specify glass number for lite. Specify glass number for lite. Specify glass number for lite. Specify glass number for lite.
96"W doors 8'0"H through 10'0"H (per row of glass)		
<ul style="list-style-type: none"> Glass price group 1: No cost Glass price group 2: +\$ 416 Glass price group 3: +\$ 499 Glass price group 4: +\$ 796 Glass price group 5: N.A. Glass price group 6: +\$1570 		Specify glass number for lite. Specify glass number for lite. Specify glass number for lite. Specify glass number for lite. Specify glass number for lite. Specify glass number for lite.
Ceiling Height	<ul style="list-style-type: none"> 8'0" through 9'0": No cost 9'1" through 10'0": +\$ 96 	Specify ceiling height in 1" increments. Specify ceiling height in 1" increments.
Pull	<ul style="list-style-type: none"> No pull: -\$ 94 	Specify <i>with no pull</i> .
Lock	<ul style="list-style-type: none"> Door lock with interior thumb latch: +\$ 452 	Specify <i>with lock</i> .
Slide Orientation	<ul style="list-style-type: none"> Left-hand slider door: No cost Right-hand slider door: No cost 	Specify <i>with left-hand slider door</i> . Specify <i>with right-hand slider door</i> .
▶ Page 49		
Post Extension	<ul style="list-style-type: none"> Post extensions modified to accommodate recessed ceiling track (ordered separately): No cost Post extensions modified to accommodate overlapping ceiling track (ordered separately): No cost 	Specify <i>with post extensions for recessed ceiling track interface</i> . Specify <i>with post extensions for overlapping ceiling track interface</i> .
Related Products	<ul style="list-style-type: none"> Switches Ceiling tracks Continuous base trim Feature strips 	▶ Page 172 ▶ Page 238 ▶ Page 244 ▶ Page 248

▶ Options, continued on next page



For Canadian Pricing

Multiply U.S. Price by the Canadian price factor.

▶ See page 1 for details.

► Options, continued from previous page

Tip: SmartTools options are available and easily ordered when using SmartTools software. If you do not have access to SmartTools software, these options can also be ordered using the normal Specials RFQ (Request For Quote) process.

Tip: Slider door assembly widths are displayed in actual sizes. Relative width of door and side panel may vary.

Tip: Muntin quantity and location must match door assembly and side panel. See Privacy Wall Slider Doors.

► Page 49.

	SmartTools Options	U.S. Price	Required to Specify
Muntin	Change muntin size • Change to 1½"H or 2¼"H	No cost	Specify muntin size.
	Change muntin location • Change muntin location	No cost	Specify muntin location.
Parametric Ceiling Height (Available in 1" increments)	• 7½"H through 7'11"H	No cost	Specify ceiling height in 1" increments.
Parametric Width Slider Door Assembly with Equal Width Door and Side Panel	• 76"W through 79"W and 81"W through 95"W	No cost	Specify slider door assembly widths in 1" increments.
	• 97"W through 113"W	+\$177	Specify slider door assembly widths in 1" increments.
Parametric Width Slider Door Assembly with Fixed Width Door and Variable Width Side Panel	• 40"W doors: 81"W through 103"W	+\$177	Specify slider door assembly widths in 1" increments.
	• 48"W doors: 97"W through 111"W	+\$177	Specify slider door assembly widths in 1" increments.
Base	• 4"H base	+\$228	Specify to accept 4"H base.

Specification Information

Width	Style Number	U.S. Base Price
...

Three Equal Divided Lites

80"	GPDSST3E80	\$3779
96"	GPDSST3E96	\$3944
...

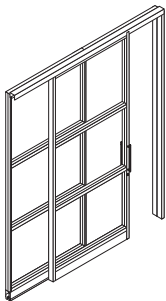

For Canadian Pricing

Multiply U.S. Price by the Canadian price factor.

► See page 1 for details.

Privacy Wall Slider Doors with Tubular Pull

Four Equal Divided Lites

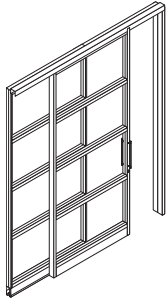

Tip: For information regarding Etched and Pattern Glass Planning.

▶ Page 104.

Tip: Upcharge per lite includes the glass in the door and the side panel.

Standard Includes	Required to Specify
<ul style="list-style-type: none"> ▶ Need help? Product details, page 48 Ceiling height from 8'0"H to 120"H, in one-inch increments Slider door: glass 1/4"-thick clear tempered glass Door frame: paint Side panel Slide hardware Floor track with adjustable levelers to accommodate continuous 5"H base trim (ordered separately): paint Tubular door pull: brushed stainless Low-voltage knockout for door switch 	<ol style="list-style-type: none"> Style number Ceiling height Paint for frame and muntins Glass color number for full glass, if selected Glass color number(s) for three or four equal divided lites, if selected Glass color number(s) for two or four transom-aligned lites, if selected Paint color number for floor track Post extension Slide orientation Options, if selected (see below) <p>▶ See <i>Surface Materials</i>, page 408.</p>

Options	U.S. Price	Required to Specify
<p>Surface Materials</p> <ul style="list-style-type: none"> Paint price group 1 Paint price group 2 Paint price group 3 	<p>No cost</p> <p>+\$ 53</p> <p>+\$ 96</p>	<p>Specify paint color number.</p> <p>Specify paint color number.</p> <p>Specify paint color number.</p>
<p>80"W doors 8'0"H through 10'0"H (per row of glass)</p>		
<ul style="list-style-type: none"> Glass price group 1 Glass price group 2 Glass price group 3 Glass price group 4 Glass price group 5 Glass price group 6 	<p>No cost</p> <p>+\$ 260</p> <p>+\$ 312</p> <p>+\$ 495</p> <p>N.A.</p> <p>+\$ 979</p>	<p>Specify glass number for lite.</p> <p>Specify glass number for lite.</p> <p>Specify glass number for lite.</p> <p>Specify glass number for lite.</p> <p>Specify glass number for lite.</p> <p>Specify glass number for lite.</p>
<p>96"W doors 8'0"H through 10'0"H (per row of glass)</p>		
<ul style="list-style-type: none"> Glass price group 1 Glass price group 2 Glass price group 3 Glass price group 4 Glass price group 5 Glass price group 6 	<p>No cost</p> <p>+\$ 312</p> <p>+\$ 375</p> <p>+\$ 597</p> <p>N.A.</p> <p>+\$1177</p>	<p>Specify glass number for lite.</p> <p>Specify glass number for lite.</p> <p>Specify glass number for lite.</p> <p>Specify glass number for lite.</p> <p>Specify glass number for lite.</p> <p>Specify glass number for lite.</p>
<p>Ceiling Height</p> <ul style="list-style-type: none"> 8'0" through 9'0" 9'1" through 10'0" 	<p>No cost</p> <p>+\$ 96</p>	<p>Specify ceiling height in 1" increments.</p> <p>Specify ceiling height in 1" increments.</p>
<p>Pull</p> <ul style="list-style-type: none"> No pull 	<p>-\$ 94</p>	<p>Specify <i>with no pull</i>.</p>
<p>Lock</p> <ul style="list-style-type: none"> Door lock with interior thumb latch 	<p>+\$ 452</p>	<p>Specify <i>with lock</i>.</p>
<p>Slide Orientation</p> <ul style="list-style-type: none"> Left-hand slider door Right-hand slider door <p>▶ Page 49</p>	<p>No cost</p> <p>No cost</p>	<p>Specify <i>with left-hand slider door</i>.</p> <p>Specify <i>with right-hand slider door</i>.</p>
<p>Post Extension</p> <ul style="list-style-type: none"> Post extensions modified to accommodate recessed ceiling track (ordered separately) Post extensions modified to accommodate overlapping ceiling track (ordered separately) 	<p>No cost</p> <p>No cost</p>	<p>Specify <i>with post extensions for recessed ceiling track interface</i>.</p> <p>Specify <i>with post extensions for overlapping ceiling track interface</i>.</p>
<p>Related Products</p> <ul style="list-style-type: none"> Switches Ceiling tracks Continuous base trim Feature strips 		<p>▶ Page 172</p> <p>▶ Page 238</p> <p>▶ Page 244</p> <p>▶ Page 248</p>

▶ Options, continued on next page



For Canadian Pricing

Multiply U.S. Price by the Canadian price factor.

▶ See page 1 for details.

► Options, continued from previous page

Tip: SmartTools options are available and easily ordered when using SmartTools software. If you do not have access to SmartTools software, these options can also be ordered using the normal Specials RFQ (Request For Quote) process.

Tip: Specify additional muntin(s) for use in five- or six-lite assembly applications. Maximum of six lites. See Privacy Wall Slider Doors. ► Page 49.

Tip: Slider door assembly widths are displayed in actual sizes. Relative width of door and side panel may vary.

	SmartTools Options	U.S. Price	Required to Specify
Surface Materials	Glass for 5th and 6th lite opening • See standard options for glass price group above		Specify glass number for lite 5 or 6.
Muntin	Change muntin size • Change to 1½"H or 2¼"H	No cost	Specify muntin size.
	Change muntin location • Change muntin location	No cost	Specify muntin location.
	Additional muntin • Muntin	+\$177	Specify with muntin.
Parametric Ceiling Height (Available in 1" increments)	• 7½"H through 7'11"H	No cost	Specify ceiling height in 1" increments.
Parametric Width Slider Door Assembly with Equal Width Door and Side Panel	• 76"W through 79"W and 81"W through 95"W	No cost	Specify slider door assembly widths in 1" increments.
	• 97"W through 113"W	+\$177	Specify slider door assembly widths in 1" increments.
Parametric Width Slider Door Assembly with Fixed Width Door and Variable Width Side Panel	• 40"W doors: 81"W through 103"W	+\$177	Specify slider door assembly widths in 1" increments.
	• 48"W doors: 97"W through 111"W	+\$177	Specify slider door assembly widths in 1" increments.
Base	• 4"H base	+\$228	Specify to accept 4"H base.

Specification Information

Width	Style Number	U.S. Base Price
...

Four Equal Divided Lites

80"	GPDSST4E80	\$3838
96"	GPDSST4E96	\$4009
...

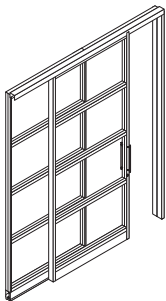

 **For Canadian Pricing**
Multiply U.S. Price by the Canadian price factor.
► See page 1 for details.

Privacy Wall Slider Doors with Tubular Pull

Four Transom-Aligned Lites

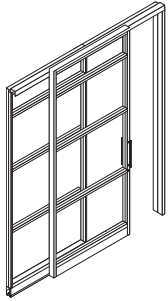

Tip: For information regarding Etched and Pattern Glass Planning.

▶ Page 104

Tip: Upcharge per lite includes the glass in the door and the side panel.

Standard Includes		Required to Specify
▶ Need help? Product details, page 48	<ul style="list-style-type: none"> Ceiling height from 8'0"H to 120"H, in one-inch increments Slider door: glass 1/4"-thick clear tempered glass Door frame: paint Side panel Slide hardware Floor track with adjustable levelers to accommodate continuous 5"H base trim (ordered separately): paint Tubular door pull: brushed stainless Low-voltage knockout for door switch 	<ol style="list-style-type: none"> Style number Ceiling height Paint for frame and muntins Glass color number for full glass, if selected Glass color number(s) for three or four equal divided lites, if selected Glass color number(s) for two or four transom-aligned lites, if selected Paint color number for floor track Post extension Slide orientation Options, if selected (see below) <p>▶ See <i>Surface Materials</i>, page 408.</p>

Options	U.S. Price	Required to Specify
Surface Materials	Glass frame surface	
• Paint price group 1	No cost	Specify paint color number.
• Paint price group 2	+\$ 53	Specify paint color number.
• Paint price group 3	+\$ 96	Specify paint color number.
80"W doors 96"H through 120"H (per top lite row of glass)		
• Glass price group 1	No cost	Specify glass number for lite.
• Glass price group 2	+\$ 194	Specify glass number for lite.
• Glass price group 3	+\$ 231	Specify glass number for lite.
• Glass price group 4	+\$ 371	Specify glass number for lite.
• Glass price group 5	N.A.	Specify glass number for lite.
• Glass price group 6	+\$ 727	Specify glass number for lite.
80"W doors 96"H through 120"H (per lower lite row of glass)		
• Glass price group 1	No cost	Specify glass number for lite.
• Glass price group 2	+\$ 280	Specify glass number for lite.
• Glass price group 3	+\$ 338	Specify glass number for lite.
• Glass price group 4	+\$ 536	Specify glass number for lite.
• Glass price group 5	N.A.	Specify glass number for lite.
• Glass price group 6	+\$1054	Specify glass number for lite.
96"W doors 96"H through 120"H (per top lite row of glass)		
• Glass price group 1	No cost	Specify glass number for lite.
• Glass price group 2	+\$ 222	Specify glass number for lite.
• Glass price group 3	+\$ 264	Specify glass number for lite.
• Glass price group 4	+\$ 421	Specify glass number for lite.
• Glass price group 5	N.A.	Specify glass number for lite.
• Glass price group 6	+\$ 833	Specify glass number for lite.
96"W doors 96"H through 120"H (per lower lite row of glass)		
• Glass price group 1	No cost	Specify glass number for lite.
• Glass price group 2	+\$ 336	Specify glass number for lite.
• Glass price group 3	+\$ 404	Specify glass number for lite.
• Glass price group 4	+\$ 643	Specify glass number for lite.
• Glass price group 5	N.A.	Specify glass number for lite.
• Glass price group 6	+\$1267	Specify glass number for lite.
Ceiling Height	• 8'0" through 9'0" • 9'1" through 10'0"	No cost +\$ 96 Specify ceiling height in 1" increments. Specify ceiling height in 1" increments.
Pull	• No pull	-\$ 94 Specify <i>with no pull</i> .
Lock	• Door lock with interior thumb latch	+\$ 452 Specify <i>with lock</i> .
Slide Orientation	• Left-hand slider door • Right-hand slider door	No cost No cost Specify <i>with left-hand slider door</i> . Specify <i>with right-hand slider door</i> .

▶ Page 49

▶ Options, continued on next page

 **For Canadian Pricing**
Multiply U.S. Price by the Canadian price factor.
▶ See page 1 for details.

► Options, continued from previous page

Options	U.S. Price	Required to Specify
Post Extension	<ul style="list-style-type: none"> • Post extensions modified to accommodate recessed ceiling track (ordered separately) • Post extensions modified to accommodate overlapping ceiling track (ordered separately) 	<p>No cost</p> <p>No cost</p> <p>Specify with post extensions for recessed ceiling track interface.</p> <p>Specify with post extensions for overlapping ceiling track interface.</p>
Related Products	<ul style="list-style-type: none"> • Switches • Ceiling tracks • Continuous base trim • Feature strips 	<ul style="list-style-type: none"> ► Page 172 ► Page 238 ► Page 244 ► Page 248

Tip: SmartTools options are available and easily ordered when using SmartTools software. If you do not have access to SmartTools software, these options can also be ordered using the normal Specials RFQ (Request For Quote) process.

Tip: Slider door assembly widths are displayed in actual sizes. Relative width of door and side panel may vary.

Tip: Specify additional muntin(s) for use in five- or six-lite assembly applications. Maximum of six lites.
► See Understanding page 49.

Tip: Muntin quantity and location must match door assembly and side panel.
► See Understanding page 49.

SmartTools Options	U.S. Price	Required to Specify
Surface Materials	Glass for 5th and 6th lite opening	Specify glass number for lite 5 or 6.
	• See standard options for lower lite row glass price group above	
Muntin	Change muntin size	Specify change muntin size.
	• Change to 1½"H or 2¼"H	No cost
	Change muntin location	Specify change muntin location.
	• Change muntin location	No cost
	Additional muntin	Specify with muntin.
	• Muntin	+\$177
Parametric Width Slider Door Assembly with Equal Width Door and Side Panel	<ul style="list-style-type: none"> • 76"W through 79"W and 81"W through 95"W • 97"W through 113"W 	<p>No cost</p> <p>+\$177</p> <p>Specify slider door assembly widths in 1" increments.</p> <p>Specify slider door assembly widths in 1" increments.</p>
Parametric Width Slider Door Assembly with Fixed Width Door and Variable Width Side Panel	<ul style="list-style-type: none"> • 40"W doors: 81"W through 103"W • 48"W doors: 97"W through 111"W 	<p>+\$177</p> <p>+\$177</p> <p>Specify slider door assembly widths in 1" increments.</p> <p>Specify slider door assembly widths in 1" increments.</p>
Base	• 4"H base	+\$228
		Specify to accept 4"H base.

Specification Information

Width	Style Number	U.S. Base Price
...

Four Transom-Aligned Lites

80"	GPDSS4L80	\$3838
96"	GPDSS4L96	\$4009
...

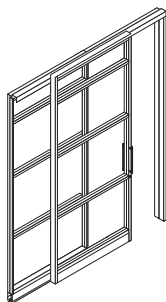

Back-to-Back Cover

For Privacy Wall Slider Doors

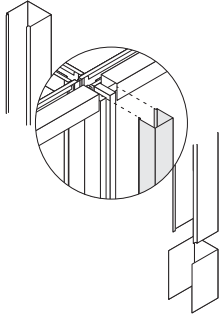

Standard Includes		Required to Specify
-------------------	--	---------------------

- | | | |
|---|--|---|
| <ul style="list-style-type: none"> ▶ Need help? Product details, page 50 | <ul style="list-style-type: none"> • Back-to-back cover: paint price group 1 • Plinth: paint | <ol style="list-style-type: none"> 1 Style number 2 Paint color number for cover and plinth 3 Options, if selected (see below) <ul style="list-style-type: none"> ▶ See <i>Surface Materials</i>, page 408. |
|---|--|---|

Options	U.S. Price	Required to Specify
---------	------------	---------------------

Surface Materials	<ul style="list-style-type: none"> • Paint price group 1 • Paint price group 2 • Paint price group 3 	No cost +\$ 8 +\$15	Specify paint color number. Specify paint color number. Specify paint color number.
--------------------------	---	---------------------------	---

Specification Information	
---------------------------	--

Style Number	U.S. Base Price
GPDSCB	\$176



For Canadian Pricing

Multiply U.S. Price by the Canadian price factor.

▶ See page 1 for details.

Mini Ends

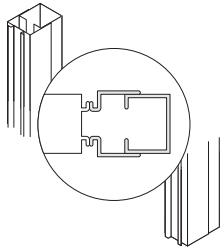

Standard Includes		Required to Specify
<ul style="list-style-type: none"> ▶ Need help? Product details, page 68 	<ul style="list-style-type: none"> • Ceiling height from 8'0"H to 10'0"H, in one-inch increments • Telescoping mini end: paint 	<ol style="list-style-type: none"> 1 Style number 2 Ceiling height 3 Paint color number for mini end 4 Options, if selected (see below) <ul style="list-style-type: none"> ▶ See <i>Surface Materials</i>, page 408.

Options	U.S. Price	Required to Specify
Surface Materials <ul style="list-style-type: none"> • Paint price group 1 • Paint price group 2 • Paint price group 3 • Fabric price group 1 • Fabric price group 2 • Fabric price group 3 • Fabric price group 5 • Customer's Own Material/ Vinyl (COM) 	<ul style="list-style-type: none"> No cost +\$ 8 +\$ 15 +\$ 88 +\$114 +\$150 +\$184 +\$ 88 	<ul style="list-style-type: none"> Specify paint color number. Specify paint color number. Specify paint color number. Specify fabric color number. Specify fabric color number. Specify fabric color number. Specify fabric color number. Specify fabric color number. <ul style="list-style-type: none"> ▶ See <i>Surface Materials Reference Manual</i>.
Ceiling Height <ul style="list-style-type: none"> • 8'0" through 10'0" 	<ul style="list-style-type: none"> No cost 	<ul style="list-style-type: none"> Specify ceiling height in 1" increments.
Related Product <ul style="list-style-type: none"> • Wall panels 		<ul style="list-style-type: none"> ▶ Page 116

Tip: SmartTools options are available and easily ordered when using SmartTools software. If you do not have access to SmartTools software, these options can also be ordered using the normal Specials RFQ (Request For Quote) process.

SmartTools Options	U.S. Price	Required to Specify
Parametric Ceiling Height <ul style="list-style-type: none"> • 7'5" through 7'11" • 10'1" through 11'0" 	<ul style="list-style-type: none"> No cost +\$ 18 	<ul style="list-style-type: none"> Specify ceiling height in 1" increments. Specify ceiling height in 1" increments.
Modified Angle (45° to 135° in 5° increments) <ul style="list-style-type: none"> • For GPMES • For GPMEM • For GPMEL 	<ul style="list-style-type: none"> +\$167 +\$177 +\$191 	<ul style="list-style-type: none"> Specify <i>with modified angle</i>. Specify <i>with modified angle</i>. Specify <i>with modified angle</i>.
Base <ul style="list-style-type: none"> • 4"H base 	<ul style="list-style-type: none"> +\$ 18 	<ul style="list-style-type: none"> Specify to accept 4"H base.

Specification Information		
• Size	• Style Number	• U.S. Base Price
1½" to 2½"	GPMES	\$273
2½" to 3½"	GPMEM	\$273
3½" to 6"	GPMEL	\$353
•	•	•

 **For Canadian Pricing**
 Multiply U.S. Price by the Canadian price factor.
 ▶ See page 1 for details.

Mini Ends, continued

Mini Ends to the Floor

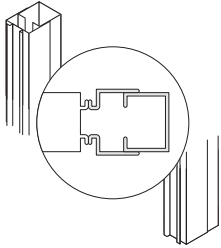

Tip: Mini ends should be specified to the floor when positioned next to a door frame. Mini ends will be field-cut by installer to final length.

▶ Page 68

Tip: SmartTools options are available and easily ordered when using SmartTools software. If you do not have access to SmartTools software, these options can also be ordered using the normal Specials RFQ (Request For Quote) process.

Standard Includes	Required to Specify
<ul style="list-style-type: none"> ▶ Need help? Product details, page 68 • Mini end: 10'1"H • Telescoping mini end: paint 	<ul style="list-style-type: none"> 1 Style number 2 Paint color number for mini end 3 Options, if selected (see below) ▶ See <i>Surface Materials</i>, page 408.

Options	U.S. Price	Required to Specify
Surface Materials <ul style="list-style-type: none"> • Paint price group 1 • Paint price group 2 • Paint price group 3 • Fabric price group 1 • Fabric price group 2 • Fabric price group 3 • Fabric price group 5 • Customer's Own Material/ Vinyl (COM) 	<ul style="list-style-type: none"> No cost +\$ 8 +\$ 15 +\$ 88 +\$114 +\$150 +\$184 +\$ 88 	<ul style="list-style-type: none"> Specify paint color number. Specify paint color number. Specify paint color number. Specify fabric color number. Specify fabric color number. Specify fabric color number. Specify fabric color number. ▶ See <i>Surface Materials Reference Manual</i>.

Related Product	
• Wall panels	▶ Page 116

SmartTools Options	U.S. Price	Required to Specify
Parametric Ceiling Height <ul style="list-style-type: none"> • 10'1" through 11'0" 	+\$ 18	Specify ceiling height in 1" increments.
Modified Angle (45° to 135° in 5° increments) <ul style="list-style-type: none"> • For GPMESF • For GPMEMF • For GPMELF 	<ul style="list-style-type: none"> +\$167 +\$177 +\$191 	<ul style="list-style-type: none"> Specify with modified angle. Specify with modified angle. Specify with modified angle.

Specification Information		
• Size	• Style Number	• U.S. Base Price
1½" to 2½"	GPMESF	\$273
2⅞" to 3½"	GPMEMF	\$273
3½" to 6"	GPMELF	\$353
•	•	•



For Canadian Pricing
 Multiply U.S. Price by the Canadian price factor.
 ▶ See page 1 for details.

Wall Channels

Wall Channels

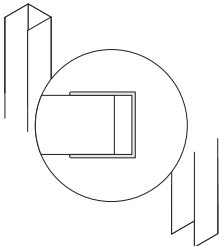

Tip: Wall channels are cut to size in the field.

Tip: Specify an end filler cut kit when cutting a panel into a wall channel. The end filler cut kit includes a wall channel and spreader.

Tip: SmartTools options are available and easily ordered when using SmartTools software. If you do not have access to SmartTools software, these options can also be ordered using the normal Specials RFQ (Request For Quote) process.

Standard Includes		Required to Specify
<ul style="list-style-type: none"> Need help? Product details, page 72 	<ul style="list-style-type: none"> Wall channel, 10'0": paint 	<ul style="list-style-type: none"> 1 Style number 2 Paint color number for wall channel 3 Options, if selected (see below) ▶ See <i>Surface Materials</i>, page 408.

Options	U.S. Price	Required to Specify
Surface Materials <ul style="list-style-type: none"> Paint price group 1 Paint price group 2 Paint price group 3 Fabric price group 1 Fabric price group 2 Fabric price group 3 Fabric price group 5 Customer's Own Material/ Vinyl (COM) 	<ul style="list-style-type: none"> No cost +\$ 8 +\$ 15 +\$ 88 +\$114 +\$150 +\$184 +\$ 88 	<ul style="list-style-type: none"> Specify paint color number. Specify paint color number. Specify paint color number. Specify fabric color number. Specify fabric color number. Specify fabric color number. Specify fabric color number. ▶ See <i>Surface Materials Reference Manual</i>.

Ceiling Height	<ul style="list-style-type: none"> 8'0" through 10'0" 	No cost	Specify ceiling height in 1" increments.
-----------------------	--	---------	--

SmartTools Options	U.S. Price	Required to Specify	
Parametric Ceiling Height (Available in 1" increments)	<ul style="list-style-type: none"> 10'1" through 11'0" 	+\$ 18	Specify ceiling height in 1" increments.

Specification Information			
Size	Length	Style Number	U.S. Base Price
1"	10'	GPWC1	\$143
2¼"	10'	GPWC2	\$143
4"	10'	GPWC4	\$169
:	:	:	:

 **For Canadian Pricing**
 Multiply U.S. Price by the Canadian price factor.
 ▶ See page 1 for details.

Panel End Cut Kit



Standard Includes **Required to Specify**

- | | | |
|--|---|---|
| <ul style="list-style-type: none"> ▶ Need help? Product details, page 76 | <ul style="list-style-type: none"> • Panel spreader • Leveler for 5" base • Leveler reinforcement • Finished end: paint | <ul style="list-style-type: none"> 1 Style number 2 Paint color number 3 Options, if selected (see below) ▶ See <i>Surface Materials</i>, page 408. |
|--|---|---|

Options **U.S. Price** **Required to Specify**

Surface Materials		U.S. Price	
• Paint price group 1		No cost	Specify paint color number.
• Paint price group 2		+\$ 8	Specify paint color number.
• Paint price group 3		+\$ 15	Specify paint color number.
• Fabric price group 1		+\$ 88	Specify fabric color number.
• Fabric price group 2		+\$114	Specify fabric color number.
• Fabric price group 3		+\$150	Specify fabric color number.
• Fabric price group 5		+\$184	Specify fabric color number.
• Customer's Own Material/ Vinyl (COM)		+\$ 88	Specify fabric color number.

▶ See *Surface Materials Reference Manual*.

Related Product • Wall panels ▶ Page 116

Specification Information

• Height	• Style Number	• U.S. Base Price
10'	GPWCCP	\$173



For Canadian Pricing

Multiply U.S. Price by the Canadian price factor.

▶ See page 1 for details.

End Filler Cut Kit

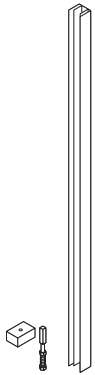

Standard Includes		Required to Specify	
<ul style="list-style-type: none"> ▶ Need help? Product details, page 76 	<ul style="list-style-type: none"> • Panel spreader • Leveler for 5" base • Leveler reinforcement • Wall channel: paint 	<ul style="list-style-type: none"> 1 Style number 2 Paint color number 3 Options, if selected (see below) 	<ul style="list-style-type: none"> ▶ See <i>Surface Materials</i>, page 408.
Options		U.S. Price	Required to Specify
Surface Materials	• Paint price group 1	No cost	Specify paint color number.
	• Paint price group 2	+\$ 8	Specify paint color number.
	• Paint price group 3	+\$ 15	Specify paint color number.
	• Fabric price group 1	+\$ 88	Specify fabric color number.
	• Fabric price group 2	+\$114	Specify fabric color number.
	• Fabric price group 3	+\$150	Specify fabric color number.
	• Fabric price group 5	+\$184	Specify fabric color number.
	• Customer's Own Material/Vinyl (COM)	+\$ 88	▶ See <i>Surface Materials Reference Manual</i> .
Related Product	• Wall panels		▶ Page 116

Specification Information	
Style Number	U.S. Base Price
GPWCCPSK	\$120

 **For Canadian Pricing**
 Multiply U.S. Price by the Canadian price factor.
 ▶ See page 1 for details.

Adapters

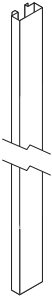

Tip: T- and X-adapter do not require finishes as those are not visible.

Tip: Panel end aligns to top of 5"H base.

Tip: SmartTools options are available and easily ordered when using SmartTools software. If you do not have access to SmartTools software, these options can also be ordered using the normal Specials RFQ (Request For Quote) process.

Standard Includes		Required to Specify
<ul style="list-style-type: none"> ▶ Need help? Product details, page 78 	<ul style="list-style-type: none"> • Ceiling height from 8'0"H to 10'0"H, in one-inch increments • Finished-end adapter or L-adapter: paint or anodized aluminum • Plinth for finished-edge: paint 	<ol style="list-style-type: none"> 1 Style number 2 Ceiling height on adapters 3 Paint color number for finished-end and L-adapter, if selected 4 Paint color number for plinths 5 Options, if selected (see below) <ul style="list-style-type: none"> ▶ See <i>Surface Materials</i>, page 408.

Options	U.S. Price	Required to Specify
Surface Materials	Finished-end and L-adapters	
<ul style="list-style-type: none"> • Paint price group 1 • Paint price group 2 • Paint price group 3 • Fabric price group 1 • Fabric price group 2 • Fabric price group 3 • Fabric price group 5 • Customer's Own Material/Vinyl (COM) • Anodized aluminum 	<ul style="list-style-type: none"> No cost +\$ 4 +\$ 8 +\$39 +\$56 +\$70 +\$88 +\$39 No cost 	<ul style="list-style-type: none"> Specify paint color number. Specify paint color number. Specify paint color number. Specify fabric color number. Specify fabric color number. Specify fabric color number. Specify fabric color number. ▶ See <i>Surface Materials Reference Manual</i>. Specify anodized aluminum.
	Finished-end base plinth 96"W doors 96"H through 120"H	
<ul style="list-style-type: none"> • Paint price group 1 • Paint price group 2 • Paint price group 3 	<ul style="list-style-type: none"> No cost +\$ 2 +\$ 4 	<ul style="list-style-type: none"> Specify paint color number. Specify paint color number. Specify paint color number.
Ceiling Height for L-, T-, and X-adapters	<ul style="list-style-type: none"> • 8'1" through 10'0" 	<ul style="list-style-type: none"> No cost Specify ceiling height in 1" increments.
Related Products	<ul style="list-style-type: none"> • Continuous base trim • Feature strips 	<ul style="list-style-type: none"> ▶ Page 244 ▶ Page 248

SmartTools Options	U.S. Price	Required to Specify
Parametric Ceiling Height (Available in 1" increments)	<ul style="list-style-type: none"> • 7'5" through 7'11" • 10'1" through 11'0" 	<ul style="list-style-type: none"> No cost +\$18
Base	<ul style="list-style-type: none"> • 4"H base 	<ul style="list-style-type: none"> +\$18 Specify to accept 4"H base.



For Canadian Pricing
Multiply U.S. Price by the Canadian price factor.
▶ See page 1 for details.

Specification Information

Style Number	U.S. Base Price
--------------	-----------------

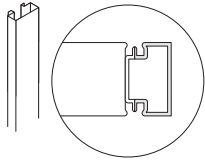

Finished-End Adapter with Base

GPAFEB	\$161
---------------	-------

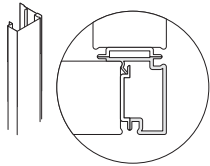

L-Adapter

GPAL	\$161
-------------	-------

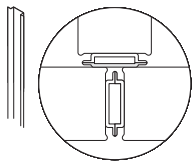

T-Adapter

GPAT	\$ 85
-------------	-------

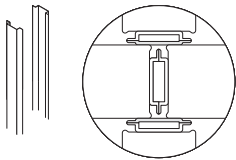

X-Adapter

GPAX	\$118
-------------	-------



For Canadian Pricing
 Multiply U.S. Price by the
 Canadian price factor.
 ▶ See page 1 for details.

Posts

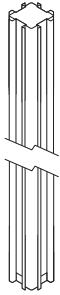

Tip: X-post does not require a finish since the post is not visible.

Tip: SmartTools options are available and easily ordered when using SmartTools software. If you do not have access to SmartTools software, these options can also be ordered using the normal Specials RFQ (Request For Quote) process.

Standard Includes		Required to Specify
<ul style="list-style-type: none"> ▶ Need help? Product details, page 82 	<ul style="list-style-type: none"> • Ceiling height from 8'0"H to 10'0"H, in one-inch increments • Post: paint or anodized aluminum (except X-post) 	<ol style="list-style-type: none"> 1 Style number 2 Ceiling height 3 Paint color number for post 4 Options, if selected (see below) <ul style="list-style-type: none"> ▶ See <i>Surface Materials</i>, page 408.

Options	U.S. Price	Required to Specify
Surface Materials Post (except X-post) <ul style="list-style-type: none"> • Paint price group 1 • Paint price group 2 • Paint price group 3 • Fabric price group 1 • Fabric price group 2 • Fabric price group 3 • Fabric price group 5 • Customer's Own Material/Vinyl (COM) • Anodized aluminum 	<ul style="list-style-type: none"> No cost +\$ 8 +\$ 15 +\$ 88 +\$114 +\$150 +\$184 +\$ 88 No cost 	<ul style="list-style-type: none"> Specify paint color number. Specify paint color number. Specify paint color number. Specify fabric color number. Specify fabric color number. Specify fabric color number. Specify fabric color number. Specify fabric color number. ▶ See <i>Surface Materials Reference Manual</i>. Specify anodized aluminum.
Ceiling Height <ul style="list-style-type: none"> • 8'0" through 10'0" 	<ul style="list-style-type: none"> No cost 	<ul style="list-style-type: none"> Specify ceiling height in 1" increments.

SmartTools Options	U.S. Price	Required to Specify
Parametric Ceiling Height (Available in 1" increments) <ul style="list-style-type: none"> • 7'5" through 7'11" • 10'1" through 11'0" 	<ul style="list-style-type: none"> No cost +\$ 18 	<ul style="list-style-type: none"> Specify ceiling height in 1" increments. Specify ceiling height in 1" increments.
Base <ul style="list-style-type: none"> • 4"H base 	<ul style="list-style-type: none"> +\$ 18 	<ul style="list-style-type: none"> Specify to accept 4"H base.
Modified Angle (70° to 175° in 5° increments) <ul style="list-style-type: none"> • For GPP120V 70°-85° • For GPP120V 95°-115° • For GPP135V 125°-175° 	<ul style="list-style-type: none"> +\$470 +\$416 +\$416 	<ul style="list-style-type: none"> Specify <i>with modified angle</i>. Specify <i>with modified angle</i>. Specify <i>with modified angle</i>.



For Canadian Pricing
 Multiply U.S. Price by the Canadian price factor.
 ▶ See page 1 for details.

Specification Information

L-Post

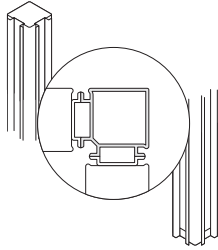

•Style
•Number
•U.S.
•Base
•Price

GPPL \$171

T-Post

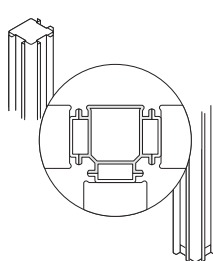

•Style
•Number
•U.S.
•Base
•Price

GPPT \$203

X-Post

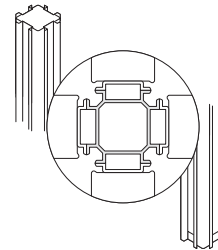

•Style
•Number
•U.S.
•Base
•Price

GPPX \$230

In-Line Post

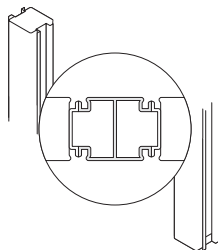

•Style
•Number
•U.S.
•Base
•Price

GPPI \$171

V-Posts

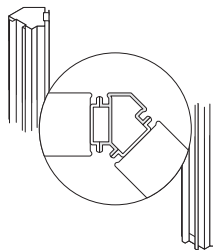

•Configuration
•Style
•Number
•U.S.
•Base
•Price

120° V-Post **GPP120V** \$203
135° V-Post **GPP135V** \$203

135° Y-Post

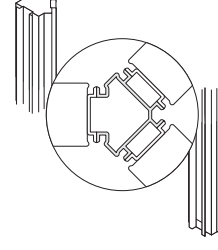

•Style
•Number
•U.S.
•Base
•Price

GPP135Y \$230



For Canadian Pricing
Multiply U.S. Price by the
Canadian price factor.
▶ See page 1 for details.

I-Line Interface Post

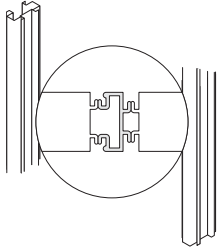

Standard Includes		Required to Specify
-------------------	--	---------------------

- | | | |
|---|---|---|
| <ul style="list-style-type: none"> ▶ Need help? Product details, page 20 | <ul style="list-style-type: none"> • Interface post: paint | <ul style="list-style-type: none"> 1 Style number 2 Paint color number 3 Options, if selected (see below) ▶ See <i>Surface Materials</i>, page 408. |
|---|---|---|

Options	U.S. Price	Required to Specify
---------	------------	---------------------

Options	U.S. Price	Required to Specify
Surface Materials I-Line post <ul style="list-style-type: none"> • Paint price group 1 • Paint price group 2 • Paint price group 3 • Fabric price group 1 • Fabric price group 2 • Fabric price group 3 • Fabric price group 5 • Customer's Own Material/Vinyl (COM) 	<ul style="list-style-type: none"> No cost +\$ 8 +\$ 15 +\$ 88 +\$114 +\$150 +\$184 +\$ 88 	<ul style="list-style-type: none"> Specify paint color number. Specify paint color number. Specify paint color number. Specify fabric color number. Specify fabric color number. Specify fabric color number. Specify fabric color number. ▶ See <i>Surface Materials Reference Manual</i>.

Related Products <ul style="list-style-type: none"> • Feature strips 	▶ Page 248
--	------------

Tip: SmartTools options are available and easily ordered when using SmartTools software. If you do not have access to SmartTools software, these options can also be ordered using the normal Specials RFQ (Request For Quote) process.

SmartTools Options	U.S. Price	Required to Specify
--------------------	------------	---------------------

Parametric Ceiling Height (Available in 1" increments)	<ul style="list-style-type: none"> • 10'1" through 11'0" 	<ul style="list-style-type: none"> +\$ 18 	<ul style="list-style-type: none"> Specify ceiling height in 1" increments.
--	---	--	--

Specification Information		
---------------------------	--	--

Length	Style Number	U.S. Base Price
10'	GPIA	\$145



For Canadian Pricing
 Multiply U.S. Price by the Canadian price factor.
 ▶ See page 1 for details.



Glass Selections All-Glass Wall Panels

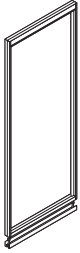

Tip: Order ceiling track, feature strip, and continuous base trim separately.

Standard Includes		Required to Specify
<ul style="list-style-type: none"> ▶ Need help? Product details, page 24 	<ul style="list-style-type: none"> • Ceiling height from 8'0"H to 10'0"H, in one-inch increments • 2³/₈"-thick panel with frame: paint or anodized aluminum • 1/4"-thick factory-installed lite: glass • Floor track with adjustable levelers to accommodate continuous 5"H base trim (ordered separately) 	<ol style="list-style-type: none"> 1 Style number 2 Ceiling height 3 Paint color number for frame 4 Glass number for lite 5 Post extension 6 Options, if selected (see below) <p>▶ See <i>Surface Materials</i>, page 408.</p>

Options	U.S. Price	Required to Specify
Surface Materials <ul style="list-style-type: none"> • Frame • Paint price group 1 • Paint price group 2 • Paint price group 3 • Anodized aluminum 	<ul style="list-style-type: none"> No cost +\$ 29 +\$ 48 No cost 	<ul style="list-style-type: none"> Specify paint color number. Specify paint color number. Specify paint color number. Specify anodized aluminum.
Panels 96"H through 120"H, 6"W to 8"W		
<ul style="list-style-type: none"> • Glass price group 1 • Glass price group 2 • Glass price group 3 • Glass price group 4 • Glass price group 5 • Glass price group 6 	<ul style="list-style-type: none"> No cost +\$ 103 +\$ 126 +\$ 201 N.A. +\$ 392 	<ul style="list-style-type: none"> Specify glass number for lite. Specify glass number for lite. Specify glass number for lite. Specify glass number for lite. Specify glass number for lite. Specify glass number for lite. <p>▶ See <i>Surface Materials Reference Manual</i>.</p>
Panels 96"H through 120"H, 18"W to 24"W		
<ul style="list-style-type: none"> • Glass price group 1 • Glass price group 2 • Glass price group 3 • Glass price group 4 • Glass price group 5 • Glass price group 6 	<ul style="list-style-type: none"> No cost +\$ 312 +\$ 373 +\$ 597 N.A. +\$1175 	<ul style="list-style-type: none"> Specify glass number for lite. Specify glass number for lite. Specify glass number for lite. Specify glass number for lite. Specify glass number for lite. Specify glass number for lite. <p>▶ See <i>Surface Materials Reference Manual</i>.</p>
Panels 96"H through 120"H, 30"W to 36"W		
<ul style="list-style-type: none"> • Glass price group 1 • Glass price group 2 • Glass price group 3 • Glass price group 4 • Glass price group 5 • Glass price group 6 	<ul style="list-style-type: none"> No cost +\$ 468 +\$ 557 +\$ 893 N.A. +\$1761 	<ul style="list-style-type: none"> Specify glass number for lite. Specify glass number for lite. Specify glass number for lite. Specify glass number for lite. Specify glass number for lite. Specify glass number for lite. <p>▶ See <i>Surface Materials Reference Manual</i>.</p>
Panels 96"H through 120"H, 40"W to 48"W		
<ul style="list-style-type: none"> • Glass price group 1 • Glass price group 2 • Glass price group 3 • Glass price group 4 • Glass price group 5 • Glass price group 6 	<ul style="list-style-type: none"> No cost +\$ 624 +\$ 742 +\$1193 N.A. +\$2349 	<ul style="list-style-type: none"> Specify glass number for lite. Specify glass number for lite. Specify glass number for lite. Specify glass number for lite. Specify glass number for lite. Specify glass number for lite. <p>▶ See <i>Surface Materials Reference Manual</i>.</p>
Panels 96"H through 120"H, 60"W		
<ul style="list-style-type: none"> • Glass price group 1 • Glass price group 2 • Glass price group 3 • Glass price group 4 • Glass price group 5 • Glass price group 6 	<ul style="list-style-type: none"> No cost +\$ 780 +\$ 927 +\$1487 N.A. +\$2937 	<ul style="list-style-type: none"> Specify glass number for lite. Specify glass number for lite. Specify glass number for lite. Specify glass number for lite. Specify glass number for lite. Specify glass number for lite. <p>▶ See <i>Surface Materials Reference Manual</i>.</p>

Post Extension <ul style="list-style-type: none"> • Post extensions modified to accommodate recessed ceiling track (ordered separately) • Post extensions modified to accommodate overlapping ceiling track (ordered separately) 	<ul style="list-style-type: none"> No cost No cost 	<ul style="list-style-type: none"> Specify with post extensions for recessed ceiling track interface. Specify with post extensions for overlapping ceiling track interface.
---	--	---

▶ Options, continued on next page

 **For Canadian Pricing**
 Multiply U.S. Price by the Canadian price factor.
 ▶ See page 1 for details.

► Options, continued from previous page

Options	U.S. Price	Required to Specify	
Ceiling Height	• 8'0" through 9'0" • 9'1" through 10'0"	No cost +\$ 96	Specify ceiling height in 1" increments. Specify ceiling height in 1" increments.
Electrical Power (For panels 30"W through 60"W)	Base power block power schematic • 3+1 • 2+2 • 3SN	+ \$207 + \$207 + \$207	Specify with 3+1 power. Specify with 2+2 power. Specify with 3SN power.
Related Products	• Power options • Ceiling tracks • Continuous base trim • Feature strips • Power receptacles • Power and communication cover plates • Infeeds • Modular harnesses • Field-installed powerkits		► Page 146 ► Page 238 ► Page 244 ► Page 248 ► Page 256 ► Page 258 ► Page 259 ► Page 261 ► Page 239

Tip: Base power block location does not include infeed. Infeed must be ordered separately, if needed.

Tip: SmartTools options are available and easily ordered when using SmartTools software. If you do not have access to SmartTools software, these options can also be ordered using the normal Specials RFQ (Request For Quote) process.

SmartTools Options	U.S. Price	Required to Specify	
Parametric Ceiling Height (Available in 1" increments)	• 7'5" through 7'11"	Use 8'0" price	Specify ceiling height in 1" increments.
Parametric Panel Widths (Available in 1" increments)	• Non standard widths • Non standard modular widths	Use U.S. Base Price of next larger width Use U.S. Base Price of next larger width	Specify panel widths in 1" increments. Specify panel widths in 1" increments.
Base	• 2½"H base • 4"H base	+ \$ 92 + \$228	Specify to accept 2½"H base. Specify to accept 4"H base.

Specification Information							
Width	Style Number	U.S. Base Price	Nominal Width	Modular Width	Style Number	U.S. Base Price	

All-Glass Wall Panels		
6"	GPGSSG06	\$ 804
8"	GPGSSG08	\$ 804
18"	GPGSSG18	\$ 891
20"	GPGSSG20	\$ 891
24"	GPGSSG24	\$ 989
30"	GPGSSG30	\$1046
36"	GPGSSG36	\$1163
40"	GPGSSG40	\$1222
42"	GPGSSG42	\$1222
48"	GPGSSG48	\$1373
60"	GPGSSG60	\$1648

Modular All-Glass Wall Panels			
8"	16 ¹ / ₁₆ "	GPGSMG08	\$ 804
18"	16 ¹ / ₁₆ "	GPGSMG18	\$ 891
20"	18 ¹ / ₁₆ "	GPGSMG20	\$ 891
24"	22 ¹ / ₁₆ "	GPGSMG24	\$ 989
30"	28 ¹ / ₁₆ "	GPGSMG30	\$1046
36"	34 ¹ / ₁₆ "	GPGSMG36	\$1163
40"	38 ¹ / ₁₆ "	GPGSMG40	\$1222
42"	40 ¹ / ₁₆ "	GPGSMG42	\$1222
48"	46 ¹ / ₁₆ "	GPGSMG48	\$1373
60"	58 ¹ / ₁₆ "	GPGSMG60	\$1648

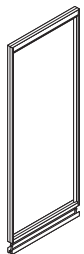

Tip: Ceiling height panels from 10'0"H through 11'0"H are available in widths up to 48" only.



For Canadian Pricing
Multiply U.S. Price by the Canadian price factor.
► See page 1 for details.

Glass Selections All-Glass Frame Kits

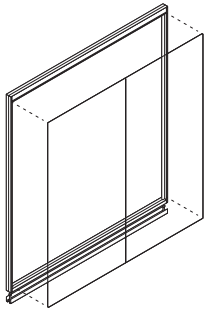

Tip: Order ceiling track, feature strip, and continuous base trim separately.

Tip: When power option is specified, connector harness is included to join power blocks with frame kit.

Tip: Frame kits include two power blocks per kit.

Tip: Frame kits are assembled in the field. Butt joints must be glazed with glazing tape or silicone sealant to be code-compliant.

Tip: SmartTools options are available and easily ordered when using SmartTools software. If you do not have access to SmartTools software, these options can also be ordered using the normal Specials RFQ (Request For Quote) process.

Standard Includes		Required to Specify
<ul style="list-style-type: none"> ▶ Need help? Product details, page 24 	<ul style="list-style-type: none"> • Ceiling height from 8'0"H to 10'0"H, in one-inch increments • 2³/₈"-thick panel with frame: paint or anodized aluminum • Floor track with adjustable levelers to accommodate continuous 5"H base trim (ordered separately) 	<ol style="list-style-type: none"> 1 Style number 2 Ceiling height 3 Paint color number for frame 4 Post extension 5 Options, if selected (see below) <p>▶ See <i>Surface Materials</i>, page 408.</p>

Options	U.S. Price	Required to Specify
Surface Materials Frame <ul style="list-style-type: none"> • Paint price group 1 • Paint price group 2 • Paint price group 3 • Anodized aluminum 	<ul style="list-style-type: none"> No cost +\$ 29 +\$ 48 No cost 	<ul style="list-style-type: none"> Specify paint color number. Specify paint color number. Specify paint color number. Specify anodized aluminum.
Post Extension <ul style="list-style-type: none"> • Post extensions modified to accommodate recessed ceiling track (ordered separately) • Post extensions modified to accommodate overlapping ceiling track (ordered separately) 	<ul style="list-style-type: none"> No cost No cost 	<ul style="list-style-type: none"> Specify with post extensions for recessed ceiling track interface. Specify with post extensions for overlapping ceiling track interface.
Ceiling Height <ul style="list-style-type: none"> • 8'0" through 9'0" • 9'1" through 10'0" 	<ul style="list-style-type: none"> No cost +\$ 50 	<ul style="list-style-type: none"> Specify ceiling height in 1" increments. Specify ceiling height in 1" increments.
Electrical Power Base power block power schematic <ul style="list-style-type: none"> • 3+1 • 2+2 • 3SN 	<ul style="list-style-type: none"> +\$505 +\$505 +\$505 	<ul style="list-style-type: none"> Specify with 3+1 power. Specify with 2+2 power. Specify with 3SN power.
Related Products <ul style="list-style-type: none"> • Power options • Ceiling tracks • Continuous base trim • Feature strips • Power receptacles • Power and communication cover plates • Infeeds • Modular harnesses • Field-installed powerkits 		<ul style="list-style-type: none"> ▶ Page 146 ▶ Page 238 ▶ Page 244 ▶ Page 248 ▶ Page 256 ▶ Page 258 ▶ Page 259 ▶ Page 261 ▶ Page 239

SmartTools Options	U.S. Price	Required to Specify	
Parametric Ceiling Height (Available in 1" increments)	<ul style="list-style-type: none"> • 7'5" through 7'11" 	<ul style="list-style-type: none"> Use 8'0" price 	<ul style="list-style-type: none"> Specify ceiling height in 1" increments.
Parametric Panel Widths (Available in 1" increments)	<ul style="list-style-type: none"> • Non standard widths • Non standard modular widths 	<ul style="list-style-type: none"> Use U.S. Base Price of next larger width Use U.S. Base Price of next larger width 	<ul style="list-style-type: none"> Specify panel widths in 1" increments. Specify panel widths in 1" increments.
Base <ul style="list-style-type: none"> • 2¹/₂"H base • 4"H base 	<ul style="list-style-type: none"> +\$187 +\$343 		<ul style="list-style-type: none"> Specify to accept 2¹/₂"H base. Specify to accept 4"H base.



For Canadian Pricing
 Multiply U.S. Price by the Canadian price factor.
 ▶ See page 1 for details.

Specification Information

Width	Style Number	U.S. Base Price	Nominal Width	Modular Width	Style Number	U.S. Base Price
All-Glass Frame Kits			Modular All-Glass Frame Kits			
72"	GPGSSGFK72	\$1148	72"	70 ¹¹ / ₁₆ "	GPGSMGFK72	\$1148
80"	GPGSSGFK80	\$1230	80"	78 ¹¹ / ₁₆ "	GPGSMGFK80	\$1230
84"	GPGSSGFK84	\$1319	84"	82 ¹¹ / ₁₆ "	GPGSMGFK84	\$1319
96"	GPGSSGFK96	\$1413	96"	94 ¹¹ / ₁₆ "	GPGSMGFK96	\$1413
108"	GPGSSGFK108	\$1507	108"	106 ¹¹ / ₁₆ "	GPGSMGFK108	\$1507
120"	GPGSSGFK120	\$1616	120"	118 ¹¹ / ₁₆ "	GPGSMGFK120	\$1616
144"	GPGSSGFK144	\$1729	144"	142 ¹¹ / ₁₆ "	GPGSMGFK144	\$1729

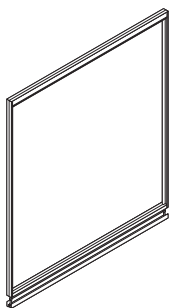

For Canadian Pricing

Multiply U.S. Price by the Canadian price factor.

▶ See page 1 for details.

Glass Selections All-Glass Glass Kits

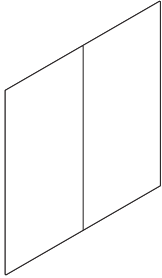

Tip: Order ceiling track, feature strip, and continuous base trim separately.

Tip: Glass kits are assembled in the field. Butt joints must be glazed with glazing tape or silicone sealant to be code-compliant.

Tip: Glass kits 72"W to 96"W have two pieces of glass. Kits 108"W to 144"W have three pieces of glass.

Standard Includes		Required to Specify
<ul style="list-style-type: none"> ▶ Need help? Product details, page 24 	<ul style="list-style-type: none"> • Ceiling height from 8'0"H to 10'0"H, in one-inch increments • 3/8"-thick clear tempered glass 	<ol style="list-style-type: none"> 1 Style number 2 Ceiling height 3 Glass number for lite 4 Options, if selected (see below) <ul style="list-style-type: none"> ▶ See <i>Surface Materials</i>, page 408.

Options	U.S. Price	Required to Specify	
Surface Materials			
Glass Panels 8'0" through 10'0" for 72"W and 80"W Kits			
<ul style="list-style-type: none"> • Glass price group 1 • Glass price group 2 • Glass price group 3 • Glass price group 4 • Glass price group 5 • Glass price group 6 	<ul style="list-style-type: none"> No cost +\$1971 +\$2390 +\$2725 N.A. +\$5311 	<ul style="list-style-type: none"> Specify glass number for lite. Specify glass number for lite. Specify glass number for lite. Specify glass number for lite. Specify glass number for lite. Specify glass number for lite. <ul style="list-style-type: none"> ▶ See <i>Surface Materials Reference Manual</i>. 	
Glass Panels 8'0" through 10'0" for 84"W and 96"W Kits			
<ul style="list-style-type: none"> • Glass price group 1 • Glass price group 2 • Glass price group 3 • Glass price group 4 • Glass price group 5 • Glass price group 6 	<ul style="list-style-type: none"> No cost +\$2365 +\$2870 +\$3269 N.A. +\$6376 	<ul style="list-style-type: none"> Specify glass number for lite. Specify glass number for lite. Specify glass number for lite. Specify glass number for lite. Specify glass number for lite. Specify glass number for lite. <ul style="list-style-type: none"> ▶ See <i>Surface Materials Reference Manual</i>. 	
Glass Panels 8'0" through 10'0" for 108"W, 120"W, and 144"W Kits			
<ul style="list-style-type: none"> • Glass price group 1 • Glass price group 2 • Glass price group 3 • Glass price group 4 • Glass price group 5 • Glass price group 6 	<ul style="list-style-type: none"> No cost +\$2957 +\$3589 +\$4088 N.A. +\$7971 	<ul style="list-style-type: none"> Specify glass number for lite. Specify glass number for lite. Specify glass number for lite. Specify glass number for lite. Specify glass number for lite. Specify glass number for lite. <ul style="list-style-type: none"> ▶ See <i>Surface Materials Reference Manual</i>. 	
Ceiling Height	<ul style="list-style-type: none"> • 8'0"H through 9'0"H • 9'1"H through 10'0"H 	<ul style="list-style-type: none"> No cost +\$ 50 	<ul style="list-style-type: none"> Specify ceiling height in 1" increments. Specify ceiling height in 1" increments.
Related Products	<ul style="list-style-type: none"> • Power options • Ceiling tracks • Continuous base trim • Feature strips • Power receptacles • Power and communication cover plates • Infeeds • Modular harnesses • Field-installed powerkits 	<ul style="list-style-type: none"> ▶ Page 146 ▶ Page 238 ▶ Page 244 ▶ Page 248 ▶ Page 256 ▶ Page 258 ▶ Page 259 ▶ Page 261 ▶ Page 239 	

▶ Options, continued on next page



For Canadian Pricing
 Multiply U.S. Price by the Canadian price factor.
 ▶ See page 1 for details.

► Options, continued from previous page

Tip: SmartTools options are available and easily ordered when using SmartTools software. If you do not have access to SmartTools software, these options can also be ordered using the normal Specials RFQ (Request For Quote) process.

SmartTools Options	U.S. Price	Required to Specify	
Parametric Ceiling Height (Available in 1" increments)	• 7'5"H through 7'11"H (for widths 96" or less) • 7'5"H through 7'11"H (for widths 97"W and greater)	No cost No cost	Specify ceiling height in 1" increments. Specify ceiling height in 1" increments.
Parametric Panel Widths (Available in 1" increments)	Overall unit widths • 61"W through 97"W (excludes standard widths) • 97"W through 143"W (excludes standard widths)	No cost No cost	Specify panel widths in 1" increments. Specify panel widths in 1" increments.
Base	2½"H base • 61"W through 96"W • 97"W through 144"W 4"H base • 4"H base	+ \$21 + \$31 No cost	Specify to accept 2½"H base. Specify to accept 2½"H base. Specify to accept 4"H base.

Specification Information

Width	Style Number	U.S. Base Price	Nominal Width	Modular Width	Style Number	U.S. Base Price
-------	--------------	-----------------	---------------	---------------	--------------	-----------------

All-Glass Glass Kits

72"	GPGSSGGK72	\$1821
80"	GPGSSGGK80	\$2026
84"	GPGSSGGK84	\$2127
96"	GPGSSGGK96	\$2433
108"	GPGSSGGK108	\$2736
120"	GPGSSGGK120	\$3040
144"	GPGSSGGK144	\$3534

Modular All-Glass Glass Kits

72"	70 ¹¹ / ₁₆ "	GPGSMGGK72	\$1821
80"	78 ¹¹ / ₁₆ "	GPGSMGGK80	\$2026
84"	82 ¹¹ / ₁₆ "	GPGSMGGK84	\$2127
96"	94 ¹¹ / ₁₆ "	GPGSMGGK96	\$2433
108"	106 ¹¹ / ₁₆ "	GPGSMGGK108	\$2736
120"	118 ¹¹ / ₁₆ "	GPGSMGGK120	\$3040
144"	142 ¹¹ / ₁₆ "	GPGSMGGK144	\$3534

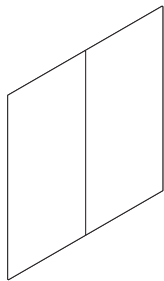

 **For Canadian Pricing**
Multiply U.S. Price by the Canadian price factor.
► See page 1 for details.

Glass Selections Wall Panels with Two Divided Lites

Transom-Aligned Top Lite

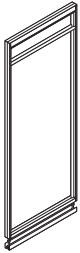

Tip: Order ceiling track, feature strip, and continuous base trim separately.

Standard Includes	Required to Specify
<ul style="list-style-type: none"> ▶ Need help? Product details, page 24 • Ceiling height from 8'0"H to 10'0"H, in one-inch increments • 2³/₈"-thick panel with frame: paint or anodized aluminum • Two, 1/4"-thick factory-installed lites—top lite is transom aligned: glass • Floor track with adjustable levelers to accommodate continuous 5"H base trim (ordered separately) 	<ol style="list-style-type: none"> 1 Style number 2 Ceiling height 3 Paint color number for frame 4 Glass number for lite 1 (from top) 5 Glass number for lite 2 6 Post extension 7 Options, if selected (see below) <p>▶ See <i>Surface Materials</i>, page 408.</p>

Options	U.S. Price	Required to Specify
Surface Materials <ul style="list-style-type: none"> • Paint price group 1 • Paint price group 2 • Paint price group 3 • Anodized aluminum 	<ul style="list-style-type: none"> No cost +\$ 29 +\$ 48 No cost 	<ul style="list-style-type: none"> Specify paint color number. Specify paint color number. Specify paint color number. Specify anodized aluminum.
Top Lite Glass Panels 8'0" through 10'0", 6"W through 8"W		
<ul style="list-style-type: none"> • Glass price group 1 • Glass price group 2 • Glass price group 3 • Glass price group 4 • Glass price group 5 • Glass price group 6 	<ul style="list-style-type: none"> No cost +\$ 18 +\$ 24 +\$ 35 N.A. +\$ 71 	<ul style="list-style-type: none"> Specify glass number for lite. Specify glass number for lite. Specify glass number for lite. Specify glass number for lite. Specify glass number for lite. Specify glass number for lite. <p>▶ See <i>Surface Materials Reference Manual</i>.</p>
Lower Lite Glass Panels 8'0" through 10'0" (per lite), 6"W through 8"W		
<ul style="list-style-type: none"> • Glass price group 1 • Glass price group 2 • Glass price group 3 • Glass price group 4 • Glass price group 5 • Glass price group 6 	<ul style="list-style-type: none"> No cost +\$ 85 +\$ 101 +\$ 162 N.A. +\$ 317 	<ul style="list-style-type: none"> Specify glass number for lite. Specify glass number for lite. Specify glass number for lite. Specify glass number for lite. Specify glass number for lite. Specify glass number for lite. <p>▶ See <i>Surface Materials Reference Manual</i>.</p>
Top Lite Glass Panels 8'0" through 10'0", 18"W through 24"W		
<ul style="list-style-type: none"> • Glass price group 1 • Glass price group 2 • Glass price group 3 • Glass price group 4 • Glass price group 5 • Glass price group 6 	<ul style="list-style-type: none"> No cost +\$ 57 +\$ 67 +\$ 106 N.A. +\$ 209 	<ul style="list-style-type: none"> Specify glass number for lite. Specify glass number for lite. Specify glass number for lite. Specify glass number for lite. Specify glass number for lite. Specify glass number for lite. <p>▶ See <i>Surface Materials Reference Manual</i>.</p>
Lower Lite Glass Panels 8'0" through 10'0" (per lite), 18"W through 24"W		
<ul style="list-style-type: none"> • Glass price group 1 • Glass price group 2 • Glass price group 3 • Glass price group 4 • Glass price group 5 • Glass price group 6 	<ul style="list-style-type: none"> No cost +\$ 253 +\$ 300 +\$ 482 N.A. +\$ 951 	<ul style="list-style-type: none"> Specify glass number for lite. Specify glass number for lite. Specify glass number for lite. Specify glass number for lite. Specify glass number for lite. Specify glass number for lite. <p>▶ See <i>Surface Materials Reference Manual</i>.</p>
Top Lite Glass Panels 8'0" through 10'0", 30"W through 36"W		
<ul style="list-style-type: none"> • Glass price group 1 • Glass price group 2 • Glass price group 3 • Glass price group 4 • Glass price group 5 • Glass price group 6 	<ul style="list-style-type: none"> No cost +\$ 83 +\$ 98 +\$ 160 N.A. +\$ 312 	<ul style="list-style-type: none"> Specify glass number for lite. Specify glass number for lite. Specify glass number for lite. Specify glass number for lite. Specify glass number for lite. Specify glass number for lite. <p>▶ See <i>Surface Materials Reference Manual</i>.</p>
Lower Lite Glass Panels 8'0" through 10'0" (per lite), 30"W through 36"W		
<ul style="list-style-type: none"> • Glass price group 1 • Glass price group 2 • Glass price group 3 • Glass price group 4 • Glass price group 5 • Glass price group 6 	<ul style="list-style-type: none"> No cost +\$ 379 +\$ 452 +\$ 721 N.A. +\$1424 	<ul style="list-style-type: none"> Specify glass number for lite. Specify glass number for lite. Specify glass number for lite. Specify glass number for lite. Specify glass number for lite. Specify glass number for lite. <p>▶ See <i>Surface Materials Reference Manual</i>.</p>

 **For Canadian Pricing**
 Multiply U.S. Price by the Canadian price factor.
 ▶ See page 1 for details.

▶ **Options, continued on next page**

► Options, continued from previous page

Options	U.S. Price	Required to Specify	
Surface Materials	Top Lite Glass Panels 8'0" through 10'0", 40"W through 48"W		
	• Glass price group 1	No cost	Specify glass number for lite.
	• Glass price group 2	+\$ 111	Specify glass number for lite.
	• Glass price group 3	+\$ 133	Specify glass number for lite.
	• Glass price group 4	+\$ 211	Specify glass number for lite.
	• Glass price group 5	N.A.	Specify glass number for lite.
	• Glass price group 6	+\$ 416	Specify glass number for lite.
	► See <i>Surface Materials Reference Manual</i> .		
	Lower Lite Glass Panels 8'0" through 10'0" (per lite), 40"W through 48"W		
	• Glass price group 1	No cost	Specify glass number for lite.
	• Glass price group 2	+\$ 504	Specify glass number for lite.
	• Glass price group 2	+\$ 602	Specify glass number for lite.
	• Glass price group 4	+\$ 962	Specify glass number for lite.
	• Glass price group 5	N.A.	Specify glass number for lite.
	• Glass price group 6	+\$1898	Specify glass number for lite.
	► See <i>Surface Materials Reference Manual</i> .		
	Top Lite Glass Panels 8'0" through 10'0", 60"W		
	• Glass price group 1	No cost	Specify glass number for lite.
	• Glass price group 2	+\$ 140	Specify glass number for lite.
	• Glass price group 3	+\$ 166	Specify glass number for lite.
• Glass price group 4	+\$ 262	Specify glass number for lite.	
• Glass price group 5	N.A.	Specify glass number for lite.	
• Glass price group 6	+\$ 520	Specify glass number for lite.	
► See <i>Surface Materials Reference Manual</i> .			
Lower Lite Glass Panels 8'0" through 10'0" (per lite), 60"W			
• Glass price group 1	No cost	Specify glass number for lite.	
• Glass price group 2	+\$ 629	Specify glass number for lite.	
• Glass price group 3	+\$ 751	Specify glass number for lite.	
• Glass price group 4	+\$1204	Specify glass number for lite.	
• Glass price group 5	N.A.	Specify glass number for lite.	
• Glass price group 6	+\$2374	Specify glass number for lite.	
► See <i>Surface Materials Reference Manual</i> .			
Post Extension	• Post extensions modified to accommodate recessed ceiling track (ordered separately)	No cost	Specify with <i>post extensions for recessed ceiling track interface</i> .
	• Post extensions modified to accommodate overlapping ceiling track (ordered separately)	No cost	Specify with <i>post extensions for overlapping ceiling track interface</i> .
Ceiling Height	• 8'0" through 9'0"	No cost	Specify ceiling height in 1" increments.
	• 9'1" through 10'0"	+\$ 96	Specify ceiling height in 1" increments.
Electrical Power (For panels 30"W through 60"W)	Base power block power schematic		
	• 3+1	+\$ 207	Specify with <i>3+1 power</i> .
	• 2+2	+\$ 207	Specify with <i>2+2 power</i> .
	• 3SN	+\$ 207	Specify with <i>3SN power</i> .
Related Products	• Power options		► Page 146
	• Ceiling tracks		► Page 238
	• Continuous base trim		► Page 244
	• Feature strips		► Page 248
	• Power receptacles		► Page 256
	• Power and communication cover plates		► Page 258
	• Infeeds		► Page 259
	• Modular harnesses		► Page 261
	• Field-installed powerkits		► Page 239

Tip: Base power block location does not include infeed. It must be ordered separately, if needed.

► Options, continued on next page

 **For Canadian Pricing**
Multiply U.S. Price by the Canadian price factor.
► See page 1 for details.

Glass Selections Wall Panels with Two Divided Lites Transom-Aligned Top Lite, continued

► Options, continued from previous page

Tip: SmartTools options are available and easily ordered when using SmartTools software. If you do not have access to SmartTools software, these options can also be ordered using the normal Specials RFQ (Request For Quote) process.

	SmartTools Options	U.S. Price	Required to Specify
Parametric Panel Widths (Available in 1" increments)	<ul style="list-style-type: none"> • Non standard widths • Non standard modular widths 	Use U.S. Base Price of next larger standard width Use U.S. Base Price of next larger standard width	Specify panel widths in 1" increments. Specify panel widths in 1" increments.
Base	<ul style="list-style-type: none"> • 2½"H base • 4"H base 	+\$ 92 +\$228	Specify to accept 2½"H base. Specify to accept 4"H base.

Specification Information

Width	Style Number	U.S. Base Price	Nominal Width	Modular Width	Style Number	U.S. Base Price
-------	--------------	-----------------	---------------	---------------	--------------	-----------------

Glass Wall Panels

6"	GPGSS2L06	\$ 917
8"	GPGSS2L08	\$ 917
18"	GPGSS2L18	\$ 995
20"	GPGSS2L20	\$ 995
24"	GPGSS2L24	\$1058
30"	GPGSS2L30	\$1082
36"	GPGSS2L36	\$1182
40"	GPGSS2L40	\$1187
42"	GPGSS2L42	\$1187
48"	GPGSS2L48	\$1296
60"	GPGSS2L60	\$1631
:	:	:

Modular Glass Wall Panels

8"	6 ¹¹ / ₁₆ "	GPGSM2L08	\$ 917
18"	18 ¹¹ / ₁₆ "	GPGSM2L18	\$ 995
20"	18 ¹¹ / ₁₆ "	GPGSM2L20	\$ 995
24"	22 ¹¹ / ₁₆ "	GPGSM2L24	\$1058
30"	28 ¹¹ / ₁₆ "	GPGSM2L30	\$1082
36"	34 ¹¹ / ₁₆ "	GPGSM2L36	\$1182
40"	38 ¹¹ / ₁₆ "	GPGSM2L40	\$1187
42"	40 ¹¹ / ₁₆ "	GPGSM2L42	\$1187
48"	46 ¹¹ / ₁₆ "	GPGSM2L48	\$1296
60"	58 ¹¹ / ₁₆ "	GPGSM2L60	\$1631
:	:	:	:

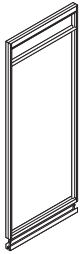

For Canadian Pricing
 Multiply U.S. Price by the Canadian price factor.
 ► See page 1 for details.

Glass Selections
Wall Panels with
Two Divided Lites

Glass Selections Two Divided Lite Frame Kits

Transom-Aligned Top Lite

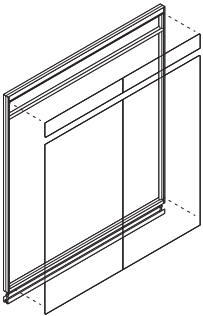

Tip: Order ceiling track, feature strip, and continuous base trim separately.

Tip: Frame kits are assembled in the field. Butt joints must be glazed with glazing tape or silicone sealant to be code-compliant.

Tip: Frame kits include two power blocks per kit.

Tip: SmartTools options are available and easily ordered when using SmartTools software. If you do not have access to SmartTools software, these options can also be ordered using the normal Specials RFQ (Request For Quote) process.

Standard Includes		Required to Specify
<ul style="list-style-type: none"> ▶ Need help? Product details, page 24 	<ul style="list-style-type: none"> • Ceiling height from 8'0"H to 10'0"H, in one-inch increments • 2³/₈"-thick panel with frame: paint or anodized aluminum • Floor track with adjustable levelers to accommodate continuous 5"H base trim (ordered separately) 	<ol style="list-style-type: none"> 1 Style number 2 Ceiling height 3 Paint color number for frame 4 Post extension 5 Options, if selected (see below) <ul style="list-style-type: none"> ▶ See <i>Surface Materials</i>, page 408.

Options	U.S. Price	Required to Specify
Surface Materials Frame <ul style="list-style-type: none"> • Paint price group 1 • Paint price group 2 • Paint price group 3 • Anodized aluminum 	<ul style="list-style-type: none"> No cost +\$ 29 +\$ 48 No cost 	<ul style="list-style-type: none"> Specify paint color number. Specify paint color number. Specify paint color number. Specify anodized aluminum.
Post Extension <ul style="list-style-type: none"> • Post extensions modified to accommodate recessed ceiling track (ordered separately) • Post extensions modified to accommodate overlapping ceiling track (ordered separately) 	<ul style="list-style-type: none"> No cost No cost 	<ul style="list-style-type: none"> Specify with post extensions for recessed ceiling track interface. Specify with post extensions for overlapping ceiling track interface.
Ceiling Height <ul style="list-style-type: none"> • 8'0" through 9'0" • 9'1" through 10'0" 	<ul style="list-style-type: none"> No cost +\$ 50 	<ul style="list-style-type: none"> Specify ceiling height in 1" increments. Specify ceiling height in 1" increments.
Electrical Power	Base power block power schematic <ul style="list-style-type: none"> • 3+1 • 2+2 • 3SN 	<ul style="list-style-type: none"> Specify with 3+1 power. Specify with 2+2 power. Specify with 3SN power.

Related Products <ul style="list-style-type: none"> • Power options • Ceiling tracks • Continuous base trim • Feature strips • Power receptacles • Power and communication cover plates • Infeeds • Modular harnesses • Field-installed powerkits 	<ul style="list-style-type: none"> ▶ Page 146 ▶ Page 238 ▶ Page 244 ▶ Page 248 ▶ Page 256 ▶ Page 258 ▶ Page 259 ▶ Page 261 ▶ Page 239
---	--

SmartTools Options	U.S. Price	Required to Specify
Parametric Panel Widths (Available in 1" increments)	<ul style="list-style-type: none"> • Non standard widths • Non standard modular widths 	<ul style="list-style-type: none"> Use U.S. Base Price of next larger standard width Use U.S. Base Price of next larger standard width
Base	<ul style="list-style-type: none"> • 2¹/₂"H base • 4"H base 	<ul style="list-style-type: none"> +\$187 +\$343
		<ul style="list-style-type: none"> Specify panel widths in 1" increments. Specify panel widths in 1" increments. Specify to accept 2¹/₂"H base. Specify to accept 4"H base.



For Canadian Pricing

Multiply U.S. Price by the Canadian price factor.

▶ See page 1 for details.

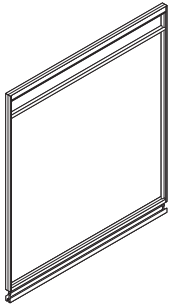

Specification Information						
Width	Style Number	U.S. Base Price	Nominal Width	Modular Width	Style Number	U.S. Base Price
Two Divided Lite Frame Kits			Modular Two Divided Lite Frame Kits			
72"	GPGSS2FK72	\$1312	72"	70 ¹¹ / ₁₆ "	GPGSM2FK72	\$1312
80"	GPGSS2FK80	\$1403	80"	78 ¹¹ / ₁₆ "	GPGSM2FK80	\$1403
84"	GPGSS2FK84	\$1502	84"	82 ¹¹ / ₁₆ "	GPGSM2FK84	\$1502
96"	GPGSS2FK96	\$1608	96"	94 ¹¹ / ₁₆ "	GPGSM2FK96	\$1608
108"	GPGSS2FK108	\$1720	108"	106 ¹¹ / ₁₆ "	GPGSM2FK108	\$1720
120"	GPGSS2FK120	\$1842	120"	118 ¹¹ / ₁₆ "	GPGSM2FK120	\$1842
144"	GPGSS2FK144	\$1969	144"	142 ¹¹ / ₁₆ "	GPGSM2FK144	\$1969

 **For Canadian Pricing**
Multiply U.S. Price by the
Canadian price factor.
▶ See page 1 for details.

Glass Selections Two Divided Lite Glass Kits

Transom-Aligned Top Lite

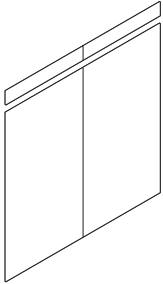

Tip: Order ceiling track, feature strip, and continuous base trim separately.

Tip: Glass kits are assembled in the field. Butt joints must be glazed with glazing tape or silicone sealant to be code-compliant.

Tip: Glass kits 72"W to 96"W have two pieces of glass. Kits 108"W to 144"W have three pieces of glass.

Standard Includes		Required to Specify
<ul style="list-style-type: none"> ▶ Need help? Product details, page 24 	<ul style="list-style-type: none"> • Ceiling height from 8'0"H to 10'0"H, in one-inch increments • 3/8"-thick clear tempered glass • Floor track with adjustable levelers to accommodate continuous 5"H base trim (ordered separately) 	<ol style="list-style-type: none"> 1 Style number 2 Ceiling height 3 Glass number for lite 1 (from top) 4 Glass number for lite 2 5 Options, if selected (see below) <p>▶ See <i>Surface Materials</i>, page 408.</p>

Options	U.S. Price	Required to Specify
Surface Materials		
Top Lite Glass Panels 8'0" through 10'0", 72"W through 80"W		
• Glass price group 1	No cost	Specify glass number for lite.
• Glass price group 2	+\$ 480	Specify glass number for lite.
• Glass price group 3	+\$ 604	Specify glass number for lite.
• Glass price group 4	+\$ 698	Specify glass number for lite.
• Glass price group 5	N.A.	Specify glass number for lite.
• Glass price group 6	+\$1439	Specify glass number for lite.
▶ See <i>Surface Materials Reference Manual</i> .		
Lower Lite Glass Panels 8'0" through 10'0" (per lite), 72"W through 80"W		
• Glass price group 1	No cost	Specify glass number for lite.
• Glass price group 2	+\$1453	Specify glass number for lite.
• Glass price group 3	+\$1769	Specify glass number for lite.
• Glass price group 4	+\$2021	Specify glass number for lite.
• Glass price group 5	N.A.	Specify glass number for lite.
• Glass price group 6	+\$3956	Specify glass number for lite.
▶ See <i>Surface Materials Reference Manual</i> .		
Top Lite Glass Panels 8'0" through 10'0", 84"W through 96"W		
• Glass price group 1	No cost	Specify glass number for lite.
• Glass price group 2	+\$ 604	Specify glass number for lite.
• Glass price group 3	+\$ 747	Specify glass number for lite.
• Glass price group 4	+\$ 863	Specify glass number for lite.
• Glass price group 5	N.A.	Specify glass number for lite.
• Glass price group 6	+\$1751	Specify glass number for lite.
▶ See <i>Surface Materials Reference Manual</i> .		
Lower Lite Glass Panels 8'0" through 10'0" (per lite), 84"W through 96"W		
• Glass price group 1	No cost	Specify glass number for lite.
• Glass price group 2	+\$1678	Specify glass number for lite.
• Glass price group 3	+\$2040	Specify glass number for lite.
• Glass price group 4	+\$2324	Specify glass number for lite.
• Glass price group 5	N.A.	Specify glass number for lite.
• Glass price group 6	+\$4541	Specify glass number for lite.
▶ See <i>Surface Materials Reference Manual</i> .		
Top Lite Glass Panels 8'0" through 10'0", 108"W through 144"W		
• Glass price group 1	No cost	Specify glass number for lite.
• Glass price group 2	+\$ 783	Specify glass number for lite.
• Glass price group 3	+\$ 964	Specify glass number for lite.
• Glass price group 4	+\$1109	Specify glass number for lite.
• Glass price group 5	N.A.	Specify glass number for lite.
• Glass price group 6	+\$2222	Specify glass number for lite.
▶ See <i>Surface Materials Reference Manual</i> .		
Lower Lite Glass Panels 8'0" through 10'0" (per lite), 108"W through 144"W		
• Glass price group 1	No cost	Specify glass number for lite.
• Glass price group 2	+\$2130	Specify glass number for lite.
• Glass price group 3	+\$2581	Specify glass number for lite.
• Glass price group 4	+\$2937	Specify glass number for lite.
• Glass price group 5	N.A.	Specify glass number for lite.
• Glass price group 6	+\$5705	Specify glass number for lite.
▶ See <i>Surface Materials Reference Manual</i> .		

Ceiling Height	U.S. Price	Required to Specify
• 8'0" through 9'0"	No cost	Specify ceiling height in 1" increments.
• 9'1" through 10'0"	+\$ 50	Specify ceiling height in 1" increments.

▶ Options, continued on next page



For Canadian Pricing
Multiply U.S. Price by the Canadian price factor.
▶ See page 1 for details.

► Options, continued from previous page

Related Products

- Power options ► Page 146
- Ceiling tracks ► Page 238
- Continuous base trim ► Page 244
- Feature strips ► Page 248
- Power receptacles ► Page 256
- Power and communication cover plates ► Page 258
- Infeeds ► Page 259
- Modular harnesses ► Page 261
- Field-installed powerkits ► Page 239

Tip: SmartTools options are available and easily ordered when using SmartTools software. If you do not have access to SmartTools software, these options can also be ordered using the normal Specials RFQ (Request For Quote) process.

SmartTools Options	U.S. Price	Required to Specify
Parametric Panel Widths (Available in 1" increments)	Overall unit widths • 61"W through 95"W (excludes standard widths) • 97"W through 143"W (excludes standard widths)	Specify panel widths in 1" increments. Specify panel widths in 1" increments.
Base	2½"H base • 61"W through 96"W • 97"W through 144"W 4"H base • 4"H base	Specify to accept 2½"H base. Specify to accept 2½"H base. Specify to accept 4"H base.

Specification Information

Width	Style Number	U.S. Base Price	Nominal Width	Modular Width	Style Number	U.S. Base Price
Two Divided Lite Glass Kits						
72"	GPGSS2GK72	\$1892	72"	70 ¹¹ / ₁₆ "	GPGSM2GK72	\$1892
80"	GPGSS2GK80	\$2070	80"	78 ¹¹ / ₁₆ "	GPGSM2GK80	\$2070
84"	GPGSS2GK84	\$2158	84"	82 ¹¹ / ₁₆ "	GPGSM2GK84	\$2158
96"	GPGSS2GK96	\$2419	96"	91 ¹ / ₁₆ "	GPGSM2GK96	\$2419
108"	GPGSS2GK108	\$2685	108"	106 ¹¹ / ₁₆ "	GPGSM2GK108	\$2685
120"	GPGSS2GK120	\$2949	120"	118 ¹¹ / ₁₆ "	GPGSM2GK120	\$2949
144"	GPGSS2GK144	\$3474	144"	142 ¹¹ / ₁₆ "	GPGSM2GK144	\$3474
...
Modular Two Divided Lite Glass Kits						

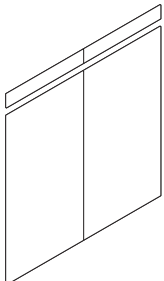

For Canadian Pricing
Multiply U.S. Price by the Canadian price factor.
► See page 1 for details.

Glass Selections Clerestory Wall Panels

Transom-Aligned Top Lite

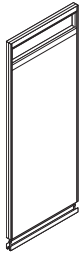

Tip: Order ceiling track feature strip, and continuous base trim separately.

Tip: For information regarding Etched and Pattern Glass Planning.
▶ Page 104.

Tip: Metallic paint is available on panel skins that are 36" wide or less.

Standard Includes	Required to Specify
<ul style="list-style-type: none"> ▶ Need help? Product details, page 24 • Frame: paint or anodized aluminum • Ceiling height from 8'0"H to 10'0"H, in one-inch increments • 2³/₈"-thick panel with steel surfaces: paint • Factory-installed Clerestory lite: glass • Integral slotted verticals • Hollow core panel for cable and panel routing • Floor track with adjustable levelers to accommodate continuous 5"H base trim (ordered separately) 	<ol style="list-style-type: none"> 1 Style number 2 Ceiling height 3 Paint color number for frame 4 Paint color number for side 1 5 Paint color number for side 2 6 Glass number for Clerestory lite 7 Post extension 8 Options, if selected (see below) <p>▶ See <i>Surface Materials</i>, page 408.</p>

Surface Materials	Options	U.S. Price	Required to Specify
	Frame <ul style="list-style-type: none"> • Paint price group 1 • Paint price group 2 • Paint price group 3 • Anodized aluminum 	<ul style="list-style-type: none"> No cost +\$ 29 +\$ 48 No cost 	<ul style="list-style-type: none"> Specify paint color number. Specify paint color number. Specify paint color number. Specify anodized aluminum.
	Lower panel surfaces 8'0"H through 10'0"H (per side), 18"W to 24"W		
	<ul style="list-style-type: none"> • Paint price group 1 • Paint price group 2 • Paint price group 3 • Fabric price group 1 	<ul style="list-style-type: none"> No cost +\$ 18 +\$ 33 +\$142 	<ul style="list-style-type: none"> Specify paint color number. Specify paint color number. Specify paint color number. Specify fabric color number for side 1 and/or side 2.
	<ul style="list-style-type: none"> • Fabric price group 2 	<ul style="list-style-type: none"> +\$201 	<ul style="list-style-type: none"> Specify fabric color number for side 1 and/or side 2.
	<ul style="list-style-type: none"> • Fabric price group 3 	<ul style="list-style-type: none"> +\$264 	<ul style="list-style-type: none"> Specify fabric color number for side 1 and/or side 2.
	<ul style="list-style-type: none"> • Fabric price group 5 	<ul style="list-style-type: none"> +\$334 	<ul style="list-style-type: none"> Specify fabric color number for side 1 and/or side 2.
	<ul style="list-style-type: none"> • Customer's Own Material/Vinyl (COM) 	<ul style="list-style-type: none"> +\$137 	<ul style="list-style-type: none"> ▶ See <i>Surface Materials Reference Manual</i>.
	Clerestory lite glass panels 8'0"H through 10'0"H		
	<ul style="list-style-type: none"> • Glass price group 1 • Glass price group 2 • Glass price group 3 • Glass price group 4 • Glass price group 5 • Glass price group 6 	<ul style="list-style-type: none"> No cost +\$ 57 +\$ 67 +\$106 N.A. +\$209 	<ul style="list-style-type: none"> Specify glass number for lite. Specify glass number for lite. Specify glass number for lite. Specify glass number for lite. Specify glass number for lite. Specify glass number for lite.
	Lower panel surfaces 8'0"H through 10'0"H (per side), 30"W to 36"W		
	<ul style="list-style-type: none"> • Paint price group 1 • Paint price group 2 • Paint price group 3 • Fabric price group 1 	<ul style="list-style-type: none"> No cost +\$ 37 +\$ 57 +\$217 	<ul style="list-style-type: none"> Specify paint color number. Specify paint color number. Specify paint color number. Specify fabric color number for side 1 and/or side 2.
	<ul style="list-style-type: none"> • Fabric price group 2 	<ul style="list-style-type: none"> +\$322 	<ul style="list-style-type: none"> Specify fabric color number for side 1 and/or side 2.
	<ul style="list-style-type: none"> • Fabric price group 3 	<ul style="list-style-type: none"> +\$477 	<ul style="list-style-type: none"> Specify fabric color number for side 1 and/or side 2.
	<ul style="list-style-type: none"> • Fabric price group 5 	<ul style="list-style-type: none"> +\$621 	<ul style="list-style-type: none"> Specify fabric color number for side 1 and/or side 2.
	<ul style="list-style-type: none"> • Customer's Own Material/Vinyl (COM) 	<ul style="list-style-type: none"> +\$201 	<ul style="list-style-type: none"> ▶ See <i>Surface Materials Reference Manual</i>.
	Clerestory lite glass panels 8'0"H through 10'0"H		
	<ul style="list-style-type: none"> • Glass price group 1 • Glass price group 2 • Glass price group 3 • Glass price group 4 • Glass price group 5 • Glass price group 6 	<ul style="list-style-type: none"> No cost +\$ 83 +\$ 98 +\$160 N.A. +\$312 	<ul style="list-style-type: none"> Specify glass number for lite. Specify glass number for lite. Specify glass number for lite. Specify glass number for lite. Specify glass number for lite. Specify glass number for lite.

▶ Options, continued on next page



For Canadian Pricing

Multiply U.S. Price by the Canadian price factor.

▶ See page 1 for details.

► Options, continued from previous page

Options	U.S. Price	Required to Specify
Surface Materials, continued		
Lower panel surfaces 8'0"H through 10'0"H (per side) 40"W to 48"W		
• Paint price group 1	No cost	Specify paint color number.
• Paint price group 3	+\$ 57	Specify paint color number.
• Fabric price group 1	+\$217	Specify fabric color number for side 1 and/or side 2.
• Fabric price group 2	+\$322	Specify fabric color number for side 1 and/or side 2.
• Fabric price group 3	+\$477	Specify fabric color number for side 1 and/or side 2.
• Fabric price group 5	+\$621	Specify fabric color number for side 1 and/or side 2.
• Customer's Own Material/Vinyl (COM)	+\$201	► See <i>Surface Materials Reference Manual</i> .
Clerestory lite glass panels 8'0"H through 10'0"H		
• Glass price group 1	No cost	Specify glass number for lite.
• Glass price group 2	+\$111	Specify glass number for lite.
• Glass price group 3	+\$133	Specify glass number for lite.
• Glass price group 4	+\$211	Specify glass number for lite.
• Glass price group 5	N.A.	Specify glass number for lite.
• Glass price group 6	+\$416	Specify glass number for lite.
Lower panel surfaces 8'0"H through 10'0"H (per side) 60"W		
• Paint price group 1	No cost	Specify paint color number.
• Paint price group 3	+\$ 57	Specify paint color number.
• Fabric price group 1	+\$217	Specify fabric color number for side 1 and/or side 2.
• Fabric price group 2	+\$322	Specify fabric color number for side 1 and/or side 2.
• Fabric price group 3	+\$477	Specify fabric color number for side 1 and/or side 2.
• Fabric price group 5	+\$621	Specify fabric color number for side 1 and/or side 2.
• Customer's Own Material/Vinyl (COM)	+\$201	► See <i>Surface Materials Reference Manual</i> .
Clerestory lite glass panels 8'0"H through 10'0"H		
• Glass price group 1	No cost	Specify glass number for lite.
• Glass price group 2	+\$140	Specify glass number for lite.
• Glass price group 3	+\$166	Specify glass number for lite.
• Glass price group 4	+\$262	Specify glass number for lite.
• Glass price group 5	N.A.	Specify glass number for lite.
• Glass price group 6	+\$520	Specify glass number for lite.
Post Extension		
• Post extensions modified to accommodate recessed ceiling track (ordered separately)	No cost	Specify with <i>post extensions for recessed ceiling track interface</i> .
• Post extensions modified to accommodate overlapping ceiling track (ordered separately)	No cost	Specify with <i>post extensions for overlapping ceiling track interface</i> .
Ceiling Height		
• 8'0" through 9'0"	No cost	Specify ceiling height in 1" increments.
• 9'1" through 10'0"	+\$ 96	Specify ceiling height in 1" increments.

► Options, continued on next page

Tip: Customer's Own Glass is available as a special at this time.

 **For Canadian Pricing**
Multiply U.S. Price by the Canadian price factor.
► See page 1 for details.

Glass Selections Clerestory Wall Panels Transom-Aligned Top Lite, continued

► Options, continued from previous page

	Options	U.S. Price	Required to Specify
Electrical Power (30"W through 60"W)	Power block location		
	• Base	+\$207	Specify with power block location at base.
	• ADA height	+\$755	Specify with power block location at ADA height.
	• Desk height	+\$755	Specify with power block location at desk height.
	Power schematic		
	• 3+1	No cost	Specify with 3+1 power.
	• 2+2	No cost	Specify with 2+2 power.
	• 3SN	No cost	Specify with 3SN power.
	New York City/Chicago power prep		
	• NYC/CHI at base	N.A.	Specify with NYC/CHI at base.
	• NYC/CHI at ADA or desk height side 1	+\$ 26	Specify with NYC/CHI at ADA or desk height side 1.
	• NYC/CHI at ADA or desk height side 2	+\$ 26	Specify with NYC/CHI at ADA or desk height side 2.
	• NYC/CHI at ADA or desk height sides 1 and 2	+\$ 52	Specify with NYC/CHI at ADA or desk height sides 1 and 2.
	Receptacle cutouts		
	• Power side 1	No cost	Specify with power side 1.
	• Power side 2	No cost	Specify with power side 2.
	• Power sides 1 and 2	+\$ 26	Specify with power sides 1 and 2.
	• Power/comm side 1	No cost	Specify with power/comm side 1.
	• Power/comm side 2	No cost	Specify with power/comm side 2.
	• Power/comm sides 1 and 2	+\$ 26	Specify with power/comm sides 1 and 2.
	Floor Infeeds		
	• Bottom left hardwire	No cost	Specify with bottom left hardwire.
	• Bottom left modular	+\$ 96	Specify with bottom left modular.

Related Products	• Power options	► Page 146
	• Ceiling tracks	► Page 238
	• Continuous base trim	► Page 244
	• Feature strips	► Page 248
	• Power receptacles	► Page 256
	• Power and communication cover plates	► Page 258
	• Infeeds	► Page 259
	• Modular harnesses	► Page 261
	• Field-installed powerkits	► Page 239

Tip: To price power in two locations, add the upcharges together.

Tip: Infeed is included in the price of ADA- or desk-height receptacle power location option.

Tip: Base power block location does not include infeed. It must be ordered separately, if needed.

Tip: NYC/CHI prices replace the receptacle power location option prices when selected.

Tip: SmartTools options are available and easily ordered when using SmartTools software. If you do not have access to SmartTools software, these options can also be ordered using the normal Specials RFQ (Request For Quote) process.

Tip: Markerboard surface cannot exceed 48"W.

	SmartTools Options	U.S. Price	Required to Specify
7610 White Markerboard Surface	• 6"W through 24"W	+\$487	Specify with markerboard.
	• 25"W through 36"W	+\$523	Specify with markerboard.
	• 37"W through 48"W	+\$559	Specify with markerboard.
Parametric Panel Widths (Available in 1" increments)	• Non standard widths	No cost	Specify panel widths in 1" increments.
	• Non standard modular widths	No cost	Specify panel widths in 1" increments.
Base	• 2½"H base	+\$ 84	Specify to accept 2½"H base.
	• 4"H base	+\$ 63	Specify to accept 4"H base.



For Canadian Pricing
Multiply U.S. Price by the Canadian price factor.
► See page 1 for details.

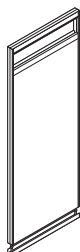

Specification Information

Width	Style Number	U.S. Base Price	Nominal Width	Modular Width	Style Number	U.S. Base Price
Clerestory Panels			Modular Clerestory Panels			
18"	GPGSSC18	\$1207	18"	16 ¹¹ / ₁₆ "	GPGSMC18	\$1207
20"	GPGSSC20	\$1207	20"	18 ¹¹ / ₁₆ "	GPGSMC20	\$1207
24"	GPGSSC24	\$1275	24"	22 ¹¹ / ₁₆ "	GPGSMC24	\$1275
30"	GPGSSC30	\$1339	30"	28 ¹¹ / ₁₆ "	GPGSMC30	\$1339
36"	GPGSSC36	\$1382	36"	34 ¹¹ / ₁₆ "	GPGSMC36	\$1382
40"	GPGSSC40	\$1425	40"	38 ¹¹ / ₁₆ "	GPGSMC40	\$1425
42"	GPGSSC42	\$1425	42"	40 ¹¹ / ₁₆ "	GPGSMC42	\$1425
48"	GPGSSC48	\$1474	48"	46 ¹¹ / ₁₆ "	GPGSMC48	\$1474
60"	GPGSSC60	\$1898	60"	58 ¹¹ / ₁₆ "	GPGSMC60	\$1898

 **For Canadian Pricing**
Multiply U.S. Price by the Canadian price factor.
▶ See page 1 for details.

Glass Selections Pivot-Hinged Door Frames

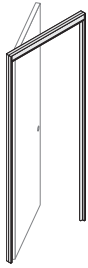

Tip: Glass door is available up to 9'0"H ceiling height.

Tip: Recommended for use with Glass Selections panels only.

Tip: Glass Selections pivot-hinged door frames work with Glass Selections door leaves only.

Tip: For information regarding Etched and Pattern Glass Planning.
▶ Page 104.

Tip: Order switch separately.

Tip: Swing orientation is available on single pivot-hinged door frame with transom only to properly orient etched and patterned glass.



For Canadian Pricing
Multiply U.S. Price by the Canadian price factor.
▶ See page 1 for details.

Standard Includes	Required to Specify
<ul style="list-style-type: none"> ▶ Need help? Product details, page 40 Ceiling height from 8'0"H to 10'0"H, in one-inch increments Reversible, pivot-hinged door frame with plinths: paint or anodized aluminum Door base: paint Factory prep for pivot hinges <i>Tip: Order door hardware separately.</i> Transom, if selected: glass 	<ol style="list-style-type: none"> Style number Ceiling height Paint color number for frame Paint color number for door base Swing orientation Glass number for transom, if selected Metal color number for strike plate, if selected: <ul style="list-style-type: none"> 9200 Satin Chrome 9201 Polished Chrome Post extension Factory prep for cylindrical or mortise passage set or lockset, if selected Options, if selected (see below) <ul style="list-style-type: none"> ▶ See <i>Surface Materials</i>, page 408.

Options	U.S. Price	Required to Specify
Surface Materials <ul style="list-style-type: none"> Frame <ul style="list-style-type: none"> Paint price group 1 Paint price group 2 Paint price group 3 Anodized aluminum Base <ul style="list-style-type: none"> Paint price group 1 Paint price group 2 Paint price group 3 Strike plate <ul style="list-style-type: none"> Satin chrome Polished chrome 	<ul style="list-style-type: none"> No cost +\$ 29 +\$ 48 No cost No cost +\$ 8 +\$ 15 No cost +\$ 26 	<ul style="list-style-type: none"> Specify paint color number. Specify paint color number. Specify paint color number. Specify anodized aluminum. Specify paint color number. Specify paint color number. Specify paint color number. Specify with 9200 Satin Chrome. Specify with 9201 Polished Chrome.
Single door frames with transom 8'0"H through 10'0"H <ul style="list-style-type: none"> Glass price group 1 Glass price group 2 Glass price group 3 Glass price group 4 Glass price group 5 Glass price group 6 		
Pair door frames with transom 8'0"H through 10'0"H <ul style="list-style-type: none"> Glass price group 1 Glass price group 2 Glass price group 3 Glass price group 4 Glass price group 5 Glass price group 6 		
Post Extension <ul style="list-style-type: none"> Post extensions modified to accommodate recessed ceiling track (ordered separately) Post extensions modified to accommodate overlapping ceiling track (ordered separately) 	<ul style="list-style-type: none"> No cost No cost 	<ul style="list-style-type: none"> Specify with post extensions for recessed ceiling track interface. Specify with post extensions for overlapping ceiling track interface.
Ceiling Height <ul style="list-style-type: none"> Single door frames <ul style="list-style-type: none"> 8'0" through 9'0" 9'1" through 10'0" Pair door frames <ul style="list-style-type: none"> 8'0" through 9'0" 9'1" through 10'0" 	<ul style="list-style-type: none"> No cost +\$ 50 No cost +\$ 96 	<ul style="list-style-type: none"> Specify ceiling height in 1" increments. Specify ceiling height in 1" increments. Specify ceiling height in 1" increments. Specify ceiling height in 1" increments.
Swing Orientation <ul style="list-style-type: none"> Page 46 	For single pivot-hinged door frame with transom <ul style="list-style-type: none"> Left-hand door frame Right-hand door frame 	<ul style="list-style-type: none"> Specify with left-hand door frame. Specify with right-hand door frame.

▶ Options, continued on next page

► Options, continued from previous page

Options	U.S. Price	Required to Specify
Lock Prep ► Page 42	• Strike plate and factory prep for cylindrical passage set or lockset • Strike plate and factory prep for mortise passage set or lockset	No cost +\$73

Related Products	Pages
• Door leaves	► Pages 216–222
• Passage sets and locksets	► Page 168
• Hinges	► Page 170
• Stops	► Page 170
• Ceiling tracks	► Page 238
• Feature strips	► Page 248

Tip: SmartTools options are available and easily ordered when using SmartTools software. If you do not have access to SmartTools software, these options can also be ordered using the normal Specials RFQ (Request For Quote) process.

SmartTools Options	U.S. Price	Required to Specify
Base	• 2½"H base • 4"H base	Specify to accept 2½"H base. Specify to accept 4"H base.

Specification Information		
Width	Style Number	U.S. Base Price
•	•	•
•	•	•
•	•	•
•	•	•

Single Door Frames

Full-Height		
40"	GPGSDSPF	\$ 791
With Transom		
40"	GPGSDSPT	\$1581
•	•	•

Pair Frames

Full-Height		
80"	GPGSDPPF	\$ 846
With Transom		
80"	GPGSDPPT	\$1686
•	•	•

Single Door Frames for Use with Switch Cutout

Full-Height		
42"	GPGSDSPFS	\$1404
With Transom		
42"	GPGSDSPTS	\$2187
•	•	•

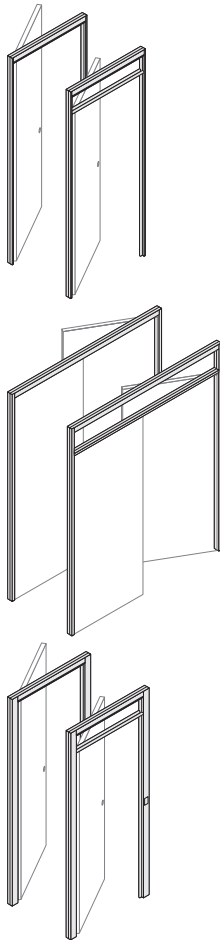

Glass Selections Full-Height Pivot-Hinged Door Leaves



Tip: Glass Selections pivot-hinged door leaves work with Glass Selections door frames only.

Tip: For information regarding Etched and Pattern Glass Planning.
▶ Page 104.

Tip: Ceiling height option is available on solid door leaves only.

Standard Includes		Required to Specify
▶ Need help? Product details, page 40	<ul style="list-style-type: none"> Ceiling height from 8'0"H to 10'0"H, in one-inch increments <i>Exception: Maximum ceiling height of glass doors is 9'0"H.</i> Reversible pivot-hinged door: paint, glass, flat-cut veneer, or anodized aluminum Door frame: paint or anodized aluminum Factory prep for pivot hinges 	<ol style="list-style-type: none"> Style number Ceiling height Paint color number for door, if solid door selected Paint color number for door frame Glass number for glass door, if glass door selected Paint color number for glass door, if glass door selected Wood veneer color number, if selected Factory prep for cylindrical or mortise passage set or lockset, if selected Options, if selected (see below) <p>▶ See <i>Surface Materials</i>, page 408.</p>
Options	U.S. Price	Required to Specify
Surface Materials	Glass door frame surface	
	<ul style="list-style-type: none"> Paint price group 1 No cost Paint price group 2 +\$ 29 Paint price group 3 +\$ 48 Anodized aluminum No cost 	Specify paint color number. Specify paint color number. Specify paint color number. Specify anodized aluminum.
	37³/₁₆"W solid single door leaf 8'0"H through 10'0"H	
	<ul style="list-style-type: none"> Paint price group 1 No cost Paint price group 3 +\$ 115 Wood veneer (flat cut) No cost Quarter-cut wood veneer +\$ 182 	Specify paint color number. Specify paint color number. Specify wood veneer color number. Specify with <i>Quarter-cut open pore veneer</i> .
	<ul style="list-style-type: none"> Customiz stain No cost 	Specify with <i>Customiz stain</i> .
	77¹/₂"W solid pair door leaves 8'0"H through 10'0"H	
	<ul style="list-style-type: none"> Paint price group 1 No cost Paint price group 3 +\$ 227 Wood veneer (flat cut) No cost Quarter-cut wood veneer +\$ 369 Customiz stain No cost 	Specify paint color number. Specify paint color number. Specify wood veneer color number. Specify wood veneer color number. Specify with <i>Customiz stain</i> .
	Glass single door 8'0"H through 9'0"H	
	<ul style="list-style-type: none"> Glass price group 1 No cost Glass price group 2 +\$ 408 Glass price group 3 +\$ 487 Glass price group 4 +\$ 783 Glass price group 5 N.A. Glass price group 6 +\$1548 	Specify glass number for door. Specify glass number for door. Specify glass number for door. Specify glass number for door. Specify glass number for door. Specify glass number for door.
Ceiling Height	Solid single door leaves	
	<ul style="list-style-type: none"> 8'0" through 9'0" No cost 9'1" through 10'0" +\$ 287 	Specify ceiling height in 1" increments. Specify ceiling height in 1" increments.
	Solid pair door leaves	
	<ul style="list-style-type: none"> 8'0" through 9'0" No cost 9'1" through 10'0" +\$ 572 	Specify ceiling height in 1" increments. Specify ceiling height in 1" increments.
Lock Prep ▶ Page 42	<ul style="list-style-type: none"> Strike plate and factory prep for cylindrical passage set or lockset No cost Strike plate and factory prep for mortise passage set or lockset +\$ 46 	Specify with <i>cylindrical prep</i> . Specify with <i>mortise prep</i> .
Related Products	<ul style="list-style-type: none"> Door frames Passage sets and locksets Hinges Stops 	<ul style="list-style-type: none"> ▶ Page 150 ▶ Page 168 ▶ Page 170 ▶ Page 170

 **For Canadian Pricing**
Multiply U.S. Price by the Canadian price factor.
▶ See page 1 for details.

Specification Information

Width	Corresponding Frame Width	Style Number	U.S. Base Price
-------	---------------------------	--------------	-----------------



Solid Single Door

37 ³ / ₁₆ "	40"	GPGSLSPF40	\$2131
-----------------------------------	-----	-------------------	--------

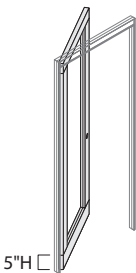

Glass Single Door with 5"H Bottom Rail

37 ³ / ₁₆ "	40"	GPGSLGSPF40	\$4718
-----------------------------------	-----	--------------------	--------



Glass Single Door with 12"H Bottom Rail

37 ³ / ₁₆ "	40"	GPGSLGSPF40B	\$4581
-----------------------------------	-----	---------------------	--------

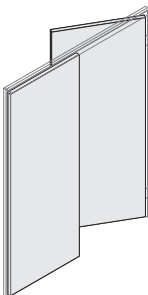

Solid Pair Door

77 ¹ / ₂ "	80"	GPGSLSPF80	\$4340
----------------------------------	-----	-------------------	--------

 **For Canadian Pricing**
Multiply U.S. Price by the
Canadian price factor.
▶ See page 1 for details.

Glass Selections Transom-Height Pivot-Hinged Door Leaves



Tip: Glass Selections pivot-hinged door leaves work with Glass Selections door frames only.

Tip: For information regarding Etched and Pattern Glass Planning.
▶ Page 104.

Standard Includes		Required to Specify
▶ Need help? Product details, page 40	<ul style="list-style-type: none"> 7'0"H Reversible pivot-hinged door: paint, glass, flat-cut veneer, or anodized aluminum Door frame: paint or anodized aluminum Factory prep for pivot hinges 	<ol style="list-style-type: none"> Style number Paint color number for door, if solid door selected Glass number for glass door, if glass door selected Paint color number for frame Paint color number for glass door, if glass door selected Wood veneer color number, if selected Factory prep for cylindrical or mortise passage set or lockset, if selected Options, if selected (see below) <p>▶ See <i>Surface Materials</i>, page 408.</p>
Options		Required to Specify
Surface Materials	U.S. Price	
Transom-height glass door frame leaves		
<ul style="list-style-type: none"> Paint price group 1 Paint price group 2 Paint price group 3 Anodized aluminum 	<ul style="list-style-type: none"> No cost +\$ 29 +\$ 48 No cost 	<ul style="list-style-type: none"> Specify paint color number. Specify paint color number. Specify paint color number. Specify anodized aluminum.
37³/₁₆"W solid single door leave 7'0"H		
<ul style="list-style-type: none"> Paint price group 1 Paint price group 3 Wood veneer (flat cut) Quarter-cut wood veneer Customiz stain 	<ul style="list-style-type: none"> No cost +\$ 115 No cost +\$ 166 No cost 	<ul style="list-style-type: none"> Specify paint color number. Specify paint color number. Specify wood veneer color number. Specify wood veneer color number. Specify with <i>Customiz stain</i>.
77¹/₂"W solid pair door leaves 7'0"H		
<ul style="list-style-type: none"> Paint price group 1 Paint price group 3 Wood veneer (flat cut) Quarter-cut wood veneer Customiz stain 	<ul style="list-style-type: none"> No cost +\$ 227 No cost +\$ 332 No cost 	<ul style="list-style-type: none"> Specify paint color number. Specify paint color number. Specify wood veneer color number. Specify wood veneer color number. Specify with <i>Customiz stain</i>.
Glass single door 7'0"H		
<ul style="list-style-type: none"> Glass price group 1 Glass price group 2 Glass price group 3 Glass price group 4 Glass price group 5 Glass price group 6 	<ul style="list-style-type: none"> No cost +\$ 408 +\$ 487 +\$ 783 N.A. +\$1548 	<ul style="list-style-type: none"> Specify glass number for door. Specify glass number for door. Specify glass number for door. Specify glass number for door. Specify glass number for door. Specify glass number for door.
▶ Lock Prep Page 42	<ul style="list-style-type: none"> Strike plate and factory prep for cylindrical passage set or lockset Strike plate and factory prep for mortise passage set or lockset 	<ul style="list-style-type: none"> No cost +\$ 46 <p>Specify with <i>cylindrical prep</i>.</p> <p>Specify with <i>mortise prep</i>.</p>
Related Products	<ul style="list-style-type: none"> Door frames Passage sets and locksets Hinges Stops 	<ul style="list-style-type: none"> ▶ Page 150 ▶ Page 168 ▶ Page 170 ▶ Page 170



For Canadian Pricing
Multiply U.S. Price by the Canadian price factor.
▶ See page 1 for details.

Specification Information

Width	Corresponding Frame Width	Style Number	U.S. Base Price
-------	---------------------------	--------------	-----------------



Solid Single Door

37 ⁷ / ₁₆ "	40"	GPGSLSSPT40	\$1886
-----------------------------------	-----	--------------------	--------

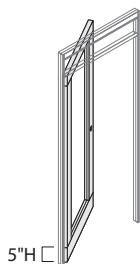

Glass Single Door with 5"H Bottom Rail

37 ⁷ / ₁₆ "	40"	GPGSLGSPT40	\$4176
-----------------------------------	-----	--------------------	--------

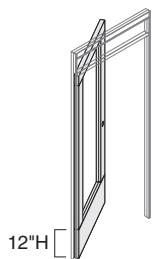

Glass Single Door with 12"H Bottom Rail

37 ⁷ / ₁₆ "	40"	GPGSLGSPT40B	\$4463
-----------------------------------	-----	---------------------	--------

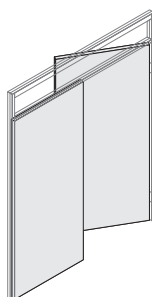

Solid Pair Door

77 ¹ / ₂ "	80"	GPGSLSPPT80	\$3847
----------------------------------	-----	--------------------	--------

 **For Canadian Pricing**
Multiply U.S. Price by the
Canadian price factor.
▶ See page 1 for details.

Glass Selections Full-Height Pivot-Hinged Door Leaves for Use with Switch Cutout

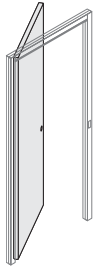

Tip: Glass Selections pivot-hinged door leaves work with Glass Selections door frames only.

Tip: For information regarding Etched and Pattern Glass Planning.
▶ Page 104.

Tip: Ceiling height option is available on solid door leaves only.

Standard Includes		Required to Specify
▶ Need help? Product details, page 40	<ul style="list-style-type: none"> Ceiling height from 8'0"H to 10'0"H, in one-inch increments <i>Exception: Maximum ceiling height of glass doors is 9'0"H.</i> Reversible pivot-hinged door: paint, glass, flat-cut veneer, or anodized aluminum Door frame: paint or anodized aluminum Factory prep for pivot hinges 	<ol style="list-style-type: none"> Style number Ceiling height Swing orientation Paint color number for door, if solid door selected Paint color number for door frame Glass number for glass door, if glass door selected Paint color number for glass door, if glass door selected Wood veneer color number, if selected Factory prep for cylindrical or mortise passage set or lockset, if selected Options, if selected (see below) <p>▶ See <i>Surface Materials</i>, page 408.</p>

Options	U.S. Price	Required to Specify	
Surface Materials	Full-height glass door frame leaves surface options		
<ul style="list-style-type: none"> Paint price group 1 Paint price group 2 Paint price group 3 Anodized aluminum 	<ul style="list-style-type: none"> No cost +\$ 29 +\$ 48 No cost 	<ul style="list-style-type: none"> Specify paint color number. Specify paint color number. Specify paint color number. Specify paint color number. 	
	36³/₈"W solid door leaves 8'0"H through 10'0"H		
<ul style="list-style-type: none"> Paint price group 1 Paint price group 3 Wood veneer (flat cut) Quarter-cut wood veneer Customiz stain 	<ul style="list-style-type: none"> No cost +\$ 115 No cost +\$ 182 No cost 	<ul style="list-style-type: none"> Specify paint color number. Specify paint color number. Specify wood veneer color number. Specify wood veneer color number. Specify with <i>Customiz stain</i>. 	
	Glass single door 8'0"H through 9'0"H		
<ul style="list-style-type: none"> Glass price group 1 Glass price group 2 Glass price group 3 Glass price group 4 Glass price group 5 Glass price group 6 	<ul style="list-style-type: none"> No cost +\$ 408 +\$ 487 +\$ 783 N.A. +\$1548 	<ul style="list-style-type: none"> Specify glass number for door. Specify glass number for door. Specify glass number for door. Specify glass number for door. Specify glass number for door. Specify glass number for door. 	
Ceiling Height	Solid single door leaves		
	<ul style="list-style-type: none"> 8'0" through 9'0" 9'1" through 10'0" 	<ul style="list-style-type: none"> No cost +\$ 287 	<ul style="list-style-type: none"> Specify ceiling height in 1" increments. Specify ceiling height in 1" increments.
Swing Orientation	For single pivot-hinged door frame		
▶ Page 46	<ul style="list-style-type: none"> Left-hand door frame Right-hand door frame 	<ul style="list-style-type: none"> No cost No cost 	<ul style="list-style-type: none"> Specify with <i>left-hand door frame</i>. Specify with <i>right-hand door frame</i>.
Lock Prep			
▶ Page 42	<ul style="list-style-type: none"> Strike plate and factory prep for cylindrical passage set or lockset Strike plate and factory prep for mortise passage set or lockset 	<ul style="list-style-type: none"> No cost +\$ 46 	<ul style="list-style-type: none"> Specify with <i>cylindrical prep</i>. Specify with <i>mortise prep</i>.
Related Products	<ul style="list-style-type: none"> Door frames Passage sets and locksets Hinges Stops 		<ul style="list-style-type: none"> ▶ Page 154 ▶ Page 168 ▶ Page 170 ▶ Page 170



For Canadian Pricing
Multiply U.S. Price by the Canadian price factor.
▶ See page 1 for details.

Glass Selections Full-Height
Pivot-Hinged Door Leaves for
Use with Switch Cutout

Specification Information

Width	Corresponding Frame Width	Style Number	U.S. Base Price
-------	---------------------------	--------------	-----------------

Solid Single Door

36 ³ / ₈ "	42"	GPGSLSSPF42	\$2131
----------------------------------	-----	--------------------	--------



Glass Single Door with 5"H Bottom Rail

36 ³ / ₈ "	42"	GPGLGSPF42	\$4718
----------------------------------	-----	-------------------	--------

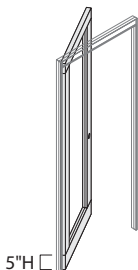

5"H

Glass Single Door with 12"H Bottom Rail

36 ³ / ₈ "	42"	GPGLGSPF42B	\$4581
----------------------------------	-----	--------------------	--------

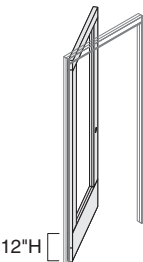

12"H

 **For Canadian Pricing**
Multiply U.S. Price by the
Canadian price factor.
▶ See page 1 for details.

Glass Selections Transom-Height Pivot-Hinged Door Leaves for Use with Switch Cutout

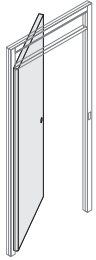

Tip: Glass Selections pivot-hinged door leaves work with Glass Selections door frames only.

Tip: In a Glass Selections door frame with glass transom, switch wiring must run down through the floor only. Wiring cannot run up to the ceiling.

Tip: For information regarding Etched and Pattern Glass Planning.
▶ Page 104.

Standard Includes		Required to Specify
▶ Need help? Product details, page 40	<ul style="list-style-type: none"> • 7'0"H • Reversible pivot-hinged door: paint, glass, flat-cut veneer, or anodized aluminum • Door frame: paint or anodized aluminum • Factory prep for pivot hinges 	<ol style="list-style-type: none"> 1 Style number 2 Swing orientation 3 Paint color number for door, if solid door selected 4 Paint color number for door frame 5 Glass number for glass door, if glass door selected 6 Paint color number for glass door, if glass door selected 7 Wood veneer color number, if selected 8 Factory prep for cylindrical or mortise passage set or lockset, if selected 9 Options, if selected (see below) <p>▶ See <i>Surface Materials</i>, page 408.</p>

Options	U.S. Price	Required to Specify	
Surface Materials	Transom-height glass frame door leaves surface options		
<ul style="list-style-type: none"> • Paint price group 1 • Paint price group 2 • Paint price group 3 • Anodized aluminum 	<ul style="list-style-type: none"> No cost +\$ 29 +\$ 48 No cost 	<ul style="list-style-type: none"> Specify paint color number. Specify paint color number. Specify paint color number. Specify anodized aluminum. 	
	36³/₈"W solid door leaves 7'0"H		
<ul style="list-style-type: none"> • Paint price group 1 • Paint price group 3 • Wood veneer (flat cut) • Quarter-cut wood veneer • Customiz stain 	<ul style="list-style-type: none"> No cost +\$ 115 No cost +\$ 166 No cost 	<ul style="list-style-type: none"> Specify paint color number. Specify paint color number. Specify wood veneer color number. Specify wood veneer color number Specify <i>with Customiz stain</i>. 	
	Glass single door 7'0"H		
<ul style="list-style-type: none"> • Glass price group 1 • Glass price group 2 • Glass price group 3 • Glass price group 4 • Glass price group 5 • Glass price group 6 	<ul style="list-style-type: none"> No cost +\$ 408 +\$ 487 +\$ 783 N.A. +\$1548 	<ul style="list-style-type: none"> Specify glass number for door. Specify glass number for door. Specify glass number for door. Specify glass number for door. Specify glass number for door. Specify glass number for door. 	
Lock Prep	<ul style="list-style-type: none"> • Strike plate and factory prep for cylindrical passage set or lockset • Strike plate and factory prep for mortise passage set or lockset 	<ul style="list-style-type: none"> No cost +\$ 46 	<ul style="list-style-type: none"> Specify <i>with cylindrical prep</i>. Specify <i>with mortise prep</i>.
Related Products	<ul style="list-style-type: none"> • Door frames • Passage sets and locksets • Hinges • Stops 		<ul style="list-style-type: none"> ▶ Page 154 ▶ Page 168 ▶ Page 170 ▶ Page 170



For Canadian Pricing
Multiply U.S. Price by the Canadian price factor.
▶ See page 1 for details.

Glass Selections
Transom-Height Pivot-Hinged
Door Leaves for Use
with Switch Cutout

Specification Information

Width	Corresponding Frame Width	Style Number	U.S. Base Price
-------	---------------------------	--------------	-----------------

Solid Single Door

36 $\frac{3}{8}$ "	42"	GPGSLSSPT42	\$1886
--------------------	-----	--------------------	--------



Glass Single Door with 5"H Bottom Rail

36 $\frac{3}{8}$ "	42"	GPGSLGSPT42	\$4176
--------------------	-----	--------------------	--------

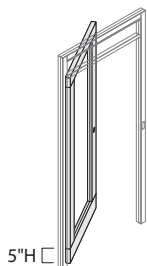

5"H

Glass Single Door with 12"H Bottom Rail

36 $\frac{3}{8}$ "	42"	GPGSLGSPT42B	\$4463
--------------------	-----	---------------------	--------

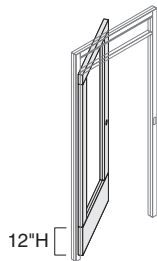

12"H

 **For Canadian Pricing**
Multiply U.S. Price by the
Canadian price factor.
▶ See page 1 for details.

Glass Selections Full-Height Polished Edge Slider Doors with Close-Assist

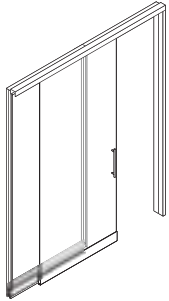

Tip: Full-height doors less than 108" ceiling height are standard with 3/8" thick glass. 1/2" thick glass can be selected for enhanced rigidity. Doors that are higher than 108" ceiling height are standard with 1/2" thick glass.

Tip: High-voltage switch is not available on Glass Selections slider door.

Tip: For information regarding Etched and Pattern Glass Planning.
▶ Page 104.

Tip: All locks are random keyed.

Tip: High-voltage switch is not available for Glass Selections slider door.

Standard Includes	Required to Specify
<ul style="list-style-type: none"> ▶ Need help? Product details, page 54 Ceiling height from 8'0"H to 10'0"H, in one-inch increments Slider door: glass with polished edges Frame: paint or anodized aluminum Side panel Door base: paint Floor track with adjustable levelers to accommodate continuous 5"H base trim (ordered separately) Slide hardware Door pull: satin chrome Door: 3/8" thick for full-height doors 9'-0" and less 	<ol style="list-style-type: none"> Style number Ceiling height Paint color number for frame Paint color number for base Glass thickness for door (if less than 108") Glass number for slider door Glass number for all-glass side panel Post extension Slide orientation Options, if selected (see below) <p>▶ See <i>Surface Materials</i>, page 408.</p>

Options	U.S. Price	Required to Specify
Surface Materials <ul style="list-style-type: none"> Frame <ul style="list-style-type: none"> Paint price group 1: No cost Paint price group 2: +\$ 52 Paint price group 3: +\$ 95 Anodized aluminum: No cost Base <ul style="list-style-type: none"> Paint price group 1: No cost Paint price group 2: +\$ 15 Paint price group 3: +\$ 26 Full-height slider doors <ul style="list-style-type: none"> Glass price group 1: No cost Glass price group 2: N.A. Glass price group 3: +\$1437 Glass price group 4: N.A. Glass price group 5: N.A. Glass price group 6: N.A. Full-height slider door panels <ul style="list-style-type: none"> Glass price group 1: No cost Glass price group 2: +\$ 606 Glass price group 3: +\$ 721 Glass price group 4: +\$1157 Glass price group 5: N.A. Glass price group 6: +\$2279 		<ul style="list-style-type: none"> Specify paint color number. Specify paint color number. Specify paint color number. Specify anodized aluminum. Specify paint color number. Specify paint color number. Specify paint color number. Specify glass number for door. Specify glass number for door. Specify glass number for door. Specify glass number for door. Specify glass number for door. Specify glass number for door. Specify glass number for door. Specify glass number for door.
Glass Thickness <ul style="list-style-type: none"> 3/8"-thick glass: No cost 1/2"-thick glass: +\$ 283 		<ul style="list-style-type: none"> Specify with 3/8". Specify with 1/2".
Post Extension <ul style="list-style-type: none"> Post extensions modified to accommodate recessed ceiling track (ordered separately): No cost Post extensions modified to accommodate overlapping ceiling track (ordered separately): No cost 		<ul style="list-style-type: none"> Specify with post extensions for recessed ceiling track interface. Specify with post extensions for overlapping ceiling track interface.
Ceiling Height <ul style="list-style-type: none"> 8'0" through 9'0": No cost 9'1" through 10'0": +\$ 206 		<ul style="list-style-type: none"> Specify ceiling height in 1" increments. Specify ceiling height in 1" increments.
Slide Orientation <ul style="list-style-type: none"> Left-hand door frame: No cost Right-hand door frame: No cost 		<ul style="list-style-type: none"> Specify with left-hand door frame. Specify with right-hand door frame.
Switch Cutout <ul style="list-style-type: none"> Without cutout: No cost With low-voltage switch cutout: +\$ 37 		<ul style="list-style-type: none"> Specify without cutout. Specify with low-voltage switch cutout.
Lock <ul style="list-style-type: none"> No lock: No cost Door lock with interior thumb latch: +\$1227 		<ul style="list-style-type: none"> Specify with no lock. Specify with lock.
Close-Assist <ul style="list-style-type: none"> None: No cost Leading edge only: +\$ 58 Leading and trailing edge: +\$ 116 		<ul style="list-style-type: none"> Specify with none. Specify with leading edge only. Specify with leading and trailing edge.

▶ Options, continued on next page

 **For Canadian Pricing**
Multiply U.S. Price by the Canadian price factor.
▶ See page 1 for details.

► Options, continued from previous page

Related Products

- Switches ► Page 172
- Ceiling tracks ► Page 238
- Continuous base trim ► Page 244
- Feature strips ► Page 248

Tip: SmartTools options are available and easily ordered when using SmartTools software. If you do not have access to SmartTools software, these options can also be ordered using the normal Specials RFQ (Request For Quote) process.

Tip: Slider door assembly widths are displayed in actual sizes. Relative width of door and side panel may vary.

Tip: For slider with frame kit as side panel, glass kit is ordered separately.

	SmartTools Options	U.S. Price	Required to Specify
Parametric Ceiling Height (Available in 1" increments)	• 7'5" through 7'11"	No cost	Specify ceiling height in 1" increments.
Parametric Width Slider Door Assembly with Equal Width Door and Slide Panel (Available in 1" increments)	• 78"W through 95"W (excludes standard widths)	No cost	Specify slider door assembly widths in 1" increments.
Parametric Width Slider Door Assembly with Fixed Width Door and Variable Width Side Panel (Available in 1" increments)	• 81"W through 108"W (excludes standard widths)	+\$ 156	Specify slider door assembly widths in 1" increments.
Parametric Width Slider Door Assembly with Variable Width Frame Kit (Available in 1" increments)	With 40" doors		
	• 112"W through 136"W	+\$ 139	Specify slider door assembly widths in 1" increments.
	• 137"W through 184"W	+\$ 408	Specify slider door assembly widths in 1" increments.
	With 42" doors		
	• 114"W through 136"W	+\$ 139	Specify slider door assembly widths in 1" increments.
	• 137"W through 186"W	+\$ 408	Specify slider door assembly widths in 1" increments.
With 48" doors			
	• 120"W through 136"W	+\$ 139	Specify slider door assembly widths in 1" increments.
	• 137"W through 192"W	+\$ 408	Specify slider door assembly widths in 1" increments.
Jamb-Mounted Lock	• Jamb-mounted lock profile - No lock	+\$ 365	Specify with jamb-mounted lock - No lock.
	• Jamb-mounted lock - SFIC less core	+\$ 974	Specify with jamb-mounted lock SFIC less core.
	• Jamb-mounted lock - Schlage cylinder without core	+\$ 978	Specify with jamb-mounted lock Schlage cylinder.
	• Jamb-mounted lock - Sargent cylinder and random keyed core (SFIC)	+\$1302	Specify with jamb-mounted lock Sargent cylinder.
Base	• 2½"H base	No cost	Specify to accept 2½"H base.
	• 4"H base	+\$ 228	Specify to accept 4"H base.

Specification Information

Width	Style Number	U.S. Base Price

Full-Height Slider Doors

80"	GPGSDFSC80	\$5952
84"	GPGSDFSC84	\$6070
96"	GPGSDFSC96	\$6501

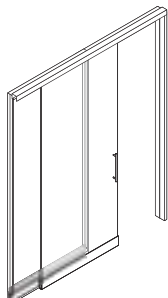

Glass Selections Transom-Height Polished Edge Slider Doors with Close-Assist

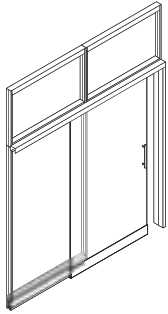

Standard Includes		Required to Specify
<ul style="list-style-type: none"> ▶ Need help? Product details, page 54 	<ul style="list-style-type: none"> • Ceiling height from 8'0"H to 10'0"H, in one-inch increments • Slider door: glass with polished edges • Frame: paint or anodized aluminum • Side panel • Door base: paint • Floor track with adjustable levelers to accommodate continuous 5"H base trim (ordered separately) • Slide hardware • Door pull: satin chrome • Door: 3/8" thick 	<ol style="list-style-type: none"> 1 Style number 2 Ceiling height 3 Paint color number for frame 4 Glass thickness for door 5 Glass number for door frame top lite (door 1) 6 Glass number for slider door (door 2) 7 Glass number for side panel top lite (glass 1) 8 Glass number for side panel (glass 2) 9 Paint color number for door base 10 Post extension 11 Slide orientation 12 Options, if selected (see below) <p>▶ See <i>Surface Materials</i>, page 408.</p>

Tip: Door height is always 7'. Transom height varies depending on ceiling height.

Tip: Transom-height doors are standard with 3/8" thick glass. 1/2" thick glass can be selected for enhanced rigidity.

Tip: High-voltage switch is not available on Glass Selections slider door.

Tip: All locks are random keyed.

Tip: For information regarding Etched and Pattern Glass Planning.
▶ Page 104.

Options	U.S. Price	Required to Specify
Surface Materials	Frame	
	<ul style="list-style-type: none"> • Paint price group 1 No cost • Paint price group 2 +\$ 52 • Paint price group 3 +\$ 95 • Anodized aluminum No cost 	Specify paint color number. Specify paint color number. Specify paint color number. Specify anodized aluminum.
	Base	
	<ul style="list-style-type: none"> • Paint price group 1 No cost • Paint price group 2 +\$ 15 • Paint price group 3 +\$ 26 	Specify paint color number. Specify paint color number. Specify paint color number.
	Transom-height slider door	
	<ul style="list-style-type: none"> • Glass price group 1 No cost • Glass price group 2 N.A. • Glass price group 3 +\$1302 • Glass price group 4 N.A. • Glass price group 5 N.A. • Glass price group 6 N.A. 	Specify glass number for door. Specify glass number for door. Specify glass number for door. Specify glass number for door. Specify glass number for door. Specify glass number for door.
	Transom-height side panel	
	<ul style="list-style-type: none"> • Glass price group 1 No cost • Glass price group 2 +\$ 506 • Glass price group 2 +\$ 602 • Glass price group 4 +\$ 964 • Glass price group 5 N.A. • Glass price group 6 +\$1900 	Specify glass number for door. Specify glass number for door. Specify glass number for door. Specify glass number for door. Specify glass number for door. Specify glass number for door.
	Transom aligned top lites (per lite)	
	<ul style="list-style-type: none"> • Glass price group 1 No cost • Glass price group 2 +\$ 113 • Glass price group 3 +\$ 133 • Glass price group 4 +\$ 211 • Glass price group 5 N.A. • Glass price group 6 +\$ 419 	Specify glass number for lite. Specify glass number for lite. Specify glass number for lite. Specify glass number for lite. Specify glass number for lite. Specify glass number for lite.
Glass Thickness	<ul style="list-style-type: none"> • 3/8"-thick glass No cost • 1/2"-thick glass +\$ 239 	Specify with 3/8". Specify with 1/2".
Post Extension	<ul style="list-style-type: none"> • Post extensions modified to accommodate recessed ceiling track (ordered separately) No cost • Post extensions modified to accommodate overlapping ceiling track (ordered separately) No cost 	Specify with post extensions for recessed ceiling track interface. Specify with post extensions for overlapping ceiling track interface.
Ceiling Height	<ul style="list-style-type: none"> • 8'0" through 9'0" No cost • 9'1" through 10'0" +\$ 118 	Specify ceiling height in 1" increments. Specify ceiling height in 1" increments.
Slide Orientation	<ul style="list-style-type: none"> • Left-hand door frame No cost • Right-hand door frame No cost 	Specify with left-hand door frame. Specify with right-hand door frame.

▶ Page 55
▶ Options, continued on next page

 **For Canadian Pricing**
Multiply U.S. Price by the Canadian price factor.
▶ See page 1 for details.

► Options, continued from previous page

Options	U.S. Price	Required to Specify
Switch Cutout • Without cutout • With low-voltage switch cutout ► Page 37	No cost +\$ 37	Specify <i>without cutout</i> . Specify <i>with low-voltage switch cutout</i> .
Lock • Door lock with interior thumb latch	+\$1227	Specify <i>with lock</i> .
Close-Assist • None • Leading edge only • Leading and trailing edge	No cost +\$ 58 +\$ 116	Specify <i>with none</i> . Specify <i>with leading edge only</i> . Specify <i>with leading and trailing edge</i> .
Related Products • Switches • Ceiling tracks • Continuous base trim • Feature strips		► Page 172 ► Page 238 ► Page 244 ► Page 248

Tip: SmartTools options are available and easily ordered when using SmartTools software. If you do not have access to SmartTools software, these options can also be ordered using the normal Specials RFQ (Request For Quote) process.

Tip: Slider door assembly widths are displayed in actual sizes. Relative width of door and side panel may vary.

Tip: For slider with frame kit as side panel, glass kit is ordered separately.

SmartTools Options	U.S. Price	Required to Specify	
Parametric Width Slider Door Assembly with Equal Width Door and Slide Panel (Available in 1" increments) • 78"W through 95"W (excludes standard widths)	No cost	Specify slider door assembly widths in 1" increments.	
Parametric Width Slider Door Assembly with Fixed Width Door and Variable Width Side Panel (Available in 1" increments) • 81"W through 108"W (excludes standard widths)	+\$174	Specify slider door assembly widths in 1" increments.	
Parametric Width Slider Door Assembly with Variable Width Frame Kit (Available in 1" increments)	With 40" doors • 112"W through 136"W	+\$279	Specify slider door assembly widths in 1" increments.
	• 137"W through 184"W	+\$601	Specify slider door assembly widths in 1" increments.
	With 42" doors • 114"W through 136"W	+\$279	Specify slider door assembly widths in 1" increments.
	• 137"W through 186"W	+\$601	Specify slider door assembly widths in 1" increments.
	With 48" doors • 120"W through 136"W	+\$279	Specify slider door assembly widths in 1" increments.
	• 137"W through 192"W	+\$601	Specify slider door assembly widths in 1" increments.
Base • 2½"H base • 4"H base	No cost +\$228	Specify to accept 2½"H base. Specify to accept 4"H base.	

Specification Information		
Width	Style Number	U.S. Base Price
...

Transom-Height Slider Doors		
80"	GPGSDFTSC80	\$5972
84"	GPGSDFTSC84	\$6064
96"	GPGSDFTSC96	\$6534
...

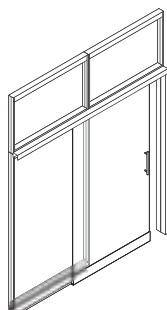

Glass Selections Polished Edge Slider Door Vertical Seal



Tip: Vertical seal assemblies are 120" long and are cut to the appropriate height during installation.

Standard Includes	Required to Specify
<ul style="list-style-type: none"> ▶ Need help? Product details, page 56 • Vertical seal: paint or anodized aluminum 	<ul style="list-style-type: none"> 1 Style number 2 Options, if selected (see below) ▶ See <i>Surface Materials</i>, page 408.

Options	U.S. Price	Required to Specify
Surface Materials <ul style="list-style-type: none"> • Paint price group 1 • Paint price group 2 • Paint price group 3 • Anodized aluminum 	<ul style="list-style-type: none"> No cost +\$ 8 +\$15 No cost 	<ul style="list-style-type: none"> Specify paint color number. Specify paint color number. Specify paint color number. Specify anodized aluminum.

Specification Information	
Style Number	U.S. Base Price
GPGSDFSVS	\$60



For Canadian Pricing
 Multiply U.S. Price by the Canadian price factor.
 ▶ See page 1 for details.

Glass Selections Mini Ends

Glass Selections Mini Ends to the Floor

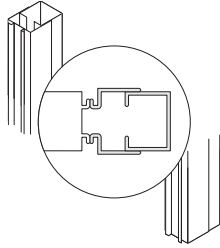

Tip: Mini ends should be specified to the floor when positioned next to a door frame. Mini ends will be field-cut by installer to final length.

Tip: For painted mini ends, use Privacy Wall mini ends.

Tip: SmartTools options are available and easily ordered when using SmartTools software. If you do not have access to SmartTools software, these options can also be ordered using the normal Specials RFQ (Request For Quote) process.

Standard Includes		Required to Specify
<ul style="list-style-type: none"> ▶ Need help? Product details, page 68 	<ul style="list-style-type: none"> • Mini end: 10'1"H • Outer channel: clear anodized aluminum • Inner channel: clear anodized aluminum 	<ul style="list-style-type: none"> 1 Style number 2 Options, if selected (see below)

SmartTools Options	U.S. Price	Required to Specify
Modified Angle (45° to 135° in 5" increments)	<ul style="list-style-type: none"> • For GPGSMESF +\$167 • For GPGSMEMF +\$177 • For GPGSMELF +\$191 	<ul style="list-style-type: none"> Specify with modified angle. Specify with modified angle. Specify with modified angle.

Specification Information		
Size	Style Number	U.S. Base Price
1 1/2" to 2 1/8"	GPGSMESF	\$270
2 1/8" to 3 1/2"	GPGSMEMF	\$301
3 1/2" to 6"	GPGSMELF	\$362

Glass Selections Mini Ends

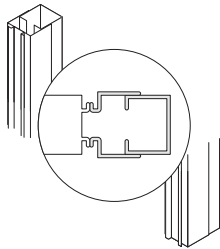

Tip: SmartTools options are available and easily ordered when using SmartTools software. If you do not have access to SmartTools software, these options can also be ordered using the normal Specials RFQ (Request For Quote) process.

Tip: For painted mini ends, use Privacy Wall mini ends.

Standard Includes		Required to Specify
<ul style="list-style-type: none"> ▶ Need help? Product details, page 68 	<ul style="list-style-type: none"> • Ceiling height from 8'0"H to 10'0"H, in one-inch increments • Telescoping mini end: clear anodized aluminum • Aligns to top of 5"H base 	<ul style="list-style-type: none"> 1 Style number 2 Ceiling height 3 Options, if selected (see below)

SmartTools Options	U.S. Price	Required to Specify
Parametric Ceiling Height (Available in 1" increments)	• 7'5" through 7'11" No cost	Specify ceiling height in 1" increments.
Modified Angle (45° to 135° in 5° increments)	<ul style="list-style-type: none"> • For GPGSMES +\$167 • For GPGSMEM +\$177 • For GPGSMEL +\$191 	<ul style="list-style-type: none"> Specify with modified angle. Specify with modified angle. Specify with modified angle.
Base	<ul style="list-style-type: none"> • 2 1/2"H base No cost • 4"H base +\$ 18 	<ul style="list-style-type: none"> Specify to accept 2 1/2"H base. Specify to accept 4"H base.

Specification Information		
Size	Style Number	U.S. Base Price
1 1/2" to 2 1/8"	GPGSMES	\$270
2 1/8" to 3 1/2"	GPGSMEM	\$301
3 1/2" to 6"	GPGSMEL	\$362

 **For Canadian Pricing**
 Multiply U.S. Price by the Canadian price factor.
 ▶ See page 1 for details.

Glass Selections Adapters

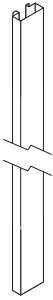

Tip: There are no T-adapters for Glass Selections, since all surfaces are concealed. For T-adapters, see Privacy Wall adapters.
▶ Page 190

Tip: SmartTools options are available and easily ordered when using SmartTools software. If you do not have access to SmartTools software, these options can also be ordered using the normal Specials RFQ (Request For Quote) process.

Tip: For painted adapters, use Privacy Wall adapters.

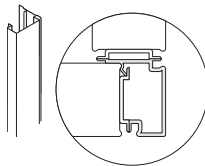
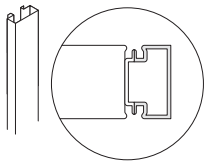

Standard Includes		Required to Specify
▶ Need help? Product details, page 78	<ul style="list-style-type: none"> Ceiling height from 8'0"H to 10'0"H, in one-inch increments Adapter: clear anodized aluminum Plinth for finish-end: paint 	<ol style="list-style-type: none"> Style number Ceiling height Paint color number for plinths Options, if selected (see below) ▶ See <i>Surface Materials</i> , page 408.

Options	U.S. Price	Required to Specify
Surface Materials		
Finished-end base plinth		
• Paint price group 1	No cost	Specify paint color number.
• Paint price group 2	+\$ 2	Specify paint color number.
• Paint price group 3	+\$ 4	Specify paint color number.

SmartTools Options	U.S. Price	Required to Specify
Parametric Ceiling Height (Available in 1" increments)	• 7'5" through 7'11" No cost	Specify ceiling height in 1" increments.
Base	• 2½"H base • 4"H base No cost +\$19	Specify to accept 2½"H base. Specify to accept 4"H base.

Specification Information	
• Style Number	• U.S. Base Price
•	•
•	•
•	•

Finished-End Adapter with Base

GPGSAFEB \$187

L-Adapter

GPGSAL \$164



For Canadian Pricing
Multiply U.S. Price by the Canadian price factor.
▶ See page 1 for details.

Glass Selections Posts

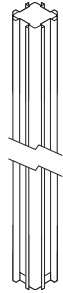

Tip: There are no X-posts for Glass Selections, since all surfaces are concealed. For X-posts, see Privacy Wall Posts.

▶ Page 192

Tip: SmartTools options are available and easily ordered when using SmartTools software. If you do not have access to SmartTools software, these options can also be ordered using the normal Specials RFQ (Request For Quote) process.

Tip: For painted posts, use Privacy Wall posts.

Standard Includes		Required to Specify
▶ Need help? Product details, page 82	<ul style="list-style-type: none"> Ceiling height from 8'0"H to 10'0"H, in one-inch increments Post: clear anodized aluminum 	1 Style number 2 Ceiling height on L-post 3 Options, if selected (see below) ▶ See <i>Surface Materials</i> , page 408.

SmartTools Options	U.S. Price	Required to Specify
Parametric Ceiling Height (Available in 1" increments)	No cost	Specify ceiling height in 1" increments.

Base	U.S. Price	Required to Specify
<ul style="list-style-type: none"> 2½"H base 4"H base 	No cost +\$19	Specify to accept 2½"H base. Specify to accept 4"H base.

Specification Information

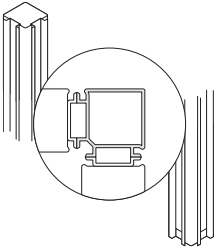
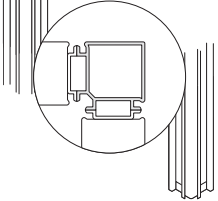
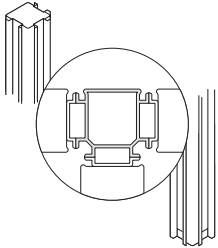
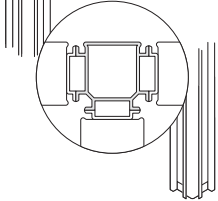
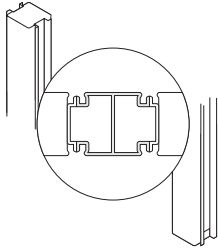
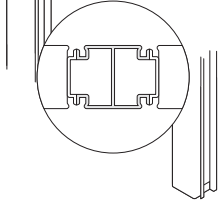
L-Post		T-Post		In-Line Post	
					
• Style Number	• U.S. Base Price	• Style Number	• U.S. Base Price	• Style Number	• U.S. Base Price
GPGSPL	\$228	GPGSPT	\$266	GPGSPI	\$228

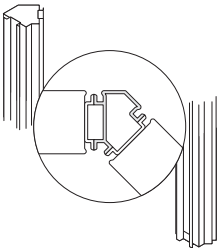
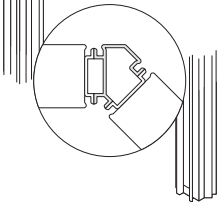
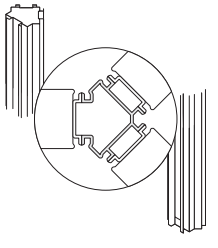
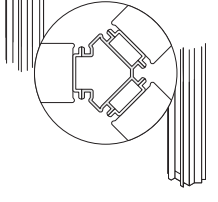
V-Posts		135° Y-Post		
				
• Configuration	• Style Number	• U.S. Base Price	• Style Number	• U.S. Base Price
120° V-Post	GPGSP120V	\$254		
135° V-Post	GPGSP135V	\$254	GPGSP135Y	\$321

 **For Canadian Pricing**
 Multiply U.S. Price by the Canadian price factor.
 ▶ See page 1 for details.

Glass Selections Transitions

All-Glass L-Corner Units and All-Glass L-Corner Units with Two Transom-Aligned Lites

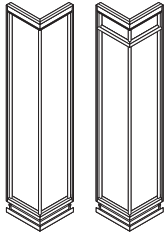

Tip: L-corner units are factory assembled. Glass joint is field-glazed (glazing tape or silicone sealant) as part of the installation process.

Tip: L-corner units plan dimensionally in the same manner as individual panels that are joined by a post.

Tip: SmartTools options are available and easily ordered when using SmartTools software. If you do not have access to SmartTools software, these options can also be ordered using the normal Specials RFQ (Request For Quote) process.

Standard Includes		Required to Specify
<ul style="list-style-type: none"> ▶ Need help? Product details, page 26 	<ul style="list-style-type: none"> Ceiling height from 8'0"H to 10'0"H, in one-inch increments 2³/₈"-thick panel with frame: paint or anodized aluminum All glass, if selected Two factory-installed lites—top lite is transom aligned: glass Floor track with adjustable levelers to accommodate continuous 5"H base trim (ordered separately): paint 	<ol style="list-style-type: none"> Style number Paint color number for frame Ceiling height Glass finish Options, if selected (see below) <ul style="list-style-type: none"> ▶ See <i>Surface Materials</i>, page 408.

Options	U.S. Price	Required to Specify
Surface Materials		
Frame		
• Paint price group 1	No cost	Specify paint color number.
• Paint price group 2	+\$ 29	Specify paint color number.
• Paint price group 3	+\$ 48	Specify paint color number.
• Anodized aluminum	No cost	Specify anodized aluminum.
L-corner unit glass panels 8'0" through 10'0"		
• Glass price group 1	No cost	Specify glass number for lite.
• Glass price group 2	+\$450	Specify glass number for lite.
• Glass price group 3	+\$516	Specify glass number for lite.
• Glass price group 4	+\$583	Specify glass number for lite.
• Glass price group 5	N.A.	Specify glass number for lite.
• Glass price group 6	+\$723	Specify glass number for lite.
L-corner unit with two transom-aligned lites, top lite glass panels 8'0" through 10'0"		
• Glass price group 1	No cost	Specify glass number for lite.
• Glass price group 2	+\$106	Specify glass number for lite.
• Glass price group 3	+\$122	Specify glass number for lite.
• Glass price group 4	+\$140	Specify glass number for lite.
• Glass price group 5	N.A.	Specify glass number for lite.
• Glass price group 6	+\$170	Specify glass number for lite.
L-corner unit with two transom-aligned lites, lower lite glass panels 8'0" through 10'0"		
• Glass price group 1	No cost	Specify glass number for lite.
• Glass price group 2	+\$342	Specify glass number for lite.
• Glass price group 3	+\$394	Specify glass number for lite.
• Glass price group 4	+\$448	Specify glass number for lite.
• Glass price group 5	N.A.	Specify glass number for lite.
• Glass price group 6	+\$551	Specify glass number for lite.
Ceiling Height		
• 8'0" through 9'0"	No cost	Specify ceiling height in 1" increments.
• 9'1" through 10'0"	+\$ 96	Specify ceiling height in 1" increments.
Related Products	<ul style="list-style-type: none"> Ceiling tracks Continuous base trim Feature strips 	<ul style="list-style-type: none"> ▶ Page 238 ▶ Page 244 ▶ Page 248

SmartTools Options	U.S. Price	Required to Specify
Parametric Ceiling Height (All glass L-corner units only)	• 7'5" through 7'11"	Use 8'0" price
Base	• 2 ¹ / ₂ "H base	+\$175
	• 4"H base	+\$343
		Specify to accept 2 ¹ / ₂ "H base.
		Specify to accept 4"H base.



For Canadian Pricing
Multiply U.S. Price by the Canadian price factor.
▶ See page 1 for details.

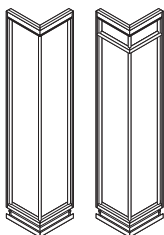

Specification Information						
Width	Style Number	U.S. Base Price	Nominal Width	Modular Width	Style Number	U.S. Base Price
L-Corner Units			L-Modular Corner Units			
All Glass						
18"	GPGSSGL	\$1543	18" x 18"	16 ⁵ / ₁₆ " x 16 ⁵ / ₁₆ "	GPGSMGL	\$1543
Two Divided Lites						
18"	GPGSS2LL	\$1946	18" x 18"	16 ⁵ / ₁₆ " x 16 ⁵ / ₁₆ "	GPGSM2LL	\$1946

Privacy Wall



For Canadian Pricing

Multiply U.S. Price by the Canadian price factor.

▶ See page 1 for details.

Glass Selections T-Corner Unit All-Glass Frame Kits

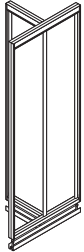

Tip: Frame and glass kits are assembled in the field. Butt joints must be glazed with glazing tape or silicone sealant to be code-compliant.

Tip: T-corner frame kits plan dimensionally in the same manner as individual 18" panels that are joined by a post.

Tip: Due to the process steps involved in installation of glass, T-corner frame kits can be placed no closer than 20" to a single mini end or wall channel.

Tip: SmartTools options are available and easily ordered when using SmartTools software. If you do not have access to SmartTools software, these options can also be ordered using the normal Specials RFQ (Request For Quote) process.

Standard Includes	Required to Specify
<ul style="list-style-type: none"> ▶ Need help? Product details, page 26 • Ceiling height from 8'0"H to 10'0"H, in one-inch increments • 2³/₈"-thick panel with clear frame: paint or anodized aluminum • Floor track with adjustable levelers to accommodate continuous 5"H base trim (ordered separately): paint 	<ul style="list-style-type: none"> 1 Style number 2 Ceiling height 3 Paint color number for frame 4 Glass number for lite ▶ See <i>Surface Materials</i>, page 408.

Options	U.S. Price	Required to Specify
Surface Materials <ul style="list-style-type: none"> • Frame • Paint price group 1 • Paint price group 2 • Paint price group 3 • Anodized aluminum 	<ul style="list-style-type: none"> No cost +\$ 29 +\$ 48 No cost 	<ul style="list-style-type: none"> Specify paint color number. Specify paint color number. Specify paint color number. Specify anodized aluminum.
Ceiling Height <ul style="list-style-type: none"> • 8'0" through 9'0" • 9'1" through 10'0" 	<ul style="list-style-type: none"> No cost +\$ 50 	<ul style="list-style-type: none"> Specify ceiling height in 1" increments. Specify ceiling height in 1" increments.
Related Products <ul style="list-style-type: none"> • Ceiling tracks • Continuous base trim • Feature strips 		<ul style="list-style-type: none"> ▶ Page 238 ▶ Page 244 ▶ Page 248

SmartTools Options	U.S. Price	Required to Specify
Parametric Ceiling Height (Available in 1" increments) <ul style="list-style-type: none"> • 7'5" through 7'11" 	<ul style="list-style-type: none"> Use 8'0" price 	<ul style="list-style-type: none"> Specify ceiling height in 1" increments.
Base <ul style="list-style-type: none"> • 2¹/₂"H base • 4"H base 	<ul style="list-style-type: none"> +\$187 +\$343 	<ul style="list-style-type: none"> Specify to accept 2¹/₂"H base. Specify to accept 4"H base.

Specification Information						
• Width	• Style Number	• U.S. Base Price	• Nominal Width	• Modular Width	• Style Number	• U.S. Base Price

All-Glass Frame Kits			Modular All-Glass Frame Kits			
18" x 18" x 18"	GPGSSGFKT	\$1425	18" x 18" x 18"	16 ³ / ₄ " x 16 ³ / ₄ " x 16 ³ / ₄ "	GPGSMGFKT	\$1425



For Canadian Pricing
 Multiply U.S. Price by the Canadian price factor.
 ▶ See page 1 for details.

Glass Selections T-Corner Units All-Glass Kits

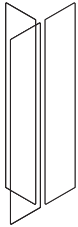

Tip: Frame and glass kits are assembled in the field. Butt joints must be glazed with glazing tape or silicone sealant to be code-compliant.

Tip: T-corner frame kits plan dimensionally in the same manner as individual 18" panels that are joined by a post.

Tip: T-corner glass kits include three pieces of glass.

Tip: Due to the process steps involved in installation of glass, T-corner frame kits can be placed no closer than 20" to a single mini-end or wall channel.

Tip: SmartTools options are available and easily ordered when using SmartTools software. If you do not have access to SmartTools software, these options can also be ordered using the normal Specials RFQ (Request For Quote) process.

	Standard Includes	Required to Specify
▶ Need help? Product details, page 26	<ul style="list-style-type: none"> Ceiling height from 8'0"H to 10'0"H, in one-inch increments 2³/₈"-thick panel with clear anodized aluminum frame: paint Floor track with adjustable levelers to accommodate continuous 5"H base trim (ordered separately): paint 	<ol style="list-style-type: none"> Style number Ceiling height Glass number for lite <p>▶ See <i>Surface Materials</i>, page 408.</p>

	Options	U.S. Price	Required to Specify
Surface Materials	Top lite glass panels 8'0" through 10'0"		
	<ul style="list-style-type: none"> Glass price group 1 Glass price group 2 Glass price group 3 Glass price group 4 Glass price group 5 Glass price group 6 	No cost +\$ 839 +\$1520 +\$2198 N.A. +\$3943	Specify glass number for lite. Specify glass number for lite. Specify glass number for lite. Specify glass number for lite. Specify glass number for lite. Specify glass number for lite.
Ceiling Height	<ul style="list-style-type: none"> 8'0" through 9'0" 9'1" through 10'0" 	No cost +\$ 50	Specify ceiling height in 1" increments. Specify ceiling height in 1" increments.
Related Products	<ul style="list-style-type: none"> Ceiling tracks Continuous base trim Feature strips 		▶ Page 238 ▶ Page 244 ▶ Page 248

	SmartTools Options	U.S. Price	Required to Specify
Parametric Ceiling Height (Available in 1" increments)	7'5" through 7'11"	Use 8'0" price	Specify ceiling height in 1" increments.
Base	<ul style="list-style-type: none"> 2¹/₂"H base 4"H base 	+\$ 40 No cost	Specify to accept 2 ¹ / ₂ "H base. Specify to accept 4"H base.

Specification Information						
Width	Style Number	U.S. Base Price	Nominal Width	Modular Width	Style Number	U.S. Base Price
...

All-Glass Glass Kits			Modular All-Glass Glass Kits			
18" x 18" x 18"	GPGSSGGKT	\$534	18" x 18" x 18"	16 ³ / ₄ " x 16 ³ / ₄ " x 16 ³ / ₄ "	GPGSMGGKT	\$534
...

For Canadian Pricing
 Multiply U.S. Price by the Canadian price factor.
 ▶ See page 1 for details.

Glass Selections T-Corner Units Two Divided Lite Frame Kits

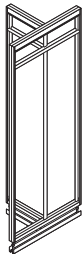

Tip: Frame and glass kits are assembled in the field. Butt joints must be glazed with glazing tape or silicone sealant to be code-compliant.

Tip: T-corner frame kits plan dimensionally in the same manner as individual 18" panels that are joined by a post.

Tip: Due to the process steps involved in installation of glass, T-corner frame kits can be placed no closer than 20" to a mini end or wall channel.

Tip: SmartTools options are available and easily ordered when using SmartTools software. If you do not have access to SmartTools software, these options can also be ordered using the normal Specials RFQ (Request For Quote) process.

Standard Includes	Required to Specify
<ul style="list-style-type: none"> ▶ Need help? Product details, page 26 • Ceiling height from 8'0"H to 10'0"H, in one-inch increments • 2³/₈"-thick panel with frame: paint or anodized aluminum • Floor track with adjustable levelers to accommodate continuous 5"H base trim (ordered separately): paint 	<ol style="list-style-type: none"> 1 Style number 2 Ceiling height 3 Paint color number for frame 4 Glass number for lite 5 Options, if selected (see below) <ul style="list-style-type: none"> ▶ See <i>Surface Materials</i>, page 408.

Options	U.S. Price	Required to Specify
Surface Materials <ul style="list-style-type: none"> • Frame • Paint price group 1 • Paint price group 2 • Paint price group 3 • Anodized aluminum 	No cost +\$ 29 +\$ 48 No cost	Specify paint color number. Specify paint color number. Specify paint color number. Specify anodized aluminum.
Ceiling Height <ul style="list-style-type: none"> • 8'0" through 9'0" • 9'1" through 10'0" 	No cost +\$ 50	Specify ceiling height in 1" increments. Specify ceiling height in 1" increments.
Related Products <ul style="list-style-type: none"> • Ceiling tracks • Continuous base trim • Feature strips 		<ul style="list-style-type: none"> ▶ Page 238 ▶ Page 244 ▶ Page 248

SmartTools Options	U.S. Price	Required to Specify
Base <ul style="list-style-type: none"> • 2¹/₂"H base • 4"H base 	+\$175 +\$343	Specify to accept 2 ¹ / ₂ "H base. Specify to accept 4"H base.

Specification Information						
Width	Style Number	U.S. Base Price	Nominal Width	Modular Width	Style Number	U.S. Base Price

Two Divided Lite Frame Kits		
18" x 18" x 18"	GPGSS2FKT	\$1500

Modular Two Divided Lite Frame Kits			
18" x 18" x 18"	16 ³ / ₄ " x 16 ³ / ₄ " x 16 ³ / ₄ "	GPGSM2FKT	\$1500



For Canadian Pricing
 Multiply U.S. Price by the Canadian price factor.
 ▶ See page 1 for details.

Glass Selections T-Corner Units Two Divided Lite Glass Kits

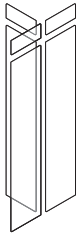

Tip: Frame and glass kits are assembled in the field. Butt joints must be glazed with glazing tape or silicone sealant to be code-compliant.

Tip: T-corner frame kits plan dimensionally in the same manner as individual 18" panels that are joined by a post.

Tip: T-corner glass kits include three pieces of glass.

Tip: Due to the process steps involved in installation of glass, T-corner frame kits can be placed no closer than 20" to a single mini-end or wall channel.

Tip: SmartTools options are available and easily ordered when using SmartTools software. If you do not have access to SmartTools software, these options can also be ordered using the normal Specials RFQ (Request For Quote) process.

Standard Includes	Required to Specify
<ul style="list-style-type: none"> Need help? Product details, page 26 Ceiling height from 8'0"H to 10'0"H, in one-inch increments 2³/₈"-thick panel with clear anodized aluminum frame: paint Floor track with adjustable levelers to accommodate continuous 5"H base trim (ordered separately): paint 	<ol style="list-style-type: none"> Style number Ceiling height Glass number for lite Options, if selected (see below) <p>▶ See <i>Surface Materials</i>, page 408.</p>

Options	U.S. Price	Required to Specify
Surface Materials <ul style="list-style-type: none"> Top Lite Glass Panels 8'0" through 10'0" <ul style="list-style-type: none"> Glass price group 1: No cost Glass price group 2: +\$ 253 Glass price group 3: +\$ 457 Glass price group 4: +\$ 655 Glass price group 5: N.A. Glass price group 6: +\$1171 Lower Lite Glass Panels 8'0" through 10'0" <ul style="list-style-type: none"> Glass price group 1: No cost Glass price group 2: +\$ 604 Glass price group 3: +\$1091 Glass price group 4: +\$1573 Glass price group 5: N.A. Glass price group 6: +\$2819 		Specify glass number for lite. Specify glass number for lite. Specify glass number for lite. Specify glass number for lite. Specify glass number for lite. Specify glass number for lite.
Ceiling Height <ul style="list-style-type: none"> 8'0" through 9'0": No cost 9'1" through 10'0": +\$ 50 		Specify ceiling height in 1" increments. Specify ceiling height in 1" increments.
Related Products <ul style="list-style-type: none"> Ceiling tracks Continuous base trim Feature strips 		▶ Page 238 ▶ Page 244 ▶ Page 248

SmartTools Options	U.S. Price	Required to Specify
Base <ul style="list-style-type: none"> 2¹/₂"H base: +\$ 40 4"H base: No cost 		Specify to accept 2 ¹ / ₂ "H base. Specify to accept 4"H base.

Specification Information						
Width	Style Number	U.S. Base Price	Nominal Width	Modular Width	Style Number	U.S. Base Price

Two Divided Lite Glass Kits			Modular Two Divided Lite Glass Kits			
18" x 18" x 18"	GPGSS2GKT	\$526	18" x 18" x 18"	16 ³ / ₄ " x 16 ³ / ₄ " x 16 ³ / ₄ "	GPGSM2GKT	\$526

For Canadian Pricing
 Multiply U.S. Price by the Canadian price factor.
 ▶ See page 1 for details.

Ceiling Tracks

Ceiling Tracks

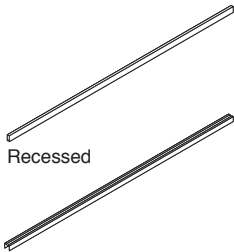

Recessed

Overlapping

Tip: No ceiling clip is included unless selected as an option.

Tip: For finished end ceiling track.
▶ See page 60.

Tip: Ceiling clip option is on straight and finished-end ceiling tracks only.

Tip: When required by the local seismic design criteria, additional ceiling fasteners and/or structural bracing may be required. For more information regarding seismic applications, visit the Architectural Solutions web site at village.steelcase.com.

Tip: SmartTools options are available and easily ordered when using SmartTools software. If you do not have access to SmartTools software, these options can also be ordered using the normal Specials RFQ (Request For Quote) process.

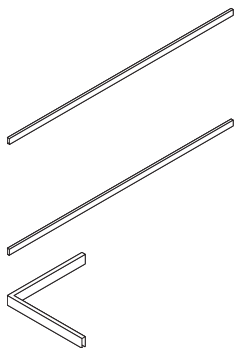

Standard Includes	Required to Specify
<ul style="list-style-type: none"> ▶ Need help? Product details, page 60 Ceiling track: paint 	<ol style="list-style-type: none"> 1 Style number 2 Ceiling track 3 Paint color number for ceiling track 4 Options, if selected (see below) <p>▶ See <i>Surface Materials</i>, page 408.</p>

Options	U.S. Price	Required to Specify
Surface Materials <ul style="list-style-type: none"> • Paint price group 1 • Paint price group 2 • Paint price group 3 	No cost +\$ 15 +\$ 26	Specify paint color number. Specify paint color number. Specify paint color number.
Ceiling Track <ul style="list-style-type: none"> • Recessed ceiling track • Overlapping ceiling track 	No cost No cost	Specify <i>with recessed ceiling track</i> . Specify <i>with overlapping ceiling track</i> .
Ceiling Clips <ul style="list-style-type: none"> • No fastener • 1" x 1/4"D tegular • 1" x 3/8"D tegular • 1" x 1/2"D tegular • 1" x 5/8"D tegular • Donn Finline 1/4" slot • Donn Finline 1/8" slot • 1"W exposed T • 1" fluted runner 1/4" – 20" • 1" tee quick clip • 9/16"W exposed tee • 9/16" x 1/4"D tegular • 9/16" x 5/16"D tegular 	No cost No cost No cost No cost No cost No cost No cost No cost No cost No cost No cost No cost No cost No cost	Specify <i>with no fastener</i> . Specify <i>with 1" x 1/4"D tegular clip</i> . Specify <i>with 1" x 3/8"D tegular clip</i> . Specify <i>with 1" x 1/2"D tegular clip</i> . Specify <i>with 1" x 5/8"D tegular clip</i> . Specify <i>with Donn Finline with 1/4" slot clip</i> . Specify <i>with Donn Finline with 1/8" slot clip</i> . Specify <i>with 1"W exposed T clip</i> . Specify <i>with 1" fluted runner 1/4" – 20" clip</i> . Specify <i>with 1" tee quick clip</i> . Specify <i>with 9/16"W exposed tee clip</i> . Specify <i>with 9/16" x 1/4"D tegular clip</i> . Specify <i>with 9/16" x 5/16"D tegular clip</i> .

SmartTools Options	U.S. Price	Required to Specify
Modified Angle (70° to 175° in 5° increments) <ul style="list-style-type: none"> • For GPCT120V 70°-115° • For GPCT135V 125°-175° 	+\$ 36 +\$ 36	Specify <i>with modified angle</i> . Specify <i>with modified angle</i> .

Specification Information		
Width	Style Number	U.S. Base Price
...

Straight Ceiling Track		
120"	GPCTS	\$161
...

Finished-End Ceiling Track		
120"	GPCTFE	\$187
...

Corner L Ceiling Track		
24"	GPCTLS	\$158
...

▶ **Specification Information, continued on next page**

► Specification Information, continued from previous page

Specification Information

Width	Style Number	U.S. Base Price
-------	--------------	-----------------

120° Corner V Ceiling Track

24"	GPCT120V	\$158
:	:	:

135° Corner V Ceiling Track

24"	GPCT135V	\$158
:	:	:

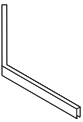
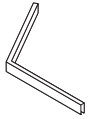

For Canadian Pricing

Multiply U.S. Price by the Canadian price factor.

► See page 1 for details.

Ceiling Track Clip Kits

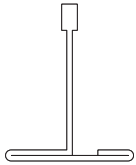

Tip: Ceiling clip attachment hardware is included with ceiling track. Additional ceiling clip kits can be ordered separately for inventory or changes.

Standard Includes	Required to Specify
<ul style="list-style-type: none"> ▶ Need help? Product details, page 61 • Quantity of 200 ceiling track clips and necessary attachment hardware 	<ul style="list-style-type: none"> 1 Style number 2 Options, if selected (see below)

Options	U.S. Price	Required to Specify
Post Extensions <ul style="list-style-type: none"> • Post extensions modified to accommodate recessed ceiling track (ordered separately) • Post extensions modified to accommodate overlapping ceiling track (ordered separately) 	No cost	Specify with post extensions for recessed ceiling track interface.
	No cost	Specify with post extensions for overlapping ceiling track interface.

Specification Information

Style Number	U.S. Price
1" x 1/4"D Tegular	
GPCFKT	\$1812
1" x 3/8"D Tegular	
GPCFKX	\$1812
1" x 1/2"D Tegular	
GPCFKY	\$2183
1" x 5/8"D Tegular	
GPCFKZ	\$2183
Donn Finline 1/4" Slot	
GPCFKM	\$ 332
Donn Finline 1/8" Slot	
GPCFKU	\$ 829
1"W Exposed T	
GPCFKA	\$ 565
1" Fluted Runner 1/4"-20"	
GPCFKP	\$ 29
1" Tee Quick Clip	
GPCFKQ	\$1053

▶ Specification Information, continued on next page

For Canadian Pricing
 Multiply U.S. Price by the Canadian price factor.
 ▶ See page 1 for details.

► Specification Information, continued from previous page

Specification Information

Style Number	U.S. Price
--------------	------------

9/16"W Exposed Tee

GPCFKR	\$ 565
--------	--------

9/16" x 1/4"D Tegular

GPCFKT5	\$1970
---------	--------

9/16" x 5/16"D Tegular

GPCFKX5	\$1970
---------	--------

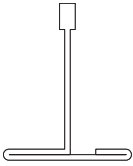

For Canadian Pricing

Multiply U.S. Price by the Canadian price factor.

► See page 1 for details.

Ceiling Track T-Clip



T-clip for recessed ceiling track



T-clip for overlapping ceiling track

Standard Includes		Required to Specify	
▶ Need help? Product details, page 61	• T-clip for ceiling track: black paint only	1 Style number 2 Options, if selected (see below)	
Options		U.S. Price	Required to Specify
Post Extensions	• Post extensions modified to accommodate recessed ceiling track (ordered separately)	No cost	Specify with post extensions for recessed ceiling track interface.
	• Post extensions modified to accommodate overlapping ceiling track (ordered separately)	No cost	Specify with post extensions for overlapping ceiling track interface.
Specification Information			
Style Number	U.S. Price		
GPCTT	\$6		

Ceiling Track Bypass Cover

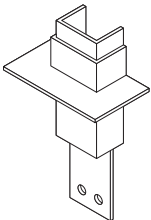

Tip: Bypass cover is required if you are using a recessed ceiling track and the track is on the ceiling grid.

Standard Includes		Required to Specify	
▶ Need help? Product details, page 61	• Bypass cover: paint	1 Style number 2 Paint color number for bypass cover 3 Options, if selected (see below) ▶ See <i>Surface Materials</i> , page 408.	
Options		U.S. Price	Required to Specify
Surface Materials	Bypass cover surface options		
	• Paint price group 1	No cost	Specify paint color number.
	• Paint price group 2	+\$4	Specify paint color number.
	• Paint price group 3	+\$6	Specify paint color number.
Specification Information			
Style Number	U.S. Base Price		
GPCTB	\$191		



For Canadian Pricing
Multiply U.S. Price by the Canadian price factor.
▶ See page 1 for details.

Cornice Track and Brackets

Tip: When required by the local seismic design criteria, structural bracing may be required. For more information regarding seismic applications, visit the Architectural Solutions web site at village.steelcase.com.

Standard Includes	Required to Specify
<ul style="list-style-type: none"> ▶ Need help? Product details, page 64 • Cornice track: paint 	<ul style="list-style-type: none"> 1 Style number 2 Paint color number for cornice track 3 Options, if selected (see below) ▶ See <i>Surface Materials</i>, page 408.

Options	U.S. Price	Required to Specify
Surface Materials		
L, T, and X Cornice Brackets		
• Paint price group 1	No cost	Specify paint color number.
• Paint price group 2	+\$ 4	Specify paint color number.
• Paint price group 3	+\$ 6	Specify paint color number.
Straight Cornice Track		
• Paint price group 1	No cost	Specify paint color number.
• Paint price group 2	+\$15	Specify paint color number.
• Paint price group 3	+\$26	Specify paint color number.

Specification Information		
Length	Style Number	U.S. Base Price

Straight Cornice Track

120"	GPRTS	\$255
------	--------------	-------

L Cornice Bracket

	GPRTL	\$ 49
--	--------------	-------

T Cornice Bracket

	GPRTT	\$ 49
--	--------------	-------

X Cornice Bracket

	GPRTX	\$ 49
--	--------------	-------

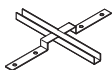
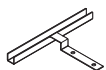

For Canadian Pricing
 Multiply U.S. Price by the Canadian price factor.
 ▶ See page 1 for details.

Trim and Accessories

Continuous Base Trim

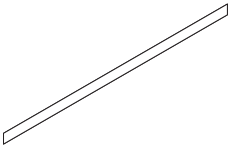

Standard Includes		Required to Specify
<ul style="list-style-type: none"> ▶ Need help? Product details, page 19 	<ul style="list-style-type: none"> • 5"H base trim: paint 	<ul style="list-style-type: none"> 1 Style number 2 Paint color number for base trim 3 Options, if selected (see below) ▶ See <i>Surface Materials</i>, page 408.

Options	U.S. Price	Required to Specify
Surface Materials Base trim surface options <ul style="list-style-type: none"> • Paint price group 1 • Paint price group 2 • Paint price group 3 	<ul style="list-style-type: none"> No cost +\$ 15 +\$ 26 	<ul style="list-style-type: none"> Specify paint color number. Specify paint color number. Specify paint color number.

SmartTools Options	U.S. Price	Required to Specify
Base <ul style="list-style-type: none"> • 2½"H base • 4"H base 	<ul style="list-style-type: none"> +\$ 10 +\$ 40 	<ul style="list-style-type: none"> Specify 2½"H base. Specify 4"H base.

Specification Information		
Width	Style Number	U.S. Base Price
120"	GPBTC	\$94

Tip: SmartTools options are available and easily ordered when using SmartTools software. If you do not have access to SmartTools software, these options can also be ordered using the normal Specials RFQ (Request For Quote) process.



For Canadian Pricing
 Multiply U.S. Price by the Canadian price factor.
 ▶ See page 1 for details.

Corner Base Trim

Standard Includes	Required to Specify
-------------------	---------------------

<ul style="list-style-type: none"> ▶ Need help? Product details, page 82 • 5"H base trim: paint 	<ul style="list-style-type: none"> 1 Style number 2 Paint color number for base trim 3 Options, if selected (see below) ▶ See <i>Surface Materials</i>, page 408.
---	---

Options	U.S. Price	Required to Specify
---------	------------	---------------------

Surface Materials <ul style="list-style-type: none"> • Paint price group 1 • Paint price group 2 • Paint price group 3 	Base trim surface options <ul style="list-style-type: none"> No cost +\$ 15 +\$ 26 	<ul style="list-style-type: none"> Specify paint color number. Specify paint color number. Specify paint color number.
--	--	---

Tip: SmartTools options are available and easily ordered when using SmartTools software. If you do not have access to SmartTools software, these options can also be ordered using the normal Specials RFQ (Request For Quote) process.

SmartTools Options	U.S. Price	Required to Specify
--------------------	------------	---------------------

Base <ul style="list-style-type: none"> • 2½"H base • 4"H base 	<ul style="list-style-type: none"> +\$ 40 +\$ 40 	<ul style="list-style-type: none"> Specify 2½"H base. Specify 4"H base.
Modified Angle (70° to 175° in 5° increments) <ul style="list-style-type: none"> • For GPCNRBT120 70°-85° • For GPCNRBT120 95°-115° • For GPCNRBT135 125°-175° 	<ul style="list-style-type: none"> +\$103 +\$ 51 +\$ 51 	<ul style="list-style-type: none"> Specify <i>with modified angle</i>. Specify <i>with modified angle</i>. Specify <i>with modified angle</i>.

Specification Information		
Width	Style Number	U.S. Base Price

:	:	:
:	:	:
:	:	:
:	:	:

90° Corner Base Trim

18"	GPCNRBT90	\$94
-----	------------------	------

120° Corner Base Trim

18"	GPCNRBT120	\$94
-----	-------------------	------

135° Corner Base Trim

18"	GPCNRBT135	\$94
-----	-------------------	------

.....



90° corner



120° corner



135° corner

For Canadian Pricing
 Multiply U.S. Price by the Canadian price factor.
 ▶ See page 1 for details.

Power and Communication Base Trim

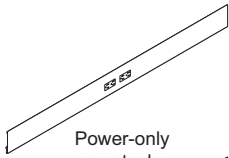

Power-only receptacles

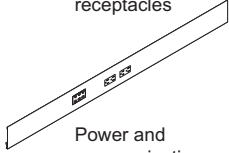

Power and communication receptacles

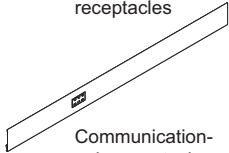

Communication-only receptacles

Tip: SmartTools options are available and easily ordered when using SmartTools software. If you do not have access to SmartTools software, these options can also be ordered using the normal Specials RFQ (Request For Quote) process.

Standard Includes	Required to Specify
<ul style="list-style-type: none"> ▶ Need help? Product details, page 21 • 5"H base trim with cutouts: paint 	<ul style="list-style-type: none"> 1 Style number 2 Paint color number for base trim 3 Options, if selected (see below) ▶ See <i>Surface Materials</i>, page 408.

Surface Materials	Options	Base trim surface options	U.S. Price	Required to Specify
	<ul style="list-style-type: none"> • Paint price group 1 • Paint price group 2 • Paint price group 3 		<ul style="list-style-type: none"> No cost +\$ 15 +\$ 26 	<ul style="list-style-type: none"> Specify paint color number. Specify paint color number. Specify paint color number.

Specification Information		
Width	Style Number	U.S. Base Price

Power and Communication Base Trim

Power Only		
59"	GPBTP	\$28
Power and Communication		
59"	GPBTCP	\$28
Communication Only		
59"	GPBTCC	\$28

Chicago Base Trim

Power Only		
59"	GPBTCHIP	\$28
Power and Communication		
59"	GPBTCHIPC	\$28
Communication Only		
59"	GPBTCC	\$28



For Canadian Pricing
 Multiply U.S. Price by the Canadian price factor.
 ▶ See page 1 for details.

Feature Strips

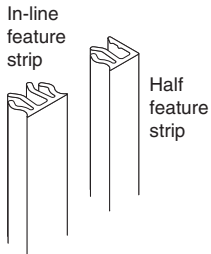

Tip: Single feature strips are 121" long and are cut to size in the field. They are required when joining door frames to other components.

Tip: To determine quantity and length of feature strips, see Feature Strip Application.
 ▶ Page 86.

Tip: Feature strip(s) may be shipped slightly longer than needed. Excess will be concealed behind base trim and no cutting is required.

Tip: Half feature strips are used in combination with in-line feature strips for inside corner applications.

Tip: For correct fit of feature strips, you must specify type of components that will be used in conjunction with feature strips. Example: One painted component and one upholstered component.

Standard Includes	Required to Specify
▶ Need help? Product details, page 18 • Feature strip(s): paint • Ceiling height from 8'0"H to 10'0"H, in one-inch increments, if package of 25 selected	1 Style number 2 Paint color number for feature strip(s) 3 Ceiling height, if package of 25 selected 4 Wall application 5 Options, if selected (see below) ▶ See <i>Surface Materials</i> , page 408.

Options	U.S. Price	Required to Specify
Surface Materials		
Single feature strips		
Paint		
• Paint price group 1	No cost	Specify paint color number.
• Paint price group 2	+\$ 4	Specify paint color number.
• Paint price group 3	+\$ 8	Specify paint color number.
Fabric		
• Fabric price group 1	+\$ 39	Specify fabric color number.
• Fabric price group 2	+\$ 56	Specify fabric color number.
• Fabric price group 3	+\$ 70	Specify fabric color number.
• Fabric price group 5	+\$ 88	Specify fabric color number.
Vinyl		
• Customer's Own Material/Vinyl (COM)	+\$ 39	▶ See <i>Surface Materials Reference Manual</i> .
Package of 25 feature strips		
Paint		
• Paint price group 1	No cost	Specify paint color number.
• Paint price group 2	+\$ 8	Specify paint color number.
• Paint price group 3	+\$ 15	Specify paint color number.
Fabric		
• Fabric price group 1	+\$ 88	Specify fabric color number.
• Fabric price group 2	+\$114	Specify fabric color number.
• Fabric price group 3	+\$150	Specify fabric color number.
• Fabric price group 5	+\$184	Specify fabric color number.
Vinyl		
• Customer's Own Material/Vinyl (COM)	+\$ 88	▶ See <i>Surface Materials Reference Manual</i> .
Wall Application		
• For use with two painted components	No cost	Specify <i>with two painted components</i> .
• For use with two upholstered components	No cost	Specify <i>with two upholstered components</i> .
• For use with one painted and one upholstered component	No cost	Specify <i>with one painted and one upholstered component</i> .
Ceiling Height		
• 8'0" through 10'0"	No cost	Specify ceiling height in 1" increments.

▶ Options, continued on next page



For Canadian Pricing
 Multiply U.S. Price by the Canadian price factor.
 ▶ See page 1 for details.

Tip: SmartTools options are available and easily ordered when using SmartTools software. If you do not have access to SmartTools software, these options can also be ordered using the normal Specials RFQ (Request For Quote) process.

► Options, continued from previous page

	SmartTools Options	U.S. Price	Required to Specify
Parametric Ceiling Height (Available in 1" increments)	• 7'5"H through 7'11"H (for GPFS and GPFSH only)	Use 8'0" price	Specify ceiling height in 1" increments.
	• 10'1"H through 11'0"H	No cost	Specify ceiling height in 1" increments.
Base	• 2½"H base (for GPFS and GPFSH only)	No cost	Specify to accept 2½"H base.
	• 4"H base (for GPFS and GPFSH only)	No cost	Specify to accept 4"H base.

Specification Information

Height	Style Number	U.S. Base Price
...

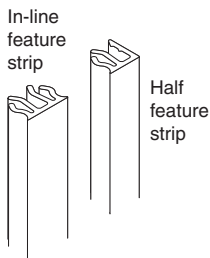

Package of 25 Feature Strips

In-Line

8'0"–10'0"	GPFS	\$550
------------	-------------	-------

Half

8'0"–10'0"	GPFSH	\$550
------------	--------------	-------

Package of 1 Feature Strip

In-Line

121"	GPFS1	\$ 28
------	--------------	-------

Half

121"	GPFSH1	\$ 28
------	---------------	-------

Package of 25 Lite Scale Feature Strips

In-Line

121"	GPFS121	\$550
------	----------------	-------

Half

121"	GPFSH121	\$550
------	-----------------	-------

 **For Canadian Pricing**
Multiply U.S. Price by the Canadian price factor.
► See page 1 for details.

Anodized Feature Strips

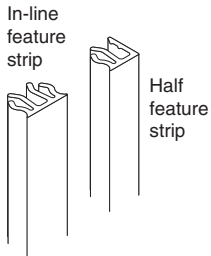

Tip: Single feature strips are 121" long and are cut to size in the field. They are required when joining door frames to other components.

Tip: To determine quantity and length of feature strips, see Feature Strip Application. ▶ Page 86.

Tip: Feature strip(s) may be shipped slightly longer than needed. Excess will be concealed behind base trim and no cutting is required.

Tip: Half feature strips are used in combination with in-line feature strips for inside corner applications.

Tip: Anodized feature strips are designed for use with Glass Selection anodized door and glass frames. They are not compatible with upholstered panels.

Tip: SmartTools options are available and easily ordered when using SmartTools software. If you do not have access to SmartTools software, these options can also be ordered using the normal Specials RFQ (Request For Quote) process.

Tip: For painted feature strips, use Privacy Wall feature strips.

Standard Includes	Required to Specify
<ul style="list-style-type: none"> ▶ Need help? Product details, page 18 • Feature strip(s): anodized aluminum • Ceiling height from 8'0"H to 10'0"H, in one-inch increments, if package of 25 selected 	<ul style="list-style-type: none"> 1 Style number 2 Ceiling height, if package of 25 selected 3 Options, if selected (see below) ▶ See <i>Surface Materials</i>, page 408.

Options	U.S. Price	Required to Specify
Ceiling Height on Half Feature Strips <ul style="list-style-type: none"> • 8'0" through 10'0" 	No cost	Specify ceiling height in 1" increments.

SmartTools Options	U.S. Price	Required to Specify
Parametric Ceiling Height (Available in 1" increments) <ul style="list-style-type: none"> • 7'5"H through 7'11"H (for GPFSA and GPFSHA only) 	No cost	Specify ceiling height in 1" increments.
Base <ul style="list-style-type: none"> • 2½"H base (for GPFSA and GPFSHA only) • 4"H base (for GPFSA and GPFSHA only) 	No cost No cost	Specify to accept 2½"H base. Specify to accept 4"H base.

Specification Information		
Height	Style Number	U.S. Price
⋮	⋮	⋮

Package of 25 Feature Strips

In-Line		
8'0"–10'0"	GPFSA	\$800
Half		
8'0"–10'0"	GPFSHA	\$800
⋮	⋮	⋮

Package of 1 Feature Strip

In-Line		
121"	GPFS1A	\$ 40
Half		
121"	GPFSH1A	\$ 40
⋮	⋮	⋮

Package of 25 Lite Scale Feature Strips

In-Line		
121"	GPFS121	\$800
Half		
121"	GPFSH121	\$800
⋮	⋮	⋮



For Canadian Pricing
Multiply U.S. Price by the Canadian price factor.
▶ See page 1 for details.

Furniture Reveal Strips



Standard Includes	Required to Specify
<ul style="list-style-type: none"> ▶ Need help? Product details, page 19 • Furniture reveal strip(s): paint price group 1 	<ol style="list-style-type: none"> 1 Style number 2 Paint color number 3 Wall application 4 Options, if selected (see below) <ul style="list-style-type: none"> ▶ See <i>Surface Materials</i>, page 408.

Tip: Furniture reveal strips are used when hanging components on Privacy Wall panels. The furniture reveal strip finishes off one half of an in-line panel joint, while allowing access to panel slots. They are cut to size from a 34" length as part of the installation process. Typically, one 34" strip is adequate to trim out both edges of a worksurface or storage cabinet.

Options	U.S. Price	Required to Specify
Surface Materials <ul style="list-style-type: none"> • Package of 4 furniture reveal strips <ul style="list-style-type: none"> • Paint price group 1 No cost • Paint price group 2 +\$ 4 • Paint price group 3 +\$ 8 • Package of 25 furniture reveal strips <ul style="list-style-type: none"> • Paint price group 1 No cost • Paint price group 2 +\$ 8 • Paint price group 3 +\$15 		Specify paint color number. Specify paint color number. Specify paint color number.
Wall Application <ul style="list-style-type: none"> • For use with two painted components No cost • For use with two upholstered components No cost • For use with one painted and one upholstered component No cost 		Specify with two painted components. Specify with two upholstered components. Specify with one painted and one upholstered component.

Specification Information		
Height	Style Number	U.S. Base Price
34"	GPFRS4	\$ 49

Package of 4 Furniture Reveal Strips

34"	GPFRS4	\$ 49
-----	--------	-------

Package of 25 Furniture Reveal Strips

34"	GPFRS	\$250
-----	-------	-------

 **For Canadian Pricing**
 Multiply U.S. Price by the Canadian price factor.
 ▶ See page 1 for details.

Acoustic Packing

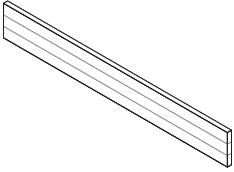

Standard Includes	Required to Specify
<ul style="list-style-type: none"> ▶ Need help? Product details, page 19 • 120" of acoustic packing for mini ends or wall channels to help improve acoustic performance 	Style number

Specification Information	
• Style Number	• U.S. Price
GPACoust	\$36

Acoustic Seals

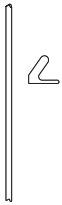

Standard Includes	Required to Specify
<ul style="list-style-type: none"> ▶ Need help? Product details, page 87 • Acoustic seal: black • Package of 10 	Style number

Specification Information		
• Height	• Style Number	• U.S. Price
18"	GPAS	\$87



For Canadian Pricing
 Multiply U.S. Price by the Canadian price factor.
 ▶ See page 1 for details.

Load Bar

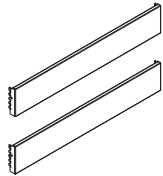

Privacy Wall

Standard Includes		Required to Specify
<ul style="list-style-type: none"> ▶ Need help? Product details, page 20 	<ul style="list-style-type: none"> • Load bar width: 18"W–60"W in 1/16" increments • Load bar: paint price group 1 • Package quantity: two 	<ol style="list-style-type: none"> 1 Style number 2 Paint color number for load bar 3 Width type (see below under Required Selections) 4 Width (see below under Required Selections) 5 Options, if selected (see below) <ul style="list-style-type: none"> ▶ See Surface Materials, page 408

	Required Selections	U.S. Price	Required to Specify
Width Type	<ul style="list-style-type: none"> • Modular • Standard 	No cost No cost	Specify modular. Specify standard.
Width	<ul style="list-style-type: none"> • 18"W–30"W • 30 1/16"W–60"W 	No cost +\$24	Specify width in 1/16" increments. Specify width in 1/16" increments.

	Options	U.S. Price	Required to Specify
Surface Materials	<ul style="list-style-type: none"> • Paint price group 1 • Paint price group 2 • Paint price group 3 	No cost +\$15 +\$23	Specify paint color number. Specify paint color number. Specify paint color number.

Related Products	<ul style="list-style-type: none"> • Solid wall panels with hollow core • Solid wall panels with enhanced core • Clerestory wall panels • Glass selections clerestory panel • Furniture reveal strips 	<ul style="list-style-type: none"> ▶ Page 116 ▶ Page 120 ▶ Page 142 ▶ Page 210 ▶ Page 251
-------------------------	--	--

Specification Information		
Height	Style Number	U.S. Base Price
6"	GPLB	\$428
.	.	.

 **For Canadian Pricing**
 Multiply U.S. Price by the Canadian price factor.
 ▶ See page 1 for details.

Post and Beam Attachment Kit



Tip: The Post and Beam attachment kit is designed for use in overhead applications only. It should not be used in fence application.

Standard Includes	Required to Specify
<ul style="list-style-type: none"> ▶ Need help? Product details, page 20 • Attachment kit: anodized aluminum 	Style number

Specification Information	
• Style Number	• U.S. Price
GPPBKIT	\$244
•	•



For Canadian Pricing
 Multiply U.S. Price by the Canadian price factor.
 ▶ See page 1 for details.

Accessories

Universal Floor Gripper

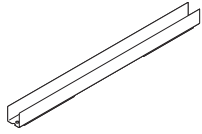

Standard Includes	Required to Specify
<ul style="list-style-type: none"> Need help? Product details, page 20 Floor gripper Double-sided hook and eye tape Double-sided adhesive tape 	Style number

Specification Information		
Height	Style Number	U.S. Price
16 ¹ / ₈ "	GPUFG	\$26

Wall-Lifting Tools

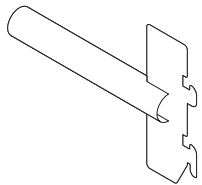

Standard Includes	Required to Specify
<ul style="list-style-type: none"> Wall-lifting tool Package quantity: two 	Style number

Specification Information	
Style Number	U.S. Price
GPWT	\$115

Wiring and Cabling

Receptacles

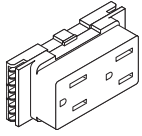

Tip: For designation of controlled receptacles, order permanent ink stamp with controlled icon; service part (1063909001SR). It includes a pair of stamps, one white and one black. Appropriate receptacles can be stamped at the job site during installation.

Standard Includes	Required to Specify
<ul style="list-style-type: none"> ▶ Need help? Product details, page 107 • Receptacle: plastic 	<ul style="list-style-type: none"> 1 Style number 2 Plastic color number for receptacle ▶ See <i>Surface Materials</i>, page 408.

Specification Information

Line	15-Amp Receptacles				20-Amp Receptacles			
	Style Number	U.S. Price	Style Number	U.S. Price	Style Number	U.S. Price	Style Number	U.S. Price

4-Circuit, 3+1 Wiring Schematic

	System Ground		Isolated Ground		System Ground		Isolated Ground	
Line 1	GP1R1SGX	\$34	GP1R1IGX	\$34	GP1R1SGHX	\$52	GP1R1IGHX	\$52
Line 2	GP1R2SGX	\$34	GP1R2IGX	\$34	GP1R2SGHX	\$52	GP1R2IGHX	\$52
Line 3	GP1R3SGX	\$34	GP1R3IGX	\$34	GP1R3SGHX	\$52	GP1R3IGHX	\$52
Line 4	GP1R4SGX	\$34	GP1R4IGX	\$34	GP1R4SGHX	\$52	GP1R4IGHX	\$52

4-Circuit, 2+2 Wiring Schematic

	System Ground		Isolated Ground		System Ground		Isolated Ground	
Line 1	GP2R1SGY	\$34	GP2R1IGY	\$34	GP2R1SGHY	\$52	GP2R1IGHY	\$52
Line 2	GP2R2SGY	\$34	GP2R2IGY	\$34	GP2R2SGHY	\$52	GP2R2IGHY	\$52
Line 3	GP2R3SGY	\$34	GP2R3IGY	\$34	GP2R3SGHY	\$52	GP2R3IGHY	\$52
Line 4	GP2R4SGY	\$34	GP2R4IGY	\$34	GP2R4SGHY	\$52	GP2R4IGHY	\$52

3-Circuit, Separate Neutrals Wiring Schematic

	System Ground		Isolated Ground		System Ground		Isolated Ground	
Line 1	GP3R1SGZ	\$34	GP3R1IGZ	\$34	GP3R1SGHZ	\$52	GP3R1IGHZ	\$52
Line 2	GP3R2SGZ	\$34	GP3R2IGZ	\$34	GP3R2SGHZ	\$52	GP3R2IGHZ	\$52
Line 3	GP3R3SGZ	\$34	GP3R3IGZ	\$34	GP3R3SGHZ	\$52	GP3R3IGHZ	\$52



For Canadian Pricing
 Multiply U.S. Price by the Canadian price factor.
 ▶ See page 1 for details.

USB Receptacles

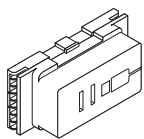

Standard Includes	Required to Specify
<ul style="list-style-type: none"> ▶ Need help? Product details, page 107 • Receptacle: plastic 	<ul style="list-style-type: none"> 1 Style number 2 Plastic color number for receptacle ▶ See <i>Surface Materials</i>, page 408.

Specification Information

Line	Style Number	U.S. Price

4-Circuit, 3+1 Wiring Schematic

Line 1	GPR1USBX	\$82
Line 2	GPR2USBX	\$82
Line 3	GPR3USBX	\$82
Line 4	GPR4USBX	\$82

4-Circuit, 2+2 Wiring Schematic

Line 1	GPR1USBY	\$82
Line 2	GPR2USBY	\$82
Line 3	GPR3USBY	\$82
Line 4	GPR4USBY	\$82

3-Circuit, Separate Neutrals Wiring Schematic

Line 1	GPR1USBZ	\$82
Line 2	GPR2USBZ	\$82
Line 3	GPR3USBZ	\$82



For Canadian Pricing
 Multiply U.S. Price by the Canadian price factor.
 ▶ See page 1 for details.

Cover Plates

Standard Includes	Required to Specify
<ul style="list-style-type: none"> ▶ Need help? Product details, page 107 • Cover plate: plastic 	<ul style="list-style-type: none"> 1 Style number 2 Plastic color number for cover plate ▶ See <i>Surface Materials</i>, page 408.

Specification Information	
• Style Number	• U.S. Price
•	•

Power and Communication

GPPDC	\$52
•	•

Power Only

GPPC	\$47
•	•

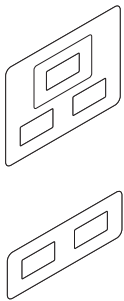

Power and Communication Fillers

Standard Includes	Required to Specify
<ul style="list-style-type: none"> ▶ Need help? Product details, page 108 • Package of 20 fillers: plastic 	<ul style="list-style-type: none"> 1 Style number 2 Plastic color number for filler ▶ See <i>Surface Materials</i>, page 408.

Specification Information	
• Style Number	• U.S. Price
•	•

GPRCE	\$98
•	•



Tip: This filler is not designed for use with the base communication cutout. Fillers for this NEMA-size cutout should be sourced locally.



For Canadian Pricing
 Multiply U.S. Price by the Canadian price factor.
 ▶ See page 1 for details.

Multipurpose Power Infeeds

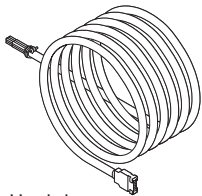

Hardwire

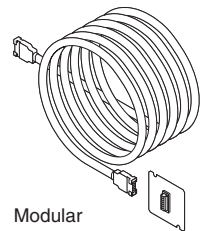

Modular

Tip: If an infeed is needed, it must be ordered separately when you order a panel with base power option. When you order a panel with ADA- or desk-height power option, a factory-installed hardwire infeed is included.

Tip: Infeed is included in the price of ADA- or desk-height receptacle power location option. Base receptacle power location does not include infeed. It must be ordered separately, if needed.

Standard Includes	Required to Specify
<ul style="list-style-type: none"> ▶ Need help? Product details, pages 106, 146 • Hardwire infeed <ul style="list-style-type: none"> — Junction box fittings — Conduit: metal • Modular infeed <ul style="list-style-type: none"> — Conduit: metal • Modular infeed cover 	Style number

Specification Information

Length and Connection	Style Number	U.S. Price

4-Circuit, 3+1 Wiring Schematic

24' Hardwire	GP1PIH24X	\$496
24' Modular	GP1PIM24X	\$598

4-Circuit, 2+2 Wiring Schematic

24' Hardwire	GP2PIH24Y	\$496
24' Modular	GP2PIM24Y	\$598

3-Circuit, Separate Neutrals Wiring Schematic

24' Hardwire	GP3PIH24Z	\$496
24' Modular	GP3PIM24Z	\$598



For Canadian Pricing

Multiply U.S. Price by the Canadian price factor.

▶ See page 1 for details.

Base Power Infeeds

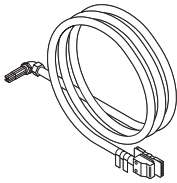

Tip: For base power infeeds for use in San Francisco, see below.

Standard Includes	Required to Specify
<ul style="list-style-type: none"> ▶ Need help? Product details, pages 106, 146 • Junction box fittings for hardwired connection • Liquid-tight flexible conduit: black plastic 	Style number

Specification Information

Length	Style Number	U.S. Price

4-Circuit, 3+1 Wiring Schematic

12'	GP1BPI12X	\$289

4-Circuit, 2+2 Wiring Schematic

12'	GP2BPI12Y	\$289

3-Circuit, Separate Neutrals Wiring Schematic

12'	GP3BPI12Z	\$289

Base Power Infeeds for Use in San Francisco

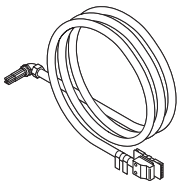

Standard Includes	Required to Specify
<ul style="list-style-type: none"> ▶ Need help? Product details, page 109 • Junction box fittings for hardwired connection • Metallic liquid-tight flexible conduit: black plastic 	Style number

Specification Information

Length	Style Number	U.S. Price

4-Circuit, 3+1 Wiring Schematic

16"	GP1BPISF12X	\$289

4-Circuit, 2+2 Wiring Schematic

16"	GP2BPISF12Y	\$289

3-Circuit, Separate Neutrals Wiring Schematic

16"	GP3BPISF12Z	\$289



For Canadian Pricing
 Multiply U.S. Price by the Canadian price factor.
 ▶ See page 1 for details.

Modular Harnesses

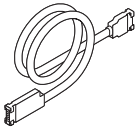

Tip: For field-installed jumpers, order a 29" harness for desk to ADA height, order a 64" harness for ADA to base height, and order a 76" harness for desk to base height.

Tip: Harnesses stretch 3". For example, a 33" harness will allow for a 33" to 36" connection.

Standard Includes	Required to Specify
<ul style="list-style-type: none"> Need help? Product details, page 108 Harness 	<ol style="list-style-type: none"> Style number Harness length (see below) Options, if selected (see below)

Options	U.S. Price	Required to Specify
Harness Length <ul style="list-style-type: none"> Harness length from 18" to 50" 	No cost	Specify <i>harness length of xx"</i> (designate length of 18", 21", 25", 29", 33", 37", 41", 46", or 50").
<ul style="list-style-type: none"> Harness length from 54" to 103" 	+\$ 57	Specify <i>harness length of xx"</i> (designate length of 54", 58", 62", 66", 70", 74", 78", 82", 90", 94", 99", or 103").
<ul style="list-style-type: none"> Harness length from 107" to 196" 	+\$166	Specify <i>harness length of xx"</i> (designate length of 107", 111", 115", 120", 124", 128", 132", 136", 140", 144", 148", 152", 156", 160", 166", 171", 175", 180", 184", 190", or 196").
<ul style="list-style-type: none"> Harness length 288" 	+\$448	Specify <i>harness length of 288"</i> .

Specification Information

Length	Style Number	U.S. Base Price
18" to 50"	GP1MHAX	\$133

4-Circuit, 3+1 Wiring Schematic

18" to 50"	GP1MHAX	\$133
------------	---------	-------

4-Circuit, 2+2 Wiring Schematic

18" to 50"	GP2MHAY	\$133
------------	---------	-------

3-Circuit, Separate Neutrals Wiring Schematic

18" to 50"	GP3MHAZ	\$133
------------	---------	-------



For Canadian Pricing

Multiply U.S. Price by the Canadian price factor.

▶ See page 1 for details.

Harness-to-Harness Connectors

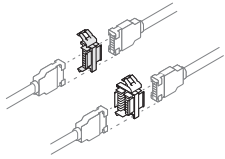

Standard Includes	Required to Specify
<ul style="list-style-type: none"> Need help? Product details, page 108 Connector: black plastic only 	Style number

Specification Information		
Description	Style Number	U.S. Price

4-Circuit, 3+1 Wiring Schematic

Harness-to-harness	GP1HHX	\$34
Branching harness-to-harness	GP1BHX	\$34

4-Circuit, 2+2 Wiring Schematic

Harness-to-harness	GP2HHY	\$34
Branching harness-to-harness	GP2BHY	\$34

3-Circuit, Separate Neutrals Wiring Schematic

Harness-to-harness	GP3HHZ	\$34
Branching harness-to-harness	GP3BHZ	\$34



For Canadian Pricing

Multiply U.S. Price by the Canadian price factor.

▶ See page 1 for details.

Field-Installed Powerkits

Tip: These powerkits are suitable for use in New York City.

Tip: Power and communication cover plate and base trim are ordered separately.
▶ Pages 246 and 258

Tip: Power and communication can be field installed in panel face. Power only cannot be field installed in panel face.

Tip: Powerkits can be installed in hollow core panels only.

Standard Includes		Required to Specify
▶ Need help? Product details, page 107	<ul style="list-style-type: none"> • Power block • Mounting bracket 	Style number

Related Products

- Power and communication base trim ▶ Page 246
- Cover plates ▶ Page 258
- Multipurpose power infeeds ▶ Page 259
- Base power infeeds ▶ Page 260
- Harness-to-harness connectors ▶ Page 262

Specification Information

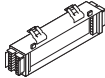
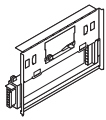
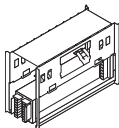
Base Powerkit		ADA/Desk Single Powerkit		ADA/Desk Double Powerkit	
					
• Style Number	• U.S. Price	• Style Number	• U.S. Price	• Style Number	• U.S. Price

4-Circuit, 3+1 Wiring Schematic

GP1PKBX	\$180	GP1PKPSX	\$211	GP1PKPX	\$211
----------------	-------	-----------------	-------	----------------	-------

4-Circuit, 2+2 Wiring Schematic

GP2PKBY	\$180	GP2PKPSY	\$211	GP2PKPY	\$211
----------------	-------	-----------------	-------	----------------	-------

3-Circuit, Separate Neutrals Wiring Schematic

GP3PKBZ	\$180	GP3PKPSZ	\$211	GP3PKPZ	\$211
----------------	-------	-----------------	-------	----------------	-------



For Canadian Pricing

Multiply U.S. Price by the Canadian price factor.

▶ See page 1 for details.

Chicago & NYC Junction Box

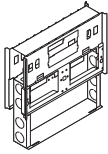

Tip: Junction boxes for base power are provided by the electrician.

Tip: Powerkits can be installed in hollow core panels only.

Standard Includes	Required to Specify
<ul style="list-style-type: none"> ▶ Need help? Product details, pages 109, 146 • Field-installed junction box for panel 	Style number

Specification Information				
• Dimensions			• Style	• U.S.
D	W	H	Number	Price
7 ²³ / ₃₂ "	5 ³ / ₄ "	1 ³ / ₃₂ "	GPJCH	\$216
:	:	:	:	:



For Canadian Pricing

Multiply U.S. Price by the Canadian price factor.

▶ See page 1 for details.

Glass Channels and Stops – Lite Scale Glazing

Standard Includes		Required to Specify
<ul style="list-style-type: none"> ▶ Need help? Product details, page 88 	<ul style="list-style-type: none"> • Glass channel, if selected: paint • Glass stop, if selected: paint • Ceiling track spacer, if selected 	<ul style="list-style-type: none"> 1 Style number 2 Paint color number for channels or stops 3 Options, if selected (see below) ▶ See <i>Surface Materials</i>, page 408.

Options	U.S. Price	Required to Specify
Surface Materials <ul style="list-style-type: none"> • Paint price group 1 • Paint price group 2 • Paint price group 3 • Clear anodized 	<ul style="list-style-type: none"> No cost +\$15 +\$24 No cost 	<ul style="list-style-type: none"> Specify paint color number. Specify paint color number. Specify paint color number. Specify anodized aluminum.

Specification Information		
Length	Style Number	U.S. Base Price
122"	GPPWGSS	\$ 86
122"	GPPWGSL	\$114
122"	GPPWGCS	\$108
122"	GPPWGCL	\$148
122"	GPPWGCCTS	\$148
122"	GPPWGCV	\$172
90"	GPPWCTSP	\$103

Glass Stop - Small

122"	GPPWGSS	\$ 86
:	:	:

Glass Stop - Large

122"	GPPWGSL	\$114
:	:	:

Glass Channel - Small

122"	GPPWGCS	\$108
:	:	:

Glass Channel - Large

122"	GPPWGCL	\$148
:	:	:

Glass Channel - Ceiling Track, Single

122"	GPPWGCCTS	\$148
:	:	:

Glass Channel - Variable Angle

122"	GPPWGCV	\$172
:	:	:

Ceiling Track - Spacer

90"	GPPWCTSP	\$103
:	:	:

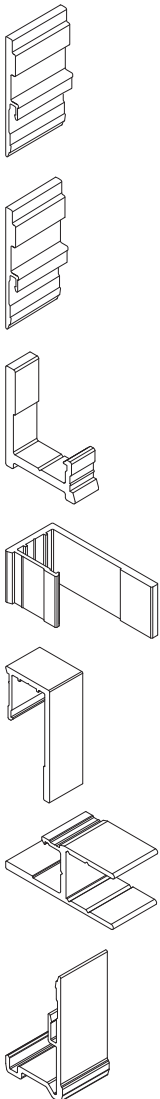

Vertical Transition and Stop – Lite Scale Glazing

	Standard Includes	Required to Specify
▶ Need help? Product details, page 88	<ul style="list-style-type: none"> Vertical transition, if selected: paint price group 1 Vertical stop, if selected: paint price group 1 	1 Style number 2 Paint color number for transition or stop 3 Options, if selected (see below) ▶ See <i>Surface Materials</i> , page 408.

	Options	U.S. Price	Required to Specify
Surface Materials	<ul style="list-style-type: none"> Paint price group 1 Paint price group 2 Paint price group 3 Clear anodized 	No cost +\$15 +\$24 No cost	Specify paint color number. Specify paint color number. Specify paint color number. Specify anodized aluminum.
Top Prep	<ul style="list-style-type: none"> No notch Left-hand notch Right-hand notch 	No cost +\$62 +\$62	Specify <i>with no notch</i> . Specify <i>with left-hand notch</i> . Specify <i>with right-hand notch</i> .

Specification Information		
Length	Style Number	U.S. Base Price
:	:	:
:	:	:

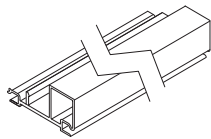

Vertical Transition

122"	GPPWVTBGS	\$172
:	:	:

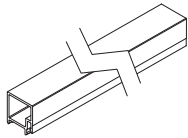

Vertical Stop

122"	GPPWVSBGS	\$115
:	:	:



For Canadian Pricing
 Multiply U.S. Price by the Canadian price factor.
 ▶ See page 1 for details.

Glass Lite Butt Glazed—Lite Scale Glazing

Glass Lite Butt Glazed—Lite Scale Glazing



Standard Includes		Required to Specify
<ul style="list-style-type: none"> ▶ Need help? Product details, page 88 	<ul style="list-style-type: none"> • 1/2" thick clear tempered glass: 6500 Clear Glass • Height: 6"–120" • Width: 6"–120" 	<ol style="list-style-type: none"> 1 Style number 2 Height (see below under Required Selections) 3 Width 4 Square foot (see below under Defaulted Components) 5 Glass color number for lite 6 Options, if selected (see below) <ul style="list-style-type: none"> ▶ See <i>Surface Materials</i>, page 408.

Required Selections	U.S. Price	Required to Specify
Height <ul style="list-style-type: none"> • Height 6"–120" 	+\$ 0.78 per inch	Specify height.

Defaulted Components	U.S. Price	Condition
Square foot <ul style="list-style-type: none"> • Square foot upcharge 	+\$27.60 per square foot	Square foot upcharge will be automatically applied based on height and width selections.

Options	U.S. Price	Required to Specify
Surface Materials <ul style="list-style-type: none"> • 6500 Clear Glass • 6540 Clear Laminated Glass 	No cost +\$ 3.13 per square foot	Specify 6500 Clear Glass. Specify 6540 Clear Laminated Glass.

Specification Information	
Style Number	U.S. Base Price

GPPWGLBG	\$8
:	:

Tip: Square footage is determined based on height and width selections.

Tip: Prices are calculated based on base price, height, and width specifications. See height and square foot upcharges above as well as base price to the right. All prices can be validated using SmartTools.

 **For Canadian Pricing**
 Multiply U.S. Price by the Canadian price factor.
 ▶ See page 1 for details.

Feature Strip Cover—Lite Scale Glazing

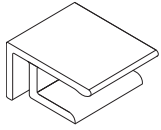

Standard Includes	Required to Specify
<ul style="list-style-type: none"> ▶ Need help? Product details, page 88 • Feature strip: paint price group 1 	<ul style="list-style-type: none"> 1 Style number 2 Paint color number for feature strip 3 Options, if selected (see below) ▶ See <i>Surface Materials</i>, page 408.

Options	U.S. Price	Required to Specify
Surface Materials <ul style="list-style-type: none"> • Paint price group 1 • Paint price group 2 • Paint price group 3 • Clear anodized 	<ul style="list-style-type: none"> No cost +\$15 +\$24 No cost 	<ul style="list-style-type: none"> Specify paint color number. Specify paint color number. Specify paint color number. Specify anodized aluminum.

Specification Information		
Length	Style Number	U.S. Base Price
48"	GPPWFSC	\$55
.....



For Canadian Pricing
 Multiply U.S. Price by the Canadian price factor.
 ▶ See page 1 for details.

Trim – Lite Scale Glazing

Standard Includes		Required to Specify
<ul style="list-style-type: none"> ▶ Need help? Product details, page 88 	<ul style="list-style-type: none"> • Plinths (pair): paint price group 1 	<ul style="list-style-type: none"> 1 Style number 2 Paint color number for plinths 3 Options, if selected (see below) ▶ See <i>Surface Materials</i>, page 408.

Options	U.S. Price	Required to Specify
Surface Materials <ul style="list-style-type: none"> • Paint price group 1 • Paint price group 2 • Paint price group 3 • Clear anodized 	No cost +\$2 +\$3 No cost	Specify paint color number. Specify paint color number. Specify paint color number. Specify anodized aluminum.
Plinth Base Height <ul style="list-style-type: none"> • 2½"H • 5"H 	No cost No cost	Specify with 2½" plinth base height. Specify with 5" plinth base height.

Specification Information		
Length	Style Number	U.S. Base Price

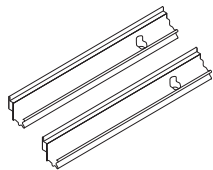

Plinth - Panel, Base (Pair)		
	GPPWPPB	\$24
:	:	:

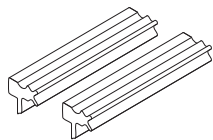

Plinth - Panel, Ceiling Track (Pair)		
2¼"	GPPWPPC	\$24
:	:	:

Tip: Plinth at ceiling track does not require a height selection.

 **For Canadian Pricing**
 Multiply U.S. Price by the Canadian price factor.
 ▶ See page 1 for details.

Tapes and Seals – Lite Scale Glazing

Standard Includes	Required to Specify
<ul style="list-style-type: none"> ▶ Need help? Product details, page 88 • Tape or seal 	<ul style="list-style-type: none"> Style number

Specification Information

• Dimensions • Length	• Style • Number	• U.S. • Price
--------------------------	---------------------	-------------------

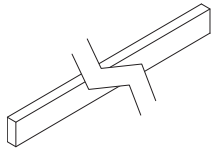

Glazing Tape - Foam

30'	GPPWGTFC	\$112
:	:	:



Glazing Tape - Black

100'	GPPWGTB	\$419
:	:	:

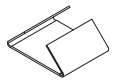

Seal - Ceiling Grid

120'	GPSCG	\$ 8
:	:	:

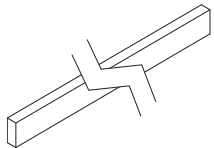

Seal - Light & Sound

122'	GPSL	\$ 12
:	:	:



For Canadian Pricing
 Multiply U.S. Price by the
 Canadian price factor.
 ▶ See page 1 for details.

Post Extension – Lite Scale Glazing

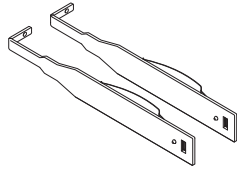

Standard Includes	Required to Specify
-------------------	---------------------

- | | |
|---|---|
| <ul style="list-style-type: none"> ▶ Need help? Product details, page 88 | <ul style="list-style-type: none"> • Post extension (pair) |
|---|---|

Style number

Specification Information

• Style Number	• U.S. Price
GPPWPE	\$24



 **For Canadian Pricing**
 Multiply U.S. Price by the Canadian price factor.
 ▶ See page 1 for details.

Butt-Hinged Door Frames – Lite Scale Glazing

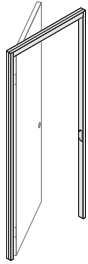

Tip: Glass door is available up to 9'0"H ceiling height.

Tip: For information regarding Etched and Pattern Glass Planning.
▶ Page 104

Tip: Recommended for use with Privacy Wall only. Not for use with Glass Selections.

Tip: Door frame glass option is available on transom door frames only.

Tip: Remember to specify switch cutout option if you want a butt-hinged door frame with a switch.

Tip: Switch cutout is located in strike jamb of single door frame and not available in pair frames. Order switch separately.
▶ Page 172

Tip: Cutout option is not available on pair door frames.
▶ Page 37

Standard Includes	Required to Specify
<ul style="list-style-type: none"> ▶ Need help? Product details, page 88 Ceiling height from 7'0"H to 10'0"H, in one-inch increments Factory prep for butt hinges <i>Tip: Order door hardware separately.</i> Hardware cutout for strike plate Transom, if selected: glass Plinth: paint 	<ol style="list-style-type: none"> Style number Ceiling height Swing orientation Paint color number for frame and plinth Glass number for transom, if selected Plinth base height Factory prep for cylindrical or mortise passage set or lockset, if selected Options, if selected (see below) <p>▶ See <i>Surface Materials</i>, page 408.</p>

Options	U.S. Price	Required to Specify	
Surface Materials <ul style="list-style-type: none"> Paint price group 1 Paint price group 2 Paint price group 3 	<ul style="list-style-type: none"> No cost +\$ 29 +\$ 48 	<ul style="list-style-type: none"> Specify paint color number. Specify paint color number. Specify paint color number. 	
Single door frames with transom 8'0"H through 10'0"H			
<ul style="list-style-type: none"> Glass price group 1 Glass price group 2 Glass price group 3 Glass price group 4 Glass price group 5 Glass price group 6 	<ul style="list-style-type: none"> No cost +\$ 92 +\$111 +\$174 N.A. +\$346 	<ul style="list-style-type: none"> Specify glass number for transom. Specify glass number for transom. Specify glass number for transom. Specify glass number for transom. Specify glass number for transom. Specify glass number for transom. 	
Pair door frames with transom 8'0"H through 10'0"H			
<ul style="list-style-type: none"> Glass price group 1 Glass price group 2 Glass price group 3 Glass price group 4 Glass price group 5 Glass price group 6 	<ul style="list-style-type: none"> No cost +\$182 +\$222 +\$348 N.A. +\$695 	<ul style="list-style-type: none"> Specify glass number for transom. Specify glass number for transom. Specify glass number for transom. Specify glass number for transom. Specify glass number for transom. Specify glass number for transom. 	
Plinth Base Height <ul style="list-style-type: none"> 2½"H 5"H 	<ul style="list-style-type: none"> No cost No cost 	<ul style="list-style-type: none"> Specify with 2½" plinth base height. Specify with 5" plinth base height. 	
Ceiling Height	Single door frames with transom <ul style="list-style-type: none"> 8'0" through 9'0" 9'1" through 10'0" 	<ul style="list-style-type: none"> No cost +\$ 50 	<ul style="list-style-type: none"> Specify ceiling height in 1" increments. Specify ceiling height in 1" increments.
	Pair door frames with transom <ul style="list-style-type: none"> 8'0" through 9'0" 9'1" through 10'0" 	<ul style="list-style-type: none"> No cost +\$ 96 	<ul style="list-style-type: none"> Specify ceiling height in 1" increments. Specify ceiling height in 1" increments.
Swing Orientation <ul style="list-style-type: none"> ▶ Page 46 	<ul style="list-style-type: none"> Left-hand door frame Right-hand door frame 	<ul style="list-style-type: none"> No cost No cost 	<ul style="list-style-type: none"> Specify with left-hand door frame. Specify with right-hand door frame.
Switch Cutout <ul style="list-style-type: none"> ▶ Page 37 	<ul style="list-style-type: none"> Without cutout With low-voltage switch cutout With high-voltage switch cutout 	<ul style="list-style-type: none"> No cost +\$ 37 +\$ 37 	<ul style="list-style-type: none"> Specify without cutout. Specify with low-voltage switch cutout. Specify with high-voltage switch cutout.
Lock Prep <ul style="list-style-type: none"> ▶ Page 42 	<ul style="list-style-type: none"> Strike plate and factory prep for cylindrical passage set or lockset Strike plate and factory prep for mortise passage set or lockset 	<ul style="list-style-type: none"> No cost No cost 	<ul style="list-style-type: none"> Specify with cylindrical prep. Specify with mortise prep.

▶ Options, continued on next page



For Canadian Pricing
Multiply U.S. Price by the Canadian price factor.
▶ See page 1 for details.

► Options, continued from previous page

Related Products

- Door leaves ▶ Page 156
- Passage sets and locksets ▶ Page 168
- Hinges ▶ Page 170
- Stops ▶ Page 170
- Switches ▶ Page 172
- Ceiling tracks ▶ Page 238
- Feature strips ▶ Page 248

Specification Information

Width	Style Number	U.S. Base Price
-------	--------------	-----------------

Single Door Frames

Full-Height

40"	GPDLSBF	\$1011
-----	----------------	--------

With Transom

40"	GPDLGBT	\$1562
-----	----------------	--------

Pair Frames

Full-Height

76"	GPDLPBF	\$1031
-----	----------------	--------

With Transom

76"	GPDLGBT	\$1656
-----	----------------	--------

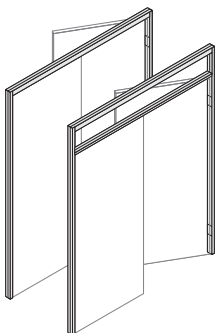
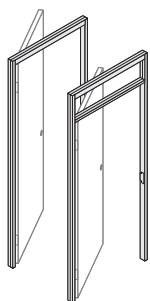

 **For Canadian Pricing**
Multiply U.S. Price by the Canadian price factor.
▶ See page 1 for details.

Pivot-Hinged Door Frames – Lite Scale Glazing

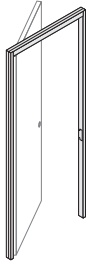

Tip: Glass door is available up to 9'0"H ceiling height.

Standard Includes	Required to Specify
<ul style="list-style-type: none"> ▶ Need help? Product details, page 88 Ceiling height from 7'0"H to 10'0"H, in one-inch increments Reversible, pivot-hinged door frame with plinths: paint Factory prep for pivot hinges <i>Tip: Order door hardware separately.</i> Transom, if selected: glass Strike plate 	<ol style="list-style-type: none"> Style number Ceiling height Swing orientation Paint color number for frame and plinths Glass number for transom, if selected Metal color number for strike plate: <ul style="list-style-type: none"> 9200 Satin Chrome 9201 Polished Chrome Plinth base height Factory prep for cylindrical or mortise passage set or lockset, if selected Options, if selected (see below) <p>▶ See <i>Surface Materials</i>, page 408.</p>

Tip: Strike plate finish is available on single frames only.

Tip: Door frame glass option is available on transom door frames only.

Tip: For information regarding Etched and Pattern Glass Planning.
▶ Page 104

Options	U.S. Price	Required to Specify
Surface Materials <ul style="list-style-type: none"> Door frame <ul style="list-style-type: none"> Paint price group 1: No cost Paint price group 2: +\$ 29 Paint price group 3: +\$ 48 Strike plate <ul style="list-style-type: none"> Satin chrome: No cost Polished chrome: +\$ 26 		Specify paint color number. Specify paint color number. Specify paint color number. Specify with 9200 Satin Chrome. Specify with 9201 Polished Chrome.
Single door frames with transom 7'0"H through 10'0"H		
<ul style="list-style-type: none"> Glass price group 1: No cost Glass price group 2: +\$ 92 Glass price group 3: +\$111 Glass price group 4: +\$174 Glass price group 5: N.A. Glass price group 6: +\$346 		Specify glass number for transom. Specify glass number for transom. Specify glass number for transom. Specify glass number for transom. Specify glass number for transom. Specify glass number for transom.
Pair door frames with transom 7'0"H through 10'0"H		
<ul style="list-style-type: none"> Glass price group 1: No cost Glass price group 2: +\$182 Glass price group 3: +\$222 Glass price group 4: +\$348 Glass price group 5: N.A. Glass price group 6: +\$695 		Specify glass number for transom. Specify glass number for transom. Specify glass number for transom. Specify glass number for transom. Specify glass number for transom. Specify glass number for transom.
Plinth Base Height <ul style="list-style-type: none"> 2½"H: No cost 5"H: No cost 		Specify with 2½" plinth base height. Specify with 5" plinth base height.
Ceiling Height <ul style="list-style-type: none"> Single door frames <ul style="list-style-type: none"> 7'0" through 9'0": No cost 9'1" through 10'0": +\$ 50 Pair door frames <ul style="list-style-type: none"> 7'0" through 9'0": No cost 9'1" through 10'0": +\$ 96 		Specify ceiling height in 1" increments. Specify ceiling height in 1" increments. Specify ceiling height in 1" increments. Specify ceiling height in 1" increments.
Swing Orientation <ul style="list-style-type: none"> ▶ Page 46 For single pivot-hinged door frame with transom <ul style="list-style-type: none"> Left-hand door frame: No cost Right-hand door frame: No cost 		Specify with left-hand door frame. Specify with right-hand door frame.
Lock Prep <ul style="list-style-type: none"> ▶ Page 42 Strike plate and factory prep for cylindrical passage set or lockset: No cost Strike plate and factory prep for mortise passage set or lockset: +\$ 72 		Specify with cylindrical prep. Specify with mortise prep.

▶ Options, continued on next page



For Canadian Pricing
 Multiply U.S. Price by the Canadian price factor.
 ▶ See page 1 for details.

► Options, continued from previous page

Related Products

- Door leaves ▶ Page 160
- Passage sets and locksets ▶ Page 168
- Hinges ▶ Page 170
- Stops ▶ Page 170
- Ceiling tracks ▶ Page 238
- Feature strips ▶ Page 248

Specification Information

Width	Style Number	U.S. Base Price

Single Door Frames

Full-Height

40"	GPDLSPF	\$ 639
-----	----------------	--------

With Transom

40"	GPDLSPPT	\$1277
-----	-----------------	--------

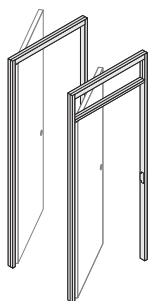

Pair Door Frames

Full-Height

80"	GPDLPPF	\$ 657
-----	----------------	--------

With Transom

80"	GPDLPPPT	\$1578
-----	-----------------	--------

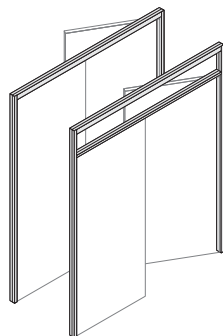

 **For Canadian Pricing**
Multiply U.S. Price by the
Canadian price factor.
▶ See page 1 for details.

Pivot-Hinged Door Frames with Switch Cutout – Lite Scale Glazing

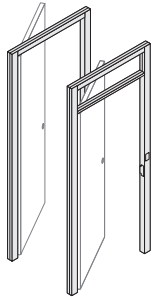

Tip: Glass door is available up to 9'0" H ceiling height.

Tip: Privacy Wall pivot-hinged frames work with Privacy Wall door leaves only.

Tip: For information regarding Etched and Pattern Glass Planning.
▶ Page 104

Tip: Glass surface option for transom door frames only.

Tip: Swing orientation is available on single pivot-hinged door frame with transom only to properly orient etched and patterned glass.

Tip: Order switch separately.

Tip: As an alternative to a 42" W frame with switch cutout, you can position a low-voltage switch in an in-line feature strip adjacent to a door frame.
▶ Page 43

Tip: Door frame glass surface option is available on transom door frames only.

Standard Includes	Required to Specify
<ul style="list-style-type: none"> ▶ Need help? Product details, page 40 Ceiling height from 7'0"H to 10'0"H, in one-inch increments Left-hand reversible, pivot-hinged door frame with plinths: paint Factory prep for pivot hinges <i>Tip: Order door hardware separately.</i> Transom, if selected: glass Strike plate 	<ol style="list-style-type: none"> Style number Ceiling height Swing orientation Paint color number for frame and plinths Glass number for transom, if selected Metal color number for strike plate: <ul style="list-style-type: none"> 9200 Satin Chrome 9201 Polished Chrome Plinth base height Factory prep for cylindrical or mortise passage set or lockset, if selected Options, if selected (see below) <p>▶ See <i>Surface Materials</i>, page 408.</p>

Options	U.S. Price	Required to Specify
Surface Materials <ul style="list-style-type: none"> Door frame <ul style="list-style-type: none"> Paint price group 1: No cost Paint price group 2: +\$ 29 Paint price group 3: +\$ 48 Strike plate <ul style="list-style-type: none"> Satin chrome: No cost Polished chrome: +\$ 26 		Specify paint color number. Specify paint color number. Specify paint color number.
Single door frames with transom 7'0"H through 10'0"H		
<ul style="list-style-type: none"> Glass price group 1: No cost Glass price group 2: +\$ 92 Glass price group 3: +\$111 Glass price group 4: +\$174 Glass price group 5: N.A. Glass price group 6: +\$346 		Specify glass number for transom. Specify glass number for transom. Specify glass number for transom. Specify glass number for transom. Specify glass number for transom. Specify glass number for transom.
Plinth Base Height <ul style="list-style-type: none"> 2 1/2"H: No cost 5"H: No cost 		Specify with 2 1/2" plinth base height. Specify with 5" plinth base height.
Ceiling Height <ul style="list-style-type: none"> Single door frames with transom <ul style="list-style-type: none"> 7'0" through 9'0": No cost 9'1" through 10'0": +\$ 50 		Specify ceiling height in 1" increments. Specify ceiling height in 1" increments.
Swing Orientation <ul style="list-style-type: none"> Left-hand door frame: No cost Right-hand door frame: No cost 		Specify with left-hand door frame. Specify with right-hand door frame.
Switch Cutout <ul style="list-style-type: none"> With low-voltage switch cutout: No cost With high-voltage switch cutout: No cost 		Specify with low-voltage switch cutout. Specify with high-voltage switch cutout.
Lock Prep <ul style="list-style-type: none"> Strike plate and factory prep for cylindrical passage set or lockset: No cost Strike plate and factory prep for mortise passage set or lockset: +\$ 72 		Specify with cylindrical prep. Specify with mortise prep.

▶ Options, continued on next page



For Canadian Pricing
Multiply U.S. Price by the Canadian price factor.
▶ See page 1 for details.

► Options, continued from previous page

Related Products

- Door leaves ► Page 160
- Passage sets and locksets ► Page 168
- Hinges ► Page 170
- Stops ► Page 170
- Ceiling tracks ► Page 238
- Feature strips ► Page 248

Specification Information

Width	Style Number	U.S. Base Price

Single Door Frames

Full-Height

42"	GPDLSPFS	\$1306
-----	-----------------	--------

With Transom

42"	GPDLSPFS	\$1772

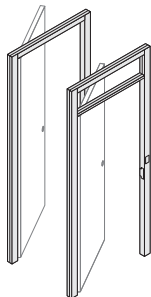

Privacy Wall

 **For Canadian Pricing**
Multiply U.S. Price by the
Canadian price factor.
► See page 1 for details.

Full-Height Butt-Hinged Door Leaves – Lite Scale Glazing



Tip: Glass door is available up to 9'0"H ceiling height.

Tip: For information regarding Etched and Pattern Glass Planning.
▶ Page 104

Standard Includes	Required to Specify
<ul style="list-style-type: none"> ▶ Need help? Product details, page 88 Ceiling height from 7'0"H to 10'0"H, in one-inch increments <i>Exception: Maximum ceiling height of glass doors is 9'0"H.</i> Butt-hinged door: paint, glass, or flat-cut veneer Factory prep for butt hinges 	<ol style="list-style-type: none"> Style number Ceiling height Swing orientation Paint color number for door, if solid door selected Glass number for glass door, if glass door selected Paint color number for glass door, if glass door selected Wood veneer color number, if selected Factory prep for cylindrical or mortise passage set or lockset, if selected Options, if selected (see below) <p>▶ See <i>Surface Materials</i>, page 408.</p>

Options	U.S. Price	Required to Specify
Surface Materials Glass door surface <ul style="list-style-type: none"> Paint price group 1 No cost Paint price group 2 +\$ 29 Paint price group 3 +\$ 48 		Specify paint color number. Specify paint color number. Specify paint color number.
36"W solid single door leaves 7'0"H through 10'0"H <ul style="list-style-type: none"> Paint price group 1 No cost Paint price group 3 +\$ 115 Wood veneer (flat cut) No cost Quarter-cut wood veneer +\$ 182 Customiz stain No cost 		Specify paint color number. Specify paint color number. Specify wood veneer color number. Specify wood veneer color number. Specify <i>with Customiz stain</i> .
72"W solid pair door leaves 7'0"H through 10'0"H <ul style="list-style-type: none"> Paint price group 1 No cost Paint price group 3 +\$ 227 Wood veneer (flat cut) No cost Quarter-cut wood veneer +\$ 369 Customiz stain No cost 		Specify paint color number. Specify paint color number. Specify wood veneer color number. Specify <i>with Quarter-cut open pore veneer</i> . Specify <i>with Customiz stain</i> .
Glass single door 7'0"H through 10'0"H <ul style="list-style-type: none"> Glass price group 1 No cost Glass price group 2 +\$ 408 Glass price group 3 +\$ 487 Glass price group 4 +\$ 783 Glass price group 5 N.A. Glass price group 6 +\$1548 		Specify glass number for lite. Specify glass number for lite. Specify glass number for lite. Specify glass number for lite. Specify glass number for lite. Specify glass number for lite.
Ceiling Height 36"W solid single door leaves butt-hinged 7'0"H through 10'0"H <ul style="list-style-type: none"> 7'0" through 9'0" No cost 9'1" through 10'0" +\$ 287 		Specify ceiling height in 1" increments. Specify ceiling height in 1" increments.
72"W solid pair door leaves butt-hinged 7'0"H through 10'0"H <ul style="list-style-type: none"> 7'0" through 9'0" No cost 9'1" through 10'0" +\$ 572 		Specify ceiling height in 1" increments. Specify ceiling height in 1" increments.
Swing Orientation <ul style="list-style-type: none"> Left-hand door frame No cost Right-hand door frame No cost 		Specify <i>with left-hand door frame</i> . Specify <i>with right-hand door frame</i> .
Lock Prep <ul style="list-style-type: none"> Strike plate and factory prep for cylindrical passage set or lockset No cost Strike plate and factory prep for mortise passage set or lockset +\$ 46 		Specify <i>with cylindrical prep</i> . Specify <i>with mortise prep</i> .

Related Products	▶ Page
Door frames	148
Passage sets and locksets	168
Hinges	170
Stops	170

 **For Canadian Pricing**
 Multiply U.S. Price by the Canadian price factor.
 ▶ See page 1 for details.

Specification Information

Width	Corresponding Frame Width	Style Number	U.S. Base Price
-------	---------------------------	--------------	-----------------

Solid Single Door

35 ¹³ / ₁₆ "	40"	GPLLSSBF40	\$1782
------------------------------------	-----	-------------------	--------



Glass Single Door with 5"H Bottom Rail

35 ¹³ / ₁₆ "	40"	GPLLGSBF40	\$4581
------------------------------------	-----	-------------------	--------



Glass Single Door with 12"H Bottom Rail

35 ¹³ / ₁₆ "	40"	GPLLGSBF40B	\$4581
------------------------------------	-----	--------------------	--------

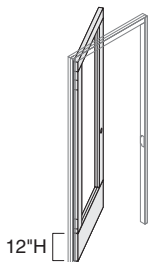

Solid Pair Door

71 ⁵ / ₈ "	76"	GPLLSPBF76	\$3640
----------------------------------	-----	-------------------	--------

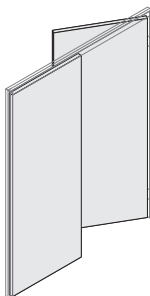

 **For Canadian Pricing**
Multiply U.S. Price by the
Canadian price factor.
▶ See page 1 for details.

Transom-Height Butt-Hinged Door Leaves – Lite Scale Glazing



Tip: For information regarding Etched and Pattern Glass Planning. ▶ Page 104.

Tip: Door frame glass surface option is available on transom door frames only.

Standard Includes		Required to Specify	
▶ Need help? Product details, page 88	<ul style="list-style-type: none"> • 7'0"H • Butt-hinged door: paint, glass, or flat-cut veneer • Factory prep for butt hinges 	<ol style="list-style-type: none"> 1 Style number 2 Paint color number for door, if solid door selected 3 Swing orientation 4 Glass number for glass door, if glass door selected 5 Paint color number for glass door, if glass door selected 6 Wood veneer color number, if selected 7 Factory prep for cylindrical or mortise passage set or lockset, if selected 8 Options, if selected (see below) 	▶ See <i>Surface Materials</i> , page 408.

Options	U.S. Price	Required to Specify
Surface Materials		
Glass door surface		
• Paint price group 1	No cost	Specify paint color number.
• Paint price group 2	+\$ 29	Specify paint color number.
• Paint price group 3	+\$ 48	Specify paint color number.
36"W solid single door leaves 7'0"H		
• Paint price group 1	No cost	Specify paint color number.
• Paint price group 3	+\$ 115	Specify paint color number.
• Wood veneer (flat cut)	No cost	Specify wood veneer color number.
• Quarter-cut wood veneer	+\$ 166	Specify with <i>Quarter-cut open pore veneer</i> .
• Customiz stain	No cost	Specify with <i>Customiz stain</i> .
72"W solid pair door leaves 7'0"H		
• Paint price group 1	No cost	Specify paint color number.
• Paint price group 3	+\$ 227	Specify paint color number.
• Wood veneer (flat cut)	No cost	Specify wood veneer color number.
• Quarter-cut wood veneer	+\$ 332	Specify with <i>Quarter-cut open pore veneer</i> .
• Customiz stain	No cost	Specify with <i>Customiz stain</i> .
Glass single door 7'0"H		
• Glass price group 1	No cost	Specify glass number for lite.
• Glass price group 2	+\$ 408	Specify glass number for lite.
• Glass price group 3	+\$ 487	Specify glass number for lite.
• Glass price group 4	+\$ 783	Specify glass number for lite.
• Glass price group 5	N.A.	Specify glass number for lite.
• Glass price group 6	+\$1548	Specify glass number for lite.
Swing Orientation		
• Left-hand door frame	No cost	Specify with <i>left-hand door frame</i> .
• Right-hand door frame	No cost	Specify with <i>right-hand door frame</i> .
Lock Prep		
▶ Page 42		
• Strike plate and factory prep for cylindrical passage set or lockset	No cost	Specify with <i>cylindrical prep</i> .
• Strike plate and factory prep for mortise passage set or lockset	+\$ 46	Specify with <i>mortise prep</i> .
Related Products		
• Door frames		▶ Page 148
• Passage sets and locksets		▶ Page 168
• Hinges		▶ Page 170
• Stops		▶ Page 170



For Canadian Pricing
 Multiply U.S. Price by the Canadian price factor.
 ▶ See page 1 for details.

Specification Information

Width	Corresponding Frame Width	Style Number	U.S. Base Price
-------	---------------------------	--------------	-----------------

Solid Single Door

35 ¹³ / ₁₆ "	40"	GPLLSSBT40	\$1635
------------------------------------	-----	-------------------	--------



Glass Single Door with 5"H Bottom Rail

35 ¹³ / ₁₆ "	40"	GPLLGSBT40	\$4463
------------------------------------	-----	-------------------	--------

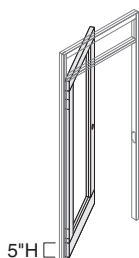

Glass Single Door with 12"H Bottom Rail

35 ¹³ / ₁₆ "	40"	GPLLGSBT40B	\$4463
------------------------------------	-----	--------------------	--------

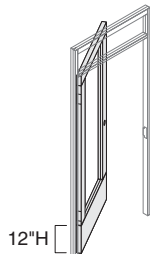

Solid Pair Door

71 ¹ / ₈ "	76"	GPLLSPBT76	\$3350
----------------------------------	-----	-------------------	--------

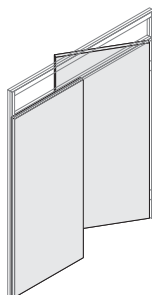

 **For Canadian Pricing**
Multiply U.S. Price by the Canadian price factor.
▶ See page 1 for details.

Full-Height Pivot-Hinged Door Leaves – Lite Scale Glazing



Tip: Glass door is available up to 9'0"H ceiling height.

Tip: Privacy Wall pivot-hinged door leaves work with Privacy Wall door frames only.

Tip: For information regarding Etched and Pattern Glass Planning. ▶ Page 104.

Tip: Door frame glass surface option is available on transom door frames only.

Tip: Ceiling height option is available on solid door leaves only.

Tip: Swing orientation is available on single pivot-hinged door frame with transom only.

Standard Includes		Required to Specify	
▶ Need help? Product details, page 88	<ul style="list-style-type: none"> Ceiling height from 7'0"H to 10'0"H, in one-inch increments <i>Exception: Maximum ceiling height of glass doors is 9'0"H.</i> Reversible pivot-hinged door: paint, glass, or flat-cut veneer Factory prep for pivot hinges 	<ol style="list-style-type: none"> Style number Ceiling height Paint color number for door, if solid door selected Glass number for glass door, if glass door selected Paint color number for glass door, if glass door selected Wood veneer color number, if selected Factory prep for cylindrical or mortise passage set or lockset, if selected Options, if selected (see below) 	▶ See <i>Surface Materials</i> , page 408.
Options	U.S. Price	Required to Specify	
Surface Materials	Glass door surface		
	<ul style="list-style-type: none"> Paint price group 1 No cost Paint price group 2 +\$ 29 Paint price group 3 +\$ 48 	Specify paint color number. Specify paint color number. Specify paint color number.	
	37³/₁₆"W solid single door leaf 7'0"H through 10'0"H		
	<ul style="list-style-type: none"> Paint price group 1 No cost Paint price group 3 +\$ 115 Wood veneer (flat cut) No cost Quarter-cut wood veneer +\$ 182 	Specify paint color number. Specify paint color number. Specify wood veneer color number. Specify with <i>Quarter-cut open pore veneer</i> .	
	<ul style="list-style-type: none"> Customiz stain No cost 	Specify with <i>Customiz stain</i> .	
	77¹/₂"W solid pair door leaves 7'0"H through 10'0"H		
	<ul style="list-style-type: none"> Paint price group 1 No cost Paint price group 3 +\$ 227 Wood veneer (flat cut) No cost Quarter-cut wood veneer +\$ 369 Customiz stain No cost 	Specify paint color number. Specify paint color number. Specify wood veneer color number. Specify wood veneer color number. Specify with <i>Customiz stain</i> .	
	Glass single door 7'0"H through 9'0"H		
	<ul style="list-style-type: none"> Glass price group 1 No cost Glass price group 2 +\$ 408 Glass price group 3 +\$ 487 Glass price group 4 +\$ 783 Glass price group 5 N.A. Glass price group 6 +\$1548 	Specify glass number for lite. Specify glass number for lite. Specify glass number for lite. Specify glass number for lite. Specify glass number for lite. Specify glass number for lite.	
Ceiling Height	Solid single door leaves		
	<ul style="list-style-type: none"> 7'0" through 9'0" No cost 9'1" through 10'0" +\$ 287 	Specify ceiling height in 1" increments. Specify ceiling height in 1" increments.	
	Solid pair door leaves		
	<ul style="list-style-type: none"> 7'0" through 9'0" No cost 9'1" through 10'0" +\$ 572 	Specify ceiling height in 1" increments. Specify ceiling height in 1" increments.	
Lock Prep	<ul style="list-style-type: none"> Strike plate and factory prep for cylindrical passage set or lockset No cost Strike plate and factory prep for mortise passage set or lockset +\$ 46 	Specify with <i>cylindrical prep</i> . Specify with <i>mortise prep</i> .	
Related Products	<ul style="list-style-type: none"> Door frames Passage sets and locksets Hinges Stops 	▶ Page 150 ▶ Page 168 ▶ Page 170 ▶ Page 170	



For Canadian Pricing
Multiply U.S. Price by the Canadian price factor.
▶ See page 1 for details.

Specification Information

Width	Corresponding Frame Width	Style Number	U.S. Base Price
-------	---------------------------	--------------	-----------------



Solid Single Door

37 ¹ / ₁₆ "	40"	GPLLSPF40	\$2174
-----------------------------------	-----	------------------	--------



Glass Single Door with 5"H Bottom Rail

37 ¹ / ₁₆ "	40"	GPLLGSPF40	\$4581
-----------------------------------	-----	-------------------	--------

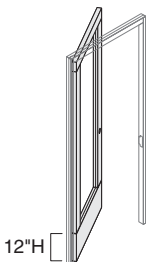

Glass Single Door with 12"H Bottom Rail

37 ¹ / ₁₆ "	40"	GPLLGSPF40B	\$4581
-----------------------------------	-----	--------------------	--------

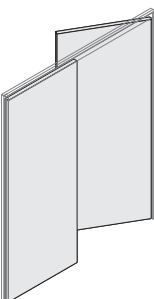

Solid Pair Door

77 ¹ / ₂ "	80"	GPLLSPF80	\$4428
----------------------------------	-----	------------------	--------

 **For Canadian Pricing**
Multiply U.S. Price by the
Canadian price factor.
▶ See page 1 for details.

Transom-Height Pivot-Hinged Door Leaves – Lite Scale Glazing



Tip: Privacy Wall pivot-hinged door leaves work with Privacy Wall door frames only.

Tip: For information regarding Etched and Pattern Glass Planning.
▶ Page 104.

Standard Includes		Required to Specify
▶ Need help? Product details, page 40	<ul style="list-style-type: none"> • 7'0"H • Reversible pivot-hinged door: paint, glass, or flat-cut veneer • Factory prep for pivot hinges 	<ol style="list-style-type: none"> 1 Style number 2 Paint color number for door, if solid door selected 3 Glass number for glass door, if glass door selected 4 Paint color number for glass door, if glass door selected 5 Wood veneer color number, if selected 6 Factory prep for cylindrical or mortise passage set or lockset, if selected 7 Options, if selected (see below) <p>▶ See <i>Surface Materials</i>, page 408.</p>

Options	U.S. Price	Required to Specify	
Surface Materials	Transom-height glass door leaves		
<ul style="list-style-type: none"> • Paint price group 1 • Paint price group 2 • Paint price group 3 	<ul style="list-style-type: none"> No cost +\$ 29 +\$ 48 	<ul style="list-style-type: none"> Specify paint color number. Specify paint color number. Specify paint color number. 	
	37³/₁₆"W solid single door leaves 7'0"H		
<ul style="list-style-type: none"> • Paint price group 1 • Paint price group 3 • Wood veneer (flat cut) • Quarter-cut wood veneer • Customiz stain 	<ul style="list-style-type: none"> No cost +\$ 115 No cost +\$ 166 No cost 	<ul style="list-style-type: none"> Specify paint color number. Specify paint color number. Specify wood veneer color number. Specify wood veneer color number. Specify with <i>Customiz stain</i>. 	
	77¹/₂"W solid pair door leaves 7'0"H		
<ul style="list-style-type: none"> • Paint price group 1 • Paint price group 3 • Wood veneer (flat cut) • Quarter-cut wood veneer • Customiz stain 	<ul style="list-style-type: none"> No cost +\$ 227 No cost +\$ 332 No cost 	<ul style="list-style-type: none"> Specify paint color number. Specify paint color number. Specify wood veneer color number. Specify wood veneer color number. Specify with <i>Customiz stain</i>. 	
	Glass single door 7'0"H		
<ul style="list-style-type: none"> • Glass price group 1 • Glass price group 2 • Glass price group 3 • Glass price group 4 • Glass price group 5 • Glass price group 6 	<ul style="list-style-type: none"> No cost +\$ 408 +\$ 487 +\$ 783 N.A. +\$1548 	<ul style="list-style-type: none"> Specify glass number for lite. Specify glass number for lite. Specify glass number for lite. Specify glass number for lite. Specify glass number for lite. Specify glass number for lite. 	
Lock Prep	<ul style="list-style-type: none"> • Strike plate and factory prep for cylindrical passage set or lockset • Strike plate and factory prep for mortise passage set or lockset 	<ul style="list-style-type: none"> No cost +\$ 46 	<ul style="list-style-type: none"> Specify with <i>cylindrical prep</i>. Specify with <i>mortise prep</i>.
Related Products	<ul style="list-style-type: none"> • Door frames • Passage sets and locksets • Hinges • Stops 	<ul style="list-style-type: none"> ▶ Page 150 ▶ Page 168 ▶ Page 170 ▶ Page 170 	



For Canadian Pricing
Multiply U.S. Price by the Canadian price factor.
▶ See page 1 for details.

Specification Information

Width	Corresponding Frame Width	Style Number	U.S. Base Price
-------	---------------------------	--------------	-----------------

Solid Single Door

37½"	40"	GPLLSSPT40	\$1992
------	-----	-------------------	--------



Glass Single Door with 5"H Bottom Rail

37½"	40"	GPLLGST40	\$4463
------	-----	------------------	--------

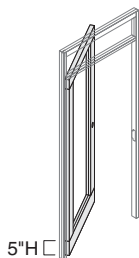

Glass Single Door with 12"H Bottom Rail

37½"	40"	GPLLGST40B	\$4463
------	-----	-------------------	--------

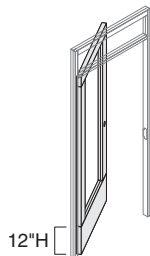

Solid Pair Door

77½"	80"	GPLLSPPT80	\$4066
------	-----	-------------------	--------

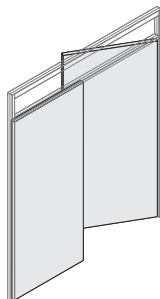

 **For Canadian Pricing**
Multiply U.S. Price by the
Canadian price factor.
▶ See page 1 for details.

Full-Height Pivot-Hinged Door Leaves for Use with Switch Cutout – Lite Scale Glazing



Tip: Glass door is available up to 9'0"H ceiling height.

Tip: Privacy Wall pivot-hinged door leaves work with Privacy Wall door frames only.

Tip: For information regarding Etched and Pattern Glass Planning. ▶ Page 104.

Tip: Ceiling height option is available on solid door leaves only.

Standard Includes		Required to Specify
▶ Need help? Product details, page 88	<ul style="list-style-type: none"> Ceiling height from 7'0"H to 10'0"H, in one-inch increments <i>Exception: Maximum ceiling height of glass doors is 9'0"H.</i> Reversible pivot-hinged door: paint, glass, or flat-cut veneer Factory prep for pivot hinges 	<ol style="list-style-type: none"> Style number Ceiling height Paint color number for door, if solid door selected Glass number for glass door, if glass door selected Paint color number for glass door, if glass door selected Wood veneer color number, if selected Factory prep for cylindrical or mortise passage set or lockset, if selected Options, if selected (see below) <p>▶ See <i>Surface Materials</i>, page 408.</p>

Options	U.S. Price	Required to Specify	
Surface Materials	Full-height glass door leaves surface options		
<ul style="list-style-type: none"> Paint price group 1 Paint price group 2 Paint price group 3 	<ul style="list-style-type: none"> No cost +\$ 29 +\$ 48 	<ul style="list-style-type: none"> Specify paint color number. Specify paint color number. Specify paint color number. 	
	36³/₈"W solid door leaves 7'0"H through 10'0"H		
<ul style="list-style-type: none"> Paint price group 1 Paint price group 3 Wood veneer (flat cut) Quarter-cut wood veneer Customiz stain 	<ul style="list-style-type: none"> No cost +\$ 115 No cost +\$ 182 No cost 	<ul style="list-style-type: none"> Specify paint color number. Specify paint color number. Specify wood veneer color number. Specify wood veneer color number. Specify with <i>Customiz stain</i>. 	
	Glass single door		
<ul style="list-style-type: none"> Glass price group 1 Glass price group 2 Glass price group 3 Glass price group 4 Glass price group 5 Glass price group 6 	<ul style="list-style-type: none"> No cost +\$ 408 +\$ 487 +\$ 783 N.A. +\$1548 	<ul style="list-style-type: none"> Specify glass number for lite. Specify glass number for lite. Specify glass number for lite. Specify glass number for lite. Specify glass number for lite. Specify glass number for lite. 	
Ceiling Height	Solid single door leaves		
	<ul style="list-style-type: none"> 7'0" through 9'0" 9'1" through 10'0" 	<ul style="list-style-type: none"> No cost +\$ 287 	<ul style="list-style-type: none"> Specify ceiling height in 1" increments. Specify ceiling height in 1" increments.
Lock Prep	<ul style="list-style-type: none"> Strike plate and factory prep for cylindrical passage set or lockset Strike plate and factory prep for mortise passage set or lockset 	<ul style="list-style-type: none"> No cost +\$ 46 	<ul style="list-style-type: none"> Specify with <i>cylindrical prep</i>. Specify with <i>mortise prep</i>.
Related Products	<ul style="list-style-type: none"> Door frames Passage sets and locksets Hinges Stops 		<ul style="list-style-type: none"> ▶ Page 154 ▶ Page 168 ▶ Page 170 ▶ Page 170



For Canadian Pricing
Multiply U.S. Price by the Canadian price factor.
▶ See page 1 for details.

Full-Height Pivot-Hinged Door
Leaves for Use with Switch
Cutout – Lite Scale Glazing

Specification Information

Width	Corresponding Frame Width	Style Number	U.S. Base Price
-------	---------------------------	--------------	-----------------

Solid Single Door

36 $\frac{3}{8}$ "	42"	GPLLSPF42	\$2174
--------------------	-----	------------------	--------



Glass Single Door with 5"H Bottom Rail

36 $\frac{3}{8}$ "	42"	GPLLGSPF42	\$4581
--------------------	-----	-------------------	--------



5"H

Glass Single Door with 12"H Bottom Rail

36 $\frac{3}{8}$ "	42"	GPLLGSPF42B	\$4581
--------------------	-----	--------------------	--------



12"H

 **For Canadian Pricing**
Multiply U.S. Price by the
Canadian price factor.
▶ See page 1 for details.

Transom-Height Pivot-Hinged Door Leaves for Use with Switch Cutout – Lite Scale Glazing



Tip: Privacy Wall pivot-hinged door leaves work with Privacy Wall door frames only.

Tip: For information regarding Etched and Pattern Glass Planning.
▶ Page 104.

Tip: Door frame glass surface option is available on transom door frames only.

Standard Includes	Required to Specify
<ul style="list-style-type: none"> ▶ Need help? Product details, page 88 • 7'0"H • Reversible pivot-hinged door: paint, glass, or flat-cut veneer • Factory prep for pivot hinges 	<ol style="list-style-type: none"> 1 Style number 2 Paint color number for door, if solid door selected 3 Glass number for glass door, if glass door selected 4 Paint color number for glass door, if glass door selected 5 Wood veneer color number, if selected 6 Factory prep for cylindrical or mortise passage set or lockset, if selected 7 Options, if selected (see below) <p>▶ See <i>Surface Materials</i>, page 408.</p>

Options	U.S. Price	Required to Specify
Surface Materials		
Transom-height glass door leaves surface options		
• Paint price group 1	No cost	Specify paint color number.
• Paint price group 2	+\$ 29	Specify paint color number.
• Paint price group 3	+\$ 48	Specify paint color number.
36³/₈"W solid door leaves 8'0"H through 10'0"H		
• Paint price group 1	No cost	Specify paint color number.
• Paint price group 3	+\$ 115	Specify paint color number.
• Wood veneer (flat cut)	No cost	Specify wood veneer color number.
• Quarter-cut wood veneer	+\$ 166	Specify wood veneer color number
• Customiz stain	No cost	Specify with <i>Customiz stain</i> .
Glass single door 7'0"H		
• Glass price group 1	No cost	Specify glass number for lite.
• Glass price group 2	+\$ 408	Specify glass number for lite.
• Glass price group 3	+\$ 487	Specify glass number for lite.
• Glass price group 4	+\$ 783	Specify glass number for lite.
• Glass price group 5	N.A.	Specify glass number for lite.
• Glass price group 6	+\$1548	Specify glass number for lite.
Lock Prep		
▶ Page 42		
• Strike plate and factory prep for cylindrical passage set or lockset	No cost	Specify with <i>cylindrical prep</i> .
• Strike plate and factory prep for mortise passage set or lockset	+\$ 46	Specify with <i>mortise prep</i> .
Related Products		
• Door frames		▶ Page 154
• Passage sets and locksets		▶ Page 168
• Hinges		▶ Page 170
• Stops		▶ Page 170



For Canadian Pricing
Multiply U.S. Price by the Canadian price factor.
▶ See page 1 for details.

Transom-Height Pivot-Hinged
Door Leaves for Use with
Switch Cutout – Lite Scale
Glazing

Specification Information

Width	Corresponding Frame Width	Style Number	U.S. Base Price
-------	---------------------------	--------------	-----------------

Solid Single Door

36 $\frac{3}{8}$ "	42"	GPLLSPT42	\$1992
--------------------	-----	------------------	--------



Glass Single Door with 5"H Bottom Rail

36 $\frac{3}{8}$ "	42"	GPLLSPT42	\$4463
--------------------	-----	------------------	--------

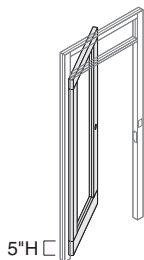

5"H

Glass Single Door with 12"H Bottom Rail

36 $\frac{3}{8}$ "	42"	GPLLSPT42B	\$4463
--------------------	-----	-------------------	--------

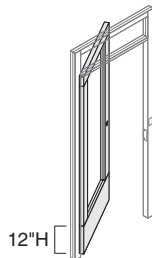

12"H

 **For Canadian Pricing**
Multiply U.S. Price by the
Canadian price factor.
▶ See page 1 for details.

Glass Selections Pivot-Hinged Door Frames – Lite Scale Glazing



Tip: Glass door is available up to 9'0"H ceiling height.

Tip: Recommended for use with Glass Selections panels only.

Tip: Glass Selections pivot-hinged door frames work with Glass Selections door leaves only.

Tip: For information regarding Etched and Pattern Glass Planning. ▶ Page 104.

Tip: Order switch separately.

Standard Includes	Required to Specify
<ul style="list-style-type: none"> ▶ Need help? Product details, page 88 • Ceiling height from 7'0"H to 10'0"H, in one-inch increments • Reversible, pivot-hinged door frame with plinths: paint or anodized aluminum • Door base: paint • Factory prep for pivot hinges <i>Tip: Order door hardware separately.</i> • Transom, if selected: glass 	<ol style="list-style-type: none"> 1 Style number 2 Ceiling height 3 Paint color number for frame 4 Paint color number for door base 5 Swing orientation 6 Glass number for transom, if selected 7 Metal color number for strike plate, if selected: <ul style="list-style-type: none"> 9200 Satin Chrome 9201 Polished Chrome 8 Plinth base height 9 Factory prep for cylindrical or mortise passage set or lockset, if selected 10 Options, if selected (see below) <ul style="list-style-type: none"> ▶ See <i>Surface Materials</i>, page 408.

Surface Materials	Options	U.S. Price	Required to Specify
	Frame		
	• Paint price group 1	No cost	Specify paint color number.
	• Paint price group 2	+\$ 29	Specify paint color number.
	Base		
	• Paint price group 1	No cost	Specify paint color number.
	• Paint price group 2	+\$ 8	Specify paint color number.
	Strike plate		
	• Satin chrome	No cost	Specify with 9200 Satin Chrome.
	• Polished chrome	+\$ 26	Specify with 9201 Polished Chrome.
	Single door frames with transom 7'0"H through 10'0"H		
	• Glass price group 1	No cost	Specify glass number for transom.
	• Glass price group 2	+\$ 92	Specify glass number for transom.
	• Glass price group 3	+\$111	Specify glass number for transom.
	• Glass price group 4	+\$174	Specify glass number for transom.
	• Glass price group 5	N.A.	Specify glass number for transom.
	• Glass price group 6	+\$346	Specify glass number for transom.
	Pair door frames with transom 7'0"H through 10'0"H		
	• Glass price group 1	No cost	Specify glass number for transom.
	• Glass price group 2	+\$182	Specify glass number for transom.
	• Glass price group 3	+\$222	Specify glass number for transom.
	• Glass price group 4	+\$348	Specify glass number for transom.
	• Glass price group 5	N.A.	Specify glass number for transom.
	• Glass price group 6	+\$695	Specify glass number for transom.
Plinth Base Height	• 2 1/2" height	No cost	Specify with 2 1/2" plinth base height.
	• 5" height	No cost	Specify with 5" plinth base height.
Ceiling Height	Single door frames		
	• 7'0" through 9'0"	No cost	Specify ceiling height in 1" increments.
	• 9'1" through 10'0"	+\$ 50	Specify ceiling height in 1" increments.
	Pair door frames		
	• 7'0" through 9'0"	No cost	Specify ceiling height in 1" increments.
	• 9'1" through 10'0"	+\$ 96	Specify ceiling height in 1" increments.
Swing Orientation	For single pivot-hinged door frame with transom		
▶ Page 46	• Left-hand door frame	No cost	Specify with left-hand door frame.
	• Right-hand door frame	No cost	Specify with right-hand door frame.

▶ Options, continued on next page

Tip: Swing orientation is available on single pivot-hinged door frame with transom only to properly orient etched and patterned glass.

► Options, continued from previous page

	Options	U.S. Price	Required to Specify
► Lock Prep Page 42	• Strike plate and factory prep for cylindrical passage set or lockset	No cost	Specify with <i>cylindrical prep.</i>
	• Strike plate and factory prep for mortise passage set or lockset	+\$72	Specify with <i>mortise prep.</i>
Related Products	<ul style="list-style-type: none"> • Door leaves • Passage sets and locksets • Hinges • Stops • Ceiling tracks • Feature strips 		<ul style="list-style-type: none"> ► Pages 216–222 ► Page 168 ► Page 170 ► Page 170 ► Page 238 ► Page 248

Specification Information		
Width	Style Number	U.S. Base Price
•	•	•
•	•	•
•	•	•

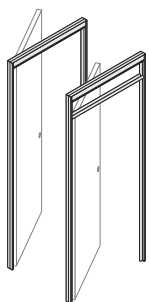

Single Door Frames

Full-Height		
40"	GPGSDLSPF	\$ 779
With Transom		
40"	GPGSDLSPT	\$1558
•	•	•

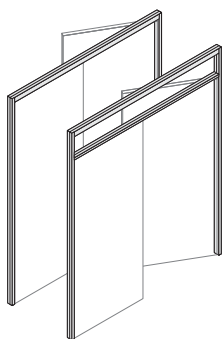

Pair Frames

Full-Height		
80"	GPGSDLPPF	\$ 833
With Transom		
80"	GPGSDLPPT	\$1662
•	•	•

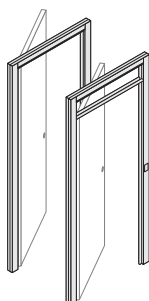

Single Door Frames for Use with Switch Cutout

Full-Height		
42"	GPGDLSPFS	\$1382
With Transom		
42"	GPGDLSPTS	\$2155
•	•	•

 **For Canadian Pricing**
Multiply U.S. Price by the Canadian price factor.
► See page 1 for details.

Glass Selections Full-Height Pivot-Hinged Door Leaves – Lite Scale Glazing



Tip: Glass Selections pivot-hinged door leaves work with Glass Selections door frames only.

Tip: For information regarding Etched and Pattern Glass Planning. ▶ Page 104.

Tip: Ceiling height option is available on solid door leaves only.

 **For Canadian Pricing**
Multiply U.S. Price by the Canadian price factor.
▶ See page 1 for details.

Standard Includes	Required to Specify
<ul style="list-style-type: none"> ▶ Need help? Product details, page 88 Ceiling height from 7'0"H to 10'0"H, in one-inch increments <i>Exception: Maximum ceiling height of glass doors is 9'0"H.</i> Reversible pivot-hinged door: paint, glass, flat-cut veneer, or anodized aluminum Factory prep for pivot hinges 	<ol style="list-style-type: none"> Style number Ceiling height Paint color number for door, if solid door selected Glass finish number for glass door, if glass door selected Paint color number for glass door, if glass door selected Wood veneer color number, if selected Factory prep for cylindrical or mortise passage set or lockset, if selected Options, if selected (see below) <p>▶ See <i>Surface Materials</i>, page 408.</p>

Options	U.S. Price	Required to Specify
Surface Materials <ul style="list-style-type: none"> Paint price group 1 No cost Paint price group 2 +\$ 29 Paint price group 3 +\$ 48 Anodized aluminum No cost 		Specify paint color number. Specify paint color number. Specify paint color number. Specify anodized aluminum.
37³/₁₆"W solid single door leaf 7'0"H through 10'0"H		
<ul style="list-style-type: none"> Paint price group 1 No cost Paint price group 3 +\$ 115 Wood veneer (flat cut) No cost Quarter-cut wood veneer +\$ 182 Customiz stain No cost 		Specify paint color number. Specify paint color number. Specify wood veneer color number. Specify with <i>Quarter-cut open pore veneer</i> . Specify with <i>Customiz stain</i> .
77¹/₂"W solid pair door leaves 7'0"H through 10'0"H		
<ul style="list-style-type: none"> Paint price group 1 No cost Paint price group 3 +\$ 227 Wood veneer (flat cut) No cost Quarter-cut wood veneer +\$ 369 Customiz stain No cost 		Specify paint color number. Specify paint color number. Specify wood veneer color number. Specify wood veneer color number. Specify with <i>Customiz stain</i> .
Glass single door 7'0"H through 9'0"H		
<ul style="list-style-type: none"> Glass price group 1 No cost Glass price group 2 +\$ 408 Glass price group 3 +\$ 487 Glass price group 4 +\$ 783 Glass price group 5 N.A. Glass price group 6 +\$1548 		Specify glass number for door. Specify glass number for door. Specify glass number for door. Specify glass number for door. Specify glass number for door. Specify glass number for door.
Ceiling Height		
Solid single door leaves		
<ul style="list-style-type: none"> 7'0" through 9'0" No cost 9'1" through 10'0" +\$ 287 		Specify ceiling height in 1" increments. Specify ceiling height in 1" increments.
Solid pair door leaves		
<ul style="list-style-type: none"> 7'0" through 9'0" No cost 9'1" through 10'0" +\$ 572 		Specify ceiling height in 1" increments. Specify ceiling height in 1" increments.
Lock Prep		
<ul style="list-style-type: none"> ▶ Page 42 Strike plate and factory prep for cylindrical passage set or lockset No cost Strike plate and factory prep for mortise passage set or lockset +\$ 46 		Specify with <i>cylindrical prep</i> . Specify with <i>mortise prep</i> .
Related Products		
<ul style="list-style-type: none"> Door frames Passage sets and locksets Hinges Stops 		<ul style="list-style-type: none"> ▶ Page 150 ▶ Page 168 ▶ Page 170 ▶ Page 170

Specification Information

Width	Corresponding Frame Width	Style Number	U.S. Base Price
-------	---------------------------	--------------	-----------------



Solid Single Door

37 ³ / ₁₆ "	40"	GPGSLLSPF40	\$2131
-----------------------------------	-----	--------------------	--------

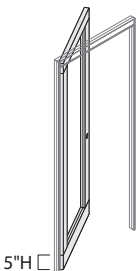

Glass Single Door with 5"H Bottom Rail

37 ³ / ₁₆ "	40"	GPGSLLGSPF40	\$4718
-----------------------------------	-----	---------------------	--------



Glass Single Door with 12"H Bottom Rail

37 ³ / ₁₆ "	40"	GPGSLLGSPF40B	\$4581
-----------------------------------	-----	----------------------	--------

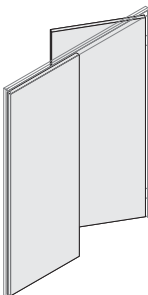

Solid Pair Door

77 ¹ / ₂ "	80"	GPGSLLSPPF80	\$4340
----------------------------------	-----	---------------------	--------

 **For Canadian Pricing**
Multiply U.S. Price by the
Canadian price factor.
▶ See page 1 for details.

Glass Selections Transom-Height Pivot-Hinged Door Leaves – Lite Scale Glazing



Tip: Glass Selections pivot-hinged door leaves work with Glass Selections door frames only.

Tip: For information regarding Etched and Pattern Glass Planning.
▶ Page 104.

Standard Includes	Required to Specify
<ul style="list-style-type: none"> ▶ Need help? Product details, page 88 • 7'0"H • Reversible pivot-hinged door: paint, glass, flat-cut veneer, or anodized aluminum • Factory prep for pivot hinges 	<ol style="list-style-type: none"> 1 Style number 2 Paint color number for door, if solid door selected 3 Glass finish number for glass door, if glass door selected 4 Paint color number for glass door, if glass door selected 5 Wood veneer color number, if selected 6 Factory prep for cylindrical or mortise passage set or lockset, if selected 7 Options, if selected (see below) <p>▶ See <i>Surface Materials</i>, page 408.</p>

Options	U.S. Price	Required to Specify
Surface Materials <ul style="list-style-type: none"> • Transom-height glass door frame leaves • Paint price group 1 No cost • Paint price group 2 +\$ 29 • Paint price group 3 +\$ 48 • Anodized aluminum No cost 		<ul style="list-style-type: none"> Specify paint color number. Specify paint color number. Specify paint color number. Specify anodized aluminum.
<ul style="list-style-type: none"> • 37³/₁₆"W solid single door leave 7'0"H • Paint price group 1 No cost • Paint price group 3 +\$ 115 • Wood veneer (flat cut) No cost • Quarter-cut wood veneer +\$ 166 • Customiz stain No cost 		<ul style="list-style-type: none"> Specify paint color number. Specify paint color number. Specify wood veneer color number. Specify wood veneer color number. Specify with <i>Customiz stain</i>.
<ul style="list-style-type: none"> • 77¹/₂"W solid pair door leaves 7'0"H • Paint price group 1 No cost • Paint price group 3 +\$ 227 • Wood veneer (flat cut) No cost • Quarter-cut wood veneer +\$ 332 • Customiz stain No cost 		<ul style="list-style-type: none"> Specify paint color number. Specify paint color number. Specify wood veneer color number. Specify wood veneer color number. Specify with <i>Customiz stain</i>.
<ul style="list-style-type: none"> • Glass single door 7'0"H • Glass price group 1 No cost • Glass price group 2 +\$ 408 • Glass price group 3 +\$ 487 • Glass price group 4 +\$ 783 • Glass price group 5 N.A. • Glass price group 6 +\$1548 		<ul style="list-style-type: none"> Specify glass number for door. Specify glass number for door. Specify glass number for door. Specify glass number for door. Specify glass number for door. Specify glass number for door.
<ul style="list-style-type: none"> • Lock Prep ▶ Page 42 • Strike plate and factory prep for cylindrical passage set or lockset No cost • Strike plate and factory prep for mortise passage set or lockset +\$ 46 		<ul style="list-style-type: none"> Specify with <i>cylindrical prep</i>. Specify with <i>mortise prep</i>.
<ul style="list-style-type: none"> • Related Products • Door frames • Passage sets and locksets • Hinges • Stops 		<ul style="list-style-type: none"> ▶ Page 150 ▶ Page 168 ▶ Page 170 ▶ Page 170



For Canadian Pricing
Multiply U.S. Price by the Canadian price factor.
▶ See page 1 for details.

Specification Information

Width	Corresponding Frame Width	Style Number	U.S. Base Price
-------	---------------------------	--------------	-----------------



Solid Single Door

37 ⁷ / ₁₆ "	40"	GPGSLLSPT40	\$1886
-----------------------------------	-----	--------------------	--------

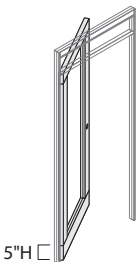

Glass Single Door with 5"H Bottom Rail

37 ⁷ / ₁₆ "	40"	GPGSLLGSPT40	\$4176
-----------------------------------	-----	---------------------	--------



Glass Single Door with 12"H Bottom Rail

37 ⁷ / ₁₆ "	40"	GPGSLLGSPT40B	\$4463
-----------------------------------	-----	----------------------	--------

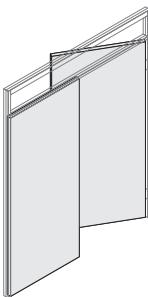

Solid Pair Door

77 ¹ / ₂ "	80"	GPGSLLSPPT80	\$3847
----------------------------------	-----	---------------------	--------

 **For Canadian Pricing**
Multiply U.S. Price by the
Canadian price factor.
▶ See page 1 for details.

Glass Selections Full-Height Pivot-Hinged Door Leaves for Use with Switch Cutout – Lite Scale Glazing

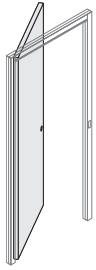

Tip: Glass Selections pivot-hinged door leaves work with Glass Selections door frames only.

Tip: For information regarding Etched and Pattern Glass Planning.
▶ Page 104.

Tip: Ceiling height option is available on solid door leaves only.

Standard Includes		Required to Specify
▶ Need help? Product details, page 88	<ul style="list-style-type: none"> Ceiling height from 7'0"H to 10'0"H, in one-inch increments <i>Exception: Maximum ceiling height of glass doors is 9'0"H.</i> Reversible pivot-hinged door: paint, glass, flat-cut veneer, or anodized aluminum Factory prep for pivot hinges 	<ol style="list-style-type: none"> Style number Ceiling height Swing orientation Paint color number for door, if solid door selected Glass finish number for glass door, if glass door selected Paint color number for glass door, if glass door selected Wood veneer color number, if selected Factory prep for cylindrical or mortise passage set or lockset, if selected Options, if selected (see below) <p>▶ See <i>Surface Materials</i>, page 408.</p>

Options	U.S. Price	Required to Specify	
Surface Materials	Full-height glass door frame leaves surface options		
<ul style="list-style-type: none"> Paint price group 1 Paint price group 2 Paint price group 3 Anodized aluminum 	<ul style="list-style-type: none"> No cost +\$ 29 +\$ 48 No cost 	<ul style="list-style-type: none"> Specify paint color number. Specify paint color number. Specify paint color number. Specify paint color number. 	
	36³/₈"W solid door leaves 7'0"H through 10'0"H		
<ul style="list-style-type: none"> Paint price group 1 Paint price group 3 Wood veneer (flat cut) Quarter-cut wood veneer Customiz stain 	<ul style="list-style-type: none"> No cost +\$ 115 No cost +\$ 182 No cost 	<ul style="list-style-type: none"> Specify paint color number. Specify paint color number. Specify wood veneer color number. Specify wood veneer color number. Specify <i>with Customiz stain</i>. 	
	Glass single door 7'0"H through 9'0"H		
<ul style="list-style-type: none"> Glass price group 1 Glass price group 2 Glass price group 3 Glass price group 4 Glass price group 5 Glass price group 6 	<ul style="list-style-type: none"> No cost +\$ 408 +\$ 487 +\$ 783 N.A. +\$1548 	<ul style="list-style-type: none"> Specify glass number for door. Specify glass number for door. Specify glass number for door. Specify glass number for door. Specify glass number for door. Specify glass number for door. 	
Ceiling Height	Solid single door leaves		
	<ul style="list-style-type: none"> 7'0" through 9'0" 9'1" through 10'0" 	<ul style="list-style-type: none"> No cost +\$ 287 	<ul style="list-style-type: none"> Specify ceiling height in 1" increments. Specify ceiling height in 1" increments.
Swing Orientation	For single pivot-hinged door frame		
▶ Page 46	<ul style="list-style-type: none"> Left-hand door frame Right-hand door frame 	<ul style="list-style-type: none"> No cost No cost 	<ul style="list-style-type: none"> Specify <i>with left-hand door frame</i>. Specify <i>with right-hand door frame</i>.
Lock Prep			
▶ Page 42	<ul style="list-style-type: none"> Strike plate and factory prep for cylindrical passage set or lockset Strike plate and factory prep for mortise passage set or lockset 	<ul style="list-style-type: none"> No cost +\$ 46 	<ul style="list-style-type: none"> Specify <i>with cylindrical prep</i>. Specify <i>with mortise prep</i>.
Related Products	<ul style="list-style-type: none"> Door frames Passage sets and locksets Hinges Stops 		<ul style="list-style-type: none"> ▶ Page 154 ▶ Page 168 ▶ Page 170 ▶ Page 170

 **For Canadian Pricing**
Multiply U.S. Price by the Canadian price factor.
▶ See page 1 for details.

Glass Selections Full-Height
Pivot-Hinged Door Leaves for
Use with Switch Cutout
– Lite Scale Glazing

Specification Information

Width	Corresponding Frame Width	Style Number	U.S. Base Price
-------	---------------------------	--------------	-----------------



Solid Single Door

36 $\frac{3}{8}$ "	42"	GPGSLLSPF42	\$2131
--------------------	-----	--------------------	--------

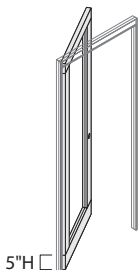

Glass Single Door with 5"H Bottom Rail

36 $\frac{3}{8}$ "	42"	GPGSLLGSPF42	\$4718
--------------------	-----	---------------------	--------

5"H

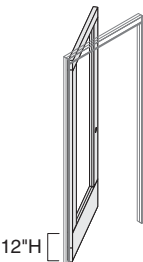

Glass Single Door with 12"H Bottom Rail

36 $\frac{3}{8}$ "	42"	GPGSLLGSPF42B	\$4581
--------------------	-----	----------------------	--------

12"H



For Canadian Pricing

Multiply U.S. Price by the Canadian price factor.

▶ See page 1 for details.

Glass Selections Transom-Height Pivot-Hinged Door Leaves for Use with Switch Cutout—Lite Scale Glazing

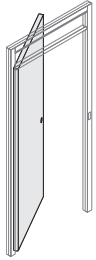

Tip: Glass Selections pivot-hinged door leaves work with Glass Selections door frames only.

Tip: In a Glass Selections door frame with glass transom, switch wiring must run down through the floor only. Wiring cannot run up to the ceiling.

Tip: For information regarding Etched and Pattern Glass Planning.
▶ Page 104.

Standard Includes	Required to Specify
-------------------	---------------------

- | | | |
|---|---|---|
| <ul style="list-style-type: none"> ▶ Need help? Product details, page 40 | <ul style="list-style-type: none"> • 7'0"H • Reversible pivot-hinged door: paint, glass, flat-cut veneer, or anodized aluminum • Door frame: paint or anodized aluminum • Factory prep for pivot hinges | <ol style="list-style-type: none"> 1 Style number 2 Swing orientation 3 Paint color number for door, if solid door selected 4 Paint color number for door frame 5 Glass finish number for glass door, if glass door selected 6 Paint color number for glass door, if glass door selected 7 Wood veneer color number, if selected 8 Factory prep for cylindrical or mortise passage set or lockset, if selected 9 Options, if selected (see below) <p>▶ See <i>Surface Materials</i>, page 408.</p> |
|---|---|---|

Options	U.S. Price	Required to Specify
---------	------------	---------------------

Surface Materials	Transom-height glass frame door leaves surface options		
<ul style="list-style-type: none"> • Paint price group 1 • Paint price group 2 • Paint price group 3 • Anodized aluminum 	<p>No cost</p> <p>+\$ 29</p> <p>+\$ 48</p> <p>No cost</p>	<p>Specify paint color number.</p> <p>Specify paint color number.</p> <p>Specify paint color number.</p> <p>Specify anodized aluminum.</p>	
	36³/₈"W solid door leaves 7'0"H		
<ul style="list-style-type: none"> • Paint price group 1 • Paint price group 3 • Wood veneer (flat cut) • Quarter-cut wood veneer • Customiz stain 	<p>No cost</p> <p>+\$ 115</p> <p>No cost</p> <p>+\$ 166</p> <p>No cost</p>	<p>Specify paint color number.</p> <p>Specify paint color number.</p> <p>Specify wood veneer color number.</p> <p>Specify wood veneer color number</p> <p>Specify <i>with Customiz stain</i>.</p>	
	Glass single door 7'0"H		
<ul style="list-style-type: none"> • Glass price group 1 • Glass price group 2 • Glass price group 3 • Glass price group 4 • Glass price group 5 • Glass price group 6 	<p>No cost</p> <p>+\$ 408</p> <p>+\$ 487</p> <p>+\$ 783</p> <p>N.A.</p> <p>+\$1548</p>	<p>Specify glass number for door.</p> <p>Specify glass number for door.</p> <p>Specify glass number for door.</p> <p>Specify glass number for door.</p> <p>Specify glass number for door.</p> <p>Specify glass number for door.</p>	
Lock Prep	<ul style="list-style-type: none"> • Strike plate and factory prep for cylindrical passage set or lockset • Strike plate and factory prep for mortise passage set or lockset 	<p>No cost</p> <p>+\$ 46</p>	<p>Specify <i>with cylindrical prep</i>.</p> <p>Specify <i>with mortise prep</i>.</p>
Related Products	<ul style="list-style-type: none"> • Door frames • Passage sets and locksets • Hinges • Stops 	<p>▶ Page 154</p> <p>▶ Page 168</p> <p>▶ Page 170</p> <p>▶ Page 170</p>	



For Canadian Pricing
Multiply U.S. Price by the Canadian price factor.
▶ See page 1 for details.

Glass Selections Transom-Height Pivot-Hinged Door Leaves for Use with Switch Cutout—Lite Scale Glazing

Specification Information

Width	Corresponding Frame Width	Style Number	U.S. Base Price
-------	---------------------------	--------------	-----------------

Solid Single Door

36 $\frac{3}{8}$ "	42"	GPGSLLSPT42	\$1886
--------------------	-----	--------------------	--------



Glass Single Door with 5"H Bottom Rail

36 $\frac{3}{8}$ "	42"	GPGSLLGSPT42	\$4176
--------------------	-----	---------------------	--------

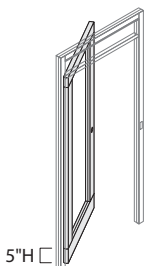

5"H

Glass Single Door with 12"H Bottom Rail

36 $\frac{3}{8}$ "	42"	GPGSLLGSPT42B	\$4463
--------------------	-----	----------------------	--------

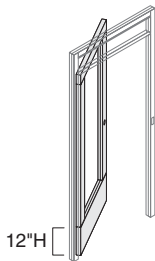

12"H

 **For Canadian Pricing**
 Multiply U.S. Price by the Canadian price factor.
 ▶ See page 1 for details.

Glass Selections Full-Height Polished Edge Slider Track—Lite Scale Glazing

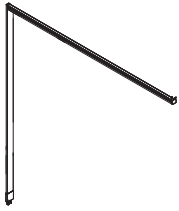

Tip: Glass Selections lite scale slider door frame and door leaves are ordered separately.

Standard Includes	Required to Specify
-------------------	---------------------

<ul style="list-style-type: none"> ▶ Need help? Product details, page 88 • Slider track: paint or anodized aluminum • Track width: 71"–144" in one-inch increments • Door width: 38"–45" in one-inch increments • Slider hardware 	<ol style="list-style-type: none"> 1 Style number 2 Track width 3 Door width 4 Paint color number for track 5 Close assist 6 Options, if selected (see below) <ul style="list-style-type: none"> ▶ See <i>Surface Materials</i>, page 408.
--	---

Options	U.S. Price	Required to Specify
---------	------------	---------------------

Surface Materials <ul style="list-style-type: none"> • Paint price group 1 • Paint price group 2 • Paint price group 3 • Anodized aluminum 	Trim <ul style="list-style-type: none"> • None • Leading edge only • Leading and trailing edge 	<ul style="list-style-type: none"> No cost +\$ 29 +\$ 48 No cost 	<ul style="list-style-type: none"> Specify paint color number. Specify paint color number. Specify <i>with anodized aluminum</i>.
Close Assist	<ul style="list-style-type: none"> • None • Leading edge only • Leading and trailing edge 	<ul style="list-style-type: none"> No cost +\$ 58 +\$116 	<ul style="list-style-type: none"> Specify <i>with none</i>. Specify <i>with leading edge only</i>. Specify <i>with leading and trailing edge</i>.
Track Width	<ul style="list-style-type: none"> • 71"–96" • 97"–144" 	<ul style="list-style-type: none"> No cost +\$119 	<ul style="list-style-type: none"> Specify track width. Specify track width.
Related Products	<ul style="list-style-type: none"> • Full-height polished edge slider door leaves—lite scale glazing • Full-height polished edge slider frame—lite scale glazing • Full-height polished edge slider hanger—lite scale glazing 	<ul style="list-style-type: none"> ▶ Page 301 ▶ Page 302 ▶ Page 303 	

Specification Information		
• Style Number	• Dimensions W	• U.S. Base Price

GPGSDTSS	75"	\$2399
----------	-----	--------

Tip: Bases prices are calculated based on width specification. See width upcharges above. All prices can be validated using SmartTools.



For Canadian Pricing

Multiply U.S. Price by the Canadian price factor.

▶ See page 1 for details.

Glass Selections Full-Height Polished Edge Slider Door Leaves—Lite Scale Glazing

Glass Selections Full-Height Polished Edge Slider Door Leaves—Lite Scale Glazing



Tip: Height upcharge is calculated per inch over 96". Width upcharge is calculated per inch over 40".

Tip: Glass Selections lite scale glazing slider door frame and door leaves are ordered separately.

Tip: Standard widths are 40", 42", or 48". Non-standard widths are available in one-inch increments.

Tip: Bases prices are calculated based on height and width specification. See height and width upcharges above. All prices can be validated using SmartTools.

Standard Includes	Required to Specify
<ul style="list-style-type: none"> ▶ Need help? Product details, page 88 • Slider door: glass with polished edges • Door base: paint • Ceiling height: 84"–120", in one-inch increments • Width: 38"–48", in one-inch increments • Glass thickness: 3/8" 	<ol style="list-style-type: none"> 1 Style number 2 Ceiling height (see below under Required Selections) 3 Door width (see below under Required Selections) 4 Paint color number for door base 5 Glass finish number for slider door 6 Glass thickness 7 Base height 8 Handedness 9 Glass surface orientation 10 Lock option 11 Options, if selected (see below) <p>▶ See <i>Surface Materials</i>, page 408.</p>

Required Selections	U.S. Price	Required to Specify
Height <ul style="list-style-type: none"> • 84"–96" • 97"–120" 	No cost +\$ 12 per inch	Specify ceiling height in 1" increments. Specify ceiling height in 1" increments.
Width <ul style="list-style-type: none"> • 38"–40" • 41"–48" 	No cost +\$ 33 per inch	Specify width in 1" increments. Specify width in 1" increments.

Options	U.S. Price	Required to Specify
Surface Materials <ul style="list-style-type: none"> • Paint price group 1 • Paint price group 2 • Paint price group 3 • Anodized aluminum 	No cost +\$ 8 +\$ 15 No cost	Specify paint color number. Specify paint color number. Specify paint color number. Specify with <i>anodized aluminum</i> .
Full-height slider door leaves		
<ul style="list-style-type: none"> • Glass price group 1 • Glass price group 3 	No cost +\$1437	Specify glass number for leaves. Specify glass number for leaves.
Glass Thickness <ul style="list-style-type: none"> • 3/8" — thick glass • 1/2" — thick glass 	No cost +\$ 283	Specify with 3/8" glass thickness. Specify with 1/2" glass thickness.
Base Height <ul style="list-style-type: none"> • 2 1/2" • 5" 	-\$ 201 No cost	Specify with 2 1/2" base height. Specify with 5" base height.
Handedness <ul style="list-style-type: none"> • Left handed • Right handed 	No cost No cost	Specify with <i>left handedness</i> . Specify with <i>right handedness</i> .
Glass Orientation <ul style="list-style-type: none"> • Polished on track • Polished away from track 	No cost No cost	Specify with <i>polished on track</i> . Specify with <i>polished away from track</i> .
Lock <ul style="list-style-type: none"> • No lock • Door lock 	No cost +\$ 48	Specify with <i>no lock</i> . Specify with <i>lock</i> .
Non-standard Width <ul style="list-style-type: none"> • Standard widths • Non-standard widths 	No cost +\$ 65	Specify width. Specify width.
Related Products <ul style="list-style-type: none"> • Full-height polished edge slider track—lite scale glazing • Full-height polished edge slider frame—lite scale glazing • Full-height polished edge slider hanger—lite scale glazing 	▶ Page 300 ▶ Page 302 ▶ Page 303	

Specification Information			
Style Number	Dimensions		U.S. Base Price
	H	W	
GPGSDFHSS	96"	40"	\$1747

Glass Selections Full-Height Polished Edge Slider Frame—Lite Scale Glazing

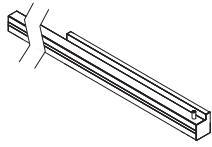

Tip: Glass Selections lite scale slider door frame and door leaves are ordered separately.

Tip: Standard widths are 40", 42", or 48". Non-standard widths are available in one-inch increments.

Tip: Bases prices are calculated based on height and width specification. See height and width upcharges above. All prices can be validated using SmartTools.

Standard Includes		Required to Specify
<ul style="list-style-type: none"> ▶ Need help? Product details, page 88 	<ul style="list-style-type: none"> • Ceiling height: 84"–120", in one-inch increments • Width: 38"–48", in one-inch increments • Frame: paint or anodized aluminum • Door pull: satin chrome 	<ol style="list-style-type: none"> 1 Style number 2 Ceiling height 3 Door width 4 Paint color number for frame 5 Paint color number for base 6 Base height 7 Handedness 8 Lock option 9 Paint color lock housing finish 10 Options, if selected (see below) <p>▶ See <i>Surface Materials</i>, page 408.</p>

Options	U.S. Price	Required to Specify
Surface Materials <ul style="list-style-type: none"> • Frame • Paint price group 1 • Paint price group 2 • Paint price group 3 • Anodized aluminum 	<ul style="list-style-type: none"> No cost +\$ 29 +\$ 48 No cost 	<ul style="list-style-type: none"> Specify paint color number. Specify paint color number. Specify paint color number. Specify with anodized aluminum.
<ul style="list-style-type: none"> • Base • Paint price group 1 • Paint price group 2 • Paint price group 3 • Anodized aluminum 	<ul style="list-style-type: none"> No cost +\$ 8 +\$ 15 No cost 	<ul style="list-style-type: none"> Specify paint color number. Specify paint color number. Specify paint color number. Specify with anodized aluminum.
Base Height <ul style="list-style-type: none"> • 2½" • 5" 	<ul style="list-style-type: none"> No cost No cost 	<ul style="list-style-type: none"> Specify 2½" base height. Specify 5" base height.
Handedness <ul style="list-style-type: none"> • Left handed • Right handed 	<ul style="list-style-type: none"> No cost No cost 	<ul style="list-style-type: none"> Specify with left handedness. Specify with right handedness.
Glass Orientation <ul style="list-style-type: none"> • Polished on track • Polished away from track 	<ul style="list-style-type: none"> No cost No cost 	<ul style="list-style-type: none"> Specify with polished on track. Specify with polished away from track.
Lock <ul style="list-style-type: none"> • No lock • Door lock 	<ul style="list-style-type: none"> No cost +\$1227 	<ul style="list-style-type: none"> Specify with no lock. Specify with door lock.
<ul style="list-style-type: none"> • Lock Housing • Paint price group 1 • Paint price group 2 • Paint price group 3 	<ul style="list-style-type: none"> No cost +\$ 8 +\$ 15 	<ul style="list-style-type: none"> Specify paint color number. Specify paint color number. Specify paint color number.
Ceiling Height <ul style="list-style-type: none"> • 84"–108" • 109"–120" 	<ul style="list-style-type: none"> No cost +\$ 50 	<ul style="list-style-type: none"> Specify ceiling height in 1" increments. Specify ceiling height in 1" increments.
Non-standard Width <ul style="list-style-type: none"> • Standard widths • Non-standard widths 	<ul style="list-style-type: none"> No cost +\$ 77 	<ul style="list-style-type: none"> Specify width. Specify width.
Related Products <ul style="list-style-type: none"> • Full-height polished edge slider door leaves—lite scale glazing • Full-height polished edge slider track—lite scale glazing • Full-height polished edge slider hanger—lite scale glazing 	<ul style="list-style-type: none"> ▶ Page 300 ▶ Page 301 ▶ Page 303 	

Specification Information			
Style Number	Dimensions		U.S. Base Price
	H	W	
GP GSDF FHSS	96"	40"	\$960

Glass Selections Full-Height Polished Edge Slider Hanger—Lite Scale Glazing

Glass Selections Full-Height Polished Edge Slider Hanger—Lite Scale Glazing

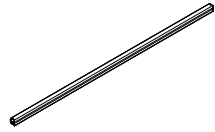

Tip: Hangers are shipped in 24" lengths and cut to length by the installer. One hanger will accommodate ten doors.

Standard Includes		Required to Specify
<ul style="list-style-type: none"> ▶ Need help? Product details, page 88 	<ul style="list-style-type: none"> • 24" hanger for slider track: paint 	<ul style="list-style-type: none"> 1 Style number 2 Paint color number for hanger 3 Options, if selected (see below) ▶ See <i>Surface Materials</i>, page 408.

Options	U.S. Price	Required to Specify
Surface Materials <ul style="list-style-type: none"> • Trim • Paint price group 1 • Paint price group 2 • Paint price group 3 • Anodized aluminum 	<ul style="list-style-type: none"> No cost +\$15 +\$23 No cost 	<ul style="list-style-type: none"> Specify paint color number. Specify paint color number. Specify paint color number. Specify <i>with anodized aluminum</i>.

Related Products <ul style="list-style-type: none"> • Full-height polished edge slider door leaves—lite scale glazing • Full-height polished edge slider track—lite scale glazing • Full-height polished edge slider frame—lite scale glazing 	<ul style="list-style-type: none"> ▶ Page 300 ▶ Page 301 ▶ Page 302
---	--

Specification Information	
Style Number	U.S. Base Price
GPGSDTH	\$39

 **For Canadian Pricing**
 Multiply U.S. Price by the Canadian price factor.
 ▶ See page 1 for details.

Privacy Wall



Understanding Thread



Statement of Line **306**

Product Details
Thread **308**

Thread

Statement of Line

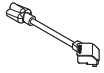
Thread



Three-Prong Plug Adapter

Understanding
▶ Page 308
Specifying
▶ Page 314

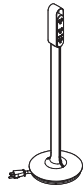

Power Hub

Understanding
▶ Page 308
Specifying
▶ Page 315

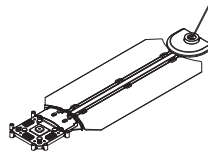

Power Track Wall Infeed with Ramps

Understanding
▶ Page 308
Specifying
▶ Page 316

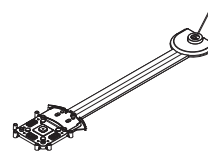

Power Track Wall Infeed with Infills

Understanding
▶ Page 308
Specifying
▶ Page 317

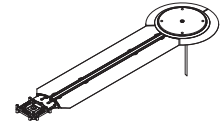

Power Track Floor Infeed with Ramps

Understanding
▶ Page 308
Specifying
▶ Page 318

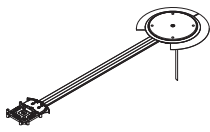

Power Track Floor Infeed with Infills

Understanding
▶ Page 308
Specifying
▶ Page 319

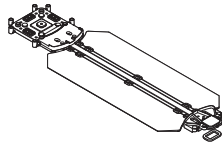

Power Track with Ramps

Understanding
▶ Page 308
Specifying
▶ Page 320

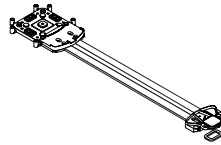

Power Track with Infills

Understanding
▶ Page 308
Specifying
▶ Page 321



Connector

Understanding
▶ Page 308
Specifying
▶ Page 322

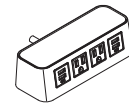

Power Strip

Specifying
▶ Page 323

Thread

Power Track and Power Track Infeeds

Power hub

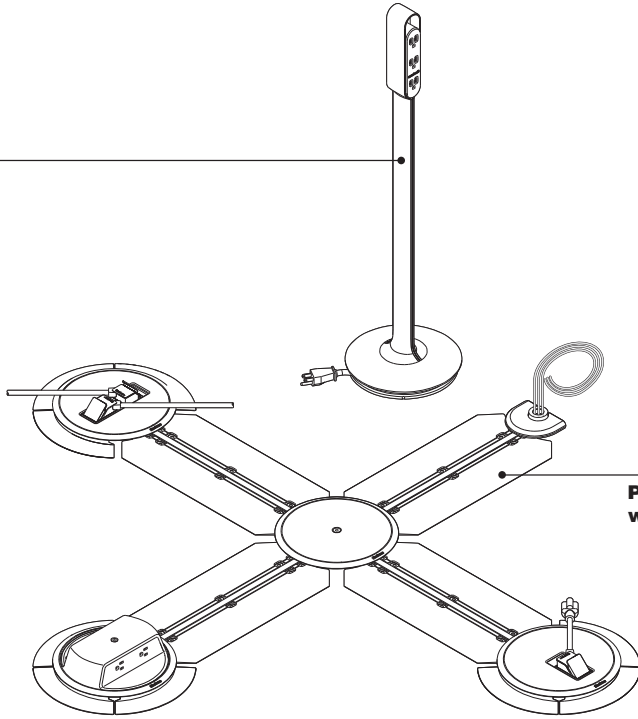

Power track infeed with ramps and wall

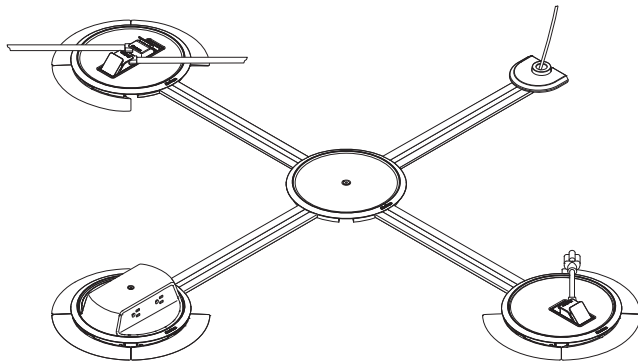

Product Details

Power track infeeds provide the option of connecting the Thread system to the building power, either through the wall or through the floor. Infeed lengths are available from 24" to 144" in 12" increments.

Power track lengths are available from 24" to 144" in 12" increments. They connect to an infeed to distribute power. Power tracks can be ordered with ramps or with infills.

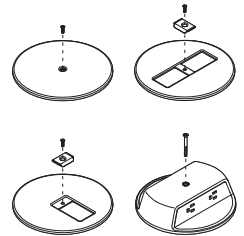

Connectors, four varieties: Blank low-profile (No power access), one-door low-profile (provides one access point utilizing Steelcase's proprietary low-profile plug), two-door low-profile (provides two access points utilizing Steelcase's proprietary low-profile plug), and the NEMA monument, which provides four standard three-prong plug (NEMA 5-15) receptacles.

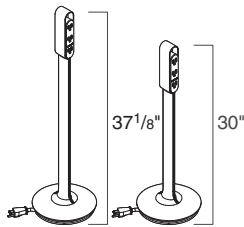

Power hub is available in lounge height and desk height and with a standard three-prong plug or Steelcase's proprietary low-profile plug. The hub provides a user interface for power that is off the floor and capable of moving around the space. It features an integrated cord wrap in the design of the base.

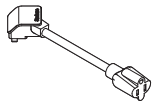

Low-profile plug adapter is an 8 3/4" long adapter that allows a single three-prong plug to connect to Steelcase's proprietary low-profile connectors.

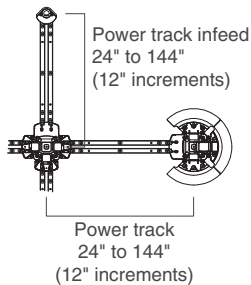

Thread power track and power track infeeds are prefabricated modular tracks capable of distributing up to 20 amps of power and come in lengths of 24" to 144" in 12" increments. These tracks must be fastened to subfloor, but can be reconfigured or removed without leaving substantial damage to the subfloor like more permanent solutions do.

► Please refer to page 310 for more information on applications and reconfiguration.

Proprietary low-profile plug can only be used with the Thread system and will not interface with existing receptacles. In order to achieve ADA compliance for connectors in an egress location, we developed our own plug design.

Note: Always consult your local inspector prior to purchasing the Thread system to ensure all local codes and ordinances are satisfied since local regulations may supersede those spelled out in the National Electric Code.

Connections

12 gauge insulated wires



The power track and power track infeeds utilize three standard 12 gauge insulated wires encased in a riveted metal housing that stands 3/16" off the subfloor.

The infeed track comes with 12' of extra wiring to easily connect to the building power through a new or existing junction box. If longer infeed wiring is necessary, it may be submitted to specials.

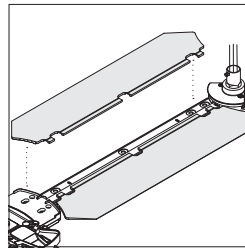

Each power track and infeed track comes with either two flexible ramps or two infills. The ramps ease the transition between the subfloor and the height of the track. These ramps simply rest on top of the track and do not need to be adhered or fastened. The infills rest within the track to create a smooth surface for the floor covering to be applied over. When ordering a power track and/or infeed track, you can specify the track and ramps or the track and infills, depending on your installation method determined by your flooring selection.

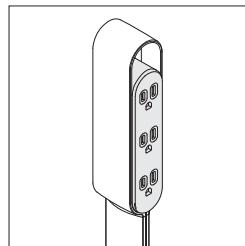

The Thread power hub provides six standard three-prong (NEMA 5-15) receptacles to provide power access where users need it. (indoor dry locations only).

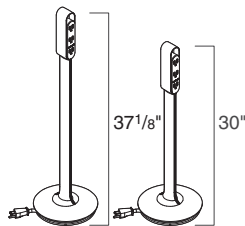

The power hub is available in two heights, lounge height and desk height. The lounge height hub is 30" tall overall with the user interface starting at 22". The desk height hub is 37 1/8" tall overall with the user interface starting at 28".

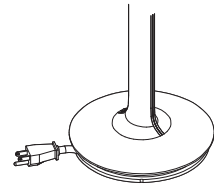

Standard three-prong plug

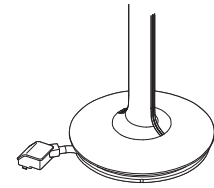

Low-profile plug

The cord is 5' long and is available with either a standard three-prong plug for use with standard receptacles or with Steelcase's proprietary low-profile plug for use with one-door and two-door low-profile connectors.

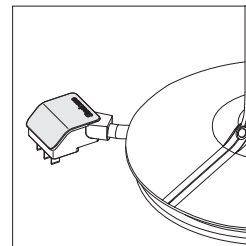

The metal connector cover on the low-profile connectors is a stamped, painted steel plate. This connector cover is ADA compliant for egress locations.

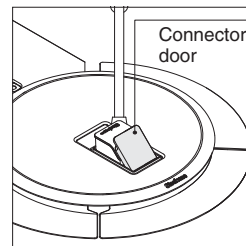

The low-profile connector doors are made of cast zinc. They are spring loaded and gasketed to ensure compliance with small liquid spill requirements. The system is not fully waterproof and is only acceptable for use indoors in dry locations.

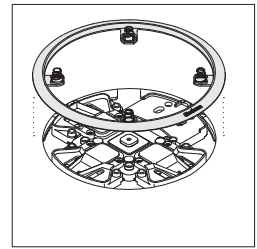

The plastic trim ring is spring loaded to provide a tight fit against the carpet. It provides a simple ramp transition to the 1/2" maximum height of the connector cover and hides any imperfections in the access hole cut in the carpet.

NEMA connector is designed to accept most standard NEMA three-prong plug and cord orientations. If cord exits in a non-standard fashion, please check for fit before ordering. A low-profile connector and adapter should be utilized for non-standard configurations.

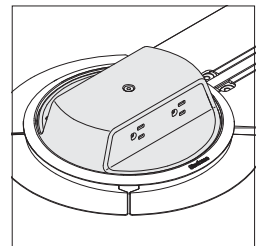

The NEMA monument is made of a two piece plastic housing that provides access to four standard three-prong receptacles. This connector is not ADA compliant for egress locations.

When planning a power network, you must calculate the amperage requirements of all your electrical components so you can provide sufficient electricity to power them.

Thread, Power Track and Power Track Infeeds, continued

Technical Electrical Information and Power Planning

The Thread system is listed as a 20 amp branch circuit. It utilizes three standard 12 gauge wires (hot, neutral, and ground). When more than one circuit is required to support a space or application, additional circuits will need to be provided using Thread power track infeeds connected to other circuits in the building. The number of circuits available to pull from will be determined by building construction. Please consult your electrician if you are unsure of the building power capabilities.

The Thread power track infeed begins with a universal connector that is capable of connecting to any standard 1/2" conduit or other listed product such as Wiremold or Conduit. The building electrical supply connection must be performed by a licensed electrician. Please consult with your electrician if you have questions regarding what type of conduit will be used.

UL limits the number of outlets on a single circuit to 10, but our connectors count differently than typical wall mounted receptacles.

- Blank covers do not count towards the number of receptacles because no access points are present.
- One-door and two-door low-profile connectors each count as a single receptacle.
- NEMA monument counts as two receptacles.
- Hub counts as zero receptacles.

Due to voltage drop, the National Electric Code (NEC) recommends that the distance between the building circuit box and the user access point not exceed 75–150 feet (depending on gauge of wires running from the building circuit box to the Thread infeed junction). Since the distance from the Thread infeed junction to the building circuit box may be difficult to ascertain, we recommend planning conservatively for the total distance of any individual Thread branch and keep it as short as possible. Thread branches longer than 70 feet may risk contributing to voltage drop exceeding acceptable levels.

Listing categories: Thread power track is listed as a multi-outlet assembly and is considered a 20 amp branch circuit, which means it meets the same requirements as the hard wire outlets in the wall. The power hub is listed as a relocatable power tap (RPT, which means it is treated the same as a typical power strip). The plug adapter is listed as an accessory to the Thread system.

UL 5 is the standard for multi-outlet assembly (which correlates to article 380 in the National Electric Code) and UL1363 is the standard for RPT, but has no direct correlation in the NEC.

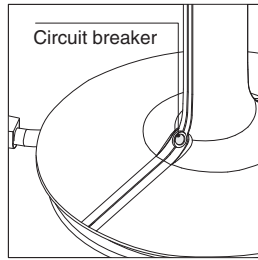

The power hub has a circuit breaker in the base that is intended to trip should excessive power draw occur. If the total draw from all receptacles on a hub exceed 15 amps, the breaker will trip and a black button will pop out of the base where it meets the stalk. Pressing the black button back in will reset the circuit.

It is important to plan for expected power consumption in a given application to ensure enough infeeds are present to prevent tripping the circuit breaker either at a hub or at the building circuit box.

Building construction varies and there may be components hidden below the floor surface that must be avoided when drilling holes to anchor the power track infeed and power track. Sub-flooring, including concrete, may contain electrical wiring, structural cabling, radiant heating lines, etc. To avoid potential property damage or unsafe conditions, consult with the building architect or Engineer of Record to plan accordingly.

The building electrical supply connection must be performed by a licensed electrician. Only connect this system to a dedicated 120-127 V~ 60Hz 20A single phase GFCI protected building power circuit.

Codes Information

Thread is UL certified as a multi-outlet assembly and not a manufactured wiring assembly. Manufactured wiring systems are defined in Article 604 of the NEC and provide very clear guidelines regarding construction methods. Thread is constructed in a manner not consistent with any defined method in this section of the NEC and because of this, cannot be considered a manufactured wiring system. It is consistent with the definition for multi-outlet assemblies as defined in Article 380.

The system is capable of distributing 20 amps of power. Power planning to 80% consumption means the system is not designed to deliver more than 16 amps total. Thread was not designed as a dedicated single outlet (it is a modular, multi outlet assembly), which would then not allow us to utilize a 20 amp receptacle. Thread is compatible with 5-15 plug types, not 5-20 plug types.

The NEC does not permit plugging an extension cord or relocatable power tap (RPT) into another extension cord or RPT. Many of the power units embedded in furniture are listed as a RPT and, per the NEC, are required to be plugged into a building hardwired receptacle. The Thread cord adapter is a listed multi outlet accessory and as such, is not considered an RPT, extension cord or a building receptacle. We recommend the NEMA monument for any Thread application where furniture-hosted power will be plugged in but some may desire to use the low-profile connector with an adapter for this application. Please note that while it is not a safety hazard, a local inspector may not approve because of the definitions and restrictions mentioned above.

Thread is listed as a multi outlet assembly in accordance with Article 380 of the NEC; it is not a flat conductor cable system (FCC) as identified in Article 324. FCC is not permitted in education, healthcare, or residential facilities.

The intent of this requirement within the code is that outlets are not to be covered by carpet. The traditional multi outlet assembly design was covered with receptacles across the entire face and field wired. With that type of design, it is easy to understand it applies to the entire product. Thread is a new design, yet certified as a multi outlet assembly. The raceway is factory wired and able to be covered with carpet, but the connector/receptacle still cannot.

Applications

Floor Specifications

The Thread power distribution system is intended for indoor use/dry locations only. Each connector in the system will require a hole to be cut in the flooring to permit access to the system. This is true for every connection point, even if only using a blank cover where no power access is needed. For this reason, we strongly recommend carpet tile when carpet is used. See installation guide for tools and direction.

Flooring surface compatibility is dependent on which track solution is used. Track with ramps is designed for carpet only. Carpet tile is preferred over broadloom. Carpet thickness must be between 0.225" and 0.450". Track with infill is used for carpet and resilient tiled surfaces with conforming properties (most types of LVT meet these standards). Rely on the flooring provider to determine if the surface meets the needs of the system (ability to screw down the connectors without the surface breaking). Flooring thickness must be between 0.100" to 0.250" for both carpet and LVT.

Infill system requires a field-supplied 5 mm plywood underlayment.

Each piece of Thread power track or power track infeed must be fastened to the subfloor using one screw at each end of the track and one additional screw every 48". This means for power tracks that are shorter than 48" only two screws are required. For tracks 60" to 96" in length, three screws are required and for tracks longer than 96", four screws are required. Connectors require additional screws in to the subfloor. The track itself has multiple holes to allow it to be screwed down and has many more holes than are needed. For example, at the end of each track you will find four holes placed closely together but only one screw needs to be used. The extra holes are available in case of a damaged screw or some form of interference in the subfloor (like a rock in concrete) that might prevent a hole from being used. The same is true for holes all the rest of the way down the track; there are holes on both sides of the track and they are placed approximately every 12" to provide multiple options in case of interference in the subfloor. Please see installation guide for detailed instructions regarding this topic, including recommended types of fasteners and locating pilot holes.

A wall power infeed may be installed perpendicular to a wall or at any angle between 45° and 135°. However, it should be noted that once the infeed track is installed, all subsequent track connections will be either inline or at right angles to this track. There is no ability to create an angled connection between two tracks. Please refer to the installation guide for detailed instructions and drawings.

The Thread system does have some flexibility to accommodate uneven floors, however flooring elevation changes greater than 1/8" must be filled in or sanded down to even out the surface. The area underneath and immediately surrounding a junction (connector of any type, including a blank) must be flat within 1/16" in a 9" radius from the center of the junction. The Thread system is not designed for use on raised floors, across building expansion joints, or in areas where it will be subject to constant or rolling loads heavier than people. Please refer to the installation guide for additional details.

For connectors that will be in an ADA defined egress location, in order for the low-profile connector to be considered ADA compliant, the floor thickness stated above must be followed. Thinner surfaces can be used but will leave gaps and will not be ADA compliant. Thicker surfaces than stated are incompatible.

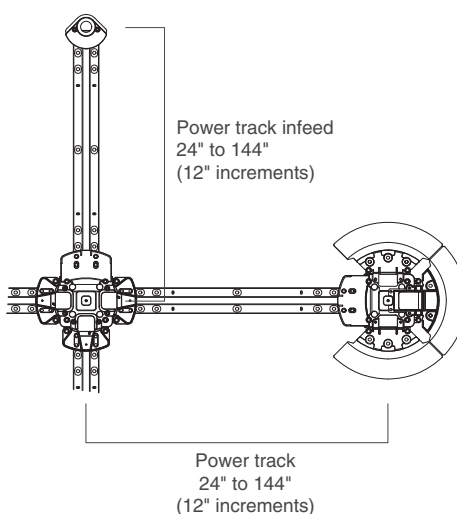

The length of a track is measured from the center of one connector to the center of another connector; a 24" power track by itself may not be precisely 24". This is intended to simplify planning and layouts. *Note: While this system has been developed to minimize its impact on the physical environment and to work with a broad range of existing furniture, certain conditions exist that may create undesirable interactions with other products. One example is the use of sled-base chairs since it may not sit flat when interacting with the track or connectors. Chairs utilizing pneumatic cylinders with minimum clearance of less than 1/2" should be used with care as the bottom of the cylinder can catch on a connector cover or on the slightly raised profile of the track beneath the carpet. Steelcase always strives to exceed the 1/2" clearance on our seating products but if you identify a seating product that does not have this level of clearance, a spacer ring is available from our service parts that can be placed between the cylinder and the base to increase the clearance. Please see part number 895446201SR in the Service Parts catalog, or part number 895446201MP for a quantity of 10 spacers.*

Notice Regarding Installation: Thread must be anchored to the building floor for safe and proper use. Building construction varies and there may be components hidden below the floor surface that must be avoided when drilling holes to anchor the power track infeed and power track. Sub-flooring, including concrete, may contain electrical wiring, structural cabling, radiant heating lines, etc. To avoid potential property damage or unsafe conditions, consult with the building's architect or Engineer of Record to plan accordingly.



Specifying Thread

Specifying

Thread Plug Adapter	314
Thread Power Hub	315
Thread Power Track Wall Infeed with Ramps	316
Thread Power Track Wall Infeed with Infills	317
Thread Power Track Floor Infeed with Ramps	318
Thread Power Track Floor Infeed with Infills	319
Thread Power Track with Ramps	320
Thread Power Track with Infills	321
Thread Connector	322
Thread Power Strip	323

Thread Plug Adapter

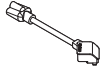

Standard Includes	Required to Specify
-------------------	---------------------

- | | |
|--|--|
| ▶ Need help?
Product details,
page 308 | <ul style="list-style-type: none"> • Plug adapter • Low-profile plug end: 6053 Seagull plastic |
| | Style number |

Related Products

- | | |
|----------------------|------------|
| • Power hub | ▶ Page 315 |
| • Power track | ▶ Page 320 |
| • Power track infeed | ▶ Page 316 |

Specification Information

• Dimensions			• Style	• U.S.
D	W	H	Number	Price
8¾"	2"	1½"	PFLADPTR	\$56



For Canadian Pricing
 Multiply U.S. Price by the
 Canadian price factor.
 ▶ See page 1 for details.

Thread Power Hub



Tip: Plugtop cap finish is 6053 Seagull. Hub receptacle faceplates are 7360 Merle.

Tip: Power cord is 5' in length.

Tip: 30" high power hub's lowest user interface is 22" off the floor. 37 1/8" high power hub's lowest user interface is 28" off the floor.

Tip: Neck is 1 3/4" wide and 1/2" deep.

Tip: Head is 2" wide and 1 1/2" deep.

Standard Includes		Required to Specify
▶ Need help? Product details, page 308	<ul style="list-style-type: none"> Power hub: 7360 Merle paint Six NEMA outlets (three on each side) Integrated cord wrap Reset button Weighted base Power cord with low-profile plug or NEMA plug 	1 Style number 2 Options, if selected (see below)

Options	U.S. Price	Required to Specify
Surface Materials <ul style="list-style-type: none"> 7360 Merle 4799 Platinum Metallic 4140 Arctic White Gloss 	No cost +\$10 +\$10	Specify with 7360 Merle. Specify with 4799 Platinum Metallic. Specify with 4140 Arctic White Gloss.
Height Options <ul style="list-style-type: none"> 30" lounge height 37 1/8" desk height 	No cost +\$ 6	Specify with lounge height. Specify with desk height.
Plug Configuration Options <ul style="list-style-type: none"> Low-profile plug Standard NEMA three-prong plug 	No cost -\$29	Specify with low profile plug. Specify with standard NEMA three-prong plug.
Related Products <ul style="list-style-type: none"> Power track Power track infeed Plug adapter Connector 		▶ Page 320 ▶ Page 316 ▶ Page 314 ▶ Page 322

Specification Information		
Dimensions	Style	U.S.
Diameter	Number	Base Price
8"	PFLHUB	\$468
:	:	:

Thread

 **For Canadian Pricing**
 Multiply U.S. Price by the Canadian price factor.
 ▶ See page 1 for details.

Thread Power Track Wall Infeed with Ramps

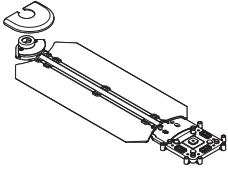

Tip: Length of power track infeed is measured from center of building infeed to center of connector.

Tip: Conduit and conduit collar are not included.

Standard Includes		Required to Specify
<ul style="list-style-type: none"> ▶ Need help? Product details, page 308 	<ul style="list-style-type: none"> • Power track infeed • Power track ramps • Infeed cover: 12' of insulated color-coded wires for hard-wire connection to building power source 	<ul style="list-style-type: none"> 1 Style number 2 Options, if selected (see below)

Options	U.S. Price	Required to Specify
Surface Materials Trim ring finish <ul style="list-style-type: none"> • 7360 Merle • 7190 Platinum 	<ul style="list-style-type: none"> No cost No cost 	<ul style="list-style-type: none"> Specify with 7360 Merle. Specify with 7190 Platinum.
Lengths <ul style="list-style-type: none"> • 24" • 36" • 48" • 60" • 72" • 84" • 96" • 108" • 120" • 132" • 144" 	<ul style="list-style-type: none"> No cost +\$ 32 +\$ 63 +\$ 95 +\$127 +\$158 +\$189 +\$221 +\$253 +\$284 +\$316 	<ul style="list-style-type: none"> Specify with 24". Specify with 36". Specify with 48". Specify with 60". Specify with 72". Specify with 84". Specify with 96". Specify with 108". Specify with 120". Specify with 132". Specify with 144".

Related Products <ul style="list-style-type: none"> • Power track • Power hub • Plug adapter • Connector 	<ul style="list-style-type: none"> ▶ Page 320 ▶ Page 315 ▶ Page 314 ▶ Page 322
---	--

Specification Information			
Dimensions		Style	U.S.
W	H	Number	Base Price
8"	1"	PFLTRKINF	\$260
.	.	.	.



For Canadian Pricing
 Multiply U.S. Price by the Canadian price factor.
 ▶ See page 1 for details.

Thread Power Track Infeed Wall with Infills

Thread Power Track Wall
Infeed with Infills

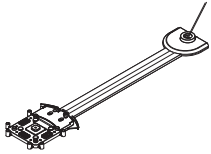

Tip: Length of power track infeed is measured from center of building infeed to center of connector.

Tip: Conduit and conduit collar are not included.

Standard Includes		Required to Specify
<ul style="list-style-type: none"> ▶ Need help? Product details, page 308 	<ul style="list-style-type: none"> • Power track infeed • Power track infills • Infeed cover: 12' of insulated color-coded wires for hard-wire connection to building power source 	<ul style="list-style-type: none"> 1 Style number 2 Options, if selected (see below)

Options	U.S. Price	Required to Specify
Surface Materials Trim ring finish <ul style="list-style-type: none"> • 7360 Merle • 7190 Platinum 	<ul style="list-style-type: none"> No cost No cost 	<ul style="list-style-type: none"> Specify with 7360 Merle. Specify with 7190 Platinum.
Lengths <ul style="list-style-type: none"> • 24" • 36" • 48" • 60" • 72" • 84" • 96" • 108" • 120" • 132" • 144" 	<ul style="list-style-type: none"> No cost +\$ 32 +\$ 63 +\$ 95 +\$127 +\$158 +\$189 +\$221 +\$253 +\$284 +\$316 	<ul style="list-style-type: none"> Specify with 24". Specify with 36". Specify with 48". Specify with 60". Specify with 72". Specify with 84". Specify with 96". Specify with 108". Specify with 120". Specify with 132". Specify with 144".

Related Products <ul style="list-style-type: none"> • Power track • Power hub • Plug adapter • Connector 	<ul style="list-style-type: none"> ▶ Page 320 ▶ Page 315 ▶ Page 314 ▶ Page 322
---	--

Specification Information			
Dimensions		Style Number	U.S. Base Price
W	H		
8"	1"	PFLTRKINFV	\$260
:	:	:	:

Thread

 **For Canadian Pricing**
 Multiply U.S. Price by the Canadian price factor.
 ▶ See page 1 for details.

Thread Power Track Floor Infeed with Ramps

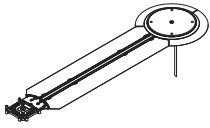

Tip: PerfectMatch is a service that allows you to create your own paint color. Refer to the Surface Materials Reference Manual for more information about this program.

Tip: Length of power track infeed is measured from center of building infeed to center of connector.

Standard Includes		Required to Specify
<ul style="list-style-type: none"> ▶ Need help? Product details, page 308 	<ul style="list-style-type: none"> • Power track infeed • Power track ramps • Black connector cover: 12' of insulated color-coded wires for hardwire connection to building power source 	<ul style="list-style-type: none"> 1 Style number 2 Options, if selected (see below)

Options	U.S. Price	Required to Specify
Surface Materials <ul style="list-style-type: none"> • Trim ring finish • 7360 Merle • 7190 Platinum • Stainless steel • PerfectMatch paint 	<ul style="list-style-type: none"> No cost No cost +\$106 +\$109 	<ul style="list-style-type: none"> Specify with 7360 Merle. Specify with 7190 Platinum. Specify with stainless steel. Specify with 4990 PerfectMatch.
Lengths <ul style="list-style-type: none"> • 24" • 36" • 48" • 60" • 72" • 84" • 96" • 108" • 120" • 132" • 144" 	<ul style="list-style-type: none"> No cost +\$ 32 +\$ 63 +\$ 95 +\$127 +\$158 +\$189 +\$221 +\$253 +\$284 +\$316 	<ul style="list-style-type: none"> Specify with 24". Specify with 36". Specify with 48". Specify with 60". Specify with 72". Specify with 84". Specify with 96". Specify with 108". Specify with 120". Specify with 132". Specify with 144".

Related Products <ul style="list-style-type: none"> • Power track • Power hub • Plug adapter • Connector 	<ul style="list-style-type: none"> ▶ Page 320 ▶ Page 315 ▶ Page 314 ▶ Page 322
---	--

Specification Information		
Dimensions	Style Number	U.S. Base Price
W H		
8" 1"	PFLINFFL	\$429



For Canadian Pricing
 Multiply U.S. Price by the Canadian price factor.
 ▶ See page 1 for details.

Thread Power Track Floor Infeed with Infills

Thread Power Track Floor
Infeed with Infills

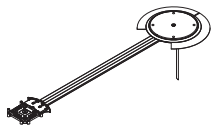

Tip: PerfectMatch is a service that allows you to create your own paint color. Refer to the Surface Materials Reference Manual for more information about this program.

Tip: Length of power track infeed is measured from center of building infeed to center of connector.

Standard Includes		Required to Specify
<ul style="list-style-type: none"> ▶ Need help? Product details, page 308 	<ul style="list-style-type: none"> • Power track infeed • Power track infills • Black connector cover: 12' of insulated color-coded wires for hardwire connection to building power source 	<ul style="list-style-type: none"> 1 Style number 2 Options, if selected (see below)

Options	U.S. Price	Required to Specify
Surface Materials <ul style="list-style-type: none"> • Trim ring finish • 7360 Merle • 7190 Platinum • Stainless steel • PerfectMatch paint 	<ul style="list-style-type: none"> No cost No cost +\$106 +\$109 	<ul style="list-style-type: none"> Specify with 7360 Merle. Specify with 7190 Platinum. Specify with stainless steel. Specify with 4990 PerfectMatch.
Lengths <ul style="list-style-type: none"> • 24" • 36" • 48" • 60" • 72" • 84" • 96" • 108" • 120" • 132" • 144" 	<ul style="list-style-type: none"> No cost +\$ 32 +\$ 63 +\$ 95 +\$127 +\$158 +\$189 +\$221 +\$253 +\$284 +\$316 	<ul style="list-style-type: none"> Specify with 24". Specify with 36". Specify with 48". Specify with 60". Specify with 72". Specify with 84". Specify with 96". Specify with 108". Specify with 120". Specify with 132". Specify with 144".

Related Products <ul style="list-style-type: none"> • Power track • Power hub • Plug adapter • Connector 	<ul style="list-style-type: none"> ▶ Page 320 ▶ Page 315 ▶ Page 314 ▶ Page 322
---	--

Specification Information

Dimensions		Style Number	U.S. Base Price
W	H		
8"	1"	PFLINFFLV	\$429



For Canadian Pricing
Multiply U.S. Price by the Canadian price factor.
▶ See page 1 for details.

Thread Power Track with Ramps

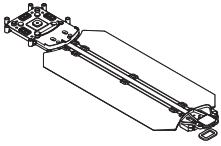

Tip: Length of power track is measured from center of connector to center of another connector.

Standard Includes	Required to Specify
-------------------	---------------------

- | | | |
|--|--|--|
| <ul style="list-style-type: none"> ▶ Need help? Product details, page 308 | <ul style="list-style-type: none"> • Power track • Power track ramps | <ul style="list-style-type: none"> 1 Style number 2 Options, if selected (see below) |
|--|--|--|

Options	U.S. Price	Required to Specify
---------	------------	---------------------

Lengths	<ul style="list-style-type: none"> • 24" • 36" • 48" • 60" • 72" • 84" • 96" • 108" • 120" • 132" • 144" 	<ul style="list-style-type: none"> No cost +\$ 32 +\$ 63 +\$ 95 +\$127 +\$158 +\$189 +\$221 +\$253 +\$284 +\$316 	<ul style="list-style-type: none"> Specify with 24". Specify with 36". Specify with 48". Specify with 60". Specify with 72". Specify with 84". Specify with 96". Specify with 108". Specify with 120". Specify with 132". Specify with 144".
----------------	---	---	---

- | | | |
|-------------------------|--|--|
| Related Products | <ul style="list-style-type: none"> • Power hub • Power track infeed • Plug adapter • Connector | <ul style="list-style-type: none"> ▶ Page 315 ▶ Page 316 ▶ Page 314 ▶ Page 322 |
|-------------------------|--|--|

Specification Information			
Dimensions		Style	U.S.
W	H	Number	Base Price

8"	3/4"	PFLTRK	\$226
:	:	:	:
:	:	:	:



For Canadian Pricing
 Multiply U.S. Price by the Canadian price factor.
 ▶ See page 1 for details.

Thread Power Track with Infills

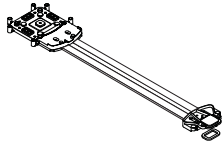

Tip: Length of power track is measured from center of connector to center of another connector.

Standard Includes	Required to Specify
-------------------	---------------------

- | | | |
|--|--|--|
| <ul style="list-style-type: none"> ▶ Need help? Product details, page 308 | <ul style="list-style-type: none"> • Power track • Power track ramps | <ul style="list-style-type: none"> 1 Style number 2 Options, if selected (see below) |
|--|--|--|

Lengths	Options	U.S. Price	Required to Specify
---------	---------	------------	---------------------

<ul style="list-style-type: none"> • 24" • 36" • 48" • 60" • 72" • 84" • 96" • 108" • 120" • 132" • 144" 	<ul style="list-style-type: none"> No cost +\$ 32 +\$ 63 +\$ 95 +\$127 +\$158 +\$189 +\$221 +\$253 +\$284 +\$316 	<ul style="list-style-type: none"> Specify with 24". Specify with 36". Specify with 48". Specify with 60". Specify with 72". Specify with 84". Specify with 96". Specify with 108". Specify with 120". Specify with 132". Specify with 144".
---	---	---

Related Products	Options	Required to Specify
------------------	---------	---------------------

- | | |
|--|--|
| <ul style="list-style-type: none"> • Power hub • Power track infeed • Plug adapter • Connector | <ul style="list-style-type: none"> ▶ Page 315 ▶ Page 316 ▶ Page 314 ▶ Page 322 |
|--|--|

Specification Information			
Dimensions		Style	U.S.
W	H	Number	Base Price

8"	3/4"	PFLTRKV	\$226
----	------	----------------	-------



For Canadian Pricing
Multiply U.S. Price by the Canadian price factor.
▶ See page 1 for details.

Thread Connector



Tip: PerfectMatch is a service that allows you to create your own paint color. Refer to the Surface Materials Reference Manual for more information about this program.

Tip: NEMA monument is plastic molded. Specify with 6527 Merle plastic or 6249 Platinum plastic. Paint, including perfect match paint, is not available.

Tip: The connectors are only available with textured paint. When using perfect match paints, only textured paints will be permitted.

Standard Includes		Required to Specify
▶ Need help? Product details, page 308	<ul style="list-style-type: none"> Connector cover: 7360 Merle paint Connector trim ring: 6527 Merle plastic Fillers: 6000 Black Hardware 	1 Style number 2 Options, if selected (see below)

Options	U.S. Price	Required to Specify
Surface Materials	Cover	
	<ul style="list-style-type: none"> 7360 Merle paint 7190 Platinum Solid paint 6527 Merle plastic 6249 Platinum plastic 4990 PerfectMatch paint Stainless steel 	No cost No cost No cost No cost +\$109 +\$275
	Trim ring	
	<ul style="list-style-type: none"> 6527 Merle plastic 6249 Platinum plastic 	No cost No cost
	NEMA cover and trim ring	
	<ul style="list-style-type: none"> 6527 Merle plastic 6249 Platinum plastic 6249 Platinum plastic 	No cost No cost No cost
Configurations	<ul style="list-style-type: none"> Blank low-profile connector, 9½" diameter x ¾" height One-door low-profile connector, 9½" diameter x ¾" height Two-door low-profile connector, 9½" diameter x ¾" height NEMA monument connector 9½" diameter and 2½" height NEMA monument connector with tamper-resistant receptacles 9½" diameter and 2½" height 	No cost +\$ 29 +\$ 56 +\$ 85 +\$ 97
		Specify with 7360 Merle. Specify with 7190 Platinum Solid. Specify with 6527 Merle. Specify with 6249 Platinum. Specify with 4990 PerfectMatch. Specify with stainless steel. Specify with 6527 Merle. Specify with 6249 Platinum. Specify with 6527 Merle. Specify with 6249 Platinum. Specify with 6527 Merle. Specify with 6249 Platinum. Specify with 6249 Platinum. Specify with blank low profile connector. Specify with one-door low profile connector. Specify with two-door low profile connector. Specify with NEMA monument connector. Specify with NEMA monument connector with tamper-resistant.

Related Products	<ul style="list-style-type: none"> Power track Power track infeed Plug adapter 	▶ Page 320 ▶ Page 316 ▶ Page 314
-------------------------	---	--

Specification Information	
Style Number	U.S. Base Price
PFLCNCTR	\$169

 **For Canadian Pricing**
 Multiply U.S. Price by the Canadian price factor.
 ▶ See page 1 for details.

Thread Power Strip

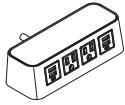

Tip: Thread power strip with clamp-on mount works on worksurfaces that range from 3/4" to 2 1/2" thick.

Standard Includes	Required to Specify
<ul style="list-style-type: none"> Rectangular shaped power and USB strip with Thread low-profile plug, 3 power / 1 USB format Non tamper-resistant receptacles 6' cord Freestanding mount 	<ul style="list-style-type: none"> 1 Style number 2 Options, if selected (see below)

Options	U.S. Price	Required to Specify
Cord Length • 10' cord	+\$26	Specify with 10' cord.
Power Plug • Standard NEMA	-\$29	Specify NEMA plug.
Power • 1 USB / 2 power / 1 USB	+\$48	Specify with 1 USB / 2 power / 1 USB.
Tamper-Resistant • With tamper-resistant	+\$21	Specify with tamper-resistant.
Mount • Clamp-on mount	+\$18	Specify with clamp-on mount.
Related Products	<ul style="list-style-type: none"> Power hub Power track infeed Power track Plug adapter Connector 	<ul style="list-style-type: none"> ▶ Page 315 ▶ Page 316 ▶ Page 320 ▶ Page 314 ▶ Page 322

Specification Information				
• Dimensions			• Style	• Base
D	W	H	Number	Price
7 ⁵ / ₁₆ "	2 ¹ / ₁₆ "	2 ³ / ₄ "	PFLPWRST	\$317

Thread

For Canadian Pricing
 Multiply U.S. Price by the Canadian price factor.
 ▶ See page 1 for details.



Understanding Underscore Floor

	
Statement of Line	326

	
Product Details	
Underscore Floor Power and Communication Overview	327
Underscore Floor	328
Underscore Floor Specification Examples	332

Statement of Line

Underscore Floor

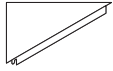

Triangle Tiles

Understanding
▶ Page 329
Specifying
▶ Page 336

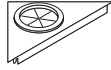

Grommet Triangle Tiles

Understanding
▶ Page 329
Specifying
▶ Page 336

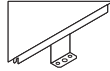

Seismic Triangle Tile

Understanding
▶ Page 329
Specifying
▶ Page 337

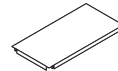

Rectangle Tiles

Understanding
▶ Page 329
Specifying
▶ Page 337

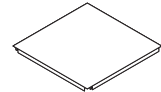

Square Tiles

Understanding
▶ Page 329
Specifying
▶ Page 337

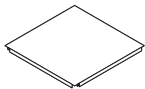

Distribution Tiles

Understanding
▶ Page 329
Specifying
▶ Page 338

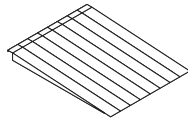

Ramp Kits

Understanding
▶ Page 329
Specifying
▶ Page 340

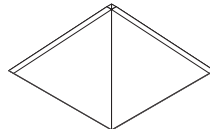

Corner Ramp Kit

Understanding
▶ Page 329
Specifying
▶ Page 341

Underscore Floor Power and Communication Overview

Architectural Power System

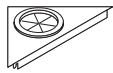
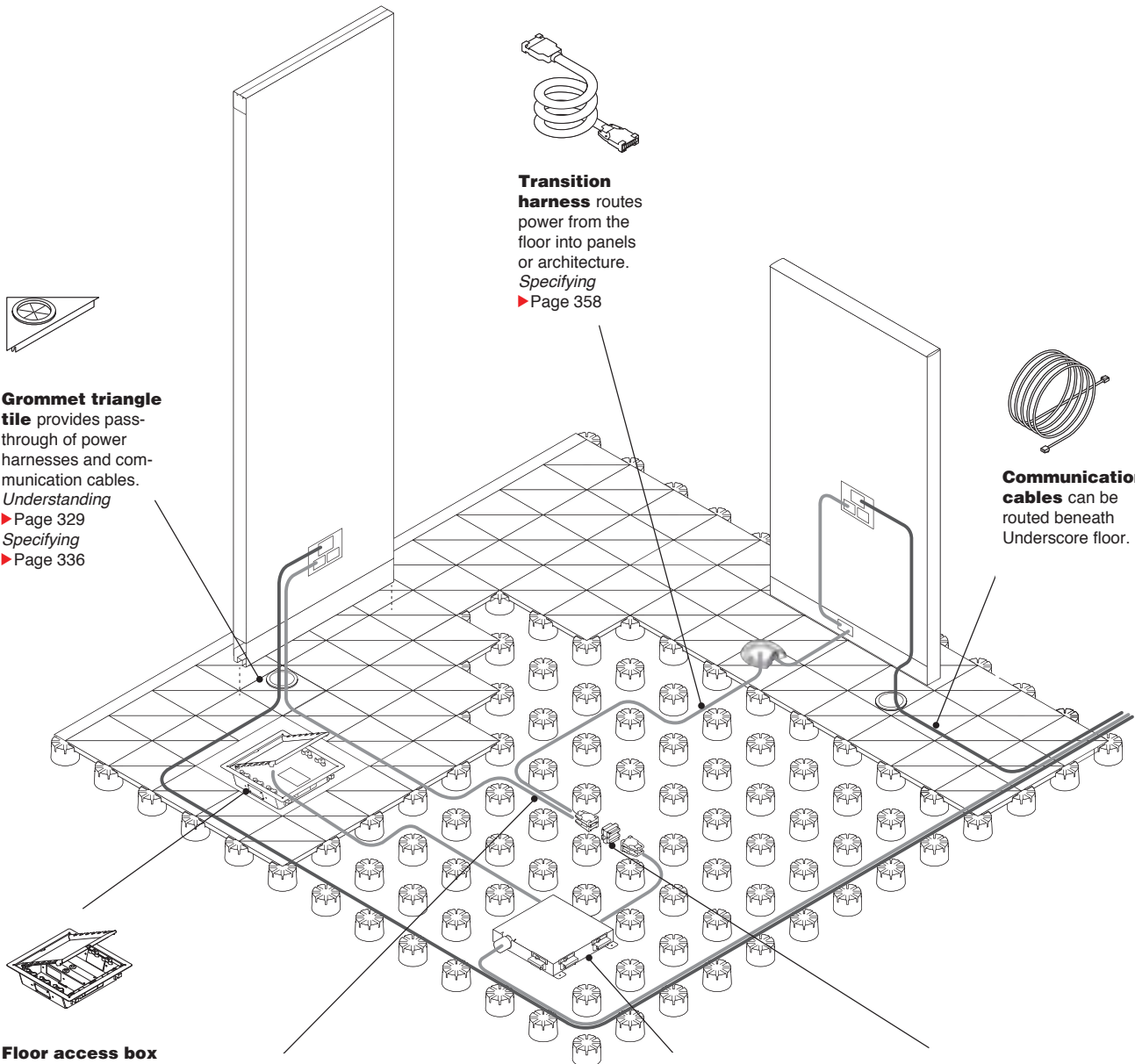

Grommet triangle tile provides pass-through of power harnesses and communication cables.
Understanding
▶ Page 329
Specifying
▶ Page 336

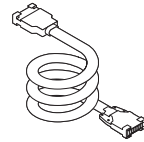

Transition harness routes power from the floor into panels or architecture.
Specifying
▶ Page 358

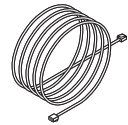

Communication cables can be routed beneath Underscore floor.

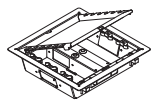

Floor access box provides access to power and communication.
Understanding
▶ Page 349
Specifying
▶ Page 363

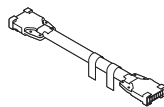

Extension harness routes power to hub products from branching connector.
Specifying
▶ Page 353

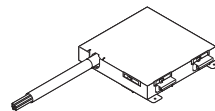

Zone box allows electrical connection to a circuit breaker box.
Understanding
▶ Page 346
Specifying
▶ Page 355

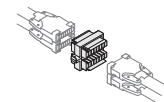

Branching connector supplies power to a maximum of three harnesses.
Understanding
▶ Page 347
Specifying
▶ Page 356

Underscore Floor

Underscore floor is a raised platform of triangular tiles on 2½"H supports. It is designed for routing wiring and cabling to access tile locations determined by the user. It can be reconfigured to support changing utility needs.

► Specifying, page 336

Floor access boxes

provide access to power and communication routed beneath Underscore floor. Modular and hardwire versions are available.

Customer-supplied carpet tiles

cover Underscore floor tiles, trim, and ramps.

Edge trim is cut on site to finish exposed edges. It is available in two depths—2"D and 4"D.

Tiles interlock with supports without screws or adhesives.

Wall scribe trim is cut on site to accommodate field conditions such as building walls or structural columns.

Supports interlock with tiles for a tight fit.

Ramp kits provide a gradual transition from the subfloor to Underscore floor.

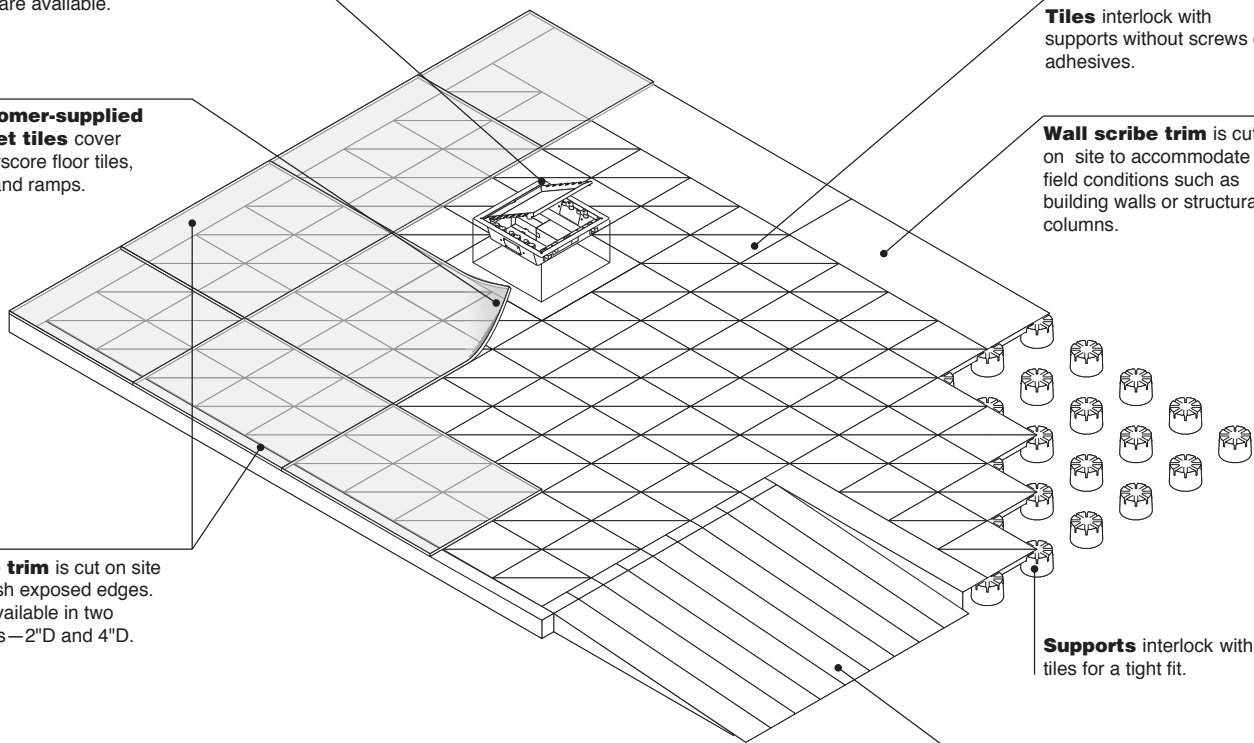

Actual Dimensions

► Page 331

Product Details

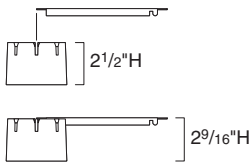

Supports are 2 1/2"H. The overall height when tiles are installed is 2 9/16"H.

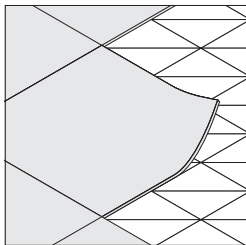

Customer-supplied carpet tiles are used to cover Underscore floor tiles, trim, and ramps. Follow floor covering manufacturer's recommendations concerning floor preparation, adhesive coverage and dry time.

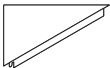

Triangle tile is the primary tile used in an Underscore floor installation. Triangle tiles cannot be used against a wall. Instead use wall scribe trim or edge trim.

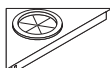

Grommet triangle tile provides pass-through of power harnesses and communication cables.

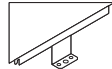

Seismic triangle tile provides lateral bracing of the Underscore floor in areas of seismic activity as required by local building codes. The seismic triangular tile Z bracket can also be used by the electrical contractor to make electrical ground connections of the floor installation to ground. *Tip: Any requirements for ground wiring should be addressed as part of the electrical contractor's work, along with other power connections to the building source.*

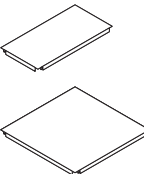

Rectangular and square tiles are cut on site to accommodate field conditions such as structural columns. Extra supports are placed underneath the tiles to support the infill condition. Wall scribe trim can also be used for infill conditions.

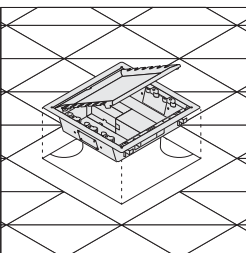

Floor box access tile provides a factory formed opening for the Underscore floor box.

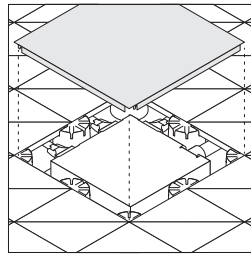

Distribution tile must be positioned over a power distribution module, transition module, zone box, and consolidation point.

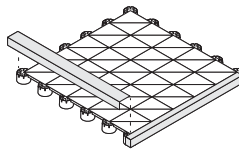

Edge trim is cut on site to finish exposed edges.

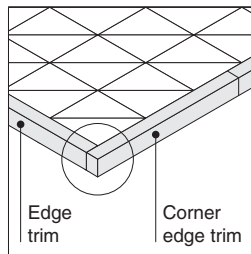

Corner edge trim has closed ends to finish the exposed edge at the end of the run. Both ends are closed so corner edge trim can be used in either left- or right-hand position.

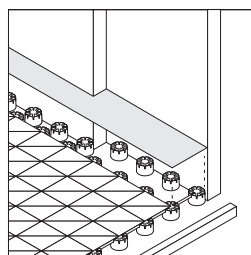

Wall scribe trim is cut on site for a flush, finished edge against a building wall. Wall scribe trim requires extra supports underneath.

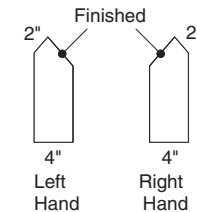
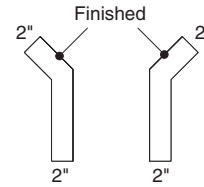

Transition trim finishes angled corners. Sizes are available to accommodate depth changes between ramp edge trim and the trim on the surrounding edges.

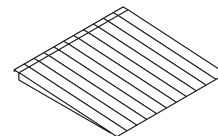

Ramp kit includes ramp tiles that can be inset or out-set. A corner ramp kit is also available.

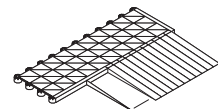

Ramp edge trim finishes the exposed sides of a ramp. Edge trim is included with the ramp kit.

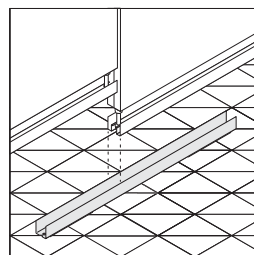

When positioning Privacy Wall on Underscore floor, include universal floor grippers in the wall specification. **▶ Page 20**

Commercial handrails are customer-supplied. Most codes will not require handrails when the Underscore floor height is less than 6 inches above the slab or the length of the ramp is less than 72 inches.

Underscore Floor Performance Data (per CISCA)

Concentrated point load - 32 square inches per triangular tile. 500 lb on 1 square inch.

Deflection 0.057"

Permanent set 0.002"

Recovery > 99%

Ultimate point load - 32 square inches per triangular tile. Edge - 1,291 lb on 1 square inch. Safety factor ultimate to concentrated > 2.5:1. Center - 2,399 lb on 1 square inch. Safety factor ultimate to concentrated > 4.5:1.

Rolling load (net weight per wheel) 500 lb (3" hard phenolic tread wheel at 10 cycles < 0.02" permanent set.) 350 lb (6" soft alathane tread wheel at 10,000 cycles < 0.02 permanent set.)

Supports Axial load 4,200 lb Slow buckling in failure.

System uniform load 320 psf < 0.02" deflection.

Connections

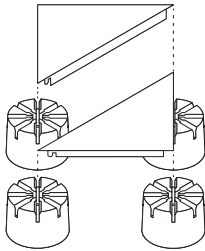

Tiles interlock tightly into grooves on supports. Screws and glue are not needed.

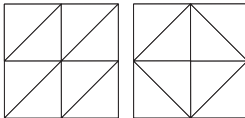

Recommended Not Recommended

Place tiles in the recommended pattern for maximum stability.

8" Outset ramp

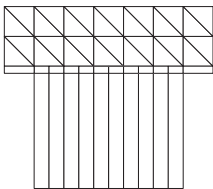

11 1/4" Outset ramp

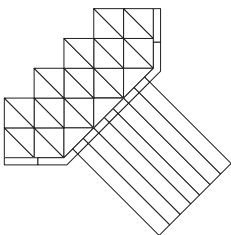

Ramp tiles can be positioned on the 8" side or 11 1/4" side of the triangle tile. Connect as many ramp tiles as needed to create the ramp width needed. Individual ramp sections are manufactured at 8.3% slope (ratio of rise: run of 1:12) and designed to connect into the top of the individual supports when installed.

Wiring & Cabling

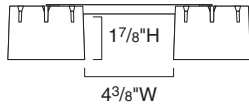

Routing space between supports is 4 3/8"W and 1 7/8"H.

Architectural power components are used to distribute and terminate power in Underscore floor and zone cabling.

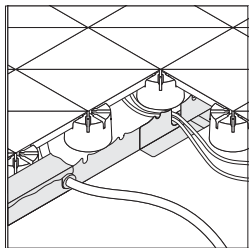

Fire stop creates a draft-tight enclosure and accommodates routing of wiring and cabling. Local codes may require fire stops to be installed every 100 square feet.

Local electrical codes vary. Consult a qualified electrical contractor or engineer for the proper installation of electrical equipment. *Tip: Any requirements for ground wiring should be addressed as part of the electrical contractor's work, along with other power connections to the building source.*

Surface Materials

Tile
• Galvanized steel only

Support
• Black plastic only

Grommet on tile
• 6653 Solar Black plastic only

Access cover
• Galvanized steel only

Edge trim
• Paint

Transition trim
• Paint

Wall scribe trim
• Galvanized steel only

Ramp surface
• Galvanized steel only

Ramp edge
• Paint

Fire stop
• Galvanized steel only

Application Topics

Underscore Floor Specification Examples
▶ Page 332

Underscore Floor Power and Communication Overview
▶ Page 327

Actual Dimensions

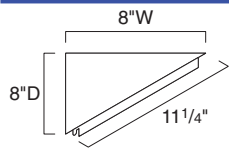

Triangle Tile

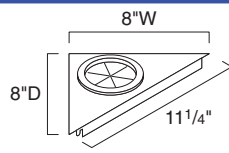

Grommet Triangle Tile

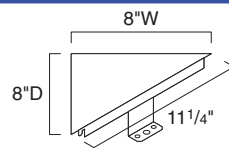

Seismic Triangle Tile

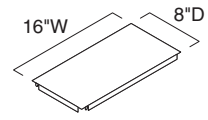

Rectangle Tile

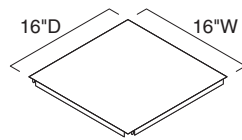

Square Tile

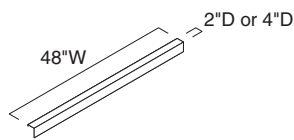

Edge Trim

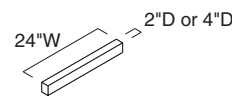

Corner Edge Trim

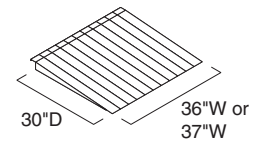

Ramp Kit

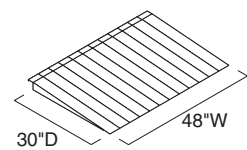

Ramp Kit

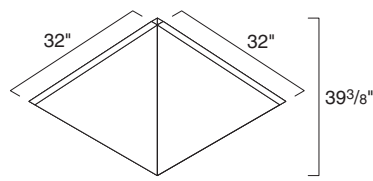

Corner Ramp

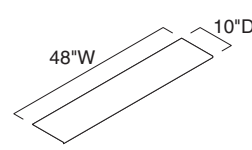

Wall Scribe Trim

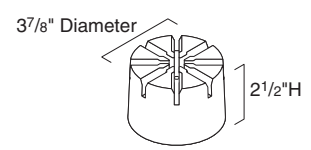

Support

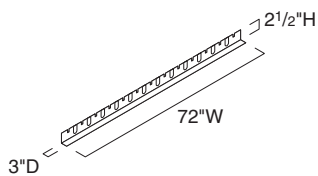

Fire Stop

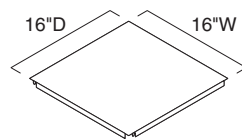

Distribution Tile

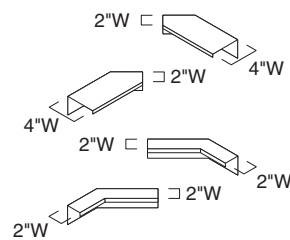

Transition Trim

Underscore Floor Specification Examples

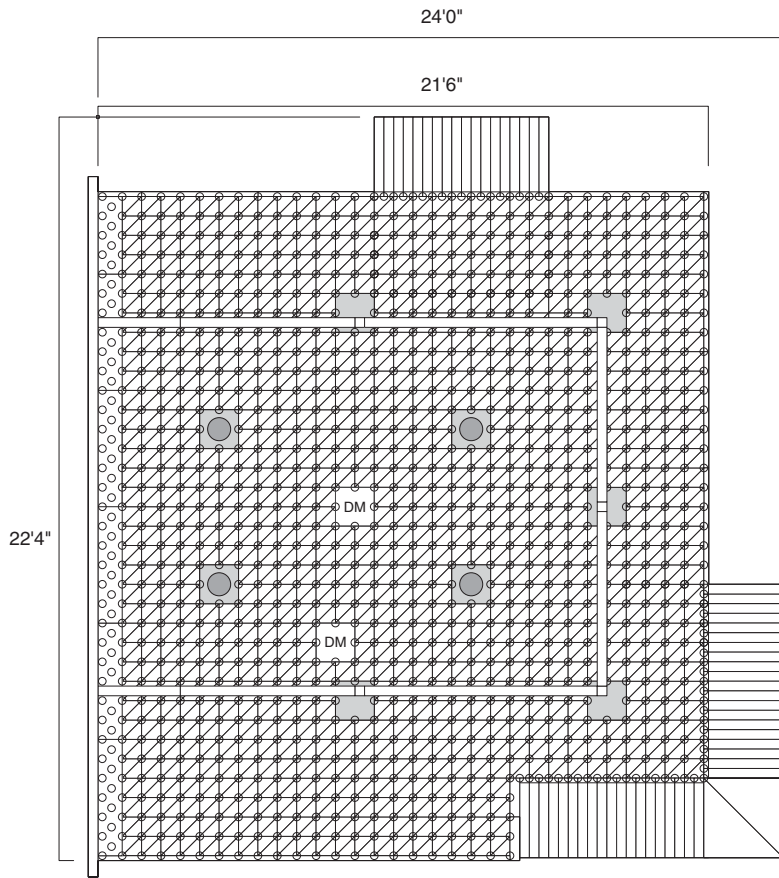

DM Distribution tile that covers a branching connector, zone box, distribution box, or consolidation point

 Floor access box

Quantity	Style Number	Description
5	GUNTR450	Triangle tiles
14	GUNSU100	Supports
1	GUNSQ16161	Square tiles
1	GUNSQ16164	Square tiles
1	GUNCR3232	Corner ramp
2	GUNDS16161	Distribution tiles
3	GUNET248	2" Edge trim
1	GUNET448	4" Edge trim
1	GUNCT224	2" Corner edge trim
1	GUNCT424	4" Corner edge trim
1	GUNWT10486	Wall scribe trim
1	GUNRA36328	Ramp tiles
4	GUNRA48328	Ramp tiles
4	GAPFBD_(X,Y, or Z suffix)	Floor access box
4	GUNFBT1616	Floor box access tile

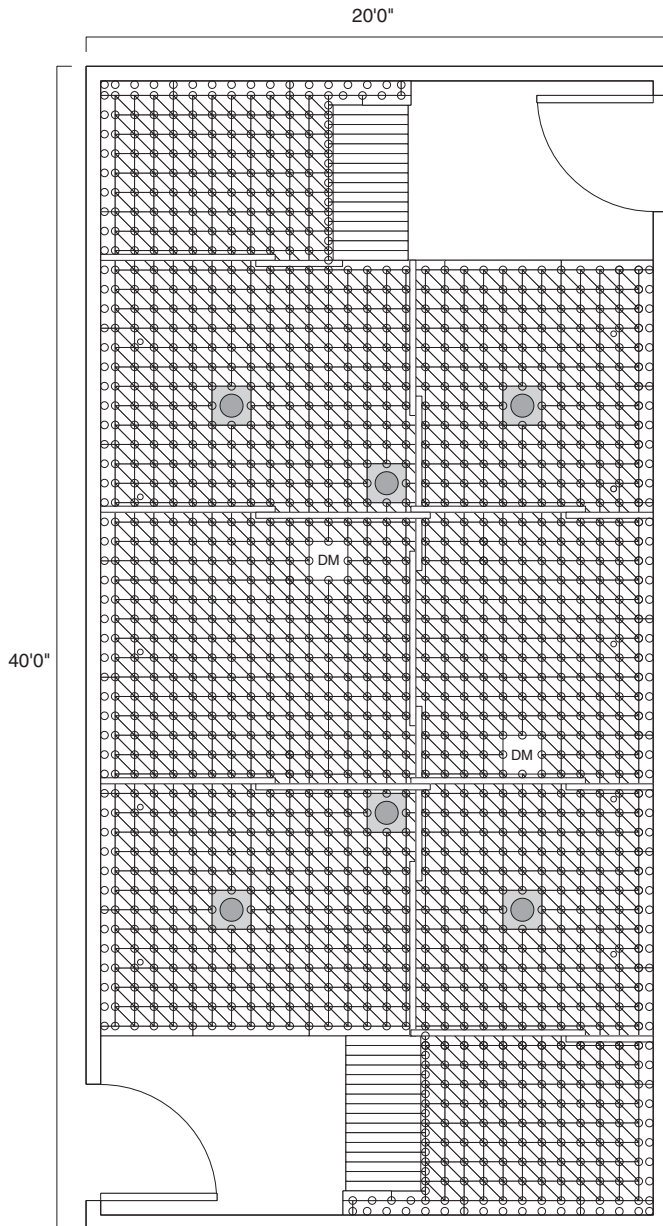

Quantity	Style Number	Description
5	GUNTR450	Triangle tiles
6	GUNTR48	Triangle tiles
17	GUNSU100	Supports
2	GUNDS16161	Distribution tiles
1	GUNET448	4" Edge trim
1	GUNCT424	4" Corner edge trim
4	GUNRA36328	Ramp tiles
4	GUNWT10486	Wall scribe trim
3	GUNFS726	Fire stop
6	GUNFBT1616	Floor box access tile
6	GAPFBD_(X,Y, or Z suffix)	Floor access box

Underscore Floor

DM Distribution tile that covers a branching connector, zone box, distribution box, or consolidation point

 Floor access box



Specifying Underscore Floor

Specifying

Underscore Floor

Triangle Tiles	336
Supports	336
Grommet Triangle Tiles	336
Seismic Triangle Tiles	337
Rectangle Tiles	337
Square Tiles	337
Distribution Tiles	338
Floor Box Access Tile	338
Edge Trim	338
Corner Edge Trim	339
Transition Trim	339
Wall Scribe Trim	340
Ramp Kits	340
Corner Ramp Kit	341
Fire Stop	341

Underscore Floor

Triangle Tiles

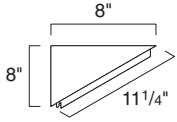

Tip: Packages accommodate the approximate areas shown below:
 48 pkg. = 10 sq. ft. approx.
 450 pkg. = 100 sq. ft. approx.

Tip: The 450-piece package requires a forklift or pallet jack to facilitate transportation to the installation site.

Standard Includes	Required to Specify
<ul style="list-style-type: none"> Need help? Product details, page 329 Tile: galvanized steel only 	Style number

Specification Information				
Dimensions		Quantity in Package	Style Number	U.S. Price
D	W			
8"	8"	48	GUNTR48	\$ 196
8"	8"	450	GUNTR450	\$1786

Supports



Tip: For projects 1000-3000 square feet in size, one package of 100 supports is needed for approximately every 40 square feet. For projects 3000 square feet and up in size, one package of 100 supports is needed for approximately every 42 square feet.

Standard Includes	Required to Specify
<ul style="list-style-type: none"> Need help? Product details, page 328 Supports, package of 100: black plastic only 	Style number

Specification Information			
Height	Diameter	Style Number	U.S. Price
2 1/2"	3 7/8"	GUNSU100	\$191

Grommet Triangle Tiles

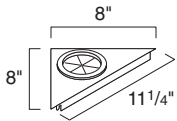

Standard Includes	Required to Specify
<ul style="list-style-type: none"> Need help? Product details, page 329 Tile: galvanized steel only Grommet: 6653 Solar Black plastic only 	Style number

Specification Information				
Dimensions		Quantity in Package	Style Number	U.S. Price
D	W			
8"	8"	2	GUNGR2	\$ 40
8"	8"	10	GUNGR10	\$167



For Canadian Pricing
 Multiply U.S. Price by the Canadian price factor.
 ▶ See page 1 for details.

Seismic Triangle Tiles

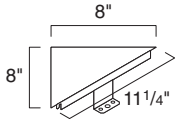

Standard Includes	Required to Specify
<ul style="list-style-type: none"> ▶ Need help? Product details, page 329 • Tile: galvanized steel only • Mounting bracket 	Style number

Specification Information				
Dimensions		Quantity in Package	Style Number	U.S. Price
D	W			
8"	8"	8	GUNST8	\$140
:	:	:	:	:

Rectangle Tiles

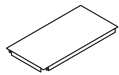

Standard Includes	Required to Specify
<ul style="list-style-type: none"> ▶ Need help? Product details, page 329 • Tile: galvanized steel only 	Style number

Specification Information				
Dimensions		Quantity in Package	Style Number	U.S. Price
D	W			
8"	16"	1	GUNRC8161	\$ 70
8"	16"	4	GUNRC8164	\$230
:	:	:	:	:

Square Tiles

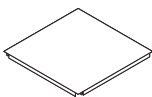

Standard Includes	Required to Specify
<ul style="list-style-type: none"> ▶ Need help? Product details, page 329 • Tile: galvanized steel only 	Style number

Specification Information				
Dimensions		Quantity in Package	Style Number	U.S. Price
D	W			
16"	16"	1	GUNSQ16161	\$ 94
16"	16"	4	GUNSQ16164	\$301
:	:	:	:	:

 **For Canadian Pricing**
 Multiply U.S. Price by the Canadian price factor.
 ▶ See page 1 for details.

Distribution Tiles

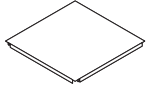

Standard Includes	Required to Specify
<ul style="list-style-type: none"> ▶ Need help? Product details, page 329 • Distribution tile: galvanized steel only 	Style number

Specification Information					
Dimensions			Quantity in Package	Style Number	U.S. Price
D	W	H			
16"	16"	2½"	1	GUNDS16161	\$106
16"	16"	2½"	4	GUNDS16164	\$359

Floor Box Access Tile

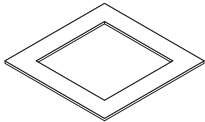

Standard Includes	Required to Specify
<ul style="list-style-type: none"> ▶ Need help? Product details, page 329 • Floor box access tile: galvanized steel only 	Style number

Specification Information				
Dimensions			Style Number	U.S. Price
D	W	H		
16"	16"	2½"	GUNFBT1616	\$119

Edge Trim

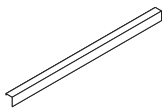

Tip: Edge trim can be cut on site to fit the exact dimensions.

Standard Includes	Required to Specify
<ul style="list-style-type: none"> ▶ Need help? Product details, page 328 • Trim: 0835 Black paint only 	Style number

Specification Information					
Dimensions			Quantity in Package	Style Number	U.S. Price
D	W	H			
2"	48"	2½"	6	GUNET248	\$210
4"	48"	2½"	6	GUNET448	\$259



For Canadian Pricing
 Multiply U.S. Price by the Canadian price factor.
 ▶ See page 1 for details.

Corner Edge Trim

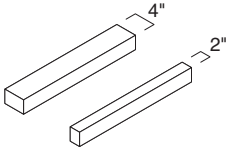

Tip: Corner edge trim can be cut on site to fit the exact dimensions.

Standard Includes		Required to Specify
<ul style="list-style-type: none"> Need help? Product details, page 329 Trim: 0835 Black paint only 		Style number

Specification Information						
Dimensions			Quantity in Package	Style Number	U.S. Price	
D	W	H				
2"	24"	2 1/2"	2	GUNCT224	\$109	
4"	24"	2 1/2"	2	GUNCT424	\$242	

Transition Trim



Standard Includes		Required to Specify
<ul style="list-style-type: none"> Need help? Product details, page 329 Trim: 0835 Black paint only 		Style number

Specification Information						
Dimensions			Orientation	Quantity in Package	Style Number	U.S. Price
D	W	H				
2" to 2"						
2"	8"	2 1/2"	Left hand	1	GUNTT22L	\$100
2"	8"	2 1/2"	Right hand	1	GUNTT22R	\$100

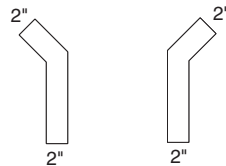

2" to 4"						
4"	8"	2 1/2"	Left hand	1	GUNTT42L	\$106
4"	8"	2 1/2"	Right hand	1	GUNTT42R	\$106

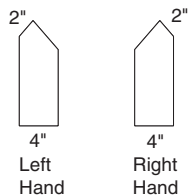

For Canadian Pricing
 Multiply U.S. Price by the Canadian price factor.
 ▶ See page 1 for details.

Wall Scribe Trim

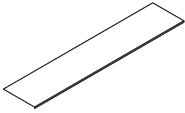

Tip: Wall scribe trim can be cut on site to fit the exact dimensions.

Standard Includes	Required to Specify
<ul style="list-style-type: none"> Need help? Product details, page 329 Wall scribe trim: galvanized steel only 	Style number

Specification Information				
Dimensions		Quantity in Package	Style Number	U.S. Price
D	W			
10"	48"	6	GUNWT10486	\$308

Ramp Kits

Standard Includes	Required to Specify
<ul style="list-style-type: none"> Need help? Product details, page 329 Ramp tiles with 1:12 incline: galvanized steel only Two ramp edge trims: 0835 Black paint only 	Style number

Specification Information					
Dimensions			Quantity in Package	Style Number	U.S. Price
D	W	H			

8 Module to Attach to 8" Side of Triangle Tiles

30"	36"	2½"	1	GUNRA36328	\$693
30"	48"	2½"	1	GUNRA48328	\$886

11 Module to Attach to 11¼" Side of Triangle Tiles

30"	37"	2½"	1	GUNRA363211	\$693
30"	48"	2½"	1	GUNRA483211	\$886

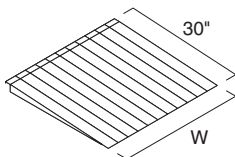
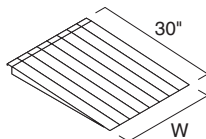

For Canadian Pricing
 Multiply U.S. Price by the Canadian price factor.
 ▶ See page 1 for details.

Corner Ramp Kit

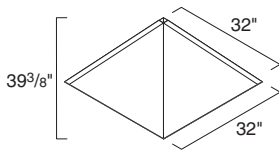

Standard Includes	Required to Specify
<ul style="list-style-type: none"> ▶ Need help? Product details, page 329 • Outside corner ramp kit with 1:12 incline: galvanized steel only • Kit contains two pieces 	<ul style="list-style-type: none"> Style number

Specification Information				
• Dimensions			• Style	• U.S.
D	W	H	Number	Price
32"	32"	2 1/2"	GUNCR3232	\$286
:	:	:	:	:

Fire Stop

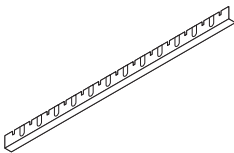

Standard Includes	Required to Specify
<ul style="list-style-type: none"> ▶ Need help? Product details, page 330 • Fire stop barrier: galvanized steel only 	<ul style="list-style-type: none"> Style number

Specification Information					
• Dimensions			• Quantity in	• Style	• U.S.
D	W	H	Package	Number	Price
3"	72"	2 1/2"	6	GUNFS726	\$259
:	:	:	:	:	:

Underscore Floor

 **For Canadian Pricing**
 Multiply U.S. Price by the Canadian price factor.
 ▶ See page 1 for details.



Understanding Modular Power



Statement of Line **344**

Product Details
Modular Power **345**

Statement of Line

Modular Power

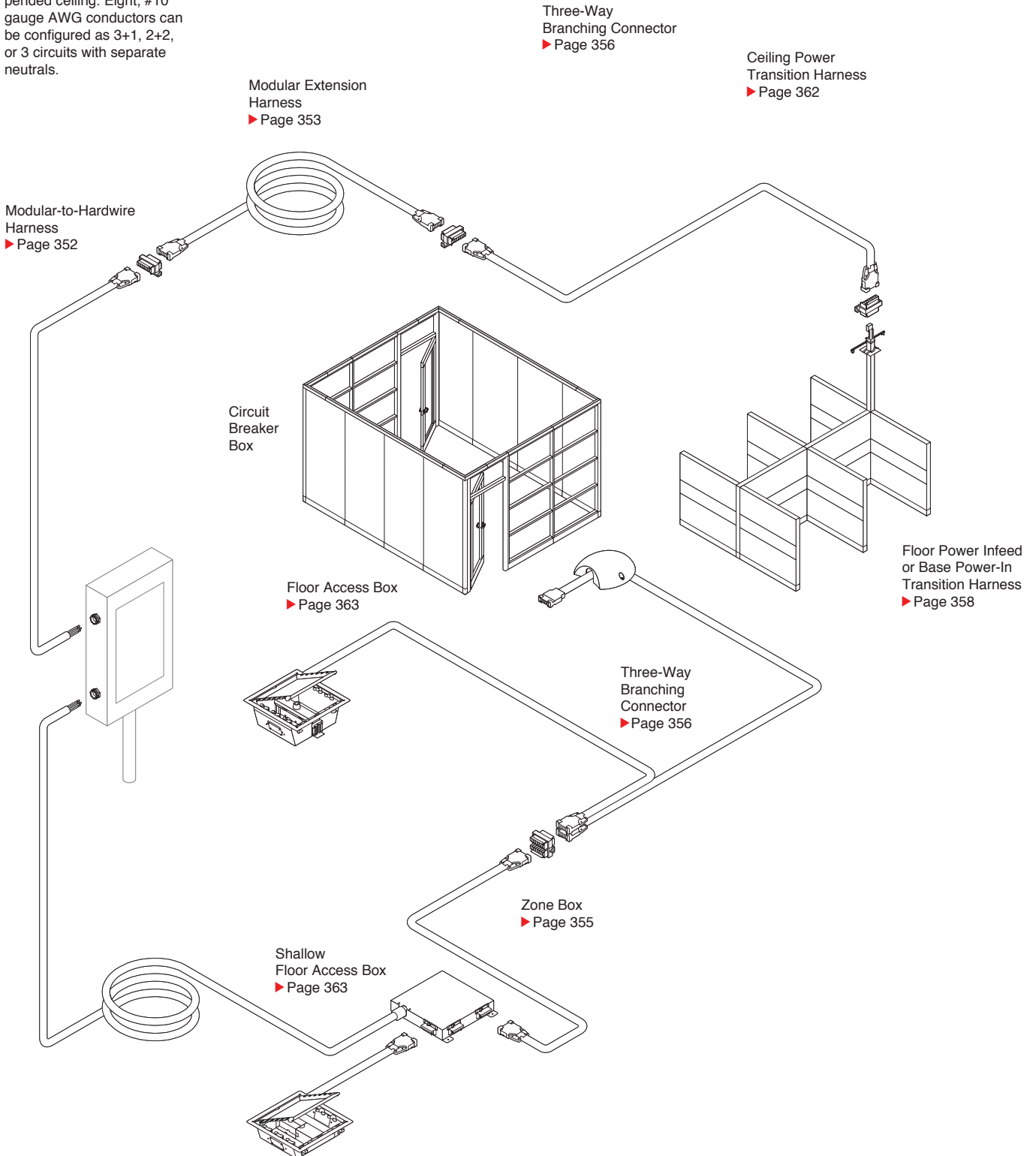
Modular components provide branch circuit power distribution through a raised access floor or above a suspended ceiling. Eight, #10 gauge AWG conductors can be configured as 3+1, 2+2, or 3 circuits with separate neutrals.



Modular Power

Modular-to-Hardwire Harnesses

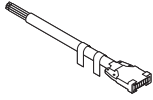

► Specifying, page 352

Product Details

Modular-to-hardwire harness routes power from the building power source to modular components or to provide power to a customer-supplied device. It can be used either above a suspended ceiling or below a raised floor.

Connections

Modular connector located on one end of the harness connects to a modular extension harness or transition harness, using a harness-to-harness connector, or to a branching connector or access box.

Surface Materials

Modular-to-hardwire harness is concealed when it is properly installed.

Actual Dimensions

Lengths 5', 10', 30', and 50'

Modular Extension Harnesses

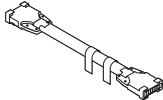

► Specifying, page 353

Product Details

Modular extension harness routes power from three-way branching connectors or lengthens the overall harness distance by using harness-to-harness connectors.

Modular extension harnesses can be connected or disconnected as needed with:

- Architectural Solutions Modular Power
- Answer
- Montage
- Post and Beam

Connections

Modular connectors located on each end of the modular extension harness, allow the harness to be relocated as power needs change.

Two modular extension harnesses can be connected together to extend the length by using a harness-to-harness connector.

Surface Materials

Harness is concealed when it is properly installed.

Actual Dimensions

Modular extension harness

Lengths 5', 10', 20', 30', 40', and 50'

Modular Connector Faceplates

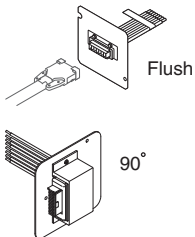

► Specifying, page 354

Product Details

Modular connection faceplate provides a way to add a modular connection to a junction box. Faceplate available with a flush or 90° connection.

Connections

Faceplate is attached to junction box with screws. Hardwire connection to power source within conventional 4" x 4" junction box is completed by electrician in the field. Modular extension harness can be connected or disconnected from faceplate as needed.

Surface Materials

Faceplate is zinc-plated steel. Modular connector is black plastic for 3+1, brown plastic for 2+2, and rust plastic for 3 circuits with separate neutrals.

Actual Dimensions

Depth 4¹¹/₁₆"

Width 4¹¹/₁₆"

Height 6"

Zone Boxes

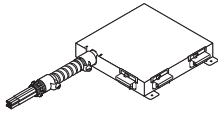

► Specifying, page 355

Product Details

Zone box includes an infeed harness to allow electrical connection to a circuit breaker box. Zone box includes three modular output connection points for power distribution for 10-gauge zone boxes, and two modular output connection points for 8-gauge zone boxes.

Connections

Zone boxes have either two or three output connection points. For 4-circuit, 3+1 and 2+2 configurations, twelve circuits are distributed to provide four circuits at each of the three connection points for 10-gauge zone boxes. For 8-gauge zone boxes, 8 circuits are distributed to provide four circuits at each of the two connection points. For 3-circuit, separate neutrals or configurations, nine circuits are distributed to provide three circuits at each of the three connection points for 10-gauge zone boxes and six circuits are distributed to provide three circuits at each end of the two connection points for 8-gauge zone boxes.

Surface Materials

Zone box is concealed when it is properly installed.

Actual Dimensions

Depth	11"
Width	10½"
Height	17⁄8"

Hardwired Zone Boxes

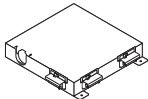

► Specifying, page 355

Product Details

Hardwired zone box is designed to be hardwired to power source by the electrician in the field.

Boxes that will be wired up to 150 feet have three output connection points (maximum of 12 circuits). Boxes that will be wired 150 feet up to a maximum of 200 feet have two output connection points (maximum of 8 circuits). All connectors are pre-wired to terminal base inside the box.

Connections

Connection from terminal bars to the circuit-breaker box should be done by a qualified electrician using 10-gauge wire for 12-circuit boxes and 8-gauge wire for 8-circuit boxes.

Boxes that have three output connectors can be 3+1, 2+2, or 3 circuits with separate neutrals. The 3+1 and 2+2 systems have a total of 12 circuits—four circuits at each connector. The 3 circuits with separate neutrals system has a total of nine circuits—three at each connector.

Boxes that have two output connectors can be 3+1, 2+2, or 3 circuits with separate neutrals. The 3+1 and 2+2 systems have a total of 8 circuits—four circuits at each connector. The 3 circuits with separate neutrals system has a total of six circuits—three at each connector.

Surface Materials

Hardwired zone box is concealed when it is properly installed.

Actual Dimensions

Depth	11"
Width	10½"
Height	17⁄8"

Three-Way Branching Connectors

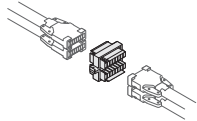

► Specifying, page 356

Product Details

Three-way branching connector has one power-infeed and three modular connection points for power distribution.

Connections

Three-way branching connector can route power to daisy chain power components such as floor boxes.

Surface Materials

Three-way branching connector is concealed beneath Architectural Solutions Low-Profile Floor when it is properly installed.

Actual Dimensions

Depth	2 ⁵ / ₈ "
Width	1 ¹ / ₂ "
Height	1 ³ / ₄ "

Harness-to-Harness Connectors

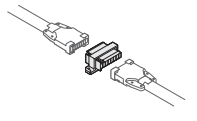

► Specifying, page 356

Product Details

Harness-to-harness connector has one power-infeed and one modular connection point for power distribution.

Connections

Harness-to-harness connectors join modular harnesses together to lengthen the overall harness distance.

Surface Materials

Harness-to-harness connector is concealed beneath the floor when it is properly installed.

Actual Dimensions

Depth	2 ⁵ / ₈ "
Width	1 ¹ / ₂ "
Height	1"

Transition Harnesses for Floor Power-Infeed or Base Power-In

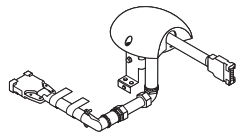

► Specifying, page 358

Product Details

Transition harness modularly connects the Modular Power system to Internode power kits. It also connects to Answer, Avenir, Montage, and Series 9000 in place of a standard base power-in.

Connections

Modular connector to connect to compatible system is included on one end of the transition harness.

Surface Materials

Transition harness is concealed beneath the floor when it is properly installed.

Power transition cover
• Black plastic

Actual Dimensions

Power harness length	6'
Infeed harness length	3'

Modular Power, continued

Ceiling Power Transition Harnesses

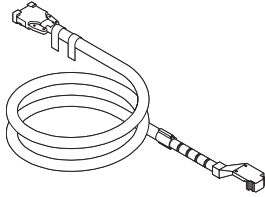

► Specifying, page 362

Product Details

Ceiling power transition harness modularly connects Modular Power routed above a suspended ceiling to Kick, Avenir, and Series 9000.

Connections

Modular connector to connect to compatible system is included on one end of the ceiling power transition harness.

Surface Materials

Ceiling power transition harness is concealed when it is properly installed.

Actual Dimensions

Lengths 12' and 24'

Shallow Floor Access Boxes

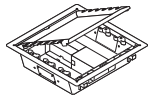

Shallow floor access box

► Specifying, page 362

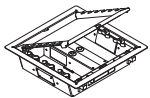

Shallow floor access box for hardwire connection

► Specifying, page 363

Product Details

Shallow floor access box includes a modular power block accepting two receptacles. Modular power block is available in three keying options, 3+1, 2+2, and 3-circuit, separate neutrals. Receptacle is specified separately for different lines and accommodates two modular furniture faceplates for communication outlets. A modular extension harness, ordered separately, of any length will connect to the shallow floor access box.

Shallow floor access box for hardwire connection

includes two duplex receptacle openings. Decora-style receptacles must be supplied in the field.

Shallow floor access boxes should be used with Low-Profile Floor and raised floors 2½"H or higher.

Connections

Shallow access box for hardwire connection can be used with a hardwire extension harness.

Surface Materials

Shallow floor access box lid
• Black zinc

Actual Dimensions

Depth 11½"

Width 11½"

Height 2½"

Floor Access Boxes

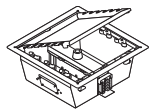

Floor access box
► Specifying, page 363

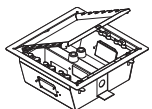

Floor access box for hardwire connection
► Specifying, page 364

Product Details

Floor access box includes a modular power block accepting four receptacles—two on each side of the block. Modular power block is available in three keying options, 3+1, 2+2, and 3-circuit separate neutrals. Receptacle is specified separately for different lines and accommodates two NEMA single-gang outlet faceplates. A modular extension harness, ordered separately, of any length will connect to the shallow floor access box.

Floor access box for hardwire connection includes four duplex receptacle openings. Decora-style receptacles must be supplied in the field.

Floor access boxes should be used with raised floors 5"H or higher.

Connections

Floor access box for hardwire connection can be used with a hardwire extension harness.

Surface Materials

Floor access box lid
• Black zinc

Actual Dimensions

Depth	11½"
Width	11½"
Height	4½"

Modular Receptacles

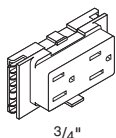

3/4"

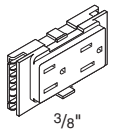

3/8"

► Specifying, page 366

Product Details

15-amp and 20-amp duplex receptacles, ordered separately, are field installed inside floor access boxes. System ground and isolated ground receptacles are available to connect to 15-amp and 20-amp systems.

Connections

Modular receptacles snap into the power block in floor access boxes.

Surface Materials

Modular receptacles
• Black plastic

Actual Dimensions

Depth	¾"	⅜"
Width	37/16"	1¾"
Height	37/16"	1¾"



Specifying Modular Power

Specifying

Modular Power

Modular-to-Hardwire Harnesses	352
Modular Extension Harnesses	353
Modular Connector Faceplates	354
Zone Boxes	355
Three-Way Branching Connectors	356
Harness-to-Harness Connectors	356
Dust Caps for Modular Connector	357
Floor Power-Infeeds or Base Power-In Transition Harnesses	358
Ceiling Power Transition Harnesses	362
Shallow Floor Access Boxes	362
Floor Access Boxes	363
Shallow Floor Access Box for Hardwire Connection	363
Floor Access Box for Hardwire Connection	364
Receptacles for Use with Floor Access Boxes	366

Modular Power

Modular-to-Hardwire Harnesses

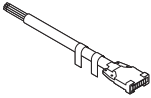

Standard Includes	Required to Specify
<ul style="list-style-type: none"> ▶ Need help? Product details, page 345 • Harness • Male modular connector • Pigtail for hardwire connection to electrical panel 	<ul style="list-style-type: none"> Style number

Specification Information

• Harness Length	• Style Number	• U.S. Price
------------------	----------------	--------------

4-Circuit, 3+1

5'	GAPMH5X	\$168
10'	GAPMH10X	\$173
30'	GAPMH30X	\$363
50'	GAPMH50X	\$551
:	:	:

4-Circuit, 2+2

5'	GAPMH5Y	\$168
10'	GAPMH10Y	\$173
30'	GAPMH30Y	\$363
50'	GAPMH50Y	\$551
:	:	:

3-Circuit, Separate Neutrals

5'	GAPMH5Z	\$168
10'	GAPMH10Z	\$173
30'	GAPMH30Z	\$363
50'	GAPMH50Z	\$551
:	:	:



For Canadian Pricing

Multiply U.S. Price by the Canadian price factor.

▶ See page 1 for details.

Modular Extension Harnesses

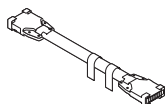

Tip: Connect multiple harnesses together for longer runs.

Tip: Modular power manufactured before May 2004 (round conduit) are not interchangeable after May 2004 (oval conduit). A power-out modular harness is available from Steelcase Service Parts to make a modular connection between the two versions.

Standard Includes	Required to Specify
-------------------	---------------------

- | | |
|--|--|
| <ul style="list-style-type: none"> ▶ Need help? Product details, page 345 | <ul style="list-style-type: none"> • Harness • Male modular connectors |
|--|--|

Style number

Specification Information

• Harness Length	• Style Number	• U.S. Price
------------------	----------------	--------------

4-Circuit, 3+1

5'	GAPHM5X	\$158
10'	GAPHM10X	\$197
15'	GAPHM15X	\$265
20'	GAPHM20X	\$333
30'	GAPHM30X	\$450
40'	GAPHM40X	\$561
50'	GAPHM50X	\$653
:	:	:

4-Circuit, 2+2

5'	GAPHM5Y	\$158
10'	GAPHM10Y	\$197
15'	GAPHM15Y	\$265
20'	GAPHM20Y	\$333
30'	GAPHM30Y	\$450
40'	GAPHM40Y	\$561
50'	GAPHM50Y	\$653
:	:	:

3-Circuit, Separate Neutrals

5'	GAPHM5Z	\$158
10'	GAPHM10Z	\$197
15'	GAPHM15Z	\$265
20'	GAPHM20Z	\$333
30'	GAPHM30Z	\$450
40'	GAPHM40Z	\$561
50'	GAPHM50Z	\$653
:	:	:



For Canadian Pricing

Multiply U.S. Price by the Canadian price factor.

▶ See page 1 for details.

Modular Connector Faceplates

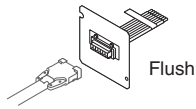

Flush

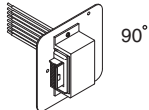

90°

Standard Includes	Required to Specify
<ul style="list-style-type: none"> ▶ Need help? Product details, page 345 • Faceplate with flush connection: galvanized steel • Faceplate with 90° connection: black paint • Female modular connector • Pigtail for hardwire connection 	<ul style="list-style-type: none"> • Style number

Specification Information

Connection	Style Number	U.S. Price
------------	--------------	------------

4-Circuit, 3+1

Flush	GAPFCMX	\$ 61
90°	GAPFCM90X	\$112
:	:	:

4-Circuit, 2+2

Flush	GAPFCMY	\$ 61
90°	GAPFCM90Y	\$112
:	:	:

3-Circuit, Separate Neutrals

Flush	GAPFCMZ	\$ 61
90°	GAPFCM90Z	\$112
:	:	:



For Canadian Pricing

Multiply U.S. Price by the Canadian price factor.

▶ See page 1 for details.

Zone Boxes

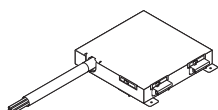

Tip: Zone boxes accommodating 150' and 200' infeed harnesses are 8 gauge.

Tip: Modular power manufactured before May 2004 (round conduit) are not interchangeable after May 2004 (oval conduit). A power-out modular harness is available from Steelcase Service Parts to make a modular connection between the two versions.

Standard Includes	Required to Specify
-------------------	---------------------

- | | |
|--|--|
| ▶ Need help? Product details, page 346 | <ul style="list-style-type: none"> • Zone box: black zinc • Lengths of 50 to 125 feet are 10 gauge home run conductors with 3 harness ports and strain reliefs • Lengths of 150 and 200 feet are 8 gauge home run conductors with 2 harness ports and strain reliefs • One power infeed • Built-in anchoring tabs |
|--|--|

Style number

Specification Information

• Harness Length	• Style Number	• U.S. Price
------------------	----------------	--------------

4-Circuit, 3+1

Hardwired, 8 gauge	GAPZBHW8X	\$ 643
Hardwired, 10 gauge	GAPZBHW10X	\$ 643
50'	GAPZBM50X	\$1652
75'	GAPZBM75X	\$2297
100'	GAPZBM100X	\$2937
125'	GAPZBM125X	\$3482
150'	GAPZBM150X	\$4038
200'	GAPZBM200X	\$5312

4-Circuit, 2+2

Hardwired, 8 gauge	GAPZBHW8Y	\$ 643
Hardwired, 10 gauge	GAPZBHW10Y	\$ 643
50'	GAPZBM50Y	\$1652
75'	GAPZBM75Y	\$2297
100'	GAPZBM100Y	\$2937
125'	GAPZBM125Y	\$3482
150'	GAPZBM150Y	\$4038
200'	GAPZBM200Y	\$5312

3-Circuit, Separate Neutrals

Hardwired, 8 gauge	GAPZBHW8Z	\$ 643
Hardwired, 10 gauge	GAPZBHW10Z	\$ 643
50'	GAPZBM50Z	\$1652
75'	GAPZBM75Z	\$2297
100'	GAPZBM100Z	\$2937
125'	GAPZBM125Z	\$3482
150'	GAPZBM150Z	\$4038
200'	GAPZBM200Z	\$5312



For Canadian Pricing

Multiply U.S. Price by the Canadian price factor.

▶ See page 1 for details.

Three-Way Branching Connectors

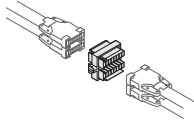

Tip: Branching connector distributes all circuits to each connection point.

Tip: Modular power manufactured before May 2004 (round conduit) are not interchangeable after May 2004 (oval conduit). A power-out modular harness is available from Steelcase Service Parts to make a modular connection between the two versions.

Standard Includes		Required to Specify
<ul style="list-style-type: none"> ▶ Need help? Product details, page 347 	<ul style="list-style-type: none"> • Branching connector: Ultramid nylon • Three modular connection attachment points • One power infeed harness connection point 	Style number
Specification Information		
Style Number	U.S. Price	
4-Circuit, 3+1		
GAP3HCX	\$27	
4-Circuit, 2+2		
GAP3HCY	\$27	
3-Circuit, Separate Neutrals		
GAP3HCZ	\$27	

Harness-to-Harness Connectors

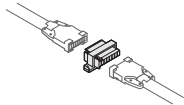

Standard Includes		Required to Specify
<ul style="list-style-type: none"> ▶ Need help? Product details, page 347 	<ul style="list-style-type: none"> • Branching connector: Ultramid nylon • One modular connection attachment point • One power infeed harness connection point 	Style number
Specification Information		
Style Number	U.S. Price	
4-Circuit, 3+1		
GAPHHCX	\$27	
4-Circuit, 2+2		
GAPHHCY	\$27	
3-Circuit, Separate Neutrals		
GAPHHCZ	\$27	



For Canadian Pricing
 Multiply U.S. Price by the Canadian price factor.
 ▶ See page 1 for details.

Dust Caps for Modular Connector



Standard Includes	Required to Specify
<ul style="list-style-type: none"> Dust caps for modular connector: Ultramid nylon Package of 20 caps 	Style number

Specification Information

Style Number	U.S. Price
GAPDC20	\$96



For Canadian Pricing
 Multiply U.S. Price by the
 Canadian price factor.
 ▶ See page 1 for details.

Floor Power-Infeeds or Base Power-In Transition Harnesses

Tip: Transition harnesses require a 3" diameter hole in floor tile.

Tip: Length of conduit between connection point wall or panel and transition point into floor is 3'.

Tip: A transition harness is not required for Answer and Montage where the power can be directly fed into the panel.

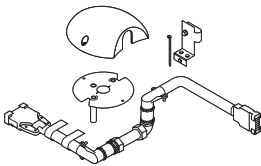

Standard Includes	Required to Specify
<ul style="list-style-type: none"> ▶ Need help? Product details, page 347 • Power transition harness • Male modular connector to Modular Power system • Modular connector to connect to compatible system • Power transition cover: black plastic only 	<ul style="list-style-type: none"> Style number

Specification Information		
Length	Style Number	U.S. Price

For Post and Beam Floor Power-Infeeds Connecting to Powerkit Blocks

4-Circuit, 3+1		
6'	GAPTHFLX	\$421
4-Circuit, 3+1 for New York		
6'	GAPTHFNYX	\$390
4-Circuit, 3+1 for San Francisco		
6'	GAPTHFLSFX	\$421
4-Circuit, 2+2		
6'	GAPTHFLY	\$421
4-Circuit, 2+2 for New York		
6'	GAPTHFNYY	\$390
4-Circuit, 2+2 for San Francisco		
6'	GAPTHFLSFY	\$421
3-Circuit, Separate Neutrals		
6'	GAPTHFLZ	\$421
3-Circuit, Separate Neutrals for New York		
6'	GAPTHFNYZ	\$390
3-Circuit, Separate Neutrals for San Francisco		
6'	GAPTHFLSFZ	\$421

▶ **Specification Information, continued on next page**



For Canadian Pricing

Multiply U.S. Price by the Canadian price factor.

▶ See page 1 for details.

► Specification Information, continued from previous page

Specification Information

Length	Style Number	U.S. Price
--------	--------------	------------

For Internode Floor Power-Infeeds

4-Circuit, 3+1

6'	GAPTHINTX	\$421
----	------------------	-------

4-Circuit, 3+1 for New York

6'	GAPTHINNYX	\$390
----	-------------------	-------

4-Circuit, 3+1 for San Francisco

6'	GAPTHINTSFX	\$421
----	--------------------	-------

4-Circuit, 2+2

6'	GAPTHINTY	\$421
----	------------------	-------

4-Circuit, 2+2 for New York

6'	GAPTHINNY	\$390
----	------------------	-------

4-Circuit, 2+2 for San Francisco

6'	GAPTHINTSFY	\$421
----	--------------------	-------

3-Circuit, Separate Neutrals

6'	GAPTHINTZ	\$421
----	------------------	-------

3-Circuit, Separate Neutrals for New York

6'	GAPTHINNYZ	\$390
----	-------------------	-------

3-Circuit, Separate Neutrals San Francisco

6'	GAPTHINTSFZ	\$421
----	--------------------	-------

► Specification Information, continued on next page

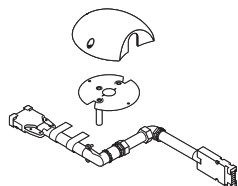

For Canadian Pricing

Multiply U.S. Price by the Canadian price factor.

► See page 1 for details.

► Specification Information, continued from previous page

Specification Information

Length	Style Number	U.S. Price
--------	--------------	------------

For Answer and Montage Base Power-Ins at a Powerkit Receptacle Location

4-Circuit, 3+1

6'	GAPTHFBPX	\$421
----	------------------	-------

4-Circuit, 3+1 for New York

6'	GAPTHFBPNYX	\$390
----	--------------------	-------

4-Circuit, 3+1 for San Francisco

6'	GAPTHFBPSFX	\$421
----	--------------------	-------

4-Circuit, 2+2

6'	GAPTHFBPY	\$421
----	------------------	-------

4-Circuit, 2+2 for New York

6'	GAPTHFBPNYY	\$390
----	--------------------	-------

4-Circuit, 2+2 for San Francisco

6'	GAPTHFBPSFY	\$421
----	--------------------	-------

3-Circuit, Separate Neutrals

6'	GAPTHFBPZ	\$421
----	------------------	-------

3-Circuit, Separate Neutrals for New York

6'	GAPTHFBPNYZ	\$390
----	--------------------	-------

3-Circuit, Separate Neutrals for San Francisco

6'	GAPTHFBPSFZ	\$421
----	--------------------	-------

► Specification Information, continued on next page

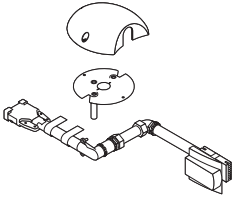

For Canadian Pricing

Multiply U.S. Price by the Canadian price factor.

► See page 1 for details.

► Specification Information, continued from previous page

Specification Information

Length	Style Number	U.S. Price
--------	--------------	------------

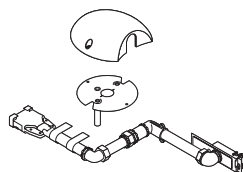

For Kick, Series 9000, and Avenir Base Power-Ins at a Powerkit Receptacle Location

4-Circuit, 3+1

6'	GAPTHBPBX	\$421
----	------------------	-------

4-Circuit, 3+1 for New York

6'	GAPTHBPNYX	\$390
----	-------------------	-------

4-Circuit, 3+1 for San Francisco

6'	GAPTHBPSSF	\$421
----	-------------------	-------

4-Circuit, 2+2

6'	GAPTHBPY	\$421
----	-----------------	-------

4-Circuit, 2+2 for New York

6'	GAPTHBPNY	\$390
----	------------------	-------

4-Circuit, 2+2 for San Francisco

6'	GAPTHBPSSFY	\$421
----	--------------------	-------

3-Circuit, Separate Neutrals

6'	GAPTHBPZ	\$421
----	-----------------	-------

3-Circuit, Separate Neutrals for New York

6'	GAPTHBPNYZ	\$390
----	-------------------	-------

3-Circuit, Separate Neutrals for San Francisco

6'	GAPTHBPSSFZ	\$421
----	--------------------	-------

.....



For Canadian Pricing

Multiply U.S. Price by the Canadian price factor.

► See page 1 for details.

Ceiling Power Transition Harnesses

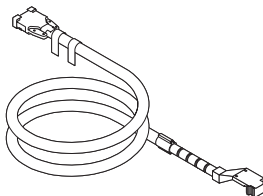

Tip: Modular power manufactured before May 2004 (round conduit) are not interchangeable after May 2004 (oval conduit). A power-out modular harness is available from Steelcase Service Parts to make a modular connection between the two versions.

Standard Includes	Required to Specify
<ul style="list-style-type: none"> ▶ Need help? Product details, page 348 • Power transition harness • Male modular connector to Modular Power system • Modular connector to connect to compatible system 	<ul style="list-style-type: none"> Style number

Specification Information		
Length	Style Number	U.S. Price

For Kick, Series 9000, and Avenir Modular Connectors

4-Circuit, 3+1		
12'	GAPTHPMP12X	\$347
24'	GAPTHPMP24X	\$474
4-Circuit, 2+2		
12'	GAPTHPMP12Y	\$347
24'	GAPTHPMP24Y	\$474
3-Circuit, Separate Neutrals		
12'	GAPTHPMP12Z	\$347
24'	GAPTHPMP24Z	\$474

Shallow Floor Access Boxes

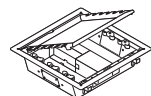

Tip: Access box requires a low-profile floor box access tile or a 10½" square cut-out in floor.

Tip: Remember to order receptacles for field installation.

▶ Page 366

Standard Includes	Required to Specify
<ul style="list-style-type: none"> ▶ Need help? Product details, page 348 • Lid with frame and carpet insert space: black zinc • Low-profile floor access box: black zinc • Modular power block kit for two duplex receptacles • Furniture faceplate-size opening for communications faceplates • Furniture voice/data mounting adapter kit 	<ul style="list-style-type: none"> Style number

Specification Information			
Dimensions			U.S. Price
D	W	H	Price

4-Circuit, 3+1			
11½"	11½"	2½"	GAPFBSX \$382
4-Circuit, 2+2			
11½"	11½"	2½"	GAPFBSY \$382
3-Circuit, Separate Neutrals			
11½"	11½"	2½"	GAPFBSZ \$382

For Canadian Pricing
 Multiply U.S. Price by the Canadian price factor.
 ▶ See page 1 for details.

Floor Access Boxes

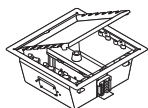

Tip: Access box requires a 10½" square cut-out in floor.

Tip: Remember to order receptacles for field installation.

▶ Page 366

Tip: Modular power manufactured before May 2004 (round conduit) are not interchangeable after May 2004 (oval conduit). A power-out modular harness is available from Steelcase Service Parts to make a modular connection between the two versions.

Standard Includes	Required to Specify
-------------------	---------------------

- | | |
|--|--|
| <ul style="list-style-type: none"> ▶ Need help? Product details, page 349 | <ul style="list-style-type: none"> • Lid with frame and carpet insert space: black zinc • Standard floor access box: black zinc • Modular power block kit for four duplex receptacles • Two furniture faceplate-size openings adaptable to single gang size for communications faceplates • Furniture voice/data mounting adapter kit |
|--|--|

Style number

Specification Information				
• Dimensions			• Style	• U.S.
D	W	H	Number	Price

4-Circuit, 3+1

11½"	11½"	4½"	GAPFBDX	\$445
------	------	-----	----------------	-------

4-Circuit, 2+2

11½"	11½"	4½"	GAPFBDY	\$445
------	------	-----	----------------	-------

3-Circuit, Separate Neutrals

11½"	11½"	4½"	GAPFBDZ	\$445
------	------	-----	----------------	-------

Shallow Floor Access Box for Hardwire Connection

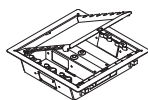

Tip: Decora-style receptacles must be supplied in the field.

Tip: Access box requires a low-profile floor box access tile or 10½" square cut-out in floor.

Standard Includes	Required to Specify
-------------------	---------------------

- | | |
|--|---|
| <ul style="list-style-type: none"> ▶ Need help? Product details, page 348 | <ul style="list-style-type: none"> • Lid with frame and carpet insert space: black zinc • Low-profile floor access box: black zinc • Two duplex receptacle openings • Furniture faceplate-size opening for communications faceplates • Furniture voice/data mounting adapter kit |
|--|---|

Style number

Specification Information				
• Dimensions			• Style	• U.S.
D	W	H	Number	Price

11½"	11½"	2½"	GAPFBSHW	\$210
------	------	-----	-----------------	-------



For Canadian Pricing

Multiply U.S. Price by the Canadian price factor.

▶ See page 1 for details.

Floor Access Box for Hardwire Connection

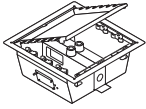

Tip: Decora-style receptacles must be supplied in the field.

Tip: Access box requires a 10½" square cut-out in floor.

Standard Includes	Required to Specify
<ul style="list-style-type: none"> ▶ Need help? Product details, page 349 • Lid with frame and carpet insert space: black zinc • Standard floor access box: black zinc • Four duplex receptacle openings • Two furniture faceplate-size openings adaptable to single gang size for communications faceplates • Furniture voice/data mounting adapter kit 	<ul style="list-style-type: none"> • Style number

Specification Information				
• Dimensions			• Style	• U.S.
D	W	H	Number	Price
11½"	11½"	4½"	GAPFBDHW	\$247



For Canadian Pricing

Multiply U.S. Price by the Canadian price factor.

▶ See page 1 for details.

Receptacles for Use with Floor Access Boxes

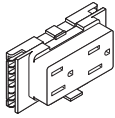

3/4"

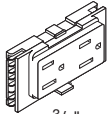

3/8"

Tip: For designation of controlled receptacles, order permanent ink stamp with controlled icon; service part (1063909001SR). It includes a pair of stamps, one white and one black. Appropriate receptacles can be stamped at the job site during installation.

Tip: All receptacle faces are 3/4" nominal height except 15-amp receptacles in the 3+1 and 2+2 wiring schematic.

Tip: Modular power manufactured before May 2004 (round conduit) are not interchangeable after May 2004 (oval conduit). A power-out modular harness is available from Steelcase Service Parts to make a modular connection between the two versions.

Standard Includes	Required to Specify
-------------------	---------------------

- ▶ Need help? Product details, page 349
- Receptacle: black plastic
- Style number

Specification Information

15-Amp Receptacles

Line	Style Number	U.S. Price	Style Number	U.S. Price
------	--------------	------------	--------------	------------

4-Circuit, 3+1 Wiring Schematic

	System Ground		Isolated Ground	
Line 1	GAPR15L1SGX	\$27	GAPR15L1IGX	\$27
Line 2	GAPR15L2SGX	\$27	GAPR15L2IGX	\$27
Line 3	GAPR15L3SGX	\$27	GAPR15L3IGX	\$27
Line 4	GAPR15L4SGX	\$27	GAPR15L4IGX	\$27

4-Circuit, 2+2 Wiring Schematic

	System Ground		Isolated Ground	
Line 1	GAPR15L1SGY	\$27	GAPR15L1IGY	\$27
Line 2	GAPR15L2SGY	\$27	GAPR15L2IGY	\$27
Line 3	GAPR15L3SGY	\$27	GAPR15L3IGY	\$27
Line 4	GAPR15L4SGY	\$27	GAPR15L4IGY	\$27

3-Circuit, Separate Neutrals (3SN) Wiring Schematic

	System Ground		Isolated Ground	
Line 1	GAPR15L1SGZ	\$27	GAPR15L1IGZ	\$27
Line 2	GAPR15L2SGZ	\$27	GAPR15L2IGZ	\$27
Line 3	GAPR15L3SGZ	\$27	GAPR15L3IGZ	\$27

▶ **Specification Information, continued on next page**



For Canadian Pricing

Multiply U.S. Price by the Canadian price factor.

▶ See page 1 for details.

► Specification Information, continued from previous page

Specification Information

20-Amp Receptacles

Line	Style Number	U.S. Price	Style Number	U.S. Price
------	--------------	------------	--------------	------------

4-Circuit, 3+1 Wiring Schematic

System Ground			Isolated Ground	
Line 1	GP1R1SGHX	\$52	GP1R1IGHX	\$52
Line 2	GP1R2SGHX	\$52	GP1R2IGHX	\$52
Line 3	GP1R3SGHX	\$52	GP1R3IGHX	\$52
Line 4	GP1R4SGHX	\$52	GP1R4IGHX	\$52

4-Circuit, 2+2 Wiring Schematic

System Ground			Isolated Ground	
Line 1	GP2R1SGHY	\$52	GP2R1IGHY	\$52
Line 2	GP2R2SGHY	\$52	GP2R2IGHY	\$52
Line 3	GP2R3SGHY	\$52	GP2R3IGHY	\$52
Line 4	GP2R4SGHY	\$52	GP2R4IGHY	\$52

3-Circuit, Separate Neutrals Wiring Schematic

System Ground			Isolated Ground	
Line 1	GP3R1SGHZ	\$52	GP3R1IGHZ	\$52
Line 2	GP3R2SGHZ	\$52	GP3R2IGHZ	\$52
Line 3	GP3R3SGHZ	\$52	GP3R3IGHZ	\$52

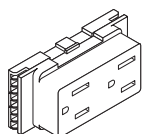

Tip: For designation of controlled receptacles, order permanent ink stamp with controlled icon; service part (1063909001SR). It includes a pair of stamps, one white and one black. Appropriate receptacles can be stamped at the job site during installation.

 **For Canadian Pricing**
 Multiply U.S. Price by the Canadian price factor.
 ► See page 1 for details.



Understanding QtPro Soundmasking

	
Statement of Line	370

	
Product Details	
QtPro Soundmasking	372
Sonet Individual Soundmasking	378
QtPro Room Control	380

Statement of Line

QtPro Soundmasking

Control Modules

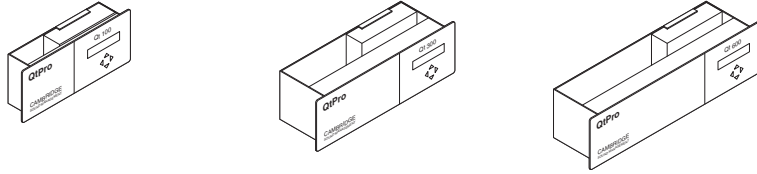

QtPro Control Modules

- Understanding
- ▶ Page 375
- Specifying
- ▶ Page 382

Emitters

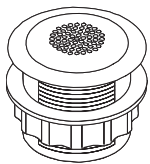

Emitters, Four Pack

- Understanding
- ▶ Page 375
- Specifying
- ▶ Page 386

Active Emitters

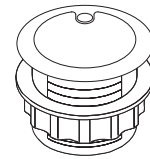

Active Emitters, Four Pack

- Understanding
- ▶ Page 374
- Specifying
- ▶ Page 391

Cabling and Components

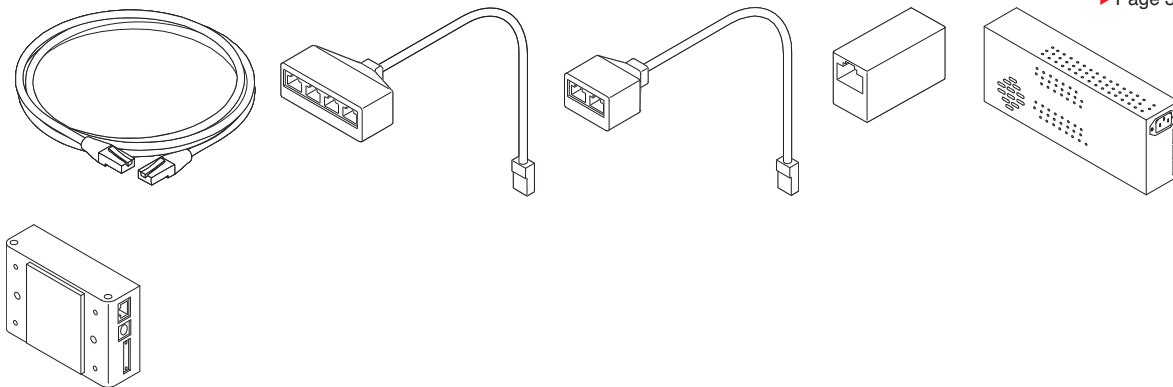

Understanding

- ▶ Page 376
- Specifying
- ▶ Page 392

Mounting Components

Understanding
▶ Page 375
Specifying
▶ Page 395

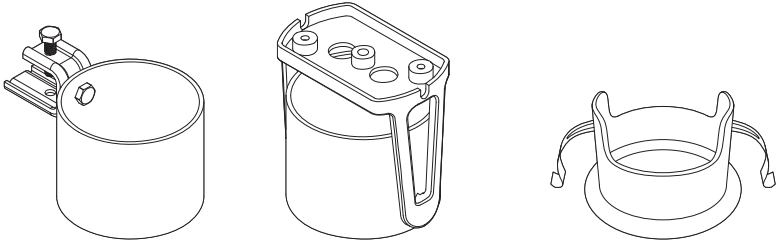

Sonet Individual Soundmasking

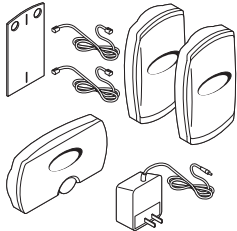

Soundmasking System with Two Speakers

Understanding
▶ Page 379
Specifying
▶ Page 398

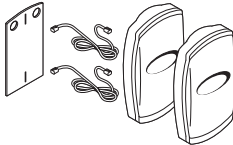

Two Speaker Extension Kit

Understanding
▶ Page 379
Specifying
▶ Page 398

QtPro Soundmasking

Soundmasking is the adding of background sound to an environment in order to make existing sounds less intelligible and less distracting. This added background sound is designed to cover up or mask unwanted conversation because it contains the same frequencies as human speech.

Qt quiet technology is a patented, low-voltage, direct field, distributed audio system designed for soundmasking, paging, and music distribution. Qt quiet technology overcomes significant design and installation issues with previous generations of soundmasking systems. Qt quiet technology is a technology that is flexible, uncomplicated, and cost effectively installed.

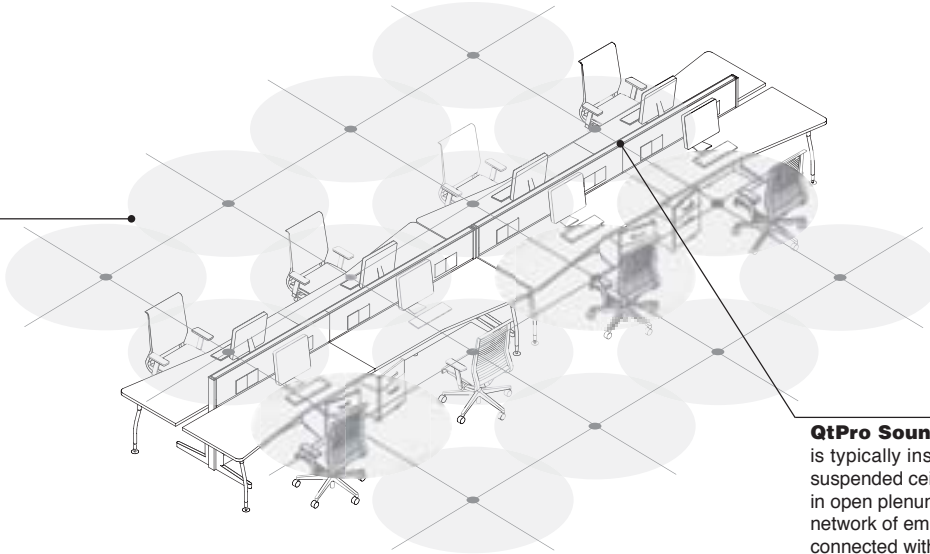

QtPro Soundmasking is typically installed in suspended ceiling tiles or in open plenum spaces. A network of emitters is interconnected with low-voltage cable. The entire system is operated via centrally located control modules.

QtPro Qt 100 Configuration

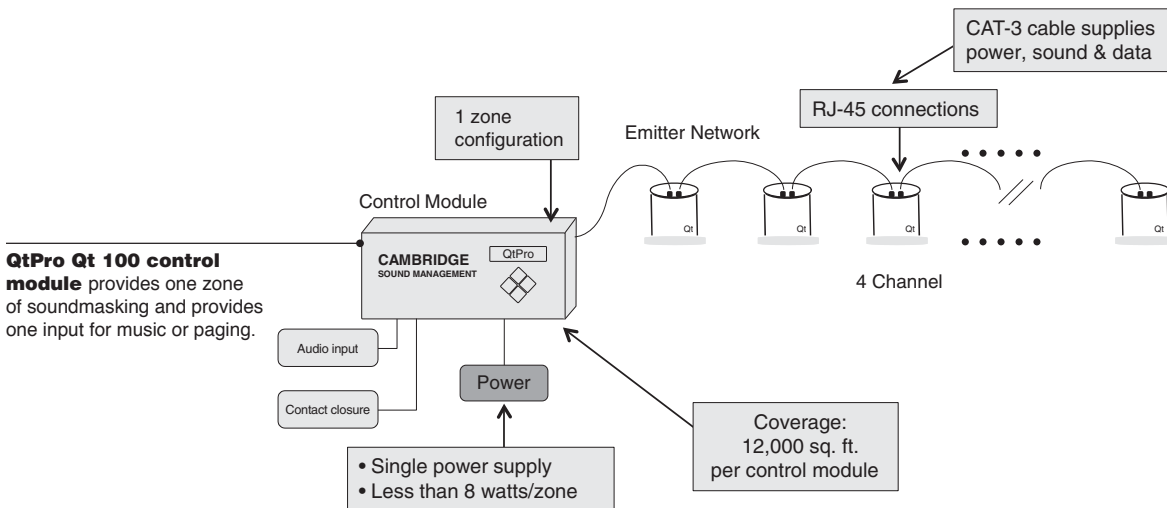

QtPro Qt 100 control module provides one zone of soundmasking and provides one input for music or paging.

QtPro Qt 300 Configuration

Emitters are direct-field miniature ceiling-mounted speakers. The emitters are driven directly from the control modules and require no external power. To compensate for different acoustic conditions within a zone, the emitters are adjustable. The soundmasking input can be reduced by up to 9dB in 3dB decrements.

QtPro Qt 300 control module provides three zones of soundmasking and provides two inputs for music or paging. Qt 300 and Qt 600 include pre-installed software for control and monitoring accessed via direct-PL connection or via Local Area Network.

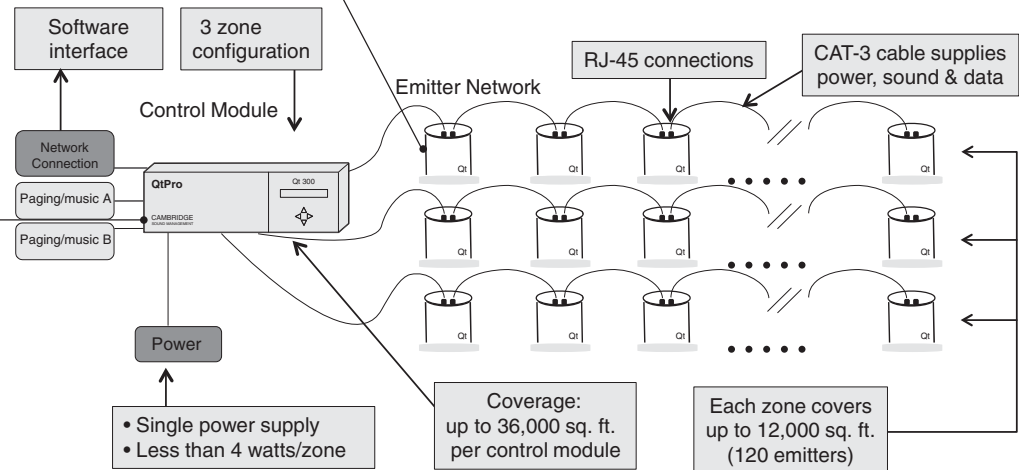

QtPro Qt 600 Configuration

QtPro Qt 600 control module provides six zones of soundmasking and provides two inputs for music or paging. Qt 600 includes pre-installed software for control and monitoring accessed via direct-PL connection or via Local Area Network.

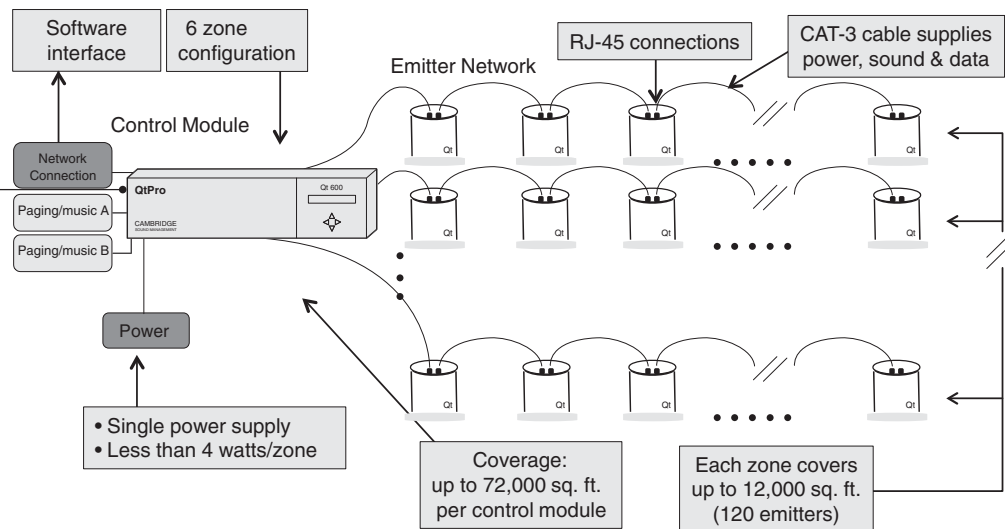

Actual Dimensions

	Qt 100	Qt 300	Qt 600
Length	7"	11"	13 1/2"
Width	3 1/2"	3 1/2"	3 1/2"
Depth	7/8"	3 1/2"	3 1/2"

QtPro 100 supports up to 120 emitters on one zone, covering up to 12,000 square feet.

QtPro 300 supports up to 360 emitters on three zones, covering up to 36,000 square feet.

QtPro 600 supports up to 720 emitters on six zones, covering up to 72,000 square feet.

QtPro Active Emitter Configuration

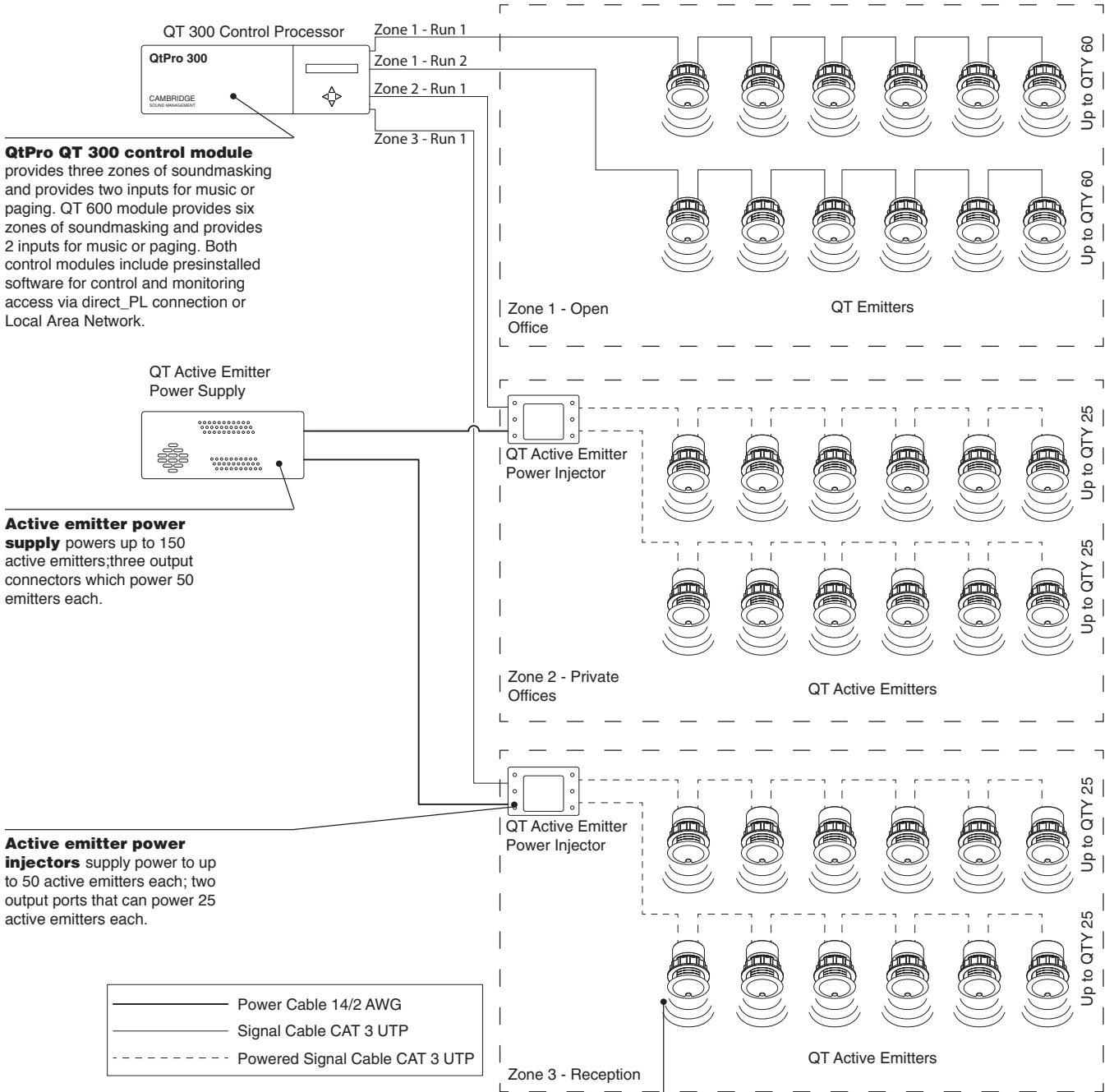

QtPro QT 300 control module provides three zones of soundmasking and provides two inputs for music or paging. QT 600 module provides six zones of soundmasking and provides 2 inputs for music or paging. Both control modules include preinstalled software for control and monitoring access via direct_PL connection or Local Area Network.

Active emitter power supply powers up to 150 active emitters; three output connectors which power 50 emitters each.

Active emitter power injectors supply power to up to 50 active emitters each; two output ports that can power 25 active emitters each.

Active emitters are direct-field miniature ceiling-mounted speakers. The active emitters are driven directly from the control modules and require no external power. To compensate for different acoustic conditions within a zone, the active emitters are adjustable. The soundmasking input can be reduced by up to 4.5dB in 1.5dB decrements.

Product Details

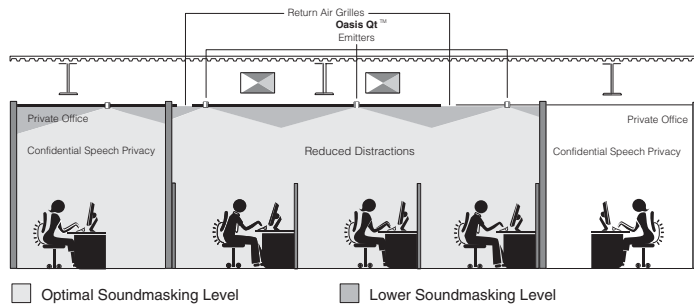

Qt quiet technology systems project sound directly into the workspace. The emitters disperse a uniform, pre-programmed sound that requires no tuning.

QtPro soundmasking system can be controlled both at the control module and also by a connected computer by using the pre-installed software. The software allows remote control of time-of-date ramping, equalizer functions for acoustic professional, email notifications of problems, and day/night customization.

QtPro soundmasking can be applied in many environments, including open plan workstations, private offices, reception and lobby areas, cafes and break rooms, banks, waiting areas, doctors', dentists' and other practitioners' offices, and in libraries.

QtPro soundmasking is designed to cover normal human voice, light office sounds such as keyboard and paper shuffling, some echoes in reverberant space, and light traffic noise.

QtPro active emitter applications include spaces where lower frequencies, paging, or music with sound masking is desired.

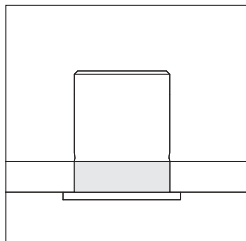

Emitters have an adjustable sleeve that captures the emitter in the ceiling tile from 1/2" to 1 1/2". Additional components are available for mounting emitters external to the ceiling, to rafters, or into drywall.

Connections

QtPro control modules typically mount onto walls or inside utility closets. Screws and drywall sleeves included. The Qt 300 and Qt 600 control modules can mount in equipment racks with the use of the rack mount bracket.

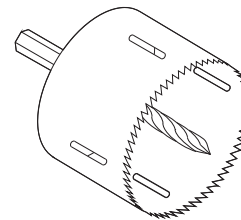

Emitters generally are mounted in acoustical ceiling tiles. A holesaw (provided with each control module) is used to create the opening for the emitters.

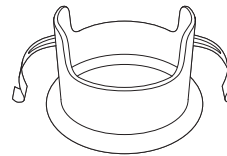

Emitters can also be mounted in drywall ceilings by using the drywall mounting bracket.

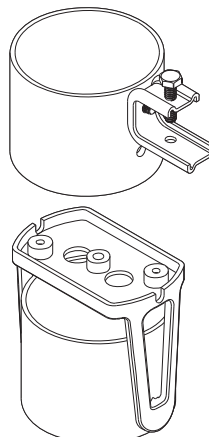

For ceilings with beams or open plenum spaces, external mounting brackets or external mounting clamps can be used.

Wiring & Cabling

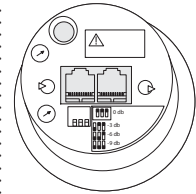

QtPro emitters are plug and play ready with pre-terminated, industry standard RJ 45 connectors.

Active emitters are 17dB louder than standard emitters and are ideal for paging and music.

Emitters are adjustable. With standard emitters, soundmasking input can be reduced up to 9dB in 3dB decrements and with active emitters soundmasking input can be reduced up to 4.5dB in 1.5dB decrements lower than what the volume is set from the control module.

Emitters are available with 16' or 30' cables. 30' cables are typically used for open-plenum installations.

Emitters are daisy-chained together using input and output jacks and Cat 3 cables. The chains of emitters then route back to zone panels within the control module.

QtPro Soundmasking, continued

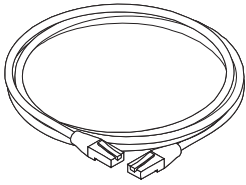

Standard cables are available in lengths of 10, 16, 25, 50, 75, and 100 feet. Active emitter home run cable is available in a length of 400 feet. Custom lengths can be created onsite with cable couplers, two way splitters, and four way splitters.

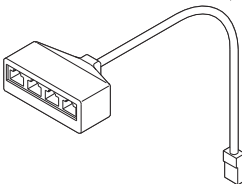
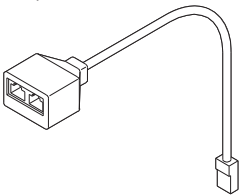
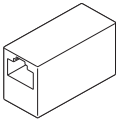

Couplers and splitters are used to create custom cable lengths and also join together different sections of soundmasking zones.

Surface Materials

Emitters are off-white plastic while mounting components are white. Couplers and splitters are grey plastic.

Control modules are dark grey.

Application Topics

QtPro control modules should be placed in a location with access to standard AC outlets and routing for zone cabling.

A Qt 100 control module has a capacity of 120 emitters.

A Qt 300 control module has a capacity of 360 emitters.

A Qt 600 control module has a capacity of 720 emitters.

Emitters are planned generally one emitter per each 10' x 10' space. In private offices, balanced soundmasking is achieved with two emitters placed per 120 square feet.

For non-acoustical tile ceilings, additional mounting components may be required.

Technical Specifications

QtPro Qt 100 power consumption: 7 watts per unit.

QtPro Qt 300 power consumption: 15 watts per unit.

QtPro Qt 600 power consumption: 27 watts per unit.

QtPro Qt 100 is a modular 100-240 VAC 50/60Hz - 0.6A input, 24.0 VDC 1.0A output CE/ETL/UL/GS/FCC/TUV - rated unit (included).

QtPro Qt 300 and Qt 600 power supply is a modular 100-240 VAC 50/60Hz - 0.9A input, 24.0 VDC 1.5A output CE/UL/CUL - rated unit (included).

QtPro page input impedance: 10K ohms, differential input.

QtPro music input impedance: 10K ohms, single ended. Two inputs mixed to mono.

QtPro digital compression and limiting: performed via DSP.

QtPro frequency response (paging and music): band pass limited from 315 Hz to 25k Hz (+/- 1.5 dB).

Sonet Individual Soundmasking

Soundmasking is the adding of background sound to an environment in order to make existing sounds less intelligible and less distracting. This added background sound is designed to cover up or mask unwanted conversation because it contains the same frequencies as human speech.

Qt quiet technology is a patented, low-voltage, direct field, distributed audio system designed for soundmasking, paging, and music distribution. Qt quiet technology overcomes significant design and installation issues with previous generations of soundmasking systems. Qt quiet technology is a technology that is flexible, uncomplicated, and cost effectively installed.

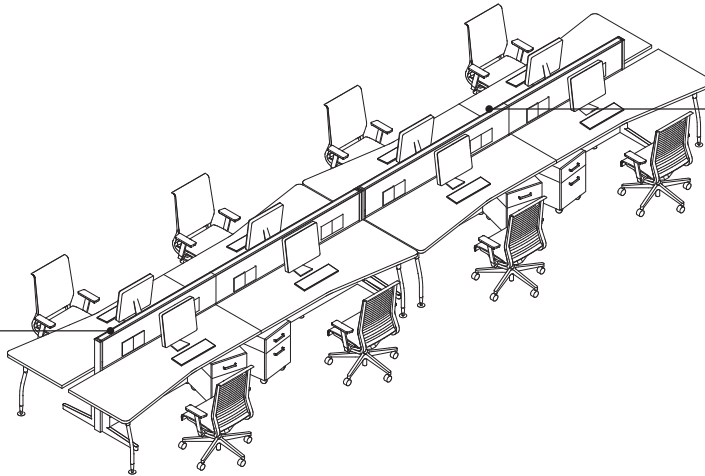

Sonet individual soundmasking is an individual speech privacy system based on Qt quiet technology, consisting of two emitters (can be expanded to four) and a volume control that is plugged into any wall outlet.

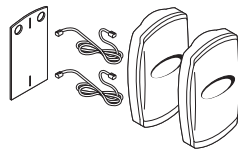

Sonet individual soundmasking system

Actual Dimensions

	Emitters	Volume Control
Length	5"	3 ² / ₃ "
Width	3"	6 ¹ / ₃ "
Depth	1 ¹ / ₂ "	1 ¹ / ₂ "

Product Details

Sonet is a cost-effective solution for spot treatment of situations where one individual is being distracted by voices or other noise around them.

Sonet installs in an individual workstation and gives the user control over the placement and level of their soundmasking.

Connections

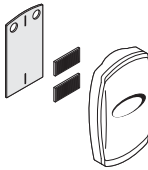

Soft wall mount



Hard wall mount

The Sonet emitters and volume control mount to the walls or panels in a workstation. A mounting plate is included for soft walls and Velcro pulls are included for hard walls.

The Sonet volume control should be placed wherever there is access to an electrical outlet.

Wiring and Cabling

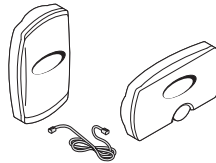

The Sonet emitters are connected to the volume control with pre-terminated modular telephone cords (included).

Surface Materials

The Sonet emitters and volume control are light gray plastic.

Application Topics

Sonet is designed for individual use and is meant for applications no larger than 400 square feet. The two speakers that come standard will provide coverage for 200 square feet. To cover 400 square feet, the two speaker extension kit must be ordered. For larger spaces, QtPro is recommended.

Technical Specifications

Sonet power consumption: 4 watts

Sonet radiated acoustic power: 0.001 acoustic watts.

Sonet power supply is 110v 50-60Hz. AC.

QtPro Room Control

Product Details

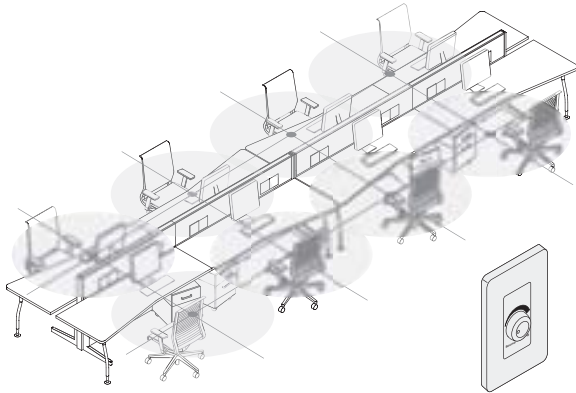

Room control allows users to adjust the sound masking level for an individual room or a space with two to eight emitters.

Connections

Room control unit is wall mounted. It fits in most standard electrical boxes and includes open back low voltage brackets. The unit supports 1-gang low voltage class two backless brackets or standard 1-gang electrical boxes. Install using RJ-45 connectors. There are no requirements for grounding since it is done over the CAT cables.

Wiring and Cabling

Room control can be its own run from the controller or part of a run to other areas.

Wiring: CAT 3, 5, 6 cables.

When using the room control, the controller needs to supply enough power over the cable run for the emitters and the room control(s). From the control modules, a single cable run can support 60 emitters; however, an added room control reduces the number of emitters that can be supported, because each room control counts as an emitter in the total for the run. The cable run can support up to a combination of 60 emitters and room control(s).

Surface Materials

Room control units are white.

Application Topics

Room control can be used to adjust the sound masking level for an individual room or a space with two to eight emitters. Since the Qt room control is designed for a room of up to eight emitters, a separate zone should be used in larger areas. The room control controlled room can be its own run from the controller or part of a run to other areas.

Room control is designed to work with any QtPro Soundmasking systems. It can be added to an existing QtPro Soundmasking installation.

The unit features a six position switch that adjusts the sound masking volume nominally in 2.5 dBA decrements.

Specifying QtPro Soundmasking

Specifying

QtPro Qt 100, Qt 300, and Qt 600 Control Modules	382
Rack Mount Bracket	383
Hole Saw Blade	384
Power Supply	385
Emitters	386
QtPro Room Control	387
Privacy Package	388
Active Emitter Power Supply	389
Active Emitter Power Injector	390
Active Emitter	391
Cables	392
Splitters	393
Couplers	394
Mounting Components	395
Sonet Qt Individual Soundmasking	398

QtPro Qt 100, Qt 300, and Qt 600 Control Modules

Standard Includes	Required to Specify
<ul style="list-style-type: none"> ▶ Need help? Product details, page 375 • One, three, or six soundmasking zones • Music or paging input jacks for Qt 100 • Music and paging input jacks for Qt 300 and Qt 600 • Installation and operations guide • 6' power cord • Attachment hardware • Holesaw driver bit 	<ul style="list-style-type: none"> ▶ Style number

Related Products	
<ul style="list-style-type: none"> • Emitters • Cables • Couplers • Mounting components 	<ul style="list-style-type: none"> ▶ Page 386 ▶ Page 392 ▶ Page 394 ▶ Page 395

Specification Information

Dimensions			Quantity in Package	Style Number	U.S. Price
D	W	H			

QtPro Qt 100, Qt 300, and Qt 600 Control Modules

Qt 100 - One Zone Control Module

7/8"	7"	3 1/2"	1	GSMQT100	\$1129
------	----	--------	---	-----------------	--------

Qt 300 - Three Zone Control Module

3 1/2"	11"	3 1/2"	1	GSMQT300	\$3100
--------	-----	--------	---	-----------------	--------

Qt 600 - Six Zone Control Module

3 1/2"	13 1/2"	3 1/2"	1	GSMQT600	\$4053
--------	---------	--------	---	-----------------	--------

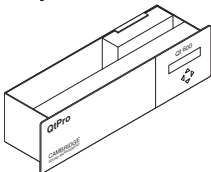
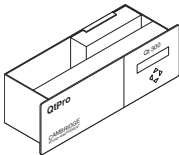

Tip: The Qt 300 and Qt 600 can be mounted in an equipment rack using the rack mount bracket.



For Canadian Pricing

Multiply U.S. Price by the Canadian price factor.

▶ See page 1 for details.

Rack Mount Bracket

For Qt 300 and Qt 600

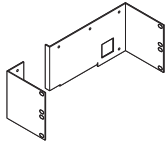

Tip: The rack mount bracket is required to mount the QtPro Qt 300 and Qt 600 control modules in an equipment rack.

Tip: If the QtPro Qt 300 and Qt 600 are to be mounted on the wall, the rack mount bracket is not required.

Standard Includes	Required to Specify
-------------------	---------------------

- | | |
|--|--|
| <ul style="list-style-type: none"> ▶ Need help? Product details, page 375 | <ul style="list-style-type: none"> • Rack mount bracket <p>Style number</p> |
|--|--|

Specification Information		
• Style Number	• Quantity in Package	• U.S. Price

GSM600RM	1	\$56
----------	---	------



For Canadian Pricing

Multiply U.S. Price by the Canadian price factor.

▶ See page 1 for details.

Hole Saw Blade

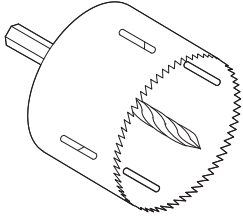

Tip: One holesaw blade is included with every control module. Order GSMHS1 for replacement or extra hole-saw blades.

Standard Includes	Required to Specify
-------------------	---------------------

- | | | |
|--|--|--|
| <ul style="list-style-type: none"> ▶ Need help? Product details, page 375 | <ul style="list-style-type: none"> • Hole saw blade | <ul style="list-style-type: none"> Style number |
|--|--|--|

Specification Information		
• Style Number	• Quantity in Package	• U.S. Price

• GSMHS1	1	\$52
•	•	•
•	•	•



For Canadian Pricing

Multiply U.S. Price by the Canadian price factor.

▶ See page 1 for details.

Power Supply

For QtPro Control Modules

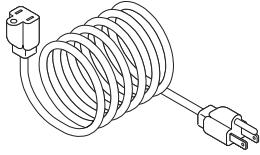

Tip: Power supply is included with control modules. Order GSMPS3 to replace lost or damaged power supply for Qt 300 and Qt 600 control modules.

Standard Includes	Required to Specify
<ul style="list-style-type: none"> ▶ Need help? Product details, page 376 • 100-240V AC power supply 	<ul style="list-style-type: none"> Style number

Specification Information

Style Number	Quantity in Package	U.S. Price
QtPro Qt 300 and Qt 600 Power Supply		
GSMPS3	1	\$275

 **For Canadian Pricing**
 Multiply U.S. Price by the Canadian price factor.
 ▶ See page 1 for details.

Emitters

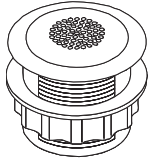

Tip: Emitters are used to project soundmasking, paging, and music.

Tip: Each emitter includes a 16' or 30' cable used to daisy chain to adjacent emitters.

Tip: Emitters with 16' cables will be used for most standard installations.

Tip: Emitters with 30' cables will be used for open-plenum installations to allow for appropriate visual management of cables.

Standard Includes	Required to Specify
-------------------	---------------------

- | | |
|--|---|
| <ul style="list-style-type: none"> ▶ Need help? Product details, page 375 | <ul style="list-style-type: none"> • Miniature direct field speaker with adjustable attachment sleeve • 16' or 30' CAT-3 or equivalent plenum-rated cable with RJ45 plugs attached to ends • 3 dip switches that adjust volume down on each emitter 3dB, 6dB, or 9dB lower increments than the overall system volume level |
|--|---|

Style number

Related Products

- | | |
|--|--|
| <ul style="list-style-type: none"> • QtPro control modules • QtPro cables • QtPro couplers • QtPro mounting components | <ul style="list-style-type: none"> ▶ Page 382 ▶ Page 392 ▶ Page 394 ▶ Page 395 |
|--|--|

Specification Information				
Dimensions		Quantity in Package	Style Number	U.S. Price
W	H			

Four Pack Emitters with 16' Cables				
3 1/2"	2 1/2"	4	GSMEMIT4	\$550

3 1/2"	2 1/2"	4	GSM30EMIT4	\$653
--------	--------	---	-------------------	-------

Four Pack Emitters with 30' Cables				
3 1/2"	2 1/2"	4	GSM30EMIT4	\$653



For Canadian Pricing

Multiply U.S. Price by the Canadian price factor.

▶ See page 1 for details.

QtPro Room Control



Tip: The QtPro room control can be used to adjust the sound masking level for an individual room or a space with two to eight emitters. A separate zone should be used in larger areas.

Tip: The length of the power cord on the Qt 100, Qt 300, and Qt 600 is 6'.

Standard Includes	Required to Specify
-------------------	---------------------

- | | |
|--|--------------------------------|
| ▶ Need help? Product details, page 380 | • Room control
Style number |
|--|--------------------------------|

Related Products

- | | |
|----------|------------|
| • Qt 100 | ▶ Page 382 |
| • Qt 300 | ▶ Page 382 |
| • Qt 600 | ▶ Page 382 |

Specification Information				
• Dimensions			• Style	• U.S.
D	W	H	Number	Price

:	:	:	:	:
:	:	:	:	:
:	:	:	:	:
:	:	:	:	:
:	:	:	:	:
:	:	:	:	:
:	:	:	:	:
:	:	:	:	:
:	:	:	:	:
:	:	:	:	:
:	:	:	:	:
:	:	:	:	:
:	:	:	:	:
:	:	:	:	:
:	:	:	:	:
:	:	:	:	:
:	:	:	:	:
:	:	:	:	:
:	:	:	:	:
:	:	:	:	:
:	:	:	:	:
:	:	:	:	:
:	:	:	:	:
:	:	:	:	:
:	:	:	:	:
:	:	:	:	:
:	:	:	:	:
:	:	:	:	:
:	:	:	:	:
:	:	:	:	:
:	:	:	:	:
:	:	:	:	:
:	:	:	:	:
:	:	:	:	:
:	:	:	:	:
:	:	:	:	:
:	:	:	:	:
:	:	:	:	:
:	:	:	:	:
:	:	:	:	:
:	:	:	:	:
:	:	:	:	:
:	:	:	:	:
:	:	:	:	:
:	:	:	:	:
:	:	:	:	:
:	:	:	:	:
:	:	:	:	:
:	:	:	:	:
:	:	:	:	:
:	:	:	:	:
:	:	:	:	:
:	:	:	:	:
:	:	:	:	:
:	:	:	:	:
:	:	:	:	:
:	:	:	:	:
:	:	:	:	:
:	:	:	:	:
:	:	:	:	:
:	:	:	:	:
:	:	:	:	:
:	:	:	:	:
:	:	:	:	:
:	:	:	:	:
:	:	:	:	:
:	:	:	:	:
:	:	:	:	:
:	:	:	:	:
:	:	:	:	:
:	:	:	:	:
:	:	:	:	:
:	:	:	:	:
:	:	:	:	:
:	:	:	:	:
:	:	:	:	:
:	:	:	:	:
:	:	:	:	:
:	:	:	:	:
:	:	:	:	:
:	:	:	:	:
:	:	:	:	:
:	:	:	:	:
:	:	:	:	:
:	:	:	:	:
:	:	:	:	:
:	:	:	:	:
:	:	:	:	:
:	:	:	:	:
:	:	:	:	:
:	:	:	:	:
:	:	:	:	:
:	:	:	:	:
:	:	:	:	:
:	:	:	:	:
:	:	:	:	:
:	:	:	:	:
:	:	:	:	:
:	:	:	:	:
:	:	:	:	:
:	:	:	:	:
:	:	:	:	:
:	:	:	:	:
:	:	:	:	:
:	:	:		

Privacy Package

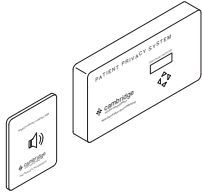

Tip: Privacy signs can be mounted on glass, surface-mounted with self-adhesive tape, or mounted using 1-gang electrical box.

Tip: Control module can be mounted to wall or flush-mounted with supplied box on suitable 4-gang electrical box.

Tip: Privacy package comes standard with one control module and two lighted privacy signs.

Standard Includes

- One wall mounted control module
- One 4-gang adaptor plate for control module
- Two automatically lighted privacy signs
- Two privacy sign adaptor plates
- Two 50' plenum rated cables for privacy sign
- One power supply
- Eight QT emitters
- Seven 16' audio cables
- One 50' home run audio cable
- One hole saw

Required to Specify

Style number

Related Products

- Emitters ▶ Page 386
- Cables ▶ Page 392
- Mounting components ▶ Page 395

Specification Information

Style Number	U.S. Price

Patient Privacy Package

GSMPPS	\$3598

Conference Room Privacy Package

GSMCRPS	\$3598



For Canadian Pricing

Multiply U.S. Price by the Canadian price factor.

▶ See page 1 for details.

Active Emitter Power Supply

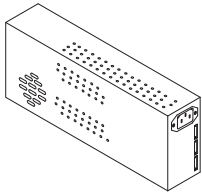

Tip: Active emitter power supply provides power to QT active emitters through active emitter power injectors.
 ▶ Page 374

Tip: Active emitter power supply powers up to 150 active emitters; three output connectors which power 50 emitters each.

Tip: Active emitter power supply is rack or wall mountable.

Standard Includes	Required to Specify
-------------------	---------------------

- | | |
|--|--------------------------------|
| ▶ Need help? Product details, page 374 | • Power supply
Style number |
|--|--------------------------------|

Related Products

- | | |
|--------------------------------|------------|
| • QtPro 300/600 control module | ▶ Page 382 |
| • Active emitters | ▶ Page 391 |
| • Mounting components | ▶ Page 395 |
| • Power injector | ▶ Page 390 |
| • Cables | ▶ Page 392 |

Specification Information				
---------------------------	--	--	--	--

• Dimensions			• Style	• U.S.
D	W	H	Number	Price
12½"	5"	2½"	GSM AEPS	\$708

 **For Canadian Pricing**
 Multiply U.S. Price by the Canadian price factor.
 ▶ See page 1 for details.

Active Emitter Power Injector

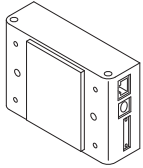

Tip: Active emitter power injectors supply power to up to 50 active emitters each; two output ports that can power 25 active emitters each.

Tip: Active emitter power injectors fit inside a standard 4x4 electrical enclosure, supplied by installer, and can be plenum or headend mounted.

Standard Includes	Required to Specify
-------------------	---------------------

- | | |
|--|--------------------------------------|
| ▶ Need help?
Product details,
page 374 | • Power injector

Style number |
|--|--------------------------------------|

Related Products

- | | |
|--------------------------------|------------|
| • QtPro 300/600 control module | ▶ Page 382 |
| • Active emitters | ▶ Page 391 |
| • Active emitters power supply | ▶ Page 389 |
| • Cables | ▶ Page 392 |

Specification Information				
---------------------------	--	--	--	--

• Dimensions			• Style	• U.S.
D	W	H	Number	Price
3¾"	2¾"	1¼"	GSMAEINJ	\$181



For Canadian Pricing

Multiply U.S. Price by the Canadian price factor.

▶ See page 1 for details.

Active Emitter

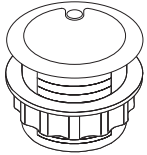

Tip: Active emitters are used to project soundmasking, paging, and music.

Tip: Each active emitter includes a 16' or 30' cable used to daisy chain to adjacent emitters.

Tip: Active emitters with 16' cables will be used for most standard installations.

Tip: Active emitters with 30' cables will be used for open-plenum installations to allow for appropriate visual management of cables.

Tip: Active emitters are compatible with the QT300 and QT600 control modules.

Tip: Active emitters require proper quantities of injectors and power supplies compliant with the application and specification instructions.

Tip: Active emitters' volume can be adjusted by 4.5 dB on 1.5 dB decrements from the overall system volume level.

Tip: Active emitters' are 17 dB louder than standard emitters.

Standard Includes	Required to Specify
<ul style="list-style-type: none"> ▶ Need help? Product details, page 374 • Four active emitters • 16' or 30' CAT 3 or equivalent plenum-rated cable with RJ45 plugs attached to ends • Three dip switches that adjust volume down on each emitter by 4.5dB on 1.5dB decrements lower than the overall system volume level 	<p>Style number</p>

Related Products	
<ul style="list-style-type: none"> • QtPro 300/600 control module • Cables • Couplers • Active emitter power injector • Active emitters power supply • Active emitters mount brackets • 400' home run cable 	<ul style="list-style-type: none"> ▶ Page 382 ▶ Page 392 ▶ Page 394 ▶ Page 390 ▶ Page 389 ▶ Page 396 ▶ Page 392

Specification Information		
Dimensions	Style	U.S.
D W	Number	Price

Four Pack Active Emitters with 16' Cables

3 1/2"	3 1/4"	GSM AEMIT4	\$617
:	:	:	:

Four Pack Active Emitters with 30' Cables

3 1/2"	3 1/4"	GSM30AEMIT4	\$710
:	:	:	:

 **For Canadian Pricing**
 Multiply U.S. Price by the Canadian price factor.
 ▶ See page 1 for details.

Cables

Standard Includes	Required to Specify
<ul style="list-style-type: none"> ▶ Need help? Product details, page 376 • CAT-3 or equivalent plenum-rated cables with RJ45 plugs attached to ends 	<ul style="list-style-type: none"> ▶ Style number

Related Products	
<ul style="list-style-type: none"> • QtPro control modules • Emitters • Couplers • Mounting components 	<ul style="list-style-type: none"> ▶ Page 382 ▶ Page 386 ▶ Page 394 ▶ Page 395

Specification Information			
• Dimensions L	• Quantity in Package	• Style Number	• U.S. Price

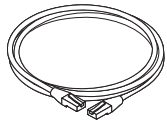

CAT-3 Cables

10'	1	GSMCABLE10	\$ 43
25'	1	GSMCABLE25	\$ 68
50'	1	GSMCABLE50	\$ 124
75'	1	GSMCABLE75	\$ 235
100'	1	GSMCABLE100	\$ 308
16' Cables, Package of 4	4	GSMCPAK4	\$ 109

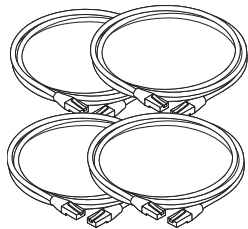

14 Gauge 2 Conductor Cable

400'	1	GSMAEHRC	\$1049
------	---	-----------------	--------

Tip: The 400' cable is used as the home run cable for active emitters.



For Canadian Pricing
 Multiply U.S. Price by the Canadian price factor.
 ▶ See page 1 for details.

Splitters

Standard Includes	Required to Specify
<ul style="list-style-type: none"> ▶ Need help? Product details, page 376 	<ul style="list-style-type: none"> • Two way or four way splitter with 10" male cable, if selected: grey • Two or four female RJ 45 jacks, if selected

Related Products
<ul style="list-style-type: none"> • QtPro control modules ▶ Page 382 • Emitters ▶ Page 386 • Couplers ▶ Page 394 • Mounting components ▶ Page 395

Specification Information		
• Quantity in Package	• Style Number	• U.S. Price

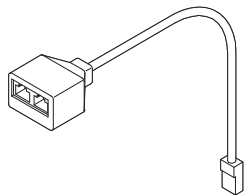

Two-Way Splitter

1	GSM2WSPLIT	\$70
---	-------------------	------

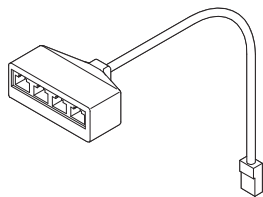

Four-Way Splitter

1	GSM4WSPLIT	\$68
---	-------------------	------

 **For Canadian Pricing**
 Multiply U.S. Price by the Canadian price factor.
 ▶ See page 1 for details.

Couplers

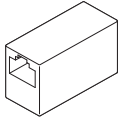

Standard Includes	Required to Specify
-------------------	---------------------

- | | |
|--|--|
| ▶ Need help?
Product details,
page 376 | • Two female RJ 45 jacks: grey

Style number |
|--|--|

Related Products

- | | |
|-------------------------|------------|
| • QtPro control modules | ▶ Page 382 |
| • Emitters | ▶ Page 386 |
| • Couplers | ▶ Page 394 |
| • Mounting components | ▶ Page 395 |

Specification Information		
• Quantity in • Package	• Style • Number	• U.S. • Price

1	GSMFFCOUP	\$25
:	:	:
:	:	:



For Canadian Pricing
Multiply U.S. Price by the
Canadian price factor.
▶ See page 1 for details.

Mounting Components

External Mounting Bracket

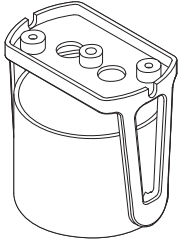

Tip: For traditional drop down ceiling tiles, emitters are installed in the tiles and no additional mounting components are needed. The mounting components are used in open plenum or special ceiling conditions.

Tip: In open plenum or in special ceiling conditions, additional components may be required.

Tip: Emitters are not included with mounting components.

Standard Includes	Required to Specify
<ul style="list-style-type: none"> ▶ Need help? Product details, page 375 • Enclosure with ceiling and wall mount 	<ul style="list-style-type: none"> ▶ Style number

Related Products
<ul style="list-style-type: none"> • QtPro control modules ▶ Page 382 • Emitters ▶ Page 386 • Couplers ▶ Page 394

Specification Information		
Quantity in Package	Style Number	U.S. Price
1	GSMEEM1	\$52

External Mounting Clamp

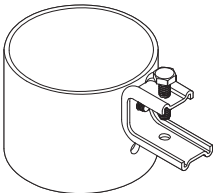

Tip: External mounting clamp is used to mount emitters to a beam. It is important to verify beam dimensions, the clamp requires a minimum beam thickness of 1/4" and no more than a maximum thickness of 3/4" for proper installation.

Tip: Emitters are not included with mounting components.

Standard Includes	Required to Specify
<ul style="list-style-type: none"> ▶ Need help? Product details, page 375 • Emitter sleeve • Beam C clamp, fits beams 1/4" to 3/4" in thickness 	<ul style="list-style-type: none"> ▶ Style number

Related Products
<ul style="list-style-type: none"> • QtPro control modules ▶ Page 382 • Emitters ▶ Page 386 • Couplers ▶ Page 394

Specification Information		
Quantity in Package	Style Number	U.S. Price
1	GSMEEM2	\$54

Soundmasking

For Canadian Pricing
 Multiply U.S. Price by the Canadian price factor.
 ▶ See page 1 for details.

Active Emitter External Mounting Bracket

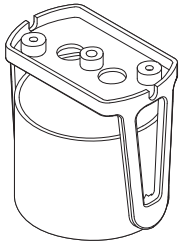

Tip: For traditional drop down ceiling tiles, active emitters are installed in the tiles and no additional mounting components are needed. The mounting components are used in open plenum or special ceiling conditions.

Tip: In open plenum or in special ceiling conditions, additional components may be required.

Tip: Active emitters are not included with mounting components.

Standard Includes	Required to Specify
<ul style="list-style-type: none"> ▶ Need help? Product details, page 375 • Enclosure with ceiling and wall mount 	<ul style="list-style-type: none"> Style number

Related Products
<ul style="list-style-type: none"> • QtPro control modules • Active emitters • Couplers

Specification Information		
Quantity in Package	Style Number	U.S. Price
1	GSMAEEM1	\$53

Active Emitter External Mounting Clamp

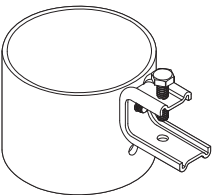

Tip: External mounting clamp is used to mount active emitters to a beam. It is important to verify beam dimensions, the clamp requires a minimum beam thickness of 1/4" and no more than a maximum thickness of 3/4" for proper installation.

Tip: Active emitters are not included with mounting components.

Standard Includes	Required to Specify
<ul style="list-style-type: none"> ▶ Need help? Product details, page 375 • Active emitter sleeve • Beam C clamp, fits beams 1/4" to 3/4" in thickness 	<ul style="list-style-type: none"> Style number

Related Products
<ul style="list-style-type: none"> • QtPro control modules • Active emitters • Couplers

Specification Information		
Quantity in Package	Style Number	U.S. Price
1	GSMAEEM2	\$56



For Canadian Pricing
 Multiply U.S. Price by the Canadian price factor.
 ▶ See page 1 for details.

Drywall Mounting Bracket

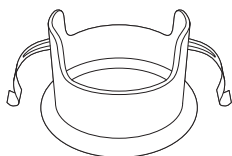

Tip: For traditional drop down ceiling tiles, emitters are installed in the tiles and no additional mounting components are needed. The mounting components are used in open plenum or special ceiling conditions.

Tip: Emitters are not included with mounting components.

Standard Includes	Required to Specify
-------------------	---------------------

- | | |
|--|--|
| ▶ Need help? Product details, page 375 | <ul style="list-style-type: none"> • Enclosure • Two clips • Installation key |
| | Style number |

Related Products

- | | |
|-------------------------|------------|
| • QtPro control modules | ▶ Page 382 |
| • Emitters | ▶ Page 386 |
| • Couplers | ▶ Page 394 |
| • Mounting components | ▶ Page 395 |

Specification Information		
• Quantity in Package	• Style Number	• U.S. Price

1	GSMDEM3	\$29
:	:	:
:	:	:



For Canadian Pricing
 Multiply U.S. Price by the Canadian price factor.
 ▶ See page 1 for details.

Sonet Qt Individual Soundmasking

Sonet Qt Individual Soundmasking System with Two Speakers

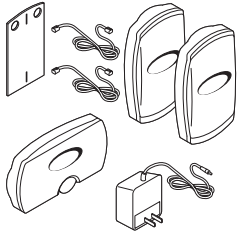

Tip: Sonet Qt provides coverage for up to 200 square feet. To reach the maximum coverage of 400 square feet, also specify the extension kit, GSMSONETXT.

Standard Includes	Required to Specify
<ul style="list-style-type: none"> ▶ Need help? Product details, page 378 • Sonet Qt controller • Two Sonet emitters • All required wiring • Mounting hardware • Power supply 	Style number

Specification Information		
Quantity in Package	Style Number	U.S. Price

1	GSMSONET	\$385
:	:	:

Sonet Two Speaker Extension Kit

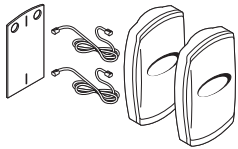

Tip: The Sonet extension kit can be specified to add two speakers to Sonet Qt, extending the coverage for up to 400 square feet.

Standard Includes	Required to Specify
<ul style="list-style-type: none"> ▶ Need help? Product details, page 378 • Two Sonet emitters • Wiring and mounting hardware 	Style number

Specification Information		
Quantity in Package	Style Number	U.S. Price

1	GSMSONETXT	\$142
:	:	:



For Canadian Pricing
 Multiply U.S. Price by the Canadian price factor.
 ▶ See page 1 for details.

Understanding IRYS Pod



Product Details

IRYS Pod

400

IRYS Pod

IRYS Pod

IRYS pod is the solution for providing choice and control to people in today's open workplace environment. Providing both an enclosed space for focus work and an exterior touchdown space, IRYS pod allows individuals and small groups to find the space they need to be productive.

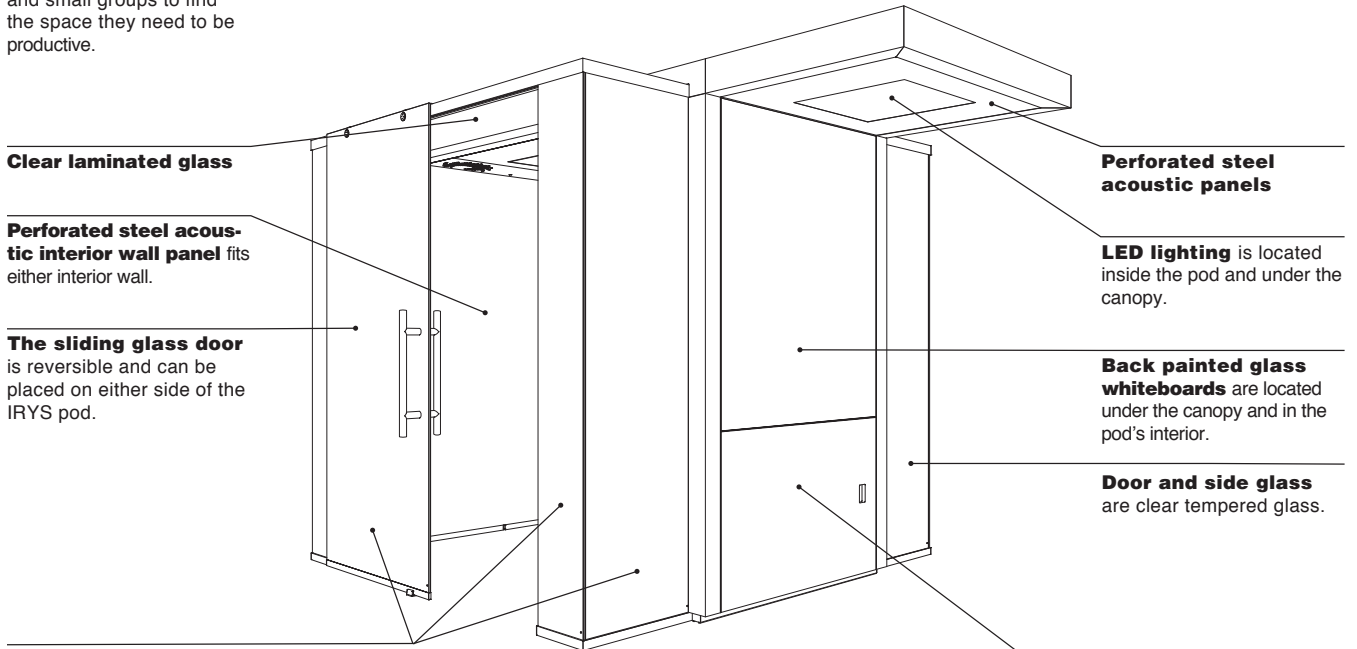

Clear laminated glass

Perforated steel acoustic interior wall panel fits either interior wall.

The sliding glass door is reversible and can be placed on either side of the IRYS pod.

Perforated steel acoustic panels

LED lighting is located inside the pod and under the canopy.

Back painted glass whiteboards are located under the canopy and in the pod's interior.

Door and side glass are clear tempered glass.

Door and side glass are clear tempered glass.

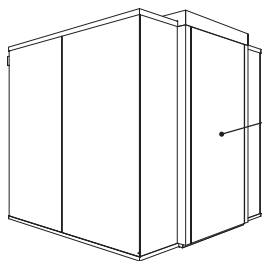

High-Pressure Laminate (HPL) panels are available in a light or dark finish option. Wood grain runs vertical on all vertical surfaces and front to back on all horizontal surfaces.

**Can be installed under ceilings as low as 9 foot.*

Actual Dimensions

Depth	8' 5 ³ / ₄ "
Width (footprint)	8' 5 ³ / ₄ "
Width (incl. overhang)	11' 9 ³ / ₄ "
Height	8' 1 ¹ / ₂ "
Leveling range	+/- 3/8"

Dimensions

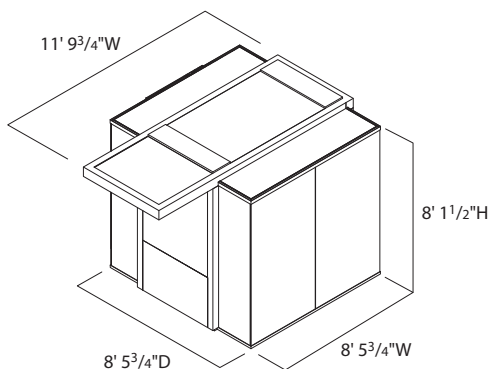

Understanding IRYS pod dimensions is important for proper planning.

Structure

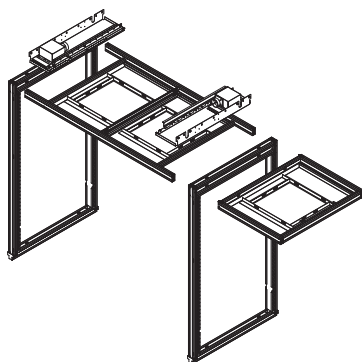

The **bridge** is the backbone of the IRYS pod. The aluminum frame of the bridge provides the structure on which the solid panels are hung, where electrical, lighting, and ventilation components are housed, and from which the glass walls are connected.

Product Details

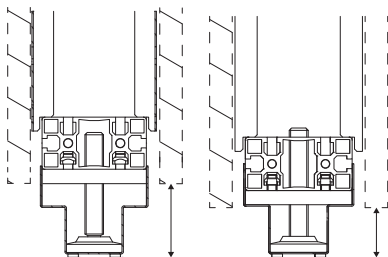

Leveling capability for the bridge is provided by levelers located within the floor track. Levelers provide a leveling range from 1 3/4" to 2 1/2".

Solid surfaces on IRYS pod are comprised of High-Pressure Laminate (HPL) finishes, whiteboards, or in the case of face B, a perforated steel panel to assist with acoustic performance.

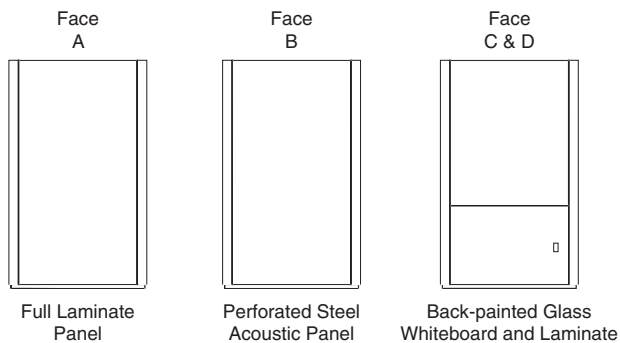
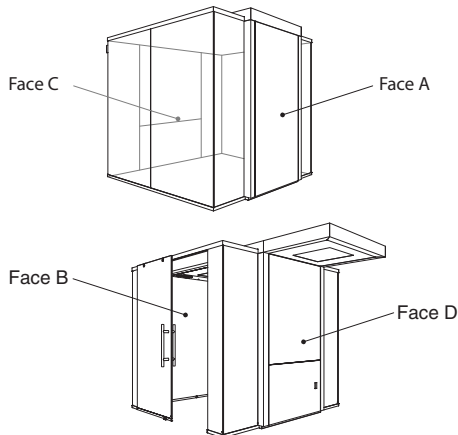

Tip: Faces B and C are reversible.

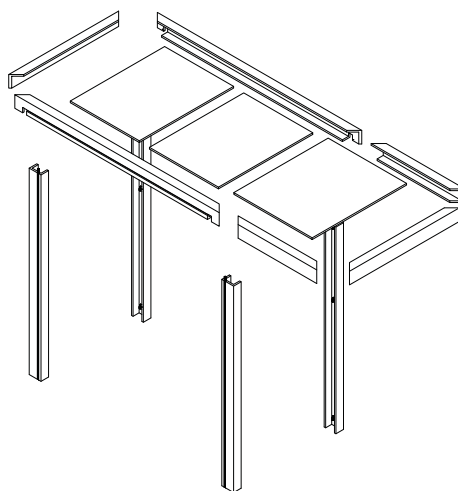

Other surfaces used for trim on the bridge edges and the finished top of the IRYS pod are provided in laminate that matches the material used on face A and the lower parts of faces C and D.

IRYS Pod, continued

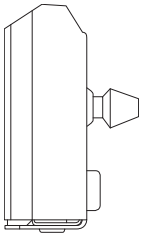

Hook rivets are used to attach solid surfaces to the IRYS pod structure.

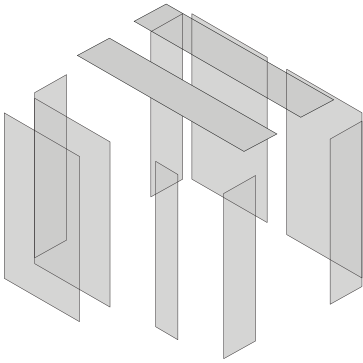

Glass elements complete the IRYS pod providing space that allows for concentration in an individual or team atmosphere. Top and bottom profiles are constructed of aluminum. Bottom profile secures to floor using either velcro for carpet or tape.

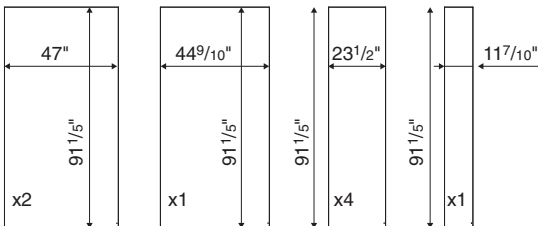
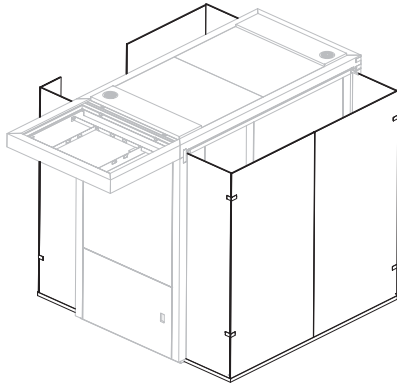

The main glass walls are composed of eight segments of 1/2" tempered glass.

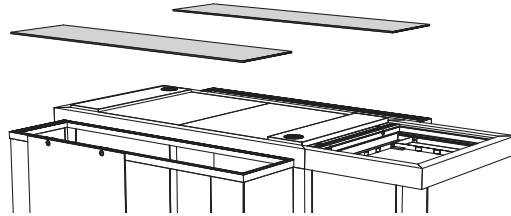

Two glass skylights allow light to enter the interior of the pod. The skylights are composed of the 1/2" thick laminated glass.

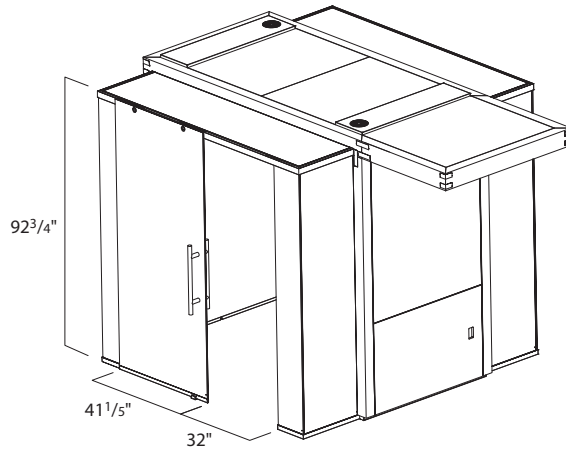

The glass door is reversible and can be located on either side of the IRYS pod. The door is comprised of 3/8" tempered glass and features open/close assist.

Electrical and Components

Electric power is delivered through a hardwired connection which will need to go to a junction box in the floor or up to a junction box in the ceiling. One 15 or 20 amp circuit is sufficient for the unit. Lighting, fan, outlets, and sensors share one circuit within the pod. Power infeed can be routed from the floor between the walls of the IRYS pod bridge, or dropped from a ceiling j-box via a whip. From the junction box, included with the IRYS pod, power is routed to the two 15 amp duplex outlets that are provided, one in each lower wood tile below the glass whiteboard. All internal wiring in the pod is copper. Lights and fan are controlled by an occupancy sensor.

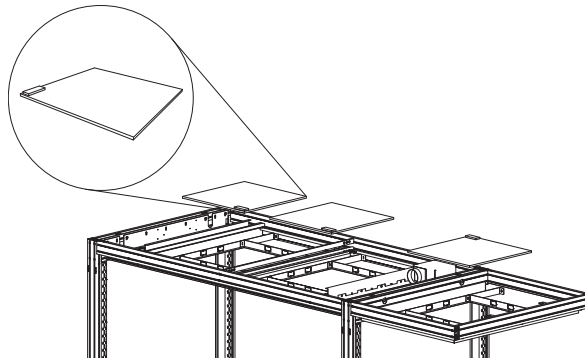

Three LED light panels are used for illumination. The lights are 4000k with a max brightness of 5200 lumens. The facility light level is able to be set through a 0-10 volt dim control switch in the electrical assembly in the ceiling (not user accessible).

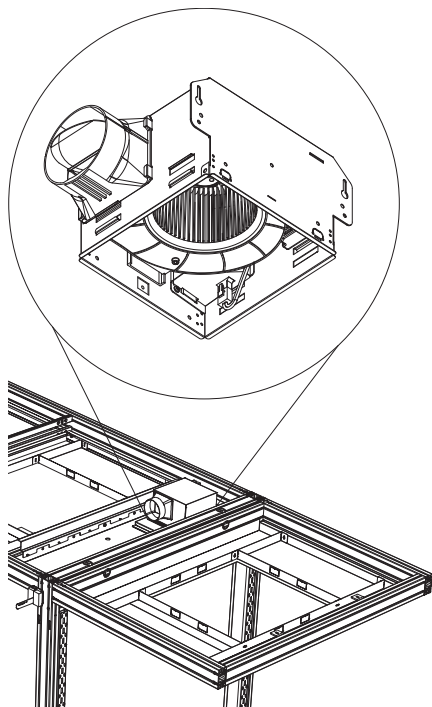

The extraction fan is rated at 80 CFM and 0.8 sones. The fan has a built-in backdraft damper.

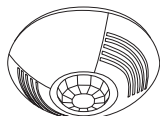

The occupancy sensor activates the lights and fan. The sensor operates at low voltage and utilizes both ultrasonic and infrared sensing to avoid false triggering.

When ordering IRYS pod, the electrical configuration may be specified one of two ways:

- Option 1: Factory assembled harness which will save time during installation.
- Option 2: Necessary electrical components provided allowing for the electrician to assemble on site.

Tip: When specifying, it will be important to weigh the upfront added cost of option 1 which provides time savings during installation against the extra time installers will spend waiting while the electrician completes the wiring work.



Seismic conditions can be accommodated with the IRYS pod. Should the building's engineer of record determine a seismic requirement for the IRYS pod installation is needed, a seismic floor guide is available.

Sprinkler requirements in the IRYS pod are an important consideration. Local codes may impact the number and location of sprinklers mandated. It is important to check with the local inspector to ensure that the IRYS pod installation meets any requirements in this regard.



Specifying IRYS Pod



Specifying

IRYS Pod

406

IRYS Pod

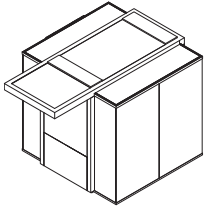

	Standard Includes	Required to Specify
<p>▶ Need help? Product details, page 400</p>	<ul style="list-style-type: none"> • Pre-assembled framing components • One full height: laminate panel • Two 2/3-height whiteboards: back-painted (white only) • Two 1/3-height: laminate panels • One full height perforated steel panel (white only) • Ceiling panels (white only) • Three LED lights • One extraction fan (ventilation) • Top and bottom glass channels • 1/2" thick glass panels • 3/8" thick glass sliding door and components • Occupancy sensor kit for lights and fan 	<ol style="list-style-type: none"> 1 Style number 2 Laminate for panels: light or dark 3 Options, if selected (see below)

	Options	U.S. Price	Required to Specify
Electrical Configuration	Field assembly	No cost	Specify <i>with field assembly</i> .
	Factory-assembly harness	+\$1650	Specify <i>with factory-assembly harness</i> .
Seismic Bracket	No bracket	No cost	Specify <i>with no bracket</i> .
	Seismic bracket	+\$ 25	Specify <i>with seismic bracket</i> .

Specification Information				
Dimensions			Style	U.S.
D	W	H	Number	Base Price
8' 5 3/4"	11' 9 3/4"	8' 1 1/2"	IRYPOD	\$60,000



For Canadian Pricing
 Multiply U.S. Price by the Canadian price factor.
 ▶ See page 1 for details.

Surface Materials

Surface Materials	408
Availability Matrices	412

Surface Materials

This listing includes all the surface material choices that are available for the products in this specification guide.

Tip: See Availability Matrices on page 412 for exact surface material availability on each Privacy Wall component.

Resources

For more information about surface materials, refer to the following resources:

Additional surface materials specification tools are available to assist you in the specification process—the Surface Materials Binders.

The global surface materials palette is a core collection of finishes that is available across multiple geographies (Americas/EMEA – Europe, Middle East, and Africa/APAC – Asia Pacific) and on global product lines, where applicable. For a list of finishes included in the offering, see the *Surface Materials Reference Manual*. Additional details, like product approvals by geography and finish number conversions, can also be found in the *Surface Materials Reference Manual* or see steelcase.com/surface-materials.

Surface Materials

Binders

- Surface Materials Reference Manual
- A complete set of swatch cards for hard surfaces, vertical surface fabrics, and seating upholstery

Architectural Solutions

Binder

- Brochures
- Swatch cards

Paint

Steelcase Surfaces

Applies to:

- Privacy Wall solid swing door

Price Group 1

Architectural Paint

- 4843 Linen
- 4844 Glacier
- 4849 Vapor

Smooth Paint

- 4242 Milk
- 4858 Seagull
- 4859 Silk

Applies to:

- Privacy Wall panel surface
- Privacy Wall panel frame
- Privacy Wall glass swing door
- Privacy Wall glass door frame
- Privacy Wall slider door
- Privacy Wall door frame
- Privacy Wall ceiling track
- Privacy Wall base trim
- Privacy Wall post, wall channel, adapter, and mini end
- Privacy Wall feature strips
- Privacy Wall furniture reveal strips
- Clerestory Panel surface

Price Group 1

Architectural Paint

- 4843 Linen
- 4844 Glacier
- 4849 Vapor

Smooth Paint

- 4242 Milk
- 4858 Seagull
- 4859 Silk

Textured Paint

- 7207 Black
- 7225 Sand
- 7236 Fog **E**
- 7237 Slate **E**
- 7238 Fieldstone
- 7239 Midnight
- 7241 Arctic White
- 7243 Seagull
- 7278 Dark Bronze
- 7360 Merle

Price Group 2

Smooth Metallic Paint

- 4728 Nickel Metallic
- 4743 Mineral Metallic
- 4744 Pearl Metallic
- 4750 Champagne Metallic
- 4752 Steel Metallic **E**
- 4788 Gold Dust Metallic **E**
- 4798 Sterling Metallic
- 4799 Platinum Metallic
- 4803 Near Black Metallic

Textured Metallic Paint

- 7245 Carbon Metallic
- 7246 Midnight Metallic

Tip: Metallic paint is not available on solid and Clerestory panels larger than 36"W.

Tip: Textured and metallic paint is difficult to field repair and replicate original finish on large solid and Clerestory panel surfaces.

Custom Surfaces

Price Group 3

PerfectMatch

PerfectMatch is a service that allows you to create your own paint color. Refer to the *Surface Materials Reference Manual* for more information about this program.

Wood

Applies to:

- Privacy Wall door

Steelcase carefully selects veneer and solid wood for consistent color and grain structure. Wood is a natural material and variations will occur in color, grain and texture. These variations are part of the inherent natural beauty of wood and are not considered defects.

All wood products will darken with age and exposure to ultraviolet light. This is especially apparent with cherry and maple veneer. We recommend that desk accessories be rearranged periodically to ensure even aging of wood surfaces.

When storing your wood furniture, please follow the following guidelines:

- Do not store products in trailers
- Store products in areas that simulate office temperatures (60°F to 90°F)
- Store products in areas that maintain constant, office-like humidity levels
- Keep product away from light. Cover products to make sure they are not exposed to light.

Steelcase Surfaces

Veneer

Veneers are matched for proper balance and consistency. Veneers are available flat cut or quarter cut, except for Oak, which is rift cut. Refer to the *Surface Materials Reference Manual* for descriptions of each cut.

Open-pore finish is a medium gloss finish that leaves the wood grain texture visible to the eye and distinguishable to the touch.

Flat-cut open-pore finish choices

- 3062 FC/OP Graphite Walnut
- 3402 FC/OP Clear Cherry (Aged)
- 3412 FC/OP Natural Cherry **E**
- 3422 FC/OP Medium Cherry
- 3522 FC/OP Clear Maple*
- 3572 FC/OP Amber on Maple **E**
- 3592 FC/OP Blonde on Maple
- 3702 FC/OP Clear Walnut
- 3712 FC/OP Natural Walnut
- 3722 FC/OP Dark Mahogany on Walnut
- 3752 FC/OP Medium Walnut
- 3762 FC/OP Dark Walnut
- 3772 FC/OP Medium Mahogany on Walnut

Quarter-cut open-pore finish choices

- 3222 QC/OP Clear Maple*
- 3272 QC/OP Amber on Maple **E**
- 3292 QC/OP Blonde on Maple

Rift-cut open-pore finish choices

- 3602 RC/OP Desert Oak
- 3612 RC/OP Warm Oak **E**
- 3692 RC/OP Espresso Oak

**To ensure an understanding of the color ranges and characteristic variations of natural veneer, a sign-off sheet is required prior to orders being accepted for this clear-coat finish. The sign-off sheet is available through Steelcase advertising stock. Form number 05-0001370.*

E = Established

Select Surfaces

For information on products within Select Surfaces, including accent paints and fabrics from Designtex, Gabriel, Kvadrat, and Pollack, please refer to the *Surface Materials Reference Manual* or visit steelcase.com/surface-materials under the Select Surfaces section.

Natural Veneer

Natural veneer is available in the Select Surfaces offering. Natural veneer may have extended leadtimes. Place your order as you normally would for any other finish, calling out the appropriate finish code. Natural veneers are Graded-In as Wood Group 1 pricing.

The following finishes are available through the natural veneer offering:

Flat-cut open-pore finish choices

35A2 FC/OP Blanch Maple
37A2 FC/OP Thunder Walnut

Quarter-cut open-pore finish choices

32A2 QC/OP Blanch Maple
33A2 QC/OP Thunder Walnut

Rift-cut open-pore finish choices

36A2 RC/OP Volcanic Oak

Planked Veneer

Planked veneer is available in the Select Surfaces offering. Planked veneer may have extended leadtimes. Place your order as you normally would for any other finish, calling out the appropriate finish code.

The following finishes are available through the planked veneer offering:

Wood Group 1

3P41 OP Planked Cherry
3P51 OP Planked Maple
3P61 OP Planked Oak
3P71 OP Planked Walnut

Tip: Known for its uniqueness, planked veneer has intentional and natural variations that include, but are not limited to: character marks, grain pattern, color, and natural color aging.

ⓔ = Established

Custom Surfaces

Customiz stain is a service that allows you to create your own stain colors and finishes on standard veneer. Customiz stain color is available on all product lines that offer wood veneer.

A \$500 stain-matching fee applies on CUSTOMIZ requests (Exception: The \$500 fee does not apply on matches to Coalesse standard finishes or for a low-gloss finish request on a standard color). The \$500 fee covers the cost of formulating the Customiz color finish and applies regardless of whether or not an order for product is placed.

In addition, an approval form must be signed to indicate customer acceptance of Customiz match. A \$1,500 initiation fee will be charged prior to first order entry. This initiation fee activates the finish for unlimited use on any Steelcase product for an 18 month time period. After the 18 month time period has lapsed, the Customiz finish may be reactivated for another 18 months for a \$1,000 fee at any point within five years after the \$1,500 initiation fee was paid. If the finish is not reactivated within five years after the \$1,500 initiation fee was paid, the finish will be culled and the customer will need to pay the \$1,500 initiation fee again. All style number related Customiz charges products are no cost as of April 2014. The matching and initiation fees are not discountable.

Customiz stain takes 10 days to formulate. Consult the *Surface Materials Reference Manual* for more information. Custom veneers are also available and must be quoted by Steelcase specials group. Customiz stain on custom veneers takes 2 to 4 weeks to formulate.

Requirements and information on ordering a Customiz stain color are found in the *Surface Materials Reference Manual*.

Plastic

Steelcase Surfaces

Applies to:

- Privacy Wall receptacle and cover plate
- Privacy Wall power and communication filler

6000 Black
6009 Arctic White
6249 Platinum Solid
6618 White
6654 Sand
6695 Midnight
6697 Fog

Metal

Steelcase Surfaces

Applies to:

- Privacy Wall door hardware

Price Group 1

9200 Satin Chrome

Price Group 2

9201 Polished Chrome

Applies to:

- Glass Selections panel frames
- Glass Selections door frames
- Glass Selections transitions
- Glass Selections pivot door leaf
- Glass Selections slider door pull
- Glass Selections feature strips

Clear Anodized Aluminum

Glass

Steelcase Surfaces

Tip: See Privacy Wall Glass Availability Matrix for glass exceptions on specific products.

► Page 414

Price Group 1

6500 Clear

Price Group 2

6540 Clear Laminated
6541 White Laminated

Customer-specified glass is available.

Price Group 3

6542 Satin

Price Group 4

6555 Ice

Price Group 6

6553 Wisp

Vertical Surface Fabric

Applies to:

- Privacy Wall panel surface
- Privacy Wall post, adapter, wall channel, and mini end
- Glass Selections Clerestory panel

Steelcase Surfaces

Price Group 1

Abacus ⓔ

P122 Entasis
P123 Portico
P124 Opus
P125 Cusp
P126 Artifact
P129 Atlas

Boccie

P200 New Rice
P201 New Almond
P202 New Nutmeg
P203 New Camel
P204 New Opal
P205 New Mist
P206 New Plum
P207 New Lichen
P208 New Spearmint
P209 New Sky

Buzz2

5F01 Camel ⓔ
5F03 Tomato
5F04 Red ⓔ
5F05 Burgundy
5F06 Sky ⓔ
5F07 Blue
5F08 Navy
5F10 Grape ⓔ
5F11 Eggplant ⓔ
5F15 Stone
5F16 Grey
5F17 Black
5G50 Dunegrass
5G51 Sable
5G52 Barley
5G53 Sunrise
5G54 Carrot
5G55 Pumpkin
5G56 Timber
5G57 Rouge
5G58 Chocolate
5G59 Meadow
5G60 Ivy
5G61 Cyan
5G62 Atlantic
5G63 Crocus
5G64 Alpine
5G65 Tornado

Charm

P505 Shell
P506 Mimosa
P507 Birch
P508 Sparkle
P509 Ginkgo
P510 Debut
P511 Clover
P512 Spicy
P513 Twilight

Embrasure ⓔ

P140 Colonnade
P141 Rotunda
P143 Baluster

Optic

P540 Hazel
P541 Twinkle
P542 Orion
P543 Seaglass
P544 Shine
P545 Halo
P546 Whiskey
P547 Bath
P548 Whisper
P549 Breezy
P550 Wry
P551 Glimmer

Rhythm

P555 Allegro
P556 Tempo
P557 Refrain
P558 Pitch
P559 Harmony
P560 Melody
P561 Stanza
P562 Opus

Price Group 2

Amiranté **E**

- 5664 Mink
- 5665 Ivory
- 5666 Silver Frost
- 5677 Moonglo
- 5679 Woodbine

Ashanti Reverse **E**

- 5654 Quince

Bariolage

- G200 New Etude
- G201 New Andante
- G202 New Cantata
- G203 New Adagio
- G204 New Melody
- G205 New Ballata
- G206 New Sonata

Bouquet **E**

- P165 Hosta
- P166 Dundee
- P169 Argenta
- P170 Hoya
- P173 Camomile

Code

- 5FA1 Fossil
- 5FA2 Gabbro
- 5FA3 Reed
- 5FA4 Bluff
- 5FA5 Sea Salt
- 5FA6 Cannon
- 5FA7 Tussah
- 5FA8 Mica
- 5FA9 Ecu
- 5FB1 Bamboo

Cogent: Geode Vertical **E**

- 5S38 Oyster
- 5S41 Sesame

Flip: Plain Jane

- 5F70 Mud Pie
- 5F71 Hummus
- 5F72 Petoskey
- 5F73 Pluto
- 5F74 Papyrus
- 5F94 Blizzard
- 5F95 Briquette

Fresco

- G001 Sandrift
- G002 Mistiblu
- G003 Faon
- G006 Chamoline
- G007 Grapenut
- G017 Flint

Latch

- P600 Seashell
- P601 Clam
- P602 Eggshell
- P603 Zen
- P604 Cool Gray
- P605 Armor
- P606 Sentinel
- P607 Rye
- P608 Billow
- P609 Nimbus

Milano **E**

- N002 Delft
- N003 Woodland
- N004 Sunshadow
- N005 Olivine
- N012 Teakwood

Select Surfaces

For information on products within Select Surfaces, including accent paints and fabrics from Designtex, Gabriel, Kvadrat, and Pollack, please refer to the *Surface Materials Reference Manual* or visit steelcase.com/surface-materials under the Select Surfaces section.

Custom Surfaces

Price Group COM (Customer's Own Material)

Fabric Approval and Yardage

To confirm whether a particular COM material has already been tested for use on a specific Steelcase product or to determine actual yardage requirements:

- Visit www.steelcase.com

For additional information regarding Customer's Own Material,

call 1.888.STEELCASE (1.888.783.3522) or send an e-mail to lineone@steelcase.com.

E = Established

Availability Matrices

Privacy Wall Paint Availability Matrix

	Price Group 1	Architectural Paint			Textured Paint							Smooth Paint				
		4843 Linen	4844 Glacier	4849 Vapor	7207 Black	7225 Sand	7236 Fog E	7237 Slate E	7238 Fieldstone	7239 Midnight	7241 Arctic White	7243 Seagull	7278 Dark Bronze	7360 Merle	4242 Milk	4858 Seagull
Privacy Wall solid panel		■	■	■	■	■	■	■	■	■	■	■	■	■	■	■
Privacy Wall glass panel frame		■	■	■	■	■	■	■	■	■	■	■	■	■	■	■
Privacy Wall Clerestory panel—solid panel		■	■	■	■	■	■	■	■	■	■	■	■	■	■	■
Privacy Wall Clerestory panel—glass panel frame		■	■	■	■	■	■	■	■	■	■	■	■	■	■	■
Privacy Wall door frame with transom		■	■	■	■	■	■	■	■	■	■	■	■	■	■	■
Privacy Wall full-height door frame		■	■	■	■	■	■	■	■	■	■	■	■	■	■	■
Privacy Wall solid swing door		■	■	■	■	■	■	■	■	■	■	■	■	■	■	■
Privacy Wall glass swing door		■	■	■	■	■	■	■	■	■	■	■	■	■	■	■
Privacy Wall ceiling channel		■	■	■	■	■	■	■	■	■	■	■	■	■	■	■
Privacy Wall base trim		■	■	■	■	■	■	■	■	■	■	■	■	■	■	■
Privacy Wall post, wall channel, mini end, and adapter		■	■	■	■	■	■	■	■	■	■	■	■	■	■	■
Privacy Wall feature strips		■	■	■	■	■	■	■	■	■	■	■	■	■	■	■
Privacy Wall furniture reveal strips		■	■	■	■	■	■	■	■	■	■	■	■	■	■	■

Tip: Metallic paint is not available on solid and Clerestory panels larger than 36"W.

Tip: Textured and metallic paint is difficult to field repair and replicate original finish on large solid and Clerestory panel surfaces.

Legend

- = Not available
- = Available
- = Available with exceptions
- E** = Established
- ▶ See specification pages for details.

Privacy Wall Glass Availability Matrix

	Price Group 1 6500 Clear	Price Group 2 6540 Clear Laminated	Price Group 3 6541 White Laminated	Price Group 4 6542 Satin	Price Group 5 6555 Ice	Price Group 6 6553 Wisp
Privacy Wall all-glass wall panels	■	■	■	■	■	■
Privacy Wall glass wall panels with three equal divided lites	■	■	■	■	■	■
Privacy Wall glass wall panels with four equal divided lites	■	■	■	■	■	■
Privacy Wall glass wall panels with four divided lites (transom-aligned top lite)	■	■	■	■	■	■
Privacy Wall glass wall panels with two divided lites (transom-aligned top lite)	■	■	■	■	■	■
Privacy Wall Clerestory wall panels	■	■	■	■	■	■
Privacy Wall door frames with transom	■	■	■	■	■	■
Privacy Wall full-height door leaves	■	■	■	■	■	■
Privacy Wall all-glass slider doors	■	■	■	■	■	■
Privacy Wall three and four equal divided lite slider doors	■	■	■	■	■	■
Privacy Wall two and four equal divided lite slider doors	■	■	■	■	■	■
Privacy Wall two and four transom-aligned lite slider doors	■	■	■	■	■	■
Privacy Wall glass lite butt glazed – lite scale glazing	■	■	•	•	•	•

▶ See page 104 to ensure that etched and pattern glass types are properly oriented during the planning process.

Legend

- = Not available
- = Available
- ▶ See specification pages for details.

Tip: COM glass for frame and glass kits must be 3/8" thick for structural integrity.

Tip: For information regarding vertical directional glass, see page 25.

Privacy Wall Glass Selections Availability Matrix

	Price Group 1	Price Group 2	Price Group 3	Price Group 4	Price Group 6
	6500 Clear	6540 Clear Laminated	6541 White Laminated	6542 Satin	6555 Ice
	6553 Wisp				
Glass Selections all-glass wall panels	■	■	■	■	■
Glass Selections all-glass frame and glass kits	■	■	■	■	■
Glass Selections wall panels with two divided lites (transom-aligned top lite)	■	■	■	■	■
Glass Selections two divided lite frame and glass kits	■	■	■	■	■
Glass Selections Clerestory wall panels	■	■	■	■	■
Glass Selections door frames with transom	■	■	■	■	■
Glass Selections full-height door leaves	■	■	■	■	■
Glass Selections transom-height door leaves	■	■	■	■	■
Glass Selections polished edge full-height and transom-height slider doors	•	•	•	•	•
Glass Selections polished edge slider door all-glass side panel	■	■	■	■	■
Glass Selections polished edge slider door transom and transom-height side panel	■	■	■	■	■
Glass Selections all-glass L-corner units	■	■	■	■	■
Glass Selections transom-height L-corner units	■	■	■	■	■
Glass Selections all-glass T-corner unit frame and glass kits	■	■	■	■	■
Glass Selections transom-height T-corner unit frame and glass kits	■	■	■	■	■
Shelf side support bracket	■	■	■	■	■

► See page 104 to ensure that etched and pattern glass types are properly oriented during the planning process.

Legend

- = Not available
- = Available
- See specification pages for details.

Tip: COM glass for frame and glass kits must be 3/8" thick for structural integrity.

Tip: For information regarding vertical directional glass, see page 25.



Resources

Wiring Schematics	418
Locations with Special Requirements	419
How to Calculate Power Needs	420
Style Number Index	422

Wiring Schematics

Details for the Electrician

Modular power components are offered in three different wiring schematics to allow you to match your specific wiring strategy to any typical building wiring plan.

Tip: All the components in an electrical system must use the same wiring schematic. The components are color coded and keyed to make it impossible to connect mismatched parts.

Black = Four-circuit, 3+1

Brown = Four-circuit, 2+2

Rust = Three-circuit, separate neutrals

Shared neutral conductors = 10 gauge

Separate neutral conductors = 10 gauge

Hot conductors = 10 gauge

Grounding conductors = 10 gauge

Four-Circuit, 3+1

Circuit Panel 1

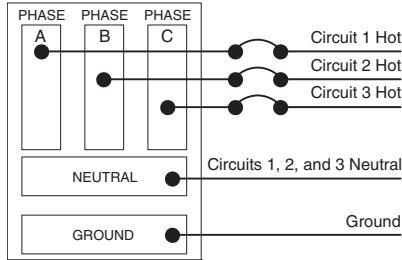

Circuit Panel 2

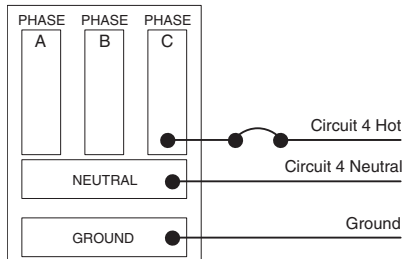

In the four-circuit 3+1 schematic, circuits 1, 2, and 3 are distributed from the first circuit panel and are supported with one shared neutral and one shared ground. Circuit 4 is distributed from a second circuit panel and is supported with a separate neutral and ground.

Single 3-Phase
Circuit Panel

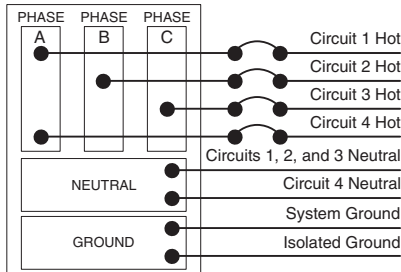

On a single 3-phase circuit panel, all four circuits are distributed as shown.

Four-Circuit, 2+2

Circuit Panel 1

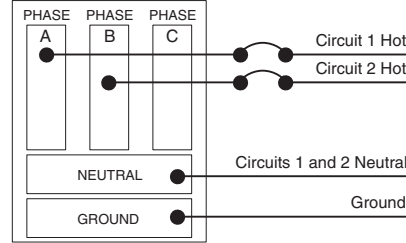

Circuit Panel 2

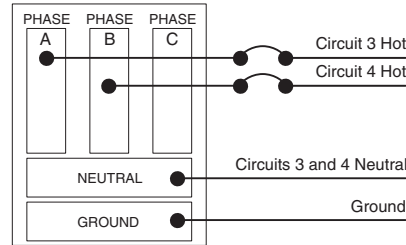

In the four-circuit 2+2 schematic, circuits 1 and 2 are distributed from two different phases from the first circuit panel and are supported with one shared neutral and one shared ground. Circuits 3 and 4 are distributed from a second circuit panel and supported by their own shared neutral and ground.

Single 3-Phase
Circuit Panel

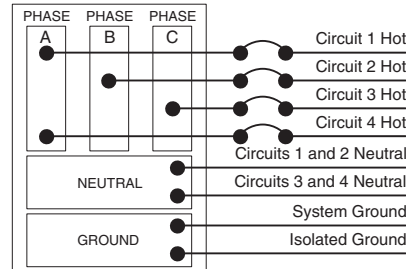

On a single 3-phase circuit panel, all four circuits are distributed as shown.

Split-Phase
Circuit Panel

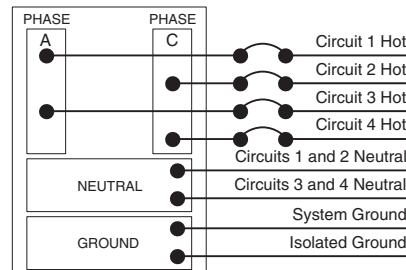

On a split-phase circuit panel, all four circuits are distributed as shown.

Three-Circuit, Separate Neutrals

Circuit Panel 1

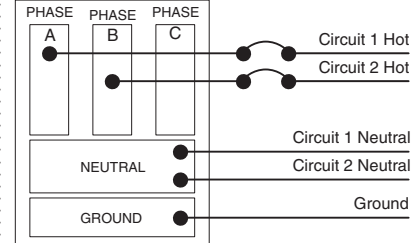

Circuit Panel 2

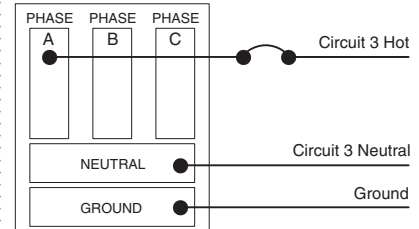

In the three-circuit, separate neutral schematic, circuits 1 and 2 are distributed from two different phases from the first circuit panel. Each circuit is supported with its own neutral and a common ground. Circuit 3 is distributed from the second circuit panel and is supported by its own neutral and ground.

Single 3-Phase
Circuit Panel

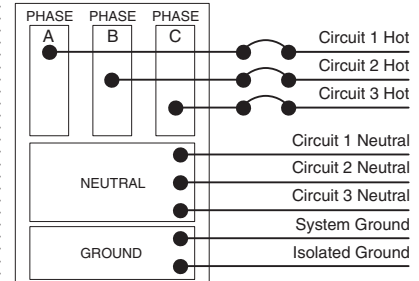

On a single 3-phase circuit panel, three circuits are distributed as shown.

Split-Phase
Circuit Panel

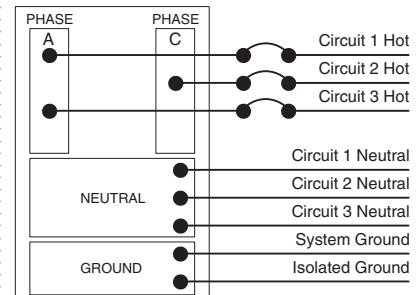

On a split-phase circuit panel, three circuits are distributed as shown.

Locations with Special Requirements

Local electrical codes

vary. Consult a qualified electrical contractor or engineer for the proper installation of all electrical components. Here are the special conditions for the cities of Chicago, New York, Los Angeles, and San Francisco.

Chicago

Chicago electrical code requires the power distribution network to be hardwired on site. There are no hardwired versions of Internode or Modular Power.

Architectural Solutions Low-Profile Floor can accommodate hardwiring using the standard conduit, wires, junction boxes, and receptacles that electrician's routinely use.

New York City

Privacy Wall modular power components, Architectural Solutions modular power, and Internode modular components are not approved for use in NYC.

Los Angeles

All modular power components are acceptable for use in Los Angeles. Cord-connected power connections are not acceptable. Wire and cable managers are not approved for use in Los Angeles.

San Francisco

Internode components are not approved for use in the city of San Francisco.

Architectural Solutions Low-Profile Floor can accommodate hardwiring using the standard conduit, wires, junction boxes, and receptacles that electrician's routinely use.

How to Calculate Power Needs

Use This to Determine How Many Power-Ins You'll Need

When planning a power network, you must calculate the amperage requirements of all your electrical components so you can provide sufficient electricity to power them.

If your usage is not known in advance:

The National Electrical Code (NEC) allows a maximum of 13 receptacles on each 20-amp circuit. This provides up to 30 receptacles for each 3-circuit power-in and 40 receptacles for each 4-circuit power-in.

If your usage is known in advance:

Add up the amperage used by each piece of equipment in the workstation. Whenever you reach 60 amps (20 amps times 3 circuits) or 80 amps (20 amps times 4 circuits) from items that are likely to be used at the same time, you have reached the limit for a single power-in. Specify another power-in and continue until all equipment is powered.

If the circuits will normally be subject to a continuous load (three or more hours of continuous use, such as lights or computers), the NEC requires that circuit capacity be "de-rated" by 20 percent. Therefore, treat circuits used for continuous loads as if they were rated at 16 amps instead of the regular 20 amps.

Try to anticipate future increases in power requirements and build some excess capacity into your plan.

▶ See table at right for typical and actual amperage usages for components.

To calculate amperage when the wattage of a device is known, divide watts by 120.

Some appliances, such as large copiers, coffee makers, or space heaters require most of the current available on a 20-amp circuit. It is recommended that such devices be supplied with their own receptacle/circuit, directly from the building. This leaves the capacity of the furniture circuits available for the more dynamic requirements of the office equipment.

Local electrical codes vary. Consult a qualified electrical contractor or engineer for the proper planning of electrical circuits in your locale.

Approximate power consumption for common devices

• Device	• Wattage	• Amperage	• Voltage	• Number of Devices Supported on Single 20 Amp Circuit*
Laptop	90	0.8	110	20
CPU/Desktop Computer	120	1.1	110	15
Monitor	60	0.5	110	29
Phone	5	0.0	110	352
High Power Tablet (e.g. Surface Pro)	40	0.4	110	44
Low Power Tablet (e.g. iPad Air)	15	0.1	110	117
Desktop Printer	40	0.4	110	44
42" LCD Screen	210	1.9	110	8
DVD Player	25	0.2	110	70
Projector	175	1.6	110	10
Desktop Lamp	19	0.2	110	93
Large Printer/Copier (high)	1900	17.3	110	1
Large Printer/Copier (low)	850	7.7	110	2
Paper Shredder	360	3.3	110	5
Desktop Fan	20	0.2	110	88
Standing Fan	180	1.6	110	10
Coffee Maker (high)	1200	10.9	110	1
Coffee Maker (low)	600	5.5	110	3
Microwave (high)	400	13.6	110	1
Microwave (low)	150	5.5	110	3
Refrigerator (high)	1500	3.6	110	4
Refrigerator (low)	200	1.4	110	12
Vacuum (high)	1500	13.6	110	1
Vacuum (low)	200	1.8	110	9
Space Heater (high)	1500	13.6	110	1
Space Heater (low)	750	6.8	110	2

Tip: These calculations are estimations and are meant solely for informational purposes. It is important to conduct proper power planning for each installation to prevent overloading a circuit.

Style Number Index

Style Number	Page	Description
GAP3HCX	356	Mod Pwr Branch Connector
GAP3HCY	356	Mod Pwr Branch Connector
GAP3HCZ	356	Mod Pwr Branch Connector
GAPDC20	357	Mod Pwr Dust Cap
GAPFBDHW	364	Mod Pwr Floor Access Box
GAPFBDX	363	Mod Pwr Floor Access Box
GAPFBDY	363	Mod Pwr Floor Access Box
GAPFBDZ	363	Mod Pwr Floor Access Box
GAPFBSHW	363	Mod Pwr Shallow Floor Access Box
GAPFBSX	362	Mod Pwr Shallow Floor Access Box
GAPFBSY	362	Mod Pwr Shallow Floor Access Box
GAPFBSZ	362	Mod Pwr Shallow Floor Access Box
GAPFCM90X	354	Modular Connector Faceplate
GAPFCM90Y	354	Modular Connector Faceplate
GAPFCM90Z	354	Modular Connector Faceplate
GAPFCMX	354	Mod Pwr Mod Conn Faceplate
GAPFCMY	354	Mod Pwr Mod Conn Faceplate
GAPFCMZ	354	Mod Pwr Mod Conn Faceplate
GAPHHCX	356	Mod Pwr Branch Connector
GAPHHCY	356	Mod Pwr Branch Connector
GAPHHCZ	356	Mod Pwr Branch Connector
GAPHM10X	353	Mod Pwr Mdlr Ext Harness
GAPHM10Y	353	Mod Pwr Mdlr Ext Harness
GAPHM10Z	353	Mod Pwr Mdlr Ext Harness
GAPHM15X	353	Mod Pwr Mdlr Ext Harness
GAPHM15Y	353	Mod Pwr Mdlr Ext Harness
GAPHM15Z	353	Mod Pwr Mdlr Ext Harness
GAPHM20X	353	Mod Pwr Mdlr Ext Harness
GAPHM20Y	353	Mod Pwr Mdlr Ext Harness
GAPHM20Z	353	Mod Pwr Mdlr Ext Harness
GAPHM30X	353	Mod Pwr Mdlr Ext Harness
GAPHM30Y	353	Mod Pwr Mdlr Ext Harness
GAPHM30Z	353	Mod Pwr Mdlr Ext Harness
GAPHM40X	353	Mod Pwr Mdlr Ext Harness
GAPHM40Y	353	Mod Pwr Mdlr Ext Harness
GAPHM40Z	353	Mod Pwr Mdlr Ext Harness
GAPHM50X	353	Mod Pwr Mdlr Ext Harness
GAPHM50Y	353	Mod Pwr Mdlr Ext Harness
GAPHM50Z	353	Mod Pwr Mdlr Ext Harness
GAPHM5X	353	Mod Pwr Mdlr Ext Harness
GAPHM5Y	353	Mod Pwr Mdlr Ext Harness
GAPHM5Z	353	Mod Pwr Mdlr Ext Harness
GAPMH10X	352	Mod Pwr Mod to Hardwire Harness
GAPMH10Y	352	Mod Pwr Mod to Hardwire Harness
GAPMH10Z	352	Mod Pwr Mod to Hardwire Harness
GAPMH30X	352	Mod Pwr Mod to Hardwire Harness
GAPMH30Y	352	Mod Pwr Mod to Hardwire Harness
GAPMH30Z	352	Mod Pwr Mod to Hardwire Harness
GAPMH50X	352	Mod Pwr Mod to Hardwire Harness
GAPMH50Y	352	Mod Pwr Mod to Hardwire Harness
GAPMH50Z	352	Mod Pwr Mod to Hardwire Harness
GAPMH5X	352	Mod Pwr Mod to Hardwire Harness
GAPMH5Y	352	Mod Pwr Mod to Hardwire Harness
GAPMH5Z	352	Mod Pwr Mod to Hardwire Harness
GAPR15L1IGX	366	Mod Pwr Receptacle

Style Number	Page	Description
GAPR15L1IGY	366	Mod Pwr Receptacle
GAPR15L1IGZ	366	Mod Pwr Receptacle
GAPR15L1SGX	366	Mod Pwr Receptacle
GAPR15L1SGY	366	Mod Pwr Receptacle
GAPR15L1SGZ	366	Mod Pwr Receptacle
GAPR15L2IGX	366	Mod Pwr Receptacle
GAPR15L2IGY	366	Mod Pwr Receptacle
GAPR15L2IGZ	366	Mod Pwr Receptacle
GAPR15L2SGX	366	Mod Pwr Receptacle
GAPR15L2SGY	366	Mod Pwr Receptacle
GAPR15L2SGZ	366	Mod Pwr Receptacle
GAPR15L3IGX	366	Mod Pwr Receptacle
GAPR15L3IGY	366	Mod Pwr Receptacle
GAPR15L3IGZ	366	Mod Pwr Receptacle
GAPR15L3SGX	366	Mod Pwr Receptacle
GAPR15L3SGY	366	Mod Pwr Receptacle
GAPR15L3SGZ	366	Mod Pwr Receptacle
GAPR15L4IGX	366	Mod Pwr Receptacle
GAPR15L4IGY	366	Mod Pwr Receptacle
GAPR15L4SGX	366	Mod Pwr Receptacle
GAPR15L4SGY	366	Mod Pwr Receptacle
GAPTHFBPNYX	360	Mod Pwr Base Power-In
GAPTHFBPNYY	360	Mod Pwr Base Power-In
GAPTHFBPNYZ	360	Mod Pwr Base Power-In
GAPTHFBPSFX	360	Modular Pwr Transition Harness
GAPTHFBPSFY	360	Modular Pwr Transition Harness
GAPTHFBPSFZ	360	Modular Pwr Transition Harness
GAPTHFBPX	360	Mod Pwr Base Power-In
GAPTHFBPY	360	Mod Pwr Base Power-In
GAPTHFBPZ	360	Mod Pwr Base Power-In
GAPTHFLSFX	358	Modular Pwr Transition Harness
GAPTHFLSFY	358	Modular Pwr Transition Harness
GAPTHFLSFZ	358	Modular Pwr Transition Harness
GAPTHFLX	358	Mod Pwr Floor Power-Infeed
GAPTHFLY	358	Mod Pwr Floor Power-Infeed
GAPTHFLZ	358	Mod Pwr Floor Power-Infeed
GAPTHFNXX	358	Mod Pwr Floor Power-Infeed
GAPTHFNYY	358	Mod Pwr Floor Power-Infeed
GAPTHFNZZ	358	Mod Pwr Floor Power-Infeed
GAPTHINNYX	359	Mod Pwr Floor Power-Infeed
GAPTHINNYZ	359	Mod Pwr Floor Power-Infeed
GAPTHINNYZ	359	Mod Pwr Floor Power-Infeed
GAPTHINTSFX	359	Modular Pwr Transition Harness
GAPTHINTSFY	359	Modular Pwr Transition Harness
GAPTHINTSFZ	359	Modular Pwr Transition Harness
GAPTHINTX	359	Mod Pwr Floor Power-Infeed
GAPTHINTY	359	Mod Pwr Floor Power-Infeed
GAPTHINTZ	359	Mod Pwr Floor Power-Infeed
GAPTHBPNYX	361	Mod Pwr Base Power-In
GAPTHBPNYZ	361	Mod Pwr Base Power-In
GAPTHBPNYZ	361	Mod Pwr Base Power-In
GAPTHBPNSFX	361	Modular Pwr Transition Harness
GAPTHBPNSFY	361	Modular Pwr Transition Harness
GAPTHBPNSFZ	361	Modular Pwr Transition Harness
GAPTHBPX	361	Mod Pwr Base Power-In

Style Number	Page	Description	Style Number	Page	Description
GAPTHBPY	361	Mod Pwr Base Power-In	GP1R4IGX	256	PW Receptacle
GAPTHBPZ	361	Mod Pwr Base Power-In	GP1R4SGHX	256, 367	PW Receptacle
GAPTHPMP12X	362	Mod Pwr Transition Harness	GP1R4SGX	256	PW Receptacle
GAPTHPMP12Y	362	Mod Pwr Transition Harness	GP2BHY	262	PW Harness-to-Harness Connector
GAPTHPMP12Z	362	Mod Pwr Transition Harness	GP2BPI12Y	260	PW Base Power Infeed
GAPTHPMP24X	362	Mod Pwr Transition Harness	GP2BPISF12Y	260	PW Base Power Infeed
GAPTHPMP24Y	362	Mod Pwr Transition Harness	GP2HHY	262	PW Harness-to-Harness Connector
GAPTHPMP24Z	362	Mod Pwr Transition Harness	GP2MHAY	261	PW Modular Harness
GAPZBHW10X	355	Mod Pwr Zone Box	GP2PIH24Y	259	PW Multipurpose Power Infeed
GAPZBHW10Y	355	Mod Pwr Zone Box	GP2PIM24Y	259	PW Multipurpose Power Infeed
GAPZBHW10Z	355	Mod Pwr Zone Box	GP2PKBY	263	PW Base Powerkit
GAPZBHW8X	355	Mod Pwr Zone Box	GP2PKPSY	263	PW ADA-Desk Single Powerkit
GAPZBHW8Y	355	Mod Pwr Zone Box	GP2PKPY	263	PW Base Powerkit
GAPZBHW8Z	355	Mod Pwr Zone Box	GP2R1IGHY	256, 367	PW Receptacle
GAPZBM100X	355	Mod Pwr Zone Box	GP2R1IGY	256	PW Receptacle
GAPZBM100Y	355	Mod Pwr Zone Box	GP2R1SGHY	256, 367	PW Receptacle
GAPZBM100Z	355	Mod Pwr Zone Box	GP2R1SGY	256	PW Receptacle
GAPZBM125X	355	Mod Pwr Zone Box	GP2R2IGHY	256, 367	PW Receptacle
GAPZBM125Y	355	Mod Pwr Zone Box	GP2R2IGY	256	PW Receptacle
GAPZBM125Z	355	Mod Pwr Zone Box	GP2R2SGHY	256, 367	PW Receptacle
GAPZBM150X	355	Mod Pwr Zone Box	GP2R2SGY	256	PW Receptacle
GAPZBM150Y	355	Mod Pwr Zone Box	GP2R3IGHY	256, 367	PW Receptacle
GAPZBM150Z	355	Mod Pwr Zone Box	GP2R3IGY	256	PW Receptacle
GAPZBM200X	355	Mod Pwr Zone Box	GP2R3SGHY	256, 367	PW Receptacle
GAPZBM200Y	355	Mod Pwr Zone Box	GP2R3SGY	256	PW Receptacle
GAPZBM200Z	355	Mod Pwr Zone Box	GP2R4IGHY	256, 367	PW Receptacle
GAPZBM50X	355	Mod Pwr Zone Box	GP2R4IGY	256	PW Receptacle
GAPZBM50Y	355	Mod Pwr Zone Box	GP2R4SGHY	256, 367	PW Receptacle
GAPZBM50Z	355	Mod Pwr Zone Box	GP2R4SGY	256	PW Receptacle
GAPZBM75X	355	Mod Pwr Zone Box	GP3BHZ	262	PW Harness-to-Harness Connector
GAPZBM75Y	355	Mod Pwr Zone Box	GP3BPI12Z	260	PW Base Power Infeed
GAPZBM75Z	355	Mod Pwr Zone Box	GP3BPISF12Z	260	PW Base Power Infeed
GP1BHX	262	PW Harness-to-Harness Connector	GP3HHZ	262	PW Harness-to-Harness Connector
GP1BPI12X	260	PW Base Power Infeed	GP3MHAZ	261	PW Modular Harness
GP1BPISF12X	260	PW Base Power Infeed	GP3PIH24Z	259	PW Multipurpose Power Infeed
GP1HHX	262	PW Harness-to-Harness Connector	GP3PIM24Z	259	PW Multipurpose Power Infeed
GP1MHAX	261	PW Modular Harness	GP3PKBZ	263	PW Base Powerkit
GP1PIH24X	259	PW Multipurpose Power Infeed	GP3PKPSZ	263	PW ADA-Desk Single Powerkit
GP1PIM24X	259	PW Multipurpose Power Infeed	GP3PKPZ	263	PW ADA-Desk Double Powerkit
GP1PKBX	263	PW Base Powerkit	GP3R1IGHZ	256, 367	PW Receptacle
GP1PKPSX	263	PW ADA-Desk Single Powerkit	GP3R1IGZ	256	PW Receptacle
GP1PKPX	263	PW ADA-Desk Double Powerkit	GP3R1SGHZ	256, 367	PW Receptacle
GP1R1IGHX	256, 367	PW Receptacle	GP3R1SGZ	256	PW Receptacle
GP1R1IGX	256	PW Receptacle	GP3R2IGHZ	256, 367	PW Receptacle
GP1R1SGHX	256, 367	PW Receptacle	GP3R2IGZ	256	PW Receptacle
GP1R1SGX	256	PW Receptacle	GP3R2SGHZ	256, 367	PW Receptacle
GP1R2IGHX	256, 367	PW Receptacle	GP3R2SGZ	256	PW Receptacle
GP1R2IGX	256	PW Receptacle	GP3R3IGHZ	256, 367	PW Receptacle
GP1R2SGHX	256, 367	PW Receptacle	GP3R3IGZ	256	PW Receptacle
GP1R2SGX	256	PW Receptacle	GP3R3SGHZ	256, 367	PW Receptacle
GP1R3IGHX	256, 367	PW Receptacle	GP3R3SGZ	256	PW Receptacle
GP1R3IGX	256	PW Receptacle	GPACOUST	252	PW Acoustic Packing
GP1R3SGHX	256, 367	PW Receptacle	GPAFEB	191	PW L-Adapter
GP1R3SGX	256	PW Receptacle	GPAL	191	PW L-Adapter
GP1R4IGHX	256, 367	PW Receptacle	GPAS	252	PW Acoustic Seal

Style Number Index, continued

Style Number	Page	Description
GPAT	191	PW T-Adapter
GPAX	191	PW X-Adapter
GPBTC	244	PW Continuous Base Trim
GPBTCC	246	PW Power and Comm Base Trim
GPBTCHIP	246	PW Power and Comm Base Trim
GPBTCHIPC	246	PW Power and Comm Base Trim
GPBTP	246	PW Power and Comm Base Trim
GPBTPC	246	PW Power and Comm Base Trim
GPCFKA	240	PW Ceiling Track Clip Kit
GPCFKM	240	Ceiling Track Clip Kit
GPCFKP	240	PW Ceiling Track Clip Kit
GPCFKQ	240	PW Ceiling Track Clip Kit
GPCFKR	241	PW Ceiling Track Clip Kit
GPCFKT	240	PW Ceiling Track Clip Kit
GPCFKT5	241	PW Ceiling Track Clip Kit
GPCFKU	240	PW Ceiling Track Clip Kit
GPCFKX	240	PW Ceiling Track Clip Kit
GPCFKX5	241	PW Ceiling Track Clip Kit
GPCFKY	240	PW Ceiling Track Clip Kit
GPCFKZ	240	PW Ceiling Track Clip Kit
GPCNRBT120	245	PW Corner Base Trim
GPCNRBT135	245	PW Corner Base Trim
GPCNRBT90	245	PW Corner Base Trim
GPCT120V	239	PW Corner V Ceiling Track
GPCT135V	239	PW Corner V Ceiling Track
GPCTB	242	PW Ceiling Track Bypass Cover
GPCTFE	238	PW Finished-End Ceiling Track
GPCTLS	238	PW Corner L Ceiling Track
GPCTS	238	PW Straight Ceiling Track
GPCTT	242	PW Ceiling Track T-Clip
GPDBH3	169	PW Butt Hinge Kit
GPDBH3P	169	PW Butt Hinge Kit
GPDBH4	169	PW Butt Hinge Kit
GPDBH4P	169	PW Butt Hinge Kit
GPDCLA	168	PW Cylindrical Passage Set
GPDCLO	168	PW Cylindrical Lockset
GPDDFS	171	PW Door Floor Stop
GPDLPBF	273	PW Butt-Hinged Door Frame Lite Scale
GPDLPBT	273	PW Butt-Hinged Door Frame Lite Scale
GPDLPPF	275	PW Pivot-Hinged Door Frame Lite Scale
GPDLPPT	275	PW Pivot-Hinged Door Frame Lite Scale
GPDLSBF	273	PW Butt-Hinged Door Frame Lite Scale
GPDLSBT	273	PW Butt-Hinged Door Frame Lite Scale
GPDLSPF	275	PW Pivot-Hinged Door Frame Lite Scale
GPDLSPFS	277	PW Pivot-Hinged Door Frame Lite Scale
GPDLSPPT	275	PW Pivot-Hinged Door Frame Lite Scale
GPDLSPPTS	277	PW Pivot-Hinged Door Frame Lite Scale
GPDMLA	168	PW Mortise Passage Set
GPDMLO	168	PW Mortise Lockset
GPDMWS	170	PW Magnetic Wall Stop
GPDPBF	149	PW Butt-Hinged Door Frame
GPDPBT	149	PW Butt-Hinged Door Frame
GPDPHS	170	PW Pivot Hinge Kit
GPDPHSP	170	PW Pivot Hinge Kit
GPDPFF	152	PW Pivot-Hinged Door Frame

Style Number	Page	Description
GPDPPT	152	PW Pivot-Hinged Door Frame
GPDS120	172	PW Low-Voltage Switch w/120V Transformer
GPDS277	172	PW Low-Voltage Switch w/277V Transformer
GPDS347	172	PW Low-Voltage Switch w/347V Transformer
GPDSBF	149	PW Butt-Hinged Door Frame
GPDSBS	171	PW Screw-In Base Stop
GPDSBT	149	PW Butt-Hinged Door Frame
GPDSCB	184	PW Back-to-Back Cover
GPDSD1	172	PW High-Voltage Switch
GPDSPF	151	PW Pivot-Hinged Door Frame
GPDSPFS	155	PW Pivot-Hinged Door Frame
GPDSPT	151	PW Pivot-Hinged Door Frame
GPDSPTS	155	PW Pivot-Hinged Door Frame
GPDS1	172	PW High-Voltage Switch
GPDSST2L80	177	PW Slider Door with Tubular Pull
GPDSST2L96	177	PW Slider Door with Tubular Pull
GPDSST3E80	179	PW Slider Door with Tubular Pull
GPDSST3E96	179	PW Slider Door with Tubular Pull
GPDSST4E80	181	PW Slider Door with Tubular Pull
GPDSST4E96	181	PW Slider Door with Tubular Pull
GPDSST4L80	183	PW Slider Door with Tubular Pull
GPDSST4L96	183	PW Slider Door with Tubular Pull
GPDSSTF80	175	PW Slider Door with Tubular Pull
GPDSSTF96	175	PW Slider Door with Tubular Pull
GPFRS	251	PW Furniture Reveal Strips
GPFRS4	251	PW Furniture Reveal Strips
GPFS	249	PW Feature Strip
GPFS1	249	PW Feature Strip
GPFS121	249	PW Feature Strip - Lite Scale
GPFS1A	250	PW Anodized Feature Strip
GPFSA	250	PW Anodized Feature Strip
GPFSA121	250	PW Anodized Feature Strip - Lite Scale
GPFSH	249	PW Feature Strip
GPFSH1	249	PW Feature Strip
GPFSH121	249	PW Feature Strip - Lite Scale
GPFSH1A	250	PW Anodized Feature Strip
GPFSHA	250	PW Anodized Feature Strip
GPFSHA121	250	PW Anodized Feature Strip - Lite Scale
GPGLGSPF40B	217	PW GS Pivot-Hinged Door Leaf
GPGLGSPF42B	221	PW GS Pivot-Hinged Door Leaf
GPGLGSPT40B	219	PW GS Pivot-Hinged Door Leaf
GPGLGSPT42B	223	PW GS Pivot-Hinged Door Leaf
GPGM08	124	PW All-Glass Wall Panel
GPGM18	124	PW All-Glass Wall Panel
GPGM20	124	PW All-Glass Wall Panel
GPGM24	124	PW All-Glass Wall Panel
GPGM2L08	141	PW Glass Wall Panel w/ 2 Lites
GPGM2L18	141	PW Glass Wall Panel w/ 2 Lites
GPGM2L20	141	PW Glass Wall Panel w/ 2 Lites
GPGM2L24	141	PW Glass Wall Panel w/ 2 Lites
GPGM2L30	141	PW Glass Wall Panel w/ 2 Lites
GPGM2L36	141	PW Glass Wall Panel w/ 2 Lites
GPGM2L40	141	PW Glass Wall Panel w/ 2 Lites
GPGM2L42	141	PW Glass Wall Panel w/ 2 Lites
GPGM2L48	141	PW Glass Wall Panel w/ 2 Lites

Style Number	Page	Description
GPGM2L60	141	PW Glass Wall Panel w/ 2 Lites
GPGM30	124	PW All-Glass Wall Panel
GPGM36	124	PW All-Glass Wall Panel
GPGM3E08	128	PW Glass Wall Panel w/ 3 Equal Lites
GPGM3E18	128	PW Glass Wall Panel w/ 3 Equal Lites
GPGM3E20	128	PW Glass Wall Panel w/ 3 Equal Lites
GPGM3E24	128	PW Glass Wall Panel w/ 3 Equal Lites
GPGM3E30	128	PW Glass Wall Panel w/ 3 Equal Lites
GPGM3E36	128	PW Glass Wall Panel w/ 3 Equal Lites
GPGM3E40	128	PW Glass Wall Panel w/ 3 Equal Lites
GPGM3E42	128	PW Glass Wall Panel w/ 3 Equal Lites
GPGM3E48	128	PW Glass Wall Panel w/ 3 Equal Lites
GPGM3E60	128	PW Glass Wall Panel w/ 3 Equal Lites
GPGM40	124	PW All-Glass Wall Panel
GPGM42	124	PW All-Glass Wall Panel
GPGM48	124	PW All-Glass Wall Panel
GPGM4E08	132	PW Glass Wall Panel w/ 4 Equal Lites
GPGM4E18	132	PW Glass Wall Panel w/ 4 Equal Lites
GPGM4E20	132	PW Glass Wall Panel w/ 4 Equal Lites
GPGM4E24	132	PW Glass Wall Panel w/ 4 Equal Lites
GPGM4E30	132	PW Glass Wall Panel w/ 4 Equal Lites
GPGM4E36	132	PW Glass Wall Panel w/ 4 Equal Lites
GPGM4E40	132	PW Glass Wall Panel w/ 4 Equal Lites
GPGM4E42	132	PW Glass Wall Panel w/ 4 Equal Lites
GPGM4E48	132	PW Glass Wall Panel w/ 4 Equal Lites
GPGM4E60	132	PW Glass Wall Panel w/ 4 Equal Lites
GPGM4L08	137	PW Glass Wall Panel w/ 4 Lites
GPGM4L18	137	PW Glass Wall Panel w/ 4 Lites
GPGM4L20	137	PW Glass Wall Panel w/ 4 Lites
GPGM4L24	137	PW Glass Wall Panel w/ 4 Lites
GPGM4L30	137	PW Glass Wall Panel w/ 4 Lites
GPGM4L36	137	PW Glass Wall Panel w/ 4 Lites
GPGM4L40	137	PW Glass Wall Panel w/ 4 Lites
GPGM4L42	137	PW Glass Wall Panel w/ 4 Lites
GPGM4L48	137	PW Glass Wall Panel w/ 4 Lites
GPGM4L60	137	PW Glass Wall Panel w/ 4 Lites
GPGM60	124	PW All-Glass Wall Panel
GPGMC18	145	PW Clerestory Wall Panel
GPGMC20	145	PW Clerestory Wall Panel
GPGMC24	145	PW Clerestory Wall Panel
GPGMC30	145	PW Clerestory Wall Panel
GPGMC36	145	PW Clerestory Wall Panel
GPGMC40	145	PW Clerestory Wall Panel
GPGMC42	145	PW Clerestory Wall Panel
GPGMC48	145	PW Clerestory Wall Panel
GPGMC60	145	PW Clerestory Wall Panel
GPGS06	124	PW All-Glass Wall Panel
GPGS08	124	PW All-Glass Wall Panel
GPGS18	124	PW All-Glass Wall Panel
GPGS20	124	PW All-Glass Wall Panel
GPGS24	124	PW All-Glass Wall Panel
GPGS2L06	141	PW Glass Wall Panel w/ 2 Lites
GPGS2L08	141	PW Glass Wall Panel w/ 2 Lites
GPGS2L18	141	PW Glass Wall Panel w/ 2 Lites
GPGS2L20	141	PW Glass Wall Panel w/ 2 Lites

Style Number	Page	Description
GPGS2L24	141	PW Glass Wall Panel w/ 2 Lites
GPGS2L30	141	PW Glass Wall Panel w/ 2 Lites
GPGS2L36	141	PW Glass Wall Panel w/ 2 Lites
GPGS2L40	141	PW Glass Wall Panel w/ 2 Lites
GPGS2L42	141	PW Glass Wall Panel w/ 2 Lites
GPGS2L48	141	PW Glass Wall Panel w/ 2 Lites
GPGS2L60	141	PW Glass Wall Panel w/ 2 Lites
GPGS30	124	PW All-Glass Wall Panel
GPGS36	124	PW All-Glass Wall Panel
GPGS3E06	128	PW Glass Wall Panel w/ 3 Equal Lites
GPGS3E08	128	PW Glass Wall Panel w/ 3 Equal Lites
GPGS3E18	128	PW Glass Wall Panel w/ 3 Equal Lites
GPGS3E20	128	PW Glass Wall Panel w/ 3 Equal Lites
GPGS3E24	128	PW Glass Wall Panel w/ 3 Equal Lites
GPGS3E30	128	PW Glass Wall Panel w/ 3 Equal Lites
GPGS3E36	128	PW Glass Wall Panel w/ 3 Equal Lites
GPGS3E40	128	PW Glass Wall Panel w/ 3 Equal Lites
GPGS3E42	128	PW Glass Wall Panel w/ 3 Equal Lites
GPGS3E48	128	PW Glass Wall Panel w/ 3 Equal Lites
GPGS3E60	128	PW Glass Wall Panel w/ 3 Equal Lites
GPGS40	124	PW All-Glass Wall Panel
GPGS42	124	PW All-Glass Wall Panel
GPGS48	124	PW All-Glass Wall Panel
GPGS4E06	132	PW Glass Wall Panel w/ 4 Equal Lites
GPGS4E08	132	PW Glass Wall Panel w/ 4 Equal Lites
GPGS4E18	132	PW Glass Wall Panel w/ 4 Equal Lites
GPGS4E20	132	PW Glass Wall Panel w/ 4 Equal Lites
GPGS4E24	132	PW Glass Wall Panel w/ 4 Equal Lites
GPGS4E30	132	PW Glass Wall Panel w/ 4 Equal Lites
GPGS4E36	132	PW Glass Wall Panel w/ 4 Equal Lites
GPGS4E40	132	PW Glass Wall Panel w/ 4 Equal Lites
GPGS4E42	132	PW Glass Wall Panel w/ 4 Equal Lites
GPGS4E48	132	PW Glass Wall Panel w/ 4 Equal Lites
GPGS4E60	132	PW Glass Wall Panel w/ 4 Equal Lites
GPGS4L06	137	PW Glass Wall Panel w/ 4 Lites
GPGS4L08	137	PW Glass Wall Panel w/ 4 Lites
GPGS4L18	137	PW Glass Wall Panel w/ 4 Lites
GPGS4L20	137	PW Glass Wall Panel w/ 4 Lites
GPGS4L24	137	PW Glass Wall Panel w/ 4 Lites
GPGS4L30	137	PW Glass Wall Panel w/ 4 Lites
GPGS4L36	137	PW Glass Wall Panel w/ 4 Lites
GPGS4L40	137	PW Glass Wall Panel w/ 4 Lites
GPGS4L42	137	PW Glass Wall Panel w/ 4 Lites
GPGS4L48	137	PW Glass Wall Panel w/ 4 Lites
GPGS4L60	137	PW Glass Wall Panel w/ 4 Lites
GPGS60	124	PW All-Glass Wall Panel
GPGSAFEB	230	PW GS Finished-End Adapter
GPGSAL	230	PW GS L-Adapter
GPGSC18	145	PW Clerestory Wall Panel
GPGSC20	145	PW Clerestory Wall Panel
GPGSC24	145	PW Clerestory Wall Panel
GPGSC30	145	PW Clerestory Wall Panel
GPGSC36	145	PW Clerestory Wall Panel
GPGSC40	145	PW Clerestory Wall Panel
GPGSC42	145	PW Clerestory Wall Panel

Style Number Index, continued

Style Number	Page	Description
GPGSC48	145	PW Clerestory Wall Panel
GPGSC60	145	PW Clerestory Wall Panel
GPGSDFHSS	302	PW GS Slider Frame Lite Scale
GPGSDFFSC80	225	PW GS Pol Edge Slider Dr w/Close Assist
GPGSDFFSC84	225	PW GS Pol Edge Slider Dr w/Close Assist
GPGSDFFSC96	225	PW GS Pol Edge Slider Dr w/Close Assist
GPGSDFSVS	228	PW GS Slider Door Vertical Seal
GPGSDFTSC80	227	PW GS Pol Edge Slider Dr w/Close Assist
GPGSDFTSC84	227	PW GS Pol Edge Slider Dr w/Close Assist
GPGSDFTSC96	227	PW GS Pol Edge Slider Dr w/Close Assist
GPGSDLFHSS	301	PW GS Slider Door Leaf Lite Scale
GPGSDLPPF	291	PW GS Pivot-Hinged Door Frame Lite Scale
GPGSDLPPT	291	PW GS Pivot-Hinged Door Frame Lite Scale
GPGSDLSPF	291	PW GS Pivot-Hinged Door Frame Lite Scale
GPGSDLSPFS	291	PW GS Pivot-Hinged Door Frame Lite Scale
GPGSDLSPT	291	PW GS Pivot-Hinged Door Frame Lite Scale
GPGSDLSPTS	291	PW GS Pivot-Hinged Door Frame Lite Scale
GPGSDPPF	215	PW GS Pivot-Hinged Door Frame
GPGSDPPT	215	PW GS Pivot-Hinged Door Frame
GPGSDSPF	215	PW GS Pivot-Hinged Door Frame
GPGSDSPFS	215	PW Pivot-Hinged Door Frame
GPGSDSPT	215	PW GS Pivot-Hinged Door Frame
GPGSDSPTS	215	PW Pivot-Hinged Door Frame
GPGSDTH	303	PW GS Slider Hanger Lite Scale
GPGSDTSS	300	PW GS Slider Track Lite Scale
GPGSLGSPF40	217	PW GS Pivot-Hinged Door Leaf
GPGSLGSPF42	221	PW GS Pivot-Hinged Door Leaf
GPGSLGSPT40	219	PW GS Pivot-Hinged Door Leaf
GPGSLGSPT42	223	PW GS Pivot-Hinged Door Leaf
GPGSLLGSPF40	293	PW GS Pivot-Hinged Door Leaf Lite Scale
GPGSLLGSPF40B	293	PW GS Pivot-Hinged Door Leaf Lite Scale
GPGSLLGSPF42	297	PW GS Pivot-Hinged Door Leaf Lite Scale
GPGSLLGSPF42B	297	PW GS Pivot-Hinged Door Leaf Lite Scale
GPGSLLGSPT40	295	PW GS Pivot-Hinged Door Leaf Lite Scale
GPGSLLGSPT40B	295	PW GS Pivot-Hinged Door Leaf Lite Scale
GPGSLLGSPT42	299	PW GS Pivot-Hinged Door Leaf
GPGSLLGSPT42B	299	PW GS Pivot-Hinged Door Leaf
GPGSLLSPPF80	293	PW Pivot-Hinged Door Leaf Lite Scale
GPGSLLSPPT80	295	PW Pivot-Hinged Door Leaf Lite Scale
GPGSLLSPPF40	293	PW GS Pivot-Hinged Door Leaf Lite Scale
GPGSLLSPPF42	297	PW GS Pivot-Hinged Door Leaf Lite Scale
GPGSLLSPT40	295	PW Pivot-Hinged Door Leaf Lite Scale
GPGSLLSPT42	299	PW GS Pivot-Hinged Door Leaf
GPGSLSPPF80	217	PW GS Pivot-Hinged Door Leaf
GPGSLSPPT80	219	PW GS Pivot-Hinged Door Leaf
GPGSLSPPF40	217	PW GS Pivot-Hinged Door Leaf
GPGSLSPPF42	221	PW GS Pivot-Hinged Door Leaf
GPGSLSSPT40	219	PW GS Pivot-Hinged Door Leaf
GPGSLSSPT42	223	PW GS Pivot-Hinged Door Leaf
GPGSM2FK108	207	PW GS Two Divided Lite Frame Kit
GPGSM2FK120	207	PW GS Two Divided Lite Frame Kit
GPGSM2FK144	207	PW GS Two Divided Lite Frame Kit
GPGSM2FK72	207	PW GS Two Divided Lite Frame Kit
GPGSM2FK80	207	PW GS Two Divided Lite Frame Kit
GPGSM2FK84	207	PW GS Two Divided Lite Frame Kit

Style Number	Page	Description
GPGSM2FK96	207	PW GS Two Divided Lite Frame Kit
GPGSM2FKT	236	PW GS All-Glass Frame Kit
GPGSM2GK108	209	PW GS Two Divided Lite Glass Kit
GPGSM2GK120	209	PW GS Two Divided Lite Glass Kit
GPGSM2GK144	209	PW GS Two Divided Lite Glass Kit
GPGSM2GK72	209	PW GS Two Divided Lite Glass Kit
GPGSM2GK80	209	PW GS Two Divided Lite Glass Kit
GPGSM2GK84	209	PW GS Two Divided Lite Glass Kit
GPGSM2GK96	209	PW GS Two Divided Lite Glass Kit
GPGSM2GKT	237	PW GS All-Glass Frame Kit
GPGSM2L08	204	PW GS Wall Panel w/ 2 Lites
GPGSM2L18	204	PW GS Wall Panel w/ 2 Lites
GPGSM2L20	204	PW GS Wall Panel w/ 2 Lites
GPGSM2L24	204	PW GS Wall Panel w/ 2 Lites
GPGSM2L30	204	PW GS Wall Panel w/ 2 Lites
GPGSM2L36	204	PW GS Wall Panel w/ 2 Lites
GPGSM2L40	204	PW GS Wall Panel w/ 2 Lites
GPGSM2L42	204	PW GS Wall Panel w/ 2 Lites
GPGSM2L48	204	PW GS Wall Panel w/ 2 Lites
GPGSM2L60	204	PW GS Wall Panel w/ 2 Lites
GPGSM2LL	233	PW GS Corner Unit
GPGSMC18	213	PW GS Clerestory Wall Panel
GPGSMC20	213	PW GS Clerestory Wall Panel
GPGSMC24	213	PW GS Clerestory Wall Panel
GPGSMC30	213	PW GS Clerestory Wall Panel
GPGSMC36	213	PW GS Clerestory Wall Panel
GPGSMC40	213	PW GS Clerestory Wall Panel
GPGSMC42	213	PW GS Clerestory Wall Panel
GPGSMC48	213	PW GS Clerestory Wall Panel
GPGSMC60	213	PW GS Clerestory Wall Panel
GPGSMEL	229	PW GS Mini End
GPGSMELF	229	PW GS Mini End
GPGSMEM	229	PW GS Mini End
GPGSMEMF	229	PW GS Mini End
GPGSMES	229	PW GS Mini End
GPGSMESF	229	PW GS Mini End
GPGSMG08	197	PW GS All-Glass Wall Panel
GPGSMG18	197	PW GS All-Glass Wall Panel
GPGSMG20	197	PW GS All-Glass Wall Panel
GPGSMG24	197	PW GS All-Glass Wall Panel
GPGSMG30	197	PW GS All-Glass Wall Panel
GPGSMG36	197	PW GS All-Glass Wall Panel
GPGSMG40	197	PW GS All-Glass Wall Panel
GPGSMG42	197	PW GS All-Glass Wall Panel
GPGSMG48	197	PW GS All-Glass Wall Panel
GPGSMG60	197	PW GS All-Glass Wall Panel
GPGSMGFK108	199	PW GS All-Glass Frame Kit
GPGSMGFK120	199	PW GS All-Glass Frame Kit
GPGSMGFK144	199	PW GS All-Glass Frame Kit
GPGSMGFK72	199	PW GS All-Glass Frame Kit
GPGSMGFK80	199	PW GS All-Glass Frame Kit
GPGSMGFK84	199	PW GS All-Glass Frame Kit
GPGSMGFK96	199	PW GS All-Glass Frame Kit
GPGSMGFKT	234	PW GS All-Glass Frame Kit
GPGSMGGK108	201	PW GS All-Glass Glass Kit

Style Number	Page	Description	Style Number	Page	Description
GPGSMGGK120	201	PW GS All-Glass Glass Kit	GPGSSG24	197	PW GS All-Glass Wall Panel
GPGSMGGK144	201	PW GS All-Glass Glass Kit	GPGSSG30	197	PW GS All-Glass Wall Panel
GPGSMGGK72	201	PW GS All-Glass Glass Kit	GPGSSG36	197	PW GS All-Glass Wall Panel
GPGSMGGK80	201	PW GS All-Glass Glass Kit	GPGSSG40	197	PW GS All-Glass Wall Panel
GPGSMGGK84	201	PW GS All-Glass Glass Kit	GPGSSG42	197	PW GS All-Glass Wall Panel
GPGSMGGK96	201	PW GS All-Glass Glass Kit	GPGSSG48	197	PW GS All-Glass Wall Panel
GPGSMGGKT	235	PW GS All-Glass Frame Kit	GPGSSG60	197	PW GS All-Glass Wall Panel
GPGSMGL	233	PW GS Corner Unit	GPGSSGFK108	199	PW GS All-Glass Frame Kit
GPGSP120V	231	PW GS V-Post	GPGSSGFK120	199	PW GS All-Glass Frame Kit
GPGSP135V	231	PW GS V-Post	GPGSSGFK144	199	PW GS All-Glass Frame Kit
GPGSP135Y	231	PW GS Y-Post	GPGSSGFK72	199	PW GS All-Glass Frame Kit
GPGSPI	231	PW GS In-Line Post	GPGSSGFK80	199	PW GS All-Glass Frame Kit
GPGSPL	231	PW GS L-Post	GPGSSGFK84	199	PW GS All-Glass Frame Kit
GPGSPT	231	PW GS T-Post	GPGSSGFK96	199	PW GS All-Glass Frame Kit
GPGSS2FK108	207	PW GS Two Divided Lite Frame Kit	GPGSSGFKT	234	PW GS All-Glass Frame Kit
GPGSS2FK120	207	PW GS Two Divided Lite Frame Kit	GPGSSGK108	201	PW GS All-Glass Glass Kit
GPGSS2FK144	207	PW GS Two Divided Lite Frame Kit	GPGSSGK120	201	PW GS All-Glass Glass Kit
GPGSS2FK72	207	PW GS Two Divided Lite Frame Kit	GPGSSGK144	201	PW GS All-Glass Glass Kit
GPGSS2FK80	207	PW GS Two Divided Lite Frame Kit	GPGSSGK72	201	PW GS All-Glass Glass Kit
GPGSS2FK84	207	PW GS Two Divided Lite Frame Kit	GPGSSGK80	201	PW GS All-Glass Glass Kit
GPGSS2FK96	207	PW GS Two Divided Lite Frame Kit	GPGSSGK84	201	PW GS All-Glass Glass Kit
GPGSS2FKT	236	PW GS All-Glass Frame Kit	GPGSSGK96	201	PW GS All-Glass Glass Kit
GPGSS2GK108	209	PW GS Two Divided Lite Glass Kit	GPGSSGKT	235	PW GS All-Glass Frame Kit
GPGSS2GK120	209	PW GS Two Divided Lite Glass Kit	GPGSSGL	233	PW GS Corner Unit
GPGSS2GK144	209	PW GS Two Divided Lite Glass Kit	GPIA	194	PW I-Line Interface Post
GPGSS2GK72	209	PW GS Two Divided Lite Glass Kit	GPIJCH	264	PW Chicago & NYC Junction Box
GPGSS2GK80	209	PW GS Two Divided Lite Glass Kit	GPLB	253	PW Load Bar
GPGSS2GK84	209	PW GS Two Divided Lite Glass Kit	GPLGSBF40	157	PW Butt-Hinged Door Leaf
GPGSS2GK96	209	PW GS Two Divided Lite Glass Kit	GPLGSBF40B	157	PW Butt-Hinged Door Leaf
GPGSS2GKT	237	PW GS All-Glass Frame Kit	GPLGSBT40	159	PW Butt-Hinged Door Leaf
GPGSS2L06	204	PW GS Wall Panel w/ 2 Lites	GPLGSBT40B	159	PW Butt-Hinged Door Leaf
GPGSS2L08	204	PW GS Wall Panel w/ 2 Lites	GPLGSPF40	161	PW Pivot-Hinged Door Leaf
GPGSS2L18	204	PW GS Wall Panel w/ 2 Lites	GPLGSPF40B	161	PW Pivot-Hinged Door Leaf
GPGSS2L20	204	PW GS Wall Panel w/ 2 Lites	GPLGSPF42	165	PW Pivot-Hinged Door Leaf for Cutout
GPGSS2L24	204	PW GS Wall Panel w/ 2 Lites	GPLGSPF42B	165	PW Pivot-Hinged Door Leaf for Cutout
GPGSS2L30	204	PW GS Wall Panel w/ 2 Lites	GPLGSPT40	163	PW Pivot-Hinged Door Leaf
GPGSS2L36	204	PW GS Wall Panel w/ 2 Lites	GPLGSPT40B	163	PW Pivot-Hinged Door Leaf
GPGSS2L40	204	PW GS Wall Panel w/ 2 Lites	GPLGSPT42	167	PW Pivot-Hinged Door Leaf for Cutout
GPGSS2L42	204	PW GS Wall Panel w/ 2 Lites	GPLGSPT42B	167	PW Pivot-Hinged Door Leaf for Cutout
GPGSS2L48	204	PW GS Wall Panel w/ 2 Lites	GPLLGSBF40	279	PW GS Butt-Hinged Door Leaf Lite Scale
GPGSS2L60	204	PW GS Wall Panel w/ 2 Lites	GPLLGSBF40B	279	W GS Butt-Hinged Door Leaf Lite Scale
GPGSS2LL	233	PW GS Corner Unit	GPLLGSBT40	281	PW GS Butt-Hinged Door Leaf Lite Scale
GPGSSC18	213	PW GS Clerestory Wall Panel	GPLLGSBT40B	281	W GS Butt-Hinged Door Leaf Lite Scale
GPGSSC20	213	PW GS Clerestory Wall Panel	GPLLGSPF40	283	PW GS Pivot-Hinged Door Leaf Lite Scale
GPGSSC24	213	PW GS Clerestory Wall Panel	GPLLGSPF40B	283	PW Pivot-Hinged Door Leaf Lite Scale
GPGSSC30	213	PW GS Clerestory Wall Panel	GPLLGSPF42	287	PW Pivot-Hinged Door Leaf Lite Scale
GPGSSC36	213	PW GS Clerestory Wall Panel	GPLLGSPF42B	287	PW Pivot-Hinged Door Leaf Lite Scale
GPGSSC40	213	PW GS Clerestory Wall Panel	GPLLGSP40	285	PW Pivot-Hinged Door Leaf Lite Scale
GPGSSC42	213	PW GS Clerestory Wall Panel	GPLLGSP40B	285	PW Pivot-Hinged Door Leaf Lite Scale
GPGSSC48	213	PW GS Clerestory Wall Panel	GPLLGSP42	289	PW Pivot-Hinged Door Leaf Lite Scale
GPGSSC60	213	PW GS Clerestory Wall Panel	GPLLGSP42B	289	PW Pivot-Hinged Door Leaf Lite Scale
GPGSSG06	197	PW GS All-Glass Wall Panel	GPLLSPBF76	279	PW Butt-Hinged Door Leaf Lite Scale
GPGSSG08	197	PW GS All-Glass Wall Panel	GPLLSPBT76	281	PW Butt-Hinged Door Leaf Lite Scale
GPGSSG18	197	PW GS All-Glass Wall Panel	GPLLSPPF80	283	PW Pivot-Hinged Door Leaf Lite Scale
GPGSSG20	197	PW GS All-Glass Wall Panel	GPLLSPPT80	285	PW Pivot-Hinged Door Leaf Lite Scale

Style Number Index, continued

Style Number	Page	Description
GPLSSBF40	279	PW Butt-Hinged Door Leaf Lite Scale
GPLSSBT40	281	PW Butt-Hinged Door Leaf Lite Scale
GPLSSPF40	283	PW Pivot-Hinged Door Leaf Lite Scale
GPLSSPF42	287	PW Pivot-Hinged Door Leaf Lite Scale
GPLSSPT40	285	PW Pivot-Hinged Door Leaf Lite Scale
GPLSSPT42	289	PW Pivot-Hinged Door Leaf Lite Scale
GPLSPBF76	157	PW Butt-Hinged Door Leaf
GPLSPBT76	159	PW Butt-Hinged Door Leaf
GPLSPPF80	161	PW Pivot-Hinged Door Leaf
GPLSPPT80	163	PW Pivot-Hinged Door Leaf
GPLSSBF40	157	PW Butt-Hinged Door Leaf
GPLSSBT40	159	PW Butt-Hinged Door Leaf
GPLSSPF40	161	PW Pivot-Hinged Door Leaf
GPLSSPF42	165	PW Pivot-Hinged Door Leaf for Cutout
GPLSSPT40	163	PW Pivot-Hinged Door Leaf
GPLSSPT42	167	PW Pivot-Hinged Door Leaf for Cutout
GPMEL	185	PW Mini End
GPMELF	186	PW Mini End
GPMEM	185	PW Mini End
GPMEMF	186	PW Mini End
GPMES	185	PW Mini End
GPMESF	186	PW Mini End
GPP120V	193	PW V-Post
GPP135V	193	PW V-Post
GPP135Y	193	PW Y-Post
GPPBKIT	254	PW Post and Beam Attachment Kit
GPPC	258	PW Cover Plate
GPPDC	258	PW Cover Plate
GPPI	193	PW In-Line Post
GPPL	193	PW L-Post
GPPT	193	PW T-Post
GPPWCTSP	265	PW Ceiling Track Spacer Lite Scale
GPPWFSC	268	PW Feature Strip, Lite Scale
GPPWGCTS	265	PW Glass Channel, Ceiling Track, Lite Scale
GPPWGCL	265	PW Glass Channel, Large, Lite Scale
GPPWGCS	265	PW Glass Channel, Small, Lite Scale
GPPWGCV	265	PW Glass Channel, Variable Angle, Lite Scale
GPPWGLBG	267	PW Glass-Lite Butt Glazed
GPPWGSL	265	PW Glass Stop, Large, Lite Scale
GPPWGSS	265	PW Glass Stop, Small, Lite Scale
GPPWGTB	270	PW Glazing Tape, Black
GPPWGTFC	270	PW Glazing Tape, Foam, Coated
GPPWPE	271	PW Post Extension Lite Scale
GPPWPPB	269	PW Plinth, Base, Lite Scale
GPPWPPC	269	PW Plinth, Ceiling Track, Lite Scale
GPPWVSBGS	266	PW Vertical Transition Lite Scale
GPPWVTBGS	266	PW Vertical Stop Lite Scale
GPPX	193	PW X-Post
GPR1USBX	257	USB Receptacle
GPR1USBY	257	USB Receptacle
GPR1USBZ	257	USB Receptacle
GPR2USBX	257	USB Receptacle
GPR2USBY	257	USB Receptacle
GPR2USBZ	257	USB Receptacle
GPR3USBX	257	USB Receptacle

Style Number	Page	Description
GPR3USBY	257	USB Receptacle
GPR3USBZ	257	USB Receptacle
GPR4USBX	257	USB Receptacle
GPR4USBY	257	USB Receptacle
GPRCE	258	PW Power/Communication Fillers
GPRTL	243	Cornice Track
GPRTS	243	Cornice Track
GPRTT	243	Cornice Track
GPRTX	243	Cornice Track
GPSAM08	121	Mod Solid Wall Panels with Enhanced Core
GPSAM18	121	Mod Solid Wall Panels with Enhanced Core
GPSAM20	121	Mod Solid Wall Panels with Enhanced Core
GPSAM24	121	Mod Solid Wall Panels with Enhanced Core
GPSAM30	121	Mod Solid Wall Panels with Enhanced Core
GPSAM36	121	Mod Solid Wall Panels with Enhanced Core
GPSAM40	121	Mod Solid Wall Panels with Enhanced Core
GPSAM42	121	Mod Solid Wall Panels with Enhanced Core
GPSAM48	121	Mod Solid Wall Panels with Enhanced Core
GPSAS06	121	Mod Solid Wall Panels with Enhanced Core
GPSAS08	121	Mod Solid Wall Panels with Enhanced Core
GPSAS18	121	Solid Wall Panels with Enhanced Core
GPSAS20	121	Solid Wall Panels with Enhanced Core
GPSAS24	121	Solid Wall Panels with Enhanced Core
GPSAS30	121	Solid Wall Panels with Enhanced Core
GPSAS36	121	Solid Wall Panels with Enhanced Core
GPSAS40	121	Solid Wall Panels with Enhanced Core
GPSAS42	121	Solid Wall Panels with Enhanced Core
GPSAS48	121	Solid Wall Panels with Enhanced Core
GPSCG	270	PW Seal, Ceiling Grid
GPSSL	270	PW Seal, Light and Sound
GPSM08	118	PW Solid Wall Panel
GPSM18	118	PW Solid Wall Panel
GPSM20	118	PW Solid Wall Panel
GPSM24	118	PW Solid Wall Panel
GPSM30	118	PW Solid Wall Panel
GPSM36	118	PW Solid Wall Panel
GPSM40	118	PW Solid Wall Panel
GPSM42	118	PW Solid Wall Panel
GPSM48	118	PW Solid Wall Panel
GPSM60	118	PW Solid Wall Panel
GPSS06	118	PW Solid Wall Panel
GPSS08	118	PW Solid Wall Panel
GPSS18	118	PW Solid Wall Panel
GPSS20	118	PW Solid Wall Panel
GPSS24	118	PW Solid Wall Panel
GPSS30	118	PW Solid Wall Panel
GPSS36	118	PW Solid Wall Panel
GPSS40	118	PW Solid Wall Panel
GPSS42	118	PW Solid Wall Panel
GPSS48	118	PW Solid Wall Panel
GPSS60	118	PW Solid Wall Panel
GPUFG	255	PPW Universal Floor Gripper
GPWC1	187	PW Wall Channel
GPWC2	187	PW Wall Channel
GPWC4	187	PW Wall Channel

Style Number	Page	Description	Style Number	Page	Description
GPWCCP	188	PW Panel End Cut Kit	GUNSU100	336	Low-Profile Supports
GPWCCPSK	189	PW End Filler Cut Kit	GUNTR450	336	Low-Profile Triangle Tile
GPWT	255	PW Wall-Lifting Tools	GUNTR48	336	Low-Profile Triangle Tile
GSM2WSPLIT	393	Splitter	GUNTT22L	339	Low-Profile Transition Trim
GSM30AEMIT4	391	Emitters	GUNTT22R	339	Low-Profile Transition Trim
GSM30EMIT4	386	Emitters	GUNTT42L	339	Low-Profile Transition Trim
GSM4WSPLIT	393	Splitter	GUNTT42R	339	Low-Profile Transition Trim
GSM60ORM	383	Rack Mount Brkt	GUNWT10486	340	Low-Profile Wall Scribe Trim
GSMAEEM1	396	Active Emitters Ext Mounting Brkt	IRYPOD	406	IRYS Pod
GSMAEEM2	396	Active Emitters Ext Mounting Clamp	PFLADPTR	314	Thread Plug Adapter
GSMAEHRC	392	Cable	PFLCNCTR	322	Thread Connector
GSMAEINJ	390	Active Emitters Power Injector	PFLHUB	315	Thread Power Hub
GSMAEEMIT4	391	Active Emitters with 16" Cable	PFLINFFL	318	Thread Power Track Floor Infeed with Ramps
GSMAEPS	389	Active Emitters Power Supply	PFLINFFLV	319	Thread Power Track Floor Infeed with Infills
GSMCABLE10	392	Cable	PFLPWRST	323	Thread Power Strip
GSMCABLE100	392	Cable	PFLTRK	320	Thread Power Track
GSMCABLE25	392	Cable	PFLTRKINF	316	Thread Power Track Infeed
GSMCABLE50	392	Cable	PFLTRKINFV	317	Thread Power Track Wall Infeed with Infills
GSMCABLE75	392	Cable	PFLTRKV	321	Thread Power Track with Infills
GSMCPAK4	392	Cables			
GSMCRPS	388	Conference Room Privacy Package			
GSMDEM3	397	Drywall Mount Brkt			
GSM EEM1	395	External Mounting Bracket			
GSM EEM2	395	External Mounting Clamp			
GSMEMIT4	386	Emitters			
GSMFFCOUP	394	Coupler			
GSMHS1	384	Hole Saw Blade			
GSMPPS	388	Patient Privacy Package			
GSMPS3	385	Power Supply			
GSMQT100	382	QtPro Qt 100 Ctrl Mod			
GSMQT300	382	QtPro Qt 300 Ctrl Mod			
GSMQT600	382	QtPro Qt 600 Ctrl Mod			
GSMQTRC	387	QtPro Room Control			
GSMSONET	398	Sonet Qt Ind Soundmasking			
GSMSONETXT	398	Sonet Qt Ind Soundmasking			
GUNCR3232	341	Low-Profile Corner Ramp Kit			
GUNCT224	339	Low-Profile Corner Edge Trim			
GUNCT424	339	Low-Profile Corner Edge Trim			
GUNDS16161	338	Low-Profile Distribution Tile			
GUNDS16164	338	Low-Profile Distribution Tile			
GUNET248	338	Low-Profile Edge Trim			
GUNET448	338	Low-Profile Edge Trim			
GUNFBT1616	338	Low-Profile Floor Box Access Tile			
GUNFS726	341	Low-Profile Fire Stop			
GUNGR10	336	Low-Profile Grom Triangle Tile			
GUNGR2	336	Low-Profile Grom Triangle Tile			
GUNRA363211	340	Low-Profile Ramp Kit			
GUNRA36328	340	Low-Profile Ramp Kit			
GUNRA483211	340	Low-Profile Ramp Kit			
GUNRA48328	340	Low-Profile Ramp Kit			
GUNRC8161	337	Low-Profile Rectangle Tile			
GUNRC8164	337	Low-Profile Rectangle Tile			
GUNSQ16161	337	Low-Profile Square Tile			
GUNSQ16164	337	Low-Profile Square Tile			
GUNST8	337	Low-Profile Seismic Triangle Tile			

Trademark List

- ® The following are registered trademarks for products of Steelcase Inc. or one of its related corporate entities: 4 o'clock, 900 Series, à la carte, Airtouch, Ally, Amia, Answer, Archipelago, Avenir, Ballet, Bix, Brayton International, Cachet, Canopy, Canto, Chancellor, Coalesse, Confidante, Context, Convene, CopyCam, Criterion, Crushed Can, Currency, dash, Designtex, Details, Detour, Drive, Elective Elements, Ellipse, Ember Chrome, Emerge, E-Table 2, FYI, Garland, Gentry, Ginkgo Biloba, Groupwork, Ideo, Jacket, Jenny, Jersey, Kart, Kick, LaCosta, Leap, Let's B, LiveBack, Max-Stacker, media:scape, Metro, Migrations, Mitra, Montage, Nurture, Oriana, Parade, Pathways, PCT, Permiso, Player, Portal, Power Pincher, Progeny, Protégé, R2, Rally, Relevant, Reply, Rizzi Arc, Sensor, Series 9000, Siento, Sieste, Sine, Softcare, Springboard, Steelcase, Steelcase Design Partnership, Stella, Stow Davis, Swathmore, TeamWork, Technique, Texpress, Think, Thunder, Topo, Train, turnstone, Underline, Unison, Vecta, Viridian, Walden, Wernld, and X-Stack.
- ® The following registered trademarks are under license from AWI Licensing Company, Dover, DE: SoundScapes, DuraBrite, BioBlock, and Armstrong.
- ® The following registered trademarks are under license from Byrne Electrical, Rockford, MI: Interport, Mini-Port, Axil Z, and Ellora.
- ® The following is a registered trademark of DuPont, Wilmington, DE: Corian.
- ® The following is a registered trademark of Genlyte Thomas Company, Louisville, KY: Lightolier.
- ® The following is a registered trademark of Hilti Corporation, FL-9494 Schaan, Principality of Liechtenstein: Hilti.
- ® The following is a registered trademark of Leviton Manufacturing Company, Little Neck, NY: Decora.
- ® The following is a registered trademark of Mechanical Plastics Corp, Elmsford, NY: Toggler.
- ® The following is a registered trademark of Microsoft Corporation, Redmond, WA: Microsoft.
- ® The following is a registered trademark of Panduit Corporation, Lockport, IL: Panduit.
- ® The following is a registered trademark of Trav (Press), Cuneo, Italy: Assisa.
- ® The following is a registered trademark of Virtual Ink, Boston, MA: mimioActive.
- ® The following registered trademarks are under license from Wilkhahn Furniture Products: Avera, Senzo, Versal, and Wilkhahn FS.

- ® The following is a registered trademark of Wilsonart International, Temple, TX: Chemsurf.
- ® The following is a registered trademark of Wiremold, West Hartford, CT: Wiremold.
- ® The following is a registered trademark of EMU Group S.P.A., Perugia, Italy: Emu.
- ™ The following are trademarks for products of Steelcase Inc. or one of its related corporate entities: Access, Active/Passive Shelf, Ainsley, Akira, Alcove, Alerion, Alight, Amaris, American Elect, American Tradition, ap40, Arbor, Arriva, Asana, Ascot, Aspekt, Astor, Await, Bassline, B-Free, Bira, Bivi, Bixby, Bottomline, Brody, Brook, Buoy, Burton, c:scape, Calla, Calm, Camber, Campfire, Capa, Cappuccino, Cesar, Chester, Chord, Circa, Clarendon, Classic Rectangular, Clipper, cobí, Collaboration, Community, Company, Convey, Cortex, Coupe, Crea, Crew, Cura, Cypress, Davenport, Dearborn, Deck, Déjà, Denizen, Denska, Derby, Divisio, Donovan, Dune, Duo, Echo, Edge, Elsna, Empath, Empress, Enea, ño, EnSync, Enviro, Escapade, Exchange, Exponents, Field, Flat Top, FlexFrame, Flip Top, Flute, Folio, FrameOne, FreeFlow, Frontier, Galilei, Gesture, Ginger, Ginkgo, Go Wall, Grip, Groove, Hatchback, Hawthorne, Hitch, Host Collection, Hosu, Huddleboard, i2i, Impact, Indy, InfoLink, IOS, I-Solve, Jack, Jarrah, Jetty, Juice, Kami, Kast, Kathryn, Lagunitas, Lark, L'Attitude, LearnLab, Leela, LessThanFive, Lincoln, Linden, LiveSeat, Loria, Lyric, Malibu, Malibu Too, Mansfield, Marathon, Martini, Mason, Masque, Migration, Millbrae, Mineral, Mingle, Mystic, Mystic Metal, Mystic Wood, Montara650, Montreal, Move, Nadia, Neighbor, nesso, Nickel, Nikko, Nod, Node, Norfolk, Ology, Ontrak, Oom, Opus, Orchid, Outlook Collection, Ovation, Paloma, Paperflo, Parliament, Pasio, Passerelle, Patriarch, Payback, Peek, Pile File, Pisa, Pool, Potrero415, PUCK, QiVi, Quba, Rave, Reed, Regard, Relay, Reunion, Ripple, Riser, Rocco, Rocky, RoomWizard, Runner, Satellite, Sawyer, ScapeSeries, Senti, Sentinel, Senza, Sequoia, Session, ShareLink, Shield, Shortcut, Sidewalk, SILQ, Skylar, Slumber, Smoke, Snug, Soft Leaf, Sonata, Sorrel, SOTO, Southside, Stationkits, Steelcase Series, Stiletto, Surprise!, Surround, Switch, Symphony, Sync, TagWizard, Tava, TeamStudio, TeamTheater, Tenaro, Terrazzo, Theorem, Thread, Topaz, Touchdown, Tour, Tower Too, Trees, Trillium, Trolley, tX2, U-Free, Umami, Underscore, Uno, V.I.A., Verb, Verge, Verlay, Victor2, Visalia, Waldorf, Woodruff, Workspring, and X-tenz.
- ™ The following is a trademark of Microsoft Corporation, Redmond, WA: Windows.
- ™ The following is a trademark of Rodman Industries, Inc., Oconomowoc, WI: ResinCore1.
- ™ The following is a trademark of Ultrafabrics, LLC, Elmsford, NY: Ultraleather.

- ™ The following trademarks are under license from Wilkhahn Furniture products: Cana, Linus, Logon, Picto, Range, Stitz, Thema, Timetable, and Tubis.
- ™ The following trademark is used under license from Cradle to Cradle Products Innovation Institute, Oakland, CA: Cradle to Cradle Certified.
- ™ The following trademarks are under license from Walter Knoll: Andoo, Bob, Lazlo, Lox, Ribbon, and Together.
- ™ The following trademarks are under license from PP Møbler: Bar and Flag Halyard.
- ™ The following trademarks are under license from Viccarbe: Davos, Holy Day, Last Minute, RS, Sistema, and Wrapp.
- ™ The following trademarks are under license from Carl Hansen: Elbow, Paddle, Shell, Wing, and Wishbone.
- ™ The following trademarks are under license from Cambridge Sound Management, LLC, Cambridge, MA: QtPro Soundmasking, Qt Quiet Technology, and Sonet Qt.
- ™ The following is a trademark of Electri-Cable Assemblies, Shelton, CT: Interact.
- ™ The following is a trademark of Clestra Hauserman: IRYS.
- ™ The following is a trademark of Wiesner-Hager Möbel GmbH: Nooi.
- ™ The following are trademarks of PolyVision: a³, e³, Motif, and PolyVision.

Trademarks used here in are the property of Steelcase, Inc. or of their respective owners.