

Define Without Confinement

USG

Open-Cell System

GridWare™ and WireWorks™

Retail
Offices
Lobbies
Hospitality
Entertainment

The open-cell ceiling system creates structure without obstruction. Latticed metal 2' x 2' WIREWORKS™ ceiling panels available in a range of dynamic patterns nestle into the high-quality DONN® brand GRIDWARE™ suspension system. Punched with only the necessary cross-tee holes, GRIDWARE tees assure clean, uncluttered grid lines, without unsightly perforations.



Give Your Design Language...



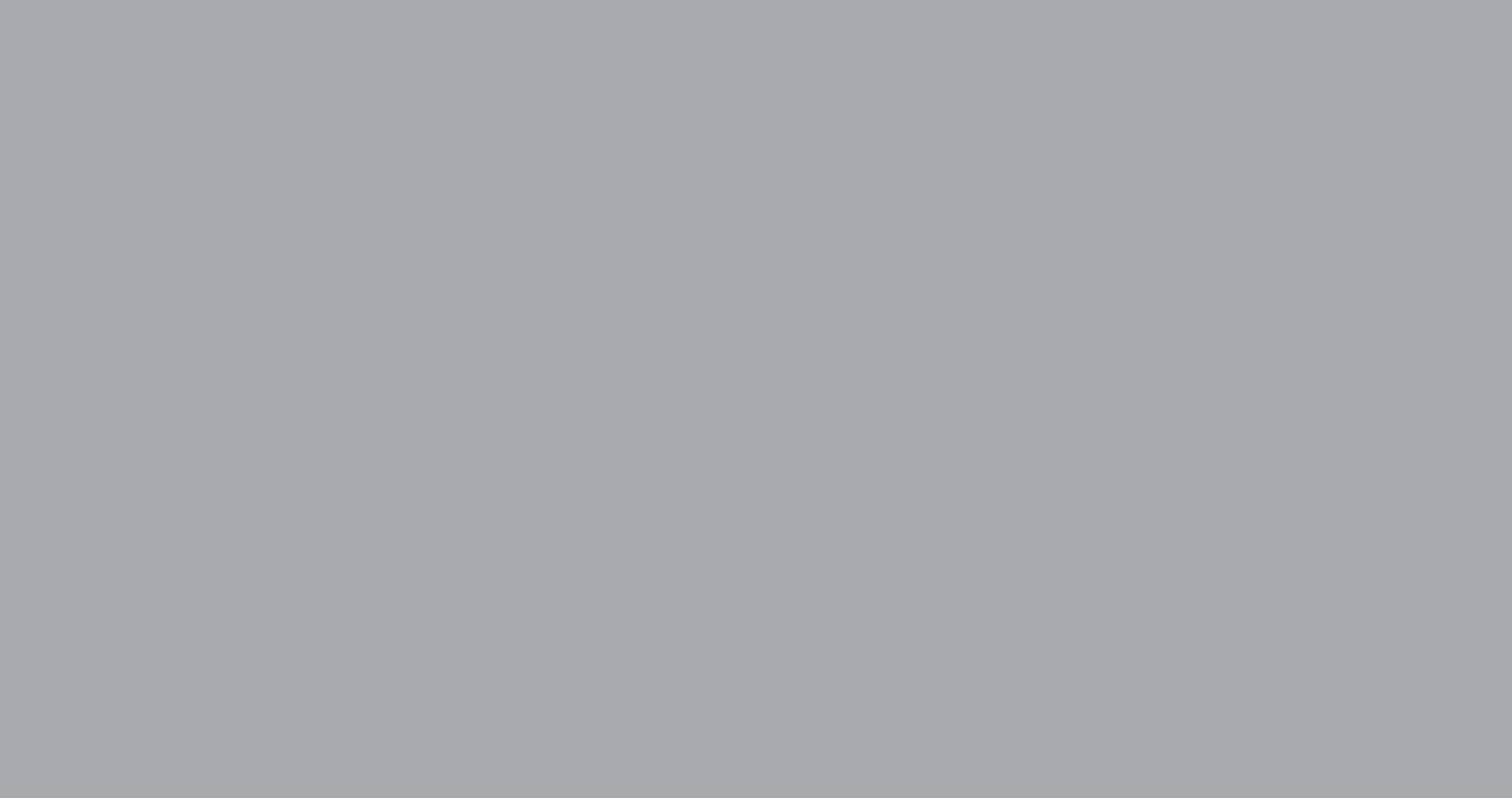

An Alluring Accent



User's Guide

Use this brochure to select and specify WIREWORKS ceiling panels and the GRIDWARE suspension system to create signature details. Use these two products together as a system or integrate WIREWORKS panels into a standard ceiling suspension system. Or, use the GRIDWARE suspension without panels to subtly set boundaries and highlight key areas. Inside, you'll find comprehensive information about components, design ideas, and guide specifications.

	Pages	
Understand Your System	2	Overview Components
Design Your System	6	Design Options Ceiling Perimeters
Specify Your System	9	Guide Specifications
For More Information		Technical Service 800 USG.4YOU Web Site www.usg.com

Overview

The open-cell ceiling system brings together a collection of graceful wire ceiling panels and a sleek, streamlined suspension system to create sophisticated planes that subtly define and organize space. These high-quality components also allow exceptional flexibility.

WIREWORKS ceiling panels can be used with the GRIDWARE suspension system, which features minimal main-tee punching (only cross-tee holes for 2'x2' modules), or integrated into a standard ceiling suspension system.

The GRIDWARE suspension system can also be used alone to enhance the airiness of your design. This suspension is available in three face widths, and exposed edges may be finished with COMPASSO™ suspension trim to create striking ceiling islands and fascias.

2' x 2' GRIDWARE suspension system with WIREWORKS Forms Big Wave panels and 2-1/4" COMPASSO suspension trim.

2' x 4' GRIDWARE suspension system with 2-1/4" COMPASSO suspension trim.

4' x 4' GRIDWARE suspension system with 2-1/4" COMPASSO suspension trim.

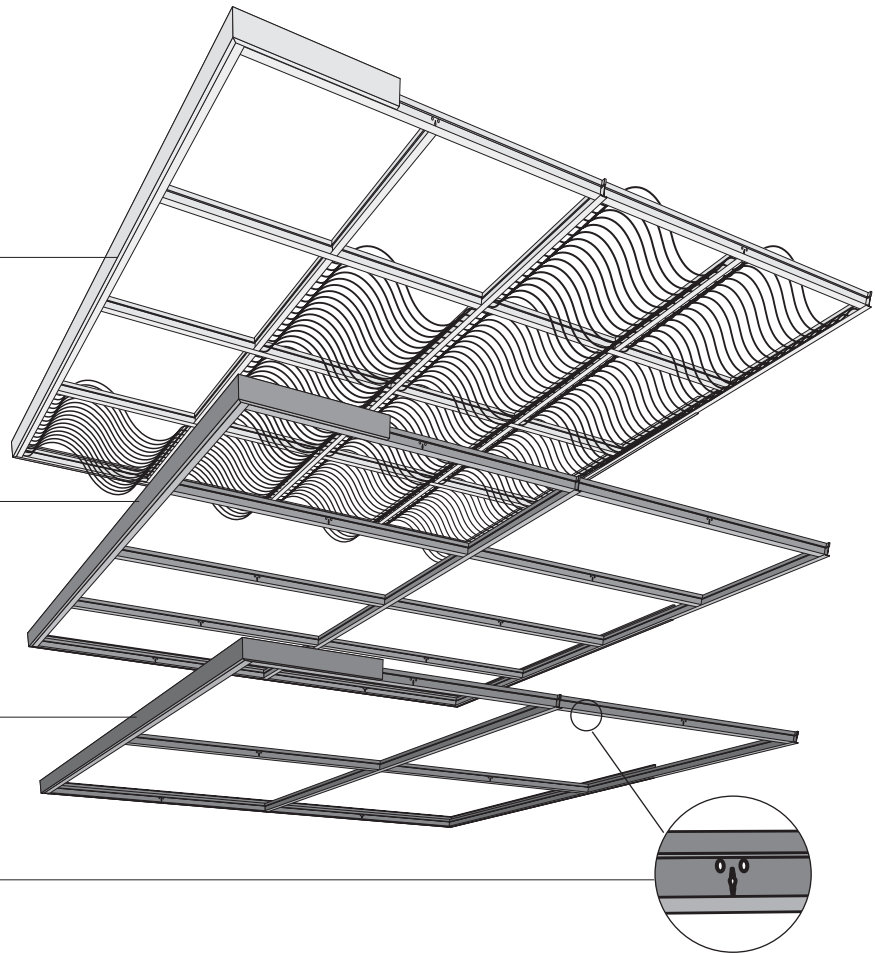

GRIDWARE tees are punched only with cross-tee holes at 2' o.c.

System Components

WireWorks Panel Options

WireWorks metal ceiling panels create a clean, linear gridwork with a choice of four cell sizes. Panels measure 2' x 2' and feature 1/8" wire.

Colors

WireWorks panels are available in Glossy White, Chrome and custom colors.

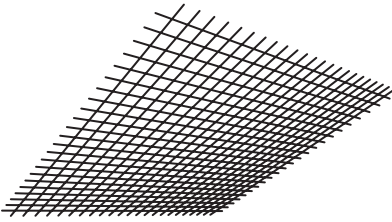
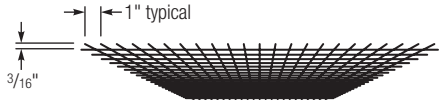
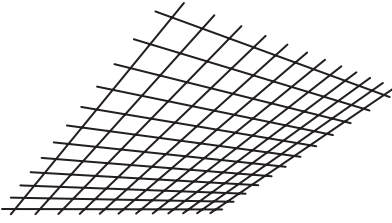
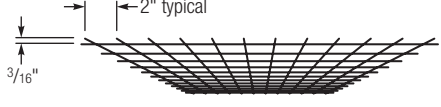
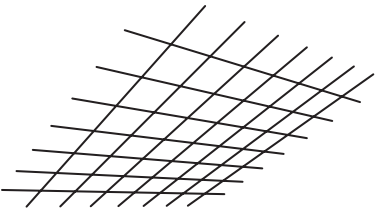
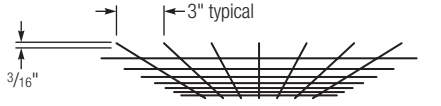
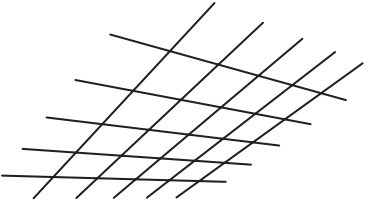
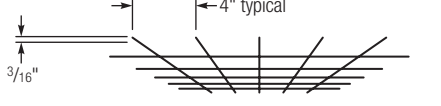
	Face	Side Profile
1" x 1" Cells		
2" x 2" Cells		
3" x 3" Cells		
4" x 4" Cells		

System Components

WireWorks Forms Panel Options

WireWorks Forms ceiling panels offer a choice of four dynamic, curvy patterns, including two 3-dimensional designs. Panels measure 2' x 2' and feature 3/16" wire.

Colors

WireWorks Forms panels are available in Glossy White, Glossy Red, Glossy Black, Chrome and custom colors.

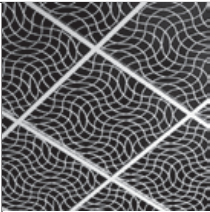
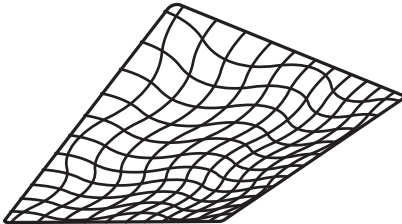
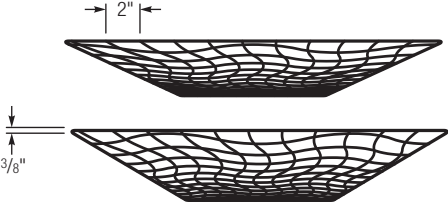
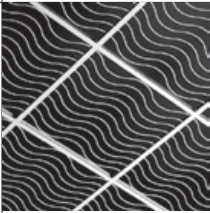
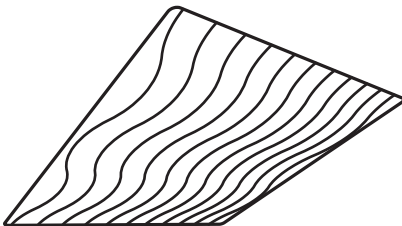
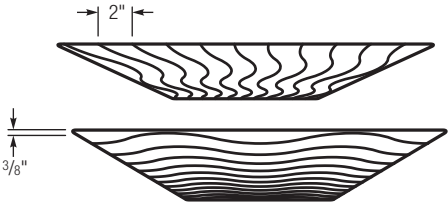
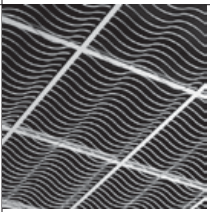
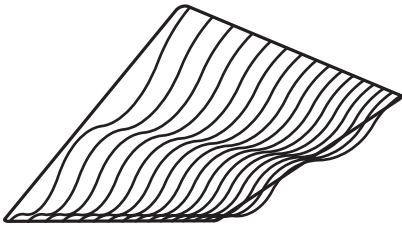
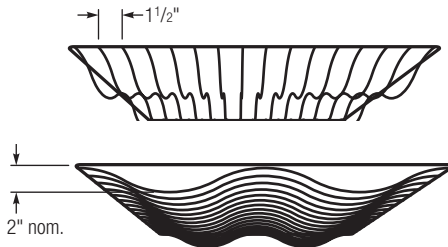
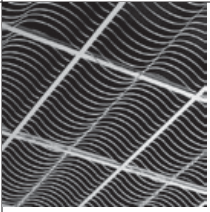
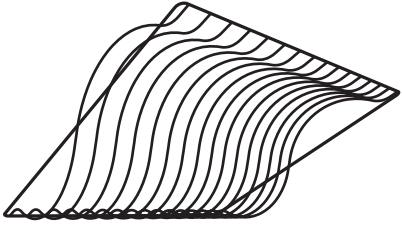
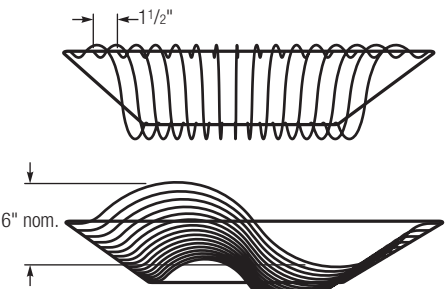
		Face	Front and Side Profile
Weave			
Ripple			
Small Wave			
Big Wave			

GridWare Suspension System

WIREWORKS and WIREWORKS Forms ceiling panels fit into the GRIDWARE suspension system. This easy-to-design system features a 1-1/2" tee height and is available in three standard grid profiles for added design options. The GRIDWARE ceiling system includes a 1-1/2"-high wall angle to match tee height and readily accommodates standard 2' x 2' and 2' x 4' lay-in light fixtures and air diffusers.

Colors Flat White, Silver Satin, Flat Black.¹ Custom colors also available.

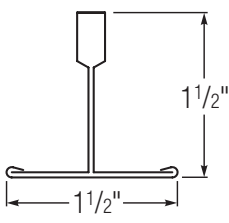
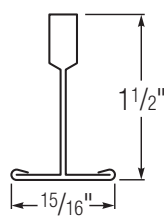
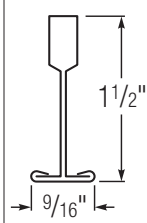
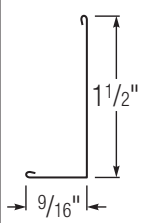
	1-1/2" Face GDXW	15/16" Face GDX	9/16" Face GDXT	Wall Angle GWM9
Face Options				
ASTM Class	Heavy Duty	Intermediate Duty	Intermediate Duty	—

Components

Main tees are punched 12" from each end and every 24" in between. 4' cross tees have one center punch; 2' cross tees have no punches.

24" Cross Tee

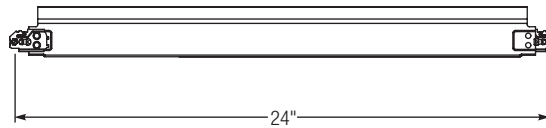

48" Cross Tee

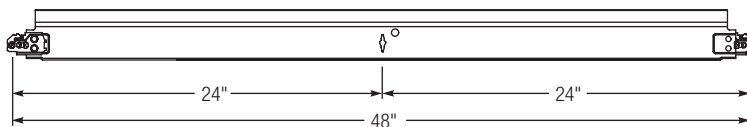

12' Main Tee

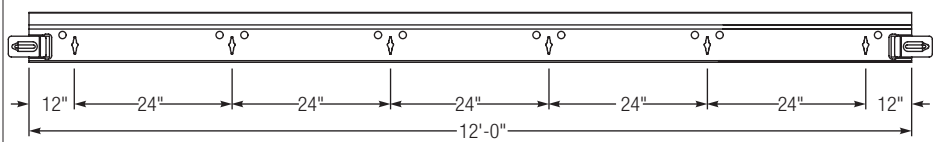

1. Colors coordinate with but do not match stock paint colors for WIREWORKS ceiling panels.

Design Options

Suspension System

The GRIDWARE system installs just like a standard T-bar suspension system. WIREWORKS panels lay in as easily as acoustical ceiling panels, but add a lightness and energy that no standard panel can provide.

The GRIDWARE suspension system is punched to create standard 2' x 2' openings and accommodate all WIREWORKS and WIREWORKS Forms panels. The system can also create 2' x 4' and 4' x 4' openings with minimal visible punching.

Standard GRIDWARE Assemblies

2' x 2' Openings

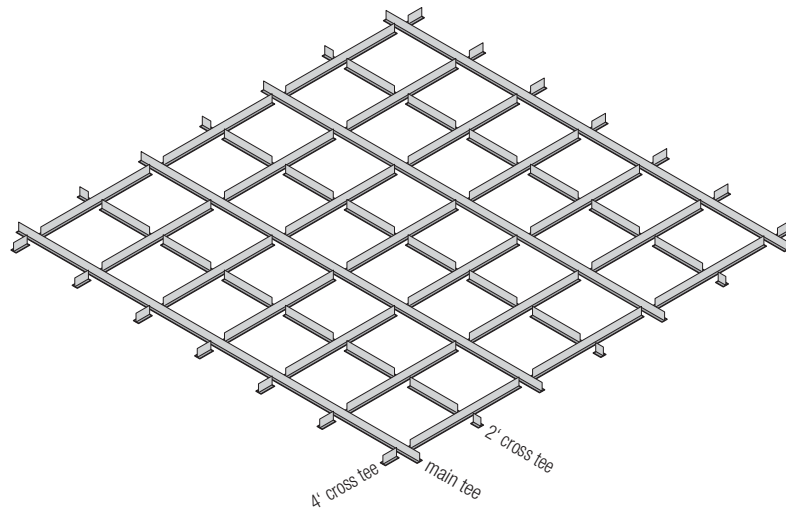

2' x 4' Openings

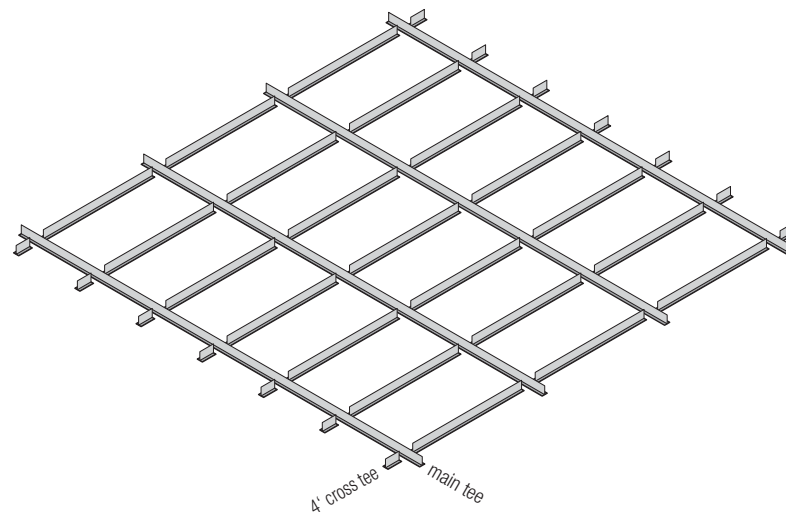

4' x 4' Openings

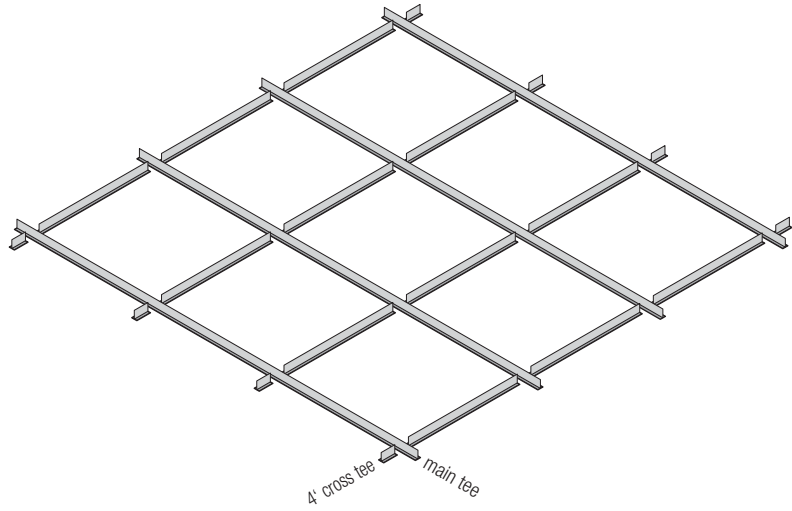

Ceiling Perimeters

Edge Details Openings less than 24"

At the perimeter where openings may be less than 24", WIREWORKS panels and Weave panels may be cut to fit with a hacksaw or linesman's pliers.

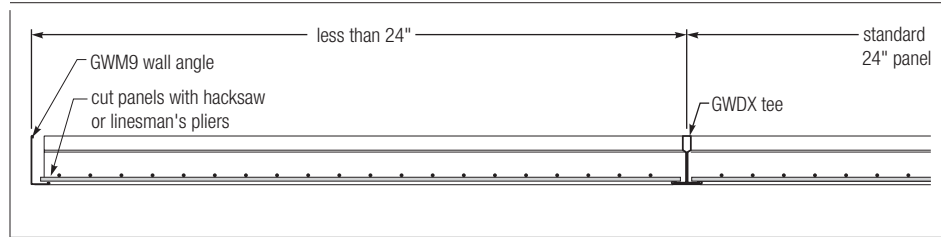

24"-wide openings

Ripple, Small Wave and Big Wave panels can be cut parallel to the inner design wires but not perpendicular; when perpendicular to the wall, these panels require openings with a full 24" width at the perimeter.

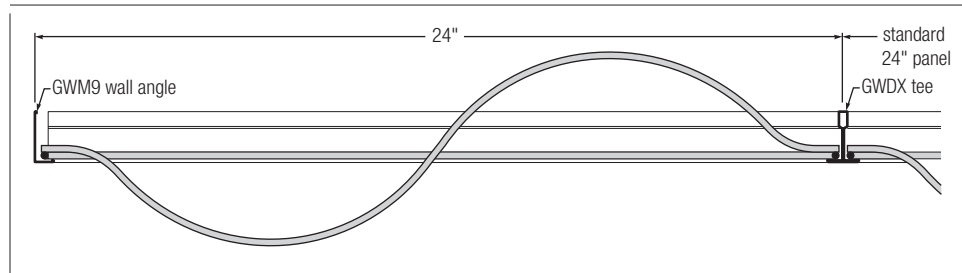

Cut Parallel

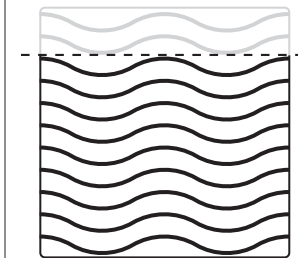

Do Not Cut Perpendicular

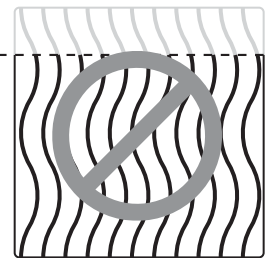

COMPASSO Edge Trim

Ceiling islands may be finished with COMPASSO edge trim for a clean, streamlined appearance.

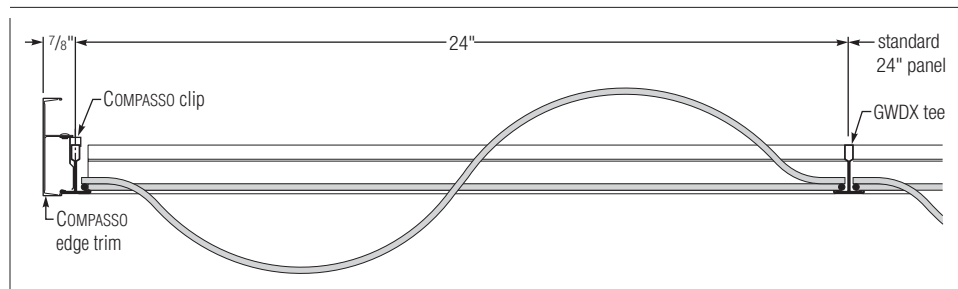

Application Guide

Specifications

Part 1 General	1.1 Summary	<p>A. Description of Work: Work of this Section includes, but is not limited to, the following</p> <ol style="list-style-type: none"> 1. Metal suspension systems. 2. Trim and accessories.
	1.2 Related Work Specified Elsewhere	<p>A. See Section _____ – HVAC</p> <p>B. See Section _____ – Lighting</p> <p>C. See Section 095100(09150) – Acoustical Ceilings</p>
	1.3 Submittals	<p>A. Product Data: Submit manufacturer's specifications and installation instructions with Project conditions and materials clearly identified or detailed for each required system.</p>
	1.4 System Requirements	<p>A. Performance Requirements: Fabricate and install systems as indicated but not less than that required to comply with ASTM C754 under the following conditions:</p> <ol style="list-style-type: none"> 1. A pre-engineered drywall suspension system consisting of straight main tees and straight furring cross tees, that snap together as a finished decorative ceiling element or to support the insert of decorative wire-grate panels and independently supported light fixtures, and air diffusers, where applicable.
	1.5 Quality Assurance	<p>A. Reference Standards</p> <ol style="list-style-type: none"> 1. ASTM C635, Standard Specifications for Metal Suspension Systems 2. ASTM C636, Recommended Practice for Installation of Metal Suspension Systems. 3. CISCA Ceiling Systems Installation Handbook <p>B. Submittals</p> <ol style="list-style-type: none"> 1. Samples: Submit actual samples and technical data for suspension system main tees and cross tees for review. 2. Shop Drawings: <ol style="list-style-type: none"> a. Reflected ceiling plans: Submit ceiling suspension system layout indicating dimensions, lighting fixture locations, and related mechanical components. b. Assembly drawings: Indicate installation details, accessory attachments and installation of related lighting fixtures and related mechanical system components. 3. Manufacturer's Data: <ol style="list-style-type: none"> a. System Details: Submit manufacturer's catalogue cuts or standard drawing showing details of system with project conditions clearly identified and manufacturer's recommended installation instructions
	1.6 Delivery, Storage And Handling	<p>A. Delivery:</p> <ol style="list-style-type: none"> 1. Deliver material to site promptly without undue exposure to weather. 2. Deliver in manufacturer's unopened containers or bundles, fully identified with name, brand, type and grade. <p>B. Inspection:</p> <ol style="list-style-type: none"> 1. Promptly inspect delivered materials, file freight claims for damage during shipment, and order replacement materials as require. Any damaged materials shall be promptly removed from the job site <p>C. Storage:</p> <ol style="list-style-type: none"> 1. Store above ground in dry, ventilated space. 2. Protect materials from soiling, rusting and damage. 3. Store board to be directly applied to masonry walls at 70 °F for 24 hours prior to installation. <p>D. Handling:</p> <ol style="list-style-type: none"> 1. Handle in such a manner to insure against racking, distortion or physical damage of any kind

Application Guide

Specifications

	1.7 Project Conditions	A. Environmental Requirements 1. Do not install system or any parts until space is enclosed and weatherproof, wet-work is complete and dry, work above installation is complete and space temperature and humidity has been maintained as designed for occupancy.
	1.8 Coordination With Other Work	A. General: 1. Coordinate with other work including mechanical and electrical work and partition systems. Installation of conduit and ductwork above suspension system shall be complete before installation of suspension system B. Protection: 1. Follow good safety and industrial hygiene practices during handling and installing of all products and systems, with personnel to take necessary precautions and wear appropriate personal protective equipment as needed. Read Material Safety Data Sheets and related literature for important information on products before installation. Contractor to be solely responsible for all personal safety issues during and subsequent to installation; architect, specifier, owner and manufacturer will rely on contractor's performance in such regard
Part 2 Products	2.1 Manufacturer	A. All manufactured by USG (United States Gypsum Company, USG Interiors), Chicago, IL, USA, in compliance with applicable ASTM Standards. 1. DONN® Brand GRIDWARE™ Suspension System 2. DONN® Brand WIREWORKS open-cell wire panels [Delete if not used] 3. DONN® Brand WIREWORKS Forms open-cell wire panels [Delete if not used]
	2.2 Materials	A. DONN® Brand GRIDWARE™ Suspension System – Commercial quality, cold-rolled steel, hot dipped galvanized coated; finish paint color (Flat Black), (Flat White), or (Siler Satin); punched only every 24"; Listed products establish standard of quality and are manufactured by USG Interiors (USG), Chicago, IL. 1. Main Tees: 1-1/2" High x 144" Long, (GWDX 15/16" Face), (GWDXT 9/16" Face), or (GWDXW 1-1/2" Face) painted 360 degrees. 2. Cross Members: 1-1/2" High, (GWDX-224 15/16" Face x 24" Long), (GWDX-424 15/16" Face x 48" Long), (GWDXT-224 9/16" Face x 24" Long), (GWDXT-424 9/16" x 48" Long), (GWDXW-224 1-1/2" Face x 24" Long), or (GWDXW-424 1-1/2" Face x 48" Long) painted 360 degrees; quick release cross tee ends for positive locking and removability without tools; with exposed chromate clips, field painted to match grid color finish (left unpainted). 3. Wall Moldings: 9/16" Face x 1-1/2" High; finish paint color (Flat Black), (Flat White), or (Siler Satin). (GWM-9 9/16" x 1-1/2" x 144" long wall molding). 4. Field Touch-up Paint Kit: color to match finish selected on Grid from USG Interiors (USG), Chicago, IL. 5. End Cap/Finish Edge Trim: DONN™ COMPASSO® Suspension trim; 2-1/4" High, 4" High, 6" High, 8" High, 10" High, 12" High. [Delete if not used] 6. Wire: Hanger Wire (12 ga.), galvanized or as noted on drawings B. DONN® Brand GRIDWARE™ Suspension System – Commercial quality, cold-rolled steel, finished painted. System can be used with DONN® Brand WIREWORKS™ and /or WIREWORKS Forms open-cell wire panels or left empty. If left empty grid can be configured in 2' x 2', 2' x 4', 4' x 4', or any combinations. 1. DONN® Brand WIREWORKS open-cell wire 24" x 24" panels – Commercial quality, 1/8" wire grate steel, and finish paint color (Glossy White), (Chrome), or (Custom Colors). Installed into and compatible with DONN® Brand GRIDWARE™ 2' x 2' Suspension System only. a. Panels (open-cell wire grate): (1" x 1" Cells), (2" x 2" Cells), (3" x 3" Cells), or (4" x 4" Cells).

		<ul style="list-style-type: none"> C. DONN® Brand WIREWORKS open-cell wire panels – Commercial quality. 1. DONN® Brand WIREWORKS Forms open-cell wire 24" x 24" panels – Commercial quality, 3/16" articulated wire grate steel, and finish paint color (Glossy White), (Glossy Red), (Glossy Black), (Chrome), or (Custom Colors). Installed into and compatible with DONN® Brand GRIDWARE™ Suspension System only. Panels (open-cell articulated wire grate): (Weave 3/8" articulation), (Ripple 3/8" articulation), (Small Wave 2" articulation), or (Big Wave 6" articulation). D. DONN® Brand WIREWORKS Forms open-cell wire 24" x 24" panels.
Part 3 Execution	3.1 Examination	<ul style="list-style-type: none"> A. Examine substrates and adjoining construction and conditions under which Work is to be installed. Do not proceed with work until unsatisfactory conditions are corrected.
	3.2 General Installation Requirements	<ul style="list-style-type: none"> A. Standard reference: Install grid members in accordance with ASTM C636, Cisca installation standards, and other applicable references. B. Manufacturer's reference: Install in accordance with manufacturer's current printed recommendations. C. Drawing reference: Install in accordance with approved shop drawings and locate ceiling in accordance with main tee dimensions relative to elevations. D. Install in accordance with reference standards and manufacturer's instructions.
	3.3 Application Installation Requirements	<ul style="list-style-type: none"> A. Lay-In Ceiling Applications: <ul style="list-style-type: none"> 1. Lay-out ceiling area as indicated on reflected ceiling plan before any installation. 2. Hanger Wire Installation: Secure hanger wires to upper structural elements and space hangers so that each hanger wire supports a maximum of 16 sq. ft. Lay-out as reflected and dimensioned in reflected ceiling plan. 3. Space main tee members a maximum span of 48" on center. 4. Space cross tees as reflected on reflected ceiling plan, usually 24" and/or 48". 5. Install bracing wires to suspension members and to supports without attachment to metal formwork, steel decks or steel deck tabs. 6. Install trim, and similar accessories as necessary and as applicable to meet project requirements where indicated on drawings. 7. Install wearing soft gloves to reduce transfer of oil to finished framing members. 8. Install mains and tees as to align joints in a straight parallel/perpendicular fashion as indicated on reflected ceiling plan. Fit all joints tight and flush. 9. If cross tee's chromate clips are to be field painted, paint after installed but before panel installation. 10. If installation of grid is not wall to wall, but free style, install trim before panels. 11. If grid is terminated at walls or not complete 24" moduals, care should be taken as panles have cutting limitations. 12. Trim WIREWORKS panels and Forms Weave panels as needed with hacksaw or linesman's pliers. Forms Ripple, Small Wave and Big Waves can only be cut parallel to the inner design wires, NOT perpendicular. 13. Install panels by dropping down into grid frame from above. 14. Remove all manufacture applied temporay protective coverings, clean and touchup minor finish damage. If parts were damaged, remove and replace as needed. 15. Upon completion, clean all exposed sufaces of decorative suspension grid including trims and edge molding.

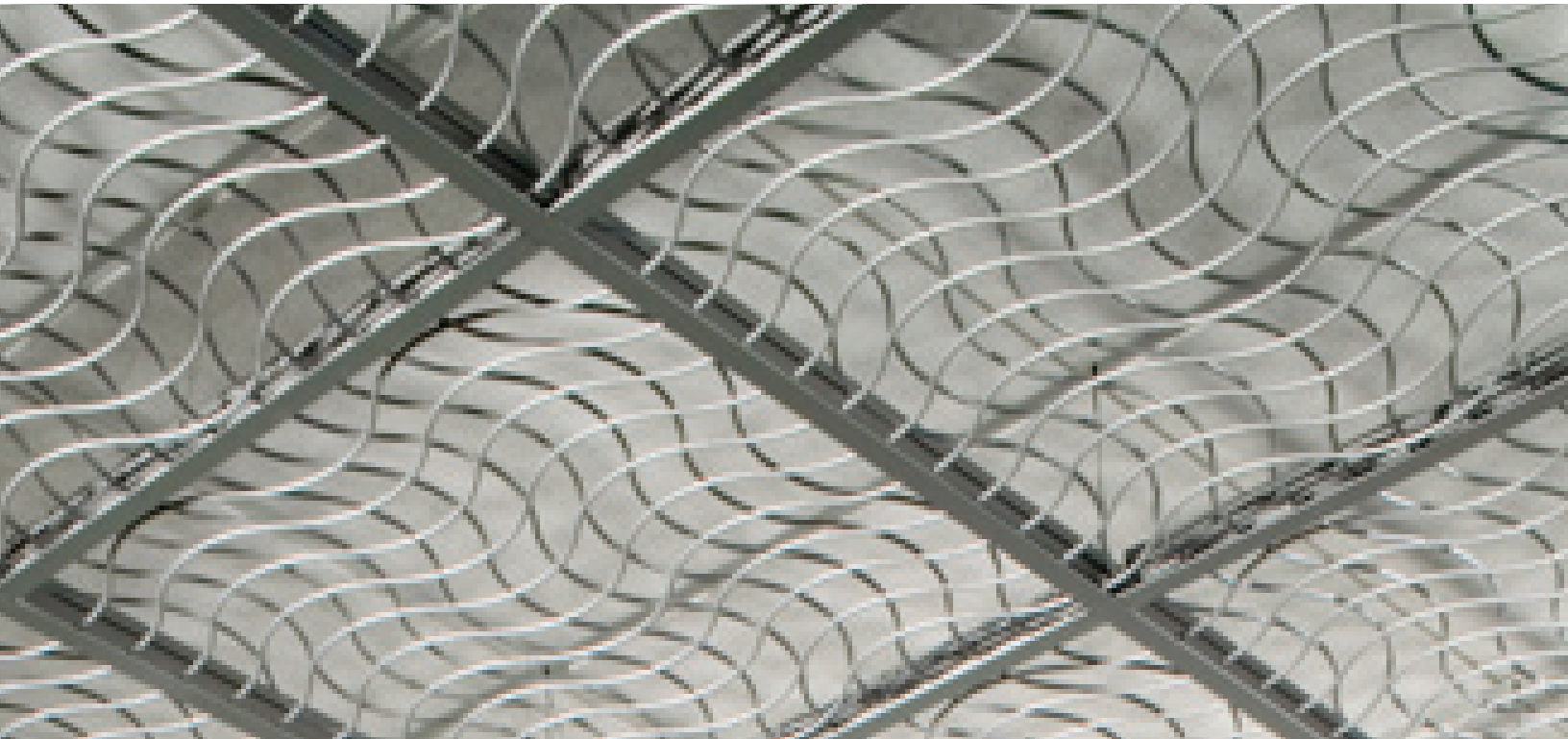

Technical Service
800 USG.4YOU

Web Site
usg.com

Samples/Literature E-mail
samplit@usg.com

Samples/Literature/Fax
888 874.2348

Customer Service
800 950.3839

Note

All products described here may not be available in all geographic markets. Consult your local sales office or representative for information.

Trademarks

The following trademarks used herein are owned by USG Interiors, LLC: COMPASSO, DONN, GRIDWARE WIREWORKS, USG, USG in stylized letters.

Notice

We shall not be liable for incidental and consequential damages, directly or indirectly sustained, nor for any loss caused by application of these goods not in accordance with current printed instructions or for other than the intended use. Our liability is expressly

limited to replacement of defective goods. Any claim shall be deemed waived unless made in writing to us within thirty (30) days from date it was or reasonably should have been discovered.

Safety First!

Follow good safety and industrial hygiene practices during handling and installation of all products and systems. Take necessary precautions and wear the appropriate personal protective equipment as needed. Read material safety data sheets and related literature on products before specification and/or installation.

