

Haworth prices in this book will increase on October 1, 2018 by 4%

Conference Tables

North America Price List / Specification Guide – April 2018



Includes Executive Wood, Immerse™ and Planes®

Electronic Update Page – Conference Tables Price List

- The table below lists all of the updates and addendums added to this price list since the original version was created.
- All **Update** pages will replace the existing pages within the document.
- All **New** pages will be placed at the back of the document.

Link	Date	Page	Description
Click Here	June 2018	350	Update – The Product Compatibility And Limited Warranty Policy Page was replaced with an updated version.
Click Here	July 2018	1A-6A	New – Price List pages for A5 Executive Wood Tables added.
Click Here	August 2018	39-67	Update – Immerse Tables has been added to GSA. Footers have been updated.
Click Here	September 2018	216, 218, 223	Update – Charts updated/corrected to better reflect number of legs.
Click Here	October 2018	All Pages	Update – Haworth prices in this book will increase on October 1, 2018 by 4%.
Click Here	November 2018	273	Update – Correction to cutout descriptions.
Click Here	November 2018	116	Update – Correction to width and depth for Planes Interior Leg Half Round Table.
Click Here	December 2018	All	Update – On December 1, 2018 all T-Mold and Cascade edges will be discontinued, all references to these edges were removed from the price list and specification guide.
Click Here	January 2019	180	Update – Correction added for wood grain directions.



This Haworth North American price book contains US list prices. Canadian customers can convert the US list price into their Canadian equivalent by going to www.Haworth.com/Canada to find the current Canadian multipliers. These multiplier factors allow you to convert the US list price into a Canadian list price.

HAWORTH

The following list gives a general overview of the content included within this price book (price list and specification guide) and explains how the book is organized and where information can be found.

- 1 Front Cover**
 - Includes the title and pricing effectivity date.
- 2 Electronic Update Page / Canadian Conversion**
 - Electronic versions of the Price Book (.pdf files) will include an Electronic Update Page listing the most recent updates and addendum added since the original version was created. If this section is blank no updates or addendums have been added.
 - Each update will include a description, page number, date and a link to the updated or new page.
 - The footer contains Canadian conversion information for converting US pricing into the Canadian equivalent.
- 3 Table of Contents**
 - Price List content with page numbers.
- 4 Price List**

Each price list page contains the following:

 - Product Illustration
 - Catalog Number
 - To Order Specify – sequencing for ordering product options and finishes
 - List Prices
 - Product Specification Dimensions
 - Features
 - Specification Tips
 - Class, Discount Group Number (used for discounting) and GSA information
- 5 Specification Guide**
 - Table of Contents – specification guide content with page numbers
 - Statement of Line – provides a pictorial outline of the product offering
 - Product Overview – brief introduction of the product and application intent
 - Easy Planning Steps – basic steps of planning with the product line
 - Product Details – product attributes, dimensions, surface materials and functionality
 - Product Application – vertical and horizontal planning guidelines including support and load, power, and storage
 - Technical Specifications – provides performance ratings, material composition and manufacturing process information
- 6 Finishes, Fabrics and COM**
 - Lists information for material finishes and availability.
 - Provides COM information and requirements (if applicable).
- 7 North American Terms of Sale**
 - Haworth terms for ordering, pricing, shipping and delivery, general terms, and services.
- 8 Index**
 - Products are listed alphabetically by alpha-numeric catalog numbers with price list page number.
- 9 Product Non-Obsolescence and Warranty Policy**
 - Provides Haworth policy for non-obsolescence and warranty.

Additional Information and Resources

Prices are subject to change without notice or approval. Haworth dealers should always submit proposals through Lynx before presenting to customers. See North American Terms of Sale for more information.

Online Resources

haworth.com

- Haworth's corporate website provides access to price books and a variety of other resources and publications.

surfaces.haworth.com

- Website provides access to the most current fabrics and finishes offered across Haworth's various product lines.

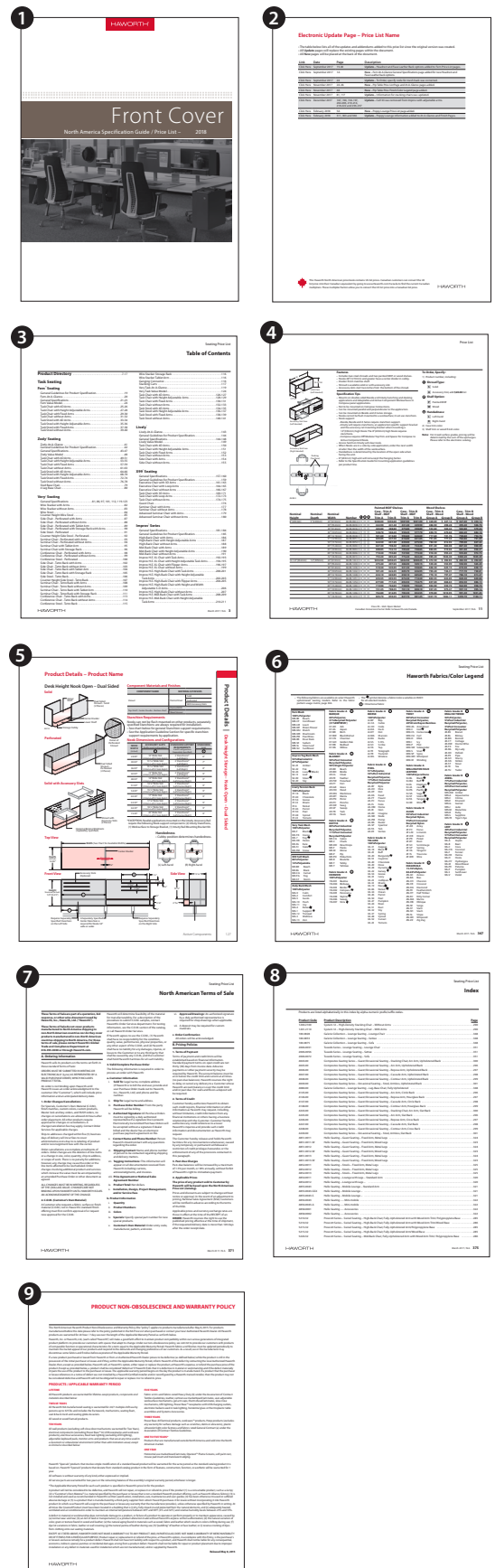

Table of Contents

Executive Wood Tables – A5

Base Kit	6
Glass Centerpiece	7
Electric Lift Interface Module	8
Telecom Plates for Interface	8

Executive Wood Tables

Specifications	10-11
Catalog Logic	12-14
Statement of Line	15-17
Base Placement	18
Round/Square	19
Base Kits – Round/Square Wood Tables	20
Rectangular	21-23
Base Kits – Rectangular Wood Tables	24
Racetrack Tables	25-27
Base Kits – Racetrack Wood Tables	28
Boat	29-31
Base Kits – Boat Wood Tables	32
Wedge	33-35
Base Kits – Wedge Wood Tables	36

Conference Buffet

Conference Buffet – Wood	37
Center Drawer	37

Accessories

Presentation Board	38
--------------------	----

Immerse — Single Table

Round – Painted Legs	39
Square – Painted Legs	40
Rectangle – Painted Legs	41
Racetrack – Painted Legs	42

Immerse — Stack Table

Rectangle – Painted Legs	43
--------------------------	----

Immerse — Shift Table

Rectangle/Rectangle – Painted Legs	44
Rectangle/Round – Painted Legs	45
Racetrack/Round – Painted Legs	46

Immerse — Overlap Table

Rectangle/Rectangle – Painted Legs	47-48
Rectangle/Round – Painted Legs	49
Racetrack/Round – Painted Legs	50
Rectangle/Ledge – Painted Legs	51

Immerse — Ledge Table

Rectangle – Painted Legs	52
--------------------------	----

Immerse — Single Table

Round – Wood Legs	53
Square – Wood Legs	54
Rectangle – Wood Legs	55
Racetrack – Wood Legs	56

Immerse — Shift Table

Rectangle/Rectangle – Wood Legs	57
Rectangle/Round – Wood Legs	58
Racetrack/Round – Wood Legs	59

Immerse — Overlap Table

Rectangle/Rectangle – Wood Legs	60-61
Rectangle/Round – Wood Legs	62

Racetrack/Round – Wood Legs	63
Rectangle/Ledge – Wood Legs	64

Immerse — Ledge Table

Rectangle – Wood Legs	65
-----------------------	----

Planter

Oblong	66
Round	67

Planes Conference Table Tops

Catalog Logic	68
Component Specification Overview	69-70
Round, Square and Pebble (for use with Column Base)	
Laminate or Wood	71
Rectangle (for use with Column Base) Laminate or Wood	73-75
Pebble (for use with Column Base) Laminate or Wood	77-79
Hexagon (for use with Column Base) Laminate or Wood	81-83

Planes End Supported Top

Catalog Logic	85
Component Specification Overview	86-87
D-Shape Convergent (for use with Column Base) Laminate or Wood	88-89
Rectangular Conference End (for use with Column Base)	
Laminate or Wood	90-91
Key Conference (for use with Column Base) Laminate or Wood	92-93
Wall Mount Bracket(s)	94
Side/Corner Bracket	94
Side Bracket for use with Knife Edge	94

Planes Conference Table

Column Frame (for use with Conference Table Top and End Supported Top)	95
Column Base Plate – Square and Round (for use with Conference Table Top and End Supported Top)	96
Cladding – Flat and Round (for use with Conference Table Top and End Supported Top)	97
J-Channel (for use with Conference Table Top)	98
J-Channel Tray (for use with Conference Table Top)	98

Electrical Accessories

Cable Reel	99
Cable Reel Bracket	99
Cable Management Processor Bracket	100
Cable Base Cable Retractor	100

Planes Accessories

Cable Base	101
Cable Column	101
HDMI or VGA Cable	102

Planes Credenza Tops

Credenza Top – Laminate or Wood	103
Grommet	103

Planes Credenza Bases

Credenza Base – 19”(483mm) High – Laminate or Wood	104
Credenza Base – 29”(737mm) High with Slider Unit – Laminate or Wood	105
Credenza Base – 35”(889mm) High with Slider Unit – Laminate or Wood	106
Credenza Base – 29”(737mm) High – Laminate or Wood	107
Credenza Base – 39”(991mm) High with Slider Unit – Laminate or Wood	108
Credenza Base – 45”(1143mm) High with Slider Unit – Laminate or Wood	109

Table of Contents

Planes Conference Tables — Interior Leg

Round – Interior Leg – Laminate	110-111
Square – Interior Leg – Laminate	110-111
Rectangular – Interior Leg – Laminate	110-111
Half Round – Interior Leg – Laminate	112
Polygon – Interior Leg – Laminate	113
Round – Interior Leg – Wood	114-115
Square – Interior Leg – Wood	114-115
Rectangular – Interior Leg – Wood	114-115
Half Round – Interior Leg – Wood	116
Polygon – Interior Leg – Wood	117
Rectangular – One-Piece Top – Interior Leg – Laminate	118-119
Pebble – One-Piece Top – Interior Leg – Laminate	120-121
Hexagon – One-Piece Top – Interior Leg – Laminate	122-123
Rectangular – One-Piece Top – Interior Leg – Wood	124-125
Pebble – One-Piece Top – Interior Leg – Wood	126-127
Hexagon – One-Piece Top – Interior Leg – Wood	128-129
Rectangular – Two-Piece Tops – Interior Leg – Laminate	130-131
Pebble – Two-Piece Tops – Interior Leg – Laminate	132-133
Hexagon – Two-Piece Tops – Interior Leg – Laminate	134-135
Rectangular – Two-Piece Tops – Interior Leg – Wood	136-137
Pebble – Two-Piece Tops – Interior Leg – Wood	138-139
Hexagon – Two-Piece Tops – Interior Leg – Wood	140-141
Rectangular – Three-Piece Tops – Interior Leg – Laminate	142-143
Pebble – Three-Piece Tops – Interior Leg – Laminate	144-145
Hexagon – Three-Piece Tops – Interior Leg – Laminate	146-147
Rectangular – Three-Piece Tops – Interior Leg – Wood	148-149
Pebble – Three-Piece Tops – Interior Leg – Wood	150-151
Hexagon – Three-Piece Tops – Interior Leg – Wood	152-153

Planes Conference Tables — Perimeter Leg

Square – 2”(51mm) Edge – Perimeter Leg – Laminate	154
Rectangular – 2”(51mm) Edge – Perimeter Leg – Laminate	154
Rectangular – 2”(51mm) Edge – One-Piece Top – Laminate	155
Rectangular – 2”(51mm) Edge – Two Piece Tops – Perimeter Leg – Laminate	156-157
Rectangular – 2”(51mm) Edge – Three-Piece Tops – Perimeter Leg – Laminate	158-159
Rectangular – 2”(51mm) Edge – Perimeter Leg – Wood	160
Square – 2”(51mm) Edge – Perimeter Leg – Wood	160
Rectangular – 2”(51mm) Edge – One-Piece Top – Perimeter Leg – Wood	161
Rectangular – 2”(51mm) Edge – Two-Piece Tops – Perimeter Leg – Wood	162-163
Rectangular – 2”(51mm) Edge – Three-Piece Tops – Perimeter Leg – Wood	164-165

Planes Carts

Small Media – Laminate or Wood	166
Medium Media – Laminate or Wood	167
Catering – Laminate	168
Podium – Laminate or Wood	169

Finish/Color Legend 170-172

Terms of Sale

North American	173-176
----------------	---------

Index 177-179

Lifetime Product Warranty Inside Back Cover

Executive Wood Tables – A5

	Height	Table Width	Base Width	Bases	Number	Wood Group	
						A	D
 <p>TEAS</p>	27.5"(700mm)	120"(3048mm)	84"(2134mm)	2	TEA5-32C0-WN4	\$10940.99	\$14450.39
		132"(3353mm)	96"(2438mm)	2	TEA5-32D2-WN4	11207.59	14802.51
		144"(3658mm)	108"(2743mm)	2	TEA5-32E4-WN4	11474.19	15154.63
		156"(3962mm)	120"(3048mm)	3	TEA5-32F6-WN4	11740.79	15506.75
		168"(4267mm)	132"(3353mm)	3	TEA5-32G8-WN4	12007.39	15858.87
		180"(4572mm)	144"(3658mm)	3	TEA5-32J0-WN4	12273.99	16210.99
		192"(4877mm)	156"(3962mm)	3	TEA5-32K2-WN4	12540.59	16563.11
		204"(5182mm)	168"(4267mm)	3	TEA5-32L4-WN4	12807.19	16915.23
		216"(5486mm)	180"(4572mm)	3	TEA5-32M6-WN4	13073.79	17267.35
		228"(5791mm)	192"(4877mm)	3	TEA5-32N8-WN4	13340.39	17619.47
		240"(6096mm)	204"(5182mm)	3	TEA5-32Q0-WN4	13606.99	17971.59

Features

- Includes stretchers and two or three pre-assembled bases depending on top size.
- Bases are constructed with AWI (Architectural Woodworking Institute) Grade AA veneer.
- Bases are angled with a maximum width of 32.6"(829mm) and taper to 18"(457mm) and are joined by 6"(152mm) aprons.
- Bases are inset 18"(457mm) from each end.
- Back panel of each base is removable.
- Inner panel features 3" x 4"(77mm x 102mm) port for wire access.
- Glides are black with 1"(25mm) height adjustment.
- Assemble stretchers to bases.

To Order, Specify:

- 1) Product Number.
- 2) Wood Finish.

Executive Wood Tables – A5

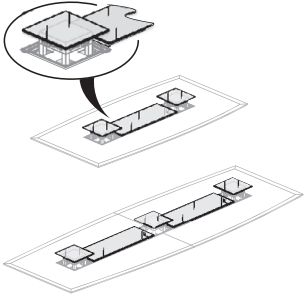
	Width	Cutouts	Number	Price
Glass Centerpiece  TEGL	No Cutouts			
	120"(3048mm)	0	TEGL-16C0-1	\$3158.33
	132"(3353mm)	0	TEGL-16D2-1	3172.35
	144"(3658mm)	0	TEGL-16E4-1	3186.37
	156"(3962mm)	0	TEGL-16F6-1	3200.39
	168"(4267mm)	0	TEGL-16G8-1	3214.41
	180"(4572mm)	0	TEGL-16J0-1	3228.43
	192"(4877mm)	0	TEGL-16K2-1	3242.45
	204"(5182mm)	0	TEGL-16L4-1	3256.47
	216"(5486mm)	0	TEGL-16M6-1	3270.49
	228"(5791mm)	0	TEGL-16N8-1	3284.51
	240"(6096mm)	0	TEGL-16Q0-1	3298.53
	Two Cutouts			
	120"(3048mm)	2	TEGL-16C0-3	\$3158.33
	132"(3353mm)	2	TEGL-16D2-3	3172.35
	144"(3658mm)	2	TEGL-16E4-3	3186.37
	156"(3962mm)	2	TEGL-16F6-3	3200.39
	168"(4267mm)	2	TEGL-16G8-3	3214.41
	180"(4572mm)	2	TEGL-16J0-3	3228.43
	192"(4877mm)	2	TEGL-16K2-3	3242.45
	204"(5182mm)	2	TEGL-16L4-3	3256.47
	216"(5486mm)	2	TEGL-16M6-3	3270.49
	228"(5791mm)	2	TEGL-16N8-3	3284.51
	240"(6096mm)	2	TEGL-16Q0-3	3298.53
	Three Cutouts			
	192"(4877mm)	3	TEGL-16K2-5	\$3242.45
	204"(5182mm)	3	TEGL-16L4-5	3256.47
	216"(5486mm)	3	TEGL-16M6-5	3270.49
	228"(5791mm)	3	TEGL-16N8-5	3284.51
	240"(6096mm)	3	TEGL-16Q0-5	3298.53



Features

- Includes set of back-painted, tempered low-iron glass, 16"(406mm) wide and 3/8"(10mm) thick.
- Edges are polished and have 1/16"(4mm) bevel.
- Set includes (1) piece of glass when no cutouts are specified, (3) glass pieces when (2) cutouts are specified or (5) glass pieces when (3) cutouts are specified: one over each Electric Lift Interface Module and between cutouts.
- Glass centerpiece between Electric Lift Interface Module units are raised 1/2"(13mm) over the top with 10"(254mm) wide black spacer.

To Order, Specify:

- 1) Product Number.
- 2) Glass back-paint color.
2G-SLW

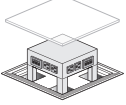
Executive Wood Tables – A5

	Description	Depth	Width	Number	Price
 EUIM 	Electric Lift Interface Module	11.76"(298.7mm)	18.5"(469.9mm)	EUIM-0000-A	\$4769.86
	Features <ul style="list-style-type: none"> • Power/data module with electric lift control. Includes: <ul style="list-style-type: none"> –(4) 15 Amp duplex receptacles (one on each side) NEMA 5-15R configuration. –(4) cutouts for separately specified telecom plates (one on each side). –15 Amp circuit breaker –12' long cord with plug (NEMA 5-15P configuration). –Mounting trim with brush –Wired switchbox mechanism mountable to the table top • Steel construction. • Lift range 4"(102mm). • Mounted to provide 1/2"(13mm) space for cables to remain plugged in. • Glass centerpiece specified separately. 		To Order, Specify: <ol style="list-style-type: none"> 1) Product number. (No finish specification required.) 		
Specification Tips <ul style="list-style-type: none"> • For A5 tables only. • Field cut not recommended. • For use with 120 volt 60 hertz power source only. • Electrical application requires prior approval by authority having jurisdiction. 					

Telecom Plates for Interface	Description	Number	Price
	(1) RJ45, (1) RJ11	EUTP-14BB	\$149.74
	(2) RJ45	EUTP-44BB	193.03
	(3) RJ45	EUTP-444B	280.77
	(4) RJ45	EUTP-4444	368.51
	(3) Cable Pass-Through Ports	EUTP-CCCB	87.72
	(2) RJ45, (1) VGA	EUTP-44VB	274.92
	(1) RJ45, (1) VGA, (1) 3.5mm Audio	EUTP-4VSB	304.16
	(1) HDMI	EUTP-HBBB	210.56
	(1) HDMI, (1) VGA, (1) 3.5mm Audio	EUTP-HVSB	409.43
	BLANK	EUTP-BBBB	17.55
Feature <ul style="list-style-type: none"> • Telecom plate for A5 Electric Lift Interface Module. Includes data and/or a/v connections as specified. 		To Order, Specify: <ol style="list-style-type: none"> 1) Product number. (No finish specification required.) 	
Specification Tip <ul style="list-style-type: none"> • For A5 Electric Lift Interface Module only. 			

This page intentionally blank

Executive Wood Tables Specifications

Construction Features

- One piece tops (36"-120"[914mm-3048mm] widths) are constructed with 1 1/2"(38mm) fiber board substrate with solid wood segmented edges.
- Two piece tops (132"-240"[3353mm-6096mm] widths) are constructed with 1 1/2"(38mm) fiber board substrate with solid wood segmented edges and tight joint fasteners. The tops are field joint built to go together.
- All base heights are 28"(711mm).
- All finished table heights are 29 1/2"(749mm).
- Solid wood edges are constructed of the same species as the veneer specified on the tops and are applied to tops in segments.
- 2 3/4"(70mm) thick edges (Bullnose Smooth and Bullnose Notched) are build-up construction with mitered corners;
- 1 1/2"(38mm) thick edges are solid core construction with butt joint corners. Refer to Edge Details.
- Dimensions are actual, however the tables are natural wood and dimensional variance is $\pm 1/4"$ (6mm) per top.

Wood/Finish Features

- All exposed veneers are plain-sliced and book-and center-matched (excludes patterns).
- Executive Wood Tables feature AWI (Architectural Woodwork Institute) Grade AA tops. They are finished with a hand-applied, water-based finish. Refer to Finish Matrix.
- Executive Wood Tables are designed for non-dining applications; it is highly recommended that a protective accessory be used on table tops when possible.

Pattern and Border Options

- Diamond (V) or Reverse Diamond (R) pattern options are available on Round or Square tops.
- Sunburst (B) pattern option is available on Round tops only.
- Border (O) with inlay option is available on all tops.

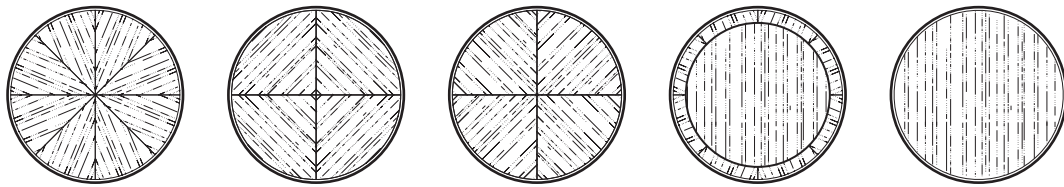

Option B
Sunburst

Option R
Reverse Diamond

Option V
Diamond

Option O
Border Inlay

Option N
None

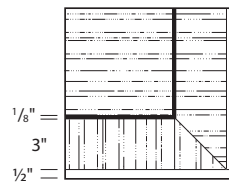
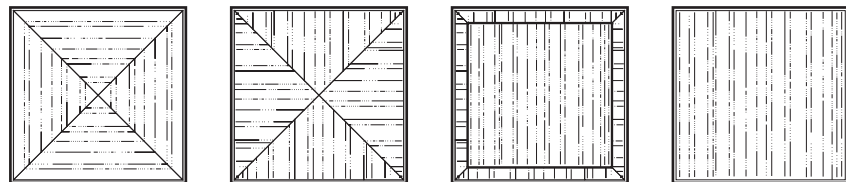

1 1/2"(38mm) edge and Border with Inlay Option (O) and butt joint corner construction.

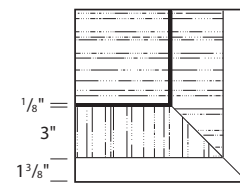

2 3/4"(70mm) edge and Border with Inlay Option (O) and mitered corner construction.

Edge Detail

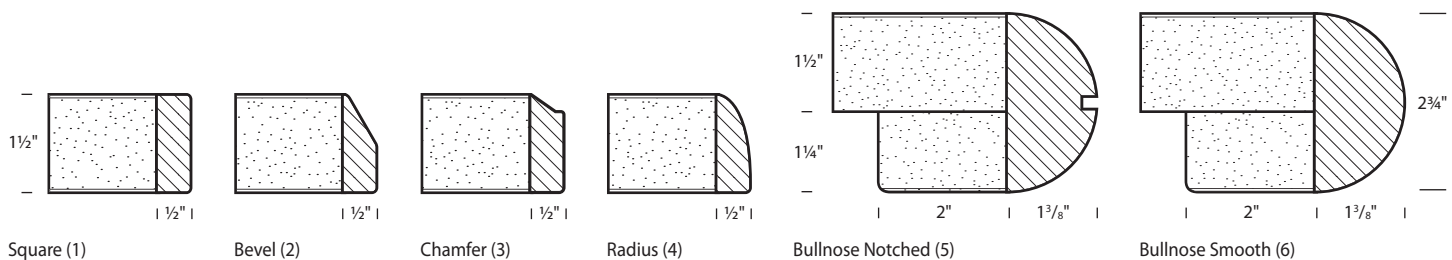

Square (1)

Bevel (2)

Chamfer (3)

Radius (4)

Bullnose Notched (5)

Bullnose Smooth (6)

Executive Wood Tables Specifications

Flip Top Unit Cutout Locations

One-piece tables are available with a single centered cutout option. If a centered flip top unit cutout is specified, the cutout is located at half the length and half the depth of the table top.

Two-piece tables are available with a dual left and right cutout option, which is located at half the depth and one-third the length from both ends. The cutout is sized for a dual-sided flip top unit, which is specified separately.

Tables: Centered Cutout

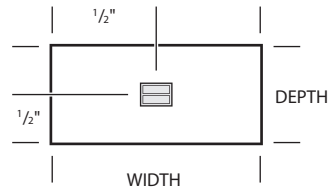

Examples:

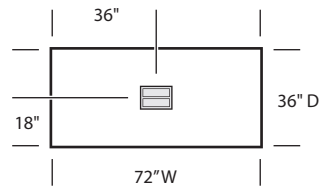

Tables: Left/Right Cutout

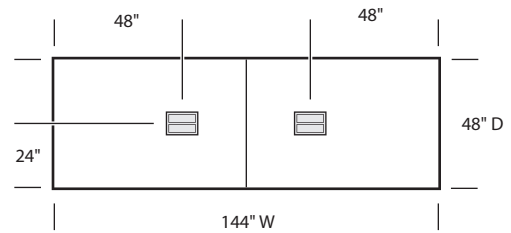
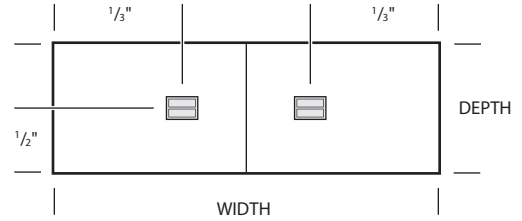

Steps to Specify an Executive Wood Table

- (1) Top
 - Shape
 - Size
 - Edge Option
 - Cutout Option for Flip Top Unit
 - Pattern or Border Option
 - Finish Option
- (2) Base Type
 - Access Door Option
 - Finish for Wood or Trim Color for Metal
- (3) Power
 - Flip Top Unit (separately specified)

On site measurements should be taken to ensure there is adequate room in elevators and/or hallway conditions to accommodate the table size.

Executive Wood Tables Catalog Logic

Executive Wood Table Tops

T	E	RA	-	48	C0	-	W	2	T	N	O

Border/Pattern:
 B – Sunburst (Round Top Only)
 N – No Border or Pattern
 O – Border
 R – Reverse Diamond
 V – Diamond

Cutout:
 S – Single Centered Cutout
 D – Two Cutouts, Left/Right
 N – No Cutout

Top:
 K – Build-up Top
 T – Solid Top

Edge:
 1 – Square
 2 – Bevel
 3 – Chamfer
 4 – Radius
 5 – Bullnose Notched
 6 – Bullnose Smooth

Material:
 W – Wood

Width:
 36" – 36" C0 – 120"
 42" – 42" D2 – 132"
 48" – 48" E4 – 134"
 54" – 54" F6 – 156"
 60" – 60" G8 – 168"
 66" – 66" J0 – 180"
 72" – 72" K2 – 192"
 78" – 78" L4 – 204"
 84" – 84" M6 – 216"
 96" – 96" N8 – 228"
 A8" – 108" Q0 – 240"

Depth:
 36" – 36"
 42" – 42"
 48" – 48"
 54" – 54"
 60" – 60"

Shape:
 BO – Boat
 RA – Rectangle
 RN – Round
 RQ – Square
 RT – Racetrack
 WE – Wedge

Platform:
 E – Executive Conference Tables

Product Type:
 T – Tables

Executive Wood Tables Catalog Logic

'Half Cylinder, Full Cylinder, and X Bases

T	E	FC	-	24	02	-	W	A	4
									<p>Height: 4" – 28" Base Height</p> <p>Access Door: A – Access Door N – No Access Door</p> <p>Material: M – Metal W – Wood</p> <p>Base Count: 01 – One Base 02 – Two Bases 03 – Three Bases</p> <p>Depth: 18" – 18" 24" – 24" 26" – 26" 28" – 28" 30" – 30" 32" – 32" 40" – 40"</p> <p>Base Style: FC – Full Cylinder FH – Full Cylinder with Half Cylinders HC – Half Cylinder XB – X Base</p> <p>Platform: E – Executive Conference Tables</p>

Product Type:

T – Tables

Slab Base

T	E	SL	-	30	60	-	W	N	4
									<p>Height: 4" – 28" Base Height</p> <p>Access Door: N – No Access Door</p> <p>Material: W – Wood</p> <p>Base Count: 60" – 60" E4 – 144" 66" – 66" F6 – 156" 72" – 72" G8 – 168" 78" – 78" J0 – 180" 84" – 84" K2 – 192" 96" – 96" L4 – 204" A8" – 108" M6 – 216" C0 – 120" N8 – 228" D2 – 132" Q0 – 240"</p> <p>Depth: 30" – 30"</p> <p>Base Style: SL – Slab Base</p> <p>Platform: E – Executive Conference Tables</p>

Product Type:

T – Tables

Executive Wood Tables Catalog Logic

Conference Buffet

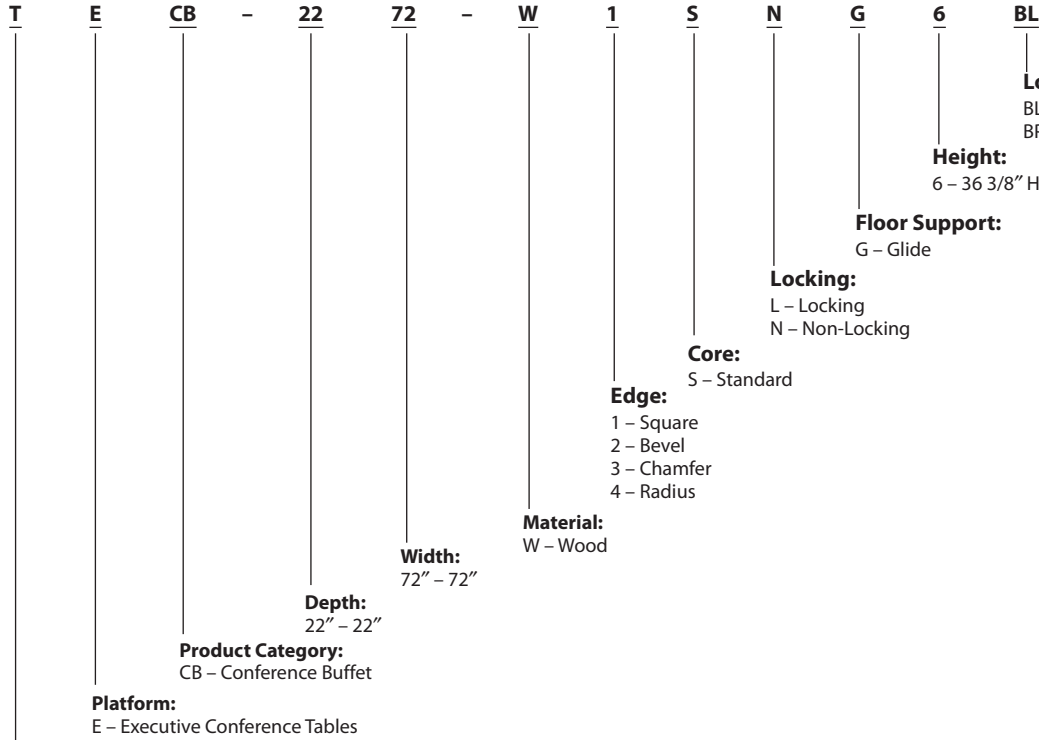

Product Type:
T – Tables

Presentation Board

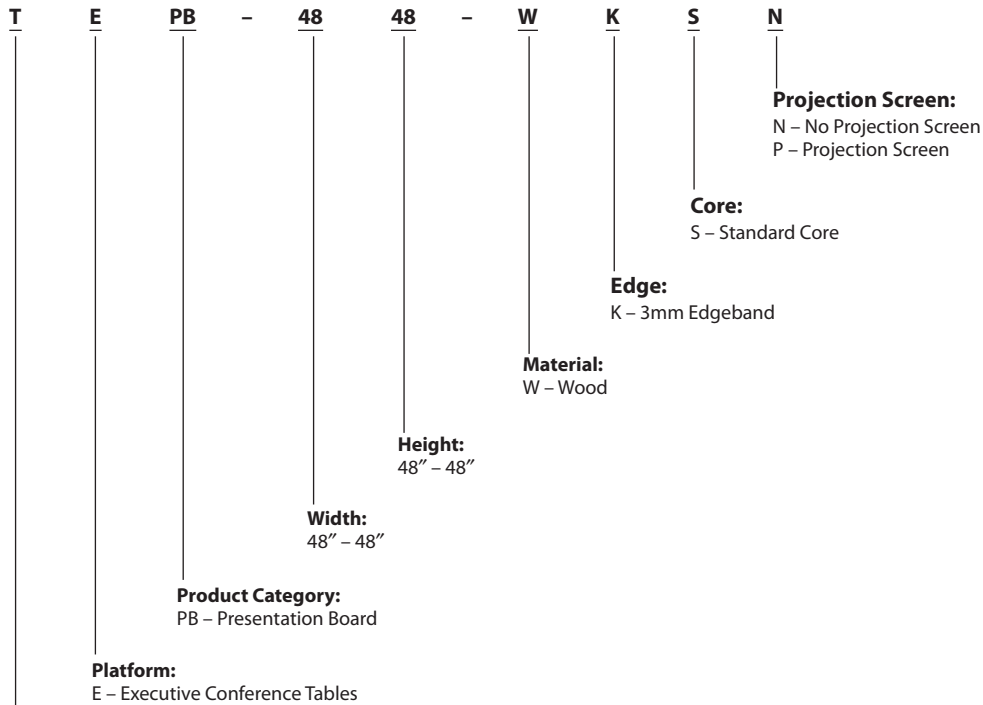

Product Type:
T – Tables

Executive Wood Tables Statement of Line

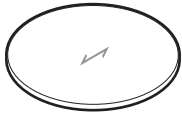

Round Table Dimensions

Depth Width

	36"	42"	48"	54"	60"
36"	X				
42"		X			
48"			X		
54"				X	
60"					X

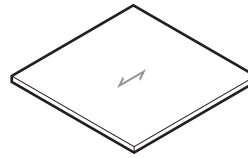

Square Table Dimensions

Depth Width

	36"	42"	48"	54"	60"
36"	X				
42"		X			
48"			X		
54"				X	
60"					X

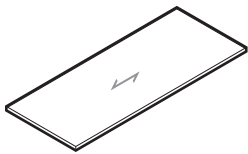

Rectangle Table Dimensions

Depth Width

	60"	66"	72"	78"	84"	96"	108"	120"	132"	144"	156"	168"	180"	192"	204"	216"	228"	240"
36"	X	X	X	X	X													
42"				X	X	X	X	X	X	X	X	X	X	X	X	X	X	X
48"					X	X	X	X	X	X	X	X	X	X	X	X	X	X
54"							X	X	X	X	X	X	X	X	X	X	X	X
60"							X	X	X	X	X	X	X	X	X	X	X	X

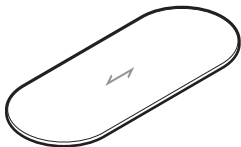

Racetrack Table Dimensions

Depth Width

	60"	66"	72"	78"	84"	96"	108"	120"	132"	144"	156"	168"	180"	192"	204"	216"	228"	240"
36"	X	X	X	X	X													
42"				X	X	X	X	X										
48"					X	X	X	X	X	X	X	X	X	X	X	X	X	X
54"							X	X	X	X	X	X	X	X	X	X	X	X
60"							X	X	X	X	X	X	X	X	X	X	X	X

Note: ↗ = Wood Grain Direction

Executive Wood Tables Statement of Line

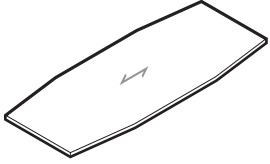

Boat Table Dimensions

Depth Width

	60"	66"	72"	78"	84"	96"	108"	120"	132"	144"	156"	168"	180"	192"	204"	216"	228"	240"
36"	X	X	X	X	X													
42"				X	X	X	X	X										
48"					X	X	X	X	X	X	X	X	X	X	X	X	X	X
54"							X	X	X	X	X	X	X	X	X	X	X	X
60"							X	X	X	X	X	X	X	X	X	X	X	X

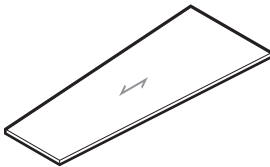

Wedge Table Dimensions

Depth

	84"	96"	108"	120"	132"	144"	156"	168"	180"	192"	204"	216"	228"	240"
48"	X	X	X	X	X	X	X	X	X	X	X	X	X	X
54"			X	X	X	X	X	X	X	X	X	X	X	X
60"			X	X	X	X	X	X	X	X	X	X	X	X

Note: ↙ = Wood Grain Direction

Executive Wood Tables Statement of Line

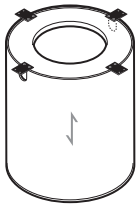

Full Cylinder
18", 24", 30" Diameter

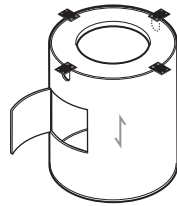

Full Cylinder with Optional Access Door

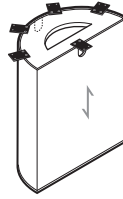

Half Cylinder
18", 24", 30"

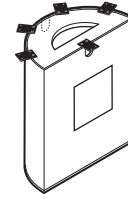
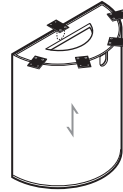

Half Cylinder with Optional Access Door

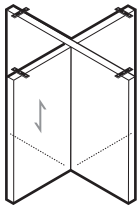

X Base
1 1/4" Thick
26", 32" Lengths

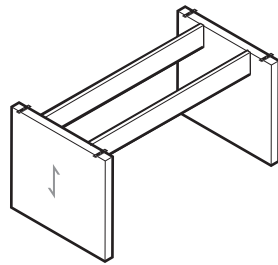

Slab Base
2" Thick
30" Long

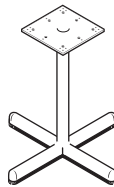

Metal X Base
28", 40"

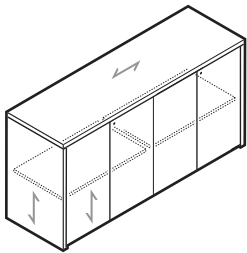

Conference Buffet

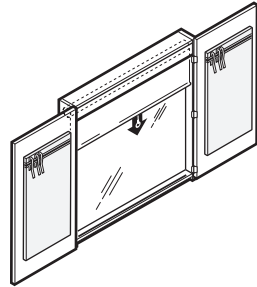

Presentation Board

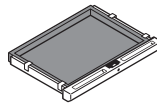

Center Drawer

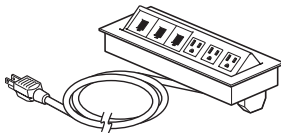

Flip Top Units

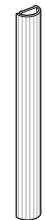
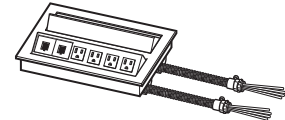
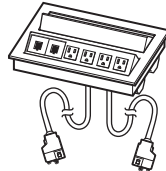
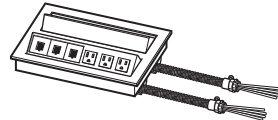

Vertical Manager — Vertical

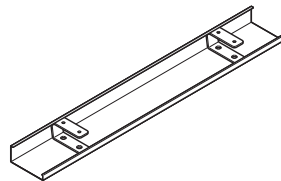

Wire Manager — Horizontal

Note: ↴ = Wood Grain Direction

Executive Wood Tables Base Placement

Base Placement

Slab Base

- 60"-78"(1524mm-1981mm) wide top base placement spacing is 12"(305mm) from ends.
- Greater than 78"(1981mm) wide top base placement spacing is 24"(610mm) from ends.
- Keel between slab base panels is 6"(152mm) tall and inset 7"(178mm) from the edge of the panels.

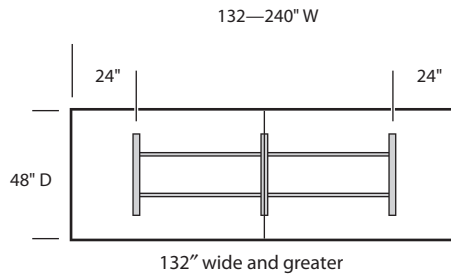
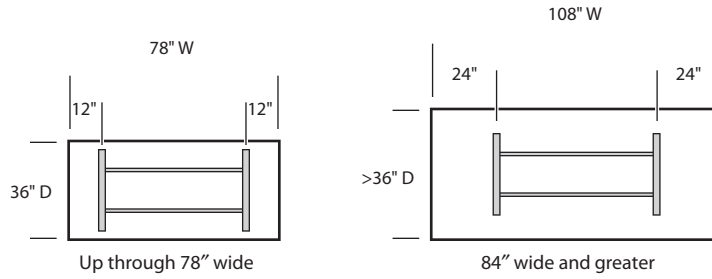

Cylinder, Half Cylinder and X Base

- $\frac{\text{Top depth} = \text{base inset}}{2}$

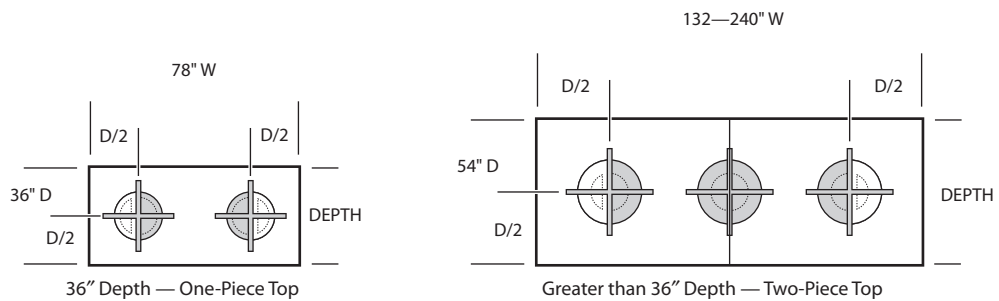

Executive Wood Tables

Size	Number	①	②	③	Pattern/Border Upcharges					
					Wood Group B	D	Sunburst (B)	Reverse Diamond (R)	Diamond (V)	Border (O)
1 1/2" (38mm) Edge — Round										
36" (914mm)	TERN-3636-W	T			\$1974.32	\$2316.11	\$ 786.28	\$ 612.09	\$ 597.76	\$1799.32
42" (1067mm)	TERN-4242-W	T			2295.08	2737.74	1070.25	811.34	811.34	2022.56
48" (1219mm)	TERN-4848-W	T			2661.20	3219.03	1403.15	1060.70	1060.70	2254.81
54" (1372mm)	TERN-5454-W	T			3072.68	3759.98	2269.36	1338.71	1338.71	2469.05
60" (1524mm)	TERN-6060-W	T			3529.52	4360.59	2796.74	1652.51	1652.51	2686.84
2 3/4" (70mm) Edge										
36" (914mm)	TERN-3636-W	K			\$4373.36	\$4706.51	\$ 786.28	\$ 612.09	\$ 597.76	\$1799.32
42" (1067mm)	TERN-4242-W	K			5093.96	5526.54	1070.25	811.34	811.34	2022.56
48" (1219mm)	TERN-4848-W	K			7411.01	7957.32	1403.15	1060.70	1060.70	2254.81
54" (1372mm)	TERN-5454-W	K			8222.33	8896.67	2269.36	1338.71	1338.71	2469.05
60" (1524mm)	TERN-6060-W	K			9079.01	9895.68	2796.74	1652.51	1652.51	2686.84
1 1/2" (38mm) Edge — Square										
36" x 36" (914mm x 914mm)	TERQ-3636-W	T			\$1695.95	\$1771.12	N/A	\$ 597.76	\$ 597.76	\$ 606.81
42" x 42" (1067mm x 1067mm)	TERQ-4242-W	T			2034.58	2187.23	N/A	811.34	811.34	708.84
48" x 48" (1219mm x 1219mm)	TERQ-4848-W	T			2420.95	2663.00	N/A	1060.70	1060.70	810.87
54" x 54" (1372mm x 1372mm)	TERQ-5454-W	T			2855.06	3198.43	N/A	1338.71	1338.71	912.90
60" x 60" (1524mm x 1524mm)	TERQ-6060-W	T			3336.91	3793.52	N/A	1652.51	1652.51	1009.56
2 3/4" (70mm) Edge										
36" x 36" (914mm x 914mm)	TERQ-3636-W	K			\$2634.75	\$2882.72	N/A	\$ 597.76	\$ 597.76	\$ 606.81
42" x 42" (1067mm x 1067mm)	TERQ-4242-W	K			2995.22	3349.47	N/A	811.34	811.34	708.84
48" x 48" (1219mm x 1219mm)	TERQ-4848-W	K			4536.92	5009.37	N/A	1060.70	1060.70	810.87
54" x 54" (1372mm x 1372mm)	TERQ-5454-W	K			4992.87	5595.44	N/A	1338.71	1338.71	912.90
60" x 60" (1524mm x 1524mm)	TERQ-6060-W	K			5496.56	6241.17	N/A	1652.51	1652.51	1009.56

Round/Square

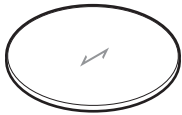

TERN

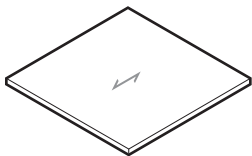

TERQ

Note: ↗ = Wood Grain Direction

Features

- Includes one piece, round or square, wood veneer top with solid wood edge:
 - 1 1/2" (38mm) Edge: Square (1), Bevel (2), Chamfer (3) or Radius (4).
 - 2 3/4" (70mm) Edge: Bullnose Notched (5) or Bullnose Smooth (6)
- Flip Top Unit Cutout Option available with Full Cylinder Base only (Flip Top Units separately specified).
- Diamond (V) and Reverse Diamond (R) pattern options are available.
- Sunburst (B) pattern option is available on round tops only.
- Border (O) option has black 1/8" (3mm) thick inlay.
- Base Kits are specified separately.
- Base kits include Full Cylinder, Metal X Base and Wood X Base.
- Finished table height with base is 29 1/2" (749mm).

To Order, Specify:

1) Product number, including:

① Edge Option:

- 1 1 1/2" Square
- 2 1 1/2" Bevel
- 3 1 1/2" Chamfer
- 4 1 1/2" Radius
- 5 2 3/4" Bullnose Notched
- 6 2 3/4" Bullnose Smooth

② Flip Top Unit Cutout:

- S Single Centered, add \$233.95 list
- N None

③ Pattern/Border Options: Upcharges (list)

- B Sunburst (Round Only)
- R Reverse Diamond
- V Diamond
- O Border
- N None

2) Wood surface finish.

Executive Wood Tables

Size	Base Qty/Size	Number ①	Price	Wood Group B	D
Base Kits — Round/Square Wood Tables					
Full Cylinder Base Kit					
36"(914mm)	1-18"(457mm)	TEFC-1801-W 4		\$1657.27	\$2188.85
42"-54"(1067mm-1372mm)	1-24"(610mm)	TEFC-2401-W 4		1677.55	2215.63
60"(1524mm)	1-30"(762mm)	TEFC-3001-W 4		1860.12	2456.76
Metal X Base Kit					
36"-42"(914mm-1067mm)	1-28"(711mm)	TEXB-2801-MN4	\$378.22		
48"(1219mm)	1-40"(1016mm)	TEXB-4001-MN4	440.27		
Wood X Base Kit					
36"-42"(914mm-1067mm)	1-26"(660mm)	TEXB-2601-WN4		\$1523.64	\$2012.36
48"-60"(1219mm-1524mm)	1-32"(813mm)	TEXB-3201-WN4		1601.20	2114.78

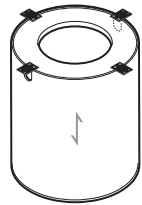

TEFC

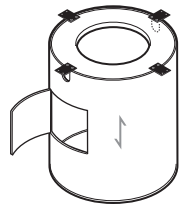

TEXB-A

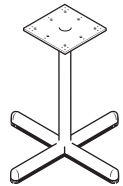

TEXB-M

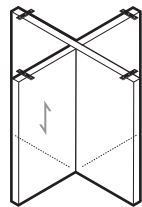

TEXB-W

Note: ↙ = Wood Grain Direction

Features

- Each kit includes one 28"(711mm) high base with attachment hardware:
 - Full Cylinder Base: Wood veneer over wood base; available with optional Access Door for power access.
 - Full Cylinder Base has cord access cutout.
 - Each Full Cylinder base includes weight for stability.
- Wood X Base: Two 26"(660mm) or 32"(813mm) deep, 1 1/4"(32mm) thick wood veneer slabs.
- X Base: two 30"(762mm) deep, 1 1/4"(32mm) thick wood veneer slabs.
- Metal X Base available in trim colors.
- Glide adjustment of 1"(25mm) on all bases.
- Cylinders ship assembled; X Bases require field assembly.

To Order, Specify:

- 1) Product number, including:

① Access Hatch Option:

- A** Access Door, add **\$472.48** list
- N** No Access Door

- 2) Wood surface finish.

X Base – Wood

- 1) Product number.
- 2) Wood surface finish.

X Base – Metal

- 1) Product number
- 2) Trim colors.

Note: **\$16.70** upcharge (list) for Metallic or accent trim colors.

Executive Wood Tables

Rectangular

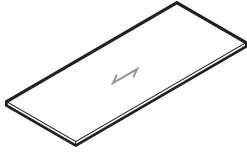

TERA
(60"-120")

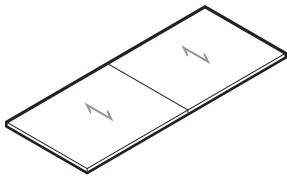

TERA
(132"-240"
[3353mm-6096mm])

Note: ↙ = Wood Grain Direction

Features

- Includes one piece (60"-120"[1524mm-3048mm] wide) or two piece (132"-240"[3353mm-6096mm] wide) Rectangular shaped wood veneer top with solid wood edge:
 - 1 1/2"(38mm) Edge: Square (1), Bevel (2), Chamfer (3) or Radius (4).
 - 2 3/4"(70mm) Edge: Bullnose Notched (5) or Bullnose Smooth (6).
- Border (O) option has black 1/8"(3mm) thick inlay.
- Base Kits are specified separately.
- Base kits include Full Cylinder, Half Cylinder, Full/Half Cylinder, Wood X Base and Wood Slab Base.
- Flip Top Unit Cutout Options available for separately specified Flip Top Unit(s) on tops greater than 36"(914mm) deep:
 - One centered cutout (S) (84"-120"[2134mm-3048mm] wide tops).
 - Two left/right cutouts (D) (132"-240"[3353mm-6096mm] wide tops).
 - Cutouts are centered between bases.

Note: On site measurements should be taken to ensure there is adequate room in elevators and/or hallway conditions to accommodate the top sizes.

To Order, Specify:

1) Product number, including:

1 Edge Option:

- 1 1 1/2" Square
- 2 1 1/2" Bevel
- 3 1 1/2" Chamfer
- 4 1 1/2" Radius
- 5 2 3/4" Bullnose Notched
- 6 2 3/4" Bullnose Smooth

2 Flip Top Unit Cutout:

- S Single Centered (84"-120"[2134mm-3048mm] Widths), add **\$233.95** list
- D Two Left/Right (132"-240"[3353mm-6096mm] Widths), add **\$467.90** list
- N None

3 Border Option: Upcharges (list)

- N None
- O Border

2) Wood surface finish.

Depth	Width	Pieces	Number	1	2	3	Wood Group B	D	Upcharge Border Option (O)
1 1/2"(38mm) Edge									
36"(914mm)	60"(1524mm)	1	TERA-3660-W	TN			\$ 2442.95	\$ 2729.88	\$ 791.10
	66"(1676mm)	1	TERA-3666-W	TN			2659.13	2972.94	839.34
	72"(1829mm)	1	TERA-3672-W	TN			2875.31	3216.00	887.58
	78"(1981mm)	1	TERA-3678-W	TN			3091.49	3459.06	935.82
	84"(2134mm)	1	TERA-3684-W	TN			3307.67	3702.12	984.06
2 3/4"(70mm) Edge									
36"(914mm)	60"(1524mm)	1	TERA-3660-W	KN			\$ 4301.45	\$ 4588.38	\$ 791.10
	66"(1676mm)	1	TERA-3666-W	KN			4681.79	4995.60	839.34
	72"(1829mm)	1	TERA-3672-W	KN			5062.13	5402.82	887.58
	78"(1981mm)	1	TERA-3678-W	KN			5442.47	5810.04	935.82
	84"(2134mm)	1	TERA-3684-W	KN			5822.81	6217.26	984.06
1 1/2"(38mm) Edge									
42"(1067mm)	78"(1981mm)	1	TERA-4278-W	TN			\$ 3427.58	\$ 3853.39	\$ 984.06
	84"(2134mm)	1	TERA-4284-W	T			3660.89	4118.06	1032.30
	96"(2438mm)	1	TERA-4296-W	T			4127.51	4647.40	1128.78
	108"(2743mm)	1	TERA-42A8-W	T			4594.13	5176.74	1225.26
	120"(3048mm)	1	TERA-42C0-W	T			5060.75	5706.08	1321.74
	132"(3353mm)	2	TERA-42D2-W	T			5987.81	6695.86	1524.49
	144"(3658mm)	2	TERA-42E4-W	T			6596.07	7366.84	1620.97
	156"(3962mm)	2	TERA-42F6-W	T			7204.33	8037.82	1717.45
	168"(4267mm)	2	TERA-42G8-W	T			7812.59	8708.80	1813.93
	180"(4572mm)	2	TERA-42J0-W	T			8952.45	9911.38	1969.44
	192"(4877mm)	2	TERA-42K2-W	T			9489.89	10511.54	2065.92
	204"(5182mm)	2	TERA-42L4-W	T			10027.33	11111.70	2162.40
	216"(5486mm)	2	TERA-42M6-W	T			10564.77	11711.86	2258.88
	228"(5791mm)	2	TERA-42N8-W	T			11102.21	12312.02	2355.36
	240"(6096mm)	2	TERA-42Q0-W	T			11639.65	12912.18	2451.84

Executive Wood Tables

Rectangular	Depth	Width	Pieces	Number	① ② ③			Wood Group		Upcharge Border Option (O)
					B	D				
2 3/4" (70mm) Edge										
	42"(1067mm)	78"(1981mm)	1	TERA-4278-W	■	KN	■	\$ 5942.72	\$ 6368.53	\$ 984.06
		84"(2134mm)	1	TERA-4284-W	■	K	■	6340.19	6797.36	1032.30
		96"(2438mm)	1	TERA-4296-W	■	K	■	7135.13	7655.02	1128.78
		108"(2743mm)	1	TERA-42A8-W	■	K	■	7930.07	8512.68	1225.26
		120"(3048mm)	1	TERA-42C0-W	■	K	■	8725.01	9370.34	1321.74
		132"(3353mm)	2	TERA-42D2-W	■	K	■	10464.57	11172.62	1524.49
		144"(3658mm)	2	TERA-42E4-W	■	K	■	11684.59	12455.36	1620.97
		156"(3962mm)	2	TERA-42F6-W	■	K	■	12904.61	13738.10	1717.45
		168"(4267mm)	2	TERA-42G8-W	■	K	■	14124.63	15020.84	1813.93
		180"(4572mm)	2	TERA-42J0-W	■	K	■	14718.78	15677.71	1969.44
		192"(4877mm)	2	TERA-42K2-W	■	K	■	15631.78	16653.43	2065.92
		204"(5182mm)	2	TERA-42L4-W	■	K	■	16544.78	17629.15	2162.40
		216"(5486mm)	2	TERA-42M6-W	■	K	■	17457.78	18604.87	2258.88
		228"(5791mm)	2	TERA-42N8-W	■	K	■	18370.78	19580.59	2355.36
		240"(6096mm)	2	TERA-42Q0-W	■	K	■	19283.78	20556.31	2451.84
1 1/2" (38mm) Edge										
	48"(1219mm)	84"(2134mm)	1	TERA-4884-W	■	T	■	\$ 4014.11	\$ 4534.00	\$ 1080.54
		96"(2438mm)	1	TERA-4896-W	■	T	■	4514.99	5106.56	1177.02
		108"(2743mm)	1	TERA-48A8-W	■	T	■	5015.87	5679.12	1273.50
		120"(3048mm)	1	TERA-48C0-W	■	T	■	5516.75	6251.68	1369.98
		132"(3353mm)	2	TERA-48D2-W	■	T	■	6466.31	7272.92	1572.73
		144"(3658mm)	2	TERA-48E4-W	■	T	■	6967.19	7845.48	1669.21
		156"(3962mm)	2	TERA-48F6-W	■	T	■	7468.07	8418.04	1765.69
		168"(4267mm)	2	TERA-48G8-W	■	T	■	7968.95	8990.60	1862.17
		180"(4572mm)	2	TERA-48J0-W	■	T	■	9579.75	10673.08	2017.68
		192"(4877mm)	2	TERA-48K2-W	■	T	■	10151.45	11316.46	2114.16
		204"(5182mm)	2	TERA-48L4-W	■	T	■	10723.15	11959.84	2210.64
		216"(5486mm)	2	TERA-48M6-W	■	T	■	11294.85	12603.22	2307.12
		228"(5791mm)	2	TERA-48N8-W	■	T	■	11866.55	13246.60	2403.60
		240"(6096mm)	2	TERA-48Q0-W	■	T	■	12438.25	13889.98	2500.08
2 3/4" (70mm) Edge										
	48"48"(1219mm)	84"(2134mm)	1	TERA-4884-W	■	K	■	\$ 6857.57	\$ 7377.46	\$ 1080.54
		96"(2438mm)	1	TERA-4896-W	■	K	■	7686.77	8278.34	1177.02
		108"(2743mm)	1	TERA-48A8-W	■	K	■	8515.97	9179.22	1273.50
		120"(3048mm)	1	TERA-48C0-W	■	K	■	9345.17	10080.10	1369.98
		132"(3353mm)	2	TERA-48D2-W	■	K	■	10847.39	11654.00	1572.73
		144"(3658mm)	2	TERA-48E4-W	■	K	■	11676.59	12554.88	1669.21
		156"(3962mm)	2	TERA-48F6-W	■	K	■	12505.79	13455.76	1765.69
		168"(4267mm)	2	TERA-48G8-W	■	K	■	13334.99	14356.64	1862.17
		180"(4572mm)	2	TERA-48J0-W	■	K	■	15628.31	16721.64	2017.68
		192"(4877mm)	2	TERA-48K2-W	■	K	■	16658.23	17823.24	2114.16
		204"(5182mm)	2	TERA-48L4-W	■	K	■	17688.15	18924.84	2210.64
		216"(5486mm)	2	TERA-48M6-W	■	K	■	18718.07	20026.44	2307.12
		228"(5791mm)	2	TERA-48N8-W	■	K	■	19747.99	21128.04	2403.60
		240"(6096mm)	2	TERA-48Q0-W	■	K	■	20777.91	22229.64	2500.08

Executive Wood Tables

	Depth	Width	Pieces	Number	① ② ③			Wood Group		Upcharge Border Option (O)	
					B	D					
Rectangular	1 1/2" (38mm) Edge										
	54"(1372mm)	108"(2743mm)	1	TERA-54A8-W	T			\$ 5437.61	\$ 6181.50	\$1321.74	
		120"(3048mm)	1	TERA-54C0-W	T			5972.75	6797.28	1418.22	
		132"(3353mm)	2	TERA-54D2-W	T			7145.46	8050.63	1620.97	
		144"(3658mm)	2	TERA-54E4-W	T			7751.42	8737.23	1717.45	
		156"(3962mm)	2	TERA-54F6-W	T			8357.38	9423.83	1813.93	
		168"(4267mm)	2	TERA-54G8-W	T			8963.34	10110.43	1910.41	
		180"(4572mm)	2	TERA-54J0-W	T			10207.05	11434.78	2065.92	
		192"(4877mm)	2	TERA-54K2-W	T			10813.01	12121.38	2162.40	
		204"(5182mm)	2	TERA-54L4-W	T			11418.97	12807.98	2258.88	
		216"(5486mm)	2	TERA-54M6-W	T			12024.93	13494.58	2355.36	
		228"(5791mm)	2	TERA-54N8-W	T			12630.89	14181.18	2451.84	
		240"(6096mm)	2	TERA-54Q0-W	T			13236.85	14867.78	2548.32	
		2 3/4" (70mm) Edge									
		54"(1372mm)	108"(2743mm)	1	TERA-54A8-W	K			\$ 9101.87	\$ 9845.76	\$1321.74
			120"(3048mm)	1	TERA-54C0-W	K			9965.33	10789.86	1418.22
			132"(3353mm)	2	TERA-54D2-W	K			11808.81	12713.98	1620.97
			144"(3658mm)	2	TERA-54E4-W	K			12884.81	13870.62	1717.45
			156"(3962mm)	2	TERA-54F6-W	K			13960.81	15027.26	1813.93
			168"(4267mm)	2	TERA-54G8-W	K			15036.81	16183.90	1910.41
			180"(4572mm)	2	TERA-54J0-W	K			16537.85	17765.58	2065.92
			192"(4877mm)	2	TERA-54K2-W	K			17672.87	18981.24	2162.40
			204"(5182mm)	2	TERA-54L4-W	K			18807.89	20196.90	2258.88
			216"(5486mm)	2	TERA-54M6-W	K			19942.91	21412.56	2355.36
			228"(5791mm)	2	TERA-54N8-W	K			21077.93	22628.22	2451.84
			240"(6096mm)	2	TERA-54Q0-W	K			22212.95	23843.88	2548.32
		1 1/2" (38mm) Edge									
		60"(1524mm)	108"(2743mm)	1	TERA-60A8-W	T			\$ 5859.35	\$ 6683.88	\$1369.98
			120"(3048mm)	1	TERA-60C0-W	T			6428.75	7342.88	1466.46
			132"(3353mm)	2	TERA-60D2-W	TN			7759.71	8763.44	1669.21
			144"(3658mm)	2	TERA-60E4-W	T			8399.93	9493.26	1765.69
			156"(3962mm)	2	TERA-60F6-W	T			9040.15	10223.08	1862.17
			168"(4267mm)	2	TERA-60G8-W	T			9680.37	10952.90	1958.65
			180"(4572mm)	2	TERA-60J0-W	T			10645.42	12007.55	2114.16
		192"(4877mm)	2	TERA-60K2-W	T			11285.64	12737.37	2210.64	
		204"(5182mm)	2	TERA-60L4-W	T			11925.86	13467.19	2307.12	
		216"(5486mm)	2	TERA-60M6-W	T			12566.08	14197.01	2403.60	
		228"(5791mm)	2	TERA-60N8-W	T			13206.30	14926.83	2500.08	
		240"(6096mm)	2	TERA-60Q0-W	T			13846.52	15656.65	2596.56	
	2 3/4" (70mm) Edge										
	60"(1524mm)	108"(2743mm)	1	TERA-60A8-W	K			\$ 9687.77	\$10512.30	\$1369.98	
		120"(3048mm)	1	TERA-60C0-W	K			10585.49	11499.62	1466.46	
		132"(3353mm)	2	TERA-60D2-W	KN			12675.77	13679.50	1669.21	
		144"(3658mm)	2	TERA-60E4-W	K			13786.03	14879.36	1765.69	
		156"(3962mm)	2	TERA-60F6-W	K			14896.29	16079.22	1862.17	
		168"(4267mm)	2	TERA-60G8-W	K			16006.55	17279.08	1958.65	
		180"(4572mm)	2	TERA-60J0-W	K			17565.45	18927.58	2114.16	
		192"(4877mm)	2	TERA-60K2-W	K			18817.39	20269.12	2210.64	
		204"(5182mm)	2	TERA-60L4-W	K			20069.33	21610.66	2307.12	
		216"(5486mm)	2	TERA-60M6-W	K			21321.27	22952.20	2403.60	
		228"(5791mm)	2	TERA-60N8-W	K			22573.21	24293.74	2500.08	
		240"(6096mm)	2	TERA-60Q0-W	K			23825.15	25635.28	2596.56	

Executive Wood Tables

Rectangular Table Depths	Widths	Base Qty/Size	Number ①	Wood Group B	D
Base Kits — Rectangular Wood Tables					
Full Cylinder Base Kits					
36-42"(914mm-1067mm)	60"120"1524mm-3048mm)	2-18"(457mm)	TEFC-1802-W █ 4	\$3149.90	\$4160.25
42"(1067mm)	132"-240"(3353mm-6096mm)	3-18"(457mm)	TEFC-1803-W █ 4	4726.05	6241.95
48"-54"(1219mm-1372mm)	84"-120"(2134mm-3048mm)	2-24"(610mm)	TEFC-2402-W █ 4	3355.12	4431.30
	132"-240"(3353mm-6096mm)	3-24"(610mm)	TEFC-2403 W █ 4	5031.49	6645.36
60"(1524mm)	108"-120"(2743mm-3048mm)	2-30"(762mm)	TEFC-3002-W █ 4	3722.63	4916.66
	132"-240"(3353mm-6096mm)	3-30"(762mm)	TEFC-3003-W █ 4	5582.72	7373.42
Full/Half Cylinder Base Kits					
42"(1067mm)	132"-240"(3353mm-6096mm)	3-18"(457mm)	TEFH-1803-W █ 4	\$4797.64	\$6336.50
48"-54"(1219mm-1372mm)	132"-240"(3353mm-6096mm)	3-24"(610mm)	TEFH-2403-W █ 4	5063.72	6687.92
60"(1524mm)	132"-240"(3353mm-6096mm)	3-30"(762mm)	TEFH-3003-W █ 4	5612.55	7412.81
Half Cylinder Base Kits					
36-42"(914mm-1067mm)	60"120"1524mm-3048mm)	2-18"(457mm)	TEHC-1802-W █ 4	\$3158.24	\$4170.90
48"-54"(1219mm-1372mm)	84"-120"(2134mm-3048mm)	2-24"(610mm)	TEHC-2402-W █ 4	3295.04	4307.70
60"(1524mm)	108"-120"(2743mm-3048mm)	2-30"(762mm)	TEHC-3002-W █ 4	3678.57	4691.23
Wood X Base Kits					
36"-54"	60"120"1524mm-3048mm)	2-26"(660mm)	TEXB-2602-WN4	\$3048.48	\$4026.31
	132"-240"(3353mm-6096mm)	3-26"(660mm)	TEXB-2603-WN4	4572.12	6038.66
60"(1524mm)	108"-120"(2743mm-3048mm)	2-32"(813mm)	TEXB-3202-WN4	3202.39	4229.60
	132"-240"(3353mm-6096mm)	3-32"(813mm)	TEXB-3203-WN4	4803.59	6344.37
Wood Slab Base Kits					
		2-60"(1524mm)	TESL-3060-WN4	\$2282.44	\$3014.54
		2-66"(1676mm)	TESL-3066-WN4	2291.80	3026.89
		2-72"(1829mm)	TESL-3072-WN4	2301.16	3039.24
		2-78"(1981mm)	TESL-3078-WN4	2310.52	3051.59
		2-84"(2134mm)	TESL-3084-WN4	2319.88	3063.94
		2-96"(2438mm)	TESL-3096-WN4	2338.60	3088.64
		2-108"(2743mm)	TESL-30A8-WN4	2357.32	3113.34
		2-120"(3048mm)	TESL-30C0-WN4	2376.04	3138.04
		3-132"(3353mm)	TESL-30D2-WN4	3807.19	5028.37
		3-144"(3658mm)	TESL-30E4-WN4	4022.33	5312.55
		3-156"(3962mm)	TESL-30F6-WN4	4237.47	5596.73
		3-168"(4267mm)	TESL-30G8-WN4	4452.61	5880.91
		3-180"(4572mm)	TESL-30J0-WN4	4667.75	6165.09
		3-192"(4877mm)	TESL-30K2-WN4	4882.89	6449.27
		3-204"(5182mm)	TESL-30L4-WN4	5098.03	6733.45
		3-216"(5486mm)	TESL-30M6-WN4	5313.17	7017.63
		3-228"(5791mm)	TESL-30N8-WN4	5528.31	7301.81
		3-240"(6096mm)	TESL-30Q0-WN4	5743.45	7585.99

Base Kits — Rectangular Wood Tables

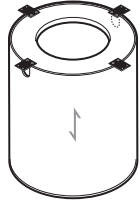

TEFC

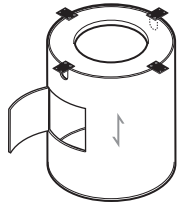

TEFH-A

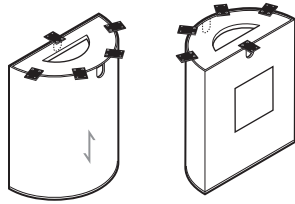

TEHC

TEHC-A

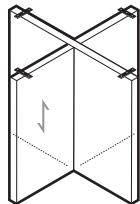

TEXB-W

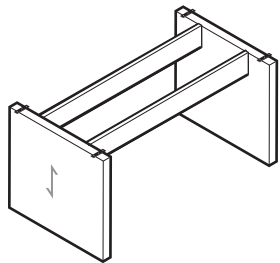

TESL

Note: ↗ = Wood Grain Direction

Features

- Each kit includes 28"(711mm) high base kit(s) with attachment hardware:
 - Full Cylinder Base: Wood veneer over wood base; available with optional Access Door for power access.
 - Full Cylinder Base and Half Cylinder Base have cord access cutout.
 - Half Cylinder Base: Wood veneer over wood base.
 - Each Full Cylinder and Half Cylinder base includes weight for stability.
- Wood X Base: Two 26"(660mm) or 32"(813mm) deep, 1 1/4"(32mm) thick wood veneer slabs.
- Slab Base: 30"(762mm) deep, 2"(51mm) thick wood veneer with Keel sets:
 - One base set includes one Keel set.
 - Three base kit includes two Keel sets.
- Glide adjustment of 1"(25mm) on all bases
- Cylinders ship assembled; other bases require field assembly.

To Order, Specify:

- 1) Product number, including:

① Access Hatch Option:

- A** Access Door, upcharges (list) per kit Base Qty Two, add \$924.91 list Base Qty Three, add \$1417.44 list
- N** No Access Door

- 2) Wood surface finish.

X Base/Slab Base

- 1) Product number.
- 2) Wood surface finish.

Executive Wood Tables

Racetrack Tables

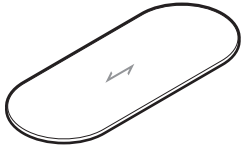

TERT
(60"-120")

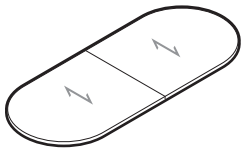

TERT
(132"-240"
[3353mm-6096mm])

Note: ↘ = Wood Grain Direction

Features

- Includes one piece (60"-120"[1524mm-3048mm] wide) or two piece (132"-240"[3353mm-6096mm] wide) Racetrack shaped wood veneer top with solid wood edge:
 - 1 1/2"(38mm) Edge: Square (1), Bevel (2), Chamfer (3) or Radius (4).
 - 2 3/4"(70mm) Edge: Bullnose Notched (5) or Bullnose Smooth (6).
- Border (O) option has black 1/8"(3mm) thick inlay.
- Base Kits are specified separately.
- Base kits include Full Cylinder, Half Cylinder, Full/Half Cylinder Wood X Base and Wood Slab Base.
- Flip Top Unit Cutout Options available for separately specified Flip Top Unit(s) on tops greater than 36"(914mm) deep:
 - One centered cutout (S) (84"-120"[2134mm-3048mm] wide tops).
 - Two left/right cutouts (D) (132"-240"[3353mm-6096mm] wide tops).
 - Cutouts are centered between bases.

Note: On site measurements should be taken to ensure there is adequate room in elevators and/or hallway conditions to accommodate the top sizes.

To Order, Specify:

1) Product number, including:

1 Edge Option:

- 1** 1 1/2" Square
- 2** 1 1/2" Bevel
- 3** 1 1/2" Chamfer
- 4** 1 1/2" Radius
- 5** 2 3/4" Bullnose Notched
- 6** 2 3/4" Bullnose Smooth

2 Flip Top Unit Cutout:

- S** Single Centered (84"-120"[2134mm-3048mm] Widths), add **\$233.95** list
- D** Two Left/Right (132"-240"[3353mm-6096mm] Widths), add **\$467.90** list
- N** None

3 Border Option: Upcharges (list)

- N** None
- O** Border

2) Wood surface finish.

Executive Wood Tables

	Depth	Width	No. of Sections	Number	①	②	③	Wood Group B	D	Upcharge Border Option (O)
Racetrack										
1 1/2"(38mm) Edge										
	36"(914mm)	60"(1524mm)	1	TERT-3660-W	TN			\$ 3604.20	\$ 4027.50	\$1167.12
		66"(1676mm)	1	TERT-3666-W	TN			3922.98	4386.06	1238.04
		72"(1829mm)	1	TERT-3672-W	TN			4241.76	4744.62	1308.96
		78"(1981mm)	1	TERT-3678-W	TN			4560.54	5103.18	1379.88
		84"(2134mm)	1	TERT-3684-W	TN			4879.32	5461.74	1450.80
2 3/4"(70mm) Edge										
	36"(914mm)	60"(1524mm)	1	TERT-3660-W	KN			\$ 6346.10	\$ 6769.40	\$1167.12
		66"(1676mm)	1	TERT-3666-W	KN			6907.40	7370.48	1238.04
		72"(1829mm)	1	TERT-3672-W	KN			7468.70	7971.56	1308.96
		78"(1981mm)	1	TERT-3678-W	KN			8030.00	8572.64	1379.88
		84"(2134mm)	1	TERT-3684-W	KN			8591.30	9173.72	1450.80
1 1/2"(38mm) Edge										
	42"(1067mm)	78"(1981mm)	1	TERT-4278-W	TN			\$ 5056.07	\$ 5684.90	\$1450.80
		84"(2134mm)	1	TERT-4284-W	T			5400.10	6075.34	1521.72
		96"(2438mm)	1	TERT-4296-W	T			6088.16	6856.22	1663.56
		108"(2743mm)	1	TERT-42A8-W	T			6776.22	7637.10	1805.40
		120"(3048mm)	1	TERT-42C0-W	T			7464.28	8417.98	1947.24
2 3/4"(70mm) Edge										
	42"(1067mm)	78"(1981mm)	1	TERT-4278-W	KN			\$ 8768.05	\$ 9396.88	\$1450.80
		84"(2134mm)	1	TERT-4284-W	K			9354.60	10029.84	1521.72
		96"(2438mm)	1	TERT-4296-W	K			10527.70	11295.76	1663.56
		108"(2743mm)	1	TERT-42A8-W	K			11700.80	12561.68	1805.40
		120"(3048mm)	1	TERT-42C0-W	K			12873.90	13827.60	1947.24
1 1/2"(38mm) Edge										
	48"(1219mm)	84"(2134mm)	1	TERT-4884-W	T			\$ 5920.88	\$ 6688.94	\$1592.64
		96"(2438mm)	1	TERT-4896-W	T			6659.44	7533.58	1734.48
		108"(2743mm)	1	TERT-48A8-W	T			7398.00	8378.22	1876.32
		120"(3048mm)	1	TERT-48C0-W	T			8136.56	9222.86	2018.16
		132"(3353mm)	2	TERT-48D2-W	T			9537.09	10729.47	2316.78
		144"(3658mm)	2	TERT-48E4-W	T			10275.65	11574.11	2458.62
		156"(3962mm)	2	TERT-48F6-W	T			11014.21	12418.75	2600.46
		168"(4267mm)	2	TERT-48G8-W	T			11752.77	13263.39	2742.30
		180"(4572mm)	2	TERT-48J0-W	T			14128.78	15745.48	2971.24
		192"(4877mm)	2	TERT-48K2-W	T			14971.86	16694.64	3113.08
		204"(5182mm)	2	TERT-48L4-W	T			15814.94	17643.80	3254.92
		216"(5486mm)	2	TERT-48M6-W	T			16658.02	18592.96	3396.76
		228"(5791mm)	2	TERT-48N8-W	T			17501.10	19542.12	3538.60
		240"(6096mm)	2	TERT-48Q0-W	T			18344.18	20491.28	3680.44
2 3/4"(70mm) Edge										
	48"(1219mm)	84"(2134mm)	1	TERT-4884-W	K			\$10117.90	\$10885.96	\$1592.64
		96"(2438mm)	1	TERT-4896-W	K			11341.50	12215.64	1734.48
		108"(2743mm)	1	TERT-48A8-W	K			12565.10	13545.32	1876.32
		120"(3048mm)	1	TERT-48C0-W	K			13788.70	14875.00	2018.16
		132"(3353mm)	2	TERT-48D2-W	K			16005.23	17197.61	2316.78
		144"(3658mm)	2	TERT-48E4-W	K			17228.83	18527.29	2458.62
		156"(3962mm)	2	TERT-48F6-W	K			18452.43	19856.97	2600.46
		168"(4267mm)	2	TERT-48G8-W	K			19676.03	21186.65	2742.30
		180"(4572mm)	2	TERT-48J0-W	K			23059.71	24676.41	2971.24
		192"(4877mm)	2	TERT-48K2-W	K			24579.43	26302.21	3113.08
		204"(5182mm)	2	TERT-48L4-W	K			26099.15	27928.01	3254.92
		216"(5486mm)	2	TERT-48M6-W	K			27618.87	29553.81	3396.76
		228"(5791mm)	2	TERT-48N8-W	K			29138.59	31179.61	3538.60
		240"(6096mm)	2	TERT-48Q0-W	K			30658.31	32805.41	3680.44

Executive Wood Tables

Depth	Width	No. of Sections	Number	①	②	③	Wood Group B	Upcharge D	Border Option (O)
Racetrack									
1 1/2"(38mm) Edge									
54"(1372mm)	108"(2743mm)	1	TERT-54A8-W	T			\$ 8019.78	\$ 9119.34	\$1947.24
	120"(3048mm)	1	TERT-54C0-W	T			8808.84	10027.74	2089.08
	132"(3353mm)	2	TERT-54D2-W	T			10538.57	11876.81	2387.70
	144"(3658mm)	2	TERT-54E4-W	T			11432.15	12889.73	2529.54
	156"(3962mm)	2	TERT-54F6-W	T			12325.73	13902.65	2671.38
	168"(4267mm)	2	TERT-54G8-W	T			13219.31	14915.57	2813.22
	180"(4572mm)	2	TERT-54J0-W	T			15053.56	16869.16	3042.16
	192"(4877mm)	2	TERT-54K2-W	T			15947.14	17882.08	3184.00
	204"(5182mm)	2	TERT-54L4-W	T			16840.72	18895.00	3325.84
	216"(5486mm)	2	TERT-54M6-W	T			17734.30	19907.92	3467.68
	228"(5791mm)	2	TERT-54N8-W	T			18627.88	20920.84	3609.52
	240"(6096mm)	2	TERT-54Q0-W	T			19521.46	21933.76	3751.36
2 3/4"(70mm) Edge									
54"(1372mm)	108"(2743mm)	1	TERT-54A8-W	K			\$13429.40	\$14528.96	\$1947.24
	120"(3048mm)	1	TERT-54C0-W	K			14703.50	15922.40	2089.08
	132"(3353mm)	2	TERT-54D2-W	K			17423.46	18761.70	2387.70
	144"(3658mm)	2	TERT-54E4-W	K			19011.12	20468.70	2529.54
	156"(3962mm)	2	TERT-54F6-W	K			20598.78	22175.70	2671.38
	168"(4267mm)	2	TERT-54G8-W	K			22186.44	23882.70	2813.22
	180"(4572mm)	2	TERT-54J0-W	K			24401.20	26216.80	3042.16
	192"(4877mm)	2	TERT-54K2-W	K			26075.98	28010.92	3184.00
	204"(5182mm)	2	TERT-54L4-W	K			27750.76	29805.04	3325.84
	216"(5486mm)	2	TERT-54M6-W	K			29425.54	31599.16	3467.68
	228"(5791mm)	2	TERT-54N8-W	K			31100.32	33393.28	3609.52
	240"(6096mm)	2	TERT-54Q0-W	K			32775.10	35187.40	3751.36
1 1/2"(38mm) Edge									
60"(1524mm)	108"(2743mm)	1	TERT-60A8-W	T			\$ 8641.56	\$ 9860.46	\$2018.16
	120"(3048mm)	1	TERT-60C0-W	T			9481.12	10832.62	2160.00
	132"(3353mm)	2	TERT-60D2-W	TN			11444.26	12928.36	2458.62
	144"(3658mm)	2	TERT-60E4-W	T			12388.34	14005.04	2600.46
	156"(3962mm)	2	TERT-60F6-W	T			13332.42	15081.72	2742.30
	168"(4267mm)	2	TERT-60G8-W	T			14276.50	16158.40	2884.14
	180"(4572mm)	2	TERT-60J0-W	T			15699.64	17714.14	3113.08
	192"(4877mm)	2	TERT-60K2-W	T			16643.72	18790.82	3254.92
	204"(5182mm)	2	TERT-60L4-W	T			17587.80	19867.50	3396.76
	216"(5486mm)	2	TERT-60M6-W	T			18531.88	20944.18	3538.60
	228"(5791mm)	2	TERT-60N8-W	T			19475.96	22020.86	3680.44
	240"(6096mm)	2	TERT-60Q0-W	T			20420.04	23097.54	3822.28
2 3/4"(70mm) Edge									
60"(1524mm)	108"(2743mm)	1	TERT-60A8-W	K			\$14293.70	\$15512.60	\$2018.16
	120"(3048mm)	1	TERT-60C0-W	K			15618.30	16969.80	2160.00
	132"(3353mm)	2	TERT-60D2-W	KN			18702.31	20186.41	2458.62
	144"(3658mm)	2	TERT-60E4-W	K			20340.47	21957.17	2600.46
	156"(3962mm)	2	TERT-60F6-W	K			21978.63	23727.93	2742.30
	168"(4267mm)	2	TERT-60G8-W	K			23616.79	25498.69	2884.14
	180"(4572mm)	2	TERT-60J0-W	K			25916.91	27931.41	3113.08
	192"(4877mm)	2	TERT-60K2-W	K			27764.13	29911.23	3254.92
	204"(5182mm)	2	TERT-60L4-W	K			29611.35	31891.05	3396.76
	216"(5486mm)	2	TERT-60M6-W	K			31458.57	33870.87	3538.60
	228"(5791mm)	2	TERT-60N8-W	K			33305.79	35850.69	3680.44
	240"(6096mm)	2	TERT-60Q0-W	K			35153.01	37830.51	3822.28

Executive Wood Tables

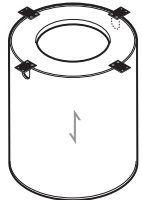
	Rectangular Table Depths	Widths	Base Qty/Size	Number ①	Wood Group B	D
Base Kits — Racetrack Wood Tables 	Full Cylinder Base Kits					
	36"-42"(914mm-1067mm)	60"-120"(1524mm-3048mm)	2-18"(457mm)	TEFC-1802-W █ 4	\$3149.90	\$4160.25
	48"-54"(1219mm-1372mm)	84"-120"(2134mm-3048mm)	2-24"(610mm)	TEFC-2402-W █ 4	3355.12	4431.30
		132"-240"(3353mm-6096mm)	3-24"(610mm)	TEFC-2403-W █ 4	5031.49	6645.36
	60"(1524mm)	108"-120"(2743mm-3048mm)	2-30"(762mm)	TEFC-3002-W █ 4	3722.63	4916.66
		132"-240"(3353mm-6096mm)	3-30"(762mm)	TEFC-3003-W █ 4	5582.72	7373.42
	Full/Half Cylinder Base Kits					
	48"-54"(1219mm-1372mm)	132"-240"(3353mm-6096mm)	3-24"(610mm)	TEFH-2403-W █ 4	\$5063.72	\$6687.92
	60"(1524mm)	132"-240"(3353mm-6096mm)	3-30"(762mm)	TEFH-3003-W █ 4	5612.55	7412.81
	Half Cylinder Base Kits					
36"-42"(914mm-1067mm)	60"-120"(1524mm-3048mm)	2-18"(457mm)	TEHC-1802-W █ 4	\$3158.24	\$4170.90	
48"-54"(1219mm-1372mm)	84"-120"(2134mm-3048mm)	2-24"(610mm)	TEHC-2402-W █ 4	3295.04	4307.70	
	132"-240"(3353mm-6096mm)	3-24"(610mm)	TEHC-2403-W █ 4	5031.49	6645.36	
60"(1524mm)	108"-120"(2743mm-3048mm)	2-30"(762mm)	TEHC-3002-W █ 4	3678.57	4691.23	
Wood X Base Kits						
36"-54"(914mm-1372mm)	60"-120"(1524mm-3048mm)	2-26"(660mm)	TEXB-2602-WN4	\$3048.48	\$4026.31	
	132"-240"(3353mm-6096mm)	3-26"(660mm)	TEXB-2603-WN4	4572.12	6038.66	
60"(1524mm)	108"-120"(2743mm-3048mm)	2-32"(813mm)	TEXB-3202-WN4	3202.39	4229.60	
	132"-240"(3353mm-6096mm)	3-32"(813mm)	TEXB-3203-WN4	4803.59	6344.37	
Wood Slab Base Kits						
		2-60"(1524mm)	TESL-3060-WN4	\$2282.44	\$3014.54	
		2-66"(1676mm)	TESL-3066-WN4	2291.80	3026.89	
		2-72"(1829mm)	TESL-3072-WN4	2301.16	3039.24	
		2-78"(1981mm)	TESL-3078-WN4	2310.52	3051.59	
		2-84"(2134mm)	TESL-3084-WN4	2319.88	3063.94	
		2-96"(2438mm)	TESL-3096-WN4	2338.60	3088.64	
		2-108"(2743mm)	TESL-30A8-WN4	2357.32	3113.34	
		2-120"(3048mm)	TESL-30C0-WN4	2376.04	3138.04	
		3-132"(3353mm)	TESL-30D2-WN4	3807.19	5028.37	
		3-144"(3658mm)	TESL-30E4-WN4	4022.33	5312.55	
		3-156"(3962mm)	TESL-30F6-WN4	4237.47	5596.73	
		3-168"(4267mm)	TESL-30G8-WN4	4452.61	5880.91	
		3-180"(4572mm)	TESL-30J0-WN4	4667.75	6165.09	
		3-192"(4877mm)	TESL-30K2-WN4	4882.89	6449.27	
		3-204"(5182mm)	TESL-30L4-WN4	5098.03	6733.45	
		3-216"(5486mm)	TESL-30M6-WN4	5313.17	7017.63	
		3-228"(5791mm)	TESL-30N8-WN4	5528.31	7301.81	
		3-240"(6096mm)	TESL-30Q0-WN4	5743.45	7585.99	

Base Kits — Racetrack Wood Tables

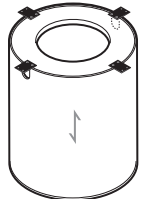

TEFC

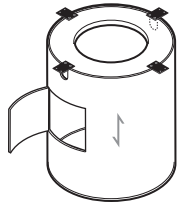

TEHC-A

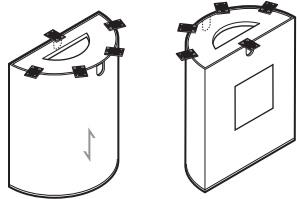

TEHC

TEHC-A

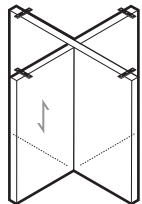

TEXB-W

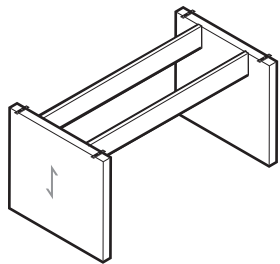

TESL

Note: ↙ = Wood Grain Direction

Features

- Each kit includes 28"(711mm) high base kit(s) with attachment hardware:
 - Full Cylinder Base: Wood veneer over wood base; available with optional Access Door for power access.
 - Full Cylinder and Half Cylinder Bases have cord access cutout.
 - Half Cylinder Base: Wood veneer over wood base.
 - Each Full Cylinder and Half Cylinder base includes weight for stability.
- Wood X Base: Two 26"(660mm) or 32"(813mm) deep, 1 1/4"(32mm) thick wood veneer slabs.
- Slab Base: 30"(762mm) deep, 2"(51mm) thick wood veneer with Keel sets:
 - One base set includes one Keel set.
 - Three base kit includes two Keel sets.
- Glide adjustment of 1"(25mm) on all bases.
- Cylinders ship assembled; other bases require field assembly.

To Order, Specify:

- 1) Product number, including:

X Base – Wood

① Access Hatch Option (Full Cylinder):

- A** Access Door, upcharges (list) per kit
Base Qty Two, add \$924.91 list
Base Qty Three, add \$1417.44 list
- N** No Access Door

- 2) Wood surface finish.

X Base/Slab Base

- 1) Product number.
- 2) Wood surface finish.

Executive Wood Tables

Boat

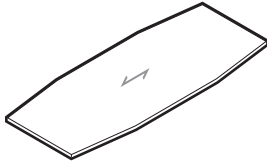

TEBO
(60"-120")

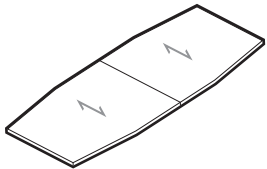

TEBO
(132"-240"
[3353mm-6096mm])

Note: ↕ = Wood Grain Direction

Features

- Includes one piece (60"-120"[1524mm-3048mm] wide) or two piece (132"-240"[3353mm-6096mm] wide) Boat shaped wood veneer top with solid wood edge:
 - 1 1/2"(38mm) Edge: Square (1), Bevel (2), Chamfer (3) or Radius (4).
 - 2 3/4"(70mm) Edge: Bullnose Notched (5) or Bullnose Smooth (6).
 - Boat top depths taper 6"(152mm) at ends; i.e., 36"(914mm) depth top is 30"(762mm) at each end.
- Border (O) option has black 1/8"(3mm) thick inlay.
- Base Kits are specified separately.
- Base kits include Full Cylinder, Half Cylinder, Full/Half Cylinder Wood X Base and Wood Slab Base.
- Flip Top Unit Cutout Options available for separately specified Flip Top Unit(s) on tops greater than 36"(914mm) deep:
 - One centered cutout (S) (84"-120"[2134mm-3048mm] wide tops).
 - Two left/right cutouts (D) (132"-240"[3353mm-6096mm] wide tops).
 - Cutouts are centered between bases.

Note: On site measurements should be taken to ensure there is adequate room in elevators and/or hallway conditions to accommodate the top sizes.

To Order, Specify:

1) Product number, including:

① Edge Option:

- 1** 1 1/2" Square
- 2** 1 1/2" Bevel
- 3** 1 1/2" Chamfer
- 4** 1 1/2" Radius
- 5** 2 3/4" Bullnose Notched
- 6** 2 3/4" Bullnose Smooth

② Flip Top Unit Cutout:

- S** Single Centered (84"-120"[2134mm-3048mm] Widths), add **\$233.95** list
- D** Two Left/Right (132"-240"[3353mm-6096mm] Widths), add **\$467.90** list
- N** None

③ Border Option: Upcharges (list)

- N** None
- O** Border

2) Wood surface finish.

Executive Wood Tables

	Depth	Width	No. of Sections	Number	①	②	③	Wood Group B	D	Upcharge Border Option (O)
Boat										
1 1/2"(38mm) Edge										
	36"/30"(914mm/762mm)	60"(1524mm)	1	TEBO-3660-W	TN			\$ 3439.87	\$ 3843.88	\$1113.93
		66"(1676mm)	1	TEBO-3666-W	TN			3744.07	4186.06	1181.61
		72"(1829mm)	1	TEBO-3672-W	TN			4048.27	4528.24	1249.29
		78"(1981mm)	1	TEBO-3678-W	TN			4352.47	4870.42	1316.97
		84"(2134mm)	1	TEBO-3684-W	TN			4656.67	5212.60	1384.65
2 3/4"(70mm) Edge										
	36"/30"(914mm/762mm)	60"(1524mm)	1	TEBO-3660-W	KN			\$ 6056.77	\$ 6460.78	\$1113.93
		66"(1676mm)	1	TEBO-3666-W	KN			6592.45	7034.44	1181.61
		72"(1829mm)	1	TEBO-3672-W	KN			7128.13	7608.10	1249.29
		78"(1981mm)	1	TEBO-3678-W	KN			7663.81	8181.76	1316.97
		84"(2134mm)	1	TEBO-3684-W	KN			8199.49	8755.42	1384.65
1 1/2"(38mm) Edge										
	42"/36"(1067mm/914mm)	78"(1981mm)	1	TEBO-4278-W	TN			\$ 4825.37	\$ 5425.61	\$1384.65
		84"(2134mm)	1	TEBO-4284-W	T			5153.67	5798.22	1452.33
		96"(2438mm)	1	TEBO-4296-W	T			5810.27	6543.44	1587.69
		108"(2743mm)	1	TEBO-42A8-W	T			6466.87	7288.66	1723.05
		120"(3048mm)	1	TEBO-42C0-W	T			7123.47	8033.88	1858.41
2 3/4"(70mm) Edge										
	42"/36"(1067mm/914mm)	78"(1981mm)	1	TEBO-4278-W	KN			\$ 8368.19	\$ 8968.43	\$1384.65
		84"(2134mm)	1	TEBO-4284-W	K			8927.97	9572.52	1452.33
		96"(2438mm)	1	TEBO-4296-W	K			10047.53	10780.70	1587.69
		108"(2743mm)	1	TEBO-42A8-W	K			11167.09	11988.88	1723.05
		120"(3048mm)	1	TEBO-42C0-W	K			12286.65	13197.06	1858.41
1 1/2"(38mm) Edge										
	48"/42"(1219mm/1067mm)	84"(2134mm)	1	TEBO-4884-W	T			\$ 5650.67	\$ 6383.84	\$1520.01
		96"(2438mm)	1	TEBO-4896-W	T			6355.47	7189.92	1655.37
		108"(2743mm)	1	TEBO-48A8-W	T			7060.27	7996.00	1790.73
		120"(3048mm)	1	TEBO-48C0-W	T			7765.07	8802.08	1926.09
		132"(3353mm)	2	TEBO-48D2-W	T			9101.65	10239.94	2211.09
		144"(3658mm)	2	TEBO-48E4-W	T			9806.45	11046.02	2346.45
		156"(3962mm)	2	TEBO-48F6-W	T			10511.25	11852.10	2481.81
		168"(4267mm)	2	TEBO-48G8-W	T			11216.05	12658.18	2617.17
		180"(4572mm)	2	TEBO-48J0-W	T			13483.68	15027.09	2835.65
		192"(4877mm)	2	TEBO-48K2-W	T			14288.24	15932.93	2971.01
		204"(5182mm)	2	TEBO-48L4-W	T			15092.80	16838.77	3106.37
		216"(5486mm)	2	TEBO-48M6-W	T			15897.36	17744.61	3241.73
		228"(5791mm)	2	TEBO-48N8-W	T			16701.92	18650.45	3377.09
		240"(6096mm)	2	TEBO-48Q0-W	T			17506.48	19556.29	3512.45
2 3/4"(70mm) Edge										
	48"/42"(1219mm/1067mm)	84"(2134mm)	1	TEBO-4884-W	K			\$ 9656.45	\$10389.62	\$1520.01
		96"(2438mm)	1	TEBO-4896-W	K			10824.21	11658.66	1655.37
		108"(2743mm)	1	TEBO-48A8-W	K			11991.97	12927.70	1790.73
		120"(3048mm)	1	TEBO-48C0-W	K			13159.73	14196.74	1926.09
		132"(3353mm)	2	TEBO-48D2-W	K			15275.17	16413.46	2211.09
		144"(3658mm)	2	TEBO-48E4-W	K			16442.93	17682.50	2346.45
		156"(3962mm)	2	TEBO-48F6-W	K			17610.69	18951.54	2481.81
		168"(4267mm)	2	TEBO-48G8-W	K			18778.45	20220.58	2617.17
		180"(4572mm)	2	TEBO-48J0-W	K			22007.79	23551.20	2835.65
		192"(4877mm)	2	TEBO-48K2-W	K			23458.19	25102.88	2971.01
		204"(5182mm)	2	TEBO-48L4-W	K			24908.59	26654.56	3106.37
		216"(5486mm)	2	TEBO-48M6-W	K			26358.99	28206.24	3241.73
		228"(5791mm)	2	TEBO-48N8-W	K			27809.39	29757.92	3377.09
		240"(6096mm)	2	TEBO-48Q0-W	K			29259.79	31309.60	3512.45

Executive Wood Tables

Boat	Depth	Width	No. of Sections	Number	① ② ③			Wood Group		Upcharge Border Option (O)
					B	D				
1 1/2"(38mm) Edge										
	54"/48"(1372mm/1219mm)	108"(2743mm)	1	TEBO-54A8-W	T			\$ 7653.67	\$ 8703.34	\$1858.41
		120"(3048mm)	1	TEBO-54C0-W	T			8406.67	9570.28	1993.77
		132"(3353mm)	2	TEBO-54D2-W	T			10057.47	11335.02	2278.77
		144"(3658mm)	2	TEBO-54E4-W	T			10910.23	12301.72	2414.13
		156"(3962mm)	2	TEBO-54F6-W	T			11762.99	13268.42	2549.49
		168"(4267mm)	2	TEBO-54G8-W	T			12615.75	14235.12	2684.85
		180"(4572mm)	2	TEBO-54J0-W	T			14366.28	16099.59	2903.33
		192"(4877mm)	2	TEBO-54K2-W	T			15219.04	17066.29	3038.69
		204"(5182mm)	2	TEBO-54L4-W	T			16071.80	18032.99	3174.05
		216"(5486mm)	2	TEBO-54M6-W	T			16924.56	18999.69	3309.41
		228"(5791mm)	2	TEBO-54N8-W	T			17777.32	19966.39	3444.77
		240"(6096mm)	2	TEBO-54Q0-W	T			18630.08	20933.09	3580.13
2 3/4"(70mm) Edge										
	54"/48"(1372mm/1219mm)	108"(2743mm)	1	TEBO-54A8-W	K			\$12816.85	\$13866.52	\$1858.41
		120"(3048mm)	1	TEBO-54C0-W	K			14032.81	15196.42	1993.77
		132"(3353mm)	2	TEBO-54D2-W	K			16315.53	17593.08	2278.77
		144"(3658mm)	2	TEBO-54E4-W	K			17830.77	19222.26	2414.13
		156"(3962mm)	2	TEBO-54F6-W	K			19346.01	20851.44	2549.49
		168"(4267mm)	2	TEBO-54G8-W	K			20861.25	22480.62	2684.85
		180"(4572mm)	2	TEBO-54J0-W	K			23288.13	25021.44	2903.33
		192"(4877mm)	2	TEBO-54K2-W	K			24886.49	26733.74	3038.69
		204"(5182mm)	2	TEBO-54L4-W	K			26484.85	28446.04	3174.05
		216"(5486mm)	2	TEBO-54M6-W	K			28083.21	30158.34	3309.41
		228"(5791mm)	2	TEBO-54N8-W	K			29681.57	31870.64	3444.77
		240"(6096mm)	2	TEBO-54Q0-W	K			31279.93	33582.94	3580.13
1 1/2"(38mm) Edge										
	60"/54"(1525mm/1372mm)	108"(2743mm)	1	TEBO-60A8-W	T			\$ 8247.07	\$ 9410.68	\$1926.09
		120"(3048mm)	1	TEBO-60C0-W	T			9048.27	10338.48	2061.45
		132"(3353mm)	2	TEBO-60D2-W	TN			10921.85	12338.66	2346.45
		144"(3658mm)	2	TEBO-60E4-W	T			11822.81	13366.22	2481.81
		156"(3962mm)	2	TEBO-60F6-W	T			12723.77	14393.78	2617.17
		168"(4267mm)	2	TEBO-60G8-W	T			13624.73	15421.34	2752.53
		180"(4572mm)	2	TEBO-60J0-W	T			14982.86	16906.07	2971.01
		192"(4877mm)	2	TEBO-60K2-W	T			15883.82	17933.63	3106.37
		204"(5182mm)	2	TEBO-60L4-W	T			16784.78	18961.19	3241.73
		216"(5486mm)	2	TEBO-60M6-W	T			17685.74	19988.75	3377.09
		228"(5791mm)	2	TEBO-60N8-W	T			18586.70	21016.31	3512.45
		240"(6096mm)	2	TEBO-60Q0-W	T			19487.66	22043.87	3647.81
2 3/4"(70mm) Edge										
	60"/54"(1525mm/1372mm)	108"(2743mm)	1	TEBO-60A8-W	K			\$13641.73	\$14805.34	\$1926.09
		120"(3048mm)	1	TEBO-60C0-W	K			14905.89	16196.10	2061.45
		132"(3353mm)	2	TEBO-60D2-W	KN			17849.27	19266.08	2346.45
		144"(3658mm)	2	TEBO-60E4-W	K			19412.71	20956.12	2481.81
		156"(3962mm)	2	TEBO-60F6-W	K			20976.15	22646.16	2617.17
		168"(4267mm)	2	TEBO-60G8-W	K			22539.59	24336.20	2752.53
		180"(4572mm)	2	TEBO-60J0-W	K			24734.73	26657.94	2971.01
		192"(4877mm)	2	TEBO-60K2-W	K			26497.67	28547.48	3106.37
		204"(5182mm)	2	TEBO-60L4-W	K			28260.61	30437.02	3241.73
		216"(5486mm)	2	TEBO-60M6-W	K			30023.55	32326.56	3377.09
		228"(5791mm)	2	TEBO-60N8-W	K			31786.49	34216.10	3512.45
		240"(6096mm)	2	TEBO-60Q0-W	K			33549.43	36105.64	3647.81

Executive Wood Tables

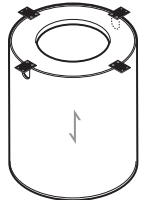
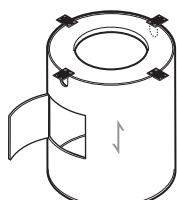
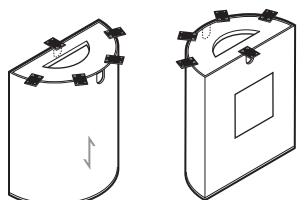
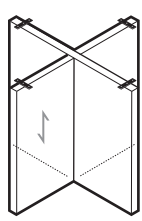
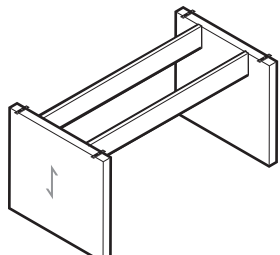
	Depths	Widths	Base Qty/Size	Number ①	Wood Group B	D
Base Kits — Boat Wood Tables						
Full Cylinder Base Kits						
	36-42"(914mm-1067mm)	60"-120"(1524mm-3048mm)	2"-18"(457mm)	TEFC-1802-W 4	\$3149.90	\$4160.25
	48"-54"(1219mm-1372mm)	84"-120"(2134mm-3048mm)	2"-24"(610mm)	TEFC-2402-W 4	3355.12	4431.30
		132"-240"(3353mm-6096mm)	3"-24"(610mm)	TEFC-2403-W 4	5031.49	6645.36
	60"(1524mm)	108"-120"(2743mm-3048mm)	2"-30"(762mm)	TEFC-3002-W 4	3722.63	4916.66
132"-240"(3353mm-6096mm)		3"-30"(762mm)	TEFC-3003-W 4	5582.72	7373.42	
Full/Half Cylinder Base Kits						
	48"-54"(1219mm-1372mm)	132"-240"(3353mm-6096mm)	3"-24"(610mm)	TEFH-2403-W 4	\$5063.72	\$6687.92
	60"(1524mm)	132"-240"	3"-30"(762mm)	TEFH-3003-W 4	5612.55	7412.81
Half Cylinder Base Kits						
	36-42"(914mm-1067mm)	60"-120"(1524mm-3048mm)	2"-18"(457mm)	TEHC-1802-W 4	\$3158.24	\$4170.90
	48"-54"(1219mm-1372mm)	84"-120"(2134mm-3048mm)	2"-24"(610mm)	TEHC-2402-W 4	3295.04	4307.70
		108"-120"(2743mm-3048mm)	2"-30"(762mm)	TEHC-3002-W 4	3678.57	4691.23
Wood X Base Kits						
	36-54"(914mm-1372mm)	60"-120"(1524mm-3048mm)	2"-26"(660mm)	TEXB-2602-WN4	\$3048.48	\$4026.31
		132"-240"(3353mm-6096mm)	3"-26"(660mm)	TEXB-2603-WN4	4572.12	6038.66
	60"(1524mm)	108"-120"(2743mm-3048mm)	2"-32"(813mm)	TEXB-3202-WN4	3202.39	4229.60
132"-240"(3353mm-6096mm)		3"-32"(813mm)	TEXB-3203-WN4	4803.59	6344.37	
Wood Slab Base Kits						
			2"-60"(1524mm)	TESL-3060-WN4	\$2282.44	\$3014.54
			2"-66"(1676mm)	TESL-3066-WN4	2291.80	3026.89
			2"-72"(1829mm)	TESL-3072-WN4	2301.16	3039.24
			2"-78"(1981mm)	TESL-3078-WN4	2310.52	3051.59
			2"-84"(2134mm)	TESL-3084-WN4	2319.88	3063.94
			2"-96"(2438mm)	TESL-3096-WN4	2338.60	3088.64
			2"-108"(2743mm)	TESL-30A8-WN4	2357.32	3113.34
			2"-120"(3048mm)	TESL-30C0-WN4	2376.04	3138.04
			3"-132"(3353mm)	TESL-30D2-WN4	3807.19	5028.37
			3"-144"(3658mm)	TESL-30E4-WN4	4022.33	5312.55
			3"-156"(3962mm)	TESL-30F6-WN4	4237.47	5596.73
			3"-168"(4267mm)	TESL-30G8-WN4	4452.61	5880.91
			3"-180"(4572mm)	TESL-30J0-WN4	4667.75	6165.09
			3"-192"(4877mm)	TESL-30K2-WN4	4882.89	6449.27
			3"-204"(5182mm)	TESL-30L4-WN4	5098.03	6733.45
			3"-216"(5486mm)	TESL-30M6-WN4	5313.17	7017.63
		3"-228"(5791mm)	TESL-30N8-WN4	5528.31	7301.81	
		3"-240"(6096mm)	TESL-30Q0-WN4	5743.45	7585.99	

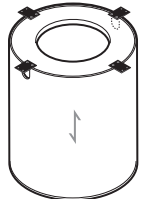

TEFC

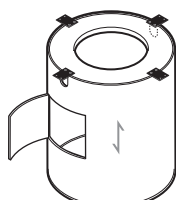

TEFC-A

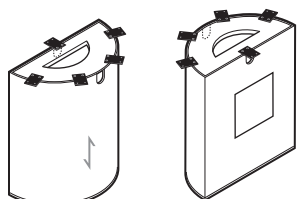

TEHC

TEHC-A

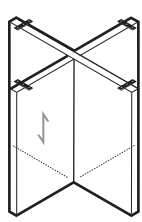

TEXB-W

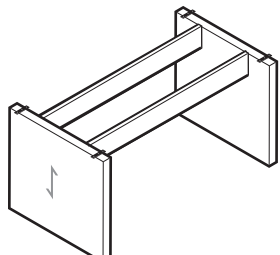

TESL

Note: ↙ = Wood Grain Direction

Features

- Each kit includes 28"(711mm) high base kit(s) with attachment hardware:
- Full Cylinder Base: Wood veneer over wood base; available with optional Access Door for power access.
- Full Cylinder and Half Cylinder Bases have cord access cutout.
 - Half Cylinder Base: Wood veneer over wood base.
 - Each Full Cylinder and Half Cylinder base includes weight for stability.
 - Wood X Base: Two 26"(660mm) or 32"(813mm) deep, 1 1/4"(32mm) thick wood veneer slabs.
- Slab Base: 30"(762mm) deep, 2"(51mm) thick wood veneer with Keel sets:
 - One base set includes one Keel set.
 - Three base kit includes two Keel sets.
- Glide adjustment of 1"(25mm) on all bases.
- Cylinders ship assembled; other bases require field assembly.

To Order, Specify:

Full/Half Cylinder Base

- 1) Product number, including:

① Access Hatch Option (Full Cylinder):

- A** Access Door, upcharges (list) per kit Base Qty Two, add \$924.91 list Base Qty Three, add \$1417.44 list
- N** No Access Door

- 2) Wood surface finish.

X Base/Slab Base

- 1) Product number.
- 2) Wood surface finish.

Executive Wood Tables

Wedge

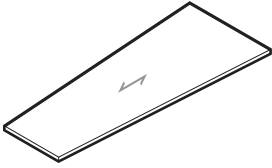

TEWE
(84" - 120")

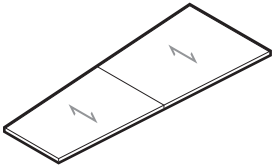

TEWE
(132"-240"
[3353mm-6096mm])

Note: ↯ = Wood Grain Direction

Features

- Includes one piece (84"-120"[2134mm-3048mm] wide) or two piece (132"-240"[3353mm-6096mm] wide) Wedge shaped wood veneer top with solid wood edge:
 - 1 1/2" Edge: Square (1), Bevel (2), Chamfer (3) or Radius (4).
 - 2 3/4" Edge: Bullnose Notched (5) or Bullnose Smooth (6).
 - Wedge top depths taper 12"(305mm) from wider end; i.e., 48"(1219mm) deep to 36"(914mm) deep.
- Border (O) option has black 1/8"(3mm) thick inlay.
- Base Kits are specified separately.
- Base kits include Full Cylinder, Half Cylinder, Full/Half Cylinder, Wood X Base and Wood Slab Base.
- Flip Top Unit Cutout Options available for separately specified Flip Top Unit(s):
 - One centered cutout (S) (84-120"[2134mm-3048mm] wide tops).
 - Two left/right cutouts (D) (132-240"[3353mm-6096mm] wide tops).
 - Cutouts are centered between bases.

Note: On site measurements should be taken to ensure there is adequate room in elevators and/or hallway conditions to accommodate the top sizes.

To Order, Specify:

1) Product number, including:

① Edge Option:

- 1** 1 1/2" Square
- 2** 1 1/2" Bevel
- 3** 1 1/2" Chamfer
- 4** 1 1/2" Radius
- 5** 2 3/4" Bullnose Notched
- 6** 2 3/4" Bullnose Smooth

② Flip Top Unit Cutout:

- S** Single Centered (84"-120"[2134mm-3048mm] Widths), add **\$233.95** list
- D** Two Left/Right (132"-240"[3353mm-6096mm] Widths), add **\$467.90** list
- N** None

③ Border Option: Upcharge (list)

- N** None
- O** Border

2) Wood surface finish.

Executive Wood Tables

	Depth	Width	No. of Sections	Number	①	②	③	Wood Group B	D	Upcharge Border Option (O)		
Wedge	1 1/2"(38mm) Edge											
	48"/36"(1219mm/914mm)	84"(2134mm)	1	TEWE-4884-W	T			\$ 4014.11	\$ 4534.00	\$1080.54		
		96"(2438mm)	1	TEWE-4896-W	T			4514.99	5106.56	1177.02		
		108"(2743mm)	1	TEWE-48A8-W	T			5015.87	5679.12	1273.50		
		120"(3048mm)	1	TEWE-48C0-W	T			5516.75	6251.68	1369.98		
		132"(3353mm)	2	TEWE-48D2-W	T			6471.03	7277.64	1572.73		
		144"(3658mm)	2	TEWE-48E4-W	T			6971.91	7850.20	1669.21		
		156"(3962mm)	2	TEWE-48F6-W	T			7472.79	8422.76	1765.69		
		168"(4267mm)	2	TEWE-48G8-W	T			7973.67	8995.32	1862.17		
		180"(4572mm)	2	TEWE-48J0-W	T			9579.75	10673.08	2017.68		
		192"(4877mm)	2	TEWE-48K2-W	T			10151.45	11316.46	2114.16		
		204"(5182mm)	2	TEWE-48L4-W	T			10723.15	11959.84	2210.64		
		216"(5486mm)	2	TEWE-48M6-W	T			11294.85	12603.22	2307.12		
		228"(5791mm)	2	TEWE-48N8-W	T			11866.55	13246.60	2403.60		
		240"(6096mm)	2	TEWE-48Q0-W	T			12438.25	13889.98	2500.08		
		2 3/4"(70mm) Edge										
		48"/36"(1219mm/914mm)	84"(2134mm)	1	TEWE-4884-W	K			\$ 6857.57	\$ 7377.46	\$1080.54	
			96"(2438mm)	1	TEWE-4896-W	K			7686.77	8278.34	1177.02	
			108"(2743mm)	1	TEWE-48A8-W	K			8515.97	9179.22	1273.50	
			120"(3048mm)	1	TEWE-48C0-W	K			9345.17	10080.10	1369.98	
			132"(3353mm)	2	TEWE-48D2-W	K			10854.47	11661.08	1572.73	
			144"(3658mm)	2	TEWE-48E4-W	K			11683.67	12561.96	1669.21	
			156"(3962mm)	2	TEWE-48F6-W	K			12512.87	13462.84	1765.69	
			168"(4267mm)	2	TEWE-48G8-W	K			13342.07	14363.72	1862.17	
			180"(4572mm)	2	TEWE-48J0-W	K			15628.31	16721.64	2017.68	
			192"(4877mm)	2	TEWE-48K2-W	K			16658.23	17823.24	2114.16	
			204"(5182mm)	2	TEWE-48L4-W	K			17688.15	18924.84	2210.64	
			216"(5486mm)	2	TEWE-48M6-W	K			18718.07	20026.44	2307.12	
			228"(5791mm)	2	TEWE-48N8-W	K			19747.99	21128.04	2403.60	
			240"(6096mm)	2	TEWE-48Q0-W	K			20777.91	22229.64	2500.08	
		1 1/2"(48mm) Edge										
		54"/42"(1372mm/1067mm)	108"(2743mm)	1	TEWE-54A8-W	T			\$ 5437.61	\$ 6181.50	\$1321.74	
			120"(3048mm)	1	TEWE-54C0-W	T			5972.75	6797.28	1418.22	
			132"(3353mm)	2	TEWE-54D2-W	T			7145.46	8050.63	1620.97	
			144"(3658mm)	2	TEWE-54E4-W	T			7751.42	8737.23	1717.45	
			156"(3962mm)	2	TEWE-54F6-W	T			8357.38	9423.83	1813.93	
			168"(4267mm)	2	TEWE-54G8-W	T			8963.34	10110.43	1910.41	
		180"(4572mm)	2	TEWE-54J0-W	T			10207.05	11434.78	2605.92		
		192"(4877mm)	2	TEWE-54K2-W	T			10813.01	12121.38	2162.40		
		204"(5182mm)	2	TEWE-54L4-W	T			11418.97	12807.98	2258.88		
		216"(5486mm)	2	TEWE-54M6-W	T			12024.93	13494.58	2355.36		
		228"(5791mm)	2	TEWE-54N8-W	T			12630.89	14181.18	2451.84		
		240"(6096mm)	2	TEWE-54Q0-W	T			13236.85	14867.78	2548.32		

Executive Wood Tables

Wedge	Depth	Width	No. of Sections	Number	① ② ③			Wood Group		Upcharge Border Option (O)
					B	D				
2 3/4"(70mm) Edge										
	54"/42"(1372mm/1067mm)	108"(2743mm)	1	TEWE-54A8-W	K			\$ 9101.87	\$ 9845.76	\$1321.74
		120"(3048mm)	1	TEWE-54C0-W	K			9965.33	10789.86	1418.22
		132"(3353mm)	2	TEWE-54D2-W	K			11808.81	12713.98	1620.97
		144"(3658mm)	2	TEWE-54E4-W	K			12884.81	13870.62	1717.45
		156"(3962mm)	2	TEWE-54F6-W	K			13960.81	15027.26	1813.93
		168"(4267mm)	2	TEWE-54G8-W	K			15036.81	16183.90	1910.41
		180"(4572mm)	2	TEWE-54J0-W	K			16537.85	17765.58	2605.92
		192"(4877mm)	2	TEWE-54K2-W	K			17672.87	18981.24	2162.40
		204"(5182mm)	2	TEWE-54L4-W	K			18807.89	20196.90	2258.88
		216"(5486mm)	2	TEWE-54M6-W	K			19942.91	21412.56	2355.36
		228"(5791mm)	2	TEWE-54N8-W	K			21077.93	22628.22	2451.84
		240"(6096mm)	2	TEWE-54Q0-W	K			22212.95	23843.88	2548.32
1 1/2"(38mm) Edge										
	60"/42"(1524mm/1067mm)	108"(2743mm)	1	TEWE-60A8-W	T			\$ 5859.35	\$ 6683.88	\$1369.98
		120"(3048mm)	1	TEWE-60C0-W	T			6428.75	7342.88	1466.46
		132"(3353mm)	2	TEWE-60D2-W	T			7759.71	8763.44	1669.21
		144"(3658mm)	2	TEWE-60E4-W	T			8399.93	9493.26	1765.69
		156"(3962mm)	2	TEWE-60F6-W	T			9040.15	10223.08	1862.17
		168"(4267mm)	2	TEWE-60G8-W	T			9680.37	10952.90	1958.65
		180"(4572mm)	2	TEWE-60J0-W	T			10645.42	12007.55	2114.16
		192"(4877mm)	2	TEWE-60K2-W	T			11285.64	12737.37	2210.64
		204"(5182mm)	2	TEWE-60L4-W	T			11925.86	13467.19	2307.12
		216"(5486mm)	2	TEWE-60M6-W	T			12566.08	14197.01	2403.60
		228"(5791mm)	2	TEWE-60N8-W	T			13206.30	14926.83	2500.08
		240"(6096mm)	2	TEWE-60Q0-W	T			13846.52	15656.65	2596.56
2 3/4"(70mm) Edge										
	60"/42"(1524mm/1067mm)	108"(2743mm)	1	TEWE-60A8-W	K			\$ 9687.77	\$10512.30	\$1369.98
		120"(3048mm)	1	TEWE-60C0-W	K			10585.49	11499.62	1466.46
		132"(3353mm)	2	TEWE-60D2-W	K			12675.77	13679.50	1669.21
		144"(3658mm)	2	TEWE-60E4-W	K			13786.03	14879.36	1765.69
		156"(3962mm)	2	TEWE-60F6-W	K			14896.29	16079.22	1862.17
		168"(4267mm)	2	TEWE-60G8-W	K			16006.55	17279.08	1958.65
		180"(4572mm)	2	TEWE-60J0-W	K			17565.45	18927.58	2114.16
		192"(4877mm)	2	TEWE-60K2-W	K			18817.39	20269.12	2210.64
		204"(5182mm)	2	TEWE-60L4-W	K			20069.33	21610.66	2307.12
		216"(5486mm)	2	TEWE-60M6-W	K			21321.27	22952.20	2403.60
		228"(5791mm)	2	TEWE-60N8-W	K			22573.21	24293.74	2500.08
		240"(6096mm)	2	TEWE-60Q0-W	K			23825.15	25635.28	2596.56

Executive Wood Tables

	Depths	Widths	Base Qty/Size	Number ①	Wood Group B	D
Base Kits — Wedge Wood Tables	Full Cylinder Base Kits					
	48"-60"(1219mm-1524mm)	84"-120"(2134mm-3048mm)	2-24"(610mm)	TEFC-2402-W 4	\$3355.12	\$4431.30
		132"-240"(3353mm-6096mm)	3-24"(610mm)	TEFC-2403-W 4	5031.49	6645.36
	Full/Half Cylinder Base Kits					
	48"-60"(1219mm-1524mm)	132"-240"(3353mm-6096mm)	3-24"(610mm)	TEFH-2403-W 4	\$5063.72	\$6687.92
	Half Cylinder Base Kits					
	48"-60"(1219mm-1524mm)	84"-120"(2134mm-3048mm)	2-24"(610mm)	TEHC-2402-W 4	\$3295.04	\$4307.70
	Wood X Base Kits					
	48"-60"(1219mm-1524mm)	84"-120"(2134mm-3048mm)	2-32"(813mm)	TEXB-3202-WN4	\$3202.39	\$4229.60
		132"-240"(3353mm-6096mm)	3-32"(813mm)	TEXB-3203-WN4	4803.59	6344.37
	Wood Slab Base Kits					
			2-84"(2134mm)	TESL-3084-WN4	\$2319.88	\$3063.94
			2-96"(2438mm)	TESL-3096-WN4	2338.60	3088.64
			2-108"(2743mm)	TESL-30A8-WN4	2357.32	3113.34
			2-120"(3048mm)	TESL-30C0-WN4	2376.04	3138.04
			3-132"(3353mm)	TESL-30D2-WN4	3807.19	5028.37
			3-144"(3658mm)	TESL-30E4-WN4	4022.33	5312.55
			3-156"(3962mm)	TESL-30F6-WN4	4237.47	5596.73
			3-168"(4267mm)	TESL-30G8-WN4	4452.61	5880.91
			3-180"(4572mm)	TESL-30J0-WN4	4667.75	6165.09
			3-192"(4877mm)	TESL-30K2-WN4	4882.89	6449.27
			3-204"(5182mm)	TESL-30L4-WN4	5098.03	6733.45
			3-216"(5486mm)	TESL-30M6-WN4	5313.17	7017.63
			3-228"(5791mm)	TESL-30N8-WN4	5528.31	7301.81
			3-240"(6096mm)	TESL-30Q0-WN4	5743.45	7585.99

Base Kits — Wedge Wood Tables

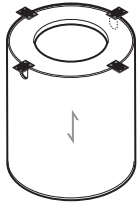

TEFC

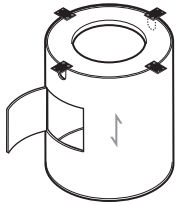

TEFH-A

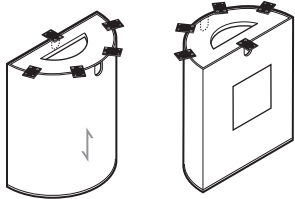

TEHC

TEHC-A

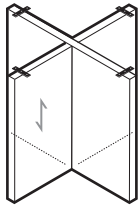

TEXB-W

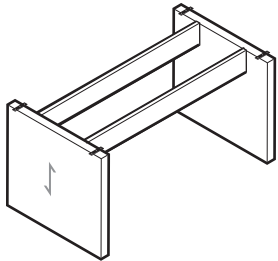

TESL

Note: ↴ = Wood Grain Direction

Features

- Each kit includes 28"(711mm) high base kit(s) with attachment hardware:
 - Full Cylinder Base: Wood veneer over wood base; available with optional Access Door for power access.
 - Full Cylinder and Half Cylinder Bases have cord access cutout.
 - Half Cylinder Base: Wood veneer over wood base.
 - Each Full Cylinder and Half Cylinder base includes weight for stability.
- Wood X Base: Two 26"(660mm) or 32"(813mm) deep, 1 1/4"(32mm) thick wood veneer slabs.
- X Base: 30"(762mm) deep, 1 1/4"(32mm) thick wood veneer slabs.
- Slab Base: 30"(762mm) deep, 2"(51mm) thick wood veneer with Keel sets:
 - One base set includes one Keel set.
 - Three base kit includes two Keel sets.
- Glide adjustment of 1"(25mm) on all bases.
- Cylinders ship assembled; other bases require field assembly.

To Order, Specify:

- 1) Product number, including:

X Base – Wood

- 1) Access Hatch Option (Full Cylinder):

- A** Access Door, upcharges (list) per kit
Base Qty Two, add \$924.91 list
Base Qty Three, add \$1417.44 list
- N** No Access Door

- 2) Wood surface finish.

X Base/Slab Base

- 1) Product number.
- 2) Wood surface finish.

Conference Buffet

	Height	Depth	Width	Number	①	②	③	Wood Group B	D
Conference Buffet — Wood	36 3/8"(924mm)	22"(559mm)	72"(1829mm)	TECB-2272-W	S	G6		\$9048.79	\$9977.07

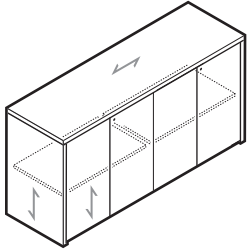

TECB

Note: ↴ = Wood Grain Direction

Features

- Includes wood veneer top with storage.
- 1 1/2"(38mm) thick wood veneer top with choice of four profile edges: –Square (1), Bevel (2), Chamfer (3) or Radius (4) on three edges with square edge on back.
- Matched veneer across doors.
- Single panel construction with four touch latch doors with concealed hinges.
- Includes two adjustable shelves with 1 1/4"(32mm) adjustment range.
- Optional Locks are available in black or chrome.
- Lock plug(s) and key(s) are shipped with random numbering unless they are specified "keyed-alike" or "master-keyed".
- Center Drawer available; separately specified.
- Glides provide 1"(25mm) adjustment range.
- Shipped assembled.

To Order, Specify:

1) Product number, including:

① Edge Option:

- 1** Square
- 2** Bevel
- 3** Chamfer
- 4** Radius

② Lock Option:

- L** Lock, add **\$118.06** list
- N** No Lock

③ Lock Color Option:

- BL** Black
- BP** Chrome

2) Wood finish color.

Center Drawer

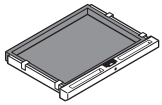

UXCD-N

	Height	Depth	Width	Number	①	Wood Group B
	1 7/8"(48mm)	17 1/2"(445mm)	24"(610mm)	UXCD-1824-		\$435.99

Features

- Includes center drawer and attachment hardware.
- Hardwood front rail with routed pencil channels.
- Drawer body in black miterfold.
- Optional lock available in black or chrome.
- Lock options; refer to Lock Program Price List.
- Field installation required.

Specification Tip

- For use within Conference Buffet.

To Order, Specify:

1) Product number, including:

① Lock Option:

- L** Lock, add **\$56.22** list
- N** No Lock

2) Wood finish color (Group B veneer only).

3) Trim color for lock plug.

Accessories

Height	Depth	Width	Number	①	Wood Group	Fabric Grade						
						A	B	C	D	E	F	G
48"(1219mm)	5 3/8"(137mm)	48"(1219mm)	TEPB-4848-WKS		B	\$5520.69	\$5545.75	\$5561.25	\$5586.31	\$5604.21	\$5686.53	\$5719.94
			TEPB-4848-WKS		D	6043.28	6068.34	6083.84	6108.90	6126.80	6209.12	6242.53

Presentation Board

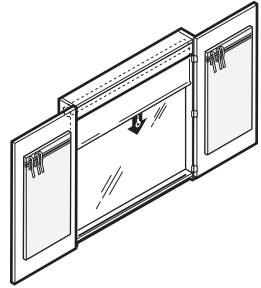

TEPB

Features

- Includes wood presentation board with hinged doors, flip chart clips, and tackboards on inside of doors and wall mount hardware.
- Fabric covered tackboards are attached in place on each door.
- Erasable porcelain writing surface on inside back panel (markers, eraser and flip charts are field supplied).
- Available with or without optional projection screen.

Specification Tip

- Must be properly anchored to a structural wall.

To Order, Specify:

- 1) Product number, including:

① Projection Screen Option:

- N No Projection Screen
- P Projection Screen, add **\$314.98** list

- 2) Wood finish color.
- 3) Tackboard fabric surface/color.

Immerse — Single Table

Round – Painted Legs



THRN

Features

- Includes top, four painted metal legs, painted understructure, adjustable glides and hardware.
- Tops: Painted, laminate, solid surface or wood veneer with knife edge.
 - Painted 1 1/8”(29mm) thick
 - Laminate and wood veneer 1 3/16”(30mm) thick
 - Solid surface 1”(25mm) thick
- Solid surface is standard in Cameo White.
- Glides have 1/2”(13mm) height adjustment and are standard in black.
- Table height options: 29”(737mm), 36”(914mm) and 39”(991mm).
- Diameter shown in nominal dimensions.
- Ships unassembled.

Specification Tips

- Separately specified power available on the 60”(1524mm) diameter table only. Use Round Planter (EHPR-____).
- 60”(1524mm) diameter table not available painted.

To Order, Specify:

- 1) Product number, including:

1 Surface Option:

- L** Laminate
- P** Painted
- S** Solid Surface
- W** Wood

2 Edge Option:

- F** Knife (Laminate)
- U** Knife (Painted or Wood Surface)
- S** Solid Surface (for use with Solid Surface only)

3 Cutout Option:

- N** No Cutout
- P** Cutout, add **\$123.00** list

- 2) Top surface finish/color.
- 3) Edge trim color (laminate only).
- 4) Understructure trim color. Grade B, add **\$40.00** list.
- 5) Trim color. Grade B, add **\$40.00** list.

Height	Diameter	Number 1 2 3	Laminate	Grade B	Paint	Grade B	Wood	Group B	Solid
			Grade A	Grade B	Grade A	Grade B	Group A	Group B	Surface
			F	F	U	U	U	U	S
29”(737mm)	48”(1219mm)	THRN-4848-■ ■ ■ SNAG4P	\$2582.32	\$2729.45	\$3470.00	\$3491.00	\$3452.08	\$3791.92	\$ 8787.12
	60”(1524mm)	THRN-6060-■ ■ ■ S ■ AG4P	3190.00	3383.57	N/A	N/A	4549.00	5080.00	12885.00
36”(914mm)	48”(1219mm)	THRN-4848-■ ■ ■ SNAG6P	\$2701.32	\$2848.45	\$3589.00	\$3610.00	\$3571.08	\$3910.92	\$ 8906.12
	60”(1524mm)	THRN-6060-■ ■ ■ S ■ AG6P	3309.00	3502.57	N/A	N/A	4668.00	5199.00	13004.00
39”(991mm)	48”(1219mm)	THRN-4848-■ ■ ■ SNAG7P	\$2752.32	\$2899.45	\$3640.00	\$3661.00	\$3622.08	\$3961.92	\$ 8957.12
	60”(1524mm)	THRN-6060-■ ■ ■ S ■ AG7P	3360.00	3553.57	N/A	N/A	4719.00	5250.00	13055.00

Immerse — Single Table

Square – Painted Legs

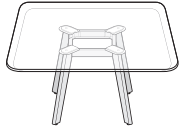

THRQ

Features

- Includes top, four painted metal legs, painted understructure, adjustable glides and hardware.
- Tops: Painted, laminate, solid surface or wood veneer top with knife edge.
 - Painted 1 1/8”(29mm) thick
 - Laminate and wood veneer 1 3/16”(30mm) thick
 - Solid surface 1”(25mm) thick
- Solid surface is standard in Cameo White.
- Glides have 1/2”(13mm) height adjustment and are standard in black.
- Table height options: 29”(737mm), 36”(914mm) and 39”(991mm).
- Depth and width shown in nominal dimensions.
- Ships unassembled.

Specification Tips

- Separately specified power available on the 60”(1524mm) depth table only. Use Round Planter (EHPR-____).
- 60”(1524mm) depth table not available painted.

To Order, Specify:

1) Product number, including:

1 Surface Option:

- L** Laminate
- P** Painted
- S** Solid Surface
- W** Wood

2 Edge Option:

- F** Knife (Laminate)
- U** Knife (Painted or Wood Surface)
- S** Solid Surface (for use with Solid Surface only)

3 Cutout Option:

- N** No Cutout
- P** Cutout, add **\$123.00** list

- 2) Top surface finish/color.
- 3) Edge trim color (laminate only).
- 4) Understructure trim color. Grade B, add **\$40.00** list.
- 5) Trim color. Grade B, add **\$40.00** list.

Height	Depth	Width	Number ① ② ③	Laminate	Paint	Wood	Solid			
				Grade A F	Grade B F	Grade A U	Grade B U	Group A U	Group B U	Surface S
29”(737mm)	48”(1219mm)	48”(1219mm)	THRQ-4848-■ ■ SNAG4P	\$2582.32	\$2729.45	\$3470.00	\$3491.00	\$3452.08	\$3791.92	\$ 8787.12
	60”(1524mm)	60”(1524mm)	THRQ-6060-■ ■ S ■ AG4P	3190.00	3383.57	N/A	N/A	4549.00	5080.00	12885.00
36”(914mm)	48”(1219mm)	48”(1219mm)	THRQ-4848-■ ■ SNAG6P	\$2701.32	\$2848.45	\$3589.00	\$3610.00	\$3571.08	\$3910.92	\$ 8906.12
	60”(1524mm)	60”(1524mm)	THRQ-6060-■ ■ S ■ AG6P	3309.00	3502.57	N/A	N/A	4668.00	5199.00	13004.00
39”(991mm)	48”(1219mm)	48”(1219mm)	THRQ-4848-■ ■ SNAG7P	\$2752.32	\$2899.45	\$3640.00	\$3661.00	\$3622.08	\$3961.92	\$ 8957.12
	60”(1524mm)	60”(1524mm)	THRQ-6060-■ ■ S ■ AG7P	3360.00	3553.57	N/A	N/A	4719.00	5250.00	13055.00

Immerse — Single Table

Rectangle – Painted Legs

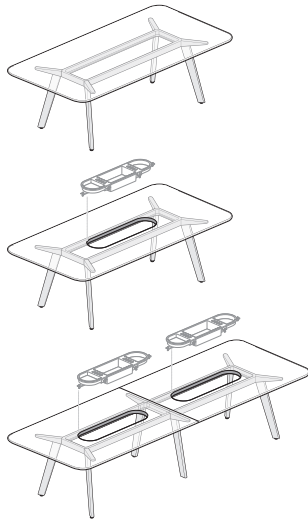

THRA

Features

- Includes top, four painted metal legs, painted understructure, adjustable glides and hardware.
- Tops: Painted, laminate, solid surface or wood veneer top with knife edge.
 - Painted 1 1/8”(29mm) thick
 - Laminate and wood veneer 1 3/16”(30mm) thick
 - Solid surface 1”(25mm) thick
- Solid surface is standard in Cameo White.
- Glides have 1/2”(13mm) height adjustment and are standard in black.
- Table height options: 29”(737mm), 36”(914mm) and 39”(991mm).
- Tops greater than 120”(3048mm) are two piece.
- One piece tops have four legs, two piece tops have 6 legs.
- Depth and width shown in nominal dimensions.
- Ships unassembled.

Specification Tips

- Separately specified power available. Use Oblong Planter (EHPO-____).
- Two piece tops specified with cutout will have two cutouts and require two Oblong Planters.
- 60”(1524mm) depth tables not available painted.

To Order, Specify:

- 1) Product number, including:

1 Surface Option:

- L** Laminate
- P** Painted
- S** Solid Surface
- W** Wood

2 Edge Option:

- F** Knife (Laminate)
- U** Knife (Painted or Wood Surface)
- S** Solid Surface (for use with Solid Surface only)

3 Cutout Option:

- N** No Cutout
- P** Cutout, add **\$123.00** list for one-piece add **\$246.00** list for two-piece

- 2) Top surface finish/color.
- 3) Edge trim color (laminate only).
- 4) Understructure trim color. Grade B, add **\$40.00** list.
- 5) Trim color. Grade B, add **\$40.00** list.

Height	Depth	Width	Number ① ② ③	Laminate		Paint		Wood		Solid	
				Grade A F	Grade B F	Grade A U	Grade B U	Group A U	Group B U	Surface S	
29”(737mm)	48”(1219mm)	96”(2438mm)	THRA-4896-■ ■ S AG4P	\$3662.64	\$3892.33	\$5438.00	\$5459.00	\$5402.16	\$ 6081.84	\$16072.24	
	48”(1219mm)	144”(3658mm)	THRA-48E4-■ ■ S AG4P	4742.96	5055.21	N/A	N/A	7352.24	8371.76	23357.36	
	60”(1524mm)	120”(3048mm)	THRA-60CO-■ ■ S AG4P	4878.00	5200.57	N/A	N/A	7596.00	8658.00	24268.00	
	60”(1524mm)	144”(3658mm)	THRA-60E4-■ ■ S AG4P	5553.20	5927.37	N/A	N/A	8814.80	10089.20	28821.20	
36”(914mm)	48”(1219mm)	96”(2438mm)	THRA-4896-■ ■ S AG6P	\$3781.64	\$4011.33	\$5557.00	\$5578.00	\$5521.16	\$ 6200.84	\$16191.24	
	60”(1524mm)	120”(3048mm)	THRA-60CO-■ ■ S AG6P	4997.00	5319.57	N/A	N/A	7715.00	8777.00	24387.00	
39”(991mm)	48”(1219mm)	96”(2438mm)	THRA-4896-■ ■ S AG7P	\$3832.64	\$4062.33	\$5608.00	\$5629.00	\$5572.16	\$ 6251.84	\$16242.24	
	60”(1524mm)	120”(3048mm)	THRA-60CO-■ ■ S AG7P	5048.00	5370.57	N/A	N/A	7766.00	8828.00	24438.00	

Conference Tables Price List

Immerse — Single Table

Racetrack – Painted Legs

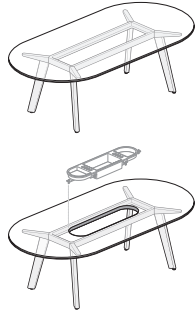

THRT

Features

- Includes top, four painted metal legs, painted understructure, adjustable glides and hardware.
- Tops: Painted, laminate, solid surface or wood veneer top with knife edge.
 - Painted 1 1/8”(29mm) thick
 - Laminate and wood veneer 1 3/16”(30mm) thick
 - Solid surface 1”(25mm) thick
- Solid surface is standard in Cameo White.
- Glides have 1/2”(13mm) height adjustment and are standard in black.
- Table height options: 29”(737mm), 36”(914mm) and 39”(991mm).
- Depth and width shown in nominal dimensions.
- Ships unassembled.

Specification Tip

- Separately specified power available. Use Oblong Planter (EHPO-____).

To Order, Specify:

1) Product number, including:

1 Surface Option:

- L** Laminate
- P** Painted
- S** Solid Surface
- W** Wood

2 Edge Option:

- F** Knife (Laminate)
- U** Knife (Painted or Wood Surface)
- S** Solid Surface (for use with Solid Surface only)

3 Cutout Option:

- N** No Cutout
- P** Cutout, add **\$123.00** list

- 2) Top surface finish/color.
- 3) Edge trim color (laminate only).
- 4) Understructure trim color. Grade B, add **\$40.00** list.
- 5) Trim color. Grade B, add **\$40.00** list.

Height	Depth	Width	Number 1 2 3	Laminate	Grade B	Paint	Grade B	Wood	Group B	Solid
				Grade A	F	Grade A	U	Group A	U	Surface
				F	F	U	U	U	U	S
29”(737mm)	48”(1219mm)	96”(2438mm)	THRT-4896- <input type="checkbox"/> <input type="checkbox"/> <input type="checkbox"/> S <input type="checkbox"/> AG4P	\$3662.64	\$3892.33	\$5438.00	\$5459.00	\$5402.16	\$6081.84	\$16072.24
36”(914mm)	48”(1219mm)	96”(2438mm)	THRT-4896- <input type="checkbox"/> <input type="checkbox"/> <input type="checkbox"/> S <input type="checkbox"/> AG6P	\$3781.64	\$4011.33	\$5557.00	\$5578.00	\$5521.16	\$6200.84	\$16191.24
39”(991mm)	48”(1219mm)	96”(2438mm)	THRT-4896- <input type="checkbox"/> <input type="checkbox"/> <input type="checkbox"/> S <input type="checkbox"/> AG7P	\$3832.64	\$4062.33	\$5608.00	\$5629.00	\$5572.16	\$6251.84	\$16242.24

Immerse — Stack Table

Rectangle – Painted Legs

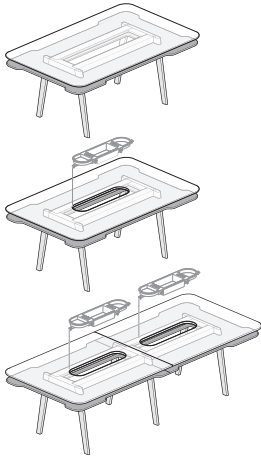

THRA

Features

- Includes top, 1/8”(3mm) thick sill (below surface), painted metal legs, painted understructure, adjustable glides and hardware.
- Top (upper surface), laminate, solid surface or wood veneer with knife edge.
 - Laminate and wood veneer 1 3/16”(30mm) thick
 - Solid surface 1”(25mm) thick
- Sill is solid surface with flat edge or laminate.
- Solid surface is standard in Cameo White.
- Glides have 1/2”(13mm) height adjustment and are standard in black.
- Tops greater than 120”(3048mm) are two piece.
- One piece tops have four legs, two piece tops have 6 legs.
- Depth and width shown in nominal dimensions.
- Ships unassembled.

Specification Tips

- Separately specified power available. Use Oblong Planter (EHPO-____).
- When cutout option (-P) is selected, single piece table has one cutout and two piece tables has two cutouts. Order the correct number of planters.
- Stack table not available painted.

To Order, Specify:

1) Product number, including:

① Surface Option:

- L** Laminate
- S** Solid Surface
- W** Wood

② Edge Option:

- F** Knife (Laminate)
- U** Knife (Wood Surface)
- S** Solid Surface (for use with Solid Surface only)

③ Cutout Option:

- N** No Cutout
- P** Cutout, add **\$123.00** list for one-piece add **\$246.00** list for two-piece

- 2) Top surface finish/color.
- 3) Edge trim color (laminate only).
- 4) Sill surface color.
- 5) Sill edge trim color (laminate only).
- 6) Understructure trim color. Grade B, add **\$40.00** list.
- 7) Trim color. Grade B, add **\$40.00** list.

Height	Depth	Width	Number ① ② ③	Laminate	Grade B	Wood	Group B	Solid
				Grade A	F	Group A	U	Surface
39”(991mm)	60”(1524mm)	96”(2438mm)	THRA-6096- S CG7P	\$ 7501.46	\$ 7772.43	\$14221.46	\$15071.06	\$27559.06
39”(991mm)	60”(1524mm)	120”(3048mm)	THRA-60C0- S CG7P	10283.06	10605.63	18683.06	19745.06	35355.06
39”(991mm)	60”(1524mm)	144”(3658mm)	THRA-60E4- S CG7P	11746.66	12120.83	21826.66	23101.06	41833.06

Conference Tables Price List

Immerse — Shift Table

Rectangle/Rectangle – Painted Legs

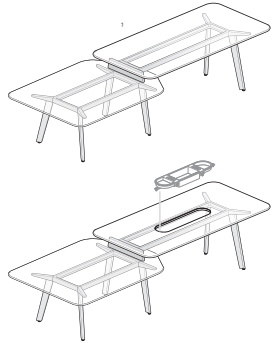

THRR

Features

- Includes two tops, 7”(178mm) high stack spacer, painted understructure, six painted metal legs, adjustable glides and hardware.
- Tops: Lower top available in laminate, solid surface and wood veneer with knife edge. Upper top available painted, laminate, solid surface or wood veneer with knife edge.
 - Painted 1 1/8”(29mm) thick
 - Laminate and wood veneer 1 3/16”(30mm) thick
 - Solid surface 1” thick
- Solid surface is standard in Cameo White.
- Stack spacer is painted MDF.
- Glides have 1/2”(13mm) height adjustment and are standard in black.
- Depth and width shown in nominal dimensions.
- Ships unassembled.

Specification Tips

- Separately specified power available. Use Oblong Planter (EHPO-____).
- When cutout option (-U) is selected, cutout is on the upper top only. Lower top not available with cutout.
- Overlap of top and bottom surfaces is 18 1/2”(470mm).
- Seating capacity of 11 based upon 27”(686mm) per chair.
- Tops share one understructure and are not designed to be separated.

Lower Top Dimensions

Height	Depth	Width
29”(737mm)	60”(1524mm)	84”(2134mm)

Upper Top Dimensions

Height	Depth	Width
36”(914mm)	48”(1219mm)	96”(2438mm)

To Order, Specify:

- 1) Product number, including:
 - 1 Cutout Option:**
 - N** No Cutout
 - U** Cutout - Upper Top, add **\$123.00** list
- 2) Lower surface finish/color.
- 3) Edge trim color (laminate only).
- 4) Upper surface finish/color.
- 5) Edge trim color (laminate only).
- 6) Understructure trim color. Grade B, add **\$40.00** list.
- 7) Trim color. Grade B, add **\$40.00** list.
- 8) Stack spacer color.

Overall Width	Number	1	Upper Top		Paint Grade A	Grade B	Wood Group A	Group B	Solid Surface
			Laminate Grade A	Grade B					
Laminate Grade A Lower Top									
156”(3962mm)	THRR-60F6-MFS	DGAP	N/A	N/A	\$ 8632.20	\$ 8653.20	N/A	N/A	N/A
	THRR-60F6-LFS	DGAP	\$ 6856.84	\$ 7086.53	N/A	N/A	N/A	N/A	N/A
	THRR-60F6-JFS	DGAP	N/A	N/A	N/A	N/A	N/A	N/A	\$19266.44
	THRR-60F6-QFS	DGAP	N/A	N/A	N/A	N/A	\$ 8596.36	\$ 9276.04	N/A
Laminate Grade B Lower Top									
156”(3962mm)	THRR-60F6-MFS	DGAP	N/A	N/A	\$ 8864.47	\$ 8885.47	N/A	N/A	N/A
	THRR-60F6-LFS	DGAP	\$ 7089.11	\$ 7318.80	N/A	N/A	N/A	N/A	N/A
	THRR-60F6-JFS	DGAP	N/A	N/A	N/A	N/A	N/A	N/A	\$19498.71
	THRR-60F6-QFS	DGAP	N/A	N/A	N/A	N/A	\$ 8828.63	\$ 9508.31	N/A
Solid Surface Lower Top									
156”(3962mm)	THRR-60F6-FUS	DGAP	N/A	N/A	\$21235.70	\$21256.70	N/A	N/A	N/A
	THRR-60F6-KFS	DGAP	\$19460.34	\$19690.03	N/A	N/A	N/A	N/A	N/A
	THRR-60F6-SSS	DGAP	N/A	N/A	N/A	N/A	N/A	N/A	\$31869.94
	THRR-60F6-EUS	DGAP	N/A	N/A	N/A	N/A	\$21199.86	\$21879.54	N/A
Wood Group A Lower Top									
156”(3962mm)	THRR-60F6-GUS	DGAP	N/A	N/A	\$10398.90	\$10419.90	N/A	N/A	N/A
	THRR-60F6-RFS	DGAP	\$ 8623.54	\$ 8853.23	N/A	N/A	N/A	N/A	N/A
	THRR-60F6-DUS	DGAP	N/A	N/A	N/A	N/A	N/A	N/A	\$21033.14
	THRR-60F6-WUS	DGAP	N/A	N/A	N/A	N/A	\$10363.06	\$11042.74	N/A
Wood Group B Lower Top									
156”(3962mm)	THRR-60F6-GUS	DGAP	N/A	N/A	\$11089.20	\$11110.20	N/A	N/A	N/A
	THRR-60F6-RFS	DGAP	\$ 9313.84	\$ 9543.53	N/A	N/A	N/A	N/A	N/A
	THRR-60F6-DUS	DGAP	N/A	N/A	N/A	N/A	N/A	N/A	\$21723.44
	THRR-60F6-WUS	DGAP	N/A	N/A	N/A	N/A	\$11053.36	\$11733.04	N/A

Immerse — Shift Table

Rectangle/Round – Painted Legs



THRD

Features

- Includes rectangle lower top and round upper top, 7”(178mm) high stack spacer, painted understructure, six painted metal legs, adjustable glides and hardware.
- Tops: Rectangle lower top available painted, laminate, solid surface and wood veneer with knife edge. Round upper top available in laminate, solid surface or wood veneer with knife edge. Round upper top not available painted.
 - Painted 1 1/8”(29mm) thick
 - Laminate and wood veneer 1 3/16”(30mm) thick
 - Solid surface 1”(25mm) thick
- Solid surface is standard in Cameo White.
- Stack spacer is painted MDF.
- Glides have 1/2”(13mm) height adjustment and are standard in black.
- Depth and width shown in nominal dimensions.
- Ships unassembled.

Specification Tips

- Separately specified power available. Use Oblong Planter (EHPO-_____) for the rectangle top and Round Planter (EHPR-_____) for the round top.
- When cutout option (-L) is selected, the cutout is on the lower top, option (-P) the cutout is on the lower and upper top and option (-U) the cutout is on the upper top only.
- Overlap of top and bottom surfaces is 15 3/4”(400mm).
- Seating capacity of 8 based upon 27”(686mm) per chair.
- Tops share one understructure and are not designed to be separated.

Lower Top Dimensions

Height	Depth	Width
29”(737mm)	48”(1219mm)	96”(2438mm)

Upper Top Dimensions

Height	Diameter
36”(914mm)	60”(1524mm)

To Order, Specify:

- 1) Product number, including:

1) Cutout Option:

- N** No Cutout
- L** Cutout - Lower Top, add **\$123.00** list
- P** Cutout - Lower and Upper Top, add **\$246.00** list
- U** Cutout - Upper Top, add **\$123.00** list

- 2) Lower surface finish/color.
- 3) Edge trim color (laminate only).
- 4) Upper surface finish/color.
- 5) Edge trim color (laminate only).
- 6) Understructure trim color. Grade B, add **\$40.00** list.
- 7) Trim color. Grade B, add **\$40.00** list.
- 8) Stack spacer color.

Overall Width	Number	①	Upper Top		Wood Group A	Group B	Solid Surface
			Laminate Grade A	Grade B			
Paint Grade A Lower Top							
138”(3505mm)	THRD-48D8-TFS	DGAP	\$ 8125.80	\$ 8319.37	N/A	N/A	N/A
	THRD-48D8-HUS	DGAP	N/A	N/A	N/A	N/A	\$17820.80
	THRD-48D8-IUS	DGAP	N/A	N/A	\$ 9484.80	\$10015.80	N/A
Paint Grade B Lower Top							
138”(3505mm)	THRD-48D8-TFS	DGAP	\$ 8146.80	\$ 8340.37	N/A	N/A	N/A
	THRD-48D8-HUS	DGAP	N/A	N/A	N/A	N/A	\$17841.80
	THRD-48D8-IUS	DGAP	N/A	N/A	\$ 9505.80	\$10036.80	N/A
Laminate Grade A Lower Top							
138”(3505mm)	THRD-48D8-LFS	DGAP	\$ 6350.44	\$ 6544.01	N/A	N/A	N/A
	THRD-48D8-JFS	DGAP	N/A	N/A	N/A	N/A	\$16045.44
	THRD-48D8-QFS	DGAP	N/A	N/A	\$ 7709.44	\$ 8240.44	N/A
Laminate Grade B Lower Top							
138”(3505mm)	THRD-48D8-LFS	DGAP	\$ 6580.13	\$ 6773.70	N/A	N/A	N/A
	THRD-48D8-JFS	DGAP	N/A	N/A	N/A	N/A	\$16275.13
	THRD-48D8-QFS	DGAP	N/A	N/A	\$ 7939.13	\$ 8470.13	N/A
Solid Surface Lower Top							
138”(3505mm)	THRD-48D8-KFS	DGAP	\$18760.04	\$18953.61	N/A	N/A	N/A
	THRD-48D8-SSS	DGAP	N/A	N/A	N/A	N/A	\$28455.04
	THRD-48D8-EUS	DGAP	N/A	N/A	\$20119.04	\$20650.04	N/A
Wood Group A Lower Top							
138”(3505mm)	THRD-48D8-RFS	DGAP	\$ 8089.96	\$ 8283.53	N/A	N/A	N/A
	THRD-48D8-DUS	DGAP	N/A	N/A	N/A	N/A	\$17784.96
	THRD-48D8-WUS	DGAP	N/A	N/A	\$ 9448.96	\$ 9979.96	N/A
Wood Group B Lower Top							
138”(3505mm)	THRD-48D8-RFS	DGAP	\$ 8769.64	\$ 8963.21	N/A	N/A	N/A
	THRD-48D8-DUS	DGAP	N/A	N/A	N/A	N/A	\$18464.64
	THRD-48D8-WUS	DGAP	N/A	N/A	\$10128.64	\$10659.64	N/A

Conference Tables Price List

Immerse — Shift Table

Racetrack/Round – Painted Legs

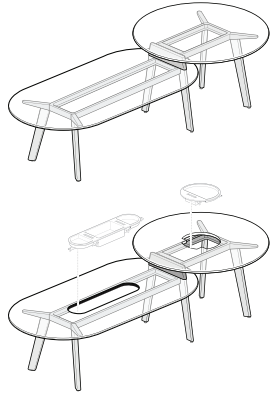

THTD

Features

- Includes racetrack lower top and round upper top, 7”(178mm) high stack spacer, painted understructure, six painted metal legs, adjustable glides and hardware.
- Tops: Racetrack lower top available painted, laminate, solid surface and wood veneer with knife edge. Round upper top available in laminate, solid surface or wood veneer with knife edge. Round upper top not available painted.
 - Painted 1 1/8”(29mm) thick
 - Laminate and wood veneer 1 3/16”(30mm) thick
 - Solid surface 1”(25mm) thick
- Solid surface is standard in Cameo White.
- Stack spacer is painted MDF.
- Glides have 1/2”(13mm) height adjustment and are standard in black.
- Depth and width shown in nominal dimensions.
- Ships unassembled.

Specification Tips

- Separately specified power available. Use Oblong Planter (EHPO-_____) for the racetrack top and Round Planter (EHPR-_____) for the round top.
- When cutout option (-L) is selected, the cutout is on the lower top, option (-P) the cutout is on the lower and upper top and option (-U) the cutout is on the upper top only.
- Overlap of top and bottom surfaces is 17 3/4”(451mm).
- Seating capacity of 8 based upon 27”(686mm) per chair.
- Tops share one understructure and are not designed to be separated.

Lower Top Dimensions

Height	Depth	Width
29”(737mm)	48”(1219mm)	96”(2438mm)

Upper Top Dimensions

Height	Diameter
36”(914mm)	60”(1524mm)

To Order, Specify:

1) Product number, including:

1 Cutout Option:

- N** No Cutout
- L** Cutout - Lower Top, add **\$123.00** list
- P** Cutout - Lower and Upper Top, add **\$246.00** list
- U** Cutout - Upper Top, add **\$123.00** list

- 2) Lower surface finish/color.
- 3) Edge trim color (laminate only).
- 4) Upper surface finish/color.
- 5) Edge trim color (laminate only).
- 6) Understructure trim color. Grade B, add **\$40.00** list.
- 7) Trim color. Grade B, add **\$40.00** list.
- 8) Stack spacer color.

Overall Width	Number	1	Upper Top		Wood Group A	Group B	Solid Surface
			Laminate Grade A	Grade B			
Paint Grade A Lower Top							
138”(3505mm)	THTD-48D8-TFS	DGAP	\$ 8125.80	\$ 8319.37	N/A	N/A	N/A
	THTD-48D8-HUS	DGAP	N/A	N/A	N/A	N/A	\$17820.80
	THTD-48D8-IUS	DGAP	N/A	N/A	\$ 9484.80	\$10015.80	N/A
Paint Grade B Lower Top							
138”(3505mm)	THTD-48D8-TFS	DGAP	\$ 8146.80	\$ 8340.37	N/A	N/A	N/A
	THTD-48D8-HUS	DGAP	N/A	N/A	N/A	N/A	\$17841.80
	THTD-48D8-IUS	DGAP	N/A	N/A	\$ 9505.80	\$10036.80	N/A
Laminate Grade A Lower Top							
138”(3505mm)	THTD-48D8-LFS	DGAP	\$ 6350.44	\$ 6544.01	N/A	N/A	N/A
	THTD-48D8-JFS	DGAP	N/A	N/A	N/A	N/A	\$16045.44
	THTD-48D8-QFS	DGAP	N/A	N/A	\$ 7709.44	\$ 8240.44	N/A
Laminate Grade B Lower Top							
138”(3505mm)	THTD-48D8-LFS	DGAP	\$ 6580.13	\$ 6773.70	N/A	N/A	N/A
	THTD-48D8-JFS	DGAP	N/A	N/A	N/A	N/A	\$16275.13
	THTD-48D8-QFS	DGAP	N/A	N/A	\$ 7939.13	\$ 8470.13	N/A
Solid Surface Lower Top							
138”(3505mm)	THTD-48D8-KFS	DGAP	\$18760.04	\$18953.61	N/A	N/A	N/A
	THTD-48D8-SSS	DGAP	N/A	N/A	N/A	N/A	\$28455.04
	THTD-48D8-EUS	DGAP	N/A	N/A	\$20119.04	\$20650.04	N/A
Wood Group A Lower Top							
138”(3505mm)	THTD-48D8-RFS	DGAP	\$ 8089.96	\$ 8283.53	N/A	N/A	N/A
	THTD-48D8-DUS	DGAP	N/A	N/A	N/A	N/A	\$17784.96
	THTD-48D8-WUS	DGAP	N/A	N/A	\$ 9448.96	\$ 9979.96	N/A
Wood Group B Lower Top							
138”(3505mm)	THTD-48D8-RFS	DGAP	\$ 8769.64	\$ 8963.21	N/A	N/A	N/A
	THTD-48D8-DUS	DGAP	N/A	N/A	N/A	N/A	\$18464.64
	THTD-48D8-WUS	DGAP	N/A	N/A	\$10128.64	\$10659.64	N/A

Immerse — Overlap Table

Rectangle/Rectangle – Painted Legs

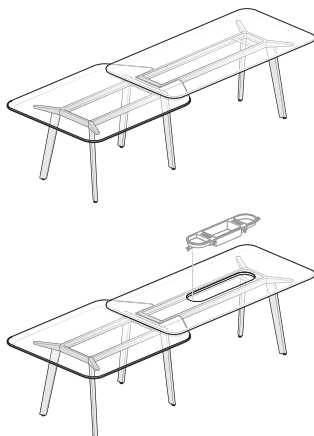

THRR

Features

- Includes two tops, painted understructure, six painted metal legs, adjustable glides and hardware.
- Tops: Lower top available in laminate, solid surface and wood veneer with knife edge. Lower top not available painted. Upper top available painted, laminate, solid surface or wood veneer with knife edge.
 - Painted 1 1/8”(29mm) thick
 - Laminate and wood veneer 3/16”(30mm) thick
 - Solid surface 1”(25mm) thick
- Solid surface is standard in Cameo White.
- Glides have 1/2”(13mm) height adjustment and are standard in black.
- Depth and width shown in nominal dimensions.
- Ships unassembled.

Specification Tips

- Power only available in the upper top.
- Separately specified power available. Use Oblong Planter (EHPO-____).
- When cutout option (-U) is selected, the cutout is on the upper top only.
- Overlap of top and bottom surfaces is 18 1/2”(470mm).
- Seating capacity of 11 based upon 27”(686mm) per chair.
- Tops share one understructure and are not designed to be separated.

Lower Top Dimensions

Height	Depth	Width
29”(737mm)	60”(1524mm)	78”(1981mm)
37.5”(953mm)	60”(1524mm)	78”(1981mm)

Upper Top Dimensions

Height	Depth	Width
30.5”(775mm)	48”(1219mm)	96”(2438mm)
39”(991mm)	48”(1219mm)	96”(2438mm)

To Order, Specify:

- 1) Product number, including:

1 Cutout Option:

- N No Cutout
- U Cutout - Upper Top, add **\$123.00** list

- 2) Lower surface finish/color.
- 3) Edge trim color (laminate only).
- 4) Upper surface finish/color.
- 5) Edge trim color (laminate only).
- 6) Understructure trim color. Grade B, add **\$40.00** list.
- 7) Trim color. Grade B, add **\$40.00** list.

Conference Tables Price List

Immerse — Overlap Table

Rectangle/Rectangle – Painted Legs

Overall Width	Number	①	Upper Top Laminate		Paint		Wood		Solid Surface
			Grade A	Grade B	Grade A	Grade B	Group A	Group B	
Laminate Grade A Lower Top – 29”(737mm) Height									
156”(3962mm)	THRR-60F6-MFS	EGBP	N/A	N/A	\$ 8306.80	\$ 8327.80	N/A	N/A	N/A
	THRR-60F6-LFS	EGBP	\$ 6531.44	\$ 6761.13	N/A	N/A	N/A	N/A	N/A
	THRR-60F6-JFS	EGBP	N/A	N/A	N/A	N/A	N/A	N/A	\$18941.04
	THRR-60F6-QFS	EGBP	N/A	N/A	N/A	N/A	\$ 8270.96	\$ 8950.64	N/A
Laminate Grade A Lower Top – 37.5”(953mm) Height									
156”(3962mm)	THRR-60F6-MFS	EGCP	N/A	N/A	\$ 8459.80	\$ 8480.80	N/A	N/A	N/A
	THRR-60F6-LSS	EGCP	\$ 6684.44	\$ 6914.13	N/A	N/A	N/A	N/A	N/A
	THRR-60F6-JFS	EGCP	N/A	N/A	N/A	N/A	N/A	N/A	\$19094.04
	THRR-60F6-QFS	EGCP	N/A	N/A	N/A	N/A	\$ 8423.96	\$ 9103.64	N/A
Laminate Grade B Lower Top – 29”(737mm) Height									
156”(3962mm)	THRR-60F6-MFS	EGBP	N/A	N/A	\$ 8539.07	\$ 8560.07	N/A	N/A	N/A
	THRR-60F6-LFS	EGBP	\$ 6763.71	\$ 6993.40	N/A	N/A	N/A	N/A	N/A
	THRR-60F6-JFS	EGBP	N/A	N/A	N/A	N/A	N/A	N/A	\$19173.31
	THRR-60F6-QFS	EGBP	N/A	N/A	N/A	N/A	\$ 8503.23	\$ 9182.91	N/A
Laminate Grade B Lower Top – 37.5”(953mm) Height									
156”(3962mm)	THRR-60F6-MFS	EGCP	N/A	N/A	\$ 8692.07	\$ 8713.07	N/A	N/A	N/A
	THRR-60F6-LSS	EGCP	\$ 6916.71	\$ 7146.40	N/A	N/A	N/A	N/A	N/A
	THRR-60F6-JFS	EGCP	N/A	N/A	N/A	N/A	N/A	N/A	\$19326.31
	THRR-60F6-QFS	EGCP	N/A	N/A	N/A	N/A	\$ 8656.23	\$ 9335.91	N/A
Solid Surface Lower Top – 29”(737mm) Height									
156”(3962mm)	THRR-60F6-FUS	EGBP	N/A	N/A	\$20910.30	\$20931.30	N/A	N/A	N/A
	THRR-60F6-KFS	EGBP	\$19134.94	\$19364.63	N/A	N/A	N/A	N/A	N/A
	THRR-60F6-SSS	EGBP	N/A	N/A	N/A	N/A	N/A	N/A	\$31544.54
	THRR-60F6-EUS	EGBP	N/A	N/A	N/A	N/A	\$20874.46	\$21554.14	N/A
Solid Surface Lower Top – 37.5”(953mm) Height									
156”(3962mm)	THRR-60F6-FUS	EGCP	N/A	N/A	\$21063.30	\$21084.30	N/A	N/A	N/A
	THRR-60F6-KFS	EGCP	\$19287.94	\$19517.63	N/A	N/A	N/A	N/A	N/A
	THRR-60F6-SSS	EGCP	N/A	N/A	N/A	N/A	N/A	N/A	\$31697.54
	THRR-60F6-EUS	EGCP	N/A	N/A	N/A	N/A	\$21027.46	\$21707.14	N/A
Wood Group A Lower Top – 29”(737mm) Height									
156”(3962mm)	THRR-60F6-GUS	EGBP	N/A	N/A	\$10073.50	\$10094.50	N/A	N/A	N/A
	THRR-60F6-RFS	EGBP	\$ 8298.14	\$ 8527.83	N/A	N/A	N/A	N/A	N/A
	THRR-60F6-DUS	EGBP	N/A	N/A	N/A	N/A	N/A	N/A	\$20707.74
	THRR-60F6-WUS	EGBP	N/A	N/A	N/A	N/A	\$10037.66	\$10717.34	N/A
Wood Group A Lower Top – 37.5”(953mm) Height									
156”(3962mm)	THRR-60F6-GUS	EGCP	N/A	N/A	\$10226.50	\$10247.50	N/A	N/A	N/A
	THRR-60F6-RFS	EGCP	\$ 8451.14	\$ 8680.83	N/A	N/A	N/A	N/A	N/A
	THRR-60F6-DUS	EGCP	N/A	N/A	N/A	N/A	N/A	N/A	\$20860.74
	THRR-60F6-WUS	EGCP	N/A	N/A	N/A	N/A	\$10190.66	\$10870.34	N/A
Wood Group B Lower Top – 29”(737mm) Height									
156”(3962mm)	THRR-60F6-GUS	EGBP	N/A	N/A	\$10763.80	\$10784.80	N/A	N/A	N/A
	THRR-60F6-RFS	EGBP	\$ 8988.44	\$ 9218.13	N/A	N/A	N/A	N/A	N/A
	THRR-60F6-DUS	EGBP	N/A	N/A	N/A	N/A	N/A	N/A	\$21398.04
	THRR-60F6-WUS	EGBP	N/A	N/A	N/A	N/A	\$10727.96	\$11407.64	N/A
Wood Group B Lower Top – 37.5”(953mm) Height									
156”(3962mm)	THRR-60F6-GUS	EGCP	N/A	N/A	\$10916.80	\$10937.80	N/A	N/A	N/A
	THRR-60F6-RFS	EGCP	\$ 9141.44	\$ 9371.13	N/A	N/A	N/A	N/A	N/A
	THRR-60F6-DUS	EGCP	N/A	N/A	N/A	N/A	N/A	N/A	\$21551.04
	THRR-60F6-WUS	EGCP	N/A	N/A	N/A	N/A	\$10880.96	\$11560.64	N/A

Immerse — Overlap Table

Rectangle/Round – Painted Legs

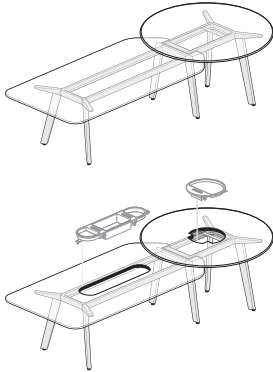

THRD

Features

- Includes lower racetrack top, upper round top, painted understructure, six painted metal legs, adjustable glides and hardware.
- Tops: Rectangle lower top available painted, laminate, solid surface and wood veneer with knife edge. Round upper top available in laminate, solid surface or wood veneer with knife edge. Round upper top not available painted.
 - Painted 1 1/8”(29mm) thick
 - Laminate and wood veneer 1 3/16”(30mm) thick
 - Solid surface 1”(25mm) thick
- Solid surface is standard in Cameo White.
- Glides have 1/2”(13mm) height adjustment and are standard in black.
- Depth and width shown in nominal dimensions.
- Ships unassembled.

Specification Tips

- Separately specified power available. Use Oblong Planter (EHPO-____) for the rectangle top and Round Planter (EHPR-____) for the round top.
- When cutout option (-L) is selected, the cutout is on the lower top, option (-P) the cutout is on the lower and upper top and option (-U) the cutout is on the upper top only.
- Overlap of top and bottom surfaces is 15 3/4”(400mm).
- Seating capacity of 8 based upon 27”(686mm) per chair.
- Tops share one understructure and are not designed to be separated.

Lower Top Dimensions

Height	Depth	Width
29”(737mm)	48”(1219mm)	96”(2438mm)

Upper Top Dimensions

Height	Diameter
30.5”(775mm)	60”(1524mm)

To Order, Specify:

- 1) Product number, including:

1 Cutout Option:

- N** No Cutout
- L** Cutout - Lower Top, add **\$123.00** list
- P** Cutout - Lower and Upper Top, add **\$246.00** list
- U** Cutout - Upper Top, add **\$123.00** list

- 2) Lower surface finish/color.
- 3) Edge trim color (laminate only).
- 4) Upper surface finish/color.
- 5) Edge trim color (laminate only).
- 6) Understructure trim color. Grade B, add **\$40.00** list.
- 7) Trim color. Grade B, add **\$40.00** list.

Overall Width	Number	1	Upper Top Laminate Grade A	Grade B	Wood Group A	Group B	Solid Surface
Paint Grade A Lower Top							
138”(3505mm)	THRD-48D8-TFS	EGBP	\$ 7800.40	\$ 7993.97	N/A	N/A	N/A
	THRD-48D8-HUS	EGBP	N/A	N/A	N/A	N/A	\$17495.40
	THRD-48D8-IUS	EGBP	N/A	N/A	\$ 9159.40	\$ 9690.40	N/A
Paint Grade B Lower Top							
138”(3505mm)	THRD-48D8-TFS	EGBP	\$ 7821.40	\$ 8014.97	N/A	N/A	N/A
	THRD-48D8-HUS	EGBP	N/A	N/A	N/A	N/A	\$17516.40
	THRD-48D8-IUS	EGBP	N/A	N/A	\$ 9180.40	\$ 9711.40	N/A
Laminate Grade A Lower Top							
138”(3505mm)	THRD-48D8-LFS	EGBP	\$ 6025.04	\$ 6218.61	N/A	N/A	N/A
	THRD-48D8-JFS	EGBP	N/A	N/A	N/A	N/A	\$15720.04
	THRD-48D8-QFS	EGBP	N/A	N/A	\$ 7384.04	\$ 7915.04	N/A
Laminate Grade B Lower Top							
138”(3505mm)	THRD-48D8-LFS	EGBP	\$ 6254.73	\$ 6448.30	N/A	N/A	N/A
	THRD-48D8-JFS	EGBP	N/A	N/A	N/A	N/A	\$15949.73
	THRD-48D8-QFS	EGBP	N/A	N/A	\$ 7613.73	\$ 8144.73	N/A
Solid Surface Lower Top							
138”(3505mm)	THRD-48D8-KFS	EGBP	\$18434.64	\$18628.21	N/A	N/A	N/A
	THRD-48D8-SSS	EGBP	N/A	N/A	N/A	N/A	\$28129.64
	THRD-48D8-EUS	EGBP	N/A	N/A	\$19793.64	\$20324.64	N/A
Wood Group A Lower Top							
138”(3505mm)	THRD-48D8-RFS	EGBP	\$ 7764.56	\$ 7958.13	N/A	N/A	N/A
	THRD-48D8-DUS	EGBP	N/A	N/A	N/A	N/A	\$17459.56
	THRD-48D8-WUS	EGBP	N/A	N/A	\$ 9123.56	\$ 9654.56	N/A
Wood Group B Lower Top							
138”(3505mm)	THRD-48D8-RFS	EGBP	\$ 8444.24	\$ 8637.81	N/A	N/A	N/A
	THRD-48D8-DUS	EGBP	N/A	N/A	N/A	N/A	\$18139.24
	THRD-48D8-WUS	EGBP	N/A	N/A	\$ 9803.24	\$10334.24	N/A

Conference Tables Price List

Immerse — Overlap Table

Racetrack/Round – Painted Legs

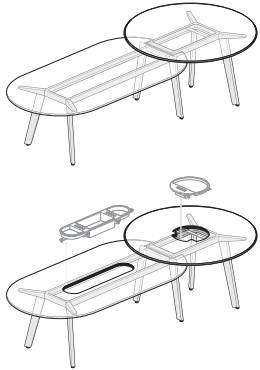

THTD

Features

- Includes lower racetrack top, upper round top, painted understructure, six painted metal legs, adjustable glides and hardware.
- Tops: Racetrack lower top available painted, laminate, solid surface and wood veneer with knife edge. Round upper top available in laminate, solid surface or wood veneer with knife edge. Round upper top not available painted.
 - Painted 1 1/8”(29mm) thick
 - Laminate and wood veneer 1 3/16”(30mm) thick
 - Solid surface 1”(25mm) thick
- Solid surface is standard in Cameo White.
- Glides have 1/2”(13mm) height adjustment and are standard in black.
- Depth and width shown in nominal dimensions.
- Ships unassembled.

Specification Tips

- Separately specified power available. Use Oblong Planter (EHPO-____) for the racetrack top and Round Planter (EHPR-____) for the round top.
- When cutout option (-L) is selected, the cutout is on the lower top, option (-P) the cutout is on the lower and upper top and option (-U) the cutout is on the upper top only.
- Overlap of top and bottom surfaces is 16 1/4”(413mm).
- Seating capacity of 8 based upon 27”(686mm) per chair.
- Tops share one understructure and are not designed to be separated.

Lower Top Dimensions

Height	Depth	Width
29”(737mm)	48”(1219mm)	96”(2438mm)

Upper Top Dimensions

Height	Diameter
30.5”(775mm)	60”(1524mm)

To Order, Specify:

1) Product number, including:

1 Cutout Option:

- N** No Cutout
- L** Cutout - Lower Top, add **\$123.00** list
- P** Cutout - Lower and Upper Top, add **\$246.00** list
- U** Cutout - Upper Top, add **\$123.00** list

2) Lower surface finish/color.

3) Edge trim color (laminate only).

4) Upper surface finish/color.

5) Edge trim color (laminate only).

6) Understructure trim color. Grade B, add **\$40.00** list.

7) Trim color. Grade B, add **\$40.00** list.

Overall Width	Number	1	Upper Top Laminate Grade A	Grade B	Wood Group A	Group B	Solid Surface
Paint Grade A Lower Top							
138”(3505mm)	THTD-48D8-TFS	EGBP	\$ 7800.40	\$ 7993.97	N/A	N/A	N/A
	THTD-48D8-HUS	EGBP	N/A	N/A	N/A	N/A	\$17495.40
	THTD-48D8-IUS	EGBP	N/A	N/A	\$ 9159.40	\$ 9690.40	N/A
Paint Grade B Lower Top							
138”(3505mm)	THTD-48D8-TFS	EGBP	\$ 7821.40	\$ 8014.97	N/A	N/A	N/A
	THTD-48D8-HUS	EGBP	N/A	N/A	N/A	N/A	\$17516.40
	THTD-48D8-IUS	EGBP	N/A	N/A	\$ 9180.40	\$ 9711.40	N/A
Laminate Grade A Lower Top							
138”(3505mm)	THTD-48D8-LFS	EGBP	\$ 6025.04	\$ 6218.61	N/A	N/A	N/A
	THTD-48D8-JFS	EGBP	N/A	N/A	N/A	N/A	\$15720.04
	THTD-48D8-QFS	EGBP	N/A	N/A	\$ 7384.04	\$ 7915.04	N/A
Laminate Grade B Lower Top							
138”(3505mm)	THTD-48D8-LFS	EGBP	\$ 6254.73	\$ 6448.30	N/A	N/A	N/A
	THTD-48D8-JFS	EGBP	N/A	N/A	N/A	N/A	\$15949.73
	THTD-48D8-QFS	EGBP	N/A	N/A	\$ 7613.73	\$ 8144.73	N/A
Solid Surface Lower Top							
138”(3505mm)	THTD-48D8-KFS	EGBP	\$18434.64	\$18628.21	N/A	N/A	N/A
	THTD-48D8-SSS	EGBP	N/A	N/A	N/A	N/A	\$28129.64
	THTD-48D8-EUS	EGBP	N/A	N/A	\$19793.64	\$20324.64	N/A
Wood Group A Lower Top							
138”(3505mm)	THTD-48D8-RFS	EGBP	\$ 7764.56	\$ 7958.13	N/A	N/A	N/A
	THTD-48D8-DUS	EGBP	N/A	N/A	N/A	N/A	\$17459.56
	THTD-48D8-WUS	EGBP	N/A	N/A	\$ 9123.56	\$ 9654.56	N/A
Wood Group B Lower Top							
138”(3505mm)	THTD-48D8-RFS	EGBP	\$ 8444.24	\$ 8637.81	N/A	N/A	N/A
	THTD-48D8-DUS	EGBP	N/A	N/A	N/A	N/A	\$18139.24
	THTD-48D8-WUS	EGBP	N/A	N/A	\$ 9803.24	\$10334.24	N/A

Immerse — Overlap Table

Rectangle/Ledge – Painted Legs

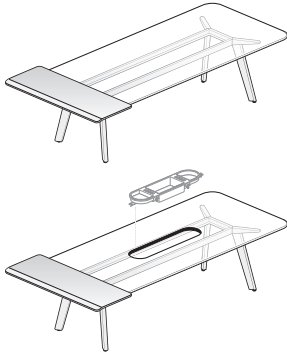

THRL

Features

- Includes one ledge upper top with 1/2"(7mm) spacer attached and one rectangle lower top, painted understructure, four painted metal legs, adjustable glides and hardware.
- Upper ledge top 1/2"(13mm) laminate or wood veneer with waterfall edge.
- Rectangle lower top available laminate, solid surface and wood veneer with knife edge.
 - Laminate and wood veneer 1 3/16"(30mm) thick
 - Solid surface 1"(25mm) thick
- Solid surface is standard in Cameo White.
- Ledge wood top is hardboard laminated core.
- Glides have 1/2"(13mm) height adjustment and are standard in black.
- Depth and width shown in nominal dimensions.
- Ships unassembled.

Specification Tips

- Separately specified power available. Use Oblong Planter (EHPO-____).
- When cutout option (-L) is selected, the cutout is on the lower top only.
- Overlap of top and bottom surfaces is 17 3/4"(451mm).
- Seating capacity of 9 based upon 27"(686mm) per chair.
- Tops share one understructure and are not designed to be separated.

Lower Top Dimensions

Height	Depth	Width
29"(737mm)	48"(1219mm)	120"(3048mm)

Upper Top Dimensions

Height	Depth	Width
30.5"(775mm)	57"(1448mm)	22"(559mm)

To Order, Specify:

- 1) Product number, including:

1 Cutout Option:

- N No Cutout
- L Cutout - Lower Top, add **\$123.00** list

- 2) Lower surface finish/color.
- 3) Edge trim color (laminate only).
- 4) Upper surface finish/color.
- 5) Understructure trim color. Grade B, add **\$40.00** list.
- 6) Trim color. Grade B, add **\$40.00** list.

Overall Width	Number	1	Upper Top		Wood	
			Laminate Grade A	Grade B	Group A	Group B
Laminate Grade A Lower Top						
124"(3150mm)	THRL-48C4-LFS	EGBP	\$ 5068.35	\$ 5267.85	N/A	N/A
	THRL-48C4-QFS	EGBP	N/A	N/A	\$ 5269.25	\$ 5455.10
Laminate Grade B Lower Top						
124"(3150mm)	THRL-48C4-LFS	EGBP	\$ 5339.32	\$ 5538.82	N/A	N/A
	THRL-48C4-QFS	EGBP	N/A	N/A	\$ 5540.22	\$ 5726.07
Solid Surface Lower Top						
124"(3150mm)	THRL-48C4-KFS	EGBP	\$20580.35	\$20779.85	N/A	N/A
	THRL-48C4-ESS	EGBP	N/A	N/A	\$20781.25	\$20967.10
Wood Group A Lower Top						
124"(3150mm)	THRL-48C4-RFS	EGBP	\$ 7242.75	\$ 7442.25	N/A	N/A
	THRL-48C4-WUS	EGBP	N/A	N/A	\$ 7443.65	\$ 7629.50
Wood Group B Lower Top						
124"(3150mm)	THRL-48C4-RFS	EGBP	\$ 8092.35	\$ 8291.85	N/A	N/A
	THRL-48C4-WUS	EGBP	N/A	N/A	\$ 8293.25	\$ 8479.10

Conference Tables Price List

Immerse — Ledge Table

Rectangle – Painted Legs



THLD

Features

- Includes one ledge top, painted understructure and foot rail, four painted metal legs, adjustable glides and hardware.
- Laminate or wood veneer 1/2" thick top with waterfall edge.
- Ledge top wood has a hardboard laminated core.
- Glides have 1/2"(13mm) height adjustment and are standard in black.
- Depth and width shown in nominal dimensions.
- Ships unassembled.

Specification Tip

- Power is not available.

To Order, Specify:

- 1) Product number, including:

① Surface Type:

- L Laminate
- W Wood

- 2) Laminate or wood finish color.
- 3) Understructure and Foot Rail trim color. Grade B, add **\$40.00** list.
- 4) Trim color. Grade B, add **\$40.00** list.

Height	Depth	Width	Number ①	Laminate Grade A	Grade B	Wood Group A	Group B
36"(914mm)	22"(559mm)	57"(1448mm)	THLD-2257- <input type="checkbox"/> WSNBG7P	\$2444.77	\$2644.27	\$2645.67	\$2831.52

Immerse — Single Table

Round – Wood Legs



THRN

Features

- Includes top, four solid wood legs, painted understructure, adjustable glides and hardware.
- Tops: Painted, laminate, solid surface or wood veneer with knife edge.
 - Painted 1 1/8”(29mm) thick
 - Laminate and wood veneer 1 3/16”(30mm) thick
 - Solid surface 1”(25mm) thick
- Solid surface is standard in Cameo White.
- Glides have 1/2”(13mm) height adjustment and are standard in black.
- Table height options: 29”(737mm), 36”(914mm) and 39”(991mm).
- Diameter shown in nominal dimensions.
- Ships unassembled.

Specification Tips

- Separately specified power available on the 60”(1524mm) diameter table only. Use Round Planter (EHPR-____).
- 60”(1524mm) diameter table not available painted.

To Order, Specify:

- 1) Product number, including:

1 Surface Option:

- L** Laminate
- P** Painted
- S** Solid Surface
- W** Wood

2 Edge Option:

- F** Knife (Laminate)
- U** Knife (Painted or Wood Surface)
- S** Solid Surface (for use with Solid Surface only)

3 Cutout Option:

- N** No Cutout
- P** Cutout, add **\$123.00** list

- 2) Top surface finish/color.
- 3) Edge trim color (laminate only).
- 4) Understructure trim color. Grade B, add **\$40.00** list.
- 5) Wood leg finish.
 - M7-W43 Ink on Ash - no upcharge
 - M5-W35 Clear on White Oak, add **\$135.99** list
 - M6-W35 Clear on Walnut, add **\$411.03** list

Height	Diameter	Number	Laminate		Paint		Wood		Solid	
			Grade A F	Grade B F	Grade A U	Grade B U	Group A U	Group B U	Surface S	
29”(737mm)	48”(1219mm)	THRN-4848- <input type="checkbox"/> <input type="checkbox"/> SNAG4W	\$4795.32	\$4942.45	\$5683.00	\$5704.00	\$5665.08	\$6004.92	\$11000.12	
	60”(1524mm)	THRN-6060- <input type="checkbox"/> <input type="checkbox"/> S <input type="checkbox"/> AG4W	\$403.00	\$596.57	N/A	N/A	\$672.00	\$7293.00	\$15098.00	
36”(914mm)	48”(1219mm)	THRN-4848- <input type="checkbox"/> <input type="checkbox"/> SNAG6W	\$4914.32	\$5061.45	\$5802.00	\$5823.00	\$5784.08	\$6123.92	\$11119.12	
	60”(1524mm)	THRN-6060- <input type="checkbox"/> <input type="checkbox"/> S <input type="checkbox"/> AG6W	\$522.00	\$715.57	N/A	N/A	\$6881.00	\$7412.00	\$15217.00	
39”(991mm)	48”(1219mm)	THRN-4848- <input type="checkbox"/> <input type="checkbox"/> SNAG7W	\$4965.32	\$5112.45	\$5853.00	\$5874.00	\$5835.08	\$6174.92	\$11170.12	
	60”(1524mm)	THRN-6060- <input type="checkbox"/> <input type="checkbox"/> S <input type="checkbox"/> AG7W	\$573.00	\$766.57	N/A	N/A	\$6932.00	\$7463.00	\$15268.00	

Conference Tables Price List

Immerse — Single Table

Square – Wood Legs

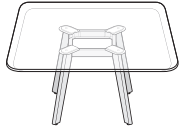

THRQ

Features

- Includes top, four solid wood legs, painted understructure, adjustable glides and hardware.
- Tops: Painted, laminate, solid surface or wood veneer top with knife edge.
 - Painted 1 1/8”(29mm) thick
 - Laminate and wood veneer 1 3/16”(30mm) thick
 - Solid surface 1”(25mm) thick
- Solid surface is standard in Cameo White.
- Glides have 1/2”(13mm) height adjustment and are standard in black.
- Table height options: 29”(737mm), 36”(914mm) and 39”(991mm).
- Depth and width shown in nominal dimensions.
- Ships unassembled.

Specification Tips

- Separately specified power available on the 60”(1524mm) depth table only. Use Round Planter (EHPR-____).
- 60”(1524mm) depth table not available painted.

To Order, Specify:

1) Product number, including:

① Surface Option:

- L** Laminate
- P** Painted
- S** Solid Surface
- W** Wood

② Edge Option:

- F** Knife (Laminate)
- U** Knife (Painted or Wood Surface)
- S** Solid Surface (for use with Solid Surface only)

③ Cutout Option:

- N** No Cutout
- P** Cutout, add **\$123.00** list

2) Top surface finish/color.

3) Edge trim color (laminate only).

4) Understructure trim color. Grade B, add **\$40.00** list.

5) Wood leg finish.

- M7-W43 Ink on Ash - no upcharge
- M5-W35 Clear on White Oak, add **\$135.99** list
- M6-W35 Clear on Walnut, add **\$411.03** list

Height	Depth	Width	Number ① ② ③	Laminate	Paint	Wood	Group B	Solid		
				Grade A	Grade B	Grade A			Group A	Surface
				F	F	U	U	S		
29”(737mm)	48”(1219mm)	48”(1219mm)	THRQ-4848-■ ■ SNAG4W	\$4795.32	\$4942.45	\$5683.00	\$5704.00	\$5665.08	\$6004.92	\$11000.12
	60”(1524mm)	60”(1524mm)	THRQ-6060-■ ■ S ■ AG4W	\$403.00	\$596.57	N/A	N/A	\$672.00	\$7293.00	\$15098.00
36”(914mm)	48”(1219mm)	48”(1219mm)	THRQ-4848-■ ■ SNAG6W	\$4914.32	\$5061.45	\$5802.00	\$5823.00	\$5784.08	\$6123.92	\$11119.12
	60”(1524mm)	60”(1524mm)	THRQ-6060-■ ■ S ■ AG6W	\$522.00	\$715.57	N/A	N/A	\$6881.00	\$7412.00	\$15217.00
39”(991mm)	48”(1219mm)	48”(1219mm)	THRQ-4848-■ ■ SNAG7W	\$4965.32	\$5112.45	\$5853.00	\$5874.00	\$5835.08	\$6174.92	\$11170.12
	60”(1524mm)	60”(1524mm)	THRQ-6060-■ ■ S ■ AG7W	\$573.00	\$766.57	N/A	N/A	\$6932.00	\$7463.00	\$15268.00

Immerse — Single Table

Rectangle – Wood Legs

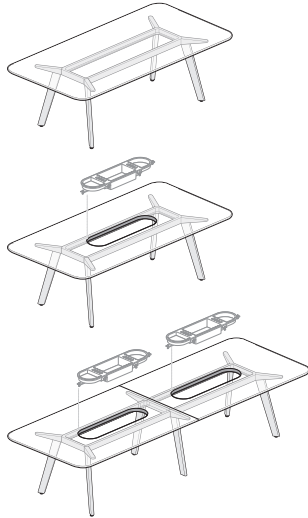

THRA

Features

- Includes top, four solid wood legs, painted understructure, adjustable glides and hardware.
- Tops: Painted, laminate, solid surface or wood veneer top with knife edge.
 - Painted 1 1/8”(29mm) thick
 - Laminate and wood veneer 1 3/16”(30mm) thick
 - Solid surface 1”(25mm) thick
- Solid surface is standard in Cameo White.
- Glides have 1/2”(13mm) height adjustment and are standard in black.
- Table height options: 29”(737mm), 36”(914mm) and 39”(991mm).
- Tops greater than 120”(3048mm) are two piece.
- One piece tops have four legs, two piece tops have 6 legs.
- Depth and width shown in nominal dimensions.
- Ships unassembled.

Specification Tips

- Separately specified power available. Use Oblong Planter (EHPO-____).
- Two piece tops specified with cutout will have two cutouts and require two Oblong Planters.
- 60”(1524mm) depth tables not available painted.

To Order, Specify:

1) Product number, including:

1 Surface Option:

- L** Laminate
- P** Painted
- S** Solid Surface
- W** Wood

2 Edge Option:

- F** Knife (Laminate)
- U** Knife (Painted or Wood Surface)
- S** Solid Surface (for use with Solid Surface only)

3 Cutout Option:

- N** No Cutout
- P** Cutout, add **\$123.00** list for one-piece add **\$246.00** list for two-piece

- Top surface finish/color.
- Edge trim color (laminate only).
- Understructure trim color. Grade B, add **\$40.00** list.
- Wood leg finish.
 - M7-W43 Ink on Ash - no upcharge
 - M5-W35 Clear on White Oak, add **\$135.99** list
 - M6-W35 Clear on Walnut, add **\$411.03** list

Height	Depth	Width	Number	① ② ③			Laminate	Grade B	Paint	Grade B	Wood	Group B	Solid	
				F	F	U	U	U	U	S				
29”(737mm)	48”(1219mm)	96”(2438mm)	THRA-4896-	■	■	S	AG4W	\$5875.64	\$6105.33	\$7651.00	\$7672.00	\$ 7615.16	\$ 8294.84	\$18285.24
	48”(1219mm)	144”(3658mm)	THRA-48E4-	■	■	S	AG4W	6955.96	7268.21	N/A	N/A	9565.24	10584.76	25570.36
	60”(1524mm)	120”(3048mm)	THRA-60C0-	■	■	S	AG4W	7091.00	7413.57	N/A	N/A	9809.00	10871.00	26481.00
	60”(1524mm)	144”(3658mm)	THRA-60E4-	■	■	S	AG4W	7766.20	8140.37	N/A	N/A	11027.80	12302.20	31034.20
36”(914mm)	48”(1219mm)	96”(2438mm)	THRA-4896-	■	■	S	AG6W	\$5994.64	\$6224.33	\$7770.00	\$7791.00	\$ 7734.16	\$ 8413.84	\$18404.24
	60”(1524mm)	120”(3048mm)	THRA-60C0-	■	■	S	AG6W	7210.00	7532.57	N/A	N/A	9928.00	10990.00	26600.00
39”(991mm)	48”(1219mm)	96”(2438mm)	THRA-4896-	■	■	S	AG7W	\$6045.64	\$6275.33	\$7821.00	\$7842.00	\$ 7785.16	\$ 8464.84	\$18455.24
	60”(1524mm)	120”(3048mm)	THRA-60C0-	■	■	S	AG7W	7261.00	7583.57	N/A	N/A	9979.00	11041.00	26651.00

Immerse — Single Table

Racetrack – Wood Legs

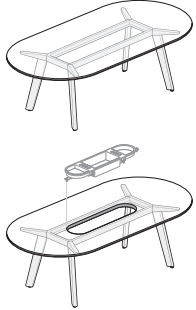

THRT

Features

- Includes top, four solid wood legs, painted understructure, adjustable glides and hardware.
- Tops: Painted, laminate, solid surface or wood veneer top with knife edge.
 - Painted 1 1/8”(29mm) thick
 - Laminate and wood veneer 1 3/16”(30mm) thick
 - Solid surface 1”(25mm) thick
- Solid surface is standard in Cameo White.
- Glides have 1/2”(13mm) height adjustment and are standard in black.
- Table height options: 29”(737mm), 36”(914mm) and 39”(991mm).
- Depth and width shown in nominal dimensions.
- Ships unassembled.

Specification Tip

- Separately specified power available. Use Oblong Planter (EHPO-____).

To Order, Specify:

1) Product number, including:

1 Surface Option:

- L** Laminate
- P** Painted
- S** Solid Surface
- W** Wood

2 Edge Option:

- F** Knife (Laminate)
- U** Knife (Painted or Wood Surface)
- S** Solid Surface (for use with Solid Surface only)

3 Cutout Option:

- N** No Cutout
- P** Cutout, add **\$123.00** list

- Top surface finish/color.
- Edge trim color (laminate only).
- Understructure trim color. Grade B, add **\$40.00** list.
- Wood leg finish.
 - M7-W43 Ink on Ash - no upcharge
 - M5-W35 Clear on White Oak, add **\$135.99** list
 - M6-W35 Clear on Walnut, add **\$411.03** list

Height	Depth	Width	Number 1 2 3	Laminate	Paint	Wood	Group B	Solid		
				Grade A F	Grade B F	Grade A U			Grade B U	Group A U
29”(737mm)	48”(1219mm)	96”(2438mm)	THRT-4896- [] S [] AG4W	\$5875.64	\$6105.33	\$7651.00	\$7672.00	\$7615.16	\$8294.84	\$18285.24
36”(914mm)	48”(1219mm)	96”(2438mm)	THRT-4896- [] S [] AG6W	\$5994.64	\$6224.33	\$7770.00	\$7791.00	\$7734.16	\$8413.84	\$18404.24
39”(991mm)	48”(1219mm)	96”(2438mm)	THRT-4896- [] S [] AG7W	\$6045.64	\$6275.33	\$7821.00	\$7842.00	\$7785.16	\$8464.84	\$18455.24

Immerse — Shift Table

Rectangle/Rectangle – Wood Legs

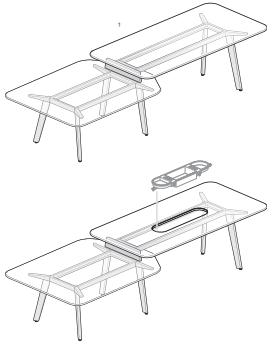

THRR

Features

- Includes two tops, 7"(178mm) high stack spacer, painted understructure, six solid wood legs, adjustable glides and hardware.
- Tops: Lower top available in laminate, solid surface and wood veneer with knife edge. Upper top available painted, laminate, solid surface or wood veneer with knife edge.
 - Painted 1 1/8"(29mm) thick
 - Laminate and wood veneer 1 3/16"(30mm) thick
 - Solid surface 1" thick
- Solid surface is standard in Cameo White.
- Stack spacer is painted MDF.
- Glides have 1/2"(13mm) height adjustment and are standard in black.
- Depth and width shown in nominal dimensions.
- Ships unassembled.

Specification Tips

- Separately specified power available. Use Oblong Planter (EHPO-_____).
- When cutout option (-U) is selected, cutout is on the upper top only. Lower top not available with cutout.
- Overlap of top and bottom surfaces is 18 1/2"(470mm).
- Seating capacity of 11 based upon 27"(686mm) per chair.
- Tops share one understructure and are not designed to be separated.

Lower Top Dimensions

Height	Depth	Width
29"(737mm)	60"(1524mm)	84"(2134mm)

Upper Top Dimensions

Height	Depth	Width
36"(914mm)	48"(1219mm)	96"(2438mm)

To Order, Specify:

- 1) Product number, including:
 - 1** **Cutout Option:**
 - N** No Cutout
 - U** Cutout - Upper Top, add **\$123.00** list
- 2) Lower surface finish/color.
- 3) Edge trim color (laminate only).
- 4) Upper surface finish/color.
- 5) Edge trim color (laminate only).
- 6) Understructure trim color. Grade B, add **\$40.00** list.
- 7) Wood leg finish.
 - M7-W43 Ink on Ash - no upcharge
 - M5-W35 Clear on White Oak, add **\$210.57** list
 - M6-W35 Clear on Walnut, add **\$636.45** list
- 8) Stack spacer color.

Overall Width	Number	1	Upper Top		Paint Grade A	Grade B	Wood Group A	Group B	Solid Surface
			Laminate Grade A	Grade B					
Laminate Grade A Lower Top									
156"(3962mm)	THRR-60F6-MFS	DGAW	N/A	N/A	\$12228.73	\$12249.73	N/A	N/A	N/A
	THRR-60F6-LFS	DGAW	\$10453.37	\$10683.06	N/A	N/A	N/A	N/A	N/A
	THRR-60F6-JFS	DGAW	N/A	N/A	N/A	N/A	N/A	N/A	\$22862.97
	THRR-60F6-QFS	DGAW	N/A	N/A	N/A	N/A	\$12192.89	\$12872.57	N/A
Laminate Grade B Lower Top									
156"(3962mm)	THRR-60F6-MFS	DGAW	N/A	N/A	\$12461.00	\$12482.00	N/A	N/A	N/A
	THRR-60F6-LFS	DGAW	\$10685.64	\$10915.33	N/A	N/A	N/A	N/A	N/A
	THRR-60F6-JFS	DGAW	N/A	N/A	N/A	N/A	N/A	N/A	\$23095.24
	THRR-60F6-QFS	DGAW	N/A	N/A	N/A	N/A	\$12425.16	\$13104.84	N/A
Solid Surface Lower Top									
156"(3962mm)	THRR-60F6-FUS	DGAW	N/A	N/A	\$24832.23	\$24853.23	N/A	N/A	N/A
	THRR-60F6-KFS	DGAW	\$23056.87	\$23286.56	N/A	N/A	N/A	N/A	N/A
	THRR-60F6-SSS	DGAW	N/A	N/A	N/A	N/A	N/A	N/A	\$35466.47
	THRR-60F6-EUS	DGAW	N/A	N/A	N/A	N/A	\$24796.39	\$25476.07	N/A
Wood Group A Lower Top									
156"(3962mm)	THRR-60F6-GUS	DGAW	N/A	N/A	\$13995.43	\$14016.43	N/A	N/A	N/A
	THRR-60F6-RFS	DGAW	\$12220.07	\$12449.76	N/A	N/A	N/A	N/A	N/A
	THRR-60F6-DUS	DGAW	N/A	N/A	N/A	N/A	N/A	N/A	\$24629.67
	THRR-60F6-WUS	DGAW	N/A	N/A	N/A	N/A	\$13959.59	\$14639.27	N/A
Wood Group B Lower Top									
156"(3962mm)	THRR-60F6-GUS	DGAW	N/A	N/A	\$14685.73	\$14706.73	N/A	N/A	N/A
	THRR-60F6-RFS	DGAW	\$12910.37	\$13140.06	N/A	N/A	N/A	N/A	N/A
	THRR-60F6-DUS	DGAW	N/A	N/A	N/A	N/A	N/A	N/A	\$25319.97
	THRR-60F6-WUS	DGAW	N/A	N/A	N/A	N/A	\$14649.89	\$15329.57	N/A

Conference Tables Price List

Immerse — Shift Table

Rectangle/Round – Wood Legs

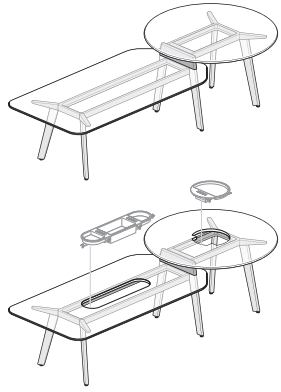

THRD

Features

- Includes rectangle lower top and round upper top, 7”(178mm) high stack spacer, painted understructure, six solid wood legs, adjustable glides and hardware.
- Tops: Rectangle lower top available painted, laminate, solid surface and wood veneer with knife edge. Round upper top available in laminate, solid surface or wood veneer with knife edge. Round upper top not available painted.
 - Painted 1 1/8”(29mm) thick
 - Laminate and wood veneer 1 3/16”(30mm) thick
 - Solid surface 1”(25mm) thick
- Solid surface is standard in Cameo White.
- Stack spacer is painted MDF.
- Glides have 1/2”(13mm) height adjustment and are standard in black.
- Depth and width shown in nominal dimensions.
- Ships unassembled.

Specification Tips

- Separately specified power available. Use Oblong Planter (EHPO-_____) for the rectangle top and Round Planter (EHPR-_____) for the round top.
- When cutout option (-L) is selected, the cutout is on the lower top, option (-P) the cutout is on the lower and upper top and option (-U) the cutout is on the upper top only.
- Overlap of top and bottom surfaces is 15 3/4”(400mm).
- Seating capacity of 8 based upon 27”(686mm) per chair.
- Tops share one understructure and are not designed to be separated.

Lower Top Dimensions

Height	Depth	Width
29”(737mm)	48”(1219mm)	96”(2438mm)

Upper Top Dimensions

Height	Diameter
36”(914mm)	60”(1524mm)

To Order, Specify:

1) Product number, including:

1 Cutout Option:

- N** No Cutout
- L** Cutout - Lower Top, add **\$123.00** list
- P** Cutout - Lower and Upper Top, add **\$246.00** list
- U** Cutout - Upper Top, add **\$123.00** list

2) Lower surface finish/color.

3) Edge trim color (laminate only).

4) Upper surface finish/color.

5) Edge trim color (laminate only).

6) Understructure trim color. Grade B, add **\$40.00** list.

7) Wood leg finish.

M7-W43 Ink on Ash - no upcharge

M5-W35 Clear on White Oak, add **\$210.57** list

M6-W35 Clear on Walnut, add **\$636.45** list

8) Stack spacer color.

Overall Width	Number	1	Upper Top Laminate Grade A	Grade B	Wood Group A	Group B	Solid Surface
Paint Grade A Lower Top							
138”(3505mm)	THRD-48D8-TFS	DGAW	\$11722.33	\$11915.90	N/A	N/A	N/A
	THRD-48D8-HUS	DGAW	N/A	N/A	N/A	N/A	\$21417.33
	THRD-48D8-IUS	DGAW	N/A	N/A	\$13081.33	\$13612.33	N/A
Paint Grade B Lower Top							
138”(3505mm)	THRD-48D8-TFS	DGAW	\$11743.33	\$11936.90	N/A	N/A	N/A
	THRD-48D8-HUS	DGAW	N/A	N/A	N/A	N/A	\$21438.33
	THRD-48D8-IUS	DGAW	N/A	N/A	\$13102.33	\$13633.33	N/A
Laminate Grade A Lower Top							
138”(3505mm)	THRD-48D8-LFS	DGAW	\$ 9946.97	\$10140.54	N/A	N/A	N/A
	THRD-48D8-JFS	DGAW	N/A	N/A	N/A	N/A	\$19641.97
	THRD-48D8-QFS	DGAW	N/A	N/A	\$11305.97	\$11836.97	N/A
Laminate Grade B Lower Top							
138”(3505mm)	THRD-48D8-LFS	DGAW	\$10176.66	\$10370.23	N/A	N/A	N/A
	THRD-48D8-JFS	DGAW	N/A	N/A	N/A	N/A	\$19871.66
	THRD-48D8-QFS	DGAW	N/A	N/A	\$11535.66	\$12066.66	N/A
Solid Surface Lower Top							
138”(3505mm)	THRD-48D8-KFS	DGAW	\$22356.57	\$22550.14	N/A	N/A	N/A
	THRD-48D8-SSS	DGAW	N/A	N/A	N/A	N/A	\$32051.57
	THRD-48D8-EUS	DGAW	N/A	N/A	\$23715.57	\$24246.57	N/A
Wood Group A Lower Top							
138”(3505mm)	THRD-48D8-RFS	DGAW	\$11686.49	\$11880.06	N/A	N/A	N/A
	THRD-48D8-DUS	DGAW	N/A	N/A	N/A	N/A	\$21381.49
	THRD-48D8-WUS	DGAW	N/A	N/A	\$13045.49	\$13576.49	N/A
Wood Group B Lower Top							
138”(3505mm)	THRD-48D8-RFS	DGAW	\$12366.17	\$12559.74	N/A	N/A	N/A
	THRD-48D8-DUS	DGAW	N/A	N/A	N/A	N/A	\$22061.17
	THRD-48D8-WUS	DGAW	N/A	N/A	\$13725.17	\$14256.17	N/A

Immerse — Shift Table

Racetrack/Round – Wood Legs



THTD

Features

- Includes racetrack lower top and round upper top, 7”(178mm) high stack spacer, painted understructure, six solid wood legs, adjustable glides and hardware.
- Tops: Racetrack lower top available painted, laminate, solid surface and wood veneer with knife edge. Round upper top available in laminate, solid surface or wood veneer with knife edge. Round upper top not available painted.
 - Painted 1 1/8”(29mm) thick
 - Laminate and wood veneer 1 3/16”(30mm) thick
 - Solid surface 1”(25mm) thick
- Solid surface is standard in Cameo White.
- Stack spacer is painted MDF.
- Glides have 1/2”(13mm) height adjustment and are standard in black.
- Depth and width shown in nominal dimensions.
- Ships unassembled.

Specification Tips

- Separately specified power available. Use Oblong Planter (EHPO-_____) for the racetrack top and Round Planter (EHPR-_____) for the round top.
- When cutout option (-L) is selected, the cutout is on the lower top, option (-P) the cutout is on the lower and upper top and option (-U) the cutout is on the upper top only.
- Overlap of top and bottom surfaces is 17 3/4”(451mm).
- Seating capacity of 8 based upon 27”(686mm) per chair.
- Tops share one understructure and are not designed to be separated.

Lower Top Dimensions

Height	Depth	Width
29”(737mm)	48”(1219mm)	96”(2438mm)

Upper Top Dimensions

Height	Diameter
36”(914mm)	60”(1524mm)

To Order, Specify:

1) Product number, including:

1 Cutout Option:

- N** No Cutout
 - L** Cutout - Lower Top, add **\$123.00** list
 - P** Cutout - Lower and Upper Top, add **\$246.00** list
 - U** Cutout - Upper Top, add **\$123.00** list
- 2) Lower surface finish/color.
- 3) Edge trim color (laminate only).
- 4) Upper surface finish/color.
- 5) Edge trim color (laminate only).
- 6) Understructure trim color. Grade B, add **\$40.00** list.
- 7) Wood leg finish.
 M7-W43 Ink on Ash - no upcharge
 M5-W35 Clear on White Oak, add **\$210.57** list
 M6-W35 Clear on Walnut, add **\$636.45** list
- 8) Stack spacer color.

Overall Width	Number	1	Upper Top		Wood Group A	Group B	Solid Surface
			Laminate Grade A	Grade B			
Paint Grade A Lower Top							
138”(3505mm)	THTD-48D8-TFS	DGAW	\$11722.33	\$11915.90	N/A	N/A	N/A
	THTD-48D8-HUS	DGAW	N/A	N/A	N/A	N/A	\$21417.33
	THTD-48D8-IUS	DGAW	N/A	N/A	\$13081.33	\$13612.33	N/A
Paint Grade B Lower Top							
138”(3505mm)	THTD-48D8-TFS	DGAW	\$11743.33	\$11936.90	N/A	N/A	N/A
	THTD-48D8-HUS	DGAW	N/A	N/A	N/A	N/A	\$21438.33
	THTD-48D8-IUS	DGAW	N/A	N/A	\$13102.33	\$13633.33	N/A
Laminate Grade A Lower Top							
138”(3505mm)	THTD-48D8-LFS	DGAW	\$ 9946.97	\$10140.54	N/A	N/A	N/A
	THTD-48D8-JFS	DGAW	N/A	N/A	N/A	N/A	\$19641.97
	THTD-48D8-QFS	DGAW	N/A	N/A	\$11305.97	\$11836.97	N/A
Laminate Grade B Lower Top							
138”(3505mm)	THTD-48D8-LFS	DGAW	\$10176.66	\$10370.23	N/A	N/A	N/A
	THTD-48D8-JFS	DGAW	N/A	N/A	N/A	N/A	\$19871.66
	THTD-48D8-QFS	DGAW	N/A	N/A	\$11535.66	\$12066.66	N/A
Solid Surface Lower Top							
138”(3505mm)	THTD-48D8-KFS	DGAW	\$22356.57	\$22550.14	N/A	N/A	N/A
	THTD-48D8-SSS	DGAW	N/A	N/A	N/A	N/A	\$32051.57
	THTD-48D8-EUS	DGAW	N/A	N/A	\$23715.57	\$24246.57	N/A
Wood Group A Lower Top							
138”(3505mm)	THTD-48D8-RFS	DGAW	\$11686.49	\$11880.06	N/A	N/A	N/A
	THTD-48D8-DUS	DGAW	N/A	N/A	N/A	N/A	\$21381.49
	THTD-48D8-WUS	DGAW	N/A	N/A	\$13045.49	\$13576.49	N/A
Wood Group B Lower Top							
138”(3505mm)	THTD-48D8-RFS	DGAW	\$12366.17	\$12559.74	N/A	N/A	N/A
	THTD-48D8-DUS	DGAW	N/A	N/A	N/A	N/A	\$22061.17
	THTD-48D8-WUS	DGAW	N/A	N/A	\$13725.17	\$14256.17	N/A

Immerse — Overlap Table

Rectangle/Rectangle – Wood Legs

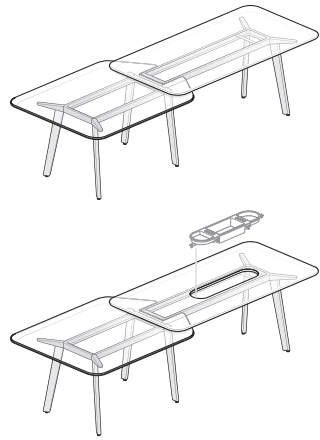

THRR

Features

- Includes two tops, painted understructure, six solid wood legs, adjustable glides and hardware.
- Tops: Lower top available in laminate, solid surface and wood veneer with knife edge. Lower top not available painted. Upper top available painted, laminate, solid surface or wood veneer with knife edge.
 - Painted 1 1/8”(29mm) thick
 - Laminate and wood veneer 1 3/16”(30mm) thick
 - Solid surface 1”(25mm) thick
- Solid surface is standard in Cameo White.
- Glides have 1/2”(13mm) height adjustment and are standard in black.
- Depth and width shown in nominal dimensions.
- Ships unassembled.

Specification Tips

- Power only available in the upper top.
- Separately specified power available. Use Oblong Planter (EHPO-____).
- When cutout option (-U) is selected, the cutout is on the upper top only.
- Overlap of top and bottom surfaces is 18 1/2”(470mm).
- Seating capacity of 11 based upon 27”(686mm) per chair.
- Tops share one understructure and are not designed to be separated.

Lower Top Dimensions

Height	Depth	Width
29”(737mm)	60”(1524mm)	78”(1981mm)
37.5”(953mm)	60”(1524mm)	78”(1981mm)

Upper Top Dimensions

Height	Depth	Width
30.5”(775mm)	48”(1219mm)	96”(2438mm)
39”(991mm)	48”(1219mm)	96”(2438mm)

To Order, Specify:

- 1) Product number, including:

1 Cutout Option:

- N** No Cutout
- U** Cutout - Upper Top, add **\$123.00** list

- 2) Lower surface finish/color.
- 3) Edge trim color (laminate only).
- 4) Upper surface finish/color.
- 5) Edge trim color (laminate only).
- 6) Understructure trim color. Grade B, add **\$40.00** list.
- 7) Wood leg finish.
 - M7-W43 Ink on Ash - no upcharge
 - M5-W35 Clear on White Oak, add **\$204.23** list
 - M6-W35 Clear on Walnut, add **\$617.27** list

Immerse — Overlap Table

Rectangle/Rectangle – Wood Legs

Overall Width	Number	①	Upper Top Laminate Grade A	Grade B	Paint Grade A	Grade B	Wood Group A	Group B	Solid Surface
Laminate Grade A Lower Top – 29”(737mm) Height									
156”(3962mm)	THRR-60F6-MFS	EGBW	N/A	N/A	\$11553.74	\$11574.74	N/A	N/A	N/A
	THRR-60F6-LFS	EGBW	\$ 9778.38	\$10008.07	N/A	N/A	N/A	N/A	N/A
	THRR-60F6-JFS	EGBW	N/A	N/A	N/A	N/A	N/A	N/A	\$22187.98
	THRR-60F6-QFS	EGBW	N/A	N/A	N/A	N/A	\$11517.90	\$12197.58	N/A
Laminate Grade A Lower Top – 37.5”(953mm) Height									
156”(3962mm)	THRR-60F6-MFS	EGCW	N/A	N/A	\$11706.74	\$11727.74	N/A	N/A	N/A
	THRR-60F6-LSS	EGCW	\$ 9931.38	\$10161.07	N/A	N/A	N/A	N/A	N/A
	THRR-60F6-JFS	EGCW	N/A	N/A	N/A	N/A	N/A	N/A	\$22340.98
	THRR-60F6-QFS	EGCW	N/A	N/A	N/A	N/A	\$11670.90	\$12350.58	N/A
Laminate Grade B Lower Top – 29”(737mm) Height									
156”(3962mm)	THRR-60F6-MFS	EGBW	N/A	N/A	\$11786.01	\$11807.01	N/A	N/A	N/A
	THRR-60F6-LFS	EGBW	\$10010.65	\$10240.34	N/A	N/A	N/A	N/A	N/A
	THRR-60F6-JFS	EGBW	N/A	N/A	N/A	N/A	N/A	N/A	\$22420.25
	THRR-60F6-QFS	EGBW	N/A	N/A	N/A	N/A	\$11750.17	\$12429.85	N/A
Laminate Grade B Lower Top – 37.5”(953mm) Height									
156”(3962mm)	THRR-60F6-MFS	EGCW	N/A	N/A	\$11939.01	\$11960.01	N/A	N/A	N/A
	THRR-60F6-LSS	EGCW	\$10163.65	\$10393.34	N/A	N/A	N/A	N/A	N/A
	THRR-60F6-JFS	EGCW	N/A	N/A	N/A	N/A	N/A	N/A	\$22573.25
	THRR-60F6-QFS	EGCW	N/A	N/A	N/A	N/A	\$11903.17	\$12582.85	N/A
Solid Surface Lower Top – 29”(737mm) Height									
156”(3962mm)	THRR-60F6-FUS	EGBW	N/A	N/A	\$24157.24	\$24178.24	N/A	N/A	N/A
	THRR-60F6-KFS	EGBW	\$22381.88	\$22611.57	N/A	N/A	N/A	N/A	N/A
	THRR-60F6-SSS	EGBW	N/A	N/A	N/A	N/A	N/A	N/A	\$34791.48
	THRR-60F6-EUS	EGBW	N/A	N/A	N/A	N/A	\$24121.40	\$24801.08	N/A
Solid Surface Lower Top – 37.5”(953mm) Height									
156”(3962mm)	THRR-60F6-FUS	EGCW	N/A	N/A	\$24310.24	\$24331.24	N/A	N/A	N/A
	THRR-60F6-KFS	EGCW	\$22534.88	\$22764.57	N/A	N/A	N/A	N/A	N/A
	THRR-60F6-SSS	EGCW	N/A	N/A	N/A	N/A	N/A	N/A	\$34944.48
	THRR-60F6-EUS	EGCW	N/A	N/A	N/A	N/A	\$24274.40	\$24954.08	N/A
Wood Group A Lower Top – 29”(737mm) Height									
156”(3962mm)	THRR-60F6-GUS	EGBW	N/A	N/A	\$13320.44	\$13341.44	N/A	N/A	N/A
	THRR-60F6-RFS	EGBW	\$11545.08	\$11774.77	N/A	N/A	N/A	N/A	N/A
	THRR-60F6-DUS	EGBW	N/A	N/A	N/A	N/A	N/A	N/A	\$23954.68
	THRR-60F6-WUS	EGBW	N/A	N/A	N/A	N/A	\$13284.60	\$13964.28	N/A
Wood Group A Lower Top – 37.5”(953mm) Height									
156”(3962mm)	THRR-60F6-GUS	EGCW	N/A	N/A	\$13473.44	\$13494.44	N/A	N/A	N/A
	THRR-60F6-RFS	EGCW	\$11698.08	\$11927.77	N/A	N/A	N/A	N/A	N/A
	THRR-60F6-DUS	EGCW	N/A	N/A	N/A	N/A	N/A	N/A	\$24107.68
	THRR-60F6-WUS	EGCW	N/A	N/A	N/A	N/A	\$13437.60	\$14117.28	N/A
Wood Group B Lower Top – 29”(737mm) Height									
156”(3962mm)	THRR-60F6-GUS	EGBW	N/A	N/A	\$14010.74	\$14031.74	N/A	N/A	N/A
	THRR-60F6-RFS	EGBW	\$12235.38	\$12235.38	N/A	N/A	N/A	N/A	N/A
	THRR-60F6-DUS	EGBW	N/A	N/A	N/A	N/A	N/A	N/A	\$24644.98
	THRR-60F6-WUS	EGBW	N/A	N/A	N/A	N/A	\$13974.90	\$14654.58	N/A
Wood Group B Lower Top – 37.5”(953mm) Height									
156”(3962mm)	THRR-60F6-GUS	EGCW	N/A	N/A	\$14163.74	\$14184.74	N/A	N/A	N/A
	THRR-60F6-RFS	EGCW	\$12388.38	\$12388.38	N/A	N/A	N/A	N/A	N/A
	THRR-60F6-DUS	EGCW	N/A	N/A	N/A	N/A	N/A	N/A	\$24797.98
	THRR-60F6-WUS	EGCW	N/A	N/A	N/A	N/A	\$14127.90	\$14807.58	N/A

Conference Tables Price List

Immerse — Overlap Table

Rectangle/Round – Wood Legs



THRD

Features

- Includes lower racetrack top, upper round top, painted understructure, six solid wood legs, adjustable glides and hardware.
- Tops: Rectangle lower top available painted, laminate, solid surface and wood veneer with knife edge. Round upper top available in laminate, solid surface or wood veneer with knife edge. Round upper top not available painted.
 - Painted 1 1/8”(29mm) thick
 - Laminate and wood veneer 1 3/16”(30mm) thick
 - Solid surface 1”(25mm) thick
- Solid surface is standard in Cameo White.
- Glides have 1/2”(13mm) height adjustment and are standard in black.
- Depth and width shown in nominal dimensions.
- Ships unassembled.

Specification Tips

- Separately specified power available. Use Oblong Planter (EHPO-____) for the rectangle top and Round Planter (EHPR-____) for the round top.
- When cutout option (-L) is selected, the cutout is on the lower top, option (-P) the cutout is on the lower and upper top and option (-U) the cutout is on the upper top only.
- Overlap of top and bottom surfaces is 15 3/4”(400mm).
- Seating capacity of 8 based upon 27”(686mm) per chair.
- Tops share one understructure and are not designed to be separated.

Lower Top Dimensions

Height	Depth	Width
29”(737mm)	48”(1219mm)	96”(2438mm)

Upper Top Dimensions

Height	Diameter
30.5”(775mm)	60”(1524mm)

To Order, Specify:

1) Product number, including:

1 Cutout Option:

- N** No Cutout
- L** Cutout - Lower Top, add **\$123.00** list
- P** Cutout - Lower and Upper Top, add **\$246.00** list
- U** Cutout - Upper Top, add **\$123.00** list

- 2) Lower surface finish/color.
- 3) Edge trim color (laminate only).
- 4) Upper surface finish/color.
- 5) Edge trim color (laminate only).
- 6) Understructure trim color. Grade B, add **\$40.00** list.
- 7) Wood leg finish.
 - M7-W43 Ink on Ash - no upcharge
 - M5-W35 Clear on White Oak, add **\$204.23** list
 - M6-W35 Clear on Walnut, add **\$617.27** list

Overall Width	Number	1	Upper Top Laminate Grade A	Grade B	Wood Group A	Group B	Solid Surface
Paint Grade A Lower Top							
138”(3505mm)	THRD-48D8-TFS	EGBW	\$11047.34	\$11240.91	N/A	N/A	N/A
	THRD-48D8-HUS	EGBW	N/A	N/A	N/A	N/A	\$20742.34
	THRD-48D8-IUS	EGBW	N/A	N/A	\$12406.34	\$12937.34	N/A
Paint Grade B Lower Top							
138”(3505mm)	THRD-48D8-TFS	EGBW	\$11068.34	\$11261.91	N/A	N/A	N/A
	THRD-48D8-HUS	EGBW	N/A	N/A	N/A	N/A	\$20763.34
	THRD-48D8-IUS	EGBW	N/A	N/A	\$12427.34	\$12958.34	N/A
Laminate Grade A Lower Top							
138”(3505mm)	THRD-48D8-LFS	EGBW	\$ 9271.98	\$ 9465.55	N/A	N/A	N/A
	THRD-48D8-JFS	EGBW	N/A	N/A	N/A	N/A	\$18966.98
	THRD-48D8-QFS	EGBW	N/A	N/A	\$10630.98	\$11161.98	N/A
Laminate Grade B Lower Top							
138”(3505mm)	THRD-48D8-LFS	EGBW	\$ 9501.67	\$ 9695.24	N/A	N/A	N/A
	THRD-48D8-JFS	EGBW	N/A	N/A	N/A	N/A	\$19196.67
	THRD-48D8-QFS	EGBW	N/A	N/A	\$10860.67	\$11391.67	N/A
Solid Surface Lower Top							
138”(3505mm)	THRD-48D8-KFS	EGBW	\$21681.58	\$21875.15	N/A	N/A	N/A
	THRD-48D8-SSS	EGBW	N/A	N/A	N/A	N/A	\$31376.58
	THRD-48D8-EUS	EGBW	N/A	N/A	\$23040.58	\$23571.58	N/A
Wood Group A Lower Top							
138”(3505mm)	THRD-48D8-RFS	EGBW	\$11011.50	\$11205.07	N/A	N/A	N/A
	THRD-48D8-DUS	EGBW	N/A	N/A	N/A	N/A	\$20706.50
	THRD-48D8-WUS	EGBW	N/A	N/A	\$12370.50	\$12901.50	N/A
Wood Group B Lower Top							
138”(3505mm)	THRD-48D8-RFS	EGBW	\$11691.18	\$11691.18	N/A	N/A	N/A
	THRD-48D8-DUS	EGBW	N/A	N/A	N/A	N/A	\$21386.18
	THRD-48D8-WUS	EGBW	N/A	N/A	\$13050.18	\$13581.18	N/A

Immerse — Overlap Table

Racetrack/Round – Wood Legs

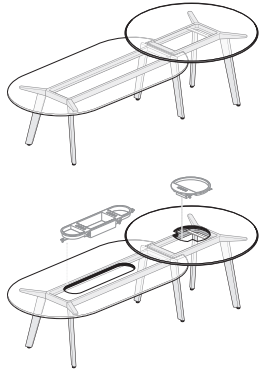

THTD

Features

- Includes lower racetrack top, upper round top, painted understructure, six solid wood legs, adjustable glides and hardware.
- Tops: Racetrack lower top available painted, laminate, solid surface and wood veneer with knife edge. Round upper top available in laminate, solid surface or wood veneer with knife edge. Round upper top not available painted.
 - Painted 1 1/8”(29mm) thick
 - Laminate and wood veneer 1 3/16”(30mm) thick
 - Solid surface 1”(25mm) thick
- Solid surface is standard in Cameo White.
- Glides have 1/2”(13mm) height adjustment and are standard in black.
- Depth and width shown in nominal dimensions.
- Ships unassembled.

Specification Tips

- Separately specified power available. Use Oblong Planter (EHPO-____) for the racetrack top and Round Planter (EHPR-____) for the round top.
- When cutout option (-L) is selected, the cutout is on the lower top, option (-P) the cutout is on the lower and upper top and option (-U) the cutout is on the upper top only.
- Overlap of top and bottom surfaces is 16 1/4”(413mm).
- Seating capacity of 8 based upon 27”(686mm) per chair.
- Tops share one understructure and are not designed to be separated.

Lower Top Dimensions

Height	Depth	Width
29”(737mm)	48”(1219mm)	96”(2438mm)

Upper Top Dimensions

Height	Diameter
30.5”(775mm)	60”(1524mm)

To Order, Specify:

- 1) Product number, including:

1 Cutout Option:

- N** No Cutout
- L** Cutout - Lower Top, add **\$123.00** list
- P** Cutout - Lower and Upper Top, add **\$246.00** list
- U** Cutout - Upper Top, add **\$123.00** list

- 2) Lower surface finish/color.
- 3) Edge trim color (laminate only).
- 4) Upper surface finish/color.
- 5) Edge trim color (laminate only).
- 6) Understructure trim color. Grade B, add **\$40.00** list.
- 7) Wood leg finish.
 - M7-W43 Ink on Ash - no upcharge
 - M5-W35 Clear on White Oak, add **\$204.23** list
 - M6-W35 Clear on Walnut, add **\$617.27** list

Overall Width	Number	1	Upper Top		Wood Group A	Group B	Solid Surface
			Laminate Grade A	Grade B			
Paint Grade A Lower Top							
138”(3505mm)	THTD-48D8-TFS	EGBW	\$11047.34	\$11240.91	N/A	N/A	N/A
	THTD-48D8-HUS	EGBW	N/A	N/A	N/A	N/A	\$20742.34
	THTD-48D8-IUS	EGBW	N/A	N/A	\$12406.34	\$12937.34	N/A
Paint Grade B Lower Top							
138”(3505mm)	THTD-48D8-TFS	EGBW	\$11068.34	\$11261.91	N/A	N/A	N/A
	THTD-48D8-HUS	EGBW	N/A	N/A	N/A	N/A	\$20763.34
	THTD-48D8-IUS	EGBW	N/A	N/A	\$12427.34	\$12958.34	N/A
Laminate Grade A Lower Top							
138”(3505mm)	THTD-48D8-LFS	EGBW	\$ 9271.98	\$ 9465.55	N/A	N/A	N/A
	THTD-48D8-JFS	EGBW	N/A	N/A	N/A	N/A	\$18966.98
	THTD-48D8-QFS	EGBW	N/A	N/A	\$10630.98	\$11161.98	N/A
Laminate Grade B Lower Top							
138”(3505mm)	THTD-48D8-LFS	EGBW	\$ 9501.67	\$ 9695.24	N/A	N/A	N/A
	THTD-48D8-JFS	EGBW	N/A	N/A	N/A	N/A	\$19196.67
	THTD-48D8-QFS	EGBW	N/A	N/A	\$10860.67	\$11391.67	N/A
Solid Surface Lower Top							
138”(3505mm)	THTD-48D8-KFS	EGBW	\$21681.58	\$21875.15	N/A	N/A	N/A
	THTD-48D8-SSS	EGBW	N/A	N/A	N/A	N/A	\$31376.58
	THTD-48D8-EUS	EGBW	N/A	N/A	\$23040.58	\$23571.58	N/A
Wood Group A Lower Top							
138”(3505mm)	THTD-48D8-RFS	EGBW	\$11011.50	\$11205.07	N/A	N/A	N/A
	THTD-48D8-DUS	EGBW	N/A	N/A	N/A	N/A	\$20706.50
	THTD-48D8-WUS	EGBW	N/A	N/A	\$12370.50	\$12901.50	N/A
Wood Group B Lower Top							
138”(3505mm)	THTD-48D8-RFS	EGBW	\$11691.18	\$11691.18	N/A	N/A	N/A
	THTD-48D8-DUS	EGBW	N/A	N/A	N/A	N/A	\$21386.18
	THTD-48D8-WUS	EGBW	N/A	N/A	\$13050.18	\$13581.18	N/A

Immerse — Overlap Table

Rectangle/Ledge – Wood Legs

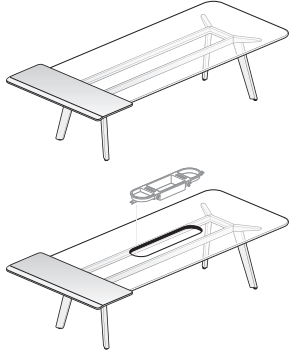

THRL

Features

- Includes one ledge upper top with 1/2"(7mm) spacer attached and one rectangle lower top, painted understructure, four solid wood legs, adjustable glides and hardware.
- Upper ledge top 1/2"(13mm) laminate or wood veneer with waterfall edge.
- Rectangle lower top available laminate, solid surface and wood veneer with knife edge.
 - Laminate and wood veneer 1 3/16"(30mm) thick
 - Solid surface 1"(25mm) thick
- Solid surface is standard in Cameo White.
- Ledge wood top is hardboard laminated core.
- Glides have 1/2"(13mm) height adjustment and are standard in black.
- Depth and width shown in nominal dimensions.
- Ships unassembled.

Specification Tips

- Separately specified power available. Use Oblong Planter (EHPO-____).
- When cutout option (-L) is selected, the cutout is on the lower top only.
- Overlap of top and bottom surfaces is 17 3/4"(451mm).
- Seating capacity of 9 based upon 27"(686mm) per chair.
- Tops share one understructure and are not designed to be separated.

Lower Top Dimensions

Height	Depth	Width
29"(737mm)	48"(1219mm)	120"(3048mm)

Upper Top Dimensions

Height	Depth	Width
30.5"(775mm)	57"(1448mm)	22"(559mm)

To Order, Specify:

- 1) Product number, including:

1 Cutout Option:

- N No Cutout
- L Cutout - Lower Top, add **\$123.00** list

- 2) Lower surface finish/color.
- 3) Edge trim color (laminate only).
- 4) Upper surface finish/color.
- 5) Understructure trim color. Grade B, add **\$40.00** list.
- 6) Wood leg finish.
 - M7-W43 Ink on Ash - no upcharge
 - M5-W35 Clear on White Oak, add **\$135.99** list
 - M6-W35 Clear on Walnut, add **\$411.03** list

Overall Width	Number	1	Upper Top Laminate Grade A	Grade B	Wood Group A	Group B
Laminate Grade A Lower Top						
124"(3150mm)	THRL-48C4-LFS	EGBW	\$ 7281.35	\$ 7480.85	N/A	N/A
	THRL-48C4-QFS	EGBW	N/A	N/A	\$ 7482.25	\$ 7668.10
Laminate Grade B Lower Top						
124"(3150mm)	THRL-48C4-LFS	EGBW	\$ 7552.32	\$ 7751.82	N/A	N/A
	THRL-48C4-QFS	EGBW	N/A	N/A	\$ 7753.22	\$ 7939.07
Solid Surface Lower Top						
124"(3150mm)	THRL-48C4-KFS	EGBW	\$22793.35	\$22992.85	N/A	N/A
	THRL-48C4-ESS	EGBW	N/A	N/A	\$22994.25	\$23180.10
Wood Group A Lower Top						
124"(3150mm)	THRL-48C4-RFS	EGBW	\$ 9455.75	\$ 9655.25	N/A	N/A
	THRL-48C4-WUS	EGBW	N/A	N/A	\$ 9656.65	\$ 9842.50
Wood Group B Lower Top						
124"(3150mm)	THRL-48C4-RFS	EGBW	\$10305.35	\$10504.85	N/A	N/A
	THRL-48C4-WUS	EGBW	N/A	N/A	\$10506.25	\$10692.10

Immerse — Ledge Table

Rectangle – Wood Legs



THLD

Features

- Includes one ledge top, painted understructure and foot rail, four solid wood legs, adjustable glides and hardware.
- Laminate or wood veneer 1/2" thick top with waterfall edge.
- Ledge top wood has a hardboard laminated core.
- Glides have 1/2"(13mm) height adjustment and are standard in black.
- Depth and width shown in nominal dimensions.
- Ships unassembled.

Specification Tip

- Power is not available.

To Order, Specify:

- 1) Product number, including:

① Surface Type:

- L Laminate
- W Wood

- 2) Laminate or wood finish color.

- 3) Understructure and Foot Rail trim color.
Grade B, add **\$40.00** list.

- 4) Wood leg finish.
M7-W43 Ink on Ash - no upcharge
M5-W35 Clear on White Oak, add **\$135.99** list
M6-W35 Clear on Walnut, add **\$411.03** list

Height	Depth	Width	Number ①	Laminate Grade A	Grade B	Wood Group A	Group B
36"(914mm)	22"(559mm)	57"(1448mm)	THLD-2257- <input type="checkbox"/> WSNBG7W	\$3694.21	\$3893.71	\$3895.11	\$4080.96

Planter — Oblong

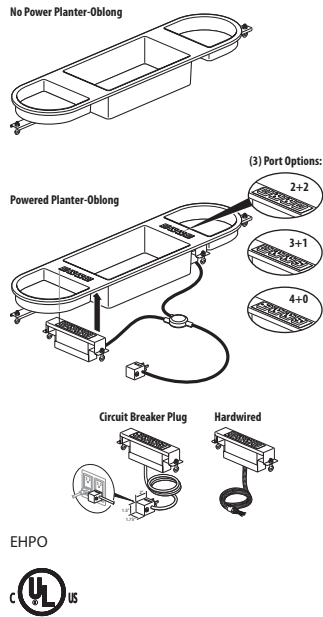

Features

- Includes planter, brackets, and mounting hardware.
- Available in Black, Smooth Plaster, Gray Tone, and Terra Cotta.
- Available with or without power.
- When ordering with power option:
 - Includes 2 power modules with a total of 8 ports that can be configured with simplex outlets (NEMA-5-15R), or USB charging simplex outlets (with 2 USB outlets). No data or cable bay options are available.
 - Includes cable management clips.
- Corded option combines both power modules into a single NEMA-5-15P style circuit breaker plug.
- Power modules are UL listed.

To Order, Specify:

- 1) Product number.
- 2) Trim finish.

Specification Tips

- The no power option cannot be modified for power in the field.
- Specify the power and USB port options (1 configuration for both power modules).
- Power modules are color matched to the planter.
- Installs in a factory cut work surface.
- Planter, brackets, and power modules are field installed. Hand tighten mounting hardware to avoid deformation of the planter.
- For use with 120 volt, 60 hertz power source only.
- Application may require approval of local authority having jurisdiction (AHJ); ensure compliance before placing orders and installation.

Width	Bezel Depth	Cord Length	Port	Configuration (per side)	Number	Price
No Power						
					EHPO-000M-00	\$ 652.00
Corded						
		6'(1829mm)	8	4 Power Receptacles	EHPO-PF0M-40	\$1542.00
				3 Power Receptacles, 1 USB Charging	EHPO-PF0M-31	1602.00
				2 Power Receptacles, 2 USB Charging	EHPO-PF0M-22	1662.00
		12'(3658mm)	8	4 Power Receptacles	EHPO-PL0M-40	\$1591.00
				3 Power Receptacles, 1 USB Charging	EHPO-PL0M-31	1651.00
				2 Power Receptacles, 2 USB Charging	EHPO-PL0M-22	1711.00
		21'(6401mm)	8	4 Power Receptacles	EHPO-PW0M-40	\$1640.00
				3 Power Receptacles, 1 USB Charging	EHPO-PW0M-31	1700.00
				2 Power Receptacles, 2 USB Charging	EHPO-PW0M-22	1760.00
Hardwire						
		6'(1829mm)	8	4 Power Receptacles	EHPO-HF0M-40	\$1676.00
				3 Power Receptacles, 1 USB Charging	EHPO-HF0M-31	1736.00
				2 Power Receptacles, 2 USB Charging	EHPO-HF0M-22	1796.00
		12'(3658mm)	8	4 Power Receptacles	EHPO-HL0M-40	\$1725.00
				3 Power Receptacles, 1 USB Charging	EHPO-HL0M-31	1785.00
				2 Power Receptacles, 2 USB Charging	EHPO-HL0M-22	1845.00

Planter — Round

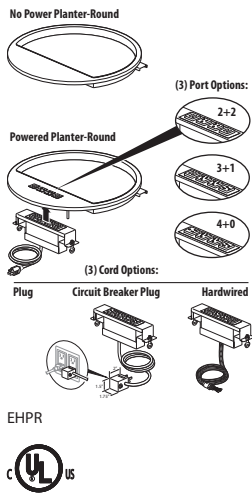

Features

- Includes planter, brackets, and mounting hardware.
- Available in Black, Smooth Plaster, Gray Tone, and Terra Cotta.
- Available with and without power.
- When ordering with power option:
 - Includes a power module with a total of 4 ports that can be configured with simplex outlets (NEMA-5-15R), or USB charging simplex outlets (with 2 USB outlets). No data or cable bay options are available.
- Power module is UL listed.

To Order, Specify:

- 1) Product number.
- 2) Trim finish.

Specification Tips

- The no power option cannot be modified for power in the field.
- **Choosing 4 power ports and 0 USB requires the use of a NEMA-5-15P style circuit breaker plug.**
- Power modules are color matched to the planter.
- Installs in a factory cut work surface.
- Planter, brackets, and power modules are field installed. Hand tighten mounting hardware to avoid deformation of the planter.
- For use with 120 volt, 60 hertz power source only.
- Application may require approval of local authority having jurisdiction (AHJ); ensure compliance before placing orders and installation.

Width	Bezel Depth	Cord Length	Port	Configuration	Number	Price
No Power						
					EHPR-000M-00	\$ 535.00
Corded						
		6'(1829mm)	4	4 Power Receptacles	EHPR-PF0M-40	\$1147.00
				3 Power Receptacles, 1 USB Charging	EHPR-PF0M-31	1207.00
				2 Power Receptacles, 2 USB Charging	EHPR-PF0M-22	1267.00
		12'(3658mm)	4	4 Power Receptacles	EHPR-PL0M-40	\$1196.00
				3 Power Receptacles, 1 USB Charging	EHPR-PL0M-31	1256.00
				2 Power Receptacles, 2 USB Charging	EHPR-PL0M-22	1316.00
		21'(6401mm)	4	4 Power Receptacles	EHPR-PW0M-40	\$1245.00
				3 Power Receptacles, 1 USB Charging	EHPR-PW0M-31	1305.00
				2 Power Receptacles, 2 USB Charging	EHPR-PW0M-22	1365.00
Hardwire						
		6'(1829mm)	4	4 Power Receptacles	EHPR-HF0M-40	\$1281.00
				3 Power Receptacles, 1 USB Charging	EHPR-HF0M-31	1341.00
				2 Power Receptacles, 2 USB Charging	EHPR-HF0M-22	1401.00
		12'(3658mm)	4	4 Power Receptacles	EHPR-HL0M-40	\$1330.00
				3 Power Receptacles, 1 USB Charging	EHPR-HL0M-31	1390.00
				2 Power Receptacles, 2 USB Charging	EHPR-HL0M-22	1450.00

Conference Table Tops for use with Column Base

EXAMPLE: Planes, Rectangle, 48" x 120", Wood, Edgeband, Standard Core, Center Double-Sided 12 Outlet Cutout, Column Base.

TA RA - 48 C0 - W K S Q B N N N

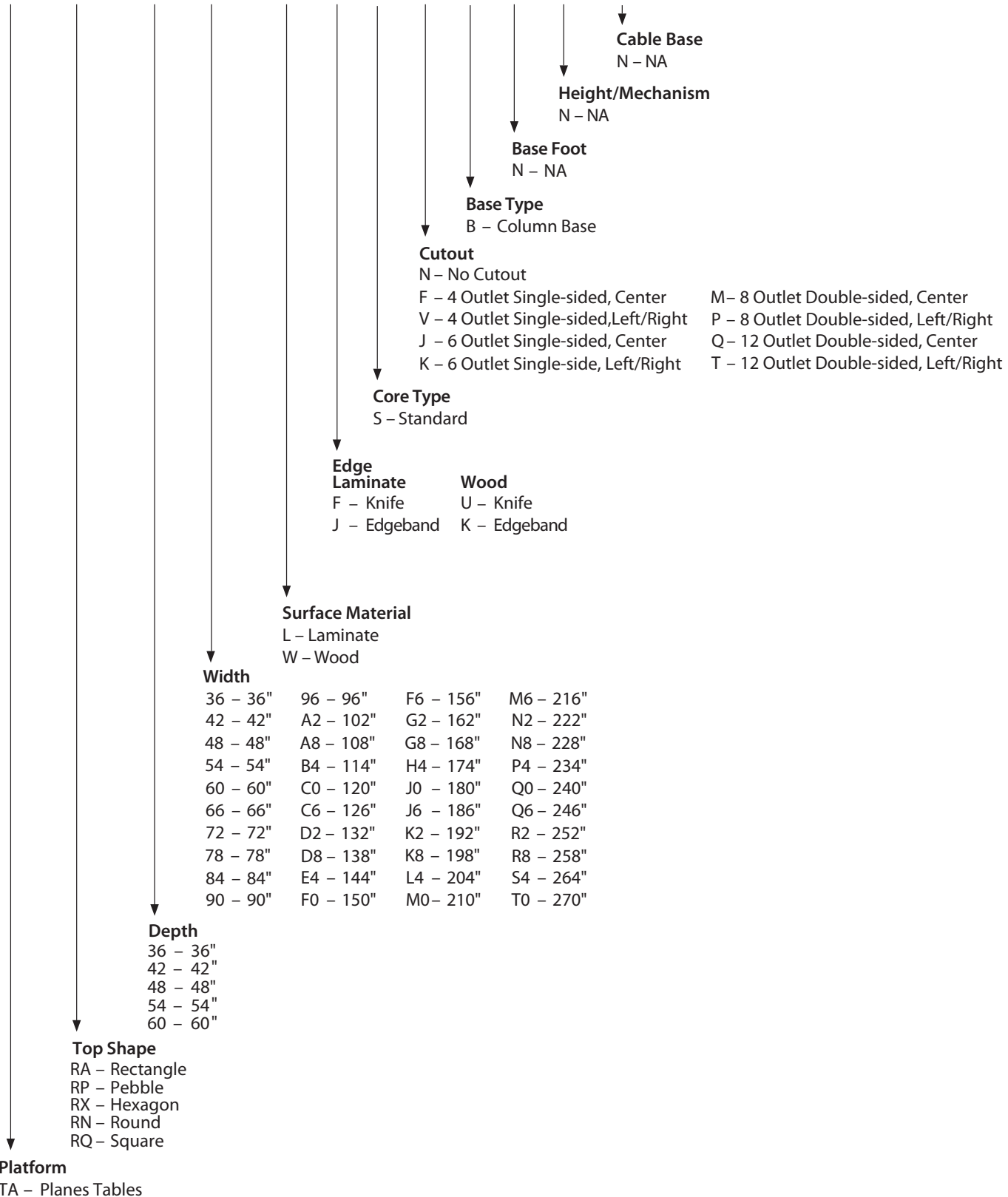

Component Specification Overview

Planes Conference Table with Column Base

Planes Conference Top(s), Column Base(s), and J-Channel(s) are separately specified. See below for required component specification.

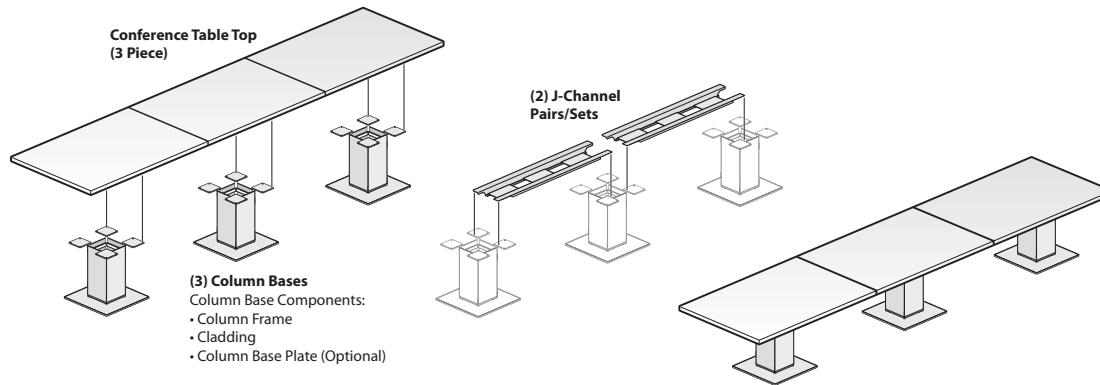

1 Conference Top

- The number of tops depend on the width of the conference table. Top options include a 1-piece top, 2-piece top or 3-piece top.

Column Base

Each Column Base requires separately specified components: **Column Frame, Column Base Plate, and Cladding.**

2 Column Frame

- Column Frames are square and are available in two sizes, 9"(229mm) & 12"(305mm) square, and three heights, 20"(508mm) lounge height, 28"(711mm) seated height and 40"(1016mm) standing height.
 - The table top width and the number of pieces dictate the quantity of column frame(s). **Refer to Matrix-A for details.**
 - The table top depth dictates the column frame size, 9"(229mm) or 12"(305mm) square. **Refer to Matrix-B for details.**

3 Column Base Plate

- Round or Square Column Base Plates are available in four sizes: 21"(533mm), 24"(610mm), 27"(686mm) and 30"(762mm).
 - The column base plate size is specific to the column frame size of 9"(229mm) or 12"(305mm); specify accordingly.
 - The column frame width and the table top depth dictate the size of the column base plate. **Refer to Matrix-B for details.**

4 Cladding

- Round or Flat Cladding is available in two widths, 9"(229mm) & 12"(305mm), and three heights, 20"(508mm) lounge height, 28"(711mm) seated height and 40"(1016mm) standing height. (Exception: Round cladding is not available 40" high)
 - Cladding is specified as one single piece per catalog number. A quantity of (4) pieces are required per each Column Frame.
 - Note: All round or flat, or a combination of round and flat cladding may be used on a column frame.
 - Specify cladding to match the column frame width and height.

5 J-Channel

- Provides wire management and the required support below the Conference Table Top.
 - J-Channel is specified as one pair per catalog number. A pair of J-Channels are used between each column base.
 - The table top width and column size dictate the number of pairs and length of J-Channel. **Refer to Matrix-A for details.**

J-Channel Tray - Optional

- J-Channel Trays are optional and provide additional wire management between columns; lays in J-Channels.
 - Specify J-Channel Tray width to match Column Frame size.
 - The J-Channel length dictates the maximum number of J-Channel Trays. **Refer to Matrix A for details.**

Component Specification Overview

Planes Conference Table with Column Base

MATRIX - A

Column Frame Quantity & J Channel Quantity and Size - Specification Matrix							
Table Width	Number of Pieces in Top	Number of Column Frames	Number of Pairs of J Channel	9"(229mm) x 9"(229mm) Column Frame		12"(305mm) x 12"(305mm) Column Frame	
				J Channel Length	# of Trays (Maximum)	J Channel Length	# of Trays (Maximum)
96"(2438mm)	1	2	1	29"(737mm)	1	26"(660mm)	1
102"(2591mm)	1	2	1	35"(889mm)	1	32"(813mm)	1
108"(2743mm)	1	2	1	41"(1041mm)	2	38"(965mm)	2
114"(2896mm)	1	2	1	47"(1194mm)	2	44"(1118mm)	2
120"(3048mm)	1	2	1	53"(1346mm)	3	50"(1270mm)	2
126"(3200mm)	2	2	1	59"(1499mm)	3	56"(1422mm)	3
132"(3353mm)	2	2	1	65"(1651mm)	3	62"(1575mm)	3
138"(3505mm)	2	2	1	71"(1803mm)	4	68"(1727mm)	4
144"(3658mm)	2	2	1	77"(1956mm)	4	74"(1880mm)	4
150"(3810mm)	2	2	1	83"(2108mm)	5	80"(2032mm)	5
156"(3962mm)	2	2	1	89"(2261mm)	5	86"(2184mm)	5
162"(4115mm)	2	2	1	95"(2413mm)	6	92"(2337mm)	5
168"(4267mm)	2	2	1	101"(2565mm)	6	98"(2489mm)	6
174"(4420mm)	2	3	2	50"(1270mm)	2	47"(1194mm)	2
180"(4572mm)	2	3	2	53"(1346mm)	3	50"(1270mm)	2
186"(4724mm)	3	3	2	56"(1422mm)	3	53"(1346mm)	3
192"(4877mm)	3	3	2	59"(1499mm)	3	56"(1422mm)	3
198"(5029mm)	3	3	2	62"(1575mm)	3	59"(1499mm)	3
204"(5182mm)	3	3	2	65"(1651mm)	3	62"(1575mm)	3
210"(5334mm)	3	3	2	68"(1727mm)	4	65"(1651mm)	3
216"(5486mm)	3	3	2	71"(1803mm)	4	68"(1727mm)	4
222"(5639mm)	3	3	2	74"(1880mm)	4	71"(1803mm)	4
228"(5791mm)	3	3	2	77"(1956mm)	4	74"(1880mm)	4
234"(5944mm)	3	3	2	80"(2032mm)	5	77"(1956mm)	4
240"(6096mm)	3	3	2	83"(2108mm)	5	80"(2032mm)	5
246"(6248mm)	3	3	2	86"(2184mm)	5	83"(2108mm)	5
252"(6401mm)	3	3	2	89"(2261mm)	5	86"(2184mm)	5
258"(6553mm)	3	3	2	92"(2337mm)	5	89"(2261mm)	5
264"(6706mm)	3	3	2	92"(2337mm)	6	92"(2337mm)	5
270"(6858mm)	3	3	2	98"(2489mm)	6	95"(2413mm)	6

MATRIX - B

Column Frame Size & Column Base Plate Size - Specification Matrix					
Table Depth	9"(229mm) x 9"(229mm) Column Frame		12"(305mm) x 12"(305mm) Column Frame		
	21"(533mm) Base Plate (Round or Square)	24"(610mm) Base Plate (Round or Square)	24"(610mm) Base Plate (Round or Square)	27"(686mm) Base Plate (Round or Square)	30"(762mm) Base Plate (Round or Square)
36"(914mm)	✓	✓	✓	✓	✓
42"(1067mm)		✓	✓	✓	✓
48"(1219mm)				✓	✓
54"(1372mm)				✓ (Square only)	✓
60"(1524mm)				✓ (Square only)	✓

Planes Conference Table Top — Round, Square and Pebble (for use with Column Base)

Laminate or Wood



TARN

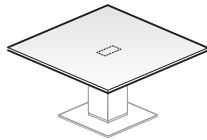

TARQ



TARP

Features

- Includes 1 3/16"(30mm) thick top.
- Laminate top with 3mm edgeband or knife, based upon shape.
- Wood veneer top with wood edgeband, knife or cascade edge.
- Top available in standard core.
- **Requires separately specified Column Base and J Channels.**
- Optional power modules are separately specified.
- Depth and width shown in nominal dimensions.

Specification Tips

- Conference Top requires separately specified components for Column Base:
 - Column Frame
 - Column Base Plate
 - Cladding (4) pieces per each Column Frame
- Conference Top requires separately specified J Channels for support and load purposes.
- Cutouts are optional. If specified they are factory installed.
- Each cutout requires a separately specified flip top unit electrical module or a select workware interface module (see workware price list).
- Separately specified Planes grommets are available for field installation.
- For separately specified required components refer to the **Component Specification Overview** located in the front of the price list; see Planes Conference Table Tops (for use with Column Base).

To Order, Specify:

- 1) Product number, including;

1 Surface Options:

- L** Laminate
- W** Wood

2 Edge Options:

Laminate:

- J** Edgeband
- F** Knife

Wood:

- K** Wood Edgeband
- U** Knife

3 Cutout Options:

- N** No Cutout
- F** Center, Single-Sided/4 outlets, add **\$31.86** list
- J** Center, Single-Sided/6 outlets, add **\$31.86** list
- M** Center, Double-Sided/8 outlets, add **\$31.86** list
- Q** Center, Double-Sided/12 outlets, add **\$31.86** list

- 2) Laminate surface color or wood finish color.

- 3) Edgeband trim color (laminate only).

No. of Pieces	Seating Capacity*	Depth	Width	Number ① ② ③	Laminate A		Laminate B		Wood Group A		Wood Group B	
					J	F	J	F	K	U	K	U
Round												
1	4	36"(914mm)	36"(914mm)	TARN-3636-■ ■ S ■ BNNN	N/A	N/A	N/A	N/A	\$ 710.29	\$ 924.10	\$ 733.64	\$ 965.74
1	4	42"(1067mm)	42"(1067mm)	TARN-4242-■ ■ S ■ BNNN	N/A	N/A	N/A	N/A	927.16	1235.95	963.91	1299.74
1	4	48"(1219mm)	48"(1219mm)	TARN-4848-■ ■ S ■ BNNN	N/A	N/A	N/A	N/A	1173.85	1596.49	1225.84	1685.89
1	8	54"(1372mm)	54"(1372mm)	TARN-5454-■ ■ S ■ BNNN	N/A	N/A	N/A	N/A	1450.36	2006.27	1519.43	2124.80
1	8	60"(1524mm)	60"(1524mm)	TARN-6060-■ ■ S ■ BNNN	N/A	N/A	N/A	N/A	1756.69	2464.24	1844.68	2615.32
Square												
1	4	36"(914mm)	36"(914mm)	TARQ-3636-■ ■ S ■ BNNN	\$ 368.13	\$ 572.29	\$ 431.44	\$ 635.60	\$ 710.29	\$ 924.10	\$ 733.64	\$ 965.74
1	4	42"(1067mm)	42"(1067mm)	TARQ-4242-■ ■ S ■ BNNN	518.24	749.76	597.93	829.45	927.16	1235.95	963.91	1299.74
1	4	48"(1219mm)	48"(1219mm)	TARQ-4848-■ ■ S ■ BNNN	690.41	949.29	789.00	1047.88	1173.85	1596.49	1225.84	1685.89
1	8	54"(1372mm)	54"(1372mm)	TARQ-5454-■ ■ S ■ BNNN	884.64	1170.88	1004.65	1290.89	1450.36	2006.27	1519.43	2124.80
1	8	60"(1524mm)	60"(1524mm)	TARQ-6060-■ ■ S ■ BNNN	1100.93	1414.53	1244.88	1558.48	1756.69	2464.24	1844.68	2615.32
Pebble												
1	4	36"(914mm)	36"(914mm)	TARP-3636-■ ■ S ■ BNNN	N/A	N/A	N/A	N/A	\$ 710.29	\$ 924.10	\$ 733.64	\$ 965.74
1	4	42"(1067mm)	42"(1067mm)	TARP-4242-■ ■ S ■ BNNN	N/A	N/A	N/A	N/A	927.16	1235.95	963.91	1299.74
1	4	48"(1219mm)	48"(1219mm)	TARP-4848-■ ■ S ■ BNNN	N/A	N/A	N/A	N/A	1173.85	1596.49	1225.84	1685.89
1	8	54"(1372mm)	54"(1372mm)	TARP-5454-■ ■ S ■ BNNN	N/A	N/A	N/A	N/A	1450.36	2006.27	1519.43	2124.80
1	8	60"(1524mm)	60"(1524mm)	TARP-6060-■ ■ S ■ BNNN	N/A	N/A	N/A	N/A	1756.69	2464.24	1844.68	2615.32

*Recommended seating capacity based upon 27"(687mm) per chair.

This page intentionally blank

Planes Conference Table Top — Rectangle (for use with Column Base)

Laminate or Wood

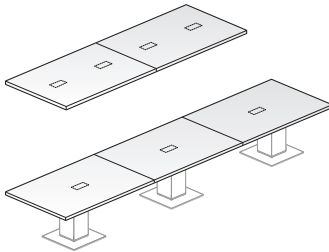

TARA

Features

- Includes 1 3/16”(30mm) thick top.
- Laminate top with 3mm edgeband or knife edge, or wood veneer top with 3mm wood edgeband or knife edge on user edges. Multiple piece tops are 1mm edgeband at the seams.
- Single piece laminate top with T-mold, or cascade edge. Multiple piece top available with 3mm edgeband, knife, T-mold, or cascade edge.
- Wood veneer top with wood edgeband, cascade or knife.
- Table top seams are 1mm edgeband.
- **Requires separately specified Column Base and J Channels.**
- Optional power modules are separately specified.
- Depth and width shown in nominal dimensions.

Specification Tips

- Multiple piece conference tops have equal sized pieces and are shipped unassembled.
- Conference Top requires separately specified components for Column Base:
 - Column Frame
 - Column Base Plate
 - Cladding (4) pieces per each Column Frame
- Conference Top requires separately specified J Channels for support and load purposes.
- Cutouts are optional. If specified they are factory installed.
- Each cutout requires a separately specified flip top unit electrical module or a select workware interface module (see workware price list).
- Separately specified Planes grommets are available for field installation.
- For separately specified required components refer to the **Component Specification Overview** located in the front of the price list; see Planes Conference Table Tops (for use with Column Base).

3 Cutout Options			
Cutout	1 Piece	2 Piece	3 Piece
F	\$31.86	\$ 63.72	\$ 95.58
V	\$63.72	\$127.44	\$191.16
J	\$31.86	\$ 63.72	\$ 95.58
K	\$63.72	\$127.44	\$191.16
M	\$31.86	\$ 63.72	\$ 95.58
P	\$63.72	\$127.44	\$191.16
Q	\$31.86	\$ 63.72	\$ 95.58
T	\$63.72	\$127.44	\$191.16

To Order, Specify:

1) Product number, including;

1 Surface Options:

- L** Laminate
- W** Wood

2 Edge Options:

Laminate:

- J** Edgeband
- F** Knife

Wood:

- K** Wood Edgeband
- U** Knife

3 Cutout Options:

- N** No Cutout
- F** Center, Single-Sided/4 outlets, see chart for upcharge
- V** Left/Right, Single-Sided/4 outlets, see chart for upcharge
- J** Center, Single-Sided/6 outlets, see chart for upcharge
- K** Left/Right, Single-Sided/6 outlets, see chart for upcharge
- M** Center, Double-Sided/8 outlets, see chart for upcharge
- P** Left/Right, Double-Sided/8 outlets, see chart for upcharge
- Q** Center, Double-Sided/12 outlets, see chart for upcharge
- T** Left/Right, Double-Sided/12 outlets, see chart for upcharge

2) Laminate surface color or wood finish color.

3) Edgeband trim color (laminate only).

This page intentionally blank

Planes Conference Table Top — Pebble (for use with Column Base)

Laminate or Wood

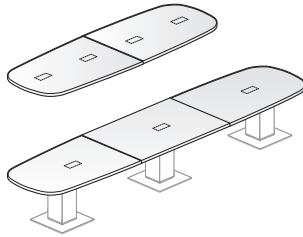

TARP

Features

- Includes 1 3/16”(30mm) thick top(s).
- Laminate top with 3mm edgeband or knife edge, or wood veneer top with 3mm wood edgeband or knife edge on user edges. Multiple piece tops are 1mm edgeband at the seams.
- Table top seams are 1mm edgeband.
- **Requires separately specified Column Base and J Channels.**
- Optional power modules are separately specified.
- Depth and width shown in nominal dimensions.

Specification Tips

- Multiple piece conference tops have equal sized pieces and are shipped unassembled.
- Conference Top requires separately specified components for Column Base:
 - Column Frame
 - Column Base Plate
 - Cladding (4) pieces per each Column Frame
- Conference Top requires separately specified J Channels for support and load purposes.
- Cutouts are optional. If specified they are factory installed.
- Each cutout requires a separately specified flip top unit electrical module or a select workware interface module (see workware price list).
- Separately specified Planes grommets are available for field installation.
- For separately specified required components refer to the **Component Specification Overview** located in the front of the price list; see Planes Conference Table Tops (for use with Column Base).

3 Cutout Options			
Cutout	1 Piece	2 Piece	3 Piece
F	\$31.86	\$ 63.72	\$ 95.58
V	\$63.72	\$127.44	\$191.16
J	\$31.86	\$ 63.72	\$ 95.58
K	\$63.72	\$127.44	\$191.16
M	\$31.86	\$ 63.72	\$ 95.58
P	\$63.72	\$127.44	\$191.16
Q	\$31.86	\$ 63.72	\$ 95.58
T	\$63.72	\$127.44	\$191.16

To Order, Specify:

1) Product number, including;

1 Surface Options:

- L** Laminate
- W** Wood

2 Edge Options:

Laminate:

- J** Edgeband
- F** Knife

Wood:

- K** Wood Edgeband
- U** Knife

3 Cutout Options:

- N** No Cutout
- F** Center, Single-Sided/4 outlets, see chart for upcharge
- V** Left/Right, Single-Sided/4 outlets, see chart for upcharge
- J** Center, Single-Sided/6 outlets, see chart for upcharge
- K** Left/Right, Single-Sided/6 outlets, see chart for upcharge
- M** Center, Double-Sided/8 outlets, see chart for upcharge
- P** Left/Right, Double-Sided/8 outlets, see chart for upcharge
- Q** Center, Double-Sided/12 outlets, see chart for upcharge
- T** Left/Right, Double-Sided/12 outlets, see chart for upcharge

2) Laminate surface color or wood finish color.

3) Edgeband trim color (laminated only).

Planes Conference Table Top — Hexagon (for use with Column Base)

Laminate or Wood

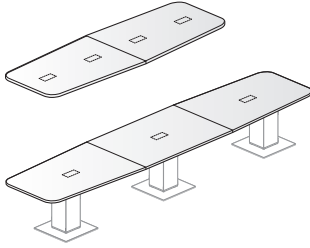

TARX

Features

- Includes 1 3/16”(30mm) thick top(s).
- Laminate top with 3mm edgeband or knife edge, or wood veneer top with 3mm wood edgeband or knife edge on user edges. Multiple piece tops are 1mm edgeband at the seams.
- Table top seams are 1mm edgeband.
- **Requires separately specified Column Base and J Channels.**
- Optional power modules are separately specified.
- Depth and width shown in nominal dimensions.

Specification Tips

- Multiple piece conference tops have equal sized pieces and are shipped unassembled.
- Conference Top requires separately specified components for Column Base:
 - Column Frame
 - Column Base Plate
 - Cladding (4) pieces per each Column Frame
- Conference Top requires separately specified J Channels for support and load purposes.
- Cutouts are optional. If specified they are factory installed.
- Each cutout requires a separately specified flip top unit electrical module or a select workware interface module (see workware price list).
- Separately specified Planes grommets are available for field installation.
- For separately specified required components refer to the **Component Specification Overview** located in the front of the price list; see Planes Conference Table Tops (for use with Column Base).

3 Cutout Options			
Cutout	1 Piece	2 Piece	3 Piece
F	\$31.86	\$ 63.72	\$ 95.58
V	\$63.72	\$127.44	\$191.16
J	\$31.86	\$ 63.72	\$ 95.58
K	\$63.72	\$127.44	\$191.16
M	\$31.86	\$ 63.72	\$ 95.58
P	\$63.72	\$127.44	\$191.16
Q	\$31.86	\$ 63.72	\$ 95.58
T	\$63.72	\$127.44	\$191.16

To Order, Specify:

1) Product number, including;

1 Surface Options:

- L** Laminate
- W** Wood

2 Edge Options:

Laminate:

- J** Edgeband
- F** Knife

Wood:

- K** Wood Edgeband
- U** Knife

3 Cutout Options:

- N** No Cutout
- F** Center, Single-Sided/4 outlets, see chart for upcharge
- V** Left/Right, Single-Sided/4 outlets, see chart for upcharge
- J** Center, Single-Sided/6 outlets, see chart for upcharge
- K** Left/Right, Single-Sided/6 outlets, see chart for upcharge
- M** Center, Double-Sided/8 outlets, see chart for upcharge
- P** Left/Right, Double-Sided/8 outlets, see chart for upcharge
- Q** Center, Double-Sided/12 outlets, see chart for upcharge
- T** Left/Right, Double-Sided/12 outlets, see chart for upcharge

2) Laminate surface color or wood finish color.

3) Edgeband trim color (laminated only).

This page intentionally blank

Planes End Supported Top — workware Tables

EXAMPLE: Planes, Key Conference End, 60" x 66", Laminate, Knife Edge, Standard Core, workware 4 Port Wide Switching, Center, Column Base

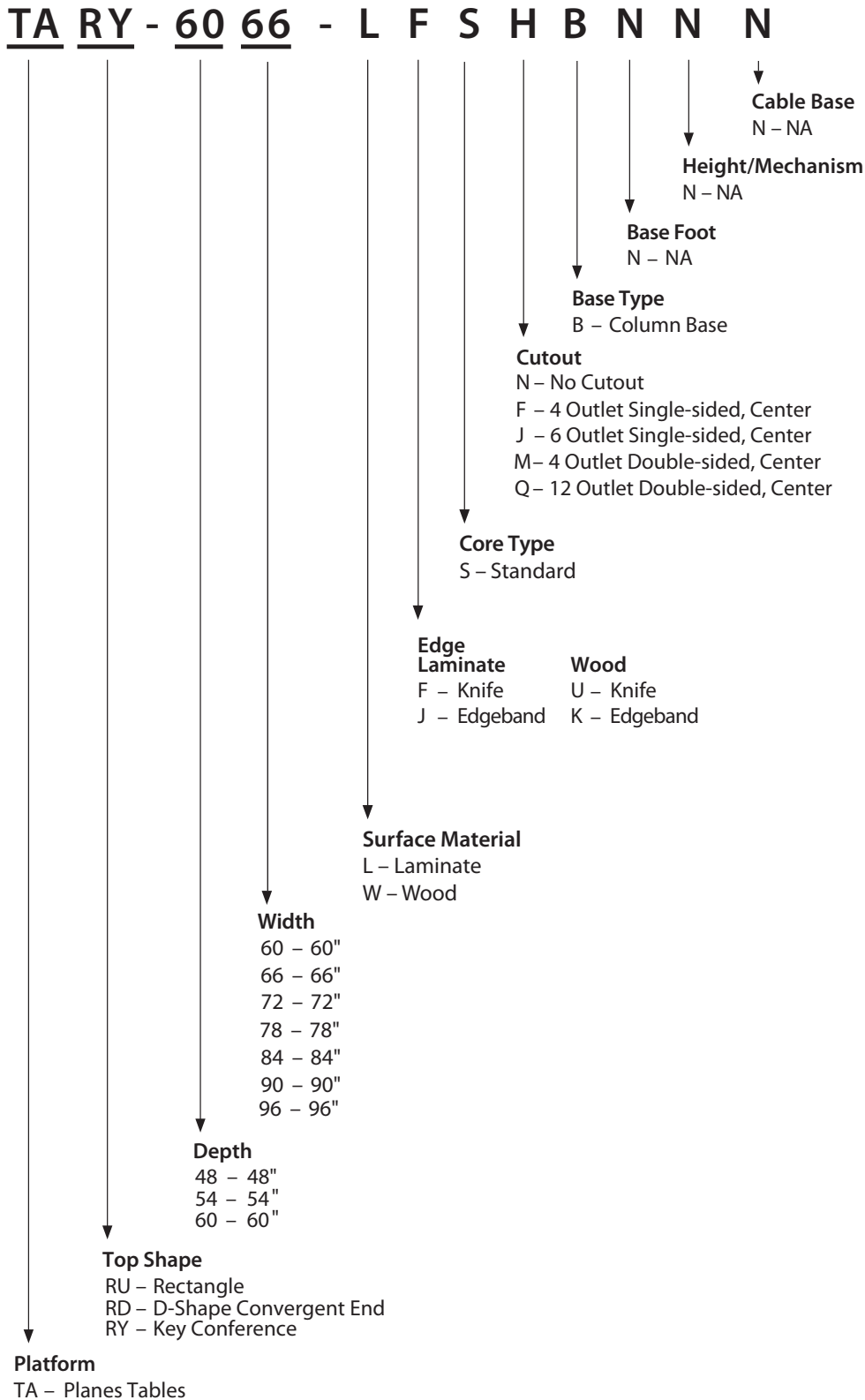

workware Cutouts

- C – 4 Port Narrow switching, Center
- D – 4 Port Narrow non-switching, Center
- E – 6 Port Narrow switching, Center
- H – 4 Port Wide switching, Center
- L – 6 Port Wide switching, Center
- W – 4 Port Wide non-switching, Center

Component Specification Overview

Planes End Supported Top with Column Base

The outboard end of an End Supported Top requires a column base for floor support and the opposite end requires brackets for attachment to a structural wall, Compose or Enclose panel. See below for required component specification.

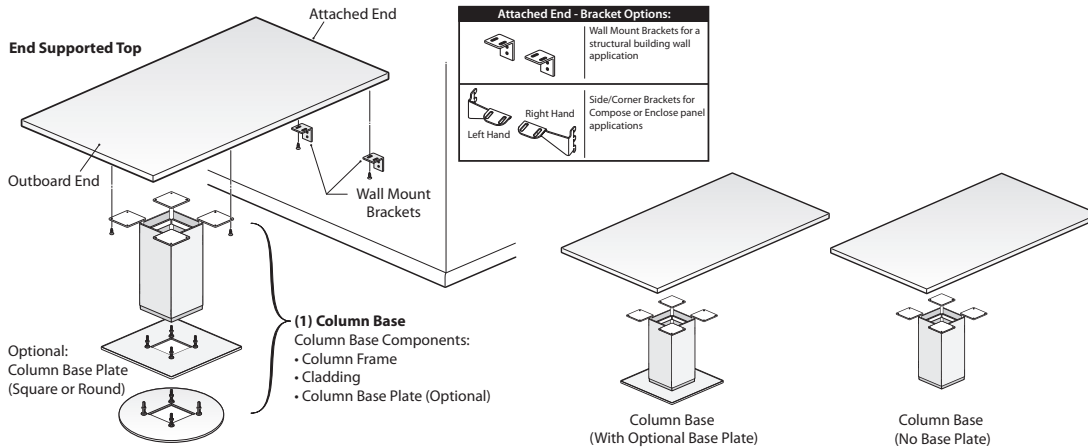

1 End Supported Top

- Always a 1-piece top.
 - Requires one column base for floor support and brackets for attachment to a structural building wall, Compose or Enclose panel.

Floor Support: Column Base

Each Column Base requires separately specified components: **Column Frame and Cladding. The Column Base Plate is optional.**

2 Column Frame

- Column Frames are square and are available in two sizes, 9”(229mm) & 12”(305mm) square, and three heights, 20”(508mm) lounge height, 28”(711mm) seated height and 40”(1016mm) standing height.
 - One Column Frame is required per End Supported Top.
 - The table top depth dictates the column frame size, 9”(229mm) or 12”(305mm) square. **Refer to Matrix-A for details.**

3 Column Base Plate - Optional

- **Column Base Plate is an optional component for an End Support Top.** (Note: Required for a Conference Table with Column Base)
- Round or Square Column Base Plates are available in four sizes: 21”(533mm), 24”(610mm), 27”(686mm) and 30”(762mm).
 - The column base plate size is specific to the column frame size of 9”(229mm) or 12”(305mm); specify accordingly.
 - The column frame width and the table top depth dictate the size of the column base plate. **Refer to Matrix-A for details.**

4 Cladding

- Round or Flat Cladding is available in two widths, 9”(229mm) & 12”(305mm), and three heights, 20”(508mm) lounge height, 28”(711mm) seated height and 40”(1016mm) standing height. (Exception: Round cladding is not available 40" high)
 - Cladding is specified as one single piece per catalog number. A quantity of (4) pieces are required per each Column Frame.
 - Note: All round or flat, or a combination of round and flat cladding may be used on a column frame.
 - Specify cladding to match the column frame width and height.

NOTE: J-Channel and J-Channel Tray are not required for an End Supported Top.

MATRIX - A

Column Frame Size / Base Plate Size - Specification Matrix					
Table Depth	9”(229mm) x 9”(229mm) Column Frame		12”(305mm) x 12”(305mm) Column Frame		
	21”(533mm) Base Plate (Round or Square)	24”(610mm) Base Plate (Round or Square)	24”(610mm) Base Plate (Round or Square)	27”(686mm) Base Plate (Round or Square)	30”(762mm) Base Plate (Round or Square)
36”(914mm)	✓	✓	✓	✓	✓
42”(1067mm)		✓	✓	✓	✓
48”(1219mm)				✓	✓
54”(1372mm)				✓	✓
60”(1524mm)				✓	✓

Component Specification Overview

Planes End Supported Top with Column Base

Attached End: Bracket Options

The attached end of the End Supported Top requires separately specified attachment brackets for a structural building wall, Compose or Enclose panel.

5 Specify the appropriate type of attachment bracket and quantity per End Supported Top application. See below for options:

Structural Building Wall Application

- Specify the required quantity to accommodate the depth of the End Supported Top.

Wall Mount Bracket

Bracket Quantity	
Depth of End Supported Top	Number of Brackets Required
36"(914mm)-42"(1067mm)	Quantity: (2)
48"(1219mm)-60"(1524mm)	Quantity: (3)

Compose and/or Enclose Panel Application

- Specify the appropriate side/corner bracket per worktop edge option. One left- and one right-hand bracket is required per Compose or Enclose panel for an attached End Supported Top.

For use with Edgeband trim:

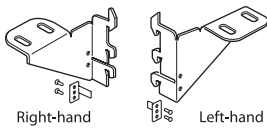

Side/Corner Bracket

For use with Cascade, T-Mold and Knife edge trim options:

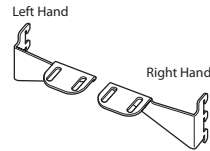

Side Bracket for use with Knife Edge

Planes End Supported Top — D-Shape Convergent (for use with Column Base)

Laminate or Wood

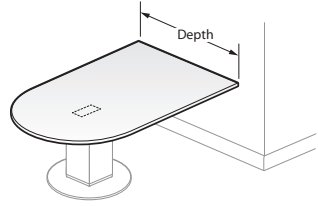

TARD

Features

- Includes 1 3/16" (30mm) thick top.
- Laminate top with knife edge or 3mm edgeband edges or wood veneer top with 3mm wood edgeband or knife edge. Edgeband tops are 3mm on user edge and 1mm on end supported edge.
- **Requires separately specified Column Base for one end and support brackets for opposite end.**
- Optional power modules are separately specified.
- Depth and width shown in nominal dimensions.

Specification Tips

- Each end of top requires separate support components:
One end of top requires separately specified components for Column Base:
 - Column Frame
 - Cladding (4) pieces per each Column Frame
 - Optional Column Base Plate can also be specified
- **Opposite End of top requires support brackets for attachment to the building wall or support brackets for Enclose or Compose.**
- Does not require J Channels.
- Cutouts are optional. If specified they are factory installed.
- Each cutout requires a separately specified flip top unit electrical module or a select workware interface module (see workware price list).
- Separately specified Planes grommets are available for field installation.
- For separately specified required components refer to the **Component Specification Overview** located in the front of the price list; see Planes End Supported Tops (for use with Column Base).

To Order, Specify:

1) Product number, including;

① Surface Options:

- L** Laminate
- W** Wood

② Edge Options:

Laminate:

- J** Edgeband
- F** Knife

Wood:

- K** Wood Edgeband
- U** Knife

③ Cutout Options:

- N** No Cutout
- F** Center, Single-Sided/4 outlets, add **\$31.86** list
- J** Center, Single-Sided/6 outlets, add **\$31.86** list
- M** Center, Double-Sided/8 outlets, add **\$31.86** list
- Q** Center, Double-Sided/12 outlets, add **\$31.86** list

workware Switching:

- C** Center, 4 Port Narrow Switching, add **\$31.86** list
- E** Center, 6 Port Narrow Switching, add **\$31.86** list
- H** Center, 4 Port Wide Switching, add **\$31.86** list
- L** Center, 6 Port Wide Switching, add **\$31.86** list

workware Non-Switching:

- D** Center, 4 Port Narrow Non-Switching, add **\$31.86** list
- W** Center, 4 Port Wide Non-Switching, add **\$31.86** list

2) Laminate surface color or wood finish color.

3) Edge trim color (laminated only).

Planes End Supported Top — D-Shape Convergent (for use with Column Base)

Laminate or Wood

Depth	Width	Number ① ② ③	Laminate A		Laminate B		Wood Group A		Wood Group B	
			J	F	J	F	K	U	K	U
42"(1067mm)	48"(1219mm)	TARD-4248- S BNNN	\$ 581.82	\$ 825.22	\$ 656.01	\$ 899.41	\$ 968.51	\$1227.39	\$1061.44	\$1354.08
	54"(1372mm)	TARD-4254- S BNNN	662.13	919.09	745.28	1002.24	1094.67	1380.24	1210.38	1533.96
	60"(1524mm)	TARD-4260- S BNNN	742.44	1012.96	834.55	1105.07	1221.09	1534.86	1359.64	1715.92
	66"(1676mm)	TARD-4266- S BNNN	822.75	1106.83	923.82	1207.90	1347.77	1691.25	1509.20	1899.95
	72"(1829mm)	TARD-4272- S BNNN	903.06	1200.70	1013.09	1310.73	1474.71	1849.41	1659.08	2086.06
48"(1219mm)	48"(1219mm)	TARD-4848- S BNNN	\$ 673.26	\$ 930.22	\$ 757.69	\$1014.65	\$1109.15	\$1382.62	\$1227.41	\$1536.88
	54"(1372mm)	TARD-4854- S BNNN	764.70	1035.22	859.37	1129.89	1251.99	1552.90	1396.01	1737.31
	60"(1524mm)	TARD-4860- S BNNN	856.14	1140.22	961.05	1245.13	1395.09	1724.96	1564.93	1939.82
	66"(1676mm)	TARD-4866- S BNNN	947.58	1245.22	1062.73	1360.37	1538.45	1898.79	1734.16	2144.40
	72"(1829mm)	TARD-4872- S BNNN	1039.02	1350.22	1164.41	1475.61	1682.06	2074.38	1903.70	2351.05
54"(1372mm)	54"(1372mm)	TARD-5454- S BNNN	\$ 867.27	\$1151.35	\$ 973.46	\$1257.54	\$1409.31	\$1725.57	\$1581.64	\$1940.67
	60"(1524mm)	TARD-5460- S BNNN	969.84	1267.48	1087.55	1385.19	1569.08	1915.06	1770.23	2163.72
	66"(1676mm)	TARD-5466- S BNNN	1072.41	1383.61	1201.64	1512.84	1729.12	2106.32	1959.12	2388.85
	72"(1829mm)	TARD-5472- S BNNN	1174.98	1499.74	1315.73	1640.49	1889.42	2299.36	2148.33	2616.05
60"(1524mm)	60"(1524mm)	TARD-6060- S BNNN	\$1083.54	\$1394.74	\$1214.05	\$1525.25	\$1743.08	\$2105.16	\$1975.52	\$2387.62
	66"(1676mm)	TARD-6066- S BNNN	1197.24	1522.00	1340.55	1665.31	1919.80	2313.86	2184.09	2633.29
	72"(1829mm)	TARD-6072- S BNNN	1310.94	1649.26	1467.05	1805.37	2096.77	2524.33	2392.96	2881.04
	78"(1981mm)	TARD-6078- S BNNN	1424.64	1776.52	1593.55	1945.43	2274.01	2736.57	2602.14	3130.86
	84"(2134mm)	TARD-6084- S BNNN	1538.34	1903.78	1720.05	2085.49	2451.51	2950.58	2811.63	3382.75

*Recommended seating capacity based upon 27"(687mm) per chair.

Planes End Supported Top — Rectangular Conference End (for use with Column Base)

Laminate or Wood

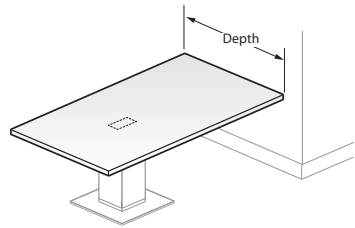

Features

- Includes 1 3/16" (30mm) thick top.
- Laminate top with knife edge or 3mm edgeband edges or wood veneer top with 3mm wood edgeband or knife edge. Edgeband tops are 3mm on user edge and 1mm on end supported edge.
- **Requires separately specified Column Base for one end and support brackets for opposite end.**
- Optional power modules are separately specified.
- Depth and width shown in nominal dimensions.

Specification Tips

- Each end of top requires separate support components:
One end of top requires separately specified components for Column Base:
 - Column Frame
 - Cladding (4) pieces per each Column Frame
 - Optional Column Base Plate can also be specified
- **Opposite End of top requires support brackets for attachment to the building wall or support brackets for Enclose or Compose.**
- Does not require J Channels.
- Cutouts are optional. If specified they are factory installed.
- Each cutout requires a separately specified flip top unit electrical module or a select workware interface module (see workware price list).
- Separately specified Planes grommets are available for field installation.
- For separately specified required components refer to the **Component Specification Overview** located in the front of the price list; see Planes End Supported Tops (for use with Column Base).

To Order, Specify:

1) Product number, including;

① Surface Options:

- L** Laminate
- W** Wood

② Edge Options:

Laminate:

- J** Edgeband
- F** Knife

Wood:

- K** Wood Edgeband
- U** Knife

③ Cutout Options:

- N** No Cutout
- F** Center, Single-Sided/4 outlets, add **\$31.86** list
- J** Center, Single-Sided/6 outlets, add **\$31.86** list
- M** Center, Double-Sided/8 outlets, add **\$31.86** list
- Q** Center, Double-Sided/12 outlets, add **\$31.86** list

workware Switching:

- C** Center, 4 Port Narrow Switching, add **\$31.86** list
- E** Center, 6 Port Narrow Switching, add **\$31.86** list
- H** Center, 4 Port Wide Switching, add **\$31.86** list
- L** Center, 6 Port Wide Switching, add **\$31.86** list

workware Non-Switching:

- D** Center, 4 Port Narrow Non-Switching, add **\$31.86** list
- W** Center, 4 Port Wide Non-Switching, add **\$31.86** list

2) Laminate surface color or wood finish color.

3) Edge trim color (laminated cascade only).

Planes End Supported Top — Rectangular Conference End (for use with Column Base)

Laminate or Wood

Depth	Width	Number ① ② ③	Laminate A		Laminate B		Wood Group A		Wood Group B	
			J	F	J	F	K	U	K	U
36"(914mm)	48"(1219mm)	TARU-3648- S BNNN	\$ 490.38	\$ 720.22	\$ 554.33	\$ 784.17	\$ 827.88	\$1072.16	\$ 895.48	\$1171.27
	54"(1372mm)	TARU-3654- S BNNN	559.56	802.96	631.19	874.59	937.36	1207.58	1024.76	1330.61
	60"(1524mm)	TARU-3660- S BNNN	628.74	885.70	708.05	965.01	1047.10	1344.76	1154.34	1492.02
	66"(1676mm)	TARU-3666- S BNNN	697.92	968.44	784.91	1055.43	1157.10	1483.72	1284.24	1655.51
	72"(1829mm)	TARU-3672- S BNNN	767.10	1051.18	861.77	1145.85	1267.35	1624.44	1414.45	1821.06
42"(1067mm)	48"(1219mm)	TARU-4248- S BNNN	\$ 581.82	\$ 825.22	\$ 656.01	\$ 899.41	\$ 968.51	\$1227.39	\$1061.44	\$1354.08
	54"(1372mm)	TARU-4254- S BNNN	662.13	919.09	745.28	1002.24	1094.67	1380.24	1210.38	1533.96
	60"(1524mm)	TARU-4260- S BNNN	742.44	1012.96	834.55	1105.07	1221.09	1534.86	1359.64	1715.92
	66"(1676mm)	TARU-4266- S BNNN	822.75	1106.83	923.82	1207.90	1347.77	1691.25	1509.20	1899.95
	72"(1829mm)	TARU-4272- S BNNN	903.06	1200.70	1013.09	1310.73	1474.71	1849.41	1659.08	2086.06
48"(1219mm)	48"(1219mm)	TARU-4848- S BNNN	\$ 673.26	\$ 930.22	\$ 757.69	\$1014.65	\$1109.15	\$1382.62	\$1227.41	\$1536.88
	54"(1372mm)	TARU-4854- S BNNN	764.70	1035.22	859.37	1129.89	1251.99	1552.90	1396.01	1737.31
	60"(1524mm)	TARU-4860- S BNNN	856.14	1140.22	961.05	1245.13	1395.09	1724.96	1564.93	1939.82
	66"(1676mm)	TARU-4866- S BNNN	947.58	1245.22	1062.73	1360.37	1538.45	1898.79	1734.16	2144.40
	72"(1829mm)	TARU-4872- S BNNN	1039.02	1350.22	1164.41	1475.61	1682.06	2074.38	1903.70	2351.05
54"(1372mm)	54"(1372mm)	TARU-5454- S BNNN	\$ 867.27	\$1151.35	\$ 973.46	\$1257.54	\$1409.31	\$1725.57	\$1581.64	\$1940.67
	60"(1524mm)	TARU-5460- S BNNN	969.84	1267.48	1087.55	1385.19	1569.08	1915.06	1770.23	2163.72
	66"(1676mm)	TARU-5466- S BNNN	1072.41	1383.61	1201.64	1512.84	1729.12	2106.32	1959.12	2388.85
	72"(1829mm)	TARU-5472- S BNNN	1174.98	1499.74	1315.73	1640.49	1889.42	2299.36	2148.33	2616.05
60"(1524mm)	60"(1524mm)	TARU-6060- S BNNN	\$1083.54	\$1394.74	\$1214.05	\$1525.25	\$1743.08	\$2105.16	\$1975.52	\$2387.62
	66"(1676mm)	TARU-6066- S BNNN	1197.24	1522.00	1340.55	1665.31	1919.80	2313.86	2184.09	2633.29
	72"(1829mm)	TARU-6072- S BNNN	1310.94	1649.26	1467.05	1805.37	2096.77	2524.33	2392.96	2881.04
	78"(1981mm)	TARU-6078- S BNNN	1424.64	1776.52	1593.55	1945.43	2274.01	2736.57	2602.14	3130.86
	84"(2134mm)	TARU-6084- S BNNN	1538.34	1903.78	1720.05	2085.49	2451.51	2950.58	2811.63	3382.75

*Recommended seating capacity based upon 27"(687mm) per chair.

Planes End Supported Top — Key Conference (for use with Column Base)

Laminate or Wood

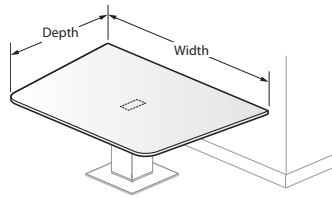

TARY

Features

- Includes 1 3/16" (30mm) thick top.
- Laminate top with knife edge or 3mm edgeband edges or wood veneer top with 3mm wood edgeband or knife edge. Edgeband tops are 3mm on user edge and 1mm on end supported edge.
- **Requires separately specified Column Base for one end and support brackets for opposite end.**
- Optional power modules are separately specified.
- Depth and width shown in nominal dimensions.

Specification Tips

- Each end of top requires separate support components:
One end of top requires separately specified components for Column Base:
 - Column Frame
 - Cladding (4) pieces per each Column Frame
 - Optional Column Base Plate can also be specified
- **Opposite End of top requires support brackets for attachment to the building wall or support brackets for Enclose or Compose.**
- Does not require J Channels.
- Cutouts are optional. If specified they are factory installed.
- Each cutout requires a separately specified flip top unit electrical module or a select workware interface module (see workware price list).
- Separately specified Planes grommets are available for field installation.
- For separately specified required components refer to the **Component Specification Overview** located in the front of the price list; see Planes End Supported Tops (for use with Column Base).

To Order, Specify:

1) Product number, including;

① Surface Options:

- L** Laminate
- W** Wood

② Edge Options:

Laminate:

- J** Edgeband
- F** Knife

Wood:

- K** Wood Edgeband
- U** Knife

③ Cutout Options:

- N** No Cutout
- F** Center, Single-Sided/4 outlets, add **\$31.86** list
- J** Center, Single-Sided/6 outlets, add **\$31.86** list
- M** Center, Double-Sided/8 outlets, add **\$31.86** list
- Q** Center, Double-Sided/12 outlets, add **\$31.86** list

workware Switching:

- C** Center, 4 Port Narrow Switching, add **\$31.86** list
- E** Center, 6 Port Narrow Switching, add **\$31.86** list
- H** Center, 4 Port Wide Switching, add **\$31.86** list
- L** Center, 6 Port Wide Switching, add **\$31.86** list

workware Non-Switching:

- D** Center, 4 Port Narrow Non-Switching, add **\$31.86** list
- W** Center, 4 Port Wide Non-Switching, add **\$31.86** list

2) Laminate surface color or wood finish color.

3) Edge trim color (laminated cascade only).

Planes End Supported Top — Key Conference (for use with Column Base)

Laminate or Wood

Depth	Width	Number ① ② ③	Laminate A		Laminate B		Wood Group A		Wood Group B	
			J	F	J	F	K	U	K	U
42"(1067mm)	42"(1067mm)	TARY-4242-■ ■ S BNNN	\$ 501.51	\$ 731.35	\$ 566.74	\$ 796.58	\$ 842.61	\$1076.31	\$ 912.81	\$1176.26
	48"(1219mm)	TARY-4248-■ ■ S BNNN	581.82	825.22	656.01	899.41	968.51	1227.39	1061.44	1354.08
	54"(1372mm)	TARY-4254-■ ■ S BNNN	662.13	919.09	745.28	1002.24	1094.67	1380.24	1210.38	1533.96
	60"(1524mm)	TARY-4260-■ ■ S BNNN	742.44	1012.96	834.55	1105.07	1221.09	1534.86	1359.64	1715.92
48"(1219mm)	48"(1219mm)	TARY-4848-■ ■ S BNNN	\$ 673.26	\$ 930.22	\$ 757.69	\$1014.65	\$1109.15	\$1382.62	\$1227.41	\$1536.88
	54"(1372mm)	TARY-4854-■ ■ S BNNN	764.70	1035.22	859.37	1129.89	1251.99	1552.90	1396.01	1737.31
	60"(1524mm)	TARY-4860-■ ■ S BNNN	856.14	1140.22	961.05	1245.13	1395.09	1724.96	1564.93	1939.82
	66"(1676mm)	TARY-4866-■ ■ S BNNN	947.58	1245.22	1062.73	1360.37	1538.45	1898.79	1734.16	2144.40
	72"(1829mm)	TARY-4872-■ ■ S BNNN	1039.02	1350.22	1164.41	1475.61	1682.06	2074.38	1903.70	2351.05
54"(1372mm)	54"(1372mm)	TARY-5454-■ ■ S BNNN	\$ 867.27	\$1151.35	\$ 973.46	\$1257.54	\$1409.31	\$1725.57	\$1581.64	\$1940.67
	60"(1524mm)	TARY-5460-■ ■ S BNNN	969.84	1267.48	1087.55	1385.19	1569.08	1915.06	1770.23	2163.72
	66"(1676mm)	TARY-5466-■ ■ S BNNN	1072.41	1383.61	1201.64	1512.84	1729.12	2106.32	1959.12	2388.85
	72"(1829mm)	TARY-5472-■ ■ S BNNN	1174.98	1499.74	1315.73	1640.49	1889.42	2299.36	2148.33	2616.05
60"(1524mm)	60"(1524mm)	TARY-6060-■ ■ S BNNN	\$1083.54	\$1394.74	\$1214.05	\$1525.25	\$1743.08	\$2105.16	\$1975.52	\$2387.62
	66"(1676mm)	TARY-6066-■ ■ S BNNN	1197.24	1522.00	1340.55	1665.31	1919.80	2313.86	2184.09	2633.29
	72"(1829mm)	TARY-6072-■ ■ S BNNN	1310.94	1649.26	1467.05	1805.37	2096.77	2524.33	2392.96	2881.04
	78"(1981mm)	TARY-6078-■ ■ S BNNN	1424.64	1776.52	1593.55	1945.43	2274.01	2736.57	2602.14	3130.86
	84"(2134mm)	TARY-6084-■ ■ S BNNN	1538.34	1903.78	1720.05	2085.49	2451.51	2950.58	2811.63	3382.75

*Recommended seating capacity based upon 27"(687mm) per chair.

Planes End Supported Top (for use with Column Base) — Bracket(s)

	Description	Number	Price						
 ZUBW-0000-PN	Single	ZUBW-0000-PN	\$23.63						
	Features <ul style="list-style-type: none"> Includes one wall mount bracket and attachment hardware to top. Screws/anchors for attachment to wall are field supplied. Supports one end of a Planes End Supported Top. Standard in black finish only. 		To Order, Specify: <ol style="list-style-type: none"> Product number. (No finish specification required.) 						
Specification Tips <ul style="list-style-type: none"> Supports the straight end of an End Supported Top in a wall mount application. Opposite end of top requires a column base. Number of brackets required is dependent on depth of the End Supported Top; see chart for quantity. Must be properly anchored to a structural wall. 									
Wall Mount Bracket Requirement: <table border="1"> <thead> <tr> <th>Width of End Supported Top</th> <th>Number of Brackets Required</th> </tr> </thead> <tbody> <tr> <td>36"-42"</td> <td>Quantity: (2)</td> </tr> <tr> <td>48"-60"</td> <td>Quantity: (3)</td> </tr> </tbody> </table>				Width of End Supported Top	Number of Brackets Required	36"-42"	Quantity: (2)	48"-60"	Quantity: (3)
Width of End Supported Top	Number of Brackets Required								
36"-42"	Quantity: (2)								
48"-60"	Quantity: (3)								

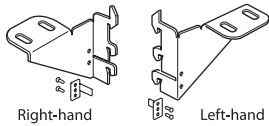
	Description	Number	Price
 Right-hand ZZBA-0000-PR ZZBA-0000-PL Left-hand	Right-hand	ZZBA-0000-PR	\$19.61
	Left-hand	ZZBA-0000-PL	\$19.61
Features <ul style="list-style-type: none"> Includes one left- or right-hand bracket, mounting screws and dislodgement clip. Standard in charcoal finish. Installs into Compose or Enclose panel frame slots and attaches to top. For use with Edgeband trim only. 		To Order, Specify: <ol style="list-style-type: none"> Product number. (No finish specification required.) 	
Specification Tips <ul style="list-style-type: none"> Supports the straight end of an End Supported Top in a Compose or Enclose panel mount application. Opposite end of top requires a column base. A left- and right-hand bracket is required for one End Supported Top. 			

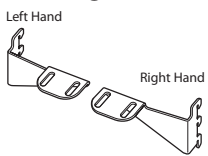
	Description	Number	Price
 Left Hand Right Hand ZZBA-0000-PRF ZZBA-0000-PLF	Right-hand	ZZBA-0000-PRF	\$57.93
	Left-hand	ZZBA-0000-PLF	\$57.93
Features <ul style="list-style-type: none"> Includes one left- or right-hand bracket, mounting screws and dislodgement clip. Installs into Compose or Enclose panel frame slots and attaches to top. For use with Knife Edge, Cascade and T-Mold trim options. 		To Order, Specify: <ol style="list-style-type: none"> Product number. Trim color. <p>Note: \$15.60 upcharge list for Metallic and accent trim colors.</p>	
Specification Tips <ul style="list-style-type: none"> Supports the straight end of an End Supported Top in a Compose or Enclose panel mount application. Opposite end of top requires a column base. A left- and right-hand bracket is required for one End Supported Top with Knife edge trim option, only. 			

Planes Conference Table — Column Base (for use with Conference Table Top and End Supported Top)

Column Frame

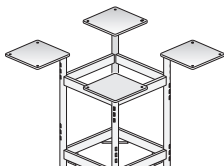
	Height	Depth	Width	Number	Price
	20"(508mm)	21"(533mm)	9"(229mm)	TACB-0900-2	\$889.10
			24"(610mm)	12"(305mm)	TACB-1200-2
	28"(711mm)	21"(533mm)	9"(229mm)	TACB-0900-4	\$899.81
			24"(610mm)	12"(305mm)	TACB-1200-4
	40"(1016mm)	21"(533mm)	9"(229mm)	TACB-0900-7	\$942.66
			24"(610mm)	12"(305mm)	TACB-1200-7

TACB-2

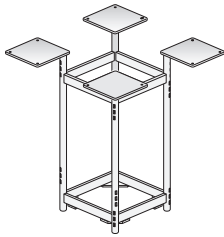

TACB-4

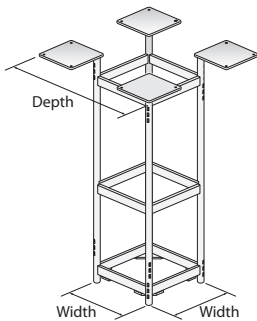

TACB-7

Features

- Includes one black square column frame, glides and mounting hardware.
- Available in two widths, 9"(229mm) x 9"(229mm) or 12"(305mm) x 12"(305mm), and three heights, 20"(508mm), 28"(711mm) or 40"(1016mm).
- Glide adjustment is 1/2" (13mm).
- For use with Planes Conference Table Top and End Supported Top.
- The quantity and width of the column frame is dependent on the top size.
- Requires separately specified cladding and column base plate (Exception: base plate is optional for End Supported Top.)

To Order, Specify:

- 1) Product number.
(No finish specification required.)

Specification Tips

- For workware at lounge height wireless is recommended.
- Specify cladding to match column frame height and width.
- Specify column base plate to match column frame width.
- For separately specified required components refer to the **Component Specification Overview** located in the front of the price list.

Planes Conference Table — Column Base (for use with Conference Table Top and End Supported Top)

Column Base Plate — Square and Round

Size	For use with Column Frame Width	Number	Paint A	B
Square				
21"(533mm)	9"(229mm)	TAPL-2109-SA	\$562.38	\$574.16
24"(610mm)	9"(229mm)	TAPL-2409-SA	\$669.50	\$681.28
	12"(305mm)	TAPL-2412-SA	669.50	681.28
27"(686mm)	12"(305mm)	TAPL-2712-SA	\$776.62	\$788.40
Round				
21"(533mm)	9"(229mm)	TAPL-2109-RA	\$508.82	\$520.60
24"(610mm)	9"(229mm)	TAPL-2409-RA	\$615.94	\$627.72
	12"(305mm)	TAPL-2412-RA	615.94	627.72
27"(686mm)	12"(305mm)	TAPL-2712-RA	\$723.06	\$734.84
30"(762mm)	12"(305mm)	TAPL-3012-RA	\$937.30	\$949.08

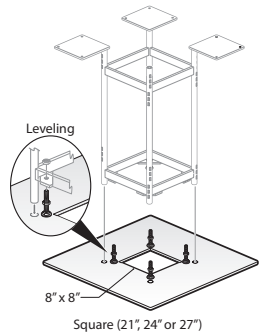

TAPL-S

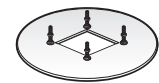

Round (21", 24" or 27" dia.)

TAPL-R

Features

- Includes 3/8" thick square or round column base plate with attached glides.
- A base plate with a 8"(203mm)x 8"(203mm) cutout accepts a 12"(305mm) column frame; base plate with a 6"(152mm) x 6"(152mm) cutout accepts a 9"(229mm) column frame.
- Column base plate attachment hardware is included with the column frame.
- The column base plate levels by adjusting the attachment hardware; 0.75"(19mm) adjustment range.
- Available in a painted finish.

To Order, Specify:

- 1) Product number.
- 2) Paint surface color.

Specification Tips

- Specify the appropriate column base plate size for use with a 9"(229mm) or 12"(305mm) column frame width.
- For use with separately specified column frame and cladding.
- Column Base Plate is required for Planes Conference Table Top and is optional for End Supported Top.
- For separately specified required components refer to the **Component Specification Overview** located in the front of the price list.

Planes Conference Table — Column Base (for use with Conference Table Top and End Supported Top)

Cladding — Flat and Round

Frame Height	Frame Width	Number ¹	Paint		Wood Group A	Group B
			A	B		
Flat						
20"(508mm)	9"(229mm)	TACC-0900- F2	\$246.38	\$251.74	\$567.74	\$575.24
	12"(305mm)	TACC-1200- F2	257.09	262.45	578.45	586.49
28"(711mm)	9"(229mm)	TACC-0900- F4	\$257.09	\$262.45	\$578.45	\$585.95
	12"(305mm)	TACC-1200- F4	267.80	273.16	589.16	597.20
40"(1016mm)	9"(229mm)	TACC-0900- F7	\$267.80	\$273.16	\$589.16	\$596.66
	12"(305mm)	TACC-1200- F7	278.51	283.87	599.87	607.91
Round						
20"(508mm)	9"(229mm)	TACC-0900- R2	\$257.09	\$262.45	\$578.45	\$585.95
	12"(305mm)	TACC-1200- R2	267.80	273.16	589.16	597.20
28"(711mm)	9"(229mm)	TACC-0900- R4	\$267.80	\$273.16	\$589.16	\$596.66
	12"(305mm)	TACC-1200- R4	278.51	283.87	599.87	607.91

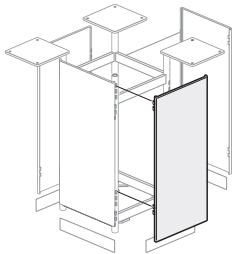

TACC-F2

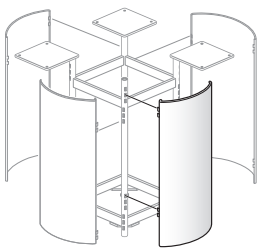

TACC-R2

Features

- Includes one piece painted or wood veneer cladding and light block for a square column frame .
- Each square column frame requires a quantity of four: flat, round or a combination of flat and round.
- Flat cladding is available in three heights 20"(508mm), 28"(711mm) or 40"(1016mm) and two widths 9"(229mm) or 12"(305mm).
- Round Cladding is available in two heights 20"(508mm) or 28"(711mm) and two widths 9"(229mm) or 12"(305mm).
- Attaches in column frame slots and is removable for easy access.
- Cladding is steel and available painted or veneer wrapped.

Specification Tips

- Specify cladding to match column frame height and width.
- Specify a quantity of (4) cladding pieces for each column frame. Individual pieces may be all flat, all round, or a combination of flat and round pieces. Surfaces may be all paint, all wood veneer or mixed surfaces.
- Specify column base plate to match column frame width.
- For separately specified required components refer to the **Component Specification Overview** located in the front of the price list.

To Order, Specify:

- 1) Product number, including:

1 Surface Option:

- P** Paint
- W** Wood Veneer

- 2) Paint surface color or wood finish color.

Planes Conference Table — Column Base (for use with Conference Table Top)

J-Channels

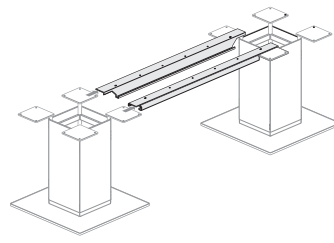

	Width	Number	Price
J-Channel	26"(660mm)	TAJC-2600	\$242.09
	29"(737mm)	TAJC-2900	270.58
	32"(813mm)	TAJC-3200	298.70
	35"(889mm)	TAJC-3500	326.82
	38"(965mm)	TAJC-3800	354.94
	41"(1041mm)	TAJC-4100	383.06
	44"(1118mm)	TAJC-4400	411.55
	47"(1194mm)	TAJC-4700	439.67
	50"(1270mm)	TAJC-5000	467.79
	53"(1346mm)	TAJC-5300	495.91
	56"(1422mm)	TAJC-5600	524.03
	59"(1499mm)	TAJC-5900	552.52
	62"(1575mm)	TAJC-6200	580.64
	65"(1651mm)	TAJC-6500	608.76
	68"(1727mm)	TAJC-6800	636.88
	71"(1803mm)	TAJC-7100	665.00
	74"(1880mm)	TAJC-7400	693.49
	77"(1956mm)	TAJC-7700	721.61
	80"(2032mm)	TAJC-8000	749.73
	83"(2108mm)	TAJC-8300	777.85
86"(2184mm)	TAJC-8600	805.97	
89"(2261mm)	TAJC-8900	834.46	
92"(2337mm)	TAJC-9200	862.58	
95"(2413mm)	TAJC-9500	890.70	
98"(2489mm)	TAJC-9800	918.82	
101"(2565mm)	TAJC-A100	946.94	

TAJC

Features

- Includes one pair of J-Channels and mounting hardware.
- Provides wire management and support below the Conference Table Top.
- Attaches to the underside of the Conference Table Top with screws.
- The Conference Table Top width and the column frame size determines the J-Channel width.
- Field-installed.
- Available in black finish color only.

To Order, Specify:

- 1) Product number.
(No finish specification required.)

Specification Tips

- J-Channels are required for Planes Conference Table Top.
- J-Channels are not required for Planes End Supported Tops.
- For separately specified required components refer to the **Component Specification Overview** located in the front of the price list.

J-Channel Tray	9"(229mm)	TA01-JT09	\$10.40
	12"(305mm)	TA01-JT12	10.40

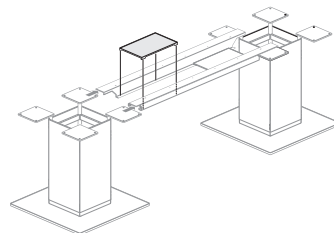

TA01

Features

- Includes one J-Channel Tray.
- Provides additional wire management between columns; wires lay in J-Channels.
- Field-installed.
- Available in black finish color only.

To Order, Specify:

- 1) Product number.
(No finish specification required.)

Specification Tips

- J-Channel Tray is an optional component.
- Specify the appropriate size for use with a 9"(229mm) or 12"(305mm) wide column frame.

Electrical Accessories

	Description	Extension Length	Number	Price
Cable Reel	60"(1524mm) HDMI	48"(1219mm)	TA01-CR48-H	\$624.00
	60"(1524mm) VGA	48"(1219mm)	TA01-CR48-V	624.00

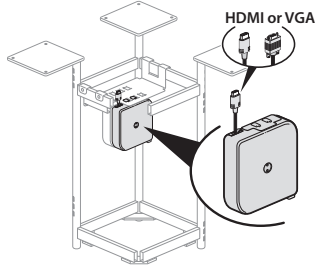

TA01-CR48

Features

- Includes cable reel with spring loaded retractor mechanism with one cable which can extend 48"(1219mm).
- Cable Reel available with one VGA or one HDMI cable.
- VGA Cable Reel has female VGA connector on housing for connection of VGA patch cable.
- HDMI Cable Reel has female HDMI connector on housing for connection of HDMI patch cable.
- VGA or HDMI patch cable typically routes to TV Monitor or workware video processor.
- VGA cable conveys video only - no audio content.
- Black only.

To Order, Specify:

- 1) Product number.
(No finish specification required.)

Specification Tips

- For use with cable reel bracket, column frame and power modules equipped with cable bay(s), seated, standing or lounge height column frame.
- Separately specify cable reel bracket.
- VGA or HDMI Cable required to route from cable reel to TV monitor or workware video processor.
- Cable reels compatible with the following power modules specified with cable bay(s):
 - workware interface
 - flip top power module
 - flush mount power module

	Description	Number	Price
Cable Reel Bracket	9"(229mm)	TA01-CRBK-T09	\$41.60
	12"(305mm)	TA01-CRBK-T12	41.60

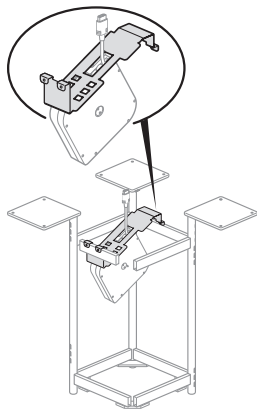

TA01-CRBK

Features

- Includes bracket and mounting hardware to mount cable reels to column frame.
- 9"(229mm) cable reel bracket for use with 9"(229mm) column frame and allows mounting of up to two cable reels.
- 12"(305mm) cable reel bracket for use with 12"(305mm) column frame and allows mounting of up to four cable reels.
- Available in black only.

To Order, Specify:

- 1) Product number.
(No finish specification required.)

Specification Tips

- For use with 9"(229mm) or 12"(305mm) base frames, seated, standing or lounge heights.
- Specify VGA or HDMI cable reels separately.
- Specify column frame, cladding, power module and table separately.

Electrical Accessories

	Height	Number	Price
Cable Management Processor Bracket	21"(533mm)	TA01-PB21	\$41.60

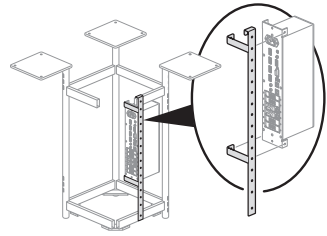

TA01-PB21

Features

- Includes mounting hardware to mount workware processor or cable management products to column frame.
- Provides multiple mounting holes for attaching cable ties or other cable management products.
- Available in black only.

Specification Tips

- For use with 9"(229mm) or 12"(305mm) column frame and power modules equipped with cable bay(s).
- For use with seated and standing height column frame.
- Not required for use with Cable Retractor (workware processor mounts to Cable Retractor).
- Recommend for use with Cable Reels and workware Processor.
- Not for use with lounge height column frame.

To Order, Specify:

- 1) Product number.
(No finish specification required.)

Cable Base Cable Retractor	Description	Width	Length	Number	Price
	2 Cable Chute	4 1/2"(114mm)	22"(559mm)	EWCX-BRWM-2A	\$341.78
	4 Cable Chute	7 1/2"(191mm)	22"(559mm)	EWCX-BRWM-4A	\$530.51

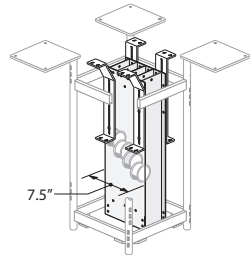
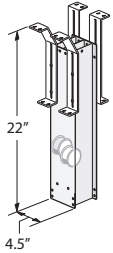

EWCX-BRWM

Features

- Includes chute, weights and mounting hardware.
- Installs on the underside of the table top.
- For use with separately ordered Cable Base, Column Base, workware Interface Module, Flip Top Unit or Flush Mount Power Module to retract cables from table top.
- Provides 34"(864mm) of cable travel.
- Provides vertical cable management within the Column Base.
- Isolates user cables from other data and power connection cables within the Column Base.

Specification Tips

- Order Cable Base, Column Base, cables and workware Interface Module separately.
- One cable per chute.
- Requires 1/4"(6mm) diameter cables or less.
- workware processor can be mounted to the side of the chute when used with 9" x 9"(229mm x 229mm) or 12" x 12"(305mm x 305mm) column base.
- For use with seated or standing height Column Base.
- Not for use with lounge height Column Base.
- 2 cable chute fits in 9" x 9"(229mm x 229mm) or 12" x 12"(305mm x 305mm) Column Base.
- 4 cable chute fits in 12" x 12"(305mm x 305mm) Column Base.

To Order, Specify:

- 1) Product number.
(No finish specification required.)

Planes Accessories

	Height	Depth	Width	Number	Laminate A	B	Wood Group A	Group B
Cable Base	Laminate							
	28"(711mm)	8"(203mm)	14"(356mm)	TA01-0814-L	\$591.33	\$638.76		
		14"(356mm)	14"(356mm)	TA01-1414-L	629.90	680.62		
	Wood							
	28"(711mm)	8"(203mm)	14"(356mm)	TA01-0814-W			\$ 999.53	\$1029.32
		14"(356mm)	14"(356mm)	TA01-1414-W			1067.50	1112.69

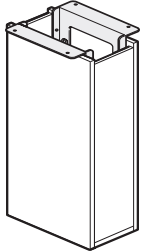

TA01-0814

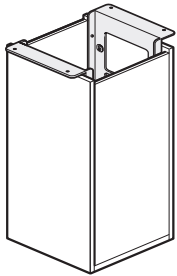

TA01-1414

Features

- Includes 28"(711mm) high cable base and mounting hardware.
- Laminate with 1mm edgeband or wood veneer with 1mm wood edgeband.
- Provides internal cable management with removable panels for access.
- Standard in green core.
- Bracket is standard in charcoal.
- Includes 1"(25mm) adjustable glides.
- Ships assembled.

To Order, Specify:

- 1) Product number.
- 2) Laminate surface color or wood finish color.
- 3) Edge trim color for laminate.

Specification Tips

- Refer to Specification Guide for use guidelines.
- **Cable base not recommended for use with 30"(762mm) deep tables, half round tables, polygon tables or Y-leg tables or 36"(914mm) deep tables with (M) or (Q) flip top unit cutout options.**
- Specify 8"(203mm) x 14"(356mm) cable base for 36"(914mm) deep tables.
- Specify 14"(356mm) x 14"(356mm) cable base for 42"(1067mm) deep and deeper tables.
- One and two-piece table tops – one cable base.
- Three-piece table tops – two cable bases.
- Cable base cord access:
 - 1 1/2"(38mm) at top
 - adjustable side panels allow 1"(25mm) gap at bottom edges
 - 8"(203mm) depth base has a 3"(76mm) deep cutout in bottom;
 - 14"(356mm) depth base has an 8"(203mm) deep cutout in bottom.

The following Planes products are separately specified:

- Horizontal wire management

Cable Column	Height	Depth	Width	Number	Price
	28"(711mm)	2"(51mm)	4 1/2"(114mm)	TA01-0217	\$214.65



TA01-0217

Features

- Cable Column offers a wire management option for conference tables when the Cable Base Option cannot be used.
- Includes one Cable Column with mounting hardware for attaching to underside of table.
- Hardware for attaching Cable Column to floor is field supplied.
- Ships unassembled.

To Order, Specify:

- 1) Product number.
- 2) Trim color.

Specification Tips

- Cable Column attaches to underside of table, extends to the floor where it is also attached.
- Cable Column is not load bearing and does not replace table leg(s).
- Cable Column can be installed anywhere under a conference table unless it would interfere with table legs, Horizontal Wire Manager or Flip Top Power/Data Units.
- The Cable Column can be used with the Horizontal Wire Manager for cable management.

Planes Accessories

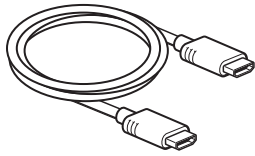
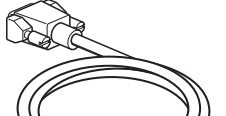
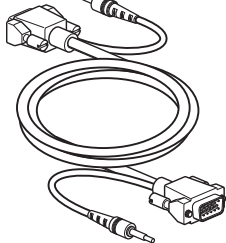
	Length	Description	Number	Price
 <p>EWCX-H</p>  <p>EWCX-5001-V</p>  <p>EWCX-V</p>	3'(914mm)	HDMI – male/male	EWCX-0301-H	\$ 86.62
	6'(1829mm)	HDMI – male/male	EWCX-0601-H	115.49
	10'(3048mm)	HDMI – male/male	EWCX-1001-H	125.11
	15'(4572mm)	HDMI – male/male	EWCX-1501-H	181.11
	25'(7620mm)	HDMI – male/male	EWCX-2501-H	293.10
	50'(15240mm)	HDMI – male/male	EWCX-5001-H	406.08
	5'(1524mm)	VGA + Audio – male/male	EWCX-0501-V	\$123.73
	10'(3048mm)	VGA + Audio – male/male	EWCX-1001-V	145.11
	15'(4572mm)	VGA + Audio – male/male	EWCX-1501-V	253.10
	25'(7620mm)	VGA + Audio – male/male	EWCX-2501-V	253.10
50'(15240mm)	VGA – male/male	EWCX-5001-V	361.08	

Features

- Includes one black HDMI or VGA/VGA + Audio cable.
- For use with:
 - HDMI transmits digital video and audio signals.
 - VGA + Audio transmits analog video and audio signals with the exception of the 50' cable.

To Order, Specify:

- 1) Product number.
(No finish specification required.)

Specification Tips

- Provides communication between components: i.e. laptop, processor, monitor, etc.
 - Daisy chaining of cables not recommended.**
 - The audio cable extension of the user VGA + Audio cable extends 20" from the connector head. Separately specify audio only cables if audio extension is not long enough for application.
- 50' VGA cable not available with audio.

Planes Credenza Tops

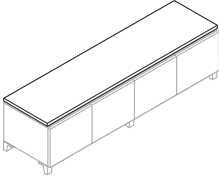
Credenza Top – Laminate or Wood	Depth	Width	Number	Laminate		Wood	
				A	B	Group A	Group B
 <p>GACJ</p>	Laminate						
	20"(508mm)	36"(914mm)	GACJ-2036-LJSNNNN	\$288.36	\$ 354.54		
		48"(1219mm)	GACJ-2048-LJSNNNN	385.26	462.56		
		54"(1372mm)	GACJ-2054-LJSNNNN	433.71	516.57		
		72"(1829mm)	GACJ-2072-LJSNNNN	579.06	678.60		
		96"(2438mm)	GACJ-2096-LJSNNNN	772.86	894.64		
		108"(2743mm)	GACJ-20A8-LJSNNNN	869.76	1002.66		
	Wood						
	20"(508mm)	36"(914mm)	GACJ-2036-WKSNNNN			\$ 463.26	\$ 473.62
		48"(1219mm)	GACJ-2048-WKSNNNN			616.90	636.34
		54"(1372mm)	GACJ-2054-WKSNNNN			693.72	717.70
		72"(1829mm)	GACJ-2072-WKSNNNN			924.18	961.78
		96"(2438mm)	GACJ-2096-WKSNNNN			1231.46	1287.22
		108"(2743mm)	GACJ-20A8-WKSNNNN			1385.10	1449.94

Features

- Includes one 1 3/16"(30mm) thick credenza top and hardware for use on Planes credenza bases.
- Laminate with 1mm edgeband or wood veneer with 1mm wood edgeband.
- Credenza top available in standard core.
- Top installs on credenza base with 1/4"(6mm) reveal.

To Order, Specify:

- 1) Product number.
- 2) Laminate surface color or wood finish color.
- 3) Edge trim color for laminate.

Specification Tip

- **Must be used with credenza base for finished aesthetic.**

Grommet



TA01

Top Thickness	Diameter	Number	Price
3/4"(19mm)	2 3/4"(70mm)	TA01-0220	\$30.72

Features

- Includes one grommet.
- Field installed into field cut opening.

To Order, Specify:

- 1) Product number.
- 2) Trim color.

Note: \$4.41 upcharge list for Metallic and accent trim colors.

Planes Credenza Bases – 19" High

	Overall Height*	Depth	Width	Number	①	Laminate		Wood	
						A	B	Group A	Group B
Credenza Base – 19"(483mm) High – Laminate or Wood									
Laminate									
	19"(483mm)	20"(508mm)	36"(914mm)	GAC1-2036-LNSN	G2	\$1084.87	\$1151.05		
			48"(1219mm)	GAC1-2048-LNSN	G2	1439.39	1541.03		
			54"(1372mm)	GAC1-2054-LNSN	G2	1616.65	1736.02		
			72"(1829mm)	GAC1-2072-LNSN	G2	2148.43	2320.99		
			96"(2438mm)	GAC1-2096-LNSN	G2	2857.47	3100.95		
			108"(2743mm)	GAC1-20A8-LNSN	G2	3211.99	3490.93		
Wood									
	19"(483mm)	20"(508mm)	36"(914mm)	GAC1-2036-WNSN	G2			\$1835.30	\$1881.78
			48"(1219mm)	GAC1-2048-WNSN	G2			2438.00	2522.32
			54"(1372mm)	GAC1-2054-WNSN	G2			2739.35	2842.59
			72"(1829mm)	GAC1-2072-WNSN	G2			3643.40	3803.40
			96"(2438mm)	GAC1-2096-WNSN	G2			4848.80	5084.48
			108"(2743mm)	GAC1-20A8-WNSN	G2			5451.50	5725.02

Features

- Includes 19"(483mm) high base cabinet with one or more shelves, doors, legs and hardware.
- **Credenza top is ordered separately.**
- Laminate with 1mm edgeband or wood veneer with wood 1mm edgeband.
- Wood door fronts are matched veneer.
- 1/8"(3mm) reveal between credenza top and base
- Credenza base available in standard core.
- Cabinet doors have touch latches.
- Optional locks are available in Black or Chrome.
- For lock options refer to Lock Program Price List.
- Leg is 2 1/4"(57mm) high painted aluminum.
- Available with black glides only; 1 1/2"(38mm) height adjustment.
- Includes one adjustable shelf per cabinet with 1 1/4"(32mm) adjustment increments.
 - 36"(914mm) wide has two doors and four legs
 - 48"(1219mm) wide has three doors and four legs
 - 54"(1372mm) wide has three doors and four legs
 - 72"(1829mm) wide has four doors and six legs
 - 96"(2438mm) wide has six doors and six legs
 - 108"(2743mm) wide has six doors and six legs
- Ships unassembled.

Specification Tips

- **Must order a 1 3/16"(30mm) thick credenza top separately.**
- Grommets are ordered separately and requires field cutting and installation.

* Overall height includes credenza base, legs, reveal and separately specified credenza top.

To Order, Specify:

- 1) Product number, including:

① Locking Option:

- N Non-locking
- A All locking, add \$63.73 list

- 2) Laminate surface color or wood finish color.
- 3) Edge trim color for laminate.
- 4) Leg trim color.
- 5) Lock plug trim color.
 - Black – LR-BL
 - Chrome – LR-BP

Note: \$44.02 upcharge (list) for Metallic trim colors.

GAC1

Planes Credenza Base with Slider Unit – 29" High

Overall Height*	Depth	Width	Number	①	Glass				Translucent
					A	C	D	F	
Credenza Base – 29" (737mm) High with Slider Unit – Laminate or Wood									
Laminate – Grade A									
29" (737mm)	20" (508mm)	36" (914mm)	GAC2-2036-LGSN	G4	\$1674.58	\$2062.20	\$2120.12	\$ 2237.22	\$1868.40
		48" (1219mm)	GAC2-2048-LGSN	G4	2229.54	2746.42	2823.98	2979.74	2487.18
		54" (1372mm)	GAC2-2054-LGSN	G4	2507.02	3088.53	3175.91	3351.00	2796.57
		72" (1829mm)	GAC2-2072-LGSN	G4	3339.46	4114.86	4231.70	4464.78	3724.74
		96" (2438mm)	GAC2-2096-LGSN	G4	4449.38	5483.30	5639.42	5949.82	4962.30
		108" (2743mm)	GAC2-20A8-LGSN	G4	5004.34	6167.52	6343.28	6692.34	5581.08
Laminate – Grade B									
29" (737mm)	20" (508mm)	36" (914mm)	GAC2-2036-LGSN	G4	\$1809.30	\$2196.92	\$2254.84	\$ 2371.94	\$2003.12
		48" (1219mm)	GAC2-2048-LGSN	G4	2408.72	2925.60	3003.16	3158.92	2666.36
		54" (1372mm)	GAC2-2054-LGSN	G4	2708.43	3289.94	3377.32	3552.41	2997.98
		72" (1829mm)	GAC2-2072-LGSN	G4	3607.56	4382.96	4499.80	4732.88	3992.84
		96" (2438mm)	GAC2-2096-LGSN	G4	4806.40	5840.32	5996.44	6306.84	5319.32
		108" (2743mm)	GAC2-20A8-LGSN	G4	5405.82	6569.00	6744.76	7093.82	5982.56
Wood Group A									
29" (737mm)	20" (508mm)	36" (914mm)	GAC2-2036-WGSN	G4	\$2969.83	\$3357.45	\$3415.37	\$ 3532.47	\$3163.65
		48" (1219mm)	GAC2-2048-WGSN	G4	3876.97	4393.85	4471.41	4627.17	4134.61
		54" (1372mm)	GAC2-2054-WGSN	G4	4330.54	4912.05	4999.43	5174.52	4620.09
		72" (1829mm)	GAC2-2072-WGSN	G4	5691.25	6466.65	6583.49	6816.57	6076.53
		96" (2438mm)	GAC2-2096-WGSN	G4	7505.53	8539.45	8695.57	9005.97	8018.45
		108" (2743mm)	GAC2-20A8-WGSN	G4	8412.67	9575.85	9751.61	10100.67	8989.41
Wood Group B									
29" (737mm)	20" (508mm)	36" (914mm)	GAC2-2036-WGSN	G4	\$3047.82	\$3435.44	\$3493.36	\$ 3610.46	\$3241.64
		48" (1219mm)	GAC2-2048-WGSN	G4	3976.00	4492.88	4570.44	4726.20	4233.64
		54" (1372mm)	GAC2-2054-WGSN	G4	4440.09	5021.60	5108.98	5284.07	4729.64
		72" (1829mm)	GAC2-2072-WGSN	G4	5832.36	6607.76	6724.60	6957.68	6217.64
		96" (2438mm)	GAC2-2096-WGSN	G4	7688.72	8722.64	8878.76	9189.16	8201.64
		108" (2743mm)	GAC2-20A8-WGSN	G4	8616.90	9780.08	9955.84	10304.90	9193.64

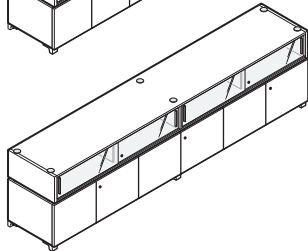
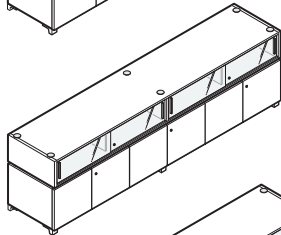
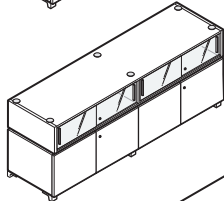
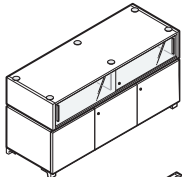
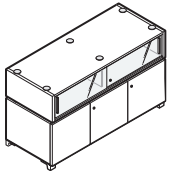
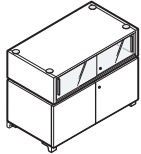

GAC2

Features

- Includes 19" (483mm) high base cabinet with one shelf, doors, legs and 10" (254mm) high upper slider unit with glass or translucent slider doors, pulls and hardware.
- Credenza top is ordered separately.**
- Laminate with 1mm edgeband or wood veneer with 1mm wood edgeband.
- Wood door fronts are matched veneer.
- 1/8" (3mm) reveal between base and slider unit and between slider unit and credenza top.
- Available in standard core.
- Cabinet doors have touch latches.
- Slider unit doors are glass or translucent with painted aluminum bar pulls.
- Optional locks are available in black or chrome.
- For lock options refer to Lock Program Price List.
- Leg is 2 1/4" (57mm) high painted metal.
- Available with black glides only; 1 1/2" (38mm) height adjustment.
- Cabinet includes one adjustable shelf per cabinet with 1 1/4" (32mm) adjustment increments.
 - 36" (914mm) wide has two doors and four legs
 - 48" (1219mm) wide has three doors and four legs
 - 54" (1372mm) wide has three doors and four legs
 - 72" (1829mm) wide has four doors and six legs
 - 96" (2438mm) wide has six doors and six legs
 - 108" (2743mm) wide has six doors and six legs
- Ships unassembled.

Specification Tip

- Must order a 1 3/16" (30mm) thick credenza top separately.**

* Overall height includes credenza base, legs, reveal, slider unit and separately specified credenza top.

To Order, Specify:

- Product number, including:

① Locking Option:

- N** Non-locking
- A** All locking, add \$127.64 list
- L** Slider unit locking only, add \$63.81 list

- Laminate surface color or wood finish color.
- Edge trim color for laminate.
- Leg and slider pull trim color.
- Slider unit glass/translucent door.
- Lock plug trim color.
 - Black – LR-BL
 - Chrome – LR-BP

Note: \$44.02 upcharge (list) for Metallic trim colors.

Planes Credenza Base with Slider Unit — 35" High

Overall Height*	Depth	Width	Number	①	Glass A	C	D	F	Translucent
Credenza Base – 35"(889mm) High with Slider Unit – Laminate or Wood									
Laminate – Grade A									
35"(889mm)	20"(508mm)	36"(914mm)	GAC2-2036-LGSN	G6	\$2010.21	\$ 2397.83	\$ 2455.75	\$ 2572.85	\$ 2204.03
		48"(1219mm)	GAC2-2048-LGSN	G6	2673.93	3190.81	3268.37	3424.13	2931.57
		54"(1372mm)	GAC2-2054-LGSN	G6	3005.79	3587.30	3674.68	3849.77	3295.34
		72"(1829mm)	GAC2-2072-LGSN	G6	4001.37	4776.77	4893.61	5126.69	4386.65
		96"(2438mm)	GAC2-2096-LGSN	G6	5328.81	6362.73	6518.85	6829.25	5841.73
		108"(2743mm)	GAC2-20A8-LGSN	G6	5992.53	7155.71	7331.47	7680.53	6569.27
Laminate – Grade B									
35"(889mm)	20"(508mm)	36"(914mm)	GAC2-2036-LGSN	G6	\$2144.93	\$ 2532.55	\$ 2590.47	\$ 2707.57	\$ 2338.75
		48"(1219mm)	GAC2-2048-LGSN	G6	2853.11	3369.99	3447.55	3603.31	3110.75
		54"(1372mm)	GAC2-2054-LGSN	G6	3207.20	3788.71	3876.09	4051.18	3496.75
		72"(1829mm)	GAC2-2072-LGSN	G6	4269.47	5044.87	5161.71	5394.79	4654.75
		96"(2438mm)	GAC2-2096-LGSN	G6	5685.83	6719.75	6875.87	7186.27	6198.75
		108"(2743mm)	GAC2-20A8-LGSN	G6	6394.01	7557.19	7732.95	8082.01	6970.75
Wood Group A									
35"(889mm)	20"(508mm)	36"(914mm)	GAC2-2036-WGSN	G6	\$3305.46	\$ 3693.08	\$ 3751.00	\$ 3868.10	\$ 3499.28
		48"(1219mm)	GAC2-2048-WGSN	G6	4321.36	4838.24	4915.80	5071.56	4579.00
		54"(1372mm)	GAC2-2054-WGSN	G6	4829.31	5410.82	5498.20	5673.29	5118.86
		72"(1829mm)	GAC2-2072-WGSN	G6	6353.16	7128.56	7245.40	7478.48	6738.44
		96"(2438mm)	GAC2-2096-WGSN	G6	8384.96	9418.88	9575.00	9885.40	8897.88
		108"(2743mm)	GAC2-20A8-WGSN	G6	9400.86	10564.04	10739.80	11088.86	9977.60
Wood Group B									
35"(889mm)	20"(508mm)	36"(914mm)	GAC2-2036-WGSN	G6	\$3383.45	\$ 3771.07	\$ 3828.99	\$ 3946.09	\$ 3577.27
		48"(1219mm)	GAC2-2048-WGSN	G6	4420.39	4937.27	5014.83	5170.59	4678.03
		54"(1372mm)	GAC2-2054-WGSN	G6	4938.86	5520.37	5607.75	5782.84	5228.41
		72"(1829mm)	GAC2-2072-WGSN	G6	6494.27	7269.67	7386.51	7619.59	6879.55
		96"(2438mm)	GAC2-2096-WGSN	G6	8568.15	9602.07	9758.19	10068.59	9081.07
		108"(2743mm)	GAC2-20A8-WGSN	G6	9605.09	10768.27	10944.03	11293.09	10181.83

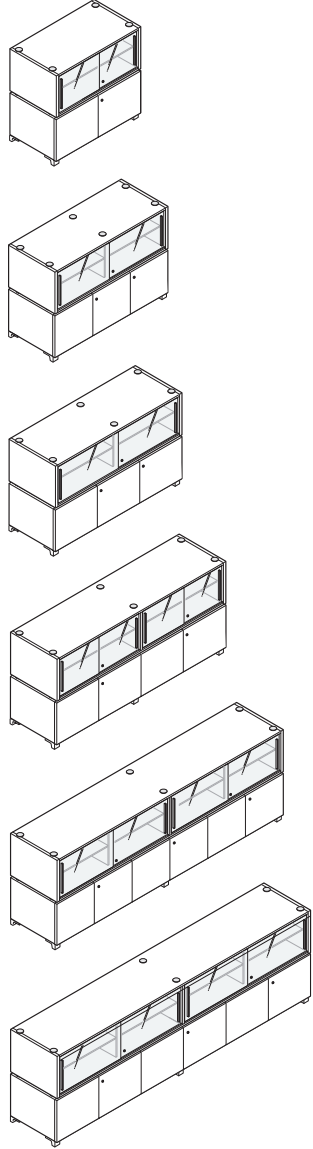

GAC2

Features

- Includes 19"(483mm) high base cabinet with one shelf, doors, legs and 16"(406mm) high upper slider unit with one shelf, glass or acrylic slider doors, door tracks, pulls and hardware.
- **Credenza top is ordered separately.**
- Laminate with 1mm edgeband or wood veneer with 1mm wood edgeband.
- Wood door fronts are matched veneer.
- 1/8"(3mm) reveal between base and slider unit and between slider unit and credenza top.
- Credenza available in standard core.
- Cabinet doors have touch latches.
- Slider unit doors are glass or translucent with painted aluminum bar pulls.
- Optional locks are available in black or chrome.
- For lock options refer to Lock Program Price List.
- Leg is 2 1/4"(57mm) high painted metal.
- Available with Black glides only; 1 1/2"(38mm) height adjustment.
- Slider unit includes one adjustable shelf per unit with 1 1/4"(32mm) adjustment increments.
- Cabinet includes one adjustable shelf per cabinet with 1 1/4"(32mm) adjustment increments.
 - 36"(914mm) wide has two doors and four legs
 - 48"(1219mm) wide has three doors and four legs
 - 54"(1372mm) wide has three doors and four legs
 - 72"(1829mm) wide has four doors and six legs
 - 96"(2438mm) wide has six doors and six legs
 - 108"(2743mm) wide has six doors and six legs
- Ships unassembled.

Specification Tip

- **Must order a 1 3/16"(30mm) thick credenza top separately.**

* Overall height includes credenza base legs, reveal, slider unit and credenza top.

To Order, Specify:

- 1) Product number, including:

① Locking Option:

- N** Non-locking
- A** All locking, add \$127.64 list
- L** Slider unit locking only, add \$63.81 list

- 2) Laminate surface color or wood finish color.
- 3) Edge trim color for laminate.
- 4) Leg and slider door pull trim color.
- 5) Slider unit glass/translucent door.
- 6) Lock plug trim color.
 - Black – LR-BL
 - Chrome – LR-BP

Note: \$44.02 upcharge (list) for Metallic trim colors.

Planes Credenza Base – 29" High

Overall Height*	Depth	Width	Number	①	Laminate A	B	Wood Group A	Group B
Credenza Base – 29" (737mm) High – Laminate or Wood								
Laminate								
29" (737mm)	20" (508mm)	36" (914mm)	GAC1-2036-LNSN	G4	\$1446.67	\$1512.85		
		48" (1219mm)	GAC1-2048-LNSN	G4	1931.84	2033.48		
		54" (1372mm)	GAC1-2054-LNSN	G4	2169.40	2288.77		
		72" (1829mm)	GAC1-2072-LNSN	G4	2872.03	3044.59		
		96" (2438mm)	GAC1-2096-LNSN	G4	3832.32	4075.80		
		108" (2743mm)	GAC1-20A8-LNSN	G4	4307.44	4586.38		
Wood								
29" (737mm)	20" (508mm)	36" (914mm)	GAC1-2036-WNSN	G4			\$2197.10	\$2243.58
		48" (1219mm)	GAC1-2048-WNSN	G4			2930.45	3014.77
		54" (1372mm)	GAC1-2054-WNSN	G4			3292.10	3395.34
		72" (1829mm)	GAC1-2072-WNSN	G4			4367.00	4527.00
		96" (2438mm)	GAC1-2096-WNSN	G4			5823.65	6059.33
		108" (2743mm)	GAC1-20A8-WNSN	G4			6546.95	6820.47

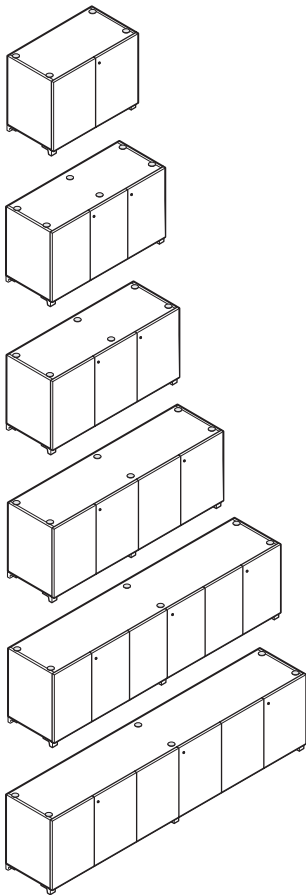

Features

- Includes 29" (737mm) high base cabinet with two shelves, doors, legs and hardware.
- **Credenza top is ordered separately.**
- Laminate with 1mm edgeband or wood veneer with 1mm wood edgeband.
- Wood door fronts are matched veneer.
- 1/8" (3mm) reveal between base unit and credenza top.
- Credenza available in standard core.
- Cabinet doors have touch latches.
- Optional locks are available in black or chrome.
- For lock options refer to Lock Program Price List.
- Leg is 2 1/4" (57mm) high painted metal.
- Available with black glides only; 1 1/2" (38mm) height adjustment.
- Includes one adjustable shelf per cabinet with 1/4" (6mm) adjustment increments.
 - 36" (914mm) wide has two doors and four legs
 - 48" (1219mm) wide has three doors and four legs
 - 54" (1372mm) wide has three doors and four legs
 - 72" (1829mm) wide has four doors and six legs
 - 96" (2438mm) wide has six doors and six legs
 - 108" (2743mm) wide has six doors and six legs
- Ships unassembled.

Specification Tips

- **Must order a 1 3/16" (30mm) thick credenza top separately.**
- Grommets are ordered separately and requires field cutting and installation.

* Overall height includes credenza base legs, reveal, slider unit and separately specified credenza top.

To Order, Specify:

- 1) Product number, including:

① Locking Option:

- N Non-locking
- A All locking, add **\$63.73** list

- 2) Laminate surface color or wood finish color.
- 3) Edge trim color for laminate.
- 4) Leg trim color.
- 5) Lock plug trim color.
 - Black – LR-BL
 - Chrome – LR-BP

Note: \$44.02 upcharge (list) for Metallic trim colors.

Planes Credenza Base with Slider Unit — 39" High

Overall Height*	Depth	Width	Number	①	Glass A	C	D	F	Translucent
Credenza Base – 39"(991mm) High with Slider Unit – Laminate or Wood									
Laminate – Grade A									
39"(991mm)	20"(508mm)	36"(914mm)	GAC2-2036-LGSN	G7	\$2026.75	\$ 2414.37	\$ 2472.29	\$ 2589.39	\$ 2220.57
		48"(1219mm)	GAC2-2048-LGSN	G7	2699.17	3216.05	3293.61	3449.37	2956.81
		54"(1372mm)	GAC2-2054-LGSN	G7	3035.38	3616.89	3704.27	3879.36	3324.93
		72"(1829mm)	GAC2-2072-LGSN	G7	4044.01	4819.41	4936.25	5169.33	4429.29
		96"(2438mm)	GAC2-2096-LGSN	G7	5388.85	6422.77	6578.89	6889.29	5901.77
		108"(2743mm)	GAC2-20A8-LGSN	G7	6061.27	7224.45	7400.21	7749.27	6638.01
Laminate – Grade B									
39"(991mm)	20"(508mm)	36"(914mm)	GAC2-2036-LGSN	G7	\$2161.47	\$ 2549.09	\$ 2607.01	\$ 2724.11	\$ 2355.29
		48"(1219mm)	GAC2-2048-LGSN	G7	2878.35	3395.23	3472.79	3628.55	3135.99
		54"(1372mm)	GAC2-2054-LGSN	G7	3236.79	3818.30	3905.68	4080.77	3526.34
		72"(1829mm)	GAC2-2072-LGSN	G7	4312.11	5087.51	5204.35	5437.43	4697.39
		96"(2438mm)	GAC2-2096-LGSN	G7	5745.87	6779.79	6935.91	7246.31	6258.79
		108"(2743mm)	GAC2-20A8-LGSN	G7	6462.75	7625.93	7801.69	8150.75	7039.49
Wood Group A									
39"(991mm)	20"(508mm)	36"(914mm)	GAC2-2036-WGSN	G7	\$3322.00	\$ 3709.62	\$ 3767.54	\$ 3884.64	\$ 3515.82
		48"(1219mm)	GAC2-2048-WGSN	G7	4346.60	4863.48	4941.04	5096.80	4604.24
		54"(1372mm)	GAC2-2054-WGSN	G7	4858.90	5440.41	5527.79	5702.88	5148.45
		72"(1829mm)	GAC2-2072-WGSN	G7	6395.80	7171.20	7288.04	7521.12	6781.08
		96"(2438mm)	GAC2-2096-WGSN	G7	8445.00	9478.92	9635.04	9945.44	8957.92
		108"(2743mm)	GAC2-20A8-WGSN	G7	9469.60	10632.78	10808.54	11157.60	10046.34
Wood Group B									
39"(991mm)	20"(508mm)	36"(914mm)	GAC2-2036-WGSN	G7	\$3399.99	\$ 3787.61	\$ 3845.53	\$ 3962.63	\$ 3593.81
		48"(1219mm)	GAC2-2048-WGSN	G7	4445.63	4962.51	5040.07	5195.83	4703.27
		54"(1372mm)	GAC2-2054-WGSN	G7	4968.45	5549.96	5637.34	5812.43	5258.00
		72"(1829mm)	GAC2-2072-WGSN	G7	6536.91	7312.31	7429.15	7662.23	6922.19
		96"(2438mm)	GAC2-2096-WGSN	G7	8628.19	9662.11	9818.23	10128.63	9141.11
		108"(2743mm)	GAC2-20A8-WGSN	G7	9673.83	10837.01	11012.77	11361.83	10250.57

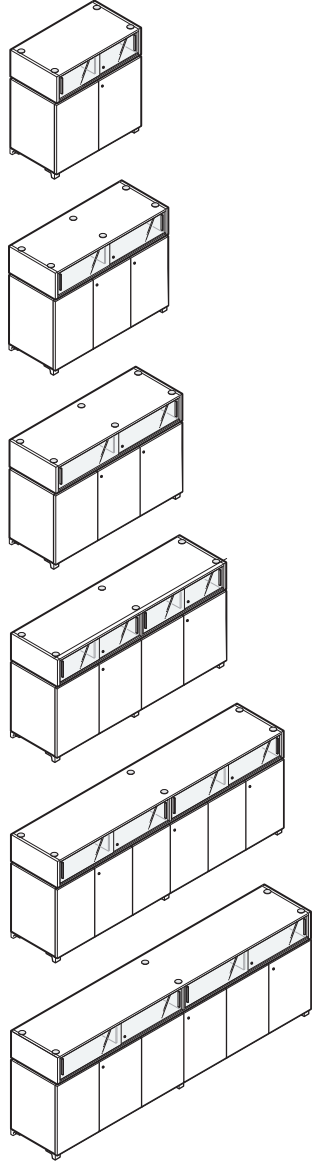

GAC2

Features

- Includes 29"(737mm) high base cabinet with two shelves, doors, legs and 10"(254mm) high upper slider unit with glass or acrylic slider doors, pulls and hardware.
- **Credenza top is ordered separately.**
- Laminate with 1mm edgeband or wood veneer with 1mm wood edgeband.
- Wood door fronts are matched veneer.
- 1/8"(3mm) reveal between base and slider unit and between slider unit and credenza top.
- Credenza available in standard core.
- Cabinet doors have touch latches.
- Slider unit doors are glass or translucent with painted aluminum bar pulls.
- Optional locks are available in black or chrome.
- For lock options refer to Lock Program Price List.
- Leg is 2 1/4"(57mm) high painted metal.
- Available with black glides only; 1 1/2"(38mm) height adjustment.
- Cabinet includes one adjustable shelf per cabinet with 1/4"(6mm) adjustment increments.
 - 36"(914mm) wide has two doors and four legs
 - 48"(1219mm) wide has three doors and four legs
 - 54"(1372mm) wide has three doors and four legs
 - 72"(1829mm) wide has four doors and six legs
 - 96"(2438mm) wide has six doors and six legs
 - 108"(2743mm) wide has six doors and six legs
- Ships unassembled.

Specification Tip

- **Must order a 1 3/16"(30mm) thick credenza top separately.**

* Overall height includes credenza base legs, reveal, slider unit and separately specified credenza top.

To Order, Specify:

- 1) Product number, including:

① Locking Option:

- N** Non-locking
- A** All locking, add \$127.64 list
- L** Slider unit locking only, add \$63.81 list

- 2) Laminate surface color or wood finish color.
- 3) Edge trim color for laminate.
- 4) Leg and slider pull trim color.
- 5) Slider unit glass/translucent door.
- 6) Lock plug trim color.
 - Black – LR-BL
 - Chrome – LR-BP

Note: \$44.02 upcharge (list) for Metallic trim colors.

Planes Credenza Base with Slider Unit — 45" High

Overall Height*	Depth	Width	Number	①	Glass				Translucent
					A	C	D	F	
Credenza Base – 45" (1143mm) High with Slider Unit – Laminate or Wood									
Laminate – Grade A									
45" (1143mm)	20" (508mm)	36" (914mm)	GAC2-2036-LGSN	G9	\$ 2357.66	\$ 2745.28	\$ 2803.20	\$ 2920.30	\$ 2551.48
		48" (1219mm)	GAC2-2048-LGSN	G9	3139.06	3655.94	3733.50	3889.26	3396.70
		54" (1372mm)	GAC2-2054-LGSN	G9	3529.76	4111.27	4198.65	4373.74	3819.31
		72" (1829mm)	GAC2-2072-LGSN	G9	4701.86	5477.26	5594.10	5827.18	5087.14
		96" (2438mm)	GAC2-2096-LGSN	G9	6264.66	7298.58	7454.70	7765.10	6777.58
		108" (2743mm)	GAC2-20A8-LGSN	G9	7046.06	8209.24	8385.00	8734.06	7622.80
Laminate – Grade B									
45" (1143mm)	20" (508mm)	36" (914mm)	GAC2-2036-LGSN	G9	\$ 2492.38	\$ 2880.00	\$ 2937.92	\$ 3055.02	\$ 2686.20
		48" (1219mm)	GAC2-2048-LGSN	G9	3318.24	3835.12	3912.68	4068.44	3575.88
		54" (1372mm)	GAC2-2054-LGSN	G9	3731.17	4312.68	4400.06	4575.15	4020.72
		72" (1829mm)	GAC2-2072-LGSN	G9	4969.96	5745.36	5862.20	6095.28	5355.24
		96" (2438mm)	GAC2-2096-LGSN	G9	6621.68	7655.60	7811.72	8122.12	7134.60
		108" (2743mm)	GAC2-20A8-LGSN	G9	7447.54	8610.72	8786.48	9135.54	8024.28
Wood Group A									
45" (1143mm)	20" (508mm)	36" (914mm)	GAC2-2036-WGSN	G9	\$ 3652.91	\$ 4040.53	\$ 4098.45	\$ 4215.55	\$ 3846.73
		48" (1219mm)	GAC2-2048-WGSN	G9	4786.49	5303.37	5380.93	5536.69	5044.13
		54" (1372mm)	GAC2-2054-WGSN	G9	5353.28	5934.79	6022.17	6197.26	5642.83
		72" (1829mm)	GAC2-2072-WGSN	G9	7053.65	7829.05	7945.89	8178.97	7438.93
		96" (2438mm)	GAC2-2096-WGSN	G9	9320.81	10354.73	10510.85	10821.25	9833.73
		108" (2743mm)	GAC2-20A8-WGSN	G9	10454.39	11617.57	11793.33	12142.39	11031.13
Wood Group B									
45" (1143mm)	20" (508mm)	36" (914mm)	GAC2-2036-WGSN	G9	\$ 3730.90	\$ 4118.52	\$ 4176.44	\$ 4293.54	\$ 3924.72
		48" (1219mm)	GAC2-2048-WGSN	G9	4885.52	5402.40	5479.96	5635.72	5143.16
		54" (1372mm)	GAC2-2054-WGSN	G9	5462.83	6044.34	6131.72	6306.81	5752.38
		72" (1829mm)	GAC2-2072-WGSN	G9	7194.76	7970.16	8087.00	8320.08	7580.04
		96" (2438mm)	GAC2-2096-WGSN	G9	9504.00	10537.92	10694.04	11004.44	10016.92
		108" (2743mm)	GAC2-20A8-WGSN	G9	10658.62	11821.80	11997.56	12346.62	11235.36

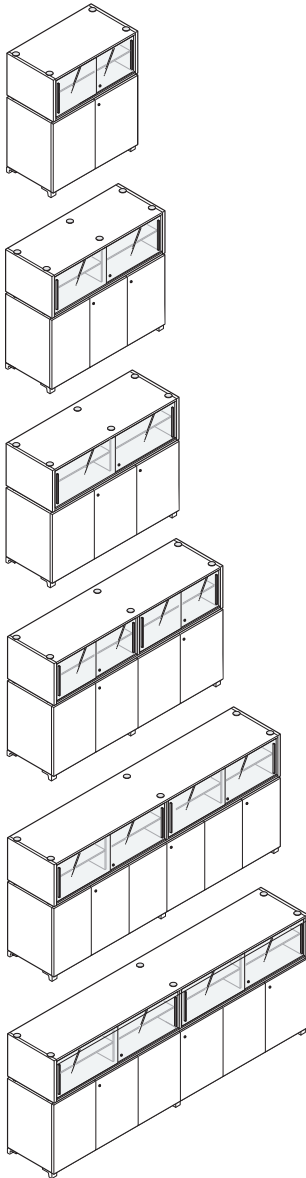

GAC2

Features

- Includes 29" (737mm) high base cabinet with two shelves, doors, legs and 16" (406mm) high upper slider unit with one shelf, glass or translucent slider doors, pulls and hardware.
- **Credenza top is ordered separately.**
- Laminate with 1mm edgeband or wood veneer with 1mm wood edgeband.
- 1/8" (3mm) reveal between base and slider unit and between slider unit and credenza top.
- Credenza available in standard core.
- Cabinet doors have touch latches.
- Slider unit doors are glass or translucent with painted aluminum bar pulls.
- Optional locks are available in black or chrome.
- Lock plugs and keys are shipped with random numbering unless specified as keyed-alike or master-keyed.
- Leg is 2 1/4" (57mm) high painted metal.
- Available with black glides only; 1 1/2" (38mm) height adjustment.
- Slider unit includes one adjustable shelf per unit.
- Cabinet includes one adjustable shelf per cabinet with 1 1/4" (32mm) adjustment increments.
 - 36" (914mm) wide has two doors and four legs
 - 48" (1219mm) wide has three doors and four legs
 - 54" (1372mm) wide has three doors and four legs
 - 72" (1829mm) wide has four doors and six legs
 - 96" (2438mm) wide has six doors and six legs
 - 108" (2743mm) wide has six doors and six legs
- Ships unassembled.

Specification Tip

- **Must order a 1 3/16" (30mm) thick credenza top separately.**

* Overall height includes credenza base legs, reveal, slider unit and separately specified credenza top.

To Order, Specify:

- 1) Product number, including:

① Locking Option:

- N** Non-locking
- A** All locking, add \$127.64 list
- L** Slider unit locking only, add \$63.81 list

- 2) Laminate surface color or wood finish color.
- 3) Edge trim color for laminate.
- 4) Leg and slider pull trim color.
- 5) Slider unit glass/translucent door.
- 6) Lock plug trim color.
 - Black – LR-BL
 - Chrome – LR-BP

Note: \$44.02 upcharge (list) for Metallic trim color.

Planes Conference Tables — Interior Leg — Laminate

Round, Square, Rectangular

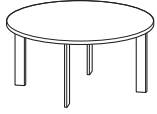

TARN



TARQ

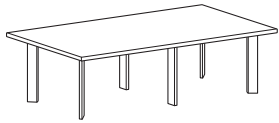

TARA

Features

- Includes 1 3/16" (30mm) top, interior leg bases and hardware.
- Standard table height is 29" (737mm).
- Laminate top with 3mm edgeband or knife edges based upon shape.
- 3mm edgeband or knife edge not available on 42" (1067mm)-60" (1524mm) round tables.
- Table top seams are 1mm edgeband on two piece tops.
- Interior legs are painted aluminum.
- Interior leg is 1 1/8" (29mm) x 3 1/4" (83mm).
- Optional Flip top unit electrical modules are separately specified. Refer to electrical components for appropriate product specification.
- Optional cable base can be specified for tables 36" (914mm) deep and deeper:
 - 36" (914mm) deep tables will ship with 8" (203mm) x 14" (356mm) cable base.
 - 42" (1067mm) deep and deeper tables will ship with 14" (356mm) x 14" (356mm) cable base.
 - One piece tops will include one cable base to be centered under table top.
 - Two piece tops will include one cable base to be centered on seams under table top.
 - Cable base and table top(s) are laminate and can be specified in different surface colors and edge trim colors.
 - Optional Cable Base may reduce number of legs shipped with product.
 - Refer to Specification Guide for use guidelines and details.
- Available with glides only; 1/2" (13mm) height adjustment.
- Depth and width shown in nominal dimensions.
- Ships unassembled.

Specification Tips

- Cable base not recommended for 30" (762mm) deep tables.
- Cable base for 36" (914mm) deep table is not compatible with Fliptop Cutout Options (M) and (Q).
- Tables with multiple-piece tops have equal sized pieces.
- The following Planes products are separately specified:
 - Grommets (field cut opening)
 - Flip top unit electrical modules
 - Horizontal wire manager
- Refer to Specification Guide for seating capacities with Cable Base Option and leg locations.

To Order, Specify:

- 1) Product number, including:

1 Edge Option:

- J** Edgeband
- F** Knife

2 Flip top unit Cutout(s):

Cutout options **F, J, M, Q**:
add **\$31.86** list for one-piece top;
add **\$63.72** list for two-piece tops.

- N** None
- F** Center – single-sided/4 outlets
- J** Center – single-sided/6 outlets
- M** Center – double-sided/8 outlets
- Q** Center – double-sided/12 outlets

3 Cable Base Option:

- N** None
- C** Cable Base:
add **\$637.24** list for 36" deep tables;
add **\$671.99** list for 42" deep and deeper tables

- 2) Laminate surface color.
- 3) 1mm edgeband trim color. (Cascade edge/multiple-tops only)*
- 4) Edge trim color.
- 5) Base trim color.
- 6) Laminate surface – Cable Base
- 7) Edge trim color – Cable Base

Note: **\$44.02** upcharge (list) for Metallic and accent trim colors.

Planes Conference Tables — Interior Leg — Laminate

No. of Pieces	No. of Legs	Seating Capacity*	Depth	Width	Number ① ② ③	Laminate A		Laminate B		
						J	F	J	F	
Round										
1	4	4	42"(1067mm)	42"(1067mm)	TARN-4242-L S JG4N	N/A	N/A	N/A	N/A	
1	4	4	48"(1219mm)	48"(1219mm)	TARN-4848-L S JG4N	N/A	N/A	N/A	N/A	
1	4	4	54"(1372mm)	54"(1372mm)	TARN-5454-L S JG4N	N/A	N/A	N/A	N/A	
1	4	4	60"(1524mm)	60"(1524mm)	TARN-6060-L S JG4N	N/A	N/A	N/A	N/A	
2	6	6	66"(1676mm)	66"(1676mm)	TARN-6666-L S JG4	\$1960.79	\$2383.44	\$2120.96	\$2543.61	
2	6	6	72"(1829mm)	72"(1829mm)	TARN-7272-L S JG4	2306.82	2758.03	2497.12	2948.33	
Square										
1	4	4	42"(1067mm)	42"(1067mm)	TARQ-4242-L S JG4N	\$ 711.98	\$ 951.90	\$ 777.83	\$1017.75	
1	4	4	48"(1219mm)	48"(1219mm)	TARQ-4848-L S JG4N	890.99	1159.47	976.49	1244.97	
1	4	4	54"(1372mm)	54"(1372mm)	TARQ-5454-L S JG4N	1092.94	1389.98	1200.71	1497.75	
1	4	8	60"(1524mm)	60"(1524mm)	TARQ-6060-L S JG4N	1317.83	1643.43	1450.49	1776.09	
2	6	8	66"(1676mm)	66"(1676mm)	TARQ-6666-L S JG4	\$1960.79	\$2353.07	\$2120.96	\$2513.24	
2	6	8	72"(1829mm)	72"(1829mm)	TARQ-7272-L S JG4	2306.82	2727.66	2497.12	2917.96	
Rectangular										
1	4	4	30"(762mm)	60"(1524mm)	TARA-3060-L S JG4N	\$ 718.28	\$ 968.88	\$ 784.79	\$1035.39	
1	4	4		66"(1676mm)	TARA-3066-L S JG4N	778.70	1043.34	851.86	1116.50	
1	6	4		72"(1829mm)	TARA-3072-L S JG4N	839.12	1117.80	918.93	1197.61	
1	4	4	36"(914mm)	60"(1524mm)	TARA-3660-L S JG4	\$ 836.60	\$1101.24	\$ 916.41	\$1181.05	
1	4	4		66"(1676mm)	TARA-3666-L S JG4	908.60	1187.28	996.39	1275.07	
1	4	4	42"(1067mm)	48"(1219mm)	TARA-4248-L S JG4	787.76	1038.36	862.25	1112.85	
1	4	4		54"(1372mm)	TARA-4254-L S JG4	871.34	1135.98	955.14	1219.78	
1	4	4		60"(1524mm)	TARA-4260-L S JG4	954.92	1233.60	1048.03	1326.71	
1	4	6		66"(1676mm)	TARA-4266-L S JG4	1038.50	1331.22	1140.92	1433.64	
1	6	6		72"(1829mm)	TARA-4272-L S JG4	1122.08	1428.84	1233.81	1540.57	
1	6	6		78"(1981mm)	TARA-4278-L S JG4	1205.66	1526.46	1326.70	1647.50	
1	4	4	48"(1219mm)	54"(1372mm)	TARA-4854-L S JG4	\$ 978.08	\$1256.76	\$1073.85	\$1352.53	
1	4	4		60"(1524mm)	TARA-4860-L S JG4	1073.24	1365.96	1179.65	1472.37	
1	4	6		66"(1676mm)	TARA-4866-L S JG4	1168.40	1475.16	1285.45	1592.21	
1	6	6		72"(1829mm)	TARA-4872-L S JG4	1263.56	1584.36	1391.25	1712.05	
1	6	8		78"(1981mm)	TARA-4878-L S JG4	1358.72	1693.56	1497.05	1831.89	
1	4	4	54"(1372mm)	60"(1524mm)	TARA-5460-L S JG4	\$1191.56	\$1498.32	\$1311.27	\$1618.03	
1	4	6		66"(1676mm)	TARA-5466-L S JG4	1298.30	1619.10	1429.98	1750.78	
1	6	6		72"(1829mm)	TARA-5472-L S JG4	1405.04	1739.88	1548.69	1883.53	
1	6	6		78"(1981mm)	TARA-5478-L S JG4	1511.78	1860.66	1667.40	2016.28	
1	4	8	60"(1524mm)	66"(1676mm)	TARA-6066-L S JG4	\$1428.20	\$1763.04	\$1574.51	\$1909.35	
1	6	8		72"(1829mm)	TARA-6072-L S JG4	1546.52	1895.40	1706.13	2055.01	
1	6	8		78"(1981mm)	TARA-6078-L S JG4	1664.84	2027.76	1837.75	2200.67	

*Recommended seating capacity based upon 27"(686mm) per chair.

Planes Conference Tables — Interior Leg — Laminate

Half Round

No. of Pieces	No. of Legs	Depth	Width	Number ① ②	Laminate A		Laminate B	
					J	F	J	F
1	4	60"(1524mm)	30"(762mm)	TAHN-3060-L S JG4N	\$709.26	\$967.54	\$775.44	\$1033.72
1	4	72"(1829mm)	36"(914mm)	TAHN-3672-L S JG4N	969.52	1272.68	1064.52	1367.68

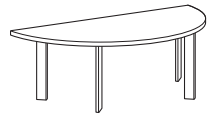

TAHN

Features

- Includes 1 3/16"(30mm) thick top, interior leg bases and hardware.
- Standard table height is 29"(737mm).
- Laminate top with 3mm edgeband or knife edges.
- Bases are painted aluminum.
- Optional Flip top unit electrical modules are separately specified. Refer to electrical components for appropriate product specification.
- Available with glides only; 1/2"(13mm) height adjustment.
- Depth and width shown in nominal dimensions.
- Ships unassembled.

Specification Tips

- Cable base not recommended for half round tables.
- 3mm edgeband edge is recommended to allow a flat seam between tables.
- Depth is meant to accommodate two 30"(762mm) or 36"(914mm) deep rectangular tables.
- The following Planes products are separately specified:
 - Grommets (field cut opening)
 - Flip top unit electrical modules
 - Horizontal wire manager
- Refer to Specification Guide for leg locations.

To Order, Specify:

- 1) Product number, including:

① Edge Option:

- J** Edgeband
- F** Knife

② Flip Top Unit Cutout(s):

- N** None
- F** Center – single sided/4 outlets, add **\$31.86** list
- J** Center – single-sided/6 outlets, add **\$31.86** list

- 2) Laminate surface color.
- 3) Edge trim color.
- 4) Base trim color.

Note: **\$44.02** upcharge (list) for Metallic and accent trim colors.

Planes Conference Tables — Interior Leg — Laminate

Polygon

No. of Pieces	No. of Legs	Depth	Width	Number ① ②	Laminate A		Laminate B	
					J	F	J	F
1	5	30"(762mm)	60"(1524mm)	TACV-3060-L S JG4N	\$714.80	\$968.52	\$781.31	\$1035.03
1	5	36"(914mm)	72"(1829mm)	TACV-3672-L S JG4N	976.38	1272.57	1072.15	1368.34

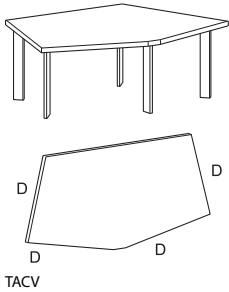

Features

- Includes 1 3/16"(30mm) thick top, interior leg bases and hardware.
- Standard table height is 29"(737mm).
- Laminate top with 3mm edgeband or knife edges.
- Bases are painted aluminum.
- Optional Flip Top unit electrical modules are separately specified. Refer to electrical components for appropriate product specification.
- Available with glides only; 1/2"(13mm) height adjustment.
- Depth and width shown in nominal dimensions.
- Ships unassembled.

Specification Tips

- Cable base not recommended for polygon table.
- 3mm edgeband edge is recommended to allow a flat seam between tables.
- Depth matches 30"(762mm) or 36"(914mm) deep rectangular tables.
- The following Planes products are separately specified:
 - Grommets (field cut opening)
 - Flip top unit electrical modules
 - Horizontal wire manager
- Refer to Specification Guide for leg locations.

To Order, Specify:

1) Product number, including:

① Edge Option:

- J** Edgeband
- F** Knife

② Flip Top Unit Cutout(s):

- N** None
- F** Center – single-sided/4 outlets, add **\$31.86** list
- J** Center – single-sided/6 outlets, add **\$31.86** list

- 2) Laminate surface color.
- 3) Edge trim color.
- 4) Base trim color.

Note: **\$44.02** upcharge (list) for Metallic and accent trim colors.

Planes Conference Tables — Interior Leg — Wood

Round, Square, Rectangular

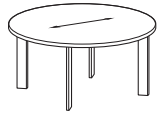

TARN



TARQ

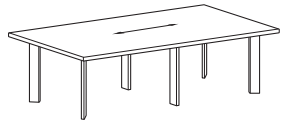

TARA

Features

- Includes 1 3/16" (30mm) top, interior leg bases and hardware.
- Standard table height is 29" (737mm).
- Wood veneer top with wood edgeband or knife edge.
- Table top seams are 1mm edge band on two piece tops.
- Interior legs are painted aluminum.
- Interior leg is 1 1/8" (29mm) x 3 1/4" (83mm).
- Optional cable base can be specified for tables 36" (914mm) deep and deeper:
 - 36" (914mm) deep tables will ship with 8" (203mm) x 14" (356mm) cable base.
 - 42" (1067mm) deep and deeper tables will ship with 14" (356mm) x 14" (356mm) cable base.
 - One piece tops will include one cable base to be centered under table top.
 - Two piece tops will include one cable base to be centered on seams under table top.
 - Cable base and table top(s) are wood veneer and can be specified in different surface colors and edge trim colors.
 - Refer to Specification Guide for use guidelines and details.
- Optional Flip top unit electrical modules are separately specified. Refer to electrical components for appropriate product specification.
- Available with glides only; 1/2" (13mm) height adjustment.
- Depth and width shown in nominal dimensions.
- Ships unassembled.

Specification Tips

- Cable base not recommended for 30" (762mm) deep tables.
- Tables with multiple-piece tops have equal sized pieces.
- The following Planes products are separately specified:
 - Grommets (field cut opening)
 - Flip top unit electrical modules
 - Horizontal wire manager
- Refer to Specification Guide for seating capacities with Cable Base Option and leg locations.

To Order, Specify:

1) Product number, including:

① Edge Option:

- K** Edgeband
- U** Knife

② Flip Top Unit Cutout(s):

Cutout options **F, J, M, Q**:
add **\$31.86** list for one-piece top;
add **\$63.72** list for two-piece tops.

- N** None
- F** Center – single-sided/4 outlets
- J** Center – single-sided/6 outlets
- M** Center – double-sided/8 outlets
- Q** Center – double-sided/12 outlets

③ Cable Base Option:

- N** None
- C** Cable Base:
add **\$637.24** list for 36" deep tables;
add **\$671.99** list for 42" deep and deeper tables

- 2) Wood finish color.
- 3) Base trim color.
- 4) Wood finish color – Cable Base.

Note: **\$44.02** upcharge (list) for Metallic and accent trim colors.

Planes Conference Tables — Interior Leg — Wood

No. of Pieces	No. of Legs	Seating Capacity*	Depth	Width	Number	①	②	③	Wood Group A		Wood Group B	
									K	U	K	U
Round												
1	4	4	42"(1067mm)	42"(1067mm)	TARN-4242-W	S	JG4N		\$1085.28	\$1336.12	\$1110.65	\$1384.67
1	4	4	48"(1219mm)	48"(1219mm)	TARN-4848-W	S	JG4N		1341.93	1701.40	1382.99	1775.85
1	4	4	54"(1372mm)	54"(1372mm)	TARN-5454-W	S	JG4N		1629.60	2117.34	1688.25	2221.30
1	4	4	60"(1524mm)	60"(1524mm)	TARN-6060-W	S	JG4N		1948.29	2584.56	2026.43	2721.73
2	6	6	66"(1676mm)	66"(1676mm)	TARN-6666-W	S	JG4		\$2997.72	\$3756.15	\$3097.25	\$3930.09
2	6	6	72"(1829mm)	72"(1829mm)	TARN-7272-W	S	JG4		3600.71	4442.47	3723.53	4656.87
Square												
1	4	4	42"(1067mm)	42"(1067mm)	TARQ-4242-W	S	JG4N		\$1085.28	\$1336.12	\$1110.65	\$1384.67
1	4	4	48"(1219mm)	48"(1219mm)	TARQ-4848-W	S	JG4N		1341.93	1701.40	1382.99	1775.85
1	4	4	54"(1372mm)	54"(1372mm)	TARQ-5454-W	S	JG4N		1629.60	2117.34	1688.25	2221.30
1	4	8	60"(1524mm)	60"(1524mm)	TARQ-6060-W	S	JG4N		1948.29	2584.56	2026.43	2721.73
2	6	8	66"(1676mm)	66"(1676mm)	TARQ-6666-W	S	JG4		\$2997.72	\$3756.15	\$3097.25	\$3930.09
2	6	8	72"(1829mm)	72"(1829mm)	TARQ-7272-W	S	JG4		3600.71	4442.47	3723.53	4656.87
Rectangular												
1	4	4	30"(762mm)	60"(1524mm)	TARA-3060-W	S	JG4N		\$1078.18	\$1369.89	\$1152.11	\$1482.81
1	4	4		66"(1676mm)	TARA-3066-W	S	JG4N		1175.15	1496.22	1266.77	1631.54
1	6	4		72"(1829mm)	TARA-3072-W	S	JG4N		1272.39	1624.40	1381.76	1782.43
1	4	4	36"(914mm)	60"(1524mm)	TARA-3660-W	S	JG4		\$1259.06	\$1567.55	\$1365.63	\$1715.71
1	4	4		66"(1676mm)	TARA-3666-W	S	JG4		1373.37	1712.01	1500.74	1885.81
1	4	4	42"(1067mm)	48"(1219mm)	TARA-4248-W	S	JG4		\$1177.42	\$1445.55	\$1268.99	\$1572.15
1	4	4		54"(1372mm)	TARA-4254-W	S	JG4		1308.54	1604.46	1423.91	1759.30
1	4	4		60"(1524mm)	TARA-4260-W	S	JG4		1439.94	1765.21	1579.15	1948.61
1	4	6		66"(1676mm)	TARA-4266-W	S	JG4		1571.60	1927.80	1734.72	2140.08
1	6	6		72"(1829mm)	TARA-4272-W	S	JG4		1703.52	2092.24	1890.61	2333.71
1	6	6		78"(1981mm)	TARA-4278-W	S	JG4		1835.72	2258.51	2046.82	2529.50
1	4	4	48"(1219mm)	54"(1372mm)	TARA-4854-W	S	JG4		\$1472.08	\$1783.99	\$1616.98	\$1970.83
1	4	4		60"(1524mm)	TARA-4860-W	S	JG4		1620.82	1962.87	1792.67	2181.51
1	4	6		66"(1676mm)	TARA-4866-W	S	JG4		1769.82	2143.59	1968.69	2394.35
1	6	6		72"(1829mm)	TARA-4872-W	S	JG4		1919.09	2326.16	2145.03	2609.35
1	6	8		78"(1981mm)	TARA-4878-W	S	JG4		2068.63	2510.56	2321.70	2826.51
1	4	4	54"(1372mm)	60"(1524mm)	TARA-5460-W	S	JG4		\$1801.69	\$2160.53	\$2006.19	\$2414.41
1	4	6		66"(1676mm)	TARA-5466-W	S	JG4		1968.04	2359.38	2202.66	2648.62
1	6	6		72"(1829mm)	TARA-5472-W	S	JG4		2134.66	2560.08	2399.45	2884.99
1	4	6		78"(1981mm)	TARA-5478-W	S	JG4		2301.54	2762.61	2596.57	3123.52
1	4	8	60"(1524mm)	66"(1676mm)	TARA-6066-W	S	JG4		\$2166.27	\$2575.17	\$2436.63	\$2902.89
1	6	8		72"(1829mm)	TARA-6072-W	S	JG4		2350.22	2794.00	2653.88	3160.63
1	6	8		78"(1981mm)	TARA-6078-W	S	JG4		2534.45	3014.66	2871.45	3420.53

*Recommended seating capacity based upon 27"(686mm) per chair.

Planes Conference Tables — Interior Leg — Wood

Half Round

No. of Pieces	No. of Legs	Depth	Width	Number	Wood Group A		Wood Group B	
					K	U	K	U
1	4	60"(1524mm)	30"(762mm)	TAHN-3060-W S JG4N	\$1086.50	\$1329.80	\$1109.36	\$1365.50
1	4	72"(1829mm)	36"(914mm)	TAHN-3672-W S JG4N	1550.92	1836.02	1576.20	1876.78



TAHN

Features

- Includes 1 3/16"(30mm) thick top, interior leg bases and hardware.
- Standard table height is 29"(737mm).
- Wood veneer top with 3mm wood edgeband or knife wood edge.
- Bases are painted aluminum.
- Optional Flip top unit electrical modules are separately specified. Refer to electrical components for appropriate product specification.
- Available with glides only; 1/2"(13mm) height adjustment.
- Depth and width shown in nominal dimensions.
- Ships unassembled.

Specification Tips

- Cable base not recommended for half round tables.
- 3mm edgeband edge is recommended to allow a flat seam between tables; refer to Specification Guide.
- Depth is meant to accommodate two 30"(762mm) or 36"(914mm) deep rectangular tables.
- The following Planes products are separately specified:
 - Grommets (field cut opening)
 - Flip top unit electrical modules
 - Horizontal wire manager
- Refer to Specification Guide for leg locations.

To Order, Specify:

1) Product number, including:

1 Edge Option:

- K** Edgeband
- U** Knife

2 Flip Top Unit Cutout(s):

- N** None
- F** Center – single-sided/4 outlets, add **\$31.86** list
- J** Center – single-sided/6 outlets, add **\$31.86** list

2) Wood finish color.

3) Base trim color.

Note: **\$44.02** upcharge (list) for Metallic and accent trim colors.

Planes Conference Tables — Interior Leg — Wood

Polygon

No. of Pieces	No. of Legs	Depth	Width	Number	① ②		Wood Group A		Wood Group B	
					K	U	K	U		
1	5	30"(762mm)	60"(1524mm)	TACV-3060-W	S	JG4N	\$1094.56	\$1337.36	\$1119.36	\$1380.88
1	5	36"(914mm)	72"(1829mm)	TACV-3672-W	S	JG4N	1502.29	1870.89	1622.89	2013.93

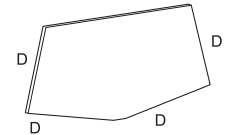

TACV

Features

- Includes 1 3/16"(30mm) thick top, interior leg bases and hardware.
- Standard table height is 29"(737mm).
- Wood veneer top with 3mm edgeband or knife wood edges
- Bases are painted aluminum.
- Optional Flip top unit electrical modules are separately specified. Refer to electrical components for appropriate product specification.
- Available with glides only; 1/2"(13mm) height adjustment.
- Depth and width shown in nominal dimensions.
- Ships unassembled.

Specification Tips

- Cable bases not recommended for polygon tables.
- 3mm edgeband edge is recommended to allow a flat seam between tables.
- Depth is meant to accommodate 30"(762mm) or 36"(914mm) deep rectangular tables.
- The following Planes products are separately specified:
 - Grommets (field cut opening)
 - Flip top unit electrical modules
 - Horizontal wire manager
- Refer to Specification Guide for leg locations.

To Order, Specify:

- 1) Product number, including:

① Edge Option:

- K** Edgeband
- U** Knife

② Flip Top Unit Cutout(s):

- N** None
- F** Center – single-sided/4 outlets, add **\$31.86** list
- J** Center – single-sided/6 outlets, add **\$31.86** list

- 2) Wood finish color.

- 3) Base trim color.

Note: **\$44.02** upcharge (list) for Metallic and accent trim colors.

Planes Conference Tables — One-Piece Top — Interior Leg — Laminate

Rectangular

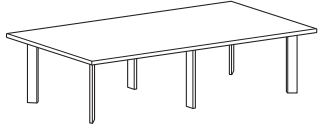

TARA

Features

- Includes 1 3/16" (30mm) thick top, interior leg bases and hardware.
- Standard table height is 29" (737mm).
- Laminate top with 3mm edgeband or knife edges based upon shape.
- Interior legs are painted aluminum.
- Interior leg is 1 1/8" (29mm) x 3 1/4" (83mm).
- Optional cable base can be specified for tables 36" (914mm) deep and deeper:
 - 36" (914mm) deep tables will ship with 8" (203mm) x 14" (356mm) cable base.
 - 42" (1067mm) deep and deeper tables will ship with 14" (356mm) x 14" (356mm) cable base.
 - One piece tops will include one cable base to be centered under table top.
 - Cable base and table top(s) are laminate and can be specified in different surface colors and edge trim colors.
 - Refer to Specification Guide for use guidelines.
- Optional Flip top unit electrical modules are separately specified. Refer to electrical components for appropriate product specification.
- Available with glides only; 1/2" (13mm) height adjustment.
- Depth and width shown in nominal dimensions.
- Ships unassembled.

Specification Tips

- Cable base for 36" (914mm) deep table is not compatible with Flip Top Cut Out Options (M) and (Q).
- The following Planes products are separately specified:
 - Grommets (field cut opening)
 - Flip top unit electrical modules
 - Horizontal wire management
- Refer to Specification Guide for seating capacities with Cable Base Option and leg locations.

To Order, Specify:

1) Product number, including:

① Edge Option:

- J** Edgeband
- F** Knife

② Flip Top Unit Cutout(s):

- N** None
- F** Center – single-sided/4 outlets, add **\$31.86** list
- V** Left/Right – single-sided/4 outlets, add **\$63.72** list
- J** Center – single-sided/6 outlets, add **\$31.86** list
- K** Left/Right – single-sided/6 outlets, add **\$63.72** list
- M** Center – double-sided/8 outlets, add **\$31.86** list
- P** Left/Right – double-sided/8 outlets, add **\$63.72** list
- Q** Center – double-sided/12 outlets, add **\$31.86** list
- T** Left/Right – double-sided/12 outlets, add **\$63.72** list

③ Cable Base Option:

- N** None
- C** Cable Base: add **\$637.24** list for 36" deep tables; add **\$671.99** list for 42" deep and deeper tables

- 2) Laminate surface color.
- 3) Edge trim color.
- 4) Base trim color.
- 5) Laminate surface – Cable Base
- 6) Edge trim color – Cable Base

Note: **\$44.02** upcharge (list) for Metallic and accent trim colors.

Planes Conference Tables — One-Piece Top — Interior Leg — Laminate

Rectangular

No. of Pieces	Seating Capacity*	Depth	Width	Number ① ② ③	Laminate A		Laminate B	
					J	F	J	F
6	6	36"(914mm)	72"(1829mm)	TARA-3672-L S JG4	\$ 980.60	\$1273.32	\$1076.37	\$1369.09
6	6		78"(1981mm)	TARA-3678-L S JG4	1052.60	1359.36	1156.35	1463.11
6	6		84"(2134mm)	TARA-3684-L S JG4	1124.60	1445.40	1236.33	1557.13
6	8		90"(2286mm)	TARA-3690-L S JG4	1196.60	1531.44	1316.31	1651.15
6	8		96"(2438mm)	TARA-3696-L S JG4	1268.60	1617.48	1396.29	1745.17
6	6	42"(1067mm)	84"(2134mm)	TARA-4284-L S JG4	\$1289.24	\$1624.08	\$1419.59	\$1754.43
6	8		90"(2286mm)	TARA-4290-L S JG4	1372.82	1721.70	1512.48	1861.36
6	8		96"(2438mm)	TARA-4296-L S JG4	1456.40	1819.32	1605.37	1968.29
6	8		102"(2591mm)	TARA-42A2-L S JG4	1539.98	1916.94	1698.26	2075.22
6	10		108"(2743mm)	TARA-42A8-L S JG4	1623.56	2014.56	1791.15	2182.15
6	10		114"(2896mm)	TARA-42B4-L S JG4	1707.14	2112.18	1884.04	2289.08
6	10		120"(3048mm)	TARA-42C0-L S JG4	1790.72	2209.80	1976.93	2396.01
6	6	48"(1291mm)	84"(2134mm)	TARA-4884-L S JG4	\$1453.88	\$1802.76	\$1602.85	\$1951.73
6	8		90"(2286mm)	TARA-4890-L S JG4	1549.04	1911.96	1708.65	2071.57
6	8		96"(2438mm)	TARA-4896-L S JG4	1644.20	2021.16	1814.45	2191.41
6	8		102"(2591mm)	TARA-48A2-L S JG4	1739.36	2130.36	1920.25	2311.25
6	10		108"(2743mm)	TARA-48A8-L S JG4	1834.52	2239.56	2026.05	2431.09
6	10		114"(2896mm)	TARA-48B4-L S JG4	1929.68	2348.76	2131.85	2550.93
6	10		120"(3048mm)	TARA-48C0-L S JG4	2024.84	2457.96	2237.65	2670.77
6	8	54"(1372mm)	84"(2134mm)	TARA-5484-L S JG4	\$1618.52	\$1981.44	\$1786.11	\$2149.03
6	10		90"(2286mm)	TARA-5490-L S JG4	1725.26	2102.22	1904.82	2281.78
6	10		96"(2438mm)	TARA-5496-L S JG4	1832.00	2223.00	2023.53	2414.53
6	10		102"(2591mm)	TARA-54A2-L S JG4	1938.74	2343.78	2142.24	2547.28
6	10		108"(2743mm)	TARA-54A8-L S JG4	2045.48	2464.56	2260.95	2680.03
6	10		114"(2896mm)	TARA-54B4-L S JG4	2152.22	2585.34	2379.66	2812.78
6	10		120"(3048mm)	TARA-54C0-L S JG4	2258.96	2706.12	2498.37	2945.53
6	10	60"(1524mm)	84"(2134mm)	TARA-6084-L S JG4	\$1783.16	\$2160.12	\$1969.37	\$2346.33
6	10		90"(2286mm)	TARA-6090-L S JG4	1901.48	2292.48	2100.99	2491.99
6	10		96"(2438mm)	TARA-6096-L S JG4	2019.80	2424.84	2232.61	2637.65
6	10		102"(2591mm)	TARA-60A2-L S JG4	2138.12	2557.20	2364.23	2783.31
6	10		108"(2743mm)	TARA-60A8-L S JG4	2256.44	2689.56	2495.85	2928.97
6	10		114"(2896mm)	TARA-60B4-L S JG4	2374.76	2821.92	2627.47	3074.63
6	10		120"(3048mm)	TARA-60C0-L S JG4	2493.08	2954.28	2759.09	3220.29

*Recommended seating capacity based upon 27"(686mm) per chair.

Planes Conference Tables — One-Piece Top — Interior Leg — Laminate

Pebble

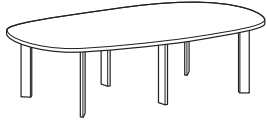

TARP

Features

- Includes 1 3/16" (30mm) thick top, interior leg bases and hardware.
- Standard table height is 29" (737mm).
- Laminate top with 3mm edgeband or knife edges.
- Top available in standard core.
- Interior legs are painted aluminum.
- Interior leg is 1 1/8" (29mm) x 3 1/4" (83mm).
- Optional cable base can be specified for tables 36" (914mm) deep and deeper:
 - 36" (914mm) deep tables will ship with 8" (203mm) x 14" (356mm) cable base.
 - 42" (1067mm) deep and deeper tables will ship with 14" (356mm) x 14" (356mm) cable base.
 - One piece tops will include one cable base to be centered under table top.
 - Cable base and table top(s) are laminate and can be specified in different surface colors and edge trim colors.
 - Refer to Specification Guide for use guidelines.
- Optional Flip top unit electrical modules are separately specified. Refer to electrical components for appropriate product specification.
- Available with glides only; 1/2" (13mm) height adjustment.
- Depth and width shown in nominal dimensions.
- Ships unassembled.

Specification Tips

- Cable base for 36" (914mm) deep table is not compatible with Flip Top Cut Out Options (M) and (Q).
- The following Planes products are separately specified:
 - Grommets (field cut grommet)
 - Flip top unit electrical modules
 - Horizontal wire management
- Refer to Specification Guide for seating capacities with Cable Base Option and leg locations.

To Order, Specify:

1) Product number, including:

① Edge Option:

- J** Edgeband
- F** Knife

② Flip Top Unit Cutout(s):

- N** None
- F** Center – single-sided/4 outlets, add **\$31.86** list
- V** Left/Right – single-sided/4 outlets, add **\$63.72** list
- J** Center – single-sided/6 outlets, add **\$31.86** list
- K** Left/Right – single-sided/6 outlets, add **\$63.72** list
- M** Center – double-sided/8 outlets, add **\$31.86** list
- P** Left/Right – double-sided/8 outlets, add **\$63.72** list
- Q** Center – double-sided/12 outlets, add **\$31.86** list
- T** Left/Right – double-sided/12 outlets, add **\$63.72** list

③ Cable Base Option:

- N** None
- C** Cable Base: add **\$637.24** list for 36" deep tables; add **\$671.99** list for 42" deep and deeper tables

- 2) Laminate surface color.
- 3) Edge trim color.
- 4) Base trim color.
- 5) Laminate surface – Cable Base
- 6) Edge trim color – Cable Base

Note: **\$44.02** upcharge (list) for Metallic and accent trim colors.

Planes Conference Tables — One-Piece Top — Interior Leg — Laminate

Pebble

No. of Legs	Seating Capacity*	Depth	Width	Number	①	②	③	Laminate A		Laminate B	
								J	F	J	F
4	6	36"(914mm)	72"(1829mm)	TARP-3672-L	S	JG4		\$1020.10	\$1325.22	\$1119.85	\$1424.97
6	6		78"(1981mm)	TARP-3678-L	S	JG4		1094.98	1414.74	1203.07	1522.83
6	6		84"(2134mm)	TARP-3684-L	S	JG4		1169.86	1504.26	1286.29	1620.69
6	8		90"(2286mm)	TARP-3690-L	S	JG4		1244.74	1593.78	1369.51	1718.55
6	8		96"(2438mm)	TARP-3696-L	S	JG4		1319.62	1683.30	1452.73	1816.41
6	6	42"(1067mm)	84"(2134mm)	TARP-4284-L	S	JG4		\$1341.06	\$1690.10	\$1476.95	\$1825.99
6	8		90"(2286mm)	TARP-4290-L	S	JG4		1427.98	1791.66	1573.60	1937.28
6	8		96"(2438mm)	TARP-4296-L	S	JG4		1514.90	1893.22	1670.25	2048.57
6	8		102"(2591mm)	TARP-42A2-L	S	JG4		1601.82	1994.78	1766.90	2159.86
6	10		108"(2743mm)	TARP-42A8-L	S	JG4		1688.74	2096.34	1863.55	2271.15
6	10		114"(2896mm)	TARP-42B4-L	S	JG4		1775.66	2197.90	1960.20	2382.44
6	10		120"(3048mm)	TARP-42C0-L	S	JG4		1862.58	2299.46	2056.85	2493.73
6	6	48"(1291mm)	84"(2134mm)	TARP-4884-L	S	JG4		\$1512.26	\$1875.94	\$1667.61	\$2031.29
6	8		90"(2286mm)	TARP-4890-L	S	JG4		1611.22	1989.54	1777.69	2156.01
6	8		96"(2438mm)	TARP-4896-L	S	JG4		1710.18	2103.14	1887.77	2280.73
6	8		102"(2591mm)	TARP-48A2-L	S	JG4		1809.14	2216.74	1997.85	2405.45
6	10		108"(2743mm)	TARP-48A8-L	S	JG4		1908.10	2330.34	2107.93	2530.17
6	10		114"(2896mm)	TARP-48B4-L	S	JG4		2007.06	2443.94	2218.01	2654.89
6	10		120"(3048mm)	TARP-48C0-L	S	JG4		2106.02	2557.54	2328.09	2779.61
6	8	54"(1372mm)	84"(2134mm)	TARP-5484-L	S	JG4		\$1683.46	\$2061.78	\$1858.27	\$2236.59
6	10		90"(2286mm)	TARP-5490-L	S	JG4		1794.46	2187.42	1981.78	2374.74
6	10		96"(2438mm)	TARP-5496-L	S	JG4		1905.46	2313.06	2105.29	2512.89
6	10		102"(2591mm)	TARP-54A2-L	S	JG4		2016.46	2438.70	2228.80	2651.04
6	10		108"(2743mm)	TARP-54A8-L	S	JG4		2127.46	2564.34	2352.31	2789.19
6	10		114"(2896mm)	TARP-54B4-L	S	JG4		2238.46	2689.98	2475.82	2927.34
6	10		120"(3048mm)	TARP-54C0-L	S	JG4		2349.46	2815.62	2599.33	3065.49
6	10	60"(1524mm)	84"(2134mm)	TARP-6084-L	S	JG4		\$1854.66	\$2247.62	\$2048.93	\$2441.89
6	10		90"(2286mm)	TARP-6090-L	S	JG4		1977.70	2385.30	2185.87	2593.47
6	10		96"(2438mm)	TARP-6096-L	S	JG4		2100.74	2522.98	2322.81	2745.05
6	10		102"(2591mm)	TARP-60A2-L	S	JG4		2223.78	2660.66	2459.75	2896.63
6	10		108"(2743mm)	TARP-60A8-L	S	JG4		2346.82	2798.34	2596.69	3048.21
6	10		114"(2896mm)	TARP-60B4-L	S	JG4		2469.86	2936.02	2733.63	3199.79
6	10		120"(3048mm)	TARP-60C0-L	S	JG4		2592.90	3073.70	2870.57	3351.37

*Recommended seating capacity based upon 27"(686mm) per chair.

Planes Conference Tables — One-Piece Top — Interior Leg — Laminate

Hexagon

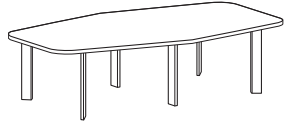

TARX

Features

- Includes 1 3/16" (30mm) thick top, interior leg bases and hardware.
- Standard table height is 29" (737mm).
- Laminate top with 3mm edgeband and knife edges.
- Top available in standard core.
- Interior legs are painted aluminum.
- Interior leg is 1 1/8" (29mm) x 3 1/4" (83mm).
- Optional cable base can be specified for tables 36" (914mm) deep and deeper:
 - 36" (914mm) deep tables will ship with 8" (203mm) x 14" (356mm) cable base.
 - 42" (1067mm) deep and deeper tables will ship with 14" (356mm) x 14" (356mm) cable base.
 - One piece tops will include one cable base to be centered under table top.
 - Cable base and table top(s) are laminate and can be specified in different surface colors and edge trim colors.
 - Refer to Specification Guide for use guidelines.
- Optional Flip top unit electrical modules are separately specified. Refer to electrical components for appropriate product specification.
- Available with glides only; 1/2" (13mm) height adjustment.
- Depth and width shown in nominal dimensions.
- Ships unassembled.

Specification Tips

- Cable base for 36" (914mm) deep table is not compatible with Flip Top Cut Out Options (M) and (Q).
- The following Planes products are separately specified:
 - Grommets (field cut opening)
 - Flip top unit electrical modules
 - Horizontal wire management
- Refer to Specification Guide for seating capacities with Cable Base Option and leg locations.

To Order, Specify:

1) Product number, including:

① Edge Option:

- J** Edgeband
- F** Knife

② Flip Top Unit Cutout(s):

- N** None
- F** Center – single-sided/4 outlets, add **\$31.86** list
- V** Left/Right – single-sided/4 outlets, add **\$63.72** list
- J** Center – single-sided/6 outlets, add **\$31.86** list
- K** Left/Right – single-sided/6 outlets, add **\$63.72** list
- M** Center – double-sided/8 outlets, add **\$31.86** list
- P** Left/Right – double-sided/8 outlets, add **\$63.72** list
- Q** Center – double-sided/12 outlets, add **\$31.86** list
- T** Left/Right – double-sided/12 outlets, add **\$63.72** list

③ Cable Base Option:

- N** None
- C** Cable Base: add **\$637.24** list for 36" deep tables; add **\$671.99** list for 42" deep and deeper tables

- 2) Laminate surface color.
- 3) Edge trim color.
- 4) Base trim color.
- 5) Laminate surface – Cable Base
- 6) Edge trim color – Cable Base

Note: **\$44.02** upcharge (list) for Metallic and accent trim colors.

Planes Conference Tables — One-Piece Top — Interior Leg — Laminate

Hexagon

No. of Legs	Seating Capacity*	Depth	Width	Number	①	②	③	Laminate A		Laminate B	
								J	F	J	F
4	6	36"(914mm)	72"(1829mm)	TARX-3672-L	S	JG4		\$1020.10	\$1325.22	\$1119.85	\$1424.97
6	6		78"(1981mm)	TARX-3678-L	S	JG4		1094.98	1414.74	1203.07	1522.83
6	6		84"(2134mm)	TARX-3684-L	S	JG4		1169.86	1504.26	1286.29	1620.69
6	8		90"(2286mm)	TARX-3690-L	S	JG4		1244.74	1593.78	1369.51	1718.55
6	8		96"(2438mm)	TARX-3696-L	S	JG4		1319.62	1683.30	1452.73	1816.41
6	6	42"(1067mm)	84"(2134mm)	TARX-4284-L	S	JG4		\$1341.06	\$1690.10	\$1476.95	\$1825.99
6	8		90"(2286mm)	TARX-4290-L	S	JG4		1427.98	1791.66	1573.60	1937.28
6	8		96"(2438mm)	TARX-4296-L	S	JG4		1514.90	1893.22	1670.25	2048.57
6	8		102"(2591mm)	TARX-42A2-L	S	JG4		1601.82	1994.78	1766.90	2159.86
6	10		108"(2743mm)	TARX-42A8-L	S	JG4		1688.74	2096.34	1863.55	2271.15
6	10		114"(2896mm)	TARX-42B4-L	S	JG4		1775.66	2197.90	1960.20	2382.44
6	10		120"(3048mm)	TARX-42C0-L	S	JG4		1862.58	2299.46	2056.85	2493.73
6	6	48"(1291mm)	84"(2134mm)	TARX-4884-L	S	JG4		\$1512.26	\$1875.94	\$1667.61	\$2031.29
6	8		90"(2286mm)	TARX-4890-L	S	JG4		1611.22	1989.54	1777.69	2156.01
6	8		96"(2438mm)	TARX-4896-L	S	JG4		1710.18	2103.14	1887.77	2280.73
6	8		102"(2591mm)	TARX-48A2-L	S	JG4		1809.14	2216.74	1997.85	2405.45
6	10		108"(2743mm)	TARX-48A8-L	S	JG4		1908.10	2330.34	2107.93	2530.17
6	10		114"(2896mm)	TARX-48B4-L	S	JG4		2007.06	2443.94	2218.01	2654.89
6	10		120"(3048mm)	TARX-48C0-L	S	JG4		2106.02	2557.54	2328.09	2779.61
6	8	54"(1372mm)	84"(2134mm)	TARX-5484-L	S	JG4		\$1683.46	\$2061.78	\$1858.27	\$2236.59
6	10		90"(2286mm)	TARX-5490-L	S	JG4		1794.46	2187.42	1981.78	2374.74
6	10		96"(2438mm)	TARX-5496-L	S	JG4		1905.46	2313.06	2105.29	2512.89
6	10		102"(2591mm)	TARX-54A2-L	S	JG4		2016.46	2438.70	2228.80	2651.04
6	10		108"(2743mm)	TARX-54A8-L	S	JG4		2127.46	2564.34	2352.31	2789.19
6	10		114"(2896mm)	TARX-54B4-L	S	JG4		2238.46	2689.98	2475.82	2927.34
6	10		120"(3048mm)	TARX-54C0-L	S	JG4		2349.46	2815.62	2599.33	3065.49
6	10	60"(1524mm)	84"(2134mm)	TARX-6084-L	S	JG4		\$1854.66	\$2247.62	\$2048.93	\$2441.89
6	10		90"(2286mm)	TARX-6090-L	S	JG4		1977.70	2385.30	2185.87	2593.47
6	10		96"(2438mm)	TARX-6096-L	S	JG4		2100.74	2522.98	2322.81	2745.05
6	10		102"(2591mm)	TARX-60A2-L	S	JG4		2223.78	2660.66	2459.75	2896.63
6	10		108"(2743mm)	TARX-60A8-L	S	JG4		2346.82	2798.34	2596.69	3048.21
6	10		114"(2896mm)	TARX-60B4-L	S	JG4		2469.86	2936.02	2733.63	3199.79
6	10		120"(3048mm)	TARX-60C0-L	S	JG4		2592.90	3073.70	2870.57	3351.37

*Recommended seating capacity based upon 27"(686mm) per chair.

Planes Conference Tables — One-Piece Top — Interior Leg — Wood

Rectangular

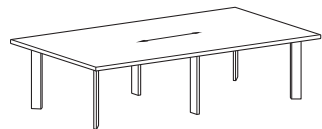

TARA

Features

- Includes 1 3/16" (30mm) thick top, interior leg bases and hardware.
- Standard table height is 29" (737mm).
- Top available in standard core.
- Wood veneer top with 3mm wood edgeband or knife wood edge.
- Interior legs are painted aluminum.
- Interior leg is 1 1/8" (29mm) x 3 1/4" (83mm).
- Optional cable base can be specified for tables 36" (914mm) deep and deeper:
 - 36" (914mm) deep tables will ship with 8" (203mm) x 14" (356mm) cable base.
 - 42" (1067mm) deep and deeper tables will ship with 14" (356mm) x 14" (356mm) cable base.
 - One piece tops will include one cable base to be centered under table top.
 - Cable base and table top(s) are wood veneer and can be specified in different surface colors and edge trim colors.
 - Refer to Specification Guide for use guidelines.
- Optional Flip top unit electrical modules are separately specified. Refer to electrical components for appropriate product specification.
- Available with glides only; 1/2" (13mm) height adjustment.
- Depth and width shown in nominal dimensions.
- Ships unassembled.

Specification Tips

- Cable base for 36" (914mm) deep table is not compatible with Flip Top Cut Out Options (M) and (Q).
- The following Planes products are separately specified:
 - Grommets (field cut opening)
 - Flip top unit electrical modules
 - Horizontal wire management
- Refer to Specification Guide for seating capacities with Cable Base Option and leg locations.

To Order, Specify:

1) Product number, including:

① Wood Edge Option:

- K** Edgeband
- U** Knife

② Flip Top Unit Cutout(s):

- N** None
- F** Center – single-sided/4 outlets, add **\$31.86** list
- V** Left/Right – single-sided/4 outlets, add **\$63.72** list
- J** Center – single-sided/6 outlets, add **\$31.86** list
- K** Left/Right – single-sided/6 outlets, add **\$63.72** list
- M** Center – double-sided/8 outlets, add **\$31.86** list
- P** Left/Right – double-sided/8 outlets, add **\$63.72** list
- Q** Center – double-sided/12 outlets, add **\$31.86** list
- T** Left/Right – double-sided/12 outlets, add **\$63.72** list

③ Cable Base Option:

- N** None
- C** Cable Base: add **\$637.24** list for 36" deep tables; add **\$671.99** list for 42" deep and deeper tables

2) Wood finish color.

3) Base trim color.

4) Wood finish color – Cable Base

Note: **\$44.02** upcharge (list) for Metallic and accent trim colors.

Planes Conference Tables — One-Piece Top — Interior Leg — Wood

Rectangular

No. of Legs	Seating Capacity*	Depth	Width	Number	①	②	③	Wood Group A		Wood Group B	
								K	U	K	U
6	6	36"(914mm)	72"(1829mm)	TARA-3672-W	S	JG4		\$1487.96	\$1858.32	\$1636.18	\$2058.07
6	6		78"(1981mm)	TARA-3678-W	S	JG4		1602.81	2006.46	1771.94	2232.49
6	6		84"(2134mm)	TARA-3684-W	S	JG4		1717.93	2156.44	1908.03	2409.07
6	8		90"(2286mm)	TARA-3690-W	S	JG4		1833.31	2308.27	2044.44	2587.81
6	8		96"(2438mm)	TARA-3696-W	S	JG4		1948.97	2461.93	2181.17	2768.71
6	6	42"(1067mm)	84"(2134mm)	TARA-4284-W	S	JG4		\$1968.18	\$2426.62	\$2203.36	\$2727.45
6	8		90"(2286mm)	TARA-4290-W	S	JG4		2100.91	2596.58	2360.22	2927.56
6	8		96"(2438mm)	TARA-4296-W	S	JG4		2233.91	2768.37	2517.41	3129.83
6	8		102"(2591mm)	TARA-42A2-W	S	JG4		2367.18	2942.01	2674.92	3334.26
6	10		108"(2743mm)	TARA-42A8-W	S	JG4		2500.71	3117.48	2832.75	3540.85
6	10		114"(2896mm)	TARA-42B4-W	S	JG4		2634.52	3294.80	2990.91	3749.60
6	10		120"(3048mm)	TARA-42C0-W	S	JG4		2768.59	3473.95	3149.39	3960.51
6	6	48"(1291mm)	84"(2134mm)	TARA-4884-W	S	JG4		\$2218.44	\$2696.80	\$2498.69	\$3045.83
6	8		90"(2286mm)	TARA-4890-W	S	JG4		2368.51	2884.89	2676.00	3267.31
6	8		96"(2438mm)	TARA-4896-W	S	JG4		2518.86	3074.81	2853.64	3490.95
6	8		102"(2591mm)	TARA-48A2-W	S	JG4		2669.47	3266.58	3031.60	3716.75
6	10		108"(2743mm)	TARA-48A8-W	S	JG4		2820.34	3460.18	3209.89	3944.71
6	10		114"(2896mm)	TARA-48B4-W	S	JG4		2971.49	3655.63	3388.50	4174.83
6	10		120"(3048mm)	TARA-48C0-W	S	JG4		3122.91	3852.91	3567.43	4407.11
6	8	54"(1372mm)	84"(2134mm)	TARA-5484-W	S	JG4		\$2468.69	\$2966.98	\$2794.01	\$3364.21
6	10		90"(2286mm)	TARA-5490-W	S	JG4		2636.11	3173.20	2991.78	3607.06
6	10		96"(2438mm)	TARA-5496-W	S	JG4		2803.80	3381.25	3189.87	3852.07
6	10		102"(2591mm)	TARA-54A2-W	S	JG4		2971.75	3591.15	3388.28	4099.24
6	10		108"(2743mm)	TARA-54A8-W	S	JG4		3139.98	3802.88	3587.02	4348.57
6	10		114"(2896mm)	TARA-54B4-W	S	JG4		3308.47	4016.46	3786.08	4600.06
6	10		120"(3048mm)	TARA-54C0-W	S	JG4		3477.22	4231.88	3985.47	4853.71
6	10	60"(1524mm)	84"(2134mm)	TARA-6084-W	S	JG4		\$2718.95	\$3237.17	\$3089.34	\$3682.59
6	10		90"(2286mm)	TARA-6090-W	S	JG4		2903.71	3461.51	3307.56	3946.81
6	10		96"(2438mm)	TARA-6096-W	S	JG4		3088.74	3687.69	3526.10	4213.19
6	10		102"(2591mm)	TARA-60A2-W	S	JG4		3274.04	3915.72	3744.97	4481.73
6	10		108"(2743mm)	TARA-60A8-W	S	JG4		3459.61	4145.59	3964.16	4752.43
6	10		114"(2896mm)	TARA-60B4-W	S	JG4		3645.44	4377.29	4183.67	5025.29
6	10		120"(3048mm)	TARA-60C0-W	S	JG4		3831.54	4610.84	4403.51	5300.31

*Recommended seating capacity based upon 27"(686mm) per chair.

Planes Conference Tables — One-Piece Top — Interior Leg — Wood

Pebble

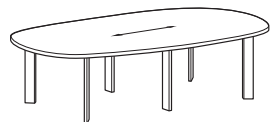

TARP

Features

- Includes 1 3/16”(30mm) thick top, interior leg bases and hardware.
- Standard table height is 29”(737mm).
- Wood veneer top with 3mm wood edgeband or knife wood edge.
- Interior legs are painted aluminum.
- Interior leg is 1 1/8”(29mm) x 3 1/4”(83mm).
- Optional cable base can be specified for tables 36”(914mm) deep and deeper:
 - 36”(914mm) deep tables will ship with 8”(203mm) x 14”(356mm) cable base.
 - 42”(1067mm) deep and deeper tables will ship with 14”(356mm) x 14”(356mm) cable base.
 - One piece tops will include one cable base to be centered under table top.
 - Cable base and table top(s) are wood veneer and can be specified in different surface colors and edge trim colors.
 - Refer to Specification Guide for use guidelines.
- Optional Flip top unit electrical modules are separately specified. Refer to electrical components for appropriate product specification.
- Available with glides only; 1/2”(13mm) height adjustment.
- Depth and width shown in nominal dimensions.
- Ships unassembled.

Specification Tips

- Cable base for 36”(914mm) deep table is not compatible with Flip Top Cut Out Options (M) and (Q).
- The following Planes products are separately specified:
 - Grommets (field cut opening)
 - Flip top unit electrical modules
 - Horizontal wire management
- Refer to Specification Guide for seating capacities with Cable Base Option and leg locations.

To Order, Specify:

1) Product number, including:

① Wood Edge Option:

- K** Edgeband
- U** Knife

② Flip Top Unit Cutout(s):

- N** None
- F** Center – single-sided/4 outlets, add **\$31.86** list
- V** Left/Right – single-sided/4 outlets, add **\$63.72** list
- J** Center – single-sided/6 outlets, add **\$31.86** list
- K** Left/Right – single-sided/6 outlets, add **\$63.72** list
- M** Center – double-sided/8 outlets, add **\$31.86** list
- P** Left/Right – double-sided/8 outlets, add **\$63.72** list
- Q** Center – double-sided/12 outlets, add **\$31.86** list
- T** Left/Right – double-sided/12 outlets, add **\$63.72** list

③ Cable Base Option:

- N** None
- C** Cable Base: add **\$637.24** list for 36” deep tables; add **\$671.99** list for 42” deep and deeper tables

- 2) Wood finish color.
- 3) Base trim color.
- 4) Wood finish color – Cable Base

Note: **\$44.02** upcharge (list) for Metallic and accent trim colors.

Planes Conference Tables — One-Piece Top — Interior Leg — Wood

Pebble

No. of Legs	Seating Capacity*	Depth	Width	Number	①	②	③	Wood Group A		Wood Group B	
								K	U	K	U
4	6	36"(914mm)	72"(1829mm)	TARP-3672-W	S	JG4		\$1487.96	\$1858.32	\$1636.18	\$2058.07
6	6		78"(1981mm)	TARP-3678-W	S	JG4		1602.81	2006.46	1771.94	2232.49
6	6		84"(2134mm)	TARP-3684-W	S	JG4		1717.93	2156.44	1908.03	2409.07
6	8		90"(2286mm)	TARP-3690-W	S	JG4		1833.31	2308.27	2044.44	2587.81
6	8		96"(2438mm)	TARP-3696-W	S	JG4		1948.97	2461.93	2181.17	2768.71
6	6	42"(1067mm)	84"(2134mm)	TARP-4284-W	S	JG4		\$1968.18	\$2426.62	\$2203.36	\$2727.45
6	8		90"(2286mm)	TARP-4290-W	S	JG4		2100.91	2596.58	2360.22	2927.56
6	8		96"(2438mm)	TARP-4296-W	S	JG4		2233.91	2768.37	2517.41	3129.83
6	8		102"(2591mm)	TARP-42A2-W	S	JG4		2367.18	2942.01	2674.92	3334.26
6	10		108"(2743mm)	TARP-42A8-W	S	JG4		2500.71	3117.48	2832.75	3540.85
6	10		114"(2896mm)	TARP-42B4-W	S	JG4		2634.52	3294.80	2990.91	3749.60
6	10		120"(3048mm)	TARP-42C0-W	S	JG4		2768.59	3473.95	3149.39	3960.51
6	6	48"(1291mm)	84"(2134mm)	TARP-4884-W	S	JG4		\$2218.44	\$2696.80	\$2498.69	\$3045.83
6	8		90"(2286mm)	TARP-4890-W	S	JG4		2368.51	2884.89	2676.00	3267.31
6	8		96"(2438mm)	TARP-4896-W	S	JG4		2518.86	3074.81	2853.64	3490.95
6	8		102"(2591mm)	TARP-48A2-W	S	JG4		2669.47	3266.58	3031.60	3716.75
6	10		108"(2743mm)	TARP-48A8-W	S	JG4		2820.34	3460.18	3209.89	3944.71
6	10		114"(2896mm)	TARP-48B4-W	S	JG4		2971.49	3655.63	3388.50	4174.83
6	10		120"(3048mm)	TARP-48C0-W	S	JG4		3122.91	3852.91	3567.43	4407.11
6	8	54"(1372mm)	84"(2134mm)	TARP-5484-W	S	JG4		\$2468.69	\$2966.98	\$2794.01	\$3364.21
6	10		90"(2286mm)	TARP-5490-W	S	JG4		2636.11	3173.20	2991.78	3607.06
6	10		96"(2438mm)	TARP-5496-W	S	JG4		2803.80	3381.25	3189.87	3852.07
6	10		102"(2591mm)	TARP-54A2-W	S	JG4		2971.75	3591.15	3388.28	4099.24
6	10		108"(2743mm)	TARP-54A8-W	S	JG4		3139.98	3802.88	3587.02	4348.57
6	10		114"(2896mm)	TARP-54B4-W	S	JG4		3308.47	4016.46	3786.08	4600.06
6	10		120"(3048mm)	TARP-54C0-W	S	JG4		3477.22	4231.88	3985.47	4853.71
6	10	60"(1524mm)	84"(2134mm)	TARP-6084-W	S	JG4		\$2718.95	\$3237.17	\$3089.34	\$3682.59
6	10		90"(2286mm)	TARP-6090-W	S	JG4		2903.71	3461.51	3307.56	3946.81
6	10		96"(2438mm)	TARP-6096-W	S	JG4		3088.74	3687.69	3526.10	4213.19
6	10		102"(2591mm)	TARP-60A2-W	S	JG4		3274.04	3915.72	3744.97	4481.73
6	10		108"(2743mm)	TARP-60A8-W	S	JG4		3459.61	4145.59	3964.16	4752.43
6	10		114"(2896mm)	TARP-60B4-W	S	JG4		3645.44	4377.29	4183.67	5025.29
6	10		120"(3048mm)	TARP-60C0-W	S	JG4		3831.54	4610.84	4403.51	5300.31

*Recommended seating capacity based upon 27"(686mm) per chair.

Planes Conference Tables — One-Piece Top — Interior Leg — Wood

Hexagon

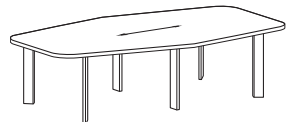

TARX

Features

- Includes 1 3/16”(30mm) thick top, interior leg bases and hardware.
- Standard table height is 29”(737mm).
- Wood veneer top with 3mm wood edgeband or knife wood edge.
- Interior legs are painted aluminum.
- Interior leg is 1 1/8”(29mm) x 3 1/4”(83mm).
- Optional cable base can be specified for tables 36”(914mm) deep and deeper:
 - 36”(914mm) deep tables will ship with 8”(203mm) x 14”(356mm) cable base.
 - 42”(1067mm) deep and deeper tables will ship with 14”(356mm) x 14”(356mm) cable base.
 - One piece tops will include one cable base to be centered under table top.
 - Cable base and table top(s) are wood veneer and can be specified in different surface colors and edge trim colors.
 - Refer to Specification Guide for use guidelines.
- Optional Flip top unit electrical modules are separately specified. Refer to electrical components for appropriate product specification.
- Available with glides only; 1/2”(13mm) height adjustment.
- Depth and width shown in nominal dimensions.
- Ships unassembled.

Specification Tips

- Cable base for 36”(914mm) deep table is not compatible with Flip Top Cut Out Options (M) and (Q).
- The following Planes products are separately specified:
 - Grommets (field cut opening)
 - Flip top unit electrical modules
 - Horizontal wire management
- Refer to Specification Guide for seating capacities with Cable Base Option and leg locations.

To Order, Specify:

1) Product number, including:

① Wood Edge Option:

- K** Edgeband
- U** Knife

② Flip Top Unit Cutout(s):

- N** None
- F** Center – single-sided/4 outlets, add **\$31.86** list
- V** Left/Right – single-sided/4 outlets, add **\$63.72** list
- J** Center – single-sided/6 outlets, add **\$31.86** list
- K** Left/Right – single-sided/6 outlets, add **\$63.72** list
- M** Center – double-sided/8 outlets, add **\$31.86** list
- P** Left/Right – double-sided/8 outlets, add **\$63.72** list
- Q** Center – double-sided/12 outlets, add **\$31.86** list
- T** Left/Right – double-sided/12 outlets, add **\$63.72** list

③ Cable Base Option:

- N** None
- C** Cable Base: add **\$637.24** list for 36” deep tables; add **\$671.99** list for 42” deep and deeper tables

- 2) Wood finish color.
- 3) Base trim color.
- 4) Wood finish color – Cable Base

Note: **\$44.02** upcharge (list) for Metallic and accent trim colors.

Planes Conference Tables — One-Piece Top — Interior Leg — Wood

Hexagon

No. of Legs	Seating Capacity*	Depth	Width	Number	①	②	③	Wood Group A		Wood Group B	
								K	U	K	U
4	6	36"(914mm)	72"(1829mm)	TARX-3672-W	S	JG4		\$1487.96	\$1858.32	\$1636.18	\$2058.07
6	6		78"(1981mm)	TARX-3678-W	S	JG4		1602.81	2006.46	1771.94	2232.49
6	6		84"(2134mm)	TARX-3684-W	S	JG4		1717.93	2156.44	1908.03	2409.07
6	8		90"(2286mm)	TARX-3690-W	S	JG4		1833.31	2308.27	2044.44	2587.81
6	8		96"(2438mm)	TARX-3696-W	S	JG4		1948.97	2461.93	2181.17	2768.71
6	6	42"(1067mm)	84"(2134mm)	TARX-4284-W	S	JG4		\$1968.18	\$2426.62	\$2203.36	\$2727.45
6	8		90"(2286mm)	TARX-4290-W	S	JG4		2100.91	2596.58	2360.22	2927.56
6	8		96"(2438mm)	TARX-4296-W	S	JG4		2233.91	2768.37	2517.41	3129.83
6	8		102"(2591mm)	TARX-42A2-W	S	JG4		2367.18	2942.01	2674.92	3334.26
6	10		108"(2743mm)	TARX-42A8-W	S	JG4		2500.71	3117.48	2832.75	3540.85
6	10		114"(2896mm)	TARX-42B4-W	S	JG4		2634.52	3294.80	2990.91	3749.60
6	10		120"(3048mm)	TARX-42C0-W	S	JG4		2768.59	3473.95	3149.39	3960.51
6	6	48"(1291mm)	84"(2134mm)	TARX-4884-W	S	JG4		\$2218.44	\$2696.80	\$2498.69	\$3045.83
6	8		90"(2286mm)	TARX-4890-W	S	JG4		2368.51	2884.89	2676.00	3267.31
6	8		96"(2438mm)	TARX-4896-W	S	JG4		2518.86	3074.81	2853.64	3490.95
6	8		102"(2591mm)	TARX-48A2-W	S	JG4		2669.47	3266.58	3031.60	3716.75
6	10		108"(2743mm)	TARX-48A8-W	S	JG4		2820.34	3460.18	3209.89	3944.71
6	10		114"(2896mm)	TARX-48B4-W	S	JG4		2971.49	3655.63	3388.50	4174.83
6	10		120"(3048mm)	TARX-48C0-W	S	JG4		3122.91	3852.91	3567.43	4407.11
6	8	54"(1372mm)	84"(2134mm)	TARX-5484-W	S	JG4		\$2468.69	\$2966.98	\$2794.01	\$3364.21
6	10		90"(2286mm)	TARX-5490-W	S	JG4		2636.11	3173.20	2991.78	3607.06
6	10		96"(2438mm)	TARX-5496-W	S	JG4		2803.80	3381.25	3189.87	3852.07
6	10		102"(2591mm)	TARX-54A2-W	S	JG4		2971.75	3591.15	3388.28	4099.24
6	10		108"(2743mm)	TARX-54A8-W	S	JG4		3139.98	3802.88	3587.02	4348.57
6	10		114"(2896mm)	TARX-54B4-W	S	JG4		3308.47	4016.46	3786.08	4600.06
6	10		120"(3048mm)	TARX-54C0-W	S	JG4		3477.22	4231.88	3985.47	4853.71
6	10	60"(1524mm)	84"(2134mm)	TARX-6084-W	S	JG4		\$2718.95	\$3237.17	\$3089.34	\$3682.59
6	10		90"(2286mm)	TARX-6090-W	S	JG4		2903.71	3461.51	3307.56	3946.81
6	10		96"(2438mm)	TARX-6096-W	S	JG4		3088.74	3687.69	3526.10	4213.19
6	10		102"(2591mm)	TARX-60A2-W	S	JG4		3274.04	3915.72	3744.97	4481.73
6	10		108"(2743mm)	TARX-60A8-W	S	JG4		3459.61	4145.59	3964.16	4752.43
6	10		114"(2896mm)	TARX-60B4-W	S	JG4		3645.44	4377.29	4183.67	5025.29
6	10		120"(3048mm)	TARX-60C0-W	S	JG4		3831.54	4610.84	4403.51	5300.31

*Recommended seating capacity based upon 27"(686mm) per chair.

Planes Conference Tables — Two-Piece Tops — Interior Leg — Laminate

Rectangular

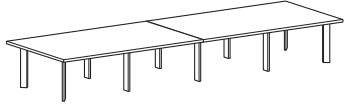

TARA

Features

- Includes 1 3/16" (30mm) thick tops, interior leg bases and hardware.
- Standard table height is 29" (737mm).
- Laminate top with 3mm edgeband or knife edges.
- Table top seam is 1mm edgeband.
- Interior legs are painted aluminum.
- Interior leg is 1 1/8" (29mm) x 3 1/4" (83mm).
- Optional cable base is available:
 - 42" (1067mm) deep and deeper tables will ship with 14" (356mm) x 14" (356mm) cable base
 - Two piece tops will include one cable base to be centered on seam under table top.
 - Cable base and table top(s) are laminate and can be specified in different surface colors and edge trim colors.
 - Refer to Specification Guide for use guidelines.
- Optional Flip top unit electrical modules are separately specified. Refer to electrical components for appropriate product specification.
- Available with glides only; 1/2" (13mm) height adjustment.
- Depth and width shown in nominal dimensions.
- Ships unassembled.

Specification Tips

- Tables with multiple-piece tops have equal sized pieces.
- The following Planes products are separately specified:
 - Grommets (field cut opening)
 - Flip top unit electrical modules
 - Horizontal wire management
- Refer to Specification Guide for seating capacities with Cable Base Option and leg locations.

To Order, Specify:

1) Product number, including:

① Edge Option:

- J** Edgeband
- F** Knife

② Flip Top Unit Cutout(s):

- N** None
- F** Center – single-sided/4 outlets, add **\$63.72** list
- V** Left/Right – single-sided/4 outlets, add **\$127.44** list
- J** Center – single-sided/6 outlets, add **\$63.72** list
- K** Left/Right – single-sided/6 outlets, add **\$127.44** list
- M** Center – double-sided/8 outlets, add **\$63.72** list
- P** Left/Right – double-sided/8 outlets, add **\$127.44** list
- Q** Center – double-sided/12 outlets, add **\$63.72** list
- T** Left/Right – double-sided/12 outlets, add **\$127.44** list

③ Cable Base Option:

- N** None
- C** Cable Base, add **\$671.99** list

- Laminate surface color.
- 1mm edgeband trim color. (Cascade edge/multiple-tops only)*
- Edge trim color.
- Base trim color.
- Laminate surface – Cable Base
- Edge trim color – Cable Base

Note: **\$44.02** upcharge (list) for Metallic and accent trim colors.

Planes Conference Tables — Two-Piece Tops — Interior Leg — Laminate

Rectangular

No. of Legs	Seating Capacity*	Depth	Width	Number	①	②	③	Laminate A		Laminate B	
								J	F	J	F
6	10	42"(1067mm)	126"(3200mm)	TARA-42C6-L	S	JG4		\$2403.96	\$2862.34	\$2599.48	\$3057.86
6	10		132"(3353mm)	TARA-42D2-L	S	JG4		2511.29	2983.71	2716.12	3188.54
10	10		138"(3505mm)	TARA-42D8-L	S	JG4		2618.62	3105.08	2832.76	3319.22
10	10		144"(3658mm)	TARA-42E4-L	S	JG4		2725.95	3226.45	2949.40	3449.90
10	10		150"(3810mm)	TARA-42F0-L	S	JG4		2833.28	3347.82	3066.04	3580.58
10	12		156"(3962mm)	TARA-42F6-L	S	JG4		2940.61	3469.19	3182.68	3711.26
10	12		162"(4115mm)	TARA-42G2-L	S	JG4		3047.94	3590.56	3299.32	3841.94
10	12		168"(4267mm)	TARA-42G8-L	S	JG4		3155.27	3711.93	3415.96	3972.62
10	12		174"(4420mm)	TARA-42H4-L	S	JG4		3262.60	3833.30	3532.60	4103.30
10	12		180"(4572mm)	TARA-42J0-L	S	JG4		3369.93	3954.67	3649.24	4233.98
6	10	48"(1219mm)	126"(3200mm)	TARA-48C6-L	S	JG4		\$2725.66	\$3198.08	\$2949.11	\$3421.53
6	10		132"(3353mm)	TARA-48D2-L	S	JG4		2844.57	3331.03	3078.66	3565.12
10	10		138"(3505mm)	TARA-48D8-L	S	JG4		2963.48	3463.98	3208.21	3708.71
10	10		144"(3658mm)	TARA-48E4-L	S	JG4		3082.39	3596.93	3337.76	3852.30
10	10		150"(3810mm)	TARA-48F0-L	S	JG4		3201.30	3729.88	3467.31	3995.89
10	12		156"(3962mm)	TARA-48F6-L	S	JG4		3320.21	3862.83	3596.86	4139.48
10	12		162"(4115mm)	TARA-48G2-L	S	JG4		3439.12	3995.78	3726.41	4283.07
10	12		168"(4267mm)	TARA-48G8-L	S	JG4		3558.03	4128.73	3855.96	4426.66
10	12		174"(4420mm)	TARA-48H4-L	S	JG4		3676.94	4261.68	3985.51	4570.25
10	12		180"(4572mm)	TARA-48J0-L	S	JG4		3795.85	4394.63	4115.06	4713.84
6	10	54"(1372mm)	126"(3200mm)	TARA-54C6-L	S	JG4		\$3047.36	\$3533.82	\$3298.74	\$3785.20
6	10		132"(3353mm)	TARA-54D2-L	S	JG4		3177.85	3678.35	3441.20	3941.70
10	10		138"(3505mm)	TARA-54D8-L	S	JG4		3308.34	3822.88	3583.66	4098.20
10	10		144"(3658mm)	TARA-54E4-L	S	JG4		3438.83	3967.41	3726.12	4254.70
10	10		150"(3810mm)	TARA-54F0-L	S	JG4		3569.32	4111.94	3868.58	4411.20
10	12		156"(3962mm)	TARA-54F6-L	S	JG4		3699.81	4256.47	4011.04	4567.70
10	12		162"(4115mm)	TARA-54G2-L	S	JG4		3830.30	4401.00	4153.50	4724.20
10	12		168"(4267mm)	TARA-54G8-L	S	JG4		3960.79	4545.53	4295.96	4880.70
10	14		174"(4420mm)	TARA-54H4-L	S	JG4		4091.28	4690.06	4438.42	5037.20
10	14		180"(4572mm)	TARA-54J0-L	S	JG4		4221.77	4834.59	4580.88	5193.70
6	10	60"(1524mm)	126"(3200mm)	TARA-60C6-L	S	JG4		\$3369.06	\$3869.56	\$3648.37	\$4148.87
6	10		132"(3353mm)	TARA-60D2-L	S	JG4		3511.13	4025.67	3803.74	4318.28
10	10		138"(3505mm)	TARA-60D8-L	S	JG4		3653.20	4181.78	3959.11	4487.69
10	10		144"(3658mm)	TARA-60E4-L	S	JG4		3795.27	4337.89	4114.48	4657.10
10	10		150"(3810mm)	TARA-60F0-L	S	JG4		3937.34	4494.00	4269.85	4826.51
10	12		156"(3962mm)	TARA-60F6-L	S	JG4		4079.41	4650.11	4425.22	4995.92
10	12		162"(4115mm)	TARA-60G2-L	S	JG4		4221.48	4806.22	4580.59	5165.33
10	12		168"(4267mm)	TARA-60G8-L	S	JG4		4363.55	4962.33	4735.96	5334.74
10	14		174"(4420mm)	TARA-60H4-L	S	JG4		4505.62	5118.44	4891.33	5504.15
10	14		180"(4572mm)	TARA-60J0-L	S	JG4		4647.69	5274.55	5046.70	5673.56

*Recommended seating capacity based upon 27"(686mm) per chair.

Planes Conference Tables — Two-Piece Tops — Interior Leg — Laminate

Pebble

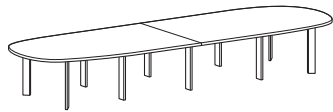

TARP

Features

- Includes 1 3/16" (30mm) thick tops, interior leg bases and hardware.
- Standard table height is 29" (737mm).
- Laminate top with 3mm edgeband or knife edges.
- Table top seam is 1mm edgeband.
- Interior legs are painted aluminum.
- Interior leg is 1 1/8" (29mm) x 3 1/4" (83mm).
- Optional cable base is available:
 - 42" (1067mm) deep and deeper tables will ship with 14" (356mm) x 14" (356mm) cable base
 - Two piece tops will include one cable base to be centered on seam under table top.
 - Cable base and table top(s) are laminate and can be specified in different surface colors and edge trim colors.
 - Refer to Specification Guide for use guidelines.
- Optional Flip top unit electrical modules are separately specified. Refer to electrical components for appropriate product specification.
- Available with glides only; 1/2" (13mm) height adjustment.
- Depth and width shown in nominal dimensions.
- Ships unassembled.

Specification Tips

- Tables with multiple-piece tops have equal sized pieces.
- The following Planes products are separately specified:
 - Grommets (field cut openings)
 - Flip top unit electrical modules
 - Horizontal wire management
- Refer to Specification Guide for seating capacities with Cable Base Option and leg locations.

To Order, Specify:

1) Product number, including:

① Edge Option:

- J** Edgeband
- F** Knife

② Flip Top Unit Cutout(s):

- N** None
- F** Center – single-sided/4 outlets, add **\$63.72** list
- V** Left/Right – single-sided/4 outlets, add **\$127.44** list
- J** Center – single-sided/6 outlets, add **\$63.72** list
- K** Left/Right – single-sided/6 outlets, add **\$127.44** list
- M** Center – double-sided/8 outlets, add **\$63.72** list
- P** Left/Right – double-sided/8 outlets, add **\$127.44** list
- Q** Center – double-sided/12 outlets, add **\$63.72** list
- T** Left/Right – double-sided/12 outlets, add **\$127.44** list

③ Cable Base Option:

- N** None
- C** Cable Base, add **\$671.99** list

- Laminate surface color.
- 1mm edgeband trim color. (Cascade edge/multiple-tops only)*
- Edge trim color.
- Base trim color.
- Laminate surface – Cable Base
- Edge trim color – Cable Base

Note: **\$44.02** upcharge (list) for Metallic and accent trim colors.

Planes Conference Tables — Two-Piece Tops — Interior Leg — Laminate

Pebble

No. of Legs	Seating Capacity*	Depth	Width	Number	①	②	③	Laminate A		Laminate B	
								J	F	J	F
6	10	42"(1067mm)	126"(3200mm)	TARP-42C6-L	S	JG4		\$2403.96	\$2862.34	\$2599.48	\$3057.86
6	10		132"(3353mm)	TARP-42D2-L	S	JG4		2511.29	2983.71	2716.12	3188.54
6	10		138"(3505mm)	TARP-42D8-L	S	JG4		2618.62	3105.08	2832.76	3319.22
6	10		144"(3658mm)	TARP-42E4-L	S	JG4		2725.95	3226.45	2949.40	3449.90
10	10		150"(3810mm)	TARP-42F0-L	S	JG4		2833.28	3347.82	3066.04	3580.58
10	10		156"(3962mm)	TARP-42F6-L	S	JG4		2940.61	3469.19	3182.68	3711.26
10	10		162"(4115mm)	TARP-42G2-L	S	JG4		3047.94	3590.56	3299.32	3841.94
10	12		168"(4267mm)	TARP-42G8-L	S	JG4		3155.27	3711.93	3415.96	3972.62
10	12		174"(4420mm)	TARP-42H4-L	S	JG4		3262.60	3833.30	3532.60	4103.30
10	12		180"(4572mm)	TARP-42J0-L	S	JG4		3369.93	3954.67	3649.24	4233.98
6	10	48"(1219mm)	126"(3200mm)	TARP-48C6-L	S	JG4		\$2725.66	\$3198.08	\$2949.11	\$3421.53
6	10		132"(3353mm)	TARP-48D2-L	S	JG4		2844.57	3331.03	3078.66	3565.12
6	10		138"(3505mm)	TARP-48D8-L	S	JG4		2963.48	3463.98	3208.21	3708.71
6	10		144"(3658mm)	TARP-48E4-L	S	JG4		3082.39	3596.93	3337.76	3852.30
10	10		150"(3810mm)	TARP-48F0-L	S	JG4		3201.30	3729.88	3467.31	3995.89
10	10		156"(3962mm)	TARP-48F6-L	S	JG4		3320.21	3862.83	3596.86	4139.48
10	10		162"(4115mm)	TARP-48G2-L	S	JG4		3439.12	3995.78	3726.41	4283.07
10	10		168"(4267mm)	TARP-48G8-L	S	JG4		3558.03	4128.73	3855.96	4426.66
10	12		174"(4420mm)	TARP-48H4-L	S	JG4		3676.94	4261.68	3985.51	4570.25
10	12		180"(4572mm)	TARP-48J0-L	S	JG4		3795.85	4394.63	4115.06	4713.84
6	10	54"(1372mm)	126"(3200mm)	TARP-54C6-L	S	JG4		\$3047.36	\$3533.82	\$3298.74	\$3785.20
6	10		132"(3353mm)	TARP-54D2-L	S	JG4		3177.85	3678.35	3441.20	3941.70
6	10		138"(3505mm)	TARP-54D8-L	S	JG4		3308.34	3822.88	3583.66	4098.20
6	10		144"(3658mm)	TARP-54E4-L	S	JG4		3438.83	3967.41	3726.12	4254.70
10	10		150"(3810mm)	TARP-54F0-L	S	JG4		3569.32	4111.94	3868.58	4411.20
10	10		156"(3962mm)	TARP-54F6-L	S	JG4		3699.81	4256.47	4011.04	4567.70
10	10		162"(4115mm)	TARP-54G2-L	S	JG4		3830.30	4401.00	4153.50	4724.20
10	10		168"(4267mm)	TARP-54G8-L	S	JG4		3960.79	4545.53	4295.96	4880.70
10	12		174"(4420mm)	TARP-54H4-L	S	JG4		4091.28	4690.06	4438.42	5037.20
10	12		180"(4572mm)	TARP-54J0-L	S	JG4		4221.77	4834.59	4580.88	5193.70
6	10	60"(1524mm)	126"(3200mm)	TARP-60C6-L	S	JG4		\$3369.06	\$3869.56	\$3648.37	\$4148.87
6	10		132"(3353mm)	TARP-60D2-L	S	JG4		3511.13	4025.67	3803.74	4318.28
6	10		138"(3505mm)	TARP-60D8-L	S	JG4		3653.20	4181.78	3959.11	4487.69
6	10		144"(3658mm)	TARP-60E4-L	S	JG4		3795.27	4337.89	4114.48	4657.10
10	10		150"(3810mm)	TARP-60F0-L	S	JG4		3937.34	4494.00	4269.85	4826.51
10	10		156"(3962mm)	TARP-60F6-L	S	JG4		4079.41	4650.11	4425.22	4995.92
10	10		162"(4115mm)	TARP-60G2-L	S	JG4		4221.48	4806.22	4580.59	5165.33
10	10		168"(4267mm)	TARP-60G8-L	S	JG4		4363.55	4962.33	4735.96	5334.74
10	12		174"(4420mm)	TARP-60H4-L	S	JG4		4505.62	5118.44	4891.33	5504.15
10	12		180"(4572mm)	TARP-60J0-L	S	JG4		4647.69	5274.55	5046.70	5673.56

*Recommended seating capacity based upon 27"(686mm) per chair.

Planes Conference Tables — Two-Piece Tops — Interior Leg — Laminate

Hexagon

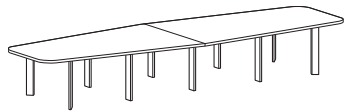

TARX

Features

- Includes 1 3/16" (30mm) thick tops, interior leg bases and hardware.
- Standard table height is 29" (737mm).
- Laminate top with 3mm edgeband or knife edges.
- Table top seam is 1mm edgeband.
- Interior legs are painted aluminum.
- Interior leg is 1 1/8" (29mm) x 3 1/4" (83mm).
- Optional cable base is available:
 - 42" (1067mm) deep and deeper tables will ship with 14" (356mm) x 14" (356mm) cable base
 - Two piece tops will include one cable base to be centered on seam under table top.
 - Cable base and table top(s) are laminate and can be specified in different surface colors and edge trim colors.
 - Refer to Specification Guide for use guidelines.
- Optional Flip top unit electrical modules are separately specified. Refer to electrical components for appropriate product specification.
- Available with glides only; 1/2" (13mm) height adjustment.
- Depth and width shown in nominal dimensions.
- Ships unassembled.

Specification Tips

- Tables with multiple-piece tops have equal sized pieces.
- The following Planes products are separately specified:
 - Grommets (field cut openings)
 - Flip top unit electrical modules
 - Horizontal wire management
- Refer to Specification Guide for seating capacities with Cable Base Option and leg locations.

To Order, Specify:

1) Product number, including:

① Edge Option:

- J** Edgeband
- F** Knife

② Flip Top Unit Cutout(s):

- N** None
- F** Center – single-sided/4 outlets, add **\$63.72** list
- V** Left/Right – single-sided/4 outlets, add **\$127.44** list
- J** Center – single-sided/6 outlets, add **\$63.72** list
- K** Left/Right – single-sided/6 outlets, add **\$127.44** list
- M** Center – double-sided/8 outlets, add **\$63.72** list
- P** Left/Right – double-sided/8 outlets, add **\$127.44** list
- Q** Center – double-sided/12 outlets, add **\$63.72** list
- T** Left/Right – double-sided/12 outlets, add **\$127.44** list

③ Cable Base Option:

- N** None
- C** Cable Base, add **\$671.99** list

- 2) Laminate surface color.
- 3) 1mm edgeband trim color. (Cascade edge/multiple-tops only)*
- 4) Edge trim color.
- 5) Base trim color.
- 6) Laminate surface – Cable Base
- 7) Edge trim color – Cable Base

Note: **\$44.02** upcharge (list) for Metallic and accent trim colors.

Planes Conference Tables — Two-Piece Tops — Interior Leg — Laminate

Hexagon

No. of Legs	Seating Capacity*	Depth	Width	Number	①	②	③	Laminate A		Laminate B	
								J	F	J	F
6	10	42"(1067mm)	126"(3200mm)	TARX-42C6-L	S	JG4		\$2403.96	\$2862.34	\$2599.48	\$3057.86
6	10		132"(3353mm)	TARX-42D2-L	S	JG4		2511.29	2983.71	2716.12	3188.54
6	10		138"(3505mm)	TARX-42D8-L	S	JG4		2618.62	3105.08	2832.76	3319.22
6	10		144"(3658mm)	TARX-42E4-L	S	JG4		2725.95	3226.45	2949.40	3449.90
10	10		150"(3810mm)	TARX-42F0-L	S	JG4		2833.28	3347.82	3066.04	3580.58
10	10		156"(3962mm)	TARX-42F6-L	S	JG4		2940.61	3469.19	3182.68	3711.26
10	10		162"(4115mm)	TARX-42G2-L	S	JG4		3047.94	3590.56	3299.32	3841.94
10	10		168"(4267mm)	TARX-42G8-L	S	JG4		3155.27	3711.93	3415.96	3972.62
10	12		174"(4420mm)	TARX-42H4-L	S	JG4		3262.60	3833.30	3532.60	4103.30
10	12		180"(4572mm)	TARX-42J0-L	S	JG4		3369.93	3954.67	3649.24	4233.98
6	10	48"(1219mm)	126"(3200mm)	TARX-48C6-L	S	JG4		\$2725.66	\$3198.08	\$2949.11	\$3421.53
6	10		132"(3353mm)	TARX-48D2-L	S	JG4		2844.57	3331.03	3078.66	3565.12
6	10		138"(3505mm)	TARX-48D8-L	S	JG4		2963.48	3463.98	3208.21	3708.71
6	10		144"(3658mm)	TARX-48E4-L	S	JG4		3082.39	3596.93	3337.76	3852.30
10	10		150"(3810mm)	TARX-48F0-L	S	JG4		3201.30	3729.88	3467.31	3995.89
10	10		156"(3962mm)	TARX-48F6-L	S	JG4		3320.21	3862.83	3596.86	4139.48
10	10		162"(4115mm)	TARX-48G2-L	S	JG4		3439.12	3995.78	3726.41	4283.07
10	10		168"(4267mm)	TARX-48G8-L	S	JG4		3558.03	4128.73	3855.96	4426.66
10	12		174"(4420mm)	TARX-48H4-L	S	JG4		3676.94	4261.68	3985.51	4570.25
10	12		180"(4572mm)	TARX-48J0-L	S	JG4		3795.85	4394.63	4115.06	4713.84
6	10	54"(1372mm)	126"(3200mm)	TARX-54C6-L	S	JG4		\$3047.36	\$3533.82	\$3298.74	\$3785.20
6	10		132"(3353mm)	TARX-54D2-L	S	JG4		3177.85	3678.35	3441.20	3941.70
6	10		138"(3505mm)	TARX-54D8-L	S	JG4		3308.34	3822.88	3583.66	4098.20
6	10		144"(3658mm)	TARX-54E4-L	S	JG4		3438.83	3967.41	3726.12	4254.70
10	10		150"(3810mm)	TARX-54F0-L	S	JG4		3569.32	4111.94	3868.58	4411.20
10	10		156"(3962mm)	TARX-54F6-L	S	JG4		3699.81	4256.47	4011.04	4567.70
10	10		162"(4115mm)	TARX-54G2-L	S	JG4		3830.30	4401.00	4153.50	4724.20
10	10		168"(4267mm)	TARX-54G8-L	S	JG4		3960.79	4545.53	4295.96	4880.70
10	12		174"(4420mm)	TARX-54H4-L	S	JG4		4091.28	4690.06	4438.42	5037.20
10	12		180"(4572mm)	TARX-54J0-L	S	JG4		4221.77	4834.59	4580.88	5193.70
6	10	60"(1524mm)	126"(3200mm)	TARX-60C6-L	S	JG4		\$3369.06	\$3869.56	\$3648.37	\$4148.87
6	10		132"(3353mm)	TARX-60D2-L	S	JG4		3511.13	4025.67	3803.74	4318.28
6	10		138"(3505mm)	TARX-60D8-L	S	JG4		3653.20	4181.78	3959.11	4487.69
6	10		144"(3658mm)	TARX-60E4-L	S	JG4		3795.27	4337.89	4114.48	4657.10
10	10		150"(3810mm)	TARX-60F0-L	S	JG4		3937.34	4494.00	4269.85	4826.51
10	10		156"(3962mm)	TARX-60F6-L	S	JG4		4079.41	4650.11	4425.22	4995.92
10	10		162"(4115mm)	TARX-60G2-L	S	JG4		4221.48	4806.22	4580.59	5165.33
10	10		168"(4267mm)	TARX-60G8-L	S	JG4		4363.55	4962.33	4735.96	5334.74
10	12		174"(4420mm)	TARX-60H4-L	S	JG4		4505.62	5118.44	4891.33	5504.15
10	12		180"(4572mm)	TARX-60J0-L	S	JG4		4647.69	5274.55	5046.70	5673.56

*Recommended seating capacity based upon 27"(686mm) per chair.

Planes Conference Tables — Two-Piece Tops — Interior Leg — Wood

Rectangular

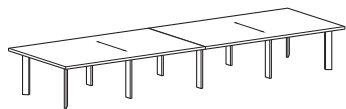

TARA

Features

- Includes 1 3/16" (30mm) thick tops, interior leg bases and hardware.
- Standard table height is 29" (737mm).
- Wood veneer top with 3mm wood edgeband or knife wood edge.
- Table top seam is 1mm edgeband.
- Interior legs are painted aluminum.
- Interior leg is 1 1/8" (29mm) x 3 1/4" (83mm).
- Optional cable base is available:
 - 42" (1067mm) deep and deeper tables will ship with 14" (356mm) x 14" (356mm) cable base
 - Two piece tops will include one cable base to be centered on seam under table top.
 - Cable base and table top(s) are wood veneer and can be specified in different surface colors and edge trim colors.
 - Refer to Specification Guide for use guidelines.
- Optional Flip top unit electrical modules are separately specified. Refer to electrical components for appropriate product specification.
- Available with glides only; 1/2" (13mm) height adjustment.
- Depth and width shown in nominal dimensions.
- Ships unassembled.

Specification Tips

- Tables with multiple-piece tops have equal sized pieces.
- The following Planes products are separately specified:
 - Grommets (field cut opening)
 - Flip top unit electrical modules
 - Horizontal wire management
- Refer to Specification Guide for seating capacities with Cable Base Option and leg locations.

To Order, Specify:

1) Product number, including:

① Wood Edge Option:

- K** Edgeband
- U** Knife

② Flip Top Unit Cutout(s):

- N** None
- F** Center – single-sided/4 outlets, add **\$63.72** list
- V** Left/Right – single-sided/4 outlets, add **\$127.44** list
- J** Center – single-sided/6 outlets, add **\$63.72** list
- K** Left/Right – single-sided/6 outlets, add **\$127.44** list
- M** Center – double-sided/8 outlets, add **\$63.72** list
- P** Left/Right – double-sided/8 outlets, add **\$127.44** list
- Q** Center – double-sided/12 outlets, add **\$63.72** list
- T** Left/Right – double-sided/12 outlets, add **\$127.44** list

③ Cable Base Option:

- N** None
- C** Cable Base, add **\$671.99** list

2) Wood finish color.

3) Base trim color.

4) Wood finish color – Cable Base

Note: **\$44.02** upcharge (list) for Metallic and accent trim colors.

Planes Conference Tables — Two-Piece Tops — Interior Leg — Wood

Rectangular

No. of Legs	Seating Capacity*	Depth	Width	Number	①	②	③	Wood Group A		Wood Group B	
								K	U	K	U
6	10	42"(1067mm)	126"(3200mm)	TARA-42C6-W	S	JG4		\$3646.34	\$4555.63	\$4051.62	\$5074.26
6	10		132"(3353mm)	TARA-42D2-W	S	JG4		3804.70	4757.47	4234.50	5308.49
10	10		138"(3505mm)	TARA-42D8-W	S	JG4		3963.32	4961.14	4417.70	5544.88
10	10		144"(3658mm)	TARA-42E4-W	S	JG4		4122.22	5166.66	4601.23	5783.43
10	10		150"(3810mm)	TARA-42F0-W	S	JG4		4281.38	5374.02	4785.08	6024.14
10	12		156"(3962mm)	TARA-42F6-W	S	JG4		4440.80	5583.21	4969.26	6267.01
10	12		162"(4115mm)	TARA-42G2-W	S	JG4		4600.50	5794.25	5153.76	6512.04
10	12		168"(4267mm)	TARA-42G8-W	S	JG4		4760.46	6007.13	5338.58	6759.23
10	12		174"(4420mm)	TARA-42H4-W	S	JG4		4920.69	6221.85	5523.73	7008.58
10	14		180"(4572mm)	TARA-42J0-W	S	JG4		5081.19	6438.41	5709.20	7260.09
6	10	48"(1219mm)	126"(3200mm)	TARA-48C6-W	S	JG4		\$4136.76	\$5202.10	\$4608.86	\$5791.61
6	10		132"(3353mm)	TARA-48D2-W	S	JG4		4312.46	5422.07	4812.19	6047.21
10	10		138"(3505mm)	TARA-48D8-W	S	JG4		4488.42	5643.87	5015.85	6304.97
10	10		144"(3658mm)	TARA-48E4-W	S	JG4		4664.66	5867.52	5219.83	6564.89
10	10		150"(3810mm)	TARA-48F0-W	S	JG4		4841.16	6093.01	5424.13	6826.97
10	12		156"(3962mm)	TARA-48F6-W	S	JG4		5017.94	6320.34	5628.76	7091.21
10	12		162"(4115mm)	TARA-48G2-W	S	JG4		5194.97	6549.51	5833.71	7357.61
10	12		168"(4267mm)	TARA-48G8-W	S	JG4		5372.28	6780.51	6038.99	7626.17
10	12		174"(4420mm)	TARA-48H4-W	S	JG4		5549.86	7013.36	6244.59	7896.89
10	14		180"(4572mm)	TARA-48J0-W	S	JG4		5727.70	7248.05	6450.51	8169.77
6	10	54"(1372mm)	126"(3200mm)	TARA-54C6-W	S	JG4		\$4627.17	\$5848.57	\$5166.10	\$6508.96
6	10		132"(3353mm)	TARA-54D2-W	S	JG4		4820.21	6086.67	5389.88	6785.93
10	10		138"(3505mm)	TARA-54D8-W	S	JG4		5013.53	6326.61	5613.99	7065.06
10	10		144"(3658mm)	TARA-54E4-W	S	JG4		5207.10	6568.38	5838.42	7346.35
10	10		150"(3810mm)	TARA-54F0-W	S	JG4		5400.95	6812.00	6063.18	7629.80
10	12		156"(3962mm)	TARA-54F6-W	S	JG4		5595.07	7057.46	6288.26	7915.41
10	12		162"(4115mm)	TARA-54G2-W	S	JG4		5789.45	7304.76	6513.66	8203.18
10	12		168"(4267mm)	TARA-54G8-W	S	JG4		5984.10	7553.90	6739.39	8493.11
10	14		174"(4420mm)	TARA-54H4-W	S	JG4		6179.02	7804.88	6965.44	8785.20
10	14		180"(4572mm)	TARA-54J0-W	S	JG4		6374.21	8057.69	7191.82	9079.45
6	10	60"(1524mm)	126"(3200mm)	TARA-60C6-W	S	JG4		\$5117.58	\$6495.04	\$5723.34	\$7226.31
6	10		132"(3353mm)	TARA-60D2-W	S	JG4		5327.97	6751.27	5967.58	7524.65
10	10		138"(3505mm)	TARA-60D8-W	S	JG4		5538.63	7009.34	6212.14	7825.15
10	10		144"(3658mm)	TARA-60E4-W	S	JG4		5749.55	7269.25	6457.02	8127.81
10	10		150"(3810mm)	TARA-60F0-W	S	JG4		5960.74	7530.99	6702.23	8432.63
10	12		156"(3962mm)	TARA-60F6-W	S	JG4		6172.20	7794.58	6947.76	8739.61
10	12		162"(4115mm)	TARA-60G2-W	S	JG4		6383.93	8060.01	7193.62	9048.75
10	12		168"(4267mm)	TARA-60G8-W	S	JG4		6595.92	8327.28	7439.80	9360.05
10	14		174"(4420mm)	TARA-60H4-W	S	JG4		6808.18	8596.39	7686.30	9673.51
10	14		180"(4572mm)	TARA-60J0-W	S	JG4		7020.71	8867.34	7933.13	9989.13

*Recommended seating capacity based upon 27"(686mm) per chair.

Planes Conference Tables — Two-Piece Tops — Interior Leg — Wood

Pebble

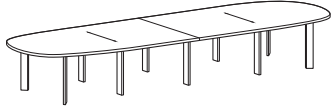

TARP

Features

- Includes 1 3/16" (30mm) thick tops, interior leg bases and hardware.
- Standard table height is 29" (737mm).
- Wood veneer top with 3mm wood edgeband or knife wood edge.
- Table top seam is 1mm edgeband.
- Interior legs are painted aluminum.
- Interior leg is 1 1/8" (29mm) x 3 1/4" (83mm).
- Optional cable base is available:
 - 42" (1067mm) deep and deeper tables will ship with 14" (356mm) x 14" (356mm) cable base
 - Two piece tops will include one cable base to be centered on seam under table top.
 - Cable base and table top(s) are wood veneer and can be specified in different surface colors and edge trim colors.
 - Refer to Specification Guide for use guidelines.
- Optional Flip top unit electrical modules are separately specified. Refer to electrical components for appropriate product specification.
- Available with glides only; 1/2" (13mm) height adjustment.
- Depth and width shown in nominal dimensions.
- Ships unassembled.

Specification Tips

- Tables with multiple-piece tops have equal sized pieces.
- The following Planes products are separately specified:
 - Grommets (field cut openings)
 - Flip top unit electrical modules
 - Horizontal wire management
- Refer to Specification Guide for seating capacities with Cable Base Option and leg locations.

To Order, Specify:

1) Product number, including:

① Wood Edge Option:

- K** Edgeband
- U** Knife

② Flip Top Unit Cutout(s):

- N** None
- F** Center – single-sided/4 outlets, add **\$63.72** list
- V** Left/Right – single-sided/4 outlets, add **\$127.44** list
- J** Center – 6 single-sided/outlets, add **\$63.72** list
- K** Left/Right – single-sided/6 outlets, add **\$127.44** list
- M** Center – double-sided/8 outlets, add **\$63.72** list
- P** Left/Right – double-sided/8 outlets, add **\$127.44** list
- Q** Center – double-sided/12 outlets, add **\$63.72** list
- T** Left/Right – double-sided/12 outlets, add **\$127.44** list

③ Cable Base Option:

- N** None
- C** Cable Base, add **\$671.99** list

2) Wood finish color.

3) Base trim color.

4) Wood finish color – Cable Base

Note: **\$44.02** upcharge (list) for Metallic and accent trim colors.

Planes Conference Tables — Two-Piece Tops — Interior Leg — Wood

Pebble

No. of Legs	Seating Capacity*	Depth	Width	Number	①	②	③	Wood Group A		Wood Group B	
								K	U	K	U
6	10	42"(1067mm)	126"(3200mm)	TARP-42C6-W	S	JG4		\$3646.34	\$4555.63	\$4051.62	\$5074.26
6	10		132"(3353mm)	TARP-42D2-W	S	JG4		3804.70	4757.47	4234.50	5308.49
6	10		138"(3505mm)	TARP-42D8-W	S	JG4		3963.32	4961.14	4417.70	5544.88
6	10		144"(3658mm)	TARP-42E4-W	S	JG4		4122.22	5166.66	4601.23	5783.43
10	10		150"(3810mm)	TARP-42F0-W	S	JG4		4281.38	5374.02	4785.08	6024.14
10	10		156"(3962mm)	TARP-42F6-W	S	JG4		4440.80	5583.21	4969.26	6267.01
10	10		162"(4115mm)	TARP-42G2-W	S	JG4		4600.50	5794.25	5153.76	6512.04
10	10		168"(4267mm)	TARP-42G8-W	S	JG4		4760.46	6007.13	5338.58	6759.23
10	12		174"(4420mm)	TARP-42H4-W	S	JG4		4920.69	6221.85	5523.73	7008.58
10	12		180"(4572mm)	TARP-42J0-W	S	JG4		5081.19	6438.41	5709.20	7260.09
6	10	48"(1219mm)	126"(3200mm)	TARP-48C6-W	S	JG4		\$4136.76	\$5202.10	\$4608.86	\$5791.61
6	10		132"(3353mm)	TARP-48D2-W	S	JG4		4312.46	5422.07	4812.19	6047.21
6	10		138"(3505mm)	TARP-48D8-W	S	JG4		4488.42	5643.87	5015.85	6304.97
6	10		144"(3658mm)	TARP-48E4-W	S	JG4		4664.66	5867.52	5219.83	6564.89
10	10		150"(3810mm)	TARP-48F0-W	S	JG4		4841.16	6093.01	5424.13	6826.97
10	10		156"(3962mm)	TARP-48F6-W	S	JG4		5017.94	6320.34	5628.76	7091.21
10	10		162"(4115mm)	TARP-48G2-W	S	JG4		5194.97	6549.51	5833.71	7357.61
10	10		168"(4267mm)	TARP-48G8-W	S	JG4		5372.28	6780.51	6038.99	7626.17
10	12		174"(4420mm)	TARP-48H4-W	S	JG4		5549.86	7013.36	6244.59	7896.89
10	12		180"(4572mm)	TARP-48J0-W	S	JG4		5727.70	7248.05	6450.51	8169.77
6	10	54"(1372mm)	126"(3200mm)	TARP-54C6-W	S	JG4		\$4627.17	\$5848.57	\$5166.10	\$6508.96
6	10		132"(3353mm)	TARP-54D2-W	S	JG4		4820.21	6086.67	5389.88	6785.93
6	10		138"(3505mm)	TARP-54D8-W	S	JG4		5013.53	6326.61	5613.99	7065.06
6	10		144"(3658mm)	TARP-54E4-W	S	JG4		5207.10	6568.38	5838.42	7346.35
10	10		150"(3810mm)	TARP-54F0-W	S	JG4		5400.95	6812.00	6063.18	7629.80
10	10		156"(3962mm)	TARP-54F6-W	S	JG4		5595.07	7057.46	6288.26	7915.41
10	10		162"(4115mm)	TARP-54G2-W	S	JG4		5789.45	7304.76	6513.66	8203.18
10	10		168"(4267mm)	TARP-54G8-W	S	JG4		5984.10	7553.90	6739.39	8493.11
10	12		174"(4420mm)	TARP-54H4-W	S	JG4		6179.02	7804.88	6965.44	8785.20
10	12		180"(4572mm)	TARP-54J0-W	S	JG4		6374.21	8057.69	7191.82	9079.45
6	10	60"(1524mm)	126"(3200mm)	TARP-60C6-W	S	JG4		\$5117.58	\$6495.04	\$5723.34	\$7226.31
6	10		132"(3353mm)	TARP-60D2-W	S	JG4		5327.97	6751.27	5967.58	7524.65
6	10		138"(3505mm)	TARP-60D8-W	S	JG4		5538.63	7009.34	6212.14	7825.15
6	10		144"(3658mm)	TARP-60E4-W	S	JG4		5749.55	7269.25	6457.02	8127.81
10	10		150"(3810mm)	TARP-60F0-W	S	JG4		5960.74	7530.99	6702.23	8432.63
10	10		156"(3962mm)	TARP-60F6-W	S	JG4		6172.20	7794.58	6947.76	8739.61
10	10		162"(4115mm)	TARP-60G2-W	S	JG4		6383.93	8060.01	7193.62	9048.75
10	10		168"(4267mm)	TARP-60G8-W	S	JG4		6595.92	8327.28	7439.80	9360.05
10	12		174"(4420mm)	TARP-60H4-W	S	JG4		6808.18	8596.39	7686.30	9673.51
10	12		180"(4572mm)	TARP-60J0-W	S	JG4		7020.71	8867.34	7933.13	9989.13

*Recommended seating capacity based upon 27"(686mm) per chair.

Planes Conference Tables — Two-Piece Tops — Interior Leg — Wood

Hexagon

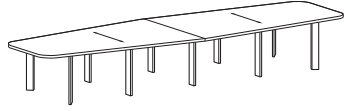

TARX

Features

- Includes 1 3/16" (30mm) thick tops, interior leg bases and hardware.
- Standard table height is 29" (737mm).
- Wood veneer top with 3mm wood edgeband or knife wood edge.
- Table top seam is 1mm edgeband.
- Interior legs are painted aluminum.
- Interior leg is 1 1/8" (29mm) x 3 1/4" (83mm).
- Optional cable base is available:
 - 42" (1067mm) deep and deeper tables will ship with 14" (356mm) x 14" (356mm) cable base
 - Two piece tops will include one cable base to be centered on seam under table top.
 - Cable base and table top(s) are wood veneer and can be specified in different surface colors and edge trim colors.
 - Refer to Specification Guide for use guidelines.
- Optional Flip top unit electrical modules are separately specified. Refer to electrical components for appropriate product specification.
- Available with glides only; 1/2" (13mm) height adjustment.
- Depth and width shown in nominal dimensions.
- Ships unassembled.

Specification Tips

- Tables with multiple-piece tops have equal sized pieces.
- The following Planes products are separately specified:
 - Grommets (field cut openings)
 - Flip top unit electrical modules
 - Horizontal wire management
- Refer to Specification Guide for seating capacities with Cable Base Option and leg locations.

To Order, Specify:

1) Product number, including:

① Wood Edge Option:

- K** Edgeband
- U** Knife

② Flip Top Unit Cutout(s):

- N** None
- F** Center – single-sided/4 outlets, add **\$63.72** list
- V** Left/Right – single-sided/4 outlets, add **\$127.44** list
- J** Center – single-sided/6 outlets, add **\$63.72** list
- K** Left/Right – single-sided/6 outlets, add **\$127.44** list
- M** Center – double-sided/8 outlets, add **\$63.72** list
- P** Left/Right – double-sided/8 outlets, add **\$127.44** list
- Q** Center – double-sided/12 outlets, add **\$63.72** list
- T** Left/Right – double-sided/12 outlets, add **\$127.44** list

③ Cable Base Option:

- N** None
- C** Cable Base, add **\$671.99** list

2) Wood finish color.

3) Base trim color.

4) Wood finish color – Cable Base

Note: **\$44.02** upcharge (list) for Metallic and accent trim colors.

Planes Conference Tables — Two-Piece Tops — Interior Leg — Wood

Hexagon

No. of Legs	Seating Capacity*	Depth	Width	Number	①	②	③	Wood Group A		Wood Group B	
								K	U	K	U
6	10	42"(1067mm)	126"(3200mm)	TARX-42C6-W	S	JG4		\$3646.34	\$4555.63	\$4051.62	\$5074.26
6	10		132"(3353mm)	TARX-42D2-W	S	JG4		3804.70	4757.47	4234.50	5308.49
6	10		138"(3505mm)	TARX-42D8-W	S	JG4		3963.32	4961.14	4417.70	5544.88
6	10		144"(3658mm)	TARX-42E4-W	S	JG4		4122.22	5166.66	4601.23	5783.43
10	10		150"(3810mm)	TARX-42F0-W	S	JG4		4281.38	5374.02	4785.08	6024.14
10	10		156"(3962mm)	TARX-42F6-W	S	JG4		4440.80	5583.21	4969.26	6267.01
10	10		162"(4115mm)	TARX-42G2-W	S	JG4		4600.50	5794.25	5153.76	6512.04
10	10		168"(4267mm)	TARX-42G8-W	S	JG4		4760.46	6007.13	5338.58	6759.23
10	12		174"(4420mm)	TARX-42H4-W	S	JG4		4920.69	6221.85	5523.73	7008.58
10	12		180"(4572mm)	TARX-42J0-W	S	JG4		5081.19	6438.41	5709.20	7260.09
6	10	48"(1219mm)	126"(3200mm)	TARX-48C6-W	S	JG4		\$4136.76	\$5202.10	\$4608.86	\$5791.61
6	10		132"(3353mm)	TARX-48D2-W	S	JG4		4312.46	5422.07	4812.19	6047.21
6	10		138"(3505mm)	TARX-48D8-W	S	JG4		4488.42	5643.87	5015.85	6304.97
6	10		144"(3658mm)	TARX-48E4-W	S	JG4		4664.66	5867.52	5219.83	6564.89
10	10		150"(3810mm)	TARX-48F0-W	S	JG4		4841.16	6093.01	5424.13	6826.97
10	10		156"(3962mm)	TARX-48F6-W	S	JG4		5017.94	6320.34	5628.76	7091.21
10	10		162"(4115mm)	TARX-48G2-W	S	JG4		5194.97	6549.51	5833.71	7357.61
10	10		168"(4267mm)	TARX-48G8-W	S	JG4		5372.28	6780.51	6038.99	7626.17
10	12		174"(4420mm)	TARX-48H4-W	S	JG4		5549.86	7013.36	6244.59	7896.89
10	12		180"(4572mm)	TARX-48J0-W	S	JG4		5727.70	7248.05	6450.51	8169.77
6	10	54"(1372mm)	126"(3200mm)	TARX-54C6-W	S	JG4		\$4627.17	\$5848.57	\$5166.10	\$6508.96
6	10		132"(3353mm)	TARX-54D2-W	S	JG4		4820.21	6086.67	5389.88	6785.93
6	10		138"(3505mm)	TARX-54D8-W	S	JG4		5013.53	6326.61	5613.99	7065.06
6	10		144"(3658mm)	TARX-54E4-W	S	JG4		5207.10	6568.38	5838.42	7346.35
10	10		150"(3810mm)	TARX-54F0-W	S	JG4		5400.95	6812.00	6063.18	7629.80
10	10		156"(3962mm)	TARX-54F6-W	S	JG4		5595.07	7057.46	6288.26	7915.41
10	10		162"(4115mm)	TARX-54G2-W	S	JG4		5789.45	7304.76	6513.66	8203.18
10	10		168"(4267mm)	TARX-54G8-W	S	JG4		5984.10	7553.90	6739.39	8493.11
10	12		174"(4420mm)	TARX-54H4-W	S	JG4		6179.02	7804.88	6965.44	8785.20
10	12		180"(4572mm)	TARX-54J0-W	S	JG4		6374.21	8057.69	7191.82	9079.45
6	10	60"(1524mm)	126"(3200mm)	TARX-60C6-W	S	JG4		\$5117.58	\$6495.04	\$5723.34	\$7226.31
6	10		132"(3353mm)	TARX-60D2-W	S	JG4		5327.97	6751.27	5967.58	7524.65
6	10		138"(3505mm)	TARX-60D8-W	S	JG4		5538.63	7009.34	6212.14	7825.15
6	10		144"(3658mm)	TARX-60E4-W	S	JG4		5749.55	7269.25	6457.02	8127.81
10	10		150"(3810mm)	TARX-60F0-W	S	JG4		5960.74	7530.99	6702.23	8432.63
10	10		156"(3962mm)	TARX-60F6-W	S	JG4		6172.20	7794.58	6947.76	8739.61
10	10		162"(4115mm)	TARX-60G2-W	S	JG4		6383.93	8060.01	7193.62	9048.75
10	10		168"(4267mm)	TARX-60G8-W	S	JG4		6595.92	8327.28	7439.80	9360.05
10	12		174"(4420mm)	TARX-60H4-W	S	JG4		6808.18	8596.39	7686.30	9673.51
10	12		180"(4572mm)	TARX-60J0-W	S	JG4		7020.71	8867.34	7933.13	9989.13

*Recommended seating capacity based upon 27"(686mm) per chair.

Planes Conference Tables — Three-Piece Tops — Interior Leg — Laminate

Rectangular

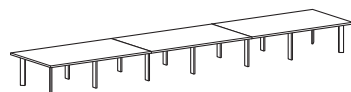

TARA

Features

- Includes 1 3/16" (30mm) thick tops, interior leg bases and hardware.
- Standard table height is 29" (737mm).
- Laminate top with 3mm edgeband or knife edges.
- Table top seams are 1mm edgeband.
- Interior legs are painted aluminum.
- Interior leg is 1 1/8" (29mm) x 3 1/4" (83mm).
- Optional cable bases are available:
 - 42" (1067mm) deep and deeper tables will ship with 14" (356mm) x 14" (356mm) cable bases.
 - Three piece tops will include two cable bases to be centered on seams.
 - Cable base and table top(s) are laminate and can be specified in different surface colors and edge trim colors.
 - Refer to Specification Guide for use guidelines.
- Optional Flip top unit electrical modules are separately specified. Refer to electrical components for appropriate product specification.
- Available with glides only; 1/2" (13mm) height adjustment.
- Depth and width shown in nominal dimensions.
- Ships unassembled.

Specification Tips

- Tables with multiple-piece tops have equal sized pieces.
- The following Planes products are separately specified:
 - Grommets (field cut opening)
 - Flip top unit electrical modules
 - Horizontal wire management
- Refer to Specification Guide for seating capacities with Cable Base Option and leg locations.

To Order, Specify:

1) Product number, including:

① Edge Option:

- J** Edgeband
- F** Knife

② Flip Top Unit Cutout(s):

- N** None
- F** Center – single-sided/4 outlets, add **\$95.58** list
- V** Left/Right – single-sided/4 outlets, add **\$191.16** list
- J** Center – single-sided/6 outlets, add **\$95.58** list
- K** Left/Right – single-sided/6 outlets, add **\$191.16** list
- M** Center – double-sided/8 outlets, add **\$95.58** list
- P** Left/Right – double-sided/8 outlets, add **\$191.16** list
- Q** Center – double-sided/12 outlets, add **\$95.58** list
- T** Left/Right – double-sided/12 outlets, add **\$191.16** list

③ Cable Base Option:

- N** None
- C** Cable Bases (2), add **\$1343.98** list

- 2) Laminate surface color.
- 3) 1mm edgeband trim color.
(Cascade edge/multiple-tops only)*
- 4) Edge trim color.
- 5) Base trim color.
- 6) Laminate surface – Cable Bases
- 7) Edge trim color – Cable Bases

Note: **\$44.02** upcharge (list) for Metallic and accent trim colors.

Planes Conference Tables — Three-Piece Tops — Interior Leg — Laminate

Rectangular

No. of Legs	Seating Capacity*	Depth	Width	Number	① ② ③			Laminate A		Laminate B	
								J	F	J	F
8	14	42"(1067mm)	186"(4724mm)	TARA-42J6-L	S	JG4	\$3489.15	\$4120.67	\$3777.77	\$4409.29	
8	14		192"(4877mm)	TARA-42K2-L	S	JG4	3596.48	4242.04	3894.41	4539.97	
8	14		198"(5029mm)	TARA-42K8-L	S	JG4	3703.81	4363.41	4011.05	4670.65	
14	14		204"(5182mm)	TARA-42L4-L	S	JG4	3811.14	4484.78	4127.69	4801.33	
14	14		210"(5334mm)	TARA-42M0-L	S	JG4	3918.47	4606.15	4244.33	4932.01	
14	14		216"(5486mm)	TARA-42M6-L	S	JG4	4025.80	4727.52	4360.97	5062.69	
14	16		222"(5639mm)	TARA-42N2-L	S	JG4	4133.13	4848.89	4477.61	5193.37	
14	16		228"(5791mm)	TARA-42N8-L	S	JG4	4240.46	4970.26	4594.25	5324.05	
14	16		234"(5944mm)	TARA-42P4-L	S	JG4	4347.79	5091.63	4710.89	5454.73	
14	16		240"(6096mm)	TARA-42Q0-L	S	JG4	4455.12	5213.00	4827.53	5585.41	
14	16		246"(6248mm)	TARA-42Q6-L	S	JG4	4562.45	5334.37	4944.17	5716.09	
14	16		252"(6401mm)	TARA-42R2-L	S	JG4	4669.78	5455.74	5060.81	5846.77	
14	18		258"(6553mm)	TARA-42R8-L	S	JG4	4777.11	5577.11	5177.45	5977.45	
14	18		264"(6706mm)	TARA-42S4-L	S	JG4	4952.84	5698.48	5362.49	6108.13	
14	20		270"(6858mm)	TARA-42T0-L	S	JG4	5060.17	5819.85	5479.13	6238.81	
8	14	48"(1219mm)	186"(4724mm)	TARA-48J6-L	S	JG4	\$3926.65	\$4572.21	\$4256.50	\$4902.06	
8	14		192"(4877mm)	TARA-48K2-L	S	JG4	4045.56	4705.16	4386.05	5045.65	
8	14		198"(5029mm)	TARA-48K8-L	S	JG4	4164.47	4838.11	4515.60	5189.24	
14	14		204"(5182mm)	TARA-48L4-L	S	JG4	4283.38	4971.06	4645.15	5332.83	
14	14		210"(5334mm)	TARA-48M0-L	S	JG4	4402.29	5104.01	4774.70	5476.42	
14	14		216"(5486mm)	TARA-48M6-L	S	JG4	4521.20	5236.96	4904.25	5620.01	
14	16		222"(5639mm)	TARA-48N2-L	S	JG4	4640.11	5369.91	5033.80	5763.60	
14	16		228"(5791mm)	TARA-48N8-L	S	JG4	4759.02	5502.86	5163.35	5907.19	
14	16		234"(5944mm)	TARA-48P4-L	S	JG4	4877.93	5635.81	5292.90	6050.78	
14	16		240"(6096mm)	TARA-48Q0-L	S	JG4	4996.84	5768.76	5422.45	6194.37	
14	16		246"(6248mm)	TARA-48Q6-L	S	JG4	5115.75	5901.71	5552.00	6337.96	
14	16		252"(6401mm)	TARA-48R2-L	S	JG4	5234.66	6034.66	5681.55	6481.55	
14	18		258"(6553mm)	TARA-48R8-L	S	JG4	5353.57	6167.61	5811.10	6625.14	
14	18		264"(6706mm)	TARA-48S4-L	S	JG4	5472.48	6300.56	5940.65	6768.73	
14	20		270"(6858mm)	TARA-48T0-L	S	JG4	5591.39	6433.51	6070.20	6912.32	
8	14	54"(1372mm)	186"(4724mm)	TARA-54J6-L	S	JG4	\$4295.75	\$5023.75	\$4666.83	\$5394.83	
8	14		192"(4877mm)	TARA-54K2-L	S	JG4	4426.24	5168.28	4809.29	5551.33	
8	14		198"(5029mm)	TARA-54K8-L	S	JG4	4556.73	5312.81	4951.75	5707.83	
14	14		204"(5182mm)	TARA-54L4-L	S	JG4	4687.22	5457.34	5094.21	5864.33	
14	14		210"(5334mm)	TARA-54M0-L	S	JG4	4817.71	5601.87	5236.67	6020.83	
14	14		216"(5486mm)	TARA-54M6-L	S	JG4	4948.20	5746.40	5379.13	6177.33	
14	16		222"(5639mm)	TARA-54N2-L	S	JG4	5078.69	5890.93	5521.59	6333.83	
14	16		228"(5791mm)	TARA-54N8-L	S	JG4	5209.18	6035.46	5664.05	6490.33	
14	16		234"(5944mm)	TARA-54P4-L	S	JG4	5339.67	6179.99	5806.51	6646.83	
14	16		240"(6096mm)	TARA-54Q0-L	S	JG4	5470.16	6324.52	5948.97	6803.33	
14	16		246"(6248mm)	TARA-54Q6-L	S	JG4	5600.65	6469.05	6091.43	6959.83	
14	16		252"(6401mm)	TARA-54R2-L	S	JG4	5731.14	6613.58	6233.89	7116.33	
14	18		258"(6553mm)	TARA-54R8-L	S	JG4	5861.63	6758.11	6376.35	7272.83	
14	18		264"(6706mm)	TARA-54S4-L	S	JG4	5992.12	6902.64	6518.81	7429.33	
14	20		270"(6858mm)	TARA-54T0-L	S	JG4	6122.61	7047.17	6661.27	7585.83	
8	14	60"(1524mm)	186"(4724mm)	TARA-60J6-L	S	JG4	\$4664.85	\$5475.29	\$5077.16	\$5887.60	
8	14		192"(4877mm)	TARA-60K2-L	S	JG4	4806.92	5631.40	5232.53	6057.01	
8	14		198"(5029mm)	TARA-60K8-L	S	JG4	4948.99	5787.51	5387.90	6226.42	
14	14		204"(5182mm)	TARA-60L4-L	S	JG4	5091.06	5943.62	5543.27	6395.83	
14	14		210"(5334mm)	TARA-60M0-L	S	JG4	5233.13	6099.73	5698.64	6565.24	
14	14		216"(5486mm)	TARA-60M6-L	S	JG4	5375.20	6255.84	5854.01	6734.65	
14	16		222"(5639mm)	TARA-60N2-L	S	JG4	5517.27	6411.95	6009.38	6904.06	
14	16		228"(5791mm)	TARA-60N8-L	S	JG4	5659.34	6568.06	6164.75	7073.47	
14	16		234"(5944mm)	TARA-60P4-L	S	JG4	5801.41	6724.17	6320.12	7242.88	
14	16		240"(6096mm)	TARA-60Q0-L	S	JG4	5943.48	6880.28	6475.49	7412.29	
14	16		246"(6248mm)	TARA-60Q6-L	S	JG4	6085.55	7036.39	6630.86	7581.70	
14	16		252"(6401mm)	TARA-60R2-L	S	JG4	6227.62	7192.50	6786.23	7751.11	
14	18		258"(6553mm)	TARA-60R8-L	S	JG4	6369.69	7348.61	6941.60	7920.52	
14	18		264"(6706mm)	TARA-60S4-L	S	JG4	6511.76	7504.72	7096.97	8089.93	
14	20		270"(6858mm)	TARA-60T0-L	S	JG4	6653.83	7660.83	7252.34	8259.34	

*Recommended seating capacity based upon 27"(686mm) per chair.

Planes Conference Tables — Three-Piece Tops — Interior Leg — Laminate

Pebble



TARP

Features

- Includes 1 3/16" (30mm) thick tops, interior leg bases and hardware.
- Standard table height is 29" (737mm).
- Laminate top with 3mm edgeband or knife edges.
- Table top seams are 1mm edgeband.
- Interior legs are painted aluminum.
- Interior leg is 1 1/8" (29mm) x 3 1/4" (83mm).
- Optional cable bases are available :
 - 42" (1067mm) deep and deeper tables will ship with 14" (356mm) x 14" (356mm) cable bases.
 - Three piece tops will include two cable bases to be centered on seams.
 - Cable base and table top(s) are laminate and can be specified in different surface colors and edge trim colors.
 - Refer to Specification Guide for use guidelines.
- Optional Flip top unit electrical modules are separately specified. Refer to electrical components for appropriate product specification.
- Available with glides only; 1/2" (13mm) height adjustment.
- Depth and width shown in nominal dimensions.
- Ships unassembled.

Specification Tips

- Tables with multiple-piece tops have equal sized pieces.
- The following Planes products are separately specified:
 - Grommets (field cut opening)
 - Flip top unit electrical modules
 - Horizontal wire management
- Refer to Specification Guide for seating capacities with Cable Base Option and leg locations.

To Order, Specify:

1) Product number, including:

① Edge Option:

- J** Edgeband
- F** Knife

② Flip Top Unit Cutout(s):

- N** None
- F** Center – single-sided/4 outlets, add **\$95.58** list
- V** Left/Right – single-sided/4 outlets, add **\$191.16** list
- J** Center – single-sided/6 outlets, add **\$95.58** list
- K** Left/Right – single-sided/6 outlets, add **\$191.16** list
- M** Center – double-sided/8 outlets, add **\$95.58** list
- P** Left/Right – double-sided/8 outlets, add **\$191.16** list
- Q** Center – double-sided/12 outlets, add **\$95.58** list
- T** Left/Right – double-sided/12 outlets, add **\$191.16** list

③ Cable Base Option:

- N** None
- C** Cable Bases (2), add **\$1343.98** list

- 2) Laminate surface color.
- 3) 1mm edgeband trim color.
(Cascade edge/multiple-tops only)*
- 4) Edge trim color.
- 5) Base trim color.
- 6) Laminate surface – Cable Bases
- 7) Edge trim color – Cable Bases

Note: **\$44.02** upcharge (list) for Metallic and accent trim colors.

Planes Conference Tables — Three-Piece Tops — Interior Leg — Laminate

Pebble

No. of Legs	Seating Capacity*	Depth	Width	Number	①	②	③	Laminate A		Laminate B	
								J	F	J	F
8	14	42"(1067mm)	186"(4724mm)	TARP-42J6-L	S	JG4		\$3489.15	\$4120.67	\$3777.77	\$4409.29
8	14		192"(4877mm)	TARP-42K2-L	S	JG4		3596.48	4242.04	3894.41	4539.97
8	14		198"(5029mm)	TARP-42K8-L	S	JG4		3703.81	4363.41	4011.05	4670.65
10	14		204"(5182mm)	TARP-42L4-L	S	JG4		3811.14	4484.78	4127.69	4801.33
10	14		210"(5334mm)	TARP-42M0-L	S	JG4		3918.47	4606.15	4244.33	4932.01
10	14		216"(5486mm)	TARP-42M6-L	S	JG4		4025.80	4727.52	4360.97	5062.69
14	14		222"(5639mm)	TARP-42N2-L	S	JG4		4133.13	4848.89	4477.61	5193.37
14	14		228"(5791mm)	TARP-42N8-L	S	JG4		4240.46	4970.26	4594.25	5324.05
14	14		234"(5944mm)	TARP-42P4-L	S	JG4		4347.79	5091.63	4710.89	5454.73
14	14		240"(6096mm)	TARP-42Q0-L	S	JG4		4455.12	5213.00	4827.53	5585.41
14	14		246"(6248mm)	TARP-42Q6-L	S	JG4		4562.45	5334.37	4944.17	5716.09
14	14		252"(6401mm)	TARP-42R2-L	S	JG4		4669.78	5455.74	5060.81	5846.77
14	14		258"(6553mm)	TARP-42R8-L	S	JG4		4777.11	5577.11	5177.45	5977.45
14	14		264"(6706mm)	TARP-42S4-L	S	JG4		4884.44	5698.48	5294.09	6108.13
14	16		270"(6858mm)	TARP-42T0-L	S	JG4		4991.77	5819.85	5410.73	6238.81
8	14	48"(1219mm)	186"(4724mm)	TARP-48J6-L	S	JG4		\$3926.65	\$4572.21	\$4256.50	\$4902.06
8	14		192"(4877mm)	TARP-48K2-L	S	JG4		4045.56	4705.16	4386.05	5045.65
8	14		198"(5029mm)	TARP-48K8-L	S	JG4		4164.47	4838.11	4515.60	5189.24
8	14		204"(5182mm)	TARP-48L4-L	S	JG4		4283.38	4971.06	4645.15	5332.83
8	14		210"(5334mm)	TARP-48M0-L	S	JG4		4402.29	5104.01	4774.70	5476.42
8	14		216"(5486mm)	TARP-48M6-L	S	JG4		4521.20	5236.96	4904.25	5620.01
14	14		222"(5639mm)	TARP-48N2-L	S	JG4		4640.11	5369.91	5033.80	5763.60
14	14		228"(5791mm)	TARP-48N8-L	S	JG4		4759.02	5502.86	5163.35	5907.19
14	14		234"(5944mm)	TARP-48P4-L	S	JG4		4877.93	5635.81	5292.90	6050.78
14	14		240"(6096mm)	TARP-48Q0-L	S	JG4		4996.84	5768.76	5422.45	6194.37
14	14		246"(6248mm)	TARP-48Q6-L	S	JG4		5115.75	5901.71	5552.00	6337.96
14	14		252"(6401mm)	TARP-48R2-L	S	JG4		5234.66	6034.66	5681.55	6481.55
14	14		258"(6553mm)	TARP-48R8-L	S	JG4		5353.57	6167.61	5811.10	6625.14
14	14		264"(6706mm)	TARP-48S4-L	S	JG4		5472.48	6300.56	5940.65	6768.73
14	16		270"(6858mm)	TARP-48T0-L	S	JG4		5591.39	6433.51	6070.20	6912.32
8	14	54"(1372mm)	186"(4724mm)	TARP-54J6-L	S	JG4		\$4295.75	\$5023.75	\$4666.83	\$5394.83
8	14		192"(4877mm)	TARP-54K2-L	S	JG4		4426.24	5168.28	4809.29	5551.33
8	14		198"(5029mm)	TARP-54K8-L	S	JG4		4556.73	5312.81	4951.75	5707.83
8	14		204"(5182mm)	TARP-54L4-L	S	JG4		4687.22	5457.34	5094.21	5864.33
8	14		210"(5334mm)	TARP-54M0-L	S	JG4		4817.71	5601.87	5236.67	6020.83
8	14		216"(5486mm)	TARP-54M6-L	S	JG4		4948.20	5746.40	5379.13	6177.33
14	14		222"(5639mm)	TARP-54N2-L	S	JG4		5078.69	5890.93	5521.59	6333.83
14	14		228"(5791mm)	TARP-54N8-L	S	JG4		5209.18	6035.46	5664.05	6490.33
14	14		234"(5944mm)	TARP-54P4-L	S	JG4		5339.67	6179.99	5806.51	6646.83
14	14		240"(6096mm)	TARP-54Q0-L	S	JG4		5470.16	6324.52	5948.97	6803.33
14	14		246"(6248mm)	TARP-54Q6-L	S	JG4		5600.65	6469.05	6091.43	6959.83
14	14		252"(6401mm)	TARP-54R2-L	S	JG4		5731.14	6613.58	6233.89	7116.33
14	14		258"(6553mm)	TARP-54R8-L	S	JG4		5861.63	6758.11	6376.35	7272.83
14	14		264"(6706mm)	TARP-54S4-L	S	JG4		5992.12	6902.64	6518.81	7429.33
14	16		270"(6858mm)	TARP-54T0-L	S	JG4		6122.61	7047.17	6661.27	7585.83
8	14	60"(1524mm)	186"(4724mm)	TARP-60J6-L	S	JG4		\$4664.85	\$5475.29	\$5077.16	\$5887.60
8	14		192"(4877mm)	TARP-60K2-L	S	JG4		4806.92	5631.40	5232.53	6057.01
8	14		198"(5029mm)	TARP-60K8-L	S	JG4		4948.99	5787.51	5387.90	6226.42
8	14		204"(5182mm)	TARP-60L4-L	S	JG4		5091.06	5943.62	5543.27	6395.83
8	14		210"(5334mm)	TARP-60M0-L	S	JG4		5233.13	6099.73	5698.64	6565.24
8	14		216"(5486mm)	TARP-60M6-L	S	JG4		5375.20	6255.84	5854.01	6734.65
14	14		222"(5639mm)	TARP-60N2-L	S	JG4		5517.27	6411.95	6009.38	6904.06
14	14		228"(5791mm)	TARP-60N8-L	S	JG4		5659.34	6568.06	6164.75	7073.47
14	14		234"(5944mm)	TARP-60P4-L	S	JG4		5801.41	6724.17	6320.12	7242.88
14	14		240"(6096mm)	TARP-60Q0-L	S	JG4		5943.48	6880.28	6475.49	7412.29
14	14		246"(6248mm)	TARP-60Q6-L	S	JG4		6085.55	7036.39	6630.86	7581.70
14	14		252"(6401mm)	TARP-60R2-L	S	JG4		6227.62	7192.50	6786.23	7751.11
14	14		258"(6553mm)	TARP-60R8-L	S	JG4		6369.69	7348.61	6941.60	7920.52
14	14		264"(6706mm)	TARP-60S4-L	S	JG4		6511.76	7504.72	7096.97	8089.93
14	16		270"(6858mm)	TARP-60T0-L	S	JG4		6653.83	7660.83	7252.34	8259.34

*Recommended seating capacity based upon 27"(686mm) per chair.

Planes Conference Tables — Three-Piece Tops — Interior Leg — Laminate

Hexagon

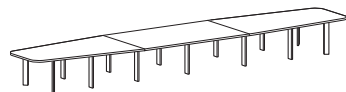

TARX

Features

- Includes 1 3/16”(30mm) thick top, interior leg bases and hardware.
- Standard table height is 29”(737mm).
- Laminate top with 3mm edgeband or knife edges.
- Table top seams are 1mm edgeband.
- Interior legs are painted aluminum.
- Interior leg is 1 1/8”(29mm) x 3 1/4”(83mm).
- Optional cable bases are available :
 - 42”(1067mm) deep and deeper tables will ship with 14”(356mm) x 14”(356mm) cable bases.
 - Three piece tops will include two cable bases to be centered on seams.
 - Cable base and table top(s) are laminate and can be specified in different surface colors and edge trim colors.
 - Refer to Specification Guide for use guidelines.
- Optional Flip top unit electrical modules are separately specified. Refer to electrical components for appropriate product specification.
- Available with glides only; 1/2”(13mm) height adjustment.
- Depth and width shown in nominal dimensions.
- Ships unassembled.

Specification Tips

- Tables with multiple-piece tops have equal sized pieces.
- The following Planes products are separately specified:
 - Grommets (field cut opening)
 - Flip top unit electrical modules
 - Horizontal wire management
- Refer to Specification Guide for seating capacities with Cable Base Option and leg locations.

To Order, Specify:

1) Product number, including:

1 Edge Option:

- J** Edgeband
- F** Knife

2 Flip Top Unit Cutout(s):

- N** None
- F** Center – single-sided/4 outlets, add **\$95.58** list
- V** Left/Right – single-sided/4 outlets, add **\$191.16** list
- J** Center – single-sided/6 outlets, add **\$95.58** list
- K** Left/Right – single-sided/6 outlets, add **\$191.16** list
- M** Center – double-sided/8 outlets, add **\$95.58** list
- P** Left/Right – double-sided/8 outlets, add **\$191.16** list
- Q** Center – double-sided/12 outlets, add **\$95.58** list
- T** Left/Right – double-sided/12 outlets, add **\$191.16** list

3 Cable Base Option:

- N** None
- C** Cable Bases (2), add **\$1343.98** list

- 2) Laminate surface color.
- 3) 1mm edgeband trim color. (Cascade edge/multiple-tops only)*
- 4) Edge trim color.
- 5) Base trim color.
- 6) Laminate surface – Cable Bases
- 7) Edge trim color – Cable Bases

Note: **\$44.02** upcharge (list) for Metallic and accent trim colors.

Planes Conference Tables — Three-Piece Tops — Interior Leg — Laminate

Hexagon

No. of Legs	Seating Capacity*	Depth	Width	Number	① ② ③			Laminate A		Laminate B	
					J	F	J	F			
8	14	42"(1067mm)	186"(4724mm)	TARX-42J6-L	S	JG4	\$3489.15	\$4120.67	\$3777.77	\$4409.29	
8	14		192"(4877mm)	TARX-42K2-L	S	JG4	3596.48	4242.04	3894.41	4539.97	
8	14		198"(5029mm)	TARX-42K8-L	S	JG4	3703.81	4363.41	4011.05	4670.65	
10	14		204"(5182mm)	TARX-42L4-L	S	JG4	3811.14	4484.78	4127.69	4801.33	
10	14		210"(5334mm)	TARX-42M0-L	S	JG4	3918.47	4606.15	4244.33	4932.01	
10	14		216"(5486mm)	TARX-42M6-L	S	JG4	4025.80	4727.52	4360.97	5062.69	
14	14		222"(5639mm)	TARX-42N2-L	S	JG4	4133.13	4848.89	4477.61	5193.37	
14	14		228"(5791mm)	TARX-42N8-L	S	JG4	4240.46	4970.26	4594.25	5324.05	
14	14		234"(5944mm)	TARX-42P4-L	S	JG4	4347.79	5091.63	4710.89	5454.73	
14	14		240"(6096mm)	TARX-42Q0-L	S	JG4	4455.12	5213.00	4827.53	5585.41	
14	14		246"(6248mm)	TARX-42Q6-L	S	JG4	4562.45	5334.37	4944.17	5716.09	
14	14		252"(6401mm)	TARX-42R2-L	S	JG4	4669.78	5455.74	5060.81	5846.77	
14	14		258"(6553mm)	TARX-42R8-L	S	JG4	4777.11	5577.11	5177.45	5977.45	
14	14		264"(6706mm)	TARX-42S4-L	S	JG4	4884.44	5698.48	5294.09	6108.13	
14	16		270"(6858mm)	TARX-42T0-L	S	JG4	4991.77	5819.85	5410.73	6238.81	
8	14	48"(1219mm)	186"(4724mm)	TARX-48J6-L	S	JG4	\$3926.65	\$4572.21	\$4256.50	\$4902.06	
8	14		192"(4877mm)	TARX-48K2-L	S	JG4	4045.56	4705.16	4386.05	5045.65	
8	14		198"(5029mm)	TARX-48K8-L	S	JG4	4164.47	4838.11	4515.60	5189.24	
8	14		204"(5182mm)	TARX-48L4-L	S	JG4	4283.38	4971.06	4645.15	5332.83	
8	14		210"(5334mm)	TARX-48M0-L	S	JG4	4402.29	5104.01	4774.70	5476.42	
8	14		216"(5486mm)	TARX-48M6-L	S	JG4	4521.20	5236.96	4904.25	5620.01	
14	14		222"(5639mm)	TARX-48N2-L	S	JG4	4640.11	5369.91	5033.80	5763.60	
14	14		228"(5791mm)	TARX-48N8-L	S	JG4	4759.02	5502.86	5163.35	5907.19	
14	14		234"(5944mm)	TARX-48P4-L	S	JG4	4877.93	5635.81	5292.90	6050.78	
14	14		240"(6096mm)	TARX-48Q0-L	S	JG4	4996.84	5768.76	5422.45	6194.37	
14	14		246"(6248mm)	TARX-48Q6-L	S	JG4	5115.75	5901.71	5552.00	6337.96	
14	14		252"(6401mm)	TARX-48R2-L	S	JG4	5234.66	6034.66	5681.55	6481.55	
14	14		258"(6553mm)	TARX-48R8-L	S	JG4	5353.57	6167.61	5811.10	6625.14	
14	14		264"(6706mm)	TARX-48S4-L	S	JG4	5472.48	6300.56	5940.65	6768.73	
14	16		270"(6858mm)	TARX-48T0-L	S	JG4	5591.39	6433.51	6070.20	6912.32	
8	14	54"(1372mm)	186"(4724mm)	TARX-54J6-L	S	JG4	\$4295.75	\$5023.75	\$4666.83	\$5394.83	
8	14		192"(4877mm)	TARX-54K2-L	S	JG4	4426.24	5168.28	4809.29	5551.33	
8	14		198"(5029mm)	TARX-54K8-L	S	JG4	4556.73	5312.81	4951.75	5707.83	
8	14		204"(5182mm)	TARX-54L4-L	S	JG4	4687.22	5457.34	5094.21	5864.33	
8	14		210"(5334mm)	TARX-54M0-L	S	JG4	4817.71	5601.87	5236.67	6020.83	
8	14		216"(5486mm)	TARX-54M6-L	S	JG4	4948.20	5746.40	5379.13	6177.33	
14	14		222"(5639mm)	TARX-54N2-L	S	JG4	5078.69	5890.93	5521.59	6333.83	
14	14		228"(5791mm)	TARX-54N8-L	S	JG4	5209.18	6035.46	5664.05	6490.33	
14	14		234"(5944mm)	TARX-54P4-L	S	JG4	5339.67	6179.99	5806.51	6646.83	
14	14		240"(6096mm)	TARX-54Q0-L	S	JG4	5470.16	6324.52	5948.97	6803.33	
14	14		246"(6248mm)	TARX-54Q6-L	S	JG4	5600.65	6469.05	6091.43	6959.83	
14	14		252"(6401mm)	TARX-54R2-L	S	JG4	5731.14	6613.58	6233.89	7116.33	
14	14		258"(6553mm)	TARX-54R8-L	S	JG4	5861.63	6758.11	6376.35	7272.83	
14	14		264"(6706mm)	TARX-54S4-L	S	JG4	5992.12	6902.64	6518.81	7429.33	
14	16		270"(6858mm)	TARX-54T0-L	S	JG4	6122.61	7047.17	6661.27	7585.83	
8	14	60"(1524mm)	186"(4724mm)	TARX-60J6-L	S	JG4	\$4664.85	\$5475.29	\$5077.16	\$5887.60	
8	14		192"(4877mm)	TARX-60K2-L	S	JG4	4806.92	5631.40	5232.53	6057.01	
8	14		198"(5029mm)	TARX-60K8-L	S	JG4	4948.99	5787.51	5387.90	6226.42	
8	14		204"(5182mm)	TARX-60L4-L	S	JG4	5091.06	5943.62	5543.27	6395.83	
8	14		210"(5334mm)	TARX-60M0-L	S	JG4	5233.13	6099.73	5698.64	6565.24	
8	14		216"(5486mm)	TARX-60M6-L	S	JG4	5375.20	6255.84	5854.01	6734.65	
14	14		222"(5639mm)	TARX-60N2-L	S	JG4	5517.27	6411.95	6009.38	6904.06	
14	14		228"(5791mm)	TARX-60N8-L	S	JG4	5659.34	6568.06	6164.75	7073.47	
14	14		234"(5944mm)	TARX-60P4-L	S	JG4	5801.41	6724.17	6320.12	7242.88	
14	14		240"(6096mm)	TARX-60Q0-L	S	JG4	5943.48	6880.28	6475.49	7412.29	
14	14		246"(6248mm)	TARX-60Q6-L	S	JG4	6085.55	7036.39	6630.86	7581.70	
14	14		252"(6401mm)	TARX-60R2-L	S	JG4	6227.62	7192.50	6786.23	7751.11	
14	14		258"(6553mm)	TARX-60R8-L	S	JG4	6369.69	7348.61	6941.60	7920.52	
14	14		264"(6706mm)	TARX-60S4-L	S	JG4	6511.76	7504.72	7096.97	8089.93	
14	16		270"(6858mm)	TARX-60T0-L	S	JG4	6653.83	7660.83	7252.34	8259.34	

*Recommended seating capacity based upon 27"(686mm) per chair.

Planes Conference Tables — Three-Piece Tops — Interior Leg — Wood

Rectangular



TARA

Features

- Includes 1 3/16" (30mm) thick tops, interior leg bases and hardware.
- Standard table height is 29" (737mm).
- Wood veneer top with 3mm wood edgeband or knife wood edge.
- Table top seams are 1mm edgeband.
- Interior legs are painted aluminum.
- Interior leg is 1 1/8" (29mm) x 3 1/4" (83mm).
- Optional cable bases are available :
 - 42" (1067mm) deep and deeper tables will ship with 14" (356mm) x 14" (356mm) cable bases.
 - Three piece tops will include two cable bases to be centered on seams.
 - Cable base and table top(s) are wood veneer and can be specified in different surface colors and edge trim colors.
 - Refer to Specification Guide for use guidelines.
- Optional Flip top unit electrical modules are separately specified. Refer to electrical components for appropriate product specification.
- Available with glides only; 1/2" (13mm) height adjustment.
- Depth and width shown in nominal dimensions.
- Ships unassembled.

Specification Tips

- Tables with multiple-piece tops have equal sized pieces.
- The following Planes products are separately specified:
 - Grommets (field cut opening)
 - Flip top unit electrical modules
 - Horizontal wire management
- Refer to Specification Guide for seating capacities with Cable Base Option and leg locations.

To Order, Specify:

1) Product number, including:

① Wood Edge Option:

- K** Edgeband
- U** Knife

② Flip Top Unit Cutout(s):

- N** None
- F** Center – single-sided/4 outlets, add **\$95.58** list
- V** Left/Right – single-sided/4 outlets, add **\$191.16** list
- J** Center – single-sided/6 outlets, add **\$95.58** list
- K** Left/Right – single-sided/6 outlets, add **\$191.16** list
- M** Center – double-sided/8 outlets, add **\$95.58** list
- P** Left/Right – double-sided/8 outlets, add **\$191.16** list
- Q** Center – double-sided/12 outlets, add **\$95.58** list
- T** Left/Right – double-sided/12 outlets, add **\$191.16** list

③ Cable Base Option:

- N** None
- C** Cable Bases(2), add **\$1343.98** list

2) Wood finish color.

3) Base trim color.

4) Wood finish color – Cable Bases

Note: **\$44.02** upcharge (list) for Metallic and accent trim colors.

Planes Conference Tables — Three-Piece Tops — Interior Leg — Wood

Rectangular

No. of Legs	Seating Capacity*	Depth	Width	Number				Wood Group A		Wood Group B	
					①	②	③	K	U	K	U
8	14	42"(1067mm)	186"(4724mm)	TARA-42J6-W	S	JG4	\$ 5277.61	\$ 6568.87	\$ 5930.65	\$ 7425.82	
8	14		192"(4877mm)	TARA-42K2-W	S	JG4	5438.64	6781.99	6116.77	7674.53	
8	14		198"(5029mm)	TARA-42K8-W	S	JG4	5599.94	6996.95	6303.21	7925.40	
14	14		204"(5182mm)	TARA-42L4-W	S	JG4	5761.51	7213.75	6489.98	8178.43	
14	14		210"(5334mm)	TARA-42M0-W	S	JG4	5923.35	7432.39	6677.07	8433.62	
14	14		216"(5486mm)	TARA-42M6-W	S	JG4	6085.46	7652.87	6864.49	8690.97	
14	16		222"(5639mm)	TARA-42N2-W	S	JG4	6247.83	7875.19	7052.23	8950.48	
14	16		228"(5791mm)	TARA-42N8-W	S	JG4	6410.47	8099.35	7240.29	9212.15	
14	16		234"(5944mm)	TARA-42P4-W	S	JG4	6573.38	8325.35	7428.68	9475.98	
14	16		240"(6096mm)	TARA-42Q0-W	S	JG4	6736.56	8553.20	7617.39	9741.97	
14	16		246"(6248mm)	TARA-42Q6-W	S	JG4	6900.00	8782.88	7806.43	10010.12	
14	16		252"(6401mm)	TARA-42R2-W	S	JG4	7063.72	9014.40	7995.79	10280.43	
14	18		258"(6553mm)	TARA-42R8-W	S	JG4	7227.70	9247.76	8185.47	10552.90	
14	18		264"(6706mm)	TARA-42S4-W	S	JG4	7391.95	9482.97	8375.48	10827.53	
14	20		270"(6858mm)	TARA-42T0-W	S	JG4	7556.46	9720.01	8565.81	11104.32	
8	14	48"(1219mm)	186"(4724mm)	TARA-48J6-W	S	JG4	\$ 6047.17	\$ 7396.64	\$ 6798.12	\$ 8356.87	
8	14		192"(4877mm)	TARA-48K2-W	S	JG4	6225.55	7627.89	7004.69	8626.95	
8	14		198"(5029mm)	TARA-48K8-W	S	JG4	6404.19	7860.98	7211.59	8899.19	
14	14		204"(5182mm)	TARA-48L4-W	S	JG4	6583.11	8095.91	7418.81	9173.59	
14	14		210"(5334mm)	TARA-48M0-W	S	JG4	6762.29	8332.68	7626.35	9450.15	
14	14		216"(5486mm)	TARA-48M6-W	S	JG4	6941.74	8571.29	7834.22	9728.87	
14	16		222"(5639mm)	TARA-48N2-W	S	JG4	7121.46	8811.74	8042.41	10009.75	
14	16		228"(5791mm)	TARA-48N8-W	S	JG4	7301.44	9054.04	8250.93	10292.79	
14	16		234"(5944mm)	TARA-48P4-W	S	JG4	7481.70	9298.17	8459.77	10577.99	
14	16		240"(6096mm)	TARA-48Q0-W	S	JG4	7662.22	9544.14	8668.93	10865.35	
14	16		246"(6248mm)	TARA-48Q6-W	S	JG4	7843.01	9791.95	8878.42	11154.87	
14	16		252"(6401mm)	TARA-48R2-W	S	JG4	8024.06	10041.61	9088.23	11446.55	
14	18		258"(6553mm)	TARA-48R8-W	S	JG4	8205.39	10293.10	9298.37	11740.39	
14	18		264"(6706mm)	TARA-48S4-W	S	JG4	8386.98	10546.43	9508.83	12036.39	
14	20		270"(6858mm)	TARA-48T0-W	S	JG4	8568.84	10801.61	9719.61	12334.55	
8	14	54"(1372mm)	186"(4724mm)	TARA-54J6-W	S	JG4	\$ 6816.73	\$ 8224.41	\$ 7665.59	\$ 9287.92	
8	14		192"(4877mm)	TARA-54K2-W	S	JG4	7012.45	8473.79	7892.61	9579.37	
8	14		198"(5029mm)	TARA-54K8-W	S	JG4	7208.44	8725.01	8119.96	9872.98	
14	14		204"(5182mm)	TARA-54L4-W	S	JG4	7404.70	8978.08	8347.63	10168.75	
14	14		210"(5334mm)	TARA-54M0-W	S	JG4	7601.23	9232.98	8575.63	10466.68	
14	14		216"(5486mm)	TARA-54M6-W	S	JG4	7798.02	9489.72	8803.95	10766.77	
14	16		222"(5639mm)	TARA-54N2-W	S	JG4	7995.08	9748.30	9032.59	11069.02	
14	16		228"(5791mm)	TARA-54N8-W	S	JG4	8192.41	10008.72	9261.56	11373.43	
14	16		234"(5944mm)	TARA-54P4-W	S	JG4	8390.01	10270.98	9490.85	11680.00	
14	16		240"(6096mm)	TARA-54Q0-W	S	JG4	8587.87	10535.09	9720.47	11988.73	
14	16		246"(6248mm)	TARA-54Q6-W	S	JG4	8786.01	10801.03	9950.41	12299.62	
14	16		252"(6401mm)	TARA-54R2-W	S	JG4	8984.41	11068.81	10180.67	12612.67	
14	18		258"(6553mm)	TARA-54R8-W	S	JG4	9183.08	11338.43	10411.26	12927.88	
14	18		264"(6706mm)	TARA-54S4-W	S	JG4	9382.03	11610.03	10642.20	13245.40	
14	20		270"(6858mm)	TARA-54T0-W	S	JG4	9581.22	11883.20	10873.41	13564.78	
8	14	60"(1524mm)	186"(4724mm)	TARA-60J6-W	S	JG4	\$ 7586.29	\$ 9052.19	\$ 8533.06	\$ 10218.97	
8	14		192"(4877mm)	TARA-60K2-W	S	JG4	7799.36	9319.70	8780.54	10531.79	
8	14		198"(5029mm)	TARA-60K8-W	S	JG4	8012.69	9589.05	9028.34	10846.77	
14	14		204"(5182mm)	TARA-60L4-W	S	JG4	8226.29	9860.24	9276.46	11163.91	
14	14		210"(5334mm)	TARA-60M0-W	S	JG4	8440.16	10133.27	9524.91	11483.21	
14	14		216"(5486mm)	TARA-60M6-W	S	JG4	8654.30	10408.14	9773.68	11804.67	
14	16		222"(5639mm)	TARA-60N2-W	S	JG4	8868.71	10684.85	10022.78	12128.29	
14	16		228"(5791mm)	TARA-60N8-W	S	JG4	9083.38	10963.41	10272.20	12454.07	
14	16		234"(5944mm)	TARA-60P4-W	S	JG4	9298.32	11243.80	10521.94	12782.01	
14	16		240"(6096mm)	TARA-60Q0-W	S	JG4	9513.53	11526.03	10772.01	13112.11	
14	16		246"(6248mm)	TARA-60Q6-W	S	JG4	9729.01	11810.10	11022.40	13444.37	
14	16		252"(6401mm)	TARA-60R2-W	S	JG4	9944.75	12096.02	11273.12	13778.79	
14	18		258"(6553mm)	TARA-60R8-W	S	JG4	10160.76	12383.77	11524.16	14115.37	
14	18		264"(6706mm)	TARA-60S4-W	S	JG4	10377.04	12673.36	11775.52	14454.11	
14	20		270"(6858mm)	TARA-60T0-W	S	JG4	10593.59	12964.80	12027.21	14795.01	

*Recommended seating capacity based upon 27"(686mm) per chair.

Planes Conference Tables — Three-Piece Tops — Interior Leg — Wood

Pebble



TARP

Features

- Includes 1 3/16" (30mm) thick tops, interior leg bases and hardware.
- Standard table height is 29" (737mm).
- Wood veneer top with 3mm wood edgeband or knife wood edge.
- Table top seams are 1mm edgeband.
- Interior legs are painted aluminum.
- Interior leg is 1 1/8" (29mm) x 3 1/4" (83mm).
- Optional cable bases are available :
 - 42" (1067mm) deep and deeper tables will ship with 14" (356mm) x 14" (356mm) cable bases.
 - Three piece tops will include two cable bases to be centered on seams.
 - Cable base and table top(s) are wood veneer and can be specified in different surface colors and edge trim colors.
 - Refer to Specification Guide for use guidelines.
- Optional Flip top unit electrical modules are separately specified. Refer to electrical components for appropriate product specification.
- Available with glides only; 1/2" (13mm) height adjustment.
- Depth and width shown in nominal dimensions.
- Ships unassembled.

Specification Tips

- Tables with multiple-piece tops have equal sized pieces.
- The following Planes products are separately specified:
 - Grommets (field cut opening)
 - Flip top unit electrical modules
 - Horizontal wire management
- Refer to Specification Guide for seating capacities with Cable Base Option and leg locations.

To Order, Specify:

1) Product number, including:

① Wood Edge Option:

- K** Edgeband
- U** Knife

② Flip Top Unit Cutout(s):

- N** None
- F** Center – single-sided/4 outlets, add **\$95.58** list
- V** Left/Right – single-sided/4 outlets, add **\$191.16** list
- J** Center – single-sided/6 outlets, add **\$95.58** list
- K** Left/Right – single-sided/6 outlets, add **\$191.16** list
- M** Center – double-sided/8 outlets, add **\$95.58** list
- P** Left/Right – double-sided/8 outlets, add **\$191.16** list
- Q** Center – double-sided/12 outlets, add **\$95.58** list
- T** Left/Right – double-sided/12 outlets, add **\$191.16** list

③ Cable Base Option:

- N** None
- C** Cable Bases(2), add **\$1343.98** list

2) Wood finish color.

3) Base trim color.

4) Wood finish color – Cable Bases

Note: **\$44.02** upcharge (list) for Metallic and accent trim colors.

Planes Conference Tables — Three-Piece Tops — Interior Leg — Wood

Pebble

No. of Legs	Seating Capacity*	Depth	Width	Number	① ② ③			Wood Group A		Wood Group B	
					S	JG4		K	U	K	U
8	14	42"(1067mm)	186"(4724mm)	TARP-42J6-W	S	JG4		\$ 5277.61	\$ 6568.87	\$ 5930.65	\$ 7425.82
8	14		192"(4877mm)	TARP-42K2-W	S	JG4		5438.64	6781.99	6116.77	7674.53
8	14		198"(5029mm)	TARP-42K8-W	S	JG4		5599.94	6996.95	6303.21	7925.40
10	14		204"(5182mm)	TARP-42L4-W	S	JG4		5761.51	7213.75	6489.98	8178.43
10	14		210"(5334mm)	TARP-42M0-W	S	JG4		5923.35	7432.39	6677.07	8433.62
10	14		216"(5486mm)	TARP-42M6-W	S	JG4		6085.46	7652.87	6864.49	8690.97
14	14		222"(5639mm)	TARP-42N2-W	S	JG4		6247.83	7875.19	7052.23	8950.48
14	14		228"(5791mm)	TARP-42N8-W	S	JG4		6410.47	8099.35	7240.29	9212.15
14	14		234"(5944mm)	TARP-42P4-W	S	JG4		6573.38	8325.35	7428.68	9475.98
14	14		240"(6096mm)	TARP-42Q0-W	S	JG4		6736.56	8553.20	7617.39	9741.97
14	14		246"(6248mm)	TARP-42Q6-W	S	JG4		6900.00	8782.88	7806.43	10010.12
14	14		252"(6401mm)	TARP-42R2-W	S	JG4		7063.72	9014.40	7995.79	10280.43
14	14		258"(6553mm)	TARP-42R8-W	S	JG4		7227.70	9247.76	8185.47	10552.90
14	14		264"(6706mm)	TARP-42S4-W	S	JG4		7391.95	9482.97	8375.48	10827.53
14	16	270"(6858mm)	TARP-42T0-W	S	JG4		7556.46	9720.01	8565.81	11104.32	
8	14	48"(1219mm)	186"(4724mm)	TARP-48J6-W	S	JG4		\$ 6047.17	\$ 7396.64	\$ 6798.12	\$ 8356.87
8	14		192"(4877mm)	TARP-48K2-W	S	JG4		6225.55	7627.89	7004.69	8626.95
8	14		198"(5029mm)	TARP-48K8-W	S	JG4		6404.19	7860.98	7211.59	8899.19
10	14		204"(5182mm)	TARP-48L4-W	S	JG4		6583.11	8095.91	7418.81	9173.59
10	14		210"(5334mm)	TARP-48M0-W	S	JG4		6762.29	8332.68	7626.35	9450.15
10	14		216"(5486mm)	TARP-48M6-W	S	JG4		6941.74	8571.29	7834.22	9728.87
14	14		222"(5639mm)	TARP-48N2-W	S	JG4		7121.46	8811.74	8042.41	10009.75
14	14		228"(5791mm)	TARP-48N8-W	S	JG4		7301.44	9054.04	8250.93	10292.79
14	14		234"(5944mm)	TARP-48P4-W	S	JG4		7481.70	9298.17	8459.77	10577.99
14	14		240"(6096mm)	TARP-48Q0-W	S	JG4		7662.22	9544.14	8668.93	10865.35
14	14		246"(6248mm)	TARP-48Q6-W	S	JG4		7843.01	9791.95	8878.42	11154.87
14	14		252"(6401mm)	TARP-48R2-W	S	JG4		8024.06	10041.61	9088.23	11446.55
14	14		258"(6553mm)	TARP-48R8-W	S	JG4		8205.39	10293.10	9298.37	11740.39
14	14		264"(6706mm)	TARP-48S4-W	S	JG4		8386.98	10546.43	9508.83	12036.39
14	16	270"(6858mm)	TARP-48T0-W	S	JG4		8568.84	10801.61	9719.61	12334.55	
8	14	54"(1372mm)	186"(4724mm)	TARP-54J6-W	S	JG4		\$ 6816.73	\$ 8224.41	\$ 7665.59	\$ 9287.92
8	14		192"(4877mm)	TARP-54K2-W	S	JG4		7012.45	8473.79	7892.61	9579.37
8	14		198"(5029mm)	TARP-54K8-W	S	JG4		7208.44	8725.01	8119.96	9872.98
10	14		204"(5182mm)	TARP-54L4-W	S	JG4		7404.70	8978.08	8347.63	10168.75
10	14		210"(5334mm)	TARP-54M0-W	S	JG4		7601.23	9232.98	8575.63	10466.68
10	14		216"(5486mm)	TARP-54M6-W	S	JG4		7798.02	9489.72	8803.95	10766.77
14	14		222"(5639mm)	TARP-54N2-W	S	JG4		7995.08	9748.30	9032.59	11069.02
14	14		228"(5791mm)	TARP-54N8-W	S	JG4		8192.41	10008.72	9261.56	11373.43
14	14		234"(5944mm)	TARP-54P4-W	S	JG4		8390.01	10270.98	9490.85	11680.00
14	14		240"(6096mm)	TARP-54Q0-W	S	JG4		8587.87	10535.09	9720.47	11988.73
14	14		246"(6248mm)	TARP-54Q6-W	S	JG4		8786.01	10801.03	9950.41	12299.62
14	14		252"(6401mm)	TARP-54R2-W	S	JG4		8984.41	11068.81	10180.67	12612.67
14	14		258"(6553mm)	TARP-54R8-W	S	JG4		9183.08	11338.43	10411.26	12927.88
14	14		264"(6706mm)	TARP-54S4-W	S	JG4		9382.01	11609.90	10642.17	13245.25
14	16	270"(6858mm)	TARP-54T0-W	S	JG4		9581.22	11883.20	10873.41	13564.78	
8	14	60"(1524mm)	186"(4724mm)	TARP-60J6-W	S	JG4		\$ 7586.29	\$ 9052.19	\$ 8533.06	\$ 10218.97
8	14		192"(4877mm)	TARP-60K2-W	S	JG4		7799.36	9319.70	8780.54	10531.79
8	14		198"(5029mm)	TARP-60K8-W	S	JG4		8012.69	9589.05	9028.34	10846.77
10	14		204"(5182mm)	TARP-60L4-W	S	JG4		8226.29	9860.24	9276.46	11163.91
10	14		210"(5334mm)	TARP-60M0-W	S	JG4		8440.16	10133.27	9524.91	11483.21
10	14		216"(5486mm)	TARP-60M6-W	S	JG4		8654.30	10408.14	9773.68	11804.67
14	14		222"(5639mm)	TARP-60N2-W	S	JG4		8868.71	10684.85	10022.78	12128.29
14	14		228"(5791mm)	TARP-60N8-W	S	JG4		9083.38	10963.41	10272.20	12454.07
14	14		234"(5944mm)	TARP-60P4-W	S	JG4		9298.32	11243.80	10521.94	12782.01
14	14		240"(6096mm)	TARP-60Q0-W	S	JG4		9513.53	11526.03	10772.01	13112.11
14	14		246"(6248mm)	TARP-60Q6-W	S	JG4		9729.01	11810.10	11022.40	13444.37
14	14		252"(6401mm)	TARP-60R2-W	S	JG4		9944.75	12096.02	11273.12	13778.79
14	14		258"(6553mm)	TARP-60R8-W	S	JG4		10160.76	12383.77	11524.16	14115.37
14	14		264"(6706mm)	TARP-60S4-W	S	JG4		10377.04	12673.36	11775.52	14454.11
14	16	270"(6858mm)	TARP-60T0-W	S	JG4		10593.59	12964.80	12027.21	14795.01	

*Recommended seating capacity based upon 27"(686mm) per chair.

Planes Conference Tables — Three-Piece Tops — Interior Leg — Wood

Hexagon



TARX

Features

- Includes 1 3/16" (30mm) thick tops, interior leg bases and hardware.
- Standard table height is 29" (737mm).
- Wood veneer top with 3mm wood edgeband or knife wood edge.
- Table top seams are 1mm edgeband.
- Interior legs are painted aluminum.
- Interior leg is 1 1/8" (29mm) x 3 1/4" (83mm).
- Optional cable bases are available :
 - 42" (1067mm) deep and deeper tables will ship with 14" (356mm) x 14" (356mm) cable bases.
 - Three piece tops will include two cable bases to be centered on seams.
 - Cable base and table top(s) are wood veneer and can be specified in different surface colors and edge trim colors.
 - Refer to Specification Guide for use guidelines.
- Optional Flip top unit electrical modules are separately specified. Refer to electrical components for appropriate product specification.
- Available with glides only; 1/2" (13mm) height adjustment.
- Depth and width shown in nominal dimensions.
- Ships unassembled.

Specification Tips

- Tables with multiple-piece tops have equal sized pieces.
- The following Planes products are separately specified:
 - Grommets (field cut opening)
 - Flip top unit electrical modules
 - Horizontal wire management
- Refer to Specification Guide for seating capacities with Cable Base Option and leg locations.

To Order, Specify:

1) Product number, including:

① Wood Edge Option:

- K** Edgeband
- U** Knife

② Flip Top Unit Cutout(s):

- N** None
- F** Center – single-sided/4 outlets, add **\$95.58** list
- V** Left/Right – single-sided/4 outlets, add **\$191.16** list
- J** Center – single-sided/6 outlets, add **\$95.58** list
- K** Left/Right – single-sided/6 outlets, add **\$191.16** list
- M** Center – double-sided/8 outlets, add **\$95.58** list
- P** Left/Right – double-sided/8 outlets, add **\$191.16** list
- Q** Center – double-sided/12 outlets, add **\$95.58** list
- T** Left/Right – double-sided/12 outlets, add **\$191.16** list

③ Cable Base Option:

- N** None
- C** Cable Bases(2), add **\$1343.98** list

- 2) Wood finish color.
- 3) Base trim color.
- 4) Wood finish color – Cable Bases

Note: **\$44.02** upcharge (list) for Metallic and accent trim colors.

Planes Conference Tables — Three-Piece Tops — Interior Leg — Wood

Hexagon

No. of Legs	Seating Capacity*	Depth	Width	Number				Wood Group A		Wood Group B	
					①	②	③	K	U	K	U
8	14	42"(1067mm)	186"(4724mm)	TARX-42J6-W	S	JG4	\$ 5277.61	\$ 6568.87	\$ 5930.65	\$ 7425.82	
8	14		192"(4877mm)	TARX-42K2-W	S	JG4	5438.64	6781.99	6116.77	7674.53	
8	14		198"(5029mm)	TARX-42K8-W	S	JG4	5599.94	6996.95	6303.21	7925.40	
10	14		204"(5182mm)	TARX-42L4-W	S	JG4	5761.51	7213.75	6489.98	8178.43	
10	14		210"(5334mm)	TARX-42M0-W	S	JG4	5923.35	7432.39	6677.07	8433.62	
10	14		216"(5486mm)	TARX-42M6-W	S	JG4	6085.46	7652.87	6864.49	8690.97	
14	14		222"(5639mm)	TARX-42N2-W	S	JG4	6247.83	7875.19	7052.23	8950.48	
14	14		228"(5791mm)	TARX-42N8-W	S	JG4	6410.47	8099.35	7240.29	9212.15	
14	14		234"(5944mm)	TARX-42P4-W	S	JG4	6573.38	8325.35	7428.68	9475.98	
14	14		240"(6096mm)	TARX-42Q0-W	S	JG4	6736.56	8553.20	7617.39	9741.97	
14	14		246"(6248mm)	TARX-42Q6-W	S	JG4	6900.00	8782.88	7806.43	10010.12	
14	14		252"(6401mm)	TARX-42R2-W	S	JG4	7063.72	9014.40	7995.79	10280.43	
14	14		258"(6553mm)	TARX-42R8-W	S	JG4	7227.70	9247.76	8185.47	10552.90	
14	14		264"(6706mm)	TARX-42S4-W	S	JG4	7391.95	9482.97	8375.48	10827.53	
14	16		270"(6858mm)	TARX-42T0-W	S	JG4	7556.46	9720.01	8565.81	11104.32	
8	14	48"(1219mm)	186"(4724mm)	TARX-48J6-W	S	JG4	\$ 6047.17	\$ 7396.64	\$ 6798.12	\$ 8356.87	
8	14		192"(4877mm)	TARX-48K2-W	S	JG4	6225.55	7627.89	7004.69	8626.95	
8	14		198"(5029mm)	TARX-48K8-W	S	JG4	6404.19	7860.98	7211.59	8899.19	
10	14		204"(5182mm)	TARX-48L4-W	S	JG4	6583.11	8095.91	7418.81	9173.59	
10	14		210"(5334mm)	TARX-48M0-W	S	JG4	6762.29	8332.68	7626.35	9450.15	
10	14		216"(5486mm)	TARX-48M6-W	S	JG4	6941.74	8571.29	7834.22	9728.87	
14	14		222"(5639mm)	TARX-48N2-W	S	JG4	7121.46	8811.74	8042.41	10009.75	
14	14		228"(5791mm)	TARX-48N8-W	S	JG4	7301.44	9054.04	8250.93	10292.79	
14	14		234"(5944mm)	TARX-48P4-W	S	JG4	7481.70	9298.17	8459.77	10577.99	
14	14		240"(6096mm)	TARX-48Q0-W	S	JG4	7662.22	9544.14	8668.93	10865.35	
14	14		246"(6248mm)	TARX-48Q6-W	S	JG4	7843.01	9791.95	8878.42	11154.87	
14	14		252"(6401mm)	TARX-48R2-W	S	JG4	8024.06	10041.61	9088.23	11446.55	
14	14		258"(6553mm)	TARX-48R8-W	S	JG4	8205.39	10293.10	9298.37	11740.39	
14	14		264"(6706mm)	TARX-48S4-W	S	JG4	8386.98	10546.43	9508.83	12036.39	
14	16		270"(6858mm)	TARX-48T0-W	S	JG4	8568.84	10801.61	9719.61	12334.55	
8	14	54"(1372mm)	186"(4724mm)	TARX-54J6-W	S	JG4	\$ 6816.73	\$ 8224.41	\$ 7665.59	\$ 9287.92	
8	14		192"(4877mm)	TARX-54K2-W	S	JG4	7012.45	8473.79	7892.61	9579.37	
8	14		198"(5029mm)	TARX-54K8-W	S	JG4	7208.44	8725.01	8119.96	9872.98	
10	14		204"(5182mm)	TARX-54L4-W	S	JG4	7404.70	8978.08	8347.63	10168.75	
10	14		210"(5334mm)	TARX-54M0-W	S	JG4	7601.23	9232.98	8575.63	10466.68	
10	14		216"(5486mm)	TARX-54M6-W	S	JG4	7798.02	9489.72	8803.95	10766.77	
14	14		222"(5639mm)	TARX-54N2-W	S	JG4	7995.08	9748.30	9032.59	11069.02	
14	14		228"(5791mm)	TARX-54N8-W	S	JG4	8192.41	10008.72	9261.56	11373.43	
14	14		234"(5944mm)	TARX-54P4-W	S	JG4	8390.01	10270.98	9490.85	11680.00	
14	14		240"(6096mm)	TARX-54Q0-W	S	JG4	8587.87	10535.09	9720.47	11988.73	
14	14		246"(6248mm)	TARX-54Q6-W	S	JG4	8786.01	10801.03	9950.41	12299.62	
14	14		252"(6401mm)	TARX-54R2-W	S	JG4	8984.41	11068.81	10180.67	12612.67	
14	14		258"(6553mm)	TARX-54R8-W	S	JG4	9183.08	11338.43	10411.26	12927.88	
14	14		264"(6706mm)	TARX-54S4-W	S	JG4	9382.01	11609.90	10642.17	13245.25	
14	16		270"(6858mm)	TARX-54T0-W	S	JG4	9581.22	11883.20	10873.41	13564.78	
8	14	60"(1524mm)	186"(4724mm)	TARX-60J6-W	S	JG4	\$ 7586.29	\$ 9052.19	\$ 8533.06	\$ 10218.97	
8	14		192"(4877mm)	TARX-60K2-W	S	JG4	7799.36	9319.70	8780.54	10531.79	
8	14		198"(5029mm)	TARX-60K8-W	S	JG4	8012.69	9589.05	9028.34	10846.77	
10	14		204"(5182mm)	TARX-60L4-W	S	JG4	8226.29	9860.24	9276.46	11163.91	
10	14		210"(5334mm)	TARX-60M0-W	S	JG4	8440.16	10133.27	9524.91	11483.21	
10	14		216"(5486mm)	TARX-60M6-W	S	JG4	8654.30	10408.14	9773.68	11804.67	
14	14		222"(5639mm)	TARX-60N2-W	S	JG4	8868.71	10684.85	10022.78	12128.29	
14	14		228"(5791mm)	TARX-60N8-W	S	JG4	9083.38	10963.41	10272.20	12454.07	
14	14		234"(5944mm)	TARX-60P4-W	S	JG4	9298.32	11243.80	10521.94	12782.01	
14	14		240"(6096mm)	TARX-60Q0-W	S	JG4	9513.53	11526.03	10772.01	13112.11	
14	14		246"(6248mm)	TARX-60Q6-W	S	JG4	9729.01	11810.10	11022.40	13444.37	
14	14		252"(6401mm)	TARX-60R2-W	S	JG4	9944.75	12096.02	11273.12	13778.79	
14	14		258"(6553mm)	TARX-60R8-W	S	JG4	10160.76	12383.77	11524.16	14115.37	
14	14		264"(6706mm)	TARX-60S4-W	S	JG4	10377.04	12673.36	11775.52	14454.11	
14	16		270"(6858mm)	TARX-60T0-W	S	JG4	10593.59	12964.80	12027.21	14795.01	

*Recommended seating capacity based upon 27"(686mm) per chair.

Planes Conference Tables — Perimeter Leg — Laminate

Square and Rectangular – 2”(51mm) Edge

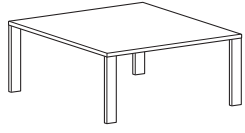
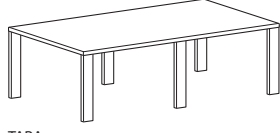
	No. of Pieces	No. of Legs	Seating Capacity*	Depth	Width	Number	①	②	Laminate A	B
Square										
	1	4	4	42”(1067mm)	42”(1067mm)	TARQ-4242-LJM	PG4N		\$ 782.54	\$ 848.39
	1	4	4	48”(1219mm)	48”(1219mm)	TARQ-4848-LJM	PG4N		987.95	1073.45
	1	4	4	54”(1372mm)	54”(1372mm)	TARQ-5454-LJM	PG4N		1219.82	1327.59
	1	4	4	60”(1524mm)	60”(1524mm)	TARQ-6060-LJM	PG4N		1478.15	1610.81
	2	6	6	66”(1676mm)	66”(1676mm)	TARQ-6666-LJM	PG4		\$2418.71	\$2578.88
	2	6	6	72”(1829mm)	72”(1829mm)	TARQ-7272-LJM	PG4		2795.38	2985.68
Rectangular										
	1	4	4	30”(762mm)	60”(1524mm)	TARA-3060-LJM	PG4N		\$ 813.29	\$ 879.80
	1	4	4		66”(1676mm)	TARA-3066-LJM	PG4N		880.81	953.97
	1	6	4		72”(1829mm)	TARA-3072-LJM	PG4N		948.33	1028.14
	1	4	4	36”(914mm)	60”(1524mm)	TARA-3660-LJM	PG4		\$ 945.81	\$1025.62
	1	4	4		66”(1676mm)	TARA-3666-LJM	PG4		1026.33	1114.12
	1	4	4	42”(1067mm)	48”(1219mm)	TARA-4248-LJM	PG4		\$ 891.29	\$ 965.78
	1	4	4		54”(1372mm)	TARA-4254-LJM	PG4		984.81	1068.61
	1	4	4		60”(1524mm)	TARA-4260-LJM	PG4		1078.33	1171.44
	1	4	6		66”(1676mm)	TARA-4266-LJM	PG4		1171.85	1274.27
	1	6	6		72”(1829mm)	TARA-4272-LJM	PG4		1265.37	1377.10
	1	6	6		78”(1981mm)	TARA-4278-LJM	PG4		1358.89	1479.93
	1	4	4	48”(1219mm)	54”(1372mm)	TARA-4854-LJM	PG4		\$1104.33	\$1200.10
	1	4	4		60”(1524mm)	TARA-4860-LJM	PG4		1210.85	1317.26
	1	4	6		66”(1676mm)	TARA-4866-LJM	PG4		1317.37	1434.42
	1	6	6		72”(1829mm)	TARA-4872-LJM	PG4		1423.89	1551.58
	1	6	8		78”(1981mm)	TARA-4878-LJM	PG4		1530.41	1668.74
	1	4	4	54”(1372mm)	60”(1524mm)	TARA-5460-LJM	PG4		\$1343.37	\$1463.08
	1	4	6		66”(1676mm)	TARA-5466-LJM	PG4		1462.89	1594.57
	1	6	6		72”(1829mm)	TARA-5472-LJM	PG4		1582.41	1726.06
	1	6	6		78”(1981mm)	TARA-5478-LJM	PG4		1701.93	1857.55
1	4	8	60”(1524mm)	66”(1676mm)	TARA-6066-LJM	PG4		\$1608.41	\$1754.72	
1	6	8		72”(1829mm)	TARA-6072-LJM	PG4		1740.93	1900.54	
1	6	8		78”(1981mm)	TARA-6078-LJM	PG4		1873.45	2046.36	

Features

- Includes 2”(51mm) thick top, perimeter leg bases, and hardware.
- Standard table height is 30”(762mm).
- Laminate top with 3mm edgeband edges only.
- Table top seam is 3mm edgeband on multiple piece tops.
- Perimeter legs are painted aluminum.
- Perimeter leg is 1 3/8”(35mm) x 4”(102mm).
- Optional cable base can be specified for tables 36”(914mm) deep and deeper:
 - 36”(914mm) deep tables will ship with 8”(203mm) x 14”(356mm) cable base.
 - 42”(1067mm) deep and deeper tables will ship with 14”(356mm) x 14”(356mm) cable base.
 - One piece tops will include one cable base to be centered under table top.
 - Two piece tops will include one cable base to be centered on seam under table top.
 - Cable base and table top(s) are laminate and can be specified in different surface colors and edge trim colors.
 - Refer to Specification Guide for use guidelines.
- Optional Flip top unit electrical modules are separately specified. Refer to electrical components for appropriate product specification.
- Available with glides only; 1/2”(13mm) height adjustment.
- Depth and width shown in nominal dimensions.
- Ships unassembled.

Specification Tips

- Cable base not recommended to 30”(762mm) deep tables.
- Cable base for 36”(914mm) deep table is not compatible with Flip Top Cut Out Options (M) and (Q).
- Tables with multiple-piece tops have equal sized pieces.
- The following Planes products are separately specified:
 - Grommets (field cut opening)
 - Flip top unit electrical modules
 - Horizontal wire management
- Refer to Specification Guide for seating capacities with Cable Base Option and leg locations.

*Recommended seating capacity based upon 27”(686mm) per chair.

To Order, Specify:

1) Product number, including:

① Flip Top Unit Cutout(s):

Cutout options F, J, M, Q:
add \$31.86 list for one-piece top;
add \$63.72 list for two-piece tops.

- N** None
- F** Center – single-sided/4 outlets
- J** Center – single-sided/6 outlets
- M** Center – double-sided/8 outlets
- Q** Center – double-sided/12 outlets

② Cable Base Option:

- N** None
- C** Cable Base:
add \$637.24 list for 36” deep tables;
add \$671.99 list for 42” deep and deeper tables

- 2) Laminate surface color.
- 3) Edge trim color.
- 4) Base trim color.
- 5) Laminate Surface – Cable Base
- 6) Edge trim color – Cable Base

Note: \$44.02 upcharge (list) for Metallic and accent trim colors.

Planes Conference Tables — One-Piece Top — Perimeter Leg — Laminate

Rectangular – 2”(51mm) Edge

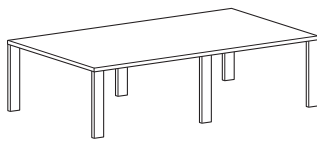

TARA

No. of Legs	Seating Capacity*	Depth	Width	Number	①	②	Laminate A	B
6	6	36”(914mm)	72”(1829mm)	TARA-3672-LJM	PG4		\$1106.85	\$1202.62
6	6		78”(1981mm)	TARA-3678-LJM	PG4		1187.37	1291.12
6	6		84”(2134mm)	TARA-3684-LJM	PG4		1267.89	1379.62
6	8		90”(2286mm)	TARA-3690-LJM	PG4		1348.41	1468.12
6	8		96”(2438mm)	TARA-3696-LJM	PG4		1428.93	1556.62
6	6	42”(1067mm)	84”(2134mm)	TARA-4284-LJM	PG4		\$1452.41	\$1582.76
6	8		90”(2286mm)	TARA-4290-LJM	PG4		1545.93	1685.59
6	8		96”(2438mm)	TARA-4296-LJM	PG4		1639.45	1788.42
6	8		102”(2591mm)	TARA-42A2-LJM	PG4		1732.97	1891.25
6	10		108”(2743mm)	TARA-42A8-LJM	PG4		1826.49	1994.08
6	10		114”(2896mm)	TARA-42B4-LJM	PG4		1920.01	2096.91
6	10		120”(3048mm)	TARA-42C0-LJM	PG4		2013.53	2199.74
6	6	48”(1219mm)	84”(2134mm)	TARA-4884-LJM	PG4		\$1636.93	\$1785.90
6	8		90”(2286mm)	TARA-4890-LJM	PG4		1743.45	1903.06
6	8		96”(2438mm)	TARA-4896-LJM	PG4		1849.97	2020.22
6	8		102”(2591mm)	TARA-48A2-LJM	PG4		1956.49	2137.38
6	10		108”(2743mm)	TARA-48A8-LJM	PG4		2063.01	2254.54
6	10		114”(2896mm)	TARA-48B4-LJM	PG4		2169.53	2371.70
6	10		120”(3048mm)	TARA-48C0-LJM	PG4		2276.05	2488.86
6	8	54”(1372mm)	84”(2134mm)	TARA-5484-LJM	PG4		\$1821.45	\$1989.04
6	10		90”(2286mm)	TARA-5490-LJM	PG4		1940.97	2120.53
6	10		96”(2438mm)	TARA-5496-LJM	PG4		2060.49	2252.02
6	10		102”(2591mm)	TARA-54A2-LJM	PG4		2180.01	2383.51
6	10		108”(2743mm)	TARA-54A8-LJM	PG4		2299.53	2515.00
6	10		114”(2896mm)	TARA-54B4-LJM	PG4		2419.05	2646.49
6	10		120”(3048mm)	TARA-54C0-LJM	PG4		2538.57	2777.98
6	10	60”(1524mm)	84”(2134mm)	TARA-6084-LJM	PG4		\$2005.97	\$2192.18
6	10		90”(2286mm)	TARA-6090-LJM	PG4		2138.49	2338.00
6	10		96”(2438mm)	TARA-6096-LJM	PG4		2271.01	2483.82
6	10		102”(2591mm)	TARA-60A2-LJM	PG4		2403.53	2629.64
6	10		108”(2743mm)	TARA-60A8-LJM	PG4		2536.05	2775.46
6	10		114”(2896mm)	TARA-60B4-LJM	PG4		2668.57	2921.28
6	10		120”(3048mm)	TARA-60C0-LJM	PG4		2801.09	3067.10

Features

- Includes 2”(51mm) thick top, perimeter leg bases, and hardware.
- Standard table height is 30”(762mm).
- Laminate top with 3mm edgeband edges only.
- Perimeter legs are painted aluminum.
- Perimeter leg is 1 3/8”(35mm) x 4”(102mm).
- Optional cable base can be specified for tables 36”(914mm) deep and deeper:
 - 36”(914mm) deep tables will ship with 8”(203mm) x 14”(356mm) cable base.
 - 42”(1067mm) deep and deeper tables will ship with 14”(356mm) x 14”(356mm) cable base.
 - One piece tops will include one cable base to be centered under table top.
 - Cable base and table top(s) are laminate and can be specified in different surface colors and edge trim colors.
 - Refer to Specification Guide for use guidelines.
- Optional Flip top unit electrical modules are separately specified. Refer to electrical components for appropriate product specification.
- Available with glides only; 1/2”(13mm) height adjustment.
- Depth and width shown in nominal dimensions.
- Ships unassembled.

Specification Tips

- The following Planes products are separately specified:
 - Grommets (field cut opening)
 - Flip top unit electrical modules
 - Horizontal wire management
- Refer to Specification Guide for seating capacities with Cable Base Option and leg locations.

*Recommended seating capacity based upon 27”(686mm) per chair.

To Order, Specify:

1) Product number, including:

① Flip Top Unit Cutout(s):

- N** None
- F** Center – single-sided/4 outlets, add \$31.86 list
- V** Left/Right – single-sided/4 outlets, add \$63.72 list
- J** Center – single-sided/6 outlets, add \$31.86 list
- K** Left/Right – single-sided/6 outlets, add \$63.72 list
- M** Center – double-sided/8 outlets, add \$31.86 list
- P** Left/Right – double-sided/8 outlets, add \$63.72 list
- Q** Center – double-sided/12 outlets, add \$31.86 list
- T** Left/Right – double-sided/12 outlets, add \$63.72 list

② Cable Base Option:

- N** None
- C** Cable Base: add \$637.24 list for 36” deep tables; add \$671.99 list for 42” deep and deeper tables

- 2) Laminate surface color.
- 3) Edge trim color.
- 4) Base trim color.
- 5) Laminate Surface – Cable Base
- 6) Edge trim color – Cable Base

Note: \$44.02 upcharge (list) for Metallic and accent trim colors.

Planes Conference Tables — Two-Piece Tops — Perimeter Leg — Laminate

Rectangular – 2”(51mm) Edge

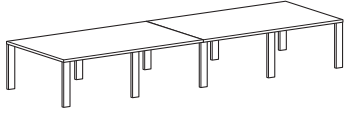

TARA

Features

- Includes 2”(51mm) thick top, perimeter leg bases, and hardware.
- Standard table height is 30”(762mm).
- Laminate top with 3mm edgeband edges only.
- Table top seam is 3mm edgeband.
- Perimeter legs are painted aluminum.
- Perimeter leg is 1 3/8”(35mm) x 4”(102mm).
- Optional cable base is available: :
 - 42”(1067mm) deep and deeper tables will ship with 14”(356mm) x 14”(356mm) cable base.
 - Two piece tops will include one cable base to be centered on seams under table top.
 - Cable base and table top(s) are laminate and can be specified in different surface colors and edge trim colors.
 - Refer to Specification Guide for use guidelines.
- Optional Flip top unit electrical modules are separately specified. Refer to electrical components for appropriate product specification.
- Available with glides only; 1/2”(13mm) height adjustment.
- Depth and width shown in nominal dimensions.
- Ships unassembled.

Specification Tips

- Tables with multiple-piece tops have equal sized pieces.
- The following Planes products are separately specified:
 - Grommets (field cut opening)
 - Flip top unit electrical modules
 - Horizontal wire management
- Refer to Specification Guide for seating capacities with Cable Base Option and leg locations.

To Order, Specify:

1) Product number, including:

① Flip Top Unit Cutout(s):

- N** None
- F** Center – single-sided/4 outlets, add **\$63.72** list
- V** Left/Right – single-sided/4 outlets, add **\$127.44** list
- J** Center – single-sided/6 outlets, add **\$63.72** list
- K** Left/Right – single-sided/6 outlets, add **\$127.44** list
- M** Center – double-sided/8 outlets, add **\$63.72** list
- P** Left/Right – double-sided/8 outlets, add **\$127.44** list
- Q** Center – double-sided/12 outlets, add **\$63.72** list
- T** Left/Right – double-sided/12 outlets, add **\$127.44** list

② Cable Base Option:

- N** None
- C** Cable Base, add **\$671.99** list

- 2) Laminate surface color.
- 3) Edge trim color.
- 4) Base trim color.
- 5) Laminate Surface – Cable Base
- 6) Edge trim color – Cable Base

Note: **\$44.02** upcharge (list) for Metallic and accent trim colors.

Planes Conference Tables — Two-Piece Tops — Perimeter Leg — Laminate

Rectangular – 2”(51mm) Edge

No. of Legs	Seating Capacity*	Depth	Width	Number	①	②	Laminate A	B
6	10	42”(1067mm)	126”(3200mm)	TARA-42C6-LJM	■	PG4 ■	\$2977.56	\$3173.08
6	10		132”(3353mm)	TARA-42D2-LJM	■	PG4 ■	3109.07	3313.90
10	10		138”(3505mm)	TARA-42D8-LJM	■	PG4 ■	3240.58	3454.72
10	10		144”(3658mm)	TARA-42E4-LJM	■	PG4 ■	3372.09	3595.54
10	10		150”(3810mm)	TARA-42F0-LJM	■	PG4 ■	3503.60	3736.36
10	12		156”(3962mm)	TARA-42F6-LJM	■	PG4 ■	3635.11	3877.18
10	12		162”(4115mm)	TARA-42G2-LJM	■	PG4 ■	3766.62	4018.00
10	12		168”(4267mm)	TARA-42G8-LJM	■	PG4 ■	3898.13	4158.82
10	12		174”(4420mm)	TARA-42H4-LJM	■	PG4 ■	4029.64	4299.64
10	14		180”(4572mm)	TARA-42J0-LJM	■	PG4 ■	4161.15	4440.46
6	10	48”(1219mm)	126”(3200mm)	TARA-48C6-LJM	■	PG4 ■	\$3358.75	\$3582.20
6	10		132”(3353mm)	TARA-48D2-LJM	■	PG4 ■	3509.22	3743.31
10	10		138”(3505mm)	TARA-48D8-LJM	■	PG4 ■	3659.69	3904.42
10	10		144”(3658mm)	TARA-48E4-LJM	■	PG4 ■	3810.16	4065.53
10	10		150”(3810mm)	TARA-48F0-LJM	■	PG4 ■	3960.63	4226.64
10	12		156”(3962mm)	TARA-48F6-LJM	■	PG4 ■	4111.10	4387.75
10	12		162”(4115mm)	TARA-48G2-LJM	■	PG4 ■	4261.57	4548.86
10	12		168”(4267mm)	TARA-48G8-LJM	■	PG4 ■	4412.04	4709.97
10	12		174”(4420mm)	TARA-48H4-LJM	■	PG4 ■	4562.51	4871.08
10	14		180”(4572mm)	TARA-48J0-LJM	■	PG4 ■	4712.98	5032.19
6	10	54”(1372mm)	126”(3200mm)	TARA-54C6-LJM	■	PG4 ■	\$3739.97	\$3991.35
6	10		132”(3353mm)	TARA-54D2-LJM	■	PG4 ■	3906.99	4170.34
10	10		138”(3505mm)	TARA-54D8-LJM	■	PG4 ■	4074.01	4349.33
10	10		144”(3658mm)	TARA-54E4-LJM	■	PG4 ■	4241.03	4528.32
10	10		150”(3810mm)	TARA-54F0-LJM	■	PG4 ■	4408.05	4707.31
10	12		156”(3962mm)	TARA-54F6-LJM	■	PG4 ■	4575.07	4886.30
10	12		162”(4115mm)	TARA-54G2-LJM	■	PG4 ■	4742.09	5065.29
10	12		168”(4267mm)	TARA-54G8-LJM	■	PG4 ■	4909.11	5244.28
10	14		174”(4420mm)	TARA-54H4-LJM	■	PG4 ■	5076.13	5423.27
10	14		180”(4572mm)	TARA-54J0-LJM	■	PG4 ■	5243.15	5602.26
6	10	60”(1524mm)	126”(3200mm)	TARA-60C6-LJM	■	PG4 ■	\$4121.17	\$4400.48
6	10		132”(3353mm)	TARA-60D2-LJM	■	PG4 ■	4304.76	4597.37
10	10		138”(3505mm)	TARA-60D8-LJM	■	PG4 ■	4488.35	4794.26
10	10		144”(3658mm)	TARA-60E4-LJM	■	PG4 ■	4671.94	4991.15
10	10		150”(3810mm)	TARA-60F0-LJM	■	PG4 ■	4855.53	5188.04
10	12		156”(3962mm)	TARA-60F6-LJM	■	PG4 ■	5039.12	5384.93
10	12		162”(4115mm)	TARA-60G2-LJM	■	PG4 ■	5222.71	5581.82
10	12		168”(4267mm)	TARA-60G8-LJM	■	PG4 ■	5406.30	5778.71
10	14		174”(4420mm)	TARA-60H4-LJM	■	PG4 ■	5589.89	5975.60
10	14		180”(4572mm)	TARA-60J0-LJM	■	PG4 ■	5343.58	5742.59

*Recommended seating capacity based upon 27”(686mm) per chair.

Planes Conference Tables — Three-Piece Tops — Perimeter Leg — Laminate

Rectangular – 2”(51mm) Edge



TARA

Features

- Includes 2”(51mm) thick top, perimeter leg bases, and hardware.
- Standard table height is 30”(762mm).
- Laminate top with 3mm edgeband edges only.
- Table top seams are 3mm edgeband.
- Perimeter legs are painted aluminum.
- Perimeter leg is 1 3/8”(35mm) x 4”(102mm).
- Optional cable bases are available:
 - 42”(1067mm) deep and deeper tables will ship with 14”(356mm) x 14”(356mm) cable base.
 - Three piece tops will include two cable bases to be centered on seams.
 - Cable base and table top(s) are laminate and can be specified in different surface colors and edge trim colors.
 - Refer to Specification Guide for use guidelines.
- Optional Flip top unit electrical modules are separately specified. Refer to electrical components for appropriate product specification.
- Available with glides only; 1/2”(13mm) height adjustment.
- Depth and width shown in nominal dimensions.
- Ships unassembled.

Specification Tips

- Tables with multiple-piece tops have equal sized pieces.
- The following Planes products are separately specified:
 - Grommets (field cut opening)
 - Flip top unit electrical modules
 - Horizontal wire management
- Refer to Specification Guide for seating capacities with Cable Base Option and leg locations.

To Order, Specify:

1) Product number, including:

① Flip Top Unit Cutout(s):

- N** None
- F** Center – single-sided/4 outlets, add **\$95.58** list
- V** Left/Right – single-sided/4 outlets, add **\$191.16** list
- J** Center – single-sided/6 outlets, add **\$95.58** list
- K** Left/Right – single-sided/6 outlets, add **\$191.16** list
- M** Center – double-sided/8 outlets, add **\$95.58** list
- P** Left/Right – double-sided/8 outlets, add **\$191.16** list
- Q** Center – double-sided/12 outlets, add **\$95.58** list
- T** Left/Right – double-sided/12 outlets, add **\$191.16** list

② Cable Base Option:

- N** None
- C** Cable Base (2), add **\$1343.98** list

- 2) Laminate surface color.
- 3) Edge trim color.
- 4) Base trim color.
- 5) Laminate Surface – Cable Base
- 6) Edge trim color – Cable Base

Note: **\$44.02** upcharge (list) for Metallic and accent trim colors.

Planes Conference Tables — Three-Piece Tops — Perimeter Leg — Laminate

Rectangular – 2”(51mm) Edge

No. of Legs	Seating Capacity*	Depth	Length	Number	①	②	Laminate A	B
8	14	42”(1067mm)	186”(4724mm)	TARA-42J6-LJM	PG4		\$4247.64	\$4536.26
8	14		192”(4877mm)	TARA-42K2-LJM	PG4		4379.15	4677.08
8	14		198”(5029mm)	TARA-42K8-LJM	PG4		4510.66	4817.90
14	14		204”(5182mm)	TARA-42L4-LJM	PG4		4642.17	4958.72
14	14		210”(5334mm)	TARA-42M0-LJM	PG4		4773.68	5099.54
14	14		216”(5486mm)	TARA-42M6-LJM	PG4		4905.19	5240.36
14	16		222”(5639mm)	TARA-42N2-LJM	PG4		5036.70	5381.18
14	16		228”(5791mm)	TARA-42N8-LJM	PG4		5168.21	5522.00
14	16		234”(5944mm)	TARA-42P4-LJM	PG4		5299.72	5662.82
14	16		240”(6096mm)	TARA-42Q0-LJM	PG4		5431.23	5803.64
14	16		246”(6248mm)	TARA-42Q6-LJM	PG4		5562.74	5944.46
14	16		252”(6401mm)	TARA-42R2-LJM	PG4		5694.25	6085.28
14	18		258”(6553mm)	TARA-42R8-LJM	PG4		5825.76	6226.10
14	18		264”(6706mm)	TARA-42S4-LJM	PG4		5957.27	6366.92
14	20		270”(6858mm)	TARA-42T0-LJM	PG4		6288.21	6707.17
8	14	48”(1219mm)	186”(4724mm)	TARA-48J6-LJM	PG4		\$4809.93	\$5139.78
8	14		192”(4877mm)	TARA-48K2-LJM	PG4		4958.03	5298.52
8	14		198”(5029mm)	TARA-48K8-LJM	PG4		5106.13	5457.26
14	14		204”(5182mm)	TARA-48L4-LJM	PG4		5254.23	5616.00
14	14		210”(5334mm)	TARA-48M0-LJM	PG4		5402.33	5774.74
14	14		216”(5486mm)	TARA-48M6-LJM	PG4		5550.43	5933.48
14	14		222”(5639mm)	TARA-48N2-LJM	PG4		5698.53	6092.22
14	16		228”(5791mm)	TARA-48N8-LJM	PG4		5846.63	6250.96
14	16		234”(5944mm)	TARA-48P4-LJM	PG4		5994.73	6409.70
14	16		240”(6096mm)	TARA-48Q0-LJM	PG4		6142.83	6568.44
14	16		246”(6248mm)	TARA-48Q6-LJM	PG4		6290.93	6727.18
14	16		252”(6401mm)	TARA-48R2-LJM	PG4		6439.03	6885.92
14	18		258”(6553mm)	TARA-48R8-LJM	PG4		6587.13	7044.66
14	18		264”(6706mm)	TARA-48S4-LJM	PG4		6735.23	7203.40
14	20		270”(6858mm)	TARA-48T0-LJM	PG4		6883.33	7362.14
8	14	54”(1372mm)	186”(4724mm)	TARA-54J6-LJM	PG4		\$5303.80	\$5674.88
8	14		192”(4877mm)	TARA-54K2-LJM	PG4		5468.45	5851.50
8	14		198”(5029mm)	TARA-54K8-LJM	PG4		5633.10	6028.12
14	14		204”(5182mm)	TARA-54L4-LJM	PG4		5797.75	6204.74
14	14		210”(5334mm)	TARA-54M0-LJM	PG4		5962.40	6381.36
14	14		216”(5486mm)	TARA-54M6-LJM	PG4		6127.05	6557.98
14	16		222”(5639mm)	TARA-54N2-LJM	PG4		6291.70	6734.60
14	16		228”(5791mm)	TARA-54N8-LJM	PG4		6456.35	6911.22
14	16		234”(5944mm)	TARA-54P4-LJM	PG4		6621.00	7087.84
14	16		240”(6096mm)	TARA-54Q0-LJM	PG4		6785.65	7264.46
14	16		246”(6248mm)	TARA-54Q6-LJM	PG4		6950.30	7441.08
14	16		252”(6401mm)	TARA-54R2-LJM	PG4		7114.95	7617.70
14	18		258”(6553mm)	TARA-54R8-LJM	PG4		7279.60	7794.32
14	18		264”(6706mm)	TARA-54S4-LJM	PG4		7444.25	7970.94
14	20		270”(6858mm)	TARA-54T0-LJM	PG4		7608.90	8147.56
8	14	60”(1524mm)	186”(4724mm)	TARA-60J6-LJM	PG4		\$5750.17	\$6162.48
8	14		192”(4877mm)	TARA-60K2-LJM	PG4		5931.39	6357.00
8	14		198”(5029mm)	TARA-60K8-LJM	PG4		6112.61	6551.52
14	14		204”(5182mm)	TARA-60L4-LJM	PG4		6293.83	6746.04
14	14		210”(5334mm)	TARA-60M0-LJM	PG4		6475.05	6940.56
14	14		216”(5486mm)	TARA-60M6-LJM	PG4		6656.27	7135.08
14	16		222”(5639mm)	TARA-60N2-LJM	PG4		6837.49	7329.60
14	16		228”(5791mm)	TARA-60N8-LJM	PG4		7018.71	7524.12
14	16		234”(5944mm)	TARA-60P4-LJM	PG4		7199.93	7718.64
14	16		240”(6096mm)	TARA-60Q0-LJM	PG4		7381.15	7913.16
14	16		246”(6248mm)	TARA-60Q6-LJM	PG4		7562.37	8107.68
14	16		252”(6401mm)	TARA-60R2-LJM	PG4		7743.59	8302.20
14	18		258”(6553mm)	TARA-60R8-LJM	PG4		7924.81	8496.72
14	18		264”(6706mm)	TARA-60S4-LJM	PG4		8106.03	8691.24
14	20		270”(6858mm)	TARA-60T0-LJM	PG4		8287.25	8885.76

*Recommended seating capacity based upon 27”(686mm) per chair.

Planes Conference Tables — Perimeter Leg — Wood

Square and Rectangular – 2”(51mm) Edge

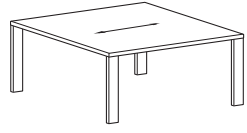
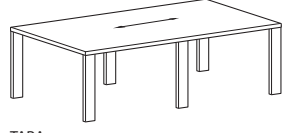
	No. of Pieces	No. of Legs	Seating Capacity*	Depth	Width	Number	①	②	Wood Group A	Group B
Square										
	1	4	4	42”(1067mm)	42”(1067mm)	TARQ-4242-WKM	PG4N		\$1155.84	\$1181.21
	1	4	4	48”(1219mm)	48”(1219mm)	TARQ-4848-WKM	PG4N		1438.89	1479.95
	1	4	4	54”(1372mm)	54”(1372mm)	TARQ-5454-WKM	PG4N		1756.48	1815.13
	1	4	4	60”(1524mm)	60”(1524mm)	TARQ-6060-WKM	PG4N		2108.61	2186.75
	2	6	6	66”(1676mm)	66”(1676mm)	TARQ-6666-WKM	PG4		\$3455.64	\$3555.17
	2	6	6	72”(1829mm)	72”(1829mm)	TARQ-7272-WKM	PG4		4089.27	4212.09
Rectangular										
	1	4	4	30”(762mm)	60”(1524mm)	TARA-3060-WKM	PG4N		\$1173.19	\$1247.12
	1	4	4		66”(1676mm)	TARA-3066-WKM	PG4N		1277.26	1368.88
	1	6	4		72”(1829mm)	TARA-3072-WKM	PG4N		1381.60	1490.97
	1	4	4	36”(914mm)	60”(1524mm)	TARA-3660-WKM	PG4		\$1368.27	\$1474.84
	1	4	4		66”(1676mm)	TARA-3666-WKM	PG4		1491.10	1618.47
	1	4	4	42”(1067mm)	48”(1219mm)	TARA-4248-WKM	PG4		\$1280.95	\$1372.52
	1	4	4		54”(1372mm)	TARA-4254-WKM	PG4		1422.01	1537.38
	1	4	4		60”(1524mm)	TARA-4260-WKM	PG4		1563.35	1702.56
	1	4	6		66”(1676mm)	TARA-4266-WKM	PG4		1704.95	1868.07
	1	6	6	72”(1829mm)	72”(1829mm)	TARA-4272-WKM	PG4		1846.81	2033.90
	1	6	6		78”(1981mm)	TARA-4278-WKM	PG4		1988.95	2200.05
	1	4	4	48”(1219mm)	54”(1372mm)	TARA-4854-WKM	PG4		\$1598.33	\$1743.23
	1	4	4		60”(1524mm)	TARA-4860-WKM	PG4		1758.43	1930.28
	1	4	6		66”(1676mm)	TARA-4866-WKM	PG4		1918.79	2117.66
	1	6	6		72”(1829mm)	TARA-4872-WKM	PG4		2079.42	2305.36
	1	6	8		78”(1981mm)	TARA-4878-WKM	PG4		2240.32	2493.39
	1	4	4	54”(1372mm)	60”(1524mm)	TARA-5460-WKM	PG4		\$1953.50	\$2158.00
	1	4	6		66”(1676mm)	TARA-5466-WKM	PG4		2132.63	2367.25
	1	6	6	72”(1829mm)	72”(1829mm)	TARA-5472-WKM	PG4		2312.03	2576.82
	1	6	6		78”(1981mm)	TARA-5478-WKM	PG4		2491.69	2786.72
	1	4	8	60”(1524mm)	66”(1676mm)	TARA-6066-WKM	PG4		\$2346.48	\$2616.84
	1	6	8	72”(1829mm)	72”(1829mm)	TARA-6072-WKM	PG4		2544.63	2848.29
1	6	8		78”(1981mm)	TARA-6078-WKM	PG4		2743.06	3080.06	

Features

- Includes 2”(51mm) thick top, perimeter leg bases, and hardware.
- Standard table height is 30”(762mm).
- Wood veneer top with 3mm wood edgeband edges.
- Table top seam is 3mm edgeband on multiple piece tops.
- Perimeter legs are painted aluminum.
- Perimeter leg is 1 3/8”(35mm) x 4”(102mm).
- Optional cable base can be specified for tables 36”(914mm) deep and deeper:
 - 36”(914mm) deep tables will ship with 8”(203mm) x 14”(356mm) cable base.
 - 42”(1067mm) deep and deeper tables will ship with 14”(356mm) x 14”(356mm) cable base.
 - One piece tops will include one cable base to be centered under table top.
 - Two piece tops will include one cable base to be centered on seam under table top.
- Cable base and table top(s) are wood veneer and can be specified in different surface colors and edge trim colors.
- Refer to Specification Guide for use guidelines.
- Optional Flip top unit electrical modules are separately specified. Refer to electrical components for appropriate product specification.
- Available with glides only; 1/2”(13mm) height adjustment.
- Depth and width shown in nominal dimensions.
- Ships unassembled.

Specification Tips

- Cable base for 36”(914mm) deep table is not compatible with Flip Top Cut Out Options (M) and (Q).
- Tables with multiple piece tops have equal sized pieces.
- The following Planes products are separately specified:
 - Grommets (field cut opening)
 - Flip top unit electrical modules
 - Horizontal wire management
- Refer to Specification Guide for seating capacities with Cable Base Option and leg locations.

*Recommended seating capacity based upon 27”(686mm) per chair.

To Order, Specify:

1) Product number, including:

① Flip Top Unit Cutout(s):

Cutout options **F, J, M, Q:**
 add \$31.86 list for one-piece top;
 add \$63.72 list for two-piece tops.

- N** None
- F** Center – single-sided/4 outlets
- J** Center – single-sided/6 outlets
- M** Center – double-sided/8 outlets
- Q** Center – double-sided/12 outlets

② Cable Base Option:

- N** None
- C** Cable Base:
 add \$637.24 list for 36” deep tables;
 add \$671.99 list for 42” deep and deeper tables

- 2) Wood finish color.
- 3) Base trim color.
- 4) Wood finish color – Cable Base

Note: \$44.02 upcharge (list) for Metallic and accent trim colors.

Planes Conference Tables — One-Piece Top — Perimeter Leg — Wood

Rectangular – 2”(51mm) Edge

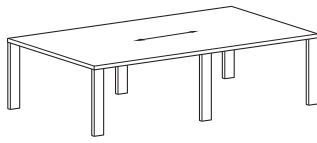

TARA

No. of Legs	Seating Capacity*	Depth	Width	Number	①	②	Wood Group A	Group B
6	6	36”(914mm)	72”(1829mm)	TARA-3672-WKM	PG4		\$1614.21	\$1762.43
6	6		78”(1981mm)	TARA-3678-WKM	PG4		1737.58	1906.71
6	6		84”(2134mm)	TARA-3684-WKM	PG4		1861.22	2051.32
6	8		90”(2286mm)	TARA-3690-WKM	PG4		1985.12	2196.25
6	8		96”(2438mm)	TARA-3696-WKM	PG4		2109.30	2341.50
6	6	42”(1067mm)	84”(2134mm)	TARA-4284-WKM	PG4		\$2131.35	\$2366.53
6	8		90”(2286mm)	TARA-4290-WKM	PG4		2274.02	2533.33
6	8		96”(2438mm)	TARA-4296-WKM	PG4		2416.96	2700.46
6	8		102”(2591mm)	TARA-42A2-WKM	PG4		2560.17	2867.91
6	10		108”(2743mm)	TARA-42A8-WKM	PG4		2703.64	3035.68
6	10		114”(2896mm)	TARA-42B4-WKM	PG4		2847.39	3203.78
6	10		120”(3048mm)	TARA-42C0-WKM	PG4		2991.40	3372.20
6	6	48”(1219mm)	84”(2134mm)	TARA-4884-WKM	PG4		\$2401.49	\$2681.74
6	8		90”(2286mm)	TARA-4890-WKM	PG4		2562.92	2870.41
6	8		96”(2438mm)	TARA-4896-WKM	PG4		2724.63	3059.41
6	8		102”(2591mm)	TARA-48A2-WKM	PG4		2886.60	3248.73
6	10		108”(2743mm)	TARA-48A8-WKM	PG4		3048.83	3438.38
6	10		114”(2896mm)	TARA-48B4-WKM	PG4		3211.34	3628.35
6	10		120”(3048mm)	TARA-48C0-WKM	PG4		3374.12	3818.64
6	8	54”(1372mm)	84”(2134mm)	TARA-5484-WKM	PG4		\$2671.62	\$2996.94
6	10		90”(2286mm)	TARA-5490-WKM	PG4		2851.82	3207.49
6	10		96”(2438mm)	TARA-5496-WKM	PG4		3032.29	3418.36
6	10		102”(2591mm)	TARA-54A2-WKM	PG4		3213.02	3629.55
6	10		108”(2743mm)	TARA-54A8-WKM	PG4		3394.03	3841.07
6	10		114”(2896mm)	TARA-54B4-WKM	PG4		3575.30	4052.91
6	10		120”(3048mm)	TARA-54C0-WKM	PG4		3756.83	4265.08
6	10	60”(1524mm)	84”(2134mm)	TARA-6084-WKM	PG4		\$2941.76	\$3312.15
6	10		90”(2286mm)	TARA-6090-WKM	PG4		3140.72	3544.57
6	10		96”(2438mm)	TARA-6096-WKM	PG4		3339.95	3777.31
6	10		102”(2591mm)	TARA-60A2-WKM	PG4		3539.45	4010.38
6	10		108”(2743mm)	TARA-60A8-WKM	PG4		3739.22	4243.77
6	10		114”(2896mm)	TARA-60B4-WKM	PG4		3939.25	4477.48
6	10		120”(3048mm)	TARA-60C0-WKM	PG4		4139.55	4711.52

Features

- Includes 2”(51mm) thick top, perimeter leg bases, and hardware.
- Standard table height is 30”(762mm).
- Wood veneer top with 3mm wood edgeband edges.
- Perimeter legs are painted aluminum.
- Perimeter leg is 1 3/8”(35mm) x 4”(102mm).
- Optional cable base can be specified for tables 36”(914mm) deep and deeper:
 - 36”(914mm) deep tables will ship with 8”(203mm) x 14”(356mm) cable base.
 - 42”(1067mm) deep and deeper tables will ship with 14”(356mm) x 14”(356mm) cable base.
 - One piece tops will include one cable base to be centered under table top.
 - Cable base and table top(s) are wood veneer and can be specified in different surface colors and edge trim colors.
 - Refer to Specification Guide for use guidelines.
- Optional Flip top unit electrical modules are separately specified. Refer to electrical components for appropriate product specification.
- Available with glides only; 1/2”(13mm) height adjustment.
- Depth and width shown in nominal dimensions.
- Ships unassembled.

Specification Tips

- The following Planes products are separately specified:
 - Grommets (field cut opening)
 - Flip top unit electrical modules
 - Horizontal wire management
- Refer to Specification Guide for seating capacities with Cable Base Option and leg locations.

*Recommended seating capacity based upon 27”(686mm) per chair.

To Order, Specify:

1) Product number, including:

① Flip Top Unit Cutout(s):

- N** None
- F** Center – single-sided/4 outlets, add \$31.86 list
- V** Left/Right – single-sided/4 outlets, add \$63.72 list
- J** Center – single-sided/6 outlets, add \$31.86 list
- K** Left/Right – single-sided/6 outlets, add \$63.72 list
- M** Center – double-sided/8 outlets, add \$31.86 list
- P** Left/Right – double-sided/8 outlets, add \$63.72 list
- Q** Center – double-sided/12 outlets, add \$31.86 list
- T** Left/Right – double-sided/12 outlets, add \$63.72 list

② Cable Base Option:

- N** None
- C** Cable Base: add \$637.24 list for 36” deep tables; add \$671.99 list for 42” deep and deeper tables

- 2) Wood finish color.
 3) Base trim color.
 4) Wood finish color – Cable Base

Note: \$44.02 upcharge (list) for Metallic and accent trim colors.

Planes Conference Tables — Two-Piece Tops — Perimeter Leg — Wood

Rectangular – 2”(51mm) Edge

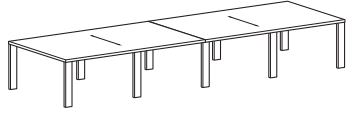

TARA

Features

- Includes 2”(51mm) thick top, perimeter leg bases, and hardware.
- Standard table height is 30”(762mm).
- Wood veneer top with 3mm wood edgeband edges.
- Table top seam is 3mm edgeband on multiple piece tops.
- Perimeter legs are painted aluminum.
- Perimeter leg is 1 3/8”(35mm) x 4”(102mm).
- Optional cable base is available:
 - 42”(1067mm) deep and deeper tables will ship with 14”(356mm) x 14”(356mm) cable base.
 - Two piece tops will include one cable base to be centered on seam under table top.
 - Cable base and table top(s) are wood veneer and can be specified in different surface colors and edge trim colors.
 - Refer to Specification Guide for use guidelines.
- Optional Flip top unit electrical modules are separately specified. Refer to electrical components for appropriate product specification.
- Available with glides only; 1/2”(13mm) height adjustment.
- Depth and width shown in nominal dimensions.
- Ships unassembled.

Specification Tips

- Tables with multiple-piece tops have equal sized pieces.
- The following Planes products are separately specified:
 - Grommets (field cut opening)
 - Flip top unit electrical modules
 - Horizontal wire management
- Refer to Specification Guide for seating capacities with Cable Base Option and leg locations.

To Order, Specify:

1) Product number, including:

① Flip Top Unit Cutout(s):

- N** None
- F** Center – single-sided/4 outlets, add **\$63.72** list
- V** Left/Right – single-sided/4 outlets, add **\$127.44** list
- J** Center – single-sided/6 outlets, add **\$63.72** list
- K** Left/Right – single-sided/6 outlets, add **\$127.44** list
- M** Center – double-sided/8 outlets, add **\$63.72** list
- P** Left/Right – double sided/8 outlets, add **\$127.44** list
- Q** Center – double-sided/12 outlets, add **\$63.72** list
- T** Left/Right – double-sided/12 outlets, add **\$127.44** list

② Cable Base Option:

- N** None
- C** Cable Base, add **\$671.99** list

2) Wood finish color.

3) Base trim color.

4) Wood finish color – Cable Base

Note: **\$44.02** upcharge (list) for Metallic and accent trim colors.

Planes Conference Tables — Two-Piece Tops — Perimeter Leg — Wood

Rectangular – 2”(51mm) Edge

No. of Legs	Seating Capacity*	Depth	Width	Number	①	②	Wood Group A	Group B
6	10	42”(1067mm)	126”(3200mm)	TARA-42C6-WKM	PG4		\$4219.94	\$4625.22
6	10		132”(3353mm)	TARA-42D2-WKM	PG4		4402.48	4832.28
10	10		138”(3505mm)	TARA-42D8-WKM	PG4		4585.28	5039.66
10	10		144”(3658mm)	TARA-42E4-WKM	PG4		4768.36	5247.37
10	10		150”(3810mm)	TARA-42F0-WKM	PG4		4951.70	5455.40
10	12		156”(3962mm)	TARA-42F6-WKM	PG4		5135.30	5663.76
10	12		162”(4115mm)	TARA-42G2-WKM	PG4		5319.18	5872.44
10	12		168”(4267mm)	TARA-42G8-WKM	PG4		5503.32	6081.44
10	12		174”(4420mm)	TARA-42H4-WKM	PG4		5687.73	6290.77
10	14		180”(4572mm)	TARA-42J0-WKM	PG4		5872.41	6500.42
6	10	48”(1219mm)	126”(3200mm)	TARA-48C6-WKM	PG4		\$4769.85	\$5241.95
6	10		132”(3353mm)	TARA-48D2-WKM	PG4		4977.11	5476.84
10	10		138”(3505mm)	TARA-48D8-WKM	PG4		5184.63	5712.06
10	10		144”(3658mm)	TARA-48E4-WKM	PG4		5392.43	5947.60
10	10		150”(3810mm)	TARA-48F0-WKM	PG4		5600.49	6183.46
10	12		156”(3962mm)	TARA-48F6-WKM	PG4		5808.83	6419.65
10	12		162”(4115mm)	TARA-48G2-WKM	PG4		6017.42	6656.16
10	12		168”(4267mm)	TARA-48G8-WKM	PG4		6226.29	6893.00
10	12		174”(4420mm)	TARA-48H4-WKM	PG4		6435.43	7130.16
10	14		180”(4572mm)	TARA-48J0-WKM	PG4		6644.83	7367.64
6	10	54”(1372mm)	126”(3200mm)	TARA-54C6-WKM	PG4		\$5319.78	\$5858.71
6	10		132”(3353mm)	TARA-54D2-WKM	PG4		5549.35	6119.02
10	10		138”(3505mm)	TARA-54D8-WKM	PG4		5779.20	6379.66
10	10		144”(3658mm)	TARA-54E4-WKM	PG4		6009.30	6640.62
10	10		150”(3810mm)	TARA-54F0-WKM	PG4		6239.68	6901.91
10	12		156”(3962mm)	TARA-54F6-WKM	PG4		6470.33	7163.52
10	12		162”(4115mm)	TARA-54G2-WKM	PG4		6701.24	7425.45
10	12		168”(4267mm)	TARA-54G8-WKM	PG4		6932.42	7687.71
10	14		174”(4420mm)	TARA-54H4-WKM	PG4		7163.87	7950.29
10	14		180”(4572mm)	TARA-54J0-WKM	PG4		7395.59	8213.20
6	10	60”(1524mm)	126”(3200mm)	TARA-60C6-WKM	PG4		\$5869.69	\$6475.45
6	10		132”(3353mm)	TARA-60D2-WKM	PG4		6121.60	6761.21
10	10		138”(3505mm)	TARA-60D8-WKM	PG4		6373.78	7047.29
10	10		144”(3658mm)	TARA-60E4-WKM	PG4		6626.22	7333.69
10	10		150”(3810mm)	TARA-60F0-WKM	PG4		6878.93	7620.42
10	12		156”(3962mm)	TARA-60F6-WKM	PG4		7131.91	7907.47
10	12		162”(4115mm)	TARA-60G2-WKM	PG4		7385.16	8194.85
10	12		168”(4267mm)	TARA-60G8-WKM	PG4		7638.67	8482.55
10	14		174”(4420mm)	TARA-60H4-WKM	PG4		7892.45	8770.57
10	14		180”(4572mm)	TARA-60J0-WKM	PG4		7716.60	8629.02

*Recommended seating capacity based upon 27”(686mm) per chair.

Planes Conference Tables — Three-Piece Tops — Perimeter Leg — Wood

Rectangular – 2”(51mm) Edge



TARA

Features

- Includes 2”(51mm) thick top, perimeter leg bases, and hardware.
- Standard table height is 30”(762mm).
- Wood veneer top with 3mm wood edgeband edges.
- Table top seams are 3mm edgeband on multiple piece tops.
- Perimeter legs are painted aluminum.
- Perimeter leg is 1 3/8”(35mm) x 4”(102mm).
- Optional cable bases are available:
 - 42”(1067mm) deep and deeper tables will ship with 14”(356mm) x 14”(356mm) cable base.
 - Three piece tops will include two cable bases to be centered on seams
 - Cable base and table top(s) are wood veneer and can be specified in different surface colors and edge trim colors.
 - Refer to Specification Guide for use guidelines.
- Optional Flip top unit electrical modules are separately specified. Refer to electrical components for appropriate product specification.
- Available with glides only; 1/2”(13mm) height adjustment.
- Depth and width shown in nominal dimensions.
- Ships unassembled.

Specification Tips

- Tables with multiple-piece tops have equal sized pieces.
- The following Planes products are separately specified:
 - Grommets (field installed)
 - Flip top unit electrical modules
 - Horizontal wire management
- Refer to Specification Guide for seating capacities with Cable Base Option and leg locations.

To Order, Specify:

1) Product number, including:

① Flip Top Unit Cutout(s):

- N** None
- F** Center – single-sided/4 outlets, add **\$95.58** list
- V** Left/Right – single-sided/4 outlets, add **\$191.16** list
- J** Center – single-sided/6 outlets, add **\$95.58** list
- K** Left/Right – single-sided/6 outlets, add **\$191.16** list
- M** Center – double-sided/8 outlets, add **\$95.58** list
- P** Left/Right – double-sided/8 outlets, add **\$191.16** list
- Q** Center – double-sided/12 outlets, add **\$95.58** list
- T** Left/Right – double-sided/12 outlets, add **\$191.16** list

② Cable Base Option:

- N** None
- C** Cable Bases(2), add **\$1343.98** list

2) Wood finish color.

3) Base trim color.

4) Wood finish color – Cable Base

Note: **\$44.02** upcharge (list) for Metallic and accent trim colors.

Planes Conference Tables — Three-Piece Tops — Perimeter Leg — Wood

Rectangular – 2”(51mm) Edge

No. of Legs	Seating Capacity*	Depth	Width	Number	①	②	Wood Group A	Group B
8	14	42”(1067mm)	186”(4724mm)	TARA-42J6-WKM	PG4		\$ 6036.10	\$ 6689.14
8	14		192”(4877mm)	TARA-42K2-WKM	PG4		6221.31	6899.44
8	14		198”(5029mm)	TARA-42K8-WKM	PG4		6406.79	7110.06
14	14		204”(5182mm)	TARA-42L4-WKM	PG4		6592.54	7321.01
14	14		210”(5334mm)	TARA-42M0-WKM	PG4		6778.56	7532.28
14	14		216”(5486mm)	TARA-42M6-WKM	PG4		6964.85	7743.88
14	16		222”(5639mm)	TARA-42N2-WKM	PG4		7151.40	7955.80
14	16		228”(5791mm)	TARA-42N8-WKM	PG4		7338.22	8168.04
14	16		234”(5944mm)	TARA-42P4-WKM	PG4		7525.31	8380.61
14	16		240”(6096mm)	TARA-42Q0-WKM	PG4		7712.67	8593.50
14	16		246”(6248mm)	TARA-42Q6-WKM	PG4		7900.29	8806.72
14	16		252”(6401mm)	TARA-42R2-WKM	PG4		8088.19	9020.26
14	18		258”(6553mm)	TARA-42R8-WKM	PG4		8276.35	9234.12
14	18		264”(6706mm)	TARA-42S4-WKM	PG4		8464.78	9448.31
14	20		270”(6858mm)	TARA-42T0-WKM	PG4		8653.47	9662.82
8	14	48”(1219mm)	186”(4724mm)	TARA-48J6-WKM	PG4		\$ 6930.45	\$ 7681.40
8	14		192”(4877mm)	TARA-48K2-WKM	PG4		7138.02	7917.16
8	14		198”(5029mm)	TARA-48K8-WKM	PG4		7345.85	8153.25
14	14		204”(5182mm)	TARA-48L4-WKM	PG4		7553.96	8389.66
14	14		210”(5334mm)	TARA-48M0-WKM	PG4		7762.33	8626.39
14	14		216”(5486mm)	TARA-48M6-WKM	PG4		7970.97	8863.45
14	16		222”(5639mm)	TARA-48N2-WKM	PG4		8179.88	9100.83
14	16		228”(5791mm)	TARA-48N8-WKM	PG4		8389.05	9338.54
14	16		234”(5944mm)	TARA-48P4-WKM	PG4		8598.50	9576.57
14	16		240”(6096mm)	TARA-48Q0-WKM	PG4		8808.21	9814.92
14	16		246”(6248mm)	TARA-48Q6-WKM	PG4		9018.19	10053.60
14	16		252”(6401mm)	TARA-48R2-WKM	PG4		9228.43	10292.60
14	18		258”(6553mm)	TARA-48R8-WKM	PG4		9438.95	10531.93
14	18		264”(6706mm)	TARA-48S4-WKM	PG4		9649.73	10771.58
14	20		270”(6858mm)	TARA-48T0-WKM	PG4		9860.78	11011.55
8	14	54”(1372mm)	186”(4724mm)	TARA-54J6-WKM	PG4		\$ 7824.78	\$ 8673.64
8	14		192”(4877mm)	TARA-54K2-WKM	PG4		8054.66	8934.82
8	14		198”(5029mm)	TARA-54K8-WKM	PG4		8284.81	9196.33
14	14		204”(5182mm)	TARA-54L4-WKM	PG4		8515.23	9458.16
14	14		210”(5334mm)	TARA-54M0-WKM	PG4		8745.92	9720.32
14	14		216”(5486mm)	TARA-54M6-WKM	PG4		8976.87	9982.80
14	16		222”(5639mm)	TARA-54N2-WKM	PG4		9208.09	10245.60
14	16		228”(5791mm)	TARA-54N8-WKM	PG4		9439.58	10508.73
14	16		234”(5944mm)	TARA-54P4-WKM	PG4		9671.34	10772.18
14	16		240”(6096mm)	TARA-54Q0-WKM	PG4		9903.36	11035.96
14	16		246”(6248mm)	TARA-54Q6-WKM	PG4		10135.66	11300.06
14	16		252”(6401mm)	TARA-54R2-WKM	PG4		10368.22	11564.48
14	18		258”(6553mm)	TARA-54R8-WKM	PG4		10601.05	11829.23
14	18		264”(6706mm)	TARA-54S4-WKM	PG4		10834.16	12094.33
14	20		270”(6858mm)	TARA-54T0-WKM	PG4		11067.51	12359.70
8	14	60”(1524mm)	186”(4724mm)	TARA-60J6-WKM	PG4		\$ 8671.61	\$ 9618.38
8	14		192”(4877mm)	TARA-60K2-WKM	PG4		8923.83	9905.01
8	14		198”(5029mm)	TARA-60K8-WKM	PG4		9176.31	10191.96
14	14		204”(5182mm)	TARA-60L4-WKM	PG4		9429.06	10479.23
14	14		210”(5334mm)	TARA-60M0-WKM	PG4		9682.08	10766.83
14	14		216”(5486mm)	TARA-60M6-WKM	PG4		9935.37	11054.75
14	16		222”(5639mm)	TARA-60N2-WKM	PG4		10188.93	11343.00
14	16		228”(5791mm)	TARA-60N8-WKM	PG4		10442.75	11631.57
14	16		234”(5944mm)	TARA-60P4-WKM	PG4		10696.84	11920.46
14	16		240”(6096mm)	TARA-60Q0-WKM	PG4		10951.20	12209.68
14	16		246”(6248mm)	TARA-60Q6-WKM	PG4		11205.83	12499.22
14	16		252”(6401mm)	TARA-60R2-WKM	PG4		11460.72	12789.09
14	18		258”(6553mm)	TARA-60R8-WKM	PG4		11715.88	13079.28
14	18		264”(6706mm)	TARA-60S4-WKM	PG4		11971.31	13369.79
14	20		270”(6858mm)	TARA-60T0-WKM	PG4		12227.01	13660.63

*Recommended seating capacity based upon 27”(686mm) per chair.

Planes Carts — Small Media

	Height	Depth	Width	Number	① ②	Laminate A	B	Wood Group A	Group B
Cart – Small Media – Laminate or Wood	Laminate								
	29"(737mm)	22"(559mm)	22 1/2"(572mm)	GAKF-1919-LJ SN	4	\$1214.86	\$1281.04		
	Wood								
	29"(737mm)	22"(559mm)	22 1/2"(572mm)	GAKF-1919-WKSN	4			\$1726.56	\$1756.82

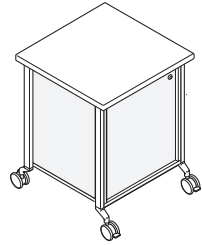

GAKF-1919

Features

- Includes cart with one door, shelf and hardware.
- Laminate with 1mm edgeband or wood veneer with 1mm wood edgeband.
- Available in standard or green core option.
- Rails are aluminum and available in metallic trim colors only.
- Cart top has overhang with 22"(559mm) x 22 1/2"(572mm) usable top surface.
- Standard with one adjustable shelf – 1"(25mm) increments.
- Cart door has touch latch with locking option.
- Optional locks are available in black or chrome.
- For lock options refer to Lock Program Price List.
- Optional casters or glides are field interchangeable:
 - Casters (two locking/two non-locking) are available with:
 - Light platinum or fog hub with graphite tread, or black hub with black tread.
 - Optional glides (four) are available in light platinum, fog or black with 1/2"(13mm) height adjustment.
 - Glide stem is painted to match base; glide base disc color must be specified.
- Cart interior dimensions:
 - 17 3/8"(411mm) W x 21 5/8"(549mm) H x 16 7/8"(429mm) D
- Cart door opening: 16 1/2"(419mm) W x 21 5/8"(549mm) H
- Ships assembled.

To Order, Specify:

1) Product number, including:

① Door Locking Option:

- N** Non-locking
- A** Locking, add **\$63.81** list

② Base Option:

- C** Caster
- G** Glide

- 2) Laminate surface color or wood finish color.
- 3) Edge trim color for laminate.
- 4) Rail trim color.
(Metallic and accent trim colors only.)
- 5) Caster/Glide base disc trim color:
 - Black – TR-F
 - Fog – TR-7
 - Light Platinum – TR-LPL
- 6) Lock plug trim color.
 - Black – LR-BL
 - Chrome – LR-BP

Planes Carts — Medium Media

	Height	Depth	Width	Number	①②	Laminate A	B	Wood Group A	Group B
Cart – Medium Media – Laminate or Wood	Laminate								
	36"(914mm)	19"(483mm)	19"(483mm)	GAKE-1919-LJ	SN ■ ■ 6 ■	\$1661.57	\$1727.75		
	Wood								
	36"(914mm)	19"(483mm)	19"(483mm)	GAKE-1919-WKSN	■ ■ 6			\$2109.46	\$2136.95

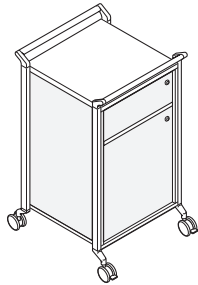

GAKE-1919

Features

- Includes cart with four doors and hardware.
- Laminate with 1mm edgeband or wood veneer with 1mm wood edgeband.
- Available in standard or green core.
- Standard with dual handles.
- Rails and handles are aluminum and available in metallic trim colors only.
- Cart standard with 2 3/4"(70mm) diameter bottom cutout for wire access to floor. Optional grommet separately specified for field retrofitting.
- Cart door configuration:
 - 6 3/8"(162mm) high upper touch latch flap door in front and back that folds down flat to allow air flow and is standard with locking option
 - 21 3/4"(552mm) lower touch latch door in front and back with locking option with adjustable shelf in 1"(25mm) increments
- 4"(101mm) deep full-height enclosure in front for power and cable management.
- Optional locks are available in black or chrome.
- For lock options refer to Lock Program Price List.
- Optional casters or glides are field interchangeable:
 - Casters (two locking/two non-locking) are available with: Light platinum or fog hub with graphite tread, or black hub with black tread.
- Optional glides (four) are available in light platinum, fog or black with 1/2"(13mm) height adjustment.
 - Glide stem is painted to match base; glide base disc color must be specified.
- Glides are light platinum with 1/2"(13mm) height adjustment.
- Ships assembled.

To Order, Specify:

1) Product number, including:

① Door Locking Option:

- N Non-locking
- A Locking, add **\$63.81** list

② Base Option:

- C Caster
- G Glide

2) Laminate surface color or wood finish color.

3) Edge trim color for laminate.

4) Rail trim color.
(Metallic and accent trim colors only.)

5) Caster/Glide base disc trim color:
Black – TR-F
Fog – TR-7
Light Platinum – TR-LPL

6) Lock plug trim color.
Black – LR-BL
Chrome – LR-BP

Specification Tip

The following Planes products are separately specified:

- Grommet

Planes Carts – Catering

	Height	Depth	Width	Number	①	Laminate A	B
Cart – Catering – Laminate	36”(914mm)	19”(483mm)	35 1/4”(895mm)	GAKG-1935-LJ	SNN ■ 6	\$1470.12	\$1536.30



GAKG-1935

Features

- Includes cart, shelf and shelf hardware.
- Laminate with 1mm edgeband.
- Available in standard or green core option.
- Standard with dual handles.
- Rails and handles are aluminum and available in metallic trim colors only.
- Standard with center adjustable shelf; 3 1/2”(89mm) increments.
- Each cart end has upper and lower open stationary shelves with shelf rails to accommodate beverage containers.
- Optional casters or glides are field interchangeable:
 - Casters (two locking/two non-locking) are available with:
 - Light platinum or fog hub with graphite tread, or
 - black hub with black tread.
 - Optional glides (four) are available in light platinum, fog or black with 1/2”(13mm) height adjustment.
 - Glide stem is painted to match base; glide base disc color must be specified.
- Ships assembled.

To Order, Specify:

- 1) Product number, including:

① Base Option:

- C Caster
- G Glide

- 2) Laminate surface color.
- 3) Edge trim color for laminate.
- 4) Rail and handles trim color. (Metallic and accent trim colors only.)
- 5) Caster/Glide base disc trim color:
 - Black – TR-F
 - Fog – TR-7
 - Light Platinum – TR-LPL

Planes Cart – Podium

Height	Depth	Width	Number	1 2	Laminate A	B	Wood Group A	Group B
Cart – Podium – Laminate or Wood								
Laminate								
46"(1168mm)	22 1/4"(565mm)	22 1/2"(572mm)	GAKD-1919-LJ	SN	9	\$2045.65	\$2111.83	
Wood								
46"(1168mm)	22 1/4"(565mm)	22 1/2"(572mm)	GAKD-1919-WKSN		9		\$3456.99	\$3540.14

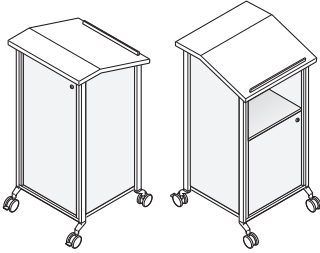

GAKD-1919

Features

- Includes podium, shelf and hardware.
- Laminate with 1mm edgeband or wood veneer with 1mm wood edge.
- Available in standard or green core.
- Podium sloping top is 22 1/2"(572mm) wide x 16 3/8"(416mm) deep with paper ledge.
- Rails are aluminum and available in metallic trim colors only.
- Optional casters or glides are field interchangeable:
 - Casters (two locking/two non-locking) are available with:
 - Light platinum or fog hub with graphite tread, or
 - black hub with black tread.
- Optional glides (four) are available in light platinum, fog or black with 1/2"(13mm) height adjustment.
 - Glide stem is painted to match base; glide base disc color must be specified.
- Podium doors are touch latch and available as all locking or all non-locking.
- Optional locks are available in black or chrome
- For lock options refer to Lock Program Price List.
- Podium user side has open shelf, lower storage with lockable touch latch door and one adjustable shelf.
- Podium back has touch latch, lockable full height door with full-height enclosure for power and cable management.
- Podium bottom has 2 3/4"(70mm) cutout for wire access to floor.
 - Optional grommet can be ordered separately for field installation.
- Ships assembled.

To Order, Specify:

- Product number, including:
 - 1 Door Locking Option:**
 - N** Non-locking, all
 - A** Locking, add **\$63.81** list
 - 2 Base Option:**
 - C** Caster
 - G** Glide
- Laminate surface color or wood finish color.
- Edge trim color for laminate.
- Rail trim color. (Metallic and accent trim colors only.)
- Caster/Glide base disc trim color:
 - Black – TR-F
 - Fog – TR-7
 - Light Platinum – TR-LPL
- Lock plug trim color.
 - Black – LR-BL
 - Chrome – LR-BP

Specification Tip

The following Planes products are separately specified:
 –Grommet

This page intentionally blank

Specification Guide Planes Conference Tables

Table of Contents – Planes Conference Tables

Statement of Line – Planes Conference Tables

Statement of Line174

Product Details – Planes Conference Tables

Planes Conference Tables – Introduction..... 178

Planes – Interior Leg Conference Tables

Overview 179

Round (One-Piece Top)..... 181

Round (Two-Piece Top) 182

Square (One-Piece Top) 183

Square (Two-Piece Top) 184

Rectangular – 48”-66” wide (One-Piece)..... 185

Half Round..... 188

Polygon..... 189

Rectangular– 72”-120” wide (One-Piece Top) 190

Pebble (One-Piece Top) 193

Hexagon (One-Piece Top) 196

Rectangular (Two-Piece Top) 199

Pebble (Two-Piece Top) 203

Hexagon (Two-Piece Top) 207

Rectangular (Three-Piece Top)..... 211

Pebble (Three-Piece Top)..... 216

Hexagon (Three-Piece Top) 221

Planes – Perimeter Leg Conference Tables

Overview 226

Square (One-Piece Top) 228

Square (Two-Piece Top) 229

Rectangular 60”-78” wide (One-Piece) 230

Rectangular 72”-120” wide (One-Piece) 233

Rectangular (Two-Piece Top) 236

Rectangular (Three-Piece Top)..... 240

Power Components – Flip Top Units 245

Cable Management

 Cable Base 246

 Cable Column 247

 Horizontal Wire Manager..... 248

 Planning Guidelines for the Horizontal Wire Manager..... 249

Table of Contents – Planes Conference Tables

Planes – Conference Table Top with Column Base / End Supported Conference Table with Column Base	
Overview	250
Conference Table Tops for use with Column Base	
Round / Square / Pebble Top (one-piece)	253
Rectangle / Pebble / Hexagon tops (one-piece)	256
Rectangle / Pebble / Hexagon tops (two-piece)	260
Rectangle / Pebble / Hexagon tops (three-piece)	266
End Supported Tops for use with Column Base	
D-Shape / Rectangle / Key Conference	273
Column Base	
Frame	281
Cladding	282
Plate	283
J-Channels	284
Planes Carts	
Overview	285
Cart – Small Media	286
Cart – Medium Media	287
Cart – Catering	288
Cart – Podium	289
Planes Credenza	
Overview	290
Credenza Top	291
Credenza Base – 19” High	292
Credenza Base with Slider– 29” High	294
Credenza Base with Slider – 35” High	296
Credenza Base – 29” High	298
Credenza Base with Slider – 39” High	300
Credenza Base with Slider – 45” High	302
Technical Specifications – Planes Conference Tables	
Technical Specifications	306

Statement of Line – Planes Conference Tables

Planes Conference Tables

Interior Leg Conference Tables

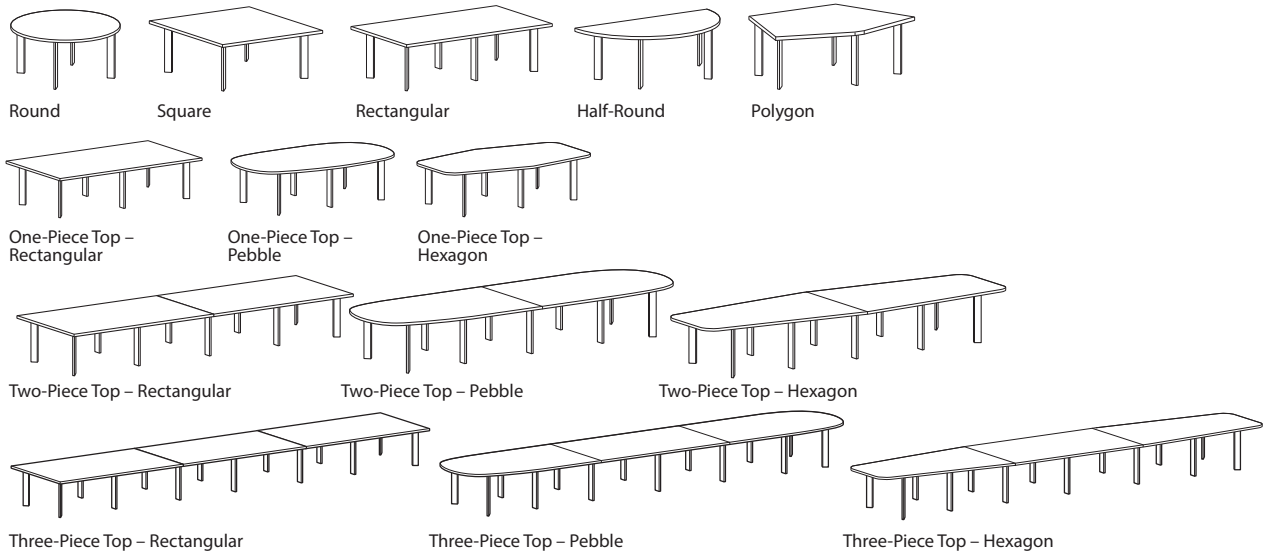

Perimeter Leg Conference Tables

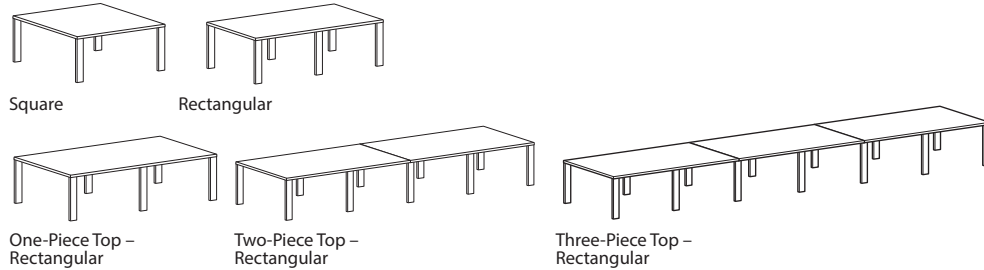

Planes Interior Leg and Perimeter Leg Conference Tables – Power Components

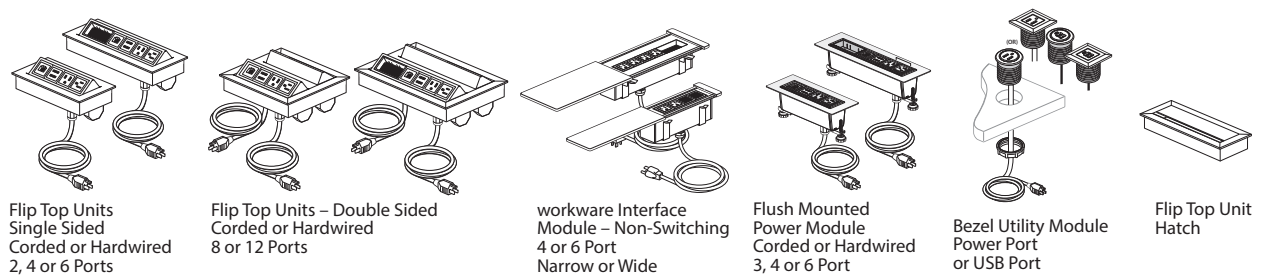

Planes Interior Leg and Perimeter Leg Conference Tables – Accessories

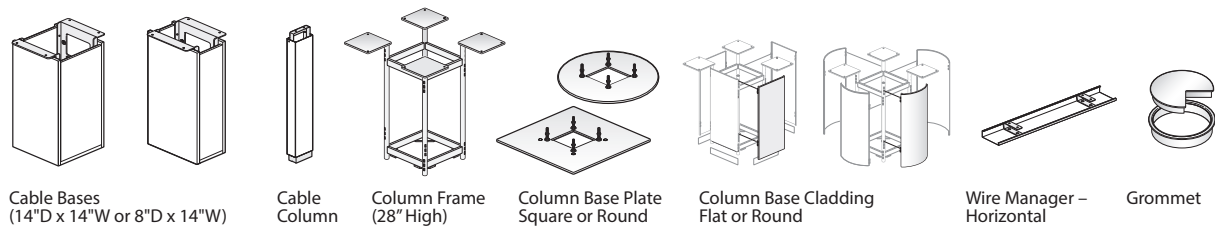

Statement of Line – Planes Conference Tables

Planes Conference Tables

Conference Table Tops (for use with Column Base)

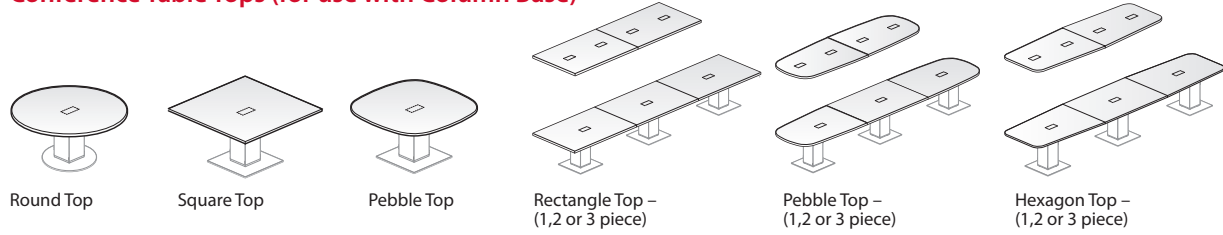

End Supported Conference Table Tops (for use with Column Base) and Brackets



Column Bases (for use with Conference Table Top or End Supported Conference Table Top)

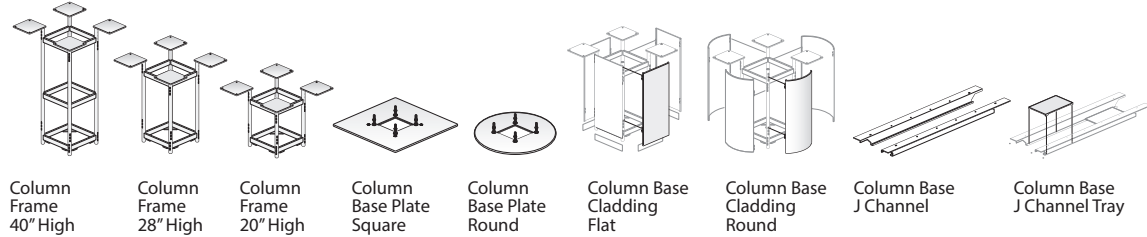

Column Bases Accessories

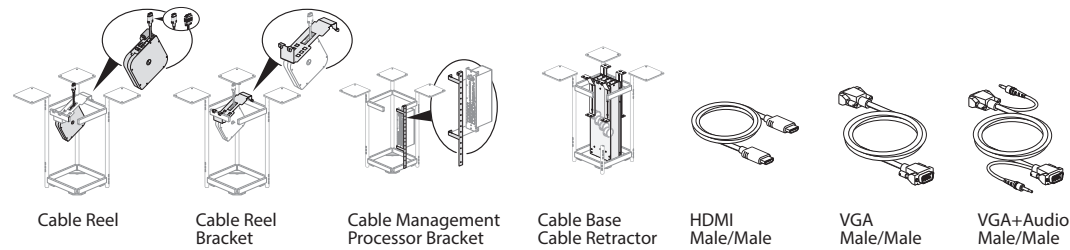

Conference Table – Power Components

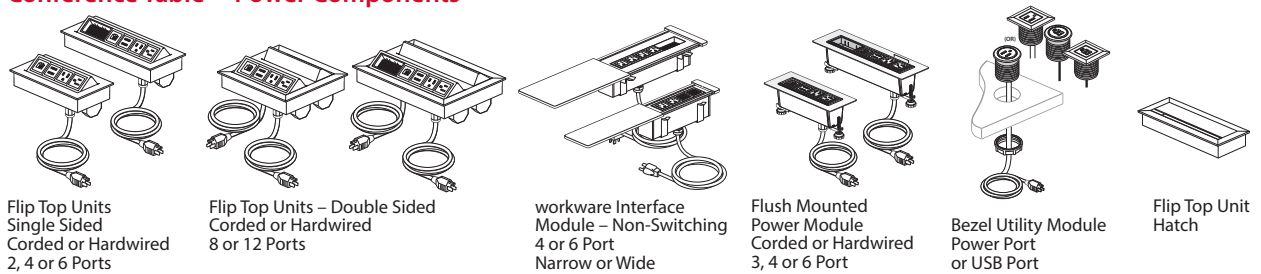

Statement of Line – Planes Conference Tables

Planes Carts

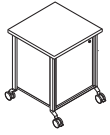

Cart – Small Media

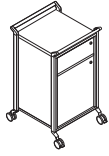

Cart – Medium Media



Cart – Catering



Cart – Podium

Planes Credenzas

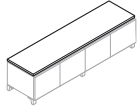

Credenza Top



Grommet

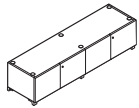

Credenza Base – 19" High

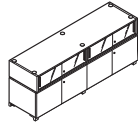

Credenza Base – 29" High with Slider Unit

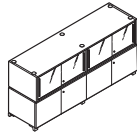

Credenza Base – 35" High with Slider Unit

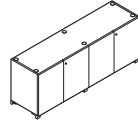

Credenza Base – 29" High

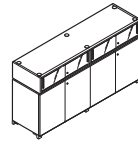

Credenza Base – 39" High with Slider Unit

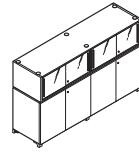

Credenza Base – 45" High with Slider Unit

Product Details Planes Conference Tables

Product Details – Planes Conference Tables

Introduction

Planes is a compelling table and ancillary product line that supports a wide variety of spaces with easy and effortless functionality. From conference rooms to individual workstations, Planes enables visual consistency throughout any work environment with its application breadth, top shapes, size range, and base choices. In addition, Planes is part of Haworth's Integrated Palette, which provides a holistic design and finish offering for effective solutions.

The Planes Collection is more than just tables, Planes offers:

- Collaborative Tables: Y-Leg, X-Base, and Disc Base
- Training Tables: C-Leg
- Height Adjustable Tables: Freestanding and Bench
- Conference Tables: Interior Leg, Perimeter Leg, and Column Base
- Carts
- Credenzas
- Easels, Information Boards, Horizontal Wall Rail System

Planes allows easy functionality with the ability to flip, store, conceal, connect, adjust, and plug in effortlessly:

- Flip – Reconfigure spaces with the flip top option
- Store – Save valuable floor space with the nesting feature
- Conceal – Cleanly manage wires and cables
- Connect – Gang tables together effortlessly
- Adjust – Raise and lower worksurfaces with manual or electrical height adjustment mechanisms
- Plug In – Power tables individually or distribute between

Global Design:

Planes offers a clean, simple, crisp aesthetic; designed in conjunction with Haworth Design Studio and Daniel Figueroa of Bad Munder, Germany. Planes is truly a global product line.

Sustainability:

Planes is BIFMA level® 3, GREENGUARD certified, contributes LEED points, and includes FSC wood.

Product Details – Planes Conference Tables

Interior Leg Conference Tables – Overview

Interior Leg Conference Tables can be specified with a variety of sizes and shapes to accommodate any conference room and any conferencing style. The rectilinear design of the interior Legs, along with the sleek profile of the top, give the table a clean, contemporary aesthetic.

Table Components

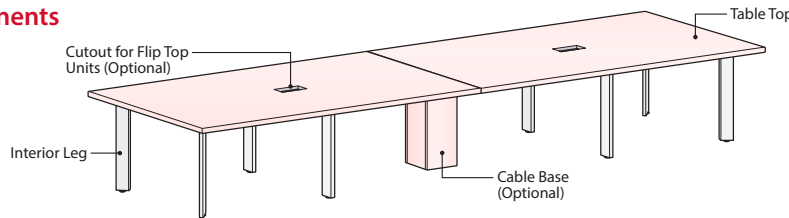

Features

- The rectangular shaped Interior Legs are inset from the edges and the corner legs are turned at a 45° angle.
- Legs are painted aluminum and include an adjustable glide that provides ½" of vertical adjustment for leveling.
- The tops are available in wood or laminate with edgeband or knife edge options.
- Tables may be specified with optional factory cutouts for separately specified Flip Top Units for power.
- Most tables are available with optional Cable Bases for Power Management. Cable Bases may be also be used to support the top and reduce the number of legs needed (If Cable Base is removed during reconfiguration, ensure top is properly supported with legs at each corner and vertical support every 60").
- For additional wire management capabilities the seated height Column Base may be separately specified.

Edge Options for Laminate Tops

3mm Edgeband Edge (Option J)

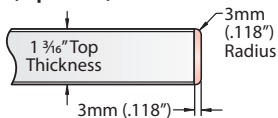

Top View Detail

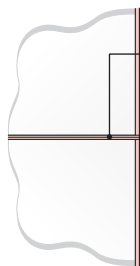

Seams with Multiple Piece Top have 1mm Edgeband

Knife Edge (Option F)

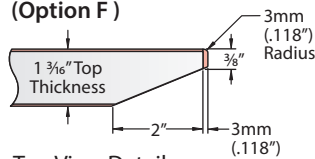

Top View Detail



Seams with Multiple Piece Top have 1mm Edgeband

Edge Options for Wood Tops

3mm Edgeband Edge (Option K)

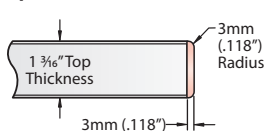

Top View Detail

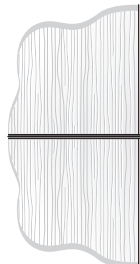

Seams with Multiple Piece Top have 1mm Edgeband

Knife Edge (Option U)

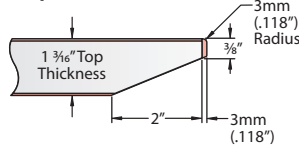

Top View Detail



Seams with Multiple Piece Top have 1mm Edgeband

- Note**
- Refer to Price List for edge availability.
 - Multiple piece tops with Cascade edge option will require an additional specification for the 1mm edgeband seam.

Product Details – Planes Conference Tables

Interior Leg Conference Tables – Overview

Wood Grain Direction for Natural, Quarter Cut, Rift Cut and Double Cut Wood Veneer and Wood Grain Laminate

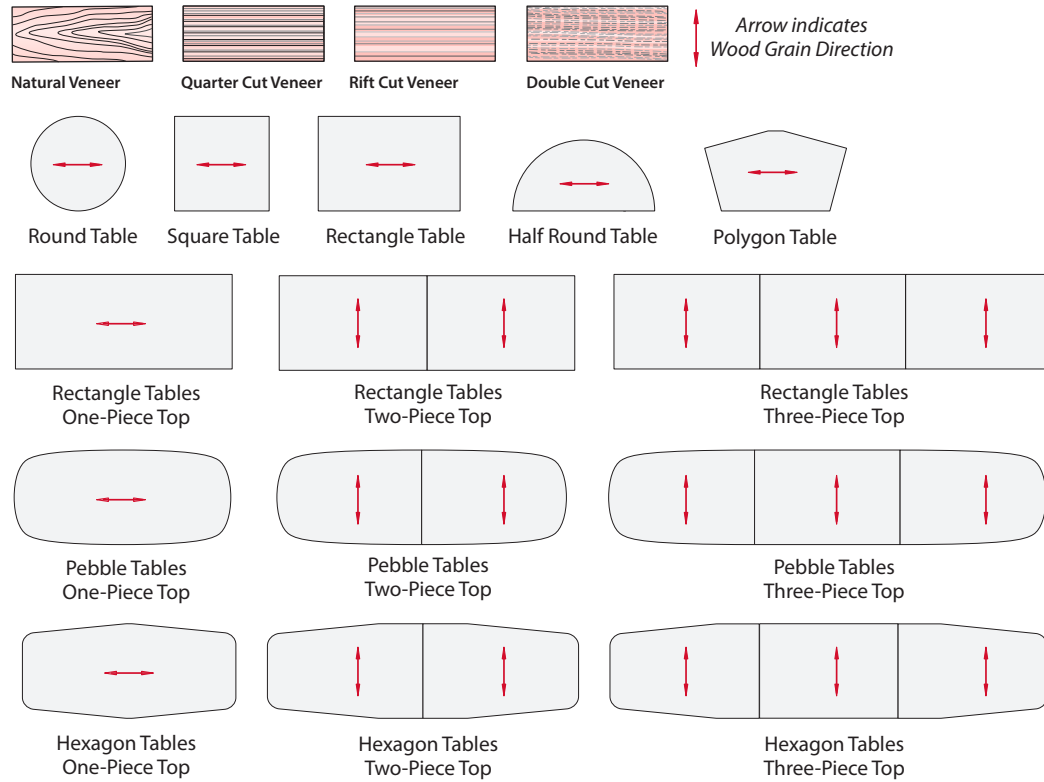

Wood Grain Direction for Wood Grain Laminate

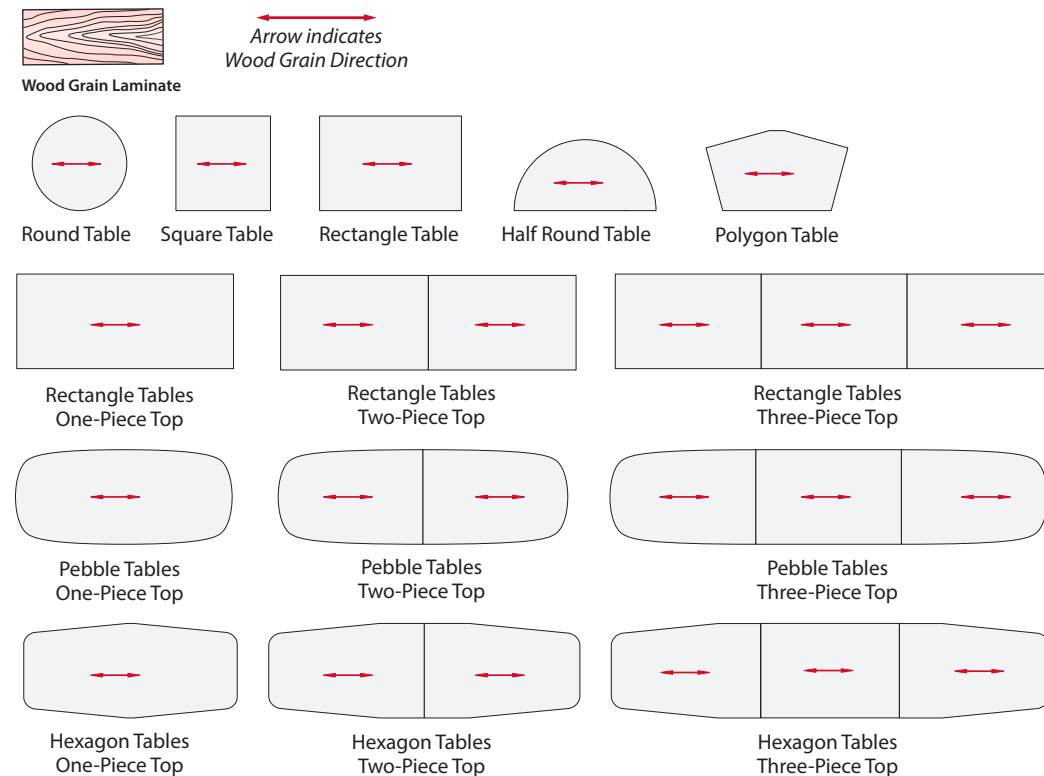

Note Laminate wood grain on multi-piece tops may not match.

Product Details – Planes Conference Tables

Interior Leg Conference Table – Round

One-Piece Top

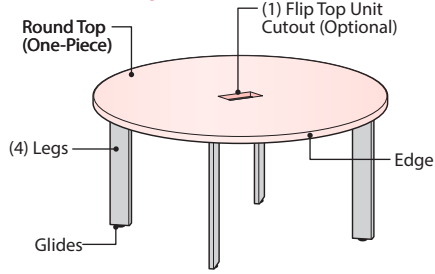

Edge Options for Laminate Tops

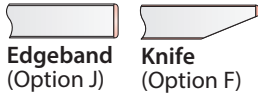

Note Knife Edge or 3mm Edgeband options are not available on 42"-60" round 1-piece Tables.

Edge Options for Wood Tops

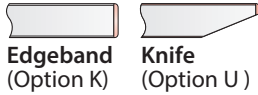

Flip Top Unit Cutout Options

Center Cutout Option
Includes 1 Flip Top Unit cutout (centered on top)

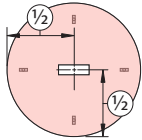

Cutout Option (F)

For use with Single Sided/ 4 Port Flip Top Unit

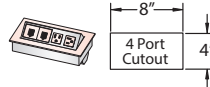

Cutout Option (J)

For use with Single Sided/ 6 Ports Flip Top Unit

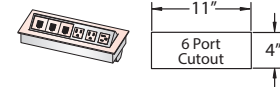

Cutout Option (M)

For use with Double Sided/ 8 Ports Flip Top Unit

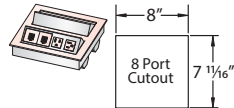

Cutout Option (Q)

For use with Double Sided/ 12 Ports Flip Top Unit

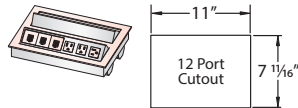

Note

- Flip Top Units are separately specified.
- Cutouts may work with some workware Interface Modules, see workware price book for details.

Component Materials/Finishes

COMPONENT NAME	MATERIALS/ FINISHES
Round Top 1-Piece top	Laminate Top – Specify separate finish colors for top and edge trim • Edge Options: (J) Edgeband, (F) Knife
	Wood Top – Specify a single finish color for the top and edge trim • Edge Options: (K) Edgeband, (U) Knife
Interior Legs	Painted Metal – Specified Trim Color
Glides	Standard in Black

Dimensions

TABLETOP		KNEESPACE (Nominal)	
Diameter Nominal (Actual)	Number of Legs Included	(A)	(B)
42" (41.68")	(4) Legs	21"	19"
48" (47.68")	(4) Legs	24"	24"
54" (53.68")	(4) Legs	27"	28"
60" (59.68")	(4) Legs	30"	32"

Top View

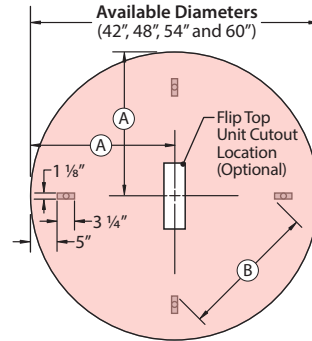

Front View

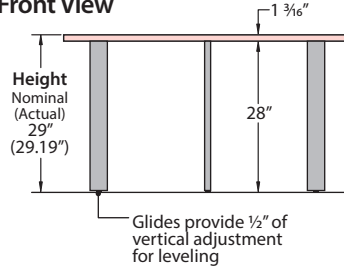
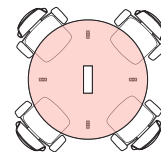

Table Sizes and Seating Capacities

TABLE SIZES	MAXIMUM NUMBER OF CHAIRS
42" Diameter	4 Chairs Maximum (4 Legs)
48" Diameter	4 Chairs Maximum (4 Legs)
54" Diameter	4 Chairs Maximum (4 Legs)
60" Diameter	4 Chairs Maximum (4 Legs)



Note

- Cable Bases are not recommended One-Piece Round Tables, due to lack of kneespace clearance. Consider kneespace when specifying cable management components.
- Recommended seating capacity based upon a width of 27" per chair.

Product Details – Planes Conference Tables

Interior Leg Conference Table – Round

Two-Piece Top – No Cable Base (Includes 6 Legs)

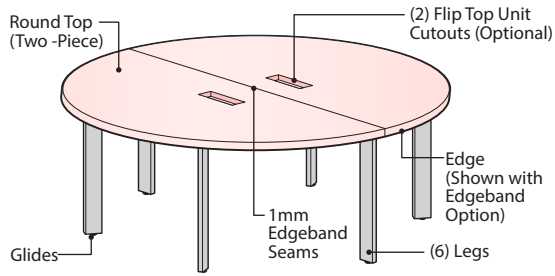

Two Piece-Top – With Cable Base (Includes 4 Legs)

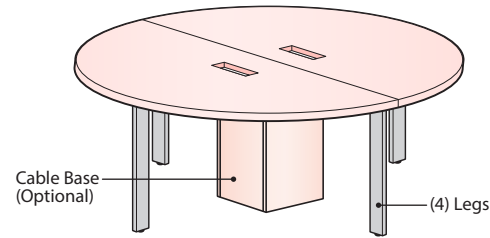

Edge Options for Laminate Tops

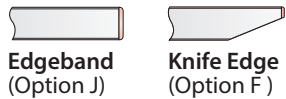

Edge Options for Wood Tops



Flip Top Unit Cutout Options

Center Cutout Locations
Includes 2 Flip Top Unit cutouts (One cutout in each top piece)

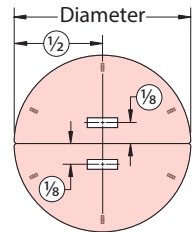

Cutout Option (F)
For use with Single Sided/ 4 Port Flip Top Unit

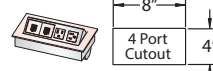

Cutout Option (J)
For use with Single Sided/ 6 Ports Flip Top Unit

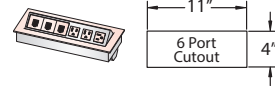

Note

- Double sided flip top units are not recommended with 2-Piece Round Tables.
- Flip Top Units are separately specified.

Cable Base Options

- Two-Piece round tables may be specified with or without Cable Bases
 - (Option N) No Cable Base.
 - (Option C) Cable Base

Cable Base Size and Location

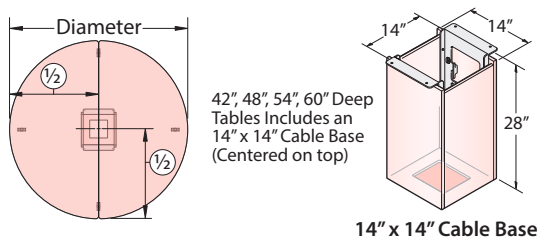

Component Materials/Finishes

COMPONENT NAME	MATERIALS/ FINISHES
Round Top 2-Piece top with 1mm edgeband seams.	Laminate Top – Specify separate finish colors for top and edge trim • Edge Options: (J) Edgeband, (F) Knife Wood Top – Specify a single finish color for the top and edge trim • Edge Options: (K) Edgeband, (U) Knife
Interior Legs	Painted Metal – Specified Trim Color
Cable Base (Optional)	Panels Laminate Panels – Specified surface and edge trim colors Wood Panels – Specified top and edge trim wood finish color
	Frame Painted Metal – Standard in Black
Glides	Standard in Black

Dimensions

TABLETOP Diameter (Width/Depth) Nominal (Actual)	KNEESPACE (Nominal)				
	A	B	C	D	E
66" (65.68")	33"	8 1/4"	24"	19"	37"
72" (71.68")	36"	9"	31"	24"	41"

No Cable Base – Includes (6) Legs

Top View

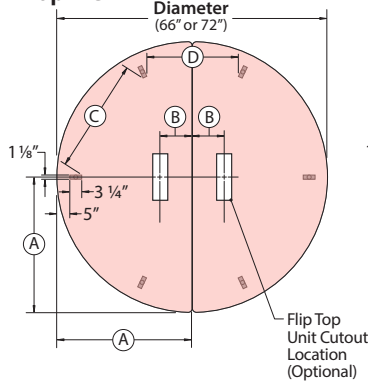

With Cable Base – Includes (4) Legs

Top View

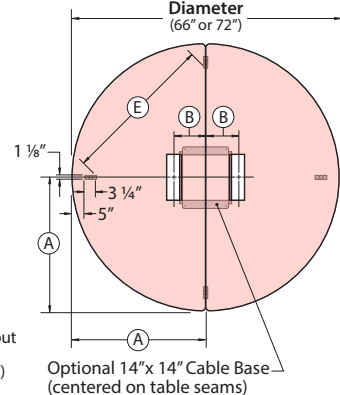

Front View

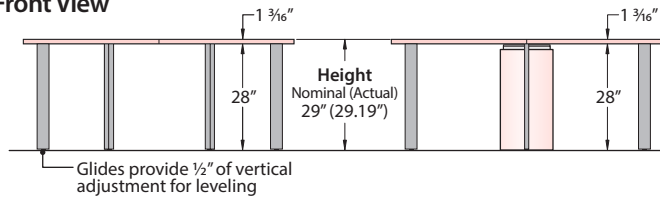

Table Sizes and Seating Capacities – Without Cable Base

TABLE SIZE	MAXIMUM NUMBER OF CHAIRS
66" Diameter	6 Chairs Maximum (6 Legs)
72" Diameter	6 Chairs Maximum (6 Legs)

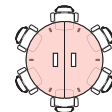
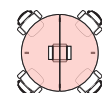

Table Sizes and Seating Capacities – With Cable Base

TABLE SIZE	MAXIMUM NUMBER OF CHAIRS
66" Diameter	4 Chairs Maximum (4 Legs)
72" Diameter	4 Chairs Maximum (4 Legs)



Note Recommended seating capacity based upon a width of 27" per chair.

Product Details – Planes Conference Tables

Interior Leg Conference Table – Square

One-Piece Top

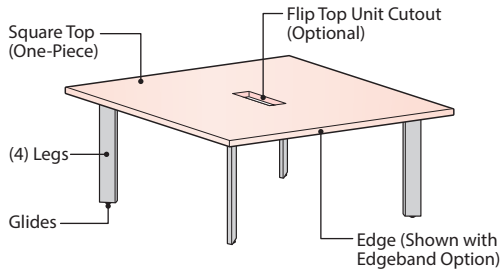

Edge Options for Laminate Tops

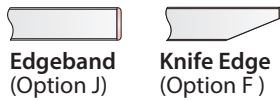

Edge Options for Wood Tops

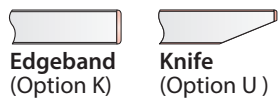

Flip Top Unit Cutout Options

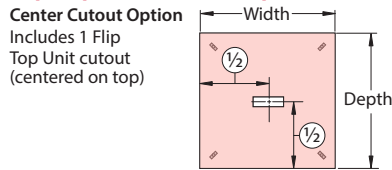

Cutout Option (F or V)
For use with Single Sided/
4 Port Flip Top Unit

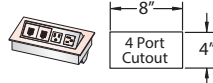

Cutout Option (J or K)
For use with Single Sided/
6 Ports Flip Top Unit

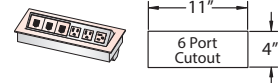

Cutout Option (M or P)
For use with Double Sided/
8 Ports Flip Top Unit

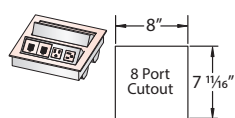

Cutout Option (Q or T)
For use with Double Sided/
12 Ports Flip Top Unit

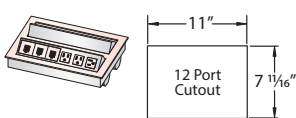

Note Flip Top Units are separately specified.

Component Materials/Finishes

COMPONENT NAME	MATERIALS/ FINISHES
Round Top 1-Piece top.	Laminate Top – Specify separate finish colors for top and edge trim • Edge Options: (J) Edgeband, (F) Knife
	Wood Top – Specify a single finish color for the top and edge trim • Edge Options: (K) Edgeband, (U) Knife
Interior Legs	Painted Metal – Specified Trim Color
Glides	Standard in Black

Dimensions

TABLETOP			KNEESPACE (Nominal)
Width Nominal (Actual)	Depth Nominal (Actual)	(A)	(B)
42" (41.68")	42" (41.68")	21"	27"
48" (47.68")	48" (47.68")	24"	33"
54" (53.68")	54" (53.68")	27"	39"
60" (59.68")	60" (59.68")	30"	45"

Top View

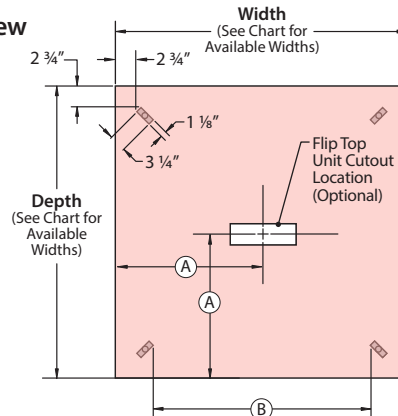

Front View

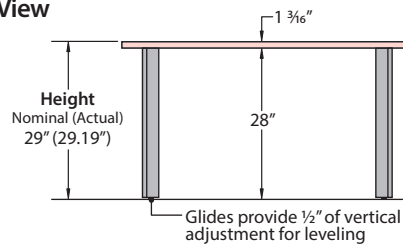

Table Sizes and Seating Capacities

TABLE SIZES		MAXIMUM NUMBER OF CHAIRS	
Depth	Wide		
42" Deep	42" Wide	4 Chairs Maximum (4 Legs)	
48" Deep	48" Wide	4 Chairs Maximum (4 Legs)	
54" Deep	54" Wide	4 Chairs Maximum (4 Legs)	
60" Deep	60" Wide	8 Chairs Maximum (4 Legs)	

Note • Recommended seating capacity based upon a width of 27" per chair.
• Cable Bases are not recommended for One-Piece Square Tables, due to lack of kneespace clearance. Consider the separately specified Cable Column for cable management.

Product Details – Planes Conference Tables

Interior Leg Conference Table – Square

Two-Piece Top – No Cable Base (Includes 6 Legs)

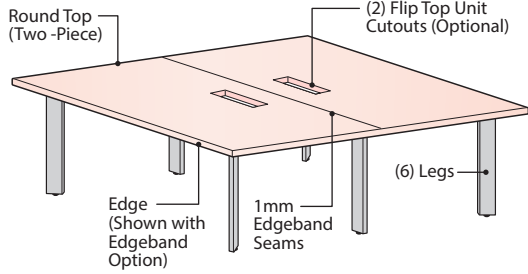

Two Piece-Top – With Cable Base (Includes 4 Legs)

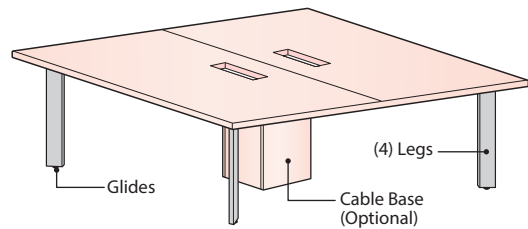

Edge Options for Laminate Tops

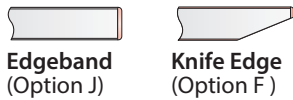

Edge Options for Wood Tops



Flip Top Unit Cutout Options

Center Cutout Locations
Includes 2 Flip Top Unit cutouts (One cutout in each top piece)

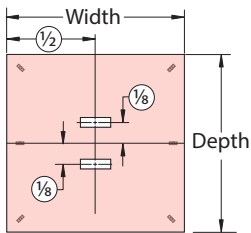

Cutout Option (F)
For use with Single Sided/4 Port

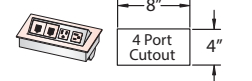

Cutout Option (J)
For use with Single Sided / 6 Ports Flip Top Unit

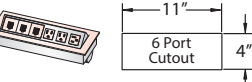

Note • Double sided flip top units are not recommended with 2-Piece Round Tables.
• Flip Top Units are separately specified.

Cable Base Options

- Two-Piece round tables may be specified with or without Cable Bases
 - (Option N) No Cable Base.
 - (Option C) Cable Base

Cable Base Size and Location

42", 48", 54", 60" Deep Tables Includes a 14" x 14" Cable Base (Centered on top)

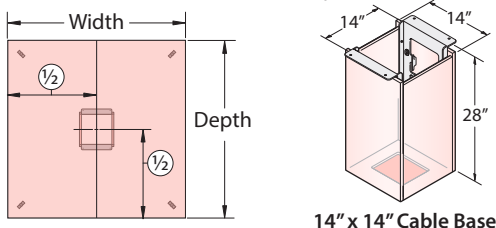

Component Materials/Finishes

COMPONENT NAME	MATERIALS/ FINISHES
Square Top 2-Piece top with 1mm edgeband seams.	Laminate Top – Specify separate finish colors for top and edge trim • Edge Options: (J) Edgeband, (F) Knife
	Wood Top – Specify a single finish color for the top and edge trim • Edge Options: (K) Edgeband, (U) Knife
Interior Legs	Painted Metal – Specified Trim Color
Cable Base (Optional)	Panels Laminate Panels – Specified surface and edge trim colors Wood Panels – Specified top and edge trim wood finish color
	Frame Painted Metal – Standard in Black
Glides	Standard in Black

Dimensions

Diameter (Width/Depth) Nominal (Actual)	TABLETOP		KNEESPACE (Nominal)	
	A	B	C	D
66" (65.68")	33"	8 1/4"	51"	25"
72" (71.68")	36"	9"	57"	28"

No Cable Base – Includes (6) Legs Top View

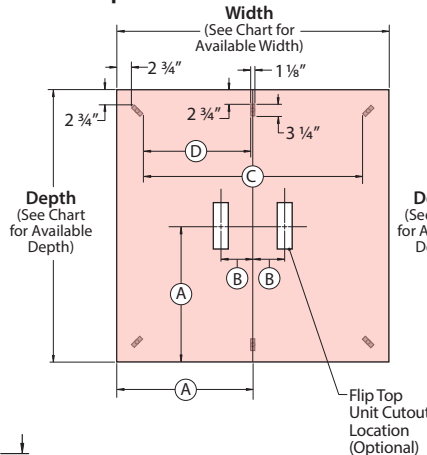

Front View

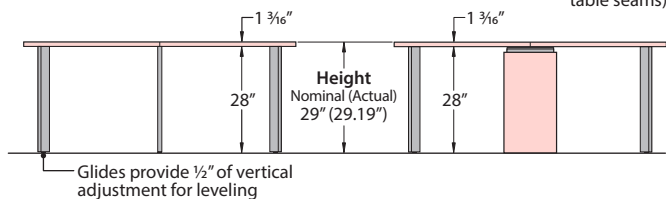

With Cable Base – Includes (4) Legs Top View

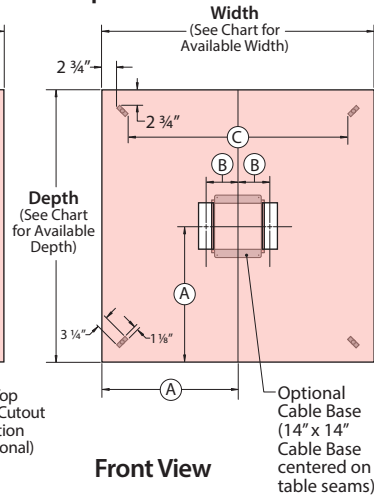

Front View

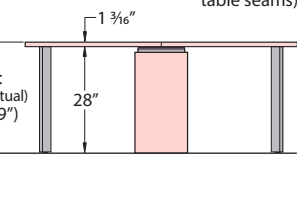

Table Sizes and Seating Capacities

TABLE SIZE	MAXIMUM NUMBER OF CHAIRS
With or Without Cable Base	8 Chairs Maximum
66" Wide/ 66" Deep	
72" Wide/ 72" Deep	

Note • Recommended seating capacity based upon a width of 27" per chair.

Product Details – Planes Conference Tables

Interior Leg Conference Table – Rectangular

48"/54"/60"/66" Wide – Without Cable Base
Includes (4) Legs

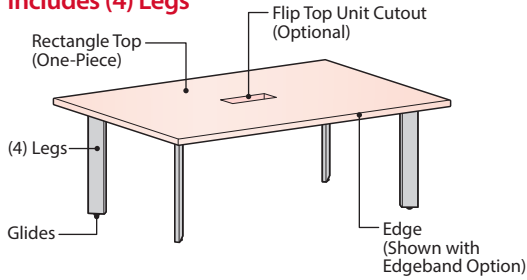

48"/54"/60"/66" Wide – With Cable Base
Includes (4) Legs

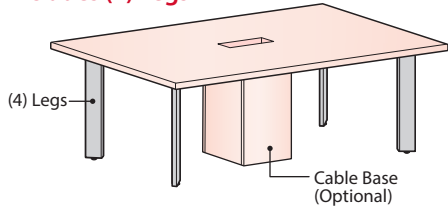

72"/78" Wide – Without Cable Base
Includes (6) Legs

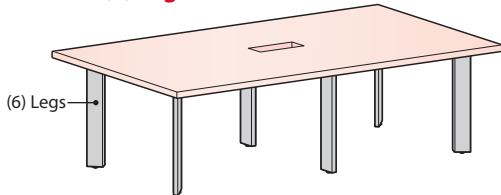

72"/78" Wide – With Cable Base
Includes (4) Legs

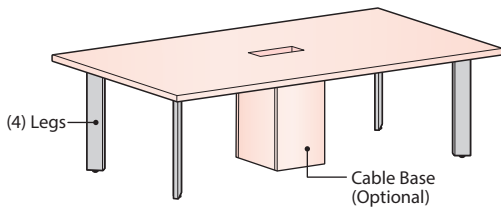

Edge Options for Laminate Tops

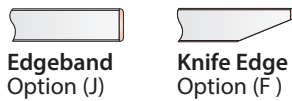

Edge Options for Wood Tops

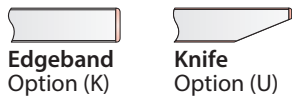

Component Materials/Finishes

COMPONENT NAME	MATERIALS/ FINISHES
Rectangle Top 1-Piece top	Laminate Top – Specify separate finish colors for top and edge trim • Edge Options: (T) T-Mold, (J) Edgeband, (V) Cascade, (F) Knife
	Wood Top – Specify a single finish color for the top and edge trim • Edge Options: (K) Edgeband, (M) Cascade*, (U) Knife
Interior Legs	Painted Metal – Specified Trim Color
Glides	Standard in Black
Cable Base (Optional)	Laminate Panels – Specified surface and edge trim colors
	Wood Panels – Specified top and edge trim wood finish color
Frame	Painted Metal – Standard in Black

Flip Top Unit Cutout Options

Center Cutout Option

- Includes 1 Flip Top Unit cutout (centered on top)

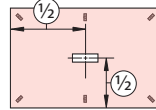

Left/Right Cutout Option

- Includes 2 Flip Top Unit cutouts (1 Left Cutout and 1 Right Cutout)

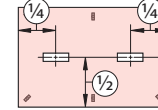

Cutout Option (F or V)

- For use with Single Sided/ 4 Port Flip Top Unit

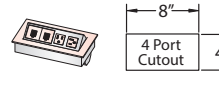

Cutout Option (J or K)

- For use with Single Sided/ 6 Ports Flip Top Unit

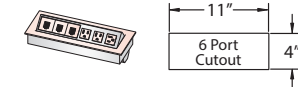

Cutout Option (M or P)

- For use with Double Sided/ 8 Ports Flip Top Unit

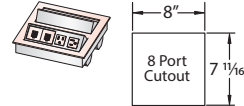

Cutout Option (Q or T)

- For use with Double Sided/ 12 Ports Flip Top Unit

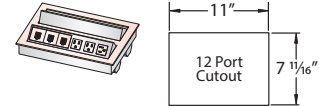

Note Flip Top Units are separately specified.

Cable Base Options

- Tables may be specified with or without Cable Bases
 - (Option N) No Cable Base.
 - (Option C) Cable Base

One-Piece Table with Cable Base option (Top View)

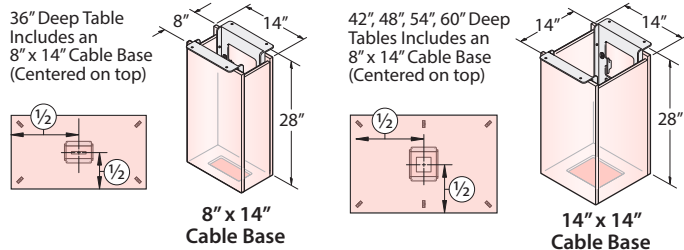

Note • Cable Base option not recommended for 30" deep tables.
• Cable base and table tops may be specified with different surface colors and edge trim colors.

Product Details – Planes Conference Tables

Interior Leg Conference Table – Rectangular – Dimensions

48"/54"/60"/66" Wide – Without Cable Base (Includes 4 Legs)

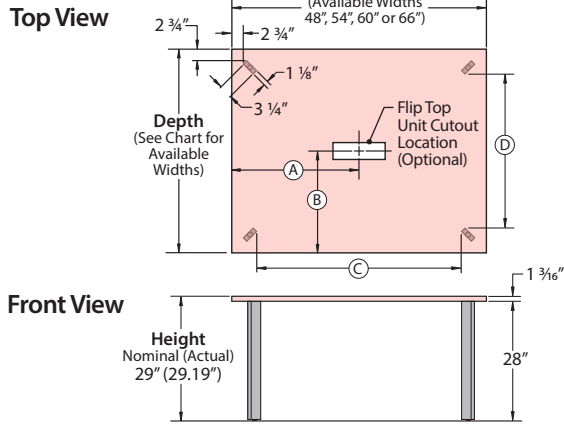

72"/78" Wide – Without Cable Base (Includes 6 Legs)

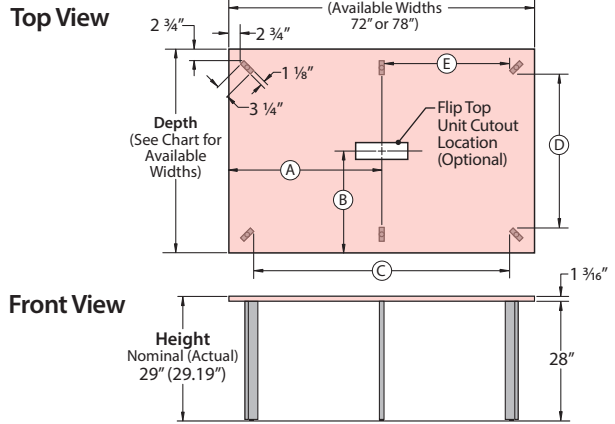

48"/54"/60"/66" Wide – With Cable Base (Includes 4 Legs)

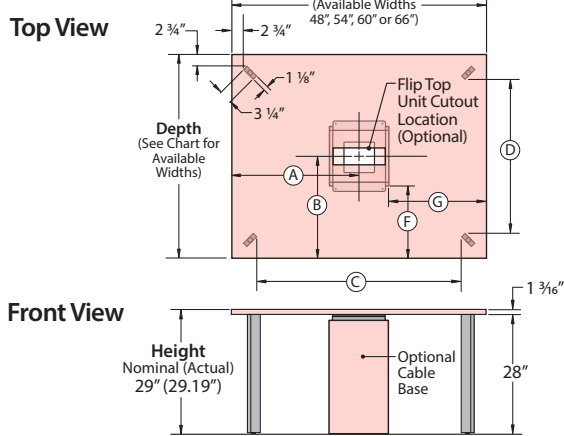

72"/78" Wide – With Cable Base (Includes 4 Legs)

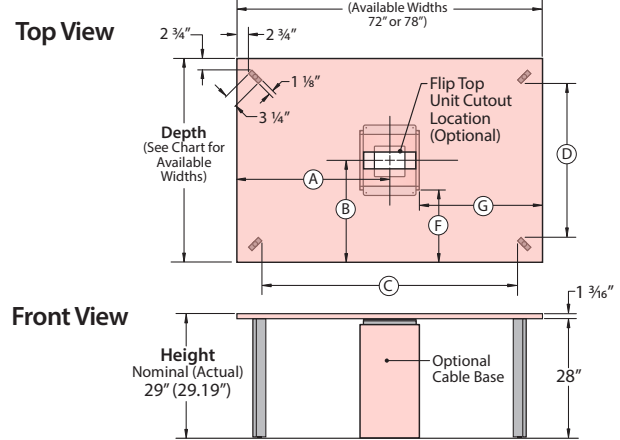

Note The optional Cable Base reduces the number of legs shipped with 72" and 78" Wide Tables to (4) legs.

Dimensions

TABLETOP					KNEESPACE (Nominal)					CABLE BASE		
Depth Nominal (Actual)	Width Nominal (Actual)	Number of Top Pieces	A	B	C	D	E	F	G	Optional Cable Base Size/ Availability	Number of Legs Without Cable Base	Number of Legs With Cable Base
30" (29.68")	60" (59.68")	1	30"	15"	45"	15"	N/A	N/A	N/A	N/A	4	N/A
	66" (65.68")	1	33"	15"	51"	15"	N/A	N/A	N/A	N/A	4	N/A
	72" (71.68")	1	36"	15"	57"	15"	28"	N/A	N/A	N/A	6	N/A
36" (35.68")	60" (59.68")	1	30"	16"	45"	21"	N/A	14"	23"	8" D x 14"W	4	4
	66" (65.68")	1	33"	16"	51"	21"	N/A	14"	26"	8" D x 14"W	4	4
42" (41.68")	48" (47.68")	1	24"	21"	33"	27"	N/A	14"	17"	14" D x 14"W	4	4
	54" (53.68")	1	27"	21"	39"	27"	N/A	14"	20"	14" D x 14"W	4	4
	60" (59.68")	1	30"	21"	45"	27"	N/A	14"	23"	14" D x 14"W	4	4
	66" (65.68")	1	33"	21"	51"	27"	N/A	14"	26"	14" D x 14"W	4	4
	72" (71.68")	1	36"	21"	57"	27"	28"	14"	29"	14" D x 14"W	6	4
	78" (77.68")	1	39"	21"	63"	27"	31"	14"	32"	14" D x 14"W	6	4
48" (47.68")	54" (53.68")	1	27"	24"	39"	33"	N/A	17"	20"	14" D x 14"W	4	4
	60" (59.68")	1	30"	24"	45"	33"	N/A	17"	23"	14" D x 14"W	4	4
	66" (65.68")	1	33"	24"	51"	33"	N/A	17"	26"	14" D x 14"W	4	4
	72" (71.68")	1	36"	24"	57"	33"	28"	17"	29"	14" D x 14"W	6	4
54" (53.68")	60" (59.68")	1	30"	24"	45"	33"	31"	17"	32"	14" D x 14"W	6	4
	66" (65.68")	1	33"	27"	51"	39"	N/A	20"	23"	14" D x 14"W	4	4
	72" (71.68")	1	36"	27"	57"	39"	28"	20"	29"	14" D x 14"W	6	4
	78" (77.68")	1	39"	27"	63"	39"	31"	20"	32"	14" D x 14"W	6	4
60" (59.68")	66" (65.68")	1	33"	30"	51"	45"	N/A	23"	26"	14" D x 14"W	4	4
	72" (71.68")	1	36"	30"	57"	45"	28"	23"	29"	14" D x 14"W	6	4
	78" (77.68")	1	39"	30"	63"	45"	31"	23"	32"	14" D x 14"W	6	4

Note

- For optional Flip Top Unit Cutout sizes and dimensions see previous page.
- 36" tables are available with 8"D x 16"W Cable Bases, which are not compatible with Double Sided Flip Top Unit Cutouts (M) or (Q).
- Cable Base option not recommended for 30" deep tables, consider the separately specified Cable Column for cable management.

Product Details – Planes Conference Tables

Interior Leg Conference Table – Rectangular

Table Sizes and Seating Capacities – Without Cable Bases

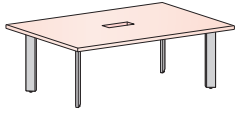

48"-66" wide Rectangle Tables specified without a Cable Base are standard with 4 Legs.

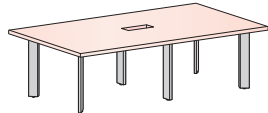

72"-78" wide Rectangle Tables specified without a Cable Base are standard with 6 Legs.

		WIDTHS					
		48" Wide	54" Wide	60" Wide	66" Wide	72" Wide	78" Wide
DEPTHS	30" Deep			6 Chairs Max. (4 Legs)	6 Chairs Max. (4 Legs)	6 Chairs Max. (6 Legs)	
	36" Deep			6 Chairs Max. (4 Legs)	6 Chairs Max. (4 Legs)		
	42" Deep	4 Chairs Max. (4 Legs)	4 Chairs Max. (4 Legs)	6 Chairs Max. (4 Legs)	6 Chairs Max. (4 Legs)	6 Chairs Max. (6 Legs)	6 Chairs Max. (6 Legs)
	48" Deep		4 Chairs Max. (4 Legs)	6 Chairs Max. (4 Legs)	6 Chairs Max. (4 Legs)	6 Chairs Max. (6 Legs)	6 Chairs Max. (6 Legs)
	54" Deep			6 Chairs Max. (6 Legs)	6 Chairs Max. (4 Legs)	6 Chairs Max. (6 Legs)	6 Chairs Max. (6 Legs)
	60" Deep				8 Chairs Max. (4 Legs)	8 Chairs Max. (6 Legs)	8 Chairs Max. (6 Legs)

Table Sizes and Seating Capacities – With Cable Bases

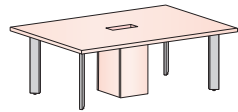

48"-66" wide Rectangle Tables specified without a Cable Base are standard with 4 Legs.

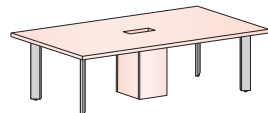

72"-78" wide Rectangle Tables specified without a Cable Base are standard with 4 Legs.

		WIDTHS					
		48" Wide	54" Wide	60" Wide	66" Wide	72" Wide	78" Wide
DEPTHS	30" Deep			Cable Base Not Recommended	Cable Base Not Recommended	Cable Base Not Recommended	
	36" Deep			6 Chairs Max. (4) Legs/ (1) 8"x14" Cable Base	6 Chairs Max. (4) Legs/ (1) 8"x14" Cable Base		
	42" Deep	4 Chairs Max. (4) Legs/ (1) 14"x14" Cable Base	4 Chairs Max. (4) Legs/ (1) 14"x14" Cable Base	6 Chairs Max. (4) Legs/ (1) 14"x14" Cable Base	6 Chairs Max. (4) Legs/ (1) 14"x14" Cable Base	6 Chairs Max. (4) Legs/ (1) 14"x14" Cable Base	6 Chairs Max. (4) Legs/ (1) 14"x14" Cable Base
	48" Deep		4 Chairs Max. (4) Legs/ (1) 14"x14" Cable Base	6 Chairs Max. (4) Legs/ (1) 14"x14" Cable Base	6 Chairs Max. (4) Legs/ (1) 14"x14" Cable Base	6 Chairs Max. (4) Legs/ (1) 14"x14" Cable Base	6 Chairs Max. (4) Legs/ (1) 14"x14" Cable Base
	54" Deep			6 Chairs Max. (4) Legs/ (1) 14"x14" Cable Base	6 Chairs Max. (4) Legs/ (1) 14"x14" Cable Base	6 Chairs Max. (4) Legs/ (1) 14"x14" Cable Base	6 Chairs Max. (4) Legs/ (1) 14"x14" Cable Base
	60" Deep				8 Chairs Max. (4) Legs/ (1) 14"x14" Cable Base	8 Chairs Max. (4) Legs/ (1) 14"x14" Cable Base	8 Chairs Max. (4) Legs/ (1) 14"x14" Cable Base

Note • Recommended seating capacity based upon a width of 27" per chair.

Product Details – Planes Conference Tables

Interior Leg Conference Table – Half Round

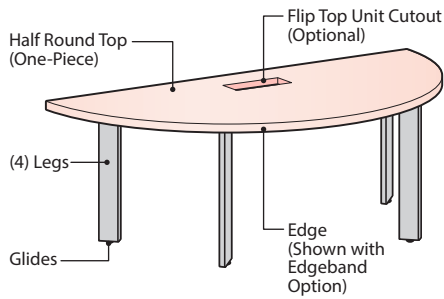

Edge Options for Laminate Tops



Edge Options for Wood Tops



Flip Top Unit Cutout Options

Cutout Option (F)
For use with Single Sided / 4 Port Flip Top Unit

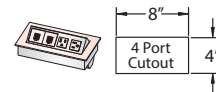

Cutout Option (J)
For use with Single Sided / 6 Ports Flip Top Unit

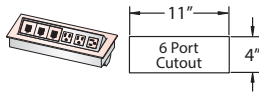

- Note**
- Double sided flip top units are not recommended for use with Half Round Tables.
 - Flip Top Units are separately specified.

Table Sizes and Seating Capacities

		WIDTHS	
		60" Wide	72" Wide
DEPTH	30" Deep	 5 Chairs Maximum (Includes 4 Legs)	N/A
	36" Deep	N/A	 5 Chairs Maximum (Includes 4 Legs)

- Note**
- Recommended seating capacity based upon a width of 27" per chair.
 - Cable Bases are not recommended for Half Round Tables, due to lack of kneespace clearance. Consider the separately specified Cable Column for cable management.

Component Materials/Finishes

COMPONENT NAME	MATERIALS/ FINISHES
Half Round Top (1-Piece top)	Laminate Top – Specify separate finish colors for top and edge trim • Edge Options: (J) Edgeband, (F) Knife
	Wood Top – Specify a single finish color for the top and edge trim • Edge Options: (K) Edgeband, (U) Knife
Interior Legs	Painted Metal – Specified Trim Color
Glides	Standard in Black

Dimensions

TABLETOP				KNEESPACE		
Width Nominal (Actual)	Depth Nominal (Actual)	(A)	(B)	(C)	(D)	(E)
60" (59.68")	30" (29.68")	30"	15"	19"	19"	45"
72" (71.68")	36" (35.68")	36"	18"	24"	25"	57"

Top View

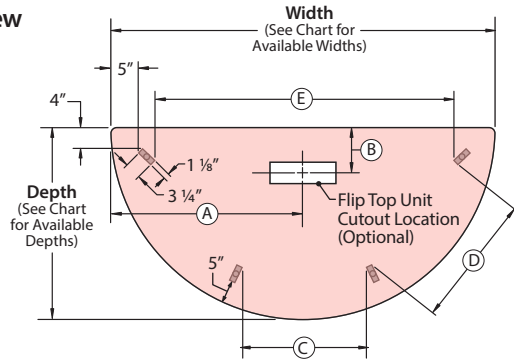

Front View

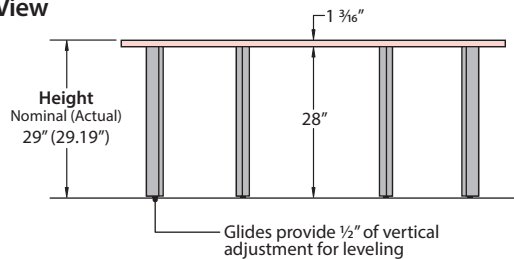

Product Details – Planes Conference Tables

Interior Leg Conference Table – Polygon

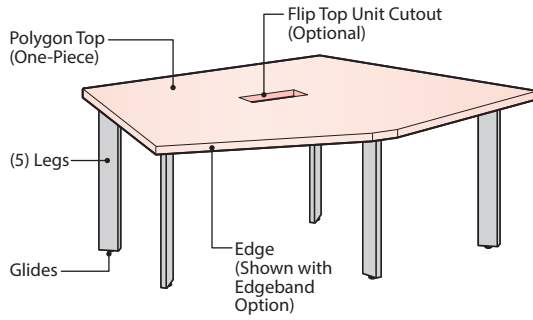

Component Materials/Finishes

COMPONENT NAME	MATERIALS/ FINISHES
Polygon Top (1-Piece top)	Laminate Top – Specify separate finish colors for top and edge trim • Edge Options: (J) Edgeband, (F) Knife
	Wood Top – Specify a single finish color for the top and edge trim • Edge Options: (K) Edgeband, (U) Wood
Interior Legs	Painted Metal – Specified Trim Color
Glides	Standard in Black

Edge Options for Laminate Tops



Edge Options for Wood Tops

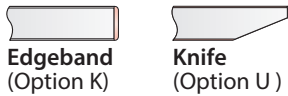

Flip Top Unit Cutout Options

Cutout Option (F)
For use with Single Sided/4 Port Flip Top Unit

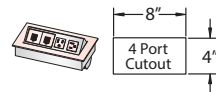

Cutout Option (J)
For use with Single Sided / 6 Ports Flip Top Unit

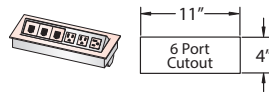

- Note**
- Double sided flip top units are not recommended for use with Polygon Tables.
 - Flip Top Units are separately specified.

Table Sizes and Seating Capacities

		WIDTHS	
		60" Wide	72" Wide
DEPTHS	30" Deep	<p>5 Chairs Maximum (Includes 5 Legs)</p>	N/A
	36" Deep	N/A	<p>6 Chairs Maximum (Includes 5 Legs)</p>

- Note**
- Recommended seating capacity based upon a width of 27" per chair.
 - Cable Bases are not recommended for Polygon Tables, due to lack of kneespace clearance. Consider the separately specified Cable Column for cable management.

Dimensions

TABLETOP							KNEESPACE			
Width Nominal (Actual)	Depth Nominal (Actual)	(A)	(B)	(C)	(D)	(E)	(F)	(G)	(H)	(I)
60" (65.84")	30" (29.68")	50 1/2"	29 1/16"	36 9/16"	8 1/2"	32 1/16"	18 1/4"	39"	17"	24"
72" (77.43")	36" (35.68")	58 1/16"	35 1/16"	43 7/8"	8 1/2"	38 3/4"	21 1/16"	47"	23"	30"

Top View

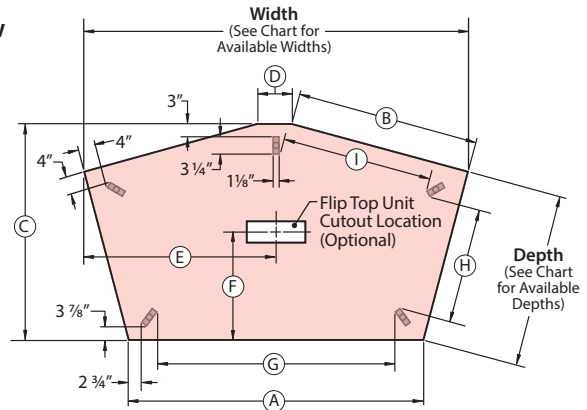

Front View

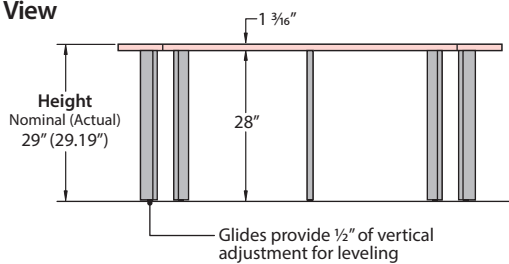

Product Details – Planes Conference Tables

Interior Leg Conference Table – One-Piece Top – Rectangular

Without Cable Base – Includes (6) Legs

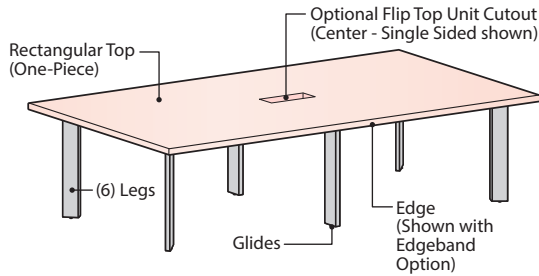

With Cable Base – Includes (4) Legs

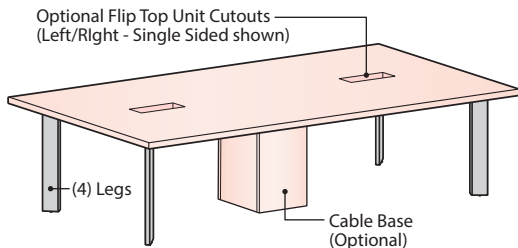

Edge Options for Laminate Tops

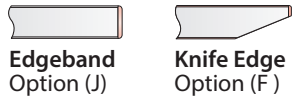

Edge Options for Wood Tops

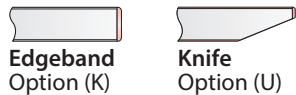

Component Materials/Finishes

COMPONENT NAME		MATERIALS/ FINISHES
Rectangle Top 1-Piece top		Laminate Top – Specify separate finish colors for top and edge trim • Edge Options: (J) Edgeband, (F) Knife
		Wood Top – Specify a single finish color for the top and edge trim • Edge Options: (K) Edgeband, (U) Knife
Interior Legs		Painted Metal – Specified Trim Color
Glides		Standard in Black
Cable Base (Optional)	Panels	Laminate Panels – Specified surface and edge trim colors Wood Panels – Specified top and edge trim wood finish color
	Frame	Painted Metal – Standard in Black

Flip Top Unit Cutout Options

Center Cutout Option

- Includes 1 Flip Top Unit cutout (centered on top)

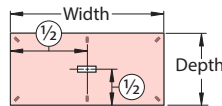

Left/Right Cutout Option

- Includes 2 Flip Top Unit cutouts (1 Left Cutout and 1 Right Cutout)

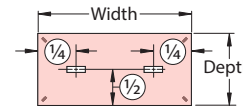

Cutout Option (F or V)

- For use with Single Sided/ 4 Port Flip Top Unit

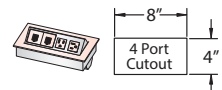

Cutout Option (J or K)

- For use with Single Sided/ 6 Ports Flip Top Unit

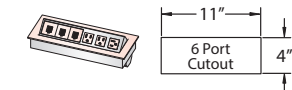

Cutout Option (M or P)

- For use with Double Sided/ 8 Ports Flip Top Unit

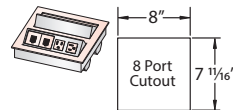

Cutout Option (Q or T)

- For use with Double Sided/ 12 Ports Flip Top Unit

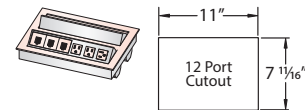

Note Flip Top Units are separately specified.

Cable Base Options

- Tables may be specified with or without Cable Bases
 - (Option N) No Cable Base.
 - (Option C) 36" deep – Includes 8" x 14" Cable Bases
 - 42", 48", 54" and 60" deep – Includes 14" x 14" Cable Bases

One-Piece Table with Cable Base option (Top View)

36" Deep Table
Includes an
8" x 14" Cable Base
(Centered on top)

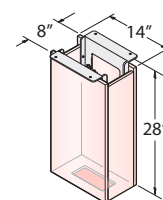
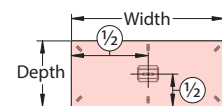

8" x 14"
Cable Base

42", 48", 54", 60" Deep
Tables Includes an
8" x 14" Cable Base
(Centered on top)

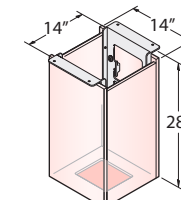
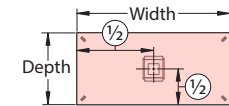

14" x 14"
Cable Base

Product Details – Planes Conference Tables

Interior Leg Conference Table – One-Piece Top – Rectangular

Dimensions – Without Cable Base – Includes (6) Legs

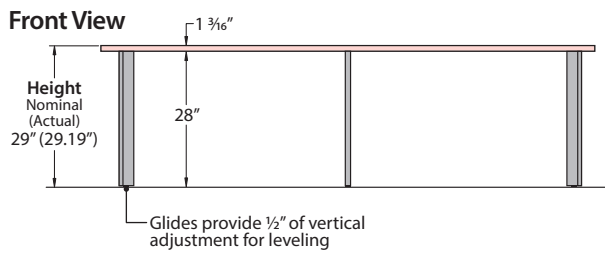
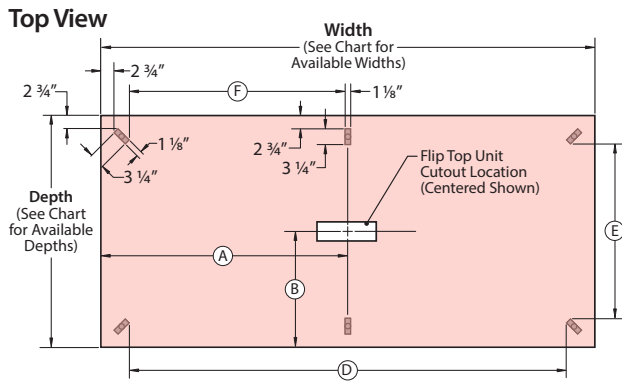

Dimensions – With Cable Base – Includes (4) Legs

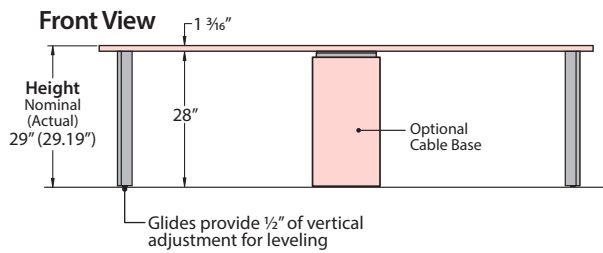
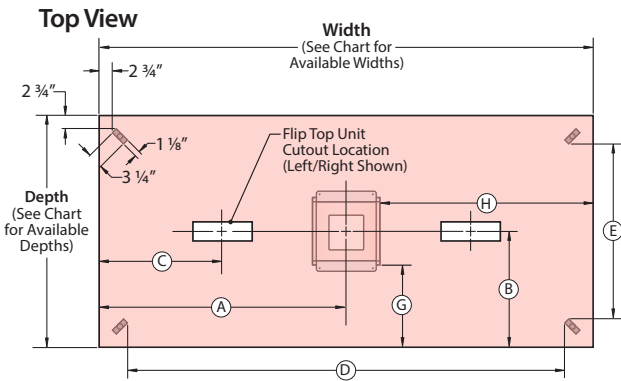

Dimensions

TABLETOP			KNEESPACE (Nominal)						LEGS		CABLE BASE		
Depth Nominal (Actual)	Width Nominal (Actual)	Number of Top Pieces	A	B	C	D	E	F	Number of Legs Without Cable Base	Number of Legs With Cable Base	Optional Cable Base Sizes	G	H
36" (35.68")	72" (71.68")	1	36"	18"	18"	57"	21"	28"	6	4	8" D x 14"W	14"	29"
	78" (77.68")	1	39"	18"	19 1/2"	63"	21"	31"	6	4	8" D x 14"W	14"	32"
	84" (83.68")	1	42"	18"	21"	69"	21"	34"	6	4	8" D x 14"W	14"	35"
	90" (89.68")	1	45"	18"	22 1/2"	75"	21"	37"	6	4	8" D x 14"W	14"	38"
	96" (95.68")	1	48"	18"	24"	81"	21"	40"	6	4	8" D x 14"W	14"	41"
42" (41.68")	84" (83.68")	1	42"	21"	21"	69"	27"	34"	6	4	14" D x 14"W	14"	32"
	90" (89.68")	1	45"	21"	22 1/2"	75"	27"	37"	6	4	14" D x 14"W	14"	35"
	96" (95.68")	1	48"	21"	24"	81"	27"	40"	6	4	14" D x 14"W	14"	38"
	102" (101.68")	1	51"	21"	25 1/2"	87"	27"	43"	6	4	14" D x 14"W	14"	41"
	108" (107.68")	1	54"	21"	27"	93"	27"	46"	6	4	14" D x 14"W	14"	47"
48" (47.68")	84" (83.68")	1	42"	24"	21"	69"	33"	34"	6	4	14" D x 14"W	17"	32"
	90" (89.68")	1	45"	24"	22 1/2"	75"	33"	37"	6	4	14" D x 14"W	17"	35"
	96" (95.68")	1	48"	24"	24"	81"	33"	40"	6	4	14" D x 14"W	17"	38"
	102" (101.68")	1	51"	24"	25 1/2"	87"	33"	43"	6	4	14" D x 14"W	17"	41"
	108" (107.68")	1	54"	24"	27"	93"	33"	46"	6	4	14" D x 14"W	17"	47"
54" (53.68")	84" (83.68")	1	42"	27"	21"	69"	39"	34"	6	4	14" D x 14"W	20"	32"
	90" (89.68")	1	45"	27"	22 1/2"	75"	39"	37"	6	4	14" D x 14"W	20"	35"
	96" (95.68")	1	48"	27"	24"	81"	39"	40"	6	4	14" D x 14"W	20"	38"
	102" (101.68")	1	51"	27"	25 1/2"	87"	39"	43"	6	4	14" D x 14"W	20"	41"
	108" (107.68")	1	54"	27"	27"	93"	39"	46"	6	4	14" D x 14"W	20"	47"
60" (59.68")	84" (83.68")	1	42"	30"	21"	69"	45"	34"	6	4	14" D x 14"W	23"	32"
	90" (89.68")	1	45"	30"	22 1/2"	75"	45"	37"	6	4	14" D x 14"W	23"	35"
	96" (95.68")	1	48"	30"	24"	81"	45"	40"	6	4	14" D x 14"W	23"	38"
	102" (101.68")	1	51"	30"	25 1/2"	87"	45"	43"	6	4	14" D x 14"W	23"	41"
	108" (107.68")	1	54"	30"	27"	93"	45"	46"	6	4	14" D x 14"W	23"	47"
120" (119.68")	114" (113.68")	1	57"	30"	28 1/2"	99"	45"	49"	6	4	14" D x 14"W	23"	50"
	120" (119.68")	1	60"	30"	30"	105"	45"	52"	6	4	14" D x 14"W	23"	53"

Product Details – Planes Conference Tables

Interior Leg Conference Table – One-Piece Top – Rectangular

Table Sizes and Seating Capacities – Without Cable Bases – Includes (6) Legs

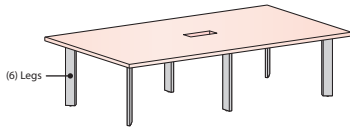

• One-Piece Top Tables specified without a Cable Base are standard with 6 Legs.

		WIDTHS								
		72" Wide	78" Wide	84" Wide	90" Wide	96" Wide	102" Wide	108" Wide	114" Wide	120" Wide
DEPTHS	36" Deep	6 Chairs Max (6 Legs)	6 Chairs Max (6 Legs)	6 Chairs Max (6 Legs)	6 Chairs Max (6 Legs)	6 Chairs Max (6 Legs)	N/A	N/A	N/A	N/A
	42" Deep	N/A	N/A	6 Chairs Max (6 Legs)	6 Chairs Max (6 Legs)	6 Chairs Max (6 Legs)	6 Chairs Max (6 Legs)	6 Chairs Max (6 Legs)	10 Chairs Max (6 Legs)	10 Chairs Max (6 Legs)
	48" Deep	N/A	N/A	6 Chairs Max (6 Legs)	6 Chairs Max (6 Legs)	6 Chairs Max (6 Legs)	6 Chairs Max (6 Legs)	6 Chairs Max (6 Legs)	10 Chairs Max (6 Legs)	10 Chairs Max (6 Legs)
	54" Deep	N/A	N/A	6 Chairs Max (6 Legs)	6 Chairs Max (6 Legs)	6 Chairs Max (6 Legs)	6 Chairs Max (6 Legs)	6 Chairs Max (6 Legs)	10 Chairs Max (6 Legs)	10 Chairs Max (6 Legs)
	60" Deep	N/A	N/A	8 Chairs Max (6 Legs)	8 Chairs Max (6 Legs)	8 Chairs Max (6 Legs)	8 Chairs Max (6 Legs)	8 Chairs Max (6 Legs)	12 Chairs Max (6 Legs)	12 Chairs Max (6 Legs)

Table Sizes and Seating Capacities – With Cable Bases – Includes (4) Legs

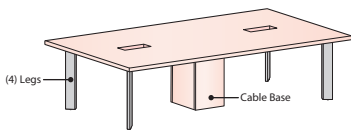

- Optional Cable Bases function as a top support allowing the number of legs to be reduced from (6) Legs down to (4) Legs.
- 36" Deep Tables specified with a Cable Base are ship with a 8" x 14" Cable Base.
- 42"-60" Deep Tables specified with a Cable Base are ship with a 14" x 14" Cable Base.

		WIDTHS								
		72" Wide	78" Wide	84" Wide	90" Wide	96" Wide	102" Wide	108" Wide	114" Wide	120" Wide
DEPTHS	36" Deep	6 Chairs Max (4 Legs/1 Cable Base)	6 Chairs Max (4 Legs/1 Cable Base)	8 Chairs Max (4 Legs/1 Cable Base)	8 Chairs Max (4 Legs/1 Cable Base)	8 Chairs Max (4 Legs/1 Cable Base)	N/A	N/A	N/A	N/A
	42" Deep	N/A	N/A	8 Chairs Max (4 Legs/1 Cable Base)	8 Chairs Max (4 Legs/1 Cable Base)	8 Chairs Max (4 Legs/1 Cable Base)	8 Chairs Max (4 Legs/1 Cable Base)	8 Chairs Max (4 Legs/1 Cable Base)	10 Chairs Max (4 Legs/1 Cable Base)	10 Chairs Max (4 Legs/1 Cable Base)
	48" Deep	N/A	N/A	8 Chairs (4 Legs/1 Cable Base)	8 Chairs (4 Legs/1 Cable Base)	8 Chairs Max (4 Legs/1 Cable Base)	8 Chairs Max (4 Legs/1 Cable Base)	8 Chairs Max (4 Legs/1 Cable Base)	10 Chairs Max (4 Legs/1 Cable Base)	10 Chairs Max (4 Legs/1 Cable Base)
	54" Deep	N/A	N/A	8 Chairs (4 Legs/1 Cable Base)	8 Chairs (4 Legs/1 Cable Base)	8 Chairs Max (4 Legs/1 Cable Base)	8 Chairs Max (4 Legs/1 Cable Base)	8 Chairs Max (4 Legs/1 Cable Base)	10 Chairs Max (4 Legs/1 Cable Base)	10 Chairs Max (4 Legs/1 Cable Base)
	60" Deep	N/A	N/A	10 Chairs (4 Legs/1 Cable Base)	10 Chairs (4 Legs/1 Cable Base)	10 Chairs Max (4 Legs/1 Cable Base)	10 Chairs Max (4 Legs/1 Cable Base)	10 Chairs Max (4 Legs/1 Cable Base)	12 Chairs Max (4 Legs/1 Cable Base)	12 Chairs Max (4 Legs/1 Cable Base)

Note Recommended seating capacity based upon a width of 27" per chair.

Product Details – Planes Conference Tables

Interior Leg Conference Table – One-Piece Top – Pebble

Without Cable Base – Includes (6) Legs

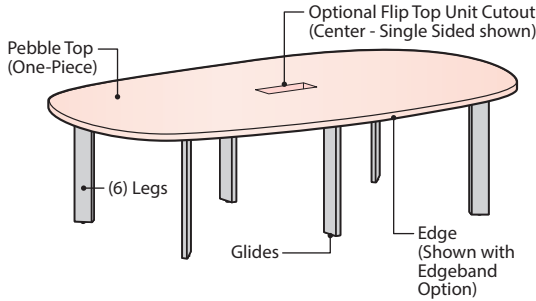

With Cable Base – Includes (4) Legs

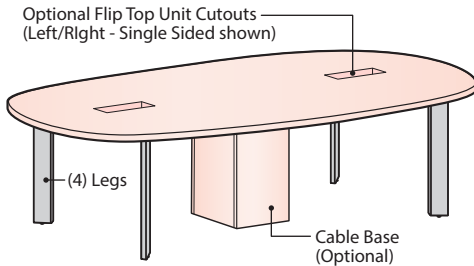

Edge Options for Laminate Tops

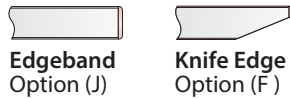

Edge Options for Wood Tops

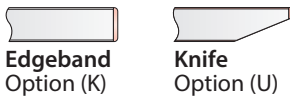

Component Materials/Finishes

COMPONENT NAME		MATERIALS/ FINISHES
Pebble Top 1-Piece top		Laminate Top – Specify separate finish colors for top and edge trim • Edge Options: (J) Edgeband, (F) Knife
		Wood Top – Specify a single finish color for the top and edge trim • Edge Options: (K) Edgeband, (U) Knife
Interior Legs		Painted Metal – Specified Trim Color
Glides		Standard in Black
Cable Base (Optional)	Panels	Laminate Panels – Specified surface and edge trim colors Wood Panels – Specified top and edge trim wood finish color
	Frame	Painted Metal – Standard in Black

Flip Top Unit Cutout Options

Center Cutout Option

- Includes 1 Flip Top Unit cutout (centered on top)

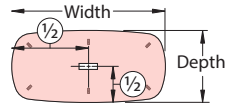

Cutout Option (F or V)

- For use with Single Sided/ 4 Port Flip Top Unit

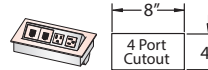

Cutout Option (M or P)

- For use with Double Sided/ 8 Ports Flip Top Unit

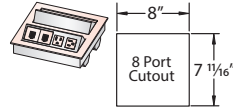

Left/Right Cutout Option

- Includes 2 Flip Top Unit cutouts (1 Left Cutout and 1 Right Cutout)

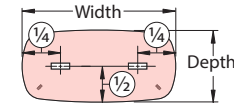

Cutout Option (J or K)

- For use with Single Sided/ 6 Ports Flip Top Unit

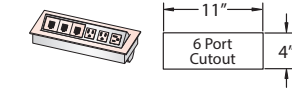

Cutout Option (Q or T)

- For use with Double Sided/ 12 Ports Flip Top Unit

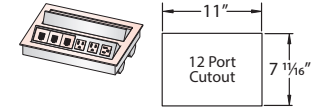

Note Flip Top Units are separately specified.

Cable Base Options

- Tables may be specified with or without Cable Bases
 - (Option N) No Cable Base.
 - (Option C) 36" deep includes 8" x 14" Cable Bases
42", 48", 54" and 60" deep includes 14" x 14" Cable Bases

One-Piece Table with Cable Base Option (Top View)

36" Deep Table
Includes an
8" x 14" Cable Base
(Centered on top)

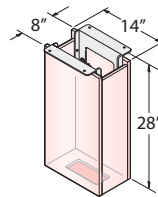
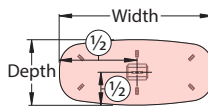

8" x 14" Cable Base

42", 48", 54", 60" Deep
Tables Includes an
8" x 14" Cable Base
(Centered on top)

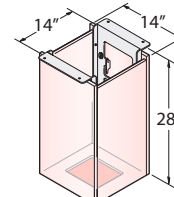
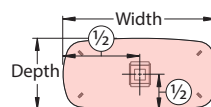

14" x 14" Cable Base

Product Details – Planes Conference Tables

Interior Leg Conference Table – One-Piece Top – Pebble

Dimensions – Without Cable Base – Includes (6) Legs

Top View

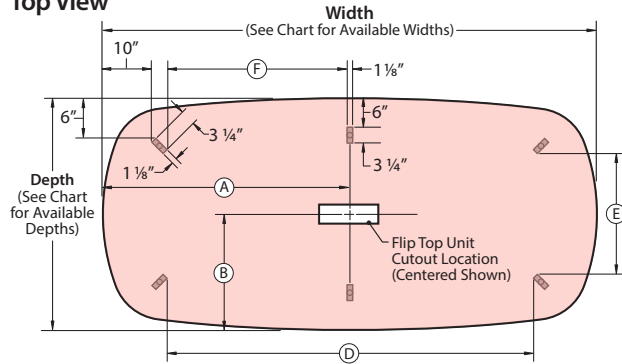

Front View

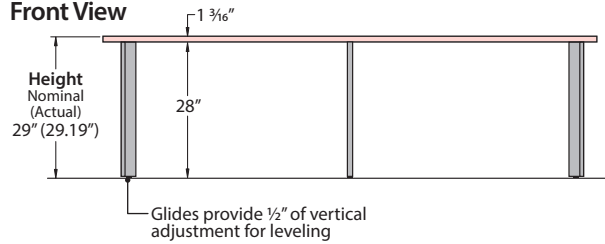

Dimensions With Cable Base – Includes (4) Legs

Top View

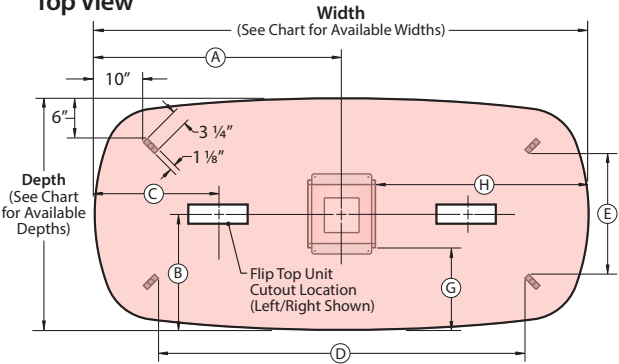

Front View

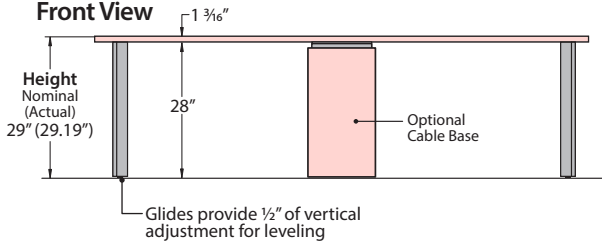

Dimensions

TABLETOP			KNEESPACE (Nominal)			LEGS		CABLE BASE					
Depth Nominal (Actual)	Width Nominal (Actual)	Number of Top Pieces	A	B	C	D	E	F	Number of Legs Without Cable Base	Number of Legs With Cable Base	Optional Cable Base Sizes	G	H
36" (35.68")	72" (71.68")	1	36"	18"	18"	46"	17"	22"	6	4	8" D x 14" W	14"	29"
	78" (77.68")	1	39"	18"	19 1/2"	52"	17"	25"	6	4	8" D x 14" W	14"	32"
	84" (83.68")	1	42"	18"	21"	58"	17"	28"	6	4	8" D x 14" W	14"	35"
	90" (89.68")	1	45"	18"	22 1/2"	64"	17"	31"	6	4	8" D x 14" W	14"	38"
	96" (95.68")	1	48"	18"	24"	70"	17"	34"	6	4	8" D x 14" W	14"	41"
42" (41.68")	84" (83.68")	1	42"	21"	21"	58"	22"	28"	6	4	14" D x 14" W	14"	35"
	90" (89.68")	1	45"	21"	22 1/2"	64"	22"	31"	6	4	14" D x 14" W	14"	38"
	96" (95.68")	1	48"	21"	24"	70"	22"	34"	6	4	14" D x 14" W	14"	41"
	102" (101.68")	1	51"	21"	25 1/2"	76"	22"	37"	6	4	14" D x 14" W	14"	47"
	108" (107.68")	1	54"	21"	27"	82"	22"	40"	6	4	14" D x 14" W	14"	50"
48" (47.68")	114" (113.68")	1	57"	21"	28 1/2"	88"	22"	43"	6	4	14" D x 14" W	14"	53"
	120" (119.68")	1	60"	21"	30"	94"	22"	46"	6	4	14" D x 14" W	14"	56"
	84" (83.68")	1	42"	24"	21"	58"	28"	28"	6	4	14" D x 14" W	17"	35"
	90" (89.68")	1	45"	24"	22 1/2"	64"	28"	31"	6	4	14" D x 14" W	17"	38"
	96" (95.68")	1	48"	24"	24"	70"	28"	34"	6	4	14" D x 14" W	17"	41"
54" (53.68")	102" (101.68")	1	51"	24"	25 1/2"	76"	28"	37"	6	4	14" D x 14" W	17"	47"
	108" (107.68")	1	54"	24"	27"	82"	28"	40"	6	4	14" D x 14" W	17"	50"
	114" (113.68")	1	57"	24"	28 1/2"	88"	28"	43"	6	4	14" D x 14" W	17"	53"
	120" (119.68")	1	60"	24"	30"	94"	28"	46"	6	4	14" D x 14" W	17"	56"
	84" (83.68")	1	42"	27"	21"	58"	34"	28"	6	4	14" D x 14" W	20"	35"
60" (59.68")	90" (89.68")	1	45"	27"	22 1/2"	64"	34"	31"	6	4	14" D x 14" W	20"	38"
	96" (95.68")	1	48"	27"	24"	70"	34"	34"	6	4	14" D x 14" W	20"	41"
	102" (101.68")	1	51"	27"	25 1/2"	76"	34"	37"	6	4	14" D x 14" W	20"	47"
	108" (107.68")	1	54"	27"	27"	82"	34"	40"	6	4	14" D x 14" W	20"	50"
	114" (113.68")	1	57"	27"	28 1/2"	88"	34"	43"	6	4	14" D x 14" W	20"	53"
60" (59.68")	120" (119.68")	1	60"	27"	30"	94"	34"	46"	6	4	14" D x 14" W	20"	56"
	84" (83.68")	1	42"	30"	21"	58"	39"	28"	6	4	14" D x 14" W	23"	35"
	90" (89.68")	1	45"	30"	22 1/2"	64"	39"	31"	6	4	14" D x 14" W	23"	38"
	96" (95.68")	1	48"	30"	24"	70"	39"	34"	6	4	14" D x 14" W	23"	41"
	102" (101.68")	1	51"	30"	25 1/2"	76"	39"	37"	6	4	14" D x 14" W	23"	47"
60" (59.68")	108" (107.68")	1	54"	30"	27"	82"	39"	40"	6	4	14" D x 14" W	23"	50"
	114" (113.68")	1	57"	30"	28 1/2"	88"	39"	43"	6	4	14" D x 14" W	23"	53"
	120" (119.68")	1	60"	30"	30"	94"	39"	46"	6	4	14" D x 14" W	23"	56"

Product Details – Planes Conference Tables

Interior Leg Conference Table – One-Piece Top – Pebble

Table Sizes and Seating Capacities – Without Cable Bases – Includes (6) Legs

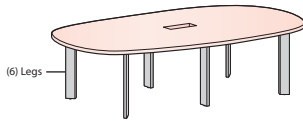

- One-Piece Top Tables specified without a Cable Base are standard with 6 Legs.

		WIDTHS								
		72" Wide	78" Wide	84" Wide	90" Wide	96" Wide	102" Wide	108" Wide	114" Wide	120" Wide
DEPTHS	36" Deep	6 Chairs Maximum	6 Chairs Maximum	6 Chairs Maximum	6 Chairs Maximum	6 Chairs Maximum	N/A	N/A	N/A	N/A
	42" Deep	N/A	N/A	6 Chairs Maximum	6 Chairs Maximum	6 Chairs Maximum	6 Chairs Maximum	6 Chairs Maximum	6 Chairs Maximum	6 Chairs Maximum
	48" Deep	N/A	N/A	6 Chairs Maximum	6 Chairs Maximum	6 Chairs Maximum	6 Chairs Maximum	6 Chairs Maximum	6 Chairs Maximum	6 Chairs Maximum
	54" Deep	N/A	N/A	8 Chairs Maximum	8 Chairs Maximum	8 Chairs Maximum	8 Chairs Maximum	6 Chairs Maximum	6 Chairs Maximum	6 Chairs Maximum
	60" Deep	N/A	N/A	6 Chairs Maximum	6 Chairs Maximum	6 Chairs Maximum	6 Chairs Maximum	6 Chairs Maximum	6 Chairs Maximum	6 Chairs Maximum

Table Sizes and Seating Capacities – With Cable Bases – Includes (4) Legs

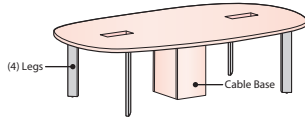

- One-Piece Top Tables specified with a Cable Base are standard with 4 Legs instead of 6 Legs because the Cable Base functions as a support for the center of the top.
- 36" Deep Tables specified with a Cable Base are ship with a 8" x 14" Cable Base.
- 42"-60" Deep Tables specified with a Cable Base are ship with a 14" x 14" Cable Base.

		WIDTHS								
		72" Wide	78" Wide	84" Wide	90" Wide	96" Wide	102" Wide	108" Wide	114" Wide	120" Wide
DEPTHS	36" Deep	6 Chairs Max (4 Legs/1 Cable Base)	6 Chairs Max (4 Legs/1 Cable Base)	6 Chairs Max (4 Legs/1 Cable Base)	6 Chairs Max (4 Legs/1 Cable Base)	8 Chairs Max (4 Legs/1 Cable Base)	N/A	N/A	N/A	N/A
	42" Deep	N/A	N/A	6 Chairs Max (4 Legs/1 Cable Base)	6 Chairs Max (4 Legs/1 Cable Base)	8 Chairs Max (4 Legs/1 Cable Base)	8 Chairs Max (4 Legs/1 Cable Base)	8 Chairs Max (4 Legs/1 Cable Base)	8 Chairs Max (4 Legs/1 Cable Base)	8 Chairs Max (4 Legs/1 Cable Base)
	48" Deep	N/A	N/A	6 Chairs (4 Legs/1 Cable Base)	6 Chairs (4 Legs/1 Cable Base)	8 Chairs Max (4 Legs/1 Cable Base)	8 Chairs Max (4 Legs/1 Cable Base)	8 Chairs Max (4 Legs/1 Cable Base)	8 Chairs Max (4 Legs/1 Cable Base)	8 Chairs Max (4 Legs/1 Cable Base)
	54" Deep	N/A	N/A	6 Chairs (4 Legs/1 Cable Base)	6 Chairs (4 Legs/1 Cable Base)	8 Chairs Max (4 Legs/1 Cable Base)	8 Chairs Max (4 Legs/1 Cable Base)	8 Chairs Max (4 Legs/1 Cable Base)	8 Chairs Max (4 Legs/1 Cable Base)	8 Chairs Max (4 Legs/1 Cable Base)
	60" Deep	N/A	N/A	6 Chairs (4 Legs/1 Cable Base)	6 Chairs (4 Legs/1 Cable Base)	8 Chairs Max (4 Legs/1 Cable Base)	8 Chairs Max (4 Legs/1 Cable Base)	8 Chairs Max (4 Legs/1 Cable Base)	8 Chairs Max (4 Legs/1 Cable Base)	8 Chairs Max (4 Legs/1 Cable Base)

Note Recommended seating capacity based upon a width of 27" per chair.

Product Details – Planes Conference Tables

Interior Leg Conference Table – One-Piece Top – Hexagon

Without Cable Base – Includes (6) Legs

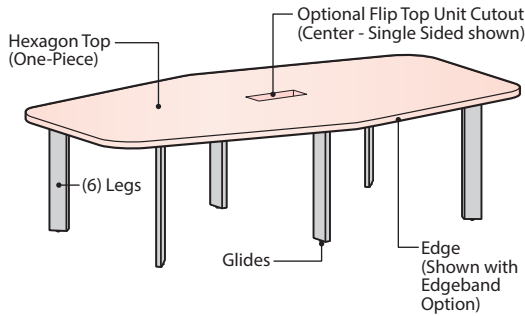

With Cable Base – Includes (4) Legs

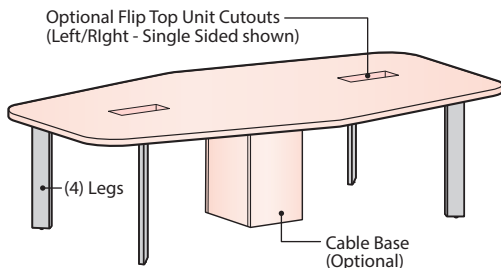

Edge Options for Laminate Tops

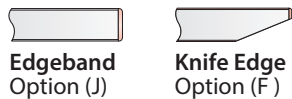

Edge Options for Wood Tops

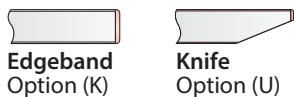

Component Materials/Finishes

COMPONENT NAME	MATERIALS/ FINISHES
Hexagon Top 1-Piece top	Laminate Top – Specify separate finish colors for top and edge trim • Edge Options: (J) Edgeband, (F) Knife
	Wood Top – Specify a single finish color for the top and edge trim • Edge Options: (K) Edgeband, (M) Cascade, (U) Knife
Interior Legs	Painted Metal – Specified Trim Color
Glides	Standard in Black
Cable Base (Optional)	Panels Laminate Panels – Specified surface and edge trim colors
	Frame Wood Panels – Specified top and edge trim wood finish color Painted Metal – Standard in Black

Flip Top Unit Cutout Options

Center Cutout Option

- Includes 3 Flip Top Unit cutouts
(1 Cutout centered on each top piece)

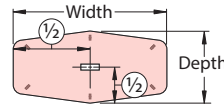

Cutout Option (F or V)

- For use with Single Sided/
4 Port Flip Top Unit

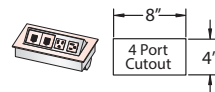

Cutout Option (M or P)

- For use with Double Sided/
8 Ports Flip Top Unit

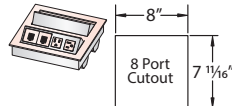

Left/Right Cutout Option

- Includes 6 Flip Top Unit cutouts
(2 Cutouts on each top piece)

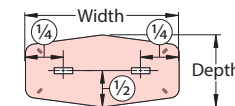

Cutout Option (J or K)

- For use with Single Sided/
6 Ports Flip Top Unit

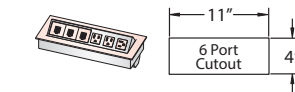

Cutout Option (Q or T)

- For use with Double Sided/
12 Ports Flip Top Unit

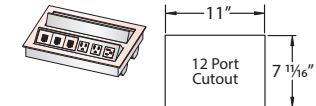

Note Flip Top Units are separately specified.

Cable Base Options

- Tables may be specified with or without Cable Bases
 - (Option N) No Cable Base.
 - (Option C) 36" deep includes 8" x 14" Cable Bases
42", 48", 54" and 60" table includes 14" x 14" Cable Bases

One-Piece Table with Cable Base option (Top View)

36" Deep Table
Includes an
8" x 14" Cable Base
(Centered on top)

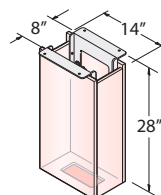
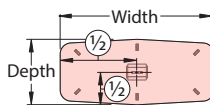

8" x 14"
Cable Base

42", 48", 54", 60" Deep
Tables Includes an
8" x 14" Cable Base
(Centered on top)

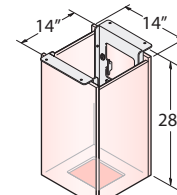
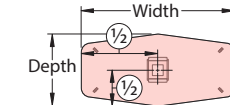

14" x 14"
Cable Base

Product Details – Planes Conference Tables

Interior Leg Conference Table – One-Piece Top – Hexagon

Dimensions – Without Cable Base – Includes (6) Legs

Top View

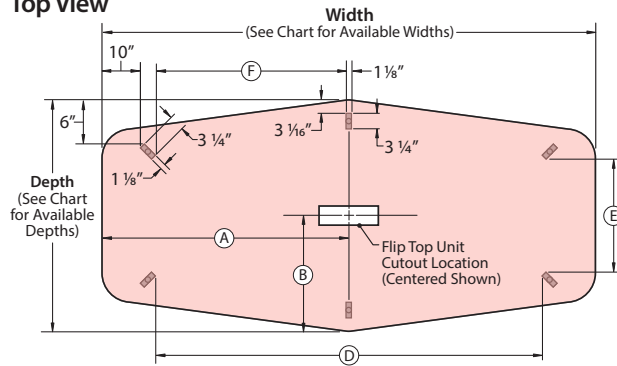

Front View

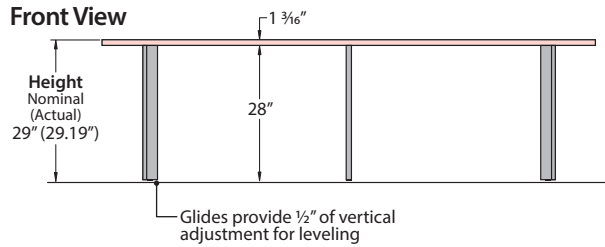

Dimensions – With Cable Base – Includes (4) Legs

Top View

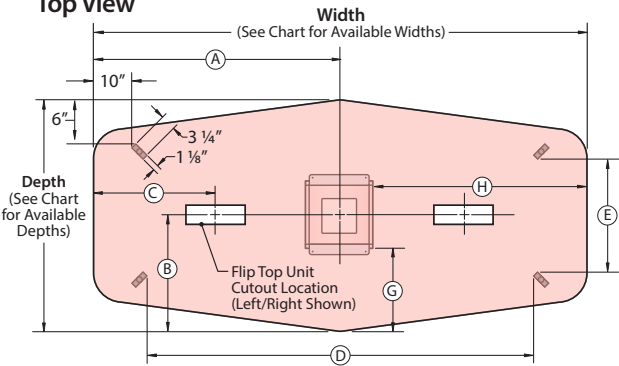

Front View

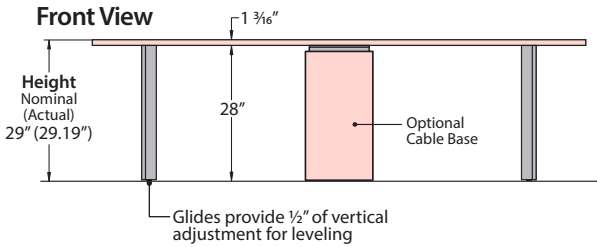

Dimensions

Depth Nominal (Actual)	TABLETOP			KNEESPACE (Nominal)			LEGS		CABLE BASE				
	Width Nominal (Actual)	Number of Top Pieces	A	B	C	D	E	F	Number of Legs Without Cable Base	Number of Legs With Cable Base	Optional Cable Base Sizes	G	H
36" (35.68")	72" (71.68")	1	36"	18"	18"	50"	18"	24"	6	4	8" D x 14" W	14"	29"
	78" (77.68")	1	39"	18"	19 1/2"	56"	18"	27"	6	4	8" D x 14" W	14"	32"
	84" (83.68")	1	42"	18"	21"	62"	18"	30"	6	4	8" D x 14" W	14"	35"
	90" (89.68")	1	45"	18"	22 1/2"	68"	18"	33"	6	4	8" D x 14" W	14"	38"
	96" (95.68")	1	48"	18"	24"	74"	18"	36"	6	4	8" D x 14" W	14"	41"
42" (41.68")	84" (83.68")	1	42"	21"	21"	62"	24"	30"	6	4	14" D x 14" W	14"	35"
	90" (89.68")	1	45"	21"	22 1/2"	68"	24"	33"	6	4	14" D x 14" W	14"	38"
	96" (95.68")	1	48"	21"	24"	74"	24"	36"	6	4	14" D x 14" W	14"	41"
	102" (101.68")	1	51"	21"	25 1/2"	80"	24"	39"	6	4	14" D x 14" W	14"	47"
	108" (107.68")	1	54"	21"	27"	86"	24"	42"	6	4	14" D x 14" W	14"	50"
	114" (113.68")	1	57"	21"	28 1/2"	92"	24"	45"	6	4	14" D x 14" W	14"	53"
48" (47.68")	120" (119.68")	1	60"	21"	30"	98"	24"	48"	6	4	14" D x 14" W	14"	56"
	84" (83.68")	1	42"	24"	21"	62"	23"	30"	6	4	14" D x 14" W	17"	35"
	90" (89.68")	1	45"	24"	22 1/2"	68"	23"	33"	6	4	14" D x 14" W	17"	38"
	96" (95.68")	1	48"	24"	24"	74"	23"	36"	6	4	14" D x 14" W	17"	41"
	102" (101.68")	1	51"	24"	25 1/2"	80"	23"	39"	6	4	14" D x 14" W	17"	47"
	108" (107.68")	1	54"	24"	27"	86"	23"	42"	6	4	14" D x 14" W	17"	50"
	114" (113.68")	1	57"	24"	28 1/2"	92"	23"	45"	6	4	14" D x 14" W	17"	53"
54" (53.68")	120" (119.68")	1	60"	24"	30"	98"	23"	48"	6	4	14" D x 14" W	17"	56"
	84" (83.68")	1	42"	27"	21"	62"	29"	30"	6	4	14" D x 14" W	20"	35"
	90" (89.68")	1	45"	27"	22 1/2"	68"	29"	33"	6	4	14" D x 14" W	20"	38"
	96" (95.68")	1	48"	27"	24"	74"	29"	36"	6	4	14" D x 14" W	20"	41"
	102" (101.68")	1	51"	27"	25 1/2"	80"	29"	39"	6	4	14" D x 14" W	20"	47"
	108" (107.68")	1	54"	27"	27"	86"	29"	42"	6	4	14" D x 14" W	20"	50"
60" (59.68")	114" (113.68")	1	57"	27"	28 1/2"	92"	29"	45"	6	4	14" D x 14" W	20"	53"
	120" (119.68")	1	60"	27"	30"	98"	29"	48"	6	4	14" D x 14" W	20"	56"
	84" (83.68")	1	42"	30"	21"	62"	35"	30"	6	4	14" D x 14" W	23"	35"
	90" (89.68")	1	45"	30"	22 1/2"	68"	35"	33"	6	4	14" D x 14" W	23"	38"
	96" (95.68")	1	48"	30"	24"	74"	35"	36"	6	4	14" D x 14" W	23"	41"
	102" (101.68")	1	51"	30"	25 1/2"	80"	35"	39"	6	4	14" D x 14" W	23"	47"
	108" (107.68")	1	54"	30"	27"	86"	35"	42"	6	4	14" D x 14" W	23"	50"

Product Details – Planes Conference Tables

Interior Leg Conference Table – One-Piece Top – Hexagon

Table Sizes and Seating Capacities – Without Cable Bases – Includes (6) Legs

• One-Piece Top Tables specified without a Cable Base are standard with 6 Legs.

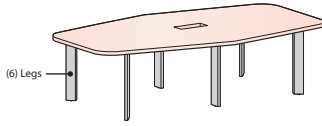

		WIDTHS								
		72" Wide	78" Wide	84" Wide	90" Wide	96" Wide	102" Wide	108" Wide	114" Wide	120" Wide
DEPTHS	36" Deep	 6 Chairs Maximum	 6 Chairs Maximum	 6 Chairs Maximum	 6 Chairs Maximum	 6 Chairs Maximum	N/A	N/A	N/A	N/A
	42" Deep	N/A	N/A	 6 Chairs Maximum	 6 Chairs Maximum	 6 Chairs Maximum	 6 Chairs Maximum	 6 Chairs Maximum	 6 Chairs Maximum	 10 Chairs Maximum
	48" Deep	N/A	N/A	 6 Chairs Maximum	 6 Chairs Maximum	 6 Chairs Maximum	 6 Chairs Maximum	 6 Chairs Maximum	 6 Chairs Maximum	 10 Chairs Maximum
	54" Deep	N/A	N/A	 6 Chairs Maximum	 6 Chairs Maximum	 6 Chairs Maximum	 6 Chairs Maximum	 6 Chairs Maximum	 6 Chairs Maximum	 10 Chairs Maximum
	60" Deep	N/A	N/A	 6 Chairs Maximum	 6 Chairs Maximum	 6 Chairs Maximum	 6 Chairs Maximum	 6 Chairs Maximum	 6 Chairs Maximum	 10 Chairs Maximum

Table Sizes and Seating Capacities – With Cable Bases – Includes (4) Legs

- One-Piece Top Tables specified with a Cable Base are standard with 4 Legs instead of 6 Legs because the Cable Base functions as a support for the center of the top.
- 36" Deep Tables specified with a Cable Base are ship with a 8" x 14" Cable Base.
- 42"-60" Deep Tables specified with a Cable Base are ship with a 14" x 14" Cable Base.

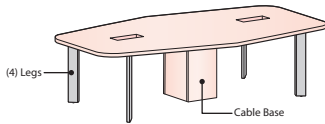

		WIDTHS								
		72" Wide	78" Wide	84" Wide	90" Wide	96" Wide	102" Wide	108" Wide	114" Wide	120" Wide
DEPTHS	36" Deep	 6 Chairs Max. (4 Legs/ 1 Cable Base)	 6 Chairs Max. (4 Legs/ 1 Cable Base)	 6 Chairs Max. (4 Legs/ 1 Cable Base)	 6 Chairs Max. (4 Legs/ 1 Cable Base)	 8 Chairs Max. (4 Legs/ 1 Cable Base)	N/A	N/A	N/A	N/A
	42" Deep	N/A	N/A	 6 Chairs Max. (4 Legs/ 1 Cable Base)	 6 Chairs Max. (4 Legs/ 1 Cable Base)	 8 Chairs Max. (4 Legs/ 1 Cable Base)	 8 Chairs Max. (4 Legs/ 1 Cable Base)	 10 Chairs Max. (4 Legs/ 1 Cable Base)	 8 Chairs Max. (4 Legs/ 1 Cable Base)	 8 Chairs Max. (4 Legs/ 1 Cable Base)
	48" Deep	N/A	N/A	 6 Chairs Max. (4 Legs/ 1 Cable Base)	 6 Chairs Max. (4 Legs/ 1 Cable Base)	 8 Chairs Max. (4 Legs/ 1 Cable Base)	 8 Chairs Max. (4 Legs/ 1 Cable Base)	 10 Chairs Max. (4 Legs/ 1 Cable Base)	 8 Chairs Max. (4 Legs/ 1 Cable Base)	 8 Chairs Max. (4 Legs/ 1 Cable Base)
	54" Deep	N/A	N/A	 6 Chairs Max. (4 Legs/ 1 Cable Base)	 6 Chairs Max. (4 Legs/ 1 Cable Base)	 8 Chairs Max. (4 Legs/ 1 Cable Base)	 8 Chairs Max. (4 Legs/ 1 Cable Base)	 8 Chairs Max. (4 Legs/ 1 Cable Base)	 8 Chairs Max. (4 Legs/ 1 Cable Base)	 8 Chairs Max. (4 Legs/ 1 Cable Base)
	60" Deep	N/A	N/A	 6 Chairs Max. (4 Legs/ 1 Cable Base)	 6 Chairs Max. (4 Legs/ 1 Cable Base)	 8 Chairs Max. (4 Legs/ 1 Cable Base)	 8 Chairs Max. (4 Legs/ 1 Cable Base)	 8 Chairs Max. (4 Legs/ 1 Cable Base)	 8 Chairs Max. (4 Legs/ 1 Cable Base)	 8 Chairs Max. (4 Legs/ 1 Cable Base)

Note Recommended seating capacity based upon a width of 27" per chair.

Product Details – Planes Conference Tables

Interior Leg Conference Table – Two-Piece Top – Rectangular

Without Cable Base

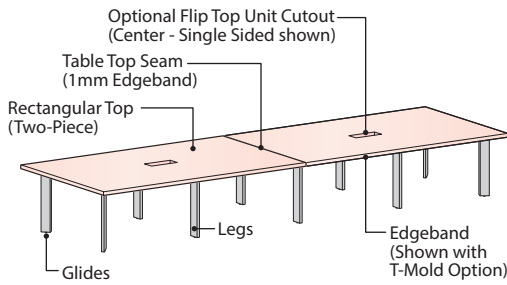

With Cable Base

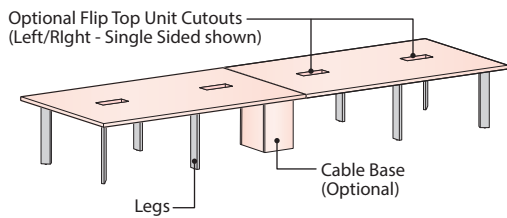

Edge Options for Laminate Tops

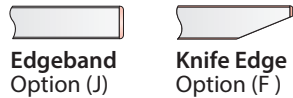

Edge Options for Wood Tops

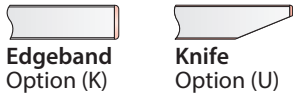

Component Materials/Finishes

COMPONENT NAME	MATERIALS/ FINISHES
Rectangle Top 2-Piece top with 1mm edgeband seam	Laminate Top – Specify separate finish colors for top and edge trim • Edge Options: (J) Edgeband, (F) Knife
	Wood Top – Specify a single finish color for the top and edge trim • Edge Options: (K) Edgeband, (U) Knife
Interior Legs	Painted Metal – Specified Trim Color
Glides	Standard in Black
Cable Base (Optional)	Panels Laminate Panels – Specified surface and edge trim colors Wood Panels – Specified top and edge trim wood finish color
	Frame Painted Metal – Standard in Black

Flip Top Unit Cutout Options

Center Cutout Option

- Includes 3 Flip Top Unit cutouts (1 Cutout centered on each top piece)

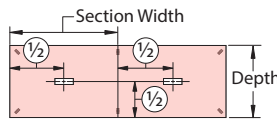

Left/Right Cutout Option

- Includes 6 Flip Top Unit cutouts (2 Cutouts on each top piece)

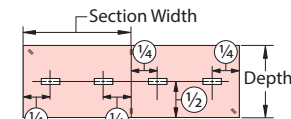

Cutout Option (F or V)

- For use with Single Sided/ 4 Port Flip Top Unit

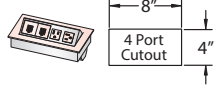

Cutout Option (J or K)

- For use with Single Sided/ 6 Ports Flip Top Unit

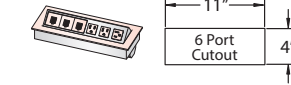

Cutout Option (M or P)

- For use with Double Sided/ 8 Ports Flip Top Unit

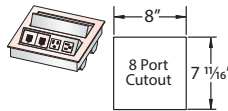

Cutout Option (Q or T)

- For use with Double Sided/ 12 Ports Flip Top Unit

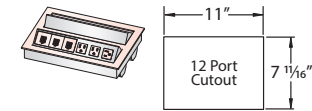

Note Flip Top Units are separately specified.

Cable Base Options

- Tables may be specified with or without Cable Bases
 - (Option N) No Cable Base.
 - (Option C) Includes 14" x 14" Cable Bases

Two-Piece Table with Cable Base option (Top View)

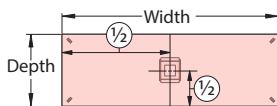

Cable Base is centered on the seam between top pieces.

14" x 14" Cable Base (42", 48", 54", 60" Deep Tables)

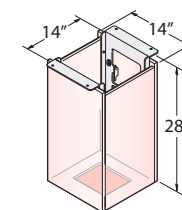

Product Details – Planes Conference Tables

Interior Leg Conference Table – Two-Piece Top – Rectangular

**Dimensions – 126"-132" Wide
Tables Without Cable Base
Includes (6) Legs**

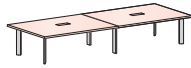

Top View

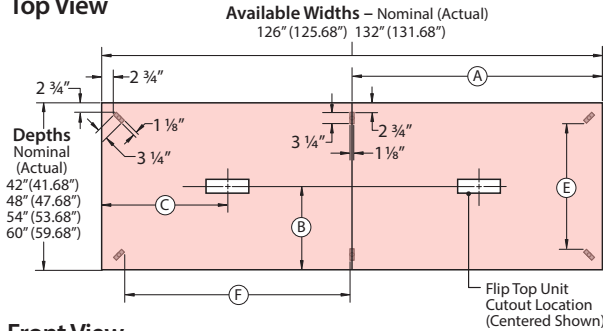

Front View

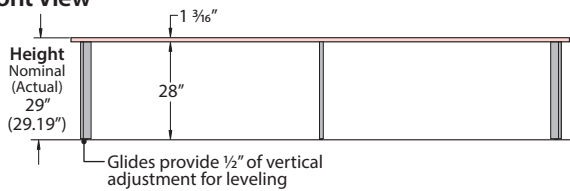

**Dimensions – 138"-180" Wide
Tables Without Cable Base
Includes (10) Legs**

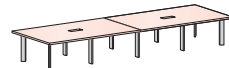

Top View

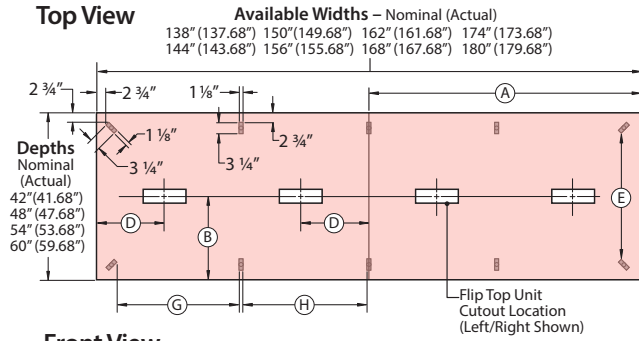

Front View

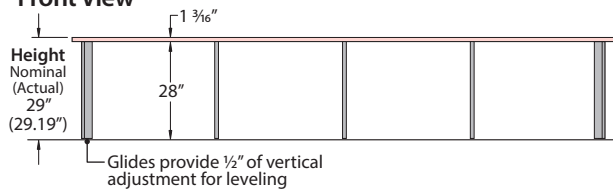

Dimensions

Depth Nominal (Actual)	TABLETOP				KNEESPACE (Nominal)				LEGS		
	Width Nominal (Actual)	Number of Top Pieces	(A)	(B)	(C)	(D)	(E)	(F)	(G)	(H)	Number of Legs Without Cable Base
42" (41.68")	126" (125.68")	2	63"	21"	31 1/2"	15 3/4"	27"	55"	N/A	N/A	6
	132" (131.68")	2	66"	21"	33"	16 1/2"	27"	58"	N/A	N/A	6
	138" (137.68")	2	69"	21"	34 1/2"	17 1/4"	27"	N/A	26"	33"	10
	144" (143.68")	2	72"	21"	36"	18"	27"	N/A	28"	34"	10
	150" (149.68")	2	75"	21"	37 1/2"	18 3/4"	27"	N/A	29"	36"	10
	156" (155.68")	2	78"	21"	39"	19 1/2"	27"	N/A	31"	37"	10
	162" (161.68")	2	81"	21"	40 1/2"	20 1/4"	27"	N/A	32"	39"	10
	168" (167.68")	2	84"	21"	42"	21"	27"	N/A	34"	40"	10
	174" (173.68")	2	87"	21"	43 1/2"	21 3/4"	27"	N/A	35"	42"	10
	180" (179.68")	2	90"	21"	45"	22 1/2"	27"	N/A	37"	43"	10
48" (47.68")	126" (125.68")	2	63"	24"	31 1/2"	15 3/4"	33"	55"	N/A	N/A	6
	132" (131.68")	2	66"	24"	33"	16 1/2"	33"	58"	N/A	N/A	6
	138" (137.68")	2	69"	24"	34 1/2"	17 1/4"	33"	N/A	26"	33"	10
	144" (143.68")	2	72"	24"	36"	18"	33"	N/A	28"	34"	10
	150" (149.68")	2	75"	24"	37 1/2"	18 3/4"	33"	N/A	29"	36"	10
	156" (155.68")	2	78"	24"	39"	19 1/2"	33"	N/A	31"	37"	10
	162" (161.68")	2	81"	24"	40 1/2"	20 1/4"	33"	N/A	32"	39"	10
	168" (167.68")	2	84"	24"	42"	21"	33"	N/A	34"	40"	10
	174" (173.68")	2	87"	24"	43 1/2"	21 3/4"	33"	N/A	35"	42"	10
	180" (179.68")	2	90"	24"	45"	22 1/2"	33"	N/A	37"	43"	10
54" (53.68")	126" (125.68")	2	63"	27"	31 1/2"	15 3/4"	39"	55"	N/A	N/A	6
	132" (131.68")	2	66"	27"	33"	16 1/2"	39"	58"	N/A	N/A	6
	138" (137.68")	2	69"	27"	34 1/2"	17 1/4"	39"	N/A	26"	33"	10
	144" (143.68")	2	72"	27"	36"	18"	39"	N/A	28"	34"	10
	150" (149.68")	2	75"	27"	37 1/2"	18 3/4"	39"	N/A	29"	36"	10
	156" (155.68")	2	78"	27"	39"	19 1/2"	39"	N/A	31"	37"	10
	162" (161.68")	2	81"	27"	40 1/2"	20 1/4"	39"	N/A	32"	39"	10
	168" (167.68")	2	84"	27"	42"	21"	39"	N/A	34"	40"	10
	174" (173.68")	2	87"	27"	43 1/2"	21 3/4"	39"	N/A	35"	42"	10
	180" (179.68")	2	90"	27"	45"	22 1/2"	39"	N/A	37"	43"	10
60" (59.68")	126" (125.68")	2	63"	30"	31 1/2"	15 3/4"	45"	55"	N/A	N/A	6
	132" (131.68")	2	66"	30"	33"	16 1/2"	45"	58"	N/A	N/A	6
	138" (137.68")	2	69"	30"	34 1/2"	17 1/4"	45"	N/A	26"	33"	10
	144" (143.68")	2	72"	30"	36"	18"	45"	N/A	28"	34"	10
	150" (149.68")	2	75"	30"	37 1/2"	18 3/4"	45"	N/A	29"	36"	10
	156" (155.68")	2	78"	30"	39"	19 1/2"	45"	N/A	31"	37"	10
	162" (161.68")	2	81"	30"	40 1/2"	20 1/4"	45"	N/A	32"	39"	10
	168" (167.68")	2	84"	30"	42"	21"	45"	N/A	34"	40"	10
	174" (173.68")	2	87"	30"	43 1/2"	21 3/4"	45"	N/A	35"	42"	10
	180" (179.68")	2	90"	30"	45"	22 1/2"	45"	N/A	37"	43"	10

Product Details – Planes Conference Tables

Interior Leg Conference Table – Two-Piece Top – Rectangular

**Dimensions – 126"-132" Wide
Tables With Cable Base
Includes (4) Legs**

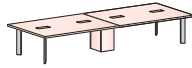

Top View

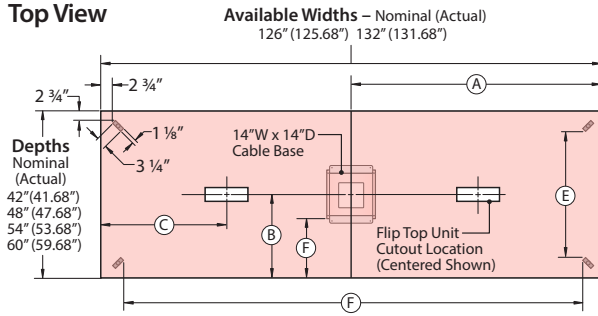

Front View

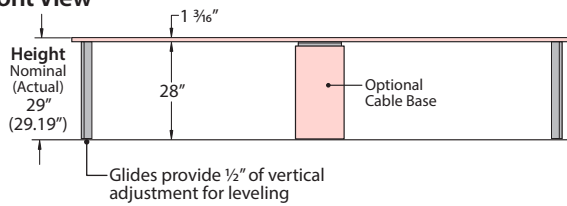

**Dimensions – 138"-180" Wide
Tables With Cable Base
Includes (8) Legs**

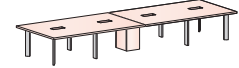

Top View

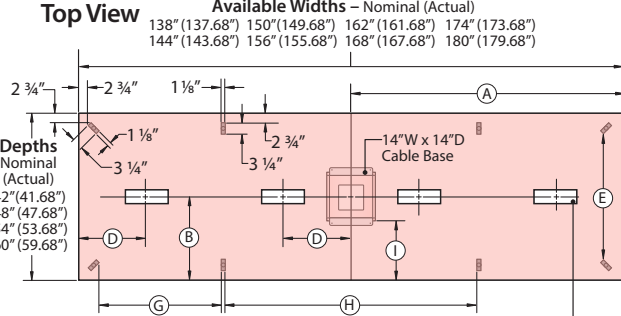

Front View

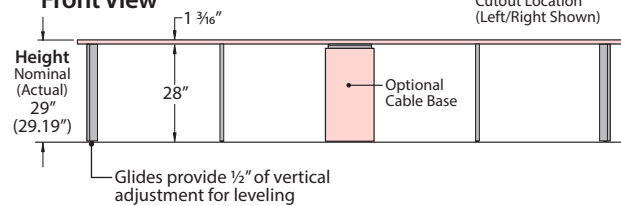

Dimensions

Depth Nominal (Actual)	TABLETOP						KNEESPACE (Nominal)					LEGS	CABLE BASE
	Width Nominal (Actual)	Number of Top Pieces	A	B	C	D	E	F	G	H	I	Number of Legs With Cable Base	Optional Cable Base Sizes
42" (41.68")	126" (125.68")	2	63"	21"	31 1/2"	15 3/4"	27"	112"	N/A	N/A	14"	4	14" D x 14" W
	132" (131.68")	2	66"	21"	33"	16 1/2"	27"	118"	N/A	N/A	14"	4	14" D x 14" W
	138" (137.68")	2	69"	21"	34 1/2"	17 1/4"	27"	N/A	26"	68"	14"	8	14" D x 14" W
	144" (143.68")	2	72"	21"	36"	18"	27"	N/A	28"	70"	14"	8	14" D x 14" W
	150" (149.68")	2	75"	21"	37 1/2"	18 3/4"	27"	N/A	29"	74"	14"	8	14" D x 14" W
	156" (155.68")	2	78"	21"	39"	19 1/2"	27"	N/A	31"	76"	14"	8	14" D x 14" W
	162" (161.68")	2	81"	21"	40 1/2"	20 1/4"	27"	N/A	32"	80"	14"	8	14" D x 14" W
	168" (167.68")	2	84"	21"	42"	21"	27"	N/A	34"	82"	14"	8	14" D x 14" W
	174" (173.68")	2	87"	21"	43 1/2"	21 3/4"	27"	N/A	35"	86"	14"	8	14" D x 14" W
180" (179.68")	2	90"	21"	45"	22 1/2"	27"	N/A	37"	88"	14"	8	14" D x 14" W	
48" (47.68")	126" (125.68")	2	63"	24"	31 1/2"	15 3/4"	33"	112"	N/A	N/A	17"	4	14" D x 14" W
	132" (131.68")	2	66"	24"	33"	16 1/2"	33"	118"	N/A	N/A	17"	4	14" D x 14" W
	138" (137.68")	2	69"	24"	34 1/2"	17 1/4"	33"	N/A	26"	68"	17"	8	14" D x 14" W
	144" (143.68")	2	72"	24"	36"	18"	33"	N/A	28"	70"	17"	8	14" D x 14" W
	150" (149.68")	2	75"	24"	37 1/2"	18 3/4"	33"	N/A	29"	74"	17"	8	14" D x 14" W
	156" (155.68")	2	78"	24"	39"	19 1/2"	33"	N/A	31"	76"	17"	8	14" D x 14" W
	162" (161.68")	2	81"	24"	40 1/2"	20 1/4"	33"	N/A	32"	80"	17"	8	14" D x 14" W
	168" (167.68")	2	84"	24"	42"	21"	33"	N/A	34"	82"	17"	8	14" D x 14" W
	174" (173.68")	2	87"	24"	43 1/2"	21 3/4"	33"	N/A	35"	86"	17"	8	14" D x 14" W
180" (179.68")	2	90"	24"	45"	22 1/2"	33"	N/A	37"	88"	17"	8	14" D x 14" W	
54" (53.68")	126" (125.68")	2	63"	27"	31 1/2"	15 3/4"	39"	112"	N/A	N/A	20"	4	14" D x 14" W
	132" (131.68")	2	66"	27"	33"	16 1/2"	39"	118"	N/A	N/A	20"	4	14" D x 14" W
	138" (137.68")	2	69"	27"	34 1/2"	17 1/4"	39"	N/A	26"	68"	20"	8	14" D x 14" W
	144" (143.68")	2	72"	27"	36"	18"	39"	N/A	28"	70"	20"	8	14" D x 14" W
	150" (149.68")	2	75"	27"	37 1/2"	18 3/4"	39"	N/A	29"	74"	20"	8	14" D x 14" W
	156" (155.68")	2	78"	27"	39"	19 1/2"	39"	N/A	31"	76"	20"	8	14" D x 14" W
	162" (161.68")	2	81"	27"	40 1/2"	20 1/4"	39"	N/A	32"	80"	20"	8	14" D x 14" W
	168" (167.68")	2	84"	27"	42"	21"	39"	N/A	34"	82"	20"	8	14" D x 14" W
	174" (173.68")	2	87"	27"	43 1/2"	21 3/4"	39"	N/A	35"	86"	20"	8	14" D x 14" W
180" (179.68")	2	90"	27"	45"	22 1/2"	39"	N/A	37"	88"	20"	8	14" D x 14" W	
60" (59.68")	126" (125.68")	2	63"	30"	31 1/2"	15 3/4"	45"	112"	N/A	N/A	23"	4	14" D x 14" W
	132" (131.68")	2	66"	30"	33"	16 1/2"	45"	118"	N/A	N/A	23"	4	14" D x 14" W
	138" (137.68")	2	69"	30"	34 1/2"	17 1/4"	45"	N/A	26"	68"	23"	8	14" D x 14" W
	144" (143.68")	2	72"	30"	36"	18"	45"	N/A	28"	70"	23"	8	14" D x 14" W
	150" (149.68")	2	75"	30"	37 1/2"	18 3/4"	45"	N/A	29"	74"	23"	8	14" D x 14" W
	156" (155.68")	2	78"	30"	39"	19 1/2"	45"	N/A	31"	76"	23"	8	14" D x 14" W
	162" (161.68")	2	81"	30"	40 1/2"	20 1/4"	45"	N/A	32"	80"	23"	8	14" D x 14" W
	168" (167.68")	2	84"	30"	42"	21"	45"	N/A	34"	82"	23"	8	14" D x 14" W
	174" (173.68")	2	87"	30"	43 1/2"	21 3/4"	45"	N/A	35"	86"	23"	8	14" D x 14" W
180" (179.68")	2	90"	30"	45"	22 1/2"	45"	N/A	37"	88"	23"	8	14" D x 14" W	

Product Details – Planes Height Adjustable Tables

Interior Leg Conference Table – Two-Piece Top – Rectangular

Table Sizes and Seating Capacities – Without Cable Bases – Includes (10) Legs

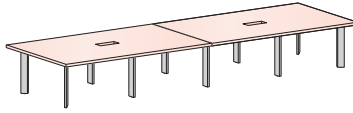

- 126" and 132" Wide Two-Piece Top Tables specified without a Cable Base are standard with 6 Legs.
- 138", 144", 150", 156", 162", 168", 174", 180" Wide Two-Piece Top Tables specified without a Cable Base are standard with 10 Legs.

		WIDTHS									
		126" Wide	132" Wide	138" Wide	144" Wide	150" Wide	156" Wide	162" Wide	168" Wide	174" Wide	180" Wide
DEPTHS	42" Deep										
	48" Deep										
	54" Deep										
	60" Deep										

Table Sizes and Seating Capacities – With Cable Bases – Includes (4) Legs

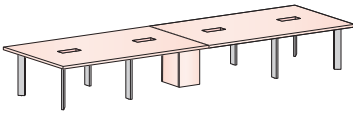

- 126" and 132" Wide Two-Piece Top Tables specified with a Cable Base are standard with 4 Legs.
- 138", 144", 150", 156", 162", 168", 174", 180" Wide Two-Piece Top Tables specified with a Cable Base are standard with 8 Legs.

		WIDTHS									
		126" Wide	132" Wide	138" Wide	144" Wide	150" Wide	156" Wide	162" Wide	168" Wide	174" Wide	180" Wide
DEPTHS	42" Deep										
	48" Deep										
	54" Deep										
	60" Deep										

Note Recommended seating capacity based upon a width of 27" per chair.

Product Details – Planes Conference Tables

Interior Leg Conference Table – Two-Piece Top – Pebble

Without Cable Base

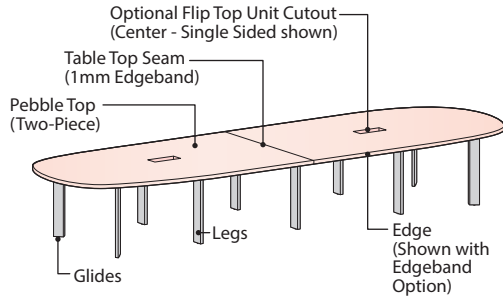

With Cable Base

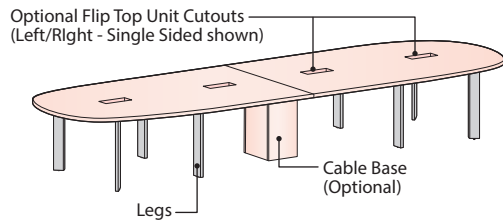

Edge Options for Laminate Tops

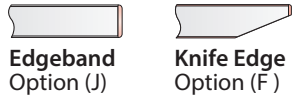

Edge Options for Wood Tops



Component Materials/Finishes

COMPONENT NAME	MATERIALS/ FINISHES
Pebble Top 2-Piece top with 1mm edgeband seam	Laminate Top – Specify separate finish colors for top and edge trim • Edge Options: (J) Edgeband, (F) Knife
	Wood Top – Specify a single finish color for the top and edge trim • Edge Options: (K) Edgeband, (U) Knife
Interior Legs	Painted Metal – Specified Trim Color
Glides	Standard in Black
Cable Base (Optional)	Panels Laminate Panels – Specified surface and edge trim colors Wood Panels – Specified top and edge trim wood finish color
	Frame Painted Metal – Standard in Black

Flip Top Unit Cutout Options

Center Cutout Option

- Includes 3 Flip Top Unit cutouts (1 Cutout centered on each top piece)

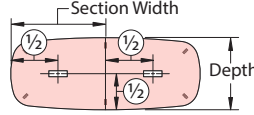

Left/Right Cutout Option

- Includes 6 Flip Top Unit cutouts (2 Cutouts on each top piece)

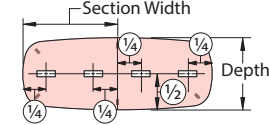

Cutout Option (F or V)

- For use with Single Sided/ 4 Port Flip Top Unit

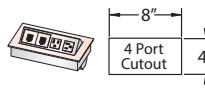

Cutout Option (J or K)

- For use with Single Sided/ 6 Ports Flip Top Unit

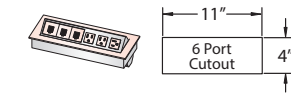

Cutout Option (M or P)

- For use with Double Sided/ 8 Ports Flip Top Unit

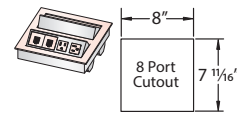

Cutout Option (Q or T)

- For use with Double Sided/ 12 Ports Flip Top Unit

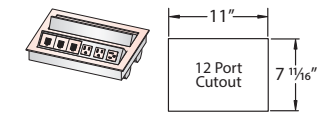

Note Flip Top Units are separately specified.

Cable Base Options

- Tables may be specified with or without Cable Bases
 - (Option N) No Cable Base.
 - (Option C) Includes 14" x 14" Cable Bases

Two-Piece Table with Cable Base option (Top View)

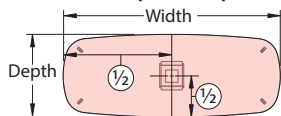

Cable Base is centered on the seam between top pieces.

14" x 14" Cable Base (42", 48", 54", 60" Deep Tables)

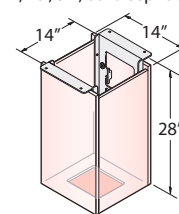

Product Details – Planes Conference Tables

Interior Leg Conference Table – Two-Piece Top – Pebble

**Dimensions – 126"-144" Wide
Tables Without Cable Base
Includes (6) Legs**

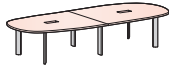

**Dimensions – 150"-180" Wide
Tables Without Cable Base
Includes (10) Legs**

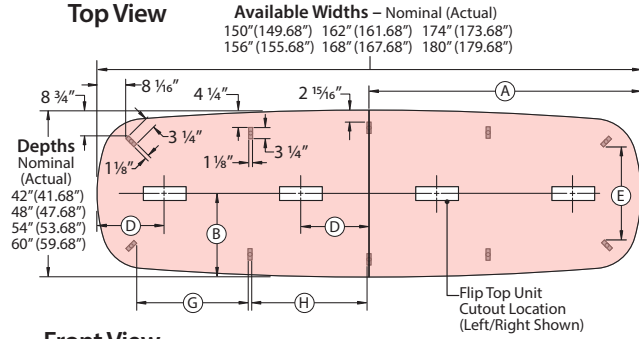
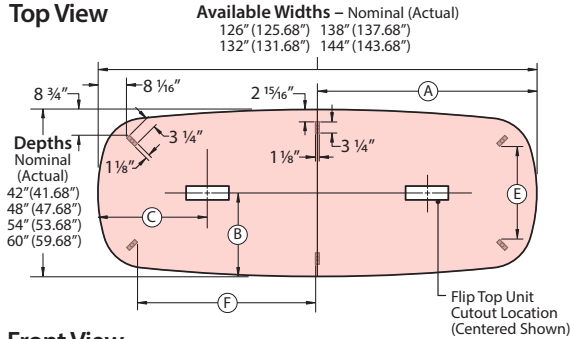
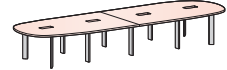

Dimensions

Depth Nominal (Actual)	TABLETOP						KNEESPACE (Nominal)				Number of Legs Without Cable Base
	Width Nominal (Actual)	Number of Top Pieces	A	B	C	D	E	F	G	H	
42" (41.68")	126" (125.68")	2	63"	21"	31 1/2"	15 3/4"	22"	51"	N/A	N/A	6
	132" (131.68")	2	66"	21"	33"	16 1/2"	22"	54"	N/A	N/A	6
	138" (137.68")	2	69"	21"	34 1/2"	17 1/4"	22"	57"	N/A	N/A	6
	144" (143.68")	2	72"	21"	36"	18"	22"	60"	N/A	N/A	6
	150" (149.68")	2	75"	21"	37 1/2"	18 3/4"	22"	N/A	30"	32"	10
	156" (155.68")	2	78"	21"	39"	19 1/2"	22"	N/A	32"	33"	10
	162" (161.68")	2	81"	21"	40 1/2"	20 1/4"	22"	N/A	33"	35"	10
	168" (167.68")	2	84"	21"	42"	21"	22"	N/A	35"	36"	10
48" (47.68")	174" (173.68")	2	87"	21"	43 1/2"	21 3/4"	22"	N/A	36"	38"	10
	180" (179.68")	2	90"	21"	45"	22 1/2"	22"	N/A	38"	39"	10
	126" (125.68")	2	63"	24"	31 1/2"	15 3/4"	27"	51"	N/A	N/A	6
	132" (131.68")	2	66"	24"	33"	16 1/2"	27"	54"	N/A	N/A	6
	138" (137.68")	2	69"	24"	34 1/2"	17 1/4"	27"	57"	N/A	N/A	6
	144" (143.68")	2	72"	24"	36"	18"	27"	60"	N/A	N/A	6
	150" (149.68")	2	75"	24"	37 1/2"	18 3/4"	27"	N/A	30"	32"	10
	156" (155.68")	2	78"	24"	39"	19 1/2"	27"	N/A	32"	33"	10
54" (53.68")	162" (161.68")	2	81"	24"	40 1/2"	20 1/4"	27"	N/A	33"	35"	10
	168" (167.68")	2	84"	24"	42"	21"	27"	N/A	35"	36"	10
	174" (173.68")	2	87"	24"	43 1/2"	21 3/4"	27"	N/A	36"	38"	10
	180" (179.68")	2	90"	24"	45"	22 1/2"	27"	N/A	38"	39"	10
	126" (125.68")	2	63"	27"	31 1/2"	15 3/4"	32"	51"	N/A	N/A	6
	132" (131.68")	2	66"	27"	33"	16 1/2"	32"	54"	N/A	N/A	6
	138" (137.68")	2	69"	27"	34 1/2"	17 1/4"	32"	57"	N/A	N/A	6
	144" (143.68")	2	72"	27"	36"	18"	32"	60"	N/A	N/A	6
60" (59.68")	150" (149.68")	2	75"	27"	37 1/2"	18 3/4"	32"	N/A	30"	32"	10
	156" (155.68")	2	78"	27"	39"	19 1/2"	32"	N/A	32"	33"	10
	162" (161.68")	2	81"	27"	40 1/2"	20 1/4"	32"	N/A	33"	35"	10
	168" (167.68")	2	84"	27"	42"	21"	32"	N/A	35"	36"	10
	174" (173.68")	2	87"	27"	43 1/2"	21 3/4"	32"	N/A	36"	38"	10
	180" (179.68")	2	90"	27"	45"	22 1/2"	32"	N/A	38"	39"	10
	126" (125.68")	2	63"	30"	31 1/2"	15 3/4"	36"	51"	N/A	N/A	6
	132" (131.68")	2	66"	30"	33"	16 1/2"	36"	54"	N/A	N/A	6
138" (137.68")	2	69"	30"	34 1/2"	17 1/4"	36"	57"	N/A	N/A	6	
144" (143.68")	2	72"	30"	36"	18"	36"	60"	N/A	N/A	6	
150" (149.68")	2	75"	30"	37 1/2"	18 3/4"	36"	N/A	30"	32"	10	
156" (155.68")	2	78"	30"	39"	19 1/2"	36"	N/A	32"	33"	10	
162" (161.68")	2	81"	30"	40 1/2"	20 1/4"	36"	N/A	33"	35"	10	
168" (167.68")	2	84"	30"	42"	21"	36"	N/A	35"	36"	10	
174" (173.68")	2	87"	30"	43 1/2"	21 3/4"	36"	N/A	36"	38"	10	
180" (179.68")	2	90"	30"	45"	22 1/2"	36"	N/A	38"	39"	10	

Product Details – Planes Conference Tables

Interior Leg Conference Table – Two-Piece Top – Pebble

**Dimensions – 126"-144" Wide
Tables With Cable Base
Includes (4) Legs**

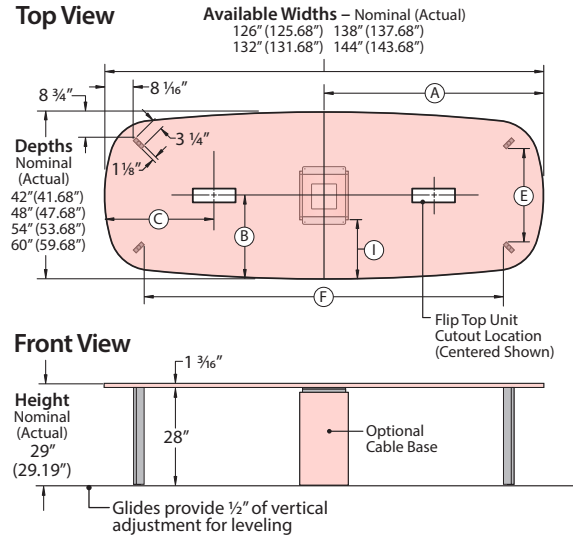
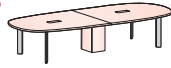

**Dimensions – 150"-180" Wide
Tables With Cable Base
Includes (8) Legs**

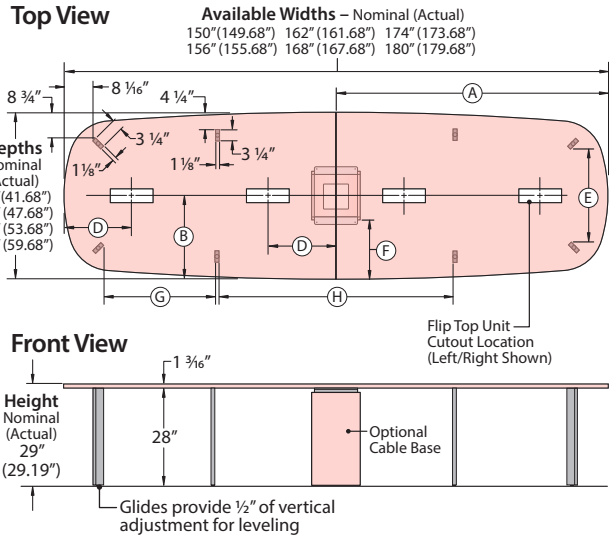
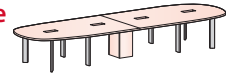

Dimensions

Depth Nominal (Actual)	TABLETOP						KNEESPACE (Nominal)					LEGS	CABLE BASE
	Width Nominal (Actual)	Number of Top Pieces	A	B	C	D	E	F	G	H	I	Number of Legs With Cable Base	Optional Cable Base Sizes
42" (41.68")	126" (125.68")	2	63"	21"	31 1/2"	15 3/4"	22"	104"	N/A	N/A	14"	4	14"D x 14"W
	132" (131.68")	2	66"	21"	33"	16 1/2"	22"	110"	N/A	N/A	14"	4	14"D x 14"W
	138" (137.68")	2	69"	21"	34 1/2"	17 1/4"	22"	116"	N/A	N/A	14"	4	14"D x 14"W
	144" (143.68")	2	72"	21"	36"	18"	22"	122"	N/A	N/A	14"	4	14"D x 14"W
	150" (149.68")	2	75"	21"	37 1/2"	18 3/4"	22"	N/A	30"	66"	14"	8	14"D x 14"W
	156" (155.68")	2	78"	21"	39"	19 1/2"	22"	N/A	32"	68"	14"	8	14"D x 14"W
	162" (161.68")	2	81"	21"	40 1/2"	20 1/4"	22"	N/A	33"	72"	14"	8	14"D x 14"W
	168" (167.68")	2	84"	21"	42"	21"	22"	N/A	35"	74"	14"	8	14"D x 14"W
48" (47.68")	174" (173.68")	2	87"	21"	43 1/2"	21 3/4"	22"	N/A	36"	78"	14"	8	14"D x 14"W
	180" (179.68")	2	90"	21"	45"	22 1/2"	22"	N/A	38"	80"	14"	8	14"D x 14"W
	126" (125.68")	2	63"	24"	31 1/2"	15 3/4"	27"	104"	N/A	N/A	17"	4	14"D x 14"W
	132" (131.68")	2	66"	24"	33"	16 1/2"	27"	110"	N/A	N/A	17"	4	14"D x 14"W
	138" (137.68")	2	69"	24"	34 1/2"	17 1/4"	27"	116"	N/A	N/A	17"	4	14"D x 14"W
	144" (143.68")	2	72"	24"	36"	18"	27"	122"	N/A	N/A	17"	4	14"D x 14"W
	150" (149.68")	2	75"	24"	37 1/2"	18 3/4"	27"	N/A	30"	66"	17"	8	14"D x 14"W
	156" (155.68")	2	78"	24"	39"	19 1/2"	27"	N/A	32"	68"	17"	8	14"D x 14"W
54" (53.68")	162" (161.68")	2	81"	24"	40 1/2"	20 1/4"	27"	N/A	33"	72"	17"	8	14"D x 14"W
	168" (167.68")	2	84"	24"	42"	21"	27"	N/A	35"	74"	17"	8	14"D x 14"W
	174" (173.68")	2	87"	24"	43 1/2"	21 3/4"	27"	N/A	36"	78"	17"	8	14"D x 14"W
	180" (179.68")	2	90"	24"	45"	22 1/2"	27"	N/A	38"	80"	17"	8	14"D x 14"W
	126" (125.68")	2	63"	27"	31 1/2"	15 3/4"	32"	104"	N/A	N/A	20"	4	14"D x 14"W
	132" (131.68")	2	66"	27"	33"	16 1/2"	32"	110"	N/A	N/A	20"	4	14"D x 14"W
	138" (137.68")	2	69"	27"	34 1/2"	17 1/4"	32"	116"	N/A	N/A	20"	4	14"D x 14"W
	144" (143.68")	2	72"	27"	36"	18"	32"	122"	N/A	N/A	20"	4	14"D x 14"W
60" (59.68")	150" (149.68")	2	75"	27"	37 1/2"	18 3/4"	32"	N/A	30"	66"	20"	8	14"D x 14"W
	156" (155.68")	2	78"	27"	39"	19 1/2"	32"	N/A	32"	68"	20"	8	14"D x 14"W
	162" (161.68")	2	81"	27"	40 1/2"	20 1/4"	32"	N/A	33"	72"	20"	8	14"D x 14"W
	168" (167.68")	2	84"	27"	42"	21"	32"	N/A	35"	74"	20"	8	14"D x 14"W
	174" (173.68")	2	87"	27"	43 1/2"	21 3/4"	32"	N/A	36"	78"	20"	8	14"D x 14"W
	180" (179.68")	2	90"	27"	45"	22 1/2"	32"	N/A	38"	80"	20"	8	14"D x 14"W
	126" (125.68")	2	63"	30"	31 1/2"	15 3/4"	36"	104"	N/A	N/A	23"	4	14"D x 14"W
	132" (131.68")	2	66"	30"	33"	16 1/2"	36"	110"	N/A	N/A	23"	4	14"D x 14"W
138" (137.68")	2	69"	30"	34 1/2"	17 1/4"	36"	116"	N/A	N/A	23"	4	14"D x 14"W	
144" (143.68")	2	72"	30"	36"	18"	36"	122"	N/A	N/A	23"	4	14"D x 14"W	
150" (149.68")	2	75"	30"	37 1/2"	18 3/4"	36"	N/A	30"	66"	23"	8	14"D x 14"W	
156" (155.68")	2	78"	30"	39"	19 1/2"	36"	N/A	32"	68"	23"	8	14"D x 14"W	
162" (161.68")	2	81"	30"	40 1/2"	20 1/4"	36"	N/A	33"	72"	23"	8	14"D x 14"W	
168" (167.68")	2	84"	30"	42"	21"	36"	N/A	35"	74"	23"	8	14"D x 14"W	
174" (173.68")	2	87"	30"	43 1/2"	21 3/4"	36"	N/A	36"	78"	23"	8	14"D x 14"W	
180" (179.68")	2	90"	30"	45"	22 1/2"	36"	N/A	38"	80"	23"	8	14"D x 14"W	

Product Details – Planes Height Adjustable Tables

Interior Leg Conference Table – Two-Piece Top – Pebble

Table Sizes and Seating Capacities – Without Cable Bases

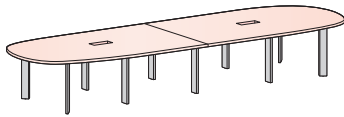

- 126", 132", 138" and 144" Wide Two-Piece Top Tables specified without a Cable Base are standard with 6 Legs.
- 150", 156", 162", 168", 174", 180" Wide Two-Piece Top Tables specified without a Cable Base are standard with 10 Legs.

		WIDTHS									
		126" Wide	132" Wide	138" Wide	144" Wide	150" Wide	156" Wide	162" Wide	168" Wide	174" Wide	180" Wide
DEPTHS	42" Deep										
	48" Deep										
	54" Deep										
	60" Deep										

Table Sizes and Seating Capacities – With Cable Bases

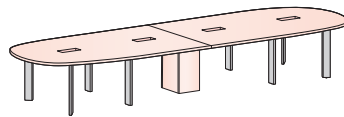

- 126", 132", 138" and 144" Wide Two-Piece Top Tables specified with a Cable Base are standard with 4 Legs.
- 150", 156", 162", 168", 174", 180" Wide Two-Piece Top Tables specified with a Cable Base are standard with 8 Legs.

		WIDTHS									
		126" Wide	132" Wide	138" Wide	144" Wide	150" Wide	156" Wide	162" Wide	168" Wide	174" Wide	180" Wide
DEPTHS	42" Deep										
	48" Deep										
	54" Deep										
	60" Deep										

Note Recommended seating capacity based upon a width of 27" per chair.

Product Details – Planes Conference Tables

Interior Leg Conference Table – Two-Piece Top – Hexagon

Without Cable Base – Includes (10) Legs

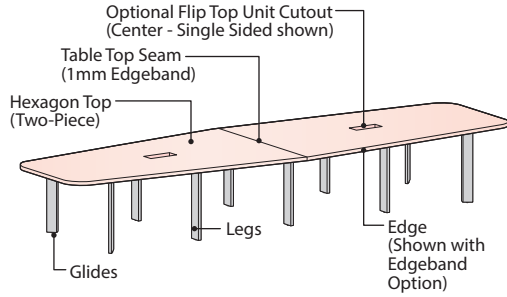

With Cable Base – Includes (8) Legs

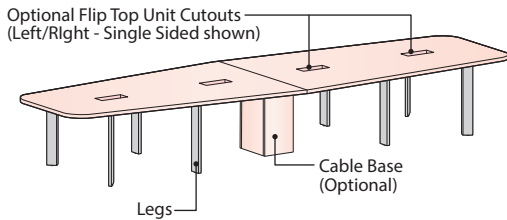

Edge Options for Laminate Tops

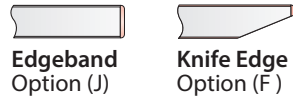

Edge Options for Wood Tops

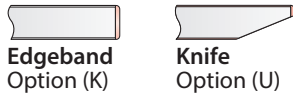

Component Materials/Finishes

COMPONENT NAME		MATERIALS/ FINISHES
Hexagon Top 2-Piece top with 1mm edgeband seam		Laminate Top – Specify separate finish colors for top and edge trim • Edge Options: (T) T-Mold, (J) Edgeband, (F) Knife Wood Top – Specify a single finish color for the top and edge trim • Edge Options: (K) Edgeband, (M) Cascade, (U) Knife
Interior Legs		Painted Metal – Specified Trim Color
Glides		Standard in Black
Cable Base (Optional)	Panels	Laminate Panels – Specified surface and edge trim colors Wood Panels – Specified top and edge trim wood finish color
	Frame	Painted Metal – Standard in Black

Flip Top Unit Cutout Options

Center Cutout Option

- Includes 3 Flip Top Unit cutouts (1 Cutout centered on each top piece)

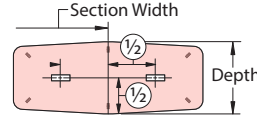

Left/Right Cutout Option

- Includes 6 Flip Top Unit cutouts (2 Cutouts on each top piece)

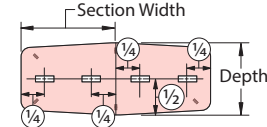

Cutout Option (F or V)

- For use with Single Sided/ 4 Port Flip Top Unit

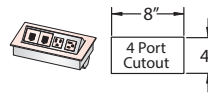

Cutout Option (J or K)

- For use with Single Sided/ 6 Port Flip Top Unit

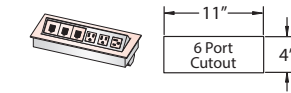

Cutout Option (M or P)

- For use with Double Sided/ 8 1/2 Ports Flip Top Unit

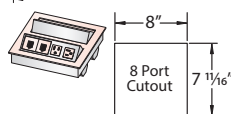

Cutout Option (Q or T)

- For use with Double Sided/ 12 Ports Flip Top Unit

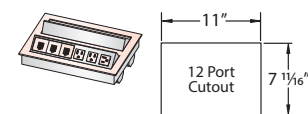

Note Flip Top Units are separately specified.

Cable Base Options

- Tables may be specified with or without Cable Bases
 - (Option N) No Cable Base.
 - (Option C) Includes (2) 14" x 14" Cable Bases

Two-Piece Table with Cable Base option (Top View)

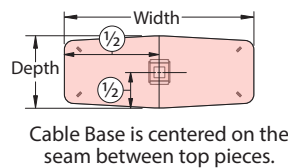

14" x 14" Cable Base (42", 48", 54", 60" Deep Tables)

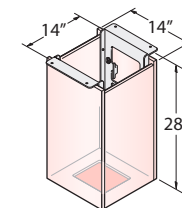

Cable Base is centered on the seam between top pieces.

Product Details – Planes Conference Tables

Interior Leg Conference Table – Two-Piece Top – Hexagon

**Dimensions – 126"-144" Wide
Tables Without Cable Base
Includes (6) Legs**

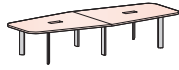

Top View

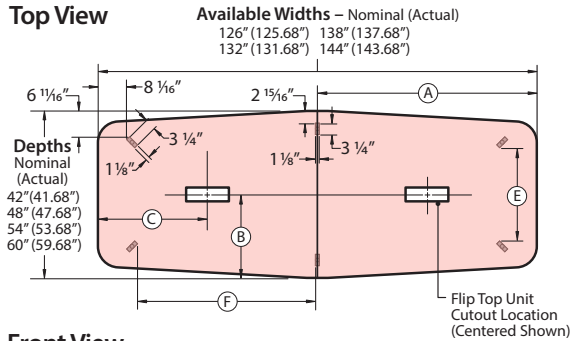

**Dimensions – 150"-180" Wide
Tables Without Cable Base
Includes (10) Legs**

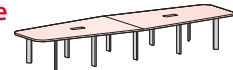

Top View

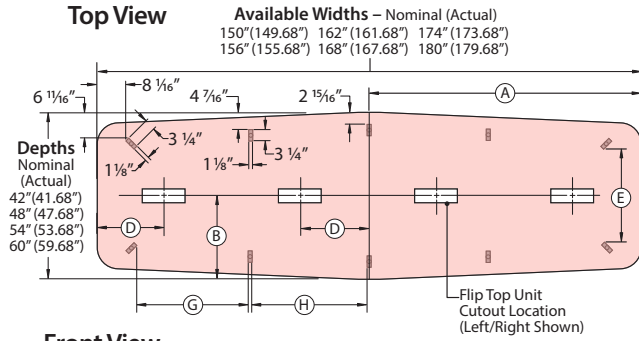

Dimensions

Depth Nominal (Actual)	Width Nominal (Actual)	Number of Top Pieces	TABLETOP				KNEESPACE (Nominal)				Number of Legs Without Cable Base
			A	B	C	D	E	F	G	H	
42" (41.68")	126" (125.68")	2	63"	21"	31 1/2"	15 3/4"	22"	51"	N/A	N/A	6
	132" (131.68")	2	66"	21"	33"	16 1/2"	22"	54"	N/A	N/A	6
	138" (137.68")	2	69"	21"	34 1/2"	17 1/4"	22"	57"	N/A	N/A	6
	144" (143.68")	2	72"	21"	36"	18"	22"	60"	N/A	N/A	6
	150" (149.68")	2	75"	21"	37 1/2"	18 3/4"	22"	N/A	30"	31"	10
	156" (155.68")	2	78"	21"	39"	19 1/2"	22"	N/A	32"	33"	10
	162" (161.68")	2	81"	21"	40 1/2"	20 1/4"	22"	N/A	33"	34"	10
	168" (167.68")	2	84"	21"	42"	21"	22"	N/A	35"	36"	10
48" (47.68")	174" (173.68")	2	87"	21"	43 1/2"	21 3/4"	22"	N/A	36"	37"	10
	180" (179.68")	2	90"	21"	45"	22 1/2"	22"	N/A	38"	39"	10
	126" (125.68")	2	63"	24"	31 1/2"	15 3/4"	28"	51"	N/A	N/A	6
	132" (131.68")	2	66"	24"	33"	16 1/2"	28"	54"	N/A	N/A	6
	138" (137.68")	2	69"	24"	34 1/2"	17 1/4"	28"	57"	N/A	N/A	6
	144" (143.68")	2	72"	24"	36"	18"	28"	60"	N/A	N/A	6
	150" (149.68")	2	75"	24"	37 1/2"	18 3/4"	28"	N/A	30"	31"	10
	156" (155.68")	2	78"	24"	39"	19 1/2"	28"	N/A	32"	33"	10
54" (53.68")	162" (161.68")	2	81"	24"	40 1/2"	20 1/4"	28"	N/A	33"	34"	10
	168" (167.68")	2	84"	24"	42"	21"	28"	N/A	35"	36"	10
	174" (173.68")	2	87"	24"	43 1/2"	21 3/4"	28"	N/A	36"	37"	10
	180" (179.68")	2	90"	24"	45"	22 1/2"	28"	N/A	38"	39"	10
	126" (125.68")	2	63"	27"	31 1/2"	15 3/4"	34"	51"	N/A	N/A	6
	132" (131.68")	2	66"	27"	33"	16 1/2"	34"	54"	N/A	N/A	6
	138" (137.68")	2	69"	27"	34 1/2"	17 1/4"	34"	57"	N/A	N/A	6
	144" (143.68")	2	72"	27"	36"	18"	34"	60"	N/A	N/A	6
60" (59.68")	150" (149.68")	2	75"	27"	37 1/2"	18 3/4"	34"	N/A	30"	31"	10
	156" (155.68")	2	78"	27"	39"	19 1/2"	34"	N/A	32"	33"	10
	162" (161.68")	2	81"	27"	40 1/2"	20 1/4"	34"	N/A	33"	34"	10
	168" (167.68")	2	84"	27"	42"	21"	34"	N/A	35"	36"	10
	174" (173.68")	2	87"	27"	43 1/2"	21 3/4"	34"	N/A	36"	37"	10
	180" (179.68")	2	90"	27"	45"	22 1/2"	34"	N/A	38"	39"	10
	126" (125.68")	2	63"	30"	31 1/2"	15 3/4"	40"	51"	N/A	N/A	6
	132" (131.68")	2	66"	30"	33"	16 1/2"	40"	54"	N/A	N/A	6
138" (137.68")	2	69"	30"	34 1/2"	17 1/4"	40"	57"	N/A	N/A	6	
144" (143.68")	2	72"	30"	36"	18"	40"	60"	N/A	N/A	6	
150" (149.68")	2	75"	30"	37 1/2"	18 3/4"	40"	N/A	30"	31"	10	
156" (155.68")	2	78"	30"	39"	19 1/2"	40"	N/A	32"	33"	10	
162" (161.68")	2	81"	30"	40 1/2"	20 1/4"	40"	N/A	33"	34"	10	
168" (167.68")	2	84"	30"	42"	21"	40"	N/A	35"	36"	10	
174" (173.68")	2	87"	30"	43 1/2"	21 3/4"	40"	N/A	36"	37"	10	
180" (179.68")	2	90"	30"	45"	22 1/2"	40"	N/A	38"	39"	10	

Product Details – Planes Conference Tables

Interior Leg Conference Table – Two-Piece Top – Hexagon

**Dimensions – 126"-144" Wide
Tables With Cable Base
Includes (4) Legs**

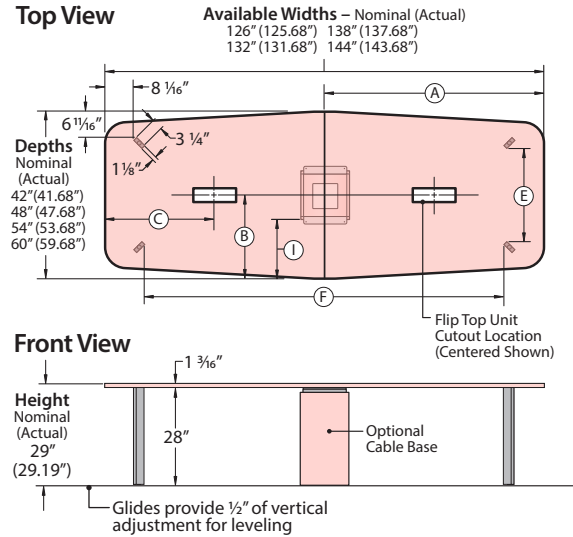
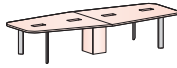

**Dimensions – 150"-180" Wide
Tables With Cable Base
Includes (8) Legs**

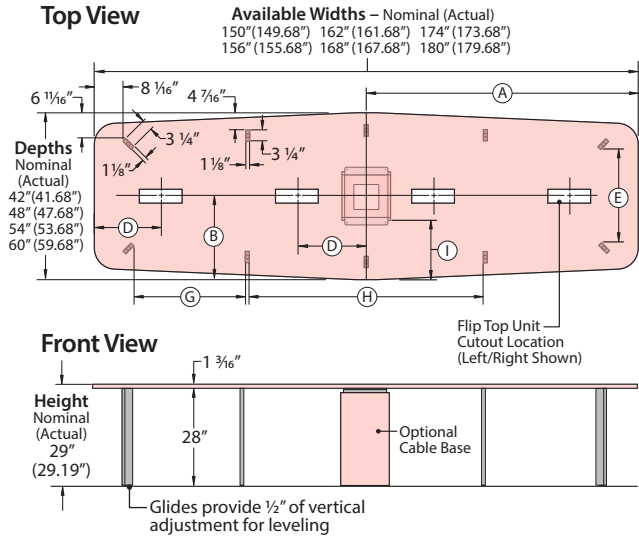
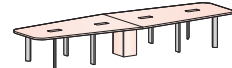

Dimensions

Depth Nominal (Actual)	TABLETOP						KNEESPACE (Nominal)					LEGS	CABLE BASE
	Width Nominal (Actual)	Number of Top Pieces	A	B	C	D	E	F	G	H	I	Number of Legs With Cable Base	Optional Cable Base Sizes
42" (41.68")	126" (125.68")	2	63"	21"	31 1/2"	15 3/4"	22"	104"	N/A	N/A	14"	4	14" D x 14" W
	132" (131.68")	2	66"	21"	33"	16 1/2"	22"	110"	N/A	N/A	14"	4	14" D x 14" W
	138" (137.68")	2	69"	21"	34 1/2"	17 1/4"	22"	116"	N/A	N/A	14"	4	14" D x 14" W
	144" (143.68")	2	72"	21"	36"	18"	22"	122"	N/A	N/A	14"	4	14" D x 14" W
	150" (149.68")	2	75"	21"	37 1/2"	18 3/4"	22"	N/A	30"	64"	14"	8	14" D x 14" W
	156" (155.68")	2	78"	21"	39"	19 1/2"	22"	N/A	32"	68"	14"	8	14" D x 14" W
	162" (161.68")	2	81"	21"	40 1/2"	20 1/4"	22"	N/A	33"	70"	14"	8	14" D x 14" W
	168" (167.68")	2	84"	21"	42"	21"	22"	N/A	35"	74"	14"	8	14" D x 14" W
	174" (173.68")	2	87"	21"	43 1/2"	21 3/4"	22"	N/A	36"	76"	14"	8	14" D x 14" W
180" (179.68")	2	90"	21"	45"	22 1/2"	22"	N/A	38"	80"	14"	8	14" D x 14" W	
48" (47.68")	126" (125.68")	2	63"	24"	31 1/2"	15 3/4"	28"	104"	N/A	N/A	17"	4	14" D x 14" W
	132" (131.68")	2	66"	24"	33"	16 1/2"	28"	110"	N/A	N/A	17"	4	14" D x 14" W
	138" (137.68")	2	69"	24"	34 1/2"	17 1/4"	28"	116"	N/A	N/A	17"	4	14" D x 14" W
	144" (143.68")	2	72"	24"	36"	18"	28"	122"	N/A	N/A	17"	4	14" D x 14" W
	150" (149.68")	2	75"	24"	37 1/2"	18 3/4"	28"	N/A	30"	64"	17"	8	14" D x 14" W
	156" (155.68")	2	78"	24"	39"	19 1/2"	28"	N/A	32"	68"	17"	8	14" D x 14" W
	162" (161.68")	2	81"	24"	40 1/2"	20 1/4"	28"	N/A	33"	70"	17"	8	14" D x 14" W
	168" (167.68")	2	84"	24"	42"	21"	28"	N/A	35"	74"	17"	8	14" D x 14" W
	174" (173.68")	2	87"	24"	43 1/2"	21 3/4"	28"	N/A	36"	76"	17"	8	14" D x 14" W
180" (179.68")	2	90"	24"	45"	22 1/2"	28"	N/A	38"	80"	17"	8	14" D x 14" W	
54" (53.68")	126" (125.68")	2	63"	27"	31 1/2"	15 3/4"	34"	104"	N/A	N/A	20"	4	14" D x 14" W
	132" (131.68")	2	66"	27"	33"	16 1/2"	34"	110"	N/A	N/A	20"	4	14" D x 14" W
	138" (137.68")	2	69"	27"	34 1/2"	17 1/4"	34"	116"	N/A	N/A	20"	4	14" D x 14" W
	144" (143.68")	2	72"	27"	36"	18"	34"	122"	N/A	N/A	20"	4	14" D x 14" W
	150" (149.68")	2	75"	27"	37 1/2"	18 3/4"	34"	N/A	30"	64"	20"	8	14" D x 14" W
	156" (155.68")	2	78"	27"	39"	19 1/2"	34"	N/A	32"	68"	20"	8	14" D x 14" W
	162" (161.68")	2	81"	27"	40 1/2"	20 1/4"	34"	N/A	33"	70"	20"	8	14" D x 14" W
	168" (167.68")	2	84"	27"	42"	21"	34"	N/A	35"	74"	20"	8	14" D x 14" W
	174" (173.68")	2	87"	27"	43 1/2"	21 3/4"	34"	N/A	36"	76"	20"	8	14" D x 14" W
180" (179.68")	2	90"	27"	45"	22 1/2"	34"	N/A	38"	80"	20"	8	14" D x 14" W	
60" (59.68")	126" (125.68")	2	63"	30"	31 1/2"	15 3/4"	40"	104"	N/A	N/A	23"	4	14" D x 14" W
	132" (131.68")	2	66"	30"	33"	16 1/2"	40"	110"	N/A	N/A	23"	4	14" D x 14" W
	138" (137.68")	2	69"	30"	34 1/2"	17 1/4"	40"	116"	N/A	N/A	23"	4	14" D x 14" W
	144" (143.68")	2	72"	30"	36"	18"	40"	122"	N/A	N/A	23"	4	14" D x 14" W
	150" (149.68")	2	75"	30"	37 1/2"	18 3/4"	40"	N/A	30"	64"	23"	8	14" D x 14" W
	156" (155.68")	2	78"	30"	39"	19 1/2"	40"	N/A	32"	68"	23"	8	14" D x 14" W
	162" (161.68")	2	81"	30"	40 1/2"	20 1/4"	40"	N/A	33"	70"	23"	8	14" D x 14" W
	168" (167.68")	2	84"	30"	42"	21"	40"	N/A	35"	74"	23"	8	14" D x 14" W
	174" (173.68")	2	87"	30"	43 1/2"	21 3/4"	40"	N/A	36"	76"	23"	8	14" D x 14" W
180" (179.68")	2	90"	30"	45"	22 1/2"	40"	N/A	38"	80"	23"	8	14" D x 14" W	

Product Details – Planes Height Adjustable Tables

Interior Leg Conference Table – Two-Piece Top – Hexagon

Table Sizes and Seating Capacities – Without Cable Bases

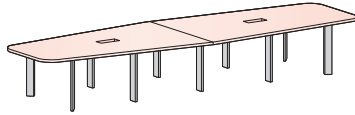

- 126", 132", 138" and 144" Wide Two-Piece Top Tables specified without a Cable Base are standard with 6 Legs.
- 150", 156", 162", 168", 174", 180" Wide Two-Piece Top Tables specified without a Cable Base are standard with 10 Legs.

		WIDTHS									
		126" Wide	132" Wide	138" Wide	144" Wide	150" Wide	156" Wide	162" Wide	168" Wide	174" Wide	180" Wide
DEPTHS	42" Deep										
	48" Deep										
	54" Deep										
	60" Deep										

Table Sizes and Seating Capacities – With Cable Bases

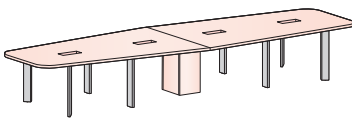

- 126", 132", 138" and 144" Wide Two-Piece Top Tables specified with a Cable Base are standard with 4 Legs.
- 150", 156", 162", 168", 174", 180" Wide Two-Piece Top Tables specified with a Cable Base are standard with 8 Legs.

		WIDTHS									
		126" Wide	132" Wide	138" Wide	144" Wide	150" Wide	156" Wide	162" Wide	168" Wide	174" Wide	180" Wide
DEPTHS	42" Deep										
	48" Deep										
	54" Deep										
	60" Deep										

Note Recommended seating capacity based upon a width of 27" per chair.

Product Details – Planes Conference Tables

Interior Leg Conference Table – Three-Piece Top – Rectangular

Without Cable Base

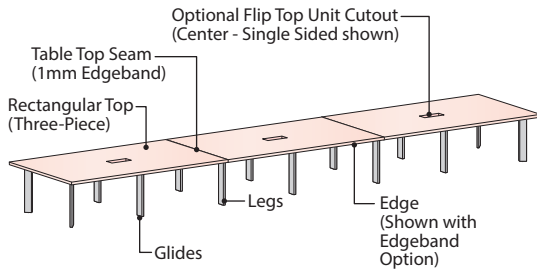

With Cable Base

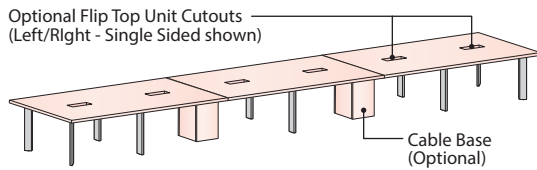

Edge Options for Laminate Tops

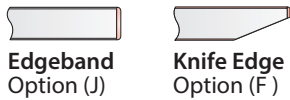

Edge Options for Wood Tops

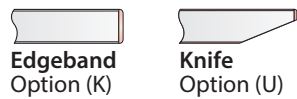

Component Materials/Finishes

COMPONENT NAME	MATERIALS/ FINISHES				
Rectangle Top 2-Piece top with 1mm edgeband seams	Laminate Top – Specify separate finish colors for top and edge trim • Edge Options: (T) T-Mold, (J) Edgeband, (F) Knife				
	Wood Top – Specify a single finish color for the top and edge trim • Edge Options: (K) Edgeband, (M) Cascade, (U) Knife				
Interior Legs	Painted Metal – Specified Trim Color				
Glides	Standard in Black				
Cable Base (Optional)	<table border="1"> <tr> <td>Panels</td> <td>Laminate Panels – Specified surface and edge trim colors</td> </tr> <tr> <td>Wood Panels</td> <td>– Specified top and edge trim wood finish color</td> </tr> </table>	Panels	Laminate Panels – Specified surface and edge trim colors	Wood Panels	– Specified top and edge trim wood finish color
	Panels	Laminate Panels – Specified surface and edge trim colors			
Wood Panels	– Specified top and edge trim wood finish color				
Frame	Painted Metal – Standard in Black				

Flip Top Unit Cutout Options

Center Cutout Option

- Includes 3 Flip Top Unit cutouts (1 Cutout centered on each top piece)

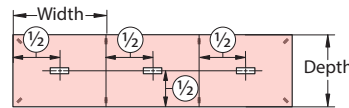

Left/Right Cutout Option

- Includes 6 Flip Top Unit cutouts (2 Cutouts on each top piece)

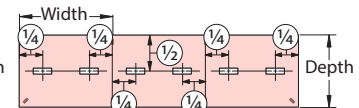

Cutout Option (F or V)

- For use with Single Sided/ 4 Port Flip Top Unit

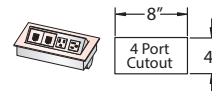

Cutout Option (J or K)

- For use with Single Sided/ 6 Ports Flip Top Unit

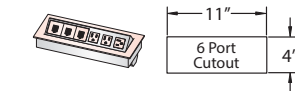

Cutout Option (M or P)

- For use with Double Sided/ 8 Ports Flip Top Unit

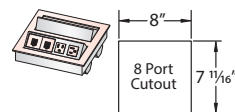

Cutout Option (Q or T)

- For use with Double Sided/ 12 Ports Flip Top Unit

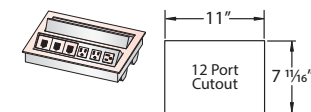

Note Flip Top Units are separately specified.

Cable Base Options

- Tables may be specified with or without Cable Bases
 - (Option N) No Cable Base.
 - (Option C) Includes (2) 14" x 14" Cable Bases

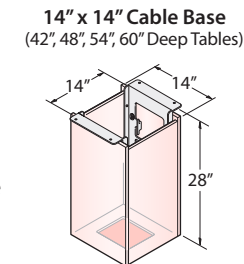
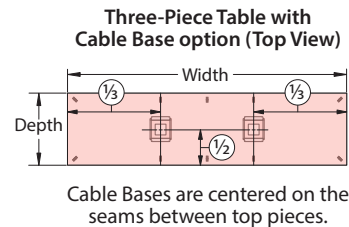

Product Details – Planes Conference Tables

Interior Leg Conference Table – Three-Piece Top – Rectangular

**Dimensions – 186"-198" Wide
Tables Without Cable Base
Includes (8) Legs**

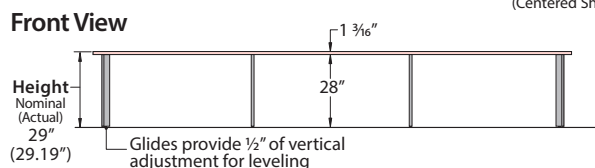
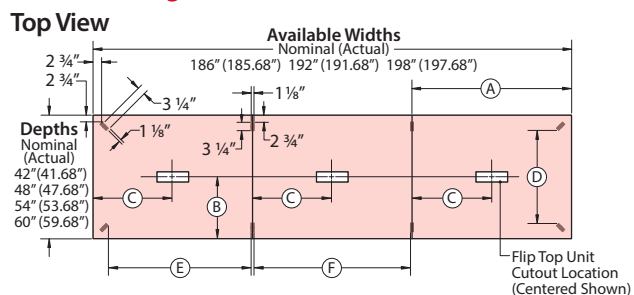
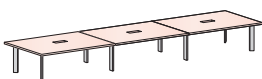

**Dimensions – 204"-270" Wide
Tables Without Cable Base
Includes (14) Legs**

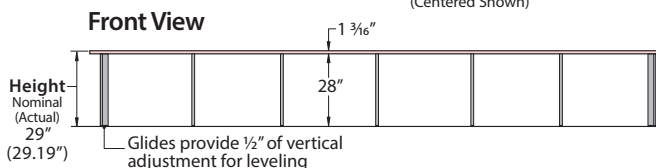
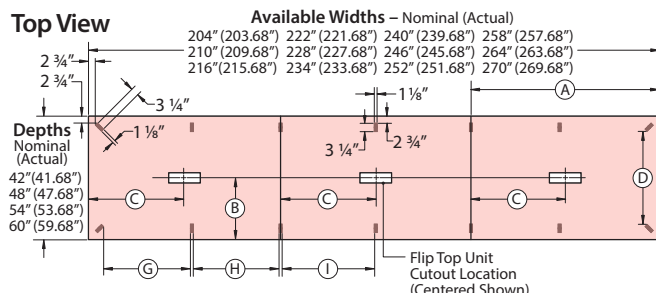
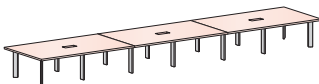

Dimensions

Depth Nominal (Actual)	TABLETOP			KNEESPACE (Nominal)							# of Legs Without Cable Base		
	Width Nominal (Actual)	# of Top Pieces		A	B	C	D	E	F	G		H	I
42" (41.68")	186"(185.68")	3	62"	21"	31"	27"	27"	60"	N/A	N/A	N/A	N/A	8
	192"(191.68")	3	64"	21"	32"	27"	33"	62"	N/A	N/A	N/A	N/A	8
	198"(197.68")	3	66"	21"	33"	27"	39"	64"	N/A	N/A	N/A	N/A	8
	204"(203.68")	3	68"	21"	34"	27"	N/A	N/A	26"	32"	32"	N/A	14
	210"(209.68")	3	70"	21"	35"	27"	N/A	N/A	27"	33"	33"	N/A	14
	216"(215.68")	3	72"	21"	36"	27"	N/A	N/A	28"	34"	34"	N/A	14
	222"(221.68")	3	74"	21"	37"	27"	N/A	N/A	29"	35"	35"	N/A	14
	228"(227.68")	3	76"	21"	38"	27"	N/A	N/A	30"	36"	36"	N/A	14
	234"(233.68")	3	78"	21"	39"	27"	N/A	N/A	31"	37"	37"	N/A	14
	240"(239.68")	3	80"	21"	40"	27"	N/A	N/A	32"	38"	38"	N/A	14
	246"(245.68")	3	82"	21"	41"	27"	N/A	N/A	33"	39"	39"	N/A	14
	252"(251.68")	3	84"	21"	42"	27"	N/A	N/A	34"	40"	40"	N/A	14
	258"(257.68")	3	86"	21"	43"	27"	N/A	N/A	35"	41"	41"	N/A	14
	264"(263.68")	3	88"	21"	44"	27"	N/A	N/A	36"	42"	42"	N/A	14
270"(269.68")	3	90"	21"	45"	27"	N/A	N/A	37"	43"	43"	N/A	14	
48" (47.68")	186"(185.68")	3	62"	24"	31"	33"	27"	60"	N/A	N/A	N/A	N/A	8
	192"(191.68")	3	64"	24"	32"	33"	33"	62"	N/A	N/A	N/A	N/A	8
	198"(197.68")	3	66"	24"	33"	33"	39"	64"	N/A	N/A	N/A	N/A	8
	204"(203.68")	3	68"	24"	34"	33"	N/A	N/A	26"	32"	32"	N/A	14
	210"(209.68")	3	70"	24"	35"	33"	N/A	N/A	27"	33"	33"	N/A	14
	216"(215.68")	3	72"	24"	36"	33"	N/A	N/A	28"	34"	34"	N/A	14
	222"(221.68")	3	74"	24"	37"	33"	N/A	N/A	29"	35"	35"	N/A	14
	228"(227.68")	3	76"	24"	38"	33"	N/A	N/A	30"	36"	36"	N/A	14
	234"(233.68")	3	78"	24"	39"	33"	N/A	N/A	31"	37"	37"	N/A	14
	240"(239.68")	3	80"	24"	40"	33"	N/A	N/A	32"	38"	38"	N/A	14
	246"(245.68")	3	82"	24"	41"	33"	N/A	N/A	33"	39"	39"	N/A	14
	252"(251.68")	3	84"	24"	42"	33"	N/A	N/A	34"	40"	40"	N/A	14
	258"(257.68")	3	86"	24"	43"	33"	N/A	N/A	35"	41"	41"	N/A	14
	264"(263.68")	3	88"	24"	44"	33"	N/A	N/A	36"	42"	42"	N/A	14
270"(269.68")	3	90"	24"	45"	33"	N/A	N/A	37"	43"	43"	N/A	14	
54" (53.68")	186"(185.68")	3	62"	27"	31"	39"	27"	60"	N/A	N/A	N/A	N/A	8
	192"(191.68")	3	64"	27"	32"	39"	33"	62"	N/A	N/A	N/A	N/A	8
	198"(197.68")	3	66"	27"	33"	39"	39"	64"	N/A	N/A	N/A	N/A	8
	204"(203.68")	3	68"	27"	34"	39"	N/A	N/A	26"	32"	32"	N/A	14
	210"(209.68")	3	70"	27"	35"	39"	N/A	N/A	27"	33"	33"	N/A	14
	216"(215.68")	3	72"	27"	36"	39"	N/A	N/A	28"	34"	34"	N/A	14
	222"(221.68")	3	74"	27"	37"	39"	N/A	N/A	29"	35"	35"	N/A	14
	228"(227.68")	3	76"	27"	38"	39"	N/A	N/A	30"	36"	36"	N/A	14
	234"(233.68")	3	78"	27"	39"	39"	N/A	N/A	31"	37"	37"	N/A	14
	240"(239.68")	3	80"	27"	40"	39"	N/A	N/A	32"	38"	38"	N/A	14
	246"(245.68")	3	82"	27"	41"	39"	N/A	N/A	33"	39"	39"	N/A	14
	252"(251.68")	3	84"	27"	42"	39"	N/A	N/A	34"	40"	40"	N/A	14
	258"(257.68")	3	86"	27"	43"	39"	N/A	N/A	35"	41"	41"	N/A	14
	264"(263.68")	3	88"	27"	44"	39"	N/A	N/A	36"	42"	42"	N/A	14
270"(269.68")	3	90"	27"	45"	39"	N/A	N/A	37"	43"	43"	N/A	14	
60" (59.68")	186"(185.68")	3	62"	30"	31"	45"	27"	60"	N/A	N/A	N/A	N/A	8
	192"(191.68")	3	64"	30"	32"	45"	33"	62"	N/A	N/A	N/A	N/A	8
	198"(197.68")	3	66"	30"	33"	45"	39"	64"	N/A	N/A	N/A	N/A	8
	204"(203.68")	3	68"	30"	34"	45"	N/A	N/A	26"	32"	32"	N/A	14
	210"(209.68")	3	70"	30"	35"	45"	N/A	N/A	27"	33"	33"	N/A	14
	216"(215.68")	3	72"	30"	36"	45"	N/A	N/A	28"	34"	34"	N/A	14
	222"(221.68")	3	74"	30"	37"	45"	N/A	N/A	29"	35"	35"	N/A	14
	228"(227.68")	3	76"	30"	38"	45"	N/A	N/A	30"	36"	36"	N/A	14
	234"(233.68")	3	78"	30"	39"	45"	N/A	N/A	31"	37"	37"	N/A	14
	240"(239.68")	3	80"	30"	40"	45"	N/A	N/A	32"	38"	38"	N/A	14
	246"(245.68")	3	82"	30"	41"	45"	N/A	N/A	33"	39"	39"	N/A	14
	252"(251.68")	3	84"	30"	42"	45"	N/A	N/A	34"	40"	40"	N/A	14
	258"(257.68")	3	86"	30"	43"	45"	N/A	N/A	35"	41"	41"	N/A	14
	264"(263.68")	3	88"	30"	44"	45"	N/A	N/A	36"	42"	42"	N/A	14
270"(269.68")	3	90"	30"	45"	45"	N/A	N/A	37"	43"	43"	N/A	14	

Product Details – Planes Conference Tables

Interior Leg Conference Table – Three-Piece Top – Rectangular

**Dimensions – 186"-198" Wide
Tables Without Cable Base
Includes (6) Legs**

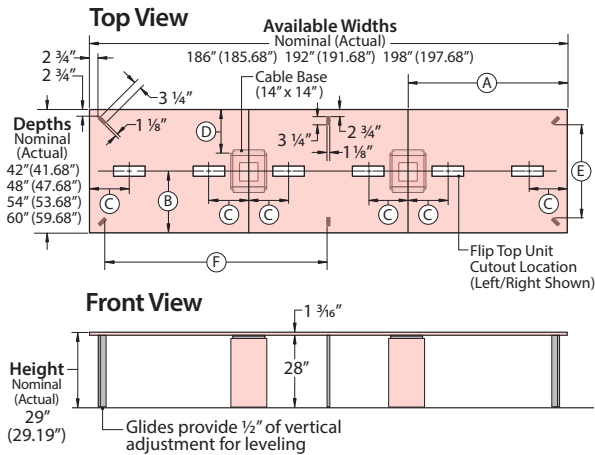
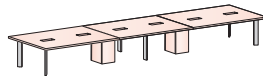

**Dimensions – 204"-270" Wide
Tables Without Cable Base
Includes (10) Legs**

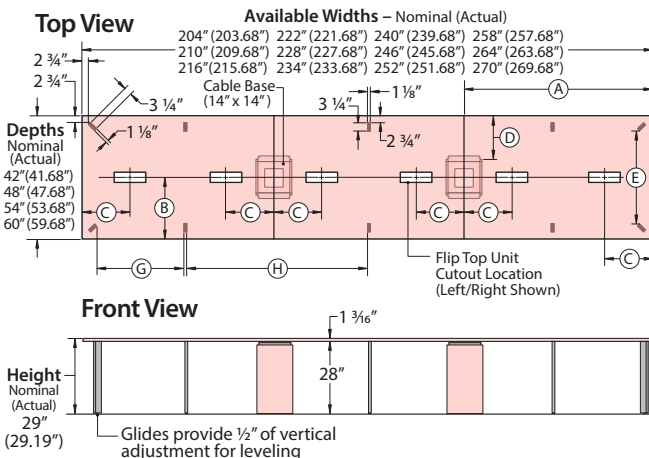
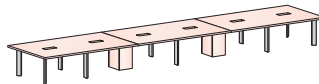

Dimensions

TABLETOP				KNEESPACE (Nominal)								# of Legs with (2) Cable Bases
Depth Nominal (Actual)	Width Nominal (Actual)	# of Top Pieces	A	B	C	D	E	F	G	H		
42" (41.68")	186"(185.68")	3	62"	21"	15 1/2"	14"	27"	85"	N/A	N/A	6	
	192"(191.68")	3	64"	21"	16"	14"	27"	88"	N/A	N/A	6	
	198"(197.68")	3	66"	21"	16 1/2"	14"	27"	91"	N/A	N/A	6	
	204"(203.68")	3	68"	21"	17"	14"	27"	N/A	26"	66"	10	
	210"(209.68")	3	70"	21"	17 1/2"	14"	27"	N/A	27"	68"	10	
	216"(215.68")	3	72"	21"	18"	14"	27"	N/A	28"	70"	10	
	222"(221.68")	3	74"	21"	18 1/2"	14"	27"	N/A	29"	72"	10	
	228"(227.68")	3	76"	21"	19"	14"	27"	N/A	30"	74"	10	
	234"(233.68")	3	78"	21"	19 1/2"	14"	27"	N/A	31"	76"	10	
	240"(239.68")	3	80"	21"	20"	14"	27"	N/A	32"	78"	10	
	246"(245.68")	3	82"	21"	20 1/2"	14"	27"	N/A	33"	80"	10	
	252"(251.68")	3	84"	21"	21"	14"	27"	N/A	34"	82"	10	
	258"(257.68")	3	86"	21"	21 1/2"	14"	27"	N/A	35"	84"	10	
	264"(263.68")	3	88"	21"	22"	14"	27"	N/A	36"	86"	10	
270"(269.68")	3	90"	21"	22 1/2"	14"	27"	N/A	37"	88"	10		
48" (47.68")	186"(185.68")	3	62"	24"	15 1/2"	17"	33"	85"	N/A	N/A	6	
	192"(191.68")	3	64"	24"	16"	17"	33"	88"	N/A	N/A	6	
	198"(197.68")	3	66"	24"	16 1/2"	17"	33"	91"	N/A	N/A	6	
	204"(203.68")	3	68"	24"	17"	17"	33"	N/A	26"	66"	10	
	210"(209.68")	3	70"	24"	17 1/2"	17"	33"	N/A	27"	68"	10	
	216"(215.68")	3	72"	24"	18"	17"	33"	N/A	28"	70"	10	
	222"(221.68")	3	74"	24"	18 1/2"	17"	33"	N/A	29"	72"	10	
	228"(227.68")	3	76"	24"	19"	17"	33"	N/A	30"	74"	10	
	234"(233.68")	3	78"	24"	19 1/2"	17"	33"	N/A	31"	76"	10	
	240"(239.68")	3	80"	24"	20"	17"	33"	N/A	32"	78"	10	
	246"(245.68")	3	82"	24"	20 1/2"	17"	33"	N/A	33"	80"	10	
	252"(251.68")	3	84"	24"	21"	17"	33"	N/A	34"	82"	10	
	258"(257.68")	3	86"	24"	21 1/2"	17"	33"	N/A	35"	84"	10	
	264"(263.68")	3	88"	24"	22"	17"	33"	N/A	36"	86"	10	
270"(269.68")	3	90"	24"	22 1/2"	17"	33"	N/A	37"	88"	10		
54" (53.68")	186"(185.68")	3	62"	27"	15 1/2"	20"	39"	85"	N/A	N/A	6	
	192"(191.68")	3	64"	27"	16"	20"	39"	88"	N/A	N/A	6	
	198"(197.68")	3	66"	27"	16 1/2"	20"	39"	91"	N/A	N/A	6	
	204"(203.68")	3	68"	27"	17"	20"	39"	N/A	26"	66"	10	
	210"(209.68")	3	70"	27"	17 1/2"	20"	39"	N/A	27"	68"	10	
	216"(215.68")	3	72"	27"	18"	20"	39"	N/A	28"	70"	10	
	222"(221.68")	3	74"	27"	18 1/2"	20"	39"	N/A	29"	72"	10	
	228"(227.68")	3	76"	27"	19"	20"	39"	N/A	30"	74"	10	
	234"(233.68")	3	78"	27"	19 1/2"	20"	39"	N/A	31"	76"	10	
	240"(239.68")	3	80"	27"	20"	20"	39"	N/A	32"	78"	10	
	246"(245.68")	3	82"	27"	20 1/2"	20"	39"	N/A	33"	80"	10	
	252"(251.68")	3	84"	27"	21"	20"	39"	N/A	34"	82"	10	
	258"(257.68")	3	86"	27"	21 1/2"	20"	39"	N/A	35"	84"	10	
	264"(263.68")	3	88"	27"	22"	20"	39"	N/A	36"	86"	10	
270"(269.68")	3	90"	27"	22 1/2"	20"	39"	N/A	37"	88"	10		
60" (59.68")	186"(185.68")	3	62"	30"	15 1/2"	23"	45"	85"	N/A	N/A	6	
	192"(191.68")	3	64"	30"	16"	23"	45"	88"	N/A	N/A	6	
	198"(197.68")	3	66"	30"	16 1/2"	23"	45"	91"	N/A	N/A	6	
	204"(203.68")	3	68"	30"	17"	23"	45"	N/A	26"	66"	10	
	210"(209.68")	3	70"	30"	17 1/2"	23"	45"	N/A	27"	68"	10	
	216"(215.68")	3	72"	30"	18"	23"	45"	N/A	28"	70"	10	
	222"(221.68")	3	74"	30"	18 1/2"	23"	45"	N/A	29"	72"	10	
	228"(227.68")	3	76"	30"	19"	23"	45"	N/A	30"	74"	10	
	234"(233.68")	3	78"	30"	19 1/2"	23"	45"	N/A	31"	76"	10	
	240"(239.68")	3	80"	30"	20"	23"	45"	N/A	32"	78"	10	
	246"(245.68")	3	82"	30"	20 1/2"	23"	45"	N/A	33"	80"	10	
	252"(251.68")	3	84"	30"	21"	23"	45"	N/A	34"	82"	10	
	258"(257.68")	3	86"	30"	21 1/2"	23"	45"	N/A	35"	84"	10	
	264"(263.68")	3	88"	30"	22"	23"	45"	N/A	36"	86"	10	
270"(269.68")	3	90"	30"	22 1/2"	23"	45"	N/A	37"	88"	10		

Product Details – Planes Conference Tables

Interior Leg Conference Table – Three-Piece Top – Rectangular

Table Sizes and Seating Capacities – Without Cable Bases

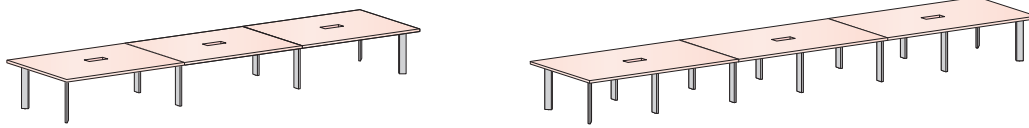

- 186", 192" and 198" Wide Three-Piece Top Tables specified without a Cable Base are standard with 8 Legs.
- 204", 210", 216", 222", 228", 234", 240", 246", 252", 258", 264" and 270" Wide Three-Piece Top Tables specified without a Cable Base are standard with 14 Legs.

		WIDTHS							
		186" Wide	192" Wide	198" Wide	204" Wide	210" Wide	216" Wide	222" Wide	228" Wide
DEPTHS	42" Deep	 14 Chairs Maximum (8 Legs)	 14 Chairs Maximum (8 Legs)	 14 Chairs Maximum (8 Legs)	 14 Chairs Maximum (14 Legs)	 14 Chairs Maximum (14 Legs)	 14 Chairs Maximum (14 Legs)	 14 Chairs Maximum (14 Legs)	 14 Chairs Maximum (14 Legs)
	48" Deep	 14 Chairs Maximum (8 Legs)	 14 Chairs Maximum (8 Legs)	 14 Chairs Maximum (8 Legs)	 14 Chairs Maximum (14 Legs)	 14 Chairs Maximum (14 Legs)	 14 Chairs Maximum (14 Legs)	 14 Chairs Maximum (14 Legs)	 14 Chairs Maximum (14 Legs)
	54" Deep	 14 Chairs Maximum (8 Legs)	 14 Chairs Maximum (8 Legs)	 14 Chairs Maximum (8 Legs)	 14 Chairs Maximum (14 Legs)	 14 Chairs Maximum (14 Legs)	 14 Chairs Maximum (14 Legs)	 14 Chairs Maximum (14 Legs)	 14 Chairs Maximum (14 Legs)
	60" Deep	 16 Chairs Maximum (8 Legs)	 16 Chairs Maximum (8 Legs)	 16 Chairs Maximum (8 Legs)	 16 Chairs Maximum (14 Legs)	 16 Chairs Maximum (14 Legs)	 16 Chairs Maximum (14 Legs)	 16 Chairs Maximum (14 Legs)	 16 Chairs Maximum (14 Legs)

		WIDTHS						
		234" Wide	240" Wide	246" Wide	252" Wide	258" Wide	264" Wide	270" Wide
DEPTHS	42" Deep	 14 Chairs Maximum (8 Legs)	 14 Chairs Maximum (8 Legs)	 14 Chairs Maximum (8 Legs)	 14 Chairs Maximum (14 Legs)	 14 Chairs Maximum (14 Legs)	 14 Chairs Maximum (14 Legs)	 14 Chairs Maximum (14 Legs)
	48" Deep	 14 Chairs Maximum (8 Legs)	 14 Chairs Maximum (8 Legs)	 14 Chairs Maximum (8 Legs)	 14 Chairs Maximum (14 Legs)	 14 Chairs Maximum (14 Legs)	 14 Chairs Maximum (14 Legs)	 14 Chairs Maximum (14 Legs)
	54" Deep	 14 Chairs Maximum (8 Legs)	 14 Chairs Maximum (8 Legs)	 14 Chairs Maximum (8 Legs)	 14 Chairs Maximum (14 Legs)	 14 Chairs Maximum (14 Legs)	 14 Chairs Maximum (14 Legs)	 14 Chairs Maximum (14 Legs)
	60" Deep	 16 Chairs Maximum (8 Legs)	 16 Chairs Maximum (8 Legs)	 16 Chairs Maximum (8 Legs)	 16 Chairs Maximum (14 Legs)	 16 Chairs Maximum (14 Legs)	 16 Chairs Maximum (14 Legs)	 16 Chairs Maximum (14 Legs)

Note Recommended seating capacity based upon a width of 27" per chair.

Product Details – Planes Conference Tables

Interior Leg Conference Table – Three-Piece Top – Rectangular

Table Sizes and Seating Capacities – With Cable Bases

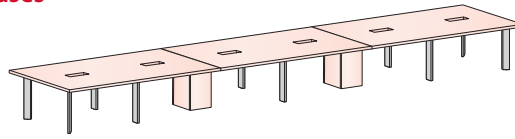
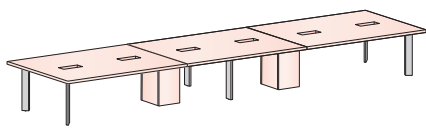

• 186", 192" and 198" Wide Three-Piece Top Tables specified with a Cable Base are standard with 2 Cable Bases and 6 Legs.

• 204", 210", 216", 222", 228", 234", 240", 246", 252", 258", 264" and 270" Wide Three-Piece Top Tables specified with a Cable Base are standard with 2 Cable Bases and 10 Legs.

		WIDTHS							
		186" Wide	192" Wide	198" Wide	204" Wide	210" Wide	216" Wide	222" Wide	228" Wide
DEPTHS	42" Deep								
	48" Deep	14 Chairs Maximum (6 Legs/2 Cable Bases)	14 Chairs Maximum (6 Legs/2 Cable Bases)	14 Chairs Maximum (6 Legs/2 Cable Bases)	14 Chairs Maximum (10 Legs/2 Cable Bases)	14 Chairs Maximum (10 Legs/2 Cable Bases)	14 Chairs Maximum (10 Legs/2 Cable Bases)	14 Chairs Maximum (10 Legs/2 Cable Bases)	14 Chairs Maximum (10 Legs/2 Cable Bases)
	54" Deep	14 Chairs Maximum (6 Legs/2 Cable Bases)	14 Chairs Maximum (6 Legs/2 Cable Bases)	14 Chairs Maximum (6 Legs/2 Cable Bases)	14 Chairs Maximum (10 Legs/2 Cable Bases)	14 Chairs Maximum (10 Legs/2 Cable Bases)	14 Chairs Maximum (10 Legs/2 Cable Bases)	14 Chairs Maximum (10 Legs/2 Cable Bases)	14 Chairs Maximum (10 Legs/2 Cable Bases)
	60" Deep	16 Chairs Maximum (6 Legs/2 Cable Bases)	16 Chairs Maximum (6 Legs/2 Cable Bases)	16 Chairs Maximum (6 Legs/2 Cable Bases)	16 Chairs Maximum (10 Legs/2 Cable Bases)	16 Chairs Maximum (10 Legs/2 Cable Bases)	16 Chairs Maximum (10 Legs/2 Cable Bases)	16 Chairs Maximum (10 Legs/2 Cable Bases)	16 Chairs Maximum (10 Legs/2 Cable Bases)

		WIDTHS						
		234" Wide	240" Wide	246" Wide	252" Wide	258" Wide	264" Wide	270" Wide
DEPTHS	42" Deep							
	48" Deep	14 Chairs Maximum (10 Legs/2 Cable Bases)	18 Chairs Maximum (10 Legs/2 Cable Bases)	18 Chairs Maximum (10 Legs/2 Cable Bases)	18 Chairs Maximum (10 Legs/2 Cable Bases)	18 Chairs Maximum (10 Legs/2 Cable Bases)	18 Chairs Maximum (10 Legs/2 Cable Bases)	18 Chairs Maximum (10 Legs/2 Cable Bases)
	54" Deep	14 Chairs Maximum (10 Legs/2 Cable Bases)	18 Chairs Maximum (10 Legs/2 Cable Bases)	18 Chairs Maximum (10 Legs/2 Cable Bases)	18 Chairs Maximum (10 Legs/2 Cable Bases)	18 Chairs Maximum (10 Legs/2 Cable Bases)	18 Chairs Maximum (10 Legs/2 Cable Bases)	18 Chairs Maximum (10 Legs/2 Cable Bases)
	60" Deep	16 Chairs Maximum (10 Legs/2 Cable Bases)	20 Chairs Maximum (10 Legs/2 Cable Bases)	20 Chairs Maximum (10 Legs/2 Cable Bases)	20 Chairs Maximum (10 Legs/2 Cable Bases)	20 Chairs Maximum (10 Legs/2 Cable Bases)	20 Chairs Maximum (10 Legs/2 Cable Bases)	20 Chairs Maximum (10 Legs/2 Cable Bases)

Note Recommended seating capacity based upon a width of 27" per chair.

Product Details – Planes Conference Tables

Interior Leg Conference Table – Three-Piece Top – Pebble

Without Cable Base

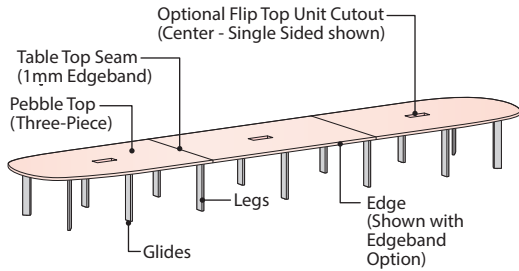

With Cable Base

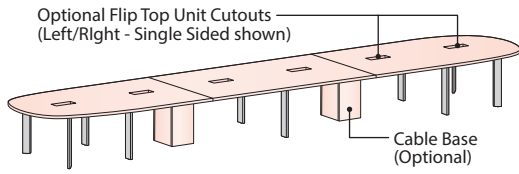

Edge Options for Laminate Tops

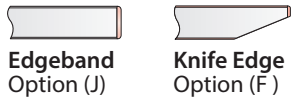

Edge Options for Wood Tops



Component Materials/Finishes

COMPONENT NAME	MATERIALS/ FINISHES
Pebble Top 3-Piece top with 1mm edgeband seams	Laminate Top – Specify separate finish colors for top and edge trim • Edge Options: (J) Edgeband, (F) Knife
	Wood Top – Specify a single finish color for the top and edge trim • Edge Options: (K) Edgeband, (U) Knife
Interior Legs	Painted Metal – Specified Trim Color
Glides	Standard in Black
Cable Base (Optional)	Panels Laminate Panels – Specified surface and edge trim colors Wood Panels – Specified top and edge trim wood finish color
	Frame Painted Metal – Standard in Black

Flip Top Unit Cutout Options

Center Cutout Option

- Includes 3 Flip Top Unit cutouts (1 Cutout centered on each top piece)

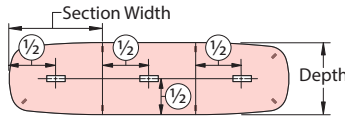

Cutout Option (F or V)

- For use with Single Sided/ 4 Port Flip Top Unit

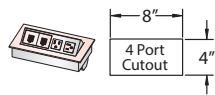

Cutout Option (M or P)

- For use with Double Sided/ 8 Ports Flip Top Unit

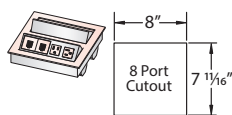

Left/Right Cutout Option

- Includes 6 Flip Top Unit cutouts (2 Cutouts on each top piece)

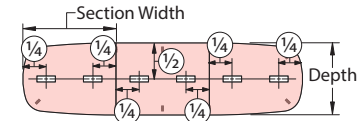

Cutout Option (J or K)

- For use with Single Sided/ 6 Ports Flip Top Unit

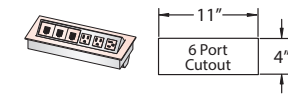

Cutout Option (Q or T)

- For use with Double Sided/ 12 Ports Flip Top Unit

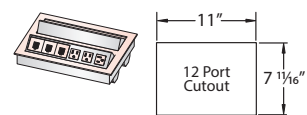

Note Flip Top Units are separately specified.

Cable Base Options

- Tables may be specified with or without Cable Bases
 - (Option N) No Cable Base.
 - (Option C) Includes (2) 14" x 14" Cable Bases

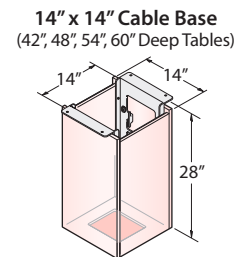
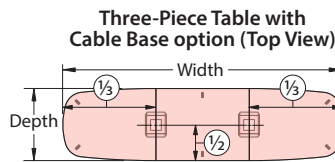

Cable Bases are centered on the seams between top pieces.

Product Details – Planes Conference Tables

Interior Leg Conference Table – Three-Piece Top – Pebble

**Dimensions – 186"-198" Wide
Tables Without Cable Base
Includes (8) Legs**

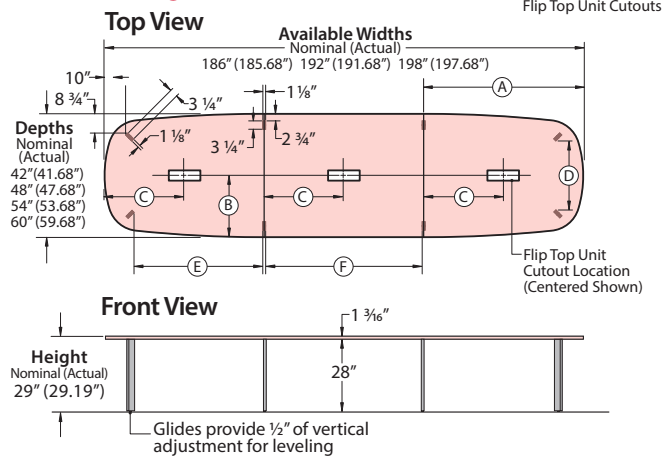

**Dimensions 204"-216" Wide
Tables Without Cable Base
Includes (10) Legs**

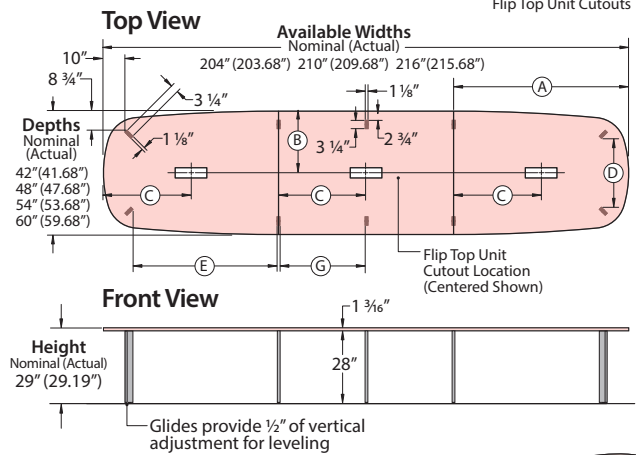

**Dimensions – 222"-270" Wide
Tables Without Cable Base
Includes (14) Legs**

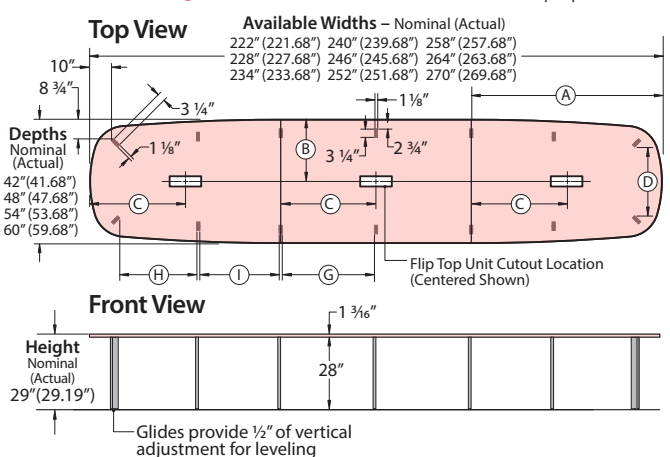

Note Tables are available with the following Flip Top Unit cutout options:
 • None – No Flip Top Unit Cutouts
 • Centered – (1) Cutout centered on each top (shown above)
 • Left/Right – (2) Cutouts on each top
 (See following page for dimensions)

Dimensions

TABLETOP				KNEESPACE (Nominal)								# of Legs
Depth Nominal (Actual)	Width Nominal (Actual)	# of Top Pieces	A	B	C	D	E	F	G	H	I	
42" (41.68")	186"(185.68")	3	62"	21"	31"	22"	50"	60"	N/A	N/A	N/A	8
	192"(191.68")	3	64"	21"	32"	22"	52"	62"	N/A	N/A	N/A	8
	198"(197.68")	3	66"	21"	33"	22"	54"	64"	N/A	N/A	N/A	8
	204"(203.68")	3	68"	21"	34"	22"	56"	N/A	32"	N/A	N/A	10
	210"(209.68")	3	70"	21"	35"	22"	58"	N/A	33"	N/A	N/A	10
	216"(215.68")	3	72"	21"	36"	22"	60"	N/A	34"	N/A	N/A	10
	222"(221.68")	3	74"	21"	37"	22"	N/A	N/A	35"	31"	30"	14
	228"(227.68")	3	76"	21"	38"	22"	N/A	N/A	36"	32"	31"	14
	234"(233.68")	3	78"	21"	39"	22"	N/A	N/A	37"	33"	32"	14
	240"(239.68")	3	80"	21"	40"	22"	N/A	N/A	38"	34"	33"	14
48" (47.68")	246"(245.68")	3	82"	21"	41"	22"	N/A	N/A	39"	35"	34"	14
	252"(251.68")	3	84"	21"	42"	22"	N/A	N/A	40"	36"	35"	14
	258"(257.68")	3	86"	21"	43"	22"	N/A	N/A	41"	37"	36"	14
	264"(263.68")	3	88"	21"	44"	22"	N/A	N/A	42"	38"	37"	14
	270"(269.68")	3	90"	21"	45"	22"	N/A	N/A	43"	39"	38"	14
	186"(185.68")	3	62"	24"	31"	27"	50"	60"	N/A	N/A	N/A	8
	192"(191.68")	3	64"	24"	32"	27"	52"	62"	N/A	N/A	N/A	8
	198"(197.68")	3	66"	24"	33"	27"	54"	64"	N/A	N/A	N/A	8
	204"(203.68")	3	68"	24"	34"	27"	56"	N/A	32"	N/A	N/A	10
	210"(209.68")	3	70"	24"	35"	27"	58"	N/A	33"	N/A	N/A	10
54" (53.68")	216"(215.68")	3	72"	24"	36"	27"	60"	N/A	34"	N/A	N/A	10
	222"(221.68")	3	74"	24"	37"	27"	N/A	N/A	35"	31"	30"	14
	228"(227.68")	3	76"	24"	38"	27"	N/A	N/A	36"	32"	31"	14
	234"(233.68")	3	78"	24"	39"	27"	N/A	N/A	37"	33"	32"	14
	240"(239.68")	3	80"	24"	40"	27"	N/A	N/A	38"	34"	33"	14
	246"(245.68")	3	82"	24"	41"	27"	N/A	N/A	39"	35"	34"	14
	252"(251.68")	3	84"	24"	42"	27"	N/A	N/A	40"	36"	35"	14
	258"(257.68")	3	86"	24"	43"	27"	N/A	N/A	41"	37"	36"	14
	264"(263.68")	3	88"	24"	44"	27"	N/A	N/A	42"	38"	37"	14
	270"(269.68")	3	90"	24"	45"	27"	N/A	N/A	43"	39"	38"	14
60" (59.68")	186"(185.68")	3	62"	30"	31"	36"	50"	60"	N/A	N/A	N/A	8
	192"(191.68")	3	64"	30"	32"	36"	52"	62"	N/A	N/A	N/A	8
	198"(197.68")	3	66"	30"	33"	36"	54"	64"	N/A	N/A	N/A	8
	204"(203.68")	3	68"	30"	34"	36"	56"	N/A	32"	N/A	N/A	10
	210"(209.68")	3	70"	30"	35"	36"	58"	N/A	33"	N/A	N/A	10
	216"(215.68")	3	72"	30"	36"	36"	60"	N/A	34"	N/A	N/A	10
	222"(221.68")	3	74"	30"	37"	36"	N/A	N/A	35"	31"	30"	14
	228"(227.68")	3	76"	30"	38"	36"	N/A	N/A	36"	32"	31"	14
	234"(233.68")	3	78"	30"	39"	36"	N/A	N/A	37"	33"	32"	14
	240"(239.68")	3	80"	30"	40"	36"	N/A	N/A	38"	34"	33"	14
60" (59.68")	246"(245.68")	3	82"	30"	41"	36"	N/A	N/A	39"	35"	34"	14
	252"(251.68")	3	84"	30"	42"	36"	N/A	N/A	40"	36"	35"	14
	258"(257.68")	3	86"	30"	43"	36"	N/A	N/A	41"	37"	36"	14
	264"(263.68")	3	88"	30"	44"	36"	N/A	N/A	42"	38"	37"	14
	270"(269.68")	3	90"	30"	45"	36"	N/A	N/A	43"	39"	38"	14

Product Details | Planes Conference Tables – Interior Leg Conference Table – Three-Piece Top – Pebble

Product Details – Planes Conference Tables

Interior Leg Conference Table – Three-Piece Top – Pebble

**Dimensions – 186"-216" Wide
Tables Without Cable Base
Includes (6) Legs**

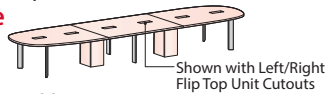

Top View

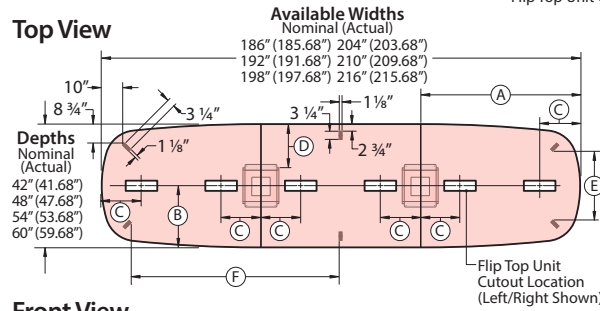

Front View

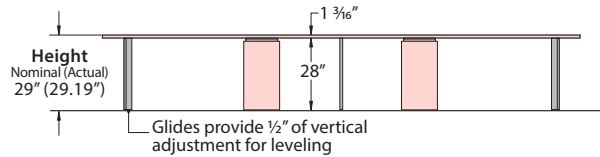

**Dimensions – 222"-270" Wide
Table Without Cable Base
Includes (10) Legs**

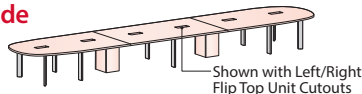

Top View

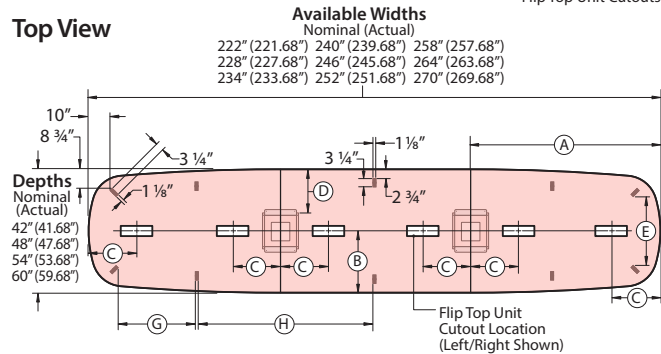

Front View

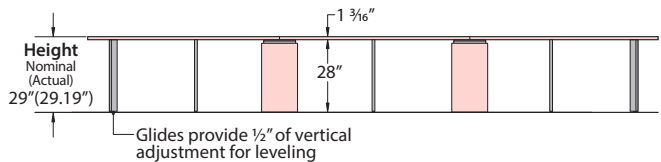

- Note** Tables are available with the following Flip Top Unit cutouts options:
- None – No Flip Top Unit Cutouts
 - Centered – (1) Cutout centered on each top (see previous page for dimensions)
 - Left/Right – (2) Cutouts on each top (shown above)

Dimensions

Depth Nominal (Actual)	TABLETOP			KNEESPACE (Nominal)								# of Legs with (2) Cable Bases
	Width Nominal (Actual)	# of Top Pieces		A	B	C	D	E	F	G	H	
42" (41.68")	186" (185.68")	3	62"	21"	31"	14"	22"	81"	N/A	N/A	6	
	192" (191.68")	3	64"	21"	32"	22"	84"	N/A	N/A	6		
	198" (197.68")	3	66"	21"	33"	22"	87"	N/A	N/A	6		
	204" (203.68")	3	68"	21"	34"	22"	N/A	N/A	61"	6		
	210" (209.68")	3	70"	21"	35"	22"	N/A	N/A	63"	6		
	216" (215.68")	3	72"	21"	36"	22"	N/A	N/A	65"	6		
	222" (221.68")	3	74"	21"	37"	22"	N/A	N/A	31"	67"	10	
	228" (227.68")	3	76"	21"	38"	22"	N/A	N/A	32"	69"	10	
	234" (233.68")	3	78"	21"	39"	22"	N/A	N/A	33"	71"	10	
	240" (239.68")	3	80"	21"	40"	22"	N/A	N/A	34"	73"	10	
	246" (245.68")	3	82"	21"	41"	22"	N/A	N/A	35"	75"	10	
	252" (251.68")	3	84"	21"	42"	22"	N/A	N/A	36"	77"	10	
48" (47.68")	186" (185.68")	3	62"	24"	31"	27"	81"	N/A	N/A	6		
	192" (191.68")	3	64"	24"	32"	27"	84"	N/A	N/A	6		
	198" (197.68")	3	66"	24"	33"	27"	87"	N/A	N/A	6		
	204" (203.68")	3	68"	24"	34"	27"	N/A	N/A	61"	6		
	210" (209.68")	3	70"	24"	35"	27"	N/A	N/A	63"	6		
	216" (215.68")	3	72"	24"	36"	27"	N/A	N/A	65"	6		
	222" (221.68")	3	74"	24"	37"	27"	N/A	N/A	31"	67"	10	
	228" (227.68")	3	76"	24"	38"	27"	N/A	N/A	32"	69"	10	
	234" (233.68")	3	78"	24"	39"	27"	N/A	N/A	33"	71"	10	
	240" (239.68")	3	80"	24"	40"	27"	N/A	N/A	34"	73"	10	
	246" (245.68")	3	82"	24"	41"	27"	N/A	N/A	35"	75"	10	
	252" (251.68")	3	84"	24"	42"	27"	N/A	N/A	36"	77"	10	
54" (53.68")	186" (185.68")	3	62"	27"	31"	32"	81"	N/A	N/A	6		
	192" (191.68")	3	64"	27"	32"	32"	84"	N/A	N/A	6		
	198" (197.68")	3	66"	27"	33"	32"	87"	N/A	N/A	6		
	204" (203.68")	3	68"	27"	34"	32"	N/A	N/A	61"	6		
	210" (209.68")	3	70"	27"	35"	32"	N/A	N/A	63"	6		
	216" (215.68")	3	72"	27"	36"	32"	N/A	N/A	65"	6		
	222" (221.68")	3	74"	27"	37"	32"	N/A	N/A	31"	67"	10	
	228" (227.68")	3	76"	27"	38"	32"	N/A	N/A	32"	69"	10	
	234" (233.68")	3	78"	27"	39"	32"	N/A	N/A	33"	71"	10	
	240" (239.68")	3	80"	27"	40"	32"	N/A	N/A	34"	73"	10	
	246" (245.68")	3	82"	27"	41"	32"	N/A	N/A	35"	75"	10	
	252" (251.68")	3	84"	27"	42"	32"	N/A	N/A	36"	77"	10	
60" (59.68")	186" (185.68")	3	62"	30"	31"	36"	81"	N/A	N/A	6		
	192" (191.68")	3	64"	30"	32"	36"	84"	N/A	N/A	6		
	198" (197.68")	3	66"	30"	33"	36"	87"	N/A	N/A	6		
	204" (203.68")	3	68"	30"	34"	36"	N/A	N/A	61"	6		
	210" (209.68")	3	70"	30"	35"	36"	N/A	N/A	63"	6		
	216" (215.68")	3	72"	30"	36"	36"	N/A	N/A	65"	6		
	222" (221.68")	3	74"	30"	37"	36"	N/A	N/A	31"	67"	10	
	228" (227.68")	3	76"	30"	38"	36"	N/A	N/A	32"	69"	10	
	234" (233.68")	3	78"	30"	39"	36"	N/A	N/A	33"	71"	10	
	240" (239.68")	3	80"	30"	40"	36"	N/A	N/A	34"	73"	10	
	246" (245.68")	3	82"	30"	41"	36"	N/A	N/A	35"	75"	10	
	252" (251.68")	3	84"	30"	42"	36"	N/A	N/A	36"	77"	10	

Product Details – Planes Conference Tables

Interior Leg Conference Table – Three-Piece Top – Pebble

Table Sizes and Seating Capacities – Without Cable Bases

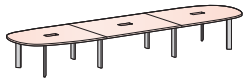

• 186", 192" and 198" Wide Three-Piece Top Tables specified without a Cable Base are standard with 8 Legs.

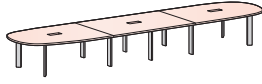

• 204", 210" and 216" Wide Three-Piece Top Tables specified without a Cable Base are standard with 10 Legs.

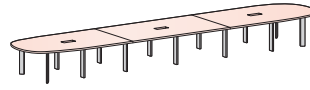

• 222", 228", 234", 240", 246", 252", 258", 264" and 270" Wide Three-Piece Top Tables specified without a Cable Base are standard with 14 Legs.

		WIDTHS							
		186" Wide	192" Wide	198" Wide	204" Wide	210" Wide	216" Wide	222" Wide	228" Wide
DEPTHS	42" Deep								
	48" Deep								
	54" Deep								
	60" Deep								

		WIDTHS						
		234" Wide	240" Wide	246" Wide	252" Wide	258" Wide	264" Wide	270" Wide
DEPTHS	42" Deep							
	48" Deep							
	54" Deep							
	60" Deep							

Note Recommended seating capacity based upon a width of 27" per chair.

Product Details – Planes Conference Tables

Interior Leg Conference Table – Three-Piece Top – Pebble

Table Sizes and Seating Capacities – Without Cable Bases

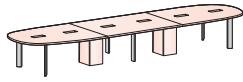

186", 192", 198", 204", 210" and 216" Wide Three-Piece Top Tables specified with Cable Bases are standard with 6 Legs and 2 Cable Bases.

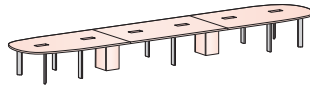

222", 228", 234", 240", 246", 252", 258", 264" and 270" Wide Three-Piece Top Tables specified with a Cable Base are standard with 10 Legs and 2 Cable Bases.

		WIDTHS							
		186" Wide	192" Wide	198" Wide	204" Wide	210" Wide	216" Wide	222" Wide	228" Wide
DEPTHS	42" Deep								
	48" Deep								
	54" Deep								
	60" Deep								

		WIDTHS						
		234" Wide	240" Wide	246" Wide	252" Wide	258" Wide	264" Wide	270" Wide
DEPTHS	42" Deep							
	48" Deep							
	54" Deep							
	60" Deep							

Note Recommended seating capacity based upon a width of 27" per chair.

Product Details – Planes Conference Tables

Interior Leg Conference Table – Three-Piece Top – Hexagon

Without Cable Base

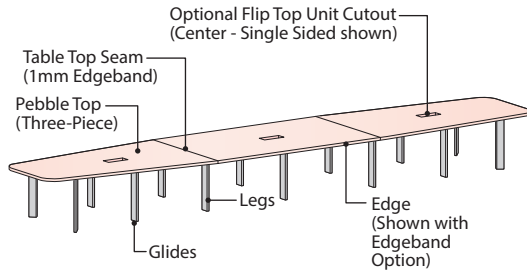

With Cable Base

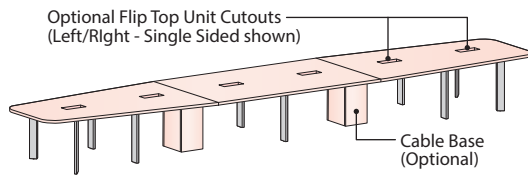

Edge Options for Laminate Tops

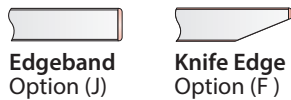

Edge Options for Wood Tops



Component Materials/Finishes

COMPONENT NAME	MATERIALS/ FINISHES
Pebble Top 3-Piece top with 1mm edgeband seams	Laminate Top – Specify separate finish colors for top and edge trim • Edge Options: (J) Edgeband, (F) Knife
Interior Legs	Painted Metal – Specified Trim Color
Glides	Standard in Black
Cable Base (Optional)	Panels
	Laminate Panels – Specified surface and edge trim colors Wood Panels – Specified top and edge trim wood finish color
Frame	Painted Metal – Standard in Black

Flip Top Unit Cutout Options

Center Cutout Option

- Includes 3 Flip Top Unit cutouts (1 Cutout centered on each top piece)

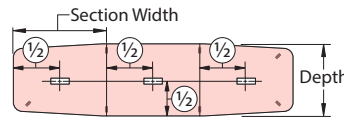

Left/Right Cutout Option

- Includes 6 Flip Top Unit cutouts (2 Cutouts on each top piece)

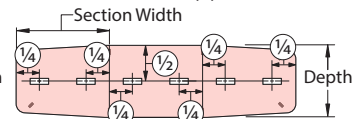

Cutout Option (F or V)

- For use with Single Sided/ 4 Port Flip Top Unit

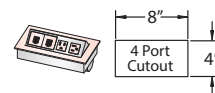

Cutout Option (J or K)

- For use with Single Sided/ 6 Ports Flip Top Unit

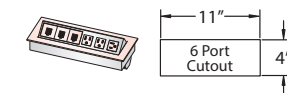

Cutout Option (M or P)

- For use with Double Sided/ 8 Ports Flip Top Unit

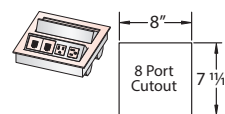

Cutout Option (Q or T)

- For use with Double Sided/ 12 Ports Flip Top Unit

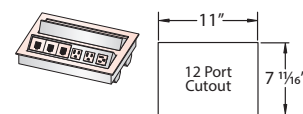

Note Flip Top Units are separately specified.

Cable Base Options

- Tables may be specified with or without Cable Bases
 - (Option N) No Cable Base.
 - (Option C) Includes (2) 14" x 14" Cable Bases

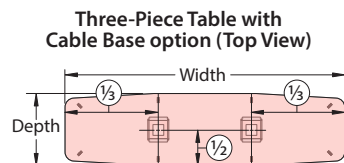

Cable Bases are centered on the seams between top pieces.

14" x 14" Cable Base

(42", 48", 54", 60" Deep Tables)

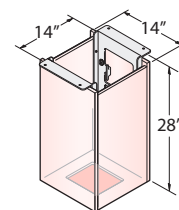

Product Details – Planes Conference Tables

Interior Leg Conference Table – Three-Piece Top – Hexagon

Dimensions – 186"-198" Wide
Tables Without Cable Base
Includes (8) Legs

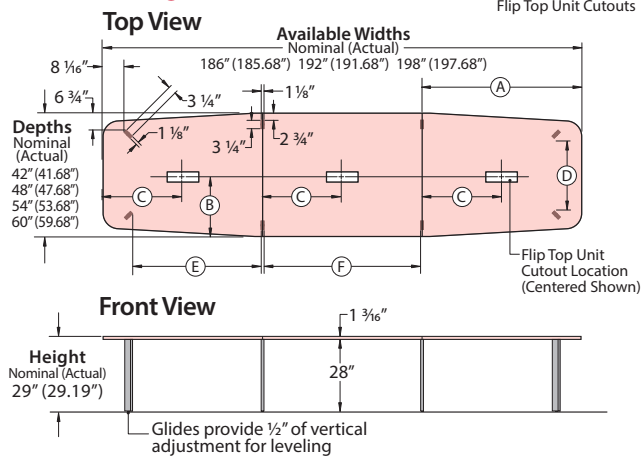

Dimensions – 204"-216" Wide
Tables Without Cable Base
Includes (10) Legs

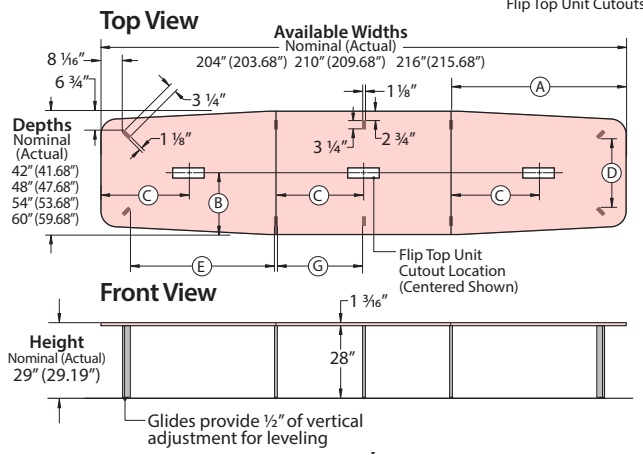

Dimensions – 222"-270" Wide
Tables Without Cable Base
Includes (14) Legs

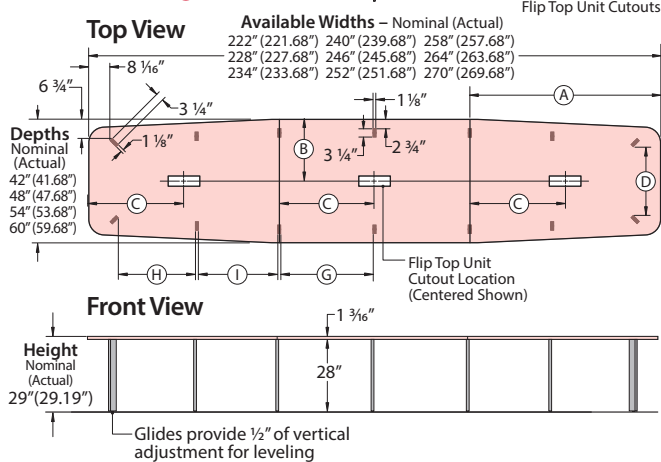

Note Tables are available with the following Flip Top Unit cutouts options:
 • None – No Flip Top Unit Cutouts
 • Centered – (1) Cutout centered on each top (shown above)
 • Left/Right – (2) Cutouts on each top
 (See following page for dimensions)

Dimensions

Depth Nominal (Actual)	TABLETOP			KNEESPACE (Nominal)								# of Legs	
	Width Nominal (Actual)	# of Top Pieces		A	B	C	D	E	F	G	H		I
42" (41.68")	186"(185.68")	3		62"	21"	31"	22"	50"	60"	N/A	N/A	N/A	8
	192"(191.68")	3		64"	21"	32"	22"	52"	62"	N/A	N/A	N/A	8
	198"(197.68")	3		66"	21"	33"	22"	54"	64"	N/A	N/A	N/A	8
	204"(203.68")	3		68"	21"	34"	22"	56"	N/A	32"	N/A	N/A	10
	210"(209.68")	3		70"	21"	35"	22"	58"	N/A	33"	N/A	N/A	10
	216"(215.68")	3		72"	21"	36"	22"	60"	N/A	34"	N/A	N/A	10
	222"(221.68")	3		74"	21"	37"	22"	N/A	N/A	35"	30"	31"	14
	228"(227.68")	3		76"	21"	38"	22"	N/A	N/A	36"	31"	32"	14
	234"(233.68")	3		78"	21"	39"	22"	N/A	N/A	37"	32"	33"	14
	240"(239.68")	3		80"	21"	40"	22"	N/A	N/A	38"	33"	34"	14
	246"(245.68")	3		82"	21"	41"	22"	N/A	N/A	39"	34"	35"	14
	252"(251.68")	3		84"	21"	42"	22"	N/A	N/A	40"	35"	36"	14
	258"(257.68")	3		86"	21"	43"	22"	N/A	N/A	41"	36"	37"	14
	264"(263.68")	3		88"	21"	44"	22"	N/A	N/A	42"	37"	38"	14
270"(269.68")	3		90"	21"	45"	22"	N/A	N/A	43"	38"	39"	14	
48" (47.68")	186"(185.68")	3		62"	24"	31"	28"	50"	60"	N/A	N/A	N/A	8
	192"(191.68")	3		64"	24"	32"	28"	52"	62"	N/A	N/A	N/A	8
	198"(197.68")	3		66"	24"	33"	28"	54"	64"	N/A	N/A	N/A	8
	204"(203.68")	3		68"	24"	34"	28"	56"	N/A	32"	N/A	N/A	10
	210"(209.68")	3		70"	24"	35"	28"	58"	N/A	33"	N/A	N/A	10
	216"(215.68")	3		72"	24"	36"	28"	60"	N/A	34"	N/A	N/A	10
	222"(221.68")	3		74"	24"	37"	28"	N/A	N/A	35"	30"	31"	14
	228"(227.68")	3		76"	24"	38"	28"	N/A	N/A	36"	31"	32"	14
	234"(233.68")	3		78"	24"	39"	28"	N/A	N/A	37"	32"	33"	14
	240"(239.68")	3		80"	24"	40"	28"	N/A	N/A	38"	33"	34"	14
	246"(245.68")	3		82"	24"	41"	28"	N/A	N/A	39"	34"	35"	14
	252"(251.68")	3		84"	24"	42"	28"	N/A	N/A	40"	35"	36"	14
	258"(257.68")	3		86"	24"	43"	28"	N/A	N/A	41"	36"	37"	14
	264"(263.68")	3		88"	24"	44"	28"	N/A	N/A	42"	37"	38"	14
270"(269.68")	3		90"	24"	45"	28"	N/A	N/A	43"	38"	39"	14	
54" (53.68")	186"(185.68")	3		62"	27"	31"	34"	50"	60"	N/A	N/A	N/A	8
	192"(191.68")	3		64"	27"	32"	34"	52"	62"	N/A	N/A	N/A	8
	198"(197.68")	3		66"	27"	33"	34"	54"	64"	N/A	N/A	N/A	8
	204"(203.68")	3		68"	27"	34"	34"	56"	N/A	32"	N/A	N/A	10
	210"(209.68")	3		70"	27"	35"	34"	58"	N/A	33"	N/A	N/A	10
	216"(215.68")	3		72"	27"	36"	34"	60"	N/A	34"	N/A	N/A	10
	222"(221.68")	3		74"	27"	37"	34"	N/A	N/A	35"	30"	31"	14
	228"(227.68")	3		76"	27"	38"	34"	N/A	N/A	36"	31"	32"	14
	234"(233.68")	3		78"	27"	39"	34"	N/A	N/A	37"	32"	33"	14
	240"(239.68")	3		80"	27"	40"	34"	N/A	N/A	38"	33"	34"	14
	246"(245.68")	3		82"	27"	41"	34"	N/A	N/A	39"	34"	35"	14
	252"(251.68")	3		84"	27"	42"	34"	N/A	N/A	40"	35"	36"	14
	258"(257.68")	3		86"	27"	43"	34"	N/A	N/A	41"	36"	37"	14
	264"(263.68")	3		88"	27"	44"	34"	N/A	N/A	42"	37"	38"	14
270"(269.68")	3		90"	27"	45"	34"	N/A	N/A	43"	38"	39"	14	
60" (59.68")	186"(185.68")	3		62"	30"	31"	40"	50"	60"	N/A	N/A	N/A	8
	192"(191.68")	3		64"	30"	32"	40"	52"	62"	N/A	N/A	N/A	8
	198"(197.68")	3		66"	30"	33"	40"	54"	64"	N/A	N/A	N/A	8
	204"(203.68")	3		68"	30"	34"	40"	56"	N/A	32"	N/A	N/A	10
	210"(209.68")	3		70"	30"	35"	40"	58"	N/A	33"	N/A	N/A	10
	216"(215.68")	3		72"	30"	36"	40"	60"	N/A	34"	N/A	N/A	10
	222"(221.68")	3		74"	30"	37"	40"	N/A	N/A	35"	30"	31"	14
	228"(227.68")	3		76"	30"	38"	40"	N/A	N/A	36"	31"	32"	14
	234"(233.68")	3		78"	30"	39"	40"	N/A	N/A	37"	32"	33"	14
	240"(239.68")	3		80"	30"	40"	40"	N/A	N/A	38"	33"	34"	14
	246"(245.68")	3		82"	30"	41"	40"	N/A	N/A	39"	34"	35"	14
	252"(251.68")	3		84"	30"	42"	40"	N/A	N/A	40"	35"	36"	14
	258"(257.68")	3		86"	30"	43"	40"	N/A	N/A	41"	36"	37"	14
	264"(263.68")	3		88"	30"	44"	40"	N/A	N/A	42"	37"	38"	14
270"(269.68")	3		90"	30"	45"	40"	N/A	N/A	43"	38"	39"	14	

Product Details – Planes Conference Tables

Interior Leg Conference Table – Three-Piece Top – Hexagon

**Dimensions – 186"-216" Wide
Tables Without Cable Base
Includes (6) Legs**

Top View

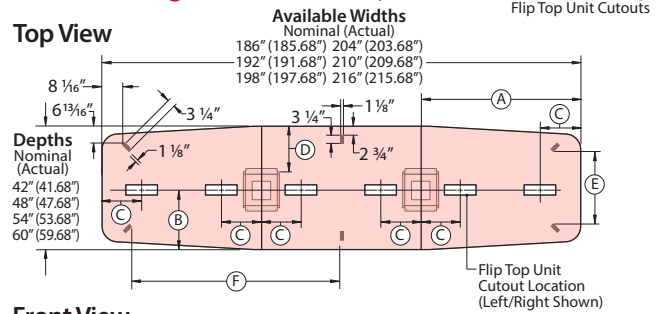

Front View

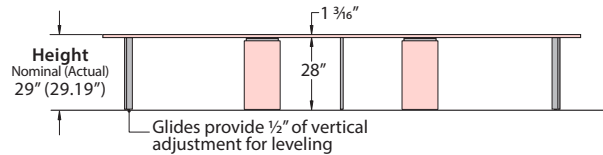

**Dimensions – 222"-270" Wide
Tables Without Cable Base
Includes (10) Legs**

Top View

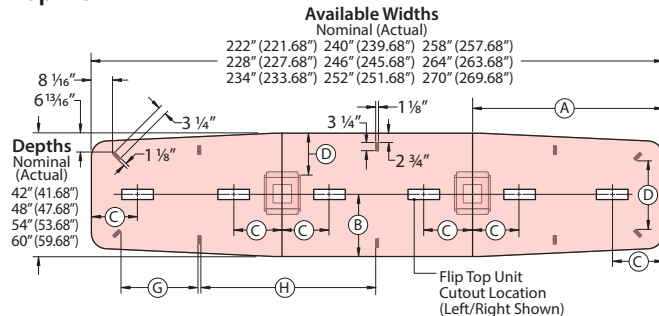

Front View

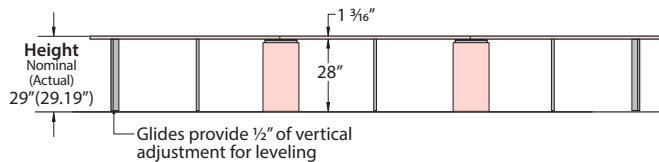

Note Tables are available with the following Flip Top Unit cutout options:
 • None – No Flip Top Unit Cutouts
 • Centered – (1) Cutout centered on each top (see previous page for dimensions)
 • Left/Right – (2) Cutouts on each top (shown above)

Dimensions

Depth Nominal (Actual)	TABLETOP			KNEESPACE (Nominal)								# of Legs with (2) Cable Bases	
	Width Nominal (Actual)	# of Top Pieces		A	B	C	D	E	F	G	H		
42" (41.68")	186"(185.68")	3		62"	21"	31"	14"	22"	81"	N/A	N/A	6	
	192"(191.68")	3		64"	21"	32"	14"	22"	84"	N/A	N/A	6	
	198"(197.68")	3		66"	21"	33"	14"	22"	87"	N/A	N/A	6	
	204"(203.68")	3		68"	21"	34"	14"	22"	N/A	N/A	62"	6	
	210"(209.68")	3		70"	21"	35"	14"	22"	N/A	N/A	63"	6	
	216"(215.68")	3		72"	21"	36"	14"	22"	N/A	N/A	64"	6	
	222"(221.68")	3		74"	21"	37"	14"	22"	N/A	N/A	30"	65"	10
	228"(227.68")	3		76"	21"	38"	14"	22"	N/A	N/A	31"	66"	10
	234"(233.68")	3		78"	21"	39"	14"	22"	N/A	N/A	32"	67"	10
	240"(239.68")	3		80"	21"	40"	14"	22"	N/A	N/A	33"	68"	10
	246"(245.68")	3		82"	21"	41"	14"	22"	N/A	N/A	34"	69"	10
	252"(251.68")	3		84"	21"	42"	14"	22"	N/A	N/A	35"	70"	10
	258"(257.68")	3		86"	21"	43"	14"	22"	N/A	N/A	36"	71"	10
	264"(263.68")	3		88"	21"	44"	14"	22"	N/A	N/A	37"	72"	10
270"(269.68")	3		90"	21"	45"	14"	22"	N/A	N/A	38"	73"	10	
48" (47.68")	186"(185.68")	3		62"	24"	31"	17"	28"	81"	N/A	N/A	6	
	192"(191.68")	3		64"	24"	32"	17"	28"	84"	N/A	N/A	6	
	198"(197.68")	3		66"	24"	33"	17"	28"	87"	N/A	N/A	6	
	204"(203.68")	3		68"	24"	34"	17"	28"	N/A	N/A	62"	6	
	210"(209.68")	3		70"	24"	35"	17"	28"	N/A	N/A	63"	6	
	216"(215.68")	3		72"	24"	36"	17"	28"	N/A	N/A	64"	6	
	222"(221.68")	3		74"	24"	37"	17"	28"	N/A	N/A	30"	65"	10
	228"(227.68")	3		76"	24"	38"	17"	28"	N/A	N/A	31"	66"	10
	234"(233.68")	3		78"	24"	39"	17"	28"	N/A	N/A	32"	67"	10
	240"(239.68")	3		80"	24"	40"	17"	28"	N/A	N/A	33"	68"	10
	246"(245.68")	3		82"	24"	41"	17"	28"	N/A	N/A	34"	69"	10
	252"(251.68")	3		84"	24"	42"	17"	28"	N/A	N/A	35"	70"	10
	258"(257.68")	3		86"	24"	43"	17"	28"	N/A	N/A	36"	71"	10
	264"(263.68")	3		88"	24"	44"	17"	28"	N/A	N/A	37"	72"	10
270"(269.68")	3		90"	24"	45"	17"	28"	N/A	N/A	38"	73"	10	
54" (53.68")	186"(185.68")	3		62"	27"	31"	20"	34"	81"	N/A	N/A	6	
	192"(191.68")	3		64"	27"	32"	20"	34"	84"	N/A	N/A	6	
	198"(197.68")	3		66"	27"	33"	20"	34"	87"	N/A	N/A	6	
	204"(203.68")	3		68"	27"	34"	20"	34"	N/A	N/A	62"	6	
	210"(209.68")	3		70"	27"	35"	20"	34"	N/A	N/A	63"	6	
	216"(215.68")	3		72"	27"	36"	20"	34"	N/A	N/A	64"	6	
	222"(221.68")	3		74"	27"	37"	20"	34"	N/A	N/A	30"	65"	10
	228"(227.68")	3		76"	27"	38"	20"	34"	N/A	N/A	31"	66"	10
	234"(233.68")	3		78"	27"	39"	20"	34"	N/A	N/A	32"	67"	10
	240"(239.68")	3		80"	27"	40"	20"	34"	N/A	N/A	33"	68"	10
	246"(245.68")	3		82"	27"	41"	20"	34"	N/A	N/A	34"	69"	10
	252"(251.68")	3		84"	27"	42"	20"	34"	N/A	N/A	35"	70"	10
	258"(257.68")	3		86"	27"	43"	20"	34"	N/A	N/A	36"	71"	10
	264"(263.68")	3		88"	27"	44"	20"	34"	N/A	N/A	37"	72"	10
270"(269.68")	3		90"	27"	45"	20"	34"	N/A	N/A	38"	73"	10	
60" (59.68")	186"(185.68")	3		62"	30"	31"	23"	40"	81"	N/A	N/A	6	
	192"(191.68")	3		64"	30"	32"	23"	40"	84"	N/A	N/A	6	
	198"(197.68")	3		66"	30"	33"	23"	40"	87"	N/A	N/A	6	
	204"(203.68")	3		68"	30"	34"	23"	40"	N/A	N/A	62"	6	
	210"(209.68")	3		70"	30"	35"	23"	40"	N/A	N/A	63"	6	
	216"(215.68")	3		72"	30"	36"	23"	40"	N/A	N/A	64"	6	
	222"(221.68")	3		74"	30"	37"	23"	40"	N/A	N/A	30"	65"	10
	228"(227.68")	3		76"	30"	38"	23"	40"	N/A	N/A	31"	66"	10
	234"(233.68")	3		78"	30"	39"	23"	40"	N/A	N/A	32"	67"	10
	240"(239.68")	3		80"	30"	40"	23"	40"	N/A	N/A	33"	68"	10
	246"(245.68")	3		82"	30"	41"	23"	40"	N/A	N/A	34"	69"	10
	252"(251.68")	3		84"	30"	42"	23"	40"	N/A	N/A	35"	70"	10
	258"(257.68")	3		86"	30"	43"	23"	40"	N/A	N/A	36"	71"	10
	264"(263.68")	3		88"	30"	44"	23"	40"	N/A	N/A	37"	72"	10
270"(269.68")	3		90"	30"	45"	23"	40"	N/A	N/A	38"	73"	10	

Product Details – Planes Conference Tables

Interior Leg Conference Table – Three-Piece Top – Hexagon

Table Sizes and Seating Capacities – Without Cable Bases

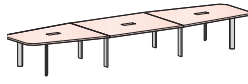

186", 192" and 198" Wide Three-Piece Top Tables specified without a Cable Base are standard with 8 Legs.

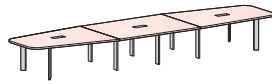

204", 210" and 216" Wide Three-Piece Top Tables specified without a Cable Base are standard with 10 Legs.

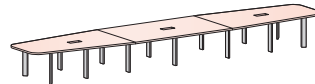

222", 228", 234", 240", 246", 252", 258", 264" and 270" Wide Three-Piece Top Tables specified without a Cable Base are standard with 14 Legs.

		WIDTHS							
		186" Wide	192" Wide	198" Wide	204" Wide	210" Wide	216" Wide	222" Wide	228" Wide
DEPTHS	42" Deep								
	48" Deep								
	54" Deep								
	60" Deep								

		WIDTHS						
		234" Wide	240" Wide	246" Wide	252" Wide	258" Wide	264" Wide	270" Wide
DEPTHS	42" Deep							
	48" Deep							
	54" Deep							
	60" Deep							

Note Recommended seating capacity based upon a width of 27" per chair.

Product Details – Planes Conference Tables

Interior Leg Conference Table – Three-Piece Top – Hexagon

Table Sizes and Seating Capacities – Without Cable Bases

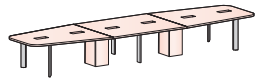

186", 192", 198", 204", 210" and 216" Wide Three-Piece Top Tables specified with Cable Bases are standard with 6 Legs and 2 Cable Bases.

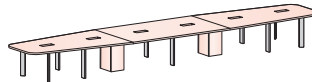

222", 228", 234", 240", 246", 252", 258", 264" and 270" Wide Three-Piece Top Tables specified with a Cable Base are standard with 10 Legs and 2 Cable Bases.

		WIDTHS							
		186" Wide	192" Wide	198" Wide	204" Wide	210" Wide	216" Wide	222" Wide	228" Wide
DEPTHS	42" Deep								
	48" Deep								
	54" Deep								
	60" Deep								

		WIDTHS						
		234" Wide	240" Wide	246" Wide	252" Wide	258" Wide	264" Wide	270" Wide
DEPTHS	42" Deep							
	48" Deep							
	54" Deep							
	60" Deep							

Note Recommended seating capacity based upon a width of 27" per chair.

Product Details – Planes Conference Tables

Perimeter Leg Conference Tables – Overview

Conference tables with the Perimeter Leg can be specified in rectangle and square in a variety of sizes to accommodate any conference room. The rectilinear design of the Perimeter Leg, along with the sleek profile of the 2" built up edge, give the table a contemporary aesthetic.

Table Components

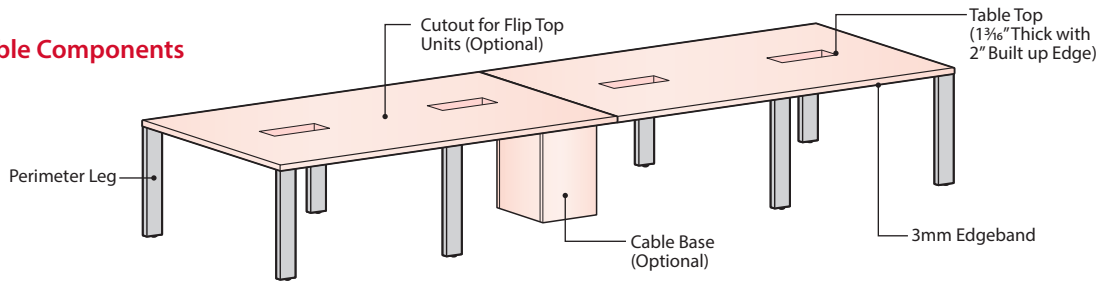

Features

- The rectangular shaped perimeter legs align with the edge of the table top at the perimeter.
- Perimeter Legs are 1 3/8" x 4" and are painted aluminum.
- Glides have a 1/2" adjustment range and are standard in black finish.
- The tops are available in wood or laminate finishes.
- Standard table height is 30" high with 28" knee clearance.
- Tables may be specified with optional factory cutouts for separately specified Flip Top Units for power.
- Most tables are available with optional Cable Bases for Power Management. Cable Bases may be also be used to support the top and reduce the number of legs needed (If Cable Base is removed during reconfiguration, ensure top is properly supported with legs at each corner and vertical support every 60").
- Perimeter Leg Conference Tables are standard with 2" thick tops.
- Tables with multiple piece tops will have equal sized pieces.
- 3mm Edgeband seams are standard on two and three-piece tops.
- Perimeter Leg Conference Tables are available with a wide variety of sizes to meet most seating capacity needs.

Edge Details

3mm Laminate Edgeband Edge

Top View

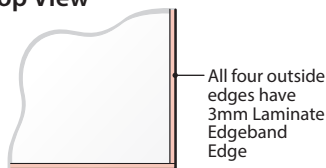

Front View

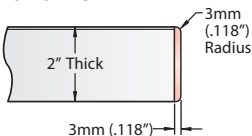

3mm Wood Edgeband Edge

Top View

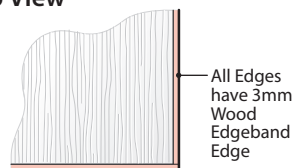

Front View

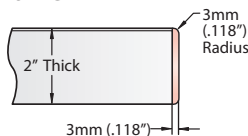

Core Material

2" Built Up Top – Engineered composite panel made with wood fiber, 100% of which is recycled fiber, bonded with resin. Table tops made with this core are compliant with GREENGUARD™ Standard for Low Emitting Products.

Product Details – Planes Conference Tables

Perimeter Leg Conference Tables – Overview

Wood Grain Direction for Natural, Quarter Cut, Rift Cut and Double Cut Wood Veneer

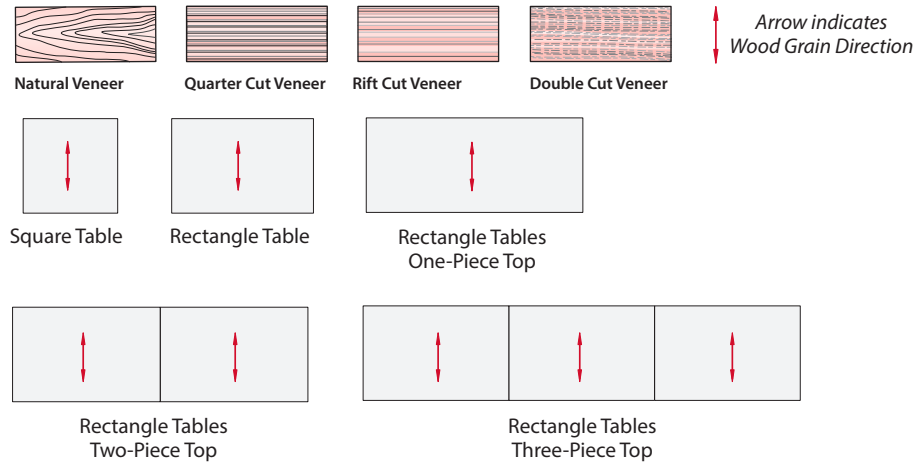

Interior Leg Conference Tables – Overview

Wood Grain Direction for Wood Grain Laminate

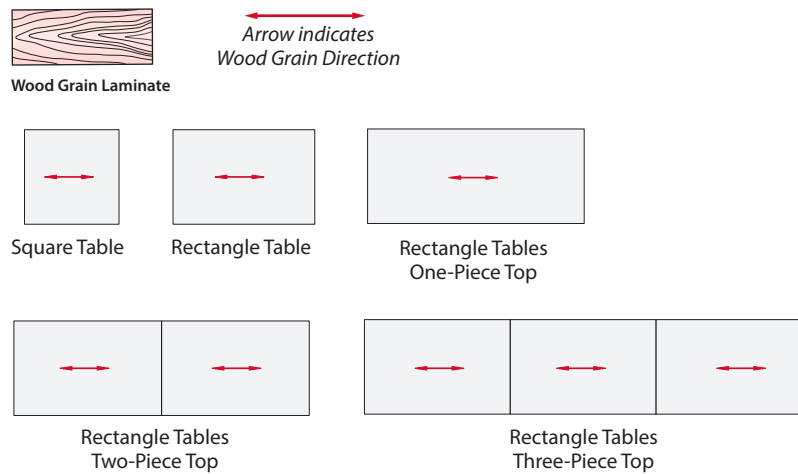

Note Laminate wood grain on multi-piece tops may not match.

Product Details – Planes Conference Tables

Perimeter Leg Conference Table – Square

One Piece-Top

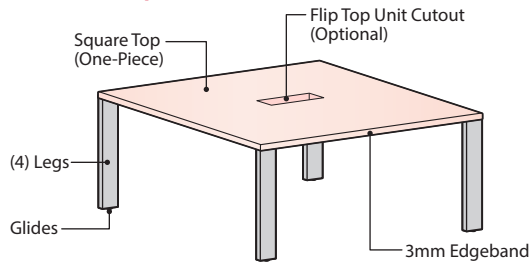

Component Materials/Finishes

COMPONENT NAME	MATERIALS/ FINISHES
Square Top Includes one-piece top.	Laminate Top – Specify separate finish colors for top and edge trim • Top is 2" thick. • Top is standard with 3mm laminate edgeband on user edges. Wood Top – Specify a single finish color for the top and edge trim • Top is 2" thick. • Top is standard with 3mm wood edgeband on user edges.
Perimeter Legs	Painted Metal – Specified Trim Color
Glides	Standard in Black

Flip Top Unit Cutout Options

Center Cutout Option
Includes 1 Flip Top Unit cutout (centered on top)

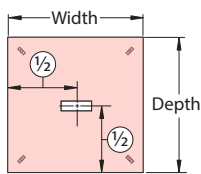

Cutout Option (F or V)
For use with Single Sided/
4 Port Flip Top Unit

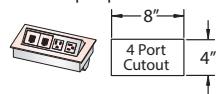

Cutout Option (J or K)
For use with Single Sided/
6 Ports Flip Top Unit

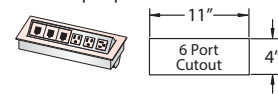

Cutout Option (M or P)
For use with Double Sided/
8 Ports Flip Top Unit

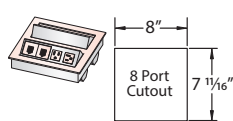

Cutout Option (Q or T)
For use with Double Sided/
12 Ports Flip Top Unit

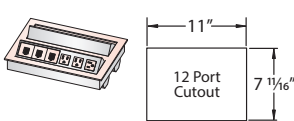

Note Flip Top Units are separately specified.

Dimensions

TABLETOP			KNEESPACE (Nominal)		
Width Nominal (Actual)	Depth Nominal (Actual)	(A)	(B)	(C)	
42" (41.68")	42" (41.68")	21"	34"	39"	
48" (47.68")	48" (47.68")	24"	40"	45"	
54" (53.68")	54" (53.68")	27"	39"	51"	
60" (59.68")	60" (59.68")	30"	52"	57"	

Top View

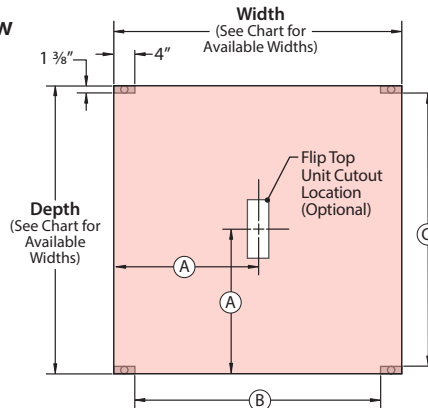

Front View

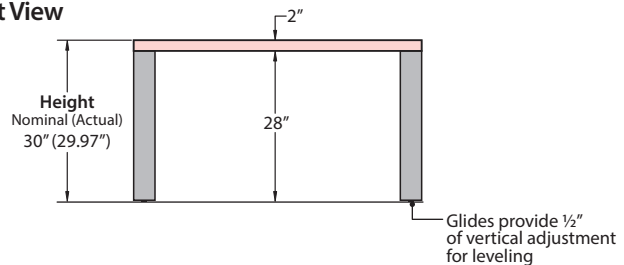

Table Sizes and Seating Capacities

TABLE SIZES		MAXIMUM NUMBER OF CHAIRS	
Depth Nominal (Actual)	Wide Nominal (Actual)		
42" (41.68")	42" (41.68")	4 Chairs Maximum (4 Legs)	
47" (46.68")	47" (46.68")	4 Chairs Maximum (4 Legs)	
54" (53.68")	54" (53.68")	4 Chairs Maximum (4 Legs)	
60" Deep	60" Wide	8 Chairs Maximum (4 Legs)	

Note

- Recommended seating capacity based upon a width of 27" per chair.
- Cable Bases are not recommended for One-Piece Square Tables, due to lack of kneespace clearance. Consider the separately specified Cable Column for cable management.

Product Details – Planes Conference Tables

Perimeter Leg Conference Table – Square

Two Piece-Top – No Cable Base (Includes 6 Legs)

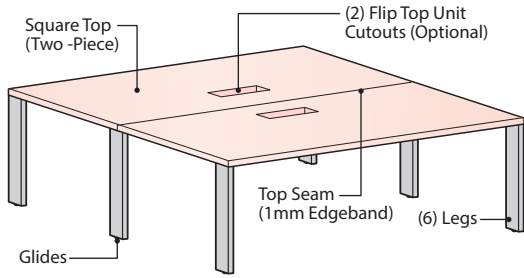

Two Piece-Top – With Cable Base (Includes 4 Legs)

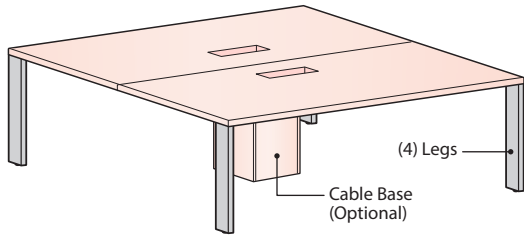

Flip Top Unit Cutout Options

Center Cutout Locations

Includes 2 Flip Top Unit cutouts (One cutout in each top piece)

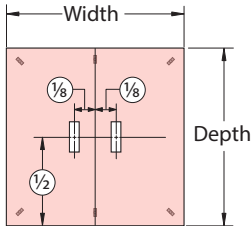

Cutout Option (F)

For use with Single Sided/4 Port

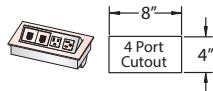

Cutout Option (J)

For use with Single Sided / 6 Ports Flip Top Unit

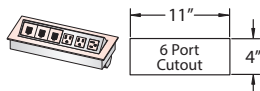

- Note**
- Double sided flip top units are not recommended with 2-Piece Square Tables.
 - Flip Top Units are separately specified.

Cable Base Options

- Two-Piece round tables may be specified with or without Cable Bases
 - (Option N) No Cable Base.
 - (Option C) Cable Base

Cable Base Size and Location

66" and 72" Deep Tables may be specified with an optional 14" x 14" Cable Base (Centered on top)

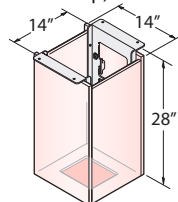
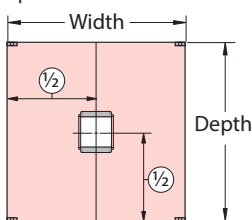

14" x 14" Cable Base

Component Materials/Finishes

COMPONENT NAME	MATERIALS/ FINISHES
Square Top Includes two-piece top.	Laminate Top – Specify separate finish colors for top and edge trim • Top is 2" thick. • Two-piece top is standard with 3mm laminate edgeband on user edges and 3mm edgeband on seam between tops.
	Wood Top – Specify a single finish color for the top and edge trim • Top is 2" thick. • Two-piece top is standard with 3mm wood edgeband on user edges and 3mm wood edgeband on seam between tops.
Perimeter Legs	Painted Metal – Specified Trim Color
Cable Base (Optional)	Panels Laminate Panels – Specified surface and edge trim colors Wood Panels – Specified top and edge trim wood finish color
	Frame Painted Metal – Standard in Black
Glides	Standard in Black

Dimensions

TABLETOP					KNEESPACE (Nominal)		
Width Nominal (Actual)	Depth Nominal (Actual)	A	B	C	D	E	F
66" (64.68")	66" (64.68")	33"	33"	8 1/4"	63"	27"	58"
72" (71.68")	72" (71.68")	36"	33"	9"	69"	30"	64"

No Cable Base – Includes (6) Legs

Top View

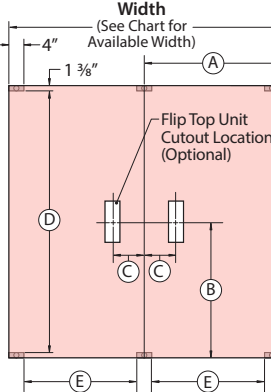

With Cable Base – Includes (4) Legs

Top View

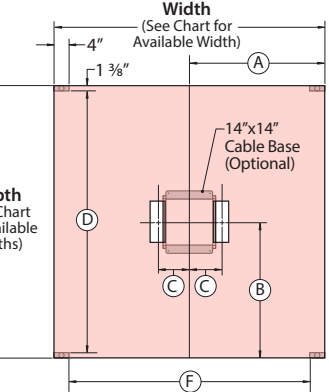

Front View

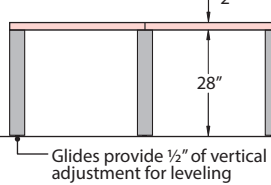

Front View

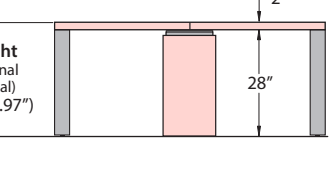

Glides provide 1/2" of vertical adjustment for leveling

Table Sizes and Seating Capacities

TABLE SIZES		MAXIMUM NUMBER OF CHAIRS
Depth Nominal (Actual)	Wide Nominal (Actual)	
66" (65.68")	66" (65.68")	8 Chairs Maximum (6 Legs or 4 Legs/ 1 Cable Base)
72" (71.68")	72" (71.68")	8 Chairs Maximum (6 Legs or 4 Legs/ 1 Cable Base)

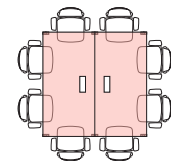

- Note**
- Recommended seating capacity based upon a width of 27" per chair.
 - Not recommended for use with workware switching Interface Module.

Product Details – Planes Conference Tables

Perimeter Leg Conference Table – Rectangular

48"/54"/60"/66" Wide – Without Cable Base
Includes (4) Legs

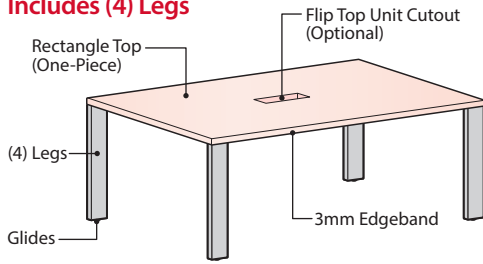

48"/54"/60"/66" Wide – With Cable Base
Includes (4) Legs

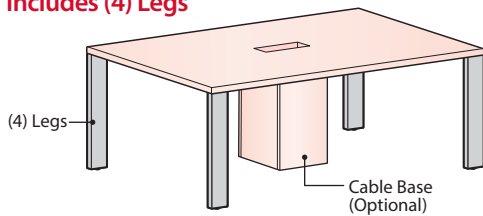

72"/78" Wide – Without Cable Base
Includes (6) Legs

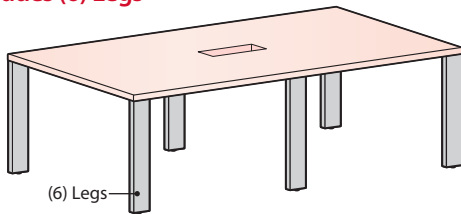

72"/78" Wide – With Cable Base
Includes (4) Legs

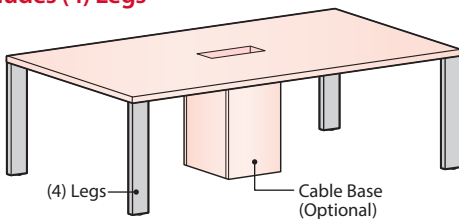

Component Materials/Finishes

COMPONENT NAME		MATERIALS/ FINISHES
Rectangle Top Includes one-piece top.		Laminate Top – Specify separate finish colors for top and edge trim • Top is 2" thick. • Top is standard with 3mm laminate edgeband on user edges.
		Wood Top – Specify a single finish color for the top and edge trim • Top is 2" thick. • Top is standard with 3mm wood edgeband on user edges.
Perimeter Legs		Painted Metal – Specified Trim Color
Glides		Standard in Black
Cable Base (Optional)	Panels	Laminate Panels – Specified surface and edge trim colors
	Frame	Painted Metal – Standard in Black

Flip Top Unit Cutout Options

Center Cutout Option

- Includes 1 Flip Top Unit cutout (centered on top)

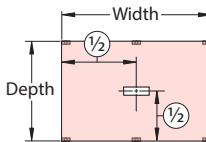

Left/Right Cutout Option

- Includes 2 Flip Top Unit cutouts (1 Left Cutout and 1 Right Cutout)

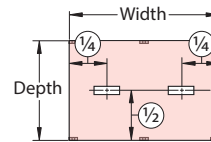

Cutout Option (F or V)

- For use with Single Sided/ 4 Port Flip Top Unit

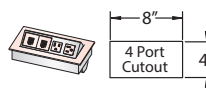

Cutout Option (J or K)

- For use with Single Sided/ 6 Ports Flip Top Unit

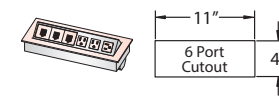

Cutout Option (M or P)

- For use with Double Sided/ 8 Ports Flip Top Unit

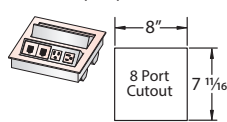

Cutout Option (Q or T)

- For use with Double Sided/ 12 Ports Flip Top Unit

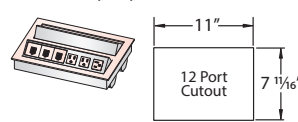

Note Flip Top Units are separately specified.

Cable Base Options

- Tables may be specified with or without Cable Bases
 - (Option N) No Cable Base.
 - (Option C) Cable Base

One-Piece Table with Cable Base option (Top View)

36" Deep Table Includes an 8" x 14" Cable Base (Centered on top)

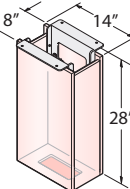
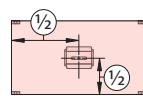

8" x 14" Cable Base

42", 48", 54", 60" Deep Tables Includes an 14" x 14" Cable Base (Centered on top)

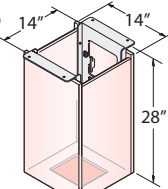
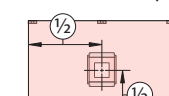

14" x 14" Cable Base

Note

- Cable Base option not recommended for 30" deep tables.
- Cable base and table tops may be specified with different surface colors and edge trim colors.

Product Details – Planes Conference Tables

Perimeter Leg Conference Table – Rectangular – Dimensions

Dimensions – 48"-66" Wide – Without Cable Base
(Includes 4 Legs)

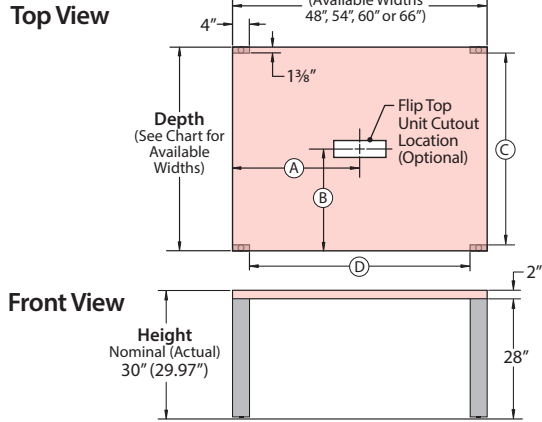

Dimensions – 72"-78" Wide – Without Cable Base
(Includes 6 Legs)

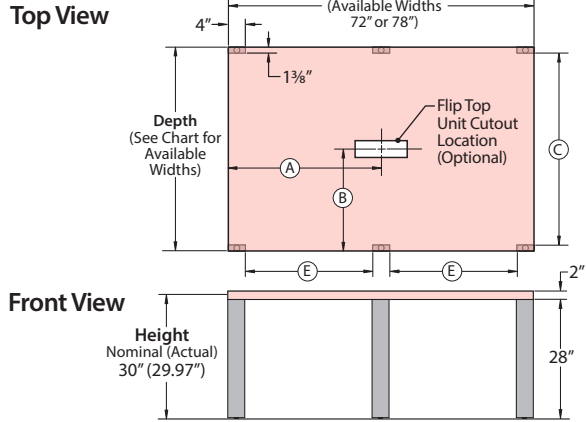

48"/54"/60"/66" Wide – With Cable Base
(Includes 4 Legs)

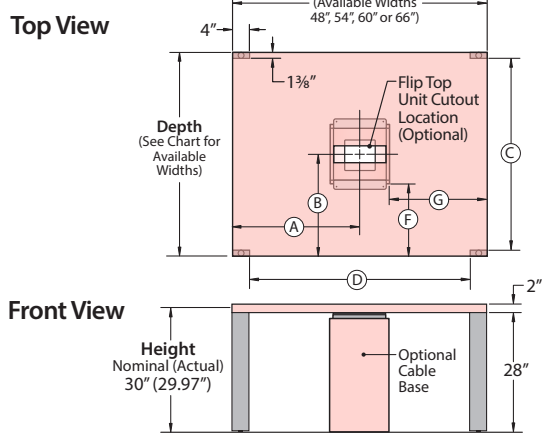

72"/78" Wide – With Cable Base
(Includes 4 Legs)

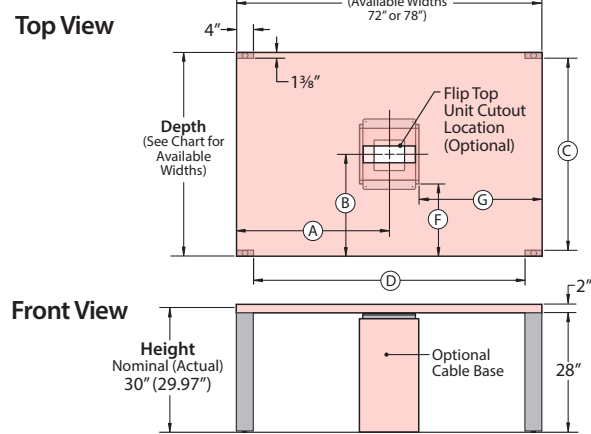

Note The optional Cable Base reduces the number of legs shipped with 72" and 78" Wide Tables to (4) legs.

Dimensions

TABLETOP				KNEESPACE (Nominal)						CABLE BASE		
Depth Nominal (Actual)	Width Nominal (Actual)	Number of Top Pieces	A	B	C	D	E	F	G	Optional Cable Base Size/ Availability	Number of Legs Without Cable Base	Number of Legs With Cable Base
30" (29.68")	60" (59.68")	1	30"	15"	27"	52"	N/A	N/A	N/A	Not Available	4	N/A
	66" (65.68")	1	33"	15"	27"	58"	N/A	N/A	N/A	Not Available	4	N/A
	72" (71.68")	1	36"	15"	27"	64"	30"	N/A	N/A	Not Available	6	N/A
36" (35.68")	60" (59.68")	1	30"	16"	33"	52"	N/A	14"	23"	8" D x 16" W	4	4
	66" (65.68")	1	33"	16"	33"	58"	N/A	14"	26"	8" D x 16" W	4	4
42" (41.68")	48" (47.68")	1	24"	21"	39"	40"	N/A	14"	17"	16" D x 16" W	4	4
	54" (53.68")	1	27"	21"	39"	46"	N/A	14"	20"	16" D x 16" W	4	4
	60" (59.68")	1	30"	21"	39"	52"	N/A	14"	23"	16" D x 16" W	4	4
	66" (65.68")	1	33"	21"	39"	58"	N/A	14"	26"	16" D x 16" W	4	4
	72" (71.68")	1	36"	21"	39"	64"	30"	14"	29"	16" D x 16" W	6	4
	78" (77.68")	1	39"	21"	39"	70"	33"	14"	32"	16" D x 16" W	6	4
48" (47.68")	54" (53.68")	1	27"	24"	45"	46"	N/A	17"	20"	16" D x 16" W	4	4
	60" (59.68")	1	30"	24"	45"	52"	N/A	17"	23"	16" D x 16" W	4	4
	66" (65.68")	1	33"	24"	45"	58"	N/A	17"	26"	16" D x 16" W	4	4
	72" (71.68")	1	36"	24"	45"	64"	30"	17"	29"	16" D x 16" W	6	4
54" (53.68")	60" (59.68")	1	30"	27"	51"	52"	N/A	20"	23"	16" D x 16" W	4	4
	66" (65.68")	1	33"	27"	51"	58"	N/A	20"	26"	16" D x 16" W	4	4
	72" (71.68")	1	36"	27"	51"	64"	30"	20"	29"	16" D x 16" W	6	4
	78" (77.68")	1	39"	27"	51"	70"	33"	20"	32"	16" D x 16" W	6	4
60" (59.68")	66" (65.68")	1	33"	30"	57"	58"	N/A	23"	26"	16" D x 16" W	4	4
	72" (71.68")	1	36"	30"	57"	64"	30"	23"	29"	16" D x 16" W	6	4
60" (59.68")	78" (77.68")	1	39"	30"	57"	70"	33"	23"	32"	16" D x 16" W	6	4

Note

- For optional Flip Top Unit Cutout sizes and dimensions see previous page.
- 36" tables are available with 8"D x 16"W Cable Bases, which are not compatible with Double Sided Flip Top Unit Cutouts (M) or (Q).
- Cable Base option not recommended for 30" deep tables, consider the separately specified Cable Column for cable management.

Product Details – Planes Conference Tables

Perimeter Leg Conference Table – Rectangular

Table Sizes and Seating Capacities – Without Cable Bases

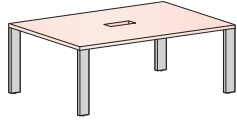

48"-66" wide Rectangle Tables specified without a Cable Base are standard with 4 Legs.

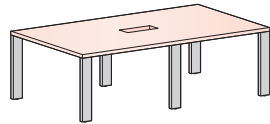

72"-78" wide Rectangle Tables specified without a Cable Base are standard with 6 Legs.

		WIDTHS					
		48" Wide	54" Wide	60" Wide	66" Wide	72" Wide	78" Wide
DEPTHS	30" Deep	N/A	N/A	 6 Chairs Max. (4 Legs)	 6 Chairs Max. (4 Legs)	 6 Chairs Max. (6 Legs)	N/A
	36" Deep	N/A	N/A	 6 Chairs Max. (4 Legs)	 6 Chairs Max. (4 Legs)	N/A	N/A
	42" Deep	 4 Chairs Max. (4 Legs)	 6 Chairs Max. (4 Legs)	 6 Chairs Max. (4 Legs)	 6 Chairs Max. (4 Legs)	 6 Chairs Max. (6 Legs)	 6 Chairs Max. (6 Legs)
	48" Deep	N/A	 6 Chairs Max. (4 Legs)	 6 Chairs Max. (4 Legs)	 6 Chairs Max. (4 Legs)	 6 Chairs Max. (6 Legs)	 6 Chairs Max. (6 Legs)
	54" Deep	N/A	N/A	 6 Chairs Max. (6 Legs)	 6 Chairs Max. (4 Legs)	 8 Chairs Max. (6 Legs)	 8 Chairs Max. (6 Legs)
	60" Deep	N/A	N/A	N/A	 8 Chairs Max. (4 Legs)	 8 Chairs Max. (6 Legs)	 8 Chairs Max. (6 Legs)

Table Sizes and Seating Capacities – With Cable Bases

- Optional Cable Bases function as a top support allowing tables with (6) legs to be reduced down to (4) Legs.
- 36" Deep Tables specified with a Cable Base ship with a 8" x 14" Cable Base.
- 42"-60" Deep Tables specified with a Cable Base ship with a 14" x 14" Cable Base.

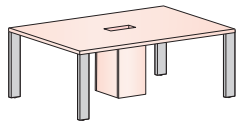

48"-66" wide Rectangle Tables specified with a Cable Base are standard with 4 Legs.

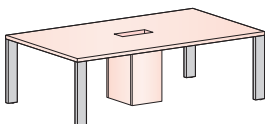

72"-78" wide Rectangle Tables specified with a Cable Base are standard with 4 Legs.

		WIDTHS					
		48" Wide	54" Wide	60" Wide	66" Wide	72" Wide	78" Wide
DEPTHS	30" Deep	N/A	N/A	 Cable Base Not Recommended	 Cable Base Not Recommended	 Cable Base Not Recommended	N/A
	36" Deep	N/A	N/A	 6 Chairs Max. (4) Legs/ (1) 8"x14" Cable Base	 6 Chairs Max. (4) Legs/ (1) 8"x14" Cable Base	N/A	N/A
	42" Deep	 4 Chairs Max. (4) Legs/ (1) 14"x14" Cable Base	 6 Chairs Max. (4) Legs/ (1) 14"x14" Cable Base	 6 Chairs Max. (4) Legs/ (1) 14"x14" Cable Base	 6 Chairs Max. (4) Legs/ (1) 14"x14" Cable Base	 6 Chairs Max. (4) Legs/ (1) 14"x14" Cable Base	 6 Chairs Max. (4) Legs/ (1) 14"x14" Cable Base
	48" Deep	N/A	 6 Chairs Max. (4) Legs/ (1) 14"x14" Cable Base	 6 Chairs Max. (4) Legs/ (1) 14"x14" Cable Base	 6 Chairs Max. (4) Legs/ (1) 14"x14" Cable Base	 6 Chairs Max. (4) Legs/ (1) 14"x14" Cable Base	 6 Chairs Max. (4) Legs/ (1) 14"x14" Cable Base
	54" Deep	N/A	N/A	 8 Chairs Max. (4) Legs/ (1) 14"x14" Cable Base	 8 Chairs Max. (4) Legs/ (1) 14"x14" Cable Base	 8 Chairs Max. (4) Legs/ (1) 14"x14" Cable Base	 8 Chairs Max. (4) Legs/ (1) 14"x14" Cable Base
	60" Deep	N/A	N/A	N/A	 8 Chairs Max. (4) Legs/ (1) 14"x14" Cable Base	 8 Chairs Max. (4) Legs/ (1) 14"x14" Cable Base	 8 Chairs Max. (4) Legs/ (1) 14"x14" Cable Base

Note Recommended seating capacity based upon a width of 27" per chair.

Product Details – Planes Conference Tables

Perimeter Leg Conference Table – One-Piece Top – Rectangular

Without Cable Base – Includes (6) Legs

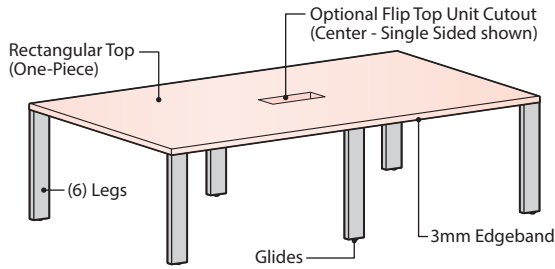

With Cable Base – Includes (4) Legs

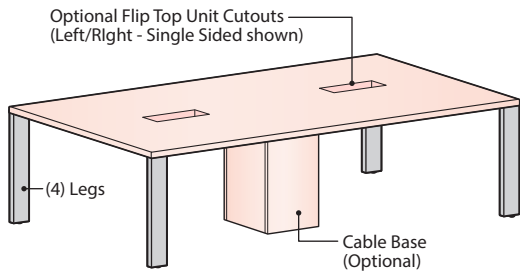

Component Materials/Finishes

COMPONENT NAME	MATERIALS/ FINISHES
Rectangle Top Includes one-piece top.	Laminate Top – Specify separate finish colors for top and edge trim • Top is 2" thick. • Top is standard with 3mm laminate edgeband on user edges.
	Wood Top – Specify a single finish color for the top and edge trim • Top is 2" thick. • Top is standard with 3mm wood edgeband on user edges.
Perimeter Legs	Painted Metal – Specified Trim Color
Glides	Standard in Black
Cable Base (Optional)	Panels Laminate Panels – Specified surface and edge trim colors
	Wood Panels – Specified top and edge trim wood finish color
Frame	Painted Metal – Standard in Black

Flip Top Unit Cutout Options

Center Cutout Option

- Includes 1 Flip Top Unit cutout (centered on top)

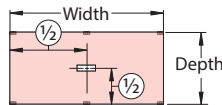

Left/Right Cutout Option

- Includes 2 Flip Top Unit cutouts (1 Left Cutout and 1 Right Cutout)

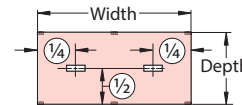

Cutout Option (F or V)

- For use with Single Sided/ 4 Port Flip Top Unit

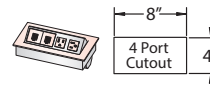

Cutout Option (J or K)

- For use with Single Sided/ 6 Ports Flip Top Unit

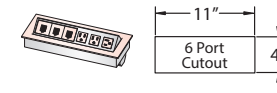

Cutout Option (M or P)

- For use with Double Sided/ 8 Ports Flip Top Unit

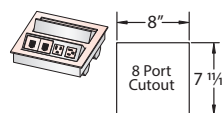

Cutout Option (Q or T)

- For use with Double Sided/ 12 Ports Flip Top Unit

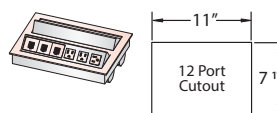

Note Flip Top Units are separately specified.

Cable Base Options

- Tables may be specified with or without Cable Bases
 - (Option N) No Cable Base.
 - (Option C) 36" deep table includes 8" x 14" Cable Base
 - 42", 48", 54" and 60" deep table includes 14" x 14" Cable Base

One-Piece Table with Cable Base option (Top View)

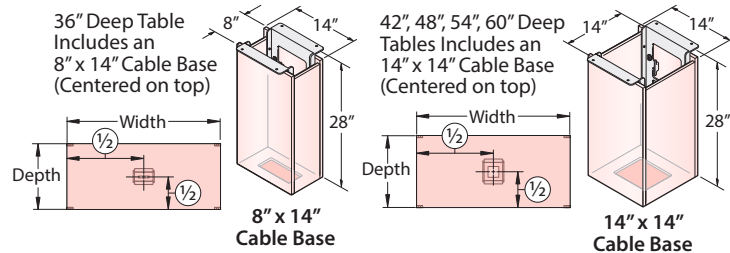

Product Details – Planes Conference Tables

Perimeter Leg Conference Table – One-Piece Top – Rectangular

Dimensions – Without Cable Base – Includes (6) Legs

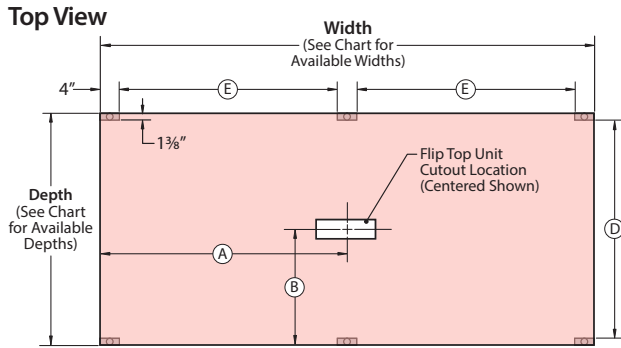

Dimensions – With Cable Base – Includes (4) Legs

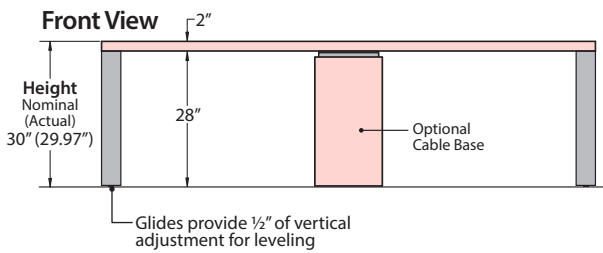
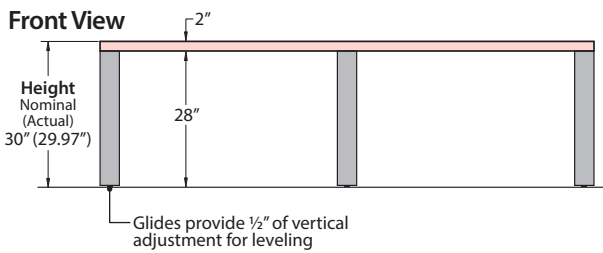
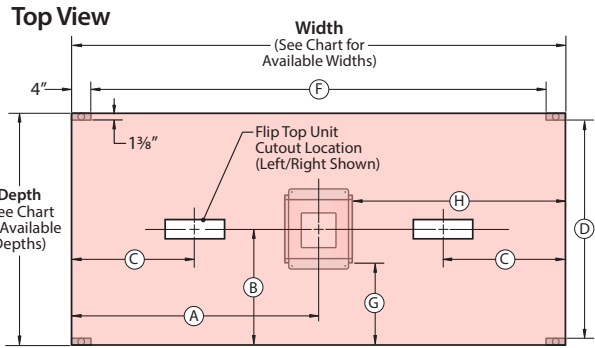

Dimensions

TABLETOP			KNEESPACE (Nominal)			LEGS		CABLE BASE					
Depth Nominal (Actual)	Width Nominal (Actual)	Number of Top Pieces	A	B	C	D	E	F	Number of Legs Without Cable Base	Number of Legs With Cable Base	Optional Cable Base Sizes	G	H
36" (35.68")	72" (71.68")	1	36"	18"	18"	33"	30"	64"	6	4	8" D x 16" W	14"	29"
	78" (77.68")	1	39"	18"	19 1/2"	33"	33"	70"	6	4	8" D x 16" W	14"	32"
	84" (83.68")	1	42"	18"	21"	33"	36"	76"	6	4	8" D x 16" W	14"	35"
	90" (89.68")	1	45"	18"	22 1/2"	33"	39"	82"	6	4	8" D x 16" W	14"	38"
	96" (95.68")	1	48"	18"	24"	33"	42"	88"	6	4	8" D x 16" W	14"	41"
42" (41.68")	84" (83.68")	1	42"	21"	21"	39"	36"	76"	6	4	16" D x 16" W	14"	32"
	90" (89.68")	1	45"	21"	22 1/2"	39"	39"	82"	6	4	16" D x 16" W	14"	35"
	96" (95.68")	1	48"	21"	24"	39"	42"	88"	6	4	16" D x 16" W	14"	38"
	102" (101.68")	1	51"	21"	25 1/2"	39"	45"	94"	6	4	16" D x 16" W	14"	41"
	108" (107.68")	1	54"	21"	27"	39"	48"	100"	6	4	16" D x 16" W	14"	47"
48" (47.68")	114" (113.68")	1	57"	21"	28 1/2"	39"	51"	106"	6	4	16" D x 16" W	14"	50"
	120" (119.68")	1	60"	21"	30"	39"	54"	112"	6	4	16" D x 16" W	14"	53"
	84" (83.68")	1	42"	24"	21"	45"	36"	76"	6	4	16" D x 16" W	17"	32"
	90" (89.68")	1	45"	24"	22 1/2"	45"	39"	82"	6	4	16" D x 16" W	17"	35"
	96" (95.68")	1	48"	24"	24"	45"	42"	88"	6	4	16" D x 16" W	17"	38"
54" (53.68")	102" (101.68")	1	51"	24"	25 1/2"	45"	45"	94"	6	4	16" D x 16" W	17"	41"
	108" (107.68")	1	54"	24"	27"	45"	48"	100"	6	4	16" D x 16" W	17"	47"
	114" (113.68")	1	57"	24"	28 1/2"	45"	51"	106"	6	4	16" D x 16" W	17"	50"
	120" (119.68")	1	60"	24"	30"	45"	54"	112"	6	4	16" D x 16" W	17"	53"
	60" (59.68")	84" (83.68")	1	42"	27"	21"	51"	36"	76"	6	4	16" D x 16" W	20"
90" (89.68")		1	45"	27"	22 1/2"	51"	39"	82"	6	4	16" D x 16" W	20"	35"
96" (95.68")		1	48"	27"	24"	51"	42"	88"	6	4	16" D x 16" W	20"	38"
102" (101.68")		1	51"	27"	25 1/2"	51"	45"	94"	6	4	16" D x 16" W	20"	41"
108" (107.68")		1	54"	27"	27"	51"	48"	100"	6	4	16" D x 16" W	20"	47"
60" (59.68")	114" (113.68")	1	57"	27"	28 1/2"	51"	51"	106"	6	4	16" D x 16" W	20"	50"
	120" (119.68")	1	60"	27"	30"	51"	54"	112"	6	4	16" D x 16" W	20"	53"
	84" (83.68")	1	42"	30"	21"	57"	36"	76"	6	4	16" D x 16" W	23"	32"
	90" (89.68")	1	45"	30"	22 1/2"	57"	39"	82"	6	4	16" D x 16" W	23"	35"
	96" (95.68")	1	48"	30"	24"	57"	42"	88"	6	4	16" D x 16" W	23"	38"
60" (59.68")	102" (101.68")	1	51"	30"	25 1/2"	57"	45"	94"	6	4	16" D x 16" W	23"	41"
	108" (107.68")	1	54"	30"	27"	57"	48"	100"	6	4	16" D x 16" W	23"	47"
	114" (113.68")	1	57"	30"	28 1/2"	57"	51"	106"	6	4	16" D x 16" W	23"	50"
	120" (119.68")	1	60"	30"	30"	57"	54"	112"	6	4	16" D x 16" W	23"	53"

Product Details – Planes Conference Tables

Perimeter Leg Conference Table – One-Piece Top – Rectangular

Table Sizes and Seating Capacities – Without Cable Bases – Includes (6) Legs

• One-Piece Top Tables specified without a Cable Base are standard with 6 Legs.

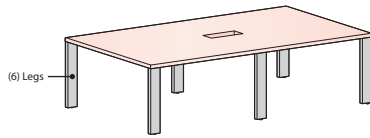

		WIDTHS								
		72" Wide	78" Wide	84" Wide	90" Wide	96" Wide	102" Wide	108" Wide	114" Wide	120" Wide
DEPTHS	36" Deep	6 Chairs Maximum	6 Chairs Maximum	6 Chairs Maximum	6 Chairs Maximum	6 Chairs Maximum	N/A	N/A	N/A	N/A
	42" Deep	N/A	N/A	6 Chairs Maximum	6 Chairs Maximum	6 Chairs Maximum	6 Chairs Maximum	12 Chairs Maximum	10 Chairs Maximum	10 Chairs Maximum
	48" Deep	N/A	N/A	6 Chairs Maximum	6 Chairs Maximum	6 Chairs Maximum	6 Chairs Maximum	12 Chairs Maximum	10 Chairs Maximum	10 Chairs Maximum
	54" Deep	N/A	N/A	8 Chairs Maximum	8 Chairs Maximum	8 Chairs Maximum	8 Chairs Maximum	12 Chairs Maximum	12 Chairs Maximum	12 Chairs Maximum
	60" Deep	N/A	N/A	8 Chairs Maximum	8 Chairs Maximum	8 Chairs Maximum	8 Chairs Maximum	12 Chairs Maximum	12 Chairs Maximum	12 Chairs Maximum

Table Sizes and Seating Capacities – With Cable Bases – Includes (4) Legs

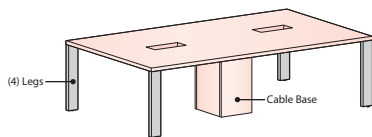

- Optional Cable Bases function as a top support allowing the number of legs to be reduced from (6) Legs down to (4) Legs.
- 36" Deep Tables specified with a Cable Base ship with a 8" x 14" Cable Base.
- 42"-60" Deep Tables specified with a Cable Base ship with a 14" x 14" Cable Base.

		WIDTHS								
		72" Wide	78" Wide	84" Wide	90" Wide	96" Wide	102" Wide	108" Wide	114" Wide	120" Wide
DEPTHS	36" Deep	6 Chairs Maximum	6 Chairs Maximum	8 Chairs Maximum	8 Chairs Maximum	8 Chairs Maximum	N/A	N/A	N/A	N/A
	42" Deep	N/A	N/A	8 Chairs Maximum	8 Chairs Maximum	8 Chairs Maximum	8 Chairs Maximum	10 Chairs Maximum	10 Chairs Maximum	10 Chairs Maximum
	48" Deep	N/A	N/A	8 Chairs Maximum	8 Chairs Maximum	8 Chairs Maximum	8 Chairs Maximum	10 Chairs Maximum	10 Chairs Maximum	10 Chairs Maximum
	54" Deep	N/A	N/A	10 Chairs Maximum	10 Chairs Maximum	10 Chairs Maximum	10 Chairs Maximum	12 Chairs Maximum	12 Chairs Maximum	12 Chairs Maximum
	60" Deep	N/A	N/A	10 Chairs Maximum	10 Chairs Maximum	10 Chairs Maximum	10 Chairs Maximum	12 Chairs Maximum	12 Chairs Maximum	12 Chairs Maximum

Note Recommended seating capacity based upon a width of 27" per chair.

Product Details – Planes Conference Tables

Perimeter Leg Conference Table – Two-Piece Top – Rectangular

Without Cable Base

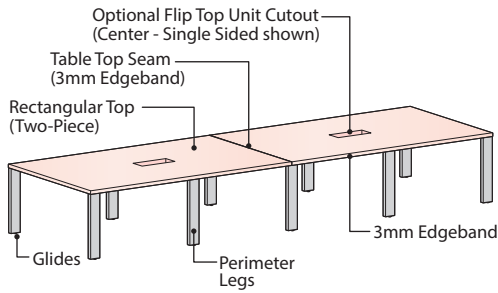

With Cable Base

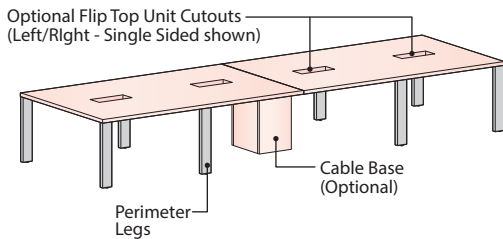

Component Materials/Finishes

COMPONENT NAME	MATERIALS/ FINISHES
Rectangle Top 2-Piece Top	Laminate Top – Specify separate finish colors for top and edge trim • Top is 2" thick. • Two-piece top is standard with 3mm laminate edgeband on user edges and 3mm edgeband on seam between tops.
	Wood Top – Specify a single finish color for the top and edge trim • Top is 2" thick. • Two-piece top is standard with 3mm wood edgeband on user edges and 3mm wood edgeband on seam between tops.
Perimeter Legs	Painted Metal – Specified Trim Color
Glides	Standard in Black
Cable Base (Optional)	Panels Laminate Panels – Specified surface and edge trim colors Wood Panels – Specified top and edge trim wood finish color
	Frame Painted Metal – Standard in Black

Flip Top Unit Cutout Options

Center Cutout Option

- Includes 3 Flip Top Unit cutouts (1 Cutout centered on each top piece)

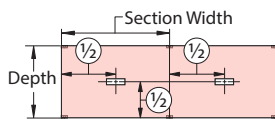

Left/Right Cutout Option

- Includes 6 Flip Top Unit cutouts (2 Cutouts on each top piece)

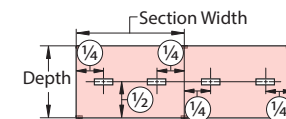

Cutout Option (F or V)

- For use with Single Sided/ 4 Port Flip Top Unit

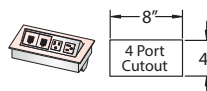

Cutout Option (J or K)

- For use with Single Sided/ 6 Ports Flip Top Unit

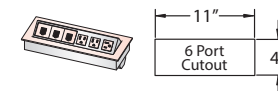

Cutout Option (M or P)

- For use with Double Sided/ 8 Ports Flip Top Unit

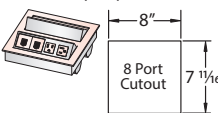

Cutout Option (Q or T)

- For use with Double Sided/ 12 Ports Flip Top Unit

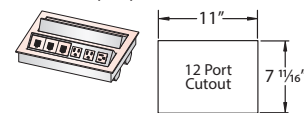

Note Flip Top Units are separately specified.

Cable Base Options

- Tables may be specified with or without Cable Bases
 - (Option N) No Cable Base.
 - (Option C) Includes 14" x 14" Cable Bases

Two-Piece Table with Cable Base option (Top View)

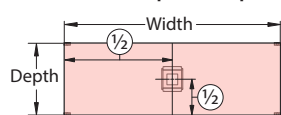

Cable Base is centered on the seam between top pieces.

14" x 14" Cable Base

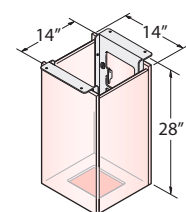

Product Details – Planes Conference Tables

Perimeter Leg Conference Table – Two-Piece Top – Rectangular

**Dimensions – 126"-132" Wide
Tables Without Cable Base
Includes (6) Legs**

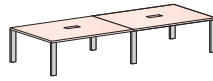

Top View

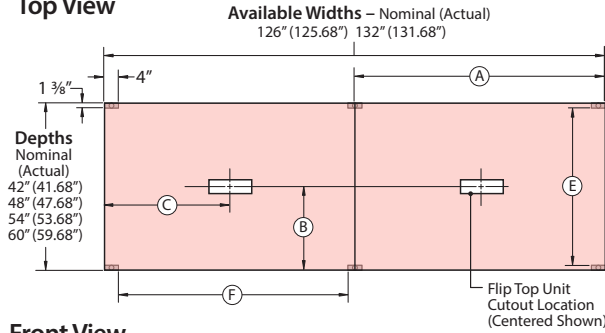

Front View

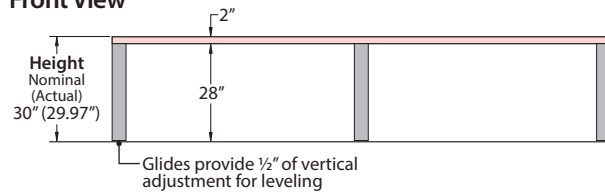

**Dimensions – 138"-180" Wide
Tables Without Cable Base
Includes (10) Legs**

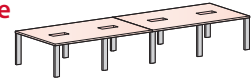

Top View

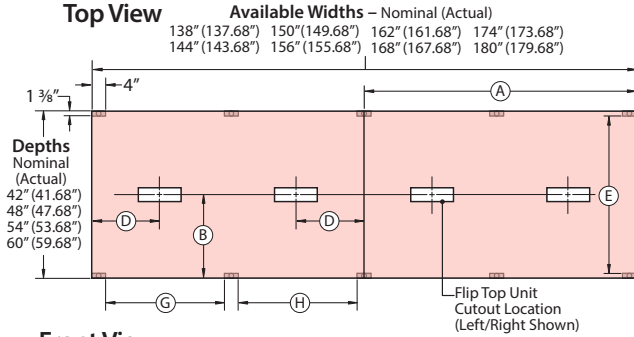

Front View

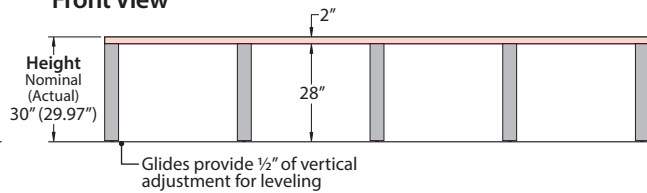

Dimensions

Depth Nominal (Actual)	TABLETOP			KNEESPACE (Nominal)						LEGS	
	Width Nominal (Actual)	Number of Top Pieces	A	B	C	D	E	F	G	H	Number of Legs Without Cable Base
42" (41.68")	126" (125.68")	2	63"	21"	31 1/2"	15 3/4"	39"	57"	N/A	N/A	6
	132" (131.68")	2	66"	21"	33"	16 1/2"	39"	60"	N/A	N/A	6
	138" (137.68")	2	69"	21"	34 1/2"	17 1/4"	39"	N/A	28"	30"	10
	144" (143.68")	2	72"	21"	36"	18"	39"	N/A	30"	32"	10
	150" (149.68")	2	75"	21"	37 1/2"	18 3/4"	39"	N/A	31"	33"	10
	156" (155.68")	2	78"	21"	39"	19 1/2"	39"	N/A	33"	35"	10
	162" (161.68")	2	81"	21"	40 1/2"	20 1/4"	39"	N/A	34"	36"	10
	168" (167.68")	2	84"	21"	42"	21"	39"	N/A	36"	38"	10
	174" (173.68")	2	87"	21"	43 1/2"	21 3/4"	39"	N/A	37"	39"	10
48" (47.68")	126" (125.68")	2	63"	24"	31 1/2"	15 3/4"	45"	57"	N/A	N/A	6
	132" (131.68")	2	66"	24"	33"	16 1/2"	45"	60"	N/A	N/A	6
	138" (137.68")	2	69"	24"	34 1/2"	17 1/4"	45"	N/A	28"	30"	10
	144" (143.68")	2	72"	24"	36"	18"	45"	N/A	30"	32"	10
	150" (149.68")	2	75"	24"	37 1/2"	18 3/4"	45"	N/A	31"	33"	10
	156" (155.68")	2	78"	24"	39"	19 1/2"	45"	N/A	33"	35"	10
	162" (161.68")	2	81"	24"	40 1/2"	20 1/4"	45"	N/A	34"	36"	10
	168" (167.68")	2	84"	24"	42"	21"	45"	N/A	36"	38"	10
	174" (173.68")	2	87"	24"	43 1/2"	21 3/4"	45"	N/A	37"	39"	10
54" (53.68")	126" (125.68")	2	63"	27"	31 1/2"	15 3/4"	51"	57"	N/A	N/A	6
	132" (131.68")	2	66"	27"	33"	16 1/2"	51"	60"	N/A	N/A	6
	138" (137.68")	2	69"	27"	34 1/2"	17 1/4"	51"	N/A	28"	30"	10
	144" (143.68")	2	72"	27"	36"	18"	51"	N/A	30"	32"	10
	150" (149.68")	2	75"	27"	37 1/2"	18 3/4"	51"	N/A	31"	33"	10
	156" (155.68")	2	78"	27"	39"	19 1/2"	51"	N/A	33"	35"	10
	162" (161.68")	2	81"	27"	40 1/2"	20 1/4"	51"	N/A	34"	36"	10
	168" (167.68")	2	84"	27"	42"	21"	51"	N/A	36"	38"	10
	174" (173.68")	2	87"	27"	43 1/2"	21 3/4"	51"	N/A	37"	39"	10
60" (59.68")	126" (125.68")	2	63"	30"	31 1/2"	15 3/4"	57"	57"	N/A	N/A	6
	132" (131.68")	2	66"	30"	33"	16 1/2"	57"	60"	N/A	N/A	6
	138" (137.68")	2	69"	30"	34 1/2"	17 1/4"	57"	N/A	28"	30"	10
	144" (143.68")	2	72"	30"	36"	18"	57"	N/A	30"	32"	10
	150" (149.68")	2	75"	30"	37 1/2"	18 3/4"	57"	N/A	31"	33"	10
	156" (155.68")	2	78"	30"	39"	19 1/2"	57"	N/A	33"	35"	10
	162" (161.68")	2	81"	30"	40 1/2"	20 1/4"	57"	N/A	34"	36"	10
	168" (167.68")	2	84"	30"	42"	21"	57"	N/A	36"	38"	10
	174" (173.68")	2	87"	30"	43 1/2"	21 3/4"	57"	N/A	37"	39"	10

Product Details – Planes Conference Tables

Perimeter Leg Conference Table – Two-Piece Top – Rectangular

**Dimensions – 126"-132" Wide
Tables With Cable Base
Includes (4) Legs**

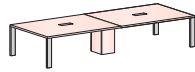

**Dimensions – 138"-180" Wide
Tables With Cable Base
Includes (8) Legs**

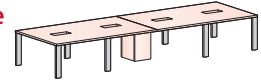

Top View

Available Widths – Nominal (Actual)
126" (125.68") 132" (131.68")

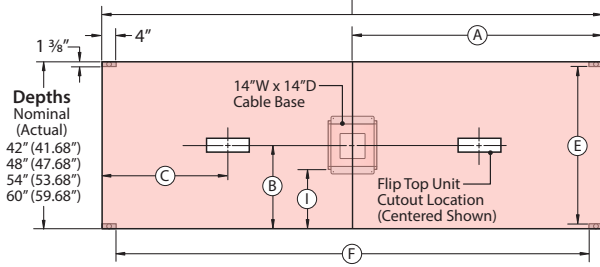

Front View

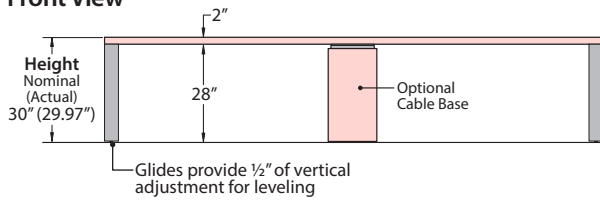

Top View

Available Widths – Nominal (Actual)
138" (137.68") 150" (149.68") 162" (161.68") 174" (176.68")
144" (143.68") 156" (155.68") 168" (167.68") 180" (179.68")

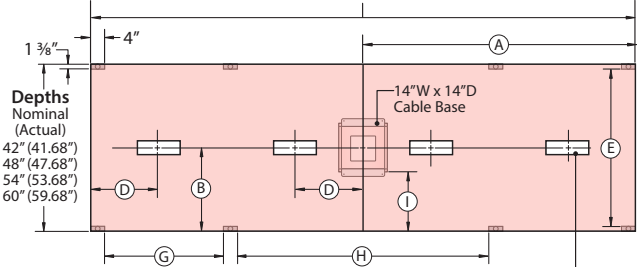

Front View

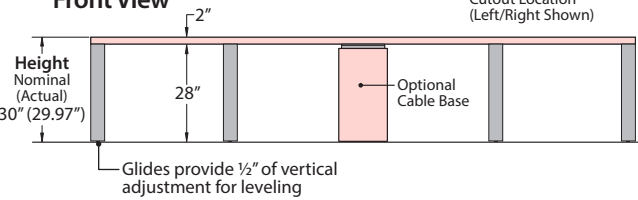

Dimensions

TABLETOP		KNEESPACE (Nominal)					LEGS		CABLE BASE				
Depth Nominal (Actual)	Width Nominal (Actual)	Number of Top Pieces	A	B	C	D	E	F	G	H	I	Number of Legs With Cable Base	Optional Cable Base Sizes
42" (41.68")	126" (125.68")	2	63"	21"	31 1/2"	15 3/4"	39"	118"	N/A	N/A	14"	4	16" D x 16" W
	132" (131.68")	2	66"	21"	33"	16 1/2"	39"	124"	N/A	N/A	14"	4	16" D x 16" W
	138" (137.68")	2	69"	21"	34 1/2"	17 1/4"	39"	N/A	28"	65"	14"	8	16" D x 16" W
	144" (143.68")	2	72"	21"	36"	18"	39"	N/A	30"	68"	14"	8	16" D x 16" W
	150" (149.68")	2	75"	21"	37 1/2"	18 3/4"	39"	N/A	31"	71"	14"	8	16" D x 16" W
	156" (155.68")	2	78"	21"	39"	19 1/2"	39"	N/A	33"	73"	14"	8	16" D x 16" W
	162" (161.68")	2	81"	21"	40 1/2"	20 1/4"	39"	N/A	34"	75"	14"	8	16" D x 16" W
	168" (167.68")	2	84"	21"	42"	21"	39"	N/A	36"	78"	14"	8	16" D x 16" W
	174" (173.68")	2	87"	21"	43 1/2"	21 3/4"	39"	N/A	37"	81"	14"	8	16" D x 16" W
48" (47.68")	126" (125.68")	2	63"	24"	31 1/2"	15 3/4"	45"	118"	N/A	N/A	17"	4	16" D x 16" W
	132" (131.68")	2	66"	24"	33"	16 1/2"	45"	124"	N/A	N/A	17"	4	16" D x 16" W
	138" (137.68")	2	69"	24"	34 1/2"	17 1/4"	45"	N/A	28"	65"	17"	8	16" D x 16" W
	144" (143.68")	2	72"	24"	36"	18"	45"	N/A	30"	68"	17"	8	16" D x 16" W
	150" (149.68")	2	75"	24"	37 1/2"	18 3/4"	45"	N/A	31"	71"	17"	8	16" D x 16" W
	156" (155.68")	2	78"	24"	39"	19 1/2"	45"	N/A	33"	73"	17"	8	16" D x 16" W
	162" (161.68")	2	81"	24"	40 1/2"	20 1/4"	45"	N/A	34"	75"	17"	8	16" D x 16" W
	168" (167.68")	2	84"	24"	42"	21"	45"	N/A	36"	78"	17"	8	16" D x 16" W
	174" (173.68")	2	87"	24"	43 1/2"	21 3/4"	45"	N/A	37"	81"	17"	8	16" D x 16" W
54" (53.68")	126" (125.68")	2	63"	27"	31 1/2"	15 3/4"	51"	118"	N/A	N/A	20"	4	16" D x 16" W
	132" (131.68")	2	66"	27"	33"	16 1/2"	51"	124"	N/A	N/A	20"	4	16" D x 16" W
	138" (137.68")	2	69"	27"	34 1/2"	17 1/4"	51"	N/A	28"	65"	20"	8	16" D x 16" W
	144" (143.68")	2	72"	27"	36"	18"	51"	N/A	30"	68"	20"	8	16" D x 16" W
	150" (149.68")	2	75"	27"	37 1/2"	18 3/4"	51"	N/A	31"	71"	20"	8	16" D x 16" W
	156" (155.68")	2	78"	27"	39"	19 1/2"	51"	N/A	33"	73"	20"	8	16" D x 16" W
	162" (161.68")	2	81"	27"	40 1/2"	20 1/4"	51"	N/A	34"	75"	20"	8	16" D x 16" W
	168" (167.68")	2	84"	27"	42"	21"	51"	N/A	36"	78"	20"	8	16" D x 16" W
	174" (173.68")	2	87"	27"	43 1/2"	21 3/4"	51"	N/A	37"	81"	20"	8	16" D x 16" W
60" (59.68")	126" (125.68")	2	63"	30"	31 1/2"	15 3/4"	57"	118"	N/A	N/A	23"	4	16" D x 16" W
	132" (131.68")	2	66"	30"	33"	16 1/2"	57"	124"	N/A	N/A	23"	4	16" D x 16" W
	138" (137.68")	2	69"	30"	34 1/2"	17 1/4"	57"	N/A	28"	65"	23"	8	16" D x 16" W
	144" (143.68")	2	72"	30"	36"	18"	57"	N/A	30"	68"	23"	8	16" D x 16" W
	150" (149.68")	2	75"	30"	37 1/2"	18 3/4"	57"	N/A	31"	71"	23"	8	16" D x 16" W
	156" (155.68")	2	78"	30"	39"	19 1/2"	57"	N/A	33"	73"	23"	8	16" D x 16" W
	162" (161.68")	2	81"	30"	40 1/2"	20 1/4"	57"	N/A	34"	75"	23"	8	16" D x 16" W
	168" (167.68")	2	84"	30"	42"	21"	57"	N/A	36"	78"	23"	8	16" D x 16" W
	174" (173.68")	2	87"	30"	43 1/2"	21 3/4"	57"	N/A	37"	81"	23"	8	16" D x 16" W
180" (179.68")	126" (125.68")	2	63"	30"	45"	22 1/2"	57"	N/A	39"	83"	23"	8	16" D x 16" W
	132" (131.68")	2	66"	30"	45"	22 1/2"	57"	N/A	39"	83"	23"	8	16" D x 16" W
	138" (137.68")	2	69"	30"	45"	22 1/2"	57"	N/A	39"	83"	23"	8	16" D x 16" W

Product Details – Planes Conference Tables

Perimeter Leg Conference Table – Two-Piece Top – Rectangular

Table Sizes and Seating Capacities – Without Cable Bases – Includes (10) Legs

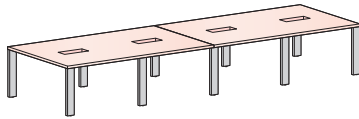

- 126" and 132" Wide Two-Piece Top Tables specified without a Cable Base are standard with 6 Legs.
- 138", 144", 150", 156", 162", 168", 174", 180" Wide Two-Piece Top Tables specified without a Cable Base are standard with 10 Legs.

		WIDTHS									
		126" Wide	132" Wide	138" Wide	144" Wide	150" Wide	156" Wide	162" Wide	168" Wide	174" Wide	180" Wide
DEPTHS	42" Deep										
	48" Deep										
	54" Deep										
	60" Deep										

Table Sizes and Seating Capacities – With Cable Bases – Includes (4) Legs

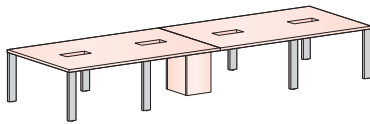

- 126" and 132" Wide Two-Piece Top Tables specified with a Cable Base are standard with 4 Legs.
- 138", 144", 150", 156", 162", 168", 174", 180" Wide Two-Piece Top Tables specified with a Cable Base are standard with 8 Legs.

		WIDTHS									
		126" Wide	132" Wide	138" Wide	144" Wide	150" Wide	156" Wide	162" Wide	168" Wide	174" Wide	180" Wide
DEPTHS	42" Deep	 10 Chairs Max. (4 Legs/ 1 Cable Base)	 10 Chairs Max. (4 Legs/ 1 Cable Base)	 10 Chairs Max. (8 Legs/ 1 Cable Base)	 10 Chairs Max. (8 Legs/ 1 Cable Base)	 10 Chairs Max. (8 Legs/ 1 Cable Base)	 10 Chairs Max. (8 Legs/ 1 Cable Base)	 12 Chairs Max. (8 Legs/ 1 Cable Base)	 12 Chairs Max. (8 Legs/ 1 Cable Base)	 12 Chairs Max. (8 Legs/ 1 Cable Base)	 12 Chairs Max. (8 Legs/ 1 Cable Base)
	48" Deep	 10 Chairs Max. (4 Legs/ 1 Cable Base)	 10 Chairs Max. (4 Legs/ 1 Cable Base)	 10 Chairs Max. (8 Legs/ 1 Cable Base)	 10 Chairs Max. (8 Legs/ 1 Cable Base)	 10 Chairs Max. (8 Legs/ 1 Cable Base)	 10 Chairs Max. (8 Legs/ 1 Cable Base)	 12 Chairs Max. (8 Legs/ 1 Cable Base)	 12 Chairs Max. (8 Legs/ 1 Cable Base)	 12 Chairs Max. (8 Legs/ 1 Cable Base)	 12 Chairs Max. (8 Legs/ 1 Cable Base)
	54" Deep	 10 Chairs Max. (4 Legs/ 1 Cable Base)	 10 Chairs Max. (4 Legs/ 1 Cable Base)	 10 Chairs Max. (8 Legs/ 1 Cable Base)	 10 Chairs Max. (8 Legs/ 1 Cable Base)	 10 Chairs Max. (8 Legs/ 1 Cable Base)	 10 Chairs Max. (8 Legs/ 1 Cable Base)	 14 Chairs Max. (8 Legs/ 1 Cable Base)	 14 Chairs Max. (8 Legs/ 1 Cable Base)	 14 Chairs Max. (8 Legs/ 1 Cable Base)	 14 Chairs Max. (8 Legs/ 1 Cable Base)
	60" Deep	 12 Chairs Max. (4 Legs/ 1 Cable Base)	 12 Chairs Max. (4 Legs/ 1 Cable Base)	 12 Chairs Max. (8 Legs/ 1 Cable Base)	 12 Chairs Max. (8 Legs/ 1 Cable Base)	 12 Chairs Max. (8 Legs/ 1 Cable Base)	 12 Chairs Max. (8 Legs/ 1 Cable Base)	 14 Chairs Max. (8 Legs/ 1 Cable Base)	 14 Chairs Max. (8 Legs/ 1 Cable Base)	 14 Chairs Max. (8 Legs/ 1 Cable Base)	 14 Chairs Max. (8 Legs/ 1 Cable Base)

Note Recommended seating capacity based upon a width of 27" per chair.

Product Details – Planes Conference Tables

Perimeter Leg Conference Table – Three-Piece Top – Rectangular

Without Cable Base

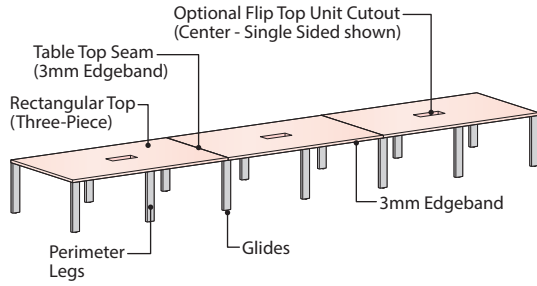

With Cable Base

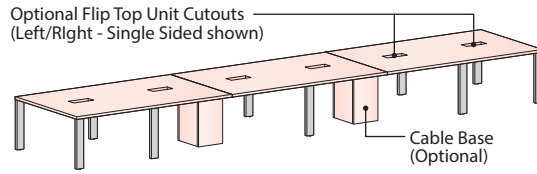

Component Materials/Finishes

COMPONENT NAME	MATERIALS/ FINISHES
Rectangle Top 3-Piece Top	Laminate Top – Specify separate finish colors for top and edge trim • Top is 2" thick. • Two-piece top is standard with 3mm laminate edgeband on user edges and 3mm edgeband on seam between tops.
	Wood Top – Specify a single finish color for the top and edge trim • Top is 2" thick. • Two-piece top is standard with 3mm wood edgeband on user edges and 3mm wood edgeband on seam between tops.
Interior Legs	Painted Metal – Specified Trim Color
Glides	Standard in Black
Cable Base (Optional)	Panels Laminate Panels – Specified surface and edge trim colors Wood Panels – Specified top and edge trim wood finish color
	Frame Painted Metal – Standard in Black

Flip Top Unit Cutout Options

Center Cutout Option

- Includes 3 Flip Top Unit cutouts (1 Cutout centered on each top piece)

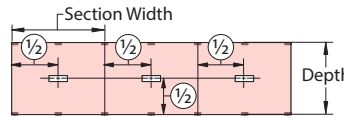

Left/Right Cutout Option

- Includes 6 Flip Top Unit cutouts (2 Cutouts on each top piece)

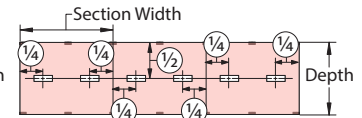

Cutout Option (F or V)

For use with Single Sided/
4 Port Flip Top Unit

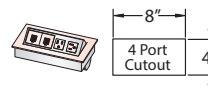

Cutout Option (J or K)

For use with Single Sided/
6 Ports Flip Top Unit

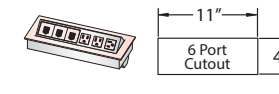

Cutout Option (M or P)

For use with Double Sided/
8 Ports Flip Top Unit

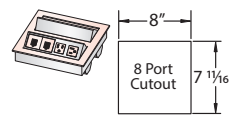

Cutout Option (Q or T)

For use with Double Sided/
12 Ports Flip Top Unit

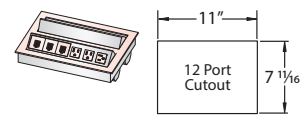

Note Flip Top Units are separately specified.

Cable Base Options

- Tables may be specified with or without Cable Bases
 - (Option N) No Cable Base.
 - (Option C) Includes (2) 14" x 14" Cable Bases

Three-Piece Table with Cable Base option (Top View)

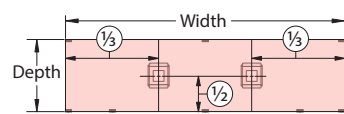

Cable Bases are centered on the seams between top pieces.

14" x 14" Cable Base

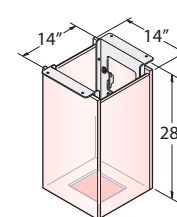

Product Details – Planes Conference Tables

Perimeter Leg Conference Table – Three-Piece Top – Rectangular

**Dimensions – 186"-198" Wide
Tables Without Cable Base
Includes (8) Legs**

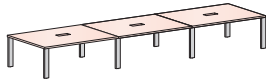

Top View

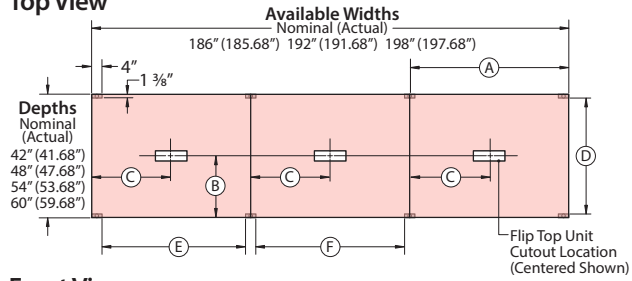

Front View

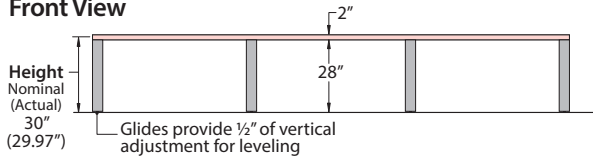

**Dimensions – 204"-270" Wide
Tables Without Cable Base
Includes (14) Legs**

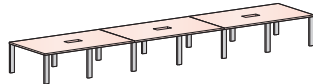

Top View

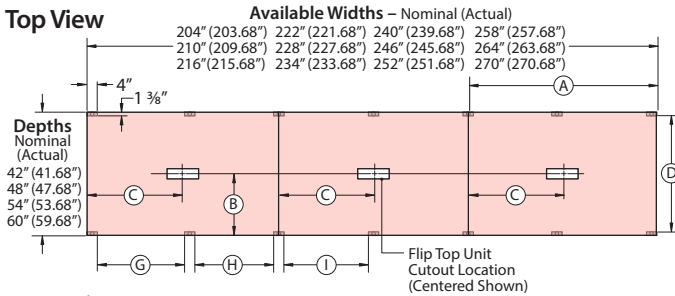

Front View

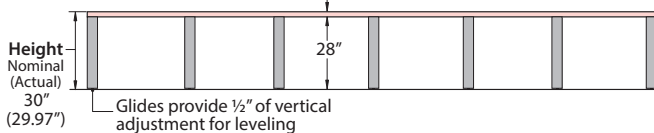

Dimensions

Depth Nominal (Actual)	TABLETOP			KNEESPACE (Nominal)							# of Legs Without Cable Base	
	Width Nominal (Actual)	# of Top Pieces		A	B	C	D	E	F	G		H
42" (41.68")	186"(185.68")	3	62"	21"	31"	39"	56"	58"	N/A	N/A	N/A	8
	192"(191.68")	3	64"	21"	32"	39"	58"	60"	N/A	N/A	N/A	8
	198"(197.68")	3	66"	21"	33"	39"	60"	62"	N/A	N/A	N/A	8
	204"(203.68")	3	68"	21"	34"	39"	N/A	N/A	28"	30"	30"	14
	210"(209.68")	3	70"	21"	35"	39"	N/A	N/A	29"	31"	31"	14
	216"(215.68")	3	72"	21"	36"	39"	N/A	N/A	30"	32"	32"	14
	222"(221.68")	3	74"	21"	37"	39"	N/A	N/A	31"	33"	33"	14
	228"(227.68")	3	76"	21"	38"	39"	N/A	N/A	32"	34"	34"	14
	234"(233.68")	3	78"	21"	39"	39"	N/A	N/A	33"	35"	35"	14
	240"(239.68")	3	80"	21"	40"	39"	N/A	N/A	34"	36"	36"	14
	246"(245.68")	3	82"	21"	41"	39"	N/A	N/A	35"	37"	37"	14
	252"(251.68")	3	84"	21"	42"	39"	N/A	N/A	36"	38"	38"	14
	258"(257.68")	3	86"	21"	43"	39"	N/A	N/A	37"	39"	39"	14
	264"(263.68")	3	88"	21"	44"	39"	N/A	N/A	38"	40"	40"	14
270"(269.68")	3	90"	21"	45"	39"	N/A	N/A	39"	41"	41"	14	
48" (47.68")	186"(185.68")	3	62"	24"	31"	45"	56"	58"	N/A	N/A	N/A	8
	192"(191.68")	3	64"	24"	32"	45"	58"	60"	N/A	N/A	N/A	8
	198"(197.68")	3	66"	24"	33"	45"	60"	62"	N/A	N/A	N/A	8
	204"(203.68")	3	68"	24"	34"	45"	N/A	N/A	28"	30"	30"	14
	210"(209.68")	3	70"	24"	35"	45"	N/A	N/A	29"	31"	31"	14
	216"(215.68")	3	72"	24"	36"	45"	N/A	N/A	30"	32"	32"	14
	222"(221.68")	3	74"	24"	37"	45"	N/A	N/A	31"	33"	33"	14
	228"(227.68")	3	76"	24"	38"	45"	N/A	N/A	32"	34"	34"	14
	234"(233.68")	3	78"	24"	39"	45"	N/A	N/A	33"	35"	35"	14
	240"(239.68")	3	80"	24"	40"	45"	N/A	N/A	34"	36"	36"	14
	246"(245.68")	3	82"	24"	41"	45"	N/A	N/A	35"	37"	37"	14
	252"(251.68")	3	84"	24"	42"	45"	N/A	N/A	36"	38"	38"	14
	258"(257.68")	3	86"	24"	43"	45"	N/A	N/A	37"	39"	39"	14
	264"(263.68")	3	88"	24"	44"	45"	N/A	N/A	38"	40"	40"	14
270"(269.68")	3	90"	24"	45"	45"	N/A	N/A	39"	41"	41"	14	
54" (53.68")	186"(185.68")	3	62"	27"	31"	51"	56"	58"	N/A	N/A	N/A	8
	192"(191.68")	3	64"	27"	32"	51"	58"	60"	N/A	N/A	N/A	8
	198"(197.68")	3	66"	27"	33"	51"	60"	62"	N/A	N/A	N/A	8
	204"(203.68")	3	68"	27"	34"	51"	N/A	N/A	28"	30"	30"	14
	210"(209.68")	3	70"	27"	35"	51"	N/A	N/A	29"	31"	31"	14
	216"(215.68")	3	72"	27"	36"	51"	N/A	N/A	30"	32"	32"	14
	222"(221.68")	3	74"	27"	37"	51"	N/A	N/A	31"	33"	33"	14
	228"(227.68")	3	76"	27"	38"	51"	N/A	N/A	32"	34"	34"	14
	234"(233.68")	3	78"	27"	39"	51"	N/A	N/A	33"	35"	35"	14
	240"(239.68")	3	80"	27"	40"	51"	N/A	N/A	34"	36"	36"	14
	246"(245.68")	3	82"	27"	41"	51"	N/A	N/A	35"	37"	37"	14
	252"(251.68")	3	84"	27"	42"	51"	N/A	N/A	36"	38"	38"	14
	258"(257.68")	3	86"	27"	43"	51"	N/A	N/A	37"	39"	39"	14
	264"(263.68")	3	88"	27"	44"	51"	N/A	N/A	38"	40"	40"	14
270"(269.68")	3	90"	27"	45"	51"	N/A	N/A	39"	41"	41"	14	
60" (59.68")	186"(185.68")	3	62"	30"	31"	57"	56"	58"	N/A	N/A	N/A	8
	192"(191.68")	3	64"	30"	32"	57"	58"	60"	N/A	N/A	N/A	8
	198"(197.68")	3	66"	30"	33"	57"	60"	62"	N/A	N/A	N/A	8
	204"(203.68")	3	68"	30"	34"	57"	N/A	N/A	28"	30"	30"	14
	210"(209.68")	3	70"	30"	35"	57"	N/A	N/A	29"	31"	31"	14
	216"(215.68")	3	72"	30"	36"	57"	N/A	N/A	30"	32"	32"	14
	222"(221.68")	3	74"	30"	37"	57"	N/A	N/A	31"	33"	33"	14
	228"(227.68")	3	76"	30"	38"	57"	N/A	N/A	32"	34"	34"	14
	234"(233.68")	3	78"	30"	39"	57"	N/A	N/A	33"	35"	35"	14
	240"(239.68")	3	80"	30"	40"	57"	N/A	N/A	34"	36"	36"	14
	246"(245.68")	3	82"	30"	41"	57"	N/A	N/A	35"	37"	37"	14
	252"(251.68")	3	84"	30"	42"	57"	N/A	N/A	36"	38"	38"	14
	258"(257.68")	3	86"	30"	43"	57"	N/A	N/A	37"	39"	39"	14
	264"(263.68")	3	88"	30"	44"	57"	N/A	N/A	38"	40"	40"	14
270"(269.68")	3	90"	30"	45"	57"	N/A	N/A	39"	41"	41"	14	

Product Details – Planes Conference Tables

Perimeter Leg Conference Table – Three-Piece Top – Rectangular

**Dimensions – 186"-198" Wide
Tables Without Cable Base
Includes (6) Legs**

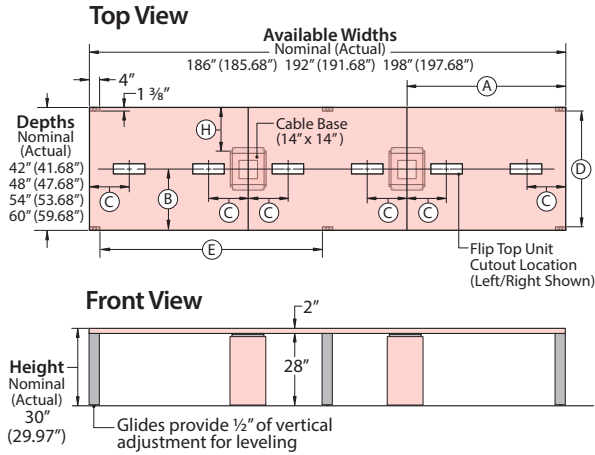
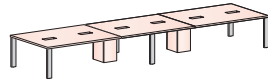

**Dimensions – 204"-270" Wide
Tables Without Cable Base
Includes (10) Legs**

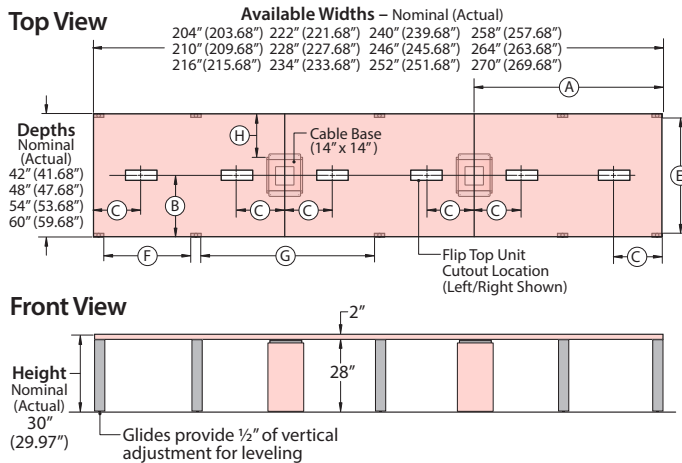
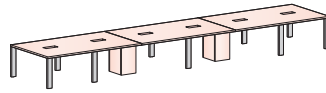

Dimensions

Depth Nominal (Actual)	TABLETOP			KNEESPACE (Nominal)								# of Legs With Cable Base
	Width Nominal (Actual)	# of Top Pieces		A	B	C	D	E	F	G	H	
42" (41.68")	186" (185.68")	3	62"	21"	15 1/2"	39"	87"	N/A	N/A	14"	6	
	192" (191.68")	3	64"	21"	16"	39"	90"	N/A	N/A	14"	6	
	198" (197.68")	3	66"	21"	16 1/2"	39"	93"	N/A	N/A	14"	6	
	204" (203.68")	3	68"	21"	17"	39"	N/A	28"	64"	14"	10	
	210" (209.68")	3	70"	21"	17 1/2"	39"	N/A	29"	66"	14"	10	
	216" (215.68")	3	72"	21"	18"	39"	N/A	30"	68"	14"	10	
	222" (221.68")	3	74"	21"	18 1/2"	39"	N/A	31"	70"	14"	10	
	228" (227.68")	3	76"	21"	19"	39"	N/A	32"	72"	14"	10	
	234" (233.68")	3	78"	21"	19 1/2"	39"	N/A	33"	74"	14"	10	
	240" (239.68")	3	80"	21"	20"	39"	N/A	34"	76"	14"	10	
	246" (245.68")	3	82"	21"	20 1/2"	39"	N/A	35"	78"	14"	10	
	252" (251.68")	3	84"	21"	21"	39"	N/A	36"	80"	14"	10	
	258" (257.68")	3	86"	21"	21 1/2"	39"	N/A	37"	82"	14"	10	
	264" (263.68")	3	88"	21"	22"	39"	N/A	38"	84"	14"	10	
270" (269.68")	3	90"	21"	22 1/2"	39"	N/A	39"	86"	14"	10		
48" (47.68")	186" (185.68")	3	62"	24"	15 1/2"	45"	87"	N/A	N/A	17"	6	
	192" (191.68")	3	64"	24"	16"	45"	90"	N/A	N/A	17"	6	
	198" (197.68")	3	66"	24"	16 1/2"	45"	93"	N/A	N/A	17"	6	
	204" (203.68")	3	68"	24"	17"	45"	N/A	28"	64"	17"	10	
	210" (209.68")	3	70"	24"	17 1/2"	45"	N/A	29"	66"	17"	10	
	216" (215.68")	3	72"	24"	18"	45"	N/A	30"	68"	17"	10	
	222" (221.68")	3	74"	24"	18 1/2"	45"	N/A	31"	70"	17"	10	
	228" (227.68")	3	76"	24"	19"	45"	N/A	32"	72"	17"	10	
	234" (233.68")	3	78"	24"	19 1/2"	45"	N/A	33"	74"	17"	10	
	240" (239.68")	3	80"	24"	20"	45"	N/A	34"	76"	17"	10	
	246" (245.68")	3	82"	24"	20 1/2"	45"	N/A	35"	78"	17"	10	
	252" (251.68")	3	84"	24"	21"	45"	N/A	36"	80"	17"	10	
	258" (257.68")	3	86"	24"	21 1/2"	45"	N/A	37"	82"	17"	10	
	264" (263.68")	3	88"	24"	22"	45"	N/A	38"	84"	17"	10	
270" (269.68")	3	90"	24"	22 1/2"	45"	N/A	39"	86"	17"	10		
54" (53.68")	186" (185.68")	3	62"	27"	15 1/2"	51"	87"	N/A	N/A	20"	6	
	192" (191.68")	3	64"	27"	16"	51"	90"	N/A	N/A	20"	6	
	198" (197.68")	3	66"	27"	16 1/2"	51"	93"	N/A	N/A	20"	6	
	204" (203.68")	3	68"	27"	17"	51"	N/A	28"	64"	20"	10	
	210" (209.68")	3	70"	27"	17 1/2"	51"	N/A	29"	66"	20"	10	
	216" (215.68")	3	72"	27"	18"	51"	N/A	30"	68"	20"	10	
	222" (221.68")	3	74"	27"	18 1/2"	51"	N/A	31"	70"	20"	10	
	228" (227.68")	3	76"	27"	19"	51"	N/A	32"	72"	20"	10	
	234" (233.68")	3	78"	27"	19 1/2"	51"	N/A	33"	74"	20"	10	
	240" (239.68")	3	80"	27"	20"	51"	N/A	34"	76"	20"	10	
	246" (245.68")	3	82"	27"	20 1/2"	51"	N/A	35"	78"	20"	10	
	252" (251.68")	3	84"	27"	21"	51"	N/A	36"	80"	20"	10	
	258" (257.68")	3	86"	27"	21 1/2"	51"	N/A	37"	82"	20"	10	
	264" (263.68")	3	88"	27"	22"	51"	N/A	38"	84"	20"	10	
270" (269.68")	3	90"	27"	22 1/2"	51"	N/A	39"	86"	20"	10		
60" (59.68")	186" (185.68")	3	62"	30"	15 1/2"	57"	87"	N/A	N/A	23"	6	
	192" (191.68")	3	64"	30"	16"	57"	90"	N/A	N/A	23"	6	
	198" (197.68")	3	66"	30"	16 1/2"	57"	93"	N/A	N/A	23"	6	
	204" (203.68")	3	68"	30"	17"	57"	N/A	28"	64"	23"	10	
	210" (209.68")	3	70"	30"	17 1/2"	57"	N/A	29"	66"	23"	10	
	216" (215.68")	3	72"	30"	18"	57"	N/A	30"	68"	23"	10	
	222" (221.68")	3	74"	30"	18 1/2"	57"	N/A	31"	70"	23"	10	
	228" (227.68")	3	76"	30"	19"	57"	N/A	32"	72"	23"	10	
	234" (233.68")	3	78"	30"	19 1/2"	57"	N/A	33"	74"	23"	10	
	240" (239.68")	3	80"	30"	20"	57"	N/A	34"	76"	23"	10	
	246" (245.68")	3	82"	30"	20 1/2"	57"	N/A	35"	78"	23"	10	
	252" (251.68")	3	84"	30"	21"	57"	N/A	36"	80"	23"	10	
	258" (257.68")	3	86"	30"	21 1/2"	57"	N/A	37"	82"	23"	10	
	264" (263.68")	3	88"	30"	22"	57"	N/A	38"	84"	23"	10	
270" (269.68")	3	90"	30"	22 1/2"	57"	N/A	39"	86"	23"	10		

Product Details – Planes Conference Tables

Perimeter Leg Conference Table – Three-Piece Top – Rectangular

Table Sizes and Seating Capacities – Without Cable Bases

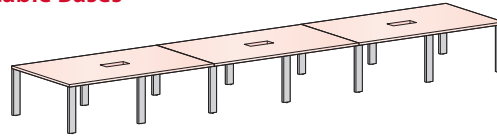
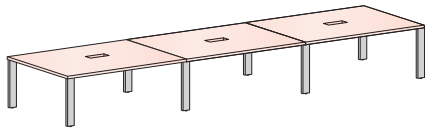

- 186", 192" and 198" Wide Three-Piece Top Tables specified without a Cable Base will include 6 Legs.
- 204", 210", 216", 222", 228", 234", 240", 246", 252", 258", 264" and 270" Wide Three-Piece Top Tables specified without a Cable Base will include 14 Legs.

		WIDTHS							
		186" Wide	192" Wide	198" Wide	204" Wide	210" Wide	216" Wide	222" Wide	228" Wide
DEPTHS	42" Deep								
	48" Deep	14 Chairs Maximum (8 Legs)	14 Chairs Maximum (8 Legs)	14 Chairs Maximum (8 Legs)	14 Chairs Maximum (14 Legs)	14 Chairs Maximum (14 Legs)	14 Chairs Maximum (14 Legs)	14 Chairs Maximum (14 Legs)	14 Chairs Maximum (14 Legs)
	54" Deep	14 Chairs Maximum (8 Legs)	14 Chairs Maximum (8 Legs)	14 Chairs Maximum (8 Legs)	14 Chairs Maximum (14 Legs)	14 Chairs Maximum (14 Legs)	14 Chairs Maximum (14 Legs)	14 Chairs Maximum (14 Legs)	14 Chairs Maximum (14 Legs)
	60" Deep	16 Chairs Maximum (8 Legs)	16 Chairs Maximum (8 Legs)	16 Chairs Maximum (8 Legs)	16 Chairs Maximum (14 Legs)	16 Chairs Maximum (14 Legs)	16 Chairs Maximum (14 Legs)	16 Chairs Maximum (14 Legs)	16 Chairs Maximum (14 Legs)

		WIDTHS						
		234" Wide	240" Wide	246" Wide	252" Wide	258" Wide	264" Wide	270" Wide
DEPTHS	42" Deep							
	48" Deep	14 Chairs Maximum (8 Legs)	14 Chairs Maximum (8 Legs)	14 Chairs Maximum (8 Legs)	14 Chairs Maximum (14 Legs)	14 Chairs Maximum (14 Legs)	14 Chairs Maximum (14 Legs)	14 Chairs Maximum (14 Legs)
	54" Deep	14 Chairs Maximum (8 Legs)	14 Chairs Maximum (8 Legs)	14 Chairs Maximum (8 Legs)	14 Chairs Maximum (14 Legs)	14 Chairs Maximum (14 Legs)	14 Chairs Maximum (14 Legs)	14 Chairs Maximum (14 Legs)
	60" Deep	16 Chairs Maximum (8 Legs)	16 Chairs Maximum (8 Legs)	16 Chairs Maximum (8 Legs)	16 Chairs Maximum (14 Legs)	16 Chairs Maximum (14 Legs)	16 Chairs Maximum (14 Legs)	16 Chairs Maximum (14 Legs)

Note Recommended seating capacity based upon a width of 27" per chair.

Product Details – Planes Conference Tables

Perimeter Leg Conference Table – Three-Piece Top – Rectangular

Table Sizes and Seating Capacities – With Cable Bases

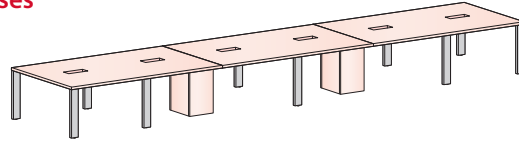
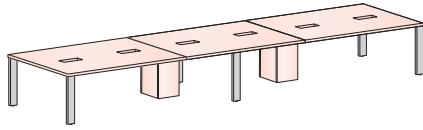

• 186", 192" and 198" Wide Three-Piece Top Tables specified with a Cable Base will include 2 Cable Bases and 6 Legs.

• 204", 210", 216", 222", 228", 234", 240", 246", 252", 258", 264" and 270" Wide Three-Piece Top Tables specified with a Cable Base will include 2 Cable Bases and 10 Legs.

		WIDTHS							
		186" Wide	192" Wide	198" Wide	204" Wide	210" Wide	216" Wide	222" Wide	228" Wide
DEPTHS	42" Deep								
	48" Deep								
	54" Deep								
	60" Deep								

		WIDTHS						
		234" Wide	240" Wide	246" Wide	252" Wide	258" Wide	264" Wide	270" Wide
DEPTHS	42" Deep							
	48" Deep							
	54" Deep							
	60" Deep							

Note Recommended seating capacity based upon a width of 27" per chair.

Product Details – Planes Conference Tables

Power Components – Flip Top Units

- Separately specified Flip Top Units are designed to be field installed into tables specified with factory cutouts (Tables must be specified with the appropriate cutouts).
- Spring release cover provides two positions; closed or fully open.
- The bezel and spring release cover are proud to table top.
- When installed into a 1 3/16" top, the Flip Top Unit will extend below the top 2 3/4"
- Flip Top Units are available with the following port options (See price list for available configurations):
 - Power Port (Simplex Outlet - NEMA5-15P)
 - USB Charging Port (with two outlets)
 - Data Port (for use with Data Jack Adapters)
 - Cable Bay (Accommodates two pull-out data/AV cables - field supplied)

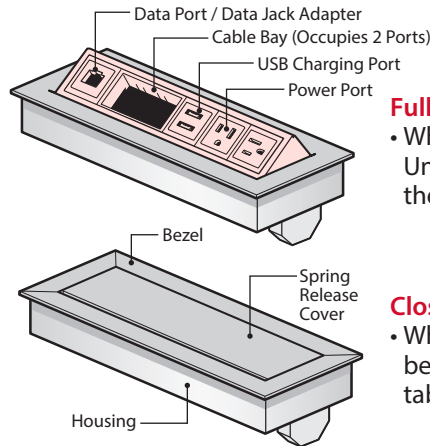

- Fully Open Position**
- When open the Flip Top Unit projects 1" above the table top.
- Closed Position**
- When closed the flip top bezel is proud to the table top.

4-Port – Single Sided
(Shown with Corded)

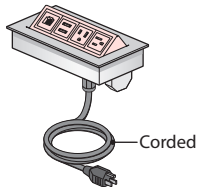

4-Port – Double Sided
(Shown with Hardwire)

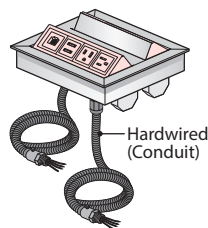

6-Port – Single Sided
(Shown with Hardwire)

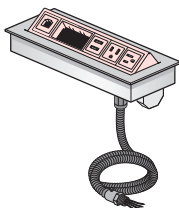

6-Port – Double Sided
(Shown with Corded)

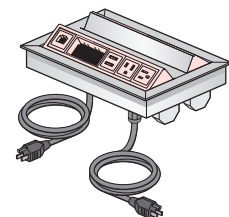

Component Materials/Finishes

COMPONENT NAME	MATERIALS/ FINISHES
Bezel/Housing/ Spring Release Cover – Ports (Power/USB/Cable Bays/Data)	• Bezel/Spring Release Cover – Clear Anodized Aluminum
	• Ports (Power/USB/Cable Bays/Data) – White Plastic
Power Connectors	• Bezel/Spring Release Cover – Black Anodized Aluminum
	• Ports (Power/USB/Cable Bays/Data) – Black Plastic
Cord with Plug	6' or 12' Long – standard in black.
	Hardwired

Corded Plugs

- Corded Flip Top Units with 3 or less Power/USB Charging ports includes a standard plug (NEMA5-15P).
- Corded Flip Top Units with four or more Power or USB Charging Ports includes a fused plug that may block adjacent building receptacle outlets.

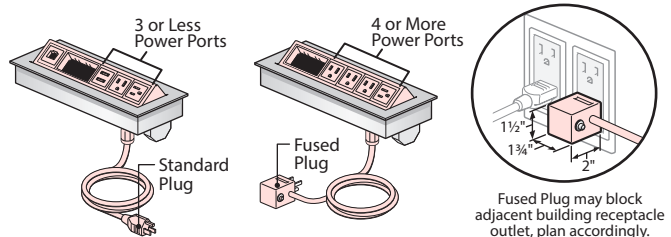

Dimensions

Side View – Single Sided

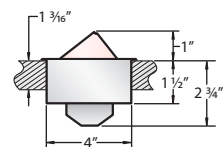

Top View – 4-Port/Single-Sided

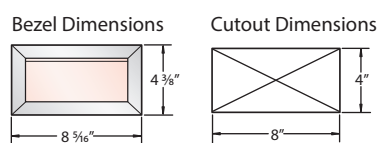

Top View – 6-Port/Single-Sided

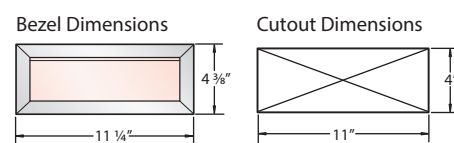

Side View – Double Sided

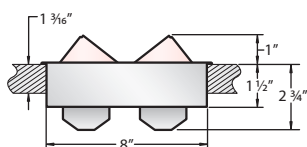

Top View – 4-Port/Double-Sided

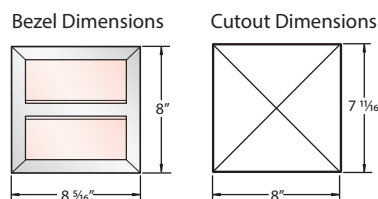

Top View – 6-Port/Double-Sided

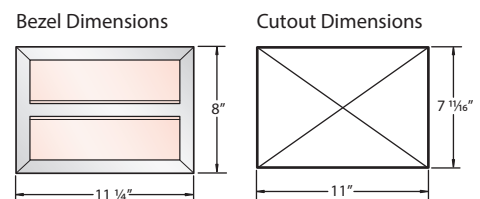

Tips

- Flip Top Units are field installed into a factory cutouts (Specify appropriate cutouts when ordering the table).
- Corded Flip Top Unit applications should be reviewed by local authorities (electrical inspector) prior to ordering this product.
- For use with 120 volt 60 hertz power source only.

Note

Configuration and quantity of power and data ports can not be modified in the field.

Product Details – Planes Conference Tables

Cable Management – Cable Bases

- Cable Bases are designed for power and data cable management and are an available option with most Interior Leg Conference Tables.
- Cable Bases are available in two sizes to accommodate different table depths.
 - 36" deep tables specified with Cable Bases includes an 8" x 14" Cable Base.
 - 42" deep and deeper tables specified with a cable base includes a 14" x 14" Cable Base.
- Cable Bases are not recommended for the following tables due to lack of kneespace clearance (Consider a separately specified Cable Column for cable management with these tables):
 - 30" Deep Tables
 - Half Round Tables
 - One-Piece Round Tables
 - Polygon Tables
 - One-Piece Square Tables
- Each Cable Base includes a cutout on the bottom of the base for routing wires and two removable side panels for access to the interior compartment.
- In addition to providing power and data cable management, the Cable Base can also provide table floor support. Depending on the shape and size of the table, it may be used in place of Interior Legs reducing the overall number of legs
- The surface and edge colors of the Cable Base are a separate specification from the table top finish.
- The Cable Base may also be ordered separately as a field installed accessory
- Cable Base locations are predetermined for support and load purposes. If the Cable Base is ordered as an option, tables are pre-drilled for field installation of legs and the Cable Base. If the Cable Base is ordered as an accessory, it must be installed according to installation instructions and field drilling is required. Refer to installation instructions for leg removal or relocation guidelines.

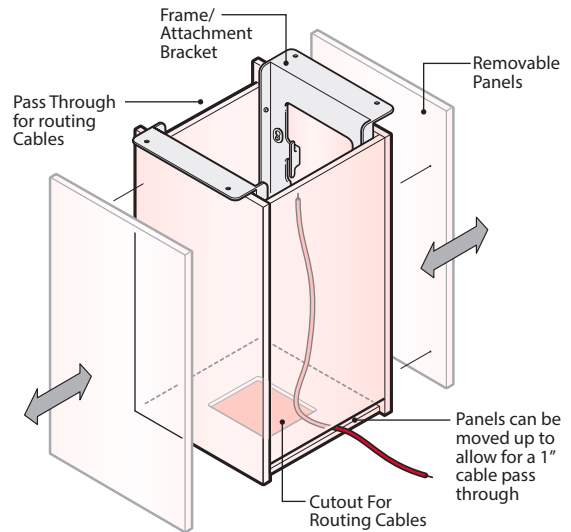

14" x 14" Cable Base – (42" Deep or Deeper Tables only)

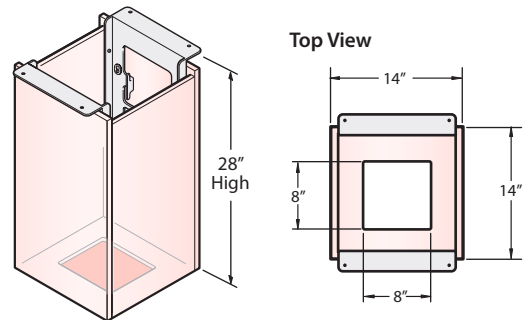

8" x 14" Cable Base – (36" Deep Tables only)

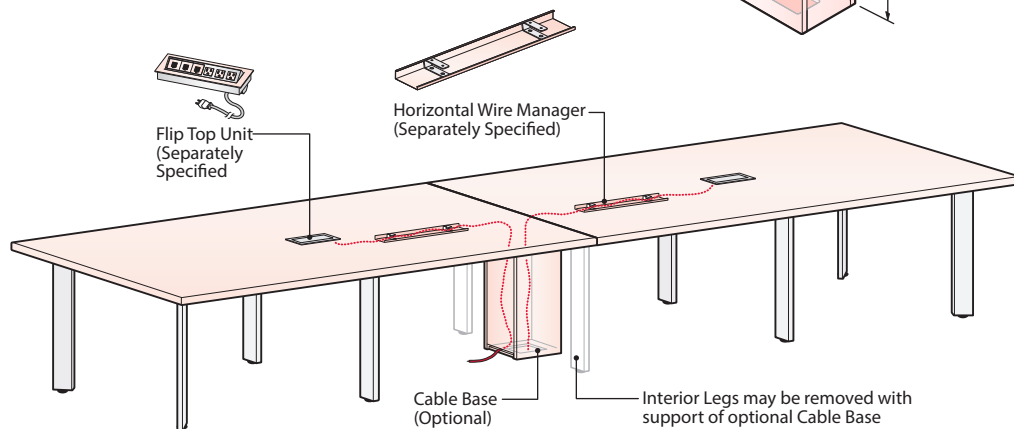
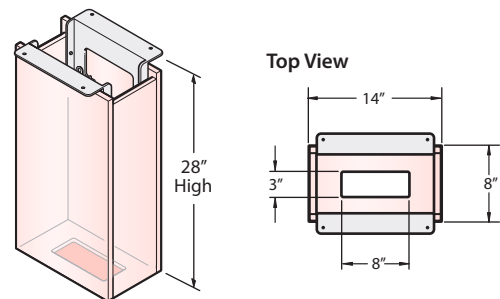

Typical Table Application with Cable Base for Wire Management

- Separately specified Flip Top Unit cables drop below the table top and can be routed via a separately specified Horizontal Wire Manager, then routed through the optional Cable Base to the building power.

Product Details – Planes Conference Tables

Cable Management – Cable Column

The Planes Cable Column provides an alternative solution to the Cable Base for vertically managing cables from beneath a Planes table to the floor. The Cable Column is ideal for tables when a Cable Base cannot be used.

- Cable Column is non-load bearing and does not replace table leg(s).
- Cable Column can be installed anywhere under a conference table unless it would interfere with table legs, Horizontal Wire Manager, or Flip Top Power/ Data Units.
- Includes one Cable Column with mounting hardware for attaching to table underside.
- Does not include hardware for attaching Cable Column to floor; field supplied.
- Floor Mount Bracket is recessed into the Cable Column with a 1" height adjustable range. When Floor Mount Bracket is fully extended the overall Cable Column height is 29" H.

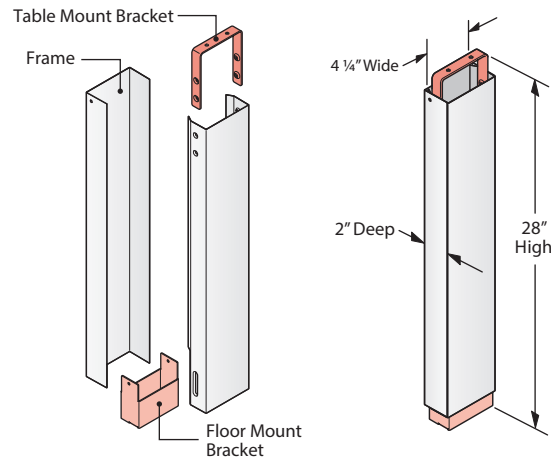

Common Cable Column Applications

The Cable Column is always attached beneath the table top and anchored to the building. Accessing the building power supply through the Cable Column can be done in two ways.

Application A

Cables exit the Cable Column directly through the bottom of the floor mount bracket. The bottom of the floor mount bracket is open.

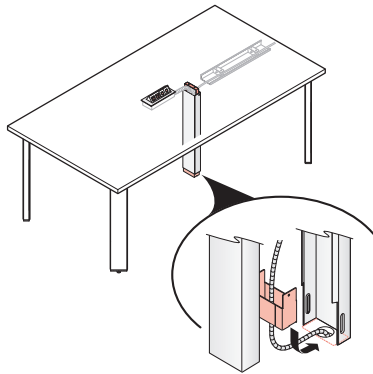

Application B

Cables exit the Cable Column through the side of the floor mount bracket. The tab located on the bracket must be field removed, resulting in a 1" H opening. The Floor Mount Bracket can be field cut, resulting in a 2.25" H opening.

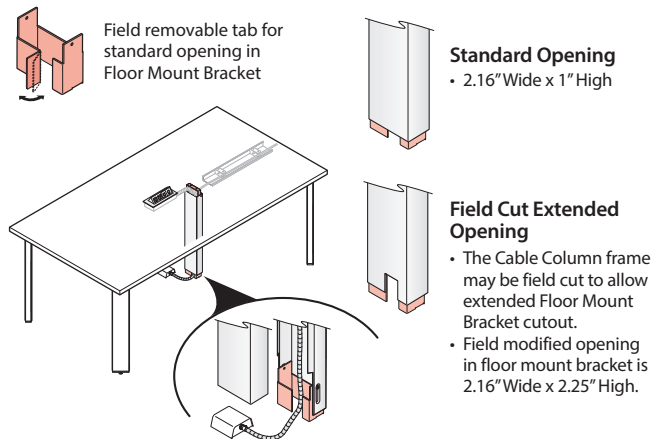

Cable Column Fill Capacity

- This chart shows the number of communication cables that can be routed through specific pathways.
- Cable capacities are based on 0.20" (5mm), 0.25" (6mm), and 0.30" (8mm) diameter cables at 60% and 40% fill capacity.
- TIA/EIA 569 suggests a cable fill of 40% for planning and up to 60% for unplanned or future additions.
- The TIA category designations for cable are not size specific but typically the higher the category number the larger the diameter the cable is.
- As a general rule a Category 5e (Enhanced) cable is approximately 0.20" in diameter, the Category 6 0.25", and a Category 6A (Augmented) 0.30". The actual diameter will vary depending on manufacturer and whether it is a plenum rated cable or riser (PVC) cable.

CABLE PATHWAY	OPENING SIZE	CABLE CAPACITY 60% FILL*			CABLE CAPACITY 40% FILL* (Cable Gauge)		
		0.20"	0.25"	0.30"	0.20"	0.25"	0.30"
Application A Routing Through Base of Floor Mount Bracket	4.95 Square Inches	94	60	42	63	40	28
Application B Routing Through Standard Opening In Floor Mount Bracket	2.17 Square Inches	41	26	18	27	17	12
Application B Routing Through Field Cut Extended Opening In Floor Mount Bracket	5.04 Square Inches	96	61	42	64	41	28

Product Details – Planes Conference Tables

Accessories – Horizontal Wire Manager

- Recommended for use with the Flip Top Units to route power and data cabling horizontally under the tabletop.
- The cables beneath the Flip Top Unit are routed through the Horizontal Wire Manager to the Cable Base and down to the building power that is located in the floor.
- The plastic Wire Manager can be cut to length in the field to accommodate a variety of applications.
- The Wire Manager snaps over Attachment Clips to attach the unit to the underside of the table. Attachment Clips should not be spaced more than 24" apart.
- The Horizontal Wire Manager is a handed component; the cables can exit from the lower side or either end, depending on application.

Note For field cut applications, refer to chart to determine if additional attachment clips are needed.

Tip Horizontal Wire Manager is not for use with Y-Leg Tables. A trough runs between the two Y-Legs in the base of all Y-Leg tables for lay-in cable management.

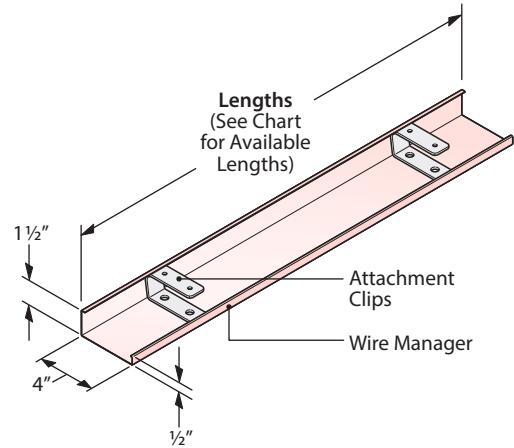

Component Materials/Finishes

COMPONENT NAME	MATERIALS/ FINISHES
Wire Manager	Plastic – Standard in Light Platinum
Attachment Clip	Metal – Standard in Black

Common Horizontal Wire Manager Applications

Adjacent to Cable Base

- Horizontal Wire Manager is mounted adjacent to the Cable Base to route cables from the Flip Top Unit.

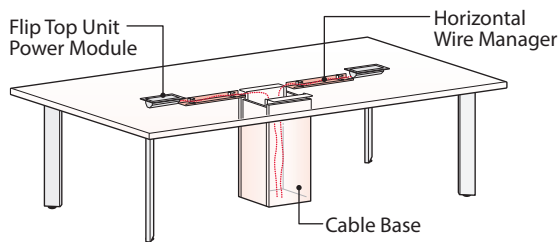

Cable Base Pass Through

- Horizontal Wire Manager passes through the Cable Base to route cables from the Flip Top Unit.

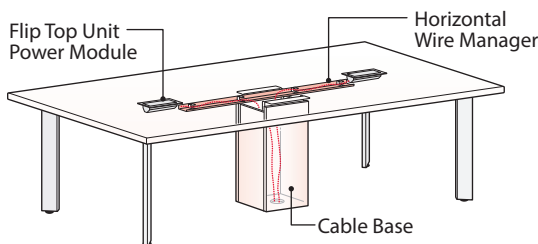

Lengths and Attachment Clip Numbers

HORIZONTAL WIRE MANAGER	
LENGTH	Included Number of Attachment Clips
48"	2 Clips
72"	3 Clips
96"	3 Clips
120"	4 Clips

Horizontal Wire Manager Fill Capacity

- This chart shows the number of communication cables that can be routed through specific pathways.
- Cable capacities are based on 0.20" (5mm), 0.25" (6mm), and 0.30" (8mm) diameter cables at 60% and 40% fill capacity.
- TIA/EIA 569 suggests a cable fill of 40% for planning and up to 60% for unplanned or future additions.
- The TIA category designations for cable are not size specific but typically the higher the category number the larger the diameter the cable is.
- As a general rule a Category 5e (Enhanced) cable is approximately 0.20" in diameter, the Category 6 0.25", and a Category 6A (Augmented) 0.30". The actual diameter will vary depending on manufacturer and whether it is a plenum rated cable or riser (PVC) cable.

CABLE PATHWAY	OPENING SIZE	CABLE CAPACITY 60% FILL* (Cable Gauge)			CABLE CAPACITY 40% FILL* (Cable Gauge)		
		0.20"	0.25"	0.30"	0.20"	0.25"	0.30"
Routing cables through the end of the Wire Manager	2 Square Inches	38	24	17	25	16	11

Product Details – Planes Conference Tables

Cable Management – Planning Guidelines for the Horizontal Wire Manager

- The Horizontal Wire Manager may be cut shorter or extend past the distance being spanned.
- All routing methods require field drilling for the attachment clips.
- The Horizontal Wire Manager should not be mounted under the Flip Top Units as it could interfere with operation of the flip top mechanism.

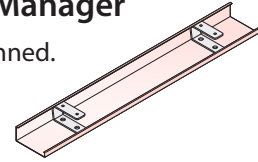

Adjacent To Cable Base Application

- Horizontal Wire Manager is mounted next to the Cable Base, with the lower side of the Horizontal Wire Manager positioned toward the Flip Top Unit.

Adjacent to Cable Base Planning Example:

- One-Piece Table (120" wide) with 14" x 14" Cable Base and Center Flip Top Unit Cutouts.
- Specify (1) 48" Horizontal Wire Manager (cut to fit).

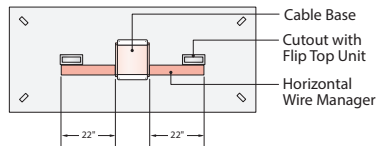

Adjacent to Cable Base Planning Example:

- Two-Piece Table (150" Wide) with 14" x 14" Cable Base and Center Flip Top Unit Cutouts.
- Specify (1) 72" Horizontal Wire Manager (cut to fit).

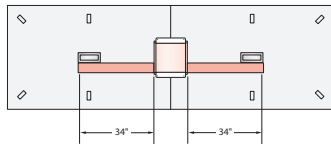

Adjacent to Cable Base Planning Example:

- Two-Piece Table (150" Wide) with 14" x 14" Cable Base and Left/Right Flip Top Unit Cutouts.
- Specify (2) 48" Horizontal Wire Managers (cut to fit).

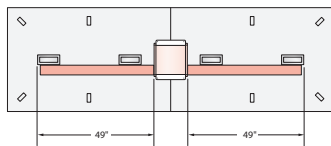

Adjacent to Cable Base Planning Example:

- Three-Piece Table (222" Wide) with 14" x 14" Cable Base and Center Flip Top Unit Cutouts.
- Specify (2) 72" Horizontal Wire Managers (cut to fit).

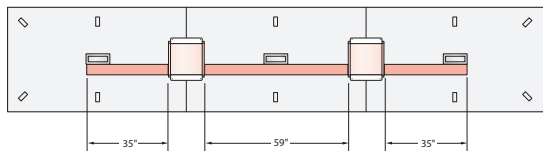

Adjacent to Cable Base Planning Example:

- Three-Piece Table (222" Wide) with 14" x 14" Cable Base and Left/Right Flip Top Unit Cutouts.
- Specify (1) 72" and (2) 48" Horizontal Wire Managers (cut to fit).

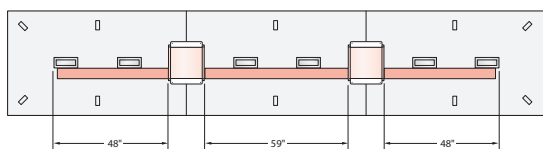

Cable Base Pass Through Application

- Horizontal Wire Manager is mounted between the Flip Top Units and passes through the top opening of the Cable Base.
- This application cannot be used if the side panels of the Cable Base are raised to utilize the 1" pass through at the bottom.

Cable Base Pass Through Planning Example:

- One-Piece Table (120" wide) with 14" x 14" Cable Base and Center Flip Top Unit Cutouts.
- Specify (1) 48" Horizontal Wire Manager (cut to fit).

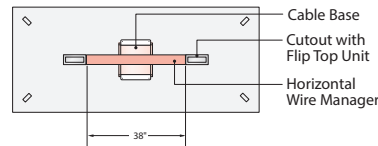

Cable Base Pass Through Planning Example:

- Two-Piece Table (150" Wide) with 14" x 14" Cable Base and Center Flip Top Unit Cutouts.
- Specify (1) 72" Horizontal Wire Manager (cut to fit).

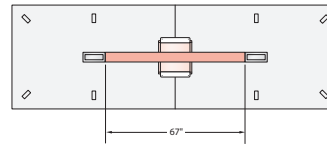

Cable Base Pass Through Planning Example:

- Two-Piece Table (150" Wide) with 14" x 14" Cable Base and Left/Right Flip Top Unit Cutouts.
- Specify (1) 72" Horizontal Wire Managers (cut to fit).

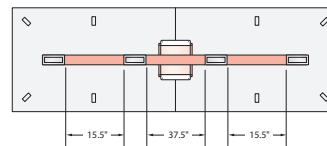

Cable Base Pass Through Planning Example:

- Three-Piece Table (222" Wide) with 14" x 14" Cable Base and Center Flip Top Unit Cutouts.
- Specify (2) 72" Horizontal Wire Managers (cut to fit).

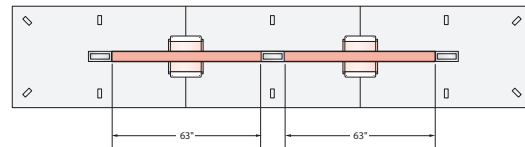

Cable Base Pass Through Planning Example:

- Three-Piece Table (222" Wide) with 14" x 14" Cable Base and Left/Right Flip Top Unit Cutouts.
- Specify (1) 72" and (1) 48" Horizontal Wire Managers (cut to fit).

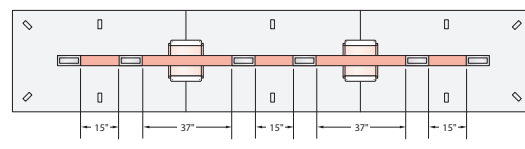

Product Details – Planes Conference Tables

Conference Table Top with Column Base – Overview

The Conference Top with Cable Column fits the needs of any conference room or conferencing style. First select a top from wide variety of table top sizes and shapes, next combine it with a column base assembly to support the top in a range of heights. The rectilinear design, along with the sleek open profile, give this conference table a clean, contemporary aesthetic.

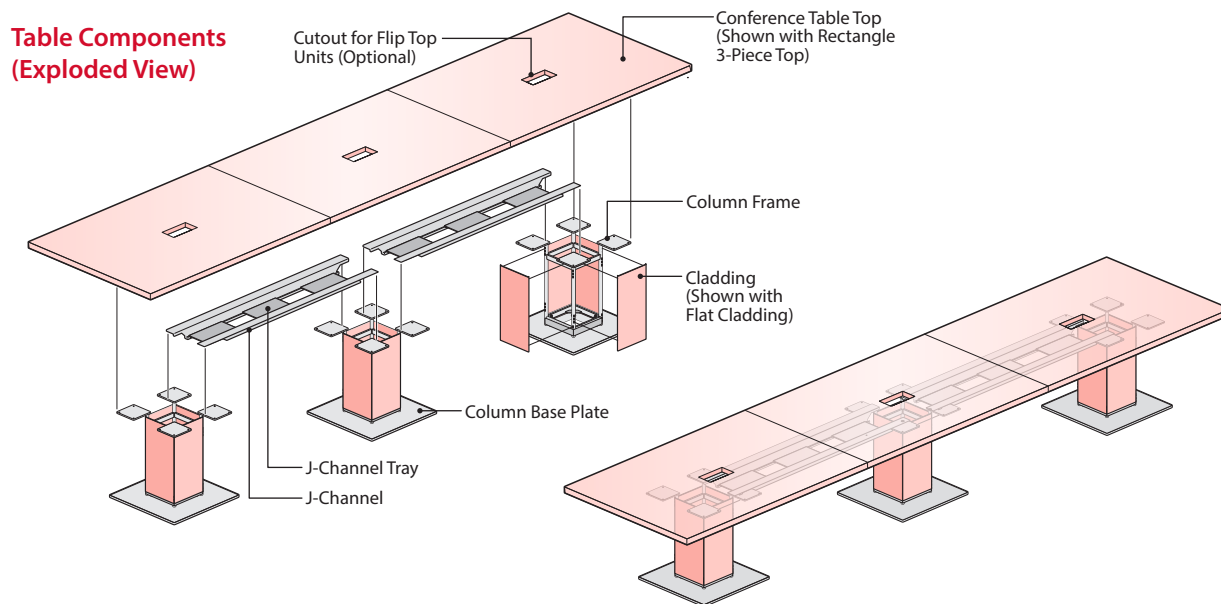

Steps to Specifying a Conference Table with Cable Base

Step 1 | Conference Top

- The number of tops depend on the width of the conference table.
- Top options include a 1-piece top, 2-piece top or 3-piece top.

Step 2 | Column Base Assembly

- Each Column Base requires separately specified components: Column Frame, Column Base Plate, and Cladding.

A. Column Frame

- Column Frames are square and are available in two sizes, 9" and 12" square, and three heights, 20" lounge height, 28" seated height and 40" standing height.
 - The table top width and the number of pieces dictate the quantity of column frame(s).
 - The table top depth dictates the column frame size, 9" or 12" square.

B. Column Base Plate

- Round or Square Column Base Plates are available in four sizes: 21", 24", 27" and 30".
- The column base plate size is specific to the column frame size of 9" or 12"; specify accordingly.
- The column frame width and the table top depth dictate the size of the column base plate.

C. Cladding

- Round or Flat Cladding is available in two widths, 9" & 12", and three heights, 20" lounge height, 28" seated height and 40" standing height. (Exception: Round cladding is not available 40" high)
 - Cladding is specified as one single piece per catalog number. A quantity of (4) pieces are required per each Column Frame. Note: All round or flat, or a combination of round and flat cladding may be used on a column frame.
 - Specify cladding to match the column frame width and height.

D. J-Channel

- Provides wire management and the required support below the Conference Table Top.
 - J-Channel is specified as one pair per catalog number. A pair of J-Channels are used between each column base.
 - The table top width and column size dictate the number of pairs and length of J-Channel.

E. J-Channel Tray (Optional)

- J-Channel Trays are optional and provide additional wire management between columns; lays in J-Channels.
 - Specify J-Channel Tray width to match Column Frame size.
 - The J-Channel length dictates the maximum number of J-Channel Trays.

Product Details – Planes Conference Tables

End Supported Conference Table with Column Base – Overview

The End Supported Top is designed to be supported on one end with a Cable Column Assembly and on the other end with brackets that attached to a structural wall, an Enclose Wall or a Compose Panel. To specify an End supported Table select a top from wide variety of sizes and shapes, next combine it with a column base assembly to support the top in a range of heights, finally select the appropriate attachment bracket for each application.

Table Components (Exploded View)

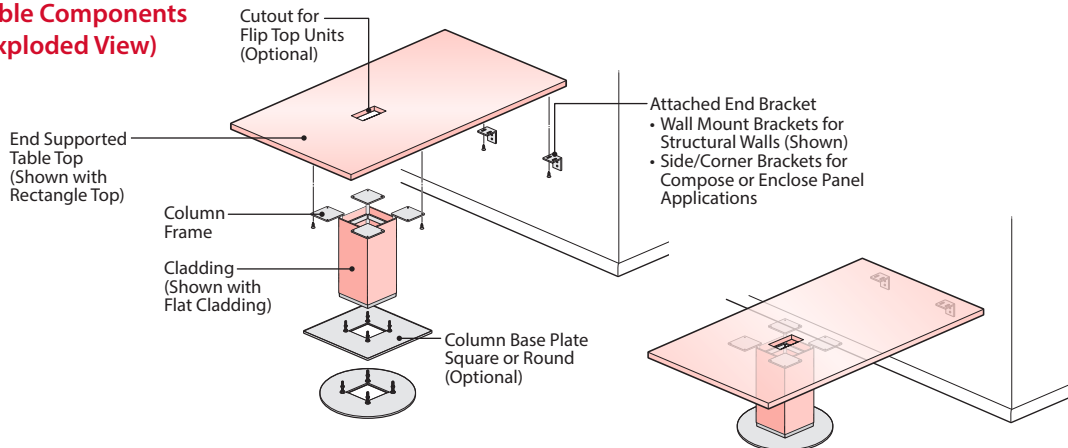

Steps to Specifying a Conference Table with Cable Base

Step 1 | End Supported Top

- Select desired top size and shape.
- Choose from rectangle, D-shape or Key shaped tops (always 1-piece top).

Step 2 | Floor Support – Column Base Assembly/Attached End Bracket

- End Supported Tables require a Column Base Assembly for floor support on one end and brackets for attachment to a structural building wall, Compose or Enclose panel on the other end.

A. Column Frame

- Column Frames are square and are available in two sizes, 9" and 12" square, and three heights, 20" lounge height, 28" seated height and 40" standing height.
 - One Column Frame is required per End Supported Top.
 - The table top depth dictates the column frame size, 9" or 12" square.

B. Column Base Plate (Optional)

- Column Base Plate is an optional component for an End Support Top.
(Note: Required for a Conference Table with Column Base)
- Round or Square Column Base Plates are available in four sizes: 21", 24", 27" and 30".
- The column base plate size is specific to the column frame size of 9" or 12"; specify accordingly.
- The column frame width and the table top depth dictate the size of the column base plate.

C. Cladding

- Round or Flat Cladding is available in two widths, 9" & 12", and three heights, 20" lounge height, 28" seated height and 40" standing height. (Exception: Round cladding is not available 40" high)
 - Cladding is specified as one single piece per catalog number. A quantity of (4) pieces are required per each Column Frame.
 - Note: All round or flat, or a combination of round and flat cladding may be used on a column frame.
 - Specify cladding to match the column frame width and height.

Note J-Channel and J-Channel Tray are not required for an End Supported Top.

Product Details – Planes Conference Tables

Conference Table Tops for use with Column Base – Overview

Edge Details for Laminate Conference Table Tops

3mm Edgeband Edge (Option J)

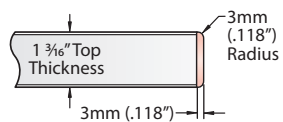

Top View Detail

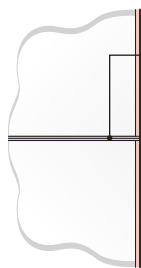

Seams with Multiple Piece Top have 1mm Edgeband

Knife Edge (Option F)

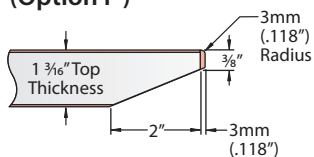

Top View Detail

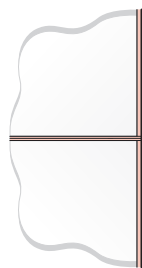

Seams with Multiple Piece Top have 1mm Edgeband

Edge Details for Wood Conference Table Tops

3mm Edgeband Edge (Option K)

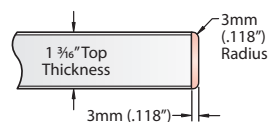

Top View Detail

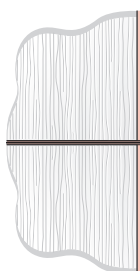

Seams with Multiple Piece Top have 1mm Edgeband

Knife Edge (Option U)

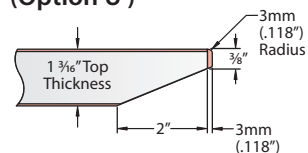

Top View Detail

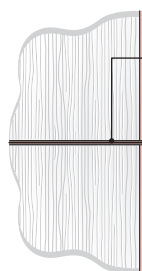

Seams with Multiple Piece Top have 1mm Edgeband

Note

- Refer to Price List for edge availability.
- Specified Edgeband option is applied to all outside edges of the top.
- Multiple piece tops with Cascade edge option will require an additional specification for the 1mm edgeband seam.

Product Details – Planes Conference Tables

Conference Table Tops for use with Column Base (1-Piece Tops)

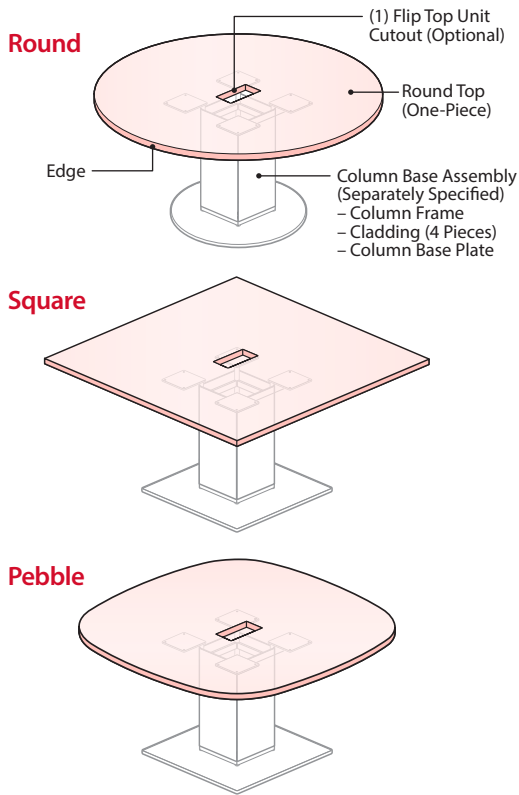

Component Materials/Finishes

COMPONENT NAME	MATERIALS/ FINISHES
Round, Square and Pebble 1-Piece Top	Laminate Top – Specified top color and specified edge trim color • Edge Options: (J) Edgeband, (F) Knife
	Wood Top – Specified top and edge trim wood finish color • Edge Options: (K) Edgeband, (U) Knife

Edge Options for Laminate Tops

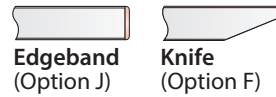

Edge Options for Wood Tops

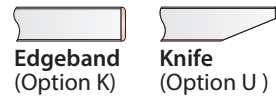

Flip Top Unit Cutout Options

- Cutout Location – Center Cutout Option**
 • Includes 1 Flip Top Unit cutout (centered on top)

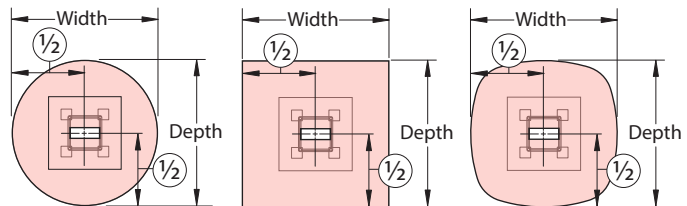

Center Cutout Options

- Includes 1 Flip Top Unit cutout (centered on top)
- Cutouts require separately specified Flip Top Unit.

Cutout Option (F)
 For use with Single Sided/
 4 Port Flip Top Unit

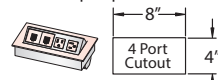

Cutout Option (J)
 For use with Single Sided/
 6 Ports Flip Top Unit

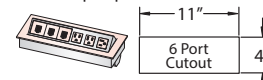

Cutout Option (M)
 For use with Double Sided/
 8 Ports Flip Top Unit

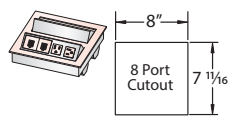

Cutout Option (Q)
 For use with Double Sided/
 12 Ports Flip Top Unit

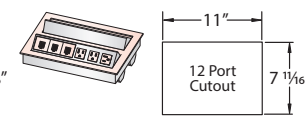

Note Double-Sided Flip Top Units cannot be placed over the 9" x 9" Column Frame.

Separately Specified Components

- One Piece Round, Square and Pebble Tops requires a separately specified Column Base.
- A Column Base is comprised of a separately specified Column Frame, Column Base Plate and Cladding.
- Column Frames are available with 20", 28" and 40" heights.

Cable Column Heights

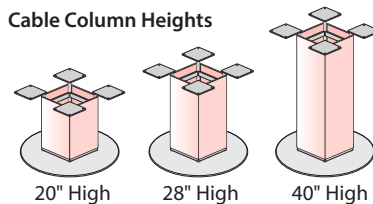

Note See the Floor Support Requirements – Specification Matrix, for Column Frames and Column Base Plates specification requirements.

Product Details – Planes Conference Tables

Conference Table Tops for use with Column Base (1-Piece Tops)

Dimensions

Top View – Round Top

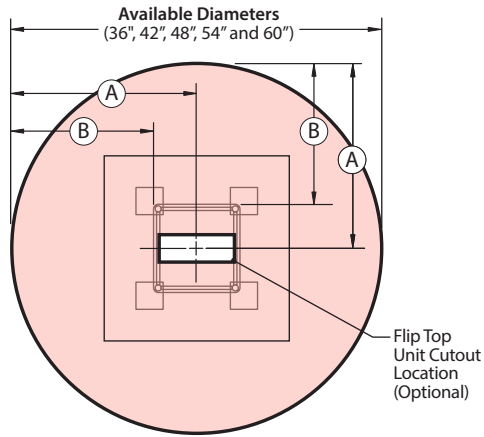

Top View – Square Top

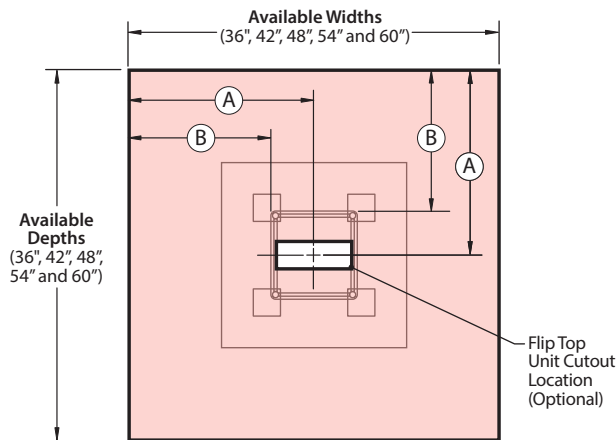

Top View – Pebble Top

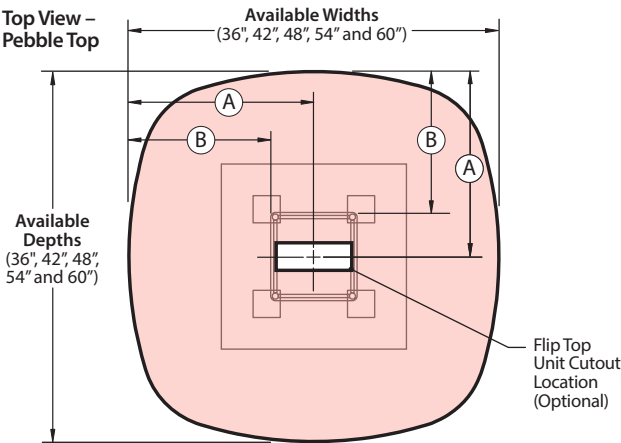

Front View

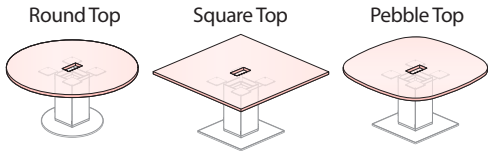
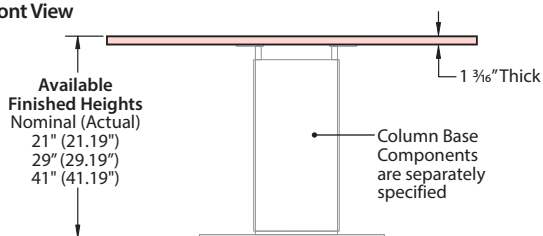

Dimensions

TABLETOP			KNEESPACE			
Width Nominal (Actual)	Depth Nominal (Actual)	A	B			
			With 9" x 9" Column Frame		With 12" x 12" Column Frame	
			Flat Cladding	Round Cladding	Flat Cladding	Round Cladding
36" (35.68")	36" (35.68")	18"	13"	11 1/4"	11 1/2"	9 1/8"
42" (41.68")	42" (41.68")	21"	16"	14 1/4"	14 1/2"	12 1/8"
48" (47.68")	48" (47.68")	24"	N/A	N/A	17 1/2"	15 1/8"
54" (53.68")	54" (53.68")	27"	N/A	N/A	20 1/2"	18 1/8"
60" (59.68")	60" (59.68")	30"	N/A	N/A	23 1/2"	21 1/8"

Table Top Sizes and Seating Capacities

Round Top

DIAMETER				
36" Diameter	42" Diameter	48" Diameter	54" Diameter	60" Diameter
4 Chairs Maximum (1 Cable Column)	4 Chairs Maximum (1 Cable Column)	5 Chairs Maximum (1 Cable Column)	6 Chairs Maximum (1 Cable Column)	7 Chairs Maximum (1 Cable Column)

Square Top

TOP SIZES – WIDTH x DEPTH				
36" W x 36" D	42" W x 42" D	48" W x 48" D	54" W x 54" D	60" W x 60" D
4 Chairs Maximum (1 Column Base)	4 Chairs Maximum (1 Column Base)	4 Chairs Maximum (1 Column Base)	6 Chairs Maximum (1 Column Base)	8 Chairs Maximum (1 Column Base)

Pebble Top

TOP SIZES – WIDTH x DEPTH				
36" W x 36" D	42" W x 42" D	48" W x 48" D	54" W x 54" D	60" W x 60" D
4 Chairs Maximum (1 Column Base)	4 Chairs Maximum (1 Column Base)	4 Chairs Maximum (1 Column Base)	6 Chairs Maximum (1 Column Base)	8 Chairs Maximum (1 Column Base)

Note Recommended seating capacity based upon a width of 27" per chair.

Product Details – Planes Conference Tables

Conference Table Tops for use with Column Base (1-Piece Tops)

Floor Support Requirements – Specification Matrix

Round Top / Column Frame with Round Base Plate

 ROUND TOP SIZES	COLUMN FRAME/BASE PLATE COMBINATIONS				
	9" x 9" Column Frame		12" x 12" Column Frame		
	21" Round Base Plate	24" Round Base Plate	24" Round Base Plate	27" Round Base Plate	30" Round Base Plate
36" Diameter Top					
42" Diameter Top	⊘ Don't				
48" Diameter Top	⊘ Don't	⊘ Don't	⊘ Don't		
54" Diameter Top	⊘ Don't	⊘ Don't	⊘ Don't	⊘ Don't	
60" Diameter Top	⊘ Don't	⊘ Don't	⊘ Don't	⊘ Don't	

Round Top / Column Frame with Square Base Plate

 ROUND TOP SIZES	COLUMN FRAME/BASE PLATE COMBINATIONS				
	9" x 9" Column Frame		12" x 12" Column Frame		
	21" Square Base Plate	24" Square Base Plate	24" Square Base Plate	27" Square Base Plate	30" Square Base Plate
36" Diameter Top				⊘ Don't	⊘ Don't
42" Diameter Top	⊘ Don't				
48" Diameter Top	⊘ Don't	⊘ Don't	⊘ Don't		
54" Diameter Top	⊘ Don't	⊘ Don't	⊘ Don't		
60" Diameter Top	⊘ Don't	⊘ Don't	⊘ Don't		

Square Top / Column Frame with Round Base Plate

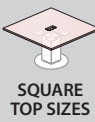
 SQUARE TOP SIZES	COLUMN FRAME/BASE PLATE COMBINATIONS				
	9" x 9" Column Frame		12" x 12" Column Frame		
	21" Round Base Plate	24" Round Base Plate	24" Round Base Plate	27" Round Base Plate	30" Round Base Plate
36" Wide x 36" Deep					
42" Wide x 42" Deep	⊘ Don't				
48" Wide x 48" Deep	⊘ Don't	⊘ Don't	⊘ Don't		
54" Wide x 54" Deep	⊘ Don't	⊘ Don't	⊘ Don't	⊘ Don't	
60" Wide x 60" Deep	⊘ Don't	⊘ Don't	⊘ Don't	⊘ Don't	

Square Top / Column Frame with Square Base Plate

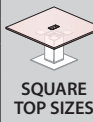
 SQUARE TOP SIZES	COLUMN FRAME/BASE PLATE COMBINATIONS				
	9" x 9" Column Frame		12" x 12" Column Frame		
	21" Square Base Plate	24" Square Base Plate	24" Square Base Plate	27" Square Base Plate	30" Square Base Plate
36" Wide x 36" Deep					
42" Wide x 42" Deep	⊘ Don't				
48" Wide x 48" Deep	⊘ Don't	⊘ Don't	⊘ Don't		
54" Wide x 54" Deep	⊘ Don't	⊘ Don't	⊘ Don't		
60" Wide x 60" Deep	⊘ Don't	⊘ Don't	⊘ Don't		

Pebble Top / Column Frame with Round Base Plate

 PEBBLE TOP SIZES	COLUMN FRAME/BASE PLATE COMBINATIONS				
	9" x 9" Column Frame		12" x 12" Column Frame		
	21" Round Base Plate	24" Round Base Plate	24" Round Base Plate	27" Round Base Plate	30" Round Base Plate
36" Wide x 36" Deep					
42" Wide x 42" Deep	⊘ Don't				
48" Wide x 48" Deep	⊘ Don't	⊘ Don't	⊘ Don't		
54" Wide x 54" Deep	⊘ Don't	⊘ Don't	⊘ Don't	⊘ Don't	
60" Wide x 60" Deep	⊘ Don't	⊘ Don't	⊘ Don't	⊘ Don't	

Pebble Top / Column Frame with Square Base Plate

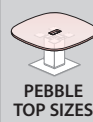
 PEBBLE TOP SIZES	COLUMN FRAME/BASE PLATE COMBINATIONS				
	9" x 9" Column Frame		12" x 12" Column Frame		
	21" Square Base Plate	24" Square Base Plate	24" Square Base Plate	27" Square Base Plate	30" Square Base Plate
36" Wide x 36" Deep					⊘ Don't
42" Wide x 42" Deep	⊘ Don't				
48" Wide x 48" Deep	⊘ Don't	⊘ Don't	⊘ Don't		
54" Wide x 54" Deep	⊘ Don't	⊘ Don't	⊘ Don't		
60" Wide x 60" Deep	⊘ Don't	⊘ Don't	⊘ Don't		

Note • Double-Sided Flip Top Units cannot be placed over the 9" x 9" Column Frames.

Product Details – Planes Conference Tables

Conference Table Tops for use with Column Base (1-Piece Tops)

Rectangle

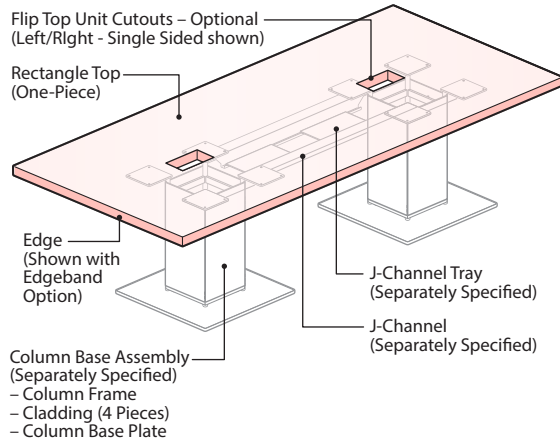

Pebble

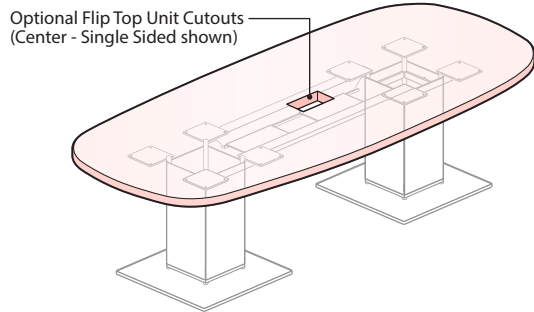

Hexagon

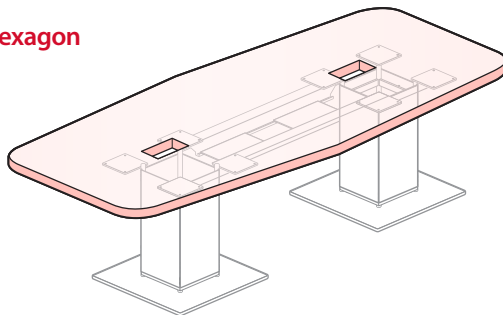

Component Materials/Finishes

COMPONENT NAME	MATERIALS/ FINISHES
1-Piece Top – Rectangle, Pebble, Hexagon	Laminate Top – Specified top color and specified edge trim color • Edge Options: (J) Edgeband, (F) Knife
	Wood Top – Specified top and edge trim wood finish color • Edge Options: (K) Edgeband, (U) Knife

Edge Options for Laminate Tops

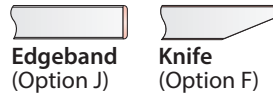

Edge Options for Wood Tops

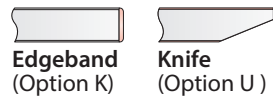

Note One Piece Laminate Tops are not available with (Option J) 3mm Laminate Edgeband or (Option F) Laminate Knife Edge.

Flip Top Unit Cutout Options

Center Cutout Option

- Includes 1 Flip Top Unit cutout (centered on top)

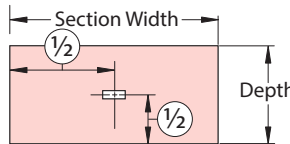

Left/Right Cutout Option

- Includes 2 Flip Top Unit cutouts (1 Left Cutout and 1 Right Cutout)

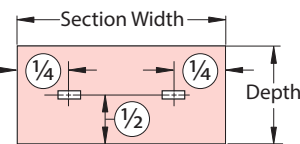

Note Cutout locations for Rectangle, Pebble and Hexagon Tops are the same.

Flip Top Unit Cutout Dimensions

Cutout Option (F or V)

- For use with Single Sided/ 4 Port Flip Top Unit

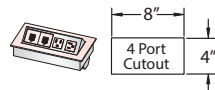

Cutout Option (J or K)

- For use with Single Sided/ 6 Ports Flip Top Unit

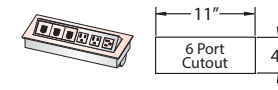

Cutout Option (M or P)

- For use with Double Sided/ 8 Ports Flip Top Unit

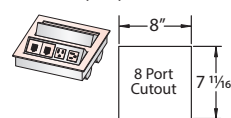

Cutout Option (Q or T)

- For use with Double Sided/ 12 Ports Flip Top Unit

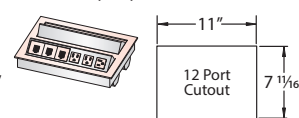

Note • Flip Top Units are separately specified.
• Double-Sided Flip Top Units cannot be placed over the 9" x 9" Column Frame.

Separately Specified Components

- One Piece Rectangle, Pebble and Hexagon Tops require a separately specified J Channel and (2) Column Bases.
- A Column Base is comprised of a separately specified Column Frame, Column Base Plates, and Cladding.
- Column Frames are available with 20", 28" and 40" heights.
- Optional J Channel Trays may be specified to provide additional wire management.

Cable Column Heights

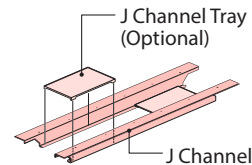
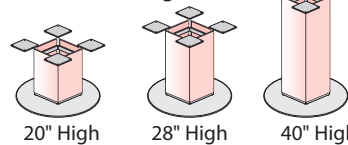

Note See the Floor Support Requirements – Specification Matrix, for Column Frames and Column Base Plates specification requirements.

Product Details – Planes Conference Tables

Conference Table Tops for use with Column Base (1-Piece Tops)

Dimensions

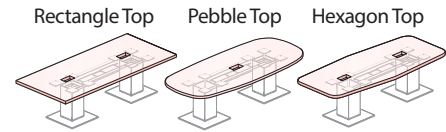
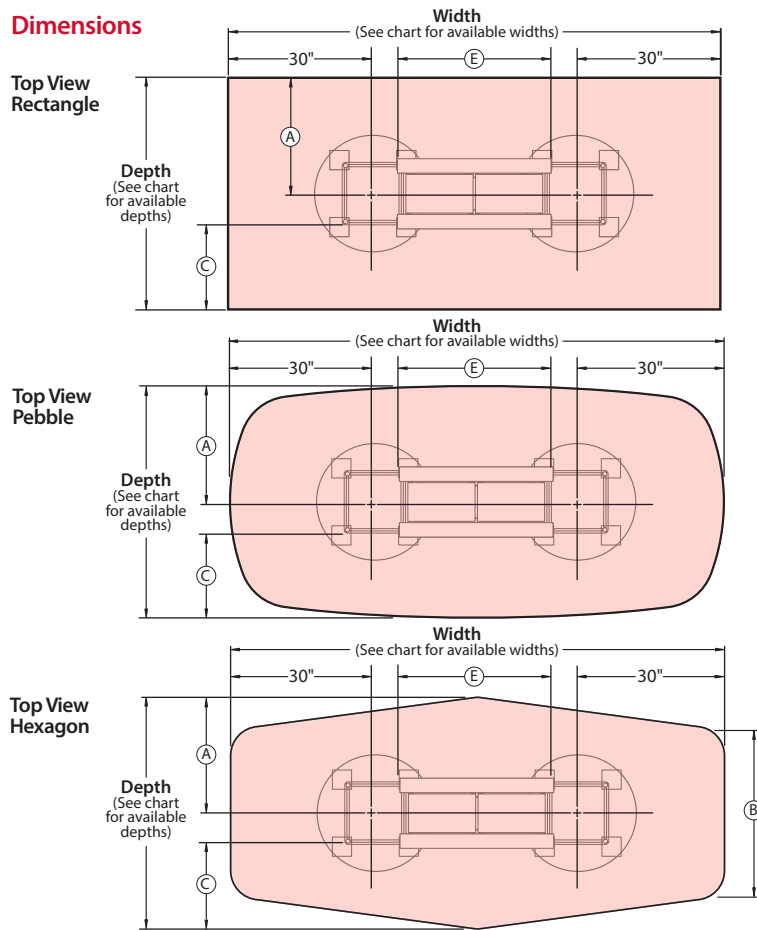

Flip Top Unit Cutout Location Centered Option (Top View)

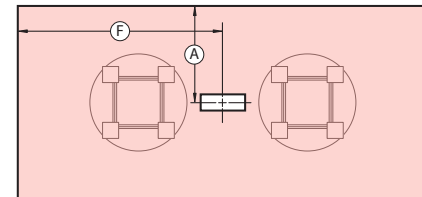

Flip Top Unit Cutout Location Left/Right Option (Top View)

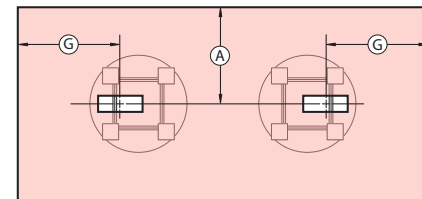

- Note**
- Cutout locations for Rectangle, Pebble and Hexagon Tops are the same.
 - Double-Sided Flip Top Units cannot be placed over the 9" x 9" Column Frames.

Front View

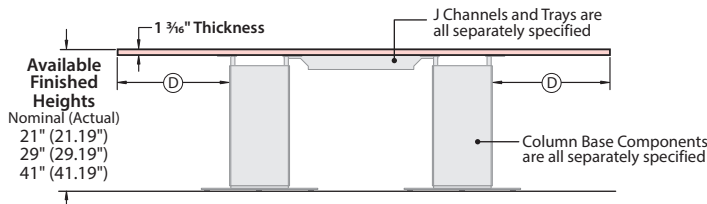

Dimensions

TABLE TOP				KNEESPACE								J CHANNEL / TRAYS				CUTOUTS	
Depth Nominal (Actual)	Width Nominal (Actual)	A	B	C				D				E				F	G
				Flat Cladding		Round Cladding		Flat Cladding		Round Cladding		9" x 9" Column Frames		12" x 12" Column Frames		Centered Cutout Option	Left/Right Cutouts Option
				9" x 9" Column Frames	12" x 12" Column Frames	9" x 9" Column Frames	12" x 12" Column Frames	9" x 9" Column Frames	12" x 12" Column Frames	9" x 9" Column Frames	12" x 12" Column Frames	J Channel Width	Maximum Number of Trays	J Channel Width	Maximum Number of Trays		
42" (41.68")	96" (95.68")	21"	38"	16"	14 1/2"	14 1/4"	12 1/8"	25"	23 1/2"	23 1/4"	21 1/8"	29"	1	26"	1	48"	24"
	102" (101.68")	21"	38"	16"	14 1/2"	14 1/4"	12 1/8"	25"	23 1/2"	23 1/4"	21 1/8"	35"	1	32"	1	51"	25 1/2"
	108" (107.68")	21"	38"	16"	14 1/2"	14 1/4"	12 1/8"	25"	23 1/2"	23 1/4"	21 1/8"	41"	2	38"	2	54"	27"
	114" (113.68")	21"	38"	16"	14 1/2"	14 1/4"	12 1/8"	25"	23 1/2"	23 1/4"	21 1/8"	47"	2	44"	2	57"	28 1/2"
	120" (119.68")	21"	38"	16"	14 1/2"	14 1/4"	12 1/8"	25"	23 1/2"	23 1/4"	21 1/8"	53"	3	50"	2	60"	30"
48" (47.68")	96" (95.68")	24"	44"	N/A	17 1/2"	N/A	15 1/8"	N/A	23 1/2"	N/A	21 1/8"	29"	1	26"	1	48"	24"
	102" (101.68")	24"	44"	N/A	17 1/2"	N/A	15 1/8"	N/A	23 1/2"	N/A	21 1/8"	35"	1	32"	1	51"	25 1/2"
	108" (107.68")	24"	44"	N/A	17 1/2"	N/A	15 1/8"	N/A	23 1/2"	N/A	21 1/8"	41"	2	38"	2	54"	27"
	114" (113.68")	24"	44"	N/A	17 1/2"	N/A	15 1/8"	N/A	23 1/2"	N/A	21 1/8"	47"	2	44"	2	57"	28 1/2"
	120" (119.68")	24"	44"	N/A	17 1/2"	N/A	15 1/8"	N/A	23 1/2"	N/A	21 1/8"	53"	3	50"	2	60"	30"
54" (53.68")	96" (95.68")	27"	50"	N/A	20 1/2"	N/A	18 1/8"	N/A	23 1/2"	N/A	21 1/8"	29"	1	26"	1	48"	24"
	102" (101.68")	27"	50"	N/A	20 1/2"	N/A	18 1/8"	N/A	23 1/2"	N/A	21 1/8"	35"	1	32"	1	51"	25 1/2"
	108" (107.68")	27"	50"	N/A	20 1/2"	N/A	18 1/8"	N/A	23 1/2"	N/A	21 1/8"	41"	2	38"	2	54"	27"
	114" (113.68")	27"	50"	N/A	20 1/2"	N/A	18 1/8"	N/A	23 1/2"	N/A	21 1/8"	47"	2	44"	2	57"	28 1/2"
	120" (119.68")	27"	50"	N/A	20 1/2"	N/A	18 1/8"	N/A	23 1/2"	N/A	21 1/8"	53"	3	50"	2	60"	30"
60" (59.68")	96" (95.68")	30"	56"	N/A	23 1/2"	N/A	21 1/8"	N/A	23 1/2"	N/A	21 1/8"	29"	1	26"	1	48"	24"
	102" (101.68")	30"	56"	N/A	23 1/2"	N/A	21 1/8"	N/A	23 1/2"	N/A	21 1/8"	35"	1	32"	1	51"	25 1/2"
	108" (107.68")	30"	56"	N/A	23 1/2"	N/A	21 1/8"	N/A	23 1/2"	N/A	21 1/8"	41"	2	38"	2	54"	27"
	114" (113.68")	30"	56"	N/A	23 1/2"	N/A	21 1/8"	N/A	23 1/2"	N/A	21 1/8"	47"	2	44"	2	57"	28 1/2"
	120" (119.68")	30"	56"	N/A	23 1/2"	N/A	21 1/8"	N/A	23 1/2"	N/A	21 1/8"	53"	3	50"	2	60"	30"

Product Details – Planes Conference Tables

Conference Table Tops for use with Column Base (1-Piece Tops)

Table Sizes and Seating Capacities Rectangle Top

		WIDTHS				
		96" Wide	102" Wide	108" Wide	114" Wide	120" Wide
DEPTHS	42" Deep	8 Chairs Maximum	8 Chairs Maximum	10 Chairs Maximum	10 Chairs Maximum	10 Chairs Maximum
	48" Deep	8 Chairs Maximum	8 Chairs Maximum	10 Chairs Maximum	10 Chairs Maximum	10 Chairs Maximum
	54" Deep	10 Chairs Maximum	10 Chairs Maximum	12 Chairs Maximum	12 Chairs Maximum	12 Chairs Maximum
	60" Deep	10 Chairs Maximum	10 Chairs Maximum	12 Chairs Maximum	12 Chairs Maximum	12 Chairs Maximum

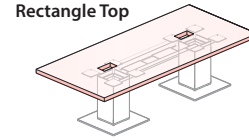

Pebble Top

		WIDTHS				
		96" Wide	102" Wide	108" Wide	114" Wide	120" Wide
DEPTHS	42" Deep	8 Chairs Maximum	8 Chairs Maximum	10 Chairs Maximum	10 Chairs Maximum	10 Chairs Maximum
	48" Deep	8 Chairs Maximum	8 Chairs Maximum	10 Chairs Maximum	10 Chairs Maximum	10 Chairs Maximum
	54" Deep	10 Chairs Maximum	10 Chairs Maximum	12 Chairs Maximum	12 Chairs Maximum	12 Chairs Maximum
	60" Deep	10 Chairs Maximum	10 Chairs Maximum	12 Chairs Maximum	12 Chairs Maximum	12 Chairs Maximum

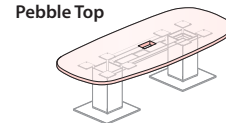

Hexagon Top

		WIDTHS				
		96" Wide	102" Wide	108" Wide	114" Wide	120" Wide
DEPTHS	42" Deep	8 Chairs Maximum	8 Chairs Maximum	10 Chairs Maximum	10 Chairs Maximum	10 Chairs Maximum
	48" Deep	8 Chairs Maximum	8 Chairs Maximum	10 Chairs Maximum	10 Chairs Maximum	10 Chairs Maximum
	54" Deep	8 Chairs Maximum	8 Chairs Maximum	10 Chairs Maximum	10 Chairs Maximum	10 Chairs Maximum
	60" Deep	10 Chairs Maximum	10 Chairs Maximum	12 Chairs Maximum	12 Chairs Maximum	12 Chairs Maximum

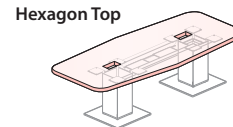

Note Recommended seating capacity based upon a width of 27" per chair.

Product Details – Planes Conference Tables

Conference Table Tops for use with Column Base (1-Piece Top)

Floor Support Requirements for Rectangle, Pebble and Hexagon Tops

- One Piece Rectangle, Pebble and Hexagon Tops require separately specified J Channels and (2) Column Bases.
- A Column Base is comprised of a separately specified Column Frame, Column Base Plate and Cladding.

Column Frame with Square Column Base Plate Specification Matrix

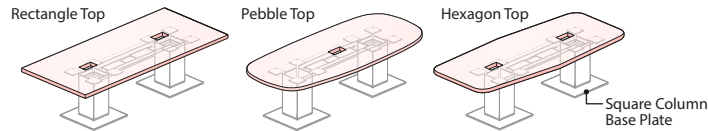

TABLE TOP DEPTH (Rectangle, Pebble or Hexagon)	COLUMN FRAME/COLUMN BASE PLATE SIZE COMBINATIONS				
	9" x 9" Column Frame		12" x 12" Column Frame		
	21" Square Base Plate	24" Square Base Plate	24" Square Base Plate	27" Square Base Plate	30" Square Base Plate
	⊘ Don't				
42" Deep Tops	⊘ Don't				
48" Deep Tops	⊘ Don't	⊘ Don't	⊘ Don't		
54" Deep Tops	⊘ Don't	⊘ Don't	⊘ Don't		
60" Deep Tops	⊘ Don't	⊘ Don't	⊘ Don't		

Column Frame with Round Column Base Plate Specification Matrix

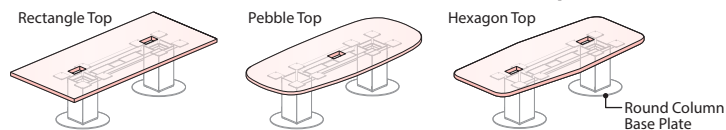

TABLE TOP DEPTH (Rectangle, Pebble or Hexagon)	COLUMN FRAME/COLUMN BASE PLATE SIZE COMBINATIONS				
	9" x 9" Column Frame		12" x 12" Column Frame		
	21" Round Base Plate	24" Round Base Plate	24" Round Base Plate	27" Round Base Plate	30" Round Base Plate
	⊘ Don't				
42" Deep Tops	⊘ Don't				
48" Deep Tops	⊘ Don't	⊘ Don't	⊘ Don't		
54" Deep Tops	⊘ Don't	⊘ Don't	⊘ Don't	⊘ Don't	
60" Deep Tops	⊘ Don't	⊘ Don't	⊘ Don't	⊘ Don't	

Note • Double-Sided Flip Top Units cannot be placed over the 9" Column Frame.

Product Details – Planes Conference Tables

Conference Table Tops for use with Column Base (2-Piece Tops)

Rectangle

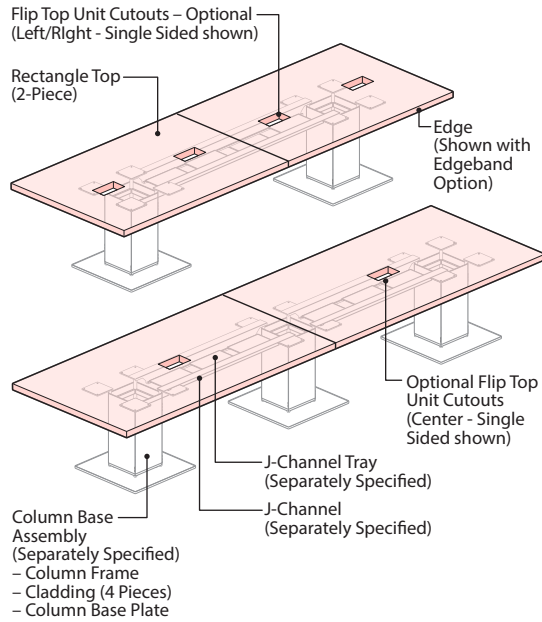

Pebble

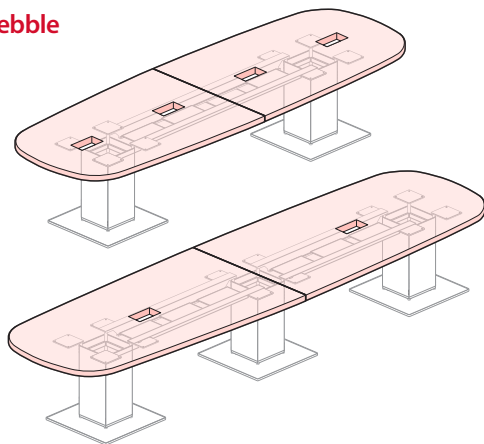

Hexagon

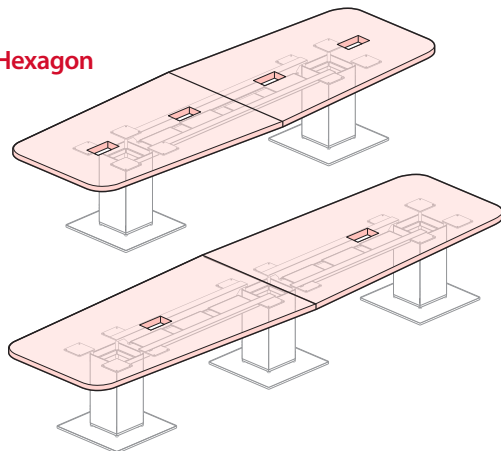

Component Materials/Finishes

COMPONENT NAME	MATERIALS/ FINISHES
2-Piece Top – Rectangle, Pebble, Hexagon	Laminate Top – Specified top color and specified edge trim color • Edge Options: (J) Edgeband, (F) Knife
	Wood Top – Specified top and edge trim wood finish color • Edge Options: (K) Edgeband, (U) Knife

Edge Options for Laminate Tops

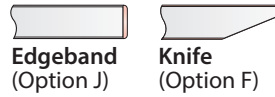

Edge Options for Wood Tops

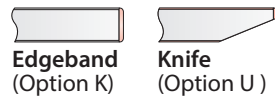

Flip Top Unit Cutout Options

Center Cutout Option

- Includes 1 Flip Top Unit Cutout (centered on each top piece)

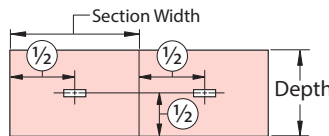

Left/Right Cutout Option

- Includes 2 Flip Top Unit Cutouts (1 left cutout and 1 right cutout on each top piece)

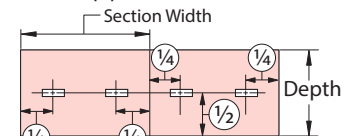

Note Cutout locations for Rectangle, Pebble and Hexagon Tops are the same.

Flip Top Unit Cutout Dimensions

Cutout Option (F or V)

For use with Single Sided/ 4 Port Flip Top Unit

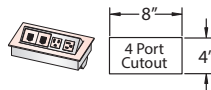

Cutout Option (J or K)

For use with Single Sided/ 6 Ports Flip Top Unit

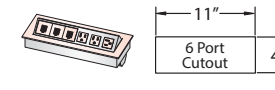

Cutout Option (M or P)

For use with Double Sided/ 8 Ports Flip Top Unit

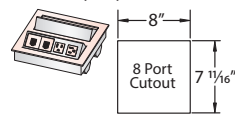

Cutout Option (Q or T)

For use with Double Sided/ 12 Ports Flip Top Unit

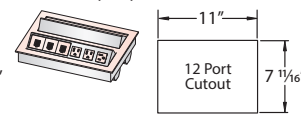

Note Flip Top Units are separately specified.

Separately Specified Components

- Two Piece Rectangle, Pebble and Hexagon Tops require a separately specified J Channel and (2 or 3) Column Bases.
- 126"-168" Wide Tops require (2) Column Bases for Floor Support
- 174"-180" Wide Tops require (3) Column Bases for Floor Support
- A Column Base is comprised of a separately specified Column Frame, Column Base Plate and Cladding.
- Column Frames are available with 20", 28", and 40" heights.

Cable Column Heights

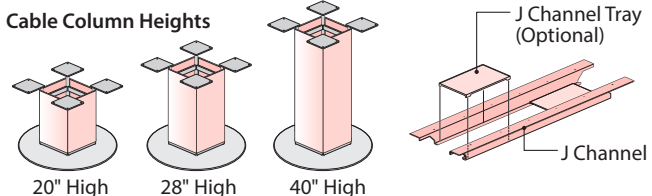

Note See the Floor Support Requirements – Specification Matrix, for Column Frames and Column Base Plates specification requirements.

Product Details – Planes Conference Tables

Conference Table Tops for use with Column Base (2-Piece Tops)

Dimensions – 2-Piece Top / Requires Two Column Bases (126"-168" Wide Tops)

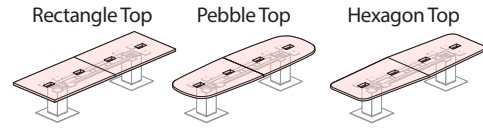
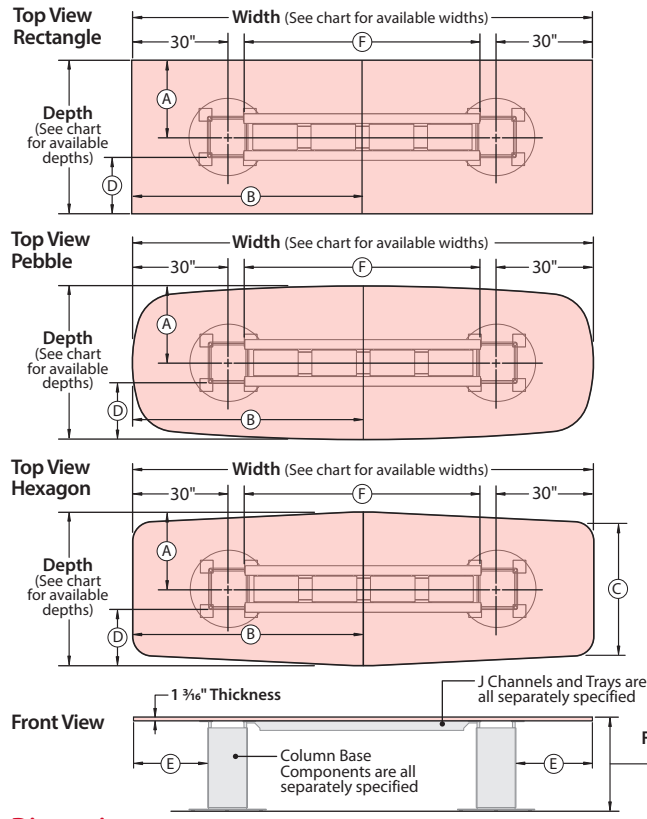

Flip Top Unit Cutout Locations

Centered Option (Top View)

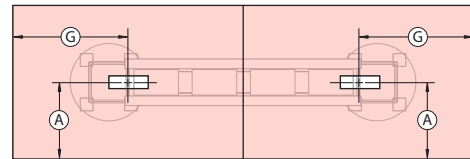

Left/Right Option (Top View)

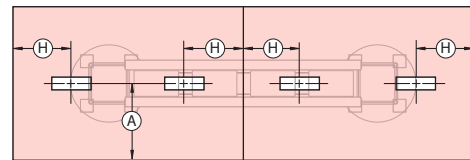

- Note**
- Cutout locations for Rectangle, Pebble and Hexagon Tops are the same.
 - Reference workware planning page when using workware products.

Dimensions

TABLE TOP					KNEESPACE								J CHANNEL / TRAYS				CUTOUTS			
Depth Nominal (Actual)	Width Nominal (Actual)	A	B	C	D				E				F				G	H		
					Flat Cladding		Round Cladding		Flat Cladding		Round Cladding		9" x 9" Column Frames		12" x 12" Column Frames				Centered Cutout Option	Left/Right Cutouts Option
					9" x 9" Column Frames	12" x 12" Column Frames	9" x 9" Column Frames	12" x 12" Column Frames	9" x 9" Column Frames	12" x 12" Column Frames	9" x 9" Column Frames	12" x 12" Column Frames	J Channel Width	Maximum Number of Trays	J Channel Width	Maximum Number of Trays				
42" (41.68")	126" (125.36")	21"	63"	36"	16"	14 1/2"	14 1/4"	12 1/8"	24 13/16"	23 3/16"	23 1/8"	21"	59"	3	56"	3	31 1/2"	15 3/4"		
	132" (131.36")	21"	66"	36"	16"	14 1/2"	14 1/4"	12 1/8"	24 13/16"	23 3/16"	23 1/8"	21"	65"	3	62"	3	33"	16 1/2"		
	138" (137.36")	21"	69"	36"	16"	14 1/2"	14 1/4"	12 1/8"	24 13/16"	23 3/16"	23 1/8"	21"	71"	4	68"	4	34 1/2"	17 1/4"		
	144" (143.36")	21"	72"	36"	16"	14 1/2"	14 1/4"	12 1/8"	24 13/16"	23 3/16"	23 1/8"	21"	77"	4	74"	4	36"	18"		
	150" (149.36")	21"	75"	36"	16"	14 1/2"	14 1/4"	12 1/8"	24 13/16"	23 3/16"	23 1/8"	21"	83"	5	80"	5	37 1/2"	18 3/4"		
	156" (155.36")	21"	78"	36"	16"	14 1/2"	14 1/4"	12 1/8"	24 13/16"	23 3/16"	23 1/8"	21"	89"	5	86"	5	39"	19 1/2"		
	162" (161.36")	21"	81"	36"	16"	14 1/2"	14 1/4"	12 1/8"	24 13/16"	23 3/16"	23 1/8"	21"	95"	6	92"	6	40 1/2"	20 1/4"		
168" (167.36")	21"	84"	36"	16"	14 1/2"	14 1/4"	12 1/8"	24 13/16"	23 3/16"	23 1/8"	21"	101"	6	98"	6	42"	21"			
48" (47.68")	126" (125.36")	24"	63"	42"	N/A	17 1/2"	N/A	15 1/8"	N/A	23 3/16"	N/A	21"	59"	3	56"	3	31 1/2"	15 3/4"		
	132" (131.36")	24"	66"	42"	N/A	17 1/2"	N/A	15 1/8"	N/A	23 3/16"	N/A	21"	65"	3	62"	3	33"	16 1/2"		
	138" (137.36")	24"	69"	42"	N/A	17 1/2"	N/A	15 1/8"	N/A	23 3/16"	N/A	21"	71"	4	68"	4	34 1/2"	17 1/4"		
	144" (143.36")	24"	72"	42"	N/A	17 1/2"	N/A	15 1/8"	N/A	23 3/16"	N/A	21"	77"	4	74"	4	36"	18"		
	150" (149.36")	24"	75"	42"	N/A	17 1/2"	N/A	15 1/8"	N/A	23 3/16"	N/A	21"	83"	5	80"	5	37 1/2"	18 3/4"		
	156" (155.36")	24"	78"	42"	N/A	17 1/2"	N/A	15 1/8"	N/A	23 3/16"	N/A	21"	89"	5	86"	5	39"	19 1/2"		
	162" (161.36")	24"	81"	42"	N/A	17 1/2"	N/A	15 1/8"	N/A	23 3/16"	N/A	21"	95"	6	92"	6	40 1/2"	20 1/4"		
168" (167.36")	24"	84"	42"	N/A	17 1/2"	N/A	15 1/8"	N/A	23 3/16"	N/A	21"	101"	6	98"	6	42"	21"			
54" (53.68")	126" (125.36")	27"	63"	48"	N/A	20 1/2"	N/A	18 1/8"	N/A	23 3/16"	N/A	21"	59"	3	56"	3	31 1/2"	15 3/4"		
	132" (131.36")	27"	66"	48"	N/A	20 1/2"	N/A	18 1/8"	N/A	23 3/16"	N/A	21"	65"	3	62"	3	33"	16 1/2"		
	138" (137.36")	27"	69"	48"	N/A	20 1/2"	N/A	18 1/8"	N/A	23 3/16"	N/A	21"	71"	4	68"	4	34 1/2"	17 1/4"		
	144" (143.36")	27"	72"	48"	N/A	20 1/2"	N/A	18 1/8"	N/A	23 3/16"	N/A	21"	77"	4	74"	4	36"	18"		
	150" (149.36")	27"	75"	48"	N/A	20 1/2"	N/A	18 1/8"	N/A	23 3/16"	N/A	21"	83"	5	80"	5	37 1/2"	18 3/4"		
	156" (155.36")	27"	78"	48"	N/A	20 1/2"	N/A	18 1/8"	N/A	23 3/16"	N/A	21"	89"	5	86"	5	39"	19 1/2"		
	162" (161.36")	27"	81"	48"	N/A	20 1/2"	N/A	18 1/8"	N/A	23 3/16"	N/A	21"	95"	6	92"	6	40 1/2"	20 1/4"		
168" (167.36")	27"	84"	48"	N/A	20 1/2"	N/A	18 1/8"	N/A	23 3/16"	N/A	21"	101"	6	98"	6	42"	21"			
60" (59.68")	126" (125.36")	30"	63"	54"	N/A	23 1/2"	N/A	21 1/8"	N/A	23 3/16"	N/A	21"	59"	3	56"	3	31 1/2"	15 3/4"		
	132" (131.36")	30"	66"	54"	N/A	23 1/2"	N/A	21 1/8"	N/A	23 3/16"	N/A	21"	65"	3	62"	3	33"	16 1/2"		
	138" (137.36")	30"	69"	54"	N/A	23 1/2"	N/A	21 1/8"	N/A	23 3/16"	N/A	21"	71"	4	68"	4	34 1/2"	17 1/4"		
	144" (143.36")	30"	72"	54"	N/A	23 1/2"	N/A	21 1/8"	N/A	23 3/16"	N/A	21"	77"	4	74"	4	36"	18"		
	150" (149.36")	30"	75"	54"	N/A	23 1/2"	N/A	21 1/8"	N/A	23 3/16"	N/A	21"	83"	5	80"	5	37 1/2"	18 3/4"		
	156" (155.36")	30"	78"	54"	N/A	23 1/2"	N/A	21 1/8"	N/A	23 3/16"	N/A	21"	89"	5	86"	5	39"	19 1/2"		
	162" (161.36")	30"	81"	54"	N/A	23 1/2"	N/A	21 1/8"	N/A	23 3/16"	N/A	21"	95"	6	92"	6	40 1/2"	20 1/4"		
168" (167.36")	30"	84"	54"	N/A	23 1/2"	N/A	21 1/8"	N/A	23 3/16"	N/A	21"	101"	6	98"	6	42"	21"			

Product Details – Planes Conference Tables

Conference Table Tops for use with Column Base (2-Piece Tops)

Dimensions – 2-Piece Top / Requires Three Column Bases (174"-180" Wide Tops)

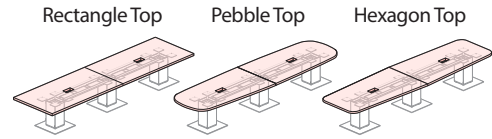
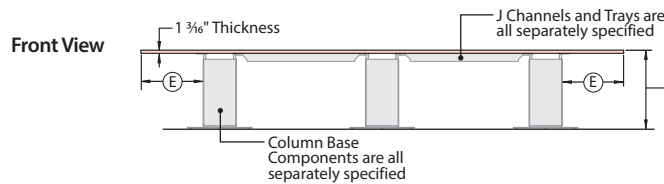
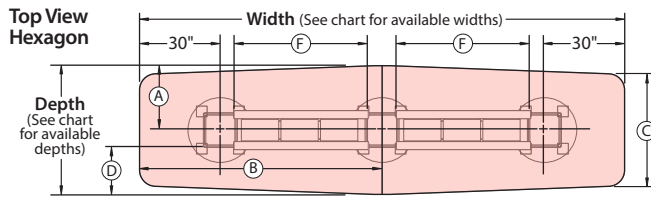
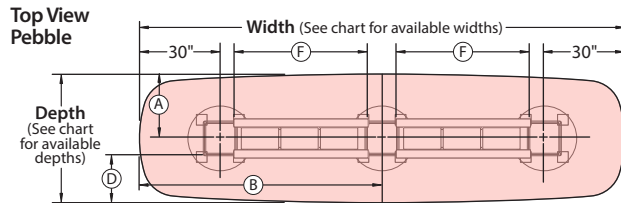
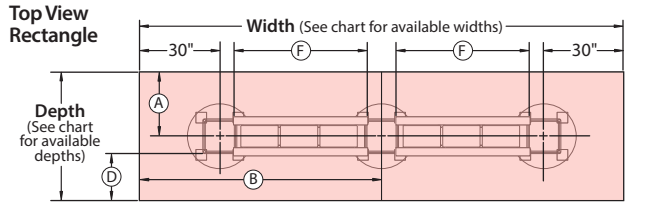

Flip Top Unit Cutout Locations

Centered Option (Top View)

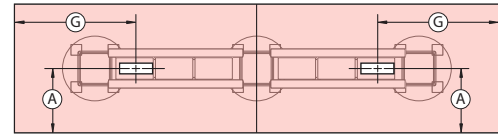

Left/Right Option (Top View)

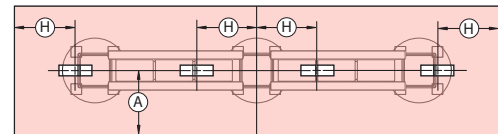

- Note**
- Cutout locations for Rectangle, Pebble and Hexagon Tops are the same.
 - Reference workware planning page when using workware products.

Available Finished Heights
Nominal (Actual)
21" (21.19")
29" (29.19")
41" (41.19")

Dimensions

TABLE TOP					KNEESPACE								J CHANNEL / TRAYS				CUTOUTS	
Depth Nominal (Actual)	Width Nominal (Actual)	A	B	C	D				E				F				G	H
					Flat Cladding		Round Cladding		Flat Cladding		Round Cladding		9" x 9" Column Frames		12" x 12" Column Frames		Centered Cutout Option	Left/Right Cutouts Option
					9" x 9" Column Frames	12" x 12" Column Frames	9" x 9" Column Frames	12" x 12" Column Frames	9" x 9" Column Frames	12" x 12" Column Frames	9" x 9" Column Frames	12" x 12" Column Frames	J Channel Width	Maximum Number of Trays	J Channel Width	Maximum Number of Trays		
42" (41.68")	174" (173.36")	21"	87"	36"	16"	14 1/2"	14 1/4"	12 1/8"	24 13/16"	23 3/16"	23 1/8"	20 15/16"	59"	3	56"	3	31 1/2"	15 3/4"
	180" (179.36")	21"	90"	36"	16"	14 1/2"	14 1/4"	12 1/8"	24 13/16"	23 3/16"	23 1/8"	20 15/16"	65"	3	62"	3	33"	16 1/2"
48" (47.68")	174" (173.36")	24"	87"	42"	N/A	17 1/2"	N/A	15 1/8"	N/A	23 3/16"	N/A	20 15/16"	59"	3	56"	3	31 1/2"	15 3/4"
	180" (179.36")	24"	90"	42"	N/A	17 1/2"	N/A	15 1/8"	N/A	23 3/16"	N/A	20 15/16"	65"	3	62"	3	33"	16 1/2"
54" (53.68")	174" (173.36")	27"	87"	48"	N/A	20 1/2"	N/A	18 1/8"	N/A	23 3/16"	N/A	20 15/16"	59"	3	56"	3	31 1/2"	15 3/4"
	180" (179.36")	27"	90"	48"	N/A	20 1/2"	N/A	18 1/8"	N/A	23 3/16"	N/A	20 15/16"	65"	3	62"	3	33"	16 1/2"
60" (59.68")	174" (173.36")	30"	87"	54"	N/A	23 1/2"	N/A	21 1/8"	N/A	23 3/16"	N/A	20 15/16"	59"	3	56"	3	31 1/2"	15 3/4"
	180" (179.36")	30"	90"	54"	N/A	23 1/2"	N/A	21 1/8"	N/A	23 3/16"	N/A	20 15/16"	65"	3	62"	3	33"	16 1/2"

Product Details – Planes Height Adjustable Tables

Conference Table Tops for use with Column Base (2-Piece Tops)

Table Sizes and Seating Capacities

Rectangle Top

- 126"-168" wide requires (2) separately specified Column Bases.
- 174"-180" wide requires (3) separately specified Column Bases.

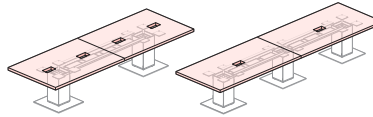

		WIDTHS									
		126" Wide	132" Wide	138" Wide	144" Wide	150" Wide	156" Wide	162" Wide	168" Wide	174" Wide	180" Wide
DEPTHS	42" Deep	10 Chairs Maximum (2 Columns)	10 Chairs Maximum (2 Columns)	12 Chairs Maximum (2 Columns)	12 Chairs Maximum (2 Columns)	12 Chairs Maximum (2 Columns)	12 Chairs Maximum (2 Columns)	14 Chairs Maximum (2 Columns)	14 Chairs Maximum (2 Columns)	14 Chairs Maximum (3 Columns)	14 Chairs Maximum (3 Columns)
	48" Deep	10 Chairs Maximum (2 Columns)	10 Chairs Maximum (2 Columns)	12 Chairs Maximum (2 Columns)	12 Chairs Maximum (2 Columns)	12 Chairs Maximum (2 Columns)	12 Chairs Maximum (2 Columns)	14 Chairs Maximum (2 Columns)	14 Chairs Maximum (2 Columns)	14 Chairs Maximum (3 Columns)	14 Chairs Maximum (3 Columns)
	54" Deep	10 Chairs Maximum (2 Columns)	10 Chairs Maximum (2 Columns)	12 Chairs Maximum (2 Columns)	12 Chairs Maximum (2 Columns)	12 Chairs Maximum (2 Columns)	12 Chairs Maximum (2 Columns)	14 Chairs Maximum (2 Columns)	14 Chairs Maximum (2 Columns)	14 Chairs Maximum (3 Columns)	14 Chairs Maximum (3 Columns)
	60" Deep	12 Chairs Maximum (2 Columns)	12 Chairs Maximum (2 Columns)	14 Chairs Maximum (2 Columns)	14 Chairs Maximum (2 Columns)	14 Chairs Maximum (2 Columns)	14 Chairs Maximum (2 Columns)	16 Chairs Maximum (2 Columns)	16 Chairs Maximum (2 Columns)	16 Chairs Maximum (3 Columns)	16 Chairs Maximum (3 Columns)

Pebble Top

- 126"-168" wide requires (2) separately specified Column Bases.
- 174"-180" wide requires (3) separately specified Column Bases.

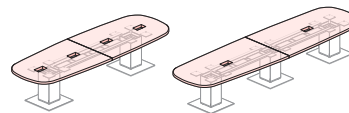

		WIDTHS									
		126" Wide	132" Wide	138" Wide	144" Wide	150" Wide	156" Wide	162" Wide	168" Wide	174" Wide	180" Wide
DEPTHS	42" Deep	10 Chairs Maximum (2 Columns)	10 Chairs Maximum (2 Columns)	10 Chairs Maximum (2 Columns)	10 Chairs Maximum (2 Columns)	10 Chairs Maximum (2 Columns)	12 Chairs Maximum (2 Columns)	14 Chairs Maximum (2 Columns)	16 Chairs Maximum (2 Columns)	14 Chairs Maximum (3 Columns)	14 Chairs Maximum (3 Columns)
	48" Deep	10 Chairs Maximum (2 Columns)	10 Chairs Maximum (2 Columns)	10 Chairs Maximum (2 Columns)	10 Chairs Maximum (2 Columns)	10 Chairs Maximum (2 Columns)	12 Chairs Maximum (2 Columns)	14 Chairs Maximum (2 Columns)	16 Chairs Maximum (2 Columns)	14 Chairs Maximum (3 Columns)	14 Chairs Maximum (3 Columns)
	54" Deep	10 Chairs Maximum (2 Columns)	10 Chairs Maximum (2 Columns)	12 Chairs Maximum (2 Columns)	12 Chairs Maximum (2 Columns)	12 Chairs Maximum (2 Columns)	12 Chairs Maximum (2 Columns)	14 Chairs Maximum (2 Columns)	14 Chairs Maximum (2 Columns)	14 Chairs Maximum (3 Columns)	14 Chairs Maximum (3 Columns)
	60" Deep	12 Chairs Maximum (2 Columns)	12 Chairs Maximum (2 Columns)	12 Chairs Maximum (2 Columns)	12 Chairs Maximum (2 Columns)	14 Chairs Maximum (2 Columns)	14 Chairs Maximum (2 Columns)	16 Chairs Maximum (2 Columns)	16 Chairs Maximum (2 Columns)	16 Chairs Maximum (3 Columns)	16 Chairs Maximum (3 Columns)

Note Recommended seating capacity based upon a width of 27" per chair.

Product Details – Planes Conference Tables

Conference Table Tops for use with Column Base (2-Piece Tops)

Table Sizes and Seating Capacities

Hexagon Top

- 126"-168" wide requires (2) separately specified Column Bases.
- 174"-180" wide requires (3) separately specified Column Bases.

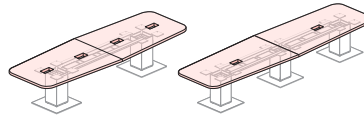

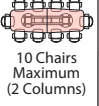
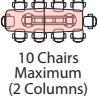
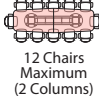
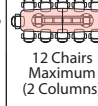
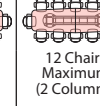
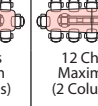
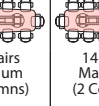
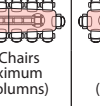
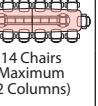
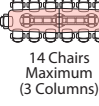
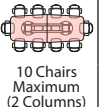
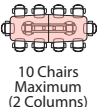
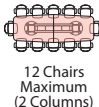
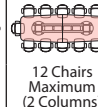
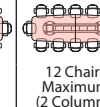
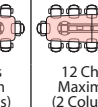
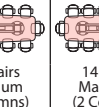
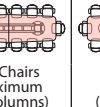
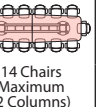
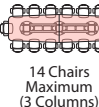
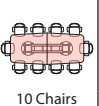
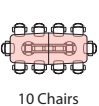
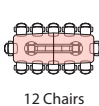
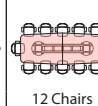
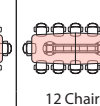
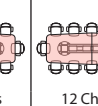
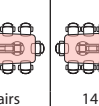
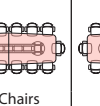
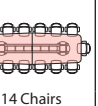
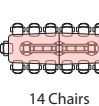
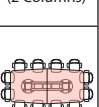
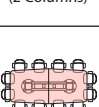
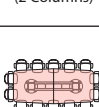
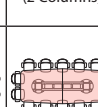
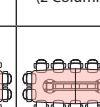
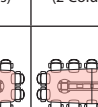
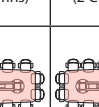
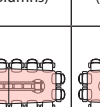
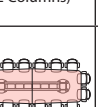
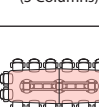
		WIDTHS									
		126" Wide	132" Wide	138" Wide	144" Wide	150" Wide	156" Wide	162" Wide	168" Wide	174" Wide	180" Wide
DEPTHS	42" Deep	 10 Chairs Maximum (2 Columns)	 10 Chairs Maximum (2 Columns)	 12 Chairs Maximum (2 Columns)	 12 Chairs Maximum (2 Columns)	 12 Chairs Maximum (2 Columns)	 12 Chairs Maximum (2 Columns)	 14 Chairs Maximum (2 Columns)	 14 Chairs Maximum (2 Columns)	 14 Chairs Maximum (3 Columns)	 14 Chairs Maximum (3 Columns)
	48" Deep	 10 Chairs Maximum (2 Columns)	 10 Chairs Maximum (2 Columns)	 12 Chairs Maximum (2 Columns)	 12 Chairs Maximum (2 Columns)	 12 Chairs Maximum (2 Columns)	 12 Chairs Maximum (2 Columns)	 14 Chairs Maximum (2 Columns)	 14 Chairs Maximum (2 Columns)	 14 Chairs Maximum (3 Columns)	 14 Chairs Maximum (3 Columns)
	54" Deep	 10 Chairs Maximum (2 Columns)	 10 Chairs Maximum (2 Columns)	 12 Chairs Maximum (2 Columns)	 12 Chairs Maximum (2 Columns)	 12 Chairs Maximum (2 Columns)	 12 Chairs Maximum (2 Columns)	 14 Chairs Maximum (2 Columns)	 14 Chairs Maximum (2 Columns)	 14 Chairs Maximum (3 Columns)	 14 Chairs Maximum (3 Columns)
	60" Deep	 12 Chairs Maximum (2 Columns)	 12 Chairs Maximum (2 Columns)	 14 Chairs Maximum (2 Columns)	 14 Chairs Maximum (2 Columns)	 14 Chairs Maximum (2 Columns)	 14 Chairs Maximum (2 Columns)	 16 Chairs Maximum (2 Columns)	 16 Chairs Maximum (2 Columns)	 16 Chairs Maximum (3 Columns)	 16 Chairs Maximum (3 Columns)

Note Recommended seating capacity based upon a width of 27" per chair.

Product Details – Planes Conference Tables

Conference Table Tops for use with Column Base (2-Piece Tops)

Floor Support Requirements for Rectangle, Pebble and Hexagon Tops

- 2-Piece Rectangle, Pebble and Hexagon Tops require separately specified J Channel and Column Bases.
- 126"-168" wide 2-Piece Tops require (2) separately specified Column Bases.
- 174"-180" wide 2-Piece Tops require (3) separately specified Column Bases.
- A Column Base is comprised of a separately specified Column Frame, Column Base Plate and Cladding.

Column Frame with Square Column Base Plate Specification Matrix

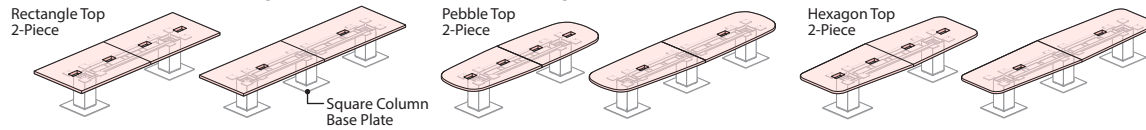

TABLE TOP DEPTH (Rectangle, Pebble or Hexagon)	COLUMN FRAME/COLUMN BASE PLATE SIZE COMBINATIONS				
	9" x 9" Column Frame		12" x 12" Column Frame		
	21" Square Base Plate	24" Square Base Plate	24" Square Base Plate	27" Square Base Plate	30" Square Base Plate
	⊘ Don't				
42" Deep Tops	⊘ Don't				
48" Deep Tops	⊘ Don't	⊘ Don't	⊘ Don't		
54" Deep Tops	⊘ Don't	⊘ Don't	⊘ Don't		
60" Deep Tops	⊘ Don't	⊘ Don't	⊘ Don't		

Column Frame with Round Column Base Plate Specification Matrix

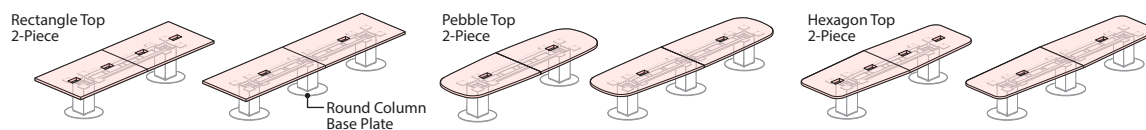

TABLE TOP DEPTH (Rectangle, Pebble or Hexagon)	COLUMN FRAME/COLUMN BASE PLATE SIZE COMBINATIONS				
	9" x 9" Column Frame		12" x 12" Column Frame		
	21" Round Base Plate	24" Round Base Plate	24" Round Base Plate	27" Round Base Plate	30" Round Base Plate
	⊘ Don't				
42" Deep Tops	⊘ Don't				
48" Deep Tops	⊘ Don't	⊘ Don't	⊘ Don't		
54" Deep Tops	⊘ Don't	⊘ Don't	⊘ Don't	⊘ Don't	
60" Deep Tops	⊘ Don't	⊘ Don't	⊘ Don't	⊘ Don't	

Note • Double-Sided Flip Top Units cannot be placed over the 9" Column Frame.

Product Details – Planes Conference Tables

Conference Table Tops for use with Column Base (3-Piece Tops)

Rectangle

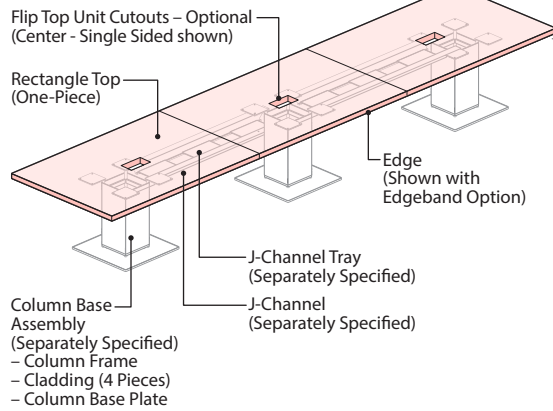

Pebble

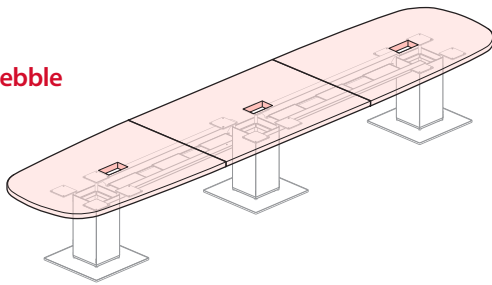

Hexagon

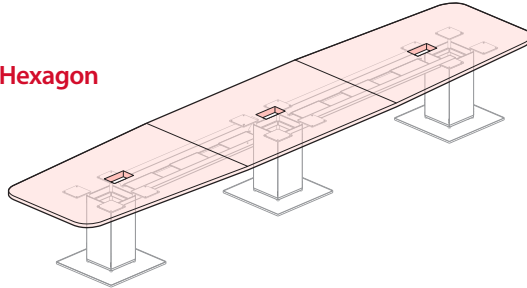

Component Materials/Finishes

COMPONENT NAME	MATERIALS/ FINISHES
3-Piece Top – Rectangle, Pebble, Hexagon	Laminate Top – Specified top color and specified edge trim color • Edge Options: (J) Edgeband, (F) Knife
	Wood Top – Specified top and edge trim wood finish color • Edge Options: (K) Edgeband, (U) Knife

Edge Options for Laminate Tops

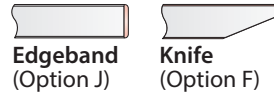

Edge Options for Wood Tops

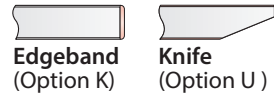

Flip Top Unit Cutout Options

Center Cutout Option

- Includes 1 Flip Top Unit cutout (centered on top)

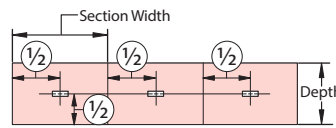

Left/Right Cutout Option

- Includes 2 Flip Top Unit cutouts (1 Left Cutout and 1 Right Cutout)

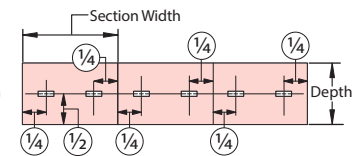

Note Cutout locations for Rectangle, Pebble and Hexagon Tops are the same.

Flip Top Unit Cutout Dimensions

Cutout Option (F or V)

- For use with Single Sided/ 4 Port Flip Top Unit

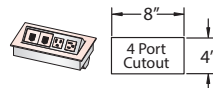

Cutout Option (J or K)

- For use with Single Sided/ 6 Ports Flip Top Unit

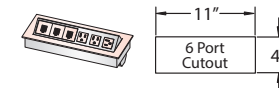

Cutout Option (M or P)

- For use with Double Sided/ 8 Ports Flip Top Unit

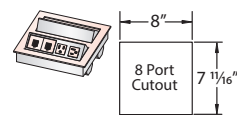

Cutout Option (Q or T)

- For use with Double Sided/ 12 Ports Flip Top Unit

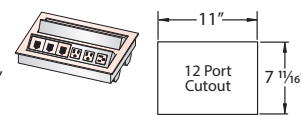

Note Flip Top Units are separately specified.

Separately Specified Components

- Two Piece Rectangle, Pebble and Hexagon Tops require a separately specified J Channel and (3) Column Bases.
- A Column Base is comprised of a separately specified Column Frame, Column Base Plate and Cladding.
- Column Frames are available with 20", 28" and 40" heights.

Cable Column Heights

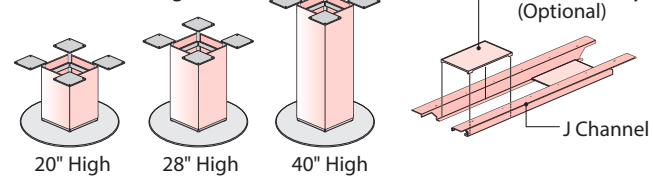

Note See the Floor Support Requirements – Specification Matrix, for Column Frames and Column Base Plates specification requirements.

Product Details – Planes Conference Tables

Conference Table Tops for use with Column Base (3-Piece Tops)

Dimensions – 3-Piece Top / Requires Three Column Bases (174"-180" Wide Tops)

(See the chart on the following page specific Dimensions)

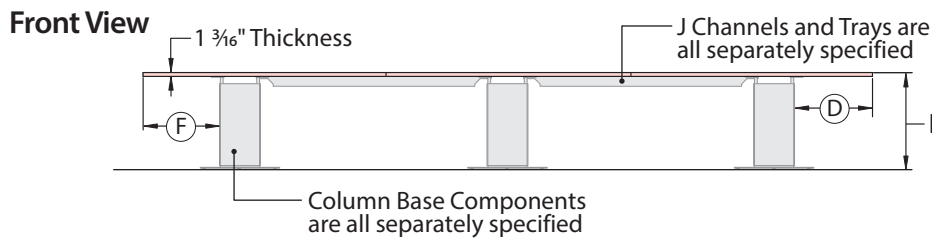
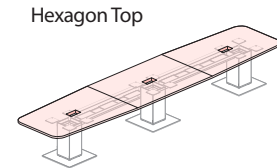
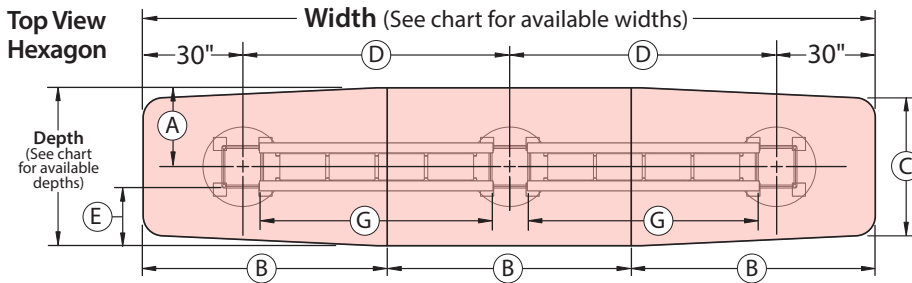
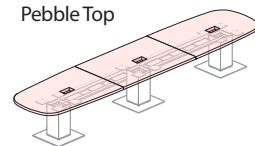
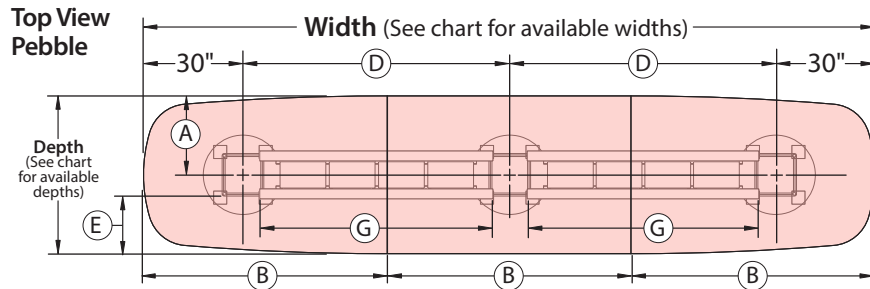
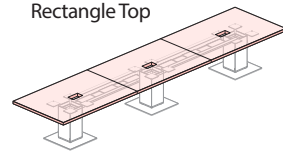
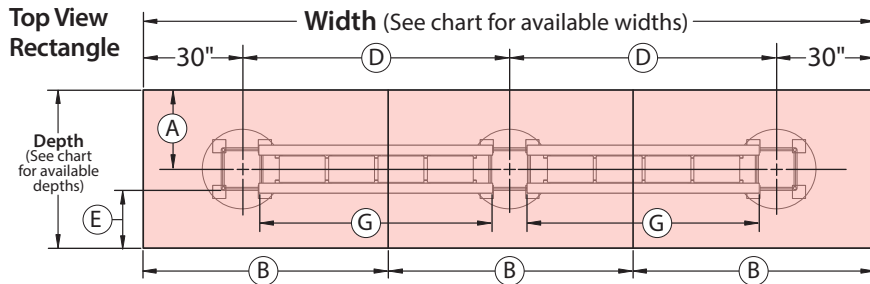

Available Finished Heights
 Nominal (Actual)
 21" (21.19")
 29" (29.19")
 41" (41.19")

Flip Top Unit Cutout Locations

Centered Option (Top View)

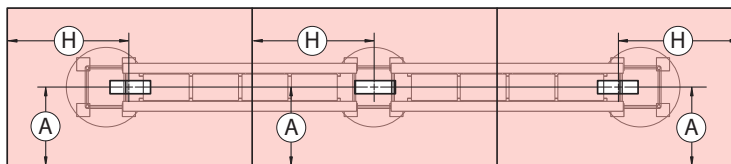

Left/Right Option (Top View)

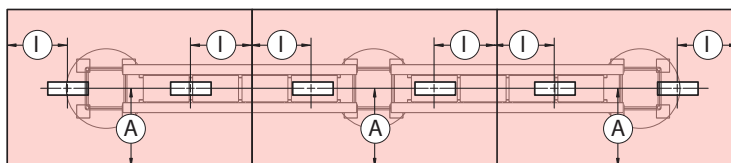

Note

- Cutout locations for Rectangle, Pebble and Hexagon Tops are the same.
- Reference workware planning page when using workware products.

Product Details – Planes Conference Tables

Conference Table Tops for use with Column Base (3-Piece Tops)

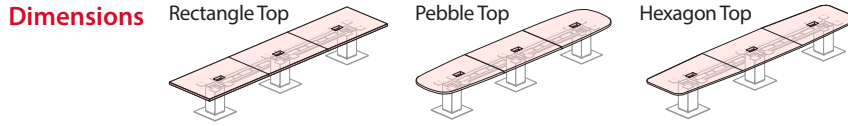

TABLE TOP						KNEESPACE								J CHANNEL / TRAYS				CUTOUTS	
Depth Nominal (Actual)	Width Nominal (Actual)	A	B	C	D	E				F				G				Centered Cutout Option	Left/Right Cutouts Option
						Flat Cladding		Round Cladding		Flat Cladding		Round Cladding		9" x 9" Column Frames		12" x 12" Column Frames			
						9" x 9" Column Frames	12" x 12" Column Frames	9" x 9" Column Frames	12" x 12" Column Frames	9" x 9" Column Frames	12" x 12" Column Frames	9" x 9" Column Frames	12" x 12" Column Frames	J Channel Width	Max. Number of Trays	J Channel Width	Max. Number of Trays		
42" (41.68")	186" (185.04")	21"	62"	36"	62 13/16"	16"	14 1/2"	14 1/4"	12 1/8"	24 13/16"	23 3/16"	23 1/16"	20 15/16"	56"	3	53"	3	31"	15 1/2"
	192" (191.04")	21"	64"	36"	65 13/16"	16"	14 1/2"	14 1/4"	12 1/8"	24 13/16"	23 3/16"	23 1/16"	20 15/16"	59"	3	56"	3	32"	16"
	198" (197.04")	21"	66"	36"	68 13/16"	16"	14 1/2"	14 1/4"	12 1/8"	24 13/16"	23 3/16"	23 1/16"	20 15/16"	62"	3	59"	3	33"	16 1/2"
	204" (203.04")	21"	68"	36"	71 13/16"	16"	14 1/2"	14 1/4"	12 1/8"	24 13/16"	23 3/16"	23 1/16"	20 15/16"	65"	3	62"	3	34"	17"
	210" (219.04")	21"	70"	36"	74 13/16"	16"	14 1/2"	14 1/4"	12 1/8"	24 13/16"	23 3/16"	23 1/16"	20 15/16"	68"	4	65"	3	35"	17 1/2"
	216" (215.04")	21"	72"	36"	77 13/16"	16"	14 1/2"	14 1/4"	12 1/8"	24 13/16"	23 3/16"	23 1/16"	20 15/16"	71"	4	68"	4	36"	18"
	222" (221.04")	21"	74"	36"	80 13/16"	16"	14 1/2"	14 1/4"	12 1/8"	24 13/16"	23 3/16"	23 1/16"	20 15/16"	74"	4	71"	4	37"	18 1/2"
	228" (227.04")	21"	76"	36"	83 13/16"	16"	14 1/2"	14 1/4"	12 1/8"	24 13/16"	23 3/16"	23 1/16"	20 15/16"	77"	4	74"	4	38"	19"
	234" (233.04")	21"	78"	36"	86 13/16"	16"	14 1/2"	14 1/4"	12 1/8"	24 13/16"	23 3/16"	23 1/16"	20 15/16"	80"	5	77"	4	39"	19 1/2"
	240" (239.04")	21"	80"	36"	89 13/16"	16"	14 1/2"	14 1/4"	12 1/8"	24 13/16"	23 3/16"	23 1/16"	20 15/16"	83"	5	80"	5	40"	20"
	246" (245.04")	21"	82"	36"	92 13/16"	16"	14 1/2"	14 1/4"	12 1/8"	24 13/16"	23 3/16"	23 1/16"	20 15/16"	86"	5	83"	5	41"	20 1/2"
	252" (251.04")	21"	84"	36"	95 13/16"	16"	14 1/2"	14 1/4"	12 1/8"	24 13/16"	23 3/16"	23 1/16"	20 15/16"	89"	5	86"	5	42"	21"
	258" (257.04")	21"	86"	36"	98 13/16"	16"	14 1/2"	14 1/4"	12 1/8"	24 13/16"	23 3/16"	23 1/16"	20 15/16"	92"	5	89"	5	43"	21 1/2"
	264" (263.04")	21"	88"	36"	101 13/16"	16"	14 1/2"	14 1/4"	12 1/8"	24 13/16"	23 3/16"	23 1/16"	20 15/16"	92"	6	92"	5	44"	22"
	270" (269.04")	21"	90"	36"	104 13/16"	16"	14 1/2"	14 1/4"	12 1/8"	24 13/16"	23 3/16"	23 1/16"	20 15/16"	98"	6	95"	6	45"	23 1/2"
	48" (47.68")	186" (185.04")	24"	62"	42"	62 13/16"	N/A	17 1/2"	N/A	15 1/8"	N/A	23 3/16"	N/A	20 15/16"	56"	3	53"	3	31"
192" (191.04")		24"	64"	42"	65 13/16"	N/A	17 1/2"	N/A	15 1/8"	N/A	23 3/16"	N/A	20 15/16"	59"	3	56"	3	32"	16"
198" (197.04")		24"	66"	42"	68 13/16"	N/A	17 1/2"	N/A	15 1/8"	N/A	23 3/16"	N/A	20 15/16"	62"	3	59"	3	33"	16 1/2"
204" (203.04")		24"	68"	42"	71 13/16"	N/A	17 1/2"	N/A	15 1/8"	N/A	23 3/16"	N/A	20 15/16"	65"	3	62"	3	34"	17"
210" (219.04")		24"	70"	42"	74 13/16"	N/A	17 1/2"	N/A	15 1/8"	N/A	23 3/16"	N/A	20 15/16"	68"	4	65"	3	35"	17 1/2"
216" (215.04")		24"	72"	42"	77 13/16"	N/A	17 1/2"	N/A	15 1/8"	N/A	23 3/16"	N/A	20 15/16"	71"	4	68"	4	36"	18"
222" (221.04")		24"	74"	42"	80 13/16"	N/A	17 1/2"	N/A	15 1/8"	N/A	23 3/16"	N/A	20 15/16"	74"	4	71"	4	37"	18 1/2"
228" (227.04")		24"	76"	42"	83 13/16"	N/A	17 1/2"	N/A	15 1/8"	N/A	23 3/16"	N/A	20 15/16"	77"	4	74"	4	38"	19"
234" (233.04")		24"	78"	42"	86 13/16"	N/A	17 1/2"	N/A	15 1/8"	N/A	23 3/16"	N/A	20 15/16"	80"	5	77"	4	39"	19 1/2"
240" (239.04")		24"	80"	42"	89 13/16"	N/A	17 1/2"	N/A	15 1/8"	N/A	23 3/16"	N/A	20 15/16"	83"	5	80"	5	40"	20"
246" (245.04")		24"	82"	42"	92 13/16"	N/A	17 1/2"	N/A	15 1/8"	N/A	23 3/16"	N/A	20 15/16"	86"	5	83"	5	41"	20 1/2"
252" (251.04")		24"	84"	42"	95 13/16"	N/A	17 1/2"	N/A	15 1/8"	N/A	23 3/16"	N/A	20 15/16"	89"	5	86"	5	42"	21"
258" (257.04")		24"	86"	42"	98 13/16"	N/A	17 1/2"	N/A	15 1/8"	N/A	23 3/16"	N/A	20 15/16"	92"	5	89"	5	43"	21 1/2"
264" (263.04")		24"	88"	42"	101 13/16"	N/A	17 1/2"	N/A	15 1/8"	N/A	23 3/16"	N/A	20 15/16"	92"	6	92"	5	44"	22"
270" (269.04")		24"	90"	42"	104 13/16"	N/A	17 1/2"	N/A	15 1/8"	N/A	23 3/16"	N/A	20 15/16"	98"	6	95"	6	45"	23 1/2"
54" (53.68")		186" (185.04")	27"	62"	48"	62 13/16"	N/A	20 1/2"	N/A	18 1/8"	N/A	23 3/16"	N/A	20 15/16"	56"	3	53"	3	31"
	192" (191.04")	27"	64"	48"	65 13/16"	N/A	20 1/2"	N/A	18 1/8"	N/A	23 3/16"	N/A	20 15/16"	59"	3	56"	3	32"	16"
	198" (197.04")	27"	66"	48"	68 13/16"	N/A	20 1/2"	N/A	18 1/8"	N/A	23 3/16"	N/A	20 15/16"	62"	3	59"	3	33"	16 1/2"
	204" (203.04")	27"	68"	48"	71 13/16"	N/A	20 1/2"	N/A	18 1/8"	N/A	23 3/16"	N/A	20 15/16"	65"	3	62"	3	34"	17"
	210" (219.04")	27"	70"	48"	74 13/16"	N/A	20 1/2"	N/A	18 1/8"	N/A	23 3/16"	N/A	20 15/16"	68"	4	65"	3	35"	17 1/2"
	216" (215.04")	27"	72"	48"	77 13/16"	N/A	20 1/2"	N/A	18 1/8"	N/A	23 3/16"	N/A	20 15/16"	71"	4	68"	4	36"	18"
	222" (221.04")	27"	74"	48"	80 13/16"	N/A	20 1/2"	N/A	18 1/8"	N/A	23 3/16"	N/A	20 15/16"	74"	4	71"	4	37"	18 1/2"
	228" (227.04")	27"	76"	48"	83 13/16"	N/A	20 1/2"	N/A	18 1/8"	N/A	23 3/16"	N/A	20 15/16"	77"	4	74"	4	38"	19"
	234" (233.04")	27"	78"	48"	86 13/16"	N/A	20 1/2"	N/A	18 1/8"	N/A	23 3/16"	N/A	20 15/16"	80"	5	77"	4	39"	19 1/2"
	240" (239.04")	27"	80"	48"	89 13/16"	N/A	20 1/2"	N/A	18 1/8"	N/A	23 3/16"	N/A	20 15/16"	83"	5	80"	5	40"	20"
	246" (245.04")	27"	82"	48"	92 13/16"	N/A	20 1/2"	N/A	18 1/8"	N/A	23 3/16"	N/A	20 15/16"	86"	5	83"	5	41"	20 1/2"
	252" (251.04")	27"	84"	48"	95 13/16"	N/A	20 1/2"	N/A	18 1/8"	N/A	23 3/16"	N/A	20 15/16"	89"	5	86"	5	42"	21"
	258" (257.04")	27"	86"	48"	98 13/16"	N/A	20 1/2"	N/A	18 1/8"	N/A	23 3/16"	N/A	20 15/16"	92"	5	89"	5	43"	21 1/2"
	264" (263.04")	27"	88"	48"	101 13/16"	N/A	20 1/2"	N/A	18 1/8"	N/A	23 3/16"	N/A	20 15/16"	92"	6	92"	5	44"	22"
	270" (269.04")	27"	90"	48"	104 13/16"	N/A	20 1/2"	N/A	18 1/8"	N/A	23 3/16"	N/A	20 15/16"	98"	6	95"	6	45"	23 1/2"
	60" (59.68")	186" (185.04")	30"	62"	54"	62 13/16"	N/A	23 1/2"	N/A	21 1/8"	N/A	23 3/16"	N/A	20 15/16"	56"	3	53"	3	31"
192" (191.04")		30"	64"	54"	65 13/16"	N/A	23 1/2"	N/A	21 1/8"	N/A	23 3/16"	N/A	20 15/16"	59"	3	56"	3	32"	16"
198" (197.04")		30"	66"	54"	68 13/16"	N/A	23 1/2"	N/A	21 1/8"	N/A	23 3/16"	N/A	20 15/16"	62"	3	59"	3	33"	16 1/2"
204" (203.04")		30"	68"	54"	71 13/16"	N/A	23 1/2"	N/A	21 1/8"	N/A	23 3/16"	N/A	20 15/16"	65"	3	62"	3	34"	17"
210" (219.04")		30"	70"	54"	74 13/16"	N/A	23 1/2"	N/A	21 1/8"	N/A	23 3/16"	N/A	20 15/16"	68"	4	65"	3	35"	17 1/2"
216" (215.04")		30"	72"	54"	77 13/16"	N/A	23 1/2"	N/A	21 1/8"	N/A	23 3/16"	N/A	20 15/16"	71"	4	68"	4	36"	18"
222" (221.04")		30"	74"	54"	80 13/16"	N/A	23 1/2"	N/A	21 1/8"	N/A	23 3/16"	N/A	20 15/16"	74"	4	71"	4	37"	18 1/2"
228" (227.04")		30"	76"	54"	83 13/16"	N/A	23 1/2"	N/A	21 1/8"	N/A	23 3/16"	N/A	20 15/16"	77"	4	74"	4	38"	19"
234" (233.04")		30"	78"	54"	86 13/16"	N/A	23 1/2"	N/A	21 1/8"	N/A	23 3/16"	N/A	20 15/16"	80"	5	77"	4	39"	19 1/2"
240" (239.04")		30"	80"	54"	89 13/16"	N/A	23 1/2"	N/A	21 1/8"	N/A	23 3/16"	N/A	20 15/16"	83"	5	80"	5	40"	20"
246" (245.04")		30"	82"	54"	92 13/16"	N/A	23 1/2"	N/A	21 1/8"	N/A	23 3/16"	N/A	20 15/16"	86"	5	83"	5	41"	20 1/2"
252" (251.04")		30"	84"	54"	95 13/16"	N/A	23 1/2"	N/A	21 1/8"	N/A	23 3/16"	N/A	20 15/16"	89"	5	86"	5	42"	21"
258" (257.04")		30"	86"	54"	98 13/16"	N/A	23 1/2"	N/A	21 1/8"	N/A	23 3/16"	N/A	20 15/16"	92"	5	89"	5	43"	21 1/2"
264" (263.04")		30"	88"	54"	101 13/16"	N/A	23 1/2"	N/A	21 1/8"	N/A	23 3/16"	N/A	20 15/16"	92"	6	92"	5	44"	22"
270" (269.04")		30"	90"	54"	104 13/16"	N/A	23 1/2"	N/A	21 1/8"	N/A	23 3/16"	N/A	20 15/16"	98"	6	95"	6	45"	23 1/2"

Product Details – Planes Height Adjustable Tables

Conference Table Tops for use with Column Base (3-Piece Tops)

Table Sizes and Seating Capacities

Rectangle Top

- 186"-270" wide requires (3) separately specified Column Bases.

Rectangle Top

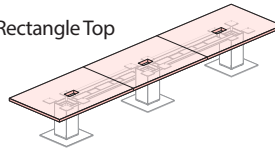

		WIDTHS							
		186" Wide	192" Wide	198" Wide	204" Wide	210" Wide	216" Wide	222" Wide	228" Wide
DEPTHS	42" Deep	14 Chairs Maximum (3 Columns)	16 Chairs Maximum (3 Columns)	16 Chairs Maximum (3 Columns)	16 Chairs Maximum (3 Columns)	16 Chairs Maximum (3 Columns)	18 Chairs Maximum (3 Columns)	18 Chairs Maximum (3 Columns)	18 Chairs Maximum (3 Columns)
	48" Deep	14 Chairs Maximum (3 Columns)	16 Chairs Maximum (3 Columns)	16 Chairs Maximum (3 Columns)	16 Chairs Maximum (3 Columns)	16 Chairs Maximum (3 Columns)	18 Chairs Maximum (3 Columns)	18 Chairs Maximum (3 Columns)	18 Chairs Maximum (3 Columns)
	54" Deep	16 Chairs Maximum (3 Columns)	18 Chairs Maximum (3 Columns)	18 Chairs Maximum (3 Columns)	18 Chairs Maximum (3 Columns)	18 Chairs Maximum (3 Columns)	20 Chairs Maximum (3 Columns)	20 Chairs Maximum (3 Columns)	20 Chairs Maximum (3 Columns)
	60" Deep	16 Chairs Maximum (3 Columns)	18 Chairs Maximum (3 Columns)	18 Chairs Maximum (3 Columns)	18 Chairs Maximum (3 Columns)	18 Chairs Maximum (3 Columns)	20 Chairs Maximum (3 Columns)	20 Chairs Maximum (3 Columns)	20 Chairs Maximum (3 Columns)

		WIDTHS						
		234" Wide	240" Wide	246" Wide	252" Wide	258" Wide	264" Wide	270" Wide
DEPTHS	42" Deep	18 Chairs Maximum (3 Columns)	18 Chairs Maximum (3 Columns)	20 Chairs Maximum (3 Columns)	20 Chairs Maximum (3 Columns)	20 Chairs Maximum (3 Columns)	20 Chairs Maximum (3 Columns)	22 Chairs Maximum (3 Columns)
	48" Deep	18 Chairs Maximum (3 Columns)	18 Chairs Maximum (3 Columns)	20 Chairs Maximum (3 Columns)	20 Chairs Maximum (3 Columns)	20 Chairs Maximum (3 Columns)	20 Chairs Maximum (3 Columns)	22 Chairs Maximum (3 Columns)
	54" Deep	20 Chairs Maximum (3 Columns)	20 Chairs Maximum (3 Columns)	22 Chairs Maximum (3 Columns)	22 Chairs Maximum (3 Columns)	22 Chairs Maximum (3 Columns)	22 Chairs Maximum (3 Columns)	24 Chairs Maximum (3 Columns)
	60" Deep	20 Chairs Maximum (3 Columns)	20 Chairs Maximum (3 Columns)	22 Chairs Maximum (3 Columns)	22 Chairs Maximum (3 Columns)	22 Chairs Maximum (3 Columns)	22 Chairs Maximum (3 Columns)	24 Chairs Maximum (3 Columns)

Note Recommended seating capacity based upon a width of 27" per chair.

Product Details – Planes Height Adjustable Tables

Conference Table Tops for use with Column Base (3-Piece Tops)

Table Sizes and Seating Capacities

Pebble Top

- 186"-270" wide requires (3) separately specified Column Bases.

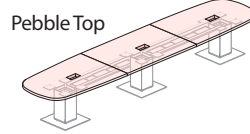

		WIDTHS							
		186" Wide	192" Wide	198" Wide	204" Wide	210" Wide	216" Wide	222" Wide	228" Wide
DEPTHS	42" Deep	14 Chairs Maximum (3 Columns)	16 Chairs Maximum (3 Columns)	16 Chairs Maximum (3 Columns)	16 Chairs Maximum (3 Columns)	16 Chairs Maximum (3 Columns)	18 Chairs Maximum (3 Columns)	18 Chairs Maximum (3 Columns)	18 Chairs Maximum (3 Columns)
	48" Deep	14 Chairs Maximum (3 Columns)	16 Chairs Maximum (3 Columns)	16 Chairs Maximum (3 Columns)	16 Chairs Maximum (3 Columns)	16 Chairs Maximum (3 Columns)	18 Chairs Maximum (3 Columns)	18 Chairs Maximum (3 Columns)	18 Chairs Maximum (3 Columns)
	54" Deep	14 Chairs Maximum (3 Columns)	16 Chairs Maximum (3 Columns)	16 Chairs Maximum (3 Columns)	16 Chairs Maximum (3 Columns)	16 Chairs Maximum (3 Columns)	18 Chairs Maximum (3 Columns)	18 Chairs Maximum (3 Columns)	18 Chairs Maximum (3 Columns)
	60" Deep	16 Chairs Maximum (3 Columns)	18 Chairs Maximum (3 Columns)	18 Chairs Maximum (3 Columns)	18 Chairs Maximum (3 Columns)	18 Chairs Maximum (3 Columns)	20 Chairs Maximum (3 Columns)	20 Chairs Maximum (3 Columns)	20 Chairs Maximum (3 Columns)

		WIDTHS						
		234" Wide	240" Wide	246" Wide	252" Wide	258" Wide	264" Wide	270" Wide
DEPTHS	42" Deep	18 Chairs Maximum (3 Columns)	18 Chairs Maximum (3 Columns)	20 Chairs Maximum (3 Columns)	20 Chairs Maximum (3 Columns)	20 Chairs Maximum (3 Columns)	20 Chairs Maximum (3 Columns)	22 Chairs Maximum (3 Columns)
	48" Deep	18 Chairs Maximum (3 Columns)	18 Chairs Maximum (3 Columns)	20 Chairs Maximum (3 Columns)	20 Chairs Maximum (3 Columns)	20 Chairs Maximum (3 Columns)	20 Chairs Maximum (3 Columns)	22 Chairs Maximum (3 Columns)
	54" Deep	18 Chairs Maximum (3 Columns)	18 Chairs Maximum (3 Columns)	20 Chairs Maximum (3 Columns)	20 Chairs Maximum (3 Columns)	20 Chairs Maximum (3 Columns)	20 Chairs Maximum (3 Columns)	22 Chairs Maximum (3 Columns)
	60" Deep	20 Chairs Maximum (3 Columns)	20 Chairs Maximum (3 Columns)	22 Chairs Maximum (3 Columns)	22 Chairs Maximum (3 Columns)	22 Chairs Maximum (3 Columns)	22 Chairs Maximum (3 Columns)	24 Chairs Maximum (3 Columns)

Note Recommended seating capacity based upon a width of 27" per chair.

Product Details – Planes Height Adjustable Tables

Conference Table Tops for use with Column Base (3-Piece Tops)

Table Sizes and Seating Capacities

Hexagon Top

- 186"-270" wide requires (3) separately specified Column Bases.

Hexagon Top

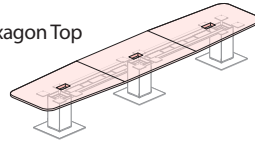

		WIDTHS							
		186" Wide	192" Wide	198" Wide	204" Wide	210" Wide	216" Wide	222" Wide	228" Wide
DEPTHS	42" Deep	14 Chairs Maximum (3 Columns)	16 Chairs Maximum (3 Columns)	16 Chairs Maximum (3 Columns)	16 Chairs Maximum (3 Columns)	16 Chairs Maximum (3 Columns)	18 Chairs Maximum (3 Columns)	18 Chairs Maximum (3 Columns)	18 Chairs Maximum (3 Columns)
	48" Deep	14 Chairs Maximum (3 Columns)	16 Chairs Maximum (3 Columns)	16 Chairs Maximum (3 Columns)	16 Chairs Maximum (3 Columns)	16 Chairs Maximum (3 Columns)	18 Chairs Maximum (3 Columns)	18 Chairs Maximum (3 Columns)	18 Chairs Maximum (3 Columns)
	54" Deep	14 Chairs Maximum (3 Columns)	16 Chairs Maximum (3 Columns)	16 Chairs Maximum (3 Columns)	16 Chairs Maximum (3 Columns)	16 Chairs Maximum (3 Columns)	18 Chairs Maximum (3 Columns)	18 Chairs Maximum (3 Columns)	18 Chairs Maximum (3 Columns)
	60" Deep	16 Chairs Maximum (3 Columns)	18 Chairs Maximum (3 Columns)	18 Chairs Maximum (3 Columns)	18 Chairs Maximum (3 Columns)	18 Chairs Maximum (3 Columns)	20 Chairs Maximum (3 Columns)	20 Chairs Maximum (3 Columns)	20 Chairs Maximum (3 Columns)

		WIDTHS						
		234" Wide	240" Wide	246" Wide	252" Wide	258" Wide	264" Wide	270" Wide
DEPTHS	42" Deep	18 Chairs Maximum (3 Columns)	18 Chairs Maximum (3 Columns)	20 Chairs Maximum (3 Columns)	20 Chairs Maximum (3 Columns)	20 Chairs Maximum (3 Columns)	20 Chairs Maximum (3 Columns)	22 Chairs Maximum (3 Columns)
	48" Deep	18 Chairs Maximum (3 Columns)	18 Chairs Maximum (3 Columns)	20 Chairs Maximum (3 Columns)	20 Chairs Maximum (3 Columns)	20 Chairs Maximum (3 Columns)	20 Chairs Maximum (3 Columns)	22 Chairs Maximum (3 Columns)
	54" Deep	18 Chairs Maximum (3 Columns)	18 Chairs Maximum (3 Columns)	20 Chairs Maximum (3 Columns)	20 Chairs Maximum (3 Columns)	20 Chairs Maximum (3 Columns)	20 Chairs Maximum (3 Columns)	22 Chairs Maximum (3 Columns)
	60" Deep	20 Chairs Maximum (3 Columns)	20 Chairs Maximum (3 Columns)	22 Chairs Maximum (3 Columns)	22 Chairs Maximum (3 Columns)	22 Chairs Maximum (3 Columns)	22 Chairs Maximum (3 Columns)	24 Chairs Maximum (3 Columns)

Note Recommended seating capacity based upon a width of 27" per chair.

Product Details – Planes Conference Tables

Conference Table Tops for use with Column Base (3-Piece Tops)

Floor Support Requirements for Rectangle, Pebble and Hexagon Tops

- 3-Piece Rectangle, Pebble and Hexagon Tops require a separately specified J Channel and Column Bases.
- 186"-270" wide 3-Piece Tops require (3) separately specified Column Bases.
- A Column Base is comprised of a separately specified Column Frame, Column Base Plate and Cladding.

Column Frame with Square Column Base Plate Specification Matrix

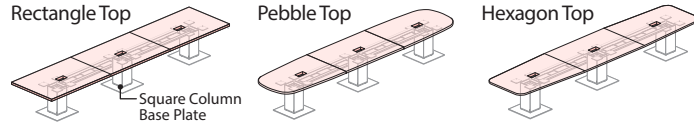

TABLE TOP DEPTH (Rectangle, Pebble or Hexagon)	COLUMN FRAME/COLUMN BASE SIZE COMBINATIONS				
	9" x 9" Column Frame		12" x 12" Column Frame		
	21" Square Base Plate	24" Square Base Plate	24" Square Base Plate	27" Square Base Plate	30" Square Base Plate
	⊘ Don't				
42" Deep Tops	⊘ Don't				
48" Deep Tops	⊘ Don't	⊘ Don't	⊘ Don't		
54" Deep Tops	⊘ Don't	⊘ Don't	⊘ Don't		
60" Deep Tops	⊘ Don't	⊘ Don't	⊘ Don't		

Column Frame with Round Column Base Plate Specification Matrix

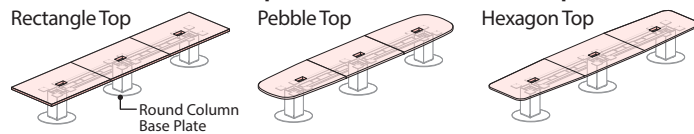

TABLE TOP DEPTH (Rectangle, Pebble or Hexagon)	COLUMN FRAME/COLUMN BASE SIZE COMBINATIONS				
	9" x 9" Column Frame		12" x 12" Column Frame		
	21" Round Base Plate	24" Round Base Plate	24" Round Base Plate	27" Round Base Plate	30" Round Base Plate
	⊘ Don't				
42" Deep Tops	⊘ Don't				
48" Deep Tops	⊘ Don't	⊘ Don't	⊘ Don't		
54" Deep Tops	⊘ Don't	⊘ Don't	⊘ Don't		
60" Deep Tops	⊘ Don't	⊘ Don't	⊘ Don't		

Note • Double-Sided Flip Top Units cannot be placed over the 9" Column Frame.

Product Details – Planes Conference Tables

End Supported Tops (for use with Column Base)

D-Shape Top

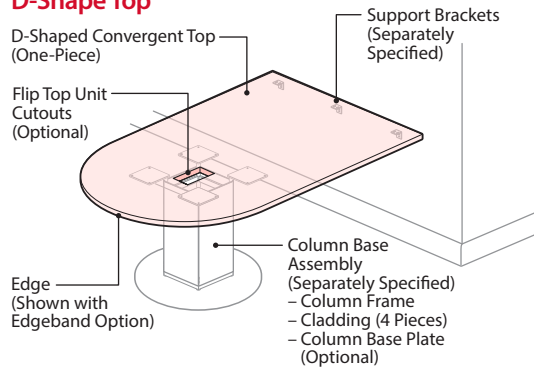

Rectangle Conference Top

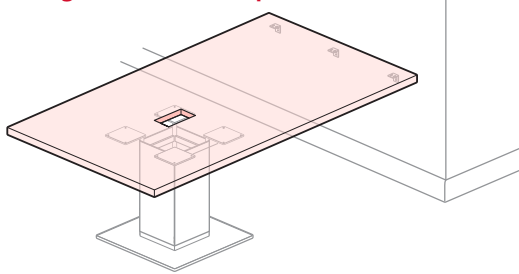

Key Conference Top

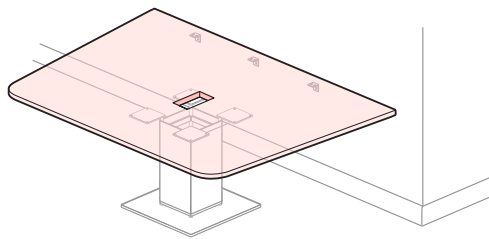

Separately Specified Components

- End Supported Tops require a separately specified Column Base on user end and support brackets for wall mounted end.

Column Base

- A Column Base is comprised of a separately specified Column Frame and Cladding. Optional Column Base Plate may also be specified.
- Column Frames are available with 20", 28" and 40" heights.

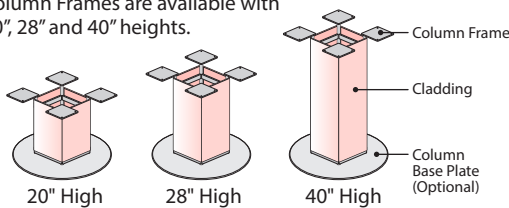

Support Brackets

- Support brackets for attachment to the building wall or support brackets for Enclose or Compose.

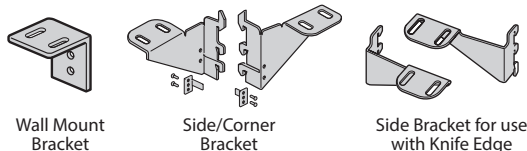

Component Materials/Finishes

COMPONENT NAME	MATERIALS/ FINISHES
End Supported Top – D-Shape, Rectangle, Key	Laminate Top – Specified top color and specified edge trim color • Edge Options: (J) Edgeband, (F) Knife • 1mm edgeband on wall mounted edge.
	Wood Top – Specified top and edge trim wood finish color • Edge Options: (K) Edgeband, (U) Knife • 1mm edgeband on wall mounted edge.

Edge Options for Laminate Tops

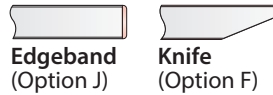

Edge Options for Wood Tops

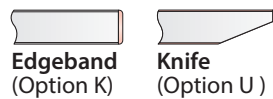

Note The specified edge option is applied only to the user edges, the wall mounted edge is standard with 1mm Edgeband.

Flip Top Unit Cutout Options

Center Cutout Option

- Includes 1 Flip Top Unit Cutout (centered on top)

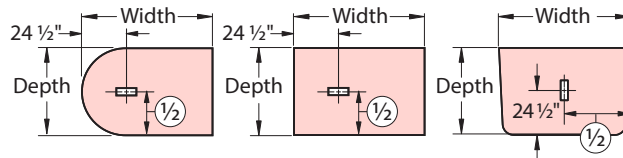

Flip Top Unit Cutout Dimensions

Cutout Option (F)

For use with Single Sided/ 4 Port Flip Top Unit (Centered)

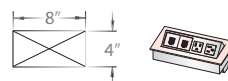

Cutout Option (J)

For use with Single Sided/ 6 Ports Flip Top Unit (Centered)

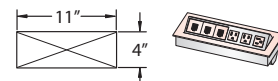

Cutout Option (M)

For use with Double Sided/ 8 Ports Flip Top Unit (Centered)

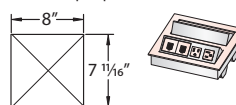

Cutout Option (Q)

For use with Double Sided/ 12 Ports Flip Top Unit (Centered)

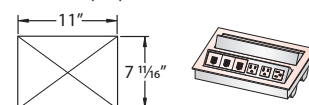

workware Interface Module Cutout Dimensions

Cutout Option (D)

For use with workware 4 Port Narrow Non-Switching Interface Module (Centered)

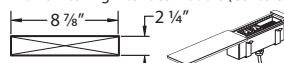

Cutout Option (W)

For use with workware 4 Port Wide Non-Switching Interface Module (Centered)

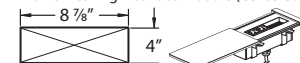

Cutout Option (C)

- workware 6 Port Narrow Non-Switching Interface Module (Centered)
- workware 4 Port Narrow Switching Interface Module (Centered)

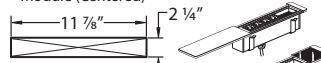

Cutout Option (H)

- workware 6 Port Wide Non-Switching Interface Module (Centered)
- workware 4 Port Wide Switching Interface Module (Centered)

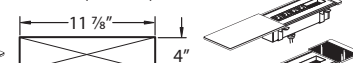

Cutout Option (E)

For use with workware 6 Port Narrow Switching Interface Module (Centered)

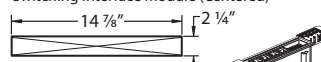

Cutout Option (L)

For use with workware 6 Port Wide Switching Interface Module (Centered)

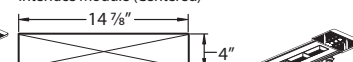

Note Flip Top Units and Interface Modules are all separately specified.

Product Details – Planes Conference Tables

End Supported Tops (for use with Column Base)

Dimensions

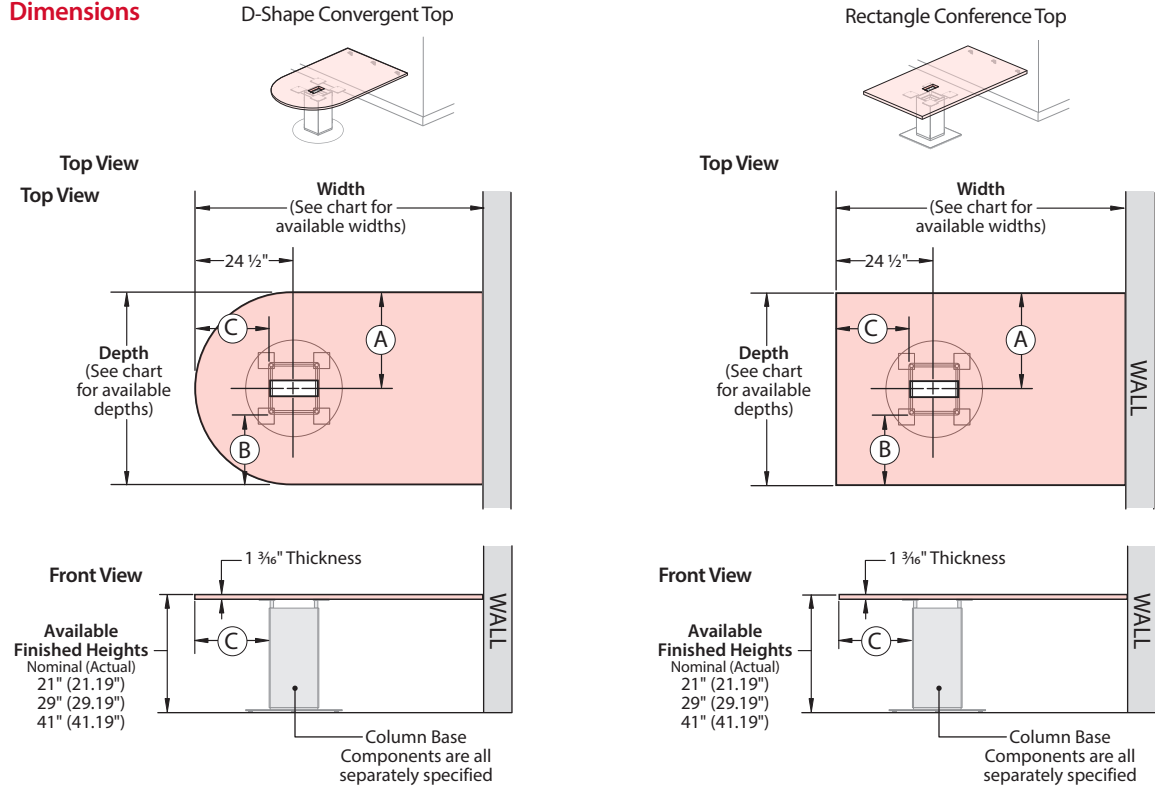

Dimensions

TABLE TOP			KNEESPACE							
Depth Nominal (Actual)	Width Nominal (Actual)	A	B				C			
			Flat Cladding		Round Cladding		Flat Cladding		Round Cladding	
			9" x 9" Column Frames	12" x 12" Column Frames	9" x 9" Column Frames	12" x 12" Column Frames	9" x 9" Column Frames	12" x 12" Column Frames	9" x 9" Column Frames	12" x 12" Column Frames
36" (35.68") (Only available with the Rectangle Top)	48" (47.68")	18"	13"	11 1/2"	11 1/4"	9 1/8"	19 5/8"	18 1/8"	17.91"	15.77"
	54" (53.68")	18"	13"	11 1/2"	11 1/4"	9 1/8"	19 5/8"	18 1/8"	17.91"	15.77"
	60" (59.68")	18"	13"	11 1/2"	11 1/4"	9 1/8"	19 5/8"	18 1/8"	17.91"	15.77"
	66" (65.68")	18"	13"	11 1/2"	11 1/4"	9 1/8"	19 5/8"	18 1/8"	17.91"	15.77"
	72" (71.68")	18"	13"	11 1/2"	11 1/4"	9 1/8"	19 5/8"	18 1/8"	17.91"	15.77"
42" (41.68")	48" (47.68")	21"	16"	14 1/2"	14 1/4"	12 1/8"	19 5/8"	18 1/8"	17.91"	15.77"
	54" (53.68")	21"	16"	14 1/2"	14 1/4"	12 1/8"	19 5/8"	18 1/8"	17.91"	15.77"
	60" (59.68")	21"	16"	14 1/2"	14 1/4"	12 1/8"	19 5/8"	18 1/8"	17.91"	15.77"
	66" (65.68")	21"	16"	14 1/2"	14 1/4"	12 1/8"	19 5/8"	18 1/8"	17.91"	15.77"
	72" (71.68")	21"	16"	14 1/2"	14 1/4"	12 1/8"	19 5/8"	18 1/8"	17.91"	15.77"
48" (47.68")	48" (47.68")	24"	N/A	17 1/2"	N/A	15 1/8"	N/A	18 1/8"	N/A	15.77"
	54" (53.68")	24"	N/A	17 1/2"	N/A	15 1/8"	N/A	18 1/8"	N/A	15.77"
	60" (59.68")	24"	N/A	17 1/2"	N/A	15 1/8"	N/A	18 1/8"	N/A	15.77"
	66" (65.68")	24"	N/A	17 1/2"	N/A	15 1/8"	N/A	18 1/8"	N/A	15.77"
	72" (71.68")	24"	N/A	17 1/2"	N/A	15 1/8"	N/A	18 1/8"	N/A	15.77"
54" (53.68")	54" (53.68")	27"	N/A	20 1/2"	N/A	18 1/8"	N/A	18 1/8"	N/A	15.77"
	60" (59.68")	27"	N/A	20 1/2"	N/A	18 1/8"	N/A	18 1/8"	N/A	15.77"
	66" (65.68")	27"	N/A	20 1/2"	N/A	18 1/8"	N/A	18 1/8"	N/A	15.77"
	72" (71.68")	27"	N/A	20 1/2"	N/A	18 1/8"	N/A	18 1/8"	N/A	15.77"
60" (59.68")	60" (59.68")	30"	N/A	23 1/2"	N/A	21 1/8"	N/A	18 1/8"	N/A	15.77"
	66" (65.68")	30"	N/A	23 1/2"	N/A	21 1/8"	N/A	18 1/8"	N/A	15.77"
	72" (71.68")	30"	N/A	23 1/2"	N/A	21 1/8"	N/A	18 1/8"	N/A	15.77"
	78" (77.68")	30"	N/A	23 1/2"	N/A	21 1/8"	N/A	18 1/8"	N/A	15.77"
	84" (83.68")	30"	N/A	23 1/2"	N/A	21 1/8"	N/A	18 1/8"	N/A	15.77"

Product Details – Planes Conference Tables

End Supported Tops (for use with Column Base)

Dimensions

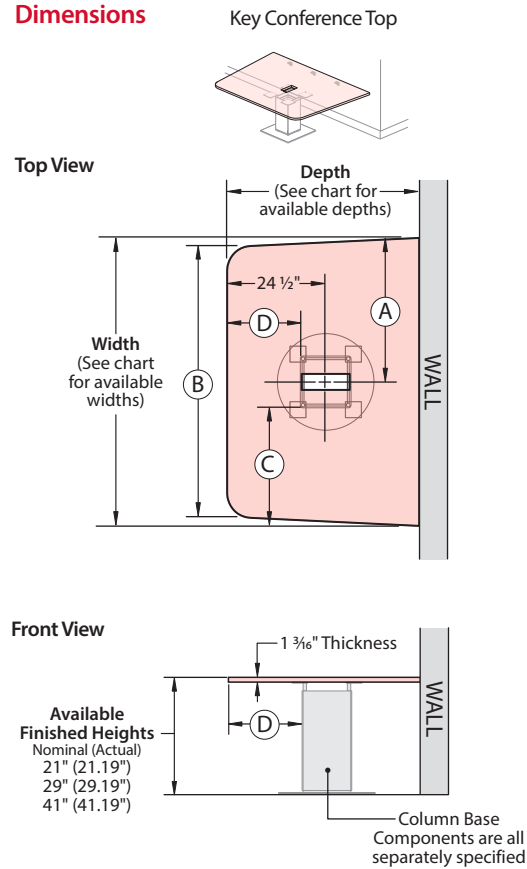

Dimensions

TABLE TOP				KNEESPACE							
Depth Nominal (Actual)	Width Nominal (Actual)	A	B	C				D			
				Flat Cladding		Round Cladding		Flat Cladding		Round Cladding	
				9" x 9" Column Frames	12" x 12" Column Frames	9" x 9" Column Frames	12" x 12" Column Frames	9" x 9" Column Frames	12" x 12" Column Frames	9" x 9" Column Frames	12" x 12" Column Frames
42" (41.68")	42" (41.68")	21"	38"	15.97"	14.47"	16.25"	12.11"	19.63"	18.13"	17.91"	15.77"
	48" (47.68")	21"	38"	18.97"	17.47"	19.25"	15.11"	19.63"	18.13"	17.91"	15.77"
	54" (53.68")	21"	38"	21.97"	20.47"	20.25"	18.11"	19.63"	18.13"	17.91"	15.77"
	60" (59.68")	21"	38"	24.97"	23.47"	23.25"	21.11"	19.63"	18.13"	17.91"	15.77"
48" (47.68")	48" (47.68")	24"	44"	N/A	17.47"	N/A	15.11"	N/A	18.13"	N/A	15.77"
	54" (53.68")	24"	44"	N/A	20.47"	N/A	18.11"	N/A	18.13"	N/A	15.77"
	60" (59.68")	24"	44"	N/A	23.47"	N/A	21.11"	N/A	18.13"	N/A	15.77"
	66" (65.68")	24"	44"	N/A	26.47"	N/A	24.11"	N/A	18.13"	N/A	15.77"
54" (53.68")	72" (71.68")	24"	44"	N/A	29.47"	N/A	27.11"	N/A	18.13"	N/A	15.77"
	54" (53.68")	27"	50"	N/A	20.47"	N/A	18.11"	N/A	18.13"	N/A	15.77"
	60" (59.68")	27"	50"	N/A	23.47"	N/A	21.11"	N/A	18.13"	N/A	15.77"
	66" (65.68")	27"	50"	N/A	26.47"	N/A	24.11"	N/A	18.13"	N/A	15.77"
60" (59.68")	72" (71.68")	27"	50"	N/A	29.47"	N/A	27.11"	N/A	18.13"	N/A	15.77"
	60" (59.68")	30"	56"	N/A	23.47"	N/A	21.11"	N/A	18.13"	N/A	15.77"
	66" (65.68")	30"	56"	N/A	26.47"	N/A	24.11"	N/A	18.13"	N/A	15.77"
	72" (71.68")	30"	56"	N/A	29.47"	N/A	27.11"	N/A	18.13"	N/A	15.77"
60" (59.68")	78" (77.68")	30"	56"	N/A	32.47"	N/A	30.11"	N/A	18.13"	N/A	15.77"
	84" (83.68")	30"	56"	N/A	35.47"	N/A	33.11"	N/A	18.13"	N/A	15.77"

Product Details – Planes Conference Tables

End Supported Tops (for use with Column Base)

Table Sizes and Seating Capacities
D-Shape Convergent

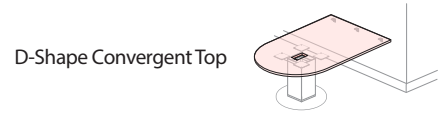

		WIDTHS						
		48" Wide	54" Wide	60" Wide	66" Wide	72" Wide	78" Wide	84" Wide
DEPTHS	42" Deep	4 Chairs Maximum	4 Chairs Maximum	5 Chairs Maximum	5 Chairs Maximum	6 Chairs Maximum	N/A	N/A
	48" Deep	4 Chairs Maximum	5 Chairs Maximum	5 Chairs Maximum	5 Chairs Maximum	6 Chairs Maximum	N/A	N/A
	54" Deep	N/A	5 Chairs Maximum	5 Chairs Maximum	6 Chairs Maximum	6 Chairs Maximum	N/A	N/A
	60" Deep	N/A	N/A	6 Chairs Maximum	6 Chairs Maximum	7 Chairs Maximum	7 Chairs Maximum	7 Chairs Maximum



Rectangle

		WIDTHS						
		48" Wide	54" Wide	60" Wide	66" Wide	72" Wide	78" Wide	84" Wide
DEPTHS	36" Deep	3 Chairs Maximum	5 Chairs Maximum	5 Chairs Maximum	5 Chairs Maximum	5 Chairs Maximum	N/A	N/A
	42" Deep	3 Chairs Maximum	5 Chairs Maximum	5 Chairs Maximum	5 Chairs Maximum	5 Chairs Maximum	N/A	N/A
	48" Deep	3 Chairs Maximum	5 Chairs Maximum	5 Chairs Maximum	5 Chairs Maximum	5 Chairs Maximum	N/A	N/A
	54" Deep	N/A	6 Chairs Maximum	6 Chairs Maximum	6 Chairs Maximum	6 Chairs Maximum	N/A	N/A
	60" Deep	N/A	N/A	6 Chairs Maximum	6 Chairs Maximum	6 Chairs Maximum	6 Chairs Maximum	8 Chairs Maximum

Note Recommended seating capacity based upon a width of 27" per chair.

Product Details – Planes Conference Tables

End Supported Tops (for use with Column Base)

Table Sizes and Seating Capacities

Key Conference Top

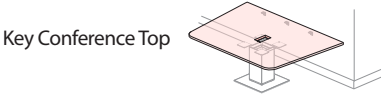

		WIDTHS							
		42" Wide	48" Wide	54" Wide	60" Wide	66" Wide	72" Wide	78" Wide	84" Wide
DEPTHS	42" Deep	 3 Chairs Maximum	 3 Chairs Maximum	 3 Chairs Maximum	 4 Chairs Maximum	N/A	N/A	N/A	N/A
	48" Deep	N/A	 3 Chairs Maximum	 3 Chairs Maximum	 4 Chairs Maximum	 4 Chairs Maximum	 4 Chairs Maximum	N/A	N/A
	54" Deep	N/A	N/A	 5 Chairs Maximum	 6 Chairs Maximum	 6 Chairs Maximum	 6 Chairs Maximum	N/A	N/A
	60" Deep	N/A	N/A	N/A	 6 Chairs Maximum	 6 Chairs Maximum	 6 Chairs Maximum	 6 Chairs Maximum	 7 Chairs Maximum

Note Recommended seating capacity based upon a width of 27" per chair.

Product Details – Planes Conference Tables

End Supported Tops (for use with Column Base)

Floor Support Requirements for End Supported Tops – Rectangle Conference End

- Requires one column base for floor support and brackets for attachment to a structural building wall, Compose or Enclose panel.
- Each Column Base requires separately specified components: Column Frame and Cladding (The Column Base Plate is optional).

Column Frame with Square Column Base Plate Specification Matrix

TABLE TOP DEPTH (Rectangle, Pebble or Hexagon)	COLUMN FRAME/COLUMN BASE PLATE SIZE COMBINATIONS				
	9" x 9" Column Frame		12" x 12" Column Frame		
	21" Square Base Plate	24" Square Base Plate	24" Square Base Plate	27" Square Base Plate	30" Square Base Plate
36" Deep Tops					
42" Deep Tops					
48" Deep Tops	⊘ Don't	⊘ Don't	⊘ Don't		
54" Deep Tops	⊘ Don't	⊘ Don't	⊘ Don't		
60" Deep Tops	⊘ Don't	⊘ Don't	⊘ Don't		

Rectangle Conference Top

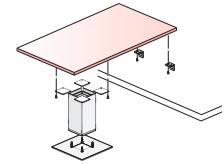

Square Column Base Plate (Optional)

Column Frame with Round Column Base Plate Specification Matrix

TABLE TOP DEPTH (Rectangle, Pebble or Hexagon)	COLUMN FRAME/COLUMN BASE PLATE SIZE COMBINATIONS				
	9" x 9" Column Frame		12" x 12" Column Frame		
	21" Round Base Plate	24" Round Base Plate	24" Round Base Plate	27" Round Base Plate	30" Round Base Plate
36" Deep Tops					
42" Deep Tops					
48" Deep Tops	⊘ Don't	⊘ Don't	⊘ Don't		
54" Deep Tops	⊘ Don't	⊘ Don't	⊘ Don't		
60" Deep Tops	⊘ Don't	⊘ Don't	⊘ Don't		

Rectangle Conference Top

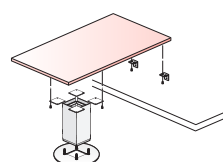

Round Column Base Plate (Optional)

- Note**
- J-Channel and J-Channel Tray are not required for End Supported Tops.
 - Double-Sided Flip Top Units cannot be placed over the 9" Column Frame.

Product Details – Planes Conference Tables

End Supported Tops (for use with Column Base)

Floor Support Requirements for End Supported Tops – D-Shape Convergent

- Requires one column base for floor support and brackets for attachment to a structural building wall, Compose or Enclose panel.
- Each Column Base requires separately specified components: Column Frame and Cladding (The Column Base Plate is optional).

Column Frame with Square Column Base Plate Specification Matrix

TABLE TOP DEPTH (Rectangle, Pebble or Hexagon)	COLUMN FRAME/COLUMN BASE PLATE SIZE COMBINATIONS				
	9" x 9" Column Frame		12" x 12" Column Frame		
	21" Square Base Plate	24" Square Base Plate	24" Square Base Plate	27" Square Base Plate	30" Square Base Plate
42" Deep Tops					
48" Deep Tops	⊘ Don't	⊘ Don't	⊘ Don't		
54" Deep Tops	⊘ Don't	⊘ Don't	⊘ Don't		
60" Deep Tops	⊘ Don't	⊘ Don't	⊘ Don't		

D-Shaped Convergent Top

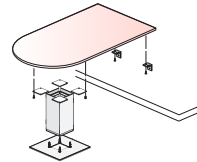

Square Column Base Plate (Optional)

Column Frame with Round Column Base Plate Specification Matrix

TABLE TOP DEPTH (Rectangle, Pebble or Hexagon)	COLUMN FRAME/COLUMN BASE PLATE SIZE COMBINATIONS				
	9" x 9" Column Frame		12" x 12" Column Frame		
	21" Round Base Plate	24" Round Base Plate	24" Round Base Plate	27" Round Base Plate	30" Round Base Plate
42" Deep Tops					
48" Deep Tops	⊘ Don't	⊘ Don't	⊘ Don't		
54" Deep Tops	⊘ Don't	⊘ Don't	⊘ Don't		
60" Deep Tops	⊘ Don't	⊘ Don't	⊘ Don't		

D-Shaped Convergent Top

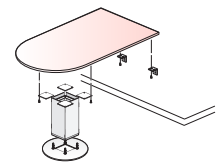

Round Column Base Plate (Optional)

- Note**
- J-Channel and J-Channel Tray are not required for an End Supported Tops.
 - Double-Sided Flip Top Units cannot be placed over the 9" Column Frame.















Product Details – Planes Conference Tables

End Supported Tops (for use with Column Base)

Floor Support Requirements for End Supported Tops – D-Shape Convergent

- End Supported Tops require one column base assembly for floor support and brackets for attachment to a structural building wall, Compose or Enclose panel.
- Each Column Base assembly requires separately specified components: Column Frame and Cladding (The Column Base Plate is optional).

Column Frame with Square Column Base Plate Specification Matrix





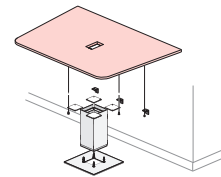









TABLE TOP DEPTH (Rectangle, Pebble or Hexagon)	COLUMN FRAME/COLUMN BASE PLATE SIZE COMBINATIONS				
	9" x 9" Column Frame		12" x 12" Column Frame		
	21" Square Base Plate	24" Square Base Plate	24" Square Base Plate	27" Square Base Plate	30" Square Base Plate
	⊘ Don't				
42" Deep Tops	⊘ Don't				
48" Deep Tops	⊘ Don't	⊘ Don't	⊘ Don't		
54" Deep Tops	⊘ Don't	⊘ Don't	⊘ Don't		
60" Deep Tops	⊘ Don't	⊘ Don't	⊘ Don't		

Key Conference Top



Square Column Base Plate (Optional)

Column Frame with Square Column Base Plate Specification Matrix

TABLE TOP DEPTH (Rectangle, Pebble or Hexagon)	COLUMN FRAME/COLUMN BASE PLATE SIZE COMBINATIONS				
	9" x 9" Column Frame		12" x 12" Column Frame		
	21" Round Base Plate	24" Round Base Plate	24" Round Base Plate	27" Round Base Plate	30" Round Base Plate
	⊘ Don't				
42" Deep Tops	⊘ Don't				
48" Deep Tops	⊘ Don't	⊘ Don't	⊘ Don't		
54" Deep Tops	⊘ Don't	⊘ Don't	⊘ Don't		
60" Deep Tops	⊘ Don't	⊘ Don't	⊘ Don't		

Key Conference Top

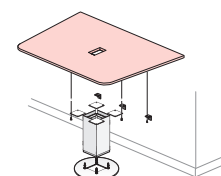

Round Column Base Plate (Optional)

- Note**
- J-Channel and J-Channel Tray are not required for an End Supported Tops.
 - Double-Sided Flip Top Units cannot be placed over the 9" Column Frame.

Product Details – Planes Conference Tables

Column Base – Column Frame

- A Column Base assembly is composed of a separately specified Column Frame, a Column Base Plate and Cladding. (Exception: the Column Base Plate is optional when used with the End Supported Top)
- The Column Frame includes a square shaped frame, glides and mounting hardware.
- Specify Cladding and Column Base Plate to match size of the column frame.
- The quantity and width of the Column Frame is dependent on the size of the top.

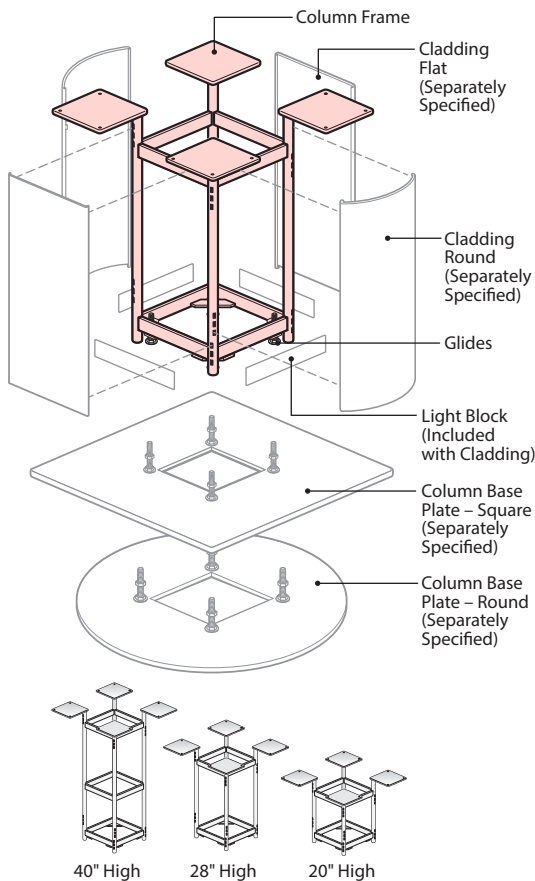

Component Materials/Finishes

COMPONENT NAME	MATERIALS/ FINISHES
Column Frame	Painted Metal – Standard in Black

Dimensions

Top View

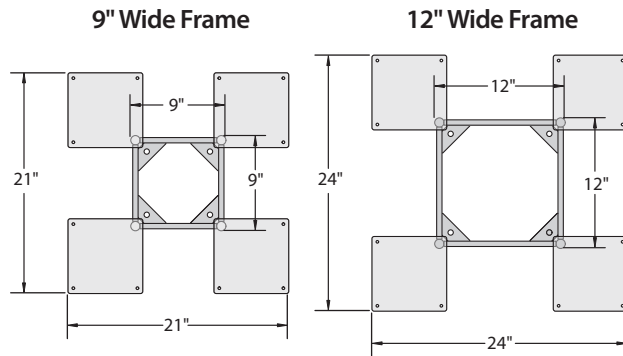

Front View

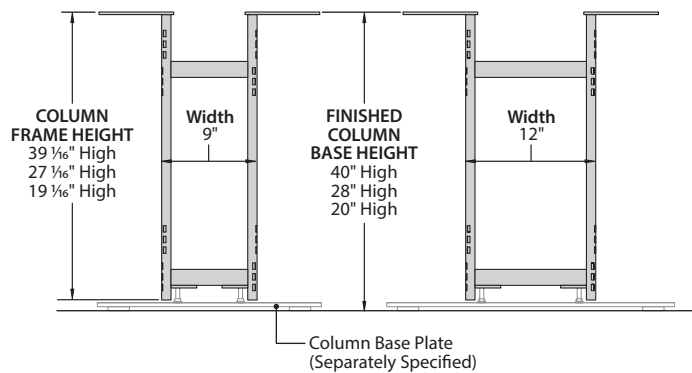

Note • Each Conference Table Top includes a Product Detail Page with Floor Support Requirements. Refer to these sections when specifying Column Base Frames to ensure proper floor support.

Column Frame Heights

- Column Frame is available in three heights: 40", 28" and 20" High.

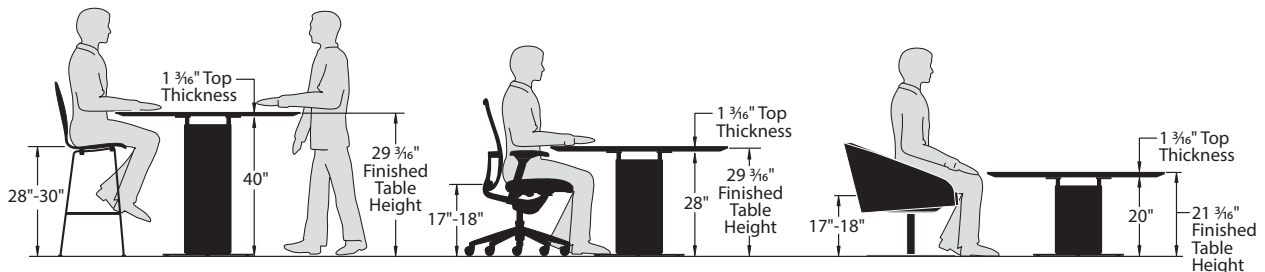

40" High Column Frame Height (Bar Height/Standing Height)

- The 41 3/8" high table top is for use with most bar height seating (28"-30" seat heights) or standing applications.

28" High Column Frame Height (Seated Height)

- The 21 3/8" high table top is for use with most standard seating (17"-18" seat heights).

20" High Column Frame Height (Lounge Height)

- The 21 3/8" high table top is for use with most lounge seating (17"-18" seat heights).

Product Details – Planes Conference Tables

Column Base – Cladding

A Column Base assembly is composed of a separately specified Column Frame, a Column Base Plate and Cladding. (Exception: the Column Base Plate is optional when used with the End Supported Top)

- Cladding includes one piece painted or wood veneer cladding and a light block.
- Attaches to Column Frame slots and is removable for easy access.
- Specify Cladding to match width and height of the Column Frame.

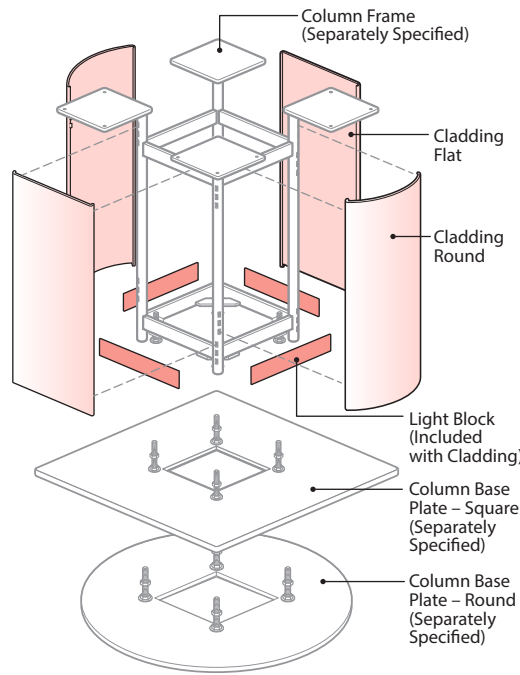

Cladding Applications

- Each Column Frame requires a quantity of four pieces of Cladding.
- Cladding can be flat, round or a combination of flat and round.

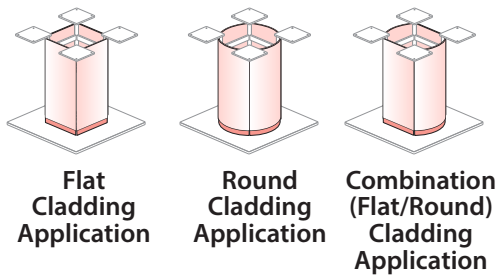

Component Materials/Finishes

COMPONENT NAME	MATERIALS/ FINISHES	
Cladding Flat or Round	Steel	Painted Finish – Select Surface Color
		Wood Veneer Finish– Select Wood Finish Color
Light Block	Plastic standard in black	

Dimensions

Top View

9" Wide Flat Cladding

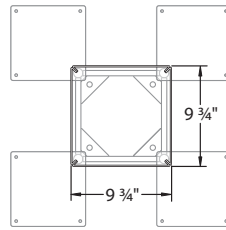

12" Wide Flat Cladding

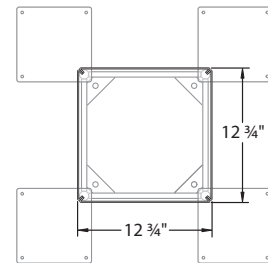

Front View

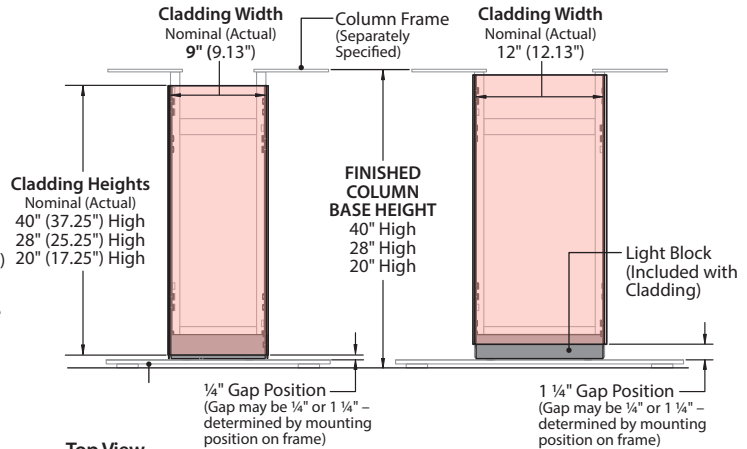

Top View

9" Wide Round Cladding

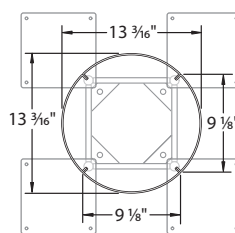

12" Wide Round Cladding

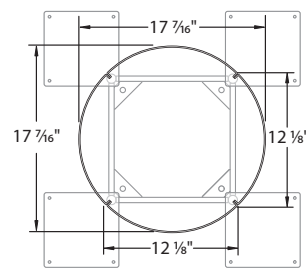

Front View

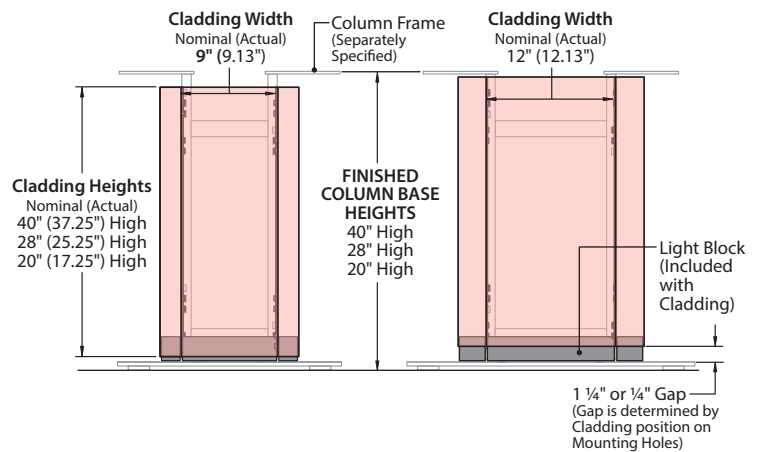

Product Details – Planes Conference Tables

Column Base – Plate

A Column Base assembly is composed of a separately specified Column Frame, a Column Base Plate and Cladding. (Exception: the Column Base Plate is optional when used with the End Supported Top)

- The Column Base Plate includes a $\frac{3}{8}$ " thick plate with attached glides and is available in a round or square shape.
- The column base plate levels by adjusting the attachment hardware; $\frac{3}{4}$ " adjustment range.
- Column Base Plate is required for Planes Conference Table Tops and is optional for End Supported Top.
- Specify Column Base Plate size to meet the floor support requirements required for each top.
- Specify Column Base Plate to match size of the 12" or 9" wide column frame.
 - A Column Base Plate with an 8" x 8" cutout accepts a 12" column frame.
 - A Column Base Plate with a 6" x 6" cutout accepts a 9" column frame.

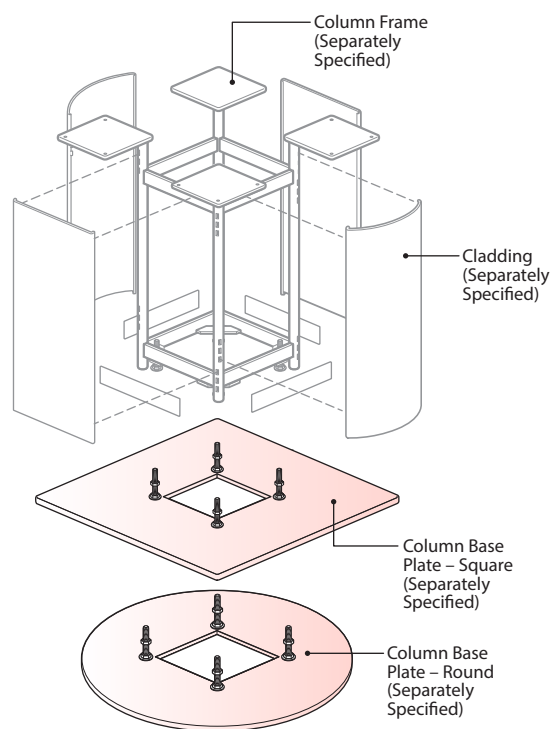

Note • Each Conference Table Top includes a Product Detail Page with Floor Support Requirements. Refer to these sections when specifying Column Base Plates to ensure proper floor support.

Component Materials/Finishes

COMPONENT NAME	MATERIALS/ FINISHES	
Column Base Plate	Steel	(A) Paint Finish – Select Paint Surface Color

Dimensions

Top View

Square – Column Base Plate

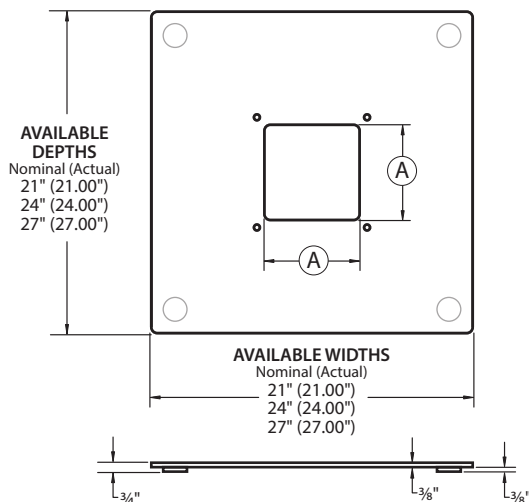

SQUARE PLATE		CUTOUT	COLUMN FRAME WIDTH
Depth Nominal (Actual)	Width Nominal (Actual)	(A)	Column Frame Width Requirement
21" (21.00")	21" (21.00")	6" Square Cutout	Requires 9" Wide Column Frame
24" (24.00")	24" (24.00")	6" Square Cutout	Requires 9" Wide Column Frame
		8" Square Cutout	Requires 12" Wide Column Frame
27" (27.00")	27" (27.00")	8" Square Cutout	Requires 12" Wide Column Frame

Round – Column Base Plate

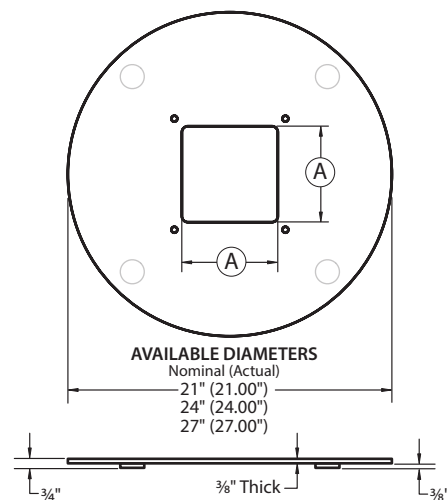

ROUND PLATE	CUTOUT	COLUMN FRAME WIDTH
Diameter (Round) Nominal (Actual)	(A)	Column Frame Size Requirements
21" (21.00")	6" Square Cutout	Requires 9" Wide Column Frame
24" (24.00")	6" Square Cutout	Requires 9" Wide Column Frame
	8" Square Cutout	Requires 12" Wide Column Frame
27" (27.00")	8" Square Cutout	Requires 12" Wide Column Frame
30" (30.00")	8" Square Cutout	Requires 12" Wide Column Frame

Product Details – Planes Conference Tables

Column Base – J-Channels

J-Channels come in pairs and are mounted between Column Bases to provide support under large Conference Table Tops.

- May be used with separately specified J-Channel Trays to provide wire management.
- The Conference Table Top width and the Column Frame size determines the needed J-Channel width. (See the Product Detail Pages for each top to determine proper J-Channel width requirements.)
- J-Channels are not for use with End-Supported Tops or tops supported by a single Column Base.

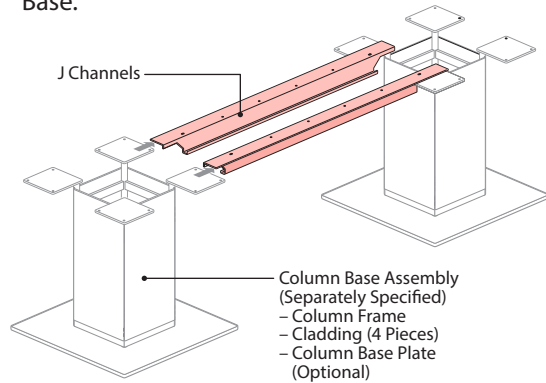

Component Materials/Finishes

COMPONENT NAME	MATERIALS/ FINISHES
Column Base Plate	Painted Steel – Standard in black finish.

Note • Each Conference Table Top includes a Product Detail Page which includes the required J-Channel Width for each specific Top. Refer to these sections to specify proper J-Channel width.

J-Channel – Conference Table Application

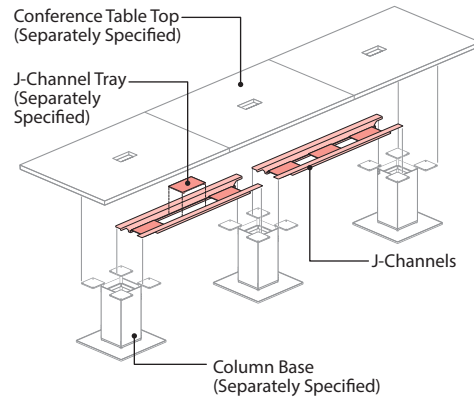

Dimensions

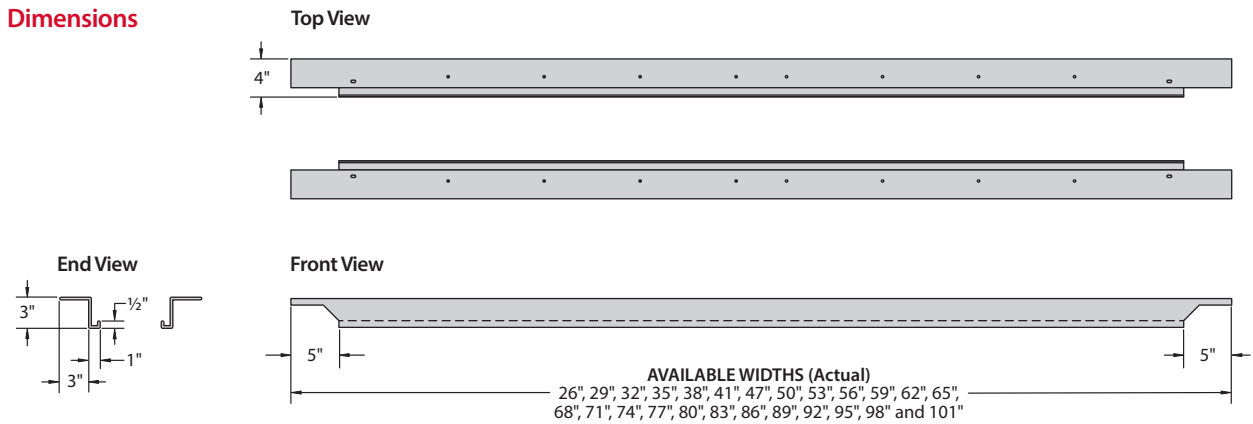

Column Base – J-Channel Tray

J-Channels Trays provides additional wire management between Column Bases; wires lay in J-Channels.

- Specify J-Channel Trays to match size of column frame width (12" or 9" wide).

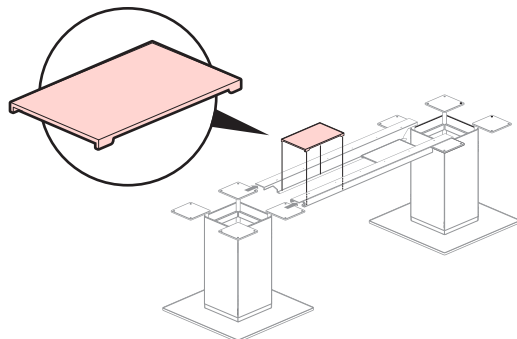

Component Materials/Finishes

COMPONENT NAME	MATERIALS/ FINISHES
J-Channel Tray	Painted Steel – Standard in black finish.

Note • Each Conference Table Top includes a Product Detail Page which includes the required J-Channel Width for each specific Top and quantity of J-Channel Trays needed. Refer to these sections to specify proper J-Channel Tray quantities.

Dimensions

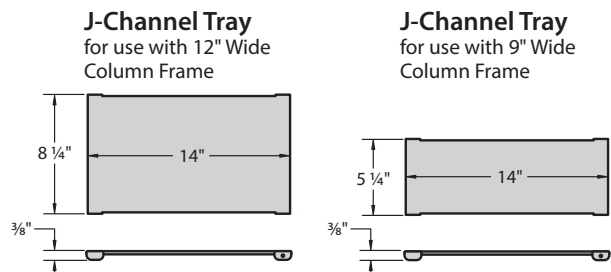

Product Details – Planes Conference Tables

Planes Carts – Overview

- The Planes Cart Collection is the perfect way to make your meeting area mobile with optional casters.
- The Cart collection can help with all of your media and catering needs.

Wood Grain Direction – Natural Veneer, Quarter Cut Veneer, Rift Cut Veneer and Wood Grain Laminate

Vertical Surfaces – Wood grain direction runs top-to-bottom on door fronts, back panels, side panels and most vertical surfaces.

Horizontal Surfaces – Wood grain direction runs side-to-side on tops, shelves and most horizontal surfaces.

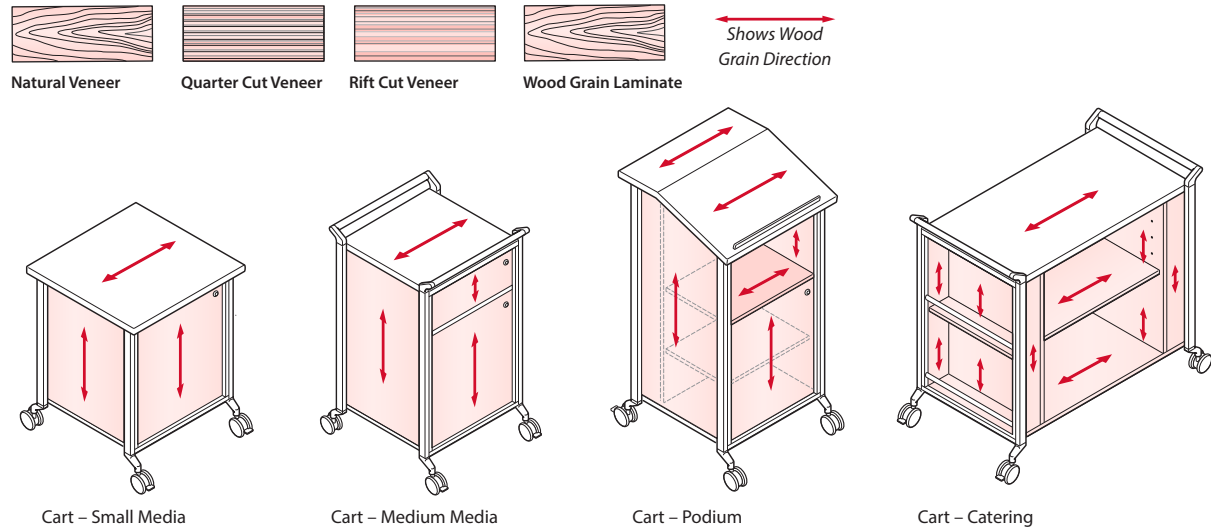

Note • Cart – Catering is only available with Laminate finish.

Wood Grain Direction – Double Cut Veneer

Vertical Surfaces – Wood grain direction runs side-to-side on door fronts, back panels, side panels and most vertical surfaces.

Horizontal Surfaces – Wood grain direction runs side-to-side on tops, shelves and most horizontal surfaces.

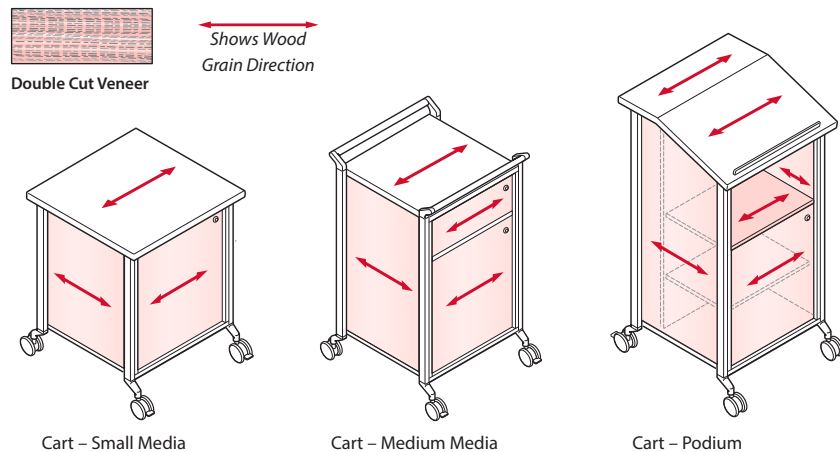

Product Details – Planes Conference Tables

Cart – Small Media

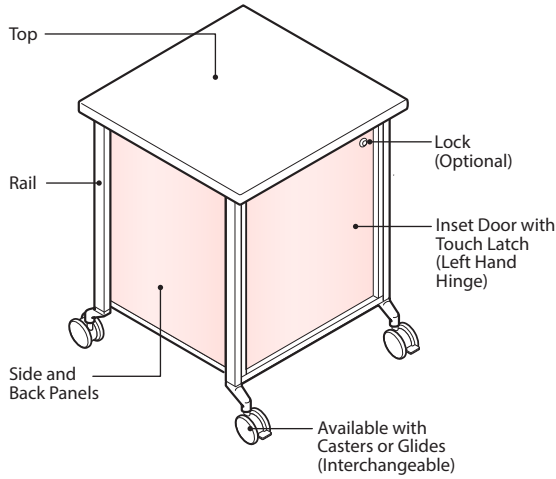

Component Materials/Finishes

COMPONENT NAME	MATERIALS/ FINISHES
Door, Top, Adjustable Shelf, Bottom, Sides, and Back Panels	Laminate – Specify surface color and separate edge color.
	Wood – Specify surface and edge wood finish color.
Rail	Painted Aluminum – Specify trim color
Casters (Optional)	(TR-F) Black hub with black tread
	(TR-7) Fog hub with graphite tread
	(TR-LPL) Light platinum hub with Graphite Tread
Glides (Optional)	(TR-F) Black Base Disk – Glide stem is painted to match base
	(TR-7) Fog Base Disk – Glide stem is painted to match base
	(TR-LPL) Light platinum Base Disk – Glide stem is painted to match base
Lock (Optional)	Available in Black or Chrome

Caster and Glide Options

- Optional casters or glides are field interchangeable.
- Casters include two locking and two non-locking.
- Heights are the same for Carts with Casters or Glides (Glides provide 1/2" of vertical adjustment for leveling).
- Casters/Glides Finish options:

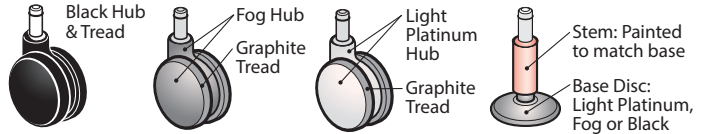

Cart Dimensions

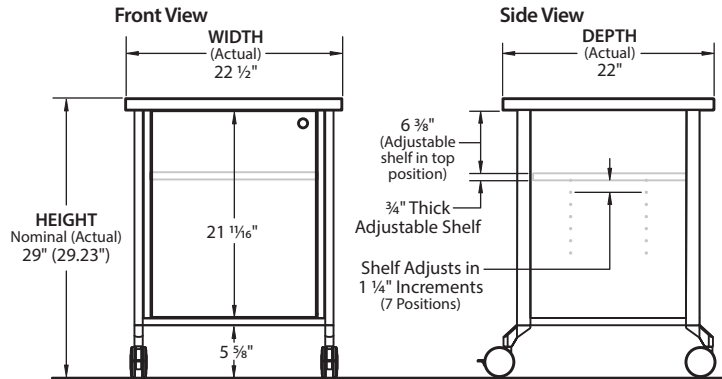

Interior Dimensions

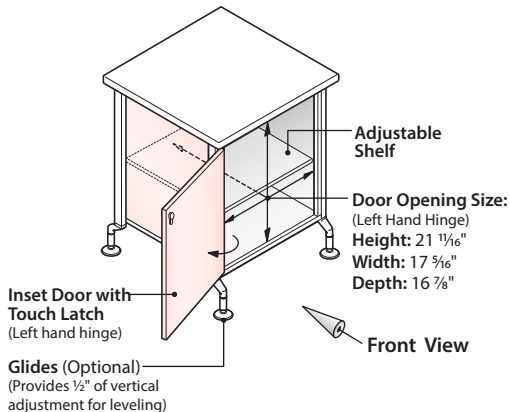

Product Details – Planes Conference Tables

Cart – Medium Media

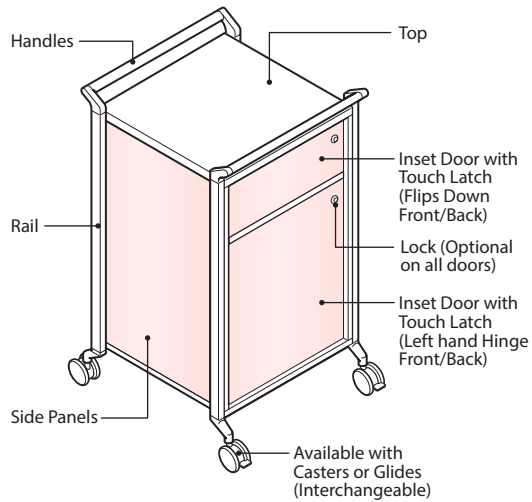

Component Materials/Finishes

COMPONENT NAME	MATERIALS/ FINISHES
Door, Top, Adjustable Shelf, Bottom, Sides, and Back Panels • Includes 1mm laminate or wood edgeband.	Laminate – Specify surface color and separate edge color.
	Wood – Specify surface and edge wood finish color.
Rails and Handles	Painted Aluminum – Specify trim color
Casters (Optional)	(TR-F) Black hub with black tread
	(TR-7) Fog hub with graphite tread
	(TR-LPL) Light platinum hub with Graphite Tread
Glides (Optional)	(TR-F) Black Base Disk – Glide stem is painted to match base
	(TR-7) Fog Base Disk – Glide stem is painted to match base
	(TR-LPL) Light platinum Base Disk – Glide stem is painted to match base
Lock (Optional on all Doors)	Available in Black or Chrome

Caster and Glide Options

- Optional casters or glides are field interchangeable.
- Casters include two locking and two non-locking.
- Heights are the same for Carts with Casters or Glides (Glides provide ½" of vertical adjustment for leveling).
- Casters/Glides Finish options:

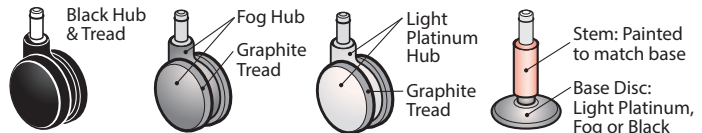

Interior Dimensions

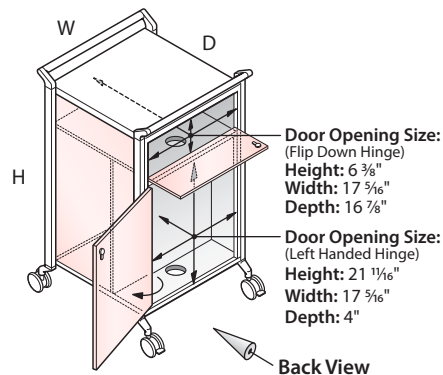
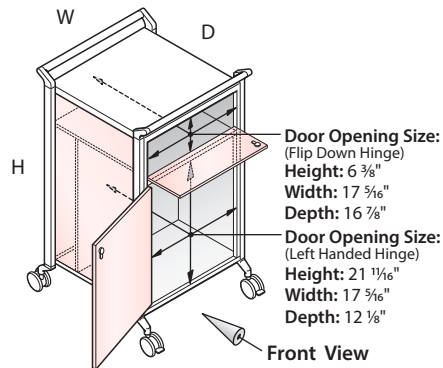

Dimensions

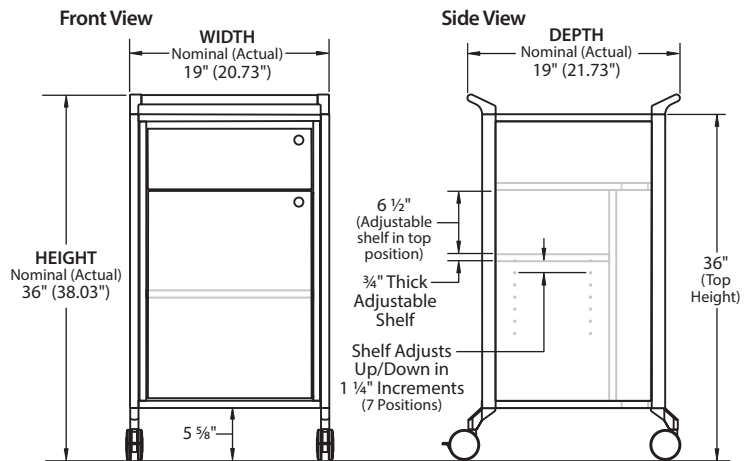
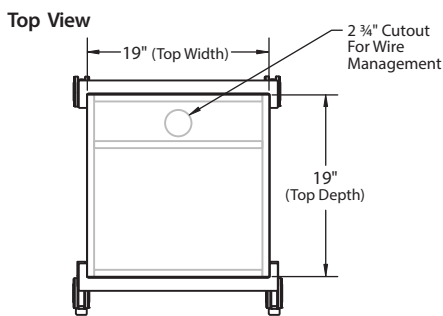

Product Details – Planes Conference Tables

Cart – Catering

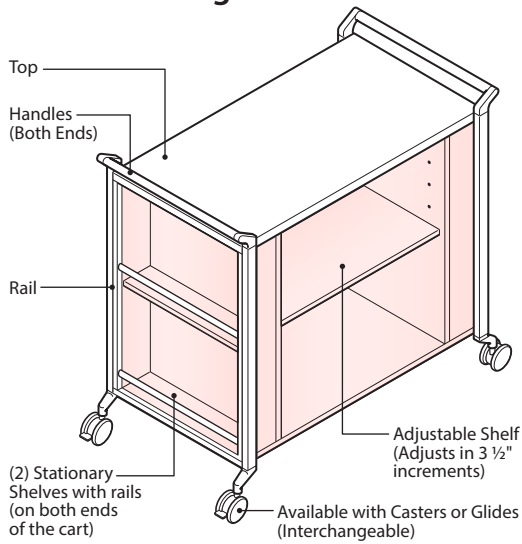

Component Materials/Finishes

COMPONENT NAME	MATERIALS/ FINISHES
Top, Shelves, Bottom, Sides and Back Panels • Includes 1mm laminate or edgeband.	Laminate – Specify surface color and separate edge color.
Rails and Handles	Painted Aluminum – Specify trim color.
Casters (Optional)	(TR-F) Black hub with black tread
	(TR-7) Fog hub with graphite tread
	(TR-LPL) Light platinum hub with Graphite Tread
Glides (Optional)	(TR-F) Black Base Disk – Glide stem is painted to match base
	(TR-7) Fog Base Disk – Glide stem is painted to match base
	(TR-LPL) Light platinum Base Disk – Glide stem is painted to match base

Caster and Glide Options

- Optional casters or glides are field interchangeable.
- Casters include two locking and two non-locking.
- Heights are the same for Carts with Casters or Glides (Glides provide 1/2" of vertical adjustment for leveling).
- Casters/Glides Finish options:

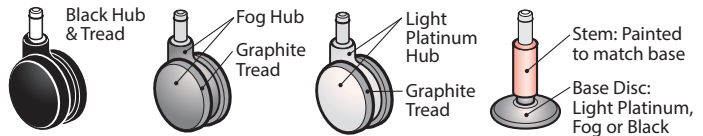

Interior Dimensions

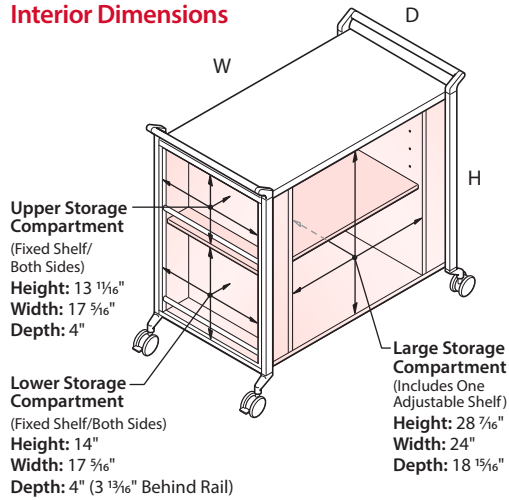

Dimensions

Top View

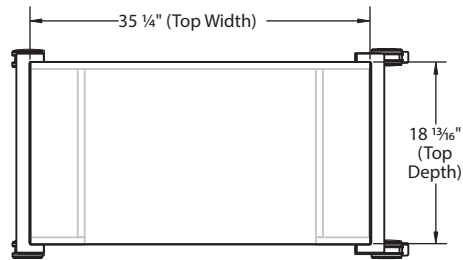

Front View

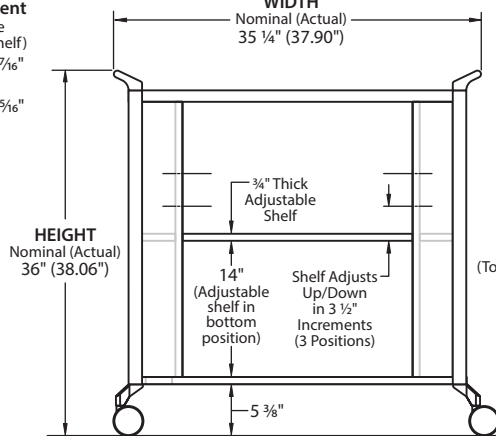

Side View

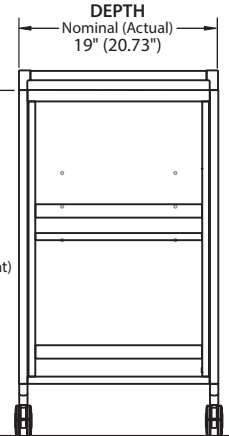

Product Details – Planes Conference Tables

Cart – Podium

User Side

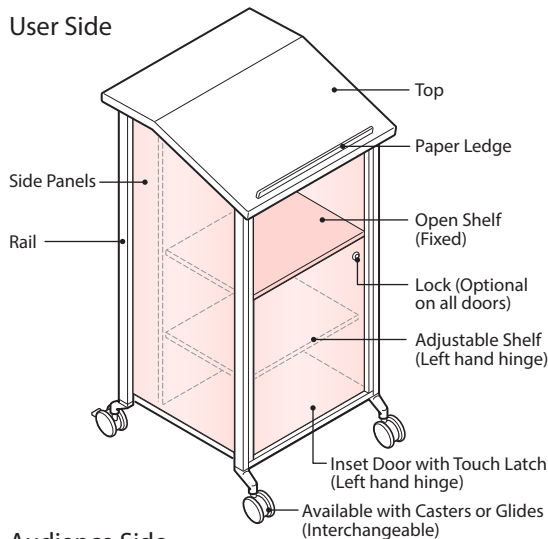

Audience Side

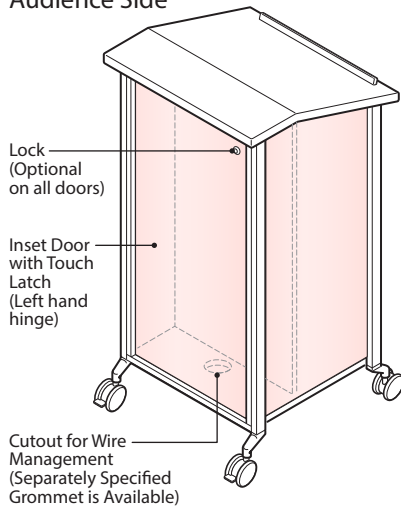

Dimensions

Top View

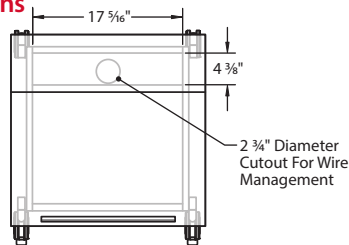

Front View

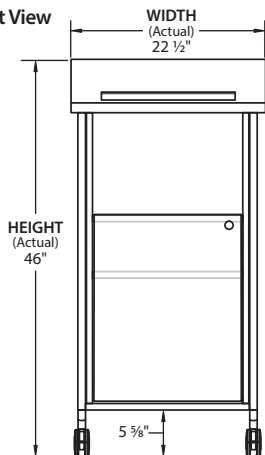

Side View

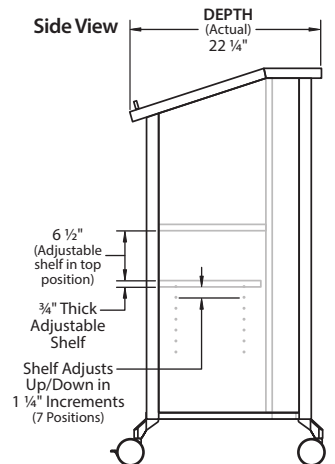

Component Materials/Finishes

COMPONENT NAME	MATERIALS/ FINISHES
Top, Doors, Shelves and Sides • Includes 1mm laminate or wood edgeband.	Laminate – Specify surface color and separate edge color.
	Wood – Specify surface and edge wood finish color.
Rails / Paper Ledge	Painted Aluminum – Specify trim color.
Casters (Optional)	(TR-F) Black hub with black tread
	(TR-7) Fog hub with graphite tread
	(TR-LPL) Light platinum hub with Graphite Tread
Glides (Optional)	(TR-F) Black Base Disk – Glide stem is painted to match base
	(TR-7) Fog Base Disk – Glide stem is painted to match base
	(TR-LPL) Light platinum Base Disk –Glide stem is painted to match base
Lock (Optional)	Available in Black or Chrome

Caster and Glide Options

- Optional casters or glides are field interchangeable.
- Casters include two locking and two non-locking.
- Heights are the same for Carts with Casters or Glides (Glides provide 1/2" of vertical adjustment for leveling).
- Casters/Glides Finish options:

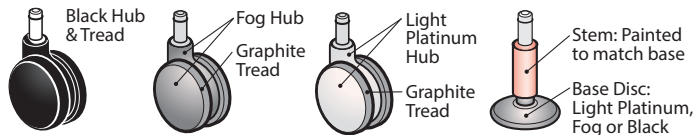

Interior Dimensions

User Side

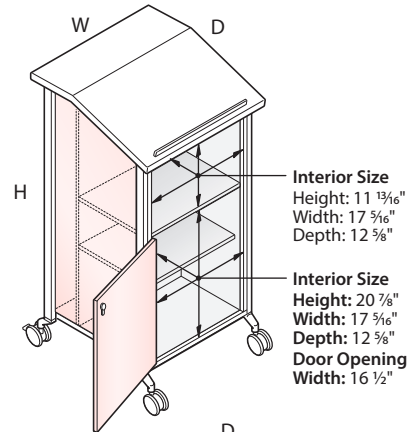

Audience Side

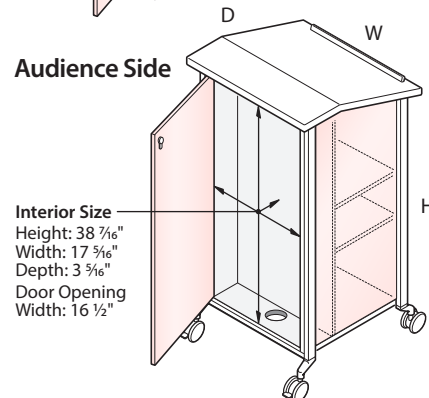

Product Details – Planes Conference Tables

Planes Credenzas – Overview

- Planes offers a wide variety of sizes of Credenzas for your storage needs.
- Credenzas have the option of laminate or wood and the Slider Unit has glass and translucent door options.

Wood Grain Direction – Natural Veneer, Quarter Cut Veneer, Rift Cut Veneer and Wood Grain Laminate

Vertical Surfaces – Wood grain direction runs top-to-bottom on door fronts, back panels, side panels and most vertical surfaces.

Horizontal Surfaces – Wood grain direction runs side-to-side on tops, shelves and most horizontal surfaces.

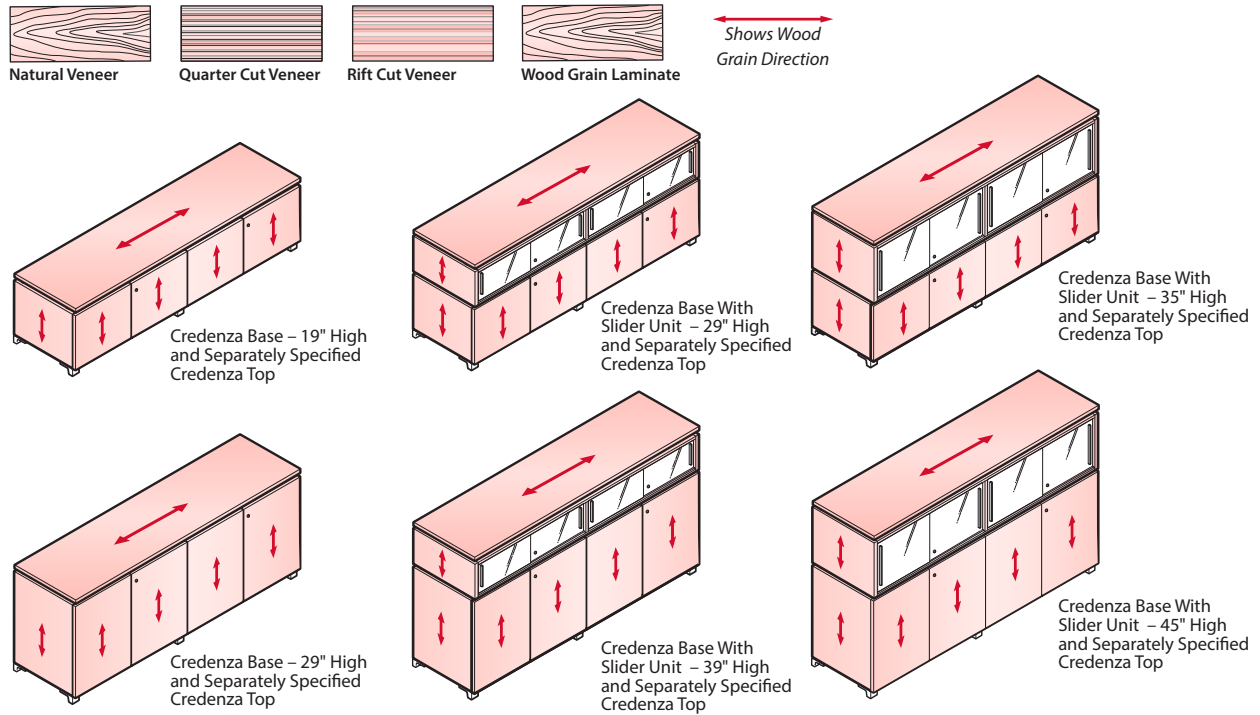

Wood Grain Direction – Double Cut Veneer

Vertical Surfaces – Wood grain direction runs side-to-side on door fronts, back panels, side panels and most vertical surfaces.

Horizontal Surfaces – Wood grain direction runs side-to-side on tops, shelves and most horizontal surfaces.

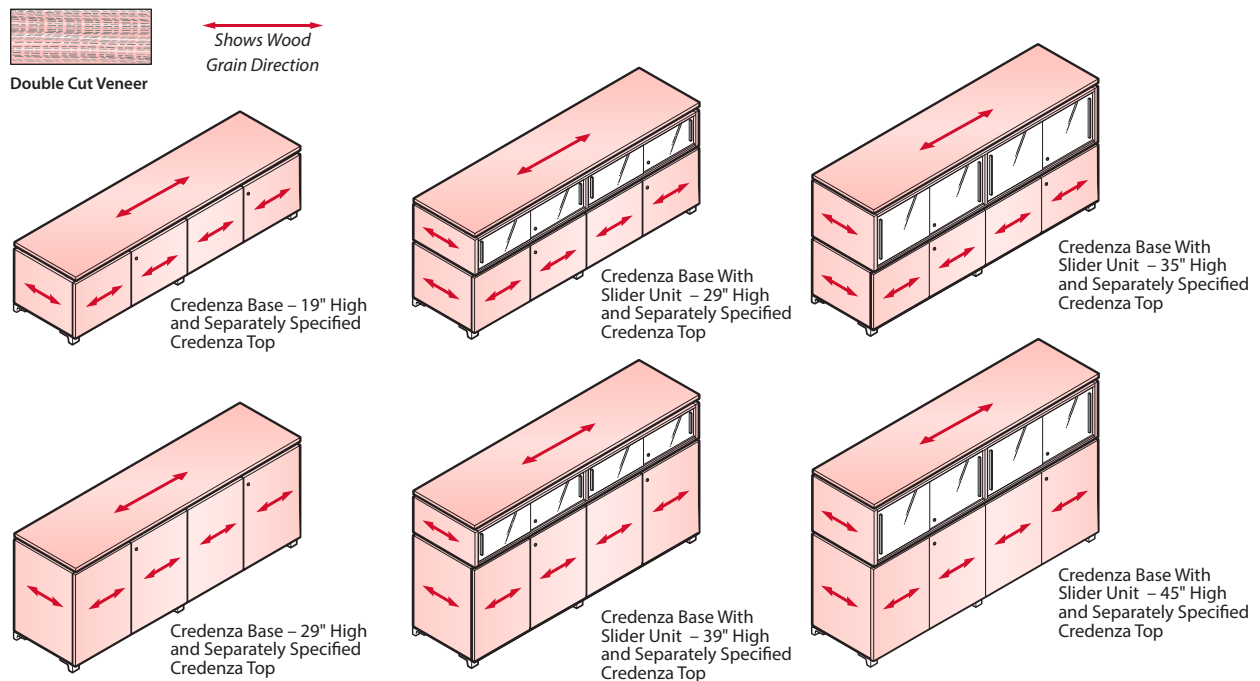

Product Details – Planes Conference Tables

Credenza – Top

- Planes Credenzas Bases and Credenza Bases with Slider Unit require a separately specified Credenza Top for a finished aesthetic.
- Specify the Credenza Top the same width as the Credenza Base.
- The hardware to install the Credenza Top is included and the attachment locations are factory drilled in the base or slider units.

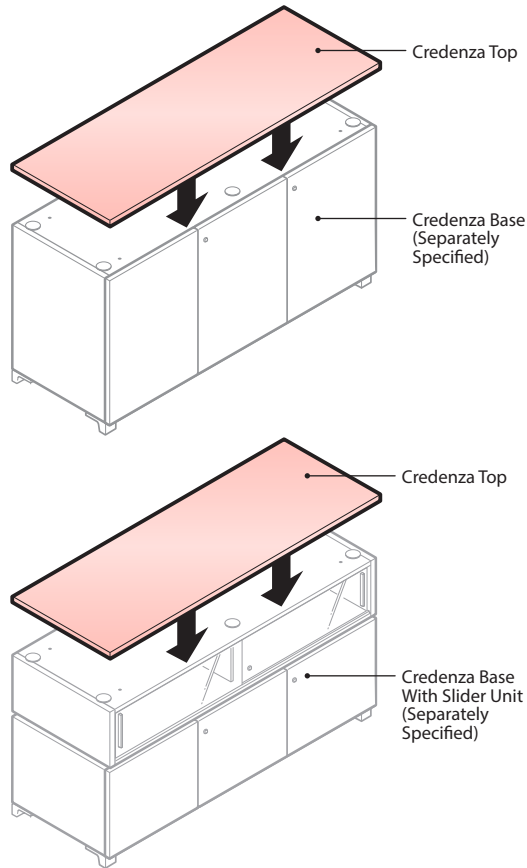

Component Materials/Finishes

COMPONENT NAME	MATERIALS/ FINISHES
Credenza Top • Includes laminate or wood edgeband.	Laminate – Specify surface color and separate edge color.
	Wood – Specify surface and edge wood finish color.

Dimensions

Top View

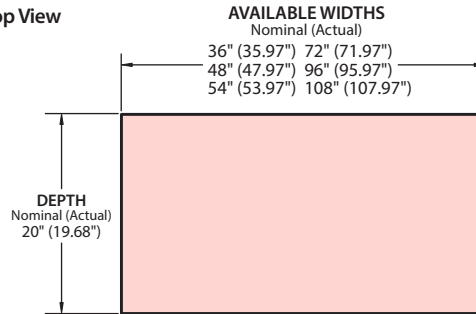

Front View

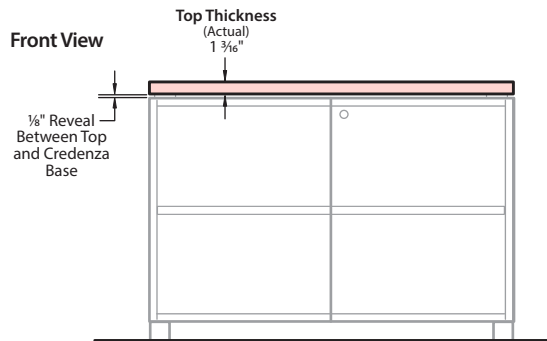

Product Details – Planes Conference Tables

Credenza Base – 19" High

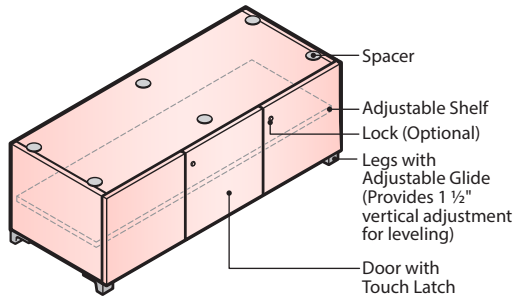

- The 19" High Credenza Base requires a separately specified Credenza Top to finish the top (Specify width of Credenza Top to match width of Credenza).
- Fixed vertical dividers are used to sub-divide interior compartments (Exception: 36" wide unit does not include vertical dividers).
- Each interior compartment in the Credenza Base includes (1) adjustable shelf.

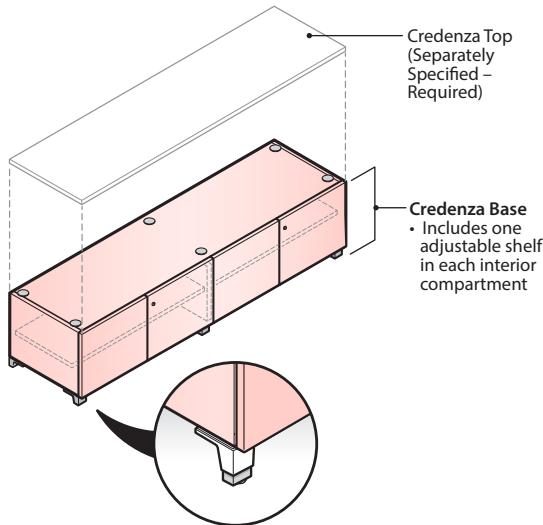

Detail of Credenza Leg

- Painted Metal with Black Glide.
- Leg is 2 1/4" High.
- Glide provides 1 1/2" of vertical adjustment for leveling.

Component Materials/Finishes

COMPONENT NAME	MATERIALS/ FINISHES
Hinged Doors, Tops, Bottoms, Sides, Backs, Shelves and Dividers Include 1mm laminate or wood edgeband.	Laminate – Specify surface color and separate edge color. Wood – Specify surface and edge wood finish color. (Door fronts are matched veneer)
Leg	Painted Aluminum – Specify trim color Glides – Standard in Black
Lock (Optional)	Locks are available in Black or Chrome.

19" High – Credenza Base Configurations

- Illustration show position and quantity of doors and locks.
- Red Arrows show door swing.

36" Wide

- 19" High Credenza Base**
- (2) Hinged Doors
 - (1) Shelf
 - (4) Legs

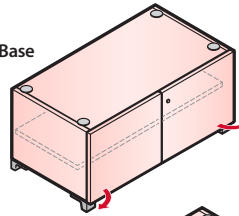

48" Wide

- 19" High Credenza Base**
- (3) Hinged Doors
 - (1) Divider
 - (2) Shelves
 - (4) Legs

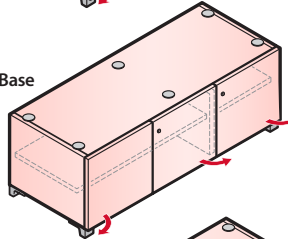

54" Wide

- 19" High Credenza Base**
- (3) Hinged Doors
 - (1) Divider
 - (2) Shelves
 - (4) Legs

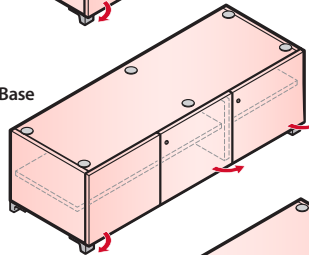

72" Wide

- 19" High Credenza Base**
- (4) Hinged Doors
 - (1) Divider
 - (2) Shelves
 - (6) Legs

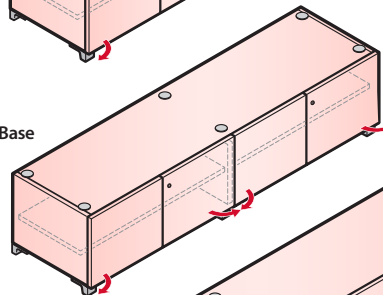

96" Wide

- 19" High Credenza Base**
- (6) Hinged Doors
 - (2) Divider
 - (3) Shelves
 - (6) Legs

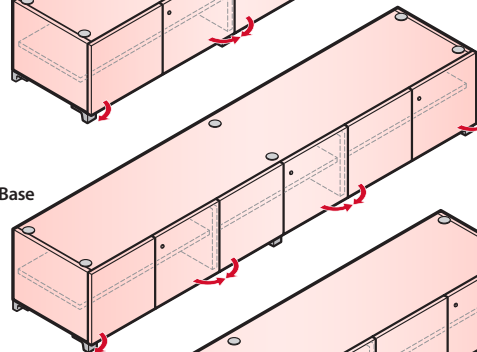

108" Wide

- 28" High Credenza Base**
- (6) Hinged Doors
 - (2) Divider
 - (3) Shelves
 - (6) Legs

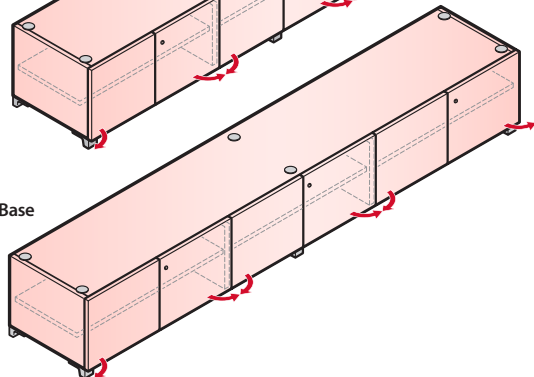

Product Details – Planes Conference Tables

Credenza Base – 19" High

Dimensions

Front View – 19" High x 36" Wide (2 Doors/4 Legs)

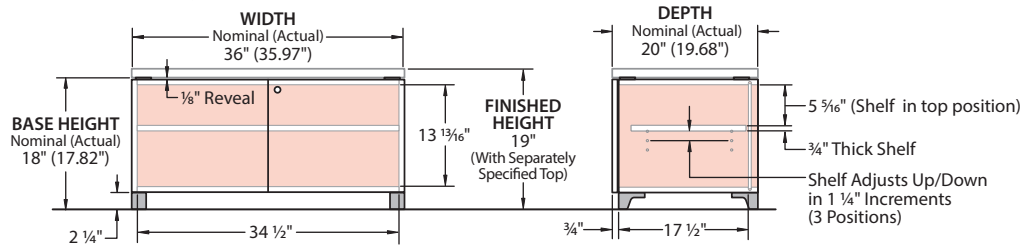

48" Wide (3 Doors/4 Legs)

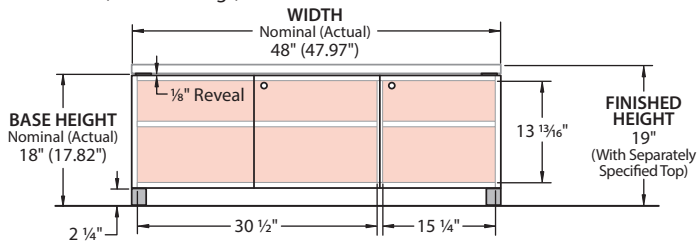

54" Wide (3 Doors/4 Legs)

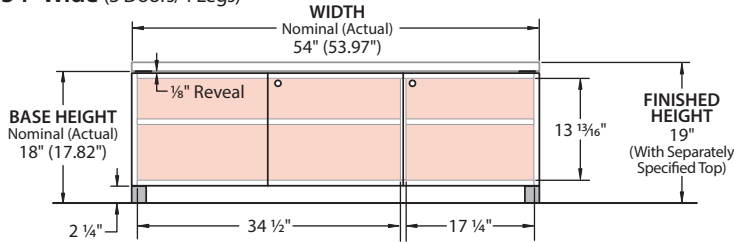

72" Wide (4 Doors/6 Legs)

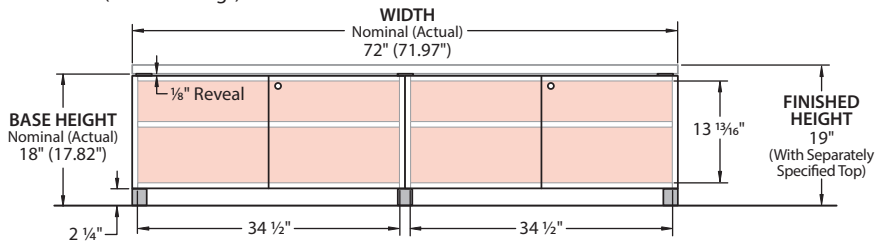

96" Wide (6 Doors/6 Legs)

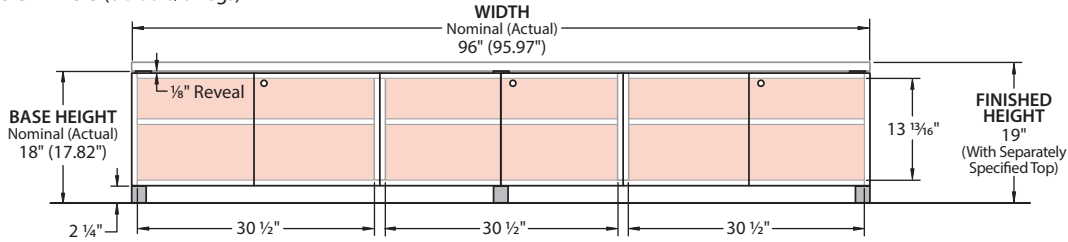

108" Wide (6 Doors/6 Legs)

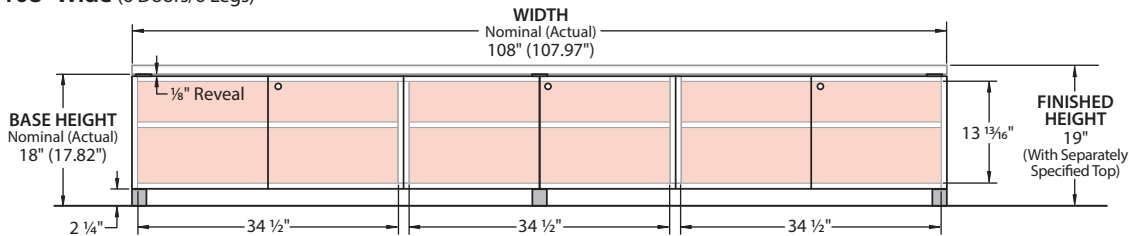

Note The side view dimensions for the 36" wide Credenza are the same for all 19" High Credenzas.

Product Details – Planes Conference Tables

Credenza Base with Slider Unit– 29" High

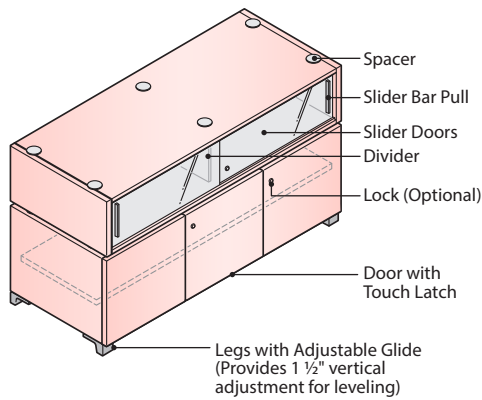

- The 29" High Credenza Base with Slider Unit includes a 10" High Slider Unit attached a 18" High Credenza Base.
- A separately specified Credenza Top is required to finish the top (Specify width of Credenza Top to match width of Credenza).
- Fixed vertical dividers are used to sub-divide interior compartments (Exception: 36" wide unit does not include vertical dividers).
- Each interior compartment in the Credenza Base includes (1) adjustable shelf (Slider Unit does not include Adjustable Shelves).

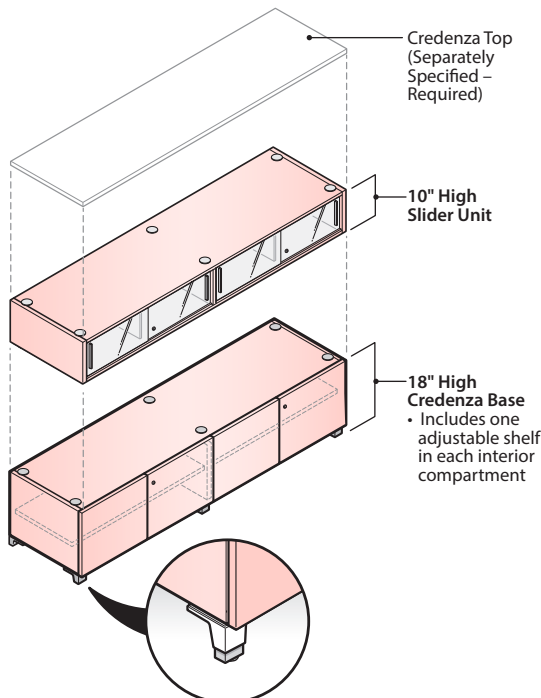

Detail of Credenza Leg

- Painted Metal with Black Glide.
- Leg is 2 1/4" High.
- Glide provides 1 1/2" of vertical adjustment for leveling.

Component Materials/Finishes

COMPONENT NAME	MATERIALS/ FINISHES
Hinged Doors, Tops, Bottoms, Sides, Backs, Shelves and Dividers Include 1mm laminate or wood edgeband.	Laminate – Specify surface color and separate edge color. Wood – Specify surface and edge wood finish color. (Base Door fronts are matched veneer)
Leg	Painted Aluminum – Specify trim color (matches Slider Bar Pull) Glides – Standard in Black
Slider Bar Pull	Painted Aluminum – Specify trim color (matches Leg)
Slider Doors	Available in Glass or Translucent
Lock (Optional)	Locks are available in Black or Chrome.

29" High – Credenza Base with Slider Unit Configurations

- Illustration show position and quantity of doors and locks.
- Red Arrows show door swing.

36" Wide

- 10" High Slider Unit
- (2) Slider Doors
- 18" High Credenza Base
- (2) Hinged Doors
- (1) Shelf
- (4) Legs

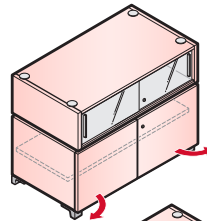

48" Wide

- 10" High Slider Unit
- (2) Slider Doors
- (1) Divider
- 18" High Credenza Base
- (3) Hinged Doors
- (1) Divider
- (2) Shelves
- (4) Legs

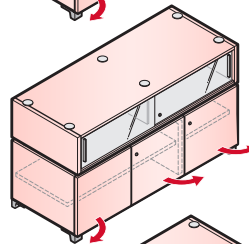

54" Wide

- 10" High Slider Unit
- (2) Slider Doors
- (1) Divider
- 18" High Credenza Base
- (3) Hinged Doors
- (1) Divider
- (2) Shelves
- (4) Legs

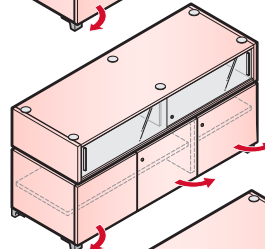

72" Wide

- 10" High Slider Unit
- (4) Slider Doors
- (1) Divider
- 18" High Credenza Base
- (4) Hinged Doors
- (1) Divider
- (2) Shelves
- (6) Legs

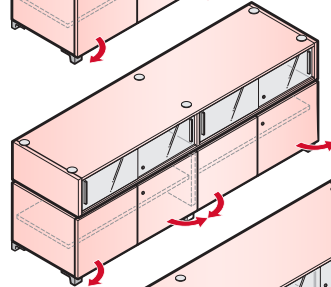

96" Wide

- 10" High Slider Unit
- (4) Slider Doors
- (3) Dividers
- 18" High Credenza Base
- (6) Hinged Doors
- (2) Divider
- (3) Shelves
- (6) Legs

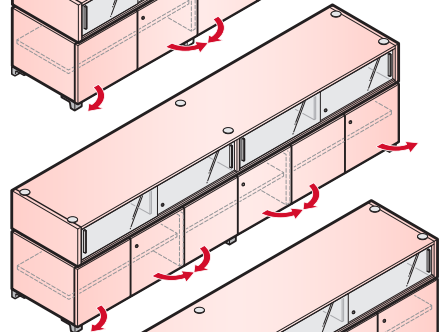

108" Wide

- 10" High Slider Unit
- (4) Slider Doors
- (3) Dividers
- 18" High Credenza Base
- (6) Hinged Doors
- (2) Divider
- (3) Shelves
- (6) Legs

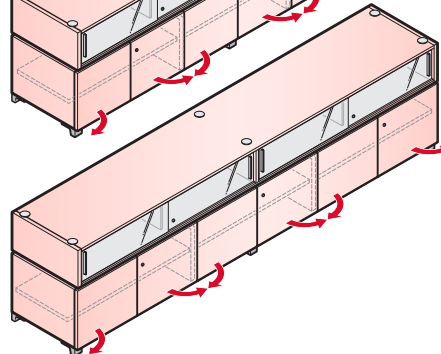

Product Details – Planes Conference Tables

Credenza Base with Slider Unit – 29" High

Dimensions

Front View – 29" High x 36" Wide (2 Doors/4 Legs)

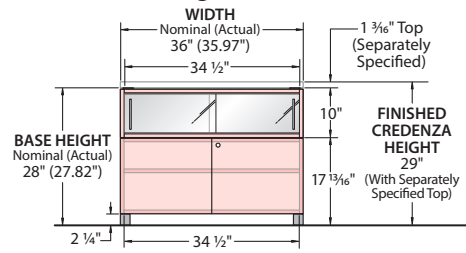

Side View – 29" High Credenza (All Widths)

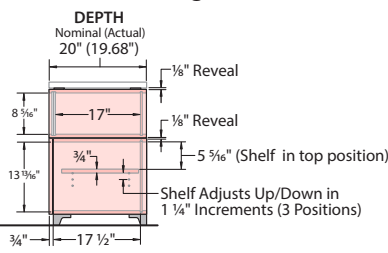

Front View – 29" High x 48" Wide (3 Doors/4 Legs)

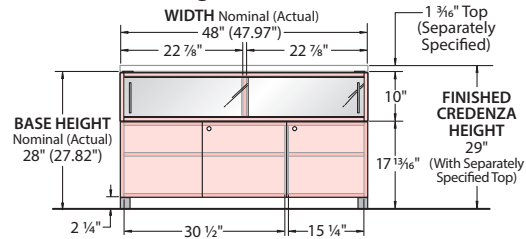

Front View – 29" High x 54" Wide (3 Doors/4 Legs)

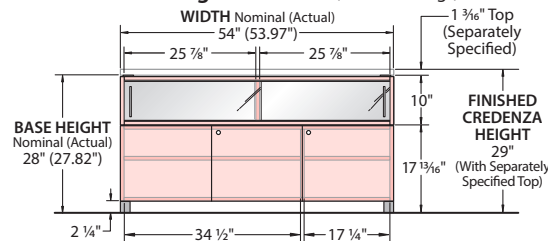

Front View – 29" High x 72" Wide (4 Doors/6 Legs)

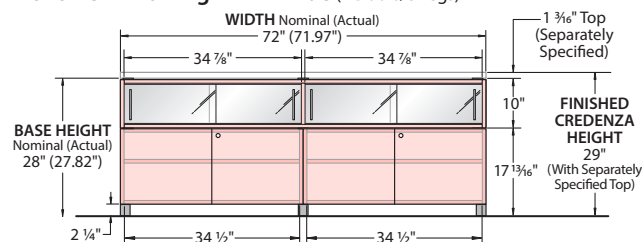

Front View – 29" High x 96" Wide (6 Doors/6 Legs)

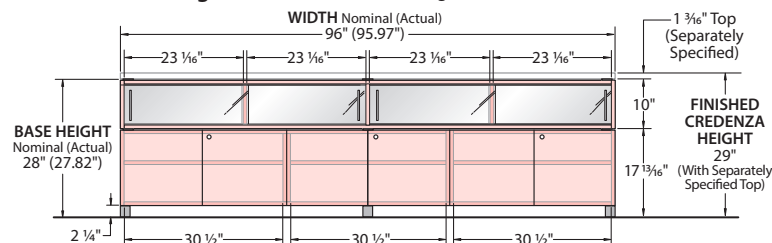

Front View – 29" High x 108" Wide (6 Doors/6 Legs)

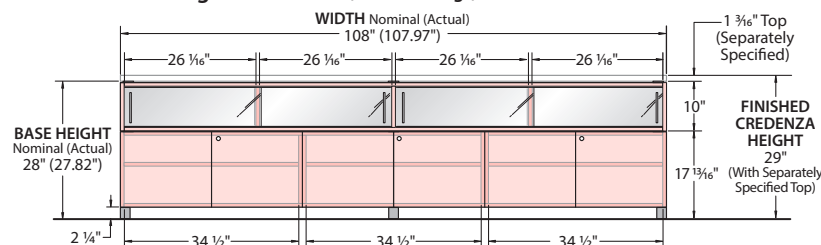

Note The side view dimensions for the 36" wide Credenza are the same for all 29" High Credenzas.

Product Details – Planes Conference Tables

Credenza Base with Slider Unit– 35" High

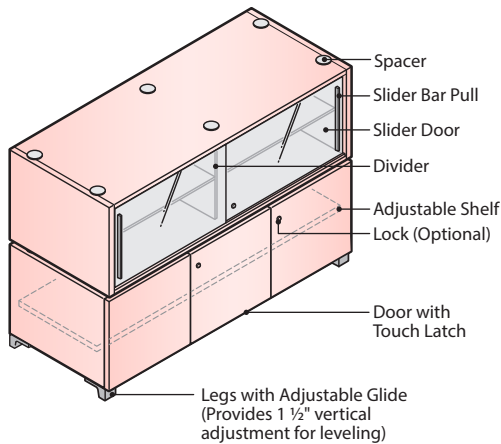

- The 29" High Credenza Base with Slider Unit includes a 10" High Slider Unit attached a 18" High Credenza Base.
- A separately specified Credenza Top is required to finish the top (Specify width of Credenza Top to match width of Credenza).
- Fixed vertical dividers are used to sub-divide interior compartments (Exception: 36" wide unit does not include vertical dividers).
- Each interior compartment in the Slider Unit and Credenza Base includes (1) adjustable shelf.

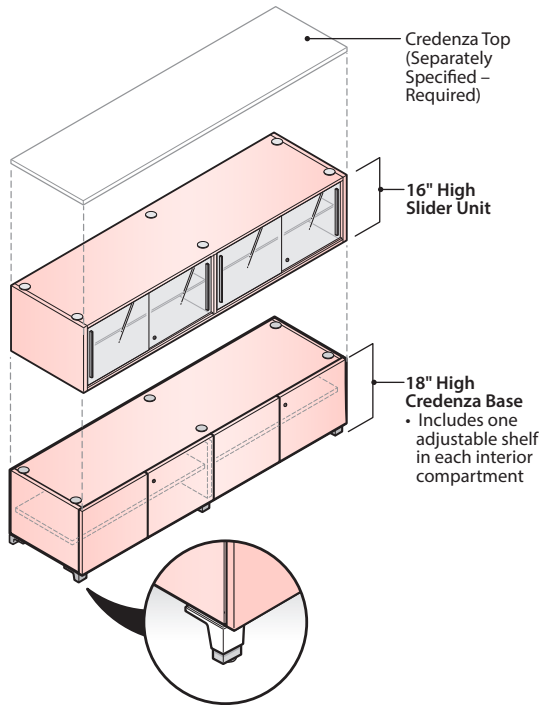

Detail of Credenza Leg

- Painted Metal with Black Glide.
- Leg is 2 1/4" High.
- Glide provides 1 1/2" of vertical adjustment for leveling.

Component Materials/Finishes

COMPONENT NAME	MATERIALS/ FINISHES
Hinged Doors, Tops, Bottoms, Sides, Backs, Shelves and Dividers Include 1mm laminate or wood edgeband.	Laminate – Specify surface color and separate edge color.
	Wood – Specify surface and edge wood finish color. (Door fronts are matched veneer)
Leg	Painted Aluminum – Specify trim color (matches Slider Bar Pull) Glides – Standard in Black
Slider Bar Pull	Painted Aluminum – Specify trim color (matches Leg)
Slider Doors	Available in Glass or Translucent
Lock (Optional)	Locks are available in Black or Chrome.

19" High Credenza Base Configurations

- Illustration show position and quantity of doors and locks.
- Red Arrows show door swing.

36" Wide

- 16" High Slider Unit**
 - (2) Slider Doors
 - (1) Shelf
- 18" High Credenza Base**
 - (2) Hinged Doors
 - (1) Shelf
 - (4) Legs

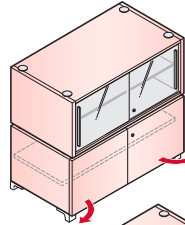

48" Wide

- 16" High Slider Unit**
 - (2) Slider Doors
 - (1) Divider
 - (2) Shelves
- 18" High Credenza Base**
 - (3) Hinged Doors
 - (1) Divider
 - (2) Shelves
 - (4) Legs

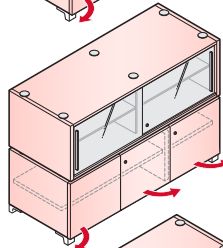

54" Wide

- 16" High Slider Unit**
 - (2) Slider Doors
 - (1) Divider
 - (2) Shelves
- 18" High Credenza Base**
 - (3) Hinged Doors
 - (1) Divider
 - (2) Shelves
 - (4) Legs

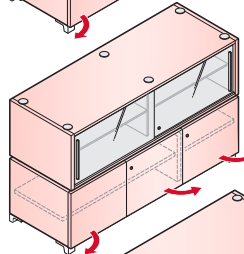

72" Wide

- 16" High Slider Unit**
 - (4) Slider Doors
 - (1) Divider
 - (2) Shelves
- 18" High Credenza Base**
 - (4) Hinged Doors
 - (1) Divider
 - (2) Shelves
 - (6) Legs

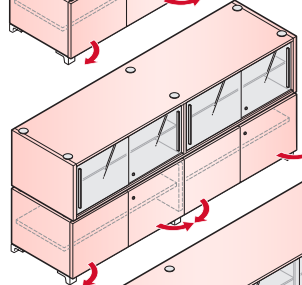

96" Wide

- 16" High Slider Unit**
 - (4) Slider Doors
 - (3) Dividers
 - (4) Shelves
- 18" High Credenza Base**
 - (6) Hinged Doors
 - (2) Divider
 - (3) Shelves
 - (6) Legs

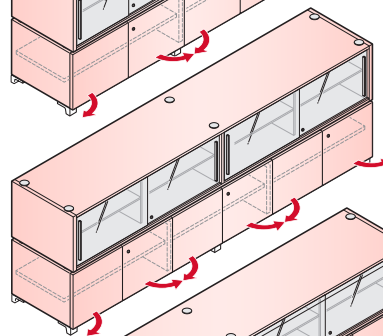

108" Wide

- 16" High Slider Unit**
 - (4) Slider Doors
 - (3) Dividers
 - (4) Shelves
- 18" High Credenza Base**
 - (6) Hinged Doors
 - (2) Divider
 - (3) Shelves
 - (6) Legs

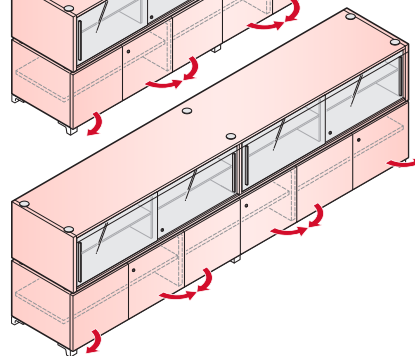

Product Details – Planes Conference Tables

Credenza Base with Slider Unit– 35" High

Dimensions

Front View – 35" High x 36" Wide (2 Doors/4 Legs)

Side View – 35" High Credenza (All Widths)

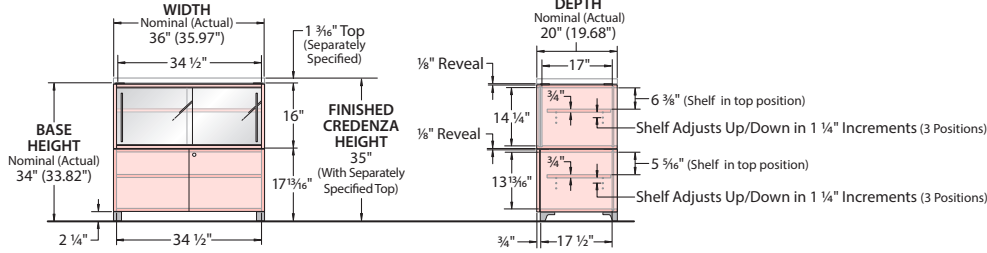

Front View – 35" High x 48" Wide (3 Doors/4 Legs)

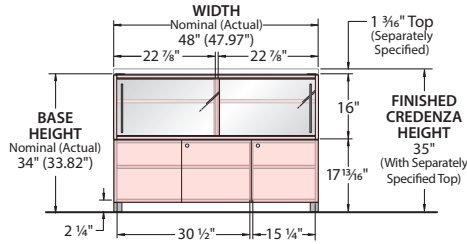

Front View – 35" High x 54" Wide (3 Doors/4 Legs)

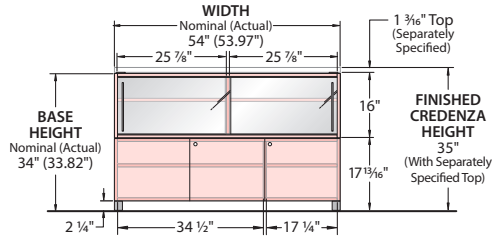

Front View – 35" High x 72" Wide (4 Doors/6 Legs)

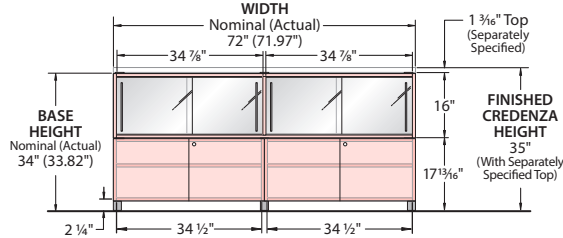

Front View – 35" High x 96" Wide (6 Doors/6 Legs)

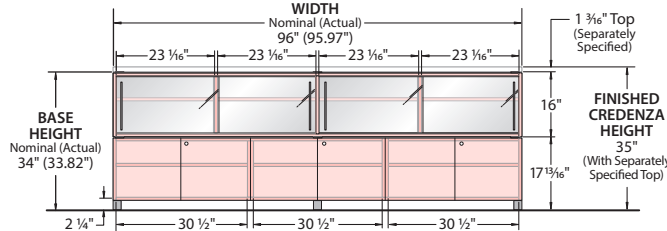

Front View – 35" High x 108" Wide (6 Doors/6 Legs)

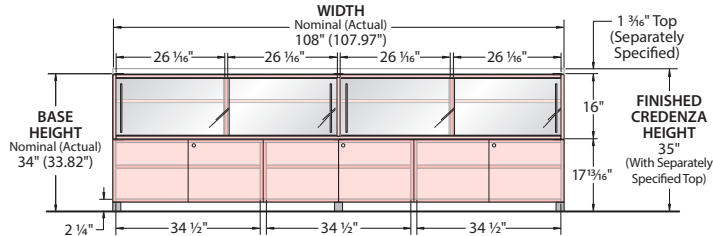

Note The side view dimensions for the 36" wide Credenza are the same for all 35" High Credenzas.

Product Details – Planes Conference Tables

Credenza Base – 29" High

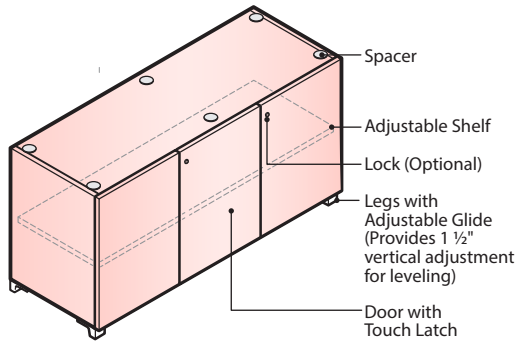

- The 29" High Credenza Base requires a separately specified Credenza Top to finish the top (Specify width of Credenza Top to match width of Credenza).
- Fixed vertical dividers are used to sub-divide interior compartments (Exception: 36" wide unit does not include vertical dividers).
- Each interior compartment in the Credenza Base includes (1) adjustable shelf.

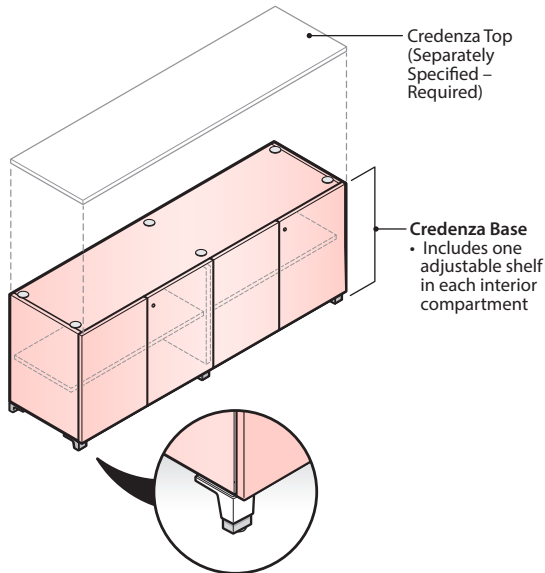

Detail of Credenza Leg

- Painted Metal with Black Glide.
- Leg is 2 1/4" High.
- Glide provides 1 1/2" of vertical adjustment for leveling.

Component Materials/Finishes

COMPONENT NAME	MATERIALS/ FINISHES
Hinged Doors, Tops, Bottoms, Sides, Backs, Shelves and Dividers Include 1mm laminate or wood edgeband.	Laminate – Specify surface color and separate edge color. Wood – Specify surface and edge wood finish color. (Door fronts are matched veneer)
Leg	Painted Aluminum – Specify trim color (matches Slider Bar Pull) Glides – Standard in Black
Lock (Optional)	Locks are available in Black or Chrome.

29" High Credenza Base Configurations

- Illustration show position and quantity of doors and locks.
- Red Arrows show door swing.

36" Wide

- 29" High Credenza Base
- (2) Hinged Doors
 - (1) Shelf
 - (4) Legs

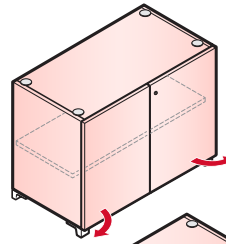

48" Wide

- 29" High Credenza Base
- (3) Hinged Doors
 - (1) Divider
 - (2) Shelves
 - (4) Legs

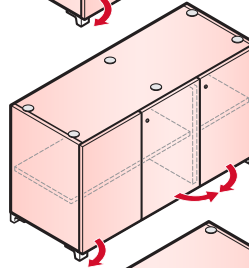

54" Wide

- 29" High Credenza Base
- (3) Hinged Doors
 - (1) Divider
 - (2) Shelves
 - (4) Legs

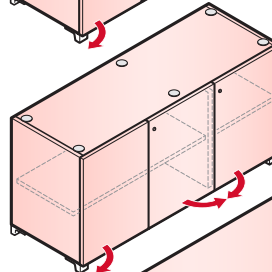

72" Wide

- 29" High Credenza Base
- (4) Hinged Doors
 - (1) Divider
 - (2) Shelves
 - (6) Legs

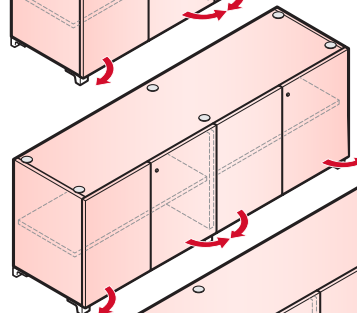

96" Wide

- 29" High Credenza Base
- (6) Hinged Doors
 - (2) Divider
 - (3) Shelves
 - (6) Legs

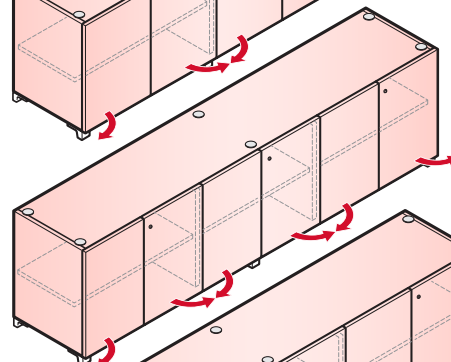

108" Wide

- 28" High Credenza Base
- (6) Hinged Doors
 - (2) Divider
 - (3) Shelves
 - (6) Legs

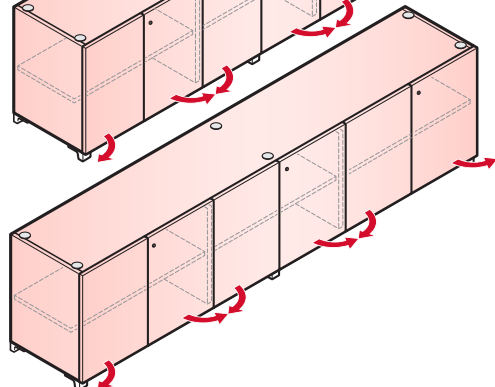

Product Details – Planes Conference Tables

Credenza Base – 29" High

Dimensions

Front View – 29" High x 36" Wide (2 Doors/4 Legs)

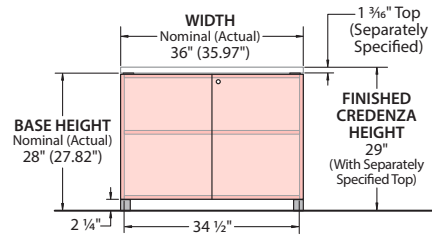

Side View – 29" High Credenza (All Widths)

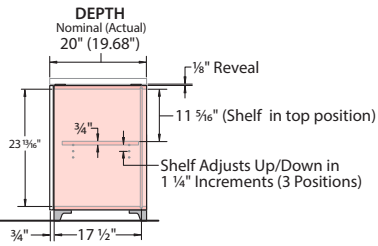

Front View – 29" High x 48" Wide (3 Doors/4 Legs)

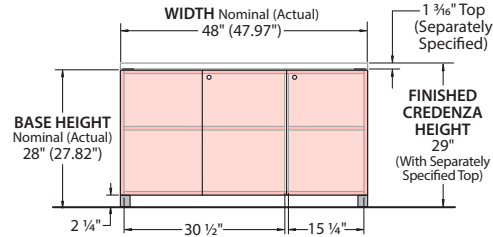

Front View – 29" High x 54" Wide (3 Doors/4 Legs)

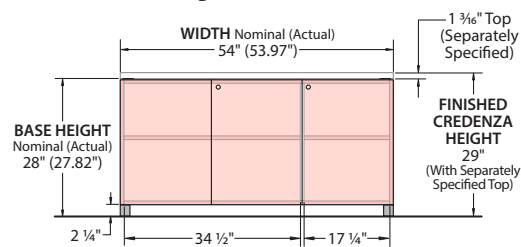

Front View – 29" High x 72" Wide (4 Doors/6 Legs)

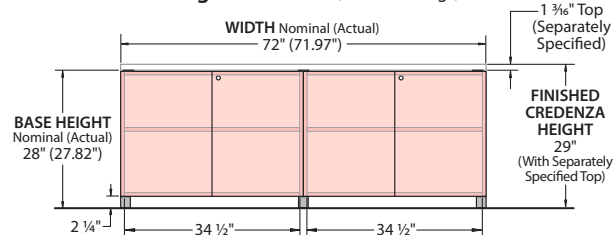

Front View – 29" High x 96" Wide (6 Doors/6 Legs)

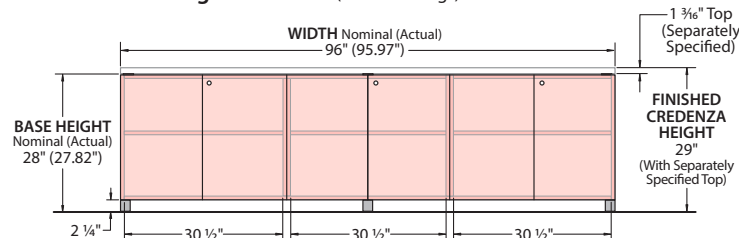

Front View – 29" High x 108" Wide (6 Doors/6 Legs)

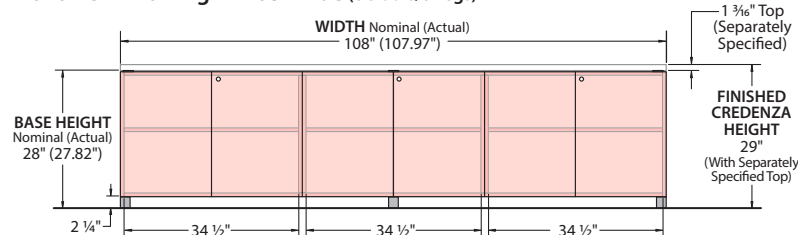

Note The side view dimensions for the 36" wide Credenza are the same for all 29" High Credenzas.

Product Details – Planes Conference Tables

Credenza Base with Slider Unit– 39" High

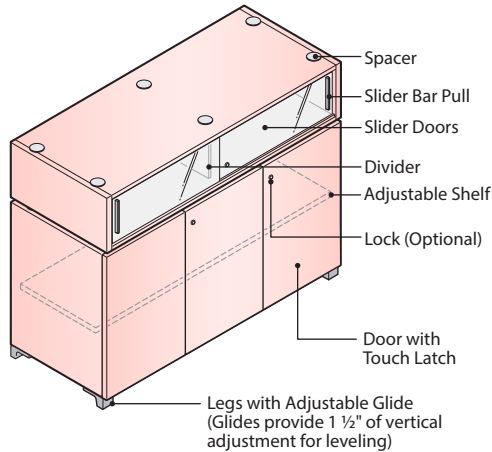

- The 39" High Credenza Base with Slider Unit includes a 10" High Slider Unit attached a 28" High Credenza Base.
- A separately specified Credenza Top is required to finish the top (Specify width of Credenza Top to match width of Credenza).
- Fixed vertical dividers are used to sub-divide interior compartments (Exception: 36" wide unit does not include vertical dividers).
- Each interior compartment in the Credenza Base includes (1) adjustable shelf (Slider Unit does not include Adjustable Shelves).

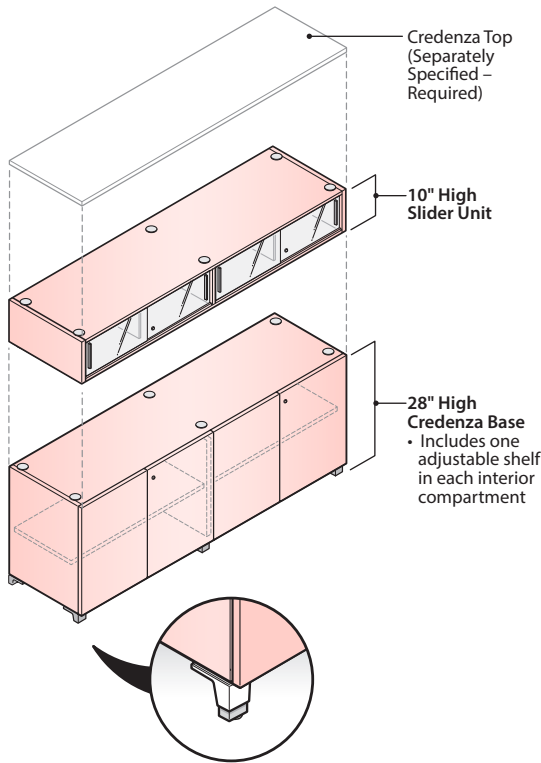

Detail of Credenza Leg

- Painted Metal with Black Glide.
- Leg is 2 1/4" High.
- Glide provides 1 1/2" of vertical adjustment for leveling.

Component Materials/Finishes

COMPONENT NAME	MATERIALS/ FINISHES
Hinged Doors, Tops, Bottoms, Sides, Backs, Shelves and Dividers Include 1mm laminate or wood edgeband.	Laminate – Specify surface color and separate edge color.
	Wood – Specify surface and edge wood finish color. (Door fronts are matched veneer)
Leg	Painted Aluminum – Specify trim color (matches Slider Bar Pull) Glides – Standard in Black
Slider Bar Pull	Painted Aluminum – Specify trim color (matches Leg)
Slider Doors	Available in Glass or Translucent
Lock (Optional)	Locks are available in Black or Chrome.

39" High Credenza Base with Slider Unit Configurations

- Illustration show position and quantity of doors and locks.
- Red Arrows show door swing.

36" Wide

- 10" High Slider Unit
- (2) Slider Doors
- 28" High Credenza Base
- (2) Hinged Doors
- (1) Shelf
- (4) Legs

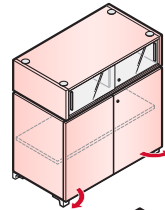

48" Wide

- 10" High Slider Unit
- (2) Slider Doors
- (1) Divider
- 28" High Credenza Base
- (3) Hinged Doors
- (1) Divider
- (2) Shelves
- (4) Legs

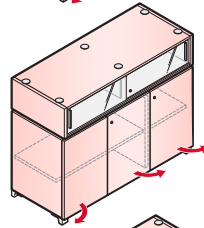

54" Wide

- 10" High Slider Unit
- (2) Slider Doors
- (1) Divider
- 28" High Credenza Base
- (3) Hinged Doors
- (1) Divider
- (2) Shelves
- (4) Legs

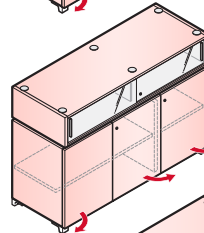

72" Wide

- 10" High Slider Unit
- (4) Slider Doors
- (1) Divider
- 28" High Credenza Base
- (4) Hinged Doors
- (1) Divider
- (2) Shelves
- (6) Legs

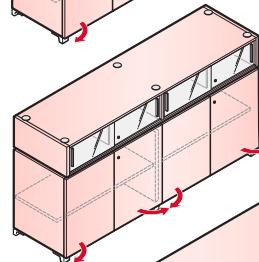

96" Wide

- 10" High Slider Unit
- (4) Slider Doors
- (3) Dividers
- 28" High Credenza Base
- (6) Hinged Doors
- (2) Divider
- (3) Shelves
- (6) Legs

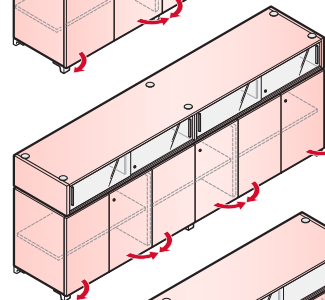

108" Wide

- 10" High Slider Unit
- (4) Slider Doors
- (3) Dividers
- 28" High Credenza Base
- (6) Hinged Doors
- (2) Divider
- (3) Shelves
- (6) Legs

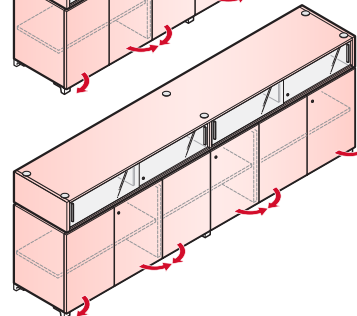

Product Details – Planes Conference Tables

Credenza Base with Slider Unit– 39" High

Dimensions

Front View – 39" High x 36" Wide (2 Doors/4 Legs)

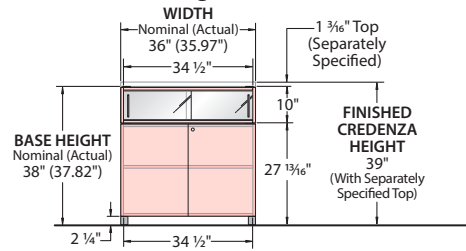

Side View – 39" High Credenza (All Widths)

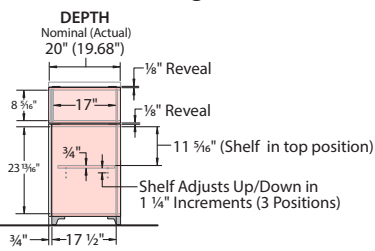

Front View – 39" High x 48" Wide (3 Doors/4 Legs)

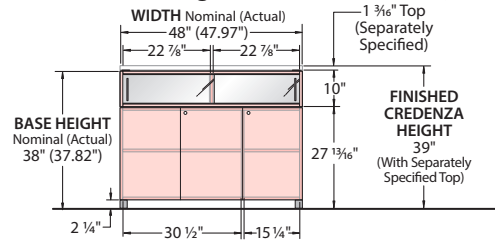

Front View – 39" High x 54" Wide (3 Doors/4 Legs)

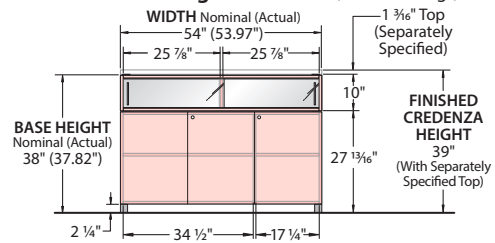

Front View – 39" High x 72" Wide (4 Doors/6 Legs)

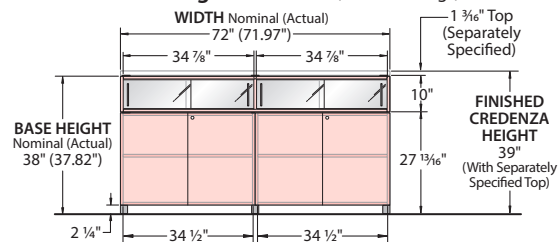

Front View – 39" High x 96" Wide (6 Doors/6 Legs)

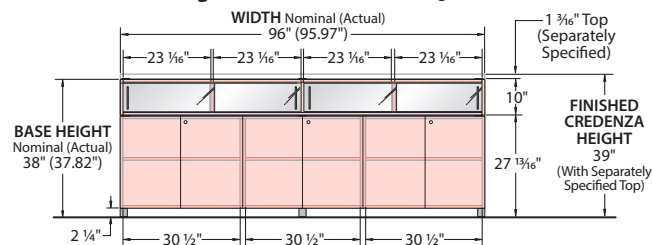

Front View – 39" High x 108" Wide (6 Doors/6 Legs)

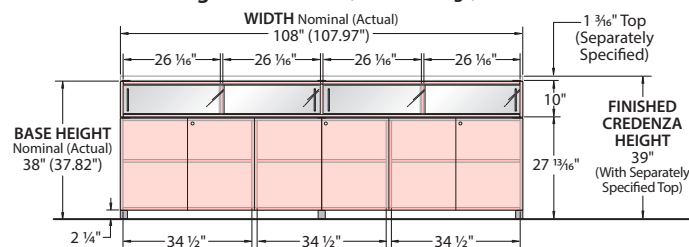

Note The side view dimensions for the 36" wide Credenza are the same for all 39" High Credenzas.

Product Details – Planes Conference Tables

Credenza Base with Slider Unit– 45" High

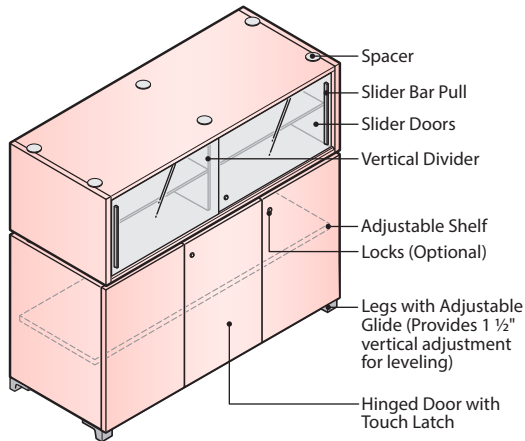

- The 45" High Credenza Base with Slider Unit includes a 16" High Slider Unit attached a 28" High Credenza Base.
- A separately specified Credenza Top is required to finish the top (Specify width of Credenza Top to match width of Credenza).
- Fixed Vertical Dividers are used to sub-divide interior compartments (Exception: 36" wide unit does not include vertical dividers).
- Each interior compartment in the Slider Unit and Credenza Base includes (1) adjustable shelf.

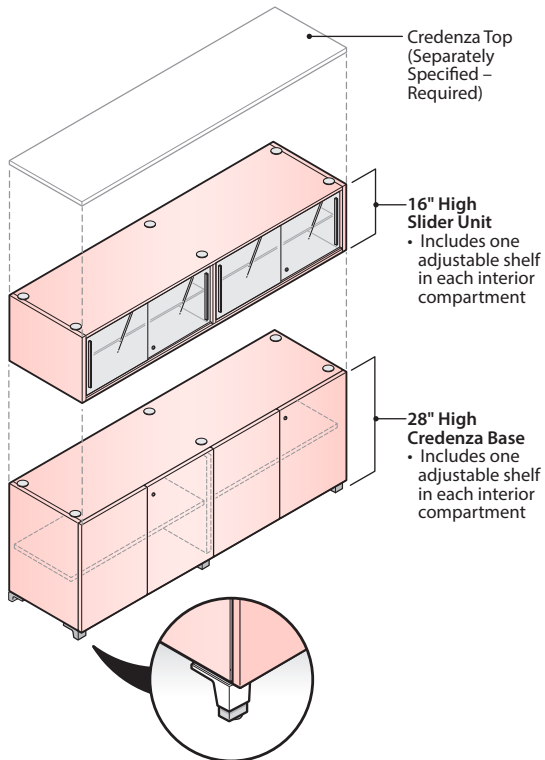

Detail of Credenza Leg

- Painted Metal with Black Glide.
- Leg is 2 1/4" High.
- Glide provides 1 1/2" of vertical adjustment for leveling.

Component Materials/Finishes

COMPONENT NAME	MATERIALS/ FINISHES
Hinged Doors, Tops, Bottoms, Sides, Backs, Shelves and Dividers Include 1mm laminate or wood edgeband.	Laminate – Specify surface color and separate edge color. Wood – Specify surface and edge wood finish color. (Door fronts are matched veneer)
Leg	Painted Aluminum – Specify trim color (matches Slider Bar Pull) Glides – Standard in Black
Slider Bar Pull	Painted Aluminum – Specify trim color (matches Leg)
Slider Doors	Available in Glass or Translucent
Lock (Optional)	Locks are available in Black or Chrome.

45" High Credenza Base with Slider Unit Configurations

- Illustrations show configurations and component quantities.
- Red Arrows show door swing.

36" Wide

16" High Slider Unit
– (2) Slider Doors
– (1) Shelf

28" High Credenza Base
– (2) Hinged Doors
– (1) Shelf
– (4) Legs

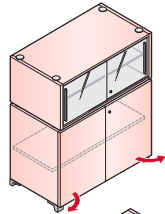

48" Wide

16" High Slider Unit
– (2) Slider Doors
– (1) Divider
– (2) Shelves

28" High Credenza Base
– (3) Hinged Doors
– (1) Divider
– (2) Shelves
– (4) Legs

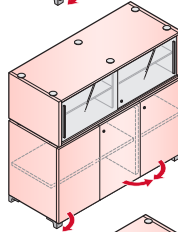

54" Wide

16" High Slider Unit
– (2) Slider Doors
– (1) Divider
– (2) Shelves

28" High Credenza Base
– (3) Hinged Doors
– (1) Divider
– (2) Shelves
– (4) Legs

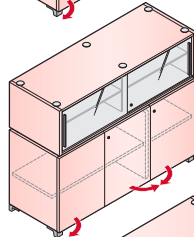

72" Wide

16" High Slider Unit
– (4) Slider Doors
– (1) Divider
– (2) Shelves

28" High Credenza Base
– (4) Hinged Doors
– (1) Divider
– (2) Shelves
– (6) Legs

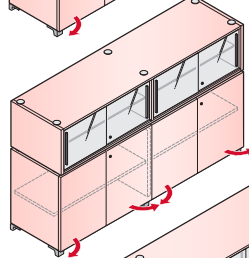

96" Wide

16" High Slider Unit
– (4) Slider Doors
– (3) Dividers
– (4) Shelves

28" High Credenza Base
– (6) Hinged Doors
– (2) Divider
– (3) Shelves
– (6) Legs

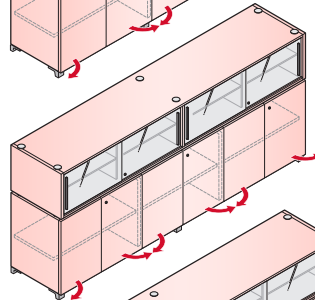

108" Wide

16" High Slider Unit
– (4) Slider Doors
– (3) Dividers
– (4) Shelves

28" High Credenza Base
– (6) Hinged Doors
– (2) Divider
– (3) Shelves
– (6) Legs

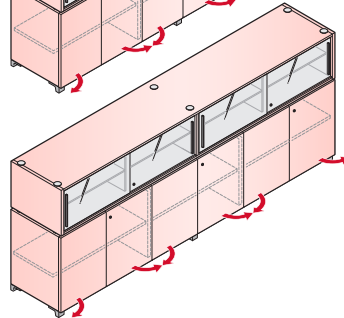

Product Details – Planes Conference Tables

Credenza Base with Slider Unit– 45" High

Dimensions

Front View – 45" High x 36" Wide (2 Doors/4 Legs)

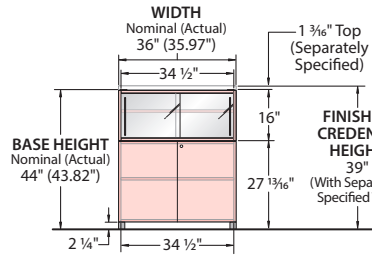

Side View – 45" High Credenza (All Widths)

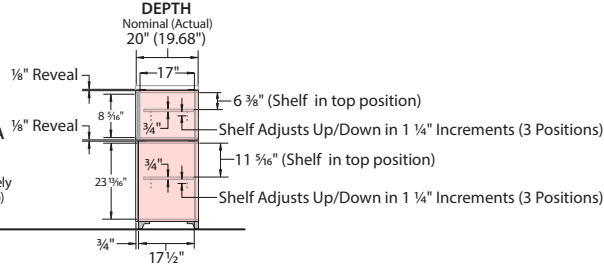

Front View – 45" High x 48" Wide (3 Doors/4 Legs)

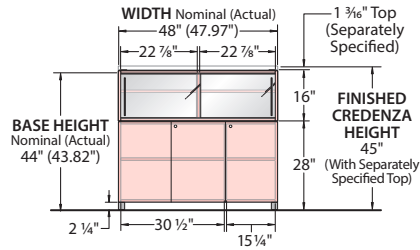

Front View – 45" High x 54" Wide (3 Doors/4 Legs)

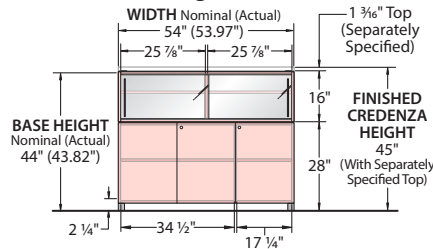

Front View – 45" High x 72" Wide (4 Doors/6 Legs)

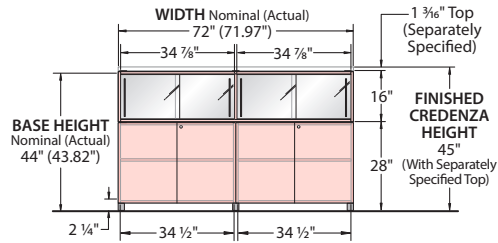

Front View – 45" High x 96" Wide (6 Doors/6 Legs)

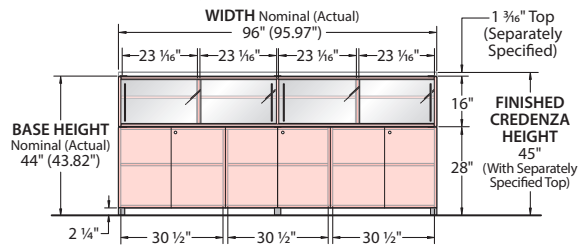

Front View – 45" High x 108" Wide (6 Doors/6 Legs)

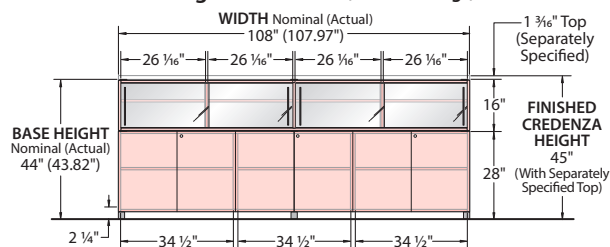

Note The side view dimensions for the 36" wide Credenza are the same for all 45" High Credenzas.

This page intentionally left blank.

Technical Specifications Planes Conference Tables

Technical Specifications – Planes Conference Tables

Table Top Construction

Surface

All Table Top Cores consists of engineered composite panel with a minimum 90% wood fiber content with a least 10% post consumer and 80% pre-consumer wood fiber bonded with resin. The tops are 3rd party certified compliant with GREENGUARD® and ANSI/BIFMA Standards for Low Emitting Products. The composite panel is 3rd party certified compliant with California Air Resource Board requirements for Phase 2 formaldehyde emission levels and include wood fiber sourced from FSC certified forests using the 70% FSC Mix Credit System.

Conference Tables, Interior Leg and Perimeter Leg - Laminate and Wood

Top Construction: Interior leg core consists of 1.125" (28.6 mm) thick engineered composite panel. Perimeter leg core is a sandwich construction with a center core of honeycomb surrounded by 6" particleboard on each side, the center core is sandwiched between an internal backer and MDF. Laminate top face is 0.028" (.7 mm) thick high-pressure laminate and underside is 0.028" (.7 mm) thick backer for balanced construction. Veneer top face is 0.020" (.5 mm) thick natural or recon veneer and 0.020" (.5 mm) thick backer for balanced construction. Perimeter leg table tops feature an additional 6" (152 mm) wide build-up along the perimeter of the top consisting thick backer. The build-up provides a 2" (51 mm) thick finished table edge.

Edges for Laminate Tops: Interior Leg edge options include 0.118" (3 mm) thick edgeband made of Acrylonitrile Butadiene Styrene (ABS); knife edge, constructed with 0.0118" (3 mm) thick edgeband that runs 0.375" (9.5 mm) down the perimeter of the edge before transitioning to a taper. The Perimeter Leg edge option is 0.118" (3 mm) thick edgeband made of Acrylonitrile Butadiene Styrene (ABS). Multi-piece tops are constructed with a 0.039" (1 mm) thick plastic edgeband at the seam on Interior Leg tops and 0.118" (3 mm) thick edgeband on Perimeter Leg tops.

Edges for Wood Tops: Interior Leg edge options include 0.100" (2.5 mm) thick wood edgeband; knife edge, constructed with 0.100" (2.5 mm) edgeband that runs 0.375" (9.5 mm) down the perimeter of the edge before transitioning to a taper. The Perimeter Leg edge option is 0.100" (2.5 mm) thick wood edgeband. Multi-piece tops are constructed with a 0.039" (1 mm) thick plastic edgeband at the seam on Interior Leg tops and 0.118" (3 mm) thick edgeband on Perimeter Leg tops.

Table Base Construction

Interior and Perimeter Leg Conference Tables

Conference Tables, Interior Leg Construction: Legs are extruded painted aluminum; glides on legs provide 0.5" (12.7 mm) vertical adjustment. Leg dimensions are 1.125" (28.6 mm) x 3.25" (83 mm).

Conference Tables, Perimeter Leg Construction: Legs are extruded painted aluminum; glides on legs provide 0.5" (12.7 mm) vertical adjustment. Leg dimensions are 1.375" (35 mm) x 4" (102 mm).

Cable Base Construction: The cable base for 36" (914 mm) deep tables are 8" (203 mm) x 14" (356 mm), and for tables deeper than 36" (914 mm), the cable base is 14" (356 mm) x 14" (356 mm). Base construction includes a 14-gauge steel frame with built-in brackets for cable management. The core consists of a 0.75" (19 mm) thick medium density fiberboard (mdf) that is finished with either 0.028" (.7 mm) thick laminate or 0.020" (.5 mm) thick veneer on both sides and 0.039" (1 mm) thick edgeband on exposed edges. The cable base provides 2.5" (64 mm) of cord access along the top of the panels facing the depth of the table that can be field adjusted for base access. Panels that face the length of the table are removable for access to the base. The 8" (203 mm) x 14" (356 mm) cable base bottom panel provides a 3" (76.2 mm) x 8" (203 mm) cutout, and 14" (356 mm) x 14" (356 mm) cable base provides an 8" (203 mm) x 8" (203 mm) cutout. Cable bases have leveling glides with 1" (25.4 mm) height adjustment.

Cable Column Construction: The Cable Column is 20-gauge steel, with a 14-gauge floor mount bracket and 12-gauge table mount bracket.

Column Base Conference Tables

Column Base: The column base frame consists of two sets (one at top and one at bottom) of four 16-gauge steel horizontal tubes welded to four 14-gauge steel vertical tubes to form a frame. Four .245 thick (6.2mm) steel top plates are welded to the top of the vertical tubes and four 0.250" thick (6.3mm) steel glide plates are welded to the bottom set of horizontal tubes. Frame is bolted to an optional .375" thick (9.5mm) round or square base plate with four non-adjustable glides. Base plate will have either a 6" (152 mm) x 6" (152 mm) or 8" (203 mm) x 8" (203 mm) cutout for routing of power and data cables. Attachment hardware allows for 0.75" (19mm) adjustment.

Column Base Cladding: Available with flat or round 18-gauge steel cladding which attach with hooks to column base for easy access. Cladding is available with painted or veneer finish.

Technical Specifications – Planes Conference Tables

Easels, Information Boards and Wall Rail System Construction

Easels: The frame, tray and legs are constructed of aluminum with a polypropylene top cap and injection molded composite casters (two locking and two non-locking) or glides. The Standard Easel accommodates one Information Board on each side while the Large Easel stores two Information Boards on each side. The center board has a 0.64" (16.3 mm) thick medium density fiberboard (mdf) core with laminate skins and Acrylonitrile Butadiene Styrene (ABS) edgeband. Both sides are writeable.

Information Boards: Constructed of 0.64" thick (16.3 mm) medium density fiberboard (mdf) with 0.039" thick (1 mm) edgeband on the edge. Offers writeable surface on one side and weighs 19 pounds. The Information Boards include cleats and bumpers to mount to Horizontal Wall Rails and/or Easels.

Horizontal Wall Rail: Provides extruded aluminum rails, 96" long (2438 mm) which can be field cut to size. The lower rail serves as a 2.25" deep (57 mm) marker tray.

Cart Construction

Cart Construction, General: Vertical and horizontal frame components are extruded aluminum. Most carts are available with either laminate or veneer surfaces except the Catering cart, which is laminate only. Core is constructed of particleboard, thicknesses are indicated below. Edges are 0.039" (1 mm) thick edgeband on laminate or 0.024" (.6 mm) thick wood edgeband with veneer surface. Each cart has the option of either glides or two locking and two non-locking casters. Casters and glides are 3.15" high (80 mm), with glides offering 0.5" height (12.7 mm) adjustment.

Small Media Carts: One internal shelf is included with routes on the underside to seat onto supporting pins. Shelf is height-adjustable in 1" (25.4 mm) increments. Carts has one door that utilizes a touch latch mechanism to hold door closed and a spring to push door open when disengaged. Top panel – 1.125" (28.6 mm) thick; side panel, back panel, bottom panel, shelves – 0.688" (17.5 mm) thick.

Medium Media Carts: Internal shelving included with routes on the underside to seat onto supporting pins. Shelf is height-adjustable in 1" (25.4 mm) increments. Two lower doors utilize a touch latch mechanism to hold doors closed and a spring to push door open when disengaged. Two upper (flap) doors are held closed with a magnetic push available in either black or chrome trim. Top panel, side panel, back panel, bottom panel, shelves – 0.688" (17 mm) thick. latch. Optional locks for doors are

Catering Carts: Include one center side access compartment with an adjustable shelf in 3.5" (89 mm) increments. Carts include two beverage compartments with retaining rails on either end. Top panel – 1.125" thick (28.6 mm); side panel, back panel, bottom panel, shelves – 0.688" (17.5 mm) thick.

Cart Podium: A 21" (533 mm) x 21" (533 mm) sloping top features an aluminum paper edge. The user side of the podium has an open shelf and lower storage with lockable touch latch door and one internal shelf with routes on the underside to seat onto supporting pins. The shelf is height-adjustable in 1" (25.4 mm) increments. The Podium back has a lockable full height door with full height enclosure for power and cable management.

Credenza Construction

Credenza Tops: Laminate top versions consist of a 1.125" (28.6 mm) thick engineered composite panel core with a 0.028" thick laminate face, 0.028" (.7 mm) thick backer and 0.039" (1 mm) thick edgeband. Veneer tops consist of a 1.125" (28.6 mm) thick engineered composite panel core with a 0.020" (.5 mm) thick veneer face, 0.020" (.5 mm) thick backer and 0.024" (.6 mm) thick edgeband

Credenza Bases: Credenza base configurations include: two doors - 36" (914 mm) width; three doors - 48" (1219 mm) and 54" (1372 mm) widths; 4 doors – 72" (1829 mm) width; 6 doors – 96" (2438 mm) and 108" (2743 mm) widths. Bases are 19.5" (495 mm) deep and available in 19" (483 mm) high with a single shelf or 29" (737 mm) high with two shelves. Shelves adjust in 1.25" (31.7 mm) increments. Credenza base legs are powder coat painted cast aluminum with a glide that provides 0.5" (12.7 mm) height adjustment. Credenzas are constructed with engineered composite panel core and are available with either laminate or veneer surface. Laminate versions are finished with a balanced 0.028" (.7 mm) thick laminate with 0.039" (1 mm) thick edgeband along exposed edges. Veneer credenza panels are finished with a balanced 0.020" (.5 mm) thick veneer with 0.024" (.6 mm) thick wood edgeband on exposed edges. A touch latch mechanism holds doors closed with a spring to push the door open when disengaged. The doors are available with a locking option.

Credenza Slider Units: 10" (254 mm) and 16" (406 mm) heights and 36" (914 mm) and 54" (1372 mm) widths are available. Core construction is an engineered composite panel core with either laminate or veneer on the case. All slider unit panel cores are 0.688" (17.5 mm) thick with balanced 0.028" (.7 mm) thick laminate or 0.020" (.5 mm) thick veneer on both sides. Slider doors are tempered glass or acrylic and are available with a lock option offered in either black or chrome. Door pulls are extruded aluminum and powder coat painted.

Technical Specifications – Planes Conference Tables

Power and Data Systems

Flip Top Unit Detail: Corded and hardwire Flip Top Units are listed for U.S. and Canadian safety standards by Underwriters Laboratories, Inc. (UL & ULC). The Flip Top Units are available in single and double-sided configurations in data and electrical Port counts and sit flush with table top. A spring assist mechanism opens the top to provide access to electrical and data ports. Single-sided ports are fed with either a single, three (3) conductor 12' black 15-Amp cord with plug (NEMA 5-15P) or a hardwire version which consists of (3) 12 AWG wires enclosed within one 3/8" (9.5 mm) flexible metal conduit, 6' (1829 mm) in length. Double-sided units are fed with either a pair of three (3) conductor 12' (3658 mm) black 15-Amp cords with plug (NEMA 5-15P) or a hardwire version which consists of a pair of three (3) 12 AWG wires enclosed within one 3/8" flexible metal conduit 6' in length. Flip top units include adapters for most types of field supplied data jacks. Flip top units also include mounting clips and are standard in an anodized aluminum finish.

Specification Guide Immerse Tables

Table of Contents – Immerse Tables Specification Guide

Statement of Line	
Statement of Line	312
Product Details	
Product Introduction	314
Product Introduction – The Immerse Family of Tables.....	315
Top Construction and Edge Details	316
Table Heights	317
Single Tables	
Round	318
Square	319
Rectangle (One-Piece Top)	320
Rectangle (Two-Piece Top)	321
Racetrack	322
Stack Tables	
Rectangle (One-Piece Top)	323
Rectangle (Two-Piece Top)	324
Shift Tables	
Rectangle / Rectangle	325
Rectangle / Round.....	326
Racetrack / Round	327
Overlap Table	
Rectangle / Rectangle	328
Rectangle / Round.....	329
Racetrack / Round	330
Rectangle / Ledge	331
Ledge Table	332
Planter Oblong.....	333
Planter Round.....	334
Technical Specifications	
Statement of Line	336

Statement of Line Immerse Tables

Statement of Line – Immerse Tables

Single Tables (Shown with optional cutout for separately specified Planter)

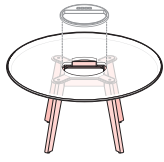

Single Table – Round

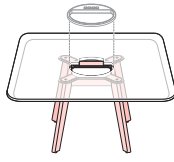

Single Table – Square

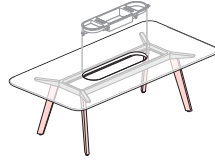

Single Table – Rectangle
(One Piece Top)

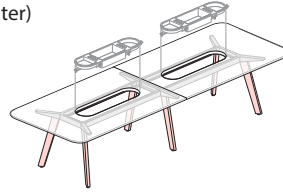

Single Table – Rectangle
(Two Piece Top)

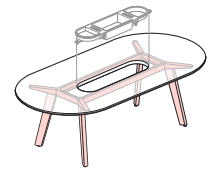

Single Table – Racetrack

Stack Tables (Shown with optional cutout for separately specified Planter)

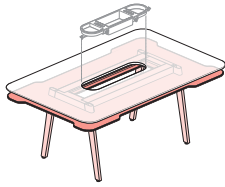

Stack Table – Rectangle
(One Piece Top)

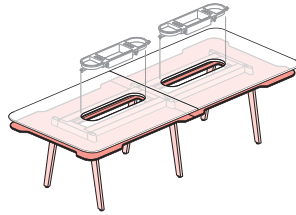

Stack Table – Rectangle
(Two Piece Top)

Shift Tables (Shown with optional cutout for separately specified Planter)

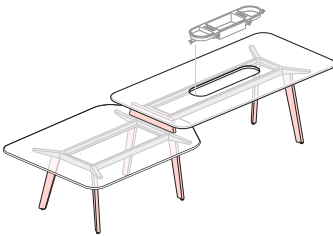

Shift Table –
Rectangle/Rectangle

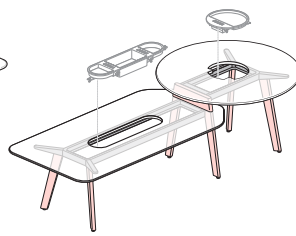

Shift Table –
Rectangle/Round

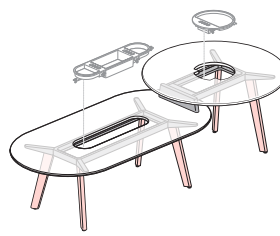

Shift Table –
Racetrack/Round

Overlap Tables (Shown with optional cutout for separately specified Planter)

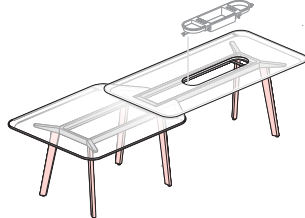

Overlap Table –
Rectangle/Rectangle

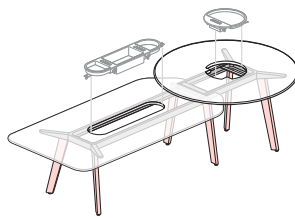

Overlap Table –
Rectangle/Round

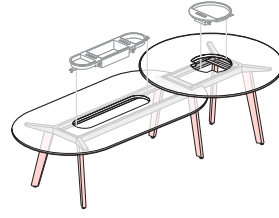

Overlap Table –
Racetrack/Round

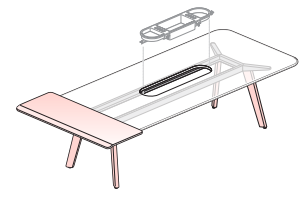

Overlap Table –
Rectangle/Ledge

Ledge Table



Ledge Table –
Rectangle

Planters

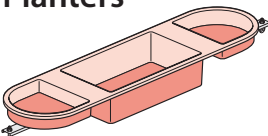

Planter Oblong
No Power

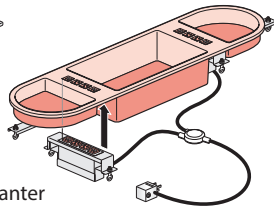

Planter
Oblong – Powered

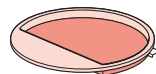

Planter Round
No Power

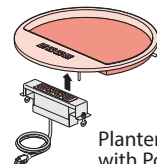

Planter Round
with Power
(Corded or Hardwire)

Product Details Immerse Tables

Product Details – Immerse Tables

Product Introduction

The Power of Spontaneous Collaboration

Human beings are social creatures. We crave interaction and thrive in moments of spontaneity. Immerse tables were thoughtfully designed out of a design partnership between Haworth and Patricia Urquiola to help us connect, collaborate, and engage. They create a landscape of varied surfaces, providing a welcoming community hub that transforms collaborative experiences, warms up the work environment, and promotes well-being.

Catalyst for Collaboration

Creativity and innovation can take shape at a moment's notice with Immerse. A catalyst for spontaneous collaboration, each table creates a social hub that invites serendipity, variety, and choice in the workplace.

Happily Engaged

Culture can't be forced or manufactured. But it can be nurtured. Immerse captures the feeling of home in the workplace. Warm and welcoming, the tables' comfortable, people-centric design keeps everyone inspired and engaged.

Positive Energy

It's proven. Healthy humans create positive energy that delivers better performance in the workplace. Immerse focuses on our natural movements, creating a landscape for you to sit, stand, and support your overall well-being.



Product Details – Immerse Tables

Product Introduction – The Immerse Family of Tables

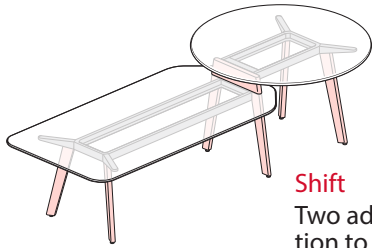

Shift

Two adjacent worktops, each at varied heights, supports natural inclination to work together. Considered the workhorse of the workplace.

Rectangle/Rectangle – 60" x 156" (Lower: 60" x 86" / Upper: 48" x 96")
Racetrack/Round – 48" x 138" (Lower: 48" x 96" / Upper: 60" x 60")
Rectangle/Round – 48" x 138" (Lower: 48" x 96" / Upper: 60" x 60")

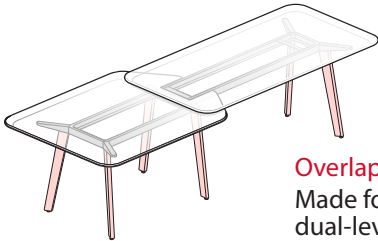

Overlap

Made for movement, sitting or standing, Overlap features a unique dual-level workspace designed to stimulate overall well-being.

Rectangle/Round – 48" x 138" (Lower: 48" x 96" / Upper: 60" x 60")
Rectangle/Ledge – 48" x 124" (Lower: 48" x 120" / Upper: 22" x 57")
Rectangle/Rectangle – 60" x 156" (Lower: 60" x 78" / Upper: 48" x 96")
Racetrack/Round – 48" x 138" (Lower: 48" x 96" / Upper: 60" x 60")

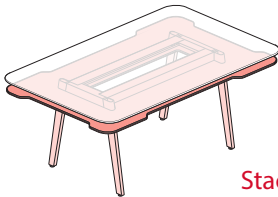

Stack

Stack's double-layer, lower sill gives you the space, storage and flexibility to do your best work, on your own terms.

Rectangle – 60" x 96", 60" x 120", 60" x 144"

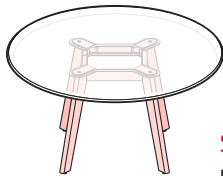

Single

Round – 48", 60"
Square – 48", 60"
Rectangle – 48" x 96", 48" x 144", 60" x 120", 60" x 144"
Racetrack – 48" x 96"

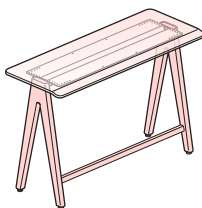

Ledge

Great for impromptu conversations, or a place to buckle down and get busy.

Rectangle – 22" x 57"

Product Details – Immerse Tables

Table Top Construction and Edge Details

(W) Wood Top Surface Options

- Standard core with a specified wood veneer top finish and matching edgeband finish/color.
- Edge Detail: Knife Edge is standard on all sides/edges of top.

(L) Laminate Top Surface Options

- Standard core with a specified laminate top finish and a separate specification for edgeband finish/color.
- Edge Detail: Knife Edge is standard on all sides/edges of top.

(P) Painted Top Surface Option

- MDF core with painted top and edge.
- Edge Detail: Knife Edge on all sides/edges of top

(S) Solid Surface Top Surface Options

- Built up solid surface edge (4" deep around table perimeter) with a 1/2" wood core.
- Solid Surface color is standard in Cameo White.
- Edge Detail: Knife Edge on all sides/edges of top

Edge Detail for Single, Shift and Overlap Table Tops

(W) Wood Top Option

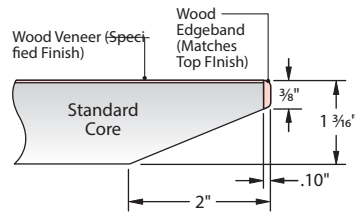

(L) Laminate Top Option

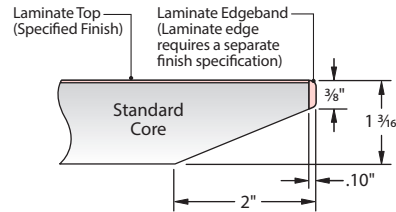

(P) Painted Top Option

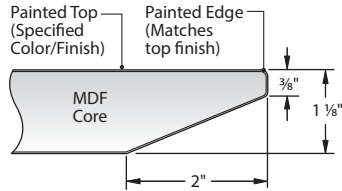

(S) Solid Surface Top Option

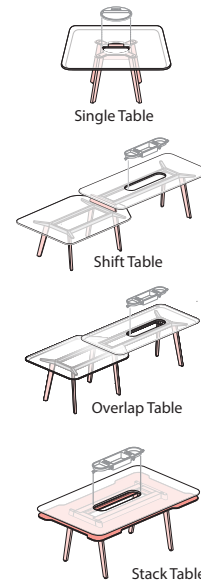
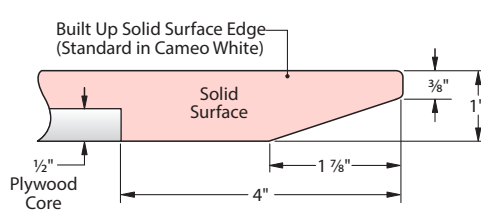

Edge Detail for Stack Tables

(W) Wood Top / Solid Surface Sill

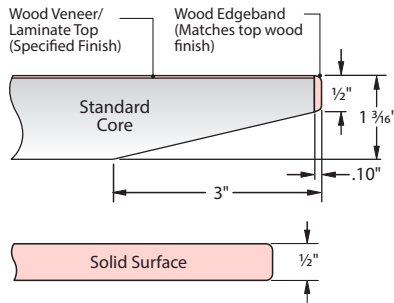

(L) Laminate Top / Laminate Sill

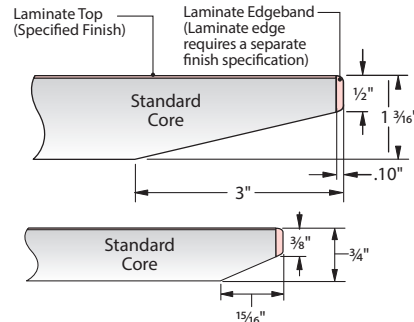

(S) Solid Surface Top / Solid Surface Sill

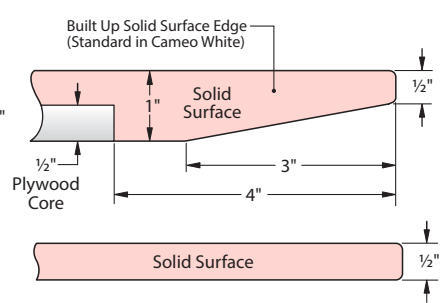

Note The Painted Surface Option (P) is not available with the Stack Table.

Edge Detail for Ledge Top

Wood or Laminate Top Option

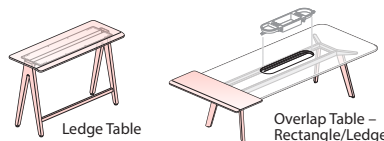
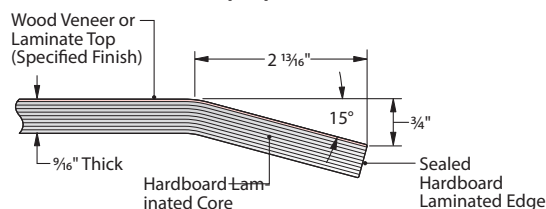

Product Details – Immerse Tables

Table Heights

- Immerse Tables are designed with variety of available heights, to accommodate both sitting and standing work styles.

29" Table Tops

- For use with standard seated height applications.
- Specify with standard seated height chairs.



The 29" high table top is for use with most standard seated height chairs.

36" High Table Tops

- For use with seated or standing applications.
- Specify with counter height stools.

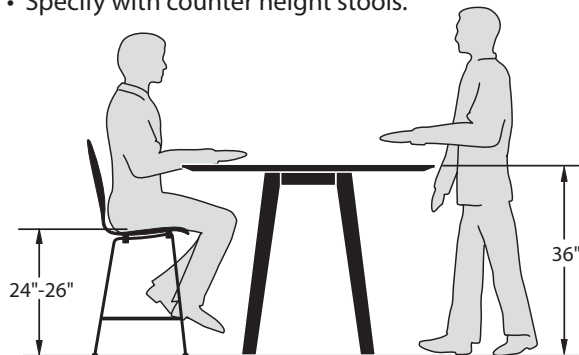

The 36" high table top is for use with most counter height stools or standing applications.

39" High Table Tops

- For use with seated or standing applications.
- Specify with bar height stools.

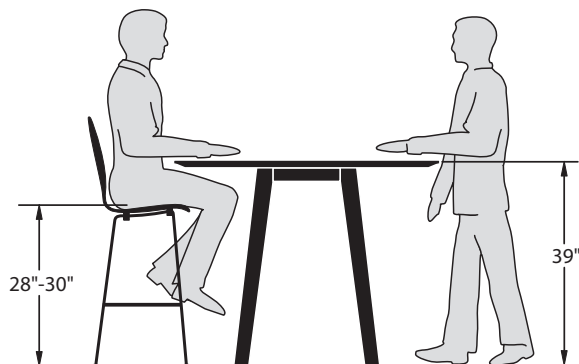

The 39" high table top is for use with most bar height stools or standing applications.

Note The Immerse Overlap Tables includes an upper top that may be specified 30 ½" high or 37 ½" high.

- 30 ½" high table tops should be specified with standard seating height chairs.
- 37 ½" high table tops may be specified with counter height or bar height stools.

Ensure seating is specified to provide proper user alignment with the top while providing adequate clearance below the top for user legs, see product details section for table dimensions.

Product Details – Immerse Tables

Single Table

Round (One Piece Top)

- Includes round top, (4) legs with adjustable glides, understructure and hardware.
- For added storage and power access, 60" diameter tables may be specified with cutout option (P) and a separately specified Round Planter (not available with 48" diameter round tables).

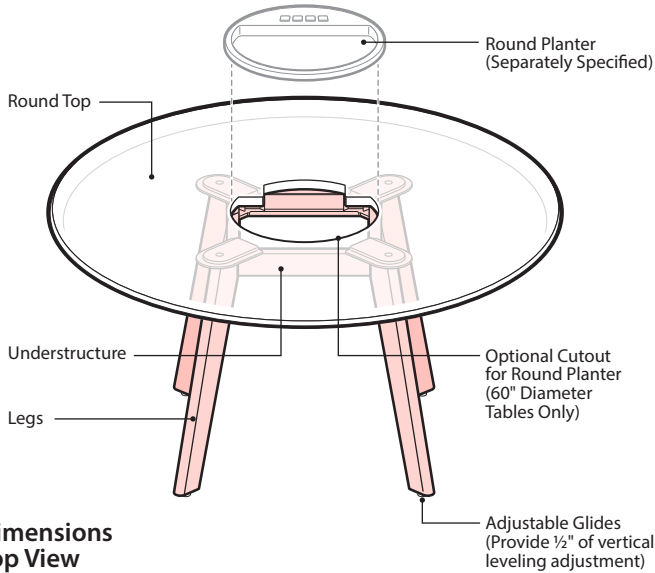

Dimensions Top View

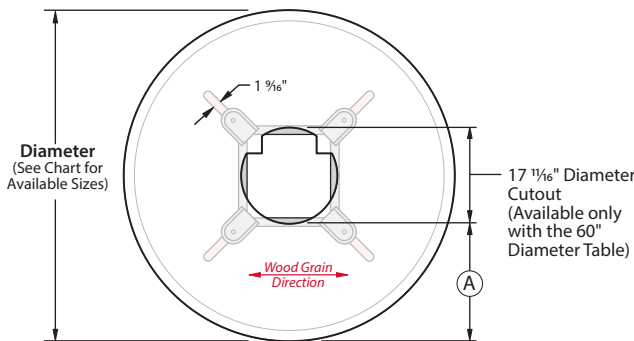

Front View

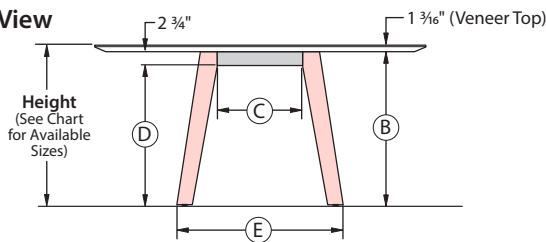

Dimensions by Table Size

Heights Nominal (Actual) (Veneer Top With glides fully recessed)	Diameter Nominal (Actual)	Top Dimensions				
		A	B	C	D	E
29" (29.43")	48" (48.00")	N/A*	28 1/4"	10 5/16"	25 1/2"	25 5/16"
	60" (60.00")	21 3/16"	28 1/4"	15 9/16"	25 1/2"	25 5/16"
36" (36.18")	48" (48.00")	N/A*	35"	12 1/16"	32 1/4"	27 1/4"
	60" (60.00")	21 3/16"	35"	16 1/16"	32 1/4"	31 1/4"
39" (39.18")	48" (48.00")	N/A*	38"	12 1/16"	35 1/4"	27 7/16"
	60" (60.00")	21 3/16"	38"	16 1/16"	35 1/4"	31 7/16"

*48" Diameter Tables are not available with cutout option.

Component Materials and Finishes

COMPONENT NAME	MATERIALS/FINISHES	
Round Top (Standard with Knife Edge)	(L) Laminate	Standard Core - Specify surface color and a separate edge finish color
	(P) Painted	MDF Core with Specified Paint finish.
	(S) Solid Surface	Wood core/built up Solid Surface edge, Standard in Cameo White.
Legs	(W) Wood	Standard Core - Specify a single color for the surface and edge finishes.
	Solid Wood	Ink on Ash (M7-W43) Clear on White Oak (M5-W35) Clear on Walnut (M6-W35)
	Painted	Painted metal - specified trim color
Understructure	Painted Metal with specified trim color	
Adjustable Glides	Standard in Black	

Table Heights

- Available in three heights for seated or standing applications.



Seating Capacity

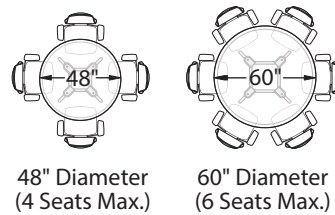

Optional Cutout for Round Planter

- For added storage and power 60" diameter tables may be specified with cutout option (P) to accommodate a separately specified Round Planter.
- The Round Planter may be specified with or without power.

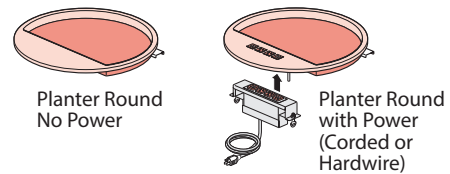

Product Details – Immerse Tables

Single Table

Square (One Piece Top)

- Includes square top, (4) legs, adjustable glides, understructure and hardware.
- For added storage and power access, 60" square tables may be specified with cutout option (P) and a separately specified Round Planter (not available with 48" deep square tables).

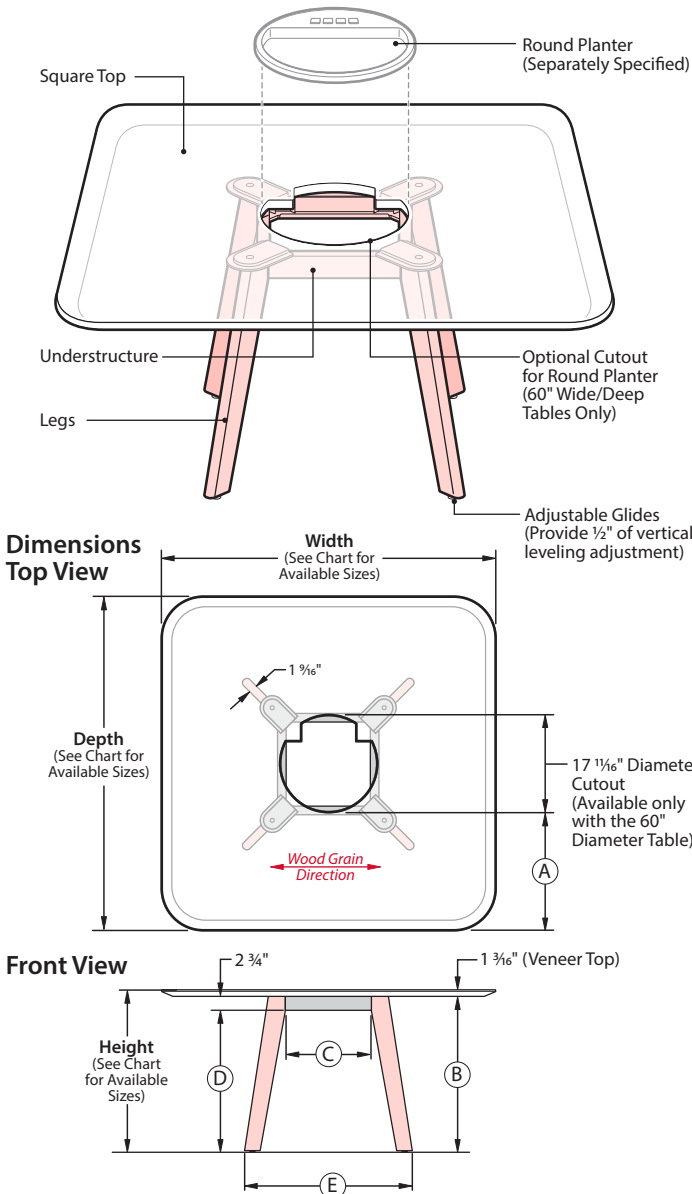

Dimensions by Table Size

Heights Nominal (Actual) (Veneer Top With glides fully recessed)	Diameter Nominal (Actual)	Top Dimensions				
		A	B	C	D	E
29" (29.43")	48" (48.00")	N/A*	28 1/4"	14"	25 1/2"	29"
	60" (60.00")	21 3/16"	28 1/4"	19 1/2"	25 1/2"	34 1/2"
36" (36.18")	48" (48.00")	N/A*	35"	15 13/16"	32 1/4"	30 3/8"
	60" (60.00")	21 3/16"	35"	20 1/16"	32 1/4"	35 1/4"
39" (39.18")	48" (48.00")	N/A*	38"	15 13/16"	35 1/4"	31 1/16"
	60" (60.00")	21 3/16"	38"	20 1/16"	35 1/4"	34 15/16"

*48" Wide/Deep Tables are not available with cutout option.

Component Materials and Finishes

COMPONENT NAME	MATERIALS/FINISHES	
Square Top (Standard with Knife Edge)	(L) Laminate	Standard Core - Specify surface color and a separate edge finish color
	(P) Painted	MDF Core with Specified Paint finish.
	(S) Solid Surface	Wood core/built up Solid Surface edge, Standard in Cameo White.
	(W) Wood	Standard Core - Specify a single color for the surface and edge finishes.
Legs	Solid Wood	Ink on Ash (M7-W43) Clear on White Oak (M5-W35) Clear on Walnut (M6-W35)
	Painted	Painted metal - specified trim color
Understructure	Painted Metal - specified trim color	
Adjustable Glides	Standard in Black	

Table Heights

- Available in three heights for seated or standing applications.

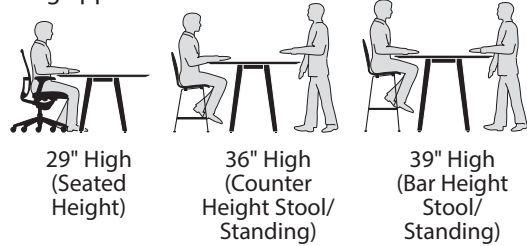

Seating Capacity

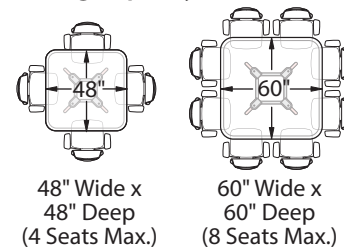

Optional Cutout for Round Planter

- For added storage and power 60" wide/deep tables may be specified with cutout option (P) to accommodate a separately specified Round Planter.
- The Round Planter may be specified with or without power.

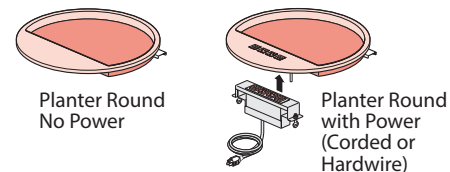

Product Details – Immerse Tables

Single Table

Rectangle (One Piece Top)

- Includes a rectangle top, (4) legs, understructure, adjustable glides, and hardware.
- For storage and/or power access, specify option (P) for Cutout. Cutout works with separately specified Oblong Planter.

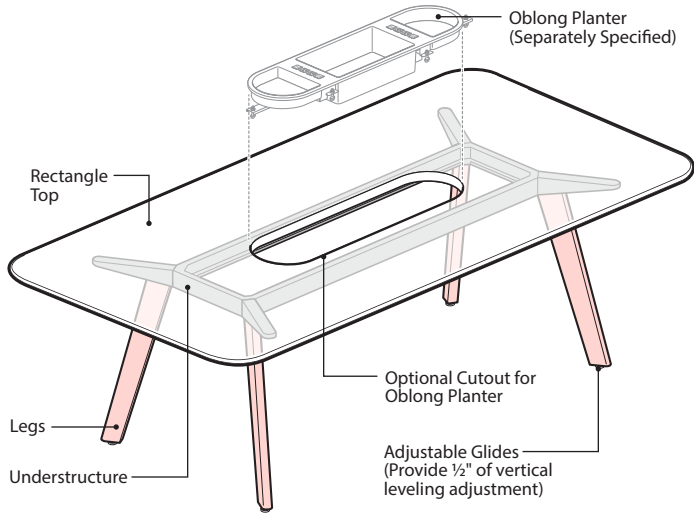

Component Materials and Finishes

COMPONENT NAME	MATERIALS/FINISHES	
Rectangle Top (1-Piece, Standard with Knife Edge)	(L) Laminate	Standard Core - Specify surface color and a separate edge finish color
	(P) Painted	MDF Core with Specified Paint finish.
	(S) Solid Surface	Wood core/built up Solid Surface edge, Standard in Cameo White.
	(W) Wood	Standard Core - Specify a single color for the surface and edge finishes.
Legs	Solid Wood	Ink on Ash (M7-W43) Clear on White Oak (M5-W35) Clear on Walnut (M6-W35)
	Painted	Painted metal – specified trim color
Understructure	Painted Metal – specified trim color	
Adjustable Glides	Standard in Black	

Table Heights

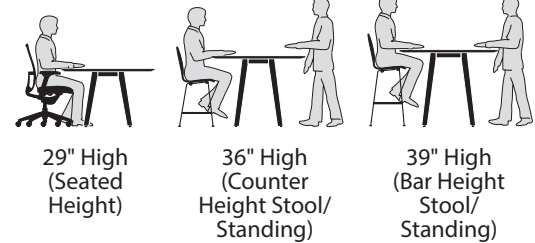

Dimensions Top View

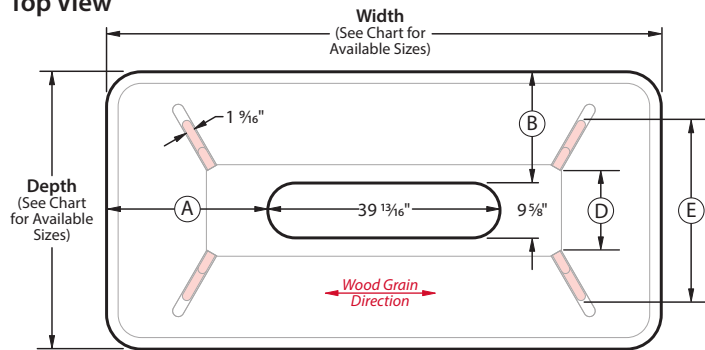

Seating Capacity

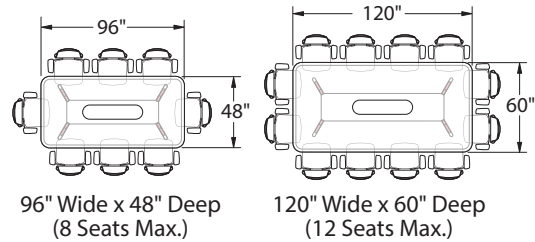

Front View

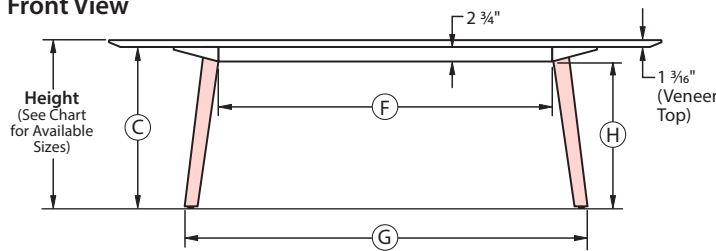

Optional Cutout for Oblong Planter

- For added storage and power specify cutout option (P) to accommodate a separately specified Oblong Planter.
- The Oblong Planter may be specified with or without power.

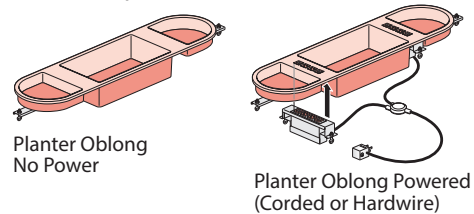

Dimensions by Table Size

Heights Nominal (Actual) (Veneer Top With glides fully recessed)	Depths Nominal (Actual)	Widths Nominal (Actual)	Top Dimensions			Kneespace Dimensions				
			A	B	C	D	E	F	G	H
29" (29.43")	48" (48.00")	96" (96.00")	28 1/8"	19 3/16"	28 1/4"	13 1/16"	31 7/8"	57 3/4"	70 1/16"	25 1/2"
	60" (60.00")	120" (120.00")	40 1/8"	25 3/16"	28 1/4"	16 3/8"	34 3/16"	78 1/2"	90 7/8"	25 1/2"
36" (36.18")	48" (48.00")	96" (96.00")	28 1/8"	19 3/16"	35"	13 1/16"	31 3/16"	57 3/4"	69 3/4"	32 1/4"
	60" (60.00")	120" (120.00")	40 1/8"	25 3/16"	35"	16 3/8"	33 7/8"	78 1/2"	90 7/16"	32 1/4"
39" (39.18")	48" (48.00")	96" (96.00")	28 1/8"	19 3/16"	38"	13 1/16"	32 3/16"	57 3/4"	70 5/16"	35 1/4"
	60" (60.00")	120" (120.00")	40 1/8"	25 3/16"	38"	16 3/8"	34 7/8"	78 1/2"	91 1/16"	35 1/4"

Product Details – Immerse Tables

Single Table

Rectangle (Two Piece Top)

- Includes a 2-piece rectangle top, (6) legs with adjustable glides, understructure and hardware.
- For storage and/or power access, specify option (P) for Cutout. Cutouts works with (2) separately specified Oblong Planters.

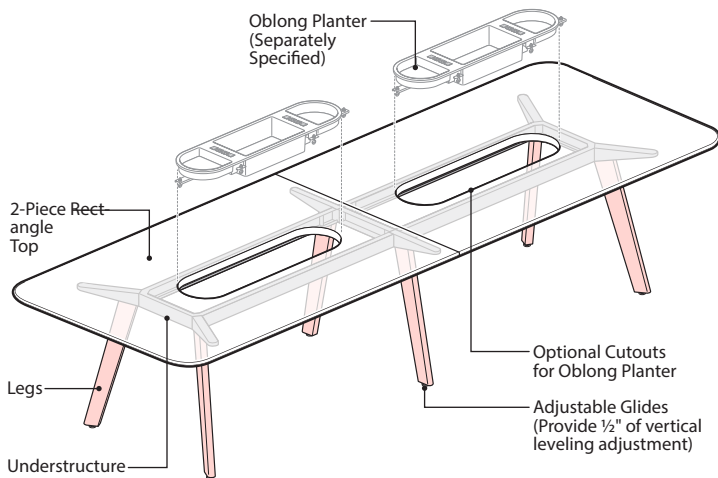

Dimensions Top View

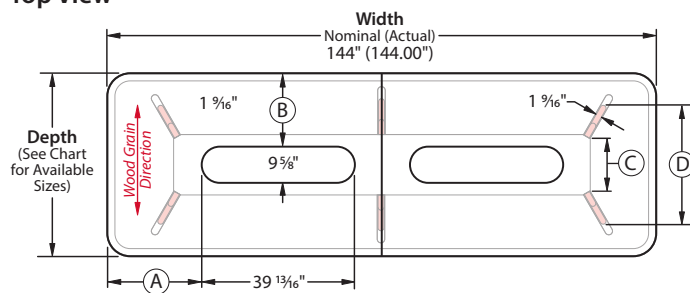

Front View

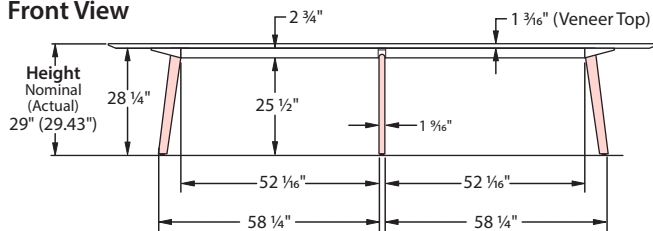

Dimensions by Table Depth

Heights Nominal (Actual) (Veneer Top With glides fully recessed)	Depths Nominal (Actual)	Widths Nominal (Actual)	Top Dimensions		Kneespace Dimensions	
			A	B	C	D
29" (29.43")	48" (48.00")	144" (144")	24 15/16"	19 3/16"	13 1/16"	31 7/8"
	60" (60.00")	144" (144")	24 15/16"	25 3/16"	16 3/8"	34 9/16"

Component Materials and Finishes

COMPONENT NAME	MATERIALS/FINISHES	
Rectangle Top (2-Piece, Standard with Knife Edge)	(L) Laminate	Standard Core - Specify surface color and a separate edge finish color
	(P) Painted	MDF Core with Specified Paint finish.
	(S) Solid Surface	Wood core/built up Solid Surface edge, Standard in Cameo White.
	(W) Wood	Standard Core - Specify a single color for the surface and edge finishes.
Legs	Solid Wood	Ink on Ash (M7-W43) Clear on White Oak (M5-W35) Clear on Walnut (M6-W35)
	Painted	Painted metal - specified trim color
Understructure	Painted Metal - specified trim color	
Adjustable Glides	Standard in Black	

Table Heights



29" High
(Seated Height)

Seating Capacity

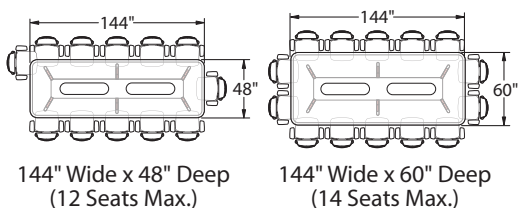

Optional Cutout for Oblong Planter

- For added storage and power specify cutout option (P) to accommodate a separately specified Oblong Planter.
- The Oblong Planter may be specified with or without power.

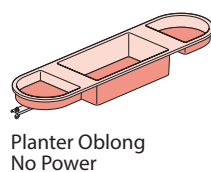

Planter Oblong
No Power

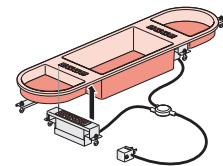

Planter Oblong Powered
(Corded or Hardwire)

Product Details – Immerse Tables

Single Table

Racetrack (One Piece Top)

- Includes a racetrack shaped top, (4) legs, understructure, adjustable glides, and hardware.
- For storage and/or power access, specify option (P) for Cutout. Cutout works with separately specified Oblong Planter.

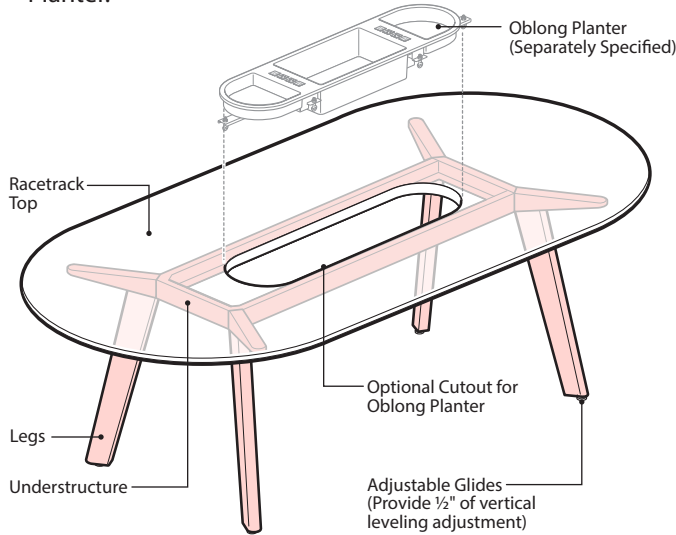

Dimensions Top View

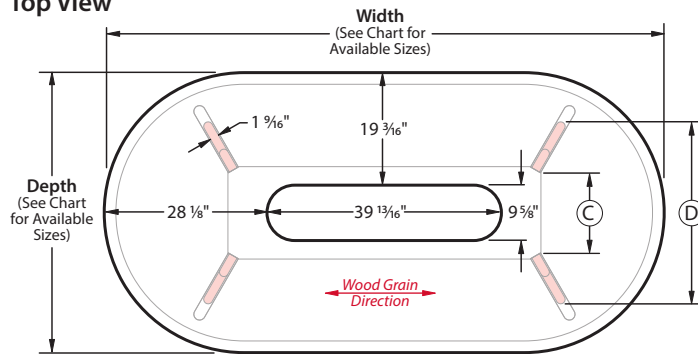

Front View

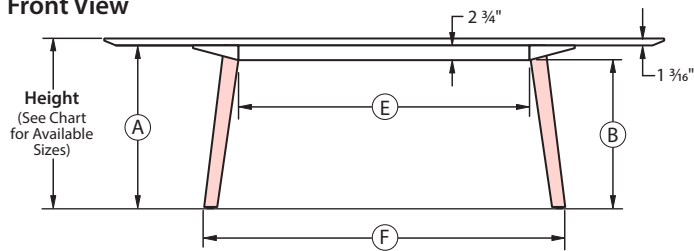

Dimensions by Table Size

Heights Nominal (Actual) (Veneer Top With glides fully recessed)	Depths Nominal (Actual)	Widths Nominal (Actual)	Kneespace Dimensions					
			A	B	C	D	E	F
29" (29.43")	48" (48.00")	96" (96.00")	28 1/4"	25 1/2"	13 11/16"	31 7/8"	49 15/16"	62 3/16"
36" (36.18")	48" (48.00")	96" (96.00")	35"	32 1/4"	13 11/16"	31 3/16"	49 15/16"	61 15/16"
39" (39.18")	48" (48.00")	96" (96.00")	38"	35 1/4"	13 11/16"	32 3/16"	49 15/16"	62 1/2"

Component Materials and Finishes

COMPONENT NAME	MATERIALS/FINISHES	
Racetrack Top (Standard with Knife Edge)	(L) Laminate	Standard Core - Specify surface color and a separate edge finish color
	(P) Painted	MDF Core with Specified Paint finish.
	(S) Solid Surface	Wood core/built up Solid Surface edge, Standard in Cameo White.
Legs	(W) Wood	Standard Core - Specify a single color for the surface and edge finishes.
	Solid Wood	Ink on Ash (M7-W43) Clear on White Oak (M5-W35) Clear on Walnut (M6-W35)
Understructure	Painted	Painted metal - specified trim color
Adjustable Glides	Painted Metal - specified trim color	
Adjustable Glides	Standard in Black	

Table Heights

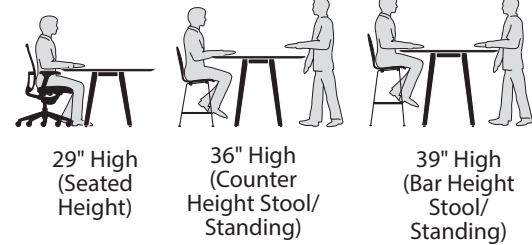

Seating Capacity

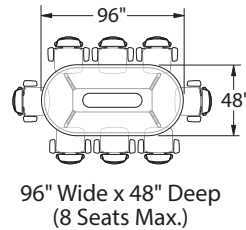

Optional Cutout for Oblong Planter

- For added storage and power specify option (P) to accommodate a separately specified Oblong Planter.
- The Oblong Planter may be specified with or without power.

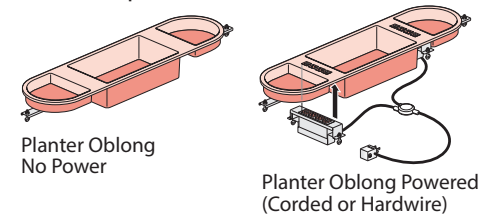

Product Details – Immerse Tables

Stack Table

Rectangle (One-Piece Tops – Upper Top and Sill)

- Includes a 1-piece upper top and sill below, (4) legs, under-structure, adjustable glides, and hardware.
- For storage and/or power access, specify option (P) for Cutout. Cutout works with separately specified Oblong Planter.

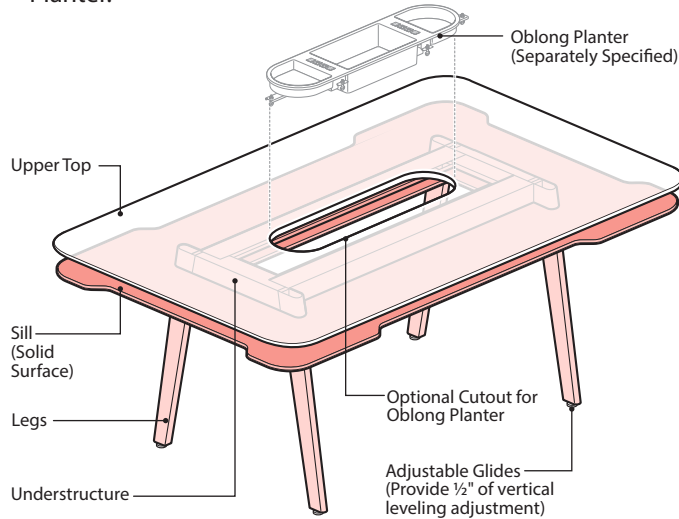

Dimensions Top View

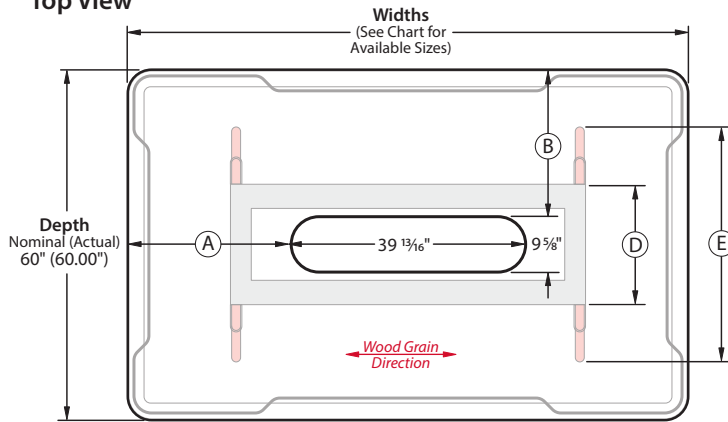

Front View

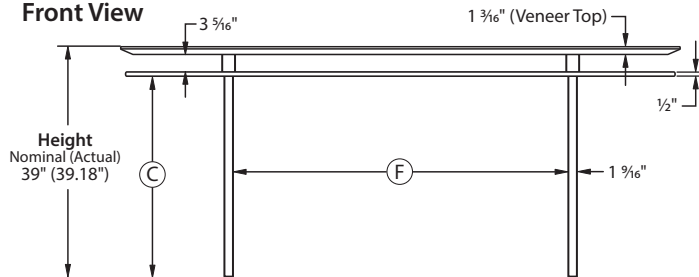

Dimensions by Table Size

Heights Nominal (Actual) (Veneer Top With glides fully recessed)	Depth Nominal (Actual)	Widths Nominal (Actual)	Top Dimensions			Kneespace Dimensions		
			A	B	C	D	E	F
39" (39.18")	60" (60.00")	96" (96.00")	28 1/8"	25 3/16"	34 3/16"	21 1/8"	40 7/16"	57 7/16"
		120" (120.00")	40 1/8"	25 3/16"	34 3/16"	21 1/8"	40 7/16"	81 7/16"

Component Materials and Finishes

COMPONENT NAME	MATERIALS/FINISHES	
Upper Top and Sill	(L) Laminate Surface Option	Upper Top – Laminate Finish with Knife Edge. Specify surface color and a separate edge finish color. Sill – Laminate Finish with Knife Edge. Defaults to same finish as Upper Top.
	(S) Solid Surface Surface Option	Upper Top – Solid Surface with knife edge. Standard in Cameo White. Sill – Solid Surface with square edge. Standard in Cameo White.
	(W) Wood Surface Option	Upper Top – Wood Veneer Finish with Knife Edge. Specify a single wood finish/color for the surface and edge. Sill – Solid Surface with square edge. Standard in Cameo White.
Legs	Solid Wood	Ink on Ash (M7-W43) Clear on White Oak (M5-W35) Clear on Walnut (M6-W35)
	Painted	Painted metal – specified trim color
Understructure	Painted Metal with specified trim color	
Adjustable Glides	Standard in Black	

Table Heights

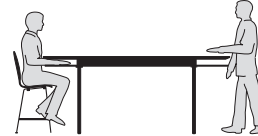

39" High
(Counter Height Stool/
Standing)

Seating Capacity

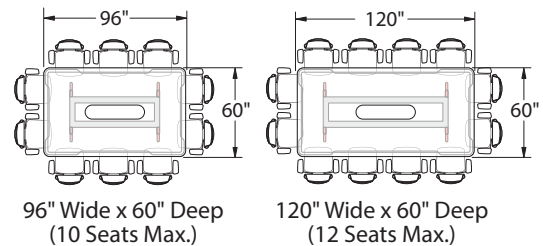

Optional Cutout for Oblong Planter

- For added storage and power specify cutout option (P) to accommodate a separately specified Oblong Planter.
- The Oblong Planter may be specified with or without power.

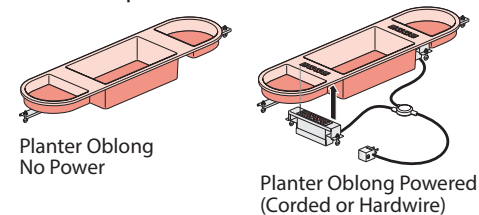

Product Details – Immerse Tables

Stack Table

Rectangle (Two-Piece Tops)

- Includes a 2-piece top above a 2-piece sill, (6) legs, under-structure, adjustable glides, and hardware.
- For storage and/or power access, specify option (P) for Cutout. Cutout works with separately specified Oblong Planter.

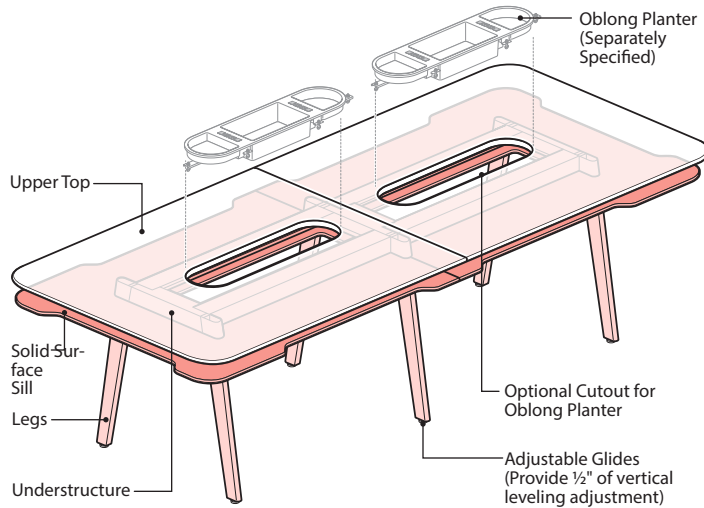

Dimensions Top View

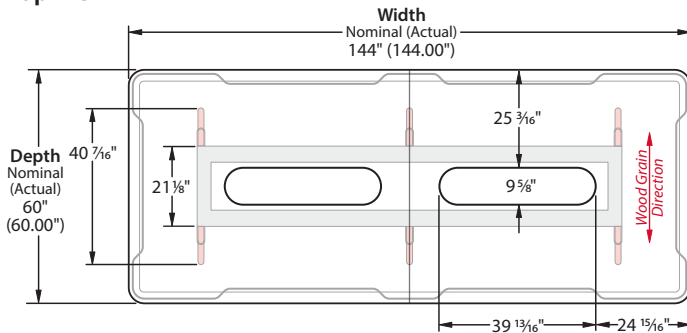

Front View

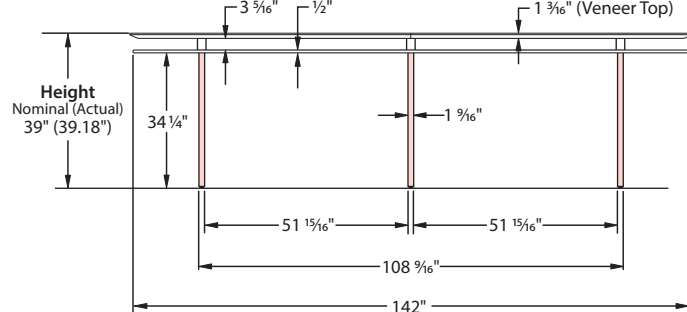

Component Materials and Finishes

COMPONENT NAME	MATERIALS/FINISHES	
Upper Top and Sill	(L) Laminate Surface Option	Upper Top – Laminate Finish with Knife Edge. Specify surface color and a separate edge finish color. Sill – Laminate Finish with Knife Edge. Defaults to same finish as Upper Top.
	(S) Solid Surface Surface Option	Upper Top – Solid Surface with knife edge. Standard in Cameo White. Sill – Solid Surface with square edge. Standard in Cameo White.
	(W) Wood Surface Option	Upper Top – Wood Veneer Finish with Knife Edge. Specify a single wood finish/color for the surface and edge. Sill – Solid Surface with square edge. Standard in Cameo White.
Legs	Solid Wood	Ink on Ash (M7-W43) Clear on White Oak (M5-W35) Clear on Walnut (M6-W35)
	Painted	Painted metal – specified trim color
Understructure	Painted Metal with specified trim color	
Adjustable Glides	Standard in Black	

Table Heights



39" High
(Counter Height Stool/
Standing)

Seating Capacity

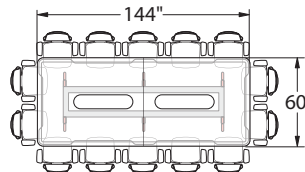

144" Wide x 60" Deep
(14 Seats Max.)

Optional Cutout for Oblong Planter

- For added storage and power specify cutout option (P) to accommodate a separately specified Oblong Planter.
- The Oblong Planter may be specified with or without power.

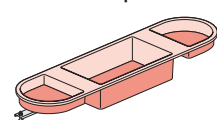

Planter Oblong
No Power

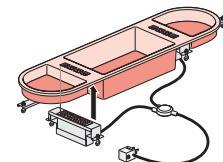

Planter Oblong Powered
(Corded or Hardware)

Product Details – Immerse Tables

Shift Table

Rectangle / Rectangle

- Includes an upper top, lower top, (6) legs, understructure, adjustable glides, stack spacer and hardware.
- For storage and/or power access, the upper top may be specified with a cutout option. Cutout works with separately specified Oblong Planter (Lower top may not be specified with Planter).

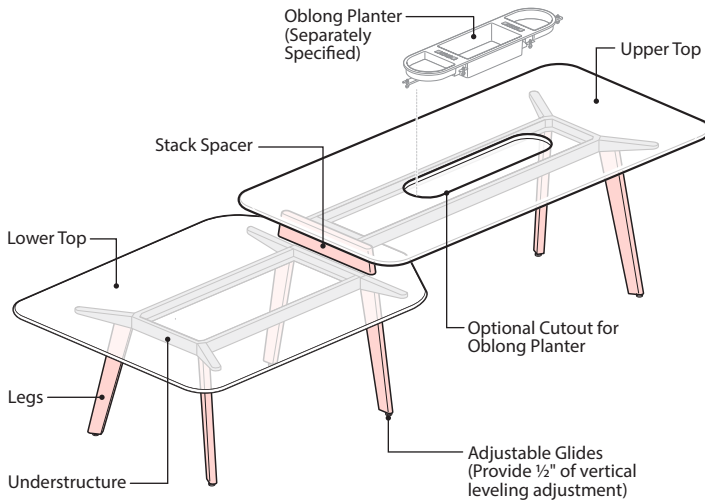

Dimensions Top View

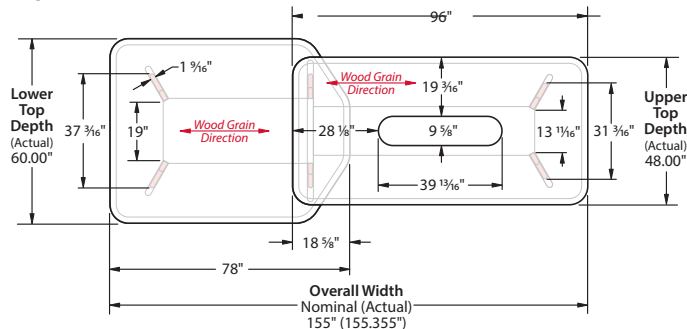

Front View

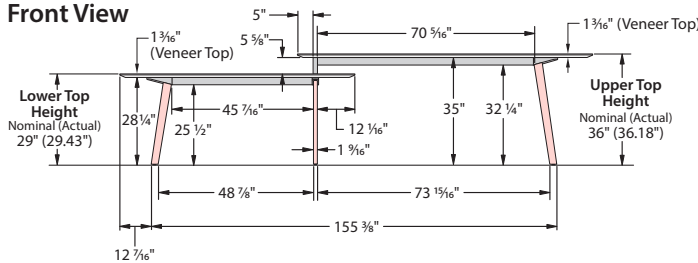

Seating Capacity

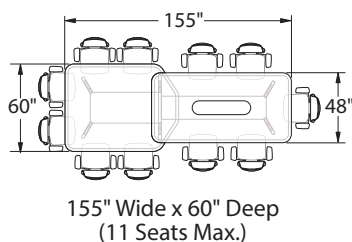

Component Materials and Finishes

COMPONENT NAME	MATERIALS/FINISHES	
Upper Top (Rectangle with Knife Edge)	Laminate	Standard Core - specify laminate finish/color and a separate edge finish/color.
	Painted	MDF Core - specify paint finish.
	Solid Surface	Wood Core – with built up solid surface edge. Standard in Cameo White.
	Wood	Standard Core - specify a single color/finish for the surface and edge finishes.
Lower Top (Rectangle with Knife Edge)	Laminate	Standard Core - specify surface finish/color and a separate edge finish color.
	Wood	Standard Core - specify a single color/finish for the surface and edge finishes.
	Solid Surface	Wood core with built up Solid Surface edge - Standard in Cameo White.
Legs	Solid Wood	Ink on Ash (M7-W43) Clear on White Oak (M5-W35) Clear on Walnut (M6-W35)
	Painted	Painted metal – specified trim color
Stack Spacer	See Stack Spacer section below	
Understructure	Painted Metal with specified trim color	
Adjustable Glides	Standard in Black	

Stack Spacer Finish

- The Stack Spacer may be specified with any Stack Spacer paint finish, except when both tops are specified with a laminate finish.
- EXCEPTION: when the upper and lower tops are both specified with a laminate finish, the Stack Spacer paint finish will be pre-defined to coordinate with the understructure trim color.

UNDERSTRUCTURE TRIM COLOR (Specified)	PRE-DEFINED STACK SPACER PAINT FINISH (Only when both tops are laminate)
Chartreuse (TR-CTS)	Chartreuse (LN-CTS)
Rusty Red (TR-RR)	Rusty Red (LN-RR)
Sable (TR-1M)	Sable (LN-1M)
Wren (TR-1K)	Wren (LN-1K)
All Other Trim Colors	Polar (LN-PL)

Table Heights

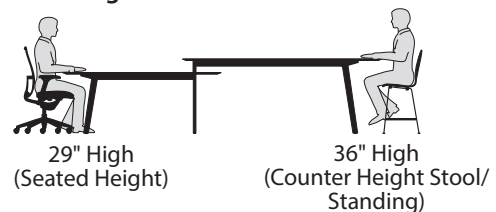

Optional Cutout for Oblong Planter

- For added storage and power specify cutout option (P) to accommodate a separately specified Oblong Planter.
- The Oblong Planter may be specified with or without power.

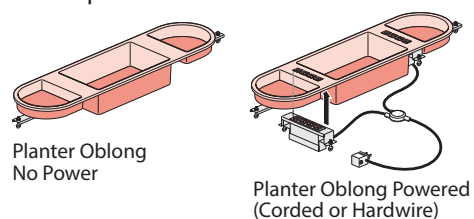

Product Details – Immerse Tables

Shift Table

Rectangle / Round

- Includes a rectangle lower top, round upper top, (6) legs, understructure, adjustable glides, stack spacer and hardware.
- For storage and/or power access, the tops may be specified with cutout options. Lower cutouts works with separately specified Oblong Planter, Upper Top works with separately specified Round Planter.

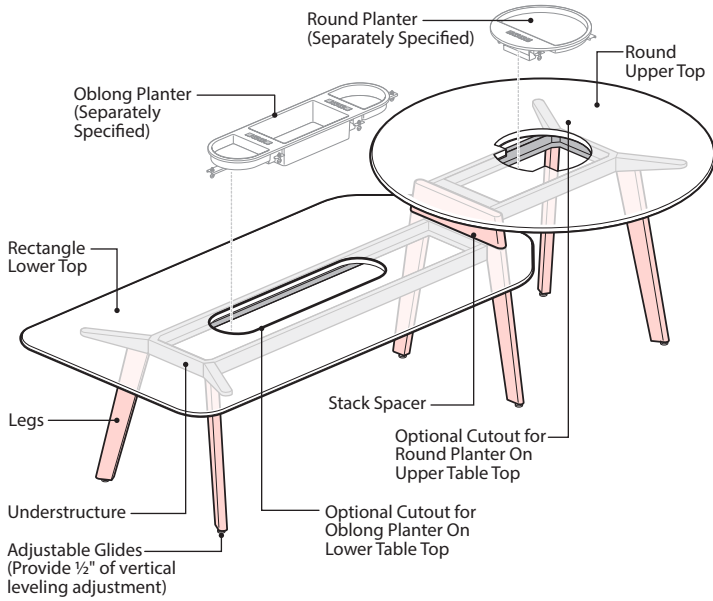

Dimensions Top View

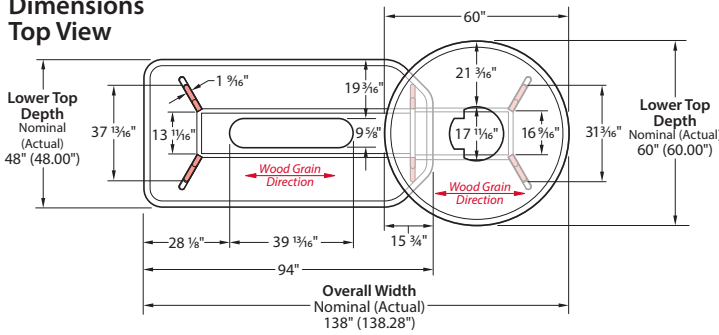

Front View

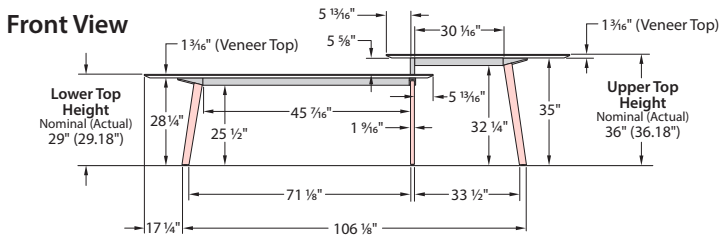

Seating Capacity

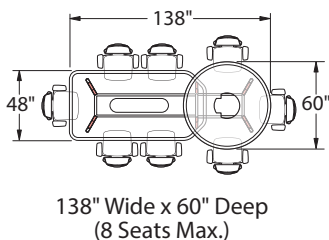

Component Materials and Finishes

COMPONENT NAME	MATERIALS/FINISHES	
Upper Top (Round with Knife Edge)	Laminate	Standard Core - specify surface finish/color and a separate edge finish color.
	Wood	Standard Core - specify a single color/finish for the surface and edge finishes.
	Solid Surface	Wood core with built up Solid Surface edge - Standard in Cameo White.
Lower Top (Rectangle with Knife Edge)	Laminate	Standard Core - specify laminate finish/color and a separate edge finish/color.
	Painted	MDF Core - specify paint finish.
	Solid Surface	Wood Core - with built up solid surface edge. Standard in Cameo White.
	Wood	Standard Core - specify a single color/finish for the surface and edge finishes.
Legs	Solid Wood	Ink on Ash (M7-W43) Clear on White Oak (M5-W35) Clear on Walnut (M6-W35)
	Painted	Painted metal - specified trim color
Stack Spacer	See Stack Spacer section below	
Understructure	Painted Metal with specified trim color	
Adjustable Glides	Standard in Black	

Stack Spacer Finish

- The Stack Spacer may be specified with any Stack Spacer paint finish, except when both tops are specified with a laminate finish.
- EXCEPTION: when the upper and lower tops are both specified with a laminate finish, the Stack Spacer paint finish will be pre-defined to coordinate with the understructure trim color.

UNDERSTRUCTURE TRIM COLOR (Specified)	PRE-DEFINED STACK SPACER PAINT FINISH (Only when both tops are laminate)
Chartreuse (TR-CTS)	Chartreuse (LN-CTS)
Rusty Red (TR-RR)	Rusty Red (LN-RR)
Sable (TR-1M)	Sable (LN-1M)
Wren (TR-1K)	Wren (LN-1K)
All Other Trim Colors	Polar (LN-PL)

Table Heights

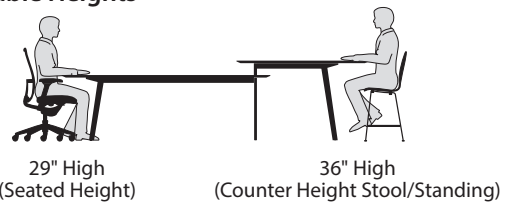

Optional Cutout for Oblong/Round Planters

- For added storage and power specify cutout option (P) to accommodate a separately specified Oblong and Round Planters.
- The Planters may be specified with or without power.

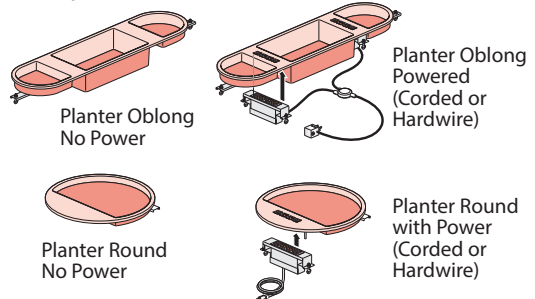

Product Details – Immerse Tables

Shift Table

Racetrack / Round

- Includes a racetrack shape lower top, round upper top, (6) legs, understructure, adjustable glides, stack spacer and hardware.
- For storage and/or power access, the tops may be specified with cutout options. Lower cutouts works with separately specified Oblong Planter, Upper Top works with separately specified Round Planter.

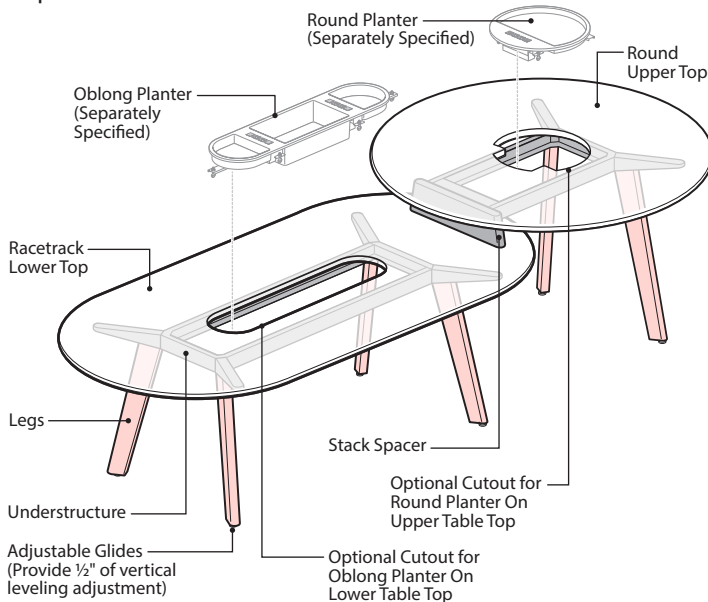

Dimensions Top View

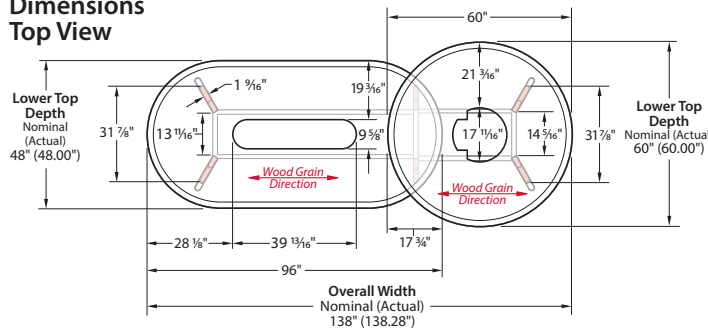

Front View

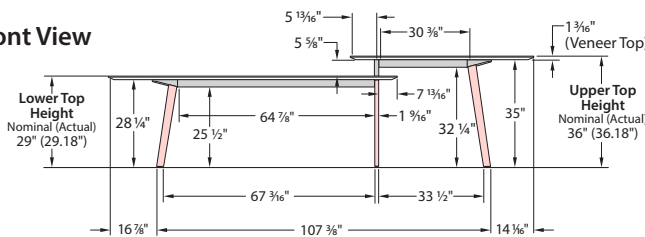

Seating Capacity

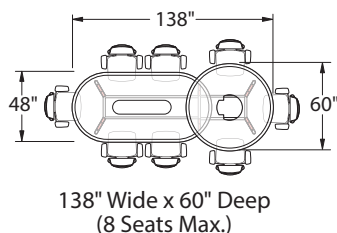

Component Materials and Finishes

COMPONENT NAME	MATERIALS/FINISHES	
Upper Top (Round with Knife Edge)	Laminate	Standard Core - specify surface finish/color and a separate edge finish color.
	Wood	Standard Core - specify a single color/finish for the surface and edge finishes.
	Solid Surface	Wood core with built up Solid Surface edge - Standard in Cameo White.
Lower Top (Racetrack with Knife Edge)	Laminate	Standard Core - specify laminate finish/color and a separate edge finish/color.
	Painted	MDF Core - specify paint finish.
	Solid Surface	Wood Core - with built up solid surface edge. Standard in Cameo White.
	Wood	Standard Core - specify a single color/finish for the surface and edge finishes.
Legs	Solid Wood	Ink on Ash (M7-W43) Clear on White Oak (M5-W35) Clear on Walnut (M6-W35)
	Painted	Painted metal - specified trim color
Stack Spacer	Painted MDF with Specified Finish	
Understructure	Painted Metal with specified trim color	
Adjustable Glides	Standard in Black	

Stack Spacer Finish

- The Stack Spacer may be specified with any Stack Spacer paint finish, except when both tops are specified with a laminate finish.
- EXCEPTION: when the upper and lower tops are both specified with a laminate finish, the Stack Spacer paint finish will be pre-defined to coordinate with the understructure trim color.

UNDERSTRUCTURE TRIM COLOR (Specified)	PRE-DEFINED STACK SPACER PAINT FINISH (Only when both tops are laminate)
Chartreuse (TR-CTS)	Chartreuse (LN-CTS)
Rusty Red (TR-RR)	Rusty Red (LN-RR)
Sable (TR-1M)	Sable (LN-1M)
Wren (TR-1K)	Wren (LN-1K)
All Other Trim Colors	Polar (LN-PL)

Table Heights

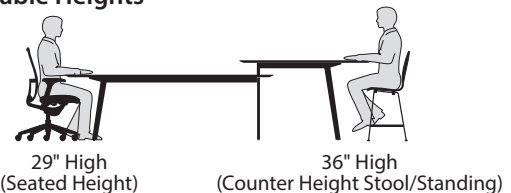

Optional Cutout for Oblong/Round Planters

- For added storage and power specify cutout options to accommodate a separately specified Oblong and/or Round Planter(s) (See Price List for cutout options).
- The Planters may be specified with or without power.

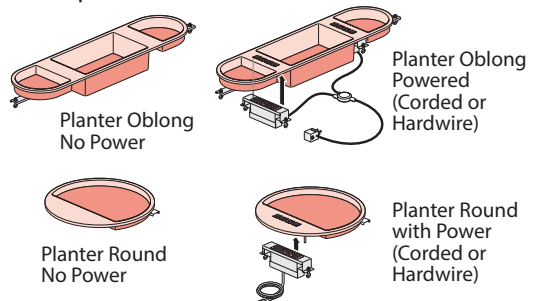

Product Details – Immerse Tables

Overlap Table

Rectangle / Rectangle

- Includes rectangle upper top, rectangle lower top, (6) legs, understructure, adjustable glides and hardware.
- For storage and/or power access, the upper top may be specified with a cutout option. Cutout works with separately specified Oblong Planter.

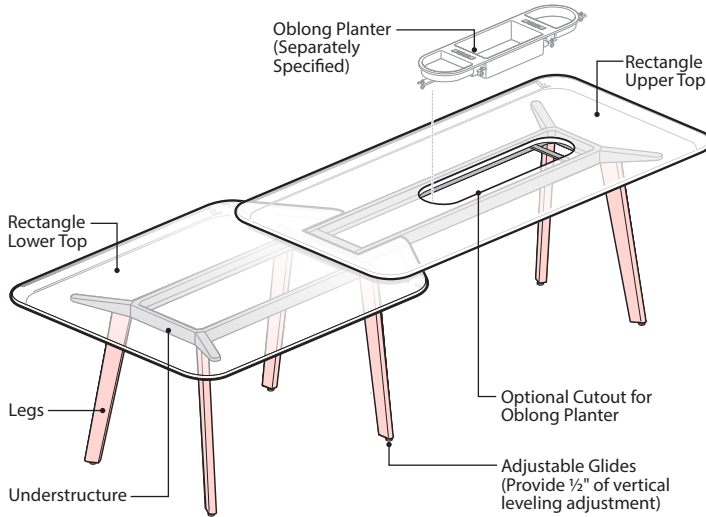

Dimensions Top View

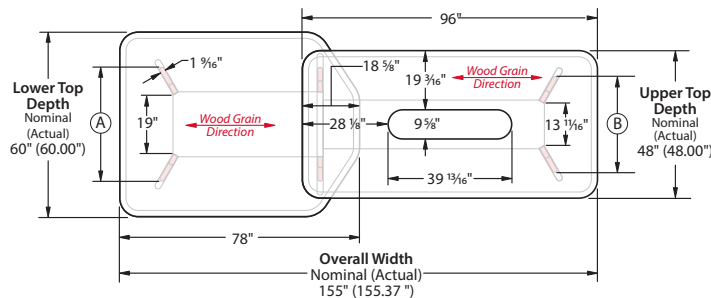

Front View

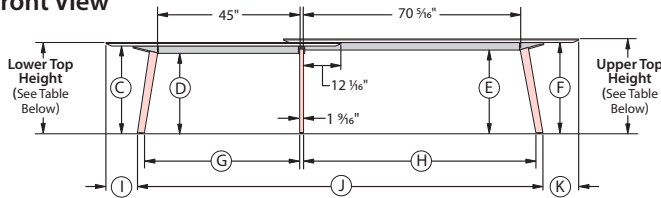

Dimensions by Table Size

Lower Top			Upper Top			Kneespace Dimensions										
Heights Nominal (Actual) (Veneer Top With glides fully recessed)	Depths (Actual)	Widths Nominal (Actual)	Heights Nominal (Actual) (Veneer Top With glides fully recessed)	Depths (Actual)	Widths (Actual)	A	B	C	D	E	F	G	H	I	J	K
29"(29.43") (37.5")	(60.00")	(78.00")	(30.56")	(48.00")	(96.00")	37 3/8"	32 1/8"	28 1/4"	25 1/2"	26 5/8"	29 3/8"	48 7/8"	73 15/16"	12 15/16"	129 1/2"	12 13/16"
	(60.00")	(78.00")	39"(39.18")	(48.00")	(96.00")	40 5/8"	32 3/16"	36 13/16"	34 1/16"	35 1/4"	38"	49 7/8"	74 1/16"	11 15/16"	130 15/16"	12 7/8"

Component Materials and Finishes

COMPONENT NAME	MATERIALS/FINISHES	
Upper Top (Rectangle with Knife Edge)	Laminate	Standard Core - specify laminate finish/color and a separate edge finish/color.
	Painted	MDF Core - specify paint finish.
	Solid Surface	Wood Core - with built up solid surface edge. Standard in Cameo White.
Lower Top (Rectangle with Knife Edge)	Wood	Standard Core - specify a single color/finish for the surface and edge finishes.
	Solid Surface	Wood core with built up Solid Surface edge - Standard in Cameo White.
Legs	Solid Wood	Ink on Ash (M7-W43) Clear on White Oak (M5-W35) Clear on Walnut (M6-W35)
	Painted	Painted metal - specified trim color
Understructure	Painted Metal with specified trim color	
Adjustable Glides	Standard in Black	

Table Heights

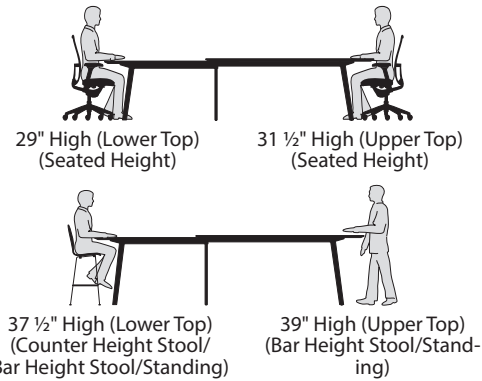

Seating Capacity

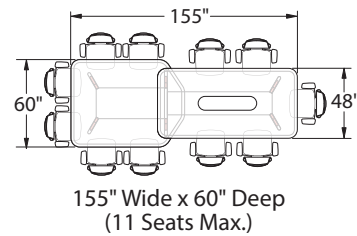

Optional Cutout for Oblong Planter

- For added storage and power specify cutout option to accommodate a separately specified Oblong Planter.
- The Oblong Planter may be specified with or without power.

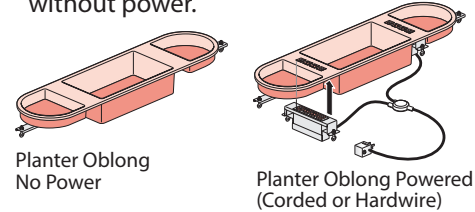

Product Details – Immerse Tables

Overlap Table

Rectangle / Round

- Includes round upper top, rectangle lower top, (6) legs, under-structure, adjustable glides and hardware.
- For storage and/or power access, the tops may be specified with cutout options. Lower cutouts works with separately specified Oblong Planter, Upper Top works with separately specified Round Planter.

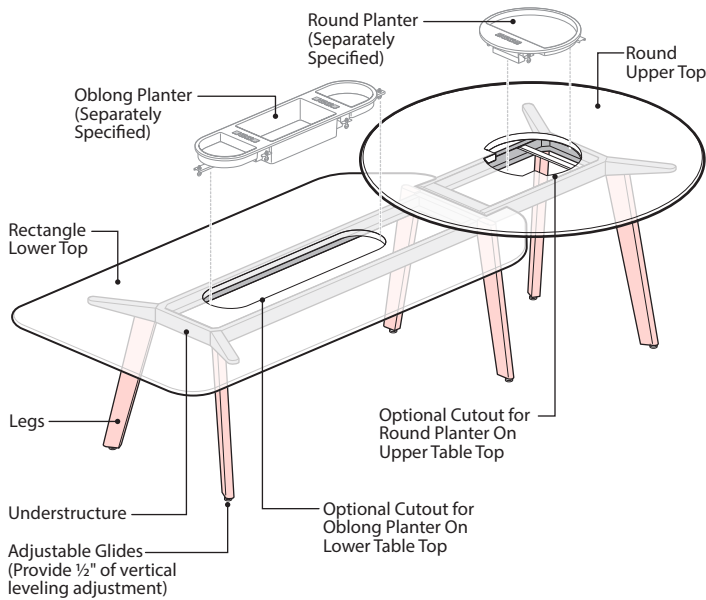

Dimensions Top View

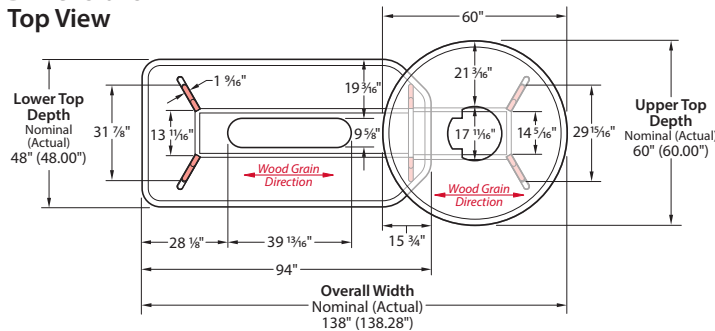

Front View

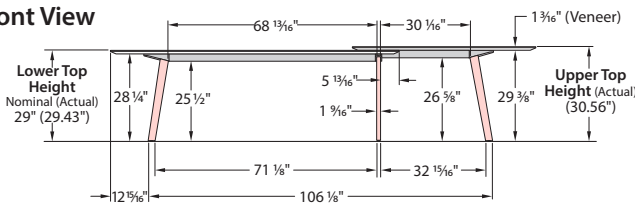

Component Materials and Finishes

COMPONENT NAME	MATERIALS/FINISHES	
Upper Top (Round with Knife Edge)	Laminate	Standard Core - specify surface finish/color and a separate edge finish color.
	Wood	Standard Core - specify a single color/finish for the surface and edge finishes.
	Solid Surface	Wood core with built up Solid Surface edge - Standard in Cameo White.
Lower Top (Rectangle with Knife Edge)	Laminate	Standard Core - specify laminate finish/color and a separate edge finish/color.
	Painted	MDF Core - specify paint finish.
	Solid Surface	Wood Core - with built up solid surface edge. Standard in Cameo White.
Legs	Solid Wood	Ink on Ash (M7-W43) Clear on White Oak (M5-W35) Clear on Walnut (M6-W35)
	Painted	Painted metal - specified trim color
Understructure	Painted Metal with specified trim color	
Adjustable Glides	Standard in Black	

Table Heights

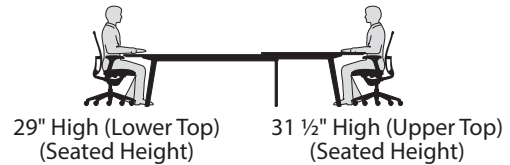

Seating Capacity

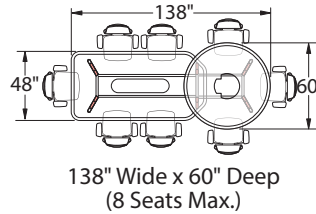

Optional Cutout for Oblong/Round Planters

- For added storage and power specify cutout options to accommodate a separately specified Oblong and/or Round Planter(s) (See Price List for cutout options).
- The Planters may be specified with or without power.

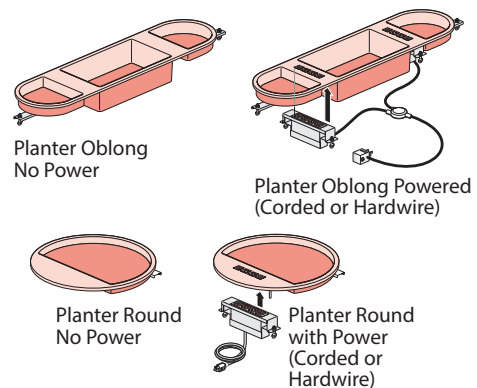

Product Details – Immerse Tables

Overlap Table

Racetrack / Round

- Includes racetrack shaped lower top, round upper top, (6) legs, understructure, adjustable glides and hardware.
- For storage and/or power access, the tops may be specified with cutout options. Lower cutouts works with separately specified Oblong Planter, Upper Top works with separately specified Round Planter.

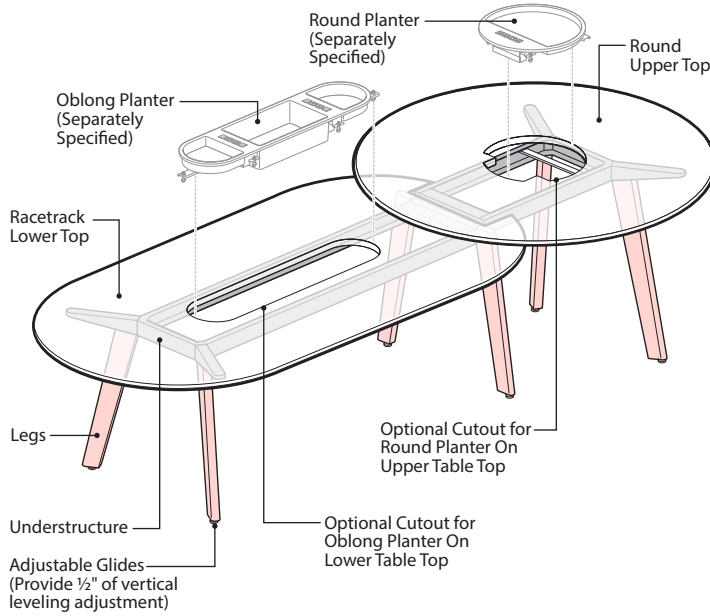

Dimensions Top View

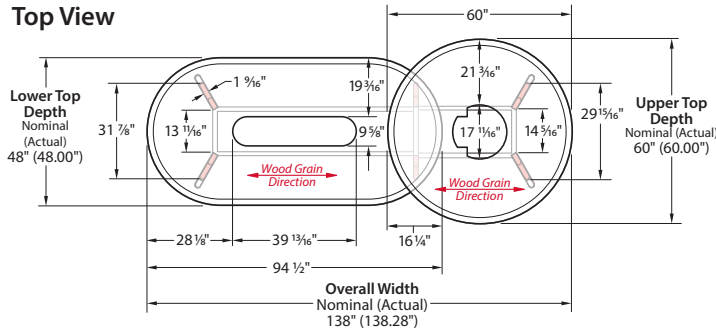

Front View

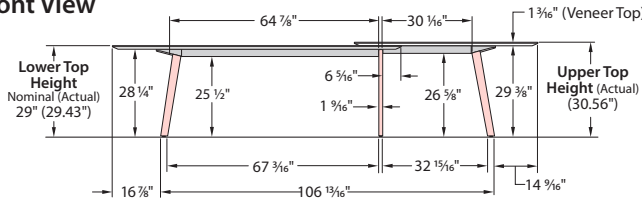

Component Materials and Finishes

COMPONENT NAME	MATERIALS/FINISHES	
Upper Top (Round with Knife Edge)	Laminate	Standard Core - specify surface finish/color and a separate edge finish color.
	Wood	Standard Core - specify a single color/finish for the surface and edge finishes.
	Solid Surface	Wood core with built up Solid Surface edge - Standard in Cameo White.
Lower Top (Racetrack with Knife Edge)	Laminate	Standard Core - specify laminate finish/color and a separate edge finish/color.
	Painted	MDF Core - specify paint finish.
	Wood	Standard Core - specify a single color/finish for the surface and edge finishes.
Legs	Solid Wood	Ink on Ash (M7-W43) Clear on White Oak (M5-W35) Clear on Walnut (M6-W35)
	Painted	Painted metal - specified trim color
Understructure	Painted Metal with specified trim color	
Adjustable Glides	Standard in Black	

Table Heights



29" High (Lower Top)
(Seated Height)

31 1/2" High (Upper Top)
(Seated Height)

Seating Capacity

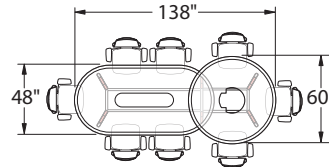

138" Wide x 60" Deep
(8 Seats Max.)

Optional Cutout for Oblong/Round Planters

- For added storage and power specify cutout options to accommodate a separately specified Oblong and/or Round Planter(s) (See Price List for cutout options).
- The Planters may be specified with or without power.

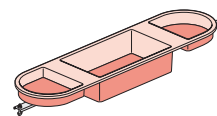

Planter Oblong
No Power

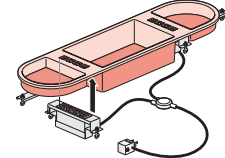

Planter Oblong Powered
(Corded or Hardwire)

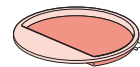

Planter Round
No Power

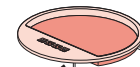

Planter Round
with Power
(Corded or
Hardwire)

Product Details – Immerse Tables

Overlap Table

Rectangle / Ledge

- Includes ledge top (upper top), Rectangle top (lower top), (6) legs, understructure, adjustable glides and hardware.
- For storage and/or power access, the rectangle top may be specified with cutout option. The Rectangle top cutouts works with separately specified Oblong Planter.

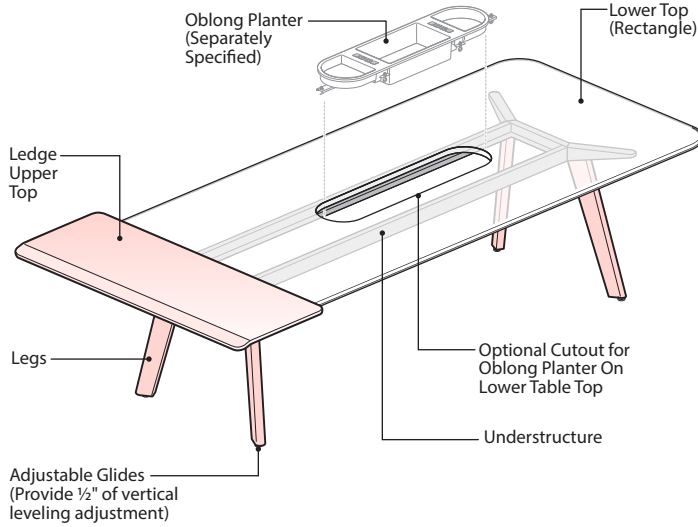

Dimensions Top View

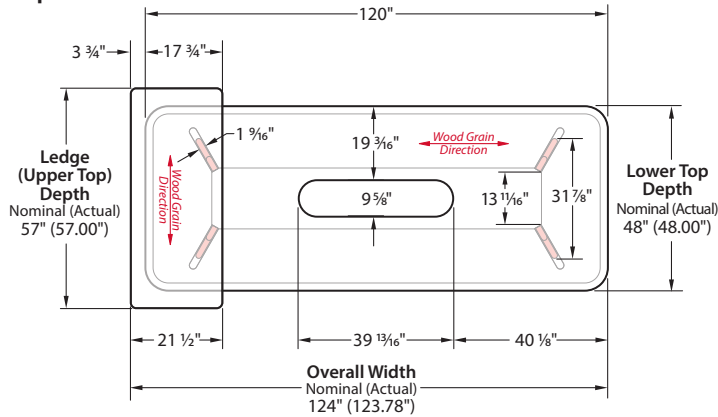

Front View

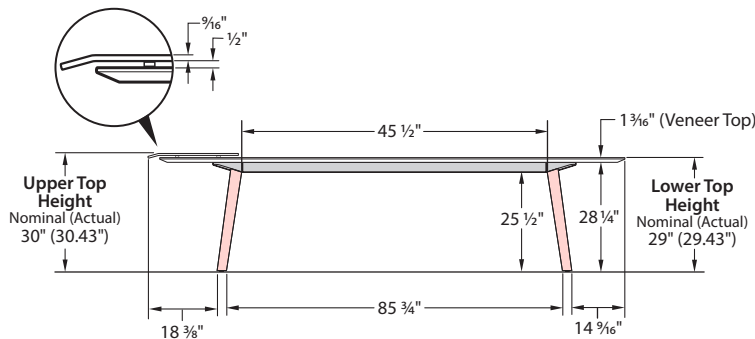

Component Materials and Finishes

COMPONENT NAME	MATERIALS/FINISHES	
Lower Top (Rectangle with Knife Edge)	Laminate	Standard Core - specify surface finish/color and a separate edge finish color.
	Wood	Standard Core - specify a single color/finish for the surface and edge finishes.
	Solid Surface	Wood core with built up Solid Surface edge - Standard in Cameo White.
Ledge Upper Top (Rectangle with Sealed Hardboard Laminated Edge)	Laminate	Laminated Hardboard Core with specified laminate top finish.
	Wood	Laminated Hardboard Core with specified wood veneer top finish.
Legs	Solid Wood	Ink on Ash (M7-W43) Clear on White Oak (M5-W35) Clear on Walnut (M6-W35)
	Painted	Painted metal - specified trim color
Understructure	Painted Metal with specified trim color	
Adjustable Glides	Standard in Black	

Table Heights

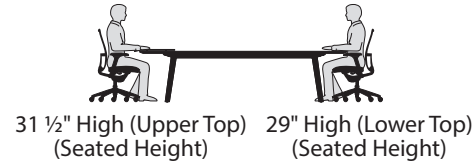

Seating Capacity

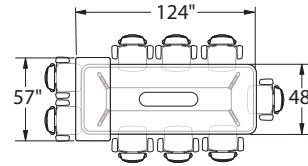

124" Wide x 57" Deep
(9 Seats Max.)

Optional Cutout for Oblong Planter

- For added storage and power specify cutout option to accommodate a separately specified Oblong Planter.
- The Oblong Planter may be specified with or without power.

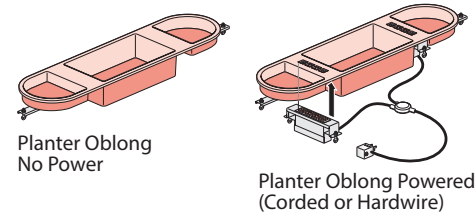

Product Details – Immerse Tables

Ledge Table

With Waterfall Edge

- Includes ledge top, (4) legs, understructure, adjustable glides and hardware.

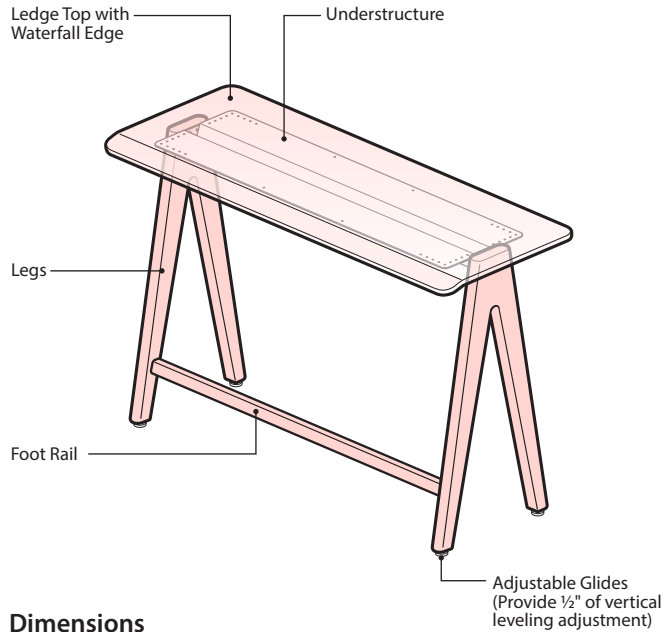

Dimensions Top View

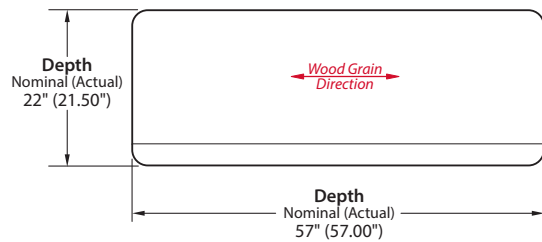

Front View

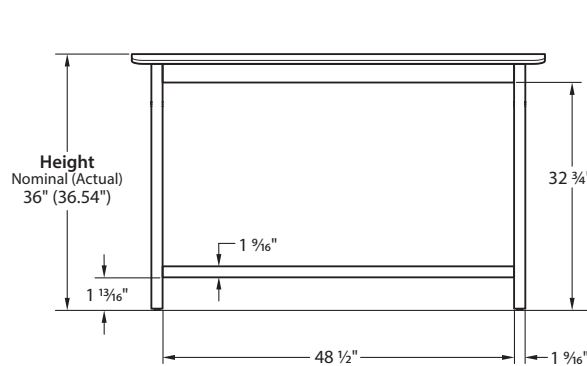

End View

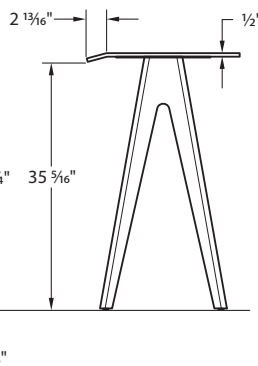

Component Materials and Finishes

COMPONENT NAME	MATERIALS/FINISHES	
Ledge Top (Rectangle with Sealed Hardboard Laminated Edge)	(L) Laminate	Laminated Hardboard Core with specified laminate top finish.
	(W) Wood	Laminated Hardboard Core with specified wood veneer top finish.
Legs	Solid Wood	Ink on Ash (M7-W43) Clear on White Oak (M5-W35) Clear on Walnut (M6-W35)
	Painted	Painted metal – specified trim color
Understructure and Foot Rail	Painted Metal with specified trim color	
Adjustable Glides	Standard in Black	

Table Height



36" High
(Counter Height Stool/Standing)

Seating Capacity

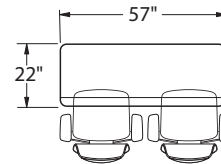

57" Wide x 22" Deep
(2 Seats Max.)

Product Details – Immerse Tables

Planter Oblong

No Power

- Includes oblong planter with (3) storage compartments, brackets and mounting Hardware.
- Designed to be installed in tables specified with the optional cutout for an Oblong Planter.
- Does not include Power Modules.

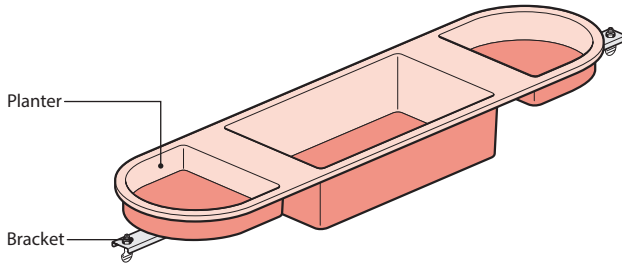

Powered – Corded or Hardwired

- Includes oblong planter with (3) storage compartments, (2) Power Modules (each with 4 ports), brackets and mounting Hardware.
- Designed to be installed in tables specified with the optional cutout for an Oblong Planter.

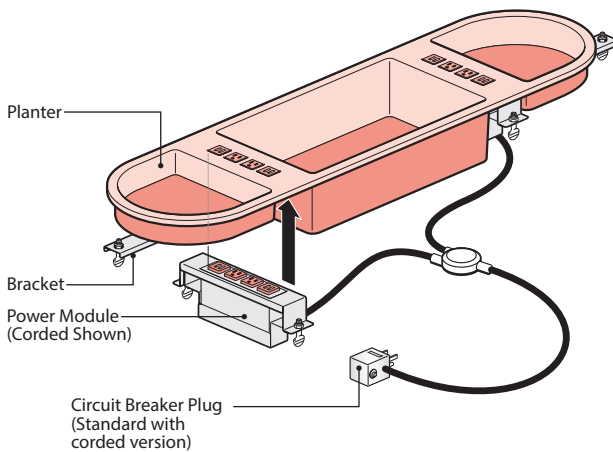

Dimensions Top View

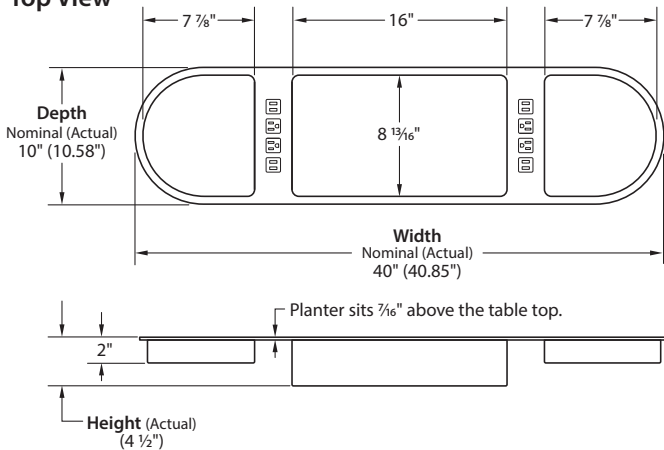

Component Materials and Finishes

COMPONENT NAME	MATERIALS/FINISHES	
Planter	Plastic	Black (TR-F) Gray Tone (TR-G) Smooth Plaster (TR-PLS) Terra Cotta (TR-TC)
Brackets	Painted Metal	Standard In Black

Component Materials and Finishes

COMPONENT NAME	MATERIALS/FINISHES	
Planter	Plastic	Black (TR-F) Gray Tone (TR-G) Smooth Plaster (TR-PLS) Terra Cotta (TR-TC)
Brackets	Painted Metal	Standard In Black
Power Module	Case and Bracket	Standard In Black
	Ports	Power Receptacle and USB Charging Ports are matched to the color of the Planter.
	Corded	Black Cord (6', 12' or 21' Long) with Circuit Breaker Plug.
	Hardwire	Galvanized Conduit (6' or 12' Long)

Power Module Configurations

- Power Modules may be specified corded with circuit breaker plug or hardwired.

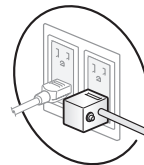

Corded with Circuit Breaker Plug (6', 12' or 21' Long)

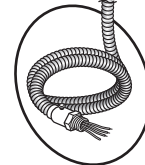

Hardwire (6' or 12' Long)

Power Module Port Configurations

- Includes 2 Power Modules with a total of 8 ports that can be configured with simplex outlets (NEMA-5-15R), or USB charging simplex outlets (with 2 USB outlets). No data or cable bay options are available.
- The specified port configuration will be the same on both Power Modules.

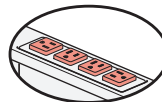

(4) Power Receptacles

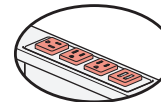

(3) Power Receptacles/
(1) USB Charging Port

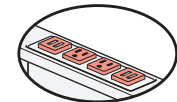

(2) Power Receptacles/
(2) USB Charging Ports

Product Details – Immerse Tables

Planter Round

No Power

- Includes planter with (1) storage compartment, brackets and mounting Hardware.
- Designed to be installed in tables specified with the optional cutout for an Round Planter.
- Does not include Power Module.

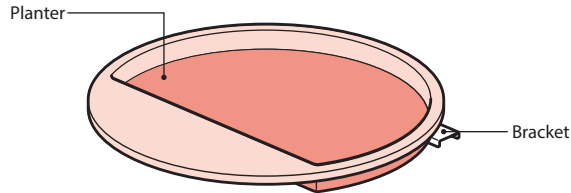

Powered – Corded or Hardwired

- Includes planter with (1) storage compartment, 4 Port Power Module with, brackets and mounting Hardware.
- Designed to be installed in tables specified with the optional cutout for an Oblong Planter.

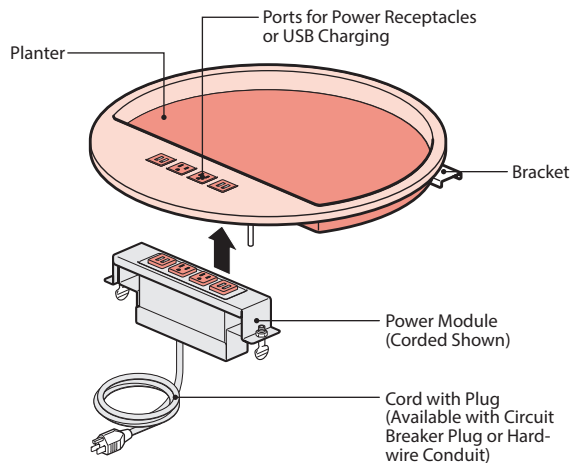

Dimensions Top View

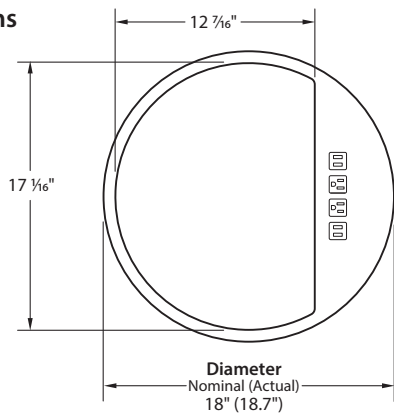

Front View

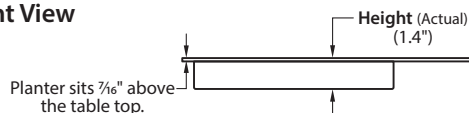

Component Materials and Finishes

COMPONENT NAME	MATERIALS/FINISHES	
Round Planter	Plastic	Black (TR-F) Gray Tone (TR-G) Smooth Plaster (TR-PLS) Terra Cotta (TR-TC)
Brackets	Painted Metal	Standard In Black

Component Materials and Finishes

COMPONENT NAME	MATERIALS/FINISHES	
Round Planter	Plastic	Black (TR-F) Gray Tone (TR-G) Smooth Plaster (TR-PLS) Terra Cotta (TR-TC)
Brackets	Painted Metal	Standard In Black
Power Module	Case and Bracket	Standard in Black
	Ports	Power Receptacle and USB Charging Ports are matched to the color of the Planter.
	Corded	Black Cord (6', 12' or 21' Long) with Plug. (Units with 4 power receptacles includes Circuit Breaker Plug)
	Hardwire	Galvanized Conduit (6' or 12' Long)

Power Module Configurations

- Power Modules may be specified corded with plug or hardwired.
- Power Modules with 4 power receptacles includes a circuit breaker plug.

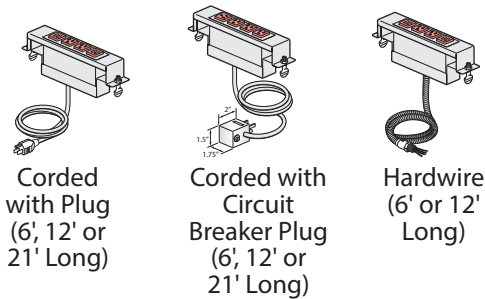

Power Module Port Configurations

- Includes Power Module with 4 ports that can be configured with simplex outlets (NEMA-5-15R), or USB charging simplex outlets (with 2 USB outlets). No data or cable bay options are available.

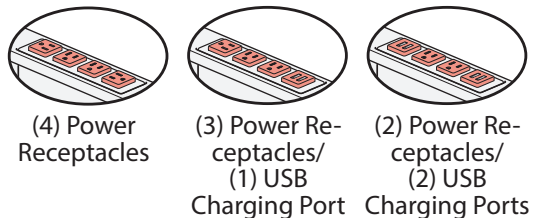

Technical Specifications Immerse Tables

Technical Specifications

Wood Composite Materials

All wood composite materials used in Immerse are engineered to meet or exceed ANSI requirements. Worksurfaces are composed of a minimum 90% wood fiber content with at least 10% post-consumer and 80% pre-consumer wood fiber bonded with resin. All parts with a wood composite core are 3rd party certified compliant with GREENGUARD® and ANSI/BIFMA Standards for low emitting products. The composite core is 3rd party certified compliant with California Air Resource Board (CARB) requirements for Phase 2 formaldehyde emission levels.

Laminate Tops

Standard core laminate tops are made with a .028 inch (.71 mm) HPL face, 1.125 inch (28.58 mm) medium density fiberboard (MDF) core and a .028 inch (.71 mm) HPL backer. Overall thickness is 1.181 inches (30 mm). The outer perimeter features a knife edge profile with 0.118 inch (3 mm) thick edgeband made of Acrylonitrile Butadiene Styrene (ABS). The edgeband is .375 inches (9.53 mm) tall with a 2.00 inch (50.8 mm), knife edge taper and is sealed with a clear finish.

Wood Tops

Standard Core Wood Tops feature a 0.020 inch (.51 mm) thick natural veneer or recon veneer face, 1.125 inch (28.58 mm) thick MDF core and a 0.020 inch (.51 mm) thick backer for balanced construction. Overall thickness is 1.165 inches (29.59 mm). The outer perimeter includes a knife edge profile with .100 (2.54 mm) inch thick wood edgeband. The edgeband is .375 inches (9.53 mm) tall with a 2.00 inch (50.8 mm), knife edge taper. The exception is the Stack table upper top knife edge with a .47 inch (11.94 mm) tall edge and a 3.00 inch (76.2 mm) taper. Wood tops are sealed with a water based finish.

Painted Tops

Standard Core Painted Tops feature a 1.125 inch (28.58 mm) thick MDF core painted on all sides. The outer perimeter has a knife edge profile with a 2.00 inch (50.8 mm) taper and no edgeband. Painted tops are not available in 60 inch (1524 mm) depths.

Solid Surface Tops

Solid surface tops include a .50 inch (12.7 mm) thick plywood core and a 3.00 inch (76.2 mm) or 4.00 inch (101.6 mm) built-up solid edge (depending on shape and frame). Overall thickness is 1.00 inch (25.4mm). Solid surface tops come in one, standard, Cameo White color. The outer perimeter has a knife edge profile without edgeband. The knife profile has a .375 inch (9.53 mm) tall flat and a 2.00 inch (50.8 mm) taper. The exception is the stack table upper top knife edge which features a .47 inch (11.94 mm) tall flat with a 3.00 inch (76.2 mm) taper.

Ledge Table Tops

Ledge tables feature a wood or laminate top with a formed waterfall edge. Wood Ledge tops are made with a .020 inch (.51 mm) veneer face, .504 inch (12.8 mm) thick high density fiberboard (HDF) core (8 layers, .063 inches (1.6 mm) each) and a .026 inch (.66 mm) thick backer. The overall thickness is .550 inches (13.97 mm). Wood Ledge tops do not have edgeband and are sealed with a water based finish. Laminate Ledge tops are made with a .028 inch (.71 mm) HPL face, .504 inch (12.8 mm) thick HDF core (8 layers, .063 inches (1.6 mm) each), and a .028 inch (.71 mm) HPL backer with an overall thickness of .560 inches (14.22 mm). Laminate tops feature a waxed edge with no edgeband.

Legs

The Immerse table line offers two options for legs. Painted (powder coated) steel legs made from 11 GA CRCS (available on all Immerse tables) and solid wood legs, made from 1.55 inch (39.37 mm) thick solid ash, white oak or walnut (available on all Immerse tables except for the Stack tables). Ash legs feature an ink stain and the white oak & walnut come standard with a clear water based finish.

Frame

Immerse framework and understructure are comprised of aluminum castings of approximately .20 inch (5.08 mm) thickness, and steel frame rails made from 14 GA CRCS. The Ledge table bracket and footrest are made from 11 GA CRCS.

Technical Specifications

Single Tables

Single tables are available in 4 different shapes. This includes round, square, rectangular one-piece, rectangular two-piece and racetrack. There are three heights available, which are 29.4 inches (747 mm), 36.2 inches (919 mm) and 39.2 inches (996 mm). The exception is the 144 inch (3658 mm) tables which are only available in 29.4 inch (747 mm) height). Glides, standard in black, offer an additional ½ inch (12.7 mm) of adjustment. Options for legs include both steel and solid wood versions. The surface options for each are laminate, painted (48 inch (1219 mm) depths only), solid surface and wood. Round and square 60 inch (1524 mm) tables have an optional round planter available with or without power. Rectangular and racetrack styles have an optional oblong planter with or without power.

Stack Tables

Stack tables feature a wood or solid surface upper top with a solid surface sill below or a laminate upper top with a laminate sill below. Available in two options, rectangular one-piece and rectangular two-piece. The height of the Stack table is 39.2 inches (996 mm) and width is 60 inches (1524 mm). Glides, standard in black, offer an additional ½ inch (12.7 mm) of adjustment. All versions of the Stack tables come standard with painted steel legs. The under-sill sits 3.32 inches (84.33 mm) below the upper surface at a 34.7 inch (881 mm) height. The solid surface sill is ½ inch (12.7 mm) thick. The Laminate sill is made with a .028 inch (.71 mm) HPL Face, .687 inch (17.45 mm) MDF core and a .028 inch (.71 mm) HPL backer with an overall thickness of .743 inches (18.87 mm). The perimeter of the laminate sill has a knife edge profile and includes a .039 inch (1.0 mm) thick edgeband made of ABS. The edgeband is .375 (9.53 mm) tall with a .914 inch (23.22 mm) taper. Stack tables have an optional oblong planter with or without power.

Shift Table

Shift tables feature two adjacent worktops with a 1.55 inch (39.37 mm) thick x 5.625 inch (142.88 mm) painted MDF spacer in-between. The three options for the shape of the worksurfaces include rectangle/rectangle, rectangle/round and racetrack/round. The height of the lower surface is standard at 29.4 inches (747 mm) and the upper surface at a height of 36.2 inches (919 mm). Glides, standard in black, offer an additional ½ inch (12.7 mm) of adjustment. Shift table leg options include both solid wood and painted steel, with surface options of painted (48 inch (1219 mm) depth tops only), laminate, wood veneer and solid surface. Shift tables can be specified with an optional planter. Round surfaces use the round planter available with or without power. Rectangular and racetrack styles have the oblong planter option. For the rectangle/rectangle option, the planter is only available in the upper surface.

Overlap Table

Overlap tables feature a dual-level workspace with two overlapping surfaces, the four options for the shapes of the worksurfaces are rectangle/rectangle, rectangle/round, racetrack/round and rectangle/ledge. The height of the rectangle/rectangle, rectangle/round and racetrack/round overlap tables are 29.4 inches (747 mm) for the lower surface and 30.6 inches (777 mm) for the upper surface. The rectangle/rectangle overlap can also be ordered in a taller height with the lower top being 38.0 inches (965 mm) and the upper top being 39.2 inches (996 mm) in height. The rectangle/ledge top heights are 29.4 inches (747 mm) for the lower top and 30.4 inches (772 mm) for the upper top. Glides, standard in black, offer an additional ½ inch (12.7 mm) of adjustment. Overlap table leg options include both solid wood and painted steel, with surface options of painted (48 inch (1219 mm) depth tops only), laminate, wood veneer and solid surface. Ledge upper tops only available in laminate or wood veneer. Overlap tables can be specified with an optional planter. Round surfaces use the round planter, available with or without power. Rectangular and racetrack styles use the oblong planter option, available with or without power. For the rectangle/rectangle option, the planter is only available on the upper surface.

Ledge Table

Ledge tables feature a wood veneer or laminate top with a formed waterfall edge. Ledge tables come standard at 36.1 inches (917mm) tall with worksurface dimensions of 21.50 inches (546 mm) x 57 inches (1448 mm) and include a painted steel foot rail. Glides, standard in black, offer an additional ½ inch (12.7 mm) of adjustment. Options for legs include both painted steel and solid wood versions.

Planter

Planters are available in two different shapes, round and oblong. Options include both powered and non-powered. Round planter powered versions come standard with a power module with 4 ports. Oblong Planter powered versions come standard with two modules with 4 ports in each. Power options cannot be modified in the field. Both corded and hardwired versions are available. Corded versions come with cord lengths of 6 feet, 12 feet (3658 mm) and 21 feet (6401 mm) long, hardwire versions come with galvanized conduit in length of 6 feet (1829 mm) or 12 feet (3658 mm). Planter color options include black, smooth plaster, gray tone and terra cotta, power modules are color matched. These are installed in the factory-cut work surfaces only. Planter material is plastic.

This page intentionally left blank.

Executive — A5 Table Finish/Color Legends

Grade B	Trim	Lock Plugs	ALERT: These materials are current, however they are being considered for future obsolescence due to low volume.
<u>Anegre Quarter Cut</u>	Grade A	TR-BL Black TR-BP Chrome	
YC-W15 Espresso YC-W08 Golden YC-W07 Light	<u>Smooth</u>		
<u>Cherry</u>	TR-R Beige TR-AK Chalk TR-K Charcoal TR-C1 Cocoa TR-J Graphite TR-G Gray Tone TR-AA Putty TR-E Smoke TR-PLS Smooth Plaster TR-FM Snow		
YD-CA1 Amber YD-W23 American YD-W33 Caramel YD-W30 Heritage YD-W32 Pacific	<u>Textured</u>		
<u>Cherry Quarter Cut</u>	TR-TY Cement TR-TG Grout TR-TF Pitch TR-TW Plaster		
Y2-U Medium			
<u>Maple</u>	Grade B		
YL-LM Light YL-N Natural YL-AD Sand	<u>Smooth</u>		
<u>Maple Quarter Cut</u>	TR-1C Accent Blue TR-1D Accent Green TR-1E Accent Orange TR-1F Accent Red TR-1G Blue Jay TR-1L Brindle TR-1R Brownstone TR-CTS Chartreuse TR-1N Night TR-1Q Park TR-RR Rusty Red TR-1M Sable TR-1P Seville TR-1J Sky Blue TR-1H Terra TR-1K Wren		
YM-N Natural	<u>Smooth Metallic</u>		
<u>Oak</u>	TR-DM Dark Bronze Metallic TR-MC Metallic Champagne TR-LE Metallic Silver		
YO-W05 Natural	<u>Textured Metallic</u>		
<u>Rift Cut White Oak</u>	TR-AL Alloy TR-AR Argent TR-HE Hellenic		
YB-W15 Espresso			
<u>Walnut</u>			
YN-W15 Espresso YN-W31 Retro			
<u>Walnut Quarter Cut</u>			
Y9-W15 Espresso Y9-W31 Retro			
Grade D			
V0-W16 Espresso V0-W08 Golden V0-W07 Light			

Immerse Table Finish/Color Legends

Wood Finishes

Grade A

Double Cut

2P-RL	Applegate
WL-RL	Beachwood
2R-RL	Butternut
WJ-RE	Ebony
2N-RL	Echo
2Z-RF	Flint
WE-RT	Melba
2Z-RS	Shale
WC-RW	Wenge

Grade B

Anegre Quarter Cut

YC-W15	Espresso
YC-W08	Golden
YC-W07	Light

Beach

YE-W04	Natural
--------	---------

Cherry

YD-CA1	Amber
YD-W23	American
YD-W33	Caramel
YD-W30	Heritage
YD-W32	Pacific

Cherry Quarter Cut

Y2-U	Medium
------	--------

Figured Anegre

V0-W16	Espresso
V0-W08	Golden
V0-W07	Light

Maple

YC-LM	Light
YC-N	Natural
YC-AD	Sand

Maple Quarter Cut

YM	Natural
----	---------

Oak

YP-W42	Brindle
YO-W05	Natural

Rift Cut White Oak

YB-W35	Clear
YB-W15	Espresso
YB-W37	Fawn
YB-W40	Mocha
YB-W38	Tuxedo

Walnut

YN-W15	Espresso
YN-W31	Retro

Satin on Walnut

YN-W12	Naturally
YN-W31	Retro

Walnut Quarter Cut

Y9-W35	Clear
Y9-W15	Espresso
Y9-W31	Retro
Y9-W41	Verdant

Paint Top Finishes

Grade A

Solid Color

PW-R	Beige
PW-F	Black
PW-AK	Chalk
PW-G	Gray Tone
PW-PL	Polar
PW-SY	Stormy
PW-VR	Vapor

Grade B

Solid Color

PW-RR	Rusty Red
PW-1J	Sky Blue
PW-SP	Sparrow
PW-ST	Straw
PW-1H	Terra

Laminate Finishes

Grade A

Solid Color

H-34	Beige
H-AK	Chalk
H-8J	Charcoal
H-3J	Graphite
H-62	Gray Tone
H-WL	Linen
H-3P	Platinum
H-AA	Putty
H-3E	Smoke

Wood

H-AM	Amber Cherry
H-AE	Maple
H-AD	Medium Cherry

Grade B

Premium Wood Grain

H-KA	Brazilwood
H-KG	Columbian Walnut
H-KP	Field Elm
H-KN	Grey Elm
H-KM	Landmark Wood
H-KL	Neo Walnut
H-KC	New Age Oak
H-KD	River Cherry
H-KE	Sanara
H-KF	Williamsburg Cherry

Solid Surface Top Finish

SS-CW	Cameo White
-------	-------------

Trim

Grade A

Smooth

TR-R	Beige
TR-AK	Chalk
TR-K	Charcoal
TR-C1	Cocoa
TR-J	Graphite
TR-G	Gray Tone
TR-AA	Putty
TR-E	Smoke
TR-PLS	Smooth Plaster
TR-FM	Snow

Textured

TR-TY	Cement
TR-TG	Grout
TR-TF	Pitch
TR-TW	Plaster

Grade B

Smooth

TR-1C	Accent Blue
TR-1D	Accent Green
TR-1E	Accent Orange
TR-1F	Accent Red
TR-1G	Blue Jay
TR-1L	Brindle
TR-1R	Brownstone
TR-CTS	Chartreuse
TR-1N	Night
TR-1Q	Park
TR-RR	Rusty Red
TR-1M	Sable
TR-1P	Seville
TR-1J	Sky Blue
TR-1H	Terra
TR-1K	Wren

Smooth Metallic

TR-DM	Dark Bronze Metallic
TR-MC	Metallic Champagne
TR-LE	Metallic Silver

Textured Metallic

TR-AL	Alloy
TR-AR	Argent
TR-HE	Hellenic

ALERT: These materials are current, however they are being considered for future obsolescence due to low volume.

Wood:

VR-W21	Mahogany Satin on Walnut
VR-W12	Naturally
WF-RC	Sorrel Double Cut

Forest Stewardship Council (FSC)

Statement:

In our continuing support of sustainable forestry and responsible purchasing, Haworth North America is offering FSC certified wood products at no up-charge. By providing FSC certified material, Haworth is supporting our client's green building goals and demonstrating our collective commitment to source materials more sustainably.

Haworth will provide to you the necessary FSC-certified paperwork with your shipment. For more information, FAQs, and a complete FSC product list (including product exceptions), go to the Library and search FSC.

Planes Table Finish/Color Legends

<p>Wood Finishes Grade A <u>Double Cut</u> 2P-RL Applegate WL-RL Beachwood 2R-RL Butternut WJ-RE Ebony 2N-RL Echo WE-RT Melba WC-RW Wenge</p> <p>Grade B <u>Anegre Quarter Cut</u> NP-W15 Espresso NP-W08 Golden NP-W07 Light</p> <p><u>Cherry</u> VC-CA1 Amber VC-W23 American VC-W33 Caramel VC-W30 Heritage VC-W32 Pacific</p> <p><u>Cherry Quarter Cut</u> NX-U Medium</p> <p><u>Maple</u> VP-LM Light VP-N Natural VP-AD Sand</p> <p><u>Maple Quarter Cut</u> NM-N Natural</p> <p><u>Oak</u> VJ-W42 Brindle VJ-W05 Natural</p> <p><u>Rift Cut White Oak</u> NR-W15 Espresso NR-W37 Fawn NR-W40 Mocha NR-W38 Tuxedo</p> <p><u>Walnut</u> VR-W15 Espresso VR-W31 Retro</p> <p><u>Walnut Quarter Cut</u> NW-W15 Espresso NW-W31 Retro NW-W41 Verdant</p>	<p>Laminate Finishes Grade A <u>Solid Color</u> H-34 Beige H-AK Chalk H-8J Charcoal H-3J Graphite H-62 Gray Tone H-WL Linen H-3P Platinum H-AA Putty H-3E Smoke</p> <p><u>Wood</u> H-AM Amber Cherry H-AE Maple H-AD Medium Cherry</p> <p>Grade B <u>Premium Wood Grain</u> H-KA Brazilwood H-KG Columbian Walnut H-KP Field Elm H-KN Grey Elm H-KM Landmark Wood H-KL Neo Walnut H-KC New Age Oak H-KR Phantom Ecru H-KS Phantom Pearl H-KD River Cherry H-KE Sanara H-KF Williamsburg Cherry</p> <p>Edgeband <u>Solid Color</u> HP-34 Beige HP-AK Chalk HP-8J Charcoal HP-3J Graphite HP-62 Gray Tone HP-WL Linen HP-3P Platinum HP-AA Putty HP-3E Smoke</p> <p><u>Wood Grain</u> HP-KA Brazilwood HP-AM Cherry HP-KG Columbian Walnut HP-KP Field Elm HP-KN Grey Elm HP-KM Landmark Wood HP-AE Maple HP-AD Medium Cherry HP-KL Neo Walnut HP-KC New Age Oak HP-KR Phantom Ecru HP-KS Phantom Pearl HP-KD River Cherry HP-KE Sanara HP-KF Williamsburg Cherry</p>	<p>Trim Grade A <u>Smooth</u> TR-R Beige TR-AK Chalk TR-K Charcoal TR-C1 Cocoa TR-J Graphite TR-G Gray Tone TR-AA Putty TR-E Smoke TR-PLS Smooth Plaster TR-FM Snow</p> <p><u>Textured</u> TR-TY Cement TR-TG GROUT TR-TF Pitch TR-TW Plaster</p> <p>Grade B <u>Smooth</u> TR-1C Accent Blue TR-1D Accent Green TR-1E Accent Orange TR-1F Accent Red TR-1G Blue Jay TR-1L Brindle TR-1R Brownstone TR-CTS Chartreuse TR-1N Night TR-1Q Park TR-RR Rusty Red TR-1M Sable TR-1P Seville TR-1J Sky Blue TR-1H Terra TR-1K Wren</p> <p><u>Smooth Metallic</u> TR-DM Dark Bronze Metallic TR-MC Metallic Champagne TR-LE Metallic Silver</p> <p><u>Textured Metallic</u> TR-AL Alloy TR-AR Argent TR-HE Hellenic</p>	<p>Casters TR-F Black TR-7 Fog TR-LPL Light Platinum</p>
---	---	--	---

ALERT: These materials are current, however they are being considered for future obsolescence due to low volume.

Wood:
VR-W21 Mahogany Satin on Walnut
VR-W12 Naturally
WF-RC Sorrel Double Cut

Laminate:
H-DH Barley Grain
H-22 Gray Spex
H-AD Medium Cherry
H-DA Oats Grain
H-EK Owl Nest
H-EC Quail Nest
H-ED Rhea Nest
H-EA Robin Nest
H-DE Wheat Grain
H-21 White Spex

Forest Stewardship Council (FSC) Statement:
In our continuing support of sustainable forestry and responsible purchasing, Haworth North America is offering FSC certified wood products at no up-charge. By providing FSC certified material, Haworth is supporting our client's green building goals and demonstrating our collective commitment to source materials more sustainably.
Haworth will provide to you the necessary FSC-certified paperwork with your shipment. For more information, FAQs, and a complete FSC product list (including product exceptions), go to the Library and search FSC.

North American Terms of Sale

These Terms of Sale are part of a quotation, bid response, or other sales document issued by Haworth, Inc., Haworth, Ltd. ("Haworth").

These Terms of Sale do not cover products manufactured in North America shipping to non-North American countries nor do they cover products manufactured in non-North American countries shipping to North America. For those terms of sale, please contact Haworth's Global Trade and Compliance Department at 616.393.3000 or through Haworth.com.

A. Ordering Information

Haworth sells its products on the terms set forth in these standard Terms of Sale:

ORDERS MUST BE SUBMITTED IN WRITING OR ELECTRONICALLY (Lynx) AS REPRESENTED BY A VALID PURCHASE ORDER, WHICH INCLUDES PRODUCT TOTAL.

An order is not binding upon Haworth until Haworth issues an order acknowledgment to the customer (the "Customer"), which will include price information and an anticipated delivery date.

1. Order Changes/Cancellations

For Specials, Customer's Own Material (C.O.M.), finish matches, custom colors, custom products, Master lock and key orders, and RUSH orders, no changes or cancellations are allowed 24 hours after order placement. All other products require approval for changes or cancellations. A change/cancellation fee may apply. Contact Order Services for applicable charges.

Ship-to addresses changed within five (5) business days of delivery will incur fees to cover administrative costs due to re-labeling of product and/or reconsignment fees with the carrier.

Order cancellations are complete annulments of orders. Order changes are the deletion of line items or a change in size, color, quantity, ship-to address, or scope of work. There is no penalty for additions; however, any change may cause the order or the line items affected to be rescheduled. Order changes involving additional product and services which increase the value must be accompanied by an amended Purchase Order or other document as agreed.

ALL CHANGES MUST BE IN WRITING, REGARDLESS OF THE (DOLLAR) VALUE. CHANGES ARE NOT BINDING UPON HAWORTH UNTIL HAWORTH ISSUES AN ACKNOWLEDGMENT OF THE CHANGE.

2. C.O.M. (Customer's Own Material)

A Customer who requests a fabric, surface or finish material (C.O.M.) not in Haworth's standard finish offering must first confirm approval of or request new approval for the C.O.M.

Haworth will determine feasibility of the material for manufacturability. For a description of the procedure to submit C.O.M. samples, contact Haworth's Order Services department. For testing information, see the C.O.M. section of the catalog, or call Haworth Order Services.

If Haworth agrees to use the C.O.M., (1) Haworth shall have no responsibility for the condition, quality, value, performance, physical properties, or any other aspect of the C.O.M.; and (2) Haworth shall have no liability for any damages, injuries, or losses to the Customer or to any third party that shall be caused by any C.O.M., and the Customer shall hold Haworth harmless for all such liability.

3. Valid/Complete Purchase Order

The following information is required in order to process an order with Haworth:

a. Customer Information

- i. **Sold To:** Legal name, complete address (if Haworth is to bill the end user, provide end user Purchase Order made out to Haworth, Inc., Haworth, Ltd.) and phone and fax number.
- ii. **Ship To:** Legal name and address.
- iii. **Purchase Order Number:** From the party Haworth will be billing.
- iv. **Authorized Signature:** All Purchase Orders must be signed by a duly authorized representative if a signature line is present. Electronically transmitted Purchase Orders will be accepted without a signature if dealer billed and the dealer has an electronic purchase payment agreement on file.
- v. **Contact Name and Phone Number:** Person Haworth should contact with any questions regarding the order.
- vi. **Shipping Contact:** Name and phone number of person to be contacted regarding shipping and delivery matters.
- vii. **Tagging Instructions:** This information will appear on all documentation received from Haworth including: cartons, acknowledgments, and invoices.
- viii. **Price Agreement or National Sales Agreement Number**
- ix. **Product Total:** Net dollars.
- x. **Installation, Design, Project Management, and/or Service Fees**

b. Product Information

- i. **Quantity**
- ii. **Product Numbers**
- iii. **Colors**
- iv. **Specials:** Specify special part number for new special products.
- v. **Customer's Own Material:** Order entry code, manufacturer, pattern, and color.

- vi. **Approval Drawings:** An authorized signature by a duly authorized representative is required for shop drawings when applicable.
- vii. A deposit may be required for custom materials.

c. Order Confirmation

All orders will be acknowledged.

B. Pricing Policies

1. Terms of Payment

Terms of payment and credit limits will be established based on financial information. Standard payment terms on open credit are net thirty (30) days from invoice date. Advance payments or other payment security may be required by Haworth. The account balance must be at or below the credit limit and current at all times (no past-due balances). Haworth reserves the right to delay or cancel any delivery to a Customer whose Haworth account balance is over the credit limit and/or past due. For walls and floors a deposit will be required.

2. Terms of Credit

Customer hereby authorizes Haworth to obtain such credit reports, financial information or other information as Haworth may request, including, without limitation, credit information from any financial institutions or others having a business relationship with the Customer. Customer hereby authorizes any credit references to answer Haworth's inquiries and provide such credit information and documentation as Haworth may request.

The Customer hereby releases and holds Haworth harmless for any inconvenience whatsoever, caused by any temporary or permanent withdrawal or restriction of credit privileges hereunder, or the enforcement of any of the provisions contained in this paragraph.

3. Past-Due Charges

Past-due balances will be increased by a maximum of 1.5% per month, or 18% annually, without forfeit of Haworth's right to immediate payment.

4. Applicable Prices

The price of any product sold to Customer by Haworth will be based upon the North American Price List (Catalog).

Prices and discounts are subject to change without notice or approval. In the event of an adjustment to pricing, National Sales Agreement (NSA) Customers will be notified in advance according to the terms of the NSA.

Applicable prices and currency exchange rates are those in effect at the time of the RECEIPT of an ORDER; Haworth reserves the right to use the published pricing effective at the time of shipment, if the requested delivery date is more than 120 days after the order receipt date.

North American Terms of Sale

Haworth Flooring products are sold using the North American price list in US dollars. Currency exchange rates at the time of the transaction will be used to convert the USD amount into the alternate currency. Should the currency exchange rate between the USD and alternate currency change between a quote and the receipt of an order, the alternate currency amount will also change to equal the current, equivalent USD amount.

5. C.O.M. (Customer's Own Material) Charges

Refer to appropriate Customer's Own Material (C.O.M.) form for applicable surface material charges.

6. Taxes

Haworth prices do not include customs duty, sales, use, value added or similar taxes. Any federal, state/provincial or other taxes or assessments based upon the sale or delivery of products or services sold applicable to the customer at present or later imposed by federal, state/provincial or municipal agencies, shall be added and paid by the customer. Customer is responsible for all such taxes.

NOTE: For all countries a valid sales tax exemption certificate must be approved by and on file with Haworth prior to product shipment. Otherwise, sales tax will be due and payable to Haworth when such tax is invoiced to Customer.

7. Services

If, as a result of Customer request, the Haworth dealer or Haworth subsidiary provides planning/design services, storage, project management, special handling, set-up, installation and/or other services, the Customer will be charged at the local Haworth dealer/subsidiary's prevailing rates.

8. Termination by Haworth

Haworth may immediately terminate an order upon written notice in the event bankruptcy or insolvency proceedings are instituted by or against the Customer, or the Customer is adjudicated as bankrupt, becomes insolvent, makes an assignment for the benefit of creditors, or proposes or makes any arrangements for the liquidation of its debts, or a receiver or receiver and manager is appointed with respect to all or any part of the assets of the Customer.

C. Shipping and Delivery

Haworth will have the right to determine the method of shipment and routing of product.

This section does not apply to any of Haworth's Flooring products. All Haworth Flooring products are sold freight collect.

If, for any reason, a delivery has to be made to an intermediate location (i.e. a location other than the "Ship To" location noted on the order or ultimate end user location), all handling and re-delivery costs incurred would be at the Customer's expense.

1. U.S.A. - Contiguous

All deliveries will be CPT (Carriage Paid To) (ICC Incoterms 2010) Haworth's manufacturing facilities or distribution centers. Freight charges will be prepaid by Haworth on all orders to locations within the continental United States. Customer bears all risk of loss or damage to the goods when they are placed on Haworth's means of transport.

2. U.S.A. - Non-contiguous (Alaska, Hawaii and Puerto Rico)

All deliveries will be CIF (Cost, Insurance and Freight) (ICC Incoterms 2010). Haworth's catalog prices include ocean freight and insurance to the port of the final destination. Haworth has the right to determine the carrier, method of shipment and routing. Haworth will contract with the insurer and provide minimal insurance coverage (CIF @ 110%) made payable to the Customer. Customer is responsible to obtain greater insurance if so desired.

Customer bears all risk of loss or damage to the goods when the goods are effectively at the disposal of the Customer on board the vessel at the named port of destination. Proof of delivery is a clean on board bill of lading. Customer will be responsible for all on-carriage from the receiving port to the final destination.

3. Canada

All deliveries will be DDP (Delivered Duty Paid) (ICC Incoterms 2010). Haworth's catalog prices include delivery to Customer's named place, not unloaded from any arriving means of transport. Customer bears all risk of loss or damage to the goods when they are delivered to the Customer's named facility not unloaded. Haworth will assume responsibility to file all freight claims with the carrier for any loss/damage which may occur while product is in transit, and will promptly repair or replace any damaged or lost product. Haworth requires the Customer to report all freight damage and/or loss to both the carrier and to Haworth.

NOTE: Under all delivery terms (U.S.A. and Canada), any additional expense resulting from Customer's request for expedited transportation, special services, packaging, handling, routing, and/or shipping method will be billed to Customer.

4. Mexico

All deliveries will be DAP (Delivered to Place) (ICC Incoterms 2010). Haworth's catalog prices include freight charges for normal surface transportation to a United States point of exportation within the 48

contiguous states. Haworth has the right to determine the carrier, method of shipment and routing.

Customer bears all risk of loss or damage to the goods when the goods are delivered to the named United States point of exportation. Haworth will provide customs clearance facilitation and arrangement of local delivery through an Authorized Dealer in Mexico, on a separately negotiated basis. Otherwise the Customer will be responsible for all customs clearance formalities and on-carriage from the United States point of exportation to the final destination in Mexico.

5. Delivery Dates and Delay

If Haworth cannot deliver products as scheduled due to causes beyond its reasonable control (such as casualty, labor disputes, or accident; inability to obtain necessary labor, material or transportation; or changes requested by the Customer), the delivery date will be extended to compensate for the delay as determined by Haworth.

6. Delivery Shortages and Damage

Product shortages and damage must be noted on delivery receipts at the time of delivery and reported to the carrier for correction.

Claims against Haworth for shortages, errors, or damage must be made within ten (10) days of the date of delivery or the Customer waives the right to make such a claim. Signed Bill of Ladings or Delivery Receipt must be sent in with claims. See the Haworth/Haworth Dealers Roles and Responsibilities document for further details.

7. Storage

Haworth may transfer product to storage at the Customer's risk and expense if the Customer is unable or unwilling to take delivery of product as originally scheduled. Upon such transfer to storage, the Customer assumes risk of loss. Haworth will invoice the Customer for storage fees and the Customer will make payments in accordance with Haworth's standard payment terms.

North American Terms of Sale

D. General Terms

1. Governing Law

For products purchased for delivery in the U.S. pursuant hereto, this Agreement shall be governed by and construed according to the laws of the State of Michigan. Where Products are purchased for delivery in Canada pursuant hereto, this Agreement shall be governed by and construed according to the laws of the Province of Alberta. In either case, the parties attorn to the exclusive jurisdiction of the courts of Michigan and Alberta, respectively for the purpose of hearing any disputes arising under this Agreement or with respect to any Products sold pursuant hereto, and agree that the provisions of the United Nations Convention on Contracts for the International Sale of Goods and any other provision or law which would have the effect of applying the laws of any jurisdiction other than Michigan or Alberta, as the case may be, shall be excluded.

2. Force Majeure

In the event that the performance of Customer or Haworth or its participating dealer assignee(s) would be prevented, restricted, interfered with or rendered commercially impracticable by reason of Force Majeure, then upon the giving of notice to the other parties, the party affected by the Force Majeure shall be excused from performing hereunder until the Force Majeure no longer prevents, restricts, interferes with, or renders such performance commercially impracticable.

"Force Majeure" shall mean: fire, explosion, breakdown of plant, epidemic, hailstorm, snow/ice storms en route, hurricane, tornado, cyclone, flood or power failure; war, revolution, civil or military disturbances, acts of public enemies, acts of terrorism, blockade or embargo; any law, order, proclamation, regulation, ordinance, demand or requirement of any applicable governmental authority or any subdivision, authority, or representative of any such government; labor difficulties, including without limitation, strikes, slowdowns, picketing or boycotts; or difficulties beyond Haworth's reasonable control in obtaining necessary raw materials, labor, fuels and electric power, components or facilities, and any other circumstances beyond the control of the party affected.

3. Delays by Customer

Where Haworth has not received adequate site dimensions, Product specifications, shipping information, installation particulars or other information required by Haworth to permit the efficient manufacture of any Products, or where site conditions are not in accordance with the Installation Requirements set forth, or are not otherwise suitable to permit effective and efficient installation, the manufacture and/or delivery of Products may be delayed, and such event shall constitute a delay by the Customer. When manufacture, delivery or installation is delayed by the Customer or at the Customer's request: (i) Haworth may, at its option, present the invoice for the full price of the Products to the Customer as then due and payable; (ii) the Customer shall pay to

Haworth all reasonable storage, handling and other reasonable incidental expenses incurred by Haworth in connection with such delay; and (iii) the Customer shall bear all risk of loss or damage to the Products being held by Haworth for the Customer.

4. Use and Installation of Products

Haworth recommends that its products be installed by certified, qualified and approved installers according to Haworth's written installation procedures. The Customer agrees to use Haworth products properly; not to remove or alter safety devices, warnings, or operation instructions placed on products by Haworth, and to instruct employees as to the proper care and use of the products according to printed instructions.

5. Warranty

Haworth's standard North American Warranty will apply as appropriate. All product line warranty specifics are available in each catalog or upon request.

E. Services

Service requests for design, installation, relocation, storage, etc. are handled by the local Haworth dealer on a separately negotiated basis. Contact the local Haworth dealer, affiliate or area sales office for more details.

Scope of Work - Design

Customer acknowledges that the Products to be manufactured or procured by Haworth in connection with the order are or may be custom manufactured for the Customer and that Haworth may be required to perform extensive work in relation to the design and specification of such Products. Where Customer requests that Haworth create as-built drawings or make more than two material revisions to any particular Product design or specification, Customer agrees that Haworth shall be entitled to invoice Customer with respect to such additional work on the basis of Haworth's then prevailing rates for related design and specification services.

Installation Requirements

Where installation services are to be provided by Haworth, its authorized dealer or subcontractor, a document will be provided setting forth the scope of installation work to be performed (the "Scope of Work") and the price to be charged therefore. Unless otherwise specified in the scope of work, Haworth's installation services are limited to products sold by Haworth with the exception of lighting, under floor electrical and data.

General Conditions

(a) Sufficient time shall be allocated by the Customer following delivery of Products and prior to Customer's occupation of the premises to allow the installation of all Products during conventional working hours, Monday through Friday, 7:30 a.m. to 4:30 p.m. Where sufficient time is not allocated and Haworth is required or requested to perform installation work outside of such times, overtime charges shall be charged at Haworth's then prevailing rates. (b) Haworth shall be given free and exclusive access to; (i) a loading dock within 150' of the freight elevator or hoist, which loading dock shall be of sufficient size to enable full-size tractor-trailer deliveries to the premises (where required by Haworth); (ii) a freight elevator or hoist of sufficient size and capacity to allow the efficient movement of the Products; (iii) an unobstructed and safe pathway to the area where Products are to be stored or staged; (iv) a secure storage / staging area; (v) convenient trash facilities; (vi) adequate lighting; (vii) a work site that complies with applicable health and safety legislation. Where such areas and facilities are not available, Haworth shall be entitled to bill Customer for all amounts incurred by Haworth for double-handling, product movement, lifting, hoisting, trash removal and any other resulting charges. (c) The installation site shall be free and clear of existing furniture, debris, or other obstructions (including construction in progress) and shall otherwise be in the reasonable opinion of Haworth ready for installation of the Products. Any building where Products are to be installed shall be fully closed in, dry and protected from the natural elements, with temperatures between 40°F and 90°F (4°C and 32°C) and relative humidity not to exceed 70% at all times including receipt of products, during and after installation and shall be adequately heated and/or air-conditioned. Where unusual site conditions exist which impede or prevent the normal installation of any Products, applicable extra charges shall apply at prevailing rates. (d) Haworth's installation pricing is based upon the installation occurring as one continuous delivery and installation project. Phased installation pricing shall be provided by Haworth on a case by case basis. (e) Electrical hardwiring, plumbing and mechanical work is not included and shall be the responsibility of the Customer. (f) Except as may be otherwise specifically indicated, installation pricing does not apply to projects where union labor is required. Where Haworth has provided installation pricing on the basis that non-union labor be utilized, and where Haworth is required to use union labor or it otherwise becomes impractical to use non-union labor, or where Haworth is required by law to use prevailing wages, Haworth shall be entitled to charge the Customer for any cost differential between the anticipated cost of non-union labor and the actual cost of utilizing union or prevailing wage labor. (g) Haworth shall not be responsible for obtaining permits.

North American Terms of Sale

Project / Site Conditions

Lateral load bracing is not included in the scope of Haworth's work and shall not be performed by Haworth. In areas where flooring Products are to be installed by Haworth overhead construction must be completed prior to the commencement of such work to avoid damage to the panels and finishes. The existing subfloor must be smooth, mopped clean, free of moisture, dust, dirt and debris. Once installed, the access floor must be maintained in the same manner. The subfloor must have a maximum vertical elevation deviation of 0.375" (10mm) over a horizontal span of 10'-0" (3m), and without discontinuities in floor slope. For greater certainty, the scope of Haworth's installation work in such areas shall not be deemed to include any work required to level such subfloor, remove protrusions, remove pre-existing floor coverings or adhesives, or any other work which is required to remedy any conditions which may impede the efficient installation of flooring. Except as may be otherwise specifically indicated in the order, installation pricing for flooring Products and the Scope of Work in relation thereto shall not include any work required to remove and replace floor panels following their initial installation to provide tradespersons or others with access to the underpanel cable management cavity. In areas where movable walls are to be installed, all flooring (including carpeting) and ceiling components (including dropped ceiling grid components) shall be fully complete and ready for the installation of the movable wall products. Further, the existing floor (or other surface on which the movable wall panels are to be installed) shall have a maximum vertical deviation of 1.25" (30mm) and the dropped ceiling grid shall have a maximum vertical deviation of 0.375" (10mm) from the specifications to which such movable wall panels were designed and manufactured (collectively the "Permitted Tolerances"), and shall otherwise comply with any site condition assumptions made known to Haworth prior to the manufacture of such Products (the "Site Assumptions"). Where the Permitted Tolerances or Site Assumptions are not strictly adhered to or met, additional charges may be incurred in connection with site remediation and/or the modification or remanufacture of affected movable wall products, together with all resulting shipping and labor charges at Haworth's then prevailing rates for such Products and services.

Installation Change Orders

Where Customer requests work to be performed or materials to be provided which are not contemplated in the Scope of Work, or Customer otherwise requests Products or services not contemplated in the order (collectively "Extras"), prior to providing such Extras Haworth reserves the right to require the Customer to provide and sign a written Purchase Order or Change Order acceptable to Haworth describing the Extras and the amounts to be charged therefore, and the Customer agrees to pay such charges.

Entire Agreement

The order and this Agreement (including applicable Schedules) constitute the sole agreement between the parties and supercede any prior understanding or written or oral agreements between the parties (excluding National Sales Agreements). No waiver of any of the provisions of these Standard Terms and Conditions shall be binding on Haworth unless expressly agreed in writing.

Revision Date: June 1, 2015

Index

Products are listed alphabetically in this index by alpha-numeric prefix/suffix codes.

Product Code	Product Description	Page
EHPO	Planter — Oblong	.66
EHPR	Planter — Round	.67
EUIM	Executive Wood Tables – A5 – Electric Lift Interface Module	.8
EUTP	Telecom Plates for Interface	.8
EWCX-5001-V	Planes Accessories – HDMI or VGA Cable	.102
EWCX-BRWM	Electrical Accessories – Cable Base Cable Retractor	.100
EWCX-H	Planes Accessories – HDMI or VGA Cable	.102
EWCX-V	Planes Accessories – HDMI or VGA Cable	.102
GAC1	Planes Credenza Base – 29” High – Credenza Base – 29”(737mm) High – Laminate or Wood	.107
GAC1	Planes Credenza Bases – 19” High – Credenza Base – 19”(483mm) High – Laminate or Wood	.104
GAC2	Planes Credenza Base with Slider Unit — 35” High – Credenza Base – 35”(889mm) High with Slider Unit – Laminate or Wood	.106
GAC2	Planes Credenza Base with Slider Unit — 39” High – Credenza Base – 39”(991mm) High with Slider Unit – Laminate or Wood	.108
GAC2	Planes Credenza Base with Slider Unit — 45” High – Credenza Base – 45”(1143mm) High with Slider Unit – Laminate or Wood	.109
GAC2	Planes Credenza Base with Slider Unit – 29” High – Credenza Base – 29”(737mm) High with Slider Unit – Laminate or Wood	.105
GACJ	Planes Credenza Tops – Credenza Top – Laminate or Wood	.103
GAKD-1919	Planes Cart – Podium – Laminate or Wood	.169
GAKE-1919	Planes Carts — Medium Media – Laminate or Wood	.167
GAKF-1919	Planes Carts — Small Media – Laminate or Wood	.166
GAKG-1935	Planes Carts – Catering – Laminate	.168
TA01	Planes Credenza Tops – Grommet	.103
TA01	Planes Conference Table — Column Base (for use with Conference Table Top) – J-Channels – J-Channel Tray	.98
TA01-0217	Planes Accessories – Cable Column	.101
TA01-0814	Planes Accessories – Cable Base	.101
TA01-1414	Planes Accessories – Cable Base	.101
TA01-CR48	Electrical Accessories – Cable Reel	.99
TA01-CRBK	Electrical Accessories – Cable Reel Bracket	.99
TA01-PB21	Electrical Accessories – Cable Management Processor Bracket	.100
TACB-2	Planes Conference Table — Column Base (for use with Conference Table Top and End Supported Top) – Column Frame	.95
TACB-4	Planes Conference Table — Column Base (for use with Conference Table Top and End Supported Top) – Column Frame	.95
TACB-7	Planes Conference Table — Column Base (for use with Conference Table Top and End Supported Top) – Column Frame	.95
TACC-F2	Planes Conference Table — Column Base (for use with Conference Table Top and End Supported Top) – Cladding — Flat and Round	.97
TACC-R2	Planes Conference Table — Column Base (for use with Conference Table Top and End Supported Top) – Cladding — Flat and Round	.97
TACV	Planes Conference Tables — Interior Leg — Laminate – Polygon	.113
TACV	Planes Conference Tables — Interior Leg — Wood – Polygon	.117
TAHN	Planes Conference Tables — Interior Leg — Laminate – Half Round	.112
TAHN	Planes Conference Tables — Interior Leg — Wood – Half Round	.116
TAJC	Planes Conference Table — Column Base (for use with Conference Table Top) – J-Channels – J-Channel	.98
TAPL-R	Planes Conference Table — Column Base (for use with Conference Table Top and End Supported Top) – Column Base Plate — Square and Round	.96
TAPL-S	Planes Conference Table — Column Base (for use with Conference Table Top and End Supported Top) – Column Base Plate — Square and Round	.96
TARA	Planes Conference Table Top — Rectangle (for use with Column Base) – Laminate or Wood	.73
TARA	Planes Conference Tables — Interior Leg — Laminate – Rectangular	.110
TARA	Planes Conference Tables — Interior Leg — Wood – Rectangular	.114
TARA	Planes Conference Tables — One-Piece Top — Interior Leg — Laminate – Rectangular	.118
TARA	Planes Conference Tables — One-Piece Top — Interior Leg — Wood – Rectangular	.124
TARA	Planes Conference Tables — One-Piece Top — Perimeter Leg — Wood – Rectangular – 2”(51mm) Edge	.161
TARA	Planes Conference Tables — Perimeter Leg — Laminate – Square and Rectangular – 2”(51mm) Edge	.154
TARA	Planes Conference Tables — Perimeter Leg — Wood – Rectangular – 2”(51mm) Edge	.160
TARA	Planes Conference Tables — Three-Piece Tops — Interior Leg — Wood – Rectangular	.148
TARA	Planes Conference Tables — Two-Piece Tops — Interior Leg — Wood – Rectangular	.136
TARA	Planes Conference Tables — Two-Piece Tops — Perimeter Leg — Wood – Rectangular – 2”(51mm) Edge	.162

Index

Product Code	Product Description	Page
TARA	Planes Conference Tables — Three-Piece Tops — Interior Leg — Laminate — Rectangular	142
TARA	Planes Conference Tables — Three-Piece Tops — Perimeter Leg — Laminate — Rectangular — 2”(51mm) Edge	158
TARA	Planes Conference Tables — Three-Piece Tops — Perimeter Leg — Wood — Rectangular — 2”(51mm) Edge	164
TARA	Planes Conference Tables — One-Piece Top — Perimeter Leg — Laminate — Rectangular — 2”(51mm) Edge	155
TARA	Planes Conference Tables — Two-Piece Tops — Interior Leg — Laminate — Rectangular	130
TARA	Planes Conference Tables — Two-Piece Tops — Perimeter Leg — Laminate — Rectangular — 2”(51mm) Edge	156
TARD	Planes End Supported Top — D-Shape Convergent (for use with Column Base) — Laminate or Wood	88
TARN	Planes Conference Tables — Interior Leg — Laminate — Round	110
TARN	Planes Conference Tables — Interior Leg — Wood — Round	114
TARN	Planes Conference Table Top — Round, Square and Pebble (for use with Column Base) — Laminate or Wood	71
TARP	Planes Conference Table Top — Pebble (for use with Column Base) — Laminate or Wood	77
TARP	Planes Conference Tables — One-Piece Top — Interior Leg — Laminate — Pebble	120
TARP	Planes Conference Tables — One-Piece Top — Interior Leg — Wood — Pebble	126
TARP	Planes Conference Tables — Three-Piece Tops — Interior Leg — Wood — Pebble	150
TARP	Planes Conference Tables — Two-Piece Tops — Interior Leg — Wood — Pebble	138
TARP	Planes Conference Tables — Three-Piece Tops — Interior Leg — Laminate — Pebble	144
TARP	Planes Conference Table Top — Round, Square and Pebble (for use with Column Base) — Laminate or Wood	71
TARP	Planes Conference Tables — Two-Piece Tops — Interior Leg — Laminate — Pebble	132
TARQ	Planes Conference Tables — Interior Leg — Laminate — Square	110
TARQ	Planes Conference Tables — Interior Leg — Wood — Square	114
TARQ	Planes Conference Tables — Perimeter Leg — Laminate — Square — 2”(51mm) Edge	154
TARQ	Planes Conference Tables — Perimeter Leg — Wood — Square — 2”(51mm) Edge	160
TARQ	Planes Conference Table Top — Round, Square and Pebble (for use with Column Base) — Laminate or Wood	71
TARU	Planes End Supported Top — Rectangular Conference End (for use with Column Base) — Laminate or Wood	90
TARX	Planes Conference Table Top — Hexagon (for use with Column Base) — Laminate or Wood	81
TARX	Planes Conference Tables — One-Piece Top — Interior Leg — Laminate — Hexagon	122
TARX	Planes Conference Tables — One-Piece Top — Interior Leg — Wood — Hexagon	128
TARX	Planes Conference Tables — Three-Piece Tops — Interior Leg — Wood — Hexagon	152
TARX	Planes Conference Tables — Two-Piece Tops — Interior Leg — Wood — Hexagon	140
TARX	Planes Conference Tables — Three-Piece Tops — Interior Leg — Laminate — Hexagon	146
TARX	Planes Conference Tables — Two-Piece Tops — Interior Leg — Laminate — Hexagon	134
TARY	Planes End Supported Top — Key Conference (for use with Column Base) — Laminate or Wood	92
TEA5	Executive Wood Tables — A5 — Base Kit	6
TEBO	Executive Wood Tables — Boat	29
TEBO	Executive Wood Tables — Boat	29
TECB	Conference Buffet — Conference Buffet — Wood	37
TEFC	Executive Wood Tables — Base Kits — Boat Wood Tables	32
TEFC	Executive Wood Tables — Base Kits — Racetrack Wood Tables	28
TEFC	Executive Wood Tables — Base Kits — Rectangular Wood Tables	24
TEFC	Executive Wood Tables — Base Kits — Round/Square Wood Tables	20
TEFC	Executive Wood Tables — Base Kits — Wedge Wood Tables	36
TEFC-A	Executive Wood Tables — Base Kits — Boat Wood Tables	32
TEFC-A	Executive Wood Tables — Base Kits — Racetrack Wood Tables	28
TEFC-A	Executive Wood Tables — Base Kits — Rectangular Wood Tables	24
TEFC-A	Executive Wood Tables — Base Kits — Round/Square Wood Tables	20
TEFC-A	Executive Wood Tables — Base Kits — Wedge Wood Tables	36
TEGL	Executive Wood Tables — A5 — Glass Centerpiece	7
TEHC	Executive Wood Tables — Base Kits — Boat Wood Tables	32
TEHC	Executive Wood Tables — Base Kits — Racetrack Wood Tables	28
TEHC	Executive Wood Tables — Base Kits — Rectangular Wood Tables	24
TEHC	Executive Wood Tables — Base Kits — Wedge Wood Tables	36
TEHC-A	Executive Wood Tables — Base Kits — Boat Wood Tables	32
TEHC-A	Executive Wood Tables — Base Kits — Racetrack Wood Tables	28
TEHC-A	Executive Wood Tables — Base Kits — Rectangular Wood Tables	24
TEHC-A	Executive Wood Tables — Base Kits — Wedge Wood Tables	36

Index

Product Code	Product Description	Page
TEPB	Accessories – Presentation Board	38
TERA	Executive Wood Tables – Rectangular	21
TERA	Executive Wood Tables – Rectangular	21
TERN	Executive Wood Tables – Round/Square	19
TERQ	Executive Wood Tables – Round/Square	19
TERT	Executive Wood Tables – Racetrack Tables	25
TERT	Executive Wood Tables – Racetrack Tables	25
TESL	Executive Wood Tables – Base Kits — Boat Wood Tables	32
TESL	Executive Wood Tables – Base Kits — Racetrack Wood Tables	28
TESL	Executive Wood Tables – Base Kits — Rectangular Wood Tables	24
TESL	Executive Wood Tables – Base Kits — Wedge Wood Tables	36
TEWE	Executive Wood Tables – Wedge	33
TEWE	Executive Wood Tables – Wedge	33
TEXB-M	Executive Wood Tables – Base Kits — Round/Square Wood Tables	20
TEXB-W	Executive Wood Tables – Base Kits — Boat Wood Tables	32
TEXB-W	Executive Wood Tables – Base Kits — Racetrack Wood Tables	28
TEXB-W	Executive Wood Tables – Base Kits — Rectangular Wood Tables	24
TEXB-W	Executive Wood Tables – Base Kits — Round/Square Wood Tables	20
TEXB-W	Executive Wood Tables – Base Kits — Wedge Wood Tables	36
THLD	Immerse — Ledge Table – Rectangle – Painted Legs	52
THLD	Immerse — Ledge Table – Rectangle – Wood Legs	65
THRA	Immerse — Single Table – Rectangle – Painted Legs	41
THRA	Immerse — Single Table – Rectangle – Wood Legs	55
THRA	Immerse — Stack Table – Rectangle – Painted Legs	43
THRD	Immerse — Overlap Table – Rectangle/Round – Painted Legs	49
THRD	Immerse — Overlap Table – Rectangle/Round – Wood Legs	62
THRD	Immerse — Shift Table – Rectangle/Round – Painted Legs	45
THRD	Immerse — Shift Table – Rectangle/Round – Wood Legs	58
THRL	Immerse — Overlap Table – Rectangle/Ledge – Painted Legs	51
THRL	Immerse — Overlap Table – Rectangle/Ledge – Wood Legs	64
THRN	Immerse — Single Table – Round – Painted Legs	39
THRN	Immerse — Single Table – Round – Wood Legs	53
THRQ	Immerse — Single Table – Square – Painted Legs	40
THRQ	Immerse — Single Table – Square – Wood Legs	54
THRR	Immerse — Overlap Table – Rectangle/Rectangle – Painted Legs	47
THRR	Immerse — Overlap Table – Rectangle/Rectangle – Wood Legs	60
THRR	Immerse — Shift Table – Rectangle/Rectangle – Painted Legs	44
THRR	Immerse — Shift Table – Rectangle/Rectangle – Wood Legs	57
THRT	Immerse — Single Table – Racetrack – Painted Legs	42
THRT	Immerse — Single Table – Racetrack – Wood Legs	56
THTD	Immerse — Overlap Table – Racetrack/Round – Painted Legs	50
THTD	Immerse — Overlap Table – Racetrack/Round – Wood Legs	63
THTD	Immerse — Shift Table – Racetrack/Round – Painted Legs	46
THTD	Immerse — Shift Table – Racetrack/Round – Wood Legs	59
UXCD-N	Conference Buffet – Center Drawer	37
ZUBW-0000-PN	Planes End Supported Top (for use with Column Base) — Bracket(s) – Wall Mount Bracket(s)	94
ZZBA-0000-PL	Planes End Supported Top (for use with Column Base) — Bracket(s) – Side/Corner Bracket	94
ZZBA-0000-PLF	Planes End Supported Top (for use with Column Base) — Bracket(s) – Side Bracket for use with Knife Edge	94
ZZBA-0000-PR	Planes End Supported Top (for use with Column Base) — Bracket(s) – Side/Corner Bracket	94
ZZBA-0000-PRF	Planes End Supported Top (for use with Column Base) — Bracket(s) – Side Bracket for use with Knife Edge	94

This page intentionally blank

Great Expectations

You have them as a Haworth customer and so do we. And because **we value our customers**, we cover our products with the Haworth North America Product Compatibility and Limited Warranty Policy.

Product Compatibility And Limited Warranty Policy

OUR COMMITMENT TO PRODUCT COMPATIBILITY – INTEGRATED PRODUCT PLATFORMS

As a market leader in the design and manufacture of workspaces that adapt to change, we strive to maintain product compatibility within our various generations of integrated product platforms. This benefits the customer who desires to update or modify their work environment. It also benefits the customer needing to replace a product due to damage or other reasons but which is no longer manufactured or is otherwise unavailable, such as a fabric or finish that is discontinued because of changing market preferences. In both circumstances, we often can provide products with comparable function and performance.

OUR COMMITMENT TO PRODUCT QUALITY – THE HAWORTH NORTH AMERICA LIMITED WARRANTY

To ensure customer satisfaction and peace of mind, we stand behind our products with the Haworth North America Limited Warranty. To review the current version of the limited warranty including its terms and conditions, please go to: www.haworth.com/resources/product-info/warranties or contact Haworth's First Call Center at **800.426.8562**.

WARRANTY REQUESTS OR QUESTIONS

For questions or service requests pertaining to the Haworth Limited Warranty, please contact your Haworth dealer. If you are unsure who your dealer is, please call Haworth's First Call Center at **800.426.8562**.

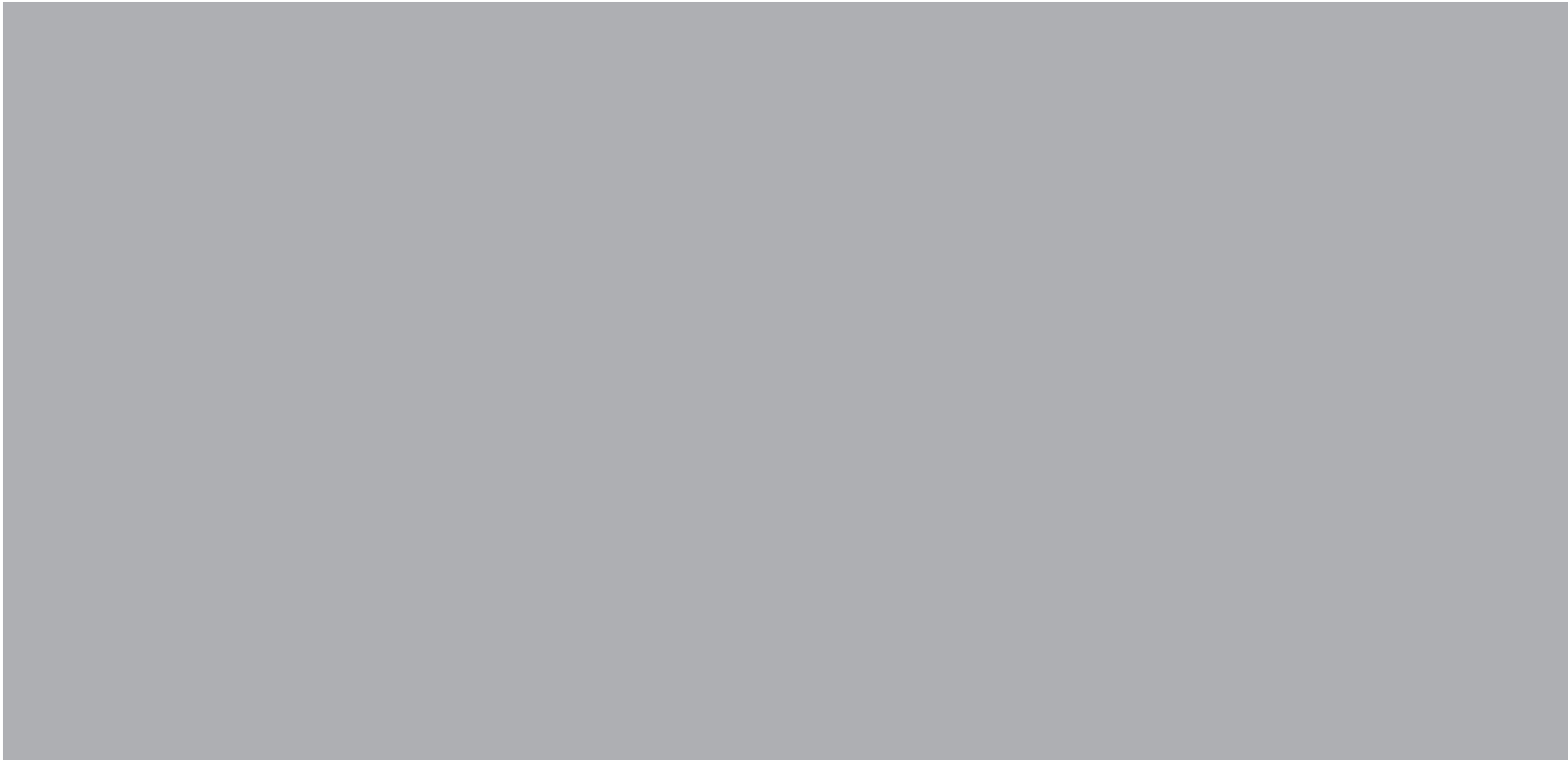

HAWORTH®

For more information call 800.344.2600 or 616.393.3000.

Haworth is a registered trademark of Haworth, Inc.
©Haworth, Inc. 2018 4.18 18 061

haworth.com | haworth-europe.com | haworth-asia.com

Executive Wood Tables – A5 — Specifications

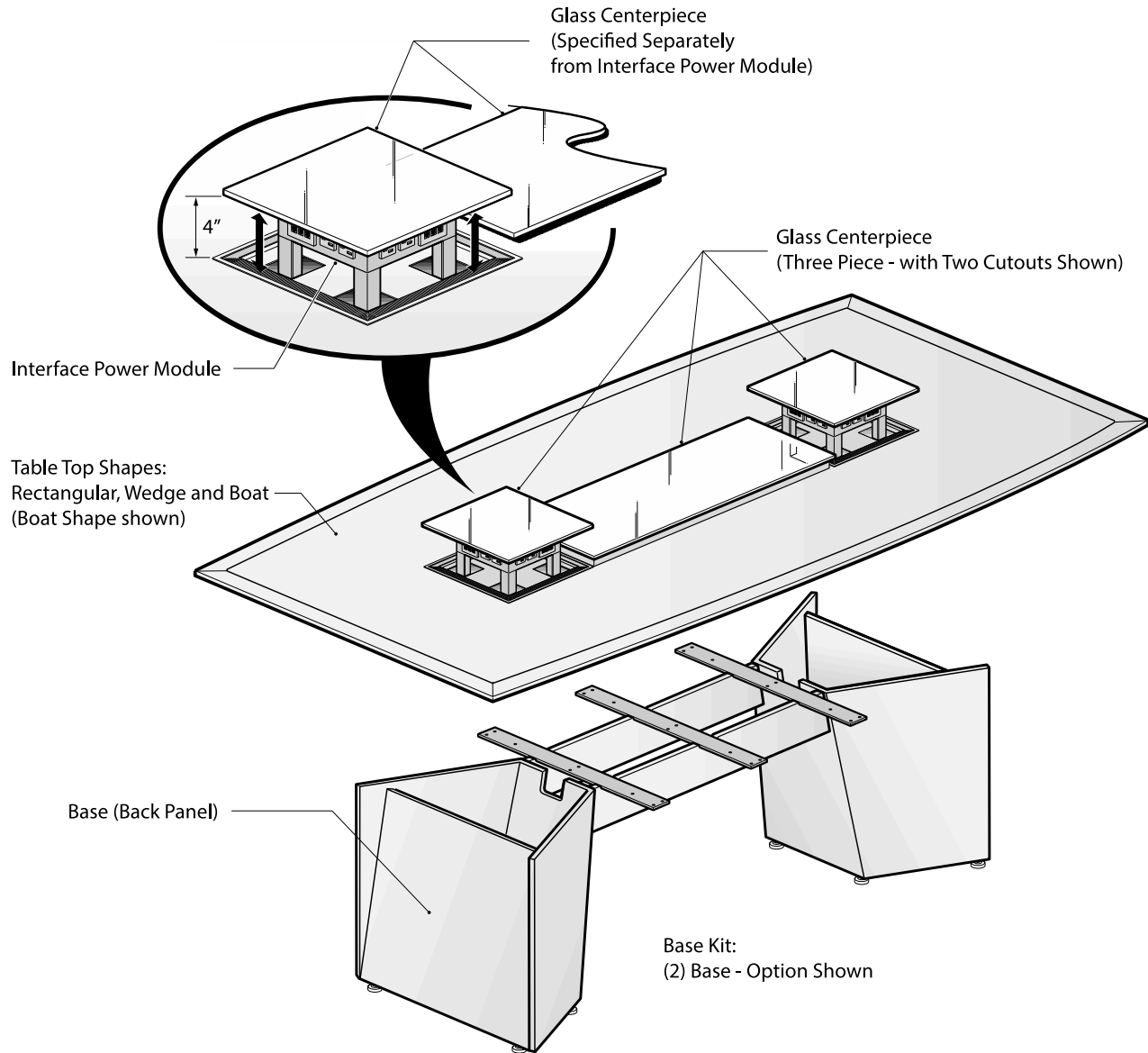

Construction Features

- One piece tops (120" [3048mm] widths) are constructed with 1 1/2" (38mm) fiber board substrate.
- Two piece tops (132" - 240" [3353mm - 6096mm] widths) are constructed with 1 1/2" (38mm) fiber board substrate and are secured together with tight joint fasteners. The tops are field joint built to go together.
- Knife edge is 1 1/2" (38mm) thick solid wood with a rake of 20.82° tapering 3" from the edge. The top of the edge is made of quarter cut veneer of the species specified for the top, creating a 3" border which is separated by the field with a 1/8" (3mm) thick black inlay.
- Base height is 28" (711mm).
- Finished table height is 29 1/2" (749mm).
- Table top dimensions are actual; however, the tables are natural wood and dimensional variance is +/- 1/4" per top.
- Boat Table Top Depth / Taper:
 - The 54" depth Boat Table Top tapers to a 48" depth at each end.
 - The 60" depth Boat Table Top tapers to a 54" depth at each end.
- Wedge Table Top Depth / Taper:
 - The 54" depth Wedge Table Top tapers to a 42" depth on one end.
 - The 60" depth Wedge Table Top tapers to a 48" depth on one end.

Wood / Finish Features

- Top field veneer is plain-sliced and book-and-center matched; border is quarter-cut veneer.
- Veneer is AWI (Architectural Woodworking Institute) Grade AA tops with conversion varnish finish. Refer to finish matrix.
- Table is designed for non-dining applications; it is highly recommended that a protective accessory be used on table tops when possible.

Executive Wood Tables – A5 — Specifications

Cutout Locations

- Cutouts available for separately specified Interface Power Module.
 - 2 Cutout option available on all sizes.
 - 3 Cutout option available on tops 192"(4877mm) wide or greater.
- Knife edge is 1 1/2"(38mm) thick solid wood with a rake of 20.82° tapering 3"(76mm) from the edge.
- Base, Interface Power Module and Glass Centerpiece must be specified separately.

Top View with (3) Cutouts

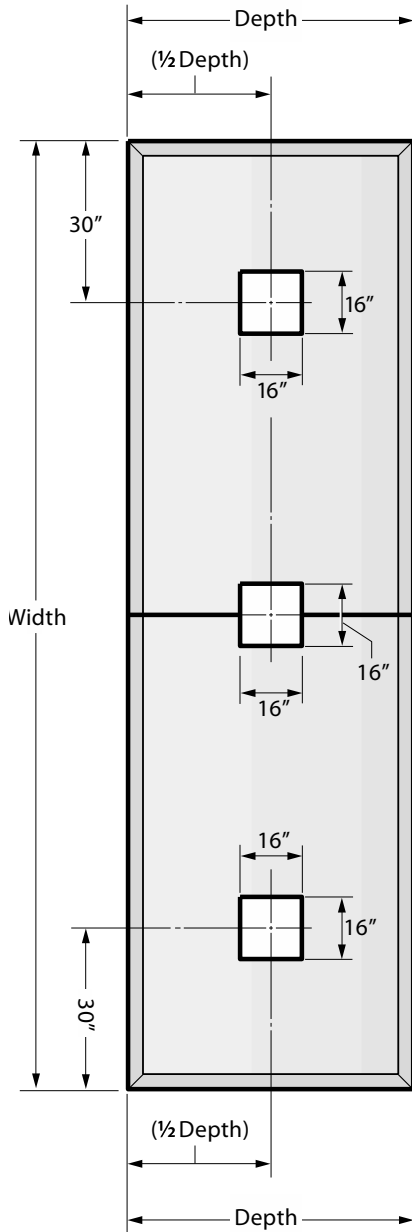

Top View with (2) Cutouts

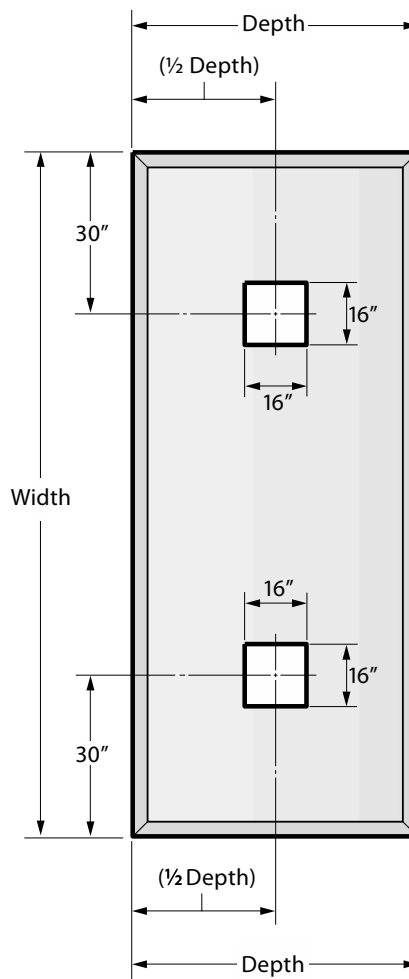

Section/Side View – Cutout Location /Edge Detail

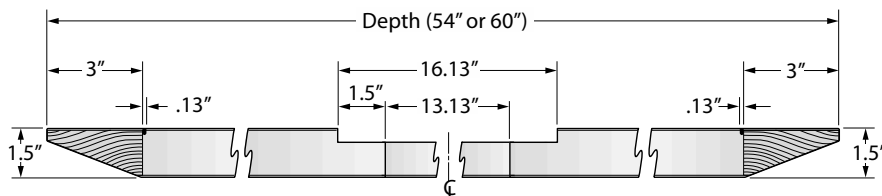

Executive Wood Tables – A5 — Specifications

Wood Grain Direction

- Two-piece tops are field joint built and secured with tight joint fasteners.
- Base, Interface Power Module and Glass Centerpiece must be specified separately.

Top View with (1) Piece Top

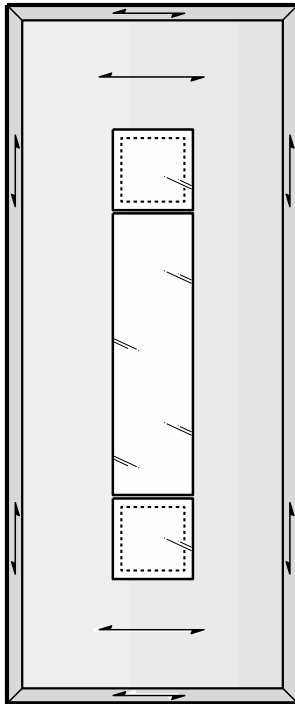

Top View with (2) Piece Top

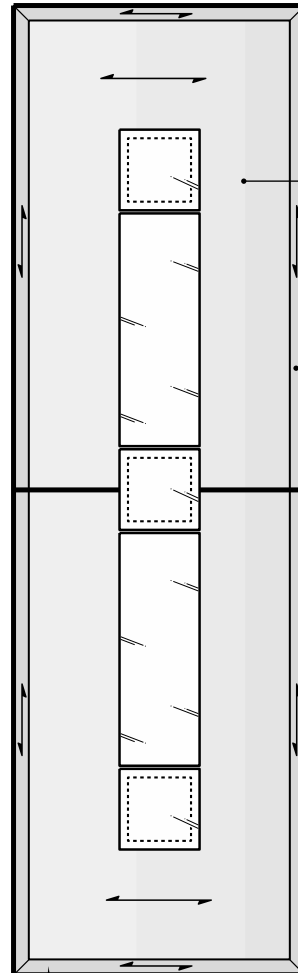

Top field veneer is plain-sliced and book-and-center matched.

Border is quarter-cut veneer.

Arrow describes Wood Grain Direction



Knife Edge / Black Inlay Detail

1/8" Black Inlay

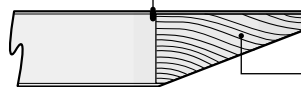

Knife edge is 1 1/2" (38mm) thick solid wood

Executive Wood Tables – A5

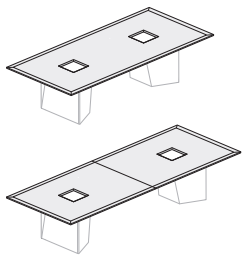
	Depth	Width	Pieces	Number	①	Wood Group	
						A	D
Rectangular Table Top  TERA	54"(1372mm)	120"(3048mm)	1	TERA-54C0-WAT	O	\$17272.81	\$24773.26
		132"(3353mm)	2	TERA-54D2-WAT	O	19991.47	28597.78
		144"(3658mm)	2	TERA-54E4-WAT	O	21801.43	31513.60
		156"(3962mm)	2	TERA-54F6-WAT	O	23611.39	34429.42
		168"(4267mm)	2	TERA-54G8-WAT	O	25421.35	37345.24
		180"(4572mm)	2	TERA-54J0-WAT	O	29038.94	42068.69
		192"(4877mm)	2	TERA-54K2-WAT	O	31601.10	45736.71
		204"(5182mm)	2	TERA-54L4-WAT	O	34163.26	49404.73
		216"(5486mm)	2	TERA-54M6-WAT	O	36725.42	53072.75
		228"(5791mm)	2	TERA-54N8-WAT	O	39287.58	56740.77
		240"(6096mm)	2	TERA-54Q0-WAT	O	41849.74	60408.79
	60"(1524mm)	120"(3048mm)	1	TERA-60C0-WAT	O	\$18263.29	\$26367.82
		132"(3353mm)	2	TERA-60D2-WAT	O	21238.63	30458.32
		144"(3658mm)	2	TERA-60E4-WAT	O	23084.23	33419.08
		156"(3962mm)	2	TERA-60F6-WAT	O	24929.83	36379.84
		168"(4267mm)	2	TERA-60G8-WAT	O	26775.43	39340.60
		180"(4572mm)	2	TERA-60J0-WAT	O	30207.62	43887.95
		192"(4877mm)	2	TERA-60K2-WAT	O	32805.42	47600.91
		204"(5182mm)	2	TERA-60L4-WAT	O	35403.22	51313.87
		216"(5486mm)	2	TERA-60M6-WAT	O	38001.02	55026.83
	228"(5791mm)	2	TERA-60N8-WAT	O	40598.82	58739.79	
	240"(6096mm)	2	TERA-60Q0-WAT	O	43196.62	62452.75	

Features

- Includes top only.
- Constructed of 1 1/2"(38mm) thick fiber board substrate with AWI (Architectural Woodworking Institute) Grade AA veneer with knife edge and mitered corners.
- Finished with conversion varnish.
- Two-piece tops are field joint built and secured with tight joint fasteners.
- Knife edge is 1 1/2"(38mm) thick solid wood with a rake of 20.82° tapering 3"(76mm) from the edge.
- Black inlay is 1/8"(3mm) thick and set 3"(76mm) from the edges.
- Cutouts available for separately specified Electric Lift Interface Module.
 - 2 Cutout option available on all sizes.
 - 3 Cutout option available on tops 192"(4877mm) wide or greater.
- Base, Electric Lift Interface Module and Glass Centerpiece must be specified separately.

Note: On site measurements should be taken to ensure there is adequate room in elevators and/or hallway conditions to accommodate the top sizes.

To Order, Specify:

1) Product number, including:

① Cutout Option:

- 2** Two (left/right) cutouts for Electric Lift Interface Module, add \$436.80 list
- 3** Three (left/center/right) cutouts for Electric Lift Interface Module, add \$655.20 list (192"(4877mm) width or greater)
- N** No cutout

2) Wood finish.

Executive Wood Tables – A5

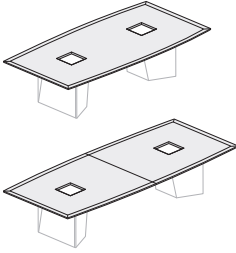
	Depth	Width	Pieces	Number	①	Wood Group		
						A	D	
Boat Table Top  TEBO	54"(1372mm)/48"(1219mm)	120"(3048mm)	1	TEBO-54C0-WAT	█ O	\$23384.51	\$32565.52	
		132"(3353mm)	2	TEBO-54D2-WAT	█ O	27095.08	37620.87	
		144"(3658mm)	2	TEBO-54E4-WAT	█ O	29630.80	41501.37	
		156"(3962mm)	2	TEBO-54F6-WAT	█ O	32166.52	45381.87	
		168"(4267mm)	2	TEBO-54G8-WAT	█ O	34702.24	49262.37	
		180"(4572mm)	2	TEBO-54J0-WAT	█ O	38849.60	54754.51	
		192"(4877mm)	2	TEBO-54K2-WAT	█ O	42137.52	59387.21	
		204"(5182mm)	2	TEBO-54L4-WAT	█ O	45425.44	64019.91	
		216"(5486mm)	2	TEBO-54M6-WAT	█ O	48713.36	68652.61	
		228"(5791mm)	2	TEBO-54N8-WAT	█ O	52001.28	73285.31	
		240"(6096mm)	2	TEBO-54Q0-WAT	█ O	55289.20	77918.01	
		60"(1524mm)/54"(1372mm)	120"(3048mm)	1	TEBO-60C0-WAT	█ O	\$24817.51	\$34743.40
			132"(3353mm)	2	TEBO-60D2-WAT	█ O	27337.94	38621.79
			144"(3658mm)	2	TEBO-60E4-WAT	█ O	29702.74	42344.55
			156"(3962mm)	2	TEBO-60F6-WAT	█ O	32067.54	46067.31
			168"(4267mm)	2	TEBO-60G8-WAT	█ O	34432.34	49790.07
			180"(4572mm)	2	TEBO-60J0-WAT	█ O	40533.20	57248.89
			192"(4877mm)	2	TEBO-60K2-WAT	█ O	43871.24	61944.89
			204"(5182mm)	2	TEBO-60L4-WAT	█ O	47209.28	66640.89
	216"(5486mm)		2	TEBO-60M6-WAT	█ O	50547.32	71336.89	
	228"(5791mm)		2	TEBO-60N8-WAT	█ O	53885.36	76032.89	
	240"(6096mm)	2	TEBO-60Q0-WAT	█ O	57223.40	80728.89		

Features

- Includes top only.
- Constructed of 1 1/2"(38mm) thick fiber board substrate with AWI (Architectural Woodworking Institute) Grade AA veneer with knife edge and mitered corners.
- Depth tapers in 6"(152mm) at ends.
- Finished with conversion varnish.
- Two-piece tops are field joint built and secured with tight joint fasteners.
- Knife edge is 1 1/2"(38mm) thick solid wood with a rake of 20.82° tapering 3"(76mm) from the edge.
- Black inlay is 1/8"(3mm) thick and set 3"(76mm) from the edges.
- Cutouts available for separately specified Electric Lift Interface Module.
 - 2 Cutout option available on all sizes.
 - 3 Cutout option available on tops 192"(4877mm) wide or greater.
- Base, Electric Lift Interface Module and Glass Centerpiece must be specified separately.

Note: On site measurements should be taken to ensure there is adequate room in elevators and/or hallway conditions to accommodate the top sizes.

To Order, Specify:

1) Product number, including:

① Cutout Option:

- 2** Two (left/right) cutouts for Electric Lift Interface Module, add \$436.80 list
- 3** Three (left/center/right) cutouts for Electric Lift Interface Module, add \$655.20 list (192"(4877mm) width or greater)
- N** No cutout

2) Wood finish.

Executive Wood Tables – A5

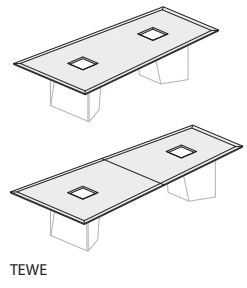
	Depth	Width	Pieces	Number	①	Wood Group	
						A	D
Wedge Table Top 	54"(1372mm)/42"(1067mm)	120"(3048mm)	1	TEWE-54C0-WAT	■ O	\$17272.81	\$24773.26
		132"(3353mm)	2	TEWE-54D2-WAT	■ O	19991.47	28597.78
		144"(3658mm)	2	TEWE-54E4-WAT	■ O	21801.43	31513.60
		156"(3962mm)	2	TEWE-54F6-WAT	■ O	23611.39	34429.42
		168"(4267mm)	2	TEWE-54G8-WAT	■ O	25421.35	37345.24
		180"(4572mm)	2	TEWE-54J0-WAT	■ O	29038.94	42068.69
		192"(4877mm)	2	TEWE-54K2-WAT	■ O	31601.10	45736.71
		204"(5182mm)	2	TEWE-54L4-WAT	■ O	34163.26	49404.73
		216"(5486mm)	2	TEWE-54M6-WAT	■ O	36725.42	53072.75
		228"(5791mm)	2	TEWE-54N8-WAT	■ O	39287.58	56740.77
	240"(6096mm)	2	TEWE-54Q0-WAT	■ O	41849.74	60408.79	
	60"(1524mm)/48"(1219mm)	120"(3048mm)	1	TEWE-60C0-WAT	■ O	\$18263.29	\$26367.82
		132"(3353mm)	2	TEWE-60D2-WAT	■ O	21238.63	30458.32
		144"(3658mm)	2	TEWE-60E4-WAT	■ O	23084.23	33419.08
		156"(3962mm)	2	TEWE-60F6-WAT	■ O	24929.83	36379.84
		168"(4267mm)	2	TEWE-60G8-WAT	■ O	26775.43	39340.60
		180"(4572mm)	2	TEWE-60J0-WAT	■ O	30207.62	43887.95
		192"(4877mm)	2	TEWE-60K2-WAT	■ O	32805.42	47600.91
		204"(5182mm)	2	TEWE-60L4-WAT	■ O	35403.22	51313.87
		216"(5486mm)	2	TEWE-60M6-WAT	■ O	38001.02	55026.83
228"(5791mm)		2	TEWE-60N8-WAT	■ O	40598.82	58739.79	
240"(6096mm)	2	TEWE-60Q0-WAT	■ O	43196.62	62452.75		

Features

- Includes top only.
- Constructed of 1 1/2"(38mm) thick fiber board substrate with AWI (Architectural Woodworking Institute) Grade AA veneer with knife edge and mitered corners.
- Depth tapers in 12"(305mm) at smaller end.
- Finished with conversion varnish.
- Two-piece tops are field joint built and secured with tight joint fasteners.
- Knife edge is 1 1/2"(38mm) thick solid wood with a rake of 20.82° tapering 3"(76mm) from the edge.
- Black inlay is 1/8"(3mm) thick and set 3"(76mm) from the edges.
- Cutouts available for separately specified Electric Lift Interface Module.
 - 2 Cutout option available on all sizes.
 - 3 Cutout option available on tops 192"(4877mm) wide or greater.
- Base, Electric Lift Interface Module and Glass Centerpiece must be specified separately.

Note: On site measurements should be taken to ensure there is adequate room in elevators and/or hallway conditions to accommodate the top sizes.

To Order, Specify:

- 1) Product number, including:

① Cutout Option:

- 2** Two (left/right) cutouts for Electric Lift Interface Module, add \$436.80 list
- 3** Three (left/center/right) cutouts for Electric Lift Interface Module, add \$655.20 list (192"(4877mm) width or greater)
- N** No cutout

- 2) Wood finish.