

Haworth prices in this book will increase on October 1, 2018 by:
0% – Ergotron
4% – All other products

Accessories

North America Price List – April 2018

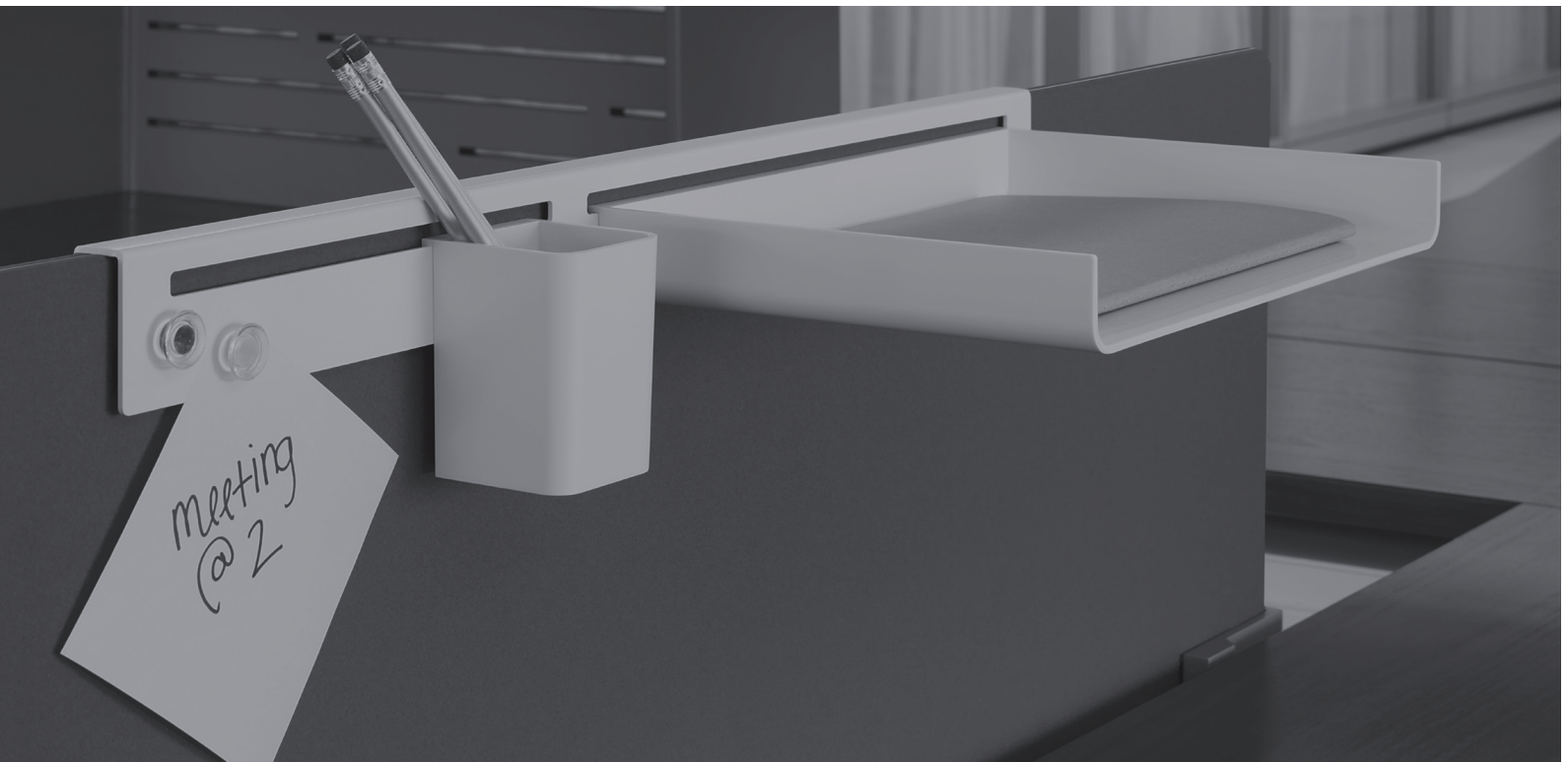

Electronic Update Page – Accessories Price List

- The table below lists all of the updates and addendums added to this price list since the original version was created.
- All **Update** pages will replace the existing pages within the document.
- All **New** pages will be placed at the back of the document.

Link	Date	Page	Description
Click Here	May 2018	107	Update – GSA information added to Pip Table page.
Click Here	June 2018	17-21, 23-29, 37, 39-43, 45-49, 51-55, 57-61	Update – Amp capacity for Flip Top Units and Enhanced Power Modules was increased.
Click Here	June 2018	1A-14A	New – Flush Mounted Power Price List pages added.
Click Here	June 2018	181	Update – The Product Compatibility And Limited Warranty Policy Page was replaced with an updated version.
Click Here	July 2018	134	Update – Correction to the catalog number for Compose Connections Cable Chain.
Click Here	July 2018	63	Update – Desktop Port was obsoleted.
Click Here	August 2018	15A	New – Additional Warranty page added.
Click Here	October 2018	122	Update – Additional trim colors added for Pixo light without Occupancy Sensor.
Click Here	October 2018	66-73	Update – Additional products were added to price list pages.
Click Here	October 2018	16A-24A	New – Additional Price List pages added for Ergotron Keyboard Trays, CPU Holders, Monitor Arms and Monitor Arm Accessories.
Click Here	October 2018	All	Update – Haworth prices in this book will increase on October 1, 2018 by 0% for Ergotron products and 4% for all other products.
Click Here	October 2018	69, 84, 85	Update – Prices reduced for the following Ergotron products: 33-397-062, 33-397-085, 33-406-062, 33-406-085, 45-295-026.
Click Here	October 2018	89	Update – Hinged Bow was obsoleted.
Click Here	November 2018	128-130	Update – GSA information added for Extend Arm Monitor Arm.



This Haworth North American price book contains US list prices. Canadian customers can convert the US list price into their Canadian equivalent by going to www.Haworth.com/Canada to find the current Canadian multipliers. These multiplier factors allow you to convert the US list price into a Canadian list price.

HAWORTH

The following list gives a general overview of the content included within this price list and explains how the book is organized and where certain information can be found.

- 1 Front Cover**
 - Includes the title and pricing effectivity date.
- 2 Electronic Update Page / Canadian Conversion**
 - Electronic versions of the Price Book (.pdf files) will include an Electronic Update Page listing the most recent updates and addendum added since the original version was created. If this section is blank no updates or addendums have been added.
 - Each update will include a description, page number, date and a link to the updated or new page.
 - The footer contains Canadian conversion information for converting US pricing into it's Canadian equivalent.
- 3 Table of Contents**
 - Price List content with page numbers.
- 4 Price List**

Each price list page contains the following:

 - Product Illustration
 - Catalog Number
 - To Order Specify – sequencing for ordering product options and finishes
 - List Prices
 - Product Specification Dimensions
 - Features
 - Specification Tips
 - Class, Discount Group Number (used for discounting) and GSA information
- 5 Finishes, Fabrics and COM**
 - Lists information for material finishes and availability.
 - Provides COM information and requirements (if applicable).
- 6 North American Terms of Sale**
 - Haworth terms for ordering, pricing, shipping and delivery, general terms, and services.
- 7 Index**
 - Products are listed alphabetically by alpha-numeric catalog numbers with price list page number.
- 8 Product Non-Obsolescence and Warranty Policy**
 - Provides Haworth policy for non-obsolence and warranty.

Additional Information and Resources

Prices are subject to change without notice or approval. Haworth dealers should always submit proposals through Lynx before presenting to customers. See North American Terms of Sale for more information.

Online Resources

haworth.com

- Haworth's corporate website provides access to price books and a variety of other resources and publications.

surfaces.haworth.com

- Website provides access to the most current fabrics and finishes offered across Haworth's various product lines.

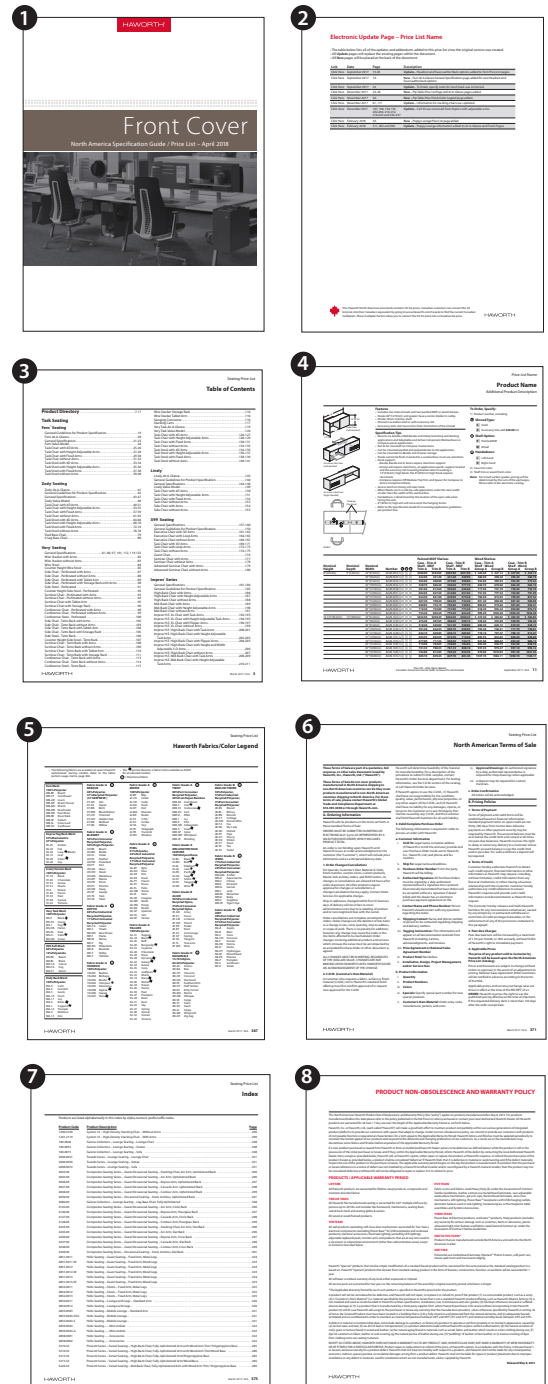

Table of Contents

Adjustable Keyboard Pads

Locking Tilt AKP	7
Dial Tilt AKP	7
Dial Tilt AKP - Extended Arm	8
Sit-to-Stand AKP	8
Keyboard Trays — included with Number KU AKP Arm	9
Thin Profile AKP	10
Boogie Board Keyboard Tray with Palm Rest and Integrated Mouse Pad	11
Boogie Board Keyboard Tray with Palm Rest	11
Boogie Board Mouse Pad	11

CPU Holders

Fixed Mount CPU Holder	12
Adjustable CPU Holder	12

Electrical Components

Power Tap — Horizontal	13
Power Tap — Vertical	14
Power Tap — Hardwire	15
Power Tap — Hardwire	15
Power Tap — Corded Horizontal and Vertical	15
Power Tap Bracket — Fixed	16
Power Tap Bracket — Adjustable	16
Power Tap Bracket — Under Surface	16
Power Tap Bracket with Grommet — Beside Storage Only	16
Enhanced Power Module — Corded	17-21
Enhanced Power Module — Hardwire	23-27
Enhanced Power Module — Spiral Corded — Height Adjustable	28
Enhanced Power Module — Cord for Height Adjustable	29
Above Worksurface — Adjustable	30
Above Worksurface — Adjustable with Tackboard Offset	31
Above Worksurface — Fixed	31
Under Worksurface — Fixed	31
For Use with Side Car — Basic	32
For Use with Side Car — Deluxe	32
For Use with X Series	33
For use with Suite Lower Storage – Mounts to the Inner Back of the Cabinet	34
For use with Suite Lower Storage – Mounts to Storage Top	34
For use with Suite Technology Access Blotter and Utility Cabinet	35
Flip Top Unit — Power and Data	36
Flip Top Unit — Non-Powered	37
Flip Top Unit — Corded — Single-Sided Power, Data and USB	39-43
Flip Top Unit — Corded — Double-Sided Power, Data and USB	45-49
Flip Top Unit — Hardwire — Single-Sided Power, Data and USB	51-55
Flip Top Unit — Hardwire — Double-Sided Power, Data and USB	57-61
Bezel Utility Module	62
Data Bezel	62
Desktop Port	63
Power/Data Dome	64
Cables	65
Retrofit USB Charging Cable	65

Ergotron Monitor Arms and Accessories

HX Single Arm	66
HX Dual Arm	67
HX Triple Monitor Bow Kit	68
LX Dock Mount Single Arm	69
LX Dock Mount Dual Arm	70
LX Sit-to-Stand Mount Single Arm	71
LX Desk Dual Direct Arm	72
LX Desk Dual Direct Handle Kit	72

LX Extension	73
LX Sit-to-Stand Extension	73
LX Pole Collar	73
LX Arm, Extension and Collar Kit	73
MX Dock Mount Single Arm	74
MX Mini Desk Mount	75
Dual Monitor and Handle Kit	76
Neo-Flex	77
Neo-Flex Extend	77
Neo-Flex Tablet	77

Ergotron

Ergotron WorkFit-A — Single Attached Sit-Stand Workstation	78
Ergotron WorkFit-A — Dual Attached Sit-Stand Workstation	79
Ergotron WorkFit-S — Single Attached Sit-Stand Workstation	80
Ergotron WorkFit-S — Dual Attached Sit-Stand Workstation	81
Ergotron WorkFit-SR — Single Attached Sit-Stand Workstation	82
Ergotron WorkFit-SR — Dual Attached Sit-Stand Workstation	83
Ergotron WorkFit-T — Desktop Sit-Stand Workstation	84
Ergotron WorkFit-TL — Desktop Sit-Stand Workstation	85
Ergotron WorkFit LX - Sit-Stand Desk Mount System	86
Grommet Mount	87
Conversion Kit Single HD to Dual	87
Conversion Kit Single HD to LCD & Laptop Worksurface	87
Large Keyboard Tray	88
Tablet/Document Holder	88
Grommet Mount	89
Hinged Bow	89
Conversion Kit: Dual to LCD & Laptop	90
Conversion Kit: LCD & Laptop to Dual	90
Tall-User Kit for WorkFit Dual	90
Deep Keyboard Tray	91
Corner Keyboard Tray	91
WorkFit Single LCD Monitor Kit	92
WorkFit Dual Monitor Kit	92
WorkFit LCD & Laptop Kit	92
Ergotron WorkFit — Anti-Fatigue Floor Mat	93
Ergotron Neo-Flex Laptop Cart	94
Ergotron Teachwell® Mobile Digital Workspace	95
LearnFit Desk	96
Storage Bin	96
Ergotron Zip 12 Charging	97

Grommets

Grommet	98
Flip Top Unit — Hatch	99

Information Display

Standard Easel	100
Large Easel	101
Information Boards	102
Horizontal Wall Rail for Information Boards	102
Wall Cleat for Information Boards	102
Horizontal Wall Rail End Caps	103
Y-Leg Bumper	103
Markerboard / Frosted Insert	104
Markerboard / Perforated Metal Insert	104
Markerboard Insert	105
Markerboard Accessories	106

Table of Contents

Pip			
Personal Laptop Table	107		
Lighting — Haworth			
Reed Premier™ Stand-Alone LED Task Light	108		
Reed Premier™ Starter LED Task Light	108		
Reed Premier™ Add-On LED Task Light — For Use with Reed Premier Starter LED Task Lights	109		
Reed Premier™ Add-On Occupancy Sensor	109		
Voyage without Occupancy Sensor	110		
Voyage with Occupancy Sensor	110		
Lighting — Haworth Collection			
Brazo — Freestanding Lighting	111		
Brazo — Mounted Lighting	111		
Brazo — Grommet	111		
Circa — Table Light	112		
Circa — Floor Light	112		
Clamp — Table Light	113		
Clamp — Floor Light	113		
Contour — Table Light	114		
Contour — Floor Light	114		
Corner Office — Table Light	115		
Corner Office — Light with Small Panel	115		
Corner Office — Light with Large Panel	115		
Giraffa — Table Light	116		
LIM — Table Light	117		
LIM — Floor Light	117		
LIM — Worksurface Mounted Light	118		
LIM — Mounted Light	119		
LIM Hardware	120		
LIM360 — Table Light	121		
LIM360 — Grommet Mounted Light	121		
Pixo — Table Light	122		
Superlight — Table Light	123		
Superlight — Floor Light	123		
Superlight — Base Pads	123		
Tube Top — Table Light	124		
Tube Top — Floor Light	124		
UMA — Audio Lantern	125		
Mobile Screens			
Perforated Metal Insert	126		
Frosted Insert	126		
Fabric Scrim Insert	127		
Translucent Insert	127		
Monitor Arms — Haworth			
Adjustable Post Arm	128		
Extend Arm	128		
Adjustable Post Arm — for Use with Intuity Benching	129		
Extend Arm — For Use with Intuity Benching	129		
Adjustable Post Arm — for Use with Reside Desking	130		
Extend Arm — For Use with Reside Desking	130		
iPad Attachment	131		
Recycling Solutions			
Recycling Solutions	132		
Recycling/Trash Bin	132		
Recycle Bin Carriage	132		
Storage Accessories			
Drawer Insert	133		
Wire Management			
Cord Manager — Mesh	134		
Cable Chain	134		
Compose Connections Cable Chain	134		
Vertical Cable Chain	134		
J-Channel	135		
Conduit Clamp	135		
Wire Management Loop	135		
Wire Manager Clips	135		
Wire Manager — Horizontal	136		
Horizontal Wire Management	136		
Vertical Cable Guide	136		
Wire Management Trough	136		
Planes C-Leg Training Table Vertical Wire Manager	137		
Compose Task Light Cord Manager	137		
PREMISE Vertical Wire Manager	137		
PREMISE Task Light Cord Manager	138		
UniGroup Too, UniGroup and PLACES Task Light Wire Manager	138		
UniGroup Too, UniGroup and PLACES Wire Manager	138		
Cable Base	139		
Cable Column	139		
Work Tools — Mounting			
Wall Accessory Slat Pad — For Use with PREMISE	140		
Slat, Wall Mount	140		
Single Side	141		
Tool Rail — Horizontal Surface Mount C-Clamp or Thru-Mount	142		
Tool Rail — Single Post — C-Clamp or Thru-mount	143		
Tool Rail — Under Horizontal Surface Mount — L-Bracket	144		
Tool Rail — Single Post — L-Bracket Mount	145		
Tool Rail — Single Sided Continuous Benching End	146		
Tool Rail — Internal Single Sided Continuous Benching Application	147		
Tool Rail — Internal Continuous Benching Application Only	148		
Tool Rail — Single Post Internal/Benching	148		
Panel Mount Rail	149		
Worksurface Mount Rail	149		
Freestanding Mount Rail	150		
Work Tools			
Territory Screen — End-of Run	151		
Territory Screen — Shared	151		
Territory L-Screen	152		
Structural Screen Tile	153		
Belong Systems Tile — External Mount for use with Compose Panels	153		
Screen Rail	154		
Open C Cubby	154		
Base Tray	155		
Desk Top L-Screen	155		
Desk Top Reference Shelf	155		
Paper Tray — Landscape	156		
Tool Cup	156		
Hanging Sorter	156		
Mini Shelf	156		
Blotter	157		
Reference Shelves	157		
Accessory Kit	157		
Tool Cup	158		
Paper Sorter	158		
Binder Bin	158		
Tack Strip	158		
Gooseneck Kit	159		
Mini Shelf	159		
Tote	159		
Tote Strap	159		
Phone Shelf	160		
Phone Shelf Bracket	160		
Personal Shelf	160		
Personal Shelf Bracket	160		
Letter Tray	161		

Table of Contents

Letter Tray Stacking Kit	161
Letter Tray Stacking Bracket	161
Waste Bin	161
Pile Master Kit	161
Team Master Kit	162
File Master Kit	162
Task Master Kit	162
Mini Master Kit	163
File Master Kit	164
Task Master Kit	164
Mini Master Kit	164
Magnet Board	165
Magnet Hooks	165
Magnet Hook	165
Round Peg Magnets	165
Mirror	165
Workstation Accessories	
Shallow Drawer	166
Steel Center Drawer	166
Pencil + Drawer	166
Pencil Drawer	166
Adjustable Laptop Holder	167
Adjustable Document Holder	167
Adjustable Footrest	167
Make-A-Corner	167
Compose All-Purpose Hook	168
PLACES All-Purpose Hook	168
PLACES All-Purpose Hook — For Low Profile Wood Top Cap Panels	168
UniGroup All-Purpose Hook	168
UniGroup Too All Purpose Hook	168
PREMISE All Purpose Hooks	168
Finishes and Fabrics	
Finish/Color Legend	169
Terms of Sale	
North American	170-173
Index	174-180
Lifetime Product Warranty	Inside Back Cover

Adjustable Keyboard Pads

Locking Tilt AKP

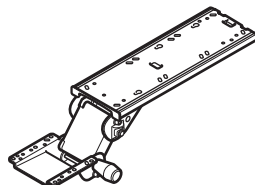

KU1A-0017

Description	Height Adjustment	Number ①	Price
17"(432mm) Long Track/Locking Tilt	2.5" Above/5.9" Below	KU1A-0017- <input type="checkbox"/> N	\$330.61
21"(533mm) Long Track/Locking Tilt	2.5" Above/5.9" Below	KU1A-0021- <input type="checkbox"/> N	330.61

Features

- Includes one locking tilt arm with track and Keyboard Tray.
- Patented spring-assisted Lift-n-Lock™ counter balancing system.
- Height adjustment range: 2.5" above/5.9" below worksurface.
- Soft-touch knob for locking tilt adjustment -15°/+15°.
- 360° rotation.
- In/Out travel:
 - 17" track length - 12"
 - 21" track length - 16.8"
- Track allows Keyboard Tray to be fully retracted under worksurface.
- Keyboard Tray Option: (Refer to Keyboard Tray for features)
 - (1) 21" wide Keyboard Tray with swivel Mouse Pad
 - (2) 21" wide Keyboard Tray without Mouse Pad
 - (3) 26" wide Keyboard Tray with space for mousing
- Standard in supplier black textured paint.
- Field installed.

To Order, Specify:

1) Product number, including:

① Keyboard Tray Option

- ① 21" Keyboard with Mouse Pad, add **\$35.22** list
- ② 21" Keyboard without Mouse Pad, no upcharge
- ③ 26" Keyboard with built-in Mouse Pad, add **\$70.44** list
(No finish specification required.)

Specification Tips

- 17" long (432mm) track fits under worksurfaces 18"(457mm) or deeper.
- 21" long (533mm) track fits under worksurfaces 22"(559mm) or deeper.
- Recommended for most corner applications.

Dial Tilt AKP

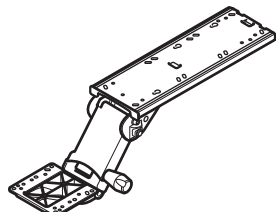

KU2A-0017

Description	Height Adjustment	Number ① ②	Price
17"(432mm) Long Track/Dial Tilt	2.5" Above/6.1" Below	KU2A-0017- <input type="checkbox"/> <input type="checkbox"/>	\$354.47
21"(533mm) Long Track/Dial Tilt	2.5" Above/6.1" Below	KU2A-0021- <input type="checkbox"/> <input type="checkbox"/>	354.47

Features

- Includes one Dial Tilt arm with track and Keyboard Tray.
- Includes gauges that show tilt and height adjustments.
- Patented Dial Tilt adjustment of keyboard tray as knob is turned.
- Patented spring-assisted Lift-n-Lock™ counter balancing system.
- Height adjustment range: 2.5" above/6.1" below worksurface.
- Tilt allows adjustment -15°/+10°.
- Positive Tilt Lock Option allows tilt adjustment -15°/+0°.
- 5.5"(140mm) standard arm length.
- In/Out travel:
 - 17" track length - 12"
 - 21" track length - 16.8"
- Track allows Keyboard Tray to be fully retracted under worksurface.
- 360° rotation.
- Keyboard Tray Option: (Refer to Keyboard Tray for features)
 - (1) 21" wide Keyboard Tray with swivel Mouse Pad
 - (2) 21" wide Keyboard Tray without Mouse Pad
 - (3) 26" wide Keyboard Tray with space for mousing
- Standard in supplier black textured paint.
- Field installed.

To Order, Specify:

1) Product number, including:

① Keyboard Tray Option

- ① 21" Keyboard with Mouse Pad, add **\$35.22** list
- ② 21" Keyboard without Mouse Pad, no upcharge
- ③ 26" Keyboard with space for mousing, add **\$70.44** list

② Positive Tilt Lock Option

- Positive Tilt Lock
- None
(No finish specification required.)

Specification Tips

- 17"(432mm) track fits under worksurfaces 18"(457mm) or deeper.
- 21"(533mm) track fits under worksurfaces 22"(559mm) or deeper.
- Recommended for most corner applications.

Adjustable Keyboard Pads

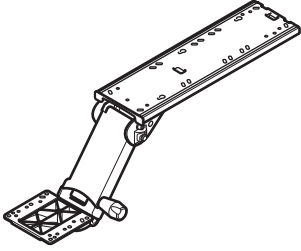
	Description	Height Adjustment	Number 1 2	Price
 <p>KU3A-0023</p>	<p>Dial Tilt AKP - Extended Arm</p> <p>23"(584mm) Long Extended Track/Dial Tilt</p> <p>Description</p> <p>Features</p> <ul style="list-style-type: none"> Includes one Dial Tilt arm with track and Keyboard Tray. Includes gauges that show tilt and height adjustments. Patented Dial Tilt adjustment of keyboard tray as knob is turned. Patented spring-assisted Lift-n-Lock™ counter balancing system. Height adjustment range: 2.75" above/8" below worksurface. Tilt allows adjustment -15°/+10°. Positive Tilt Lock Option allows tilt adjustment -15°/+0°. 7.5"(191mm) standard arm length. In/Out travel: 18.1" Track allows Keyboard Tray to be fully retracted under worksurface. 360° rotation. Keyboard Tray Option: (Refer to Keyboard Tray for features) <ul style="list-style-type: none"> (1) 21" wide Keyboard Tray with swivel Mouse Pad (2) 21" wide Keyboard Tray without Mouse Pad (3) 26" wide Keyboard Tray with space for mousing Standard in supplier black textured paint. Field installed. <p>Specification Tips</p> <ul style="list-style-type: none"> 23"(584mm) track fits under worksurfaces 23"(584mm) or deeper. Recommended for most corner applications. 	2.75" Above/8" Below	KU3A-0023- [] []	\$384.01
<p>To Order, Specify:</p> <p>1) Product number, including:</p> <p>1 Tray Option</p> <p>1 21" Keyboard with Mouse Pad, add \$35.22 list</p> <p>2 21" Keyboard without Mouse Pad, no upcharge</p> <p>3 26" Keyboard with space for mousing, add \$70.44 list</p> <p>2 Positive Tilt Lock Option</p> <p>P Positive Tilt Lock</p> <p>N None</p> <p>(No finish specification required.)</p>				

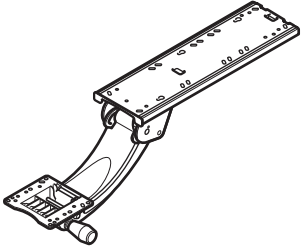
	Description	Height Adjustment	Number 1 2	Price
 <p>KU4A-0023</p>	<p>Sit-to-Stand AKP</p> <p>23"(584mm) Long Track/Sit-to-Stand</p> <p>Description</p> <p>Features</p> <ul style="list-style-type: none"> Includes one locking tilt arm with track and Keyboard Tray. Patented spring-assisted Lift-n-Lock™ counter balancing system. Height adjustment range: 8.25" above/5.9" below worksurface. Tilt allows adjustment -15°/+10°. Positive Tilt Lock Option allows tilt adjustment -15°/+0°. 7.5"(191mm) standard arm length. In/Out travel: 18.1" Track allows Keyboard Tray to be fully retracted under worksurface. 360° rotation. Keyboard Tray Option: (Refer to Keyboard Tray for features) <ul style="list-style-type: none"> (1) 21" wide Keyboard Tray with swivel Mouse Pad (2) 21" wide Keyboard Tray without Mouse Pad (3) 26" wide Keyboard Tray with space for mousing Standard in supplier black textured paint. Field installed. <p>Specification Tips</p> <ul style="list-style-type: none"> 23"(584mm) track fits under worksurfaces 23"(584mm) or deeper. Recommended for most corner applications. 	8.25" Above/5.9" Below	KU4A-0023- [] []	\$407.87
<p>To Order, Specify:</p> <p>1) Product number, including:</p> <p>1 Keyboard Tray Option</p> <p>1 21" Keyboard with Mouse Pad, add \$35.22 list</p> <p>2 21" Keyboard without Mouse Pad, no upcharge</p> <p>3 26" Keyboard with space for mousing, add \$70.44 list</p> <p>2 Positive Tilt Lock Option</p> <p>P Positive Tilt Lock</p> <p>N None</p> <p>(No finish specification required.)</p>				

Adjustable Keyboard Pads

Keyboard Trays – included with Number KU AKP Arm

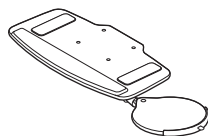

21" Keyboard Tray with swivel mouse pad (1)

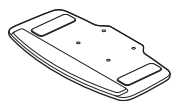

21" Keyboard Tray without mouse pad (2)

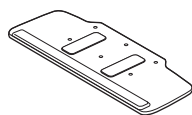

26" Keyboard Tray with space for mousing (3)

Features

- Includes one Keyboard Tray in different configurations.
- Sizes: 20"(508mm) wide x 11"(279mm) deep; Mouse Pad adds 8.4"(213mm) to width 26"(660mm) wide x 11"(279mm) deep
- Keyboard Tray Options:
 - (1) 21" wide Keyboard Tray with 360° swivel Mouse Pad with mouse edge guard and cable manager
 - (2) 21" wide Keyboard tray without Mouse Pad
 - (3) 26" wide Keyboard Tray with space for mousing
- Keyboards are made from 1/2" thick HDPE (High Density Polyethylene) in textured supplier black.
- Keyboard Trays include anti-skid strips to hold keyboard in place.
- Standard with removable palm rest.
- Keyboard with mouse pad; Mouse Pad can be attached on either right or left side of Keyboard Tray; rotates 360° independent of keyboard tray.
- Field installed.

Specification Tips

- Keyboard Tray has mounting holes for attachment to AKP numbers: KU1A, KU2A, KU3A and KU4A.
- 21" Keyboard Tray recommended for use with most corner worksurfaces.
- 26" Keyboard Tray recommended for rectangular worksurfaces with flat edges; not recommended for corner worksurfaces.

Adjustable Keyboard Pads

	Description	Number 1 2	Price
Thin Profile AKP	17"(432mm) Thin Profile	KU5A-0017- <input type="checkbox"/> <input type="checkbox"/>	\$330.61
	21"(533mm) Thin Profile	KU5A-0021- <input type="checkbox"/> <input type="checkbox"/>	330.61

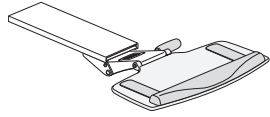

KU5A

Features

- Includes one Dial Tilt arm with track and Keyboard Tray.
- Gauges show tilt and height adjustments.
- Patented Dial Tilt adjustment of keyboard tray .
- Patented spring-assisted Lift-n-Lock™ counter balancing system.
- Height adjustment range: 1.19"(30mm) above/6.5"(165mm) below worksurface.
- Tilt allows adjustment -20°/+10°.
- Positive Tilt Lock Option allows tilt adjustment -20°/+0°.
- 7.5"(191 mm) standard arm length.
- In/Out travel: 12"(305mm) for 17"(432mm) and 16.75"(419mm) for 21"(533mm) track.
- Track allows Keyboard Tray to be fully retracted under worksurface.
- 360° rotation.
- Keyboard Tray Option: (Refer to Keyboard Tray for features)
 - (1) 21"(533mm) wide Keyboard Tray with swivel Mouse Pad
 - (2) 21"(533mm) wide Keyboard Tray without Mouse Pad
 - (3) 26"(660mm) wide Keyboard Tray with space for mousing
- Standard in supplier black textured paint.
- Field installed.

To Order, Specify:

1) Product number, including:

1 Tray Option:

- 1** Keyboard with Mouse Pad, add **\$35.22** list
- 2** Keyboard without Mouse Pad, no upcharge
- 3** Keyboard with space for mousing, add **\$70.44** list

2 Positive Tilt Lock Option:

- P** Positive Tilt Lock
- N** None

(No finish specification required.)

Adjustable Keyboard Pads

	Height	Depth	Width	Description	Number	Price
Boogie Board Keyboard Tray with Palm Rest and Integrated Mouse Pad	5.3"(135mm)	12"(305mm)	28"(711mm)	17"(432mm) track, Comfort Palm Rest	HKTC-17-M	\$588.61
				17"(432mm) track, Ergonomic Palm Rest	HKTE-17-M	588.61
				21"(533mm) track, Comfort Palm Rest	HKTC-21-M	588.61
				21"(533mm) track, Ergonomic Palm Rest	HKTE-21-M	588.61

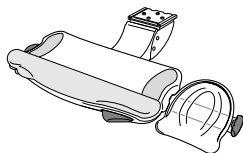

HKTC-M
HKTE-M

Features

- Palm rests available in ergonomic height adjustable or soft comfort versions.
- Stores under worksurface or lift entire tray to pull out. Release tray and it automatically saves distance-to-desk position.
- Intuitive single lever on front of AKP adjusts both height and tilt.
- Spring assisted adjustment (with automatic lock) of 6.5"(165mm) above worksurface and 4"(102mm) below.
- Integrated mouse pad tilts independently of keyboard tray.
- Includes mouse pad insert (not shown) for optional use.
- Mouse pad is interchangeable between right- and left-hand applications.
- Ease of modifying positions reduces repetitive stress injuries by encouraging AKP repositioning throughout the day.
- Superior stability (patented arm mechanism makes for smooth and stable operation).
- A simple guide for new users located within the AKP for referencing.
- Keyboard tray and mouse pad tilt +/-15°.
- 360° rotation.
- 17"(432mm) track fits under worksurfaces 18"(457mm) or deeper.
- 21"(533mm) track fits under worksurfaces 22"(559mm) or deeper.

To Order, Specify:

- 1) Product number.
- 2) Translucent finish color.

Boogie Board is available in the following finish colors:

- TR-0LX Ice (translucent blue) Keyboard tray in smoke with accents of graphite (palm rest, mouse pad insert and bottom of keyboard tray), and black (arm).
- TR-0LU Shadow (translucent charcoal) Keyboard tray in charcoal with accents of graphite (palm rest, mouse pad insert and bottom of keyboard tray), and black (arm).

Positive Tilt Lock-Out Option:

For positive tilt lock-out option (0° to -15° tilt only), add suffix **P** to the product number.

Example: HKTC-17-MP

Boogie Board Keyboard Tray with Palm Rest	5.3"(135mm)	12"(305mm)	21"(533mm)	17"(432mm) track, Comfort Palm Rest	HKTC-17-N	\$557.02
				17"(432mm) track, Ergonomic Palm Rest	HKTE-17-N	557.02
				21"(533mm) track, Comfort Palm Rest	HKTC-21-N	557.02
				21"(533mm) track, Ergonomic Palm Rest	HKTE-21-N	557.02

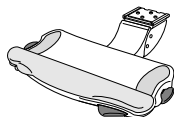

HKTC-N
HKTE-N

Features

- Palm rests available in ergonomic height adjustable or soft comfort versions.
- Stores under worksurface or lift entire tray to pull out. Release tray and it automatically saves distance-to-desk position.
- Intuitive single lever on front of AKP adjusts both height and tilt.
- Spring assisted adjustment (with automatic lock) of 6.5"(165mm) above worksurface and 4"(102mm) below.
- Ease of modifying positions reduces repetitive stress injuries by encouraging AKP repositioning throughout the day.
- Superior stability (patented arm mechanism makes for smooth and stable operation).
- A simple guide for new users located within the AKP for referencing.
- Keyboard tray and mouse pad tilt +/-15°.
- 360° rotation.
- 17"(432mm) track fits under worksurfaces 18"(457mm) or deeper.
- 21"(533mm) track fits under worksurfaces 22"(559mm) or deeper. Recommended for most corner applications.

To Order, Specify:

- 1) Product number.
- 2) Translucent finish color.

Boogie Board is available in the following finish colors:

- TR-0LX Ice (translucent blue) Keyboard tray in smoke with accents of graphite (palm rest and bottom of keyboard tray), and black (arm).
- TR-0LU Shadow (translucent charcoal) Keyboard tray in charcoal with accents of graphite (palm rest and bottom of keyboard tray), and black (arm).

Positive Tilt Lock-Out Option:

For positive tilt lock-out option (0° to -15° tilt only), add suffix **P** to the product number.

Example: HKTC-17-MP

Boogie Board Mouse Pad	1"(25mm)	11"(279mm)	8"(203mm)		HKMP-1	\$59.68
-------------------------------	----------	------------	-----------	--	--------	----------------

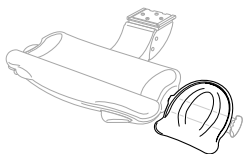

HKMP-1

Features

- For use with Boogie Board AKP or on top of worksurface.
- Integrated teeth allow right- or left-handed keyboard applications.
- Easily attaches to keyboard tray.
- Includes mouse pad insert (not shown) for optional use.

To Order, Specify:

- 1) Product number.
- 2) Translucent finish color.

Boogie Board mouse pad is available in the following finish colors:

- TR-0LX Ice (translucent blue) Mouse pad insert standard in graphite.
- TR-0LU Shadow (translucent charcoal) Mouse pad insert standard in graphite.

CPU Holders

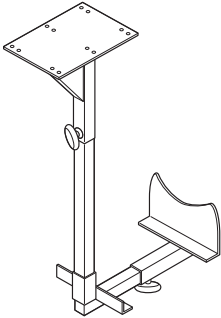
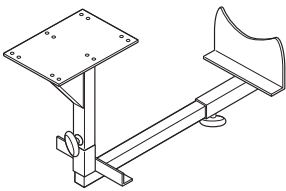
	Description	Number	Price
 <p>KU1C - Vertical</p>  <p>KU1C - Horizontal Class YA - GSA: Open Market</p>	Fixed Mount CPU Holder	KU1C-0000-N	\$106.80
	<p>Description</p> <p>Fixed Mount CPU Holder</p>		<p>Number</p> <p>KU1C-0000-N</p>
<p>Features</p> <ul style="list-style-type: none"> • Includes one fixed mount CPU holder. • Mounts under tops in either vertical or horizontal position. • Vertical Mount adjustment ranges: <ul style="list-style-type: none"> –Height adjustment for CPU: 15.5” to 20” –Width adjustment for CPU: 5.5” to 9.8” –Overall height adjustment: 17.5” to 22” –Overall width adjustment: 9.25” to 13.5” • Horizontal Mount adjustment ranges: <ul style="list-style-type: none"> –Height adjustment for CPU: 7.3” to 11.3” –Width adjustment for CPU: 13.8” to 18.8” –Overall height adjustment: 9.25” to 13.5” –Overall width adjustment: 17.5” to 22.5” • Control knobs allow adjustments as needed. • Standard in supplier black. • Field installed. 		<p>To Order, Specify:</p> <p>1) Product number. (No finish specification required.)</p>	
<p>Specification Tips</p> <ul style="list-style-type: none"> • 85 lbs. maximum weight load. • Fits under tops 18”(457mm) or deeper. • Mounting Plate Size: <ul style="list-style-type: none"> –5.35”(136mm) deep x 3.94”(100mm) wide 			
<p>Note: Recommended for use with:</p> <ul style="list-style-type: none"> –UniGroup® Too applications. –PREMISE® and Compose® applications directly adjacent to floor support. –X Series Caseloads. –Contact Sales Engineering for all other applications. 			

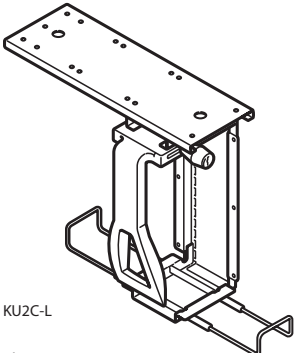
	Description	Track Length	Number	Price
 <p>KU2C-L</p> <p>Class YA - SIN 711-2; Discount Group X</p>	Adjustable Mount CPU Holder	17”(432mm)	KU2C-0000-N	\$153.38
	Adjustable Mount CPU Holder - Locking	17”(432mm)	KU2C-0000-L	\$260.18
<p>Description</p> <p>Adjustable Mount CPU Holder</p>		<p>Track Length</p> <p>17”(432mm)</p>		<p>Number</p> <p>KU2C-0000-N</p>
<p>Features</p> <ul style="list-style-type: none"> • Includes one adjustable mount CPU Holder with or without lock. • Mounts under tops. • CPU holder mechanism 360° rotation dependent upon track location. • Plastic side clamp with bumpers; control knob adjusts clamp. • Adjustment Ranges: <ul style="list-style-type: none"> –Height: 13.5” to 22.5” –Width: 3.5” to 9.3” –Depth: 14.75” to 22.3” • 17”(432mm) adjustable track with plastic glides. • Locks cannot be retrofitted nor keyed-alike to match Haworth lock plugs or keys. • Standard in supplier black textured paint. • Field installed. 		<p>To Order, Specify:</p> <p>1) Product number. (No finish specification required.)</p>		
<p>Specification Tips</p> <ul style="list-style-type: none"> • 85 lbs. maximum weight load. • 17”(432mm) track fits under tops 18”(457mm) or deeper. 				
<p>Note: Recommended for use with:</p> <ul style="list-style-type: none"> –UniGroup® Too applications. –PREMISE® and Compose® applications directly adjacent to floor support. –X Series Caseloads. –Contact Sales Engineering for all other applications. 				

Electrical Components

Belong Power Tap — Horizontal

Power Tap — Horizontal

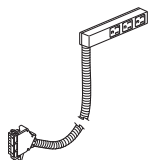

EUET-0030-3M3N
EUET-0030-2M3N
EUET-0030-4M3N



Description	Circuit Access	Number	Price
3-Circuit Conduit Length — Horizontal			
30"(762mm)	1	EUET-0030-3M3N1NL	\$136.34
	2	EUET-0030-3M3N2NL	136.34
	3	EUET-0030-3M3N3NL	136.34
6'(1829mm)	1	EUET-0072-3M3N1NL	\$158.60
	2	EUET-0072-3M3N2NL	158.60
	3	EUET-0072-3M3N3NL	158.60
9'(2743mm)	1	EUET-00A8-3M3N1NL	\$177.68
	2	EUET-00A8-3M3N2NL	177.68
	3	EUET-00A8-3M3N3NL	177.68
4-Circuit, (2+2) Conduit Length — Horizontal			
30"(762mm)	1	EUET-0030-2M3N1NL	\$136.34
	2	EUET-0030-2M3N2NL	136.34
	3	EUET-0030-2M3N3NL	136.34
	4	EUET-0030-2M3N4NL	136.34
6'(1829mm)	1	EUET-0072-2M3N1NL	\$158.60
	2	EUET-0072-2M3N2NL	158.60
	3	EUET-0072-2M3N3NL	158.60
	4	EUET-0072-2M3N4NL	158.60
9'(2743mm)	1	EUET-00A8-2M3N1NL	\$177.68
	2	EUET-00A8-2M3N2NL	177.68
	3	EUET-00A8-2M3N3NL	177.68
	4	EUET-00A8-2M3N4NL	177.68
4-Circuit, (3+1) Conduit Length — Horizontal			
30"(762mm)	1	EUET-0030-4M3N1NL	\$136.34
	2	EUET-0030-4M3N2NL	136.34
	3	EUET-0030-4M3N3NL	136.34
	4	EUET-0030-4M3N4NL	136.34
6'(1829mm)	1	EUET-0072-4M3N1NL	\$158.60
	2	EUET-0072-4M3N2NL	158.60
	3	EUET-0072-4M3N3NL	158.60
	4	EUET-0072-4M3N4NL	158.60
9'(2743mm)	1	EUET-00A8-4M3N1NL	\$177.68
	2	EUET-00A8-4M3N2NL	177.68
	3	EUET-00A8-4M3N3NL	177.68
	4	EUET-00A8-4M3N4NL	177.68

Features

- Includes Power Tap housing with three 15A receptacle outlets (NEMA 5-15R) with 3/8"(10mm) conduit and Power Base connector.
- Power Base connector is used to connect to PDA.
- Power Tap housing with receptacles available in charcoal or graphite finish; conduit standard in black only.
- Field installed.

To Order, Specify:

- 1) Product number.
- 2) Trim color.
TR-K Charcoal
TR-J Graphite

Specification Tips:

- Specify conduit length, circuit configuration and circuit access with Power Base connector.
- Specify mounting bracket separately.
 - Fixed Bracket with three patch cord holder mounts Power Tap to edge of worksurface with mounting screws. **Horizontal Power Tap required.**
 - Adjustable bracket mounts Power Tap to edge of worksurface with thumb screws for ease of relocation. **Horizontal Power Tap required.**
- Application may require approval of local authority having jurisdiction (AHJ); ensure compliance before placing orders and installation.
- Do not mix 3-circuit and 6-circuit with 4-circuit components. Do not mix 2+2 and 3+1 components. Components have unique polarity key and color coding (3-circuit=black, 6-circuit=ivory, 2+2=blue and 3+1=green).

Electrical Components

Belong Power Tap — Vertical

Power Tap — Vertical

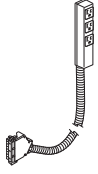

EUET-0030-3M3N
EUET-0030-2M3N
EUET-0030-4M3N



Description	Circuit Access	Number	Price
3-Circuit Conduit Length — Vertical			
30"(762mm)	1	EUET-0030-3M3N1NS	\$136.34
	2	EUET-0030-3M3N2NS	136.34
	3	EUET-0030-3M3N3NS	136.34
6'(1829mm)	1	EUET-0072-3M3N1NS	\$158.60
	2	EUET-0072-3M3N2NS	158.60
	3	EUET-0072-3M3N3NS	158.60
9'(2743mm)	1	EUET-00A8-3M3N1NS	\$177.68
	2	EUET-00A8-3M3N2NS	177.68
	3	EUET-00A8-3M3N3NS	177.68
4-Circuit (2+2) Conduit Length — Vertical			
30"(762mm)	1	EUET-0030-2M3N1NS	\$136.34
	2	EUET-0030-2M3N2NS	136.34
	3	EUET-0030-2M3N3NS	136.34
	4	EUET-0030-2M3N4NS	136.34
6'(1829mm)	1	EUET-0072-2M3N1NS	\$158.60
	2	EUET-0072-2M3N2NS	158.60
	3	EUET-0072-2M3N3NS	158.60
	4	EUET-0072-2M3N4NS	158.60
9'(2743mm)	1	EUET-00A8-2M3N1NS	\$177.68
	2	EUET-00A8-2M3N2NS	177.68
	3	EUET-00A8-2M3N3NS	177.68
	4	EUET-00A8-2M3N4NS	177.68
4-Circuit (3+1) Conduit Length — Vertical			
30"(762mm)	1	EUET-0030-4M3N1NS	\$136.34
	2	EUET-0030-4M3N2NS	136.34
	3	EUET-0030-4M3N3NS	136.34
	4	EUET-0030-4M3N4NS	136.34
6'(1829mm)	1	EUET-0072-4M3N1NS	\$158.60
	2	EUET-0072-4M3N2NS	158.60
	3	EUET-0072-4M3N3NS	158.60
	4	EUET-0072-4M3N4NS	158.60
9'(2743mm)	1	EUET-00A8-4M3N1NS	\$177.68
	2	EUET-00A8-4M3N2NS	177.68
	3	EUET-00A8-4M3N3NS	177.68
	4	EUET-00A8-4M3N4NS	177.68

Features

- Includes Power Tap housing with three 15A receptacle outlets (NEMA 5-15R) with 3/8"(10mm) conduit and Power Base connector.
- Power Base connector is used to connect to PDA.
- Power Tap housing with receptacles available in charcoal or graphite finish; conduit standard in black only.
- Field installed.

To Order, Specify:



- 1) Product number.
- 2) Trim color.
TR-K Charcoal
TR-J Graphite

Specification Tips:

- Specify conduit length, circuit configuration and circuit access with Power Base connector.
- Specify mounting bracket separately.
 - Fixed Bracket with three patch cord holder mounts Power Tap to edge of worksurface with mounting screws. **Horizontal Power Tap required.**
 - Adjustable bracket mounts Power Tap to edge of worksurface with thumb screws for ease of relocation. **Horizontal Power Tap required.**
- Application may require approval of local authority having jurisdiction (AHJ); ensure compliance before placing orders and installation.
- Do not mix 3-circuit and 6-circuit with 4-circuit components. Do not mix 2+2 and 3+1 components. Components have unique polarity key and color coding (3-circuit=black, 6-circuit=ivory, 2+2=blue and 3+1=green).

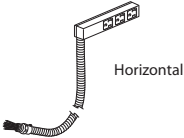
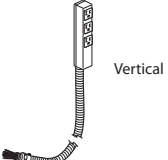

Electrical Components

Belong Power Tap — Hardwire and Corded

	Description	Circuit	Number	Price
Power Tap — Hardwire  Horizontal  Vertical EUET-0030-CM3N 	Hardwire Length — Horizontal			
	30'(9144mm)	1	EUET-0030-CM3N1NL	\$136.34
	6'(1829mm)	1	EUET-0072-CM3N1NL	158.60
	9'(2743mm)	1	EUET-00A8-CM3N1NL	177.68
	15'(4572mm)	1	EUET-00J0-CM3N1NL	215.84
	Hardwire Length — Vertical			
	30'(9144mm)	1	EUET-0030-CM3N1NS	\$136.34
	6'(1829mm)	1	EUET-0072-CM3N1NS	158.60
	9'(2743mm)	1	EUET-00A8-CM3N1NS	177.68
	15'(4572mm)	1	EUET-00J0-CM3N1NS	215.84
Features		To Order, Specify:		
<ul style="list-style-type: none"> Includes Power Tap with three 15A receptacle outlets (MEMA 5-15) with conduit and conduit fitting. Hardwire option for connection to field wired junction box with 1/2"(13mm) knockout. Power Tap housing with receptacles available in charcoal or graphite finish; conduit standard in black only. Field installed. 		1) Product number. 2) Trim color. TR-K Charcoal TR-J Graphite		

Specification Tips

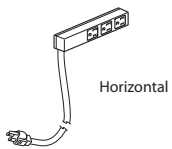
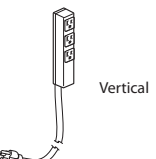
- For use with 120 volt 60 hertz power source only.
- Specify mounting bracket separately.
 - Fixed Bracket with three patch cord holder mounts Power Tap to edge of worksurface with mounting screws. **Horizontal Power Tap required.**
 - Adjustable bracket mounts Power Tap to edge of worksurface with thumb screws for ease of relocation. **Horizontal Power Tap required.**
 - Under Surface bracket mounts Power Tap under worksurface. **Vertical Power Tap required.**
- Application may require approval of local authority having jurisdiction (AHJ); ensure compliance before placing orders and installation.

	Description	Circuit	Number	Price
Power Tap — Corded Horizontal and Vertical  Horizontal  Vertical EUET-0000-1M3N 	Corded Length — Horizontal			
	6'(1829mm)	1	EUET-0000-1M3N16L	\$ 96.52
	9'(2743mm)	1	EUET-0000-1M3N19L	103.30
	15'(4572mm)	1	EUET-0000-1M3N1EL	116.86
	25'(7620mm)	1	EUET-0000-1M3N1YL	139.46
	Corded Length — Vertical			
	6'(1829mm)	1	EUET-0000-1M3N16S	\$ 96.52
	9'(2743mm)	1	EUET-0000-1M3N19S	103.30
	15'(4572mm)	1	EUET-0000-1M3N1ES	116.86
	25'(7620mm)	1	EUET-0000-1M3N1YS	139.46
Features		To Order, Specify:		
<ul style="list-style-type: none"> Includes Power Tap with three 15A receptacle outlets (MEMA 5-15R) with cord and plug (15A NEMA 5-15-P). Power Tap housing with receptacles available in charcoal or graphite finish; cord standard in black only. Field installed. 		1) Product number. 2) Trim color. TR-K Charcoal TR-J Graphite		

Specification Tips

- For use with 120 volt 60 hertz power source only.
- Specify mounting bracket separately.
 - Fixed Bracket with three patch cord holder mounts Power Tap to edge of worksurface with mounting screws. **Horizontal Power Tap required.**
 - Adjustable bracket mounts Power Tap to edge of worksurface with thumb screws for ease of relocation. **Horizontal Power Tap required.**
 - Under Surface bracket mounts Power Tap under worksurface. **Vertical Power Tap required.**
- Application may require approval of local authority having jurisdiction (AHJ); ensure compliance before placing orders and installation.

Electrical Components

Belong Power Tap Brackets

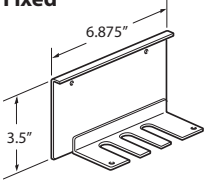
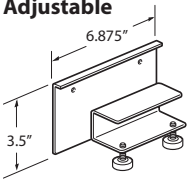
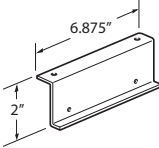
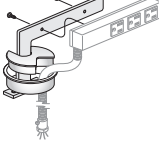
	Description	Number	Trim	
			A	B
Power Tap Bracket — Fixed  ZUAP-0000-PFD	Fixed	ZUAP-0000-PFD	\$39.76	45.45
	Features <ul style="list-style-type: none"> Includes one Power Tap mounting bracket and mounting hardware. Fixed Bracket mounts Power Tap to edge of worksurface with mounting screws. Fixed bracket accommodates three patch cords. Horizontal Power Tap required. 	To Order, Specify: <ol style="list-style-type: none"> Product number. Trim color. 		
Power Tap Bracket — Adjustable  ZUAP-0000-PAN	Adjustable	ZUAP-0000-PAN	\$49.98	55.67
	Features <ul style="list-style-type: none"> Includes one Power Tap mounting bracket and mounting hardware. Adjustable bracket mounts Power Tap to back edge of worksurface with thumb screws for ease of relocation. Horizontal Power Tap required. 	To Order, Specify: <ol style="list-style-type: none"> Product number. Trim color. 		
Power Tap Bracket — Under Surface  ZUAP-0000-PUR	Under Surface — Right-hand	ZUAP-0000-PUR	\$39.76	\$45.45
	Under Surface — Left-hand	ZUAP-0000-PUL	\$39.76	\$45.45
Power Tap Bracket with Grommet — Beside Storage Only  ZUAP-0000-PGH	Fixed Grommet — Horizontal	ZUAP-0000-PGH	\$89.74	\$95.43
	Fixed Grommet — Vertical	ZUAP-0000-PGV	\$89.74	\$95.43
	Features <ul style="list-style-type: none"> Includes one Power Tap bracket, grommet with cover and mounting hardware. Horizontal bracket mounts to Beside Storage Top through field installed grommet. Horizontal Power Tap required. Vertical bracket mounts to Beside Storage Top through field installed grommet. Vertical Power Tap required. 	To Order, Specify: <ol style="list-style-type: none"> Product number. Trim color. 		
	Specification Tips <ul style="list-style-type: none"> Designed for use with 1 3/16" (30mm) thick tops. Application may require approval of local authority having jurisdiction (AHJ); ensure compliance before placing orders and installation. Power Tab Bracket with grommet can only be used with 3-Circuit, 4-Circuit and Hardwired power taps. 			

Electrical Components

Enhanced Power Module — Corded

3-Port:

- (2) Power
- (1) USB

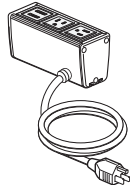

EUD1-PF0B-2010

4-Port:

- (2) Power
- (1) USB
- (1) Data

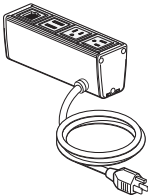

EUD1-PF0B-2110

6-Port:

- (2) Power
- (1) USB
- (1) Data
- (1) Cable Bay

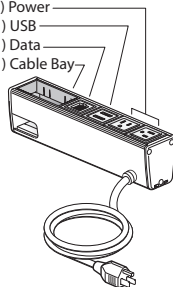

EUD1-PF0B-2112

4-Port:

- (4) Power

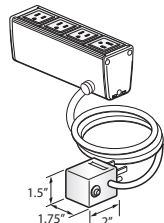

NOTE:

Always Fused Plug when more than 3 power outlets specified.

EUD1-PF0B-4000



Features

- Includes power module with 3, 4 or 6 ports that can be configured with simplex outlets (NEMA-5-15R), USB charging port (with two USB outlets), data ports or cable bay(s) that can accept up to two pull out data/AV cables and mounting hardware.
- Data port accommodate most varieties of field supplied data/AV jacks.
- Attaches to surface with use of separately specified mounting brackets.
- Corded power module available with 15 amp - 6'(1829mm) or 12'(3658mm) long cord with plug (NEMA 5-15P).
- USB Charging Port consists of two USB 2.0 style A outlets. 4 Amp (shared) charging capacity.
- Color option of black anodized housing with black receptacles or clear anodized housing with white receptacles.

Specification Tips

- **Configuration and quantity of power and data ports cannot be modified in the field.**
- **For use with 120 volt 60 hertz power source only.**
- Separately specify attachment hardware for desired application.
- Requires field installation.
- Specify AV cables separately.
- Cable Bay requires cables less than 0.3"(7.6mm) diameter.
- Application may require approval of local authority having jurisdiction (AHJ); ensure compliance before placing orders and installation.

To Order, Specify:

- 1) Product number.
(No finish specification required.)

Electrical Components

Enhanced Power Module — Corded

Top Width	Top Depth	Cord Length	Housing Color	Port Color	Port	Configuration	Number	Price
5" (127mm)	3" (76mm)	6' (1829mm)	Black Anodized	Black	3	1 Power Receptacle, 1 Cable Bay	EUD1-PF0B-1002	\$507.90
						1 Power Receptacle, 2 Data Ports	EUD1-PF0B-1020	507.90
						1 Power Receptacle, 1 Data Port, 1 USB Charging	EUD1-PF0B-1110	570.92
						1 Power Receptacle, 2 USB Charging	EUD1-PF0B-1200	633.94
						2 Power Receptacles, 1 Data Port	EUD1-PF0B-2010	507.90
						2 Power Receptacles, 1 USB Charging	EUD1-PF0B-2100	570.92
6 1/2" (165mm)	3" (76mm)				4	1 Power Receptacle, 1 Data Port, 1 Cable Bay	EUD1-PF0B-1012	\$507.90
						1 Power Receptacle, 3 Data Ports	EUD1-PF0B-1030	507.90
						1 Power Receptacle, 1 USB Charging, 1 Cable Bay	EUD1-PF0B-1102	570.92
						1 Power Receptacle, 3 USB Charging	EUD1-PF0B-1300	696.96
						2 Power Receptacles, 1 Cable Bay	EUD1-PF0B-2002	507.90
						2 Power Receptacles, 2 Data Ports	EUD1-PF0B-2020	507.90
						2 Power Receptacles, 1 USB Charging, 1 Data Port	EUD1-PF0B-2110	570.92
						2 Power Receptacles, 2 USB Charging	EUD1-PF0B-2200	633.94
						3 Power Receptacles, 1 Data Port	EUD1-PF0B-3010	507.90
						3 Power Receptacles, 1 USB Charging	EUD1-PF0B-3100	570.92
						4 Power Receptacles	EUD1-PF0B-4000	507.90
						9 1/2" (241mm)	3" (76mm)	
1 Power Receptacle, 1 USB Charging, 2 Data Ports, 1 Cable Bay	EUD1-PF0B-1122	625.54						
1 Power Receptacle, 1 USB Charging, 4 Data Ports	EUD1-PF0B-1140	625.54						
1 Power Receptacle, 2 USB Charging, 1 Data Port, 1 Cable Bay	EUD1-PF0B-1212	688.56						
1 Power Receptacle, 2 USB Charging, 3 Data Ports	EUD1-PF0B-1230	688.56						
1 Power Receptacle, 3 USB Charging, 1 Cable Bay	EUD1-PF0B-1302	751.58						
1 Power Receptacle, 3 USB Charging, 2 Data Ports	EUD1-PF0B-1320	751.58						
1 Power Receptacle, 4 USB Charging, 1 Data Port	EUD1-PF0B-1410	814.60						
2 Power Receptacles, 2 Cable Bays	EUD1-PF0B-2004	562.52						
2 Power Receptacles, 2 Data Ports, 1 Cable Bay	EUD1-PF0B-2022	562.52						
2 Power Receptacles, 4 Data Ports	EUD1-PF0B-2040	562.52						
2 Power Receptacles, 1 USB Charging, 1 Data Port, 1 Cable Bay	EUD1-PF0B-2112	625.54						
2 Power Receptacles, 1 USB Charging, 3 Data Ports	EUD1-PF0B-2130	625.54						
2 Power Receptacles, 2 USB Charging, 1 Cable Bay	EUD1-PF0B-2202	688.56						
2 Power Receptacles, 2 USB Charging, 2 Data Ports	EUD1-PF0B-2220	688.56						
2 Power Receptacles, 3 USB Charging, 1 Data Port	EUD1-PF0B-2310	751.58						
2 Power Receptacles, 4 USB Charging	EUD1-PF0B-2400	814.60						
3 Power Receptacles, 3 Data Ports	EUD1-PF0B-3030	562.52						
3 Power Receptacles, 1 USB Charging, 1 Cable Bay	EUD1-PF0B-3102	625.54						
3 Power Receptacles, 1 USB Charging, 2 Data Ports	EUD1-PF0B-3120	625.54						
3 Power Receptacles, 2 USB Charging, 1 Data Port	EUD1-PF0B-3210	688.56						
3 Power Receptacles, 3 USB Charging	EUD1-PF0B-3300	751.58						
4 Power Receptacles, 1 Cable Bay	EUD1-PF0B-4002	562.52						
4 Power Receptacles, 2 Data Ports	EUD1-PF0B-4020	562.52						
4 Power Receptacles, 1 USB Charging, 1 Data Port	EUD1-PF0B-4110	625.54						
4 Power Receptacles, 2 USB Charging	EUD1-PF0B-4200	688.56						
5 Power Receptacles, 1 Data Port	EUD1-PF0B-5010	562.52						
5 Power Receptacles, 1 USB Charging	EUD1-PF0B-5100	625.54						
6 Power Receptacles	EUD1-PF0B-6000	562.52						

Electrical Components

Enhanced Power Module — Corded

Top Width	Top Depth	Cord Length	Housing Color	Port Color	Port	Configuration	Number	Price	
9 1/2" (241mm)	3" (76mm)	6' (1829mm)	Clear Anodized	White	3	1 Power Receptacle, 1 Cable Bay	EUR1-PF0W-1002	\$398.66	
						1 Power Receptacle, 2 Data Ports	EUR1-PF0W-1020	398.66	
						1 Power Receptacle, 1 Data Port, 1 USB Charging	EUR1-PF0W-1110	461.68	
					1 Power Receptacle, 2 USB Charging	EUR1-PF0W-1200	524.70		
					2 Power Receptacles, 1 Data Port	EUR1-PF0W-2010	398.66		
					2 Power Receptacles, 1 USB Charging	EUR1-PF0W-2100	461.68		
					3 Power Receptacles	EUR1-PF0W-3000	398.66		
					4	1 Power Receptacle, 1 Data Port, 1 Cable Bay	EUR1-PF0W-1012	\$398.66	
						1 Power Receptacle, 3 Data Ports	EUR1-PF0W-1030	398.66	
						1 Power Receptacle, 1 USB Charging, 1 Cable Bay	EUR1-PF0W-1102	461.68	
						1 Power Receptacle, 3 USB Charging	EUR1-PF0W-1300	587.72	
						2 Power Receptacles, 1 Cable Bay	EUR1-PF0W-2002	398.66	
						2 Power Receptacles, 2 Data Ports	EUR1-PF0W-2020	398.66	
						2 Power Receptacles, 1 USB Charging, 1 Data Port	EUR1-PF0W-2110	461.68	
						2 Power Receptacles, 2 USB Charging	EUR1-PF0W-2200	524.70	
						3 Power Receptacles, 1 Data Port	EUR1-PF0W-3010	398.66	
						3 Power Receptacles, 1 USB Charging	EUR1-PF0W-3100	461.68	
						4 Power Receptacles	EUR1-PF0W-4000	398.66	
						6	1 Power Receptacle, 1 USB Charging, 2 Cable Bays	EUR1-PF0W-1104	\$516.30
							1 Power Receptacle, 1 USB Charging, 2 Data Ports, 1 Cable Bay	EUR1-PF0W-1122	516.30
							1 Power Receptacle, 1 USB Charging, 4 Data Ports	EUR1-PF0W-1140	516.30
							1 Power Receptacle, 2 USB Charging, 1 Data Port, 1 Cable Bay	EUR1-PF0W-1212	579.32
					1 Power Receptacle, 2 USB Charging, 3 Data Ports		EUR1-PF0W-1230	579.32	
					1 Power Receptacle, 3 USB Charging, 1 Cable Bay		EUR1-PF0W-1302	642.34	
					1 Power Receptacle, 3 USB Charging, 2 Data Ports		EUR1-PF0W-1320	642.34	
					1 Power Receptacle, 4 USB Charging, 1 Data Port		EUR1-PF0W-1410	705.36	
					2 Power Receptacles, 2 Cable Bays		EUR1-PF0W-2004	453.28	
					2 Power Receptacles, 2 Data Ports, 1 Cable Bay		EUR1-PF0W-2022	453.28	
					2 Power Receptacles, 4 Data Ports		EUR1-PF0W-2040	453.28	
					2 Power Receptacles, 1 USB Charging, 1 Data Port, 1 Cable Bay		EUR1-PF0W-2112	516.30	
					2 Power Receptacles, 1 USB Charging, 3 Data Ports		EUR1-PF0W-2130	516.30	
					2 Power Receptacles, 2 USB Charging, 1 Cable Bay		EUR1-PF0W-2202	579.32	
					2 Power Receptacles, 2 USB Charging, 2 Data Ports		EUR1-PF0W-2220	579.32	
2 Power Receptacles, 3 USB Charging, 1 Data Port	EUR1-PF0W-2310	642.34							
2 Power Receptacles, 4 USB Charging	EUR1-PF0W-2400	705.36							
3 Power Receptacles, 3 Data Ports	EUR1-PF0W-3030	453.28							
3 Power Receptacles, 1 USB Charging, 1 Cable Bay	EUR1-PF0W-3102	516.30							
3 Power Receptacles, 1 USB Charging, 2 Data Ports	EUR1-PF0W-3120	516.30							
3 Power Receptacles, 2 USB Charging, 1 Data Port	EUR1-PF0W-3210	579.32							
3 Power Receptacles, 3 USB Charging	EUR1-PF0W-3300	642.34							
4 Power Receptacles, 1 Cable Bay	EUR1-PF0W-4002	453.28							
4 Power Receptacles, 2 Data Ports	EUR1-PF0W-4020	453.28							
4 Power Receptacles, 1 USB Charging, 1 Data Port	EUR1-PF0W-4110	516.30							
4 Power Receptacles, 2 USB Charging	EUR1-PF0W-4200	579.32							
5 Power Receptacles, 1 Data Port	EUR1-PF0W-5010	453.28							
5 Power Receptacles, 1 USB Charging	EUR1-PF0W-5100	516.30							
6 Power Receptacles	EUR1-PF0W-6000	453.28							

Electrical Components

Enhanced Power Module — Corded

Top Width	Top Depth	Cord Length	Housing Color	Port Color	Port	Configuration	Number	Price
9 1/2" (241mm)	3" (76mm)	12' (3658mm)	Black Anodized	Black	3	1 Power Receptacle, 1 Cable Bay	EUD1-PL0B-1002	\$559.25
						1 Power Receptacle, 2 Data Ports	EUD1-PL0B-1020	559.25
						1 Power Receptacle, 1 Data Port, 1 USB Charging	EUD1-PL0B-1110	622.27
						1 Power Receptacle, 2 USB Charging	EUD1-PL0B-1200	685.29
						2 Power Receptacles, 1 Data Port	EUD1-PL0B-2010	559.25
						2 Power Receptacles, 1 USB Charging	EUD1-PL0B-2100	622.27
						3 Power Receptacles	EUD1-PL0B-3000	559.25
					4	1 Power Receptacle, 1 Data Port, 1 Cable Bay	EUD1-PL0B-1012	\$559.25
						1 Power Receptacle, 3 Data Ports	EUD1-PL0B-1030	559.25
						1 Power Receptacle, 1 USB Charging, 1 Cable Bay	EUD1-PL0B-1102	622.27
						1 Power Receptacle, 3 USB Charging	EUD1-PL0B-1300	748.31
						2 Power Receptacles, 1 Cable Bay	EUD1-PL0B-2002	559.25
						2 Power Receptacles, 2 Data Ports	EUD1-PL0B-2020	559.25
						2 Power Receptacles, 1 USB Charging, 1 Data Port	EUD1-PL0B-2110	622.27
						2 Power Receptacles, 2 USB Charging	EUD1-PL0B-2200	685.29
						3 Power Receptacles, 1 Data Port	EUD1-PL0B-3010	559.25
						3 Power Receptacles, 1 USB Charging	EUD1-PL0B-3100	622.27
						4 Power Receptacles	EUD1-PL0B-4000	559.25
					6	1 Power Receptacle, 1 USB Charging, 2 Cable Bays	EUD1-PL0B-1104	\$676.89
						1 Power Receptacle, 1 USB Charging, 2 Data Ports, 1 Cable Bay	EUD1-PL0B-1122	676.89
						1 Power Receptacle, 1 USB Charging, 4 Data Ports	EUD1-PL0B-1140	676.89
						1 Power Receptacle, 2 USB Charging, 1 Data Port, 1 Cable Bay	EUD1-PL0B-1212	739.91
						1 Power Receptacle, 2 USB Charging, 3 Data Ports	EUD1-PL0B-1230	739.91
						1 Power Receptacle, 3 USB Charging, 1 Cable Bay	EUD1-PL0B-1302	802.93
						1 Power Receptacle, 3 USB Charging, 2 Data Ports	EUD1-PL0B-1320	802.93
						1 Power Receptacle, 4 USB Charging, 1 Data Port	EUD1-PL0B-1410	865.95
						2 Power Receptacles, 2 Cable Bays	EUD1-PL0B-2004	613.87
						2 Power Receptacles, 2 Data Ports, 1 Cable Bay	EUD1-PL0B-2022	613.87
						2 Power Receptacles, 4 Data Ports	EUD1-PL0B-2040	613.87
						2 Power Receptacles, 1 USB Charging, 1 Data Port, 1 Cable Bay	EUD1-PL0B-2112	676.89
						2 Power Receptacles, 1 USB Charging, 3 Data Ports	EUD1-PL0B-2130	676.89
						2 Power Receptacles, 2 USB Charging, 1 Cable Bay	EUD1-PL0B-2202	739.91
						2 Power Receptacles, 2 USB Charging, 2 Data Ports	EUD1-PL0B-2220	739.91
						2 Power Receptacles, 3 USB Charging, 1 Data Port	EUD1-PL0B-2310	802.93
						2 Power Receptacles, 4 USB Charging	EUD1-PL0B-2400	865.95
						3 Power Receptacles, 3 Data Ports	EUD1-PL0B-3030	613.87
						3 Power Receptacles, 1 USB Charging, 1 Cable Bay	EUD1-PL0B-3102	676.89
						3 Power Receptacles, 1 USB Charging, 2 Data Ports	EUD1-PL0B-3120	676.89
						3 Power Receptacles, 2 USB Charging, 1 Data Port	EUD1-PL0B-3210	739.91
						3 Power Receptacles, 3 USB Charging	EUD1-PL0B-3300	802.93
						4 Power Receptacles, 1 Cable Bay	EUD1-PL0B-4002	613.87
						4 Power Receptacles, 2 Data Ports	EUD1-PL0B-4020	613.87
						4 Power Receptacles, 1 USB Charging, 1 Data Port	EUD1-PL0B-4110	676.89
						4 Power Receptacles, 2 USB Charging	EUD1-PL0B-4200	739.91
						5 Power Receptacles, 1 Data Port	EUD1-PL0B-5010	613.87
						5 Power Receptacles, 1 USB Charging	EUD1-PL0B-5100	676.89
						6 Power Receptacles	EUD1-PL0B-6000	613.87

Electrical Components

Enhanced Power Module — Corded

Top Width	Top Depth	Cord Length	Housing Color	Port Color	Port	Configuration	Number	Price	
9 1/2" (241mm)	3" (76mm)	12' (3658mm)	Clear Anodized	White	3	1 Power Receptacle, 1 Cable Bay	EUR1-PL0W-1002	\$450.01	
						1 Power Receptacle, 2 Data Ports	EUR1-PL0W-1020	450.01	
						1 Power Receptacle, 1 Data Port, 1 USB Charging	EUR1-PL0W-1110	513.03	
					4	1 Power Receptacle, 2 USB Charging	EUR1-PL0W-1200	576.05	
						2 Power Receptacles, 1 Data Port	EUR1-PL0W-2010	450.01	
						2 Power Receptacles, 1 USB Charging	EUR1-PL0W-2100	513.03	
						3 Power Receptacles	EUR1-PL0W-3000	450.01	
						1 Power Receptacle, 1 Data Port, 1 Cable Bay	EUR1-PL0W-1012	\$450.01	
						1 Power Receptacle, 3 Data Ports	EUR1-PL0W-1030	450.01	
						1 Power Receptacle, 1 USB Charging, 1 Cable Bay	EUR1-PL0W-1102	513.03	
						1 Power Receptacle, 3 USB Charging	EUR1-PL0W-1300	639.07	
						2 Power Receptacles, 1 Cable Bay	EUR1-PL0W-2002	450.01	
						2 Power Receptacles, 2 Data Ports	EUR1-PL0W-2020	450.01	
						2 Power Receptacles, 1 USB Charging, 1 Data Port	EUR1-PL0W-2110	513.03	
						2 Power Receptacles, 2 USB Charging	EUR1-PL0W-2200	576.05	
						3 Power Receptacles, 1 Data Port	EUR1-PL0W-3010	450.01	
						3 Power Receptacles, 1 USB Charging	EUR1-PL0W-3100	513.03	
						4 Power Receptacles	EUR1-PL0W-4000	450.01	
						6	1 Power Receptacle, 1 USB Charging, 2 Cable Bays	EUR1-PL0W-1104	\$567.65
							1 Power Receptacle, 1 USB Charging, 2 Data Ports, 1 Cable Bay	EUR1-PL0W-1122	567.65
							1 Power Receptacle, 1 USB Charging, 4 Data Ports	EUR1-PL0W-1140	567.65
					1 Power Receptacle, 2 USB Charging, 1 Data Port, 1 Cable Bay		EUR1-PL0W-1212	630.67	
					1 Power Receptacle, 2 USB Charging, 3 Data Ports		EUR1-PL0W-1230	630.67	
					1 Power Receptacle, 3 USB Charging, 1 Cable Bay		EUR1-PL0W-1302	693.69	
					1 Power Receptacle, 3 USB Charging, 2 Data Ports		EUR1-PL0W-1320	693.69	
					1 Power Receptacle, 4 USB Charging, 1 Data Port		EUR1-PL0W-1410	756.71	
					2 Power Receptacles, 2 Cable Bays		EUR1-PL0W-2004	504.63	
2 Power Receptacles, 2 Data Ports, 1 Cable Bay	EUR1-PL0W-2022	504.63							
2 Power Receptacles, 4 Data Ports	EUR1-PL0W-2040	504.63							
2 Power Receptacles, 1 USB Charging, 1 Data Port, 1 Cable Bay	EUR1-PL0W-2112	567.65							
2 Power Receptacles, 1 USB Charging, 3 Data Ports	EUR1-PL0W-2130	567.65							
2 Power Receptacles, 2 USB Charging, 1 Cable Bay	EUR1-PL0W-2202	630.67							
2 Power Receptacles, 2 USB Charging, 2 Data Ports	EUR1-PL0W-2220	630.67							
2 Power Receptacles, 3 USB Charging, 1 Data Port	EUR1-PL0W-2310	693.69							
2 Power Receptacles, 4 USB Charging	EUR1-PL0W-2400	756.71							
3 Power Receptacles, 3 Data Ports	EUR1-PL0W-3030	504.63							
3 Power Receptacles, 1 USB Charging, 1 Cable Bay	EUR1-PL0W-3102	567.65							
3 Power Receptacles, 1 USB Charging, 2 Data Ports	EUR1-PL0W-3120	567.65							
3 Power Receptacles, 2 USB Charging, 1 Data Port	EUR1-PL0W-3210	630.67							
3 Power Receptacles, 3 USB Charging	EUR1-PL0W-3300	693.69							
4 Power Receptacles, 1 Cable Bay	EUR1-PL0W-4002	504.63							
4 Power Receptacles, 2 Data Ports	EUR1-PL0W-4020	504.63							
4 Power Receptacles, 1 USB Charging, 1 Data Port	EUR1-PL0W-4110	567.65							
4 Power Receptacles, 2 USB Charging	EUR1-PL0W-4200	630.67							
5 Power Receptacles, 1 Data Port	EUR1-PL0W-5010	504.63							
5 Power Receptacles, 1 USB Charging	EUR1-PL0W-5100	567.65							
6 Power Receptacles	EUR1-PL0W-6000	504.63							

This page intentionally blank

Electrical Components

Enhanced Power Module — Hardwire

3-Port:

- (2) Power
- (1) USB

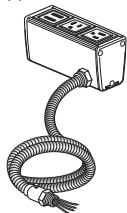

EUD1-HF0B-2010

4-Port:

- (2) Power
- (1) USB
- (1) Data

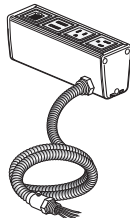

EUD1-HF0B-2110

6-Port:

- (2) Power
- (1) USB
- (1) Data
- (1) Cable Bay

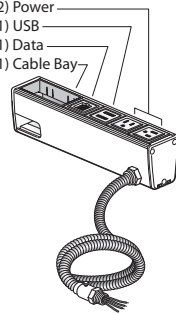

EUD1-HF0B-2112



Features

- Includes power module with 3, 4 or 6 ports that can be configured with simplex outlets (NEMA-5-15R), USB charging port (with two USB outlets), data ports or cable bay(s) that can accept up to two pull out data/AV cables and mounting hardware.
- Data port accommodate most varieties of field supplied data/AV jacks.
- Attaches to surface with use of separately specified mounting brackets.
- Hardwired power module with 6’(1829mm) or 12’(3658mm) long flexible metal conduit feed, 1/2”(13mm) conduit fitting and wires for hardwire connection.
- USB Charging Port consists of two USB 2.0 style A outlets. 4 Amp (shared) charging capacity.
- Color option of black anodized housing with black receptacles or clear anodized housing with white receptacles.

Specification Tips

- **Configuration and quantity of power and data ports cannot be modified in the field.**
- **For use with 120 volt 60 hertz power source only.**
- Separately specify attachment hardware for desired application.
- Requires field installation.
- Specify AV cables separately.
- Cable Bay requires cables less than 0.3”(7.6mm) diameter.
- Application may require approval of local authority having jurisdiction (AHJ); ensure compliance before placing orders and installation.

To Order, Specify:

- 1) Product number.
(No finish specification required.)

Electrical Components

Enhanced Power Module — Hardwire

Top Width	Top Depth	Conduit Length	Housing Color	Port Color	Port	Configuration	Number	Price						
5" (127mm)	3" (76mm)	6' (1829mm)	Black Anodized	Black	3	1 Power Receptacle, 1 Cable Bay	EUD1-HF0B-1002	\$572.27						
						1 Power Receptacle, 2 Data Ports	EUD1-HF0B-1020	572.27						
						1 Power Receptacle, 1 Data Port, 1 USB Charging	EUD1-HF0B-1110	635.29						
						1 Power Receptacle, 2 USB Charging	EUD1-HF0B-1200	698.31						
						2 Power Receptacles, 1 Data Port	EUD1-HF0B-2010	572.27						
						2 Power Receptacles, 1 USB Charging	EUD1-HF0B-2100	635.29						
						3 Power Receptacles	EUD1-HF0B-3000	572.27						
6 1/2" (165mm)	3" (76mm)				4	1 Power Receptacle, 1 Data Port, 1 Cable Bay	EUD1-HF0B-1012	\$572.27						
						1 Power Receptacle, 3 Data Ports	EUD1-HF0B-1030	572.27						
						1 Power Receptacle, 1 USB Charging, 1 Cable Bay	EUD1-HF0B-1102	635.29						
						1 Power Receptacle, 3 USB Charging	EUD1-HF0B-1300	761.33						
						2 Power Receptacles, 1 Cable Bay	EUD1-HF0B-2002	572.27						
						2 Power Receptacles, 2 Data Ports	EUD1-HF0B-2020	572.27						
						2 Power Receptacles, 1 USB Charging, 1 Data Port	EUD1-HF0B-2110	635.29						
						2 Power Receptacles, 2 USB Charging	EUD1-HF0B-2200	698.31						
						3 Power Receptacles, 1 Data Port	EUD1-HF0B-3010	572.27						
						3 Power Receptacles, 1 USB Charging	EUD1-HF0B-3100	635.29						
						4 Power Receptacles	EUD1-HF0B-4000	572.27						
						9 1/2" (241mm)	3" (76mm)				6	1 Power Receptacle, 1 USB Charging, 2 Cable Bays	EUD1-HF0B-1104	\$689.91
												1 Power Receptacle, 1 USB Charging, 2 Data Ports, 1 Cable Bay	EUD1-HF0B-1122	689.91
1 Power Receptacle, 1 USB Charging, 4 Data Ports	EUD1-HF0B-1140	689.91												
1 Power Receptacle, 2 USB Charging, 1 Data Port, 1 Cable Bay	EUD1-HF0B-1212	752.93												
1 Power Receptacle, 2 USB Charging, 3 Data Ports	EUD1-HF0B-1230	752.93												
1 Power Receptacle, 3 USB Charging, 1 Cable Bay	EUD1-HF0B-1302	815.95												
1 Power Receptacle, 3 USB Charging, 2 Data Ports	EUD1-HF0B-1320	815.95												
1 Power Receptacle, 4 USB Charging, 1 Data Port	EUD1-HF0B-1410	878.97												
2 Power Receptacles, 2 Cable Bays	EUD1-HF0B-2004	626.89												
2 Power Receptacles, 2 Data Ports, 1 Cable Bay	EUD1-HF0B-2022	626.89												
2 Power Receptacles, 4 Data Ports	EUD1-HF0B-2040	626.89												
2 Power Receptacles, 1 USB Charging, 1 Data Port, 1 Cable Bay	EUD1-HF0B-2112	689.91												
2 Power Receptacles, 1 USB Charging, 3 Data Ports	EUD1-HF0B-2130	689.91												
2 Power Receptacles, 2 USB Charging, 1 Cable Bay	EUD1-HF0B-2202	752.93												
2 Power Receptacles, 2 USB Charging, 2 Data Ports	EUD1-HF0B-2220	752.93												
2 Power Receptacles, 3 USB Charging, 1 Data Port	EUD1-HF0B-2310	815.95												
2 Power Receptacles, 4 USB Charging	EUD1-HF0B-2400	878.97												
3 Power Receptacles, 3 Data Ports	EUD1-HF0B-3030	626.89												
3 Power Receptacles, 1 USB Charging, 1 Cable Bay	EUD1-HF0B-3102	689.91												
3 Power Receptacles, 1 USB Charging, 2 Data Ports	EUD1-HF0B-3120	689.91												
3 Power Receptacles, 2 USB Charging, 1 Data Port	EUD1-HF0B-3210	752.93												
3 Power Receptacles, 3 USB Charging	EUD1-HF0B-3300	815.95												
4 Power Receptacles, 1 Cable Bay	EUD1-HF0B-4002	626.89												
4 Power Receptacles, 2 Data Ports	EUD1-HF0B-4020	626.89												
4 Power Receptacles, 1 USB Charging, 1 Data Port	EUD1-HF0B-4110	689.91												
4 Power Receptacles, 2 USB Charging	EUD1-HF0B-4200	752.93												
5 Power Receptacles, 1 Data Port	EUD1-HF0B-5010	626.89												
5 Power Receptacles, 1 USB Charging	EUD1-HF0B-5100	689.91												
6 Power Receptacles	EUD1-HF0B-6000	626.89												

Electrical Components

Enhanced Power Module — Hardwire

Top Width	Top Depth	Conduit Length	Housing Color	Port Color	Port	Configuration	Number	Price						
5" (127mm)	3" (76mm)	6' (1829mm)	Clear Anodized	White	3	1 Power Receptacle, 1 Cable Bay	EUD1-HF0W-1002	\$463.03						
						1 Power Receptacle, 2 Data Ports	EUD1-HF0W-1020	463.03						
						1 Power Receptacle, 1 Data Port, 1 USB Charging	EUD1-HF0W-1110	526.05						
						1 Power Receptacle, 2 USB Charging	EUD1-HF0W-1200	589.07						
						2 Power Receptacles, 1 Data Port	EUD1-HF0W-2010	463.03						
						2 Power Receptacles, 1 USB Charging	EUD1-HF0W-2100	526.05						
						3 Power Receptacles	EUD1-HF0W-3000	463.03						
6 1/2" (165mm)	3" (76mm)				4	1 Power Receptacle, 1 Data Port, 1 Cable Bay	EUD1-HF0W-1012	\$463.03						
						1 Power Receptacle, 3 Data Ports	EUD1-HF0W-1030	463.03						
						1 Power Receptacle, 1 USB Charging, 1 Cable Bay	EUD1-HF0W-1102	526.05						
						1 Power Receptacle, 3 USB Charging	EUD1-HF0W-1300	652.09						
						2 Power Receptacles, 1 Cable Bay	EUD1-HF0W-2002	463.03						
						2 Power Receptacles, 2 Data Ports	EUD1-HF0W-2020	463.03						
						2 Power Receptacles, 1 USB Charging, 1 Data Port	EUD1-HF0W-2110	526.05						
						2 Power Receptacles, 2 USB Charging	EUD1-HF0W-2200	589.07						
						3 Power Receptacles, 1 Data Port	EUD1-HF0W-3010	463.03						
						3 Power Receptacles, 1 USB Charging	EUD1-HF0W-3100	526.05						
						4 Power Receptacles	EUD1-HF0W-4000	463.03						
						9 1/2" (241mm)	3" (76mm)				6	1 Power Receptacle, 1 USB Charging, 2 Cable Bays	EUD1-HF0W-1104	\$580.67
												1 Power Receptacle, 1 USB Charging, 2 Data Ports, 1 Cable Bay	EUD1-HF0W-1122	580.67
1 Power Receptacle, 1 USB Charging, 4 Data Ports	EUD1-HF0W-1140	580.67												
1 Power Receptacle, 2 USB Charging, 1 Data Port, 1 Cable Bay	EUD1-HF0W-1212	643.69												
1 Power Receptacle, 2 USB Charging, 3 Data Ports	EUD1-HF0W-1230	643.69												
1 Power Receptacle, 3 USB Charging, 1 Cable Bay	EUD1-HF0W-1302	706.71												
1 Power Receptacle, 3 USB Charging, 2 Data Ports	EUD1-HF0W-1320	706.71												
1 Power Receptacle, 4 USB Charging, 1 Data Port	EUD1-HF0W-1410	769.73												
2 Power Receptacles, 2 Cable Bays	EUD1-HF0W-2004	517.65												
2 Power Receptacles, 2 Data Ports, 1 Cable Bay	EUD1-HF0W-2022	517.65												
2 Power Receptacles, 4 Data Ports	EUD1-HF0W-2040	517.65												
2 Power Receptacles, 1 USB Charging, 1 Data Port, 1 Cable Bay	EUD1-HF0W-2112	580.67												
2 Power Receptacles, 1 USB Charging, 3 Data Ports	EUD1-HF0W-2130	580.67												
2 Power Receptacles, 2 USB Charging, 1 Cable Bay	EUD1-HF0W-2202	643.69												
2 Power Receptacles, 2 USB Charging, 2 Data Ports	EUD1-HF0W-2220	643.69												
2 Power Receptacles, 3 USB Charging, 1 Data Port	EUD1-HF0W-2310	706.71												
2 Power Receptacles, 4 USB Charging	EUD1-HF0W-2400	769.73												
3 Power Receptacles, 3 Data Ports	EUD1-HF0W-3030	517.65												
3 Power Receptacles, 1 USB Charging, 1 Cable Bay	EUD1-HF0W-3102	580.67												
3 Power Receptacles, 1 USB Charging, 2 Data Ports	EUD1-HF0W-3120	580.67												
3 Power Receptacles, 2 USB Charging, 1 Data Port	EUD1-HF0W-3210	643.69												
3 Power Receptacles, 3 USB Charging	EUD1-HF0W-3300	706.71												
4 Power Receptacles, 1 Cable Bay	EUD1-HF0W-4002	517.65												
4 Power Receptacles, 2 Data Ports	EUD1-HF0W-4020	517.65												
4 Power Receptacles, 1 USB Charging, 1 Data Port	EUD1-HF0W-4110	580.67												
4 Power Receptacles, 2 USB Charging	EUD1-HF0W-4200	643.69												
5 Power Receptacles, 1 Data Port	EUD1-HF0W-5010	517.65												
5 Power Receptacles, 1 USB Charging	EUD1-HF0W-5100	580.67												
6 Power Receptacles	EUD1-HF0W-6000	517.65												

Electrical Components

Enhanced Power Module — Hardwire

Top Width	Top Depth	Conduit Length	Housing Color	Port Color	Port	Configuration	Number	Price
5" (127mm)	3" (76mm)	12' (3658mm)	Black Anodized	Black	3	1 Power Receptacle, 1 Cable Bay	EUD1-HLOB-1002	\$623.62
						1 Power Receptacle, 2 Data Ports	EUD1-HLOB-1020	623.62
						1 Power Receptacle, 1 Data Port, 1 USB Charging	EUD1-HLOB-1110	686.64
						1 Power Receptacle, 2 USB Charging	EUD1-HLOB-1200	749.66
						2 Power Receptacles, 1 Data Port	EUD1-HLOB-2010	623.62
						2 Power Receptacles, 1 USB Charging	EUD1-HLOB-2100	686.64
6 1/2" (165mm)	3" (76mm)				4	1 Power Receptacle, 1 Data Port, 1 Cable Bay	EUD1-HLOB-1012	\$623.62
						1 Power Receptacle, 3 Data Ports	EUD1-HLOB-1030	623.62
						1 Power Receptacle, 1 USB Charging, 1 Cable Bay	EUD1-HLOB-1102	686.64
						1 Power Receptacle, 3 USB Charging	EUD1-HLOB-1300	812.68
						2 Power Receptacles, 1 Cable Bay	EUD1-HLOB-2002	623.62
						2 Power Receptacles, 2 Data Ports	EUD1-HLOB-2020	623.62
						2 Power Receptacles, 1 USB Charging, 1 Data Port	EUD1-HLOB-2110	686.64
						2 Power Receptacles, 2 USB Charging	EUD1-HLOB-2200	749.66
						3 Power Receptacles, 1 Data Port	EUD1-HLOB-3010	623.62
						3 Power Receptacles, 1 USB Charging	EUD1-HLOB-3100	686.64
						4 Power Receptacles	EUD1-HLOB-4000	623.62
						9 1/2" (241mm)	3" (76mm)	
1 Power Receptacle, 1 USB Charging, 2 Data Ports, 1 Cable Bay	EUD1-HLOB-1122	741.26						
1 Power Receptacle, 1 USB Charging, 4 Data Ports	EUD1-HLOB-1140	741.26						
1 Power Receptacle, 2 USB Charging, 1 Data Port, 1 Cable Bay	EUD1-HLOB-1212	804.28						
1 Power Receptacle, 2 USB Charging, 3 Data Ports	EUD1-HLOB-1230	804.28						
1 Power Receptacle, 3 USB Charging, 1 Cable Bay	EUD1-HLOB-1302	867.30						
1 Power Receptacle, 3 USB Charging, 2 Data Ports	EUD1-HLOB-1320	867.30						
1 Power Receptacle, 4 USB Charging, 1 Data Port	EUD1-HLOB-1410	930.32						
2 Power Receptacles, 2 Cable Bays	EUD1-HLOB-2004	678.24						
2 Power Receptacles, 2 Data Ports, 1 Cable Bay	EUD1-HLOB-2022	678.24						
2 Power Receptacles, 4 Data Ports	EUD1-HLOB-2040	678.24						
2 Power Receptacles, 1 USB Charging, 1 Data Port, 1 Cable Bay	EUD1-HLOB-2112	741.26						
2 Power Receptacles, 1 USB Charging, 3 Data Ports	EUD1-HLOB-2130	741.26						
2 Power Receptacles, 2 USB Charging, 1 Cable Bay	EUD1-HLOB-2202	804.28						
2 Power Receptacles, 2 USB Charging, 2 Data Ports	EUD1-HLOB-2220	804.28						
2 Power Receptacles, 3 USB Charging, 1 Data Port	EUD1-HLOB-2310	867.30						
2 Power Receptacles, 4 USB Charging	EUD1-HLOB-2400	930.32						
3 Power Receptacles, 3 Data Ports	EUD1-HLOB-3030	678.24						
3 Power Receptacles, 1 USB Charging, 1 Cable Bay	EUD1-HLOB-3102	741.26						
3 Power Receptacles, 1 USB Charging, 2 Data Ports	EUD1-HLOB-3120	741.26						
3 Power Receptacles, 2 USB Charging, 1 Data Port	EUD1-HLOB-3210	804.28						
3 Power Receptacles, 3 USB Charging	EUD1-HLOB-3300	867.30						
4 Power Receptacles, 1 Cable Bay	EUD1-HLOB-4002	678.24						
4 Power Receptacles, 2 Data Ports	EUD1-HLOB-4020	678.24						
4 Power Receptacles, 1 USB Charging, 1 Data Port	EUD1-HLOB-4110	741.26						
4 Power Receptacles, 2 USB Charging	EUD1-HLOB-4200	804.28						
5 Power Receptacles, 1 Data Port	EUD1-HLOB-5010	678.24						
5 Power Receptacles, 1 USB Charging	EUD1-HLOB-5100	741.26						
6 Power Receptacles	EUD1-HLOB-6000	678.24						

Electrical Components

Enhanced Power Module — Hardwire

Top Width	Top Depth	Conduit Length	Housing Color	Port Color	Port	Configuration	Number	Price						
5" (127mm)	3" (76mm)	12' (3658mm)	Clear Anodized	White	3	1 Power Receptacle, 1 Cable Bay	EUD1-HLOW-1002	\$514.38						
						1 Power Receptacle, 2 Data Ports	EUD1-HLOW-1020	514.38						
						1 Power Receptacle, 1 Data Port, 1 USB Charging	EUD1-HLOW-1110	577.40						
						1 Power Receptacle, 2 USB Charging	EUD1-HLOW-1200	640.42						
						2 Power Receptacles, 1 Data Port	EUD1-HLOW-2010	514.38						
						2 Power Receptacles, 1 USB Charging	EUD1-HLOW-2100	577.40						
						3 Power Receptacles	EUD1-HLOW-3000	514.38						
6 1/2" (165mm)	3" (76mm)				4	1 Power Receptacle, 1 Data Port, 1 Cable Bay	EUD1-HLOW-1012	\$514.38						
						1 Power Receptacle, 3 Data Ports	EUD1-HLOW-1030	514.38						
						1 Power Receptacle, 1 USB Charging, 1 Cable Bay	EUD1-HLOW-1102	577.40						
						1 Power Receptacle, 3 USB Charging	EUD1-HLOW-1300	703.44						
						2 Power Receptacles, 1 Cable Bay	EUD1-HLOW-2002	514.38						
						2 Power Receptacles, 2 Data Ports	EUD1-HLOW-2020	514.38						
						2 Power Receptacles, 1 USB Charging, 1 Data Port	EUD1-HLOW-2110	577.40						
						2 Power Receptacles, 2 USB Charging	EUD1-HLOW-2200	640.42						
						3 Power Receptacles, 1 Data Port	EUD1-HLOW-3010	514.38						
						3 Power Receptacles, 1 USB Charging	EUD1-HLOW-3100	577.40						
						4 Power Receptacles	EUD1-HLOW-4000	514.38						
						9 1/2" (241mm)	3" (76mm)				6	1 Power Receptacle, 1 USB Charging, 2 Cable Bays	EUD1-HLOW-1104	\$632.02
												1 Power Receptacle, 1 USB Charging, 2 Data Ports, 1 Cable Bay	EUD1-HLOW-1122	632.02
1 Power Receptacle, 1 USB Charging, 4 Data Ports	EUD1-HLOW-1140	632.02												
1 Power Receptacle, 2 USB Charging, 1 Data Port, 1 Cable Bay	EUD1-HLOW-1212	695.04												
1 Power Receptacle, 2 USB Charging, 3 Data Ports	EUD1-HLOW-1230	695.04												
1 Power Receptacle, 3 USB Charging, 1 Cable Bay	EUD1-HLOW-1302	758.06												
1 Power Receptacle, 3 USB Charging, 2 Data Ports	EUD1-HLOW-1320	758.06												
1 Power Receptacle, 4 USB Charging, 1 Data Port	EUD1-HLOW-1410	821.08												
2 Power Receptacles, 2 Cable Bays	EUD1-HLOW-2004	569.00												
2 Power Receptacles, 2 Data Ports, 1 Cable Bay	EUD1-HLOW-2022	569.00												
2 Power Receptacles, 4 Data Ports	EUD1-HLOW-2040	569.00												
2 Power Receptacles, 1 USB Charging, 1 Data Port, 1 Cable Bay	EUD1-HLOW-2112	632.02												
2 Power Receptacles, 1 USB Charging, 3 Data Ports	EUD1-HLOW-2130	632.02												
2 Power Receptacles, 2 USB Charging, 1 Cable Bay	EUD1-HLOW-2202	695.04												
2 Power Receptacles, 2 USB Charging, 2 Data Ports	EUD1-HLOW-2220	695.04												
2 Power Receptacles, 3 USB Charging, 1 Data Port	EUD1-HLOW-2310	758.06												
2 Power Receptacles, 4 USB Charging	EUD1-HLOW-2400	821.08												
3 Power Receptacles, 3 Data Ports	EUD1-HLOW-3030	569.00												
3 Power Receptacles, 1 USB Charging, 1 Cable Bay	EUD1-HLOW-3102	632.02												
3 Power Receptacles, 1 USB Charging, 2 Data Ports	EUD1-HLOW-3120	632.02												
3 Power Receptacles, 2 USB Charging, 1 Data Port	EUD1-HLOW-3210	695.04												
3 Power Receptacles, 3 USB Charging	EUD1-HLOW-3300	758.06												
4 Power Receptacles, 1 Cable Bay	EUD1-HLOW-4002	569.00												
4 Power Receptacles, 2 Data Ports	EUD1-HLOW-4020	569.00												
4 Power Receptacles, 1 USB Charging, 1 Data Port	EUD1-HLOW-4110	632.02												
4 Power Receptacles, 2 USB Charging	EUD1-HLOW-4200	695.04												
5 Power Receptacles, 1 Data Port	EUD1-HLOW-5010	569.00												
5 Power Receptacles, 1 USB Charging	EUD1-HLOW-5100	632.02												
6 Power Receptacles	EUD1-HLOW-6000	569.00												

Electrical Components

Enhanced Power Module — Spiral Corded — Height Adjustable

Top Depth	Top Width	Cord Length	Housing Color	Port Color	Port	Configuration	Number	Price
3" (76mm)	6 1/2" (165mm)	10'(3048mm)- 12'(3658mm)	Black Anodized	Black	4	2 Power Receptacles, 1 USB Charging, 1 Data Port	EUD1-SF0B-2110	\$805.79
					4	2 Power Receptacles, 2 USB Charging	EUD1-SF0B-2200	868.81
					4	3 Power Receptacles, 1 Data Port	EUD1-SF0B-3010	742.77
					4	3 Power Receptacles, 1 USB Charging	EUD1-SF0B-3100	805.79
			4	4 Power Receptacles	EUD1-SF0B-4000	742.77		
			Clear Anodized	White	4	2 Power Receptacles, 1 USB Charging, 1 Data Port	EUD1-SF0W-2110	\$696.55
			4		2 Power Receptacles, 2 USB Charging	EUD1-SF0W-2200	759.57	
			4		3 Power Receptacles, 1 Data Port	EUD1-SF0W-3010	633.53	
			4		3 Power Receptacles, 1 USB Charging	EUD1-SF0W-3100	696.55	
			4	4 Power Receptacles	EUD1-SF0W-4000	633.53		

4-Port:

- (2) Power
- (1) USB
- (1) Data

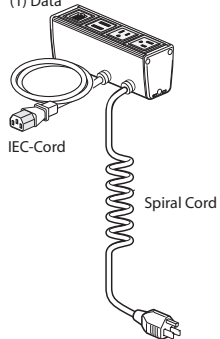

EUD1-SF0B-2110

4-Port:

- (4) Power

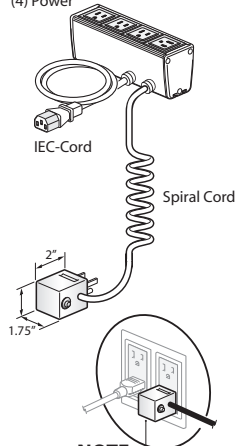

EUD1-SF0B-4000



Features

- Includes power module with 3, 4 or 6 ports that can be configured with simplex outlets (NEMA-5-15R), USB charging port (with two USB outlets), data ports or cable bay(s) that can accept up to two pull out data/AV cables and mounting hardware.
- Data port accommodate most varieties of field supplied data/AV jacks.
- Spiral Cord includes 15 amp plug (NEMA 5-15P) and expands to 12'(3658mm) when stretched.
- Auxiliary 24"(610mm) power cord includes IEC connector (IEC C13) for motor controller.
- Attaches to surface with use of separately specified mounting brackets.
- USB Charging Port consists of two USB 2.0 style A outlets. 4 Amp (shared) charging capacity.
- Color option of black anodized housing with black receptacles or clear anodized housing with white receptacles.

Specification Tips

- **Configuration and quantity of power and data ports cannot be modified in the field.**
- **For use with 120 volt 60 hertz power source only.**
- **For use with Suite, Planes Height Adjustable Tables, Planes Height Adjustable Bench, Hop 120° Benches and 3-Leg Hop Height Adjustable Tables use IEC C6 to IEC C14 adapter.**
- Separately specify attachment hardware for desired application.
- Not for use with cable chain.
- Requires field installation.
- Application may require approval of local authority having jurisdiction (AHJ); ensure compliance before placing orders and installation.

To Order, Specify:

- 1) Product number.
(No finish specification required.)

NOTE:
Always Fused Plug
when more than 3
power outlets specified.

Electrical Components

Enhanced Power Module — Cord for Height Adjustable

Top Depth	Top Width	Cord Length	Housing Color	Port Color	Port	Configuration	Number	Price
3" (76mm)	6 1/2" (165mm)	10'(3048mm)- 12'(3658mm)	Black Anodized	Black	4	2 Power Receptacles, 1 USB Charging, 1 Data Port	EUD1-SLOB-2110	\$857.14
					4	2 Power Receptacles, 2 USB Charging	EUD1-SLOB-2200	920.16
					4	3 Power Receptacles, 1 Data Port	EUD1-SLOB-3010	794.12
					4	3 Power Receptacles, 1 USB Charging	EUD1-SLOB-3100	857.14
			4	4 Power Receptacles	EUD1-SLOB-4000	794.12		
			Clear Anodized	White	4	2 Power Receptacles, 1 USB Charging, 1 Data Port	EUD1-SLOW-2110	\$747.90
					4	2 Power Receptacles, 2 USB Charging	EUD1-SLOW-2200	810.92
					4	3 Power Receptacles, 1 Data Port	EUD1-SLOW-3010	684.88
					4	3 Power Receptacles, 1 USB Charging	EUD1-SLOW-3100	747.90
					4	4 Power Receptacles	EUD1-SLOW-4000	684.88

4-Port:

- (2) Power
- (1) USB
- (1) Data

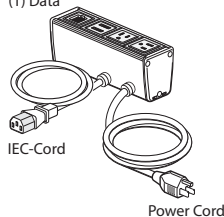

EUD1-SLOB-2110

4-Port:

- (4) Power

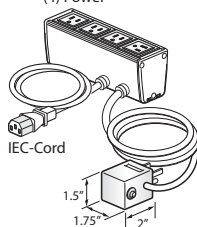

NOTE:
Always Fused Plug when more than 3 power outlets specified.

EUD1-SLOB-4000



Features

- Includes power module with 3, 4 or 6 ports that can be configured with simplex outlets (NEMA-5-15R), USB charging port (with two USB outlets), data ports or cable bay(s) that can accept up to two pull out data/AV cables and mounting hardware.
- Data port accommodate most varieties of field supplied data/AV jacks.
- Corded power module with 15 amp - 12'(3658mm) long cord with plug (NEMA 5-15P).
- Auxiliary 24"(610mm) power cord includes IEC connector (IEC C13) for motor controller.
- Attaches to surface with use of separately specified mounting brackets.
- USB Charging Port consists of two USB 2.0 style A outlets. 4 Amp (shared) charging capacity.
- Color option of black anodized housing with black receptacles or clear anodized housing with white receptacles.

To Order, Specify:

- 1) Product number.
(No finish specification required.)

Specification Tips

- **Configuration and quantity of power and data ports cannot be modified in the field.**
- **For use with 120 volt 60 hertz power source only.**
- **For use with Suite, Planes Height Adjustable Tables, Planes Height Adjustable Bench, Hop 120° Benches and 3-Leg Hop Height Adjustable Tables. For 2-Leg Hop Height Adjustable Tables use IEC C6 to IEC C14 adapter.**
- Separately specify attachment hardware for desired application.
- Designed to be used with cable chain.
- Requires field installation.
- Application may require approval of local authority having jurisdiction (AHJ); ensure compliance before placing orders and installation.

Electrical Components

Enhanced Power Module Brackets

	Height	Width	Length	Description	Number	Price
Above Worksurface – Adjustable	4"(102mm)	3 1/2"(89mm)	3 1/2"(89mm)	Black Bracket	EUDB-0000-HB	\$54.62
				White Bracket	EUDB-0000-HW	54.62

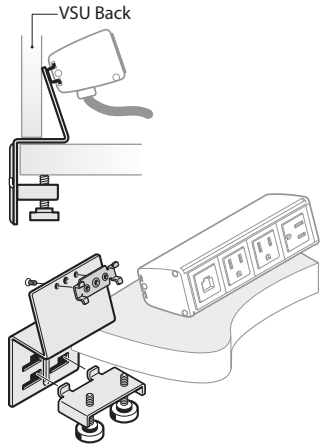

EUDB-0000-H
Class YA - SIN 711-2
Discout Group XIII



Features

- Includes bracket and mounting hardware.
- For use with 3, 4 or 6 port Enhanced Power Module.
- Available in black or white.
- Mounts to back edge of 1 1/8"(29mm) to 2"(51mm) worktop.
- Not for use with a tack board.

To Order, Specify:

- 1) Product number.
(No finish specification required.)

Specification Tips

- Specify Enhanced Power Module separately.
- Requires field installation.
- Application may require approval of local authority having jurisdiction (AHJ); ensure compliance before placing orders and installation.

	4"(102mm)	3 1/2"(89mm)	3 1/2"(89mm)	Black Bracket	EUDB-0000-NB	\$78.00
				White Bracket	EUDB-0000-NW	78.00

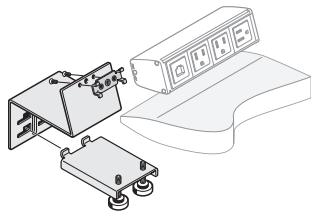

EUDB-0000-NB

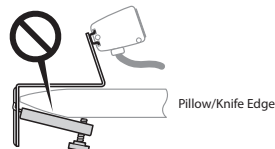
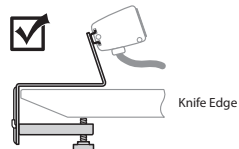
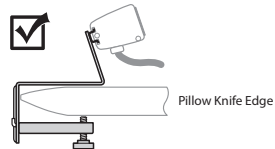

EUDB-0000-N
Class YA – GSA: Open Market



Features

- Includes bracket and mounting hardware.
- For use with 3, 4 or 6 port Enhanced Power Module.
- Available in black or white.
- Mounts to worksurface edge.

To Order, Specify:

- 1) Product number.
(No finish specification required.)

Specification Tips

- Specify Enhanced Power Module separately.
- Requires field installation.
- Application may require approval of local authority having jurisdiction (AHJ); ensure compliance before placing orders and installation.
- Designed to be used with knife edge or pillowed knife edge worksurfaces.

Electrical Components

Enhanced Power Module Brackets

	Height	Width	Length	Description	Number	Price
Above Worksurface – Adjustable with Tackboard Offset	4"(102mm)	3 1/2"(89mm)	3 1/2"(89mm)	Black Bracket	EUDB-0000-TB	\$54.62
				White Bracket	EUDB-0000-TW	54.62

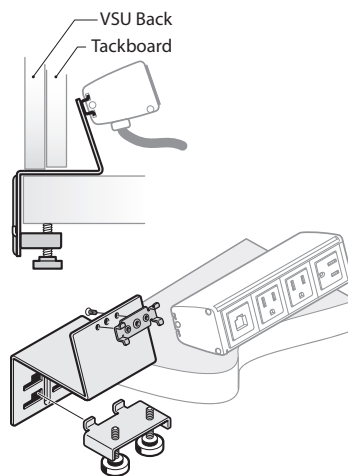

EUDB-0000-T

Features

- Includes bracket and mounting hardware.
- For use with 3, 4 or 6 port Enhanced Power Module.
- Available in black or white.
- Mounts to back edge of 1 1/8"(29mm) to 2"(51mm) worktop when a tackboard is present.

To Order, Specify:

- 1) Product number.
(No finish specification required.)

Specification Tips

- Specify Enhanced Power Module separately.
- Requires field installation.
- Application may require approval of local authority having jurisdiction (AHJ); ensure compliance before placing orders and installation.

Above Worksurface – Fixed	4 1/4"(107mm)	3"(76mm)	2"(51mm)	Black Bracket	EUDB-0000-WB	\$54.62
				White Bracket	EUDB-0000-WW	54.62

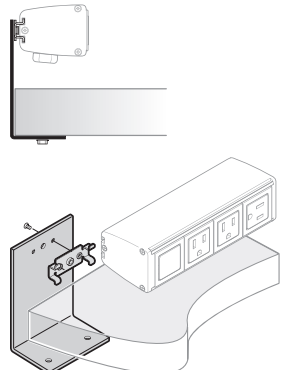

EUDB-0000-W

Features

- Includes bracket and mounting hardware.
- For use with 3, 4 or 6 port Enhanced Power Module.
- Available in black or white.
- Mounts under worksurface with Enhanced Power Module above worksurface.

To Order, Specify:

- 1) Product number.
(No finish specification required.)

Specification Tips

- Specify Enhanced Power Module separately.
- Requires field installation.
- Application may require approval of local authority having jurisdiction (AHJ); ensure compliance before placing orders and installation.

Under Worksurface – Fixed	2"(51mm)	3"(76mm)	2 1/2"(64mm)	Black Bracket	EUDB-0000-UB	\$54.62
				White Bracket	EUDB-0000-UW	54.62

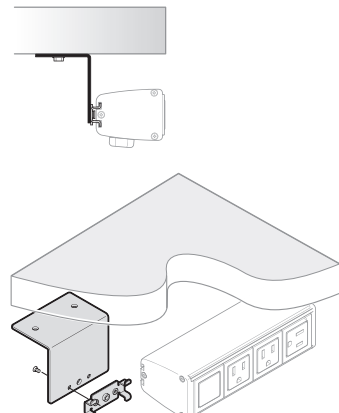

EUDB-0000-U

Features

- Includes bracket and mounting hardware.
- For use with 3, 4 or 6 port Enhanced Power Module.
- Available in black or white.
- Mounts under worksurface with offset to accommodate most transformer plugs.

To Order, Specify:

- 1) Product number.
(No finish specification required.)

Specification Tips

- Specify Enhanced Power Module separately.
- Requires field installation.
- Application may require approval of local authority having jurisdiction (AHJ); ensure compliance before placing orders and installation.

Electrical Components

Enhanced Power Module Brackets

	Height	Width	Length	Description	Number	Price
For Use with Side Car — Basic	4"(102mm)	3 1/2"(89mm)	3 1/2"(89mm)	Black Bracket	EUDB-0000-SBB	\$78.78
				White Bracket	EUDB-0000-SBW	78.78

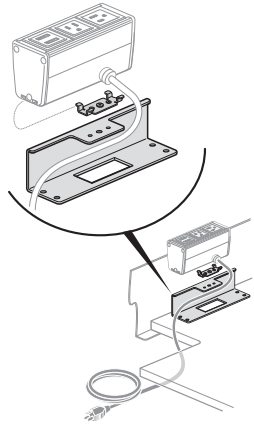

EUDB-0000-SB



Features

- Includes bracket and mounting hardware.
- For use with 3 port Enhanced Power Module.
- Available in black or white.
- Mounts to bottom shelf of Side Car - Basic.

Specification Tips

- Designed to be used with Side Car - Basic only.
- Specify Enhanced Power Module separately.
- Requires field installation.
- Application may require approval of local authority having jurisdiction (AHJ); ensure compliance before placing orders and installation.

To Order, Specify:

- 1) Product number.
(No finish specification required.)

For Use with Side Car — Deluxe	4"(102mm)	3 1/2"(89mm)	3 1/2"(89mm)	Black Bracket	EUDB-0000-SDB	\$54.62
				White Bracket	EUDB-0000-SDW	54.62

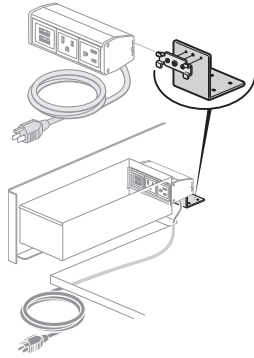

EUDB-0000-SD



Features

- Includes bracket and mounting hardware.
- For use with 3 port Enhanced Power Module.
- Available in black or white.
- Mounts to drop in Accessory Box with power cutout.

Specification Tips

- Designed to be used with Side Car - Deluxe only.
- Specify Enhanced Power Module separately.
- Requires field installation.
- Application may require approval of local authority having jurisdiction (AHJ); ensure compliance before placing orders and installation.

To Order, Specify:

- 1) Product number.
(No finish specification required.)

Electrical Components

Enhanced Power Module Bracket

For Use with X Series

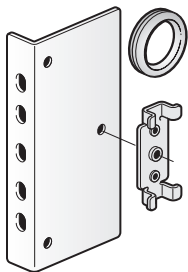

EUDB-J

Height	Width	Depth	Trim Color	Number	Price
5"(127mm)	23/8"(60mm)	11/8"(29mm)	Black	EUDB-0000-JB	\$54.62
			White	EUDB-0000-JW	\$54.62

Features

- Includes bracket, grommet and mounting hardware.
- Field installed.

Specification Tips

- Bracket designed to be used with X Series Enhanced Power Module only.
- Designed to be used in open storage cavities of lockers, group lockers, cubby lockers and combination units.
- Cannot be used in drawers or personal storage towers.
- A 1 1/4"(32mm) diameter Greenlee punch is recommended to punch the power hole through the back of our products (lockers).
- Application may require approval of local authority having jurisdiction (AHJ); ensure compliance before placing orders and installation.

To Order, Specify:

- 1) Product number.

Electrical Components

Enhanced Power Module Brackets

	Height	Width	Length	Description	Number	Price
For use with Suite Lower Storage – Mounts to the Inner Back of the Cabinet	1 3/4" (44mm)	2" (51mm)	3 3/8" (85mm)	Black Bracket	EUDB-0000-BB	\$54.62
				White Bracket	EUDB-0000-BW	54.62

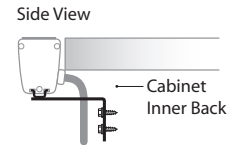
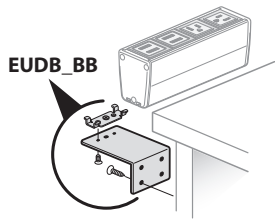

EUDB-0000-B



Features

- Includes bracket and mounting hardware.
- For use with 3, 4 or 6 port Enhanced Power Module on Suite cabinets.
- Available in black or white.
- Mounts to inner back of cabinet to position Enhanced Power Module at back edge of worktop.

To Order, Specify:

- 1) Product number.
(No finish specification required.)

Specification Tips

- Specify Enhanced Power Module separately.
- Requires field installation.
- Requires field cut of brush at back edge of cabinet.
- Power Module face must be mounted above worktop to accommodate transformer plugs.
- Application may require approval of local authority having jurisdiction (AHJ); ensure compliance before placing orders and installation.

For use with Suite Lower Storage – Mounts to Storage Top	2" (51mm)	2" (51mm)	3" (76mm)	Black Bracket	EUDB-0000-CB	\$54.62
				White Bracket	EUDB-0000-CW	54.62

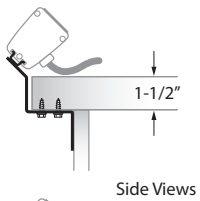
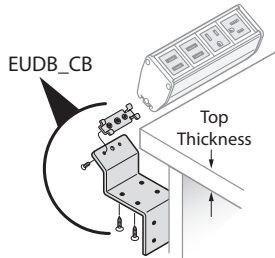

Side Views

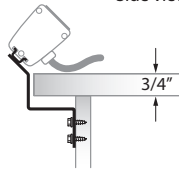

EUDB-0000-C



Features

- Includes bracket and mounting hardware.
- For use with 3, 4 or 6 port Enhanced Power Module on Suite cabinets.
- Available in black or white.
- Mounts to bottom of work top for 2H or inner back for 1.5h.
- Mounts to bottom of work top to position Enhanced Power Module at 45° angle at back edge of worktop.

To Order, Specify:

- 1) Product number.
(No finish specification required.)

Specification Tips

- Specify Enhanced Power Module separately.
- Requires field installation.
- Requires field cut of brush at back edge of cabinet.
- Application may require approval of local authority having jurisdiction (AHJ); ensure compliance before placing orders and installation.

Electrical Components

Enhanced Power Module Brackets

	Height	Width	Length	Description	Number	Price
For use with Suite Technology Access Blotter and Utility Cabinet	1 3/8"(35mm)	2"(51mm)	2"(51mm)	Black Bracket	EUDB-0000-AB	\$54.62
				White Bracket	EUDB-0000-AW	54.62

For use with Suite Technology Access Blotter and Utility Cabinet

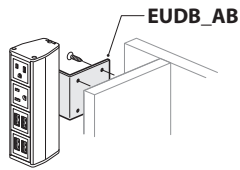

Top View

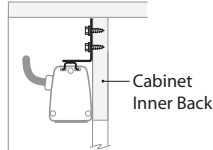

Side View

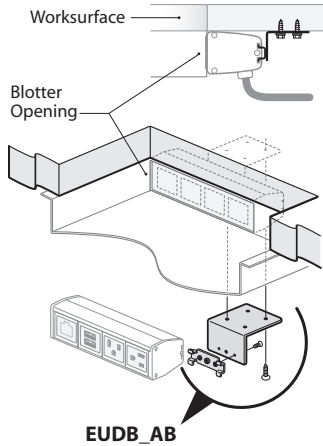

EUDB-0000-A



Features

- Includes bracket and mounting hardware.
- For use with 4 port Enhanced Power Module under Suite blotter.
- Mounts to bottom of work top adjacent to blotter opening.
- For use with 3, 4 or 6 port Enhanced Power Module in Suite utility cabinet.
- Mounts to inner back of Suite utility cabinet.
- Available in black or white.

Specification Tips

- Specify Enhanced Power Module separately.
- Requires field installation.
- Application may require approval of local authority having jurisdiction (AHJ); ensure compliance before placing orders and installation.

To Order, Specify:

- 1) Product number.
(No finish specification required.)

Electrical Components

Flip Top Units

Power and Data

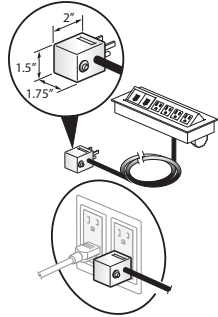
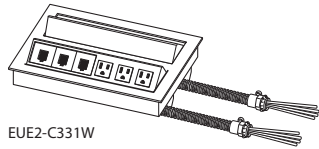
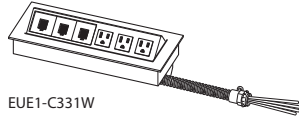
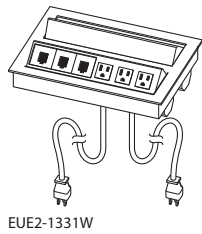
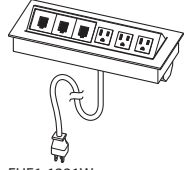
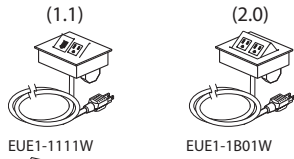

Fused Plug Detail

Width	Bezel Depth	Configuration	Number	Price
Corded Single-Sided Outlets				
5 5/16"(133mm)	4 3/8"(111mm)	1 Power, 1 Data	EUE1-0000-1111W	\$ 422.89
		2 Power, 0 Data	EUE1-0000-1B01W	422.89
8 5/16"(211mm)	4 3/8"(111mm)	2 Power, 2 Data	EUE1-0000-1221W	497.35
		3 Power, 1 Data	EUE1-0000-1311W	497.35
11 1/4"(286mm)		3 Power, 3 Data	EUE1-0000-1331W	497.35
		4 Power, 2 Data	EUE1-0000-1421W	497.35
Corded Double-Sided Outlets				
8 5/16"(211mm)	8"(203mm)	2 Power, 2 Data	EUE2-0000-1221W	\$ 994.68
		3 Power, 1 Data	EUE2-0000-1311W	994.68
11 1/4"(286mm)		3 Power, 3 Data	EUE2-0000-1331W	994.68
		4 Power, 2 Data	EUE2-0000-1421W	994.68
Hardwire Single-Sided Outlets				
8 5/16"(211mm)	4 3/8"(111mm)	2 Power, 2 Data	EUE1-0000-C221W	\$ 516.07
11 1/4"(286mm)		3 Power, 3 Data	EUE1-0000-C331W	516.07
Hardwire Double-Sided Outlets				
8 5/16"(211mm)	8"(203mm)	2 Power, 2 Data	EUE2-0000-C221W	\$1083.61
11 1/4"(286mm)		3 Power, 3 Data	EUE2-0000-C331W	1083.61

Features

- Hardwire flip top unit includes one flip top unit with power outlets and communication openings, mounting clips, 6 foot flexible metal conduit feed with wires for hardwire, multiple data jack adapters to accommodate most varieties of field supplied data jacks, also includes blank data covers.
- Corded flip top unit includes one flip top unit with power outlets and communication openings, 12 foot long – 15-amp cord with plug, mounting clips, multiple data jack adapters to accommodate most varieties of field supplied data jacks, also includes blank data covers.
- Flip top unit is flush mounted with spring release cover.
- Flip top unit overall height is 2 3/4"(70mm) and will extend below the table tops.
- Standard in anodized finish.
- Ships assembled.

To Order, Specify:

- 1) Product number.
(No finish specification required.)

Specification Tips

- **For use with 120 volt 60 hertz power source only.**
- Flip top unit plug-in cord drops down from bottom of unit to plug into external power outlet.
- Flip top unit must be field installed on worksurfaces by field cutting hole.
- Corded flip top units with four receptacles utilize a fused plug that may block adjacent building receptacle outlet.
- Application may require approval of local authority having jurisdiction (AHJ); ensure compliance before placing orders and installation.

Electrical Components

Flip Top Unit — Non-Powered

Width	Bezel Depth	Trim Color	Port Color	Port	Configuration	Number	Price
Single-Sided Outlets							
5 5/16"(135mm)	4 7/16"(113mm)	Black Anodized	Black	2	1 Cable Bay	EUE1-000B-0002	\$ 670.90
					2 Data Ports	EUE1-000B-0020	670.90
8 5/16"(211mm)	4 7/16"(113mm)			4	2 Data Ports, 1 Cable Bay	EUE1-000B-0022	\$ 670.90
					4 Data Ports	EUE1-000B-0040	670.90
11 5/16"(287mm)	4 7/16"(113mm)			6	4 Data Ports, 1 Cable Bay	EUE1-000B-0042	\$ 670.90
					6 Data Ports	EUE1-000B-0060	670.90
5 5/16"(135mm)	4 7/16"(113mm)	Clear Anodized	White	2	1 Cable Bay	EUE1-000W-0002	\$ 500.48
					2 Data Ports	EUE1-000W-0020	500.48
8 5/16"(211mm)	4 7/16"(113mm)			4	2 Data Ports, 1 Cable Bay	EUE1-000W-0022	\$ 500.48
					4 Data Ports	EUE1-000W-0040	500.48
11 5/16"(287mm)	4 7/16"(113mm)			6	4 Data Ports, 1 Cable Bay	EUE1-000W-0042	\$ 500.48
					6 Data Ports	EUE1-000W-0060	500.48
Double-Sided Outlets							
8 5/16"(211mm)	8 1/16"(205mm)	Black Anodized	Black	4	2 Data Ports, 1 Cable Bay	EUE2-000B-0022	\$1168.23
					4 Data Ports	EUE2-000B-0040	1168.23
11 5/16"(287mm)	8 1/16"(205mm)			6	4 Data Ports, 1 Cable Bay	EUE2-000B-0042	\$1168.23
					6 Data Ports	EUE2-000B-0060	1168.23
8 5/16"(211mm)	8 1/16"(205mm)	Clear Anodized	White	4	2 Data Ports, 1 Cable Bay	EUE2-000W-0022	\$ 997.81
					4 Data Ports	EUE2-000W-0040	997.81
11 5/16"(287mm)	8 1/16"(205mm)			6	4 Data Ports, 1 Cable Bay	EUE2-000W-0042	\$ 997.81
					6 Data Ports	EUE2-000W-0060	997.81

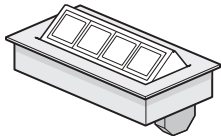

EUE1-000B

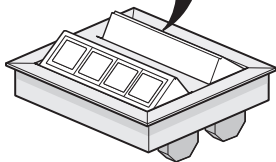
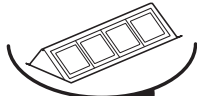

EUE2-000B



Features

- Includes bezel and nonpowered flip top module with 2, 4 or 6 ports that can be configured with data ports or cable bays and mounting hardware.
- Data port accommodate most varieties of field supplied data/AV jacks.
- Each Cable Bay can accept up to 2 pull out data/AV cables
- Flip top unit is flush mounted with spring release flip module(s).
- Flip top unit overall height is 2 3/4"(70mm) and will extend below the table tops.
- Color option of black anodized housing with black receptacles or clear anodized housing with white receptacles.
- Ships assembled.

Specification Tips

- **Configuration and quantity of power and data ports cannot be modified in the field.**
- Requires field installation.
- Specify factory cut hole or field cut hole as required.
- Specify AV cables separately.
- Cable Bay requires cables less than 0.3"(7.6mm) diameter.
- Application may require approval of local authority having jurisdiction (AHJ); ensure compliance before placing orders and installation.

To Order, Specify:

- 1) Product number.
(No finish specification required.)

This page intentionally blank

Electrical Components

Flip Top Unit – Corded – Single-Sided

Power, Data and USB

4-Port:

- (2) Power
- (1) USB
- (1) Data

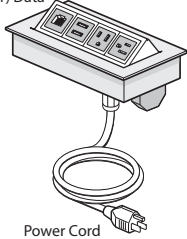

Power Cord
EUE1-PF0B-2110

6-Port:

- (2) Power
- (1) USB
- (1) Data
- (1) Cable Bay

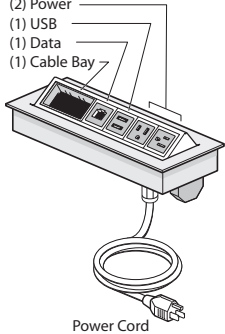

Power Cord

EUE1-PF0B-1212

4-Port:

- (4) Power

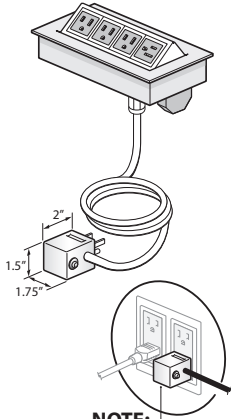

NOTE:

Always Fused Plug when more than 3 power outlets specified.

EUE1-PF0B-4000



Features

- Includes bezel and flip top module with 2, 4 or 6 ports that can be configured with simplex outlets (NEMA-5-15R), USB charging port (with two USB outlets), data ports or cable bay(s) that can accept up to 2 pull out data/AV cables and mounting hardware.
- Data port accommodate most varieties of field supplied data/AV jacks.
- Corded power module available with 15 amp - 6'(1829mm) or 12'(3658mm) long cord with plug (NEMA 5-15P).
- USB Charging Port consists of two USB 2.0 style A outlets. 4 Amp (shared) charging capacity.
- Flip top unit is flush mounted with spring release flip module.
- Flip top unit overall height is 2 3/4"(70mm) and will extend below the table tops.
- Color option of black anodized housing with black receptacles or clear anodized housing with white receptacles.
- Ships assembled.

Specification Tips

- **Configuration and quantity of power and data ports cannot be modified in the field.**
- **For use with 120 volt 60 hertz power source only.**
- Requires field installation.
- Specify factory cut hole or field cut hole as required.
- Specify AV cables separately.
- Cable Bay requires cables less than 0.3"(7.6mm) diameter.
- Corded flip top units with four or more receptacles utilize a fused plug that may block adjacent building receptacle outlet.
- Application may require approval of local authority having jurisdiction (AHJ); ensure compliance before placing orders and installation.

To Order, Specify:

- 1) Product number.
(No finish specification required.)

Note: Order flip top units to match flip top unit cutout option specified for each top (A/B, F/V or J/K).

Electrical Components

Flip Top Unit – Corded – Single-Sided

Bezel Width	Bezel Depth	Cord Length	Trim Color	Port Color	Port	Configuration	Flip Top Unit Cutout Code Options	Number	Price						
5 5/16" (135mm)	4 7/16" (113mm)	6' (1829mm)	Black Anodized	Black	2	1 Power Receptacle, 1 Data Port	A, B	EUE1-PF0B-1010	\$670.90						
						1 Power Receptacle, 1 USB Charging	A, B	EUE1-PF0B-1100	733.92						
						2 Power Receptacles	A, B	EUE1-PF0B-2000	670.90						
8 5/16" (211mm)	4 7/16" (113mm)				4	1 Power Receptacle, 1 Data Port, 1 Cable Bay	F, V	EUE1-PF0B-1012	\$670.90						
						1 Power Receptacle, 3 Data Ports	F, V	EUE1-PF0B-1030	670.90						
						1 Power Receptacle, 1 USB Charging, 1 Cable Bay	F, V	EUE1-PF0B-1102	733.92						
						1 Power Receptacle, 1 USB Charging, 2 Data Ports	F, V	EUE1-PF0B-1120	733.92						
						1 Power Receptacle, 3 USB Charging	F, V	EUE1-PF0B-1300	859.96						
						2 Power Receptacles, 1 Cable Bay	F, V	EUE1-PF0B-2002	670.90						
						2 Power Receptacles, 2 Data Ports	F, V	EUE1-PF0B-2020	670.90						
						2 Power Receptacles, 1 USB Charging, 1 Data Port	F, V	EUE1-PF0B-2110	733.92						
						2 Power Receptacles, 2 USB Charging	F, V	EUE1-PF0B-2200	796.94						
						3 Power Receptacles, 1 Data Port	F, V	EUE1-PF0B-3010	670.90						
						3 Power Receptacles, 1 USB Charging	F, V	EUE1-PF0B-3100	733.92						
						4 Power Receptacles	F, V	EUE1-PF0B-4000	670.90						
						11 5/16" (287mm)	4 7/16" (113mm)				6	1 Power Receptacle, 3 Data Ports, 1 Cable Bay	J, K	EUE1-PF0B-1032	\$670.90
												1 Power Receptacle, 5 Data Ports	J, K	EUE1-PF0B-1050	670.90
												1 Power Receptacle, 1 USB Charging, 2 Data Ports, 1 Cable Bay	J, K	EUE1-PF0B-1122	733.92
1 Power Receptacle, 1 USB Charging, 4 Data Ports	J, K	EUE1-PF0B-1140	733.92												
1 Power Receptacle, 2 USB Charging, 1 Data Port, 1 Cable Bay	J, K	EUE1-PF0B-1212	796.94												
1 Power Receptacle, 2 USB Charging, 3 Data Ports	J, K	EUE1-PF0B-1230	796.94												
1 Power Receptacle, 3 USB Charging, 1 Cable Bay	J, K	EUE1-PF0B-1302	859.96												
1 Power Receptacle, 3 USB Charging, 2 Data Ports	J, K	EUE1-PF0B-1320	859.96												
2 Power Receptacles, 2 Data Ports, 1 Cable Bay	J, K	EUE1-PF0B-2022	670.90												
2 Power Receptacles, 4 Data Ports	J, K	EUE1-PF0B-2040	670.90												
2 Power Receptacles, 1 USB Charging, 1 Data Port, 1 Cable Bay	J, K	EUE1-PF0B-2112	733.92												
2 Power Receptacles, 1 USB Charging, 3 Data Ports	J, K	EUE1-PF0B-2130	733.92												
2 Power Receptacles, 2 USB Charging, 1 Cable Bay	J, K	EUE1-PF0B-2202	796.94												
2 Power Receptacles, 2 USB Charging, 2 Data Ports	J, K	EUE1-PF0B-2220	796.94												
2 Power Receptacles, 3 USB Charging, 1 Data Port	J, K	EUE1-PF0B-2310	859.96												
2 Power Receptacles, 4 USB Charging	J, K	EUE1-PF0B-2400	922.98												
3 Power Receptacles, 1 Data Port, 1 Cable Bay	J, K	EUE1-PF0B-3012	670.90												
3 Power Receptacles, 3 Data Ports	J, K	EUE1-PF0B-3030	670.90												
3 Power Receptacles, 1 USB Charging, 1 Cable Bay	J, K	EUE1-PF0B-3102	733.92												
3 Power Receptacles, 1 USB Charging, 2 Data Ports	J, K	EUE1-PF0B-3120	733.92												
3 Power Receptacles, 2 USB Charging, 1 Data Port	J, K	EUE1-PF0B-3210	796.94												
3 Power Receptacles, 3 USB Charging	J, K	EUE1-PF0B-3300	859.96												
4 Power Receptacles, 1 Cable Bay	J, K	EUE1-PF0B-4002	670.90												
4 Power Receptacles, 2 Data Ports	J, K	EUE1-PF0B-4020	670.90												
4 Power Receptacles, 1 USB Charging, 1 Data Port	J, K	EUE1-PF0B-4110	733.92												
4 Power Receptacles, 2 USB Charging	J, K	EUE1-PF0B-4200	796.94												
5 Power Receptacles, 1 Data Port	J, K	EUE1-PF0B-5010	670.90												
5 Power Receptacles, 1 USB Charging	J, K	EUE1-PF0B-5100	733.92												
6 Power Receptacles	J, K	EUE1-PF0B-6000	670.90												

Electrical Components

Flip Top Unit – Corded – Single-Sided

Bezel Width	Bezel Depth	Cord Length	Trim Color	Port Color	Port	Configuration	Flip Top Unit Cutout Code Options	Number	Price						
5 5/16" (135mm)	4 7/16" (113mm)	6' (1829mm)	Clear Anodized	White	2	1 Power Receptacle, 1 Data Port	A, B	EUE1-PF0W-1010	\$500.48						
						1 Power Receptacle, 1 USB Charging	A, B	EUE1-PF0W-1100	563.50						
						2 Power Receptacles	A, B	EUE1-PF0W-2000	500.48						
8 5/16" (211mm)	4 7/16" (113mm)				4	1 Power Receptacle, 1 Data Port, 1 Cable Bay	F, V	EUE1-PF0W-1012	\$500.48						
						1 Power Receptacle, 3 Data Ports	F, V	EUE1-PF0W-1030	500.48						
						1 Power Receptacle, 1 USB Charging, 1 Cable Bay	F, V	EUE1-PF0W-1102	563.50						
						1 Power Receptacle, 1 USB Charging, 2 Data Ports	F, V	EUE1-PF0W-1120	563.50						
						1 Power Receptacle, 3 USB Charging	F, V	EUE1-PF0W-1300	689.54						
						2 Power Receptacles, 1 Cable Bay	F, V	EUE1-PF0W-2002	500.48						
						2 Power Receptacles, 2 Data Ports	F, V	EUE1-PF0W-2020	500.48						
						2 Power Receptacles, 1 USB Charging, 1 Data Port	F, V	EUE1-PF0W-2110	563.50						
						2 Power Receptacles, 2 USB Charging	F, V	EUE1-PF0W-2200	626.52						
						3 Power Receptacles, 1 Data Port	F, V	EUE1-PF0W-3010	500.48						
						3 Power Receptacles, 1 USB Charging	F, V	EUE1-PF0W-3100	563.50						
						4 Power Receptacles	F, V	EUE1-PF0W-4000	500.48						
						11 5/16" (287mm)	4 7/16" (113mm)				6	1 Power Receptacle, 3 Data Ports, 1 Cable Bay	J, K	EUE1-PF0W-1032	\$500.48
												1 Power Receptacle, 5 Data Ports	J, K	EUE1-PF0W-1050	500.48
												1 Power Receptacle, 1 USB Charging, 2 Data Ports, 1 Cable Bay	J, K	EUE1-PF0W-1122	563.50
1 Power Receptacle, 1 USB Charging, 4 Data Ports	J, K	EUE1-PF0W-1140	563.50												
1 Power Receptacle, 2 USB Charging, 1 Data Port, 1 Cable Bay	J, K	EUE1-PF0W-1212	626.52												
1 Power Receptacle, 2 USB Charging, 3 Data Ports	J, K	EUE1-PF0W-1230	626.52												
1 Power Receptacle, 3 USB Charging, 1 Cable Bay	J, K	EUE1-PF0W-1302	689.54												
1 Power Receptacle, 3 USB Charging, 2 Data Ports	J, K	EUE1-PF0W-1320	689.54												
2 Power Receptacles, 2 Data Ports, 1 Cable Bay	J, K	EUE1-PF0W-2022	500.48												
2 Power Receptacles, 4 Data Ports	J, K	EUE1-PF0W-2040	500.48												
2 Power Receptacles, 1 USB Charging, 1 Data Port, 1 Cable Bay	J, K	EUE1-PF0W-2112	563.50												
2 Power Receptacles, 1 USB Charging, 3 Data Ports	J, K	EUE1-PF0W-2130	563.50												
2 Power Receptacles, 2 USB Charging, 1 Cable Bay	J, K	EUE1-PF0W-2202	626.52												
2 Power Receptacles, 2 USB Charging, 2 Data Ports	J, K	EUE1-PF0W-2220	626.52												
2 Power Receptacles, 3 USB Charging, 1 Data Port	J, K	EUE1-PF0W-2310	689.54												
2 Power Receptacles, 4 USB Charging	J, K	EUE1-PF0W-2400	752.56												
3 Power Receptacles, 1 Data Port, 1 Cable Bay	J, K	EUE1-PF0W-3012	500.48												
3 Power Receptacles, 3 Data Ports	J, K	EUE1-PF0W-3030	500.48												
3 Power Receptacles, 1 USB Charging, 1 Cable Bay	J, K	EUE1-PF0W-3102	563.50												
3 Power Receptacles, 1 USB Charging, 2 Data Ports	J, K	EUE1-PF0W-3120	563.50												
3 Power Receptacles, 2 USB Charging, 1 Data Port	J, K	EUE1-PF0W-3210	626.52												
3 Power Receptacles, 3 USB Charging	J, K	EUE1-PF0W-3300	689.54												
4 Power Receptacles, 1 Cable Bay	J, K	EUE1-PF0W-4002	500.48												
4 Power Receptacles, 2 Data Ports	J, K	EUE1-PF0W-4020	500.48												
4 Power Receptacles, 1 USB Charging, 1 Data Port	J, K	EUE1-PF0W-4110	563.50												
4 Power Receptacles, 2 USB Charging	J, K	EUE1-PF0W-4200	626.52												
5 Power Receptacles, 1 Data Port	J, K	EUE1-PF0W-5010	500.48												
5 Power Receptacles, 1 USB Charging	J, K	EUE1-PF0W-5100	563.50												
6 Power Receptacles	J, K	EUE1-PF0W-6000	500.48												

Electrical Components

Flip Top Unit – Corded – Single-Sided

Bezel Width	Bezel Depth	Cord Length	Trim Color	Port Color	Port	Configuration	Flip Top Unit Cutout Code Options	Number	Price						
5 5/16" (135mm)	4 7/16" (113mm)	12' (3658mm)	Black Anodized	Black	2	1 Power Receptacle, 1 Data Port	A, B	EUE1-PL0B-1010	\$722.39						
						1 Power Receptacle, 1 USB Charging	A, B	EUE1-PL0B-1100	785.41						
						2 Power Receptacles	A, B	EUE1-PL0B-2000	722.39						
8 5/16" (211mm)	4 7/16" (113mm)				4	1 Power Receptacle, 1 Data Port, 1 Cable Bay	F, V	EUE1-PL0B-1012	\$722.39						
						1 Power Receptacle, 3 Data Ports	F, V	EUE1-PL0B-1030	722.39						
						1 Power Receptacle, 1 USB Charging, 1 Cable Bay	F, V	EUE1-PL0B-1102	785.41						
						1 Power Receptacle, 1 USB Charging, 2 Data Ports	F, V	EUE1-PL0B-1120	785.41						
						1 Power Receptacle, 3 USB Charging	F, V	EUE1-PL0B-1300	911.45						
						2 Power Receptacles, 1 Cable Bay	F, V	EUE1-PL0B-2002	722.39						
						2 Power Receptacles, 2 Data Ports	F, V	EUE1-PL0B-2020	722.39						
						2 Power Receptacles, 1 USB Charging, 1 Data Port	F, V	EUE1-PL0B-2110	785.41						
						2 Power Receptacles, 2 USB Charging	F, V	EUE1-PL0B-2200	848.43						
						3 Power Receptacles, 1 Data Port	F, V	EUE1-PL0B-3010	722.39						
						3 Power Receptacles, 1 USB Charging	F, V	EUE1-PL0B-3100	785.41						
						4 Power Receptacles	F, V	EUE1-PL0B-4000	722.39						
						11 5/16" (287mm)	4 7/16" (113mm)				6	1 Power Receptacle, 3 Data Ports, 1 Cable Bay	J, K	EUE1-PL0B-1032	\$722.39
												1 Power Receptacle, 5 Data Ports	J, K	EUE1-PL0B-1050	722.39
												1 Power Receptacle, 1 USB Charging, 2 Data Ports, 1 Cable Bay	J, K	EUE1-PL0B-1122	785.41
1 Power Receptacle, 1 USB Charging, 4 Data Ports	J, K	EUE1-PL0B-1140	785.41												
1 Power Receptacle, 2 USB Charging, 1 Data Port, 1 Cable Bay	J, K	EUE1-PL0B-1212	848.43												
1 Power Receptacle, 2 USB Charging, 3 Data Ports	J, K	EUE1-PL0B-1230	848.43												
1 Power Receptacle, 3 USB Charging, 1 Cable Bay	J, K	EUE1-PL0B-1302	911.45												
1 Power Receptacle, 3 USB Charging, 2 Data Ports	J, K	EUE1-PL0B-1320	911.45												
2 Power Receptacles, 2 Data Ports, 1 Cable Bay	J, K	EUE1-PL0B-2022	722.39												
2 Power Receptacles, 4 Data Ports	J, K	EUE1-PL0B-2040	722.39												
2 Power Receptacles, 1 USB Charging, 1 Data Port, 1 Cable Bay	J, K	EUE1-PL0B-2112	785.41												
2 Power Receptacles, 1 USB Charging, 3 Data Ports	J, K	EUE1-PL0B-2130	785.41												
2 Power Receptacles, 2 USB Charging, 1 Cable Bay	J, K	EUE1-PL0B-2202	848.43												
2 Power Receptacles, 2 USB Charging, 2 Data Ports	J, K	EUE1-PL0B-2220	848.43												
2 Power Receptacles, 3 USB Charging, 1 Data Port	J, K	EUE1-PL0B-2310	911.45												
2 Power Receptacles, 4 USB Charging	J, K	EUE1-PL0B-2400	974.47												
3 Power Receptacles, 1 Data Port, 1 Cable Bay	J, K	EUE1-PL0B-3012	722.39												
3 Power Receptacles, 3 Data Ports	J, K	EUE1-PL0B-3030	722.39												
3 Power Receptacles, 1 USB Charging, 1 Cable Bay	J, K	EUE1-PL0B-3102	785.41												
3 Power Receptacles, 1 USB Charging, 2 Data Ports	J, K	EUE1-PL0B-3120	785.41												
3 Power Receptacles, 2 USB Charging, 1 Data Port	J, K	EUE1-PL0B-3210	848.43												
3 Power Receptacles, 3 USB Charging	J, K	EUE1-PL0B-3300	911.45												
4 Power Receptacles, 1 Cable Bay	J, K	EUE1-PL0B-4002	722.39												
4 Power Receptacles, 2 Data Ports	J, K	EUE1-PL0B-4020	722.39												
4 Power Receptacles, 1 USB Charging, 1 Data Port	J, K	EUE1-PL0B-4110	785.41												
4 Power Receptacles, 2 USB Charging	J, K	EUE1-PL0B-4200	848.43												
5 Power Receptacles, 1 Data Port	J, K	EUE1-PL0B-5010	722.39												
5 Power Receptacles, 1 USB Charging	J, K	EUE1-PL0B-5100	785.41												
6 Power Receptacles	J, K	EUE1-PL0B-6000	722.39												

Electrical Components

Flip Top Unit – Corded – Single-Sided

Bezel Width	Bezel Depth	Cord Length	Trim Color	Port Color	Port	Configuration	Flip Top Unit Cutout Code Options	Number	Price						
5 5/16" (135mm)	4 7/16" (113mm)	12' (3658mm)	Clear Anodized	White	2	1 Power Receptacle, 1 Data Port	A, B	EUE1-PL0W-1010	\$551.97						
						1 Power Receptacle, 1 USB Charging	A, B	EUE1-PL0W-1100	614.99						
						2 Power Receptacles	A, B	EUE1-PL0W-2000	551.97						
8 5/16" (211mm)	4 7/16" (113mm)				4	1 Power Receptacle, 1 Data Port, 1 Cable Bay	F, V	EUE1-PL0W-1012	\$551.97						
						1 Power Receptacle, 3 Data Ports	F, V	EUE1-PL0W-1030	551.97						
						1 Power Receptacle, 1 USB Charging, 1 Cable Bay	F, V	EUE1-PL0W-1102	614.99						
						1 Power Receptacle, 1 USB Charging, 2 Data Ports	F, V	EUE1-PL0W-1120	614.99						
						1 Power Receptacle, 3 USB Charging	F, V	EUE1-PL0W-1300	741.03						
						2 Power Receptacles, 1 Cable Bay	F, V	EUE1-PL0W-2002	551.97						
						2 Power Receptacles, 2 Data Ports	F, V	EUE1-PL0W-2020	551.97						
						2 Power Receptacles, 1 USB Charging, 1 Data Port	F, V	EUE1-PL0W-2110	614.99						
						2 Power Receptacles, 2 USB Charging	F, V	EUE1-PL0W-2200	678.01						
						3 Power Receptacles, 1 Data Port	F, V	EUE1-PL0W-3010	551.97						
						3 Power Receptacles, 1 USB Charging	F, V	EUE1-PL0W-3100	614.99						
						4 Power Receptacles	F, V	EUE1-PL0W-4000	551.97						
						11 5/16" (287mm)	4 7/16" (113mm)				6	1 Power Receptacle, 3 Data Ports, 1 Cable Bay	J, K	EUE1-PL0W-1032	\$551.97
												1 Power Receptacle, 5 Data Ports	J, K	EUE1-PL0W-1050	551.97
												1 Power Receptacle, 1 USB Charging, 2 Data Ports, 1 Cable Bay	J, K	EUE1-PL0W-1122	614.99
1 Power Receptacle, 1 USB Charging, 4 Data Ports	J, K	EUE1-PL0W-1140	614.99												
1 Power Receptacle, 2 USB Charging, 1 Data Port, 1 Cable Bay	J, K	EUE1-PL0W-1212	678.01												
1 Power Receptacle, 2 USB Charging, 3 Data Ports	J, K	EUE1-PL0W-1230	678.01												
1 Power Receptacle, 3 USB Charging, 1 Cable Bay	J, K	EUE1-PL0W-1302	741.03												
1 Power Receptacle, 3 USB Charging, 2 Data Ports	J, K	EUE1-PL0W-1320	741.03												
2 Power Receptacles, 2 Data Ports, 1 Cable Bay	J, K	EUE1-PL0W-2022	551.97												
2 Power Receptacles, 4 Data Ports	J, K	EUE1-PL0W-2040	551.97												
2 Power Receptacles, 1 USB Charging, 1 Data Port, 1 Cable Bay	J, K	EUE1-PL0W-2112	614.99												
2 Power Receptacles, 1 USB Charging, 3 Data Ports	J, K	EUE1-PL0W-2130	614.99												
2 Power Receptacles, 2 USB Charging, 1 Cable Bay	J, K	EUE1-PL0W-2202	678.01												
2 Power Receptacles, 2 USB Charging, 2 Data Ports	J, K	EUE1-PL0W-2220	678.01												
2 Power Receptacles, 3 USB Charging, 1 Data Port	J, K	EUE1-PL0W-2310	741.03												
2 Power Receptacles, 4 USB Charging	J, K	EUE1-PL0W-2400	804.05												
3 Power Receptacles, 1 Data Port, 1 Cable Bay	J, K	EUE1-PL0W-3012	551.97												
3 Power Receptacles, 3 Data Ports	J, K	EUE1-PL0W-3030	551.97												
3 Power Receptacles, 1 USB Charging, 1 Cable Bay	J, K	EUE1-PL0W-3102	614.99												
3 Power Receptacles, 1 USB Charging, 2 Data Ports	J, K	EUE1-PL0W-3120	614.99												
3 Power Receptacles, 2 USB Charging, 1 Data Port	J, K	EUE1-PL0W-3210	678.01												
3 Power Receptacles, 3 USB Charging	J, K	EUE1-PL0W-3300	741.03												
4 Power Receptacles, 1 Cable Bay	J, K	EUE1-PL0W-4002	551.97												
4 Power Receptacles, 2 Data Ports	J, K	EUE1-PL0W-4020	551.97												
4 Power Receptacles, 1 USB Charging, 1 Data Port	J, K	EUE1-PL0W-4110	614.99												
4 Power Receptacles, 2 USB Charging	J, K	EUE1-PL0W-4200	678.01												
5 Power Receptacles, 1 Data Port	J, K	EUE1-PL0W-5010	551.97												
5 Power Receptacles, 1 USB Charging	J, K	EUE1-PL0W-5100	614.99												
6 Power Receptacles	J, K	EUE1-PL0W-6000	551.97												

This page intentionally blank

Electrical Components

Flip Top Unit — Corded — Double-Sided

Power, Data and USB

4-Port:

- (2) Power
- (1) USB
- (1) Data

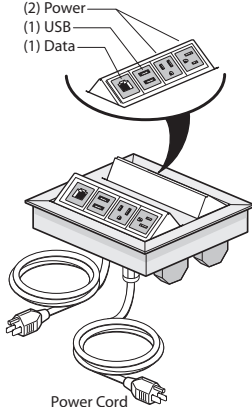

Power Cord

EUE2-PF0B-2110

6-Port:

- (2) Power
- (1) USB
- (1) Data
- (1) Cable Bay

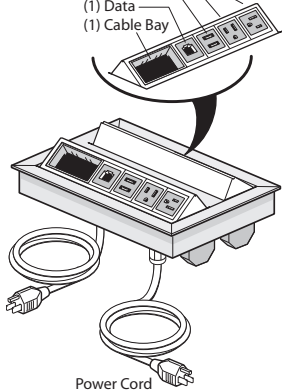

Power Cord

EUE2-PF0B-1212

4-Port:

- (4) Power

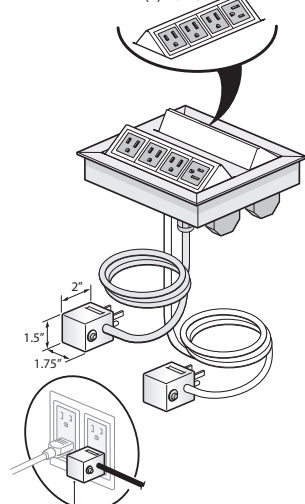

NOTE:
Always Fused Plug
when more than 3
power outlets specified.

EUE2-PF0B-4000



Features

- Includes bezel and two flip top modules, each flip top module with 2, 4 or 6 ports that can be configured with simplex outlets (NEMA-5-15R), USB charging port (with two USB outlets), data ports or cable bay(s) that can accept up to 2 pull out data/AV cables and mounting hardware.
- Data port accommodate most varieties of field supplied data/AV jacks.
- Each flip top module within the bezel provided with 15 amp - 6'(1829mm) or 12'(3658mm) long cord with plug (NEMA5-15P).
- USB Charging Port consists of two USB 2.0 style A outlets. 4 Amp (shared) charging capacity.
- Flip top unit is flush mounted with spring release flip module.
- Flip top unit overall height is 2 3/4"(70mm) and will extend below the table tops.
- Color option of black anodized housing with black receptacles or clear anodized housing with white receptacles.
- Ships assembled.

Specification Tips

- **Configuration and quantity of power and data ports cannot be modified in the field.**
- **For use with 120 volt 60 hertz power source only.**
- Requires field installation.
- Specify factory cut hole or field cut hole as required.
- Specify AV cables separately.
- Cable Bay requires cables less than 0.3"(7.6mm) diameter.
- Corded flip top units with four receptacles utilize a fused plug that may block adjacent building receptacle outlet.
- Application may require approval of local authority having jurisdiction (AHJ); ensure compliance before placing orders and installation.

Note: Two cord feeds are provided from the double-sided flip top unit.

To Order, Specify:

- 1) Product number.
(No finish specification required.)

Note: Order flip top units to match flip top unit cutout option specified for each top (M/P or Q/V).

Electrical Components

Flip Top Unit — Corded — Double-Sided

Width	Bezel Depth	Cord Length	Trim Color	Port Color	Port	Configuration	Flip Top Unit Cutout Code Options	Number	Price	
5 5/16" (135mm)	4 3/8" (111mm)	6' (1829mm)	Black Anodized	Black	4	1 Power Receptacle, 1 Data Port, 1 Cable Bay	M, P	EUE2-PF0B-1012	\$1168.23	
						1 Power Receptacle, 3 Data Ports	M, P	EUE2-PF0B-1030	1168.23	
						1 Power Receptacle, 1 USB Charging, 1 Cable Bay	M, P	EUE2-PF0B-1102	1231.25	
						1 Power Receptacle, 1 USB Charging, 2 Data Ports	M, P	EUE2-PF0B-1120	1231.25	
						1 Power Receptacle, 3 USB Charging	M, P	EUE2-PF0B-1300	1357.29	
						2 Power Receptacles, 1 Cable Bay	M, P	EUE2-PF0B-2002	1168.23	
						2 Power Receptacles, 2 Data Ports	M, P	EUE2-PF0B-2020	1168.23	
						2 Power Receptacles, 1 USB Charging, 1 Data Port	M, P	EUE2-PF0B-2110	1231.25	
						2 Power Receptacles, 2 USB Charging	M, P	EUE2-PF0B-2200	1294.27	
						3 Power Receptacles, 1 Data Port	M, P	EUE2-PF0B-3010	1168.23	
						3 Power Receptacles, 1 USB Charging	M, P	EUE2-PF0B-3100	1231.25	
						4 Power Receptacles	M, P	EUE2-PF0B-4000	1168.23	
						6	1 Power Receptacle, 3 Data Ports, 1 Cable Bay	Q, V	EUE2-PF0B-1032	\$1168.23
							1 Power Receptacle, 5 Data Ports	Q, V	EUE2-PF0B-1050	1168.23
							1 Power Receptacle, 1 USB Charging, 2 Data Ports, 1 Cable Bay	Q, V	EUE2-PF0B-1122	1231.25
							1 Power Receptacle, 1 USB Charging, 4 Data Ports	Q, V	EUE2-PF0B-1140	1231.25
							1 Power Receptacle, 2 USB Charging, 1 Data Port, 1 Cable Bay	Q, V	EUE2-PF0B-1212	1294.27
							1 Power Receptacle, 2 USB Charging, 3 Data Ports	Q, V	EUE2-PF0B-1230	1294.27
							1 Power Receptacle, 3 USB Charging, 2 Cable Bays	Q, V	EUE2-PF0B-1302	1357.29
							1 Power Receptacle, 3 USB Charging, 2 Data Ports	Q, V	EUE2-PF0B-1320	1357.29
					2 Power Receptacles, 2 Data Ports, 2 Cable Bays		Q, V	EUE2-PF0B-2022	1168.23	
					2 Power Receptacles, 4 Data Ports		Q, V	EUE2-PF0B-2040	1168.23	
					2 Power Receptacles, 1 USB Charging, 1 Data Port, 2 Cable Bays		Q, V	EUE2-PF0B-2112	1231.25	
					2 Power Receptacles, 1 USB Charging, 3 Data Ports		Q, V	EUE2-PF0B-2130	1231.25	
					2 Power Receptacles, 2 USB Charging, 2 Cable Bays		Q, V	EUE2-PF0B-2202	1294.27	
					2 Power Receptacles, 2 USB Charging, 2 Data Ports		Q, V	EUE2-PF0B-2220	1294.27	
					2 Power Receptacles, 3 USB Charging, 1 Data Port		Q, V	EUE2-PF0B-2310	1357.29	
					2 Power Receptacles, 4 USB Charging		Q, V	EUE2-PF0B-2400	1420.31	
					3 Power Receptacles, 1 Data Port, 2 Cable Bays		Q, V	EUE2-PF0B-3012	1168.23	
					3 Power Receptacles, 3 Data Ports		Q, V	EUE2-PF0B-3030	1168.23	
					3 Power Receptacles, 1 USB Charging, 2 Cable Bays		Q, V	EUE2-PF0B-3102	1231.25	
					3 Power Receptacles, 1 USB Charging, 2 Data Ports		Q, V	EUE2-PF0B-3120	1231.25	
					3 Power Receptacles, 2 USB Charging, 1 Data Port	Q, V	EUE2-PF0B-3210	1294.27		
					3 Power Receptacles, 3 USB Charging	Q, V	EUE2-PF0B-3300	1357.29		
					4 Power Receptacles, 2 Cable Bays	Q, V	EUE2-PF0B-4002	1168.23		
					4 Power Receptacles, 2 Data Ports	Q, V	EUE2-PF0B-4020	1168.23		
					4 Power Receptacles, 1 USB Charging, 1 Data Port	Q, V	EUE2-PF0B-4110	1231.25		
					4 Power Receptacles, 2 USB Charging	Q, V	EUE2-PF0B-4200	1294.27		
					5 Power Receptacles, 1 Data Port	Q, V	EUE2-PF0B-5010	1168.23		
					5 Power Receptacles, 1 USB Charging	Q, V	EUE2-PF0B-5100	1231.25		
6 Power Receptacles	Q, V	EUE2-PF0B-6000	1168.23							

Electrical Components

Flip Top Unit — Corded — Double-Sided

Width	Bezel Depth	Cord Length	Trim Color	Port Color	Port	Configuration	Flip Top Unit Cutout Code Options	Number	Price	
5 5/16" (135mm)	4 3/8" (111mm)	6' (1829mm)	Clear Anodized	White	4	1 Power Receptacle, 1 Data Port, 1 Cable Bay	M, P	EUE2-PF0W-1012	\$ 997.81	
						1 Power Receptacle, 3 Data Ports	M, P	EUE2-PF0W-1030	997.81	
						1 Power Receptacle, 1 USB Charging, 1 Cable Bay	M, P	EUE2-PF0W-1102	1060.83	
						1 Power Receptacle, 1 USB Charging, 2 Data Ports	M, P	EUE2-PF0W-1120	1060.83	
						1 Power Receptacle, 3 USB Charging	M, P	EUE2-PF0W-1300	1186.87	
						2 Power Receptacles, 1 Cable Bay	M, P	EUE2-PF0W-2002	997.81	
						2 Power Receptacles, 2 Data Ports	M, P	EUE2-PF0W-2020	997.81	
						2 Power Receptacles, 1 USB Charging, 1 Data Port	M, P	EUE2-PF0W-2110	1060.83	
						2 Power Receptacles, 2 USB Charging	M, P	EUE2-PF0W-2200	1123.85	
						3 Power Receptacles, 1 Data Port	M, P	EUE2-PF0W-3010	997.81	
						3 Power Receptacles, 1 USB Charging	M, P	EUE2-PF0W-3100	1060.83	
						4 Power Receptacles	M, P	EUE2-PF0W-4000	997.81	
						6	1 Power Receptacle, 3 Data Ports, 1 Cable Bay	Q, V	EUE2-PF0W-1032	\$ 997.81
							1 Power Receptacle, 5 Data Ports	Q, V	EUE2-PF0W-1050	997.81
							1 Power Receptacle, 1 USB Charging, 2 Data Ports, 1 Cable Bay	Q, V	EUE2-PF0W-1122	1060.83
					1 Power Receptacle, 1 USB Charging, 4 Data Ports		Q, V	EUE2-PF0W-1140	1060.83	
					1 Power Receptacle, 2 USB Charging, 1 Data Port, 1 Cable Bay		Q, V	EUE2-PF0W-1212	1123.85	
					1 Power Receptacle, 2 USB Charging, 3 Data Ports		Q, V	EUE2-PF0W-1230	1123.85	
					1 Power Receptacle, 3 USB Charging, 1 Cable Bay		Q, V	EUE2-PF0W-1302	1186.87	
					1 Power Receptacle, 3 USB Charging, 2 Data Ports		Q, V	EUE2-PF0W-1320	1186.87	
					2 Power Receptacles, 2 Data Ports, 1 Cable Bay		Q, V	EUE2-PF0W-2022	997.81	
					2 Power Receptacles, 4 Data Ports		Q, V	EUE2-PF0W-2040	997.81	
					2 Power Receptacles, 1 USB Charging, 1 Data Port, 1 Cable Bay		Q, V	EUE2-PF0W-2112	1060.83	
					2 Power Receptacles, 1 USB Charging, 3 Data Ports		Q, V	EUE2-PF0W-2130	1060.83	
					2 Power Receptacles, 2 USB Charging, 1 Cable Bay		Q, V	EUE2-PF0W-2202	1123.85	
					2 Power Receptacles, 2 USB Charging, 2 Data Ports		Q, V	EUE2-PF0W-2220	1123.85	
					2 Power Receptacles, 3 USB Charging, 1 Data Port		Q, V	EUE2-PF0W-2310	1186.87	
					2 Power Receptacles, 4 USB Charging	Q, V	EUE2-PF0W-2400	1249.89		
					3 Power Receptacles, 1 Data Port, 1 Cable Bay	Q, V	EUE2-PF0W-3012	997.81		
					3 Power Receptacles, 3 Data Ports	Q, V	EUE2-PF0W-3030	997.81		
3 Power Receptacles, 1 USB Charging, 1 Cable Bay	Q, V	EUE2-PF0W-3102	1060.83							
3 Power Receptacles, 1 USB Charging, 2 Data Ports	Q, V	EUE2-PF0W-3120	1060.83							
3 Power Receptacles, 2 USB Charging, 1 Data Port	Q, V	EUE2-PF0W-3210	1123.85							
3 Power Receptacles, 3 USB Charging	Q, V	EUE2-PF0W-3300	1186.87							
4 Power Receptacles, 1 Cable Bay	Q, V	EUE2-PF0W-4002	997.81							
4 Power Receptacles, 2 Data Ports	Q, V	EUE2-PF0W-4020	997.81							
4 Power Receptacles, 1 USB Charging, 1 Data Port	Q, V	EUE2-PF0W-4110	1060.83							
4 Power Receptacles, 2 USB Charging	Q, V	EUE2-PF0W-4200	1123.85							
5 Power Receptacles, 1 Data Port	Q, V	EUE2-PF0W-5010	997.81							
5 Power Receptacles, 1 USB Charging	Q, V	EUE2-PF0W-5100	1060.83							
6 Power Receptacles	Q, V	EUE2-PF0W-6000	997.81							

Electrical Components

Flip Top Unit — Corded — Double-Sided

Width	Bezel Depth	Cord Length	Trim Color	Port Color	Port	Configuration	Flip Top Unit Cutout Code Options	Number	Price
5 5/16" (135mm)	4 3/8" (111mm)	12' (3658mm)	Black Anodized	Black	4	1 Power Receptacle, 1 Data Port, 1 Cable Bay	M, P	EUE2-PL0B-1012	\$1219.72
						1 Power Receptacle, 3 Data Ports	M, P	EUE2-PL0B-1030	1219.72
						1 Power Receptacle, 1 USB Charging, 1 Cable Bay	M, P	EUE2-PL0B-1102	1282.74
						1 Power Receptacle, 1 USB Charging, 2 Data Ports	M, P	EUE2-PL0B-1120	1282.74
						1 Power Receptacle, 3 USB Charging	M, P	EUE2-PL0B-1300	1408.78
						2 Power Receptacles, 1 Cable Bay	M, P	EUE2-PL0B-2002	1219.72
						2 Power Receptacles, 2 Data Ports	M, P	EUE2-PL0B-2020	1219.72
						2 Power Receptacles, 1 USB Charging, 1 Data Port	M, P	EUE2-PL0B-2110	1282.74
						2 Power Receptacles, 2 USB Charging	M, P	EUE2-PL0B-2200	1345.76
						3 Power Receptacles, 1 Data Port	M, P	EUE2-PL0B-3010	1219.72
						3 Power Receptacles, 1 USB Charging	M, P	EUE2-PL0B-3100	1282.74
						4 Power Receptacles	M, P	EUE2-PL0B-4000	1219.72
					6	1 Power Receptacle, 3 Data Ports, 1 Cable Bay	Q, V	EUE2-PL0B-1032	\$1219.72
						1 Power Receptacle, 5 Data Ports	Q, V	EUE2-PL0B-1050	1219.72
						1 Power Receptacle, 1 USB Charging, 2 Data Ports, 1 Cable Bay	Q, V	EUE2-PL0B-1122	1282.74
						1 Power Receptacle, 1 USB Charging, 4 Data Ports	Q, V	EUE2-PL0B-1140	1282.74
						1 Power Receptacle, 2 USB Charging, 1 Data Port, 1 Cable Bay	Q, V	EUE2-PL0B-1212	1345.76
						1 Power Receptacle, 2 USB Charging, 3 Data Ports	Q, V	EUE2-PL0B-1230	1345.76
						1 Power Receptacle, 3 USB Charging, 1 Cable Bay	Q, V	EUE2-PL0B-1302	1408.78
						1 Power Receptacle, 3 USB Charging, 2 Data Ports	Q, V	EUE2-PL0B-1320	1408.78
						2 Power Receptacles, 2 Data Ports, 1 Cable Bay	Q, V	EUE2-PL0B-2022	1219.72
						2 Power Receptacles, 4 Data Ports	Q, V	EUE2-PL0B-2040	1219.72
						2 Power Receptacles, 1 USB Charging, 1 Data Port, 1 Cable Bay	Q, V	EUE2-PL0B-2112	1282.74
						2 Power Receptacles, 1 USB Charging, 3 Data Ports	Q, V	EUE2-PL0B-2130	1282.74
						2 Power Receptacles, 2 USB Charging, 1 Cable Bay	Q, V	EUE2-PL0B-2202	1345.76
						2 Power Receptacles, 2 USB Charging, 2 Data Ports	Q, V	EUE2-PL0B-2220	1345.76
						2 Power Receptacles, 3 USB Charging, 1 Data Port	Q, V	EUE2-PL0B-2310	1408.78
						2 Power Receptacles, 4 USB Charging	Q, V	EUE2-PL0B-2400	1471.80
						3 Power Receptacles, 1 Data Port, 1 Cable Bay	Q, V	EUE2-PL0B-3012	1219.72
						3 Power Receptacles, 3 Data Ports	Q, V	EUE2-PL0B-3030	1219.72
						3 Power Receptacles, 1 USB Charging, 1 Cable Bay	Q, V	EUE2-PL0B-3102	1282.74
						3 Power Receptacles, 1 USB Charging, 2 Data Ports	Q, V	EUE2-PL0B-3120	1282.74
						3 Power Receptacles, 2 USB Charging, 1 Data Port	Q, V	EUE2-PL0B-3210	1345.76
						3 Power Receptacles, 3 USB Charging	Q, V	EUE2-PL0B-3300	1408.78
						4 Power Receptacles, 1 Cable Bay	Q, V	EUE2-PL0B-4002	1219.72
						4 Power Receptacles, 2 Data Ports	Q, V	EUE2-PL0B-4020	1219.72
						4 Power Receptacles, 1 USB Charging, 1 Data Port	Q, V	EUE2-PL0B-4110	1282.74
						4 Power Receptacles, 2 USB Charging	Q, V	EUE2-PL0B-4200	1345.76
						5 Power Receptacles, 1 Data Port	Q, V	EUE2-PL0B-5010	1219.72
						5 Power Receptacles, 1 USB Charging	Q, V	EUE2-PL0B-5100	1282.74
						6 Power Receptacles	Q, V	EUE2-PL0B-6000	1219.72

Electrical Components

Flip Top Unit — Corded — Double-Sided

Width	Bezel Depth	Cord Length	Trim Color	Port Color	Port	Configuration	Flip Top Unit Cutout Code Options	Number	Price	
5 5/16" (135mm)	4 3/8" (111mm)	12' (3658mm)	Clear Anodized	White	4	1 Power Receptacle, 1 Data Port, 1 Cable Bay	M, P	EUE2-PL0W-1012	\$1049.30	
						1 Power Receptacle, 3 Data Ports	M, P	EUE2-PL0W-1030	1049.30	
						1 Power Receptacle, 1 USB Charging, 1 Cable Bay	M, P	EUE2-PL0W-1102	1112.32	
						1 Power Receptacle, 1 USB Charging, 2 Data Ports	M, P	EUE2-PL0W-1120	1112.32	
						1 Power Receptacle, 3 USB Charging	M, P	EUE2-PL0W-1300	1238.36	
						2 Power Receptacles, 1 Cable Bay	M, P	EUE2-PL0W-2002	1049.30	
						2 Power Receptacles, 2 Data Ports	M, P	EUE2-PL0W-2020	1049.30	
						2 Power Receptacles, 1 USB Charging, 1 Data Port	M, P	EUE2-PL0W-2110	1112.32	
						2 Power Receptacles, 2 USB Charging	M, P	EUE2-PL0W-2200	1175.34	
						3 Power Receptacles, 1 Data Port	M, P	EUE2-PL0W-3010	1049.30	
						3 Power Receptacles, 1 USB Charging	M, P	EUE2-PL0W-3100	1112.32	
						4 Power Receptacles	M, P	EUE2-PL0W-4000	1049.30	
						6	1 Power Receptacle, 3 Data Ports, 1 Cable Bay	Q, V	EUE2-PL0W-1032	\$1049.30
							1 Power Receptacle, 5 Data Ports	Q, V	EUE2-PL0W-1050	1049.30
							1 Power Receptacle, 1 USB Charging, 2 Data Ports, 1 Cable Bay	Q, V	EUE2-PL0W-1122	1112.32
					1 Power Receptacle, 1 USB Charging, 4 Data Ports		Q, V	EUE2-PL0W-1140	1112.32	
					1 Power Receptacle, 2 USB Charging, 1 Data Port, 1 Cable Bay		Q, V	EUE2-PL0W-1212	1175.34	
					1 Power Receptacle, 2 USB Charging, 3 Data Ports		Q, V	EUE2-PL0W-1230	1175.34	
					1 Power Receptacle, 3 USB Charging, 1 Cable Bay		Q, V	EUE2-PL0W-1302	1238.36	
					1 Power Receptacle, 3 USB Charging, 2 Data Ports		Q, V	EUE2-PL0W-1320	1238.36	
					2 Power Receptacles, 2 Data Ports, 1 Cable Bay		Q, V	EUE2-PL0W-2022	1049.30	
					2 Power Receptacles, 4 Data Ports		Q, V	EUE2-PL0W-2040	1049.30	
					2 Power Receptacles, 1 USB Charging, 1 Data Port, 1 Cable Bay		Q, V	EUE2-PL0W-2112	1112.32	
					2 Power Receptacles, 1 USB Charging, 3 Data Ports		Q, V	EUE2-PL0W-2130	1112.32	
					2 Power Receptacles, 2 USB Charging, 1 Cable Bay		Q, V	EUE2-PL0W-2202	1175.34	
					2 Power Receptacles, 2 USB Charging, 2 Data Ports		Q, V	EUE2-PL0W-2220	1175.34	
					2 Power Receptacles, 3 USB Charging, 1 Data Port		Q, V	EUE2-PL0W-2310	1238.36	
					2 Power Receptacles, 4 USB Charging	Q, V	EUE2-PL0W-2400	1301.38		
					3 Power Receptacles, 1 Data Port, 1 Cable Bay	Q, V	EUE2-PL0W-3012	1049.30		
					3 Power Receptacles, 3 Data Ports	Q, V	EUE2-PL0W-3030	1049.30		
3 Power Receptacles, 1 USB Charging, 1 Cable Bay	Q, V	EUE2-PL0W-3102	1112.32							
3 Power Receptacles, 1 USB Charging, 2 Data Ports	Q, V	EUE2-PL0W-3120	1112.32							
3 Power Receptacles, 2 USB Charging, 1 Data Port	Q, V	EUE2-PL0W-3210	1175.34							
3 Power Receptacles, 3 USB Charging	Q, V	EUE2-PL0W-3300	1238.36							
4 Power Receptacles, 1 Cable Bay	Q, V	EUE2-PL0W-4002	1049.30							
4 Power Receptacles, 2 Data Ports	Q, V	EUE2-PL0W-4020	1049.30							
4 Power Receptacles, 1 USB Charging, 1 Data Port	Q, V	EUE2-PL0W-4110	1112.32							
4 Power Receptacles, 2 USB Charging	Q, V	EUE2-PL0W-4200	1175.34							
5 Power Receptacles, 1 Data Port	Q, V	EUE2-PL0W-5010	1049.30							
5 Power Receptacles, 1 USB Charging	Q, V	EUE2-PL0W-5100	1112.32							
6 Power Receptacles	Q, V	EUE2-PL0W-6000	1049.30							

This page intentionally blank

Electrical Components

Flip Top Unit — Hardwire — Single-Sided

Power, Data and USB

4-Port:

- (2) Power
- (1) USB
- (1) Data

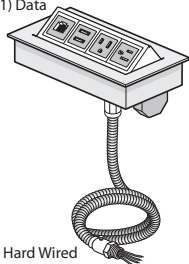

Hard Wired

EUE1-HF0B-2110

6-Port:

- (2) Power
- (1) USB
- (1) Data
- (1) Cable Bay

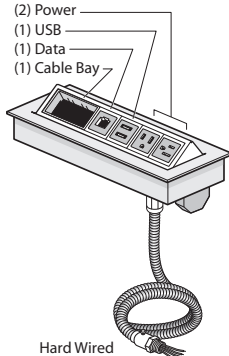

Hard Wired

EUE1-HF0B-1212



Features

- Includes bezel and flip top module with 2, 4 or 6 ports that can be configured with simplex outlets (NEMA-5-15R), USB charging port (with two USB outlets), data ports or cable bay(s) that can accept up to 2 pull out data/AV cables and mounting hardware.
- Data port accommodate most varieties of field supplied data/AV jacks.
- Hardwired power module with 6'(1829mm) or 12'(3658mm) long flexible metal conduit feed, 1/2"(13mm) conduit fitting and wires for hardwire connection.
- USB Charging Port consists of two USB 2.0 style A outlets. 4 Amp (shared) charging capacity.
- Flip top unit is flush mounted with spring release flip module(s).
- Flip top unit overall height is 2 3/4"(70mm) and will extend below the table tops.
- Color option of black anodized housing with black receptacles or clear anodized housing with white receptacles.

Specification Tips

- **Configuration and quantity of power and data ports cannot be modified in the field.**
- **For use with 120 volt 60 hertz power source only.**
- Requires field installation.
- Specify factory cut hole or field cut hole as required.
- Specify AV cables separately.
- Cable Bay requires cables less than 0.3"(7.6mm) diameter.
- Application may require approval of local authority having jurisdiction (AHJ); ensure compliance before placing orders and installation.

To Order, Specify:

- 1) Product number.
(No finish specification required.)

Note: Order flip top units to match flip top unit cutout option specified for each top (A/B, F/V or J/K).

Electrical Components

Flip Top Unit — Hardwire — Single-Sided

Width	Bezel Depth	Cord Length	Trim Color	Port Color	Port	Configuration	Flip Top Unit Cutout Code Options	Number	Price
5 5/16" (135mm)	4 3/8" (111mm)	6' (1829mm)	Black Anodized	Black	2	1 Power Receptacle, 1 Data Port	A, B	EUE1-HFOB-1010	\$741.11
						1 Power Receptacle, 1 USB Charging	A, B	EUE1-HFOB-1100	804.13
						2 Power Receptacles	A, B	EUE1-HFOB-2000	741.11
					4	1 Power Receptacle, 1 Data Port, 1 Cable Bay	F, V	EUE1-HFOB-1012	\$741.11
						1 Power Receptacle, 3 Data Ports	F, V	EUE1-HFOB-1030	741.11
						1 Power Receptacle, 1 USB Charging, 1 Cable Bay	F, V	EUE1-HFOB-1102	804.13
						1 Power Receptacle, 1 USB Charging, 2 Data Ports	F, V	EUE1-HFOB-1120	804.13
						1 Power Receptacle, 3 USB Charging	F, V	EUE1-HFOB-1300	930.17
						2 Power Receptacles, 1 Cable Bay	F, V	EUE1-HFOB-2002	741.11
						2 Power Receptacles, 2 Data Ports	F, V	EUE1-HFOB-2020	741.11
						2 Power Receptacles, 1 USB Charging, 1 Data Port	F, V	EUE1-HFOB-2110	804.13
						2 Power Receptacles, 2 USB Charging	F, V	EUE1-HFOB-2200	867.15
						3 Power Receptacles, 1 Data Port	F, V	EUE1-HFOB-3010	741.11
						3 Power Receptacles, 1 USB Charging	F, V	EUE1-HFOB-3100	804.13
						4 Power Receptacles	F, V	EUE1-HFOB-4000	741.11
					6	1 Power Receptacle, 3 Data Ports, 1 Cable Bay	J, K	EUE1-HFOB-1032	\$741.11
						1 Power Receptacle, 5 Data Ports	J, K	EUE1-HFOB-1050	741.11
						1 Power Receptacle, 1 USB Charging, 2 Data Ports, 1 Cable Bay	J, K	EUE1-HFOB-1122	804.13
						1 Power Receptacle, 1 USB Charging, 4 Data Ports	J, K	EUE1-HFOB-1140	804.13
						1 Power Receptacle, 2 USB Charging, 1 Data Port, 1 Cable Bay	J, K	EUE1-HFOB-1212	867.15
						1 Power Receptacle, 2 USB Charging, 3 Data Ports	J, K	EUE1-HFOB-1230	867.15
						1 Power Receptacle, 3 USB Charging, 1 Cable Bay	J, K	EUE1-HFOB-1302	930.17
						1 Power Receptacle, 3 USB Charging, 2 Data Ports	J, K	EUE1-HFOB-1320	930.17
						2 Power Receptacles, 2 Data Ports, 1 Cable Bay	J, K	EUE1-HFOB-2022	741.11
						2 Power Receptacles, 4 Data Ports	J, K	EUE1-HFOB-2040	741.11
						2 Power Receptacles, 1 USB Charging, 1 Data Port, 1 Cable Bay	J, K	EUE1-HFOB-2112	804.13
						2 Power Receptacles, 1 USB Charging, 3 Data Ports	J, K	EUE1-HFOB-2130	804.13
						2 Power Receptacles, 2 USB Charging, 1 Cable Bay	J, K	EUE1-HFOB-2202	867.15
						2 Power Receptacles, 2 USB Charging, 2 Data Ports	J, K	EUE1-HFOB-2220	867.15
						2 Power Receptacles, 3 USB Charging, 1 Data Port	J, K	EUE1-HFOB-2310	930.17
						2 Power Receptacles, 4 USB Charging	J, K	EUE1-HFOB-2400	993.19
						3 Power Receptacles, 1 Data Port, 1 Cable Bay	J, K	EUE1-HFOB-3012	741.11
						3 Power Receptacles, 3 Data Ports	J, K	EUE1-HFOB-3030	741.11
						3 Power Receptacles, 1 USB Charging, 1 Cable Bay	J, K	EUE1-HFOB-3102	804.13
						3 Power Receptacles, 1 USB Charging, 2 Data Ports	J, K	EUE1-HFOB-3120	804.13
						3 Power Receptacles, 2 USB Charging, 1 Data Port	J, K	EUE1-HFOB-3210	867.15
						3 Power Receptacles, 3 USB Charging	J, K	EUE1-HFOB-3300	930.17
						4 Power Receptacles, 1 Cable Bay	J, K	EUE1-HFOB-4002	741.11
						4 Power Receptacles, 2 Data Ports	J, K	EUE1-HFOB-4020	741.11
						4 Power Receptacles, 1 USB Charging, 1 Data Port	J, K	EUE1-HFOB-4110	804.13
						4 Power Receptacles, 2 USB Charging	J, K	EUE1-HFOB-4200	867.15
						5 Power Receptacles, 1 Data Port	J, K	EUE1-HFOB-5010	741.11
						5 Power Receptacles, 1 USB Charging	J, K	EUE1-HFOB-5100	804.13
						6 Power Receptacles	J, K	EUE1-HFOB-6000	741.11

Electrical Components

Flip Top Unit — Hardwire — Single-Sided

Width	Bezel Depth	Cord Length	Trim Color	Port Color	Port	Configuration	Flip Top Unit Cutout Code Options	Number	Price
5 5/16" (135mm)	4 3/8" (111mm)	6' (1829mm)	Clear Anodized	White	2	1 Power Receptacle, 1 Data Port	A, B	EUE1-HFOW-1010	\$570.69
						1 Power Receptacle, 1 USB Charging	A, B	EUE1-HFOW-1100	633.71
						2 Power Receptacles	A, B	EUE1-HFOW-2000	570.69
					4	1 Power Receptacle, 1 Data Port, 1 Cable Bay	F, V	EUE1-HFOW-1012	\$570.69
						1 Power Receptacle, 3 Data Ports	F, V	EUE1-HFOW-1030	570.69
						1 Power Receptacle, 1 USB Charging, 1 Cable Bay	F, V	EUE1-HFOW-1102	633.71
						1 Power Receptacle, 1 USB Charging, 2 Data Ports	F, V	EUE1-HFOW-1120	633.71
						1 Power Receptacle, 3 USB Charging	F, V	EUE1-HFOW-1300	759.75
						2 Power Receptacles, 1 Cable Bay	F, V	EUE1-HFOW-2002	570.69
						2 Power Receptacles, 2 Data Ports	F, V	EUE1-HFOW-2020	570.69
						2 Power Receptacles, 1 USB Charging, 1 Data Port	F, V	EUE1-HFOW-2110	633.71
						2 Power Receptacles, 2 USB Charging	F, V	EUE1-HFOW-2200	696.73
						3 Power Receptacles, 1 Data Port	F, V	EUE1-HFOW-3010	570.69
						3 Power Receptacles, 1 USB Charging	F, V	EUE1-HFOW-3100	633.71
						4 Power Receptacles	F, V	EUE1-HFOW-4000	570.69
					6	1 Power Receptacle, 3 Data Ports, 1 Cable Bay	J, K	EUE1-HFOW-1032	\$570.69
						1 Power Receptacle, 5 Data Ports	J, K	EUE1-HFOW-1050	570.69
						1 Power Receptacle, 1 USB Charging, 2 Data Ports, 1 Cable Bay	J, K	EUE1-HFOW-1122	633.71
						1 Power Receptacle, 1 USB Charging, 4 Data Ports	J, K	EUE1-HFOW-1140	633.71
						1 Power Receptacle, 2 USB Charging, 1 Data Port, 1 Cable Bay	J, K	EUE1-HFOW-1212	696.73
						1 Power Receptacle, 2 USB Charging, 3 Data Ports	J, K	EUE1-HFOW-1230	696.73
						1 Power Receptacle, 3 USB Charging, 1 Cable Bay	J, K	EUE1-HFOW-1302	759.75
						1 Power Receptacle, 3 USB Charging, 2 Data Ports	J, K	EUE1-HFOW-1320	759.75
						2 Power Receptacles, 2 Data Ports, 1 Cable Bay	J, K	EUE1-HFOW-2022	570.69
						2 Power Receptacles, 4 Data Ports	J, K	EUE1-HFOW-2040	570.69
						2 Power Receptacles, 1 USB Charging, 1 Data Port, 1 Cable Bay	J, K	EUE1-HFOW-2112	633.71
						2 Power Receptacles, 1 USB Charging, 3 Data Ports	J, K	EUE1-HFOW-2130	633.71
						2 Power Receptacles, 2 USB Charging, 1 Cable Bay	J, K	EUE1-HFOW-2202	696.73
						2 Power Receptacles, 2 USB Charging, 2 Data Ports	J, K	EUE1-HFOW-2220	696.73
						2 Power Receptacles, 3 USB Charging, 1 Data Port	J, K	EUE1-HFOW-2310	759.75
						2 Power Receptacles, 4 USB Charging	J, K	EUE1-HFOW-2400	822.77
						3 Power Receptacles, 1 Data Port, 1 Cable Bay	J, K	EUE1-HFOW-3012	570.69
						3 Power Receptacles, 3 Data Ports	J, K	EUE1-HFOW-3030	570.69
						3 Power Receptacles, 1 USB Charging, 1 Cable Bay	J, K	EUE1-HFOW-3102	633.71
						3 Power Receptacles, 1 USB Charging, 2 Data Ports	J, K	EUE1-HFOW-3120	633.71
						3 Power Receptacles, 2 USB Charging, 1 Data Port	J, K	EUE1-HFOW-3210	696.73
						3 Power Receptacles, 3 USB Charging	J, K	EUE1-HFOW-3300	759.75
						4 Power Receptacles, 1 Cable Bay	J, K	EUE1-HFOW-4002	570.69
						4 Power Receptacles, 2 Data Ports	J, K	EUE1-HFOW-4020	570.69
						4 Power Receptacles, 1 USB Charging, 1 Data Port	J, K	EUE1-HFOW-4110	633.71
						4 Power Receptacles, 2 USB Charging	J, K	EUE1-HFOW-4200	696.73
						5 Power Receptacles, 1 Data Port	J, K	EUE1-HFOW-5010	570.69
						5 Power Receptacles, 1 USB Charging	J, K	EUE1-HFOW-5100	633.71
						6 Power Receptacles	J, K	EUE1-HFOW-6000	570.69

Electrical Components

Flip Top Unit — Hardwire — Single-Sided

Width	Bezel Depth	Cord Length	Trim Color	Port Color	Port	Configuration	Flip Top Unit Cutout Code Options	Number	Price		
5 5/16" (135mm)	4 3/8" (111mm)	12' (3658mm)	Black Anodized	Black	2	1 Power Receptacle, 1 Data Port	A, B	EUE1-HLOB-1010	\$ 792.60		
						1 Power Receptacle, 1 USB Charging	A, B	EUE1-HLOB-1100	855.62		
						2 Power Receptacles	A, B	EUE1-HLOB-2000	792.60		
						4	1 Power Receptacle, 1 Data Port, 1 Cable Bay	F, V	EUE1-HLOB-1012	\$ 792.60	
							1 Power Receptacle, 3 Data Ports	F, V	EUE1-HLOB-1030	792.60	
							1 Power Receptacle, 1 USB Charging, 1 Cable Bay	F, V	EUE1-HLOB-1102	855.62	
							1 Power Receptacle, 1 USB Charging, 2 Data Ports	F, V	EUE1-HLOB-1120	855.62	
							1 Power Receptacle, 3 USB Charging	F, V	EUE1-HLOB-1300	981.66	
							2 Power Receptacles, 1 Cable Bay	F, V	EUE1-HLOB-2002	792.60	
							2 Power Receptacles, 2 Data Ports	F, V	EUE1-HLOB-2020	792.60	
							2 Power Receptacles, 1 USB Charging, 1 Data Port	F, V	EUE1-HLOB-2110	855.62	
							2 Power Receptacles, 2 USB Charging	F, V	EUE1-HLOB-2200	918.64	
							3 Power Receptacles, 1 Data Port	F, V	EUE1-HLOB-3010	792.60	
							3 Power Receptacles, 1 USB Charging	F, V	EUE1-HLOB-3100	855.62	
							4 Power Receptacles	F, V	EUE1-HLOB-4000	792.60	
							6	1 Power Receptacle, 3 Data Ports, 1 Cable Bay	J, K	EUE1-HLOB-1032	\$ 792.60
								1 Power Receptacle, 5 Data Ports	J, K	EUE1-HLOB-1050	792.60
								1 Power Receptacle, 1 USB Charging, 2 Data Ports, 1 Cable Bay	J, K	EUE1-HLOB-1122	855.62
								1 Power Receptacle, 1 USB Charging, 4 Data Ports	J, K	EUE1-HLOB-1140	855.62
								1 Power Receptacle, 2 USB Charging, 1 Data Port, 1 Cable Bay	J, K	EUE1-HLOB-1212	918.64
								1 Power Receptacle, 2 USB Charging, 3 Data Ports	J, K	EUE1-HLOB-1230	918.64
						1 Power Receptacle, 3 USB Charging, 1 Cable Bay		J, K	EUE1-HLOB-1302	981.66	
						1 Power Receptacle, 3 USB Charging, 2 Data Ports		J, K	EUE1-HLOB-1320	981.66	
						2 Power Receptacles, 2 Data Ports, 1 Cable Bay		J, K	EUE1-HLOB-2022	792.60	
						2 Power Receptacles, 4 Data Ports		J, K	EUE1-HLOB-2040	792.60	
						2 Power Receptacles, 1 USB Charging, 1 Data Port, 1 Cable Bay		J, K	EUE1-HLOB-2112	855.62	
						2 Power Receptacles, 1 USB Charging, 3 Data Ports		J, K	EUE1-HLOB-2130	855.62	
						2 Power Receptacles, 2 USB Charging, 1 Cable Bay	J, K	EUE1-HLOB-2202	918.64		
						2 Power Receptacles, 2 USB Charging, 2 Data Ports	J, K	EUE1-HLOB-2220	918.64		
						2 Power Receptacles, 3 USB Charging, 1 Data Port	J, K	EUE1-HLOB-2310	981.66		
2 Power Receptacles, 4 USB Charging	J, K	EUE1-HLOB-2400	1044.68								
3 Power Receptacles, 1 Data Port, 1 Cable Bay	J, K	EUE1-HLOB-3012	792.60								
3 Power Receptacles, 3 Data Ports	J, K	EUE1-HLOB-3030	792.60								
3 Power Receptacles, 1 USB Charging, 1 Cable Bay	J, K	EUE1-HLOB-3102	855.62								
3 Power Receptacles, 1 USB Charging, 2 Data Ports	J, K	EUE1-HLOB-3120	855.62								
3 Power Receptacles, 2 USB Charging, 1 Data Port	J, K	EUE1-HLOB-3210	918.64								
3 Power Receptacles, 3 USB Charging	J, K	EUE1-HLOB-3300	981.66								
4 Power Receptacles, 1 Cable Bay	J, K	EUE1-HLOB-4002	792.60								
4 Power Receptacles, 2 Data Ports	J, K	EUE1-HLOB-4020	792.60								
4 Power Receptacles, 1 USB Charging, 1 Data Port	J, K	EUE1-HLOB-4110	855.62								
4 Power Receptacles, 2 USB Charging	J, K	EUE1-HLOB-4200	918.64								
5 Power Receptacles, 1 Data Port	J, K	EUE1-HLOB-5010	792.60								
5 Power Receptacles, 1 USB Charging	J, K	EUE1-HLOB-5100	855.62								
6 Power Receptacles	J, K	EUE1-HLOB-6000	792.60								

Electrical Components

Flip Top Unit — Hardwire — Single-Sided

Width	Bezel Depth	Cord Length	Trim Color	Port Color	Port	Configuration	Flip Top Unit Cutout Code Options	Number	Price						
5 5/16" (135mm)	4 3/8" (111mm)	6' (1829mm)	Clear Anodized	White	2	1 Power Receptacle, 1 Data Port	A, B	EUE1-HLOW-1010	\$622.18						
						1 Power Receptacle, 1 USB Charging	A, B	EUE1-HLOW-1100	685.20						
						2 Power Receptacles	A, B	EUE1-HLOW-2000	622.18						
4						1 Power Receptacle, 1 Data Port, 1 Cable Bay	F, V	EUE1-HLOW-1012	\$622.18						
						1 Power Receptacle, 3 Data Ports	F, V	EUE1-HLOW-1030	622.18						
						1 Power Receptacle, 1 USB Charging, 1 Cable Bay	F, V	EUE1-HLOW-1102	685.20						
						1 Power Receptacle, 1 USB Charging, 2 Data Ports	F, V	EUE1-HLOW-1120	685.20						
						1 Power Receptacle, 3 USB Charging	F, V	EUE1-HLOW-1300	811.24						
						2 Power Receptacles, 1 Cable Bay	F, V	EUE1-HLOW-2002	622.18						
						2 Power Receptacles, 2 Data Ports	F, V	EUE1-HLOW-2020	622.18						
						2 Power Receptacles, 1 USB Charging, 1 Data Port	F, V	EUE1-HLOW-2110	685.20						
						2 Power Receptacles, 2 USB Charging	F, V	EUE1-HLOW-2200	748.22						
						3 Power Receptacles, 1 Data Port	F, V	EUE1-HLOW-3010	622.18						
						3 Power Receptacles, 1 USB Charging	F, V	EUE1-HLOW-3100	685.20						
						4 Power Receptacles	F, V	EUE1-HLOW-4000	622.18						
						6						1 Power Receptacle, 3 Data Ports, 1 Cable Bay	J, K	EUE1-HLOW-1032	\$622.18
												1 Power Receptacle, 5 Data Ports	J, K	EUE1-HLOW-1050	622.18
												1 Power Receptacle, 1 USB Charging, 2 Data Ports, 1 Cable Bay	J, K	EUE1-HLOW-1122	685.20
												1 Power Receptacle, 1 USB Charging, 4 Data Ports	J, K	EUE1-HLOW-1140	685.20
												1 Power Receptacle, 2 USB Charging, 1 Data Port, 1 Cable Bay	J, K	EUE1-HLOW-1212	748.22
												1 Power Receptacle, 2 USB Charging, 3 Data Ports	J, K	EUE1-HLOW-1230	748.22
												1 Power Receptacle, 3 USB Charging, 1 Cable Bay	J, K	EUE1-HLOW-1302	811.24
												1 Power Receptacle, 3 USB Charging, 2 Data Ports	J, K	EUE1-HLOW-1320	811.24
												2 Power Receptacles, 2 Data Ports, 1 Cable Bay	J, K	EUE1-HLOW-2022	622.18
												2 Power Receptacles, 4 Data Ports	J, K	EUE1-HLOW-2040	622.18
												2 Power Receptacles, 1 USB Charging, 1 Data Port, 1 Cable Bay	J, K	EUE1-HLOW-2112	685.20
												2 Power Receptacles, 1 USB Charging, 3 Data Ports	J, K	EUE1-HLOW-2130	685.20
												2 Power Receptacles, 2 USB Charging, 1 Cable Bay	J, K	EUE1-HLOW-2202	748.22
												2 Power Receptacles, 2 USB Charging, 2 Data Ports	J, K	EUE1-HLOW-2220	748.22
												2 Power Receptacles, 3 USB Charging, 1 Data Port	J, K	EUE1-HLOW-2310	811.24
2 Power Receptacles, 4 USB Charging	J, K	EUE1-HLOW-2400	874.26												
3 Power Receptacles, 1 Data Port, 1 Cable Bay	J, K	EUE1-HLOW-3012	622.18												
3 Power Receptacles, 3 Data Ports	J, K	EUE1-HLOW-3030	622.18												
3 Power Receptacles, 1 USB Charging, 1 Cable Bay	J, K	EUE1-HLOW-3102	685.20												
3 Power Receptacles, 1 USB Charging, 2 Data Ports	J, K	EUE1-HLOW-3120	685.20												
3 Power Receptacles, 2 USB Charging, 1 Data Port	J, K	EUE1-HLOW-3210	748.22												
3 Power Receptacles, 3 USB Charging	J, K	EUE1-HLOW-3300	811.24												
4 Power Receptacles, 1 Cable Bay	J, K	EUE1-HLOW-4002	622.18												
4 Power Receptacles, 2 Data Ports	J, K	EUE1-HLOW-4020	622.18												
4 Power Receptacles, 1 USB Charging, 1 Data Port	J, K	EUE1-HLOW-4110	685.20												
4 Power Receptacles, 2 USB Charging	J, K	EUE1-HLOW-4200	748.22												
5 Power Receptacles, 1 Data Port	J, K	EUE1-HLOW-5010	622.18												
5 Power Receptacles, 1 USB Charging	J, K	EUE1-HLOW-5100	685.20												
6 Power Receptacles	J, K	EUE1-HLOW-6000	622.18												

This page intentionally blank

Electrical Components

Flip Top Unit — Hardwire — Double-Sided

Power, Data and USB

4-Port:

- (2) Power
- (1) USB
- (1) Data

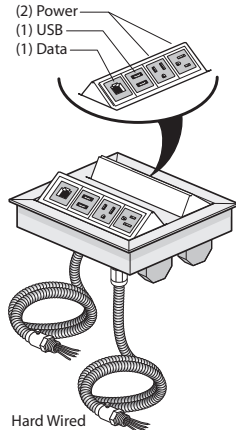

Hard Wired

EUE2-HF0B-2110

6-Port:

- (2) Power
- (1) USB
- (1) Data
- (1) Cable Bay

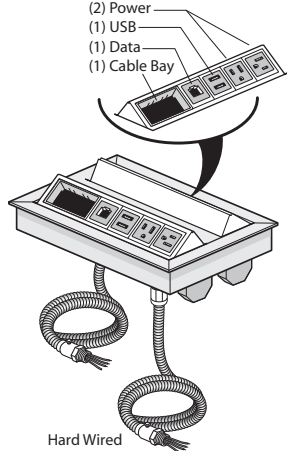

Hard Wired

EUE2-HF0B-1212



Features

- Includes bezel and two flip top modules, each with 2, 4 or 6 ports that can be configured with simplex outlets (NEMA-5-15R), USB charging port (with two USB outlets), data ports or cable bay(s) that can accept up to 2 pull out data/AV cables and mounting hardware.
- Data port accommodate most varieties of field supplied data/AV jacks.
- Each flip top module within the bezel provided with 6'(1829mm) or 12'(3658mm) long flexible metal conduit feed, 1/2"(13mm) conduit fitting and wires for hardwire connection.
- USB Charging Port consists of two USB 2.0 style A outlets. 4 Amp (shared) charging capacity.
- Flip top frame is flush mounted with two spring release flip module(s).
- Flip top unit overall height is 2 3/4"(70mm) and will extend below the table tops.
- Color option of black anodized housing with black receptacles or clear anodized housing with white receptacles.
- Ships assembled.

Specification Tips

- **Configuration and quantity of power and data ports cannot be modified in the field.**
- **For use with 120 volt 60 hertz power source only.**
- Note two conduit feeds are provided from the double-sided flip top unit.
- Requires field installation.
- Specify factory cut hole or field cut hole as required.
- Specify AV cables separately.
- Cable Bay requires cables less than 0.3"(7.6mm) diameter.
- Application may require approval of local authority having jurisdiction (AHJ); ensure compliance before placing orders and installation.

To Order, Specify:

- 1) Product number.
(No finish specification required.)

Note: Order flip top units to match flip top unit cutout option specified for each top (M/P or Q/V).

Electrical Components

Flip Top Unit — Hardwire — Double-Sided

Width	Bezel Depth	Cord Length	Trim Color	Port Color	Port	Configuration	Flip Top Unit Cutout Code Options	Number	Price						
5 5/16" (135mm)	4 3/8" (111mm)	6' (1829mm)	Black Anodized	Black	4	1 Power Receptacle, 1 Data Port, 1 Cable Bay	M, P	EUE2-HF0B-1012	\$1308.65						
						1 Power Receptacle, 3 Data Ports	M, P	EUE2-HF0B-1030	1308.65						
						1 Power Receptacle, 1 USB Charging, 1 Cable Bay	M, P	EUE2-HF0B-1102	1371.67						
						1 Power Receptacle, 1 USB Charging, 2 Data Ports	M, P	EUE2-HF0B-1120	1371.67						
						1 Power Receptacle, 3 USB Charging	M, P	EUE2-HF0B-1300	1497.71						
						2 Power Receptacles, 1 Cable Bay	M, P	EUE2-HF0B-2002	1308.65						
						2 Power Receptacles, 2 Data Ports	M, P	EUE2-HF0B-2020	1308.65						
						2 Power Receptacles, 1 USB Charging, 1 Data Port	M, P	EUE2-HF0B-2110	1371.67						
						2 Power Receptacles, 2 USB Charging	M, P	EUE2-HF0B-2200	1434.69						
						3 Power Receptacles, 1 Data Port	M, P	EUE2-HF0B-3010	1308.65						
						3 Power Receptacles, 1 USB Charging	M, P	EUE2-HF0B-3100	1371.67						
						4 Power Receptacles	M, P	EUE2-HF0B-4000	1308.65						
						6						1 Power Receptacle, 3 Data Ports, 1 Cable Bay	Q, V	EUE2-HF0B-1032	\$1308.65
												1 Power Receptacle, 5 Data Ports	Q, V	EUE2-HF0B-1050	1308.65
												1 Power Receptacle, 1 USB Charging, 2 Data Ports, 1 Cable Bay	Q, V	EUE2-HF0B-1122	1371.67
												1 Power Receptacle, 1 USB Charging, 4 Data Ports	Q, V	EUE2-HF0B-1140	1371.67
												1 Power Receptacle, 2 USB Charging, 1 Data Port, 1 Cable Bay	Q, V	EUE2-HF0B-1212	1434.69
												1 Power Receptacle, 2 USB Charging, 3 Data Ports	Q, V	EUE2-HF0B-1230	1434.69
												1 Power Receptacle, 3 USB Charging, 1 Cable Bay	Q, V	EUE2-HF0B-1302	1497.71
												1 Power Receptacle, 3 USB Charging, 2 Data Ports	Q, V	EUE2-HF0B-1320	1497.71
2 Power Receptacles, 2 Data Ports, 1 Cable Bay	Q, V	EUE2-HF0B-2022	1308.65												
2 Power Receptacles, 4 Data Ports	Q, V	EUE2-HF0B-2040	1308.65												
2 Power Receptacles, 1 USB Charging, 1 Data Port, 1 Cable Bay	Q, V	EUE2-HF0B-2112	1371.67												
2 Power Receptacles, 1 USB Charging, 3 Data Ports	Q, V	EUE2-HF0B-2130	1371.67												
2 Power Receptacles, 2 USB Charging, 1 Cable Bay	Q, V	EUE2-HF0B-2202	1434.69												
2 Power Receptacles, 2 USB Charging, 2 Data Ports	Q, V	EUE2-HF0B-2220	1434.69												
2 Power Receptacles, 3 USB Charging, 1 Data Port	Q, V	EUE2-HF0B-2310	1497.71												
2 Power Receptacles, 4 USB Charging	Q, V	EUE2-HF0B-2400	1560.73												
3 Power Receptacles, 1 Data Port, 1 Cable Bay	Q, V	EUE2-HF0B-3012	1308.65												
3 Power Receptacles, 3 Data Ports	Q, V	EUE2-HF0B-3030	1308.65												
3 Power Receptacles, 1 USB Charging, 1 Cable Bay	Q, V	EUE2-HF0B-3102	1371.67												
3 Power Receptacles, 1 USB Charging, 2 Data Ports	Q, V	EUE2-HF0B-3120	1371.67												
3 Power Receptacles, 2 USB Charging, 1 Data Port	Q, V	EUE2-HF0B-3210	1434.69												
3 Power Receptacles, 3 USB Charging	Q, V	EUE2-HF0B-3300	1497.71												
4 Power Receptacles, 1 Cable Bay	Q, V	EUE2-HF0B-4002	1308.65												
4 Power Receptacles, 2 Data Ports	Q, V	EUE2-HF0B-4020	1308.65												
4 Power Receptacles, 1 USB Charging, 1 Data Port	Q, V	EUE2-HF0B-4110	1371.67												
4 Power Receptacles, 2 USB Charging	Q, V	EUE2-HF0B-4200	1434.69												
5 Power Receptacles, 1 Data Port	Q, V	EUE2-HF0B-5010	1308.65												
5 Power Receptacles, 1 USB Charging	Q, V	EUE2-HF0B-5100	1371.67												
6 Power Receptacles	Q, V	EUE2-HF0B-6000	1308.65												

Electrical Components

Flip Top Unit — Hardwire — Double-Sided

Width	Bezel Depth	Cord Length	Trim Color	Port Color	Port	Configuration	Flip Top Unit Cutout Code Options	Number	Price
5 5/16" (135mm)	4 3/8" (111mm)	6' (1829mm)	Clear Anodized	White	4	1 Power Receptacle, 1 Data Port, 1 Cable Bay	M, P	EUE2-HF0W-1012	\$1138.23
						1 Power Receptacle, 3 Data Ports	M, P	EUE2-HF0W-1030	1138.23
						1 Power Receptacle, 1 USB Charging, 1 Cable Bay	M, P	EUE2-HF0W-1102	1201.25
						1 Power Receptacle, 1 USB Charging, 2 Data Ports	M, P	EUE2-HF0W-1120	1201.25
						1 Power Receptacle, 3 USB Charging	M, P	EUE2-HF0W-1300	1327.29
						2 Power Receptacles, 1 Cable Bay	M, P	EUE2-HF0W-2002	1138.23
						2 Power Receptacles, 2 Data Ports	M, P	EUE2-HF0W-2020	1138.23
						2 Power Receptacles, 1 USB Charging, 1 Data Port	M, P	EUE2-HF0W-2110	1201.25
						2 Power Receptacles, 2 USB Charging	M, P	EUE2-HF0W-2200	1264.27
						3 Power Receptacles, 1 Data Port	M, P	EUE2-HF0W-3010	1138.23
						3 Power Receptacles, 1 USB Charging	M, P	EUE2-HF0W-3100	1201.25
						4 Power Receptacles	M, P	EUE2-HF0W-4000	1138.23
					6	1 Power Receptacle, 3 Data Ports, 1 Cable Bay	Q, V	EUE2-HF0W-1032	\$1138.23
						1 Power Receptacle, 5 Data Ports	Q, V	EUE2-HF0W-1050	1138.23
						1 Power Receptacle, 1 USB Charging, 2 Data Ports, 1 Cable Bay	Q, V	EUE2-HF0W-1122	1201.25
						1 Power Receptacle, 1 USB Charging, 4 Data Ports	Q, V	EUE2-HF0W-1140	1201.25
						1 Power Receptacle, 2 USB Charging, 1 Data Port, 1 Cable Bay	Q, V	EUE2-HF0W-1212	1264.27
						1 Power Receptacle, 2 USB Charging, 3 Data Ports	Q, V	EUE2-HF0W-1230	1264.27
						1 Power Receptacle, 3 USB Charging, 1 Cable Bay	Q, V	EUE2-HF0W-1302	1327.29
						1 Power Receptacle, 3 USB Charging, 2 Data Ports	Q, V	EUE2-HF0W-1320	1327.29
						2 Power Receptacles, 2 Data Ports, 1 Cable Bay	Q, V	EUE2-HF0W-2022	1138.23
						2 Power Receptacles, 4 Data Ports	Q, V	EUE2-HF0W-2040	1138.23
						2 Power Receptacles, 1 USB Charging, 1 Data Port, 1 Cable Bay	Q, V	EUE2-HF0W-2112	1201.25
						2 Power Receptacles, 1 USB Charging, 3 Data Ports	Q, V	EUE2-HF0W-2130	1201.25
						2 Power Receptacles, 2 USB Charging, 1 Cable Bay	Q, V	EUE2-HF0W-2202	1264.27
						2 Power Receptacles, 2 USB Charging, 2 Data Ports	Q, V	EUE2-HF0W-2220	1264.27
						2 Power Receptacles, 3 USB Charging, 1 Data Port	Q, V	EUE2-HF0W-2310	1327.29
						2 Power Receptacles, 4 USB Charging	Q, V	EUE2-HF0W-2400	1390.31
3 Power Receptacles, 1 Data Port, 1 Cable Bay	Q, V	EUE2-HF0W-3012	1138.23						
3 Power Receptacles, 3 Data Ports	Q, V	EUE2-HF0W-3030	1138.23						
3 Power Receptacles, 1 USB Charging, 1 Cable Bay	Q, V	EUE2-HF0W-3102	1201.25						
3 Power Receptacles, 1 USB Charging, 2 Data Ports	Q, V	EUE2-HF0W-3120	1201.25						
3 Power Receptacles, 2 USB Charging, 1 Data Port	Q, V	EUE2-HF0W-3210	1264.27						
3 Power Receptacles, 3 USB Charging	Q, V	EUE2-HF0W-3300	1327.29						
4 Power Receptacles, 1 Cable Bay	Q, V	EUE2-HF0W-4002	1138.23						
4 Power Receptacles, 2 Data Ports	Q, V	EUE2-HF0W-4020	1138.23						
4 Power Receptacles, 1 USB Charging, 1 Data Port	Q, V	EUE2-HF0W-4110	1201.25						
4 Power Receptacles, 2 USB Charging	Q, V	EUE2-HF0W-4200	1264.27						
5 Power Receptacles, 1 Data Port	Q, V	EUE2-HF0W-5010	1138.23						
5 Power Receptacles, 1 USB Charging	Q, V	EUE2-HF0W-5100	1201.25						
6 Power Receptacles	Q, V	EUE2-HF0W-6000	1138.23						

Electrical Components

Flip Top Unit — Hardwire — Double-Sided

Width	Bezel Depth	Cord Length	Trim Color	Port Color	Port	Configuration	Flip Top Unit Cutout Code Options	Number	Price						
5 5/16" (135mm)	4 3/8" (111mm)	12' (3658mm)	Black Anodized	Black	4	1 Power Receptacle, 1 Data Port, 1 Cable Bay	M, P	EUE2-HLOB-1012	\$1360.14						
						1 Power Receptacle, 3 Data Ports	M, P	EUE2-HLOB-1030	1360.14						
						1 Power Receptacle, 1 USB Charging, 1 Cable Bay	M, P	EUE2-HLOB-1102	1423.16						
						1 Power Receptacle, 1 USB Charging, 2 Data Ports	M, P	EUE2-HLOB-1120	1423.16						
						1 Power Receptacle, 3 USB Charging	M, P	EUE2-HLOB-1300	1549.20						
						2 Power Receptacles, 1 Cable Bay	M, P	EUE2-HLOB-2002	1360.14						
						2 Power Receptacles, 2 Data Ports	M, P	EUE2-HLOB-2020	1360.14						
						2 Power Receptacles, 1 USB Charging, 1 Data Port	M, P	EUE2-HLOB-2110	1423.16						
						2 Power Receptacles, 2 USB Charging	M, P	EUE2-HLOB-2200	1486.18						
						3 Power Receptacles, 1 Data Port	M, P	EUE2-HLOB-3010	1360.14						
						3 Power Receptacles, 1 USB Charging	M, P	EUE2-HLOB-3100	1423.16						
						4 Power Receptacles	M, P	EUE2-HLOB-4000	1360.14						
						6						1 Power Receptacle, 3 Data Ports, 1 Cable Bay	Q, V	EUE2-HLOB-1032	\$1360.14
												1 Power Receptacle, 5 Data Ports	Q, V	EUE2-HLOB-1050	1360.14
												1 Power Receptacle, 1 USB Charging, 2 Data Ports, 1 Cable Bay	Q, V	EUE2-HLOB-1122	1423.16
												1 Power Receptacle, 1 USB Charging, 4 Data Ports	Q, V	EUE2-HLOB-1140	1423.16
												1 Power Receptacle, 2 USB Charging, 1 Data Port, 1 Cable Bay	Q, V	EUE2-HLOB-1212	1486.18
												1 Power Receptacle, 2 USB Charging, 3 Data Ports	Q, V	EUE2-HLOB-1230	1486.18
												1 Power Receptacle, 3 USB Charging, 1 Cable Bay	Q, V	EUE2-HLOB-1302	1549.20
												1 Power Receptacle, 3 USB Charging, 2 Data Ports	Q, V	EUE2-HLOB-1320	1549.20
2 Power Receptacles, 2 Data Ports, 1 Cable Bay	Q, V	EUE2-HLOB-2022	1360.14												
2 Power Receptacles, 4 Data Ports	Q, V	EUE2-HLOB-2040	1360.14												
2 Power Receptacles, 1 USB Charging, 1 Data Port, 1 Cable Bay	Q, V	EUE2-HLOB-2112	1423.16												
2 Power Receptacles, 1 USB Charging, 3 Data Ports	Q, V	EUE2-HLOB-2130	1423.16												
2 Power Receptacles, 2 USB Charging, 1 Cable Bay	Q, V	EUE2-HLOB-2202	1486.18												
2 Power Receptacles, 2 USB Charging, 2 Data Ports	Q, V	EUE2-HLOB-2220	1486.18												
2 Power Receptacles, 3 USB Charging, 1 Data Port	Q, V	EUE2-HLOB-2310	1549.20												
2 Power Receptacles, 4 USB Charging	Q, V	EUE2-HLOB-2400	1612.22												
3 Power Receptacles, 1 Data Port, 1 Cable Bay	Q, V	EUE2-HLOB-3012	1360.14												
3 Power Receptacles, 3 Data Ports	Q, V	EUE2-HLOB-3030	1360.14												
3 Power Receptacles, 1 USB Charging, 1 Cable Bay	Q, V	EUE2-HLOB-3102	1423.16												
3 Power Receptacles, 1 USB Charging, 2 Data Ports	Q, V	EUE2-HLOB-3120	1423.16												
3 Power Receptacles, 2 USB Charging, 1 Data Port	Q, V	EUE2-HLOB-3210	1486.18												
3 Power Receptacles, 3 USB Charging	Q, V	EUE2-HLOB-3300	1549.20												
4 Power Receptacles, 1 Cable Bay	Q, V	EUE2-HLOB-4002	1360.14												
4 Power Receptacles, 2 Data Ports	Q, V	EUE2-HLOB-4020	1360.14												
4 Power Receptacles, 1 USB Charging, 1 Data Port	Q, V	EUE2-HLOB-4110	1423.16												
4 Power Receptacles, 2 USB Charging	Q, V	EUE2-HLOB-4200	1486.18												
5 Power Receptacles, 1 Data Port	Q, V	EUE2-HLOB-5010	1360.14												
5 Power Receptacles, 1 USB Charging	Q, V	EUE2-HLOB-5100	1423.16												
6 Power Receptacles	Q, V	EUE2-HLOB-6000	1360.14												

Electrical Components

Flip Top Unit — Hardwire — Double-Sided

Width	Bezel Depth	Cord Length	Trim Color	Port Color	Port	Configuration	Flip Top Unit Cutout Code Options	Number	Price	
5 5/16" (135mm)	4 3/8" (111mm)	12' (3658mm)	Clear Anodized	White	4	1 Power Receptacle, 1 Data Port, 1 Cable Bay	M, P	EUE2-HLOW-1012	\$1189.72	
						1 Power Receptacle, 3 Data Ports	M, P	EUE2-HLOW-1030	1189.72	
						1 Power Receptacle, 1 USB Charging, 1 Cable Bay	M, P	EUE2-HLOW-1102	1252.74	
						1 Power Receptacle, 1 USB Charging, 2 Data Ports	M, P	EUE2-HLOW-1120	1252.74	
						1 Power Receptacle, 3 USB Charging	M, P	EUE2-HLOW-1300	1378.78	
						2 Power Receptacles, 1 Cable Bay	M, P	EUE2-HLOW-2002	1189.72	
						2 Power Receptacles, 2 Data Ports	M, P	EUE2-HLOW-2020	1189.72	
						2 Power Receptacles, 1 USB Charging, 1 Data Port	M, P	EUE2-HLOW-2110	1252.74	
						2 Power Receptacles, 2 USB Charging	M, P	EUE2-HLOW-2200	1315.76	
						3 Power Receptacles, 1 Data Port	M, P	EUE2-HLOW-3010	1189.72	
						3 Power Receptacles, 1 USB Charging	M, P	EUE2-HLOW-3100	1252.74	
						4 Power Receptacles	M, P	EUE2-HLOW-4000	1189.72	
						6	1 Power Receptacle, 3 Data Ports, 1 Cable Bay	Q, V	EUE2-HLOW-1032	\$1189.72
							1 Power Receptacle, 5 Data Ports	Q, V	EUE2-HLOW-1050	1189.72
							1 Power Receptacle, 1 USB Charging, 2 Data Ports, 1 Cable Bay	Q, V	EUE2-HLOW-1122	1252.74
					1 Power Receptacle, 1 USB Charging, 4 Data Ports		Q, V	EUE2-HLOW-1140	1252.74	
					1 Power Receptacle, 2 USB Charging, 1 Data Port, 1 Cable Bay		Q, V	EUE2-HLOW-1212	1315.76	
					1 Power Receptacle, 2 USB Charging, 3 Data Ports		Q, V	EUE2-HLOW-1230	1315.76	
					1 Power Receptacle, 3 USB Charging, 1 Cable Bay		Q, V	EUE2-HLOW-1302	1378.78	
					1 Power Receptacle, 3 USB Charging, 2 Data Ports		Q, V	EUE2-HLOW-1320	1378.78	
					2 Power Receptacles, 2 Data Ports, 1 Cable Bay		Q, V	EUE2-HLOW-2022	1189.72	
					2 Power Receptacles, 4 Data Ports		Q, V	EUE2-HLOW-2040	1189.72	
					2 Power Receptacles, 1 USB Charging, 1 Data Port, 1 Cable Bay		Q, V	EUE2-HLOW-2112	1252.74	
					2 Power Receptacles, 1 USB Charging, 3 Data Ports		Q, V	EUE2-HLOW-2130	1252.74	
					2 Power Receptacles, 2 USB Charging, 1 Cable Bay		Q, V	EUE2-HLOW-2202	1315.76	
					2 Power Receptacles, 2 USB Charging, 2 Data Ports		Q, V	EUE2-HLOW-2220	1315.76	
					2 Power Receptacles, 3 USB Charging, 1 Data Port		Q, V	EUE2-HLOW-2310	1378.78	
					2 Power Receptacles, 4 USB Charging	Q, V	EUE2-HLOW-2400	1441.80		
					3 Power Receptacles, 1 Data Port, 1 Cable Bay	Q, V	EUE2-HLOW-3012	1189.72		
					3 Power Receptacles, 3 Data Ports	Q, V	EUE2-HLOW-3030	1189.72		
3 Power Receptacles, 1 USB Charging, 1 Cable Bay	Q, V	EUE2-HLOW-3102	1252.74							
3 Power Receptacles, 1 USB Charging, 2 Data Ports	Q, V	EUE2-HLOW-3120	1252.74							
3 Power Receptacles, 2 USB Charging, 1 Data Port	Q, V	EUE2-HLOW-3210	1315.76							
3 Power Receptacles, 3 USB Charging	Q, V	EUE2-HLOW-3300	1378.78							
4 Power Receptacles, 1 Cable Bay	Q, V	EUE2-HLOW-4002	1189.72							
4 Power Receptacles, 2 Data Ports	Q, V	EUE2-HLOW-4020	1189.72							
4 Power Receptacles, 1 USB Charging, 1 Data Port	Q, V	EUE2-HLOW-4110	1252.74							
4 Power Receptacles, 2 USB Charging	Q, V	EUE2-HLOW-4200	1315.76							
5 Power Receptacles, 1 Data Port	Q, V	EUE2-HLOW-5010	1189.72							
5 Power Receptacles, 1 USB Charging	Q, V	EUE2-HLOW-5100	1252.74							
6 Power Receptacles	Q, V	EUE2-HLOW-6000	1189.72							

Electrical Components

Bezel Utility Module

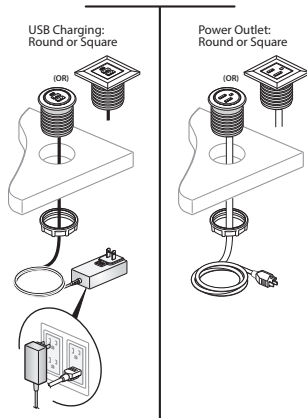

EURT-0072-1100
EURT-0072-1010



Features

- Includes: Either a round or square faced Power Module and mounting hardware.
- For use on surfaces 0.75"(19mm) - 2.0"(51mm) thick.
- Available with either:
 - One power outlet (NEMA 5-15R)
 - One two port USB charger. Consists of two USB outlets with 1000mA of charging power (5 volts) per USB outlet.
 - One data/video jack
- Available in black or supplier white only.

Specification Tips

- For use with 120 volt 60 hertz power source only.
- Power configuration has one cord with plug (NEMA 5-15P).
- USB configuration has one cord with 2"(51mm) x 1"(25mm) x 3"(76mm) voltage transformer plug. Transformer may block adjacent outlets (see illustration).
- Data jacks and AV cables field supplied.
- Data jack adapters accomodate most varities of field supplied data jacks or separately specified AV cables.
- Requires field cut 1.75"(44mm) hole and field installation.
- Application may require approval of local authority having jurisdiction (AHJ); ensure compliance before placing orders and installing.

To Order, Specify:

1) Product number, including:

1 Shape:

- S** Square
- C** Round

2 Color Options:

- B** Black
- W** White

Description	Depth	Number	1 2	Price
6' Cord				
Power	1.75"(44mm)	EURT-0072-1100	■ ■	\$ 73.53
USB		EURT-0072-1010	■ ■	220.59
12' Cord				
Power	1.75"(44mm)	EURT-00E4-1100	■ ■	\$126.05
USB		EURT-00E4-1010	■ ■	273.11

Data Bezel

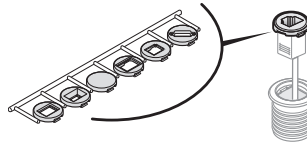

EURT-0000-N001CB
EURT-0000-N001CW

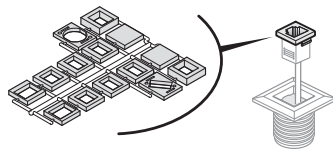

EURT-0000-N001SB
EURT-0000-N001SW

Description	Number	Price
Round		
Black	EURT-0000-N001CB	\$73.53
White	EURT-0000-N001CW	73.53
Square		
Black	EURT-0000-N001SB	\$73.53
White	EURT-0000-N001SW	73.53

Feature

- Includes one round or square bezel for the Bezel Utility Module.
- Available in black or supplier white only.

To Order, Specify:

1) Product number.
(No finish specification required.)

Electrical Components

Desktop Port

Desktop Port

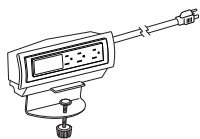

BEDP



Description	Height	Width	Number	Price
Desktop Port with 6'(1829mm) cord	3 1/2"(89mm)	9 5/8"(244mm)	BEDP-6	\$336.61
Desktop Port with 12'(3658mm) cord			BE	336.61

Features

- 6'(1829mm) or 12'(3658mm) black cord option.
- Three power outlets and one modular furniture telecommunications outlet opening [1.38"(35mm) x 2.71"(69mm)] with blank cover.
- Mounts on worktops from 3/4"(19mm) to 1 3/4"(44mm) thick.
- Not available for use in Los Angeles, Chicago or New York.
- Power can be routed from panel, floor or wall.
- Allows for off-modularity.
- Module and bracket available in graphite finish only with black cord.
- Shipped assembled.

To Order, Specify

- 1) Product number.
(None with specification required.)

Specification Tips

- **Not for power sources other than 120 volt 60 hertz.**
- Attaches to back edge of worktop with threaded knob.
- Power cord plugs into receptacle outlet or into a building outlet.
- Desktop ports cannot be linked together.
- Modular furniture telecommunications outlet must be field applied.
- For worksurfaces without wireway, install desktop port prior to attaching worksurface to panel.
- Application may require approval of local authority having jurisdiction (AHJ); ensure compliance before placing order and installation.

OBSOLETE! July 2018

Electrical Components

Power/Data Dome

	Description	Number	Price
Power/Data Dome	Two power outlets and two plates for data connection	4TWP-2	\$251.79
	Four(4) power outlets	4TWP-4	275.13

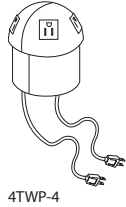
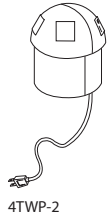

Features

- Provides power and communication access at table top height.
- Field-installed on standard-weight tops only. Mounts into a 3" diameter hole.
- Available in black finish color only.
- Power cord is 72" long.
- Cutouts for AMP connectors are .585" x .745"

To Order, Specify:

- 1) Product number.
(No finish specification required.)

Specification Tip

- Application may require approval of local authority having jurisdiction (AHJ); ensure compliance before placing orders and installation.

4TWP-2 Data Connection Cutout Sizes

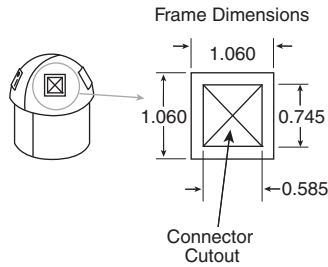

It is recommended that the cutout sizes are confirmed before ordering connectors from suppliers.

Electrical Components

Cables

	Length	Description	Color	Number	Price
Cables	HDMI Coupler				
	N/A	HDMI	Black	EUDX-H000-B	\$136.55
	N/A	HDMI	White	EUDX-H000-W	136.55
	VGA Cable				
	120"(3048mm)	VGA	Black	EUDX-V000-B	\$163.86
		VGA	White	EUDX-V000-W	163.86
	Audio Cable — 3.5mm				
	120"(3048mm)	VGA	Black	EUDX-3000-B	\$ 38.24
		VGA	White	EUDX-3000-W	38.24
	Features				
<ul style="list-style-type: none"> Includes one black HDMI Coupler, one VGA cable or one 3.5mm mini audio cable. Installs in an open data port in one of the following products: <ul style="list-style-type: none"> –Flip Top Unit –Double Sided Flip Top Unit –Quick Connect Power –Workware Interface Module –Flush Mount Module –Enhanced Power Module 			To Order, Specify: 1) Product number. (No finish specification required.)		
Specification Tips					
<ul style="list-style-type: none"> Provides communication between components: i.e. laptop, processor, monitor, etc. HDMI transmits digital video signals. VGA transmits analog video signals without audio. 					

Retrofit USB Charging Cable	72"(1829mm)		Black	EUDX-U000-B	\$98.32
			White	EUDX-U000-W	98.32
Features					
<ul style="list-style-type: none"> Includes one USB charging simplex (with two USB outlets) with 72"(1829mm) cord and power supply. Installs in an open data port in one of the following products: <ul style="list-style-type: none"> –Flip Top Unit –Double Sided Flip Top Unit –Quick Connect Power –Workware Interface Module –Flush Mount Module –Enhanced Power Module USB Charging Port consists of 2 USB outlets. 1,000mA of charging power per USB outlet. 			To Order, Specify: 1) Product number. (No finish specification required.)		

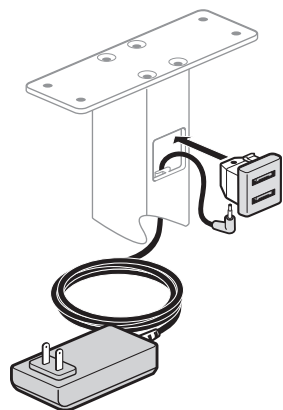

EUDX-3000-B



Ergotron Monitor Arms

HX Single Arm

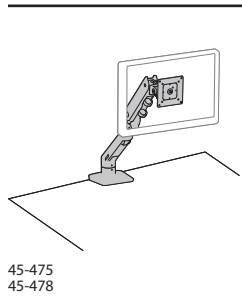

Description	Number	Price
Desk Mount		
Polished Aluminum	45-475-026	\$621.00
White	45-475-216	621.00
Wall Mount		
Polished Aluminum	45-478-026	\$621.00
White	45-478-216	621.00

Features

- Includes: Adjustable height monitor arm, extension, monitor pivot, mounting hardware.
 - Desk mount includes desk clamp and grommet mount.
 - Wall mount includes mounting hardware.
- For use with screen 42”(1067mm) or smaller.
- Weight capacity 20-42 pounds.
- Height adjustment range is 11.5”(292mm).
- Tilts 70° up and 5° down from center.
- 180° rotation base stop.
- Pans 180°.
- Rotates 360°.
- Extends out up to 25”(635mm).
- Integrated cable management.
- One touch adjustment.

To Order, Specify:

- 1) Product number.

Specification Tips

- Desk clamp mounts on worksurface 0.4”(10mm)-2.5”(64mm) thick.
- Grommet mount attaches through surface holes 0.4”(10mm)-2”(51mm) wide and up to 2.25”(57mm) thick.

Ergotron Monitor Arms

HX Dual Arm

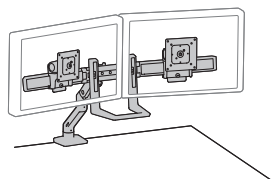

45-476
45-479

Description	Number	Price
Desk Mount		
Polished Aluminum	45-476-026	\$1011.00
White	45-476-216	1011.00
Wall Mount		
Polished Aluminum	45-479-026	\$1011.00
White	45-479-216	1011.00

Features

- Includes: Adjustable height monitor arm, extension, two monitor pivots, hinged bow, handle, mounting hardware.
 - Desk mount includes desk clamp and grommet mount.
 - Wall mount includes mounting hardware.
- For use with screen 32”(813mm) or smaller.
- Weight capacity is 5-17.5 pounds per screen. Maximum combined weight is 35 pounds.
- Height adjustment range is 11.5”(292mm).
- Tilts 70° up and 5° down from center.
- 180° rotation base stop.
- Pans 180° - Hinged bow allows monitors to pan from left to right independently.
- Rotates 360°.
- Extends out up to 24”(610mm).
- Quick release monitor.
- Integrated cable management.
- One touch adjustment.
- Handle allows for easy positioning of multiple monitors simultaneously.

To Order, Specify:

- 1) Product number.

Specification Tips

- Desk clamp mounts on worksurface 0.6”(15mm)-2.5”(64mm) thick.
- Grommet mount attaches through surface holes 0.4”(10mm)-2”(51mm) wide and up to 2.25”(57mm) thick.

Ergotron Monitor Arms

HX Triple Monitor Bow Kit

Description	Number	Price
Polished Aluminum	98-009-026	\$571.00
White	98-009-216	571.00

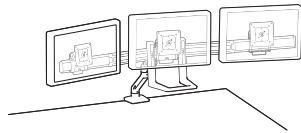
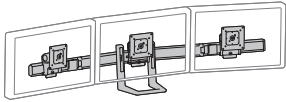

98-009-026
98-009-216

Features

- Includes: Triple monitor hinge bow, three monitor pivots, handle, monitor mounting hardware.
- For use with screen 24"(610mm) or smaller.
- Maximum weight capacity is 10.2 pounds per arm. Maximum combined weight is 30.6 pounds.
- Tilts 70° up and 5° down from center.
- Pans 180°.
- Rotates 360°.
- Extends out up to 24"(610mm).
- Quick release monitor.
- One touch adjustment.
- Handle allows for easy positioning of multiple monitors simultaneously.

To Order, Specify:

- 1) Product number.

Specification Tip

- Attaches to HX single or dual monitor arm.

Ergotron Monitor Arms

LX Desk Mount

Single Arm

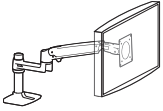

45-241-026
45-490-216
45-295-026
45-537-216

Description	Number	Price
Single Arm		
Polished Aluminum	45-241-026	\$282.00
White	45-490-216	282.00
Single Arm — Tall Pole		
Polished Aluminum	45-295-026	\$382.00
White	45-537-216	382.00

Features

- Includes: Adjustable height monitor arm, pole, extension, desk clamp and grommet mount base (polished aluminum only).
- Grommet mount base available on Polished Aluminum model only.
- Standard pole length is 7”(178mm). Tall pole length is 13.25”(337mm).
- Standard pole height for use with screen 32”(813mm) or smaller. Tall pole for use with screens 34”(864mm) or smaller.
- Accommodates monitors from 7-25 pounds.
- Height adjustment range is 13”(330mm) from installed height.
- Tilts 70° up and 5° down from center.
- Rotates 360°.
- Extends LCD's out up to 25”(635mm).
- Integrated cable management.
- One touch adjustment.

To Order, Specify:

- 1) Product number.

Specification Tips

- Desk clamp mounts on worksurface 0.4”(10mm)-2.4”(61mm) thick.
- Grommet mount attaches through surface holes 0.31”(8mm)-2”(51mm) wide and up to 3”(76mm) thick.

Ergotron Monitor Arms

LX Desk Mount

Dual Arm

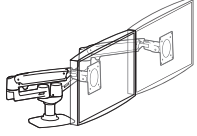

45-245-026
 45-491-216
 45-248-026
 45-492-216

Description	Number	Price
Side-by-Side		
Polished Aluminum	45-245-026	\$563.00
White	45-491-216	563.00
Stacking		
Polished Aluminum	45-248-026	\$563.00
White	45-492-216	563.00

Features

- Includes: Two adjustable height monitor arms, extensions, pole, grommet mount (polished aluminum only) and desk clamp.
- Grommet mount base available on Polished Aluminum model only.
- Screen size:
 - Side by Side application; screens 27”(686mm) or smaller.
 - Stacking application; screens 24”(610mm) or smaller. Screen height cannot exceed 14”(356mm) when stacking.
- Accommodates monitors from 7-20 pounds per arm. Maximum combined weight is 40 pounds.
- Height adjustment range is 13”(330mm).
- Tilts 70° up and 5° down from center.
- Pans 360°.
- Rotates 360°.
- Extends LCD's out up to 25”(635mm).
- Integrated cable management.
- One touch adjustment.

To Order, Specify:

- 1) Product number.

Specification Tips

- Desk clamp mounts on worksurface 0.4”(10mm)-2.4”(61mm) thick.
- Grommet mounts attached through surface holes 0.31”(8mm)-2”(51mm) wide and up to 3”(76mm) thick.

Ergotron Monitor Arms

LX Sit-to-Stand Mount

Single Arm

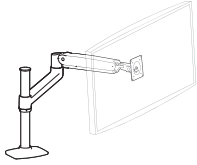

45-360-026
45-384-026

Description	Number	Price
LD — Light Duty		
Polished Aluminum	45-360-026	\$542.00
HD — Heavy Duty		
Polished Aluminum	45-384-026	\$667.00

Features

- Includes: Adjustable height monitor arm, extension, desk clamp and grommet base.
- Screen size:
 - LD - Light Duty for use with screen 42”(1067mm) or smaller.
 - HD - Heavy Duty for use with screen 46”(1168mm) or smaller.
- Monitor weight:
 - LD - Light Duty 7-25 pounds.
 - HD - Heavy Duty 14-30 pounds.
- Height adjustment range is 20”(508mm).
- Tilts 70° up and 5° down from center.
- Pans 360°.
- Rotates 90°.
- Extends LCD's out up to 33”(838mm).
- Integrated cable management.
- One touch adjustment.
- Locking connections between arm, extension and base provides theft deterrence and prevent potential disconnections caused by jarring or impacts.

To Order, Specify:

- 1) Product number.

Specification Tips

- Desk clamp mounts on worksurface 0.8”(20mm)-2.6”(66mm) thick.
- Grommet mounts attached through surface holes 0.5”(13mm)-2.5”(64mm) wide and up to 2.25”(57mm) thick.

Ergotron Monitor Arms

LX Desk Dual Direct

	Description	Number	Price
Dual Direct Arm	Polished Aluminum	45-489-026	\$428.58
	White	45-489-216	428.58

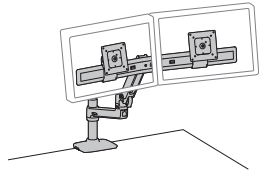

45-489

Features

- Includes: LX arm, extension, desk clamp, dual bow, two monitor pivots, pole and mounting hardware.
- For use with screens 25”(635mm) or smaller.
- Accommodates monitors from 2-11 pounds per monitor. Maximum combined weight is 22 pounds.
- Height adjustment range is 13”(330mm).
- Each monitor has individual tilt of 15° up and 15° down from center.
- Pans 360°.
- Rotates 360°.
- Extends LCD's out up to 24”(610mm).
- Integrated cable management.
- One touch adjustment.
- Move two monitors simultaneously.

To Order, Specify:

- 1) Product number.

Specification Tip

- Desk clamp mounts on worksurface 0.4”(10mm)-2.4”(61mm) thick.

Dual Direct Handle Kit	Polished Aluminum	98-037-062	\$94.00
-------------------------------	-------------------	------------	----------------

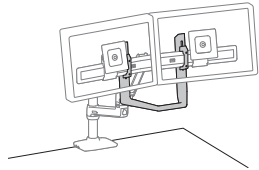

98-037-062



Features

- Includes: One handle and mounting hardware.
- For use with LX Dual Direct monitor arm.
- Allows repositioning of screens without touching the screen.

To Order, Specify:

- 1) Product number.

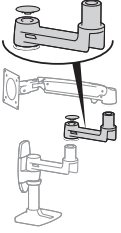
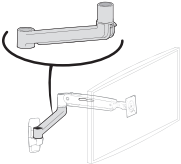
Ergotron Monitor Arm Accessories

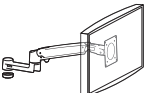
	Description	Number	Price
LX Extension  45-289-026	Polished Aluminum	45-289-026	\$71.00
	Features <ul style="list-style-type: none"> Includes: One extension. Add additional pivot-point for additional flexibility. Increases the reach of an LX arm by 9"(229mm). 		To Order, Specify: 1) Product number.
LX Sit-to-Stand Extension  45-362-026	Polished Aluminum	45-362-026	\$121.00
	Features <ul style="list-style-type: none"> Includes: One sit-to-stand extension. Add additional pivot-point for additional flexibility. Increases the reach of an LX Sit-to-Stand arm by 11.7"(297mm). 		To Order, Specify: 1) Product number.
LX Pole Collar  97-844	Polished Aluminum	97-844	\$11.00
	Features <ul style="list-style-type: none"> Includes: One collar and hardware. Used to attach a second LX Sit-to-Stand Arm at any point of an installed base. Reposition height on pole by loosening/tightening the collar's set screws. 		To Order, Specify: 1) Product number.
LX Arm, Extension and Collar Kit  97-940-026 98-130-216	Polished Aluminum	97-940-026	\$333.00
	White	98-130-216	333.00
	Features <ul style="list-style-type: none"> Includes: LX arm, extension, collar and hardware. Converts existing LX Tall Pole Arm to hold two monitors creating an LX Dual Stacking Arm configuration. Attaches to pole of the desk mount base. For use with screen 32"(813mm) or smaller. Weight capacity is 7-20 pounds. Height adjustment range is 13"(330mm). Tilts 70° up and 5° down from center. Pans 360°. Rotates 360°. Extends LCD's out up to 25"(635mm). Integrated cable management. One touch adjustment. 		To Order, Specify: 1) Product number.
Specification Tip <ul style="list-style-type: none"> Recommended for use with LX Desk Mount LCD Arm, Tall Pole. 			

Ergotron Monitor Arms

MX Desk Mount

	Description	Number	Price
Single Arm	Polished Aluminum	45-214-026	\$365.00



Features

- Includes: Adjustable height monitor arm, desk clamp and grommet mount.
- For use with screen 30”(762mm) or smaller.
- Accommodates monitors from 14-30 pounds.
- Height adjustment range is 5”(127mm).
- Tilts 75° up and 5° down from center.
- Rotates 90°.
- Pans 360°.
- Extends LCD's out up to 17”(432mm).
- Integrated cable management.
- One touch adjustment.

To Order, Specify:

- 1) Product number.

Specification Tips

- Desk clamp mounts on worksurface 0.4”(10mm)-2.5”(64mm) thick.
- Grommet mounts attach through surface holes 0.31”(8mm)-2”(51mm) wide and up to 3”(76mm) thick.

Ergotron Monitor Arms

MX Mini Desk Mount

Description	Number	Price
Polished Aluminum	45-436-026	\$361.00

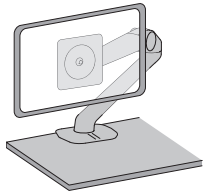

45-436-026

Features

- Includes: Adjustable height monitor arm, desk clamp and grommet mount.
- For use with screen 24”(610mm) or smaller.
- Weight capacity is 8 pounds.
- Height adjustment range is 13”(330mm).
- Tilts 90° up and 5° down from center.
- Rotates 360°.
- Pans 360°.
- Extends LCD's out up to 19.5”(495mm).
- Integrated cord management.
- One touch adjustment

To Order, Specify:

- 1) Product number.

Specification Tips

- Desk clamp mounts on worksurface 0.4”(10mm)-2.5”(64mm) thick.
- Grommet mounts attach through surface holes 0.31”(8mm)-2”(51mm) wide and up to 3”(76mm) thick.
- Can be installed on Ergotron WorkFit-T or TL.

Ergotron Monitor Arms

Dual Monitor and Handle Kit

Description	Number	Price
Polished Aluminum/Black	97-783	\$199.00

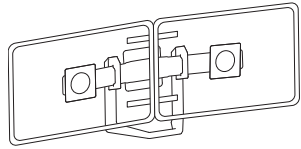

97-783

Features

- Includes: Monitor bow, two monitor pivots, handle and mounting hardware.
- For use with screens 26" (660mm) or smaller.
- Maximum weight capacity is 18 pounds per arm.
- Maximum combined weight is 36 pounds.
- Rotates 360°.
- Arm in polished aluminum, bow and handle in black.

To Order, Specify:

- 1) Product number.

Specification Tip

- This product adds an additional 6 pounds to your mounting solution. Monitor arm's maximum weight capacity must be reduced by 6 pounds.
- Attaches to mounts with four-hole interface of 50 x 50 mm or 100 x 100 mm.

Ergotron Monitor Arms

Neo-Flex

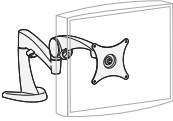
	Description	Number	Price
Neo-Flex	Silver	45-174-300	\$179.00
 <p>45-174-300</p>	Features <ul style="list-style-type: none"> Includes: Arm, extension, LCD pivot, desk clamp and grommet mount. For use with screen 22"(559mm) or smaller. Maximum weight capacity 18 pounds. Height adjustment range is 8"(203mm). Tilts 180° up and down. Rotates 360°. Pans 360°. Extends LCD's out up to 19.3"(490mm). Integrated cord management. 	To Order, Specify: 1) Product number.	
	Specification Tips <ul style="list-style-type: none"> Desk clamp mounts to surfaces up to 2"(51mm) thick. Grommet mounts attach through surface holes up to 2"(51mm) wide and up to 1.75"(44mm) thick. 		

	Description	Number	Price
Neo-Flex Extend	Polished Aluminum	45-235-194	\$274.00
 <p>45-235-194</p>	Features <ul style="list-style-type: none"> Includes: Two extensions, LCD pivot, desk clamp and grommet mount. For use with screen 24"(610mm) or smaller. Weight capacity 7-20 pounds. Pole height adjustment range is 9.5"(241mm). Tilts 75° up and 5° down from center. Rotates 360°. Pans 360°. Extends LCD's out up to 22"(559mm). Integrated cable management. 	To Order, Specify: 1) Product number.	
	Specification Tips <ul style="list-style-type: none"> Desk clamp mounts on worksurface 0.5"(13mm)-2"(51mm) thick. Grommet mounts attached through surface holes 0.3"(8mm)-2"(51mm) wide and up to 2.5"(64mm) thick. 		

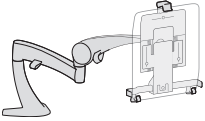
	Description	Number	Price
Neo-Flex Tablet	Black	45-306-101	\$240.00
 <p>45-306-101</p>	Features <ul style="list-style-type: none"> Includes: Arm, optional extension, tablet cradle, desk clamp and grommet mount. Accommodates tablets with a minimum size of 5.5"(140mm) x 8"(203mm) and a maximum size of 8"(203mm) x 9.75"(248mm). Depth of tablet cannot exceed 0.75"(19mm). Maximum weight capacity is 2.5 pounds. Height adjustment range is 8"(203mm). Tilts 180°. Pans 360°. Rotates 360°. Extends tablets out up to 19.3"(490mm). 	To Order, Specify: 1) Product number.	
	Specification Tips <ul style="list-style-type: none"> Desk clamp mounts on worksurface 0.5"(13mm)-1.8"(46mm) thick. Grommet mounts attached through surface holes 0.3"(8mm)-2"(51mm) wide and up to 1.75"(44mm) thick. 		

Ergotron WorkFit-A — Single Attached Sit-Stand Workstation

Description	Height	Depth	Width	Number	Price
LD — Light Duty with WorkSurface					
Polished Aluminum/Black	42.7"(1085mm)	16.9"(429mm)- 43.7"(1110mm)	27"(686mm)	24-317-026	\$ 940.00
LD — Light Duty with WorkSurface and Suspended Keyboard					
Polished Aluminum/Black	38.8"(986mm)	16.9"(429mm)- 43.7"(1110mm)	27"(686mm)	24-390-026	\$ 978.00
HD — Heavy Duty with Worksurface and Suspended Keyboard					
Polished Aluminum/Black	38.8"(986mm)	16.9"(429mm)- 43.7"(1110mm)	27"(686mm)	24-391-026	\$1036.00

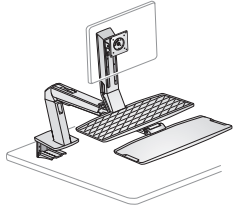

24-317-026
LD with Worksurface

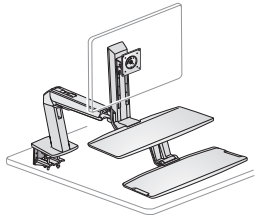

24-390-026
LD with Suspended Keyboard

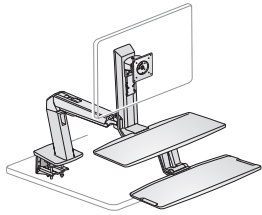

24-391-026
HD with Suspended Keyboard

Features

- Includes: Height-adjustment column, desk clamp, LCD pivot, keyboard tray, worksurface (when applicable) and hardware.
- Grommet mount included on models with suspended keyboard tray.
- Keyboard tray dimensions: 9.75"(248mm) D x 27"(686mm)W.
- Worksurface dimensions: 9.75"(248mm) D x 23"(584mm)W.
- Height adjustment range is 20"(508mm) with LCD and keyboard tray in tandem. LCD's adjust 5"(127mm) independently from worksurface. Maximum LCD height adjustment is 25"(635mm).
- Tilts 30°.
- Pans 180°.
- Rotates 90°.
- In seated position, suspended keyboard tray can drop down approximately 4"(102mm) below desktop surface.
- Integrated cable management.
- Black with polished aluminum arm extension and base.

To Order, Specify:

- 1) Product number.

Specification Tips

- Desk clamp mounts on worksurface up to 31.5"(800mm) deep and 0.78"(29mm)-2.6"(66mm) thick.
- Keyboard tray can be installed in three different positions: centered, offset right or offset left.

Description	Maximum Screen Size	Weight Capacity			
		Total	LCD	Keyboard Tray	Worksurface
LD with Worksurface	24"(610mm)	20 lbs.	5-15 lbs.	5 lbs.	5 lbs.
LD with Suspended Keyboard	24"(610mm)	20 lbs.	5-15 lbs.	5 lbs.	5 lbs.
HD with Suspended Keyboard	27"(686mm)	25 lbs.	10-20 lbs.	5 lbs.	5 lbs.

Ergotron WorkFit-A — Dual Attached Sit-Stand Workstation

Description	Height	Depth	Width	Number	Price
Without Worksurface	42.7"(1085mm)	16.9"(429mm)- 43.7"(1110mm)	27"(686mm)	24-312-026	\$ 858.00
With Worksurface	42.7"(1085mm)	16.9"(429mm)- 43.7"(1110mm)	27"(686mm)	24-316-026	1036.00
With Worksurface and Suspended Keyboard	38.8"(986mm)	16.9"(429mm)- 43.7"(1110mm)	27"(686mm)	24-392-026	1080.00

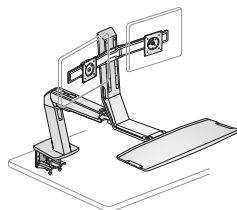

24-312-026

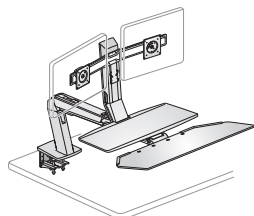

24-316-026

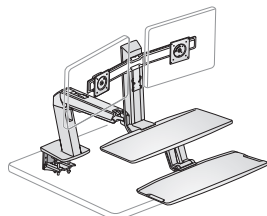

24-392-026

Features

- Includes: Arm, two LCD pivots, worksurface (if applicable), crossbow, keyboard tray, desk clamp and hardware.
- For use with screen 24"(610mm) or smaller.
- Maximum weight capacity:
 - Total capacity 25 pounds
 - LCD - 4.5-10 pounds each.
 - Keyboard tray - 2 pounds
 - Worksurface - 5 pounds
- Keyboard tray dimension: 9.75"(248mm) D x 27"(686mm) W.
- In seated position, keyboard tray can drop down approximately 4"(102mm) below desktop surface.
- Worksurface dimension: 9.75"(248mm) D x 22.63"(575mm) W.
- Height adjustment range is 20"(508mm) with LCD and keyboard tray in tandem. LCD's adjust 5"(127mm) independently from worksurface. Maximum LCD height adjustment is 25"(635mm).
- Pans 180°.
- Rotates 360°.
- Integrated cable management.
- Black with polished aluminum extension and base.

To Order, Specify:

- 1) Product number.

Specification Tips

- Desk clamp mounts on worksurface up to 31.5"(800mm) deep and 0.5"(13mm) - 2.5(64mm) thick.
- Minimum weight capacity of 12 pounds to ensure proper operation.
- Keyboard tray can be installed in three different positions: centered, offset right or offset left.

Ergotron WorkFit-S — Single Attached Sit-Stand Workstation

Description	Height	Depth	Width	Number	Price
LD — Light Duty					
Black	29.4(747mm)-35"(889mm)	16.3"(414mm)	24"(610mm)	33-342-200	\$ 822.00
LD — Light Duty with WorkSurface					
Black	29.4(747mm)-35"(889mm)	16.3"(414mm)	27"(686mm)	33-350-200	\$1032.00
White	29.4(747mm)-35"(889mm)	16.3"(414mm)	27"(686mm)	33-350-211	1032.00
HD — Heavy Duty with Worksurface					
Black	29.4(747mm)-35"(889mm)	16.3"(414mm)	27"(686mm)	33-351-200	\$1089.00
White	29.4(747mm)-35"(889mm)	16.3"(414mm)	27"(686mm)	33-351-211	1089.00

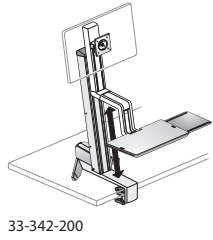

33-342-200

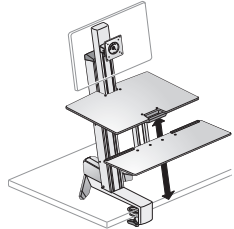

33-350-200
33-350-211

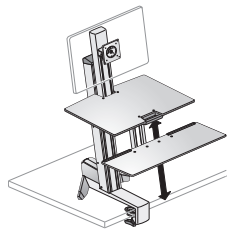

33-351-200
33-351-211

Features

- Includes: Height-adjustment column, desk clamp, LCD pivot, keyboard tray, and left/right mouse tray or worksurface when applicable.
- Keyboard tray dimensions:
 - Without Worksurface - 9.3"(236mm) D x 16.5"(419mm) W.
 - With Worksurface - 9"(229mm) D x 27"(686mm) W.
- Worksurface dimensions: 15"(381mm) D x 23"(584mm) W.
- Mouse tray available on no worksurface model only. May be installed on left or right side of keyboard tray. Dimensions: 7.9"(201mm) D x 7.5"(191mm) W.
- Height adjustment range is 18"(457mm) with LCD and keyboard tray in tandem. LCD's adjust 5"(127mm) independently. Maximum LCD height adjustment is 23"(584mm).
- Tilts 30°.
- Rotation: LD rotates 360°. HD rotates 90°.
- Keyboard tray tilts back 5°.

To Order, Specify:

- 1) Product number.

Specification Tips

- Desk clamp mounts on front of worksurface 0.5"(13mm)-2.4"(61mm) thick.
- Height measured from desktop to lowest and highest positions.

Description	Maximum Screen Size	Weight Capacity			
		Total	LCD	Keyboard Tray	Worksurface
LD	24"(610mm)	24 lbs.	6-16 lbs.	5 lbs.	NA
LD with Worksurface	24"(610mm)	24 lbs.	6-16 lbs.	5 lbs.	5 lbs.
HD with Worksurface	30"(762mm)	29 lbs.	16-28 lbs.	5 lbs.	5 lbs.

Ergotron WorkFit-S — Dual Attached Sit-Stand Workstation

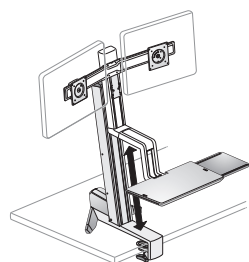

33-341-200

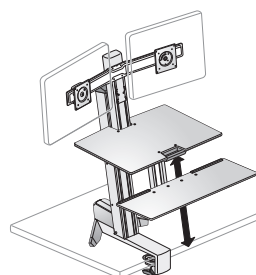

33-349-200
33-349-211

Description	Height	Depth	Width	Number	Price
Without Worksurface					
Black	29.4(747mm)-35"(889mm)	16.3"(414mm)	24"(610mm)	33-341-200	\$ 879.00
With Worksurface					
Black	29.4(747mm)-35"(889mm)	16.3"(414mm)	27"(686mm)	33-349-200	\$1137.00
White	29.4(747mm)-35"(889mm)	16.3"(414mm)	27"(686mm)	33-349-211	1147.00

Features

- Includes: Height-adjustment column, desk clamp, crossbar, two LCD pivots, keyboard tray, and left/right mouse tray or worksurface when applicable.
- For use with screen 24"(610mm) or smaller.
- Maximum weight capacity:
 - Total capacity 31 pounds.
 - LCD - 6-14 pounds without worksurface. With worksurface LCD weight capacity 6-12 pounds..
 - Keyboard tray - 5 pounds.
 - Worksurface (when specified) - 5 pounds
- Keyboard tray dimensions:
 - Without Worksurface - 9.3"(236mm) D x 16.5"(419mm) W.
 - With Worksurface - 9"(229mm) D x 27"(686mm) W.
- Mouse tray available on without worksurface model only. May be installed on left or right side of keyboard tray. Dimensions: 7.9"(201mm) D x 7.5"(191mm) W.
- Worksurface dimensions: 15"(381mm) D x 23"(584mm) W.
- Height adjustment range is 18"(457mm) with LCD and keyboard tray in tandem. LCD's adjust 5"(127mm) independently. Maximum LCD height adjustment is 23"(584mm).
- Rotates 90°.
- Keyboard tray tilts back 5°.

To Order, Specify:

- 1) Product number.

Specification Tips

- Desk clamp mounts on front of worksurface 0.5"(13mm)-2.4"(61mm) thick.
- Height measured from desktop to lowest and highest positions.

Ergotron WorkFit-SR — Single Attached Sit-Stand Workstation

Description	Height	Depth	Width	Number	Price
Standard					
Black	28.9(734mm)-37"(940mm)	24.2"(615mm)	29.5"(749mm)	33-415-085	\$1280.00
White	28.9(734mm)-37"(940mm)	24.2"(615mm)	29.5"(749mm)	33-415-062	1280.00

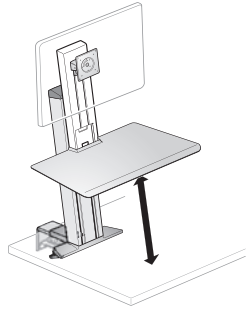

33-415-085
33-415-062

Features

- Includes: Height-adjustment column, LCD pivot, worksurface, one USB extension cable, one cable wrap and desk clamp.
- For use with screen size 24"(610mm) or smaller.
- Maximum weight capacity:
 - Total capacity 24 lbs.
 - LCD 3-13 lbs.
 - Worksurface 5 lbs.
- Worksurface dimensions: 22"(559mm) D x 29.5"(749mm) W.
- Height adjustment range is 18"(457mm) with monitor and keyboard in tandem. Monitors have an additional 5"(127mm) of independent lift.
- Tilts 30°.
- Rotates 360°.
- Integrated cable management.
- Standard with pre-installed USB cable.

To Order, Specify:

- 1) Product number.

Specification Tips

- Desk clamp attaches to the rear of surfaces up to 2.5"(64mm) thick.
- Recommended for use on 30"(762mm)-36"(914mm) worksurfaces. Desks shorter than 30"(762mm) worksurface will extend beyond desktop edge. Desks deeper than 36"(914mm), worksurface will not extend to desktop edge.
- Short surface model available for worksurfaces less than 30"(762mm) deep.
- Height measured from desktop to lowest and highest positions.

Ergotron WorkFit-SR — Dual Attached Sit-Stand Workstation

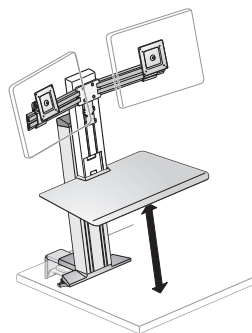

33-407-085
33-407-062

Description	Height	Depth	Width	Number	Price
Black	28.9(734mm)- 37”(940mm)	25.2”(640mm)	29.5”(749mm)	33-407-085	\$1395.00
White	28.9(734mm)- 37”(940mm)	25.2”(640mm)	29.5”(749mm)	33-407-062	1395.00

Features

- Includes: Height-adjustment column, crossbar, two LCD pivots, worksurface, one USB extension cable, two cable wraps and desk clamp.
- For use with screen 24”(610mm) or smaller.
- Maximum weight capacity:
 - Total capacity 25 pounds.
 - Monitor arm 3-11 pounds each.
 - Worksurface 5 pounds.
- Worksurface dimensions: 22”(559mm) D x 30”(762mm) W.
- Height adjustment range is 18”(457mm) with monitor and keyboard in tandem. Monitors lift independently 5”(127mm) additional.
- Tilts 35°.
- Rotates 360°.

To Order, Specify:

- 1) Product number.

Specification Tips

- Desk clamp attaches to rear of surfaces up to 2.5”(64mm) thick.
- Recommended for use on 30”(762mm)-36”(914mm) worksurfaces. Desks shorter than 30”(762mm) worksurface will extend beyond desktop edge. Desks deeper than 36”(914mm), worksurface will not extend to desktop edge.
- Height measured from desktop to lowest and highest positions.

Ergotron WorkFit-T — Desktop Sit-Stand Workstation

Description	Depth	Width	Number	Price
Black	25"(635mm)	35"(889mm)	33-397-085	\$762.00
White	25"(635mm)	35"(889mm)	33-397-062	762.00

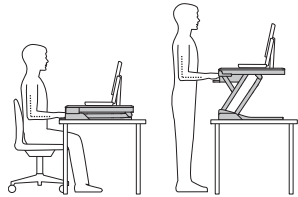
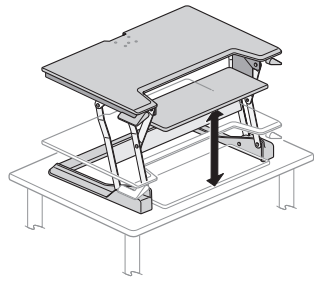

33-397-085
33-397-062

Features

- Includes: One height adjustable workstation with keyboard tray.
- For use with screen 30"(762mm) or smaller.
- Maximum weight capacity: 10-35 pounds.
- Keyboard tray dimensions are 25"(635mm) W x 9"(229mm) D.
- Total height adjustment range is 15"(381mm). Monitor and keyboard move in tandem.
- Keyboard tray sits 4.5"(114mm) below WorkFit worksurface.
- Ships fully assembled.

To Order, Specify:

- 1) Product number.

Specification Tips

- Fits on surfaces 24"(610mm) deep or larger including corner surfaces.
- Monitor can be placed directly on the worksurface or monitor mount can be used; sold separately.

Ergotron WorkFit-TL — Desktop Sit-Stand Workstation

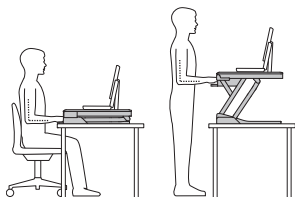
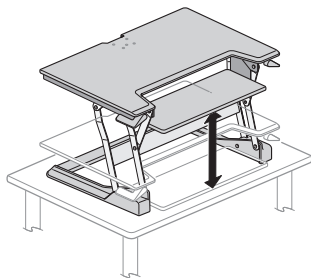

33-406-085
33-406-062
33-418-085

Description	Depth	Width	Number	Price
Black	27"(686mm)	37.5"(953mm)	33-406-085	\$ 822.00
White	27"(686mm)	37.5"(953mm)	33-406-062	822.00
Black - TAA Compliant	27"(686mm)	37.5"(953mm)	33-418-085	1240.00

Features

- Includes: One height adjustable workstation with keyboard tray.
- TAA compliant version assembled in the USA in black only.
- For use with screen 30"(762mm) or smaller.
- Maximum weight capacity: 10-40 pounds.
- Keyboard tray dimensions are 27.5"(699mm) W x 11"(279mm) D.
- Total height adjustment range is 15"(381mm). Monitor and keyboard move in tandem.
- Keyboard tray sits 4.5"(114mm) below WorkFit worksurface.
- Ships fully assembled.

To Order, Specify:

- 1) Product number.

Specification Tips

- Fits on desks 24"(610mm) deep or larger.
- Monitor can be placed directly on the worksurface or monitor mount can be used; sold separately.

Ergotron WorkFit LX - Sit-Stand Desk Mount System

Description	Number	Price
Polished Aluminum	45-405-026	\$1271.00

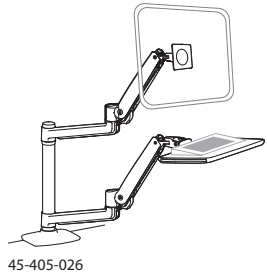

Features

- Includes: Monitor arm, two extensions, keyboard arm and tray, slide-out mouse tray, pole, two pole collars, desk clamp, grommet mount, VESA brackets, wrist rest and hardware.
- For use with screen 42"(1067mm) or smaller.
- Maximum weight capacity:
 - Monitor arm 7-25 pounds.
 - Keyboard arm 5 pounds.
- Keyboard tray dimensions: 8.9"(226mm) D x 18.3"(465mm) W.
- Keyboard tray tilts back 5°.
- Mouse tray dimensions: 8"(203mm) D x 8"(203mm) W.
- Height adjustment range is 20"(508mm).
- Side-to-Side movement range of 62"(1575mm).
- Arm extension is 33"(838mm).
- Tilts 75°.
- Pans 360°.
- Rotates 360°.
- Mouse Tray may be installed on the left or right side.

To Order, Specify:

- 1) Product number.

Specification Tips

- Desk clamp attaches to rear edge up to 2.5"(64mm) thick.
- Grommet mount attaches through hole 0.5"(13mm) to 2.5"(64mm) wide and up to 2.25"(57mm) thick.

Ergotron WorkFit — Accessories

WorkFit-A

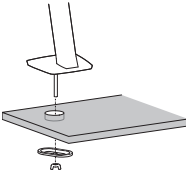
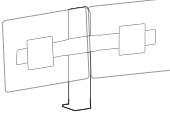
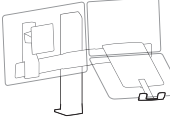
	Description	Number	Price
Grommet Mount	Polished Aluminum/Black	97-692	\$50.00
	<p>Features</p> <ul style="list-style-type: none"> • Includes one grommet mount. • For use with WorkFit-A. • Black pole and hardware with polished aluminum base. 	To Order, Specify:	1) Product number.
97-692	<p>Specification Tips</p> <ul style="list-style-type: none"> • Attaches through surface hole 0.5”(13mm) to 2.5”(64mm) wide and up to 2.6”(66mm) thick. • For maximum support, screw should be centered through hole. 		
Conversion Kit Single HD to Dual	Black	97-606	\$109.00
	<p>Features</p> <ul style="list-style-type: none"> • Includes: Crossbar, two monitor pivots and mounting hardware. • Converts WorkFit-A single HD workstation into a WorkFit Dual workstation. • For use with screens 24”(610mm) or smaller. • Pivots 360°. • LCD weight capacity is 6-14 pounds. • Total weight capacity is contingent on the WorkFit platform to which the kit is added. 	To Order, Specify:	1) Product number.
97-606	<p>Specification Tips</p> <ul style="list-style-type: none"> • Compatible with WorkFit-A products. • Not for use with WorkFit-S. 		
Conversion Kit Single HD to LCD & Laptop	Black	97-605	\$157.00
	<p>Features</p> <ul style="list-style-type: none"> • Includes: Laptop tray, riser bracket, LCD pivot and mounting hardware. • Converts WorkFit-A single HD workstation into a WorkFit LCD and laptop workstation. • For use with screens 20”(508mm) or smaller. • Monitor tilts 30°. • Rotates 360°. • LCD weight capacity is 6-16 pounds. • Laptop weight capacity is 10 pounds. • Total weight capacity is contingent on the WorkFit platform to which the kit is added. 	To Order, Specify:	1) Product number.
97-605	<p>Specification Tips</p> <ul style="list-style-type: none"> • Compatible with WorkFit-A products. • Not for use with WorkFit-S. 		

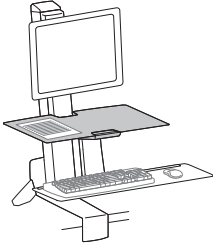
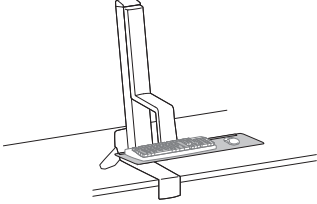
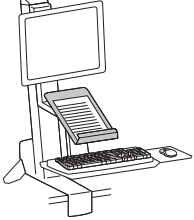

Ergotron WorkFit — Accessories

WorkFit-S

	Description	Height	Depth	Width	Number	Price
 <p>97-581-019</p>	Black	.25"(6mm)	15"(381mm)	23"(584mm)	97-581-019	\$174.00
	Features <ul style="list-style-type: none"> Includes: Worksurface, mounting brackets and mounting hardware. For use on WorkFit-S workstation. Weight capacity is 5 pounds. 		To Order, Specify: <ul style="list-style-type: none"> 1) Product number. 			
Specification Tips <ul style="list-style-type: none"> Does not affect normal range of WorkFit S. When added to WorkFit-S reduce total weight capacity by 6 pounds. May not be used in conjunction with Tablet/Document Holder. 						
 <p>97-653</p>	Black	.25"(6mm)	9"(229mm)	27"(686mm)	97-653	\$96.00
	Features <ul style="list-style-type: none"> Includes: Keyboard tray and mounting hardware. For use on WorkFit-S workstation. Weight capacity is 5 pounds. 		To Order, Specify: <ul style="list-style-type: none"> 1) Product number. 			
Specification Tips <ul style="list-style-type: none"> Can be attached centered on the workstation or offset to the right or left using alternate mounting holes. May be installed using only back mounting holes to increase distance between keyboard and monitor. 						
 <p>97-558-200</p>	Black	10.7"(272mm)	1.5"(38mm)	7.25"(184mm)	97-558-200	\$57.00
	Features <ul style="list-style-type: none"> Includes: document holder, handle and mounting hardware. For use with WorkFit-S. Maximum weight capacity: 2.2 pounds 		To Order, Specify: <ul style="list-style-type: none"> 1) Product number. 			
Specification Tips <ul style="list-style-type: none"> Installs in three different positions under laptop or displays. Tablet/Document Holder may reduce WorkFit's 5"(127mm) independent height adjustment range for displays. When added to the WorkFit-S, total weight capacity of workstation is reduced by 1 pound. Not for use with WorkFit-S worksurface. 						

Ergotron WorkFit — Accessories

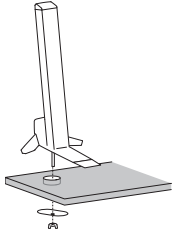
WorkFit-S

	Description	Number	Price
 <p>97-649-085</p>	<p>Grommet Mount</p> <p>Black</p> <p>Features</p> <ul style="list-style-type: none"> Includes one grommet mount. For use with WorkFit-S. <p>Specification Tips</p> <ul style="list-style-type: none"> Attaches through surface hole 3/8”(10mm) to 2.5”(64mm) wide and .47”(12mm) to 2.4”(61mm) thick. For maximum support, screw should be centered through hole. 	97-649-085	\$38.00
	<p>To Order, Specify:</p> <ol style="list-style-type: none"> Product number. 		
 <p>97-583-009</p>	<p>Hinged Bow</p> <p>Black</p> <p>Features</p> <ul style="list-style-type: none"> Includes: Center hinge and two outboard crossbar pieces and mounting hardware. Provides ability to pivot and adjust monitor back or forth to view screen. Compatible with WorkFit-Dual Monitor Station. For use with screw (6mm) diameter. Maximum weight capacity is 26 pounds. Two (2) weight capacity is 14 pounds each. Combined maximum weight capacity 28 pounds. Monitor rotates 360°. Pans 180°. <p>Specification Tip</p> <ul style="list-style-type: none"> For use with WorkFit-S dual monitor only. 	97-583-009	\$96.00
	<p>To Order, Specify:</p> <ol style="list-style-type: none"> Product number. 		

OBSOLETE! Oct 2018



Ergotron WorkFit — Accessories

WorkFit-A / WorkFit-S

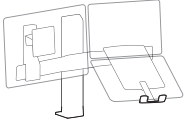
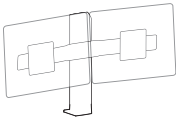
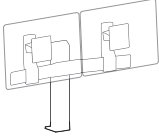
	Description	Number	Price
 <p>97-617</p>	<p>Conversion Kit: Dual to LCD & Laptop</p> <p>Black</p> <p>Features</p> <ul style="list-style-type: none"> • Includes: Laptop tray, riser bracket, monitor pivot and mounting hardware. • Converts WorkFit-S or WorkFit-A Dual workstation into a WorkFit LCD and laptop workstation. • For use with screens 24"(610mm) or smaller. • Monitor tilts 30°. • Pans 180°. • Monitor rotates 360°. • Weight capacity is contingent on the WorkFit platform to which the kit is added. <p>Specification Tip</p> <ul style="list-style-type: none"> • Compatible with WorkFit-A or WorkFit-S workstation. 	97-617	\$118.00
 <p>97-616</p>	<p>Conversion Kit: LCD & Laptop to Dual</p> <p>Black</p> <p>Features</p> <ul style="list-style-type: none"> • Includes: Two monitor pivots and mounting hardware. • Converts WorkFit-S or WorkFit-A LCD & Laptop workstation into a Dual Workstation. • For use with screens 22"(559mm) or smaller. • Rotates 360°. • Weight capacity is contingent on the WorkFit platform to which the kit is added. 	97-616	\$69.00
 <p>97-615</p>	<p>Tall-User Kit for WorkFit Dual</p> <p>Black</p> <p>Features</p> <ul style="list-style-type: none"> • Includes: Two monitor pivots, two riser brackets and mounting hardware. • Converts WorkFit-S or WorkFit-A Dual display workstation to improve ergonomic height requirements of taller users. • For use with screens 24"(610mm) or smaller. • Maximum weight capacity: <ul style="list-style-type: none"> –Total capacity 28 pounds. –LCD – 6-14 pounds. • Rotates 360°. • Adds 30° of up/down tilt to displays. • Weight capacity is contingent on the WorkFit platform to which the kit is added. <p>Specification Tip</p> <ul style="list-style-type: none"> • Compatible with WorkFit-S and WorkFit-A. Also works with Dual Monitor Kit for WorkFit-T. 	97-615	\$96.00

Ergotron WorkFit — Accessories

WorkFit-A/WorkFit-S

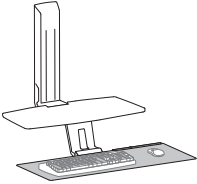
	Description	Height	Depth	Width	Number	Price
 <p>97-897</p>	Black	.25"(6mm)	11"(279mm)	27"(686mm)	97-897	\$117.00
	Features <ul style="list-style-type: none"> Includes: Large single piece keyboard tray and mounting hardware. Maximum weight capacity is 5 pounds. 		To Order, Specify: <ul style="list-style-type: none"> 1) Product number. 			
Specification Tips <ul style="list-style-type: none"> Compatible with WorkFit-S and WorkFit-A. Installs centered of offset to the right or left side. 						

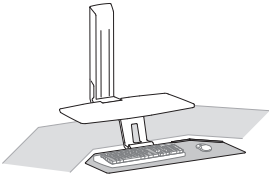
 <p>97-898</p>	Black	.25"(6mm)	11"(279mm)	27"(686mm)	97-898	\$117.00
	Features <ul style="list-style-type: none"> Includes: Corner single piece keyboard tray and mounting hardware. Maximum weight capacity is 5 pounds. 		To Order, Specify: <ul style="list-style-type: none"> 1) Product number. 			
Specification Tips <ul style="list-style-type: none"> Compatible with WorkFit-S and WorkFit-A. Installs centered of offset to the right or left side. 						

Ergotron WorkFit — Accessories

WorkFit-T/WorkFit-TL

	Description	Number	Price
WorkFit Single LCD Monitor Kit	Black	97-905	\$195.00
	White	97-935-062	189.00

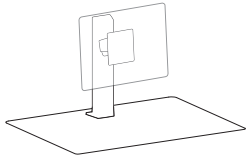

97-905
97-935-062

Features

- Includes: 5”(127mm) lift engine, one monitor pivot, dual bow, and hardware.
- For use with screen 24”(610mm) or smaller.
- Maximum weight capacity: 6-16 pounds.
- Tilts 30°.
- Rotates 360°.

To Order, Specify:

- 1) Product number.

Specification Tips

- Compatible with WorkFit-T and WorkFit-TL.
- When added to the WorkFit-T, overall capacity of the WorkFit-T decreases from 35 pounds to 28.4 pounds.
- When added to the WorkFit-TL, overall capacity of the WorkFit-TL is decreased from 40 pounds to 33.4 pounds.

WorkFit Dual Monitor Kit	Black	97-904	\$292.00
	White	97-934-062	285.00

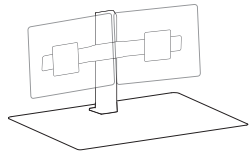

97-904
97-934-062

Features

- Includes: 5”(127mm) lift engine, two monitor pivots, dual bow, and hardware.
- For use with screen 24”(610mm) or smaller.
- Maximum weight capacity:
 - Total weight 12-28 pounds.
 - LCD weight 6-14 pounds each.
- Rotates 360°.

To Order, Specify:

- 1) Product number.

Specification Tips

- Compatible with WorkFit-T and WorkFit-TL.
- When added to the WorkFit-T, overall capacity of the WorkFit-T decreases from 35 pounds to 25.3 pounds.
- When added to WorkFit-TL, overall capacity of the WorkFit TL is decreased from 40 pounds to 30.3 pounds.

WorkFit LCD & Laptop Kit	Black	97-907	\$292.00
	White	97-933-062	285.00

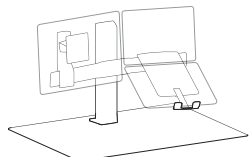

97-907
97-933-062

Features

- Includes: 5”(127mm) lift engine, one monitor pivot, one laptop tray, dual bow, and hardware.
- For use with screen 24”(610mm) or smaller.
- Maximum weight capacity: 12-26 pounds.
 - LCD 6-16 pounds.
 - Laptop Tray 10 pounds.
- Monitor tilts 30°.
- Monitor rotates 360°.

To Order, Specify:

- 1) Product number.

Specification Tips

- Compatible with WorkFit-T and WorkFit-TL.
- When added to the WorkFit-T, overall capacity of the WorkFit-T decreases from 35 pounds to 25 pounds.
- When added to the WorkFit-TL, overall capacity of the WorkFit-TL decreases from 40 pounds to 30 pounds.

Ergotron WorkFit — Anti-Fatigue Floor Mat

Height	Depth	Width	Number	Price
6.25"(159mm)	24"(610mm)	36"(914mm)	97-620-060	\$392.00

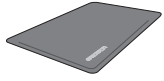

97-620-060

Features

- Includes: One floor mat.
- 5/8"(16mm) thick.
- Custom blended medium density polyurethane foam.
- High tear strength polyurethane outer membrane.
- Black only.
- TAA (Trade Agreements Act) compliant.

To Order, Specify:

- 1) Product number.

Ergotron Neo-Flex Laptop Cart

Height	Depth	Width	Number	Price
26.6"(676mm)-46.6"(1184mm)	22.8"(579mm)	17.5"(445mm)	24-205-214	\$1413.00

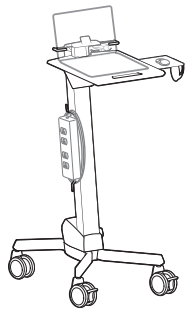

24-205-214
(power strip shown not included)

Features

- Includes: Integrated worksurface/keyboard tray with left/right mouse tray, scanner holder bracket, mouse holder, cable storage area, four dual casters (two locking), laptop security system, bracket for power strip and cable wrap.
- Compatible with most 12"(305mm)-17"(432mm) laptops. Maximum outside width of laptop is 18"(457mm).
- Maximum weight capacity is 15 pounds.
- Front handle on worksurface allows for easy mobility.
- 20"(508mm) height range adjustment allows for use from a seated or standing position.
- Worksurface dimensions 16.5"(419mm) W x 20.5"(521mm) D.
- Laptop cart standard in gray with 2 piece gray plastic worksurface.

To Order, Specify:

- 1) Product number.

Ergotron Teachwell® Mobile Digital Workspace

Height	Depth	Width	Number	Price
32"(813mm)-52"(1321mm)	24"(610mm)	31"(787mm)	24-220-055	\$1175.00

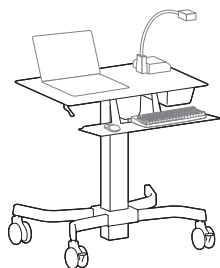

24-220-055

Features

- Includes: Cart, integrated phenolic worksurface, seamless keyboard/mousing tray, cable management box, cable winding brackets, four dual casters (two locking).
- Maximum weight capacity 38.5 pounds.
- Worksurface height adjustment range: 32"(813mm)-52"(1321mm).
Note: worksurface and keyboard tray adjust in tandem.
- Worksurface dimensions: 31"(787mm) W x 21"(533mm) D.
- Keyboard Tray: 26"(660mm) W x 9.4"(239mm) D stows under worksurface. Includes 5° back-tilt.
- Cable management box interior: 13.4"(340mm) W x 5"(127mm) D x 3.4"(86mm) H. Provides storage for one standard six-outlet power strip, two power bricks and the associated cables.
- Available in supplier graphite grey only.
- Includes mechanical mounting holes to mount many major document camera models. Ordered separately.
- Ships assembled.

To Order, Specify:

- 1) Product number.

Ergotron LearnFit

LearnFit Desk

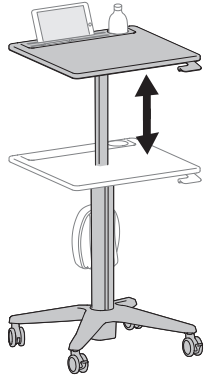

24-547-003
24-481-003

Description	Height	Depth	Width	Number	Price
Sit-Stand	29"(737mm)-44"(1118mm)	22"(559mm)	24"(610mm)	24-547-003	\$720.00
Standing	33"(838mm)-49"(1245mm)	22"(559mm)	24"(610mm)	24-481-003	720.00

Features

- Includes: One adjustable height desk with two locking and 2 non-locking casters and backpack hook.
- PrecisionHeight™ Technology allows for one-touch height adjustment.
- Worksurface includes built in cup holder, tablet stand pocket and pencil tray.
- Maximum weight capacity for desk surface is 15 pounds.
- Sit-Stand desk height range is 29"(737mm)-45"(1143mm). Adjustable Standing desk height range is 33"(838mm)-49"(1245mm).
- Standard with polished aluminum column and base with feathered gray laminate surface. Edgeband and cup holder/pencil tray standard in dark gray.

To Order, Specify:

- 1) Product number.

Storage Bin

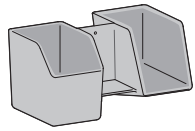

97-926-064

Dark Gray	8"(203mm)	8"(203mm)	14.5"(368mm)	97-926-064	\$75.00
-----------	-----------	-----------	--------------	------------	----------------

Features

- Includes: Molded plastic bins and mounting hardware.
- Sized to hold notebooks, folders and books.
- Smooth plastic surface.
- Maximum weight capacity is 8 pounds.
- Three separate compartments:
 - Enclosed, top-loaded on left side.
 - 3-sided, front-loaded on right side.
 - Smaller, 3-sided, front-loaded in center.

To Order, Specify:

- 1) Product number.

Specification Tips

- Compatible with LearnFit Adjustable Standing Desk
- Attaches at any height along the desk column.

Ergotron Zip 12 Charging

Height	Depth	Width	Number	Price
35.6"(904mm)	5.9"(150mm)	40.9"(1039mm)	DM12-1006-1	\$1756.00

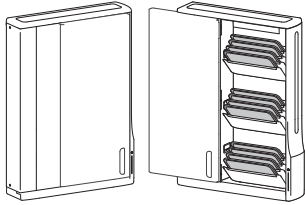

DM12-1006-1



Features

- Includes: Cabinet, 6' power cord, key and wall mounting hardware.
- Charges and secures up to 12 tablets or notebooks with screens up to 12"(305mm).
- Show & Stow™ technology tilting tablet trays pull out to load/unload and automatically retract.
- Sliding front access door.
- 12 receptacle outlet strip designed to work with oversized adapters. AC adapter maximum dimensions 4.1(104mm) H x 2"(51mm) W x 4"(102mm) D.
- Individual device maximum weight 3 pounds. Total weight capacity 44.4 pounds.
- Contains one 12V DC continuous operation cooling fan.
- Uses AC adapters that come with each device. AC adapters not included.
- Black with polished aluminum sliding door and laptop tray fronts.

To Order, Specify:

- 1) Product number.

Grommets

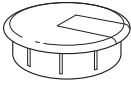

Height	Inside Diameter	Outside Diameter	Number	Price
1"(25mm)	2 3/4"(70mm)	3"(76mm)	WUAC-WSG	\$21.18

WUAC-WSG
Class CA – SIN 711-1;
Discount Group I

Features

- Includes one cover.
- Must be field-installed.
- Available in Charcoal color only.

To Order, Specify:

- 1) Product number.
(No finish specification required.)



Top Thickness	Diameter	Number	Trim A	B
1 3/16"(30mm)	3"(76mm)	WQAG-0303-PS	\$31.56	\$37.88
2"(51mm)	3"(76mm)	WQAG-0303-PM	31.56	37.88

WQAG
Class PT – SIN 711-11;
Discount Group IX

Features

- Includes one 3"(76mm) diameter grommet with cover.
- Requires 2 3/4"(70mm) diameter field drilled hole.
- Field installed.

To Order, Specify:

- 1) Product number.
- 2) Trim color.



Size	Diameter	Hole Size	Number	Price
Large grommet	2-3/4" inside	3"(76mm)	JAG-1	\$15.20

JAG-1
Class TS – GSA: Open Market

Features

- Includes one 1 9/16"(40mm) round grommet.
- Field drilled 1 3/4"(44mm) hole.
- Standard in black.

To Order, Specify:

- 1) Product number.
(No finish specification required.)



Size	Diameter	Hole Size	Number	Price
Large grommet	2-3/4" inside	3"(76mm)	JAG-2	\$17.54

JAG-2
Class TA – SIN 711-11;
Discount Group X

Features

- Install in field drilled 3"(76mm) hole.
- Standard in black.
- Removable cap.

To Order, Specify:

- 1) Product number.
(No finish specification required.)



Top Thickness	Diameter	Number	Trim A	B
3/4"(19mm)	2 3/4"(70mm)	TA01-0220	\$30.72	\$35.45

TA01-0220
Class TA – SIN 711-11;
Discount Group X

Features

- Includes one grommet.
- Field installed into field cut opening.

To Order, Specify:

- 1) Product number.
- 2) Trim color.

Grommets

Flip Top Unit — Hatch

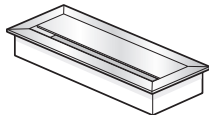

EUG1

Finishes	Bezel Width	Bezel Depth	Flip Top Unit Cutout Code	Configuration	Number	Price
Anodized						
	5 5/16"(133mm)	4 3/8"(111mm)	A, B	2	EUG1-0000-G2NNNW	\$185.38
	8 5/16"(211mm)		F, V	4	EUG1-0000-G4NNNW	196.97
	11 1/4(286mm)		J, K	6	EUG1-0000-G6NNNW	208.56
Black						
	5 5/16"(133mm)	4 3/8"(111mm)	A, B	2	EUG1-0000-G2NNNB	\$243.31
	8 5/16"(211mm)		F, V	4	EUG1-0000-G4NNNB	254.90
	11 1/4(286mm)		J, K	6	EUG1-0000-G6NNNB	266.49

Features

- Includes one flip top unit hatch.
- Hatch is flush mounted with spring release cover; 1/2"(13mm) gap between cover and bezel for cords.
- Available in anodized or black finish.
- Field installed.

To Order, Specify:

- 1) Product number.
(No finish specification required.)

Specification Tips

- Specify for cord management as needed.
- Order hatch to match cutouts specified for each table.

Information Display

Planes Easels

	Height	Depth	Width	Number	①	Trim A	B
Standard Easel	75"(1905mm)	28"(711mm)	45"(1143mm)	KAIE-0029-LJS	■ B	\$1615.35	\$1659.07

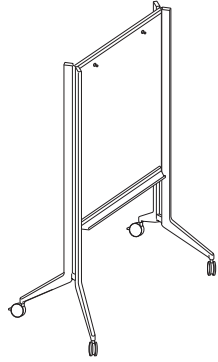

KAIE-0029

Features

- Includes frame and attached, two-sided laminate writing surface/center board with attached marker tray.
- Markers and erasers separately specified.
- **One information board can be hung from each side of easel; specify separately.**
- Center board has pins to allow hanging of standard size easel paper pad.
- Writable surface/center board is 0.64"(16mm) thick with 1mm bright white edgeband and has a 31"(787mm) wide x 43"(1092mm) high writing surface.
- Aluminum frame available in metallic trim colors only.
- Easel marker tray is 30"(762mm) wide x 1 3/8"(35mm) high x 3"(76mm) deep. Accessible from one side only.
- Optional casters or glides are field interchangeable:
 - Casters (two locking/two non-locking) are available with:
 - Light platinum or fog hub with graphite tread, or
 - black hub with black tread.
- Optional glides (four) are available in light platinum, fog or black with 1/2"(13mm) height adjustment.
 - Glide stem is painted to match base; glide base disc color must be specified.
- Easel can be used as a projection screen and/or space divider.
- Easel height with information board(s) attached is 78"(1981mm).
- Ships unassembled.

To Order, Specify:

1) Product number, including:

① Base Option:

- C** Caster
- G** Glide, add **\$75.00** list

2) Frame trim color.

3) Caster/Glide base disc trim color:
 Black – TR-F
 Fog – TR-7
 Light Platinum – TR-LPL

Specification Tips

- Only Planes information boards can be hung off the Planes easel.
- The following Planes products are separately specified:
 - Information Boards
- **The following products are recommended to maintain the markerboard appearance:**
 - Dry erase marker kit (includes holder, six markers and eraser), order part# 7062-8001.
 - Markerboard cleaner and conditioner, order part# 7031-7001.
 - Markerboard spray cleaner, order part# 7031-7002.

Information Display

Planes Easels

	Height	Depth	Width	Number	①	Trim A	B
Large Easel	75"(1905mm)	28"(711mm)	88"(2235mm)	KAIE-0072-LJS	■	B	\$2265.35 \$2309.07

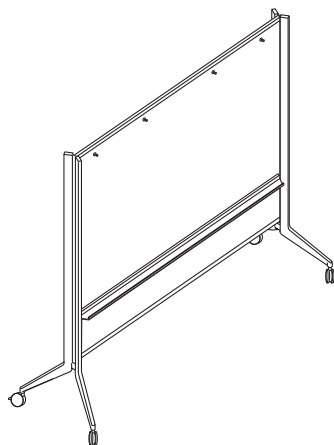

KAIE-0072

Features

- Includes frame, and attached, two-sided laminate writing surface/center board with attached marker tray.
- Markers and erasers separately specified.
- **Two information boards can be hung from each side of easel; specify separately.**
- Center board has pins to allow hanging of standard size easel paper pads.
- Writable surface/center board is 0.64"(16mm) thick with 1mm bright white edgeband and has a 74"(1880mm) wide x 43"(1092mm) high writing surface.
- Aluminum frame available in metallic trim colors only.
- Easel marker tray is 73"(1854mm) wide x 1 3/8"(35mm) high x 3"(76mm) deep. Accessible from one side only.
- Optional casters or glides are field interchangeable:
 - Casters (two locking/two non-locking) are available with: Light platinum or fog hub with graphite tread, or black hub with black tread.
- Optional glides (four) are available in light platinum, fog or black with 1/2"(13mm) height adjustment.
 - Glide stem is painted to match base; glide base disc color must be specified.
- Easel can be used as a projection screen and/or space divider.
- Easel height with information board(s) attached is 78"(1981mm).
- Ships unassembled.

To Order, Specify:

- 1) Product number, including:
 - ① **Base Option:**
 - Caster
 - Glide, add **\$75.00** list
- 2) Frame trim color.
- 3) Caster/Glide base disc trim color:
 - Black – TR-F
 - Fog – TR-7
 - Light Platinum – TR-LPL

Specification Tips

- Only Planes information boards can be hung off the Planes easel.
- The following Planes products are separately specified:
 - Information Boards
- **The following products are recommended to maintain the markerboard appearance:**
 - Dry erase marker kit (includes holder, six markers and eraser), order part# 7062-8001.
 - Markerboard cleaner and conditioner, order part# 7031-7001.
 - Markerboard spray cleaner, order part# 7031-7002.

Information Display

Planes Boards and Accessories

	Height	Width	Number	Price
Information Boards	42"(1067mm)	40"(1016mm)	KAIB-0040-LJSNA	\$487.06

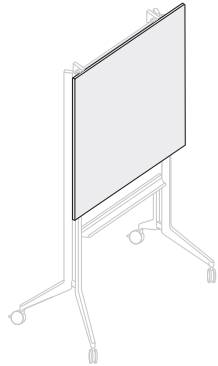

KAIB-0040

Features

- Includes one information board and attachment cleats.
- Markers and erasers separately specified.
- Laminate writable surface/information boards are 0.64"(16mm) thick with one usable side and 1mm bright white edgeband.
- Safety interlock prevents dislodgement from easels and horizontal wall rail.
- Lightweight construction – each board is approximately 19 pounds.
- Information board cleats and bumpers are light platinum.
- Ships assembled.

To Order, Specify:

- 1) Product number.
(No finish specification required.)

Specification Tips

- **Planes information boards add 3"(76mm) to overall easel height.**
- Information board back cleats (2) fit over top rail of easel and lower bumpers (2) allow vertical alignment.
- The following Planes products are separately specified:
 - Standard Easel
 - Large Easel
 - Horizontal Wall Rail for Information Boards
- **The following products are recommended to maintain the markerboard appearance:**
 - Dry erase marker kit (includes holder, six markers and eraser), order part# 7062-8001.
 - Markerboard cleaner and conditioner, order part# 7031-7001.
 - Markerboard spray cleaner, order part# 7031-7002.

Horizontal Wall Rail for Information Boards

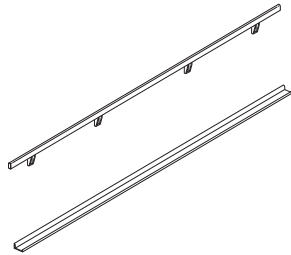

KAIW-0096

	Width	Number	Trim A	B
	96"(2438mm)	KAIW-0096	\$1149.88	\$1193.90

Features

- Includes upper and lower rails, four wall cleats, two end caps and hardware.
- Lower rail also functions as a 2 1/4"(57mm) x 96"(2438mm) marker tray.
- 96"(2438mm) horizontal wall rail accommodates two information boards side-by-side.
- Rails can be cut down to accommodate desired width.
- Rail end caps and cleats are light platinum.
- Wall rails are mounted horizontally.
- Ships unassembled.

To Order, Specify:

- 1) Product number.
- 2) Trim color for rail.

Specification Tips

- **Planes horizontal wall rail requires proper structural wall backing for support. Mounting hardware is field supplied.**
- The following Planes products are separately specified:
 - Information Boards

Wall Cleat for Information Boards

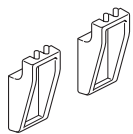

KAIH-0000

	Height	Depth	Width	Number	Price
	3-1/2"(89mm)	1-1/2"(38mm)	1-3/4"(44mm)	KAIH-0000	\$79.86

Features

- Includes two cleats in light platinum.
- For use with the Planes information board horizontal wall rail in field modified application.

To Order, Specify:

- 1) Product number.
(No finish specification required.)

Specification Tip

- **Planes horizontal wall rail requires proper structural wall backing for support. Mounting hardware is field supplied.**

Information Display

Planes Boards and Accessories

	Number	Price
Horizontal Wall Rail End Caps	KAIC-0000	\$14.16

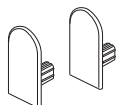

KAIC-0000

Features

- Includes two end caps in light platinum.
- For use with the Planes information board horizontal wall rail in field modified application.

To Order, Specify:

- 1) Product number.
(No finish specification required.)

Specification Tip

- **Planes horizontal wall rail requires proper structural wall backing for support. Mounting hardware is field supplied.**

	Number	Price
Y-Leg Bumper	TA01-0214	\$8.04

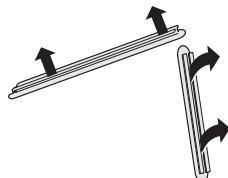

TA01-0214

Description

For use on 30"(762mm) deep top

Feature

- Includes 4 bumpers in light platinum, for easel Y-leg.

To Order, Specify:

- 1) Product number
(No color specification required.)

Specification Tip

- Protects Y-leg tables when nested.

Information Display

	Height	Width	Number	Trim A	B
Markerboard / Frosted Insert	47"(1194mm)	36"(914mm)	BBF-4736-MC	\$1316.73	\$1335.72
		48"(1219mm)	BBF-4748-MC	1517.38	1536.98
	52"(1321mm)	36"(914mm)	BBF-5236-MC	\$1359.93	\$1380.42
		48"(1219mm)	BBF-5248-MC	1560.58	1581.68
	63"(1600mm)	36"(914mm)	BBF-6336-MC	\$1454.97	\$1478.76
		48"(1219mm)	BBF-6348-MC	1655.62	1680.02

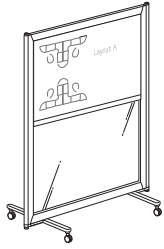

BBF-MC

To Order, Specify:

- 1) Product number.
- 2) Trim color for frame.
- 3) Metallic trim color for feet and casters.

Markerboard / Perforated Metal Insert

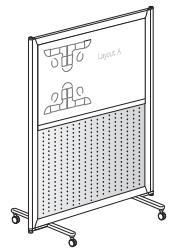

BBF-MB

Height	Width	Number	Trims A/A	A/B	B/B	B/A
47"(1194mm)	36"(914mm)	BBF-4736-MB	\$1452.38	\$1465.85	\$1471.37	\$1484.84
	48"(1219mm)	BBF-4748-MB	1653.03	1666.50	1672.63	1686.10
52"(1321mm)	36"(914mm)	BBF-5236-MB	\$1495.58	\$1509.05	\$1516.07	\$1529.54
	48"(1219mm)	BBF-5248-MB	1696.23	1709.70	1717.33	1730.80
63"(1600mm)	36"(914mm)	BBF-6336-MB	\$1590.62	\$1604.09	\$1614.41	\$1627.88
	48"(1219mm)	BBF-6348-MB	1791.27	1804.74	1815.67	1829.14

Features

- Includes screen, two O-rings, two T-Leg bases with 2 non-locking casters and 2 locking casters.
- Mobile freestanding screen has two-sided markerboard on top with frosted or perforated metal insert on the bottom.
- Includes single marker/eraser that can be mounted to the screen.
- O-ring accommodates joining of same height screens.
- T-Legs are Metallic trim color.
- Magnets can be used with perforated metal inserts.
- Perforated metal insert screen has no acoustical or tackable value.
- Screens are non-load bearing.
- 19"(438mm) T-Leg centered on 1 1/8"(29mm) thick frame.
- Frosted insert is identical to frosted and textured acrylic material used in desktop screens.
- T-Legs shipped unassembled.

To Order, Specify:

- 1) Product number.
- 2) Trim color for frame.
- 3) Trim color for perforated metal insert.
- 4) Metallic trim color for feet and casters.

Specification Tips

- No limit to number of same height screens ganged together.
- Screens cannot be folded together.

Information Display

Markerboard Insert

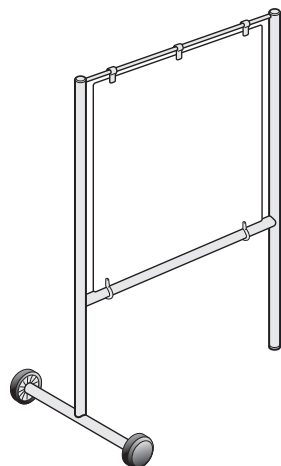

NBFS-M

Height	Width	Number	Trim	
			A	B
53"(1346mm)	36"(914mm)	NBFS-5336-M	\$1130.04	\$1153.63
	48"(1219mm)	NBFS-5348-M	1372.86	1401.17
64"(1626mm)	36"(914mm)	NBFS-6436-M	\$1278.43	\$1304.38
	48"(1219mm)	NBFS-6448-M	1575.21	1605.88

Features

- Includes frame, markerboard insert, and attachment hardware.
- Markers and erasers not included.
- Attachment hardware is clear.
- 4"(102mm) wheels are non-locking. Standard in black finish color only.
- Screens are non-load bearing.
- Two-sided acrylic markerboard.
- Screens are shipped unassembled.

To Order, Specify:

- 1) Product number.
- 2) Trim color for frame.

Specification Tips

- 53"(1346mm) high freestanding screens have 20"(508mm) wheel span centered on 1 1/4"(32mm) thick frame.
- 64"(1626mm) high freestanding screens have 24"(610mm) wheel span centered on 1 1/4"(32mm) thick frame.
- Clearance height is 17 3/8"(441mm).
- **The following products are recommended to maintain the markerboard appearance:**
 - Dry erase marker kit (includes holder, six markers and eraser), order part# 7062-8001.
 - Markerboard cleaner and conditioner, order part# 7031-7001.
 - Markerboard spray cleaner, order part# 7031-7002.

Information Display

	Description	Number	Price
Markerboard Accessories	Dry Erase Marker Kit (holder, six markers and eraser)	7062-8001	\$121.56
	Cleaner and Conditioner	7031-7001	139.11
	Spray Cleaner	7031-7002	44.31

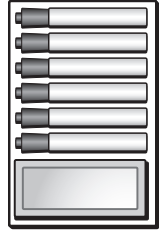

7062-8001



7031-7002



7031-7001

Feature

- Recommended dry erase marker products to maintain, clean & condition markerboards.

To Order, Specify:

- 1) Product number
(No finish specification required.)

Pip

Personal Laptop Table



STP-P26-TH

Height	Depth	Width	Number		Painted MDF	White Oak	Walnut
			1	2			
26"(660mm)	13"(330mm)	21.25"(540mm)	STP-	26-T	\$531.00	\$965.00	\$1085.00

Features

- Includes table top, base and hardware.
- Top available in painted MDF or planked wood in White Oak or Walnut.
- Wood tops are designed to be unique using solid wood planks with a clear, low-gloss finish showing natural variation.
- Base: Painted aluminum support plate and column with painted steel base plate.
- Ships unassembled.

To Order, Specify:

1) Product number, including:

1 Surface Material:

- P** Painted MDF
- W** Planked Wood

2 Glide Type:

- H** Hard Plastic
- F** Felt

2) Top surface and color.

3) Base trim color.

Lighting — Haworth

	Fixture Length	Watts	Number	Price
Reed Premier™ Stand-Alone LED Task Light	16.4"(417mm)	7.8	LUTS-0017-19ULD5	\$220.58

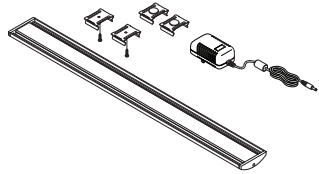

LUTS-0017-19ULD5



Features

- Includes 17"(432mm) LED fixture, 15 watt power supply with nine foot removable power cord.
- Standard in anodized (silver) color with white end caps.
- Height: 0.5"(12.7mm); Width: 2.0"(51mm); Length: 16.4"(417mm).

Specification Tips

- For use with 120 volt, 60 hertz electrical system.
- Color Temp: 3500K.
- Color Rendition Index: 84 CRI.
- Rated Lifespan: 5 0,000 hour.
- Not intended for daisy chaining.
- Single touch on/off with continuous dimming from 15-100%.
- Includes screw and magnetic attachment hardware for steel, laminate and wood.
- Intended for use in horizontal applications.

To Order, Specify:

- 1) Product number.
(No finish specification required.)

Reed Premier™ Starter LED Task Light	16.4"(417mm)	7.8	LUTS-0017-12ULD6	\$303.30
	30.1"(765mm)	17.6	LUTS-0031-12ULD6	441.34
	43.7"(1110mm)	25.9	LUTS-0044-12ULD6	569.52
	57.4"(1458mm)	33.6	LUTS-0058-12ULD6	707.56

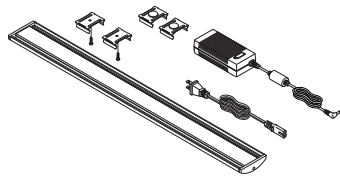

LUTS-0017-12ULD6



Features

- Includes LED fixture, 60 watt power supply with twelve foot removable power cord.
- Standard in anodized (silver) color with white end caps.
- Height: 0.5"(12.7mm); Width: 2.0"(51mm); Lengths: 16.4"(417mm), 30.1"(765mm), 43.7"(1110mm) or 57.4"(1458mm).

Specification Tips

- For use with 120 volt, 60 hertz electrical system.
- Color Temp: 3500K.
- Color Rendition Index: 84 CRI.
- Rated Lifespan: 5 0,000 hour.
- Refer to the Specification Guide for a chart showing the total number of light fixtures that can be daisy chained together.
- Single touch on/off with continuous dimming from 15-100%.
- Includes screw and magnetic attachment hardware for steel, laminate and wood.
- Intended for use in horizontal applications.

To Order, Specify:

- 1) Product number.
(No finish specification required.)

Lighting — Haworth

	Fixture Length	Watts	Number	Price
Reed Premier™	16.4"(417mm)	7.8	LUTD-0017-1NULDN	\$220.58
Add-On LED Task Light —	30.1"(765mm)	17.6	LUTD-0031-1NULDN	358.62
For Use with Reed Premier Starter	43.7"(1110mm)	25.9	LUTD-0044-1NULDN	486.80
LED Task Lights	57.4"(1458mm)	33.6	LUTD-0058-1NULDN	624.84

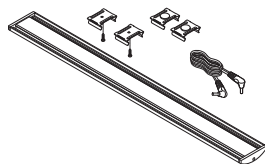

LUTD-0017-1NULDN



Features

- Includes LED fixture, 8"(203mm) and 30"(762mm) daisy chain cord.
- Standard in anodized (silver) color with white end caps.
- Height: 0.5"(12.7mm); Width: 2.0"(51mm); Lengths: 16.4"(417mm), 30.1"(765mm), 43.7"(1110mm) or 57.4"(1458mm).

To Order, Specify:

- 1) Product number.
(No finish specification required.)

Specification Tips

- For use with 120 volt, 60 hertz electrical system.
- Color Temp: 3500K.
- Color Rendition Index: 84 CRI.
- Rated Lifespan: 5 0,000 hour.
- Refer to the Specification Guide for a chart showing the total number of light fixtures that can be daisy chained together.
- Single touch on/off with continuous dimming from 15-100%.
- Includes screw and magnetic attachment hardware for steel, laminate and wood.
- Intended for use in horizontal applications.

Reed Premier™
Add-On Occupancy Sensor

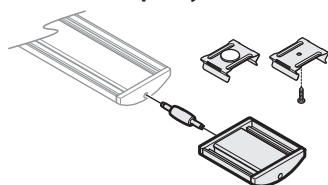

LUTS-0000



LUTS-0000

\$248.16

Features

- Includes occupancy sensor and attachment connector.
- Standard in anodized (silver) color with white end caps.
- Height: 0.7"(17.8mm); Width: 2.0"(51mm); Length: 2.3"(58mm).

To Order, Specify:

- 1) Product number.
(No finish specification required.)

Specification Tips

- For use with 120 volt, 60 hertz electrical system.
- Includes screw and magnetic attachment hardware for steel, laminate and wood.
- Intended for use in horizontal applications.

Lighting — Haworth

Voyage without Occupancy Sensor

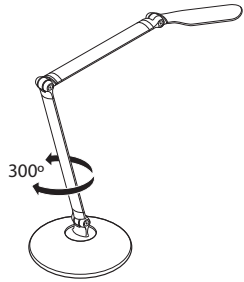

LUV1



Features

- Includes base, adjustable arm fixture with LED light and 6'(182cm) removable cord.
- Available in supplier silver, white or black.
- Touch controls for On/Off switching and continuous 100-15% dimming.
- Arm rotates 300°.
- Base footprint: 6"(152mm) diameter.
- Clamp mount can be used on horizontal surfaces from 0.90"(23mm) to 1.87"(47mm) thick.
- Minor assembly required.
- Auto turn off after 10 hours of use.
- **For use with 120 volt 60 hertz electrical system.**
- Power consumption: 7W.
- Color temperature 3500k.
- Luminosity: 250 Lumens.
- Color Rendition Index: 84 CRI.
- 50K hour lifespan.
- Cord length: 6'(182cm).

LUV1-0012-07 LC

\$482.85

To Order, Specify:

- 1) Product number, including:

① Attachment:

- F Freestanding
- G Clamp

- 2) Trim color.
 - TR-11 Black
 - TR-12 Silver
 - TR-13 White

Voyage with Occupancy Sensor

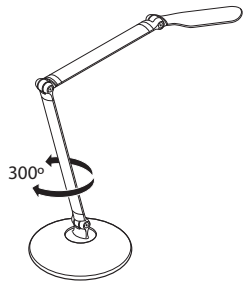

LUV2



Features

- Includes base, adjustable arm fixture with LED light and 6'(182cm) removable cord.
- Available in supplier silver, white or black.
- Touch controls for On/Off switching and continuous 100-15% dimming.
- Arm rotates 300°.
- Base footprint: 6"(152mm) diameter.
- Clamp mount can be used on horizontal surfaces from 0.90"(23mm) to 1.87"(47mm) thick.
- Minor assembly required.
- **For use with 120 volt 60 hertz electrical system.**
- Power consumption: 7W.
- Color temperature 3500k.
- Luminosity: 250 Lumens.
- Color Rendition Index: 84 CRI.
- 50K hour lifespan.
- Cord length: 6'(182cm).

LUV2-0012-07 LO

\$710.07

To Order, Specify:

- 1) Product number, including:

① Attachment:

- F Freestanding
- G Clamp

- 2) Trim color.
 - TR-11 Black
 - TR-12 Silver
 - TR-13 White

Lighting — Haworth Collection

Brazo

	Base Diameter	Model	Number	Price
Freestanding Lighting	8.5"(216mm)	Table Light	LBJ1-0026-19FLC	\$460.00
		Floor Light	LBJ2-0026-19FLC	510.00

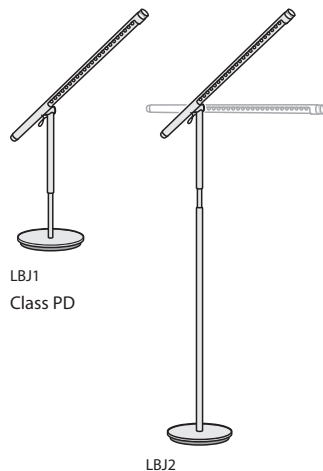

LBJ1
Class PD

LBJ2



Features

- Includes base, adjustable height fixture, 26 1/2"(673mm) arm with LED light and clear lens, nine foot removable silvertone cord.
- Available in Brushed Aluminum, Gloss White, Anodized Black or Anodized Bronze finish colors.
- Features a LED light source with full dim control knob located on end of arm and 90° disbursement adjustment.
- 1.5 to 9 watts.
- Arm rotates 360°.
- Table light adjustable height fixture range is 14"-22"(356mm-559mm) from desktop.
- Floor light adjustable height fixture range is 48"-56"(1219-1422mm) from floor.
- Base includes scratch-resistant bottom cover with side cord location.
- **For use with 120 volt 60 hertz electrical system.**
- Table light overall height range with arm extended at 180° is 41"(1041mm).
- Floor light overall height range with arm extended at 180° is 74 3/4"(1899mm).
- Minor assembly required.

To Order, Specify:

1) Product number, including:

1 Finish Color

- N** Brushed Aluminum
- W** Gloss White
- B** Anodized Black
- Z** Anodized Bronze

Mounted Lighting

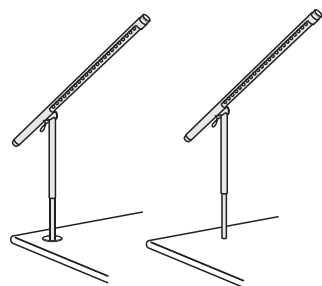

LBJ3
Class PD

LBJ4



	Grommet/Hole Diameter	Model	Number	Price
	3"(76mm)	Grommet Mounted Light	LBJ3-0026-19GLC	\$445.00
	1"(25mm)	Worksurface Mounted Light	LBJ4-0026-19GLC	445.00

Features

- Grommet Mount includes adjustable height fixture, 26 1/2"(673mm) arm with LED light and clear lens, nine foot removable silvertone cord and attachment hardware. **Grommet ordered separately.**
- Worksurface Mount includes adjustable height fixture, 26 1/2"(673mm) arm with LED light and clear lens, nine foot removable silvertone cord and attachment hardware with trim ring.
- Available in Brushed Aluminum, Gloss White, Anodized Black or Anodized Bronze finish colors.
- Features a LED light source with full dim control knob located on end of arm and 90° disbursement adjustment.
- 1.5 to 9 watts.
- Arm rotates 360°.
- Both mounted light adjustable height fixture range is 13"-21"(330mm-533mm) from desktop.
- **For use with 120 volt 60 hertz electrical system.**
- Overall height range with arm extended at 180° is 40"(1016mm).
- Minor assembly required.

To Order, Specify:

1) Product number, including:

1 Finish Color

- N** Brushed Aluminum
- W** Gloss White
- B** Anodized Black
- Z** Anodized Bronze

2 Worksurface Thickness

- S** 1 3/16"(30mm)
- M** 2"(51mm)
- Q** 3"(76mm)

Specification Tips

- **Grommet Mount Brazo requires a separately specified grommet.**
- Field drilling of surface required.

Grommet — For Use with Brazo Grommet Mounted Light Only



WQAG
Class PT

Top Thickness	Number	Price
1 3/16"(30mm)	WQAG-0303-PSN	\$25.00
2"(51mm)	WQAG-0303-PMN	25.00
3"(76mm)	WQAG-0303-PQN	25.00

Feature

- Includes one 3"(76mm) diameter grommet without cover.

Specification Tips

- Specify grommet to match product top thickness.
- Requires a 2 3/4"(70mm) diameter field drilled hole.
- For use with Brazo Grommet Mounted Light only.

To Order, Specify:

- Product number.
- Trim color.
 - TR-TW Plaster
 - TR-LE Metallic Silver
 - TR-MC Metallic Champagne

Lighting — Haworth Collection

Circa

Description	Number	Price
Table Light	LRT1-1408	\$450.00
Grommet Mounted Light	LRT1-1408-G	435.00

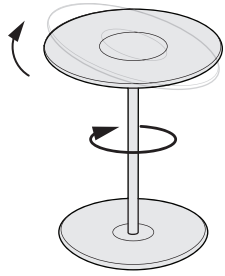

LRT1-1408



Features

- Includes base, aluminum stem, lamp shade with LED flat panel light, polycarbonate lens assembly and 8' fabric wrapped cord.
- Grommet mounted base includes attachment hardware with grommet.
- Base: 10"(254mm) diameter plastic with a steel insert and built-in USB charging port.
- 12"(305mm) diameter flat panel lamp shade is plastic with a polycarbonate lens assembly.
- Lamp shade rotates 360° and tilts 45° in two directions.
- Stem 14"(356mm) high.
- Features a LED light source with full range dim control.
- 9 watts.

To Order, Specify:

- 1) Product number.
- 2) Trim color.
TR-R01 Graphite
TR-R02 White

Specification Tips

- For use with 120 volt 60 hertz electrical system.
- Minor assembly required.

Floor Light

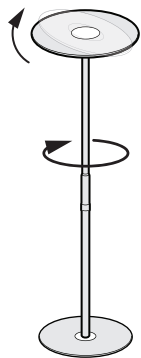

LRF0-5208

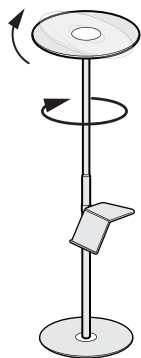

LRF1-5208



Without Pedestal	LRF0-5208	\$695.00
With Pedestal	LRF1-5208	760.00

Features

- Includes base, aluminum stem, lamp shade with LED flat panel light, polycarbonate lens assembly and 8' fabric wrapped cord.
- Base: 14"(356mm) diameter base is plastic with a steel insert.
- 16"(406mm) diameter flat panel lamp shade is plastic with a polycarbonate lens assembly.
- Lamp shade rotates 360° and tilts 45° in two directions.
- Stem 52"(1321mm) high with built-in USB port.
- Features a LED light source with full range dim control.
- 11 watts.
- Available with optional steel pedestal that can be used to dock tablets, phones and books.
- Optional pedestal is 22.5"(572mm) from floor and 5.5"(140mm) wide.

To Order, Specify:



- 1) Product number.
- 2) Trim color.
TR-R01 Graphite
TR-R02 White



Specification Tips

- For use with 120 volt 60 hertz electrical system.
- Minor assembly required.

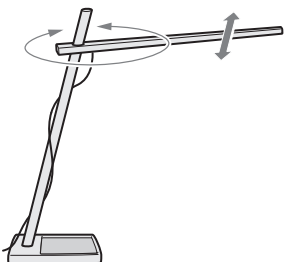
Lighting — Haworth Collection

Clamp

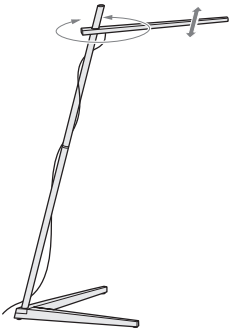
	Number	Price
Table Light  LCC1-1808-NFLC 	LCC1-1808-NFLC	\$310.00
Features <ul style="list-style-type: none"> • Includes wooden base, arm and stem, clear polycarbonate lens, 8' fabric wrapped cord. • Advanced LED array eliminates shadows and has dim control. • Arm slides up and down stem of light and rotates 360°. • Table base features an integrated tray. • Base: 8"(203mm) wide and 5.5"(140mm) deep. • Arm: 18.25"(464mm) wide. • Stem: 18"(457mm) high. • 6 watts. 		
Specification Tips <ul style="list-style-type: none"> • For use with 120 volt 60 hertz electrical system. • Minor assembly required. 		
To Order, Specify: <ol style="list-style-type: none"> 1) Product number. 2) Wood finish. VR-2 Walnut NR-2 White Oak 3) Cord fabric color. TR-H31 Black TR-H30 Red 		

Floor Light  LCC2-2608-NFLC 	LCC2-2608-NFLC	\$600.00
Features <ul style="list-style-type: none"> • Includes wooden base, arm and stem, clear polycarbonate lens, and 8' fabric wrapped cord. • Advanced LED array eliminates shadows and has dim control. • Arm slides up and down stem of light and rotates 360°. • Base: 18.5"(470mm) wide and 18.25"(464mm) deep. • Arm: 26"(660mm) wide. • Stem: 52"(1321mm) high. • 9 watts. 		
Specification Tips <ul style="list-style-type: none"> • For use with 120 volt 60 hertz electrical system. • Minor assembly required. 		
To Order, Specify: <ol style="list-style-type: none"> 1) Product number. 2) Wood finish. VR-2 Walnut NR-2 White Oak 3) Cord fabric color. TR-H31 Black TR-H30 Red 		

Lighting — Haworth Collection

Contour

Table Light



LCT1-1708



Description	Height	Depth	Width	Number	Price
Small Table Light					
Fabric Interior	17.5"(445mm)	6"(152mm)	12"(305mm)	LCT1-1708	\$350.00
Wood Interior	17.5"(445mm)	6"(152mm)	12"(305mm)	LCT1-1708	385.00
Large Table Light					
Fabric Interior	25"(635mm)	6"(152mm)	13"(330mm)	LCT2-2508	\$415.00
Wood Interior	25"(635mm)	6"(152mm)	13"(330mm)	LCT2-2508	450.00

Features

- Includes one aluminum body construction light with polycarbonate lens assembly, USB charging port and 8' fabric wrapped cord.
- Full range dim control for glare free, high output LED light.
- Base: Plastic with built-in USB charging port. Interior of light is lined with wood veneer or fabric.
- 8 watts.
- Available in the following colors:
 - Fabric Interior
 - Graphite Exterior, Coal Interior (TR-C04)
 - White Exterior, Pearl Interior (TR-C07)
 - Wood Interior
 - Graphite Exterior, Walnut Interior (TR-C05)
 - Graphite Exterior, White Oak Interior (TR-C06)
 - White Exterior, Walnut Interior (TR-C08)
 - White Exterior, White Oak Interior (TR-C09)

To Order, Specify:

- 1) Product number.
- 2) Trim color.

Specification Tip

- For use with 120 volt 60 hertz electrical system.

Floor Light

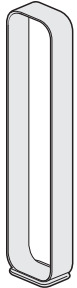

LCF1-6009



Fabric Interior	60"(1524mm)	8"(203mm)	13"(330mm)	LCF1-6009	\$645.00
Wood Interior	60"(1524mm)	8"(203mm)	13"(330mm)	LCF1-6009	690.00

Features

- Includes one aluminum body construction light with polycarbonate lens assembly, USB charging port and 9' fabric wrapped cord.
- Full range dim control for glare free, high output LED light.
- Base: Plastic with built-in USB charging port. Interior of light is lined with wood veneer or fabric.
- 21.5 watts.
- Available in the following colors:
 - Fabric Interior
 - Graphite Exterior, Coal Interior (TR-C04)
 - White Exterior, Pearl Interior (TR-C07)
 - Wood Interior
 - Graphite Exterior, Walnut Interior (TR-C05)
 - Graphite Exterior, White Oak Interior (TR-C06)
 - White Exterior, Walnut Interior (TR-C08)
 - White Exterior, White Oak Interior (TR-C09)

To Order, Specify:

- 1) Product number.
- 2) Trim color.

Specification Tip

- For use with 120 volt 60 hertz electrical system.

Lighting — Haworth Collection

Corner Office

	Height	Depth	Width	Number	Price
Table Light	18"(457mm)	7.5"(191mm)	7.5"(191mm)	HCPL-COT1-07	\$475.00

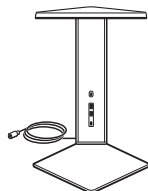

HCPL-COT1-07



Features

- Includes one white metal base and arm, light and 10' cord.
- LED light with full range dim control.
- Optical touch switch.
- Two USB 2.0 ports (10W) and one USB-C 3.1 C port (35W) built into arm.
- Light: 8 watts.
- System power: 63 watts.

To Order, Specify:

- 1) Product number.

Specification Tips

- **For use with 120 volt 60 hertz electrical systems.**
- Minor assembly required.

Table Light with Small Panel	18"(457mm)	15.5"(390mm)	15.5"(390mm)	HCPL-COT2-15	\$695.00
-------------------------------------	------------	--------------	--------------	--------------	-----------------

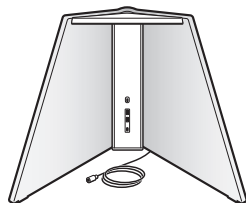

HCPL-COT2-15



Features

- Includes one white metal base and arm, fabric panel, light, and 10' cord.
- LED light with full range dim control.
- Optical touch switch.
- Two USB 2.0 ports (10W) and one USB-C 3.1 C port (35W) built into arm.
- Fabric panel provides visual and acoustic privacy.
- Light 8 watts.
- System power: 63 watts

To Order, Specify:

- 1) Product number.
- 2) Fabric color.
 - 6P-1 Anthracite
 - 6P-2 Chestnut
 - 6P-3 Stone Grey
 - 6P-4 Turquoise

Specification Tips

- **For use with 120 volt 60 hertz electrical system.**
- Minor assembly required.

Table Light with Large Panel	18"(457mm)	15.5"(390mm)	30"(762mm)	HCPL-COT3-30	\$795.00
-------------------------------------	------------	--------------	------------	--------------	-----------------

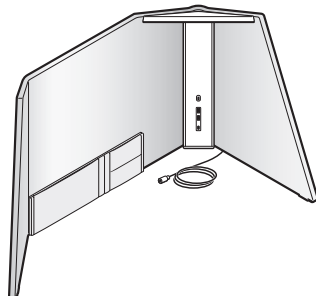

HCPL-COT3-30



Features

- Includes one white metal base and arm, fabric panel, light, 10' cord, and removable pocket accessory.
- LED light with full range dim control.
- Optical touch switch.
- Two USB 2.0 ports (10W) and one USB-C 3.1 C port (35W) built into arm.
- Reversible fabric panel provides visual and acoustic privacy.
- Light 8 watts.
- System power: 63 watts

To Order, Specify:

- 1) Product number.
- 2) Fabric color.
 - 6P-1 Anthracite
 - 6P-2 Chestnut
 - 6P-3 Stone Grey
 - 6P-4 Turquoise

Specification Tips

- **For use with 120 volt 60 hertz electrical system.**
- Minor assembly required.

Lighting — Haworth Collection

Giraffa

	Description	Height	Depth	Width	Number	Price
Table Light	Standard Trim	13"(330mm)	2.25"(57mm)	7"(178mm)	HCPL-GFT1-13	\$249.00
	Premium Trim				HCPL-GFT1-13	269.00

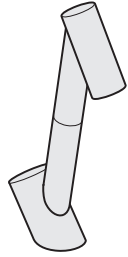

HCPL-GFT1-13



Features

- Includes one high output LED light with aluminum body and polycarbonate lens assembly, and 6' fabric cord.
- Integrated touch switch control.
- Full range dimming built into the base.
- Light source rotates 360°.
- 4.6 watts.

Specification Tip

- **For use with 120 volt 60 hertz electrical system.**

To Order, Specify:

- 1) Product number.
- 2) Trim color.
 Standard
 TR-G01 Black
 TR-G03 White
 Premium
 TR-G02 Copper

Lighting — Haworth Collection

LIM

	Base/Mount	Number	Price
Freestanding Lighting	Table Light with Block	LLL1-0022-19FLC	\$330.00
	Table Light with Pivot	LLL2-0022-19FLC	300.00
	Floor Light	LLL3-0022-19FLC	375.00

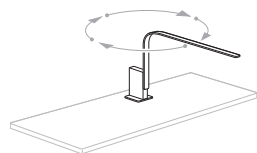

Table Light with Block
LLL1

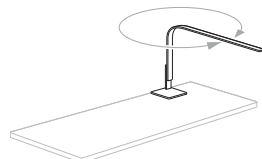
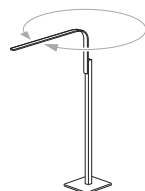

Table Light with Pivot
LLL2



Floor Light
LLL3



Features

- Includes base/mount, 22”(559mm) arm with LED light with a clear lens, nine foot removable silvertone cord, and one wire management clip.
- Features two-stage light control with 3.0 watt and 7.3 watt selection.
- All lights use magnets to attach to base or brackets.
- **Table Light with Block:**
 - Available in Textured White, Textured Black and Brushed Aluminum.
 - Arm rotates around magnetic connection between base and light arm.
 - Adjustable height fixture range is 12”-15.75”(305mm-400mm) from desktop.
 - Base includes scratch-resistant bottom with cord management.
 - Base size: 6.63”(168mm) height, 3”(76mm) width, 3.5”(89mm) depth.
- **Table Light with Pivot:**
 - Available in Textured White and Textured Black.
 - Pivot rotates 360° around the base.
 - Arm rotates around magnetic connection between base and light arm.
 - Pivot light does not have adjustable height.
 - Base includes scratch-resistant bottom.
 - Base size: 5”(127mm) height, 4.5”(114mm) width, 5.5”(140mm) depth.
- **Floor Light:**
 - Available in Textured White and Textured Black.
 - Arm rotates around magnetic connection between base and light arm.
 - Adjustable height fixture range is 13”-50.75”(330mm-1289mm) from floor.
 - Base includes scratch-resistant bottom.
 - Base size: 38”(965mm) height, 9”(229mm) width, 9”(229mm) depth.

To Order, Specify:

- 1) Product number.
- 2) Trim color:
 - Pivot/Floor available in:
 - TR-L2 Textured White
 - TR-L3 Textured Black
 - Block available in:
 - TR-L2 Textured White
 - TR-L3 Textured Black
 - TR-L1 Brushed Aluminum

Specification Tips

- For use with 120 volt 60 hertz electrical system.
- Minor assembly required.

Lighting — Haworth Collection

LIM

	Base/Mount	Average Height	Number	Price
Worksurface Mounted Lighting	Worksurface Mounted Light	18 1/2"(470mm)	LLC1-0022-19WLC	\$275.00

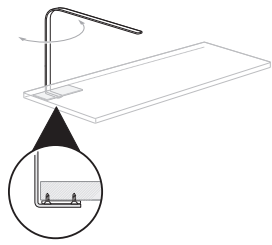

Worksurface Mount
LLC1



Features

- Includes base/mount, 22"(559mm) arm with LED light with a clear lens, nine foot removable silvertone cord, and one wire management clip.
- Under Shelf attachment bracket painted to compliment the LED light.
- Features two-stage light control with 3.0 watt and 7.3 watt selection.
- All lights use magnets to attach to base or brackets.
- **Worksurface Mount:**
 - Available in **Brushed Aluminum, Textured White, Textured Black.**
 - Arm rotates at Under Worksurface attachment bracket.
 - Light does not have adjustable height.
 - Flat Bracket is scratch-resistant.
 - Mount includes a 11"(279mm) flat bracket with adhesive.

To Order, Specify:

- 1) Product number.
- 2) Trim color:
 - TR-L2 Textured White
 - TR-L3 Textured Black
 - TR-L1 Brushed Aluminum

Specification Tips

- **For use with 120 volt 60 hertz electrical system.**
- Minor assembly required.

Lighting — Haworth Collection

LIM

Mounted Lighting

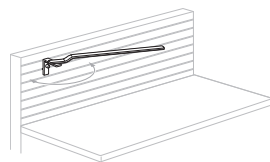

Slat
LLM1

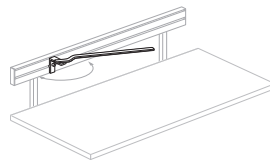

Belong Rail
LLM1

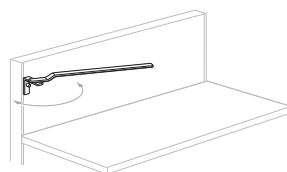

Panel
LLM2

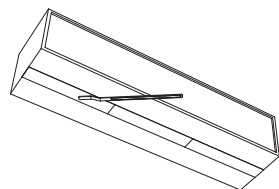

Under Shelf
LLU2



Base/Mount	Panel System	Number	Price
Slat/Rail		LLM1-0023-19MLC	\$250.00
Panel	for PREMISE	LLM2-0023-19MLCN	\$250.00
	for Compose	LLM2-0023-19MLCZ	250.00
	for UniGroup Too	LLM2-0023-19MLCE	250.00
Under Shelf Proud		LLU2-0023-19ULC	\$250.00

Features

- Includes base/mount, 23 1/4" (591mm) arm with LED light with a clear lens, nine foot removable silvertone cord, and one wire management clip.
- Features two-stage light control with 3.0 watt and 7.3 watt selection.
- Overall height ranges dependent on the mount.
- All lights use magnets to attach to base or brackets.
- Slat:**
 - Available in Textured White and Textured Black.
 - Rotates 180 degrees horizontally around the mount.
 - Slat Mount can be adjusted within the slat profiles – hooks into the second bottom slat and can be adjusted to the top slat off the slat tiles.
 - Mount is scratch-resistant.
 - Can be used on any Haworth slat tile.
 - Slat Tile Bracket size: 3" (76mm) height, 1" (25mm) width, 3" (76mm) depth.
- Panel:**
 - Available in Textured White and Textured Black.
 - Rotates 180 degrees horizontally around the mount.
 - Panel Mount can be adjusted within the panel slot profiles.
 - Mount is scratch-resistant.
 - Can be used on any Haworth Panel System.
 - Panel Mount Bracket size: 3" (76mm) height, 1" (25mm) width, 3" (76mm) depth.
- Under Shelf Proud:**
 - Available in Brushed Aluminum, Textured White, Textured Black.
 - Arm rotates at Under Shelf attachment bracket.
 - Slat Mount can be adjusted within the slat tile profiles.
 - Flat Bracket is scratch-resistant.
 - Can be used on: Adaptable Upper Storage.
- Under Shelf attachment bracket painted to complement the LED light.

To Order, Specify:

- Product number.
- Trim color:
 - Slat/Panel mount available in:
 - TR-L2 Textured White
 - TR-L3 Textured Black
 - Under Shelf mount available in:
 - TR-L2 Textured White
 - TR-L3 Textured Black
 - TR-L1 Brushed Aluminum

Specification Tips

- For use with 120 volt 60 hertz electrical system.
- Minor assembly required.

Lighting — Haworth Collection

LIM

LIM Hardware	Base/Mount	Panel System	Units	Number	Price
	Slat Mount Bracket		1	LLH1-0000	\$35.00
	Panel Mount Bracket	for PREMISE	1	LLH2-0000-N	\$35.00
		for Compose	1	LLH2-0000-Z	35.00
		for UniGroup Too	1	LLH2-0000-E	35.00
	Under Shelf Flat/Under Shelf Proud/Worksurface Bracket*		5	LLH3-0000	\$90.00
	Wire Management Clips		10	LLH6-0000	\$45.00

Features

- Hardware for use with LIM lights to provide additional attachment.
- Each bracket description correlates with the appropriate LIM light. Please specify accordingly.
- For use if greater user adjustment is required.
- Slat and Panel Mount available in Textured White and Textured Black.
- Under Shelf available in Textured White, Textured Black and Brushed Aluminum.
- Wire management clips are standard in White.

***Same brackets are used for Under Shelf Proud and Worksurface Mount LIM light applications.**

To Order, Specify:

- 1) Product number.
- 2) Trim color for brackets:

TR-L2	Textured White
TR-L3	Textured Black
TR-L1	Brushed Aluminum

Lighting — Haworth Collection

LIM360

		Number	Price
Table Light	Grade A	LL31-2210-NFLC	\$315.00
	Grade B	LL31-2210-NFLC	\$325.00
	Grade C	LL31-2210-NFLC	\$335.00

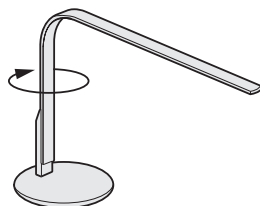

LL31-2210-NFLC



Features

- Includes base, aluminum arm with USB charging port, LED lights, clear lens, full range dim control and 10' removable cord.
- Base is scratch resistant aluminum ring with wood or plastic magnetic base insert.
- Base is 6.5"(165mm) diameter.
- Arm is 13.5"(343mm) high x 21.5"(546mm) wide and 1"(25mm) deep.
- Features a LED light source with full range dim control and 360° swivel adjustment.
- 7 watts.

Specification Tips

- **For use with 120 volt 60 hertz electrical system.**
- Minor assembly required.

To Order, Specify:

- 1) Product number.
- 2) Trim color.
 - Grade A
 - TR-L8 White Arm, Silver Base
 - TR-L13 Black Arm, Black Base
 - Grade B
 - TR-L10 Aluminum Arm, Silver Base
 - TR-L11 Aluminum Arm, Walnut Base
 - TR-L14 Black Arm, Walnut Base
 - TR-L12 Naranjo Arm, Walnut Base
 - Grade C
 - TR-L9 White Arm, Walnut Base
 - TR-L25 Brass Arm, Brushed Brass Base
 - TR-L26 Copper Arm, Copper Base

Grommet Mounted Light	Grade A	LL32-2210-NGLC	\$300.00
	Grade B	LL32-2210-NGLC	\$310.00
	Grade C	LL32-2210-NGLC	\$320.00

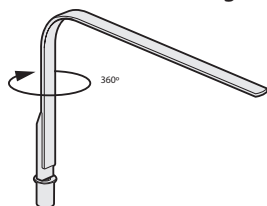

LL32-2210-NGLC



Features

- Includes base, aluminum arm with USB charging port, LED lights, clear lens, full range dim control and 10' removable cord.
- Surface mount grommet is 2"(51mm) high and 1"(25mm) wide and finished in satin aluminum.
- Arm is 13"(330mm) high x 20"(508mm) wide and 1"(25mm) deep.
- Features a LED light source with full range dim control and 360° swivel adjustment.
- 7 watts.

Specification Tips

- **For use with 120 volt 60 hertz electrical system.**
- Minor assembly required.

To Order, Specify:

- 1) Product number.
- 2) Trim color.
 - Grade A
 - TR-L4 White
 - TR-L6 Black
 - Grade B
 - TR-L5 Aluminum
 - Grade C
 - TR-L7 Naranjo
 - TR-L27 Brass
 - TR-L28 Copper

Lighting — Haworth Collection

Pixo

Table Light

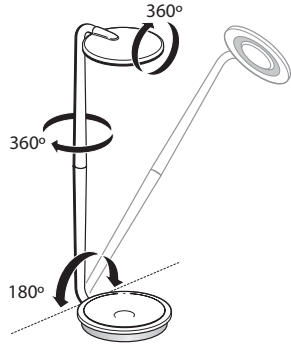

LUPT



Features

- Includes base/mount with USB charging port, 16.5”(419mm) arm with LED light and 6’(182cm) attached cord.
- Available with optional integrated occupancy sensor.
- Hi-low dim control.
- 360° arm rotation.
- 180° arm tilt.
- 360° shade rotation.
- USB port for charging cell phones.
- Advanced LED array eliminates multiple shadows.
- Minor assembly required.
- **For use with 120 volt 60 hertz electrical system.**
- Power consumption: 6W.
- Color temperature: 3000K.
- Luminosity: 285 Lumens.
- Color Rendition Index: 90 CRI.
- 50K hour lifespan.
- Cord length: 6’(182cm).

Number	①	Standard Trim	Premium Trim
LUPT-0016-05FL		\$230.00	\$240.00

To Order, Specify:

1) Product number.

① Occupancy Sensor:

- C No Occupancy Sensor
- O Occupancy Sensor, add \$100 list

2) Trim color.

No Occupancy Sensor

Standard Trim

- TR-11 Black
- TR-12 Silver
- TR-13 White
- TR-16 Azure
- TR-17 Glow
- TR-18 Orange

Premium Trim

- TR-19 White/Brass

With Occupancy Sensor

Standard Trim

- TR-11 Black
- TR-12 Silver
- TR-13 White

Lighting — Haworth Collection

Superlight

	Height	Depth	Width	Number	Price
Table Light	25.75"(645mm)	8"(203mm)	23.5"(597mm)	HCPL-SLT1-17	\$285.00

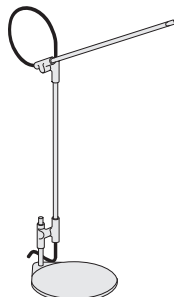

HCPL-SLT1-17



Features

- Includes one aluminum body with polycarbonate lens, steel base 9' cord and magnetic base pad.
- Ultra light, minimal frame.
- LED array with full range dim control.
- Lens rotates 90°.
- Joints have three axis rotation.
- Six hour energy saving auto-off timer.
- 8.6 watts.

Specification Tips

- **For use with 120 volt 60 hertz electrical system.**
- Minor assembly required.

To Order, Specify:

- 1) Product number.
- 2) Trim color.
TR-S10 Black
TR-S11 White
- 3) Base Pad
TR-S15 Charcoal
TR-S16 Chestnut
TR-S18 Mustard
TR-S17 Turquoise

Floor Light	57.5"(1460mm)	8"(203mm)	23.5"(597mm)	HCPL-SLF1-47	\$335.00
--------------------	---------------	-----------	--------------	--------------	-----------------

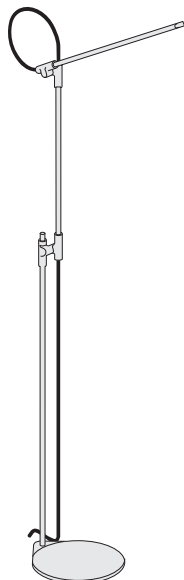

HCPL-SLF1-47



Features

- Includes one aluminum body with polycarbonate lens, steel base 9' cord and magnetic base pad.
- Slim ultra light, minimal frame.
- LED light with full range dim control.
- Lens rotates 90°.
- Joints have three axis rotation.
- Six hour energy saving auto-off timer.
- 8.6 watts.

Specification Tips

- **For use with 120 volt 60 hertz electrical system.**
- Minor assembly required.

To Order, Specify:

- 1) Product number.
- 2) Trim color.
TR-S10 Black
TR-S11 White
- 3) Base Pad
TR-S15 Charcoal
TR-S16 Chestnut
TR-S18 Mustard
TR-S17 Turquoise

	Diameter	Number	Price
Base Pads	8"(203mm)	HCPL-SLSV-4BP	\$50.00

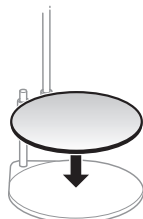

HCPL-SLSV-4BP

Feature

- Includes set of four felt base pads, one each of four colors.

To Order, Specify:

- 1) Product number.

Lighting — Haworth Collection

Tube Top

	Description	Height	Depth	Width	Number	Price
Table Light	Small	14"(356mm)	4.5"(114mm)	9.5"(241mm)	HCPL-TTT1-14	\$145.00
	Medium	21"(533mm)	6.5"(165mm)	15"(381mm)	HCPL-TTT2-21	275.00
	Large	27"(686mm)	9"(229mm)	18"(457mm)	HCPL-TTT3-27	420.00

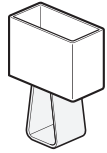

HCPL-TTT1-14

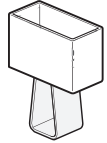

HCPL-TTT2-21

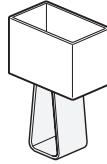

HCPL-TTT3-27



Features

- Includes one polyester mesh shade, acrylic body and 6' fabric cord.
- Fully dimmable LED light controlled by in-line rotary dimmer.
- 6 watts (small table light)
- 13 watts (medium and large table lights)

Specification Tip

- **For use with 120 volt 60 hertz electrical system.**

To Order, Specify:

- 1) Product number.
- 2) Trim color.
 TR-T40 Charcoal Shade, Charcoal Body
 TR-T41 Silver Shade, Clear Body
 TR-T42 White Shade, Charcoal Body
 TR-T43 White Shade, Clear Body

Additional colors for Small Table Light only:

- TR-T44 White Shade, Green Body
- TR-T45 White Shade, Cobalt Body
- TR-T46 White Shade, Hot Pink Body
- TR-T47 White Shade, Ruby Red Body
- TR-T48 White Shade, Sky Blue Body
- TR-T49 White Shade, Yellow Body

Floor Light

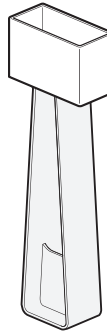

HCPL-TTF1-60



	60"(1524mm)	9"(229mm)	18"(457mm)	HCPL-TTF1-60	\$800.00
--	-------------	-----------	------------	--------------	-----------------

Features

- Includes one polyester mesh shade, acrylic body and 6' fabric cord.
- Fully dimmable LED light controlled by in-line rotary dimmer.
- 13 watts.

Specification Tip



- **For use with 120 volt 60 hertz electrical system.**

To Order, Specify:

- 1) Product number.
- 2) Trim color.
 TR-T40 Charcoal Shade, Charcoal Body
 TR-T41 Silver Shade, Clear Body
 TR-T42 White Shade, Charcoal Body
 TR-T43 White Shade, Clear Body

Lighting — Haworth Collection

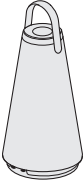
UMA

	Number	Price
<p>Audio Lantern</p>  <p>HCPL-UMT2-11</p> 	<p>HCPL-UMT2-11</p> <p>Features</p> <ul style="list-style-type: none"> • Includes one battery powered light with polycarbonate lens, steel grille and silicone feet, two interchangeable leather handles (one grey and one tan) and storage bag. • Portable and rechargeable. <ul style="list-style-type: none"> –Battery Life - 8 hours –Charging time - up to 3.5 hours • Bluetooth connectivity provides 360° sound with touch sensitive volume control. • Intuitive full range light control dial adjusts warm dim LED technology. • Storage bag is cotton with a leather drawstring. • Light is 6”(152mm) in diameter at the base and 11”(279mm) high (leather handle adds 2.25”(57mm) to height.) • 4.2 watts (light), 12 watts (speakers). <p>Specification Tip</p> <ul style="list-style-type: none"> • For use with 120 volt 60 hertz electrical system. 	<p>To Order, Specify:</p> <p>1) Product number.</p>

Mobile Screens

Perforated Metal Insert

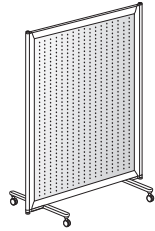

BBF-PB

Height	Width	Number	Trims A/A	A/B	B/B	B/A
47"(1194mm)	36"(914mm)	BBF-4736-PB	\$1152.04	\$1165.51	\$1171.03	\$1184.50
	48"(1219mm)	BBF-4748-PB	1352.69	1366.16	1372.29	1385.76
52"(1321mm)	36"(914mm)	BBF-5236-PB	\$1195.24	\$1208.71	\$1215.73	\$1229.20
	48"(1219mm)	BBF-5248-PB	1395.89	1409.36	1416.99	1430.46
63"(1600mm)	36"(914mm)	BBF-6336-PB	\$1290.28	\$1303.75	\$1314.07	\$1327.54
	48"(1219mm)	BBF-6348-PB	1490.93	1504.40	1515.33	1528.80

Feature

- Includes screen, two O-rings, two T-Leg bases with two non-locking casters and two locking casters.

To Order, Specify:

- 1) Product number.
- 2) Trim color for frame.
- 3) Trim color for perforated metal insert.
- 4) Metallic trim color for feet and casters.

Frosted Insert

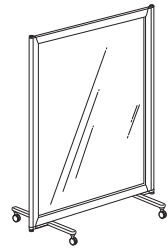

BBF-AC

Height	Width	Number	Trim A	B
47"(1194mm)	36"(914mm)	BBF-4736-AC	\$1016.39	\$1035.38
	48"(1219mm)	BBF-4748-AC	1217.04	1236.64
52"(1321mm)	36"(914mm)	BBF-5236-AC	\$1059.59	\$1080.08
	48"(1219mm)	BBF-5248-AC	1260.24	1281.34
63"(1600mm)	36"(914mm)	BBF-6336-AC	\$1154.63	\$1178.42
	48"(1219mm)	BBF-6348-AC	1355.28	1379.68

Feature

- Includes screen, two O-rings, two T-Leg bases with two non-locking casters and two locking casters.

To Order, Specify:

- 1) Product number.
- 2) Trim color for frame.
- 3) Metallic trim color for feet and casters.

Common Features

- O-ring accommodates joining of same height screens.
- T-Legs are Metallic trim color.
- Metallic perforated metal screens have no acoustical or tackable value.
- Screens are non-load bearing.
- Magnets can be used with perforated metal insert.
- 19"(483mm) T-Leg centered on 1 1/8"(29mm) thick frame.
- Frosted insert is identical to frosted and textured acrylic material used in desktop screens.
- T-Leg shipped unassembled.

Specification Tip

- No limit to number of same height screens ganged together.

Mobile Screens

Fabric Scrim Insert

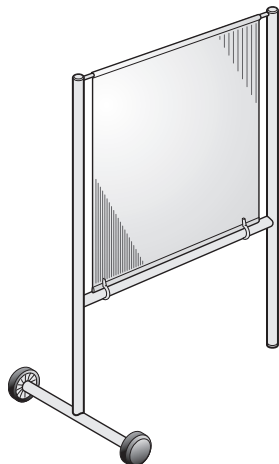

NBFS-F

Height	Width	Number	Trim	
			A	B
53"(1346mm)	36"(914mm)	NBFS-5336-F	\$ 801.21	\$ 824.80
	48"(1219mm)	NBFS-5348-F	933.69	962.00
64"(1626mm)	36"(914mm)	NBFS-6436-F	\$ 882.17	\$ 908.12
	48"(1219mm)	NBFS-6448-F	1044.09	1074.76

Features

- Includes frame, fabric scrim insert, and attachment hardware.
- Scrim is a lightweight open weave textile.
- Attachment hardware is clear.
- 4"(102mm) wheels are non-locking. Standard in black finish color only.
- Screens are non-load bearing.
- Screens have no acoustical or tackable properties.
- Screens are shipped unassembled.

To Order, Specify:

- 1) Product number.
- 2) Fabric scrim/colorway; FO-NW (New White).
- 3) Trim color for frame.

Specification Tips

- 53"(1346mm) high freestanding screens have 20"(508mm) wheel span centered on 1 1/4"(32mm) thick frame.
- 64"(1626mm) high freestanding screens have 24"(610mm) wheel span centered on 1 1/4"(32mm) thick frame.
- Clearance height is 17 3/8"(441mm).

Translucent Insert

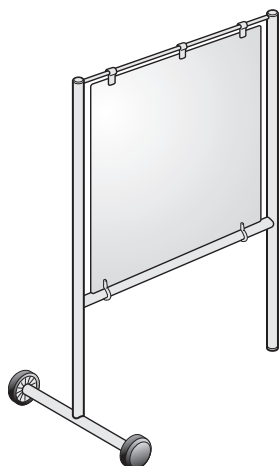

NBFS-X

Height	Width	Number	White		Color/Pattern	
			A	B	A	B
53"(1346mm)	36"(914mm)	NBFS-5336-X	\$1255.19	\$1278.78	\$1490.77	\$1514.36
	48"(1219mm)	NBFS-5348-X	1464.89	1493.20	1877.23	1905.54
64"(1626mm)	36"(914mm)	NBFS-6436-X	\$1383.34	\$1409.29	\$1726.94	\$1752.89
	48"(1219mm)	NBFS-6448-X	1639.64	1670.31	2199.28	2229.95

Features

- Includes frame, translucent insert, and attachment hardware.
- Attachment hardware is clear.
- 4"(102mm) wheels are non-locking. Standard in black finish color only.
- Screens are non-load bearing.
- Screens have no acoustical or writable properties.
- Screens are shipped unassembled.

To Order, Specify:

- 1) Product number.
- 2) Translucent color/pattern.
- 3) Trim color for frame.

Specification Tips

- 53"(1346mm) high freestanding screens have 20"(508mm) wheel span centered on 1 1/4"(32mm) thick frame.
- 64"(1626mm) high freestanding screens have 24"(610mm) wheel span centered on 1 1/4"(32mm) thick frame.
- Clearance height is 17 3/8"(441mm).

Monitor Arms — Haworth

	Description	Number	Price
Adjustable Post Arm	Single Arm	KU5M-0000-1NNN	\$511.25
	Double Arm	KU5M-0000-2NNN	852.08

Adjustable Post Arm

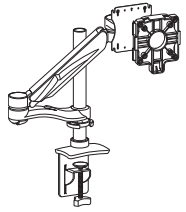

KU5M-1NNN

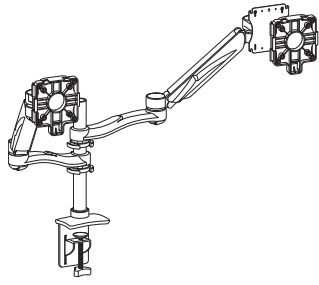

KU5M-2NNN

GSA: Open Market

Features

- Includes one single or double Monitor Arm with quick connect bracket, desk clamp and grommet mount.
- Quick-install mechanism allows flat-screen monitors to quickly and securely snap into position.
- Allows for installation of one or two flat-screen monitors above worksurface.
- Provides easy adjustment of monitor height and position up and down post or by adjustable arm. Requires adjustment of monitor arm to weight of monitor with supplied allen wrench.
- Integrated cord management.
- Monitor Arms:
 - Extension 24”(610mm)
 - Height Adjustment range: 13”(330mm)counter balance adjustable arm and 9”(229mm) post adjustment.
 - Joint rotation 360° at three joints
 - Pivots from landscape to portrait positions
 - 180° of tilt
 - 180° of side to side movement
- Double arm will displays screens up to 35”(889mm).
- Displays screens 5-20 lbs per Monitor Arm.
- Double Monitor Arms attach to central post.
- Monitor Arms available in supplier silver, black, white, or polished.

To Order, Specify:

- 1) Product number.
- 2) Trim color.
 - TR-SR Silver
 - TR-OF Black
 - TR-OW White
 - TR-PD Polished

Specification Tips

- Certified VESA plate includes 75mm and 100mm hole patterns.
- For additional monitor arms options see Ergotron Monitor Arms.

Extend Arm

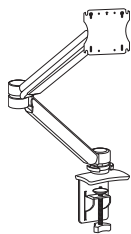

KU6M-1NNN

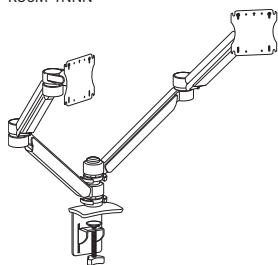

KU6M-2NNN

SIN 711-2;
Discount Group XIII

Extend Arm	Single Arm	KU6M-0000-1NNN	\$284.02
	Double Arm	KU6M-0000-2NNN	511.24

Features

- Includes one single or double Monitor Arm with desk clamp and grommet mount.
- Allows for installation of one or two flat-screen monitors above worksurface.
- Provides easy adjustment of monitor by adjustable arm. Requires adjustment of monitor arm to weight of monitor with supplied allen wrench.
- Integrated cord management.
- Monitor Arms:
 - Extension 26”(660mm)
 - Height Adjustment range: 13”(330mm)
 - Joint rotation 360° at three joints
 - Pivots from landscape to portrait positions
 - 180° degrees of tilt
 - 180° of side to side movement
- Double arm will displays screens up to 35”(889mm).
- Displays screens up to 2 lbs – 14 lbs per arm.
- Double Monitors Arms attach to central post.
- Monitor Arms available in supplier silver, black, or white.

To Order, Specify:

- 1) Product number.
- 2) Trim color.
 - TR-SR Silver
 - TR-OF Black
 - TR-OW White

Specification Tips

- Certified VESA plate includes 75mm x 75mm and 100mm x 100mm hole patterns.
- For additional monitor arms options see Ergotron Monitor Arms.

Monitor Arms — Haworth

	Description	Number	Price
Adjustable Post Arm – for Use with Intuity Benching	Single Arm	KU5M-0000-1NNB	\$511.25
	Double Arm	KU5M-0000-2NNB	852.08

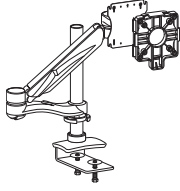

KU5M-1NNB

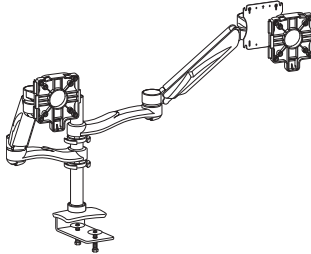

KU5M-2NNB
GSA: Open Market

Features

- Includes one single or double Monitor Arm with desk clamp and grommet mount.
- Quick-install mechanism allows flat-screen monitors to quickly and securely snap into position.
- Allows for installation of one or two flat-screen monitors above worksurface.
- Provides easy adjustment of monitor height and position up and down post or by adjustable arm. Requires adjustment of monitor arm to weight of monitor with supplied allen wrench.
- Integrated cord management.
- Monitor Arms:
 - Extension 24”(610mm)
 - Height Adjustment range: 13”(330mm) counter balance adjustable arm and 9”(229mm) post adjustment for a maximum height adjustment of 15.5”(394mm)
 - Joint rotation 360° at three joints
 - Pivots from landscape to portrait positions
 - 180° of tilt
 - 180° of side to side movement
- Double arm will displays screens up to 35”(889mm).
- Displays screens 5-20 lbs per Monitor Arm.
- Double Monitor Arms attach to central post.
- Monitor Arms available in supplier silver, black, white, or polished.

To Order, Specify:

- 1) Product number.
- 2) Trim color.
 - TR-SR Silver
 - TR-OBA Black
 - TR-OWH White
 - TR-PD Polished

Specification Tips

- Intuity desk clamp can mount to 1 3/16”(30mm) thick worksurfaces.
- Certified VESA plate includes 75mm and 100mm hole patterns.

Extend Arm – For Use with Intuity Benching	Single Arm	KU6M-0000-1NNB	\$284.02
	Double Arm	KU6M-0000-2NNB	511.24

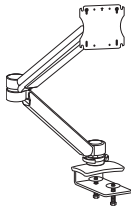

KU6M-1NNB

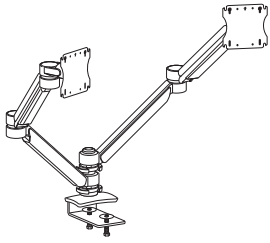

KU6M-2NNB
SIN 711-2;
Discount Group XIII

Features

- Includes one single or double Monitor Arm with desk clamp and grommet mount.
- Allows for installation of one or two flat-screen monitors above worksurface.
- Provides easy adjustment of monitor by adjustable arm. Requires adjustment of monitor arm to weight of monitor with supplied allen wrench.
- Integrated cord management.
- Monitor Arms:
 - Extension 26”(660mm)
 - Height Adjustment range: 13”(330mm)
 - Joint rotation 360° at three joints
 - Pivots from landscape to portrait positions
 - 180° of tilt
 - 180° of side to side movement
- Double arm will displays screens up to 35”(889mm).
- Displays screens up to 2 lbs. – 14 lbs.
- Double Monitors Arms attach to central post.
- Monitor Arms available in supplier silver, black, or white.

To Order, Specify:

- 1) Product number.
- 2) Trim color.
 - TR-SR Silver
 - TR-OBA Black
 - TR-OWH White

Specification Tips

- Intuity desk clamp can mount to 1 3/16”(30mm) thick worksurfaces.
- Certified VESA plate includes 75mm and 100mm hole patterns.

Monitor Arms — Haworth

	Description	Number	Price
Adjustable Post Arm – for Use with Reside Desking	Single Arm	KU5M-0000-1NNK	\$511.25
	Double Arm	KU5M-0000-2NNK	852.08

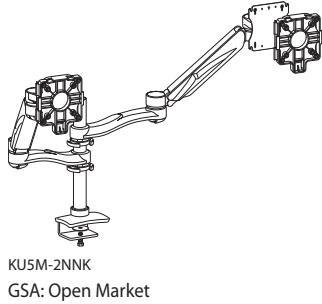
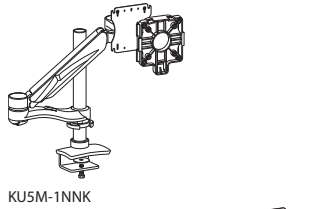

Features

- Includes one single or double Monitor Arm with desk clamp and grommet mount.
- Quick-install mechanism allows flat-screen monitors to quickly and securely snap into position.
- Allows for installation of one or two flat-screen monitors above worksurface.
- Provides easy adjustment of monitor height and position up and down post or by adjustable arm. Requires adjustment of monitor arm to weight of monitor with supplied allen wrench.
- Integrated cord management.
- Monitor Arms:
 - Extension 24”(610mm)
 - Height Adjustment range: 13”(330mm) counter balance adjustable arm and 9”(229mm) post adjustment for a maximum height adjustment of 15.5”(394mm)
 - Joint rotation 360° at three joints
 - Pivots from landscape to portrait positions
 - 180° of tilt
 - 180° of side to side movement
- Double arm will displays screens up to 35”(889mm).
- Displays screens 5-20 lbs per Monitor Arm.
- Double Monitor Arms attach to central post.
- Monitor Arms available in supplier silver, black, white, or polished.

To Order, Specify:

- 1) Product number.
- 2) Trim color.
 - TR-SR Silver
 - TR-OBA Black
 - TR-OWH White
 - TR-PD Polished

Specification Tips

- Reside desk clamp can mount to 1 3/16”(30mm) thick worksurfaces.
- Certified VESA plate includes 75mm and 100mm hole patterns.

Extend Arm — For Use with Reside Desking	Single Arm	KU6M-0000-1NNK	\$284.02
	Double Arm	KU6M-0000-2NNK	511.24

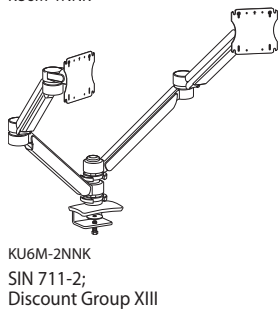
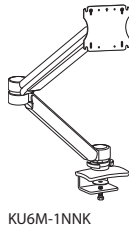

Features

- Includes one single or double Monitor Arm with desk clamp and grommet mount.
- Allows for installation of one or two flat-screen monitors above worksurface.
- Provides easy adjustment of monitor by adjustable arm. Requires adjustment of monitor arm to weight of monitor with supplied allen wrench.
- Integrated cord management.
- Monitor Arms:
 - Extension 26”(660mm)
 - Height Adjustment range: 13”(330mm)
 - Joint rotation 360° at three joints
 - Pivots from landscape to portrait positions
 - 180° of tilt
 - 180° of side to side movement
- Double arm will displays screens up to 35”(889mm).
- Displays screens up to 2 lbs. – 14 lbs.
- Double Monitors Arms attach to central post.
- Monitor Arms available in supplier silver, black, or white.

To Order, Specify:

- 1) Product number.
- 2) Trim color.
 - TR-SR Silver
 - TR-OBA Black
 - TR-OWH White

Specification Tips

- Reside desk clamp can mount to 1 3/16”(30mm) thick worksurfaces.
- Certified VESA plate includes 75mm and 100mm hole patterns.

Monitor Arms — Haworth

	Height	Width	Number	Price
iPad Attachment	7.88"(200mm)	8"(203mm)	KU6T-0000	\$284.02

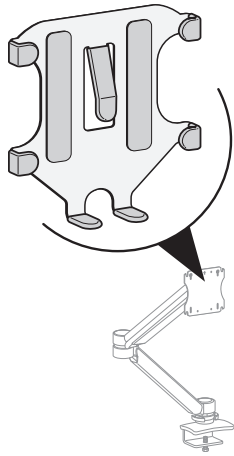

KU6T

Features

- Includes one steel tablet holder with cutouts and mounting hardware.
- Works with tablets size 6.75"-7.5"(171-191mm) wide and at least 7"(178mm) high with a 1/2"(13mm) maximum thickness.
- Mounts directly onto the Extend Arm with standard VESA 100mm connection.
- Rotates from landscape orientation to portrait orientation.
- Cutouts allow for use of cables.

To Order, Specify:

- 1) Product number.
- 2) Trim color.
 TR-SR Silver
 TR-OF Black
 TR-OW White

Specification Tips

- Designed to be used with Extend Arm.
- iPad not included.

Recycling Solutions

Height	Depth	Width	Number	Painted A	B
39 1/2"(1003mm)	18 3/4"(476mm)	48"(1219mm)	JRPY-3948-SJAN	\$3540.30	\$3734.64

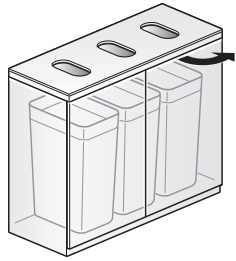

JRPY-3948
Class FM – SIN 711-3,
Discount Group XII

Features

- Includes:
 - Painted steel cabinet and top with three 11”(279mm) x 6”(152mm) openings.
 - Non-locking hinged doors
 - Clear acrylic overlay for top
 - 3 removable Rubbermaid recycle bins

To Order, Specify:

- Product number.
- Trim color.

Recycling/Trash Bin

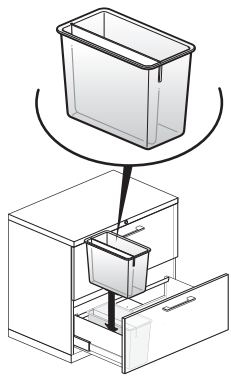

KURB
Class YA – SIN 711-2,
Discount Group XIII

Nominal Height	Nominal Depth	Nominal Width	Number	Price
9”(229mm)	12.5”(318mm)	6.5”(165mm)	KURB-0912	\$189.47

Features

- Includes one plastic bin with removable plastic divider.
- Can be used with Recycle Bin Carriage for Reside or suspended from hanging rails in X Series, V Series, A Series, Beside, Compose and Masters Series pedestals and lateral filing drawers.
- Recycling/Trash Bin can be easily removed from carriage or drawer body to dispose of waste contents.
- Not designed to be freestanding.
- Available in Snow only.
- The removable divider subdivides the space into nominal 4.25”(108mm) and 1.5”(38mm) sections.

To Order, Specify:

- Product number.
(No finish specification required.)

Specification Tip

- Cannot accommodate hanging files.

Recycle Bin Carriage

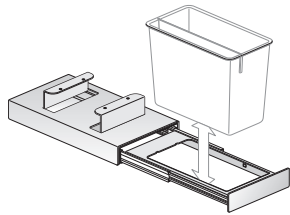

KURD
Class YA – GSA: Open Market

Description	Depth	Width	Number	Trim A	B
For use with Reside	15.34”(390mm)	8.35”(212mm)	KURD-0000	\$213.70	\$227.33

Features

- Includes one painted metal carriage with steel ball bearing slides and attachment bracket.
- Full extension carriage.
- To be used with separately specified Recycling/Trash Bin.
- Attaches to underside of Reside worksurface between support beams.
- Carriage plus Recycling/Trash Bin suspends 12.5”(318mm) underneath worksurface.
- To accommodate the support beams, there will be a 2”(51mm) gap from the underside of the worksurface to the top of the carriage.

To Order, Specify:

- Product number.
- Trim color.

Specification Tips

- For use with Reside Rectangular worksurfaces only; mechanism is not designed for use with any other worksurface platform.
- Carriage requires separately specified Recycling/Trash Bin; not intended to house any other inserts/bins.

Storage Accessories

Lateral File Drawer Insert

Drawer Insert

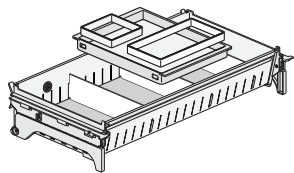

KJFI-00XX-D

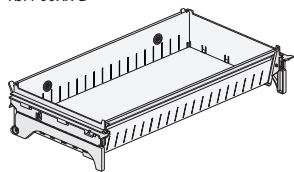

KFI-00XX-B

Description	Height	Depth	Width	Number	Price
Deluxe Drawer Insert					
	5"(127mm)	14"(356mm)	30"(762mm)	KJFI-0030-D	\$250.39
	5"(127mm)	14"(356mm)	36"(914mm)	KJFI-0036-D	268.10
	5"(127mm)	14"(356mm)	42"(1067mm)	KJFI-0042-D	285.81
Base Option Insert					
	5"(127mm)	14"(356mm)	30"(762mm)	KJFI-0030-B	\$192.51
	5"(127mm)	14"(356mm)	36"(914mm)	KJFI-0036-B	210.22
	5"(127mm)	14"(356mm)	42"(1067mm)	KJFI-0042-B	227.93

Features

- Includes drawer insert that subdivides a 12" high lateral file drawer into two 6" deep compartments.
- **For use in X Series, V Series and 950 Series 12" high lateral file drawers.**
- Drawer Insert is 5" shallower than file drawer allowing the Drawer Insert to slide from front-to-back to access contents in the lower compartment.
- Deluxe Drawer Insert:
 - Includes: Drawer Insert, Drawer Liner, three dividers and one PDA Tray with ring subdivision.
 - Drawer Insert available in Accent Red (TR-1F) or Smoke (TR-E).
- Base Option Insert:
 - Includes: Drawer insert only.
 - Available in black only.
- Drawer Insert and PDA Tray have cut outs/grommets to allow for low voltage cable routing. Lateral files can be modified in the field to accommodate routing of cables to access building power.
- PDA Tray, rings and dividers are plastic in Snow trim color.

To Order, Specify:

- 1) Product number.
- 2) Trim color (Deluxe Drawer Insert only)
 - TR-1F Accent Red
 - TR-E Smoke

Specification Tips

- Drawer Insert cannot be used in lateral files that have full backs on the drawer body. (ex. Beside, Compose Storage, Master Series)
- Drawer Insert cannot be used in lateral files with individually locking drawers.
- Top lateral file drawer, or only file drawer, of an X Series combination unit will not accommodate a Drawer Insert; the remaining positions are able to accommodate the Drawer Insert.
- Top lateral file drawer in an X Series Lateral File with sliding or hinge doors cannot accommodate a Drawer Insert; the remaining positions are able to accommodate the Drawer Insert.
- Drawer Insert cannot be used in a drawer with a receding door.
- PDA Tray is designed to slide side-to-side along the Drawer Insert front and back panels allowing access to drawer contents below the PDA Tray.

Note: Snow (TR-FM) plastic trim color is not recommended for use with painted trim colors Plaster (TR-TW) or Chalk (TR-AK). Refer to Very™ Seating chainset for Snow.

Wire Management

	Diameter	Length	Mesh Color	Number	Price
Cord Manager — Mesh	1"(25mm)	100'(30480mm)	Black	EUAW-0000-NHS	\$653.27
			Grey	EUAW-0000-NHSG	653.27
			Orange	EUAW-0000-NHSO	653.27
			White	EUAW-0000-NHSW	653.27
	2"(51mm)	50'(15240mm)	Black	EUAW-0000-NHL	\$653.27
			Grey	EUAW-0000-NHLG	653.27
			Orange	EUAW-0000-NHLO	653.27
			White	EUAW-0000-NHLW	653.27

EUAW-0000-NHS
Class YA – SIN 711-2,
Discount Group XIII

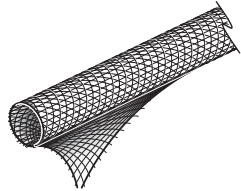

Features

- Includes flexible mesh cord manager.
- Available in black, grey, orange and white.
- Field cut to length.

To Order, Specify:

- 1) Product number.
(No finish specification required.)

Specification Tip

- Wraps around and manages power cords and data cables.

	Height	Width	Actual Length	Installed Length	Number	Price
Cable Chain	3/4"(19mm)	2 1/4"(58mm)	40"(1016mm)	36"(914mm)	EAAW-0000-H	\$210.08

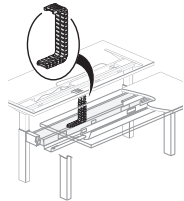

EAAW-0000-H
Class YA – SIN 711-2,
Discount Group XIII

Features

- Includes 36"(914mm) active length cable chain and mounting hardware.
- Color black only.
- Mounts to cable trough and underside of worksurface to contain power cords/data cables that are routed from the cable tray to the worksurface.

To Order, Specify:

- 1) Product number.
(No finish specification required.)

Specification Tip

- Holds up to three power cords and two data cables.

Compose Connections Cable Chain	3/4"(19mm)	2 1/4"(58mm)	40"(1016mm)	36"(914mm)	EUAW-4000-V	\$275.00
--	------------	--------------	-------------	------------	-------------	-----------------

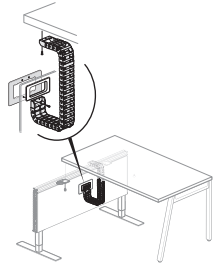

EUAW-4000-V
Class YA – SIN 711-2,
Discount Group XIII

Features

- Includes grommet, grommet backer plate, cable chain, bracket to mount to adjacent table and mounting hardware.
- Color black only.
- Mounts to tile and underside of adjacent worksurface to contain power cords and data cables that are routed from inside Compose Connections panel to an adjacent worksurface.

To Order, Specify:

- 1) Product number.
(No finish specification required.)

Specification Tip

- Holds up to three power cords and two data cables.

	Description	Number	Price
Vertical Cable Chain	31"(787mm) cable chain	EUAW-3100-NV	\$181.78



EUAW-3100-NV
Class YA – SIN 711-11,
Discount Group XIII

Features

- Includes cable chain and attachment hardware (2 screws).
- Bottom cable chain link is weighted.
- Available in translucent material only.
- Chain is clear translucent. Weight is painted as specified.

To Order, Specify:

- 1) Product number.
- 2) Trim color.

Specification Tip

- Not designed to be used with 36"(914mm) and 42"(1067mm) high tables.

Wire Management

	Length	Height	Width	Description	Number	Price
J-Channel	72"(1829mm)	4 1/4"(108mm)	2 3/4"(70mm)	Straight table	4TJC-72	\$149.07

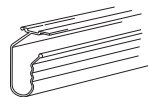

4TJC-72
Class TA – SIN 711-11;
Discount Group X

Features

- Includes J-Channel and mounting hardware.
- Field-installed.
- Provides wire management below table tops.
- Attaches to the underside of the table top with screws.
- J-channel to be field cut to length.
- Available in black finish color only.

To Order, Specify:

- 1) Product number.
(No finish specification required.)

Conduit Clamp

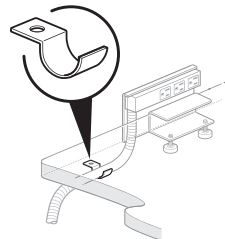

EUAM-0000
Class YA – SIN 711-2
Discount Group XIII

Features

- Includes 25 clamps and 25 screws.
- For managing Power Tap cord or conduit under horizontal surfaces.

EUAM-0000

\$56.80

Wire Management Loop

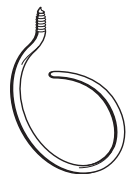

NEH-8
Class CA – SIN 711-1;
Discount Group I

Width	Installed Height	Number	Price
2 3/4"(70mm)	3 1/4"(83mm)	NEH-8	\$38.03

Features

- Includes box of eight wire management loops.
- Manages and stores wires or cables through loops attached to horizontal surface.
- Threaded top allows installation anywhere under horizontal surfaces in recommended 18"(457mm) intervals.
- Wire management loop is 2"(51mm) in diameter with 3.1 sq. in.(2000mm²) of cross section area.
- Standard in charcoal trim color only.

To Order, Specify:

- 1) Product number.
(No finish specification required.)

Wire Manager Clips

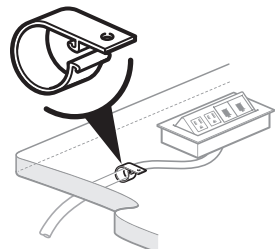

TA01-0225
Class TA – SIN 711-11;
Discount Group X

Number	Price
TA01-0225	\$22.50

Features

- Includes ten wire manager clips and screws.
- Standard in black plastic.
- Field installed.

To Order, Specify:

- 1) Product number.
(No finish specification required.)

Specification Tip

- Specify for cord management as needed.

Wire Management

	Length	Clips	Number	Price
Wire Manager — Horizontal	48"(1219mm)	2	EUAW-0048-NH	\$135.00
	72"(1829mm)	3	EUAW-0072-NH	202.52
	96"(2438mm)	3	EUAW-0096-NH	270.05
	120"(3048mm)	4	EUAW-00C0-NH	337.46

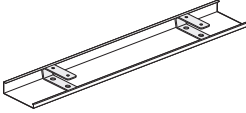

EUAW-NH
Class PT – SIN 711-11;
Discount Group IX

Features

- Includes one wire manager and attachment clips.
- Standard in light platinum.
- Field installed.

To Order, Specify:

- 1) Product number.
(No finish specification required.)

	Length	Depth	Number	Price
Horizontal Wire Management	15"(381mm)	2"(51mm)	WUAW-1500-PNH	\$158.40

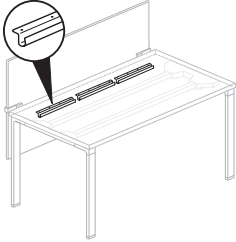

WUAW-PNH
Class CA – SIN 711-1;
Discount Group I

Features

- Includes ten plastic wire managers and attachment hardware.
- Manages and stores wires or cables under horizontal surface.
- Standard in charcoal trim color only.

To Order, Specify:

- 1) Product number.
(No finish specification required.)

	Height	Depth	Width	Number	Price
Vertical Cable Guide	3/4"(19mm)	1/2"(13mm)	3"(76mm)	NECG-V	\$52.75

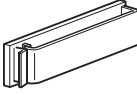

NECG-V
Class FA – SIN 711-1
Discount Group XI

Features

- Includes package of twelve cable guides.
- Manages communication cables.
- Self-adhesive back attaches to the top or bottom of horizontal surface.
- Standard in gray trim color only.

To Order, Specify:

- 1) Product number.
(No finish specification required.)

	Length	Application	Number	Price
Wire Management Trough	24"(610mm)	Stationary/Flip-Top Tables Only	KWT-24	\$ 38.15
	30"(762mm)		KWT-30	46.50
	36"(914mm)		KWT-36	54.85
	42"(1067mm)		KWT-42	63.20
	48"(1219mm)		KWT-48	71.55
	54"(1372mm)		KWT-54	79.90
	60"(1524mm)		KWT-60	88.25
	66"(1676mm)		KWT-66	96.60
	72"(1829mm)		KWT-72	104.95
		For 60", 66" and 72" folding tables only	KWMF-72	104.95
	For 84" and 96" folding tables only	KWMF-96	138.35	

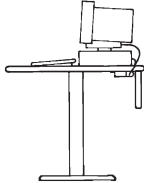

KWT
KWMF
Class TA – SIN 711-11;
Discount Group X



Features

- KWT wire management trough for use with stationary and flip-top tables only, with or without modesty panels.
- KWMF wire management trough for use with folding tables only, with or without modesty panels.
- Wire management trough attaches to underside of rectangle tables for storage of electronic equipment wiring and cabling.
- Both trough versions are field-attached.
- KWT wire management trough must be specified 6"(152mm) shorter than the table width.
- KWMF-72 is two pieces, and KWMF-96 is four pieces to allow for folding table leg clearance.
- Standard in Charcoal finish only.

To Order, Specify:

- 1) Product number.
(No finish specification required.)

Wire Management

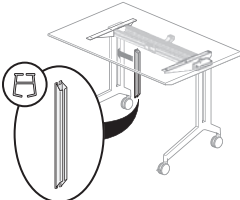
	Length	Number	Price
Planes C-Leg Training Table Vertical Wire Manager 	16"(406mm)	TA01-0228-F	\$41.62
Features <ul style="list-style-type: none"> Includes one plastic wire manager. Standard in black. Field installed. 		To Order, Specify: <ol style="list-style-type: none"> Product number. (No finish specification required.) 	
Specification Tip <ul style="list-style-type: none"> For use on Planes C-Leg Training Tables for wire management. Snaps into top portion of C-leg base. 			

TA01-0228-F
Class TA – SIN 711-11;
Discount Group X

	Description	Length	Number	Price
Compose Task Light Cord Manager 	Wire Manager, Vertical	17"(432mm)	VZAW-0000-V	\$174.58
Features <ul style="list-style-type: none"> Includes package of 10. Vertical wire manager conceals task light cord. Attaches into Compose panel frame slots. Black finish only. 		To Order, Specify: <ol style="list-style-type: none"> Product number. (No finish specification required.) 		

VZAW-0000-V
Class BC – SIN 711-1;
Discount Group XI

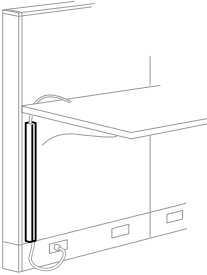
	Height	Depth	Width	Number	Price
PREMISE Vertical Wire Manager 	60"(1524mm)	5/8"(16mm)	1"(25mm)	NEV-1	\$49.09
Features <ul style="list-style-type: none"> Includes one vertical wire manager and six attachment clips. Guides wires or cables vertically from base raceway to worksurface or from worksurface to overhead storage unit or shelf. Two wire managers will fit in a single set of panel slots. 		To Order, Specify: <ol style="list-style-type: none"> Product number. Trim color (standard trim only). 			
Specification Tips <ul style="list-style-type: none"> May be field cut to appropriate length. Requires two attachment clips per field cut section. Wire manager may be installed in same connector slots with shared or handed cantilever support. Attached into PREMISE panel frame slots. 					

NEV-1
Class FA – SIN 711-1;
Discount Group XI

Wire Management

	Height	Inside Diameter	Number	Price
PREMISE Task Light Cord Manager	17 1/2"(444mm)	7/16"(11mm)	NEV-2	\$119.02



NEV-2

Class FA – SIN 711-1;
Discount Group XI

Features

- Includes ten vertical wire managers.
- Vertically routes and conceals cords along panel surface above or below the worksurface.
- Wire manager, NEV-2, extends 1/2"(13mm) from panel surface.
- Standard in black trim only.

Specification Tips

- Suggested application: use to conceal single task light cord between overhead storage and worksurface.
- May be field cut to appropriate size.
- For NEV-2, panel connectors slots will accommodate a wire manager and one adjacent panel mounted component.
- Attached into PREMISE panel frame slots.

To Order, Specify:

- 1) Product number.
(No finish specification required.)

	Height	Inside Diameter	Number	Price
UniGroup Too, UniGroup and PLACES Task Light Wire Manager	17 1/2"(444mm)	7/16"(11mm)	WC-17	\$105.52



Class AA – SIN 711-1;
Discount Group I

Features

- Includes ten vertical wire managers.
- Vertically routes and conceals cords along panel surface above or below the worksurface.
- Wire manager extends 1/2"(13mm) from panel surface.
- Standard in black finish only.

Specification Tips

- Suggested application: use to conceal single task light cord between overhead storage and worksurface.
- May be field cut to appropriate size.
- Insert into panel side rail reveals.
- Panel side rails will not accommodate multiple components in the same location.
- For use with UniGroup Too, UniGroup and PLACES.

To Order, Specify:

- 1) Product number.
(No finish specification required.)

	Height	Depth	Width	Number	Price
UniGroup Too, UniGroup and PLACES Wire Manager	72"(1829mm)	3/4"(19mm)	3/4"(19mm)	WC-6	\$27.64

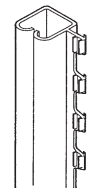

WC-6

Class AA – SIN 711-1;
Discount Group I

Features

- Includes field-cutable channel.
- Guides wires or cables vertically.
- Inserts into the panel side rail reveals.
- Not available for use in the city of Los Angeles.

Specification Tip

- For use with UniGroup Too, UniGroup and PLACES.

To Order, Specify:

- 1) Product number.
- 2) Trim color.

Wire Management

	Height	Depth	Width	Number	Laminate A	B	Wood Group A	Group B
Cable Base	Laminate							
	28"(711mm)	8"(203mm)	14"(356mm)	TA01-0814-L	\$633.43	\$684.24		
			14"(356mm)	TA01-1414-L	674.73	729.04		
	Wood							
	28"(711mm)	8"(203mm)	14"(356mm)	TA01-0814-W			\$1070.70	\$1102.61
		14"(356mm)	14"(356mm)	TA01-1414-W			1143.50	1191.93

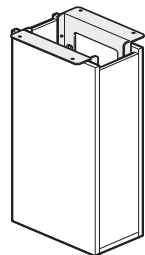

TA01-0814

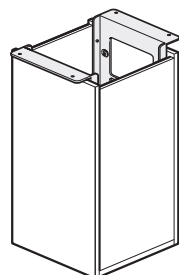

TA01-1414

Features

- Includes 28"(711mm) high cable base and mounting hardware.
- Laminate with 1mm edgeband or wood veneer with 1mm wood edgeband.
- Provides internal cable management with removable panels for access.
- Standard in green core.
- Bracket is standard in charcoal.
- Includes 1"(25mm) adjustable glides.
- Ships assembled.

To Order, Specify:

- 1) Product number.
- 2) Laminate surface color or wood finish color.
- 3) Edge trim color for laminate.

Specification Tips

- Refer to Specification Guide for use guidelines.
- **Cable base not recommended for use with 30"(762mm) deep tables, half round tables, polygon tables or Y-leg tables or 36"(914mm) deep tables with (M) or (Q) flip top unit cutout options.**
- Specify 8"(203mm) x 14"(356mm) cable base for 36"(914mm) deep tables.
- Specify 14"(356mm) x 14"(356mm) cable base for 42"(1067mm) deep and deeper tables.
- One and two-piece table tops – one cable base.
- Three-piece table tops – two cable bases.
- Cable base cord access:
 - 1 1/2"(38mm) at top
 - adjustable side panels allow 1"(25mm) gap at bottom edges
 - 8"(203mm) depth base has a 3"(76mm) deep cutout in bottom;
 - 14"(356mm) depth base has an 8"(203mm) deep cutout in bottom.

The following Planes products are separately specified:

- Horizontal wire management

Cable Column	Height	Depth	Width	Number	Price
	28"(711mm)	2"(51mm)	4 1/2"(114mm)	TA01-0217	\$223.24



TA01-0217

Features

- Cable Column offers a wire management option for conference tables when the Cable Base Option cannot be used.
- Includes one Cable Column with mounting hardware for attaching to underside of table.
- Hardware for attaching Cable Column to floor is field supplied.
- Ships unassembled.

To Order, Specify:

- 1) Product number.
- 2) Trim color.

Specification Tips

- Cable Column attaches to underside of table, extends to the floor where it is also attached.
- Cable Column is not load bearing and does not replace table leg(s).
- Cable Column can be installed anywhere under a conference table unless it would interfere with table legs, Horizontal Wire Manager or Flip Top Power/Data Units.
- The Cable Column can be used with the Horizontal Wire Manager for cable management.

Work Tools — Mounting

	Height	Width	Number	Trim A	B
Wall Accessory Slat Pad – For Use with PREMISE	16"(406mm)	24"(610mm)	NAPY-1624	\$264.90	\$296.49
		30"(762mm)	NAPY-1630	297.71	329.30
		36"(914mm)	NAPY-1636	330.52	362.11
		42"(1067mm)	NAPY-1642	363.33	394.92
		48"(1219mm)	NAPY-1648	396.14	427.73
		60"(1524mm)	NAPY-1660	461.76	493.35

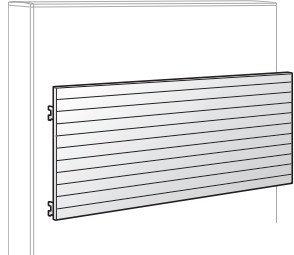

NAPY
Class FA – SIN 711-1;
Discount Group XI

Features

- Includes one pad and attachment brackets.
- Assembled stack pad thickness is 3/8"(10mm).

To Order, Specify:

- 1) Product number.
- 2) Trim color.

Specification Tips

- To be installed in connector slots on same size panel or on a combination of panels that equal the pad width.
- Designed to work with Jump Stuff and Belong slat pad tools.
- For use with PREMISE monolithic panels or wall track only.

Slat, Wall Mount

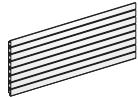

KUPY
Class CA – SIN 711-1;
Discount Group I

Nominal Height	Width	Number	Trim A	B
16"(406mm)	18"(457mm)	KUPY-1618	\$250.31	\$254.95
	24"(610mm)	KUPY-1624	270.97	276.76
	30"(762mm)	KUPY-1630	291.63	298.57
	36"(914mm)	KUPY-1636	312.29	320.38
	42"(1067mm)	KUPY-1642	332.95	342.19
	48"(1219mm)	KUPY-1648	353.61	364.00
	54"(1372mm)	KUPY-1654	374.27	385.81
	60"(1524mm)	KUPY-1660	394.93	407.62

Features

- Includes slat tile & attachment brackets for structural wall.
- Belong and Jump Stuff work tools may be used; separately specified.

To Order, Specify:

- 1) Product number.
- 2) Trim color.

Specification Tips

- Designed to be used under wall mounted overhead storage units.
- Allows space for task light cord routing.
- **Not for use with wall track.**

Work Tools — Mounting

Belong

Single Side

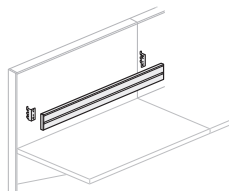

KUR1-0424-PZN

Height	Depth	Width	Number	Trim A	B
Compose					
4"(102mm)	1"(25mm)	24"(610mm)	KUR1-0424-PZN	\$147.02	\$159.52
		30"(762mm)	KUR1-0430-PZN	157.64	171.27
		36"(914mm)	KUR1-0436-PZN	168.26	183.02
		42"(1067mm)	KUR1-0442-PZN	178.88	194.77
		48"(1219mm)	KUR1-0448-PZN	189.50	206.52
		54"(1372mm)	KUR1-0454-PZN	200.12	218.27
		60"(1524mm)	KUR1-0460-PZN	286.86	306.14
PREMISE					
4"(102mm)	1"(25mm)	24"(610mm)	KUR1-0424-PNN	\$147.02	\$159.52
		30"(762mm)	KUR1-0430-PNN	157.64	171.27
		36"(914mm)	KUR1-0436-PNN	168.26	183.02
		42"(1067mm)	KUR1-0442-PNN	178.88	194.77
		48"(1219mm)	KUR1-0448-PNN	189.50	206.52
		60"(1524mm)	KUR1-0460-PNN	286.86	306.14
UniGroup					
4"(102mm)	1"(25mm)	24"(610mm)	KUR1-0424-PEN	\$147.02	\$159.52
		30"(762mm)	KUR1-0430-PEN	157.64	171.27
		36"(914mm)	KUR1-0436-PEN	168.26	183.02
		42"(1067mm)	KUR1-0442-PEN	178.88	194.77
		48"(1219mm)	KUR1-0448-PEN	189.50	206.52
		60"(1524mm)	KUR1-0460-PEN	286.86	306.14

Features

- Includes one rail with panel attachment brackets.
- Mounts to panel side trim rails/connectors/slotted frame/wall track to support rail tools.
- Tool Rail is 5/8"(16mm) thick; brackets provide 3/8"(10mm) gap for cord management.
- Belong and Jump Stuff work tools may be used; separately specified.

To Order, Specify:

- 1) Product number.
- 2) Trim Color for rail/brackets (product line specific; refer to appropriate price list).

Specification Tips

- **Supports maximum load of 40 pounds of Paper Management evenly distributed.**
- Panel mounted rail may span one or more panels equivalent to rail width.
- Recommended mounting position is approximately 9"(229mm) above worksurface.
- Rail is for use with specific product lines: Compose®, PREMISE® and UniGroup Too®.

Work Tools — Mounting

Belong

Tool Rail — Horizontal Surface Mount C-Clamp or Thru-Mount

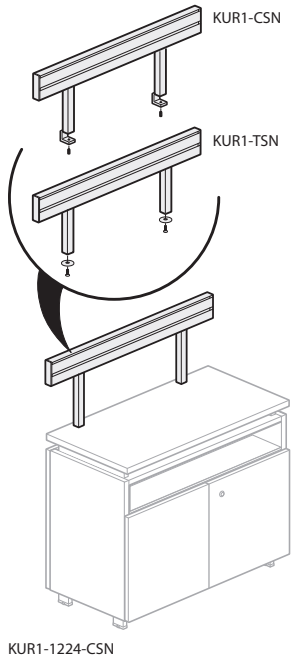

Rail Height	Width	Description	Number	Trim A	B
1 3/16" (30mm) Thick Top					
4" (102mm)	24" (610mm)	C-Clamp	KUR1-1224-CSN	\$278.35	\$290.85
	30" (762mm)		KUR1-1230-CSN	293.12	306.75
	36" (914mm)		KUR1-1236-CSN	307.89	322.65
	42" (1067mm)		KUR1-1242-CSN	322.66	338.55
	48" (1219mm)		KUR1-1248-CSN	337.43	354.45
	54" (1372mm)		KUR1-1254-CSN	352.20	370.35
	60" (1524mm)		KUR1-1260-CSN	443.09	462.37
2" (51mm) Thick Top					
4" (102mm)	24" (610mm)	C-Clamp	KUR1-1224-CMN	\$278.35	\$290.85
	30" (762mm)		KUR1-1230-CMN	293.12	306.75
	36" (914mm)		KUR1-1236-CMN	307.89	322.65
	42" (1067mm)		KUR1-1242-CMN	322.66	338.55
	48" (1219mm)		KUR1-1248-CMN	337.43	354.45
	54" (1372mm)		KUR1-1254-CMN	352.20	370.35
	60" (1524mm)		KUR1-1260-CMN	443.09	462.37
1 3/16" (30mm) Thick Top					
4" (102mm)	24" (610mm)	Thru-mount	KUR1-1224-TSN	\$278.35	\$290.85
	30" (762mm)		KUR1-1230-TSN	293.12	306.75
	36" (914mm)		KUR1-1236-TSN	307.89	322.65
	42" (1067mm)		KUR1-1242-TSN	322.66	338.55
	48" (1219mm)		KUR1-1248-TSN	337.43	354.45
	54" (1372mm)		KUR1-1254-TSN	352.20	370.35
	60" (1524mm)		KUR1-1260-TSN	443.09	462.37
2" (51mm) Thick Top					
4" (102mm)	24" (610mm)	Thru-mount	KUR1-1224-TMN	\$278.35	\$290.85
	30" (762mm)		KUR1-1230-TMN	293.12	306.75
	36" (914mm)		KUR1-1236-TMN	307.89	322.65
	42" (1067mm)		KUR1-1242-TMN	322.66	338.55
	48" (1219mm)		KUR1-1248-TMN	337.43	354.45
	54" (1372mm)		KUR1-1254-TMN	352.20	370.35
	60" (1524mm)		KUR1-1260-TMN	443.09	462.37

Features

- Includes one double sided rail with two posts, two rail end caps and attachment hardware.
- Mounts to horizontal surface to support rail tools.
- 1 3/16" (30mm) C-clamp Rail mounts on horizontal surfaces from 3/4" (19mm) to 1 3/4" (44mm) thick.
- Thru-mount Rail mounts on 1 3/16" (30mm) thick horizontal surfaces.
- Posts are 1 1/4" (32mm) thick.
- Belong and Jump Stuff work tools may be used; separately specified.
- Rail overall height above horizontal surface: 11 13/16" (300mm).
- Distance between rail bottom and top of horizontal surface: 7 7/16" (189mm).
- Ships unassembled.

To Order, Specify:

- 1) Product number.
- 2) Trim color for rail/post.
- 3) Trim color for rail end caps:
 - TR-K Charcoal
 - TR-J Graphite
 - TR-FM Snow

Specification Tips

- Designed for single sided Reside desking and single sided benching applications or Beside base units.
- **Not designed to be used in front of panel mounted accessories (tackboard, markerboard).**
- For ease of installation, it is required that tool rail posts are attached to Beside storage top prior to attaching storage top to base unit.
- Tool Rail supports a maximum load of 40 pounds evenly distributed on user side.
- If supporting two monitor arms (up to 13 pounds each); an additional C-clamp or thru-mount post is recommended.
- Rail may be installed off modular.
- Heavy load application; additional posts can be ordered.
- Monitor arm cannot be mounted in post positions.
- Thru-mount post can be attached flush to back edge of horizontal surface.
- C-clamp rail can be attached to panel mounted horizontal surface with notch or radius wireways without removing the horizontal surface.
- Under horizontal surface: 4" (102mm) of clearance is necessary between back of horizontal surface and adjacent component for clamp attachment.
- Gap between screen and horizontal surface allows installation of Belong Tool Rail.
- Utility tray provides clearance for installation of Belong Tool Rail.

Note: No more than 6" (152mm) of rail can be extended beyond outside of support.

Work Tools — Mounting

Belong

Tool Rail — Single Post — C-Clamp or Thru-mount

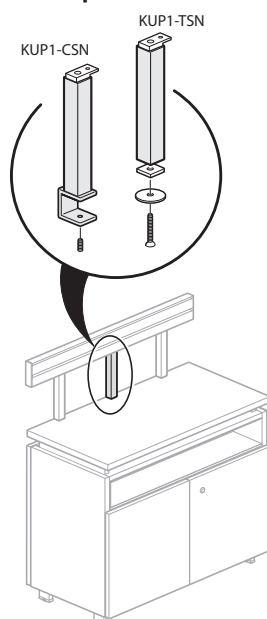

KUP1-0000-CSN

Post Height	Description	Number	Trim A	B
1 3/16" (30mm) Thick Top				
7 1/2" (191mm)	C-Clamp	KUP1-0000-CSN	\$86.34	\$93.16
2" (51mm) Thick Top				
7 1/2" (191mm)	C-Clamp	KUP1-0000-CMN	\$86.34	\$93.16
1 3/16" (30mm) Thick Top				
7 1/2" (191mm)	Thru-mount	KUP1-0000-TSN	\$86.34	\$93.16
2" (51mm) Thick Top				
7 1/2" (191mm)	Thru-mount	KUP1-0000-TMN	\$86.34	\$93.16

Features

- Includes one C-clamp or one Thru-mount Post and attachment hardware.
- Posts mount on horizontal surfaces 1 13/16"-2" (46mm-51mm) thick.
- Posts are 1 1/4" (32mm) thick.

To Order, Specify:

- 1) Product number.
- 2) Trim color.

Specification Tips

- For ease of installation, it is required that tool rail post is attached to Beside storage top prior to attaching storage top to base unit.
- Posts supports slide along rail bottom groove.
- For use with C-clamp or Thru-mount tool rail only.
- Monitor arm cannot be mounted in post position.
- Extra single posts can be ordered when additional support for monitor arms and paper management are attached to Tool Rail.

Work Tools — Mounting

Belong

Tool Rail — Under Horizontal Surface Mount — L-Bracket	Rail Height	Width	Number	Trim A	B
	4"(102mm)	24"(610mm)	KUR1-1224-USN	\$278.35	\$290.85
	30"(762mm)	KUR1-1230-USN	293.12	306.75	
	36"(914mm)	KUR1-1236-USN	307.89	322.65	
	42"(1067mm)	KUR1-1242-USN	322.66	338.55	
	48"(1219mm)	KUR1-1248-USN	337.43	354.45	
	54"(1372mm)	KUR1-1254-USN	352.20	370.35	
	60"(1524mm)	KUR1-1260-USN	443.09	462.37	
	66"(1676mm)	KUR1-1266-USN	468.06	489.60	
	72"(1829mm)	KUR1-1272-USN	493.03	514.57	
	78"(1981mm)	KUR1-1278-USN	518.00	540.67	
	84"(2134mm)	KUR1-1284-USN	542.97	566.77	
	90"(2286mm)	KUR1-1290-USN	567.94	592.87	
	96"(2438mm)	KUR1-1296-USN	592.91	618.97	

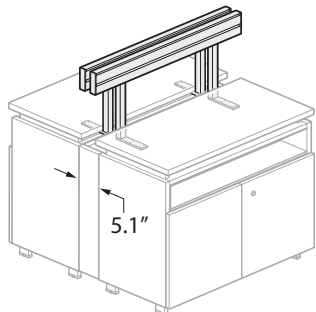
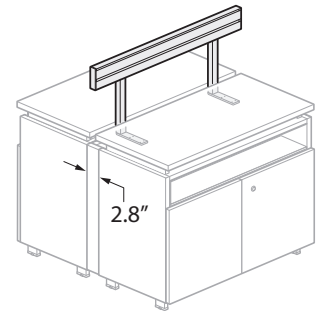
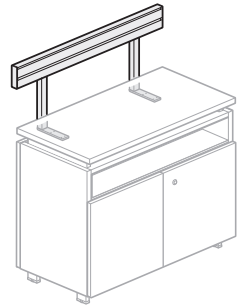

KUR1-1224-USN

Features

- One double sided rail with two or three posts, two rail end caps and attachment brackets.
- Rails 66"-96"(1676mm-2438mm) include three posts.
- L-bracket mounts under 1 3/16"(30mm) thick horizontal surface to support rail tools on both sides.
- Belong Work Tools or JumpStuff Slat Pad Tools may be used; separately specified.
- Rail overall height above horizontal surface: 11 3/16"(284mm).
- Distance between rail bottom and top of horizontal surface: 7 7/16"(189mm).
- Post is 1 1/4"(32mm) thick.
- Ships unassembled.

To Order, Specify:

- 1) Product number.
- 2) Trim color for rail/post.
- 3) Trim color for rail end caps:
 - TR-K Charcoal
 - TR-J Graphite
 - TR-FM Snow

Specification Tips

- Rail with L-bracket or shared bracket mount can only be used in non-panel applications.
- Designed for single sided Beside desking and single sided benching applications or Beside base unit.
- Tool Rail supports a maximum load of 40 pounds (18.14kg) evenly distributed on user side or supports two monitor arms up to 13 pounds each; additional L-bracket mount post recommended.
- For use with one Beside base unit or back-to-back base units; L-Bracket Tool Rail is double sided to accommodate Belong work tool accessories on both sides.
- For back-to-back Beside base unit applications, one or two L-Bracket tool rail(s) may be used:
 - One L-Bracket tool rail may be used between base units which results in an aesthetically unbalanced tool rail condition. Both users share a single tool rail. L-Brackets are attached to only one of the two back-to-back Beside storage tops. (Note: KUR2-USN Under Worksurface Mount T-Bracket is not recommended for use with back-to-back base units due to installation issues.)
 - Two back-to-back L-Bracket tool rails may be used between base units for an aesthetically balanced tool rail condition.
 - For a single tool rail application, a 2.8"(71mm) deep filler panel may be used to fill gap between back-to-back units.
 - For two back-to-back tool rails, a 5.1"(130mm) deep filler panel may be used to fill gap between back-to-back base units.
- Tool Rail should be specified 6"(152mm) shorter than screen if both are specified.
- Can be installed off modular.
- Under horizontal surface: 4"(102mm) of clearance is necessary between back of horizontal surface and adjacent component for flat bracket attachment.
- Heavy load application; additional posts can be ordered.
- Monitor arm cannot be mounted in post positions.
- Gap between screen and horizontal surface allows installation of Belong Tool Rail.
- Utility tray provides clearance for installation of Belong Tool Rail.
- Posts mount flush to back edge of horizontal surface.

Note: No more than 6"(152mm) of rail can be extended beyond outside of support.

Work Tools — Mounting

Belong

	Post Height	Number	Trim A	B
Tool Rail — Single Post — L-Bracket Mount	8 7/8"(225mm)	KUP1-0000-USN	\$86.34	\$93.16

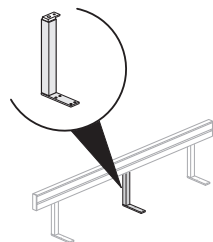

KUP1-0000-USN

Features

- Includes one under horizontal surface L-Bracket mount post and attachment hardware.
- Post is 1 1/4"(32mm) thick.

To Order, Specify:

- 1) Product number.
- 2) Trim color.

Specification Tips

- For use with under horizontal surface mount tool rail.
- Single Support Post may interfere with central casting.
- Monitor arm cannot be mounted in post position.
- Extra single posts can be ordered when additional support for monitor arms and paper management are attached to Tool Rail.

Work Tools — Mounting

Belong

	Rail Height	Width	Description	Number	Trim A	B
Tool Rail — Single Sided Continuous Benching End	4"(102mm)	24"(610mm)	End	KUR1-1224-USE	\$278.35	\$290.85
		30"(762mm)		KUR1-1230-USE	293.12	306.75
		36"(914mm)		KUR1-1236-USE	307.89	322.65
		42"(1067mm)		KUR1-1242-USE	322.66	338.55
		48"(1219mm)		KUR1-1248-USE	337.43	354.45
		54"(1372mm)		KUR1-1254-USE	352.20	370.35
		60"(1524mm)		KUR1-1260-USE	443.09	462.37
		66"(1676mm)		KUR1-1266-USE	468.06	489.60
		72"(1829mm)		KUR1-1272-USE	493.03	514.57
		78"(1981mm)		KUR1-1278-USE	518.00	540.67
		84"(2134mm)		KUR1-1284-USE	542.97	566.77
		90"(2286mm)		KUR1-1290-USE	567.94	592.87
	96"(2438mm)		KUR1-1296-USE	592.91	618.97	

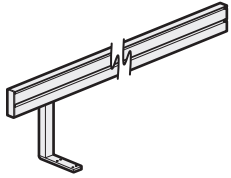

KUR1-1224-USE

Features

- One single sided tool rail with one or two posts, one rail end cap and attachment brackets.
- Tool Rails 66"-96" includes two posts.
- Mounts under 1 3/16"(30mm) thick horizontal surface to support rail tools.
- Belong Work Tools or JumpStuff Slat Pad Tools may be used; separately specified.
- Tool rail overall height above horizontal surface: 11 3/16"(284mm).
- Distance between tool rail bottom and top of horizontal surface: 7 7/16"(189mm).
- Post is 1 1/4"(32mm) thick.
- Ships unassembled.

Specification Tips

- **Designed for Reside Single Sided Continuous Benching or Beside continuous storage applications only.**
- **For use with another tool rail end or internal tool rail; internal benching single post must be specified.**
- **Tool Rail supports maximum of 40 pounds(18.14kg) evenly distributed on one side.**
- **For continuous benching application, two monitor arms up to 13 pounds each side, requires additional post.**
- **Tool Rail should be specified 6" shorter than screen if both are specified.**
- Can be installed off modular.
- Under horizontal surface: 4"(102mm) of clearance is necessary between back of horizontal surface and pedestal for flat bracket attachment.
- Gap between screen and horizontal surface allows installation of Belong Tool Rail.
- Utility tray provides clearance for installation of Belong Tool Rail.

Note: No more than 6"(152mm) of rail can be extended beyond outside of support.

To Order, Specify:

- 1) Product number.
- 2) Trim color for tool rail/post.
- 3) Trim color for tool rail end cap:
 - TR-K Charcoal
 - TR-J Graphite
 - TR-FM Snow

Work Tools — Mounting

Belong

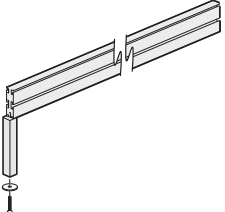
	Rail Height	Width	Description	Number	Trim A	B
Tool Rail — Internal Single Sided Continuous Benching Application  KUR1-1224-USI	4"(102mm)	24"(610mm)	Internal	KUR1-1224-USI	\$278.35	\$290.85
		30"(762mm)		KUR1-1230-USI	293.12	306.75
		36"(914mm)		KUR1-1236-USI	307.89	322.65
		42"(1067mm)		KUR1-1242-USI	322.66	338.55
		48"(1219mm)		KUR1-1248-USI	337.43	354.45
		54"(1372mm)		KUR1-1254-USI	352.20	370.35
		60"(1524mm)		KUR1-1260-USI	443.09	462.37
		66"(1676mm)		KUR1-1266-USI	468.06	489.60
		72"(1829mm)		KUR1-1272-USI	493.03	514.57
		78"(1981mm)		KUR1-1278-USI	518.00	540.67
		84"(2134mm)		KUR1-1284-USI	542.97	566.77
		90"(2286mm)		KUR1-1290-USI	567.94	592.87
	96"(2438mm)		KUR1-1296-USI	592.91	618.97	

Features

- One single sided tool rail with one or two post and attachment brackets.
- Tool Rails 66"-96" includes two posts.
- Mounts on 1 3/16"(30mm) thick horizontal surface to support rail tools.
- Belong Work Tools or JumpStuff Slat Pad Tools may be used; separately specified.
- Tool rail overall height above horizontal surface: 11 3/16"(284mm).
- Distance between tool rail bottom and top of horizontal surface: 7 7/16"(189mm).
- Post is 1 1/4"(32mm) thick.
- Ships unassembled.

Specification Tips

- **Designed for Reside Single Sided Continuous Benching or Beside continuous storage applications only.**
- **For use with two rail ends; Internal Benching single post must be specified.**
- **Tool Rail supports a maximum of 40 pounds(18.14kg) evenly distributed on one side.**
- **For use with benching application, 1 or 2 monitors up to 13 pounds each side, requires additional post.**
- Mounts into 1/4"(6mm) gap between shared block connectors or center attachment location on shared column.
- Under horizontal surface: 4"(102mm) of clearance is necessary between back of horizontal surface and pedestal for flat bracket attachment.
- Gap between screen and horizontal surface allows installation of Belong Tool Rail.
- Utility tray provides clearance for installation of Belong Tool Rail.

To Order, Specify:

- 1) Product number.
- 2) Trim color for tool rail/post.

Work Tools — Mounting

Belong

	Rail Height	Width	Description	Number	Trim A	B
Tool Rail — Internal Continuous Benching Application Only	4"(102mm)	24"(610mm)	Internal	KUR2-1224-UBI	\$278.35	\$290.85
		30"(762mm)		KUR2-1230-UBI	293.12	306.75
		36"(914mm)		KUR2-1236-UBI	307.89	322.65
		42"(1067mm)		KUR2-1242-UBI	322.66	338.55
		48"(1219mm)		KUR2-1248-UBI	337.43	354.45
		54"(1372mm)		KUR2-1254-UBI	352.20	370.35
		60"(1524mm)		KUR2-1260-UBI	443.09	462.37
		66"(1676mm)		KUR2-1266-UBI	468.06	489.60
		72"(1829mm)		KUR2-1272-UBI	493.03	514.57
		78"(1981mm)		KUR2-1278-UBI	518.00	540.67
		84"(2134mm)		KUR2-1284-UBI	542.97	566.77
		90"(2286mm)		KUR2-1290-UBI	567.94	592.87
	96"(2438mm)		KUR2-1296-UBI	592.91	618.97	

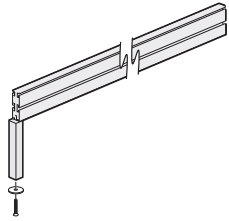

KUR2-1224-UBI

Features

- One double sided tool rail with one or two post and attachment brackets.
- Tool Rails 66"-96" includes two posts.
- Mounts on 1 3/16"(30mm) thick horizontal surface to support rail tools.
- Belong Work Tools or JumpStuff Slat Pad Tools may be used; separately specified.
- Tool rail overall height above horizontal surface: 11 3/16"(284mm).
- Distance between tool rail bottom and top of horizontal surface: 7 7/16"(189mm).
- Post is 1 1/4"(32mm) thick.
- Ships unassembled.

To Order, Specify:

- 1) Product number.
- 2) Trim color for tool rail/post.

Specification Tips

- **Designed for Reside Continuous Benching and Beside continuous storage applications only.**
- **For use with two rail ends; Internal Benching single post must be specified.**
- **Tool Rail supports a maximum of 40 pounds(18.14kg) evenly distributed.**
- **Tool Rail should be specified 6" shorter than screen if both are specified.**
- **For use with benching application, 1 or 2 monitors up to 13 pounds each side, requires additional post.**
- Mounts into 1/4"(6mm) gap between shared block connectors or center attachment location on shared column.
- Under horizontal surface: 4"(102mm) of clearance is necessary between back of horizontal surface and pedestal for flat bracket attachment.
- Gap between screen and horizontal surface allows installation of Belong Tool Rail.
- Utility tray provides clearance for installation of Belong Tool Rail.
- Posts mount centered within 3.65"(93mm) gap.

Note: No more than 6"(152mm) of rail can be extended beyond outside of support.

Tool Rail — Single Post Internal/Benching

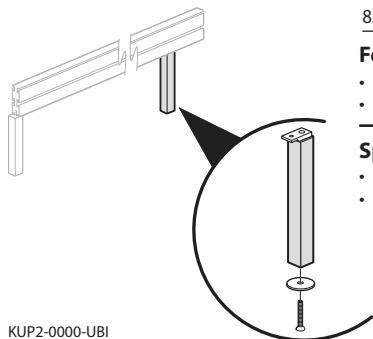

KUP2-0000-UBI

	Post Height	Description	Number	Trim A	B
	8.9"(226mm)	Internal	KUP2-0000-UBI	\$86.34	\$93.16

Features

- Includes one Internal position post and attachment hardware.
- Post is 1 1/4"(32mm) thick.

To Order, Specify:

- 1) Product number.
- 2) Trim color.

Specification Tips

- For use with benching mount tool rail.
- Mounts into 1/4"(6mm) gap between shared block connectors or center attachment location on shared column.

Work Tools — Mounting

Jump Stuff

	Height	Depth	Width	Description	Number	Price
Panel Mount Rail	4 1/2"(114mm)	7"(178mm)	24"(610mm)	Two Supports	DSR-24-H	\$ 97.45
			30"(762mm)		DSR-30-H	103.95
			36"(914mm)		DSR-36-H	110.45
			42"(1067mm)		DSR-42-H	116.95
			48"(1219mm)		DSR-48-H	123.45
			60"(1524mm)		DSR-60-H	136.45

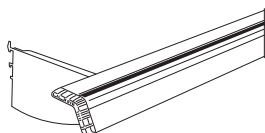

DSR-H

Features

- Includes two supports, one rail with two end caps.
- Mounts to PREMISE, PLACES and UniGroup panel side rails to support rail tools.
- Belong and Jump Stuff work tools may be used; separately specified.
- Rail is standard in brushed aluminum.

To Order, Specify:

- 1) Product number.
- 2) Metallic trim color for rail supports only.

Specification Tips

- Supports maximum load of 50 pounds (23kg), evenly distributed.
- Can be mounted on Haworth wall track.
- Can span one or more panels equivalent to rail width.
- Mounts approximately 18"(457mm) below overhead storage units and 7"(178mm) above worksurfaces.
- Rail should not be mounted directly in front of tackboards.

Note: No more than 12"(305mm) of rail can be extended beyond outside of support.

	Height	Depth	Width	Description	Number	Price
Worksurface Mount Rail	7"(178mm)	7"(178mm)	24"(610mm)	One Support	DSR-24-W	\$183.19
			30"(762mm)		DSR-30-W	189.69
			36"(914mm)	Two Supports	DSR-36-W	\$196.19
			42"(1067mm)		DSR-42-W	202.69
			48"(1219mm)		DSR-48-W	209.19
			60"(1524mm)		DSR-60-W	222.19

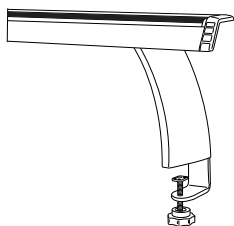

DSR-W

Features

- Includes support(s) with mounting clamp(s) and one rail with two end caps.
- Mounts to worksurface to support rail tools.
- Mounts on worksurfaces from 3/4"(19mm) to 1 3/4"(44mm) thick. With minimum of 1/4"(6mm) of clearance depth does not require worksurface removal.
- Belong and Jump Stuff work tools may be used; separately specified.
- Rail is standard in brushed aluminum.

To Order, Specify:

- 1) Product number.
- 2) Metallic trim color for rail supports only.

Specification Tips

- Single support holds up to a maximum of 25 pounds (11kg), evenly distributed. Double support holds up to a maximum of 50 pounds (23kg), evenly distributed.
- Can be installed off modular.
- Rail should not be mounted directly in front of tackboards.
- Under worksurface 4"(102mm) of clearance is necessary between back of worksurface and pedestal for clamp.

Note: No more than 12"(305mm) of rail can be extended beyond outside of support.

Work Tools — Mounting

Jump Stuff

	Height	Depth	Width	Description	Number	Price
Freestanding Mount Rail	7"(178mm)	9"(229mm)	24"(610mm)	Two Supports	DSR-24-F	\$227.37
			30"(762mm)		DSR-30-F	233.87
			36"(914mm)		DSR-36-F	240.37
			42"(1067mm)		DSR-42-F	246.87
			48"(1219mm)		DSR-48-F	253.37
			60"(1524mm)		DSR-60-F	266.37

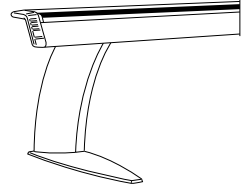

DSR-F

Features

- Includes two supports with feet, one rail with two end caps.
- Freestanding mount rail supports rail tools on most flat surfaces.
- Belong and Jump Stuff work tools may be used; separately specified.
- Supports maximum load of 50 pounds (23kg), evenly distributed.
- Rail is standard in brushed aluminum.

Note: No more than 12"(305mm) of rail can be extended beyond outside of support.

To Order, Specify:

- 1) Product number.
- 2) Metallic trim color for rail supports only.

Work Tools

Belong

	Actual Height	Actual Depth	Actual Width	Weight Pounds	Description	Number	Trim A	Trim B
Territory Screen — End-of Run	11.78"(299mm)	3"(76mm)	23.75"(603mm)	8.0 (3.6kg)	With Slots	KUTS-1224-ESN	\$149.96	\$156.78
				8.7 (3.9kg)	Without Slots	KUTS-1224-ENN	113.61	120.43

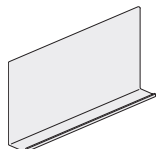
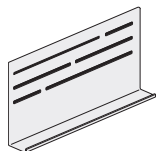

KUTS-E

Features

- Includes one freestanding steel End-of-Run Territory Screen with double sided attachment material.
- End-of-Run Territory Screen Options:
 - With Slots (S); without Slots (N).
 - With Accessory Kit (A) (square and rectangular trays with bud base).
 - Without Accessory Kit (N).
- Optional Slotted Territory Screen includes three rows of two slots; 2"(51mm) between rows (centerline-to-centerline):
- Slot Widths:
 - Top Row: 5.25"(133mm) and 15.31"(389mm).
 - Middle Row: 10.28"(261mm) and 10.28"(261mm).
 - Bottom Row: 15.31"(389mm) and 5.25"(133mm).
- Supports maximum weight of 5 pounds (2.3kg) on side with ledge.
- Non-writable, magnetic surface.

To Order, Specify:

- 1) Product number including:

1 Accessory Kit Option:

A Accessory Kit, add **\$41.34** list

N No Accessory Kit

- 2) Trim color.

Specification Tips

- End-of-Run Territory Screen is not designed for use with Base Tray.
- For use with separately specified Belong or Jump Stuff work tools.
- Accessory Kit is designed to sit on ledge of End-of-Run Territory Screen.
- Hanging accessories should be mounted in ledge side of End-of-Run Territory Screen with slots.

Territory Screen — Shared	11.78"(299mm)	6"(152mm)	23.75"(603mm)	8.0 (3.6kg)	With Slots	KUTS-1224-SSN	\$161.32	\$168.14
				8.7 (3.9kg)	Without Slots	KUTS-1224-SNN	124.97	131.79

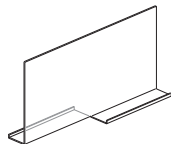
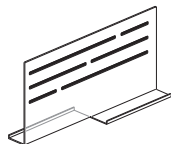

KUTS-S

Features

- Includes one freestanding steel Shared Territory Screen with double sided attachment material.
- Shared Territory Screen Options:
 - With Slots (S); without Slots (N).
 - With Accessory Kit (A) (square and rectangular trays with bud base).
 - Without Accessory Kit (N).
- Optional Slotted Territory Screen includes three rows of two slots; 2"(51mm) between rows (centerline-to-centerline):
- Slot Widths:
 - Top Row: 5.25"(133mm) and 15.31"(389mm).
 - Middle Row: 10.28"(261mm) and 10.28"(261mm).
 - Bottom Row: 15.31"(389mm) and 5.25"(133mm).
- Supports maximum weight of 5 pounds (2.3kg).
- Non-writable, magnetic surface.

To Order, Specify:

- 1) Product number including:

1 Accessory Kit Option:

A Accessory Kit, add **\$41.34** list

N No Accessory Kit

- 2) Trim color.

Specification Tips

- Shared Territory Screen is not designed for use with Base Tray.
- For use with separately specified Belong or Jump Stuff work tools.
- Accessory Kit is designed to sit on 11.8"(300mm) wide ledges of Shared Territory Screen.
- Hanging accessories may be mounted from either side of Shared Territory Screen with slots.

Work Tools

Belong

	Actual Height	Actual Depth	Actual Width	Weight Pounds	Description	Number	①	Trim A	B
Territory L-Screen									
Right-hand									
	11.78"(299mm)	10"(254mm)	23.75"(603mm)	11.0 (5.4kg)	With Slots	KUTS-1224-LSR		\$184.05	\$190.87
				11.9 (5.0kg)	Without Slots	KUTS-1224-LNR		147.70	154.52
Left-hand									
	11.78"(299mm)	10"(254mm)	23.75"(603mm)	11.0 (5.4kg)	With Slots	KUTS-1224-LSL		\$184.05	\$190.87
				11.9 (5.0kg)	Without Slots	KUTS-1224-LNL		147.70	154.52

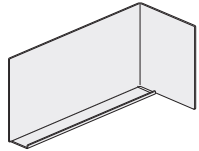
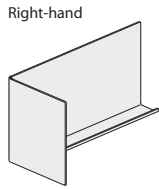
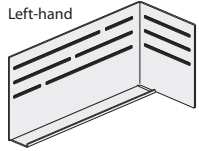
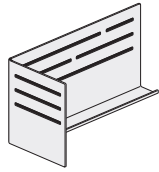

KUTS-L

Features

- Includes one freestanding steel Territory L-Screen with double sided attachment material.
- Territory L-Screen Options:
 - With Slots (S); without Slots (N).
 - With Accessory Kit (A) (square and rectangular trays with bud base).
 - Without Accessory Kit (N).
- Optional Slotted Territory L-Screen includes three rows of two slots; 2"(51mm) between rows (centerline-to-centerline):
 - Slot Widths on 23.75" portion:
 - Top Row: 5.25"(133mm) and 15.31"(388mm).
 - Middle Row: 10.28"(261mm) and 10.28"(261mm).
 - Bottom Row: 15.31"(389mm) and 5.25"(133mm).
 - Slot widths on 10"(254mm) portion: three rows of 8.25"(210mm).
- Supports maximum weight of 5 pounds (2.3kg) on inside of Territory L-Screen.
- Non-writable, magnetic surface.

Specification Tips

- Territory L-Screen is not designed for use with Base Tray.
- For use with separately specified Belong or Jump Stuff work tools.
- Accessory Kit is designed to sit on ledge of Territory L-Screen.
- Hanging accessories should be mounted on inside of Territory L-Screen with slots.

To Order, Specify:

- 1) Product number, including:

① Accessory Kit Option:

- A** Accessory Kit, add \$41.34 list
- N** No Accessory Kit

- 2) Trim color.

Work Tools

Belong

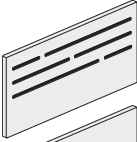
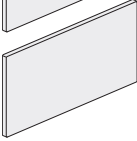
Structural Screen Tile	Actual Height	Actual Depth	Actual Width	Weight Pounds	Number	Trim		
						A	B	
  KUTB	With Slots							
	12"(305mm)	0.67"(17mm)	18"(457mm)	7.1 (3.2kg)	KUTB-1218-S	\$150.92	\$155.64	
			22.5"(572mm)	8.9 (4.0kg)	KUTB-1222-S	157.13	165.39	
			27"(686mm)	10.6 (4.8kg)	KUTB-1227-S	167.48	181.64	
			31.5"(800mm)	12.5 (5.7kg)	KUTB-1232-S	177.83	197.89	
			36"(914mm)	14.2 (6.4kg)	KUTB-1236-S	186.11	210.89	
	Without Slots							
	12"(305mm)	0.67"(17mm)	18"(457mm)	7.5 (3.4kg)	KUTB-1218-N	\$101.31	\$106.03	
			22.5"(572mm)	9.4 (4.3kg)	KUTB-1222-N	107.52	115.78	
			27"(686mm)	11.2 (5.1kg)	KUTB-1227-N	117.87	132.03	
		31.5"(800mm)	13.1 (5.9kg)	KUTB-1232-N	128.22	148.28		
		36"(914mm)	15.0 (6.8kg)	KUTB-1236-N	136.50	161.28		

Features

- Includes one steel Structural Screen Tile with or without slats and attachment hardware.
- Supports maximum weights of:
 - 18"(457mm) - 10 pounds (4.5kg).
 - 22.5"(572mm) - 10 pounds (4.5kg).
 - 27"(686mm) - 15 pounds (6.8kg).
 - 31.5"(800mm) - 17 pounds (7.7kg).
 - 36"(914mm) - 20 pounds (9.0kg).
- Non-writable, magnetic surface.

To Order, Specify:

- 1) Product number.
- 2) Trim color.

Specification Tips

- Designed for use on Belong Structural Screen (defaces screen) or structural building wall.
- May be wall mounted to structural building wall if properly mounted;
 - Anchors are not provided, must be field supplied.
- Cords cannot be passed behind the Structural Screen Tile.
- Not for use with Wall Track.
- For use with separately specified Belong or Jump Stuff work tools.

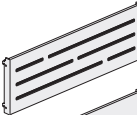
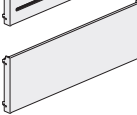
Belong Systems Tile — External Mount for use with Compose Panels	Actual Height	Actual Depth	Actual Width	Weight Pounds	Number	Trim		
						A	B	
  KZTB	With Slots							
	7.87"(200mm)	1.36"(35mm)	24"(610mm)	4.8 (2.2kg)	KZTB-0824-S	\$132.91	\$143.53	
			30"(762mm)	6.0 (2.7kg)	KZTB-0830-S	145.33	163.03	
			36"(914mm)	7.1 (3.2kg)	KZTB-0836-S	157.75	182.53	
			42"(1067mm)	8.2 (3.7kg)	KZTB-0842-S	170.17	202.03	
			48"(1219mm)	9.3 (4.2kg)	KZTB-0848-S	182.59	221.53	
	Without Slots							
	7.87"(200mm)	1.36"(35mm)	24"(610mm)	5.4 (2.4kg)	KZTB-0824-N	\$ 83.30	\$ 93.92	
			30"(762mm)	6.6 (3.0kg)	KZTB-0830-N	95.72	113.42	
			36"(914mm)	7.8 (3.5kg)	KZTB-0836-N	108.14	132.92	
		42"(1067mm)	9.1 (4.1kg)	KZTB-0842-N	120.56	152.42		
		48"(1219mm)	10.3 (4.7kg)	KZTB-0848-N	132.98	171.92		

Features

- Includes one steel external mount Systems Tile with or without slots with integrated attachment brackets for use with Compose Panel Frames with Tiles.
- Supports maximum weights of:
 - 24"(610mm) - 15 pounds (6.8kg).
 - 30"(762mm) - 17 pounds (7.7kg).
 - 36"(914mm) - 17 pounds (7.7kg).
 - 42"(1067mm) - 20 pounds (9.0kg).
 - 48"(1219mm) - 20 pounds (9.0kg).
- Non-writable, magnetic surface.

To Order, Specify:

- 1) Product number.
- 1) Trim color.

Specification Tips

- Designed for use with Compose Panel Frames with Tiles only.
- Nominal height is 8"(203mm).
- To be installed in panel frame slots on same width panel, a combination of panels equal to tile width.
- Vertical panel frame face dimensions:
 - Panel frame/non-raceway cover = frame height minus 2"(51mm).
 - Panel frame with raceway cover = frame height minus 10"(254mm).
- For use with separately specified Belong or Jump Stuff work tools.

Work Tools

Belong

	Actual Height	Actual Width	Weight Pounds	Description	Number	Trim	
						A	B
Screen Rail	2.19"(56mm)	23.75"(603mm)	2.8 (1.3kg)	Single Sided	KUSR-0224-S	\$64.96	\$76.77
			2.8 (1.3kg)	Double Sided	KUSR-0224-D	76.77	88.58

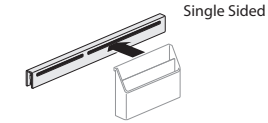
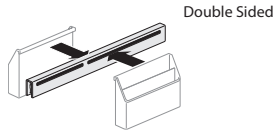

KUSR

Features

- Includes one steel Screen Rail; single sided with row of two slots or double sided with two slots on each side.
- Slot Widths: 8.19"(208mm) and 12.94"(329mm).
- Supports maximum weight of:
 - Single Sided: 5 pounds (2.3kg).
 - Double Sided: 5 pounds (2.3kg) each side.
- Non-writable, magnetic surface.

To Order, Specify:

- 1) Product number.
- 2) Trim color.

Specification Tips

- For use with separately specified Belong or Jump Stuff work tools.
- For use on top of fabric, laminate or wood Belong Screens.
- Not for use on Glass Screens, Structural L-screens or Territory Screens.

Open C Cubby

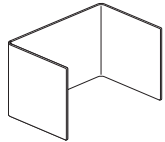

KUCU-0915-BNN

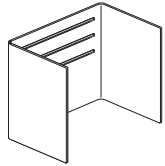

KUCU-1215-BNS

Height	Depth	Width	Description	Number	Trim	
					A	B
9"(229mm)	10"(254mm)	15"(381mm)	No Slots	KUCU-0915-BNN	\$ 99.20	\$111.01
12"(305mm)	10"(254mm)	15"(381mm)	No Slots	KUCU-1215-BNN	103.93	115.74
12"(305mm)	10"(254mm)	15"(381mm)	With Slots	KUCU-1215-BNS	115.74	127.55

Features

- Includes one freestanding Open C Cubby.
- Freestanding Open C Cubby's are designed for supporting binders and books.
- Open C Cubby with slots allows use of Belong Work Tools or Jump Stuff Slat Pad work tools; separately specified.
- Open C Cubby's can be used in Beside Overhead Storage.

To Order, Specify:

- 1) Product number.
- 2) Trim color.

Work Tools

Belong

	Actual Height	Actual Depth	Actual Width	Weight Pounds	Description	Number	Trim A	B
Base Tray	2.09"(53mm)	3.55"(90mm)	23.75"(603mm)	5.0 (2.3kg)	With Accessory Kit	KUBT-0224-A	\$165.36	\$177.17
					Without Accessory Kit	KUBT-0224-N	124.02	135.83

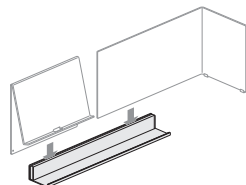

KUBT

Features

- Includes one freestanding steel Base Tray with aluminum insert rail.
- Base Tray is available with or without Accessory Kit.

Specification Tips

- Designed for use with L-Screen, Reference Shelf and Accessory Kit.
- L-Screen and Reference Shelf slide into space between steel back and aluminum insert.
- Base Tray accommodates one Reference Shelf and one L-Screen.
- Accessory Kit is designed to sit on 2.84"(72mm) deep base tray ledge.

To Order, Specify:

- 1) Product number.
- 2) Trim color.

Desk Top L-Screen	11.87"(301mm)	10"(254mm)	23.75"(603mm)	9.7 (4.4kg)	Right-hand	KULS-0000-TR	\$114.58	\$126.39
					Left-hand	KULS-0000-TL	114.58	126.39

Left-hand

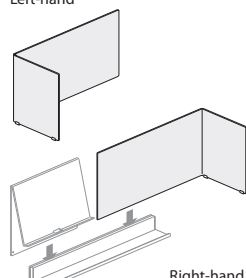

Right-hand

KULS

Features

- Includes one steel Desk Top L-screen with semi-transparent plastic feet.
- Non-writable, magnetic surface.
- Desk Top L-Screen is handed.
- Supports maximum weight of 5 pounds (2.3kg).

Specification Tips

- Designed for use with Base Tray or as freestanding.
- Desk Top L-Screen may be used alone in Base Tray or with Reference Shelf.
- Depth portion of L-Screen, when used adjacent to Reference Shelf, is the same width as Base Tray; width portion of L-Screen perpendicularly wraps around Base Tray ledge.
- Width portion of Desk Top L-Screen may be positioned to fill Base Tray or a portion may overhang past end of Base Tray to accommodate Reference Shelf.

To Order, Specify:

- 1) Product number.
- 2) Trim color.

Desk Top Reference Shelf	12.03"(306mm)	4.25"(108mm)	14.5"(368mm)	8.1 (3.7kg)		KURS-0014-T	\$59.05	\$64.96
---------------------------------	---------------	--------------	--------------	-------------	--	-------------	---------	---------

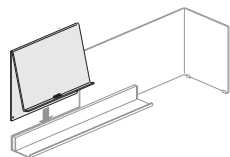

KURS

Features

- Includes one steel desk Top Reference Shelf.
- Desk Top Reference Shelf lip is 1"(25mm) deep with a 15 degree angle.
- Includes a cutout for cord drop if used for charging of electronic devices.
- Supports maximum weight of 5 pounds (2.3kg).
- Non-writable, magnetic surface.

Specification Tips



- Desk Top Reference Shelf may not be used alone in Base Tray; must be used together with Desk Top L-Screen for support purposes.
- Desk Top Reference Shelf is not freestanding.
- Desk Top Reference Shelf adjacent to depth portion of L-Screen are the same width as Base Tray; width portion of L-Screen perpendicularly wraps around Base Tray ledge.
- Desk Top Reference Shelf adjacent to width portion of L-Screen will overhang past end of Base Tray.

To Order, Specify:

- 1) Product number.
- 2) Trim color.

Work Tools

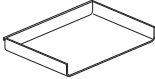
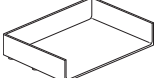
Belong

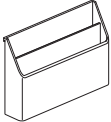
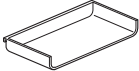
	Height	Depth	Width	Description	Number	Price
Paper Tray — Landscape	1 1/2"(38mm)	8 7/8"(225mm)	12 3/4"(324mm)	Slat — Document Tray	KUPT-0913-H	\$24.80
	2 1/2"(38mm)	8 7/8"(225mm)	12 3/4"(324mm)	Freestanding — Stacking Tray	KUPT-0913-F	29.53
 KUPT-0913-H  KUPT-0913-F	Features <ul style="list-style-type: none"> Includes one plastic tray. Slat document tray mounts on Belong rail, Belong slat tile and Beside stanchion. Slat document tray supports maximum of one ream (5 pounds/2.3kg) of paper. Freestanding stacking tray is freestanding and stacks 4 high. 			To Order, Specify: <ol style="list-style-type: none"> Product number. Trim color. <ul style="list-style-type: none"> TR-R Beige TR-1R Brownstone TR-RR Rusty Red TR-FM Snow <p>Note: Snow (TR-FM) plastic trim color is not recommended for use with painted trim colors Plaster (TR-TW) or Chalk (TR-AK). Refer to Very' Seating chainset for Snow.</p>		
Tool Cup	3 1/2"(90mm)	2 1/2"(38mm)	2 1/2"(38mm)		KUTC-0000-H	\$21.26
 KUTC-0000-H	Features <ul style="list-style-type: none"> Includes one plastic tool cup. Tool cup mounts on: <ul style="list-style-type: none"> –Belong rail –Belong slat tile –Beside stanchion –Open C Cubby with slots Can also be used in freestanding applications. 			To Order, Specify: <ol style="list-style-type: none"> Product number. Trim color. <ul style="list-style-type: none"> TR-R Beige TR-1R Brownstone TR-RR Rusty Red TR-FM Snow <p>Note: Snow (TR-FM) plastic trim color is not recommended for use with painted trim colors Plaster (TR-TW) or Chalk (TR-AK). Refer to Very' Seating chainset for Snow.</p>		
Hanging Sorter	8 1/2"(216mm)	2 1/2"(64mm)	12 3/4"(324mm)		KUHS-0000-H	\$57.88
 KUHS-0000-H	Features <ul style="list-style-type: none"> Includes one hanging sorter with two paper sorters. Interior depth of each sorter is 1"(25mm). Hanging sorter mounts on: <ul style="list-style-type: none"> –Belong rail –Belong slat tile –Beside stanchion –Open C Cubby with slots 			To Order, Specify: <ol style="list-style-type: none"> Product number. Trim color. <ul style="list-style-type: none"> TR-R Beige TR-1R Brownstone TR-RR Rusty Red TR-FM Snow <p>Note: Snow (TR-FM) plastic trim color is not recommended for use with painted trim colors Plaster (TR-TW) or Chalk (TR-AK). Refer to Very' Seating chainset for Snow.</p>		
Mini Shelf	1"(25mm)	4"(102mm)	8"(203mm)		KUSH-0408-H	\$21.26
 KUSH-0408-H	Features <ul style="list-style-type: none"> Includes one plastic shelf. Mini shelf mounts on: <ul style="list-style-type: none"> –Belong rail –Belong slat tile –Beside stanchion –Open C Cubby with slots 			To Order, Specify: <ol style="list-style-type: none"> Product number. Trim color. <ul style="list-style-type: none"> TR-R Beige TR-1R Brownstone TR-RR Rusty Red TR-FM Snow <p>Note: Snow (TR-FM) plastic trim color is not recommended for use with painted trim colors Plaster (TR-TW) or Chalk (TR-AK). Refer to Very' Seating chainset for Snow.</p>		

Work Tools

Belong

	Depth	Width	Edge	Number	Fabric Grade	
					A	E
Blotter	19.7"(500mm)	29.5"(749mm)	3mm	KUBL-2030-FJ	\$479.54	\$506.71
	19.7"(500mm)	35.4"(899mm)		KUBL-2036-FJ	491.35	520.88
	23.6"(599mm)	35.4"(899mm)		KUBL-2436-FJ	503.16	535.05
	19.7"(500mm)	29.5"(749mm)	Knife	KUBL-2030-FF	\$479.54	\$506.71
	19.7"(500mm)	35.4"(899mm)		KUBL-2036-FF	491.35	520.88
	23.6"(599mm)	35.4"(899mm)		KUBL-2436-FF	503.16	535.05

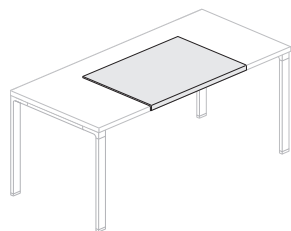

KUBL-2030-FJ

Features

- Includes one blotter with protective back.
- Specify blotter profile to match desking edge:
 - 3mm Edgeband
 - Knife edge
- Belong Blotter radius is 1/2"(13mm).

To Order, Specify:

- 1) Product number.
- 2) Fabric

Specification Tips

- 20"(508mm) deep blotter can be used on 24"(610mm) deep desking without hatch.
- 20"(508mm) deep blotter can be used on 30"(762mm) deep desking with hatch.
- 24"(610mm) deep blotter can be used on 36"(914mm) deep desking with hatch.

Reference Shelves

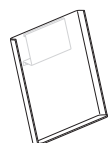

KURS-0010-H

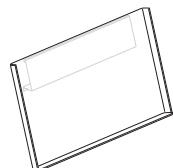

KURS-0019-H

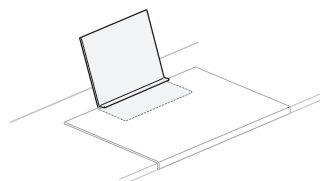

KURS-0012-B

Height	Width	Description	Number	Trim	
				A	B
11 1/4"(286mm)	9 7/8"(251mm)	Reference — Small	KURS-0010-H	\$59.05	\$64.96
	18 1/2"(470mm)	Reference — Large	KURS-0019-H	88.58	94.49
9 7/8"(251mm)	11 5/8"(295mm)	Blotter Reference Shelf	KURS-0012-B	\$59.05	\$64.96

Features

- Includes one metal reference shelf
- Large and Small Reference shelves mount on:
 - Belong rail
 - Belong slat tile
 - Beside stanchion
 - Open C Cubby with slots
- Blotter Reference Shelf slides under blotter for support.

To Order, Specify:

- 1) Product number.
- 2) Trim color.

Specification Tips

- In installed position large and small referencing shelves are 0.88"(22mm) high and 4.3"(109mm) deep.
- Reference shelf lip is 1.375"(35mm) deep.

Accessory Kit

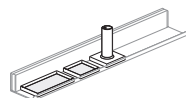

KUAK

Number	Price
KUAK-0000-BSR	\$48.43

Features

- Includes one square tray, one rectangular tray and bud vase with square base. All items are plastic.
- Sizes:
 - Square tray: 2.75"(70mm).
 - Rectangular tray: 2.75" x 5.5"(70mm x 140mm).
 - Bud Vase: 4"(102mm) tall, 0.75"(19mm) inside diameter, 2.75"(70mm) square base.
- Designed for use with the Base Tray, Territory Screen or as freestanding pieces.
- Standard in snow trim color.

To Order, Specify:

- 1) Product number.
(No finish specification required)

Note: Snow (TR-FM) plastic trim color is not recommended for use with painted trim colors Plaster (TR-TW) or Chalk (TR-AK). Refer to Very Seating chainset for Snow.

Work Tools

Jump Stuff

	Height	Depth	Width	Number	Price
Tool Cup	5 1/2"(140mm)	3 1/2"(89mm)	4"(102mm)	DTWC-2	\$22.94

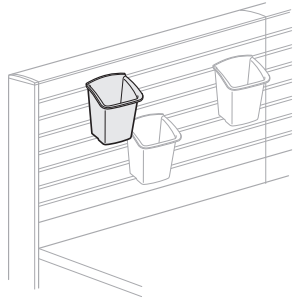

DTWC-2

Feature

- Mounts on rail and slat pad. Can also be used in freestanding applications.

To Order, Specify:

- 1) Product number.
- 2) Translucent trim color.

	Height	Depth	Width	Number	Trim A	B	Price
Paper Sorter	9 1/4"(235mm)	11"(279mm)	9"-12"(229mm-305mm)	DTPR-3	\$72.64	\$75.19	

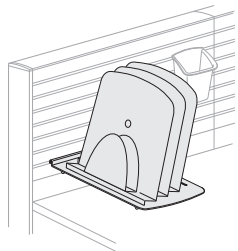

DTPR-3

Features

- Includes three dividers, one shelf, and mounting bracket.
- Mounts on slat pad.
- Can also be used as a horizontal freestanding tray.
- Supports maximum of two reams (ten pounds/4.6 kilograms) of paper.

To Order, Specify:

- 1) Product number.
- 2) Translucent trim color.
- 3) Trim color for bracket.

	Height	Depth	Width	Number	Price
Binder Bin	12 1/2"(318mm)	10 1/2"(267mm)	6 1/2"(165mm)	DTSB-3	\$54.80

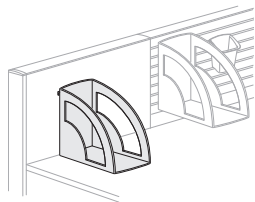

DTSB-3

Features

- Mounts on slat pad. Can also be used in freestanding applications.
- Bin accommodates two 3"(76mm) thick binders.

To Order, Specify:

- 1) Product number.
- 2) Translucent trim color.

	Height	Depth	Width	Number	Price
Tack Strip	2 1/2"(64mm)	1/2"(13mm)	12"(305mm)	DTTS-12	\$31.86
			24"(610mm)	DTTS-24	38.23

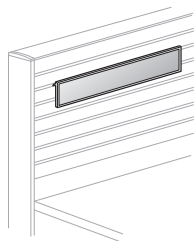

DTTS-12
DTTS-24

Features

- Mounts on slat pad.
- Brown and black cork and rubber composite material.

To Order, Specify:

- 1) Product number.
- 2) Trim color for bracket.

Work Tools

Jump Stuff

	Number	Price
Gooseneck Kit	DTGK-3	\$66.83

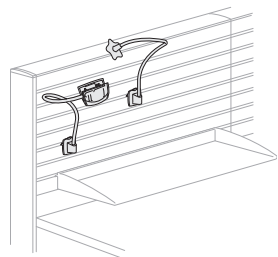

DTGK-3

Features

- Includes two flex arms, two base clips, assortment of three tops (one grip clip, one round top, and one flower top) and two stick-on clips.
- Mounts on slat pad to display miscellaneous notes/items or anywhere with stick-on clips.
- Stick-on clips include double-sided tape.

To Order, Specify:

- 1) Product number.
- 2) Translucent trim color.

Mini Shelf

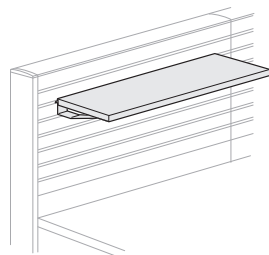

DMSP

Height	Depth	Width	Number	Laminate	
				A	B
1 3/4"(44mm)	6 1/4"(159mm)	18"(457mm)	DMSP-18	\$111.61	\$120.52
		24"(610mm)	DMSP-24	116.70	125.61
		30"(762mm)	DMSP-30	121.76	130.67
		36"(914mm)	DMSP-36	126.85	135.76
		42"(1067mm)	DMSP-42	131.90	140.81
		48"(1219mm)	DMSP-48	136.96	145.87

Features

- Includes shelf and brackets.
- Mounts on slat pad.
- Shelf thickness 3/4"(19mm)
- Designed for lightweight accessories.

To Order, Specify:

- 1) Product number.
- 2) Shelf trim color.
- 3) Edgeband color.
- 4) Trim color for brackets.

	Height	Depth	Width	Description	Number	Price
Tote	10"(254mm)	4"(102mm)	13"(330mm)	Tote	DTTE-3	\$63.72
				Tote, clips, and strap	DTTH-3	90.49

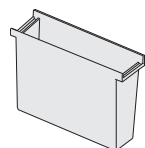

DTTE-3

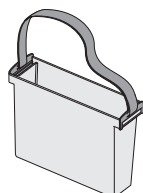

DTTH-3

Features

- Mounts on slat pad.
- Clip and strap standard in black.
- Fits in lateral files.
- Accommodates hanging files.

To Order, Specify:

- 1) Product number.
- 2) Translucent trim color.

Tote Strap



DTHT-1

Features

- Includes strap and two clips.
- Strap is 27"(686mm) long and non-adjustable.
- Converts DTTE-3 to DTTH-3.
- Standard in black.

To Order, Specify:

- 1) Product number.
(No finish specification required.)

DTHT-1	\$29.33
--------	---------

Work Tools

Jump Stuff

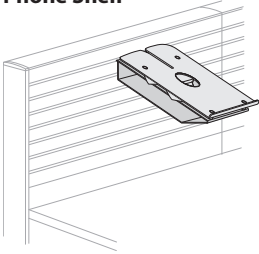
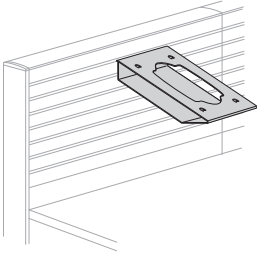
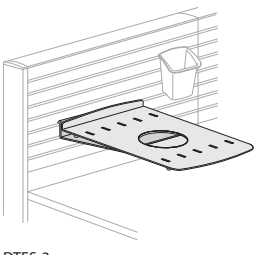
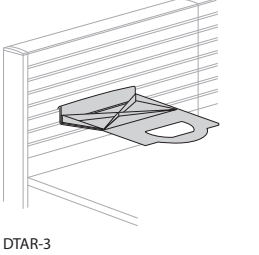
	Height	Depth	Width	Number	Trim A	B
 <p>DTPT-3</p>	2 1/2"(64mm)	11 1/4"(286mm)	9"(229mm)	DTPT-3	\$86.66	\$89.21
<p>Phone Shelf</p> <p>Features</p> <ul style="list-style-type: none"> • Includes phone shelf and bracket. • Mounts on slat pad at 30° angle. • Supports maximum of two reams (ten pounds/4.6 kilograms) of paper. 			<p>To Order, Specify:</p> <ol style="list-style-type: none"> 1) Product number. 2) Translucent trim color. 3) Trim color for bracket. 			
 <p>DTBS-3</p>	1 1/2"(38mm)	11"(279mm)	7 1/2"(191mm)	DTBS-3	\$53.53	\$56.08
<p>Phone Shelf Bracket</p> <p>Feature</p> <ul style="list-style-type: none"> • Used to convert DTPT-1 for mounting rail phone shelf to slat pad. 			<p>To Order, Specify:</p> <ol style="list-style-type: none"> 1) Product number. 2) Trim color for bracket. 			
 <p>DTES-3</p>	1 3/4"(44mm)	11"(279mm)	8"(203mm)	DTES-3	\$59.90	\$62.45
<p>Personal Shelf</p> <p>Features</p> <ul style="list-style-type: none"> • Includes mounting bracket and personal shelf. • Mounts on rail at 60° angle or horizontally. • Can also be used as a horizontal freestanding tray. • Supports maximum of two reams (ten pounds/4.6 kilograms) of paper. 			<p>To Order, Specify:</p> <ol style="list-style-type: none"> 1) Product number. 2) Translucent trim color. 3) Trim color for bracket. 			
 <p>DTAR-3</p>				DTAR-3	\$39.51	\$42.06
<p>Personal Shelf Bracket</p> <p>Feature</p> <ul style="list-style-type: none"> • Used in combination with DTPR-3 or DTES-3 for mounting rail personal shelf or paper sorter to slat pad. 			<p>To Order, Specify:</p> <ol style="list-style-type: none"> 1) Product number. 2) Trim color for bracket. 			

Work Tools

Jump Stuff

	Height	Depth	Width		Number	Price
--	--------	-------	-------	--	--------	-------

Letter Tray

2 1/2"(64mm) 12"(305mm) 10 1/2"(267mm)

DTLT-2

\$26.77

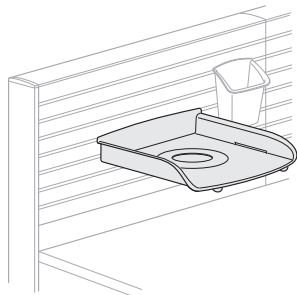

DTLT-2

Features

- Mounts on rail at 60° angle or horizontally.
- Mounts on slat pad horizontally.
- Can also be used in freestanding applications.
- Use Letter Tray Stacking Brackets (DTLS-2) to convert to stacking letter trays.
- Supports maximum of one ream (five pounds/2.3 kilograms) of paper.

To Order, Specify:

- 1) Product number.
- 2) Translucent trim color.

Letter Tray Stacking Kit

8"(203mm) 12"(305mm) 10 1/2"(267mm)

DTLS-2

\$68.82

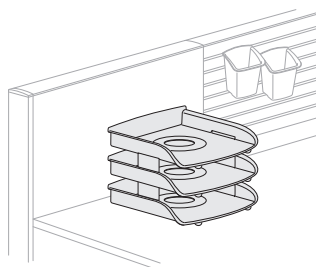

DTLS-2

Features

- Includes three letter trays and two stacking brackets.
- Used in freestanding applications.

To Order, Specify:

- 1) Product number.
- 2) Translucent trim color.

Letter Tray Stacking Bracket

2 1/4"(57mm) 5"(127mm) 9 1/2"(241mm)

DTSB-1

\$19.12

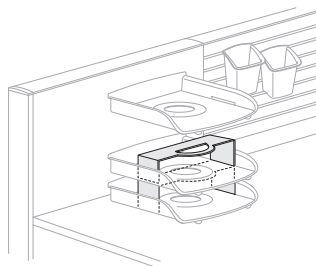

DTSB-1

Features

- Includes two stacking brackets.
- Used in freestanding applications.

To Order, Specify:

- 1) Product number.
- 2) Translucent trim color.

Waste Bin

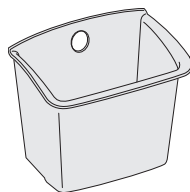

DTRB

Height	Depth	Width	Description	Number	Price
15 1/2"(394mm)	12"(305mm)	13"(330mm)	Black	DTRB-1B	\$50.97
			Translucent	DTRB-1	67.55

Features

- Used in freestanding applications.
- Five gallon capacity.

To Order, Specify:

- 1) Product number.
- 2) Translucent trim color.

Pile Master Kit

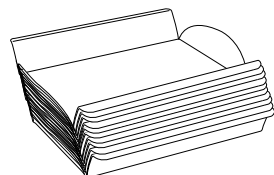

DPKY-1

	Description	Number	Price
	Pre-Packaged	DPKY-1	\$307.15

Features

- Kit includes ten pile dividers.
- Requires no mounting rail.

To Order, Specify:

- 1) Product number.
- 2) Translucent trim color.

Work Tools

Jump Stuff

Team Master Kit

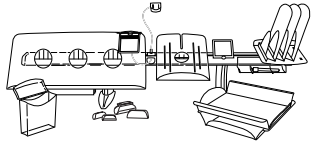

DPKC-48
DBKC-48

Mounting System	Packaging	Number	Price
Panel Mount*	Pre-Packaged	DPKC-48-H	\$734.10
Worksurface Mount		DPKC-48-W	935.47
Freestanding Mount		DPKC-48-F	881.94
Panel Mount*	Bulk-Packaged	DBKC-48-H	\$623.22
Worksurface Mount		DBKC-48-W	824.59
Freestanding Mount		DBKC-48-F	771.06

Feature

- Kit includes gooseneck kit, paper sorter, file frame, two pile dividers, disk box, phone caddy, sketch pad kit, 2-way display, catch-all tray, wire wraps, and one 48”(1219mm) wide rail mount with appropriate supports.

To Order, Specify:

- 1) Product number.
- 2) Translucent trim color.
- 3) Metallic trim color for rail supports only.

File Master Kit

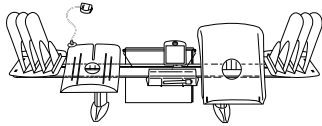

DPKP-48
DBKP-48

Panel Mount*	Pre-Packaged	DPKP-48-H	\$631.28
Worksurface Mount		DPKP-48-W	832.65
Freestanding Mount		DPKP-48-F	779.12
Panel Mount*	Bulk-Packaged	DBKP-48-H	\$549.71
Worksurface Mount		DBKP-48-W	717.94
Freestanding Mount		DBKP-48-F	697.55

Feature

- Kit includes 2-way tray, two paper sorters, phone caddy, gooseneck kit, sketch pad kit, file frame, catch-all tray, and one 48”(1219mm) wide mounting rail with appropriate supports.

To Order, Specify:

- 1) Product number.
- 2) Translucent trim color.
- 3) Metallic trim color for rail supports only.

Task Master Kit

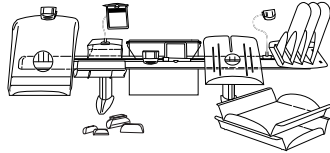

DPKT-48
DBKT-48

Panel Mount*	Pre-Packaged	DPKT-48-H	\$714.21
Worksurface Mount		DPKT-48-W	922.92
Freestanding Mount		DPKT-48-F	859.18
Panel Mount*	Bulk-Packaged	DBKT-48-H	\$654.22
Worksurface Mount		DBKT-48-W	862.93
Freestanding Mount		DBKT-48-F	799.19

Feature

- Kit includes gooseneck kit, two grip clips, paper sorter, file frame, two pile dividers, disk box, catch-all tray, 3-layer tray, sketch pad kit, phone caddy, wire wraps, and one 48”(1219mm) wide mounting rail with appropriate supports.

To Order, Specify:

- 1) Product number.
- 2) Translucent trim color.
- 3) Metallic trim color for rail supports only.

Common Features

- Ships either pre-packaged or bulk-packaged.
- Pre-packaged ships in two cartons, one for rail system and one for tools.
- Bulk-packaged offers reduced list price, and ships with each set of parts packaged in separate cartons.

Note: Minimum 10 kits required to order as bulk-packaged.

Note: Mounts to Compose, PREMISE, PLACES and UniGroup Panel frame slots/side rails to support rail tools.

Work Tools

Jump Stuff

Mini Master Kit

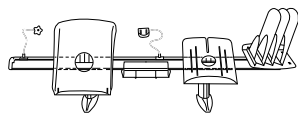

DPKS
DBKS

Mounting System	Rail Width	Packaging	Number	Price
Panel Mount	36"(914mm)	Pre-Packaged	DPKS-36-H	\$448.61
Worksurface Mount			DPKS-36-W	614.28
Freestanding Mount			DPKS-36-F	574.78
Panel Mount	36"(914mm)	Bulk-Packaged	DBKS-36-H	\$400.18
Worksurface Mount			DBKS-36-W	565.85
Freestanding Mount			DBKS-36-F	526.35
Panel Mount	48"(1219mm)	Pre-Packaged	DPKS-48-H	\$471.53
Worksurface Mount			DPKS-48-W	637.20
Freestanding Mount			DPKS-48-F	597.70
Panel Mount	48"(1219mm)	Bulk-Packaged	DBKS-48-H	\$423.10
Worksurface Mount			DBKS-48-W	588.77
Freestanding Mount			DBKS-48-F	549.27

Feature

- Kit includes paper sorter, catch-all tray, 2-way tray, gooseneck kit, phone caddy and one 36"(914mm) or 48"(1219mm) wide mounting rail with appropriate supports.

To Order, Specify:

- 1) Product number.
- 2) Translucent trim color.
- 3) Metallic trim color for rail supports only.

Common Features

- Ships either pre-packaged or bulk-packaged.
- Pre-packaged ships in two cartons, one for rail system and one for tools.
- Bulk-packaged offers reduced list price, and ships with each set of parts packaged in separate cartons.

Note: Minimum 10 kits required to order as bulk-packaged.

Note: Mounts to Compose, PREMISE, PLACES and UniGroup Panel frame slots/side rails to support rail tools.

Work Tools

Jump Stuff

	Mounting System	Slat Pad Width	Packaging	Number	Trim	
					A	B
File Master Kit	Slat Pad	69"(1753mm)	Pre-Packaged	DPKP-S	\$500.87	\$511.49
	Slat Pad		Bulk-Packaged	DBKP-S	438.42	449.04

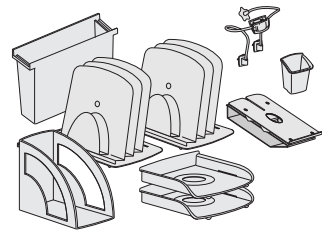

DPKP-S
DBKP-S

Features

- Kit includes gooseneck kit, two paper sorters, two letter trays, phone shelf, tote, tool cup, and binder bin.
- Mounts on separately specified slat pad.
- Ships either pre-packaged or bulk-packaged.
- Bulk-packaged offers reduced list price, and ships with each set of parts packaged in separate cartons.

Note: Minimum 10 kits required to order as bulk-packaged.

To Order, Specify:

- 1) Product number.
- 2) Translucent trim color.
- 3) Trim color for brackets.

Task Master Kit	Slat Pad	51"(1295mm)	Pre-Packaged	DPKT-S	\$479.89	\$490.51
	Slat Pad		Bulk-Packaged	DBKT-S	419.90	430.52

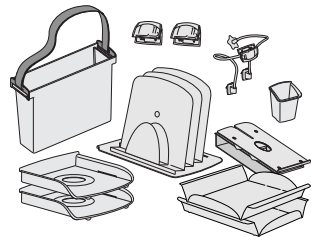

DPKT-S
DBKT-S

Features

- Kit includes gooseneck kit, paper sorter, two letter trays, phone shelf, tote, two grip clips, two pile dividers, and tool cup.
- Mounts on separately specified slat pad.
- Ships either pre-packaged or bulk-packaged.
- Bulk-packaged offers reduced list price, and ships with each set of parts packaged in separate cartons.

Note: Minimum 10 kits required to order as bulk-packaged.

To Order, Specify:

- 1) Product number.
- 2) Translucent trim color.
- 3) Trim color for brackets.

Mini Master Kit	Slat Pad	49"(1245mm)	Pre-Packaged	DPKS-S	\$318.61	\$326.26
	Slat Pad		Bulk-Packaged	DBKS-S	270.18	277.83

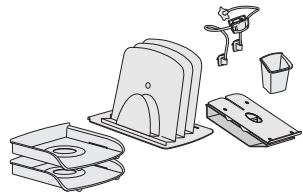

DPKS-S
DBKS-S

Features

- Kit includes gooseneck kit, paper sorter, two letter trays, phone shelf, and tool cup.
- Mounts on separately specified slat pad.
- Ships either pre-packaged or bulk-packaged.
- Bulk-packaged offers reduced list price, and ships with each set of parts packaged in separate cartons.

Note: Minimum 10 kits required to order as bulk-packaged.

To Order, Specify:

- 1) Product number.
- 2) Translucent trim color.
- 3) Trim color for brackets.

Work Tools

Magnetic Accessories

	Actual Height	Actual Width	Number	Price
Magnet Board	11"(279mm)	4"(102mm)	KUAM-0411	\$27.30
	18"(457mm)	5"(127mm)	KUAM-0518	54.60

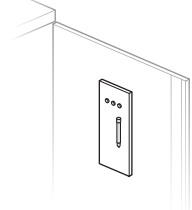

KUAM-0411

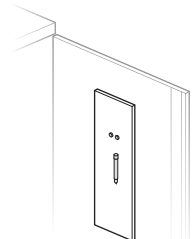

KUAM-0518

Features

- Includes:
 - Magnetic dry-erase board
 - Three round magnets on 11"(279mm) high magnet board, two round magnets on 18"(457mm) high magnet board
 - One magnetic dry erase pen
 - Magnetic attachment strip for attachment to magnetic surfaces
 - Adhesive strip for attachment to non-magnetic surfaces
- Available in white (not matched to Haworth's color palette).

To Order, Specify:

- Product number.

Specification Tip

- Use on non-textured surfaces for best performance.

	Diameter	Number	Price
Magnet Hooks	1 1/2"(38mm)	KUAH-0002	\$26.21

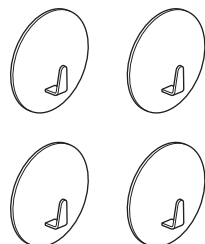

KUAH-0002

Features

- Includes four 1 1/2"(38mm)-diameter magnetic hooks for holding personal items.
- Available in white (not matched to Haworth's color palette).

To Order, Specify:

- Product number.

Specification Tip

- Use on non-textured surfaces for best performance.

	Diameter	Number	Price
Magnet Hook	3"(76mm)	KUAH-0003	\$16.38



KUAH-0003

Features

- Includes one 3"(76mm)-diameter magnetic hook for holding personal items.
- Available in white (not matched to Haworth's color palette).

To Order, Specify:

- Product number.

Specification Tip

- Use on non-textured surfaces for best performance.

	Depth	Diameter	Number	Price
Round Peg Magnets	3/8"(10mm)	5/32"(4mm)	KUAP-0000	\$26.21

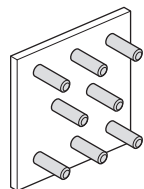

KUAP-0000

Features

- Includes eight round magnets and acrylic storage box.
- Available in chrome.

To Order, Specify:

- Product number.

Specification Tips

- Use on non-textured surfaces for best performance.
- Each magnet can hold up to eight sheets of letter-size paper.

	Actual Width	Actual Length	Number	Price
Mirror	3 1/8"(80mm)	4 3/8"(111mm)	KUAR-0403	\$18.56

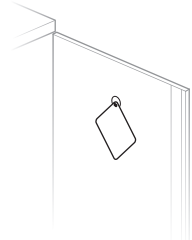

KUAR-0403

Features

- Includes one acrylic mirror.
- Can be hung from a Belong magnetic hook, or placed in a Belong pouch (specified separately).

To Order, Specify:

- Product number.
(No color specification required.)

Workstation Accessories

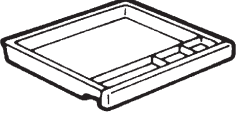
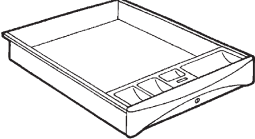
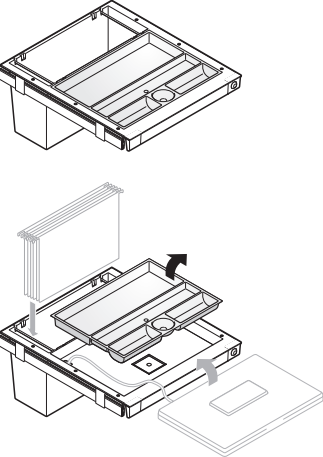
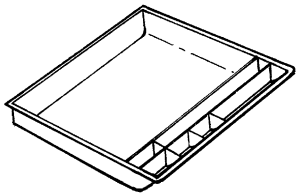
	Height	Depth	Width	Number	Price
Shallow Drawer  DS-3 Class AA – SIN 711-1; Discount Group I	3"(76mm)	15 3/8"(391mm)	18 1/4"(464mm)	DS-3	\$59.06
Features <ul style="list-style-type: none"> • Shallow drawer has four compartments. • Drawer does not stack. • Available in charcoal or gray tone finish colors only. 				To Order, Specify: <ol style="list-style-type: none"> 1) Product number. 2) Trim color. TR-K Charcoal TR-G Gray Tone 	
Steel Center Drawer  SCD-19 Class MA – SIN 711-3; Discount Group II	2"(51mm)	17 1/2"(445mm)	19 1/8"(486mm)	SCD-19	\$288.71
Features <ul style="list-style-type: none"> • Includes mounting hardware. • Standard with lock. • Standard in charcoal finish color only. 				To Order, Specify: <ol style="list-style-type: none"> 1) Product number. (No finish specification required.) 	
Pencil + Drawer  KUDP-2420 Class YA – SIN 711-1; Discount Group XIII	11"(279mm)	24"(610mm)	19 1/2"(495mm)	KUDP-2420	\$353.02
Features <ul style="list-style-type: none"> • Multi-purpose drawer provides organization, hanging filing along with laptop storage. • Knock-outs at rear of drawer provide electronic charging access while contents are locked. • Removable organizing tray. • Thin profile maximizes knee clearance under front of drawer. • Standard in black trim color with black locks. • Standard with lock (shipped separately); keyed-alike and master keying options available. 				To Order, Specify: <ol style="list-style-type: none"> 1) Product number. (No finish specification required.) 	
Specification Tips <ul style="list-style-type: none"> • To be mounted below worksurfaces 24"(610mm) or deeper. • Not for use with 24"(610mm) deep knife edge worksurface. • Pencil + drawer must be used adjacent to worksurface floor support when specified for use with panel system. 					
Pencil Drawer  JAC-18 Class FP – SIN 711-11; Discount Group XII	1 5/8"(41mm)	19"(483mm)	18"(457mm)	JAC-18	\$72.68
Features <ul style="list-style-type: none"> • Includes black plastic drawer, slides, and mounting hardware. • Attaches under freestanding desks, returns, bridges, system convergent or rectangular worksurfaces. 				To Order, Specify: <ol style="list-style-type: none"> 1) Product number. (No finish specification required.) 	
Specification Tip <ul style="list-style-type: none"> • Do not install in area where cantilever bracket is installed. 					

Workstation Accessories

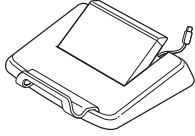
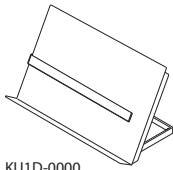
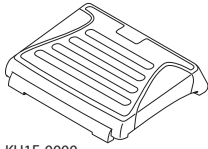
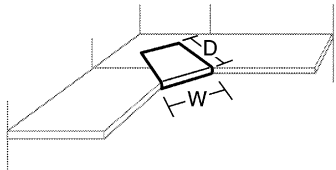
	Description	Number	Price								
 <p>KU1L-0000-U</p>	<p>Adjustable Laptop Holder</p> <p>Laptop Holder with 4-port USB</p> <p>Description</p> <p>Features</p> <ul style="list-style-type: none"> • Includes adjustable Laptop Holder with or without built-in 4-port USB hub (2.0). • Accommodates laptops 16"(406mm) wide x 12"(305mm) deep. • Five laptop angle adjustments: 4°, 14°, 23°, 33° and 43°. • Size: 12.75" wide x 10" deep. 1.25" high in stored position. • Protective pads on bottom. • Standard in supplier black with silver accent. <p>Specification Tips</p> <ul style="list-style-type: none"> • Hub Specifications: <ul style="list-style-type: none"> -Fully compliant with universal serial bus specification revision 2.0 (data rate 1.5/12/480 Mbps) -LED indicates the hub is ready -Direct bus power mode eliminates need for external power -Over-current detection and protection for each downstream port -Plug and play and hot swap function supported -Windows and Mac compatible -CE/US/FCC approved -RoHS compliant 	KU1L-0000-U	\$140.88								
	<p>To Order, Specify:</p> <p>1) Product number. (No finish specification required.)</p>										
 <p>KU1D-0000</p>	<p>Adjustable Document Holder</p> <p>Document Holder</p> <p>Description</p> <p>Features</p> <ul style="list-style-type: none"> • Includes painted steel Adjustable Document Holder with magnetic attached line guide. • Infinite angle adjustment up to 80° with tension adjustment lever. • Accommodates papers or books. • Size: 16.7"(425mm) wide x 7.5"(191mm) deep x 9.75"(215mm) high. • Standard in supplier black. • Protection pads on bottom. 	KU1D-0000	\$118.16								
	<p>To Order, Specify:</p> <p>1) Product number. (No finish specification required.)</p>										
 <p>KU1F-0000</p>	<p>Adjustable Footrest</p> <p>Footrest</p> <p>Description</p> <p>Features</p> <ul style="list-style-type: none"> • Includes Adjustable Foot Rest with anti-slip rubber mat on top. • Angle adjustment by hand: 6°, 12°, 16° and 25° • Size: 15.75"(400mm) wide x 14.75"(375mm) deep x 3.25"-5"(83mm-127mm) high. • Folds flat for easy storage. • Standard in supplier black with silver accent. • Protective pads on bottom. 	KU1F-0000	\$118.16								
	<p>To Order, Specify:</p> <p>1) Product number. (No finish specification required.)</p>										
 <p>MAC-0001 Class AA</p>	<p>Make-A-Corner</p> <table border="1"> <thead> <tr> <th>Depth</th> <th>Width</th> <th>Number</th> <th>Price</th> </tr> </thead> <tbody> <tr> <td>21 1/8"(537mm)</td> <td>26 1/8"(664mm)</td> <td>MAC-0001</td> <td>\$174.61</td> </tr> </tbody> </table> <p>Description</p> <p>Features</p> <ul style="list-style-type: none"> • Creates an angled edge between two (2) perpendicular regular worksurfaces. • Slides over the top of 1 13/16"(30mm) thick worksurfaces. • Accommodates an adjustable keyboard or mouse pad track (screws included). 	Depth	Width	Number	Price	21 1/8"(537mm)	26 1/8"(664mm)	MAC-0001	\$174.61	MAC-0001	\$174.61
	Depth	Width	Number	Price							
21 1/8"(537mm)	26 1/8"(664mm)	MAC-0001	\$174.61								
<p>To Order, Specify:</p> <p>1) Product number. 2) Non-metallic trim color.</p>											

Workstation Accessories

	Height	Width	Depth	Number	Trim A	B
Compose All-Purpose Hook	1 3/8"(35mm)	1/2"(13mm)	3/4"(19mm)	VZAC-0000-P	\$381.64	\$397.30
	1 3/8"(35mm)	5/8"(16mm)	3 3/8"(86mm)	VZAC-0000-H	362.39	378.05

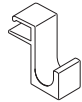

VZAC-0000-P

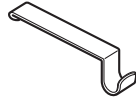

VZAC-0000-H

Class BC – SIN 711-1,
Discount Group XI

Features

- Includes eight coat hooks.
- (P) For use with full profile aluminum trim.
- (H) For use with thin profile steel trim.

To Order, Specify:

- 1) Product number.
- 2) Trim color.

Specification Tip

- Attaches to Compose panel frame or stack frame top with trim.

Note: Not available for use on Glass panels or glass stacks.

PLACES All-Purpose Hook	1"(25mm)	3"(76mm)	1/2"(13mm)	HCH-0008	\$130.92	
--------------------------------	----------	----------	------------	----------	-----------------	--

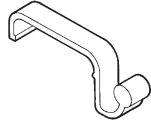

HCH-0008

Class BA – SIN 711-1,
Discount Group I

Features

- Includes eight hooks.
- Attaches to PLACES steel top cap panels only.

To Order, Specify:

- 1) Product number.
- 2) Trim color.

PLACES All-Purpose Hook — For Low Profile Wood Top Cap Panels	1"(25mm)	3"(76mm)	5/8"(16mm)	HCH-0008-W	\$130.92	
--	----------	----------	------------	------------	-----------------	--

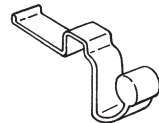

HCH-0008-W

Class BA – SIN 711-1,
Discount Group I

Features

- Includes eight hooks.
- Attaches to PLACES wood top cap panels only.

To Order, Specify:

- 1) Product number.
- 2) Trim color.

UniGroup All-Purpose Hook	1"(25mm)	3"(76mm)	5/8"(16mm)	CH-8	\$113.05	
----------------------------------	----------	----------	------------	------	-----------------	--



CH-8

Class AA – SIN 711-1,
Discount Group I

Features

- Includes eight hooks.
- Attaches to panel steel top cap.
- For use with UniGroup panels only.

To Order, Specify:

- 1) Product number.
- 2) Trim color.

UniGroup Too All Purpose Hook				Number	Trim A	B
				E2CH-8	\$101.31	\$119.18



E2CH-8

Class AC – SIN 711-1,
Discount Group I

Features

- Includes eight hooks.
- For use with UniGroup Too square painted top cap panels.

To Order, Specify:

- 1) Product number.
- 2) Trim color.

PREMISE All Purpose Hooks	Application	Number	Trim A	B
			PREMISE Monolithic Panels	NAH-12
	PREMISE Stack Kits	NAH-12-S	85.90	99.40



NAH-12

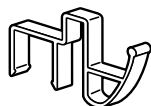

NAH-12-S

Class FA – SIN 711-1,
Discount Group XI

Features

- Includes package of eight hooks.
- Attaches to the top of a monolithic panel or cross bar on a stack kit.
- Fifty pound capacity.
- NAH-12 hook can be used with standard, grooved, or wood top caps. Standard and wood top cap hooks are installed under the top cap. Grooved top cap hooks are installed above the top cap in the outer channel. NAH-12-S can not be used with grooved top caps.

To Order, Specify:

- 1) Product number.
- 2) Trim color.

Finish/Color Legend

Trim

Grade A

Smooth

TR-R	Beige
TR-AK	Chalk
TR-K	Charcoal
TR-C1	Cocoa
TR-J	Graphite
TR-G	Gray Tone
TR-AA	Putty
TR-E	Smoke
TR-PLS	Smooth Plaster
TR-FM	Snow

Textured

TR-TY	Cement
TR-TG	Grout
TR-TF	Pitch
TR-TW	Plaster

Translucents

TR-LQ	Frost
TR-LX	Ice
TR-LY	Moon
TR-LU	Shadow

Grade B

Smooth

TR-1C	Accent Blue
TR-1D	Accent Green
TR-1E	Accent Orange
TR-1F	Accent Red
TR-1G	Blue Jay
TR-1L	Brindle
TR-1R	Brownstone
TR-CTS	Chartreuse
TR-1N	Night
TR-1Q	Park
TR-RR	Rusty Red
TR-1M	Sable
TR-1P	Seville
TR-1J	Sky Blue
TR-1H	Terra
TR-1K	Wren

Smooth Metallic

TR-DM	Dark Bronze
	Metallic
TR-MC	Metallic Champagne
TR-LE	Metallic Silver

Textured Metallic

TR-AL	Alloy
TR-AR	Argent
TR-HE	Hellenic

Laminate

Grade A

Solid Color

H-34	Beige
H-AK	Chalk
H-8J	Charcoal
H-3J	Graphite
H-62	Gray Tone
H-WL	Linen
H-3P	Platinum
H-AA	Putty
H-3E	Smoke

Wood Grain

H-AM	Amber Cherry
H-AE	Maple
H-AD	Medium Cherry

Grade B

Premium Wood Grain

H-KA	Brazilwood
H-KG	Columbian Walnut
H-KP	Field Elm
H-KN	Grey Elm
H-KM	Landmark Wood
H-KL	Neo Walnut
H-KC	New Age Oak
H-KR	Phantom Ecru
H-KS	Phantom Pearl
H-KD	River Cherry
H-KE	Sanara
H-KF	Williamsburg Cherry

Edgeband

Solid Color

HP-34	Beige
HP-AK	Chalk
HP-8J	Charcoal
HP-3J	Graphite
HP-62	Gray Tone
HP-WL	Linen
HP-3P	Platinum
HP-AA	Putty
HP-3E	Smoke

Wood Grain

HP-AM	Amber Cherry
HP-KA	Brazilwood
HP-KG	Columbian Walnut
HP-KP	Field Elm
HP-KN	Grey Elm
HP-KM	Landmark Wood
HP-AE	Maple
HP-AD	Medium Cherry
HP-KL	Neo Walnut
HP-KC	New Age Oak
HP-KR	Phantom Ecru
HP-KS	Phantom Pearl
HP-KD	River Cherry
HP-KE	Sanara
HP-KF	Williamsburg Cherry

Planked Wood

VH-W35	Walnut
VB-W35	White Oak

Painted MDF

PW-R	Beige
PW-F	Black
PW-AK	Chalk
PW-G	Gray Tone
PW-PL	Polar
PW-RR	Rusty Red
PW-1J	Sky Blue
PW-SP	Sparrow
PW-SY	Stormy
PW-ST	Straw
PW-1H	Terra
PW-VA	Vapor

ALERT: These materials are current, however they are being considered for future obsolescence due to low volume.

Laminate:

H-DH	Barley Grain
H-22	Gray Spex
H-AD	Medium Cherry
H-DA	Oats Grain
H-EK	Owl Nest
H-EC	Quail Nest
H-ED	Rhea Nest
H-EA	Robin Nest
H-DE	Wheat Grain
H-21	White Spex

Forest Stewardship Council (FSC) Statement:

In our continuing support of sustainable forestry and responsible purchasing, Haworth North America is offering FSC certified wood products at no up-charge. By providing FSC certified material, Haworth is supporting our client's green building goals and demonstrating our collective commitment to source materials more sustainably.

Haworth will provide to you the necessary FSC-certified paperwork with your shipment. For more information, FAQs, and a complete FSC product list (including product exceptions), go to the Library and search FSC.

North American Terms of Sale

These Terms of Sale are part of a quotation, bid response, or other sales document issued by Haworth, Inc., Haworth, Ltd. ("Haworth").

These Terms of Sale do not cover products manufactured in North America shipping to non-North American countries nor do they cover products manufactured in non-North American countries shipping to North America. For those terms of sale, please contact Haworth's Global Trade and Compliance Department at 616.393.3000 or through Haworth.com.

A. Ordering Information

Haworth sells its products on the terms set forth in these standard Terms of Sale:

ORDERS MUST BE SUBMITTED IN WRITING OR ELECTRONICALLY (Lynx) AS REPRESENTED BY A VALID PURCHASE ORDER, WHICH INCLUDES PRODUCT TOTAL.

An order is not binding upon Haworth until Haworth issues an order acknowledgment to the customer (the "Customer"), which will include price information and an anticipated delivery date.

1. Order Changes/Cancellations

For Specials, Customer's Own Material (C.O.M.), finish matches, custom colors, custom products, Master lock and key orders, and RUSH orders, no changes or cancellations are allowed 24 hours after order placement. All other products require approval for changes or cancellations. A change/cancellation fee may apply. Contact Order Services for applicable charges.

Ship-to addresses changed within five (5) business days of delivery will incur fees to cover administrative costs due to re-labeling of product and/or reconsignment fees with the carrier.

Order cancellations are complete annulments of orders. Order changes are the deletion of line items or a change in size, color, quantity, ship-to address, or scope of work. There is no penalty for additions; however, any change may cause the order or the line items affected to be rescheduled. Order changes involving additional product and services which increase the value must be accompanied by an amended Purchase Order or other document as agreed.

ALL CHANGES MUST BE IN WRITING, REGARDLESS OF THE (DOLLAR) VALUE. CHANGES ARE NOT BINDING UPON HAWORTH UNTIL HAWORTH ISSUES AN ACKNOWLEDGMENT OF THE CHANGE.

2. C.O.M. (Customer's Own Material)

A Customer who requests a fabric, surface or finish material (C.O.M.) not in Haworth's standard finish offering must first confirm approval of or request new approval for the C.O.M.

Haworth will determine feasibility of the material for manufacturability. For a description of the procedure to submit C.O.M. samples, contact Haworth's Order Services department. For testing information, see the C.O.M. section of the catalog, or call Haworth Order Services.

If Haworth agrees to use the C.O.M., (1) Haworth shall have no responsibility for the condition, quality, value, performance, physical properties, or any other aspect of the C.O.M.; and (2) Haworth shall have no liability for any damages, injuries, or losses to the Customer or to any third party that shall be caused by any C.O.M., and the Customer shall hold Haworth harmless for all such liability.

3. Valid/Complete Purchase Order

The following information is required in order to process an order with Haworth:

a. Customer Information

- i. **Sold To:** Legal name, complete address (if Haworth is to bill the end user, provide end user Purchase Order made out to Haworth, Inc., Haworth, Ltd.) and phone and fax number.
- ii. **Ship To:** Legal name and address.
- iii. **Purchase Order Number:** From the party Haworth will be billing.
- iv. **Authorized Signature:** All Purchase Orders must be signed by a duly authorized representative if a signature line is present. Electronically transmitted Purchase Orders will be accepted without a signature if dealer billed and the dealer has an electronic purchase payment agreement on file.
- v. **Contact Name and Phone Number:** Person Haworth should contact with any questions regarding the order.
- vi. **Shipping Contact:** Name and phone number of person to be contacted regarding shipping and delivery matters.
- vii. **Tagging Instructions:** This information will appear on all documentation received from Haworth including: cartons, acknowledgments, and invoices.
- viii. **Price Agreement or National Sales Agreement Number**
- ix. **Product Total:** Net dollars.
- x. **Installation, Design, Project Management, and/or Service Fees**

b. Product Information

- i. **Quantity**
- ii. **Product Numbers**
- iii. **Colors**
- iv. **Specials:** Specify special part number for new special products.
- v. **Customer's Own Material:** Order entry code, manufacturer, pattern, and color.

- vi. **Approval Drawings:** An authorized signature by a duly authorized representative is required for shop drawings when applicable.
- vii. A deposit may be required for custom materials.

c. Order Confirmation

All orders will be acknowledged.

B. Pricing Policies

1. Terms of Payment

Terms of payment and credit limits will be established based on financial information. Standard payment terms on open credit are net thirty (30) days from invoice date. Advance payments or other payment security may be required by Haworth. The account balance must be at or below the credit limit and current at all times (no past-due balances). Haworth reserves the right to delay or cancel any delivery to a Customer whose Haworth account balance is over the credit limit and/or past due. For walls and floors a deposit will be required.

2. Terms of Credit

Customer hereby authorizes Haworth to obtain such credit reports, financial information or other information as Haworth may request, including, without limitation, credit information from any financial institutions or others having a business relationship with the Customer. Customer hereby authorizes any credit references to answer Haworth's inquiries and provide such credit information and documentation as Haworth may request.

The Customer hereby releases and holds Haworth harmless for any inconvenience whatsoever, caused by any temporary or permanent withdrawal or restriction of credit privileges hereunder, or the enforcement of any of the provisions contained in this paragraph.

3. Past-Due Charges

Past-due balances will be increased by a maximum of 1.5% per month, or 18% annually, without forfeit of Haworth's right to immediate payment.

4. Applicable Prices

The price of any product sold to Customer by Haworth will be based upon the North American Price List (Catalog).

Prices and discounts are subject to change without notice or approval. In the event of an adjustment to pricing, National Sales Agreement (NSA) Customers will be notified in advance according to the terms of the NSA.

Applicable prices and currency exchange rates are those in effect at the time of the RECEIPT of an ORDER; Haworth reserves the right to use the published pricing effective at the time of shipment, if the requested delivery date is more than 120 days after the order receipt date.

North American Terms of Sale

Haworth Flooring products are sold using the North American price list in US dollars. Currency exchange rates at the time of the transaction will be used to convert the USD amount into the alternate currency. Should the currency exchange rate between the USD and alternate currency change between a quote and the receipt of an order, the alternate currency amount will also change to equal the current, equivalent USD amount.

5. C.O.M. (Customer's Own Material) Charges

Refer to appropriate Customer's Own Material (C.O.M.) form for applicable surface material charges.

6. Taxes

Haworth prices do not include customs duty, sales, use, value added or similar taxes. Any federal, state/provincial or other taxes or assessments based upon the sale or delivery of products or services sold applicable to the customer at present or later imposed by federal, state/provincial or municipal agencies, shall be added and paid by the customer. Customer is responsible for all such taxes.

NOTE: For all countries a valid sales tax exemption certificate must be approved by and on file with Haworth prior to product shipment. Otherwise, sales tax will be due and payable to Haworth when such tax is invoiced to Customer.

7. Services

If, as a result of Customer request, the Haworth dealer or Haworth subsidiary provides planning/design services, storage, project management, special handling, set-up, installation and/or other services, the Customer will be charged at the local Haworth dealer/subsidiary's prevailing rates.

8. Termination by Haworth

Haworth may immediately terminate an order upon written notice in the event bankruptcy or insolvency proceedings are instituted by or against the Customer, or the Customer is adjudicated as bankrupt, becomes insolvent, makes an assignment for the benefit of creditors, or proposes or makes any arrangements for the liquidation of its debts, or a receiver or receiver and manager is appointed with respect to all or any part of the assets of the Customer.

C. Shipping and Delivery

Haworth will have the right to determine the method of shipment and routing of product.

This section does not apply to any of Haworth's Flooring products. All Haworth Flooring products are sold freight collect.

If, for any reason, a delivery has to be made to an intermediate location (i.e. a location other than the "Ship To" location noted on the order or ultimate end user location), all handling and re-delivery costs incurred would be at the Customer's expense.

1. U.S.A. - Contiguous

All deliveries will be CPT (Carriage Paid To) (ICC Incoterms 2010) Haworth's manufacturing facilities or distribution centers. Freight charges will be prepaid by Haworth on all orders to locations within the continental United States. Customer bears all risk of loss or damage to the goods when they are placed on Haworth's means of transport.

2. U.S.A. - Non-contiguous (Alaska, Hawaii and Puerto Rico)

All deliveries will be CIF (Cost, Insurance and Freight) (ICC Incoterms 2010). Haworth's catalog prices include ocean freight and insurance to the port of the final destination. Haworth has the right to determine the carrier, method of shipment and routing. Haworth will contract with the insurer and provide minimal insurance coverage (CIF @ 110%) made payable to the Customer. Customer is responsible to obtain greater insurance if so desired.

Customer bears all risk of loss or damage to the goods when the goods are effectively at the disposal of the Customer on board the vessel at the named port of destination. Proof of delivery is a clean on board bill of lading. Customer will be responsible for all on-carriage from the receiving port to the final destination.

3. Canada

All deliveries will be DDP (Delivered Duty Paid) (ICC Incoterms 2010). Haworth's catalog prices include delivery to Customer's named place, not unloaded from any arriving means of transport. Customer bears all risk of loss or damage to the goods when they are delivered to the Customer's named facility not unloaded. Haworth will assume responsibility to file all freight claims with the carrier for any loss/damage which may occur while product is in transit, and will promptly repair or replace any damaged or lost product. Haworth requires the Customer to report all freight damage and/or loss to both the carrier and to Haworth.

NOTE: Under all delivery terms (U.S.A. and Canada), any additional expense resulting from Customer's request for expedited transportation, special services, packaging, handling, routing, and/or shipping method will be billed to Customer.

4. Mexico

All deliveries will be DAP (Delivered to Place) (ICC Incoterms 2010). Haworth's catalog prices include freight charges for normal surface transportation to a United States point of exportation within the 48

contiguous states. Haworth has the right to determine the carrier, method of shipment and routing.

Customer bears all risk of loss or damage to the goods when the goods are delivered to the named United States point of exportation. Haworth will provide customs clearance facilitation and arrangement of local delivery through an Authorized Dealer in Mexico, on a separately negotiated basis. Otherwise the Customer will be responsible for all customs clearance formalities and on-carriage from the United States point of exportation to the final destination in Mexico.

5. Delivery Dates and Delay

If Haworth cannot deliver products as scheduled due to causes beyond its reasonable control (such as casualty, labor disputes, or accident; inability to obtain necessary labor, material or transportation; or changes requested by the Customer), the delivery date will be extended to compensate for the delay as determined by Haworth.

6. Delivery Shortages and Damage

Product shortages and damage must be noted on delivery receipts at the time of delivery and reported to the carrier for correction.

Claims against Haworth for shortages, errors, or damage must be made within ten (10) days of the date of delivery or the Customer waives the right to make such a claim. Signed Bill of Ladings or Delivery Receipt must be sent in with claims. See the Haworth/Haworth Dealers Roles and Responsibilities document for further details.

7. Storage

Haworth may transfer product to storage at the Customer's risk and expense if the Customer is unable or unwilling to take delivery of product as originally scheduled. Upon such transfer to storage, the Customer assumes risk of loss. Haworth will invoice the Customer for storage fees and the Customer will make payments in accordance with Haworth's standard payment terms.

North American Terms of Sale

D. General Terms

1. Governing Law

For products purchased for delivery in the U.S. pursuant hereto, this Agreement shall be governed by and construed according to the laws of the State of Michigan. Where Products are purchased for delivery in Canada pursuant hereto, this Agreement shall be governed by and construed according to the laws of the Province of Alberta. In either case, the parties attorn to the exclusive jurisdiction of the courts of Michigan and Alberta, respectively for the purpose of hearing any disputes arising under this Agreement or with respect to any Products sold pursuant hereto, and agree that the provisions of the United Nations Convention on Contracts for the International Sale of Goods and any other provision or law which would have the effect of applying the laws of any jurisdiction other than Michigan or Alberta, as the case may be, shall be excluded.

2. Force Majeure

In the event that the performance of Customer or Haworth or its participating dealer assignee(s) would be prevented, restricted, interfered with or rendered commercially impracticable by reason of Force Majeure, then upon the giving of notice to the other parties, the party affected by the Force Majeure shall be excused from performing hereunder until the Force Majeure no longer prevents, restricts, interferes with, or renders such performance commercially impracticable.

"Force Majeure" shall mean: fire, explosion, breakdown of plant, epidemic, hailstorm, snow/ice storms en route, hurricane, tornado, cyclone, flood or power failure; war, revolution, civil or military disturbances, acts of public enemies, acts of terrorism, blockade or embargo; any law, order, proclamation, regulation, ordinance, demand or requirement of any applicable governmental authority or any subdivision, authority, or representative of any such government; labor difficulties, including without limitation, strikes, slowdowns, picketing or boycotts; or difficulties beyond Haworth's reasonable control in obtaining necessary raw materials, labor, fuels and electric power, components or facilities, and any other circumstances beyond the control of the party affected.

3. Delays by Customer

Where Haworth has not received adequate site dimensions, Product specifications, shipping information, installation particulars or other information required by Haworth to permit the efficient manufacture of any Products, or where site conditions are not in accordance with the Installation Requirements set forth, or are not otherwise suitable to permit effective and efficient installation, the manufacture and/or delivery of Products may be delayed, and such event shall constitute a delay by the Customer. When manufacture, delivery or installation is delayed by the Customer or at the Customer's request: (i) Haworth may, at its option, present the invoice for the full price of the Products to the Customer as then due and payable; (ii) the Customer shall pay to

Haworth all reasonable storage, handling and other reasonable incidental expenses incurred by Haworth in connection with such delay; and (iii) the Customer shall bear all risk of loss or damage to the Products being held by Haworth for the Customer.

4. Use and Installation of Products

Haworth recommends that its products be installed by certified, qualified and approved installers according to Haworth's written installation procedures. The Customer agrees to use Haworth products properly; not to remove or alter safety devices, warnings, or operation instructions placed on products by Haworth, and to instruct employees as to the proper care and use of the products according to printed instructions.

5. Warranty

Haworth's standard North American Warranty will apply as appropriate. All product line warranty specifics are available in each catalog or upon request.

E. Services

Service requests for design, installation, relocation, storage, etc. are handled by the local Haworth dealer on a separately negotiated basis. Contact the local Haworth dealer, affiliate or area sales office for more details.

Scope of Work - Design

Customer acknowledges that the Products to be manufactured or procured by Haworth in connection with the order are or may be custom manufactured for the Customer and that Haworth may be required to perform extensive work in relation to the design and specification of such Products. Where Customer requests that Haworth create as-built drawings or make more than two material revisions to any particular Product design or specification, Customer agrees that Haworth shall be entitled to invoice Customer with respect to such additional work on the basis of Haworth's then prevailing rates for related design and specification services.

Installation Requirements

Where installation services are to be provided by Haworth, its authorized dealer or subcontractor, a document will be provided setting forth the scope of installation work to be performed (the "Scope of Work") and the price to be charged therefore. Unless otherwise specified in the scope of work, Haworth's installation services are limited to products sold by Haworth with the exception of lighting, under floor electrical and data.

General Conditions

(a) Sufficient time shall be allocated by the Customer following delivery of Products and prior to Customer's occupation of the premises to allow the installation of all Products during conventional working hours, Monday through Friday, 7:30 a.m. to 4:30 p.m. Where sufficient time is not allocated and Haworth is required or requested to perform installation work outside of such times, overtime charges shall be charged at Haworth's then prevailing rates. (b) Haworth shall be given free and exclusive access to; (i) a loading dock within 150' of the freight elevator or hoist, which loading dock shall be of sufficient size to enable full-size tractor-trailer deliveries to the premises (where required by Haworth); (ii) a freight elevator or hoist of sufficient size and capacity to allow the efficient movement of the Products; (iii) an unobstructed and safe pathway to the area where Products are to be stored or staged; (iv) a secure storage / staging area; (v) convenient trash facilities; (vi) adequate lighting; (vii) a work site that complies with applicable health and safety legislation. Where such areas and facilities are not available, Haworth shall be entitled to bill Customer for all amounts incurred by Haworth for double-handling, product movement, lifting, hoisting, trash removal and any other resulting charges. (c) The installation site shall be free and clear of existing furniture, debris, or other obstructions (including construction in progress) and shall otherwise be in the reasonable opinion of Haworth ready for installation of the Products. Any building where Products are to be installed shall be fully closed in, dry and protected from the natural elements, with temperatures between 40°F and 90°F (4°C and 32°C) and relative humidity not to exceed 70% at all times including receipt of products, during and after installation and shall be adequately heated and/or air-conditioned. Where unusual site conditions exist which impede or prevent the normal installation of any Products, applicable extra charges shall apply at prevailing rates. (d) Haworth's installation pricing is based upon the installation occurring as one continuous delivery and installation project. Phased installation pricing shall be provided by Haworth on a case by case basis. (e) Electrical hardwiring, plumbing and mechanical work is not included and shall be the responsibility of the Customer. (f) Except as may be otherwise specifically indicated, installation pricing does not apply to projects where union labor is required. Where Haworth has provided installation pricing on the basis that non-union labor be utilized, and where Haworth is required to use union labor or it otherwise becomes impractical to use non-union labor, or where Haworth is required by law to use prevailing wages, Haworth shall be entitled to charge the Customer for any cost differential between the anticipated cost of non-union labor and the actual cost of utilizing union or prevailing wage labor. (g) Haworth shall not be responsible for obtaining permits.

North American Terms of Sale

Project / Site Conditions

Lateral load bracing is not included in the scope of Haworth's work and shall not be performed by Haworth. In areas where flooring Products are to be installed by Haworth overhead construction must be completed prior to the commencement of such work to avoid damage to the panels and finishes. The existing subfloor must be smooth, mopped clean, free of moisture, dust, dirt and debris. Once installed, the access floor must be maintained in the same manner. The subfloor must have a maximum vertical elevation deviation of 0.375" (10mm) over a horizontal span of 10'-0" (3m), and without discontinuities in floor slope. For greater certainty, the scope of Haworth's installation work in such areas shall not be deemed to include any work required to level such subfloor, remove protrusions, remove pre-existing floor coverings or adhesives, or any other work which is required to remedy any conditions which may impede the efficient installation of flooring. Except as may be otherwise specifically indicated in the order, installation pricing for flooring Products and the Scope of Work in relation thereto shall not include any work required to remove and replace floor panels following their initial installation to provide tradespersons or others with access to the underpanel cable management cavity. In areas where movable walls are to be installed, all flooring (including carpeting) and ceiling components (including dropped ceiling grid components) shall be fully complete and ready for the installation of the movable wall products. Further, the existing floor (or other surface on which the movable wall panels are to be installed) shall have a maximum vertical deviation of 1.25" (30mm) and the dropped ceiling grid shall have a maximum vertical deviation of 0.375" (10mm) from the specifications to which such movable wall panels were designed and manufactured (collectively the "Permitted Tolerances"), and shall otherwise comply with any site condition assumptions made known to Haworth prior to the manufacture of such Products (the "Site Assumptions"). Where the Permitted Tolerances or Site Assumptions are not strictly adhered to or met, additional charges may be incurred in connection with site remediation and/or the modification or remanufacture of affected movable wall products, together with all resulting shipping and labor charges at Haworth's then prevailing rates for such Products and services.

Installation Change Orders

Where Customer requests work to be performed or materials to be provided which are not contemplated in the Scope of Work, or Customer otherwise requests Products or services not contemplated in the order (collectively "Extras"), prior to providing such Extras Haworth reserves the right to require the Customer to provide and sign a written Purchase Order or Change Order acceptable to Haworth describing the Extras and the amounts to be charged therefore, and the Customer agrees to pay such charges.

Entire Agreement

The order and this Agreement (including applicable Schedules) constitute the sole agreement between the parties and supercede any prior understanding or written or oral agreements between the parties (excluding National Sales Agreements). No waiver of any of the provisions of these Standard Terms and Conditions shall be binding on Haworth unless expressly agreed in writing.

Revision Date: June 1, 2015

Index

Products are listed alphabetically in this index by alpha-numeric prefix/suffix codes.

Product Code	Product Description	Page
24-205-214	Ergotron Neo-Flex Laptop Cart – Ergotron Neo-Flex Laptop Cart	.94
24-220-055	Ergotron Teachwell® Mobile Digital Workspace	.95
24-312-026	Ergotron WorkFit-A — Dual Attached Sit-Stand Workstation	.79
24-316-026	Ergotron WorkFit-A — Dual Attached Sit-Stand Workstation	.79
24-317-026	Ergotron WorkFit-A — Single Attached Sit-Stand Workstation	.78
24-390-026	Ergotron WorkFit-A — Single Attached Sit-Stand Workstation	.78
24-391-026	Ergotron WorkFit-A — Single Attached Sit-Stand Workstation	.78
24-392-026	Ergotron WorkFit-A — Dual Attached Sit-Stand Workstation	.79
24-481-003	Ergotron LearnFit – LearnFit Desk	.96
24-547-003	Ergotron LearnFit – LearnFit Desk	.96
33-341-200	Ergotron WorkFit-S — Dual Attached Sit-Stand Workstation	.81
33-342-200	Ergotron WorkFit-S — Single Attached Sit-Stand Workstation	.80
33-349-200	Ergotron WorkFit-S — Dual Attached Sit-Stand Workstation	.81
33-349-211	Ergotron WorkFit-S — Dual Attached Sit-Stand Workstation	.81
33-350-200	Ergotron WorkFit-S — Single Attached Sit-Stand Workstation	.80
33-350-211	Ergotron WorkFit-S — Single Attached Sit-Stand Workstation	.80
33-351-200	Ergotron WorkFit-S — Single Attached Sit-Stand Workstation	.80
33-351-211	Ergotron WorkFit-S — Single Attached Sit-Stand Workstation	.80
33-397-062	Ergotron WorkFit-T — Desktop Sit-Stand Workstation	.84
33-397-085	Ergotron WorkFit-T — Desktop Sit-Stand Workstation	.84
33-406-062	Ergotron WorkFit-TL — Desktop Sit-Stand Workstation	.85
33-406-085	Ergotron WorkFit-TL — Desktop Sit-Stand Workstation	.85
33-407-062	Ergotron WorkFit-SR — Dual Attached Sit-Stand Workstation	.83
33-407-085	Ergotron WorkFit-SR — Dual Attached Sit-Stand Workstation	.83
33-415-062	Ergotron WorkFit-SR — Single Attached Sit-Stand Workstation	.82
33-415-085	Ergotron WorkFit-SR — Single Attached Sit-Stand Workstation	.82
33-418-085	Ergotron WorkFit-TL — Desktop Sit-Stand Workstation	.85
45-174-300	Ergotron Monitor Arms – Neo-Flex	.77
45-214-026	Ergotron Monitor Arms – Single Arm	.74
45-235-194	Ergotron Monitor Arms – Neo-Flex Extend	.77
45-241-026	Ergotron Monitor Arms – Single Arm	.69
45-245-026	Ergotron Monitor Arms – Dual Arm	.70
45-289-026	Ergotron Monitor Arm Accessories – LX Extension	.73
45-306-101	Ergotron Monitor Arms – Neo-Flex Tablet	.77
45-360-026	Ergotron Monitor Arms – Single Arm	.71
45-362-026	Ergotron Monitor Arm Accessories – LX Sit-to-Stand Extension	.73
45-405-026	Ergotron WorkFit LX - Sit-Stand Desk Mount System	.86
45-436-026	Ergotron Monitor Arms – MX Mini Desk Mount	.75
45-475-216	Ergotron Monitor Arms – HX Single Arm	.66
45-476-216	Ergotron Monitor Arms – HX Dual Arm	.67
45-489-026	Ergotron Monitor Arms – Dual Direct Arm	.72
45-490-216	Ergotron Monitor Arms – Single Arm	.69
45-491-216	Ergotron Monitor Arms – Dual Arm	.70
4TJC-72	Wire Management – J-Channel	.135
4TWP-2	Electrical Components – Power/Data Dome	.64
4TWP-4	Electrical Components – Power/Data Dome	.64
7031-7001	Information Display – Markerboard Accessories	.106
7031-7002	Information Display – Markerboard Accessories	.106
7062-8001	Information Display – Markerboard Accessories	.106
97-558-200	Ergotron WorkFit — Accessories – Tablet/Document Holder	.88
97-581-019	Ergotron WorkFit — Accessories – Worksurface	.88

Index

Product Code	Product Description	Page
97-583-009	Ergotron WorkFit — Accessories – Hinged Bow	89
97-605	Ergotron WorkFit — Accessories – Conversion Kit Single HD to LCD & Laptop	87
97-606	Ergotron WorkFit — Accessories – Conversion Kit Single HD to Dual	87
97-615	Ergotron WorkFit — Accessories – Tall-User Kit for WorkFit Dual	90
97-616	Ergotron WorkFit — Accessories – Conversion Kit: LCD & Laptop to Dual	90
97-617	Ergotron WorkFit — Accessories – Conversion Kit: Dual to LCD & Laptop	90
97-620-060	Ergotron WorkFit — Anti-Fatigue Floor Mat	93
97-649-085	Ergotron WorkFit — Accessories – Grommet Mount	89
97-653	Ergotron WorkFit — Accessories – Large Keyboard Tray	88
97-692	Ergotron WorkFit — Accessories – Grommet Mount	87
97-783	Ergotron Monitor Arms – Dual Monitor and Handle Kit	76
97-844	Ergotron Monitor Arm Accessories – LX Pole Collar	73
97-897	Ergotron WorkFit — Accessories – Deep Keyboard Tray	91
97-898	Ergotron WorkFit — Accessories – Corner Keyboard Tray	91
97-904	Ergotron WorkFit — Accessories – WorkFit Dual Monitor Kit	92
97-905	Ergotron WorkFit — Accessories – WorkFit Single LCD Monitor Kit	92
97-907	Ergotron WorkFit — Accessories – WorkFit LCD & Laptop Kit	92
97-926-064	Ergotron LearnFit – Storage Bin	96
97-933-062	Ergotron WorkFit — Accessories – WorkFit LCD & Laptop Kit	92
97-934-062	Ergotron WorkFit — Accessories – WorkFit Dual Monitor Kit	92
97-935-062	Ergotron WorkFit — Accessories – WorkFit Single LCD Monitor Kit	92
97-940-026	Ergotron Monitor Arm Accessories – LX Arm, Extension and Collar Kit	73
98-009-026	Ergotron Monitor Arms – HX Triple Monitor Bow Kit	68
98-009-216	Ergotron Monitor Arms – HX Triple Monitor Bow Kit	68
98-037-062	Ergotron Monitor Arms – Dual Direct Handle Kit	72
BBF-AC	Freestanding Mobile Screens – Frosted Insert	126
BBF-MB	Information Display – Markerboard / Perforated Metal Insert	104
BBF-MC	Information Display – Markerboard / Frosted Insert	104
BBF-PB	Mobile Screens – Perforated Metal Insert	126
BEDP	Electrical Components – Desktop Port	63
KU5M-2NNB	Monitor Arms — Haworth – Adjustable Post Arm – for Use with Intuity Benching	129
KU5M-2NNK	Monitor Arms — Haworth – Adjustable Post Arm – for Use with Reside Desking	130
KU6M-2NNB	Monitor Arms — Haworth – Extend Arm – For Use with Intuity Benching	129
KU6M-2NNK	Monitor Arms — Haworth – Extend Arm — For Use with Reside Desking	130
KU6M-2NNN	Monitor Arms — Haworth – Extend Arm	128
CH-8	Workstation Accessories – UniGroup All-Purpose Hook	168
DBKC-48	Work Tools – Team Master Kit	162
DBKP-48	Work Tools – File Master Kit	162
DBKP-S	Work Tools – File Master Kit	164
DBKS	Work Tools – Mini Master Kit	163
DBKS-S	Work Tools – Mini Master Kit	164
DBKT-48	Work Tools – Task Master Kit	162
DBKT-S	Work Tools – Task Master Kit	164
DM12-1006-1	Ergotron Zip 12 Charging	97
DMSP	Work Tools – Mini Shelf	159
DPKC-48	Work Tools – Team Master Kit	162
DPKP-48	Work Tools – File Master Kit	162
DPKP-S	Work Tools – File Master Kit	164
DPKS	Work Tools – Mini Master Kit	163
DPKS-S	Work Tools – Mini Master Kit	164
DPKT-48	Work Tools – Task Master Kit	162
DPKT-S	Work Tools – Task Master Kit	164
DPKY-1	Work Tools – Pile Master Kit	161

Index

<u>Product Code</u>	<u>Product Description</u>	<u>Page</u>
DS-3	Workstation Accessories – Shallow Drawer	166
DSR-F	Work Tools — Mounting – Freestanding Mount Rail	150
DSR-H	Work Tools — Mounting – Panel Mount Rail	149
DSR-W	Work Tools — Mounting – Worksurface Mount Rail	149
DTAR-3	Work Tools – Personal Shelf Bracket	160
DTBS-3	Work Tools – Phone Shelf Bracket	160
DTES-3	Work Tools – Personal Shelf	160
DTGK-3	Work Tools – Gooseneck Kit	159
DTHT-1	Work Tools – Tote Strap	159
DTLS-2	Work Tools – Letter Tray Stacking Kit	161
DTLT-2	Work Tools – Letter Tray	161
DTPR-3	Work Tools – Paper Sorter	158
DTPT-3	Work Tools – Phone Shelf	160
DTRB	Work Tools – Waste Bin	161
DTSB-1	Work Tools – Letter Tray Stacking Bracket	161
DTSB-3	Work Tools – Binder Bin	158
DTTE-3	Work Tools – Tote	159
DTTH-3	Work Tools – Tote	159
DTTS-12	Work Tools – Tack Strip	158
DTTS-24	Work Tools – Tack Strip	158
DTWC-2	Work Tools – Tool Cup	158
E2CH-8	Workstation Accessories – UniGroup Too All Purpose Hook	168
EAAW-0000-H	Wire Management – Cable Chain	134
EUAM-0000	Wire Management – Conduit Clamp	135
EUAW-0000-NHS	Wire Management – Cord Manager — Mesh	134
EUAW-3100-NV	Wire Management – Vertical Cable Chain	134
EUAW-4000-V	Wire Management – Compose Connections Cable Chain	134
EUAW-NH	Wire Management – Wire Manager — Horizontal	136
EUD1-HF0B-2010	Electrical Components – Hardwire	23
EUD1-HF0B-2110	Electrical Components – Hardwire	23
EUD1-HF0B-2112	Electrical Components – Hardwire	23
EUD1-PF0B-2010	Electrical Components – Corded	17
EUD1-PF0B-2110	Electrical Components – Corded	17
EUD1-PF0B-2112	Electrical Components – Corded	17
EUD1-PF0B-4000	Electrical Components – Corded	17
EUD1-SF0B-2110	Electrical Components – Enhanced Power Module — Spiral Corded — Height Adustable	28
EUD1-SF0B-4000	Electrical Components – Enhanced Power Module — Spiral Corded — Height Adustable	28
EUD1-SL0B-2110	Electrical Components – Enhanced Power Module — Cord for Height Adjustable	29
EUD1-SL0B-4000	Electrical Components – Enhanced Power Module — Cord for Height Adjustable	29
EUIDB-0000-A	Electrical Components – For use with Suite Technology Access Blotter and Utility Cabinet	35
EUIDB-0000-B	Electrical Components – For use with Suite Lower Storage – Mounts to the Inner Back of the Cabinet	34
EUIDB-0000-C	Electrical Components – For use with Suite Lower Storage – Mounts to Storage Top	34
EUIDB-0000-H	Electrical Components – Above Worksurface – Adjustable	30
EUIDB-0000-N	Electrical Components – Above Worksurface – Adjustable	30
EUIDB-0000-SB	Electrical Components – For Use with Side Car — Basic	32
EUIDB-0000-SD	Electrical Components – For Use with Side Car — Deluxe	32
EUIDB-0000-T	Electrical Components – Above Worksurface – Adjustable with Tackboard Offset	31
EUIDB-0000-U	Electrical Components – Under Worksurface – Fixed	31
EUIDB-0000-W	Electrical Components – Above Worksurface – Fixed	31
EUIDB-J	Electrical Components – For Use with X Series	33
EUDX-3000-B	Electrical Components – Cables	65
EUDX-3000-B	Electrical Components – Retrofit USB Charging Cable	65
EUDX-H000-B	Electrical Components – Cables	65

Index

Product Code	Product Description	Page
EUDX-V000-B	Electrical Components – Cables	.65
EUE1-000B	Electrical Components – Flip Top Unit — Non-Powered	.37
EUE1-1111W	Electrical Components – Power and Data	.36
EUE1-1331W	Electrical Components – Power and Data	.36
EUE1-1B01W	Electrical Components – Power and Data	.36
EUE1-C331W	Electrical Components – Power and Data	.36
EUE1-HF0B-1212	Electrical Components – Power, Data and USB	.51
EUE1-HF0B-2110	Electrical Components – Power, Data and USB	.51
EUE1-PF0B-1212	Electrical Components – Power, Data and USB	.39
EUE1-PF0B-2110	Electrical Components – Power, Data and USB	.39
EUE1-PF0B-4000	Electrical Components – Power, Data and USB	.39
EUE2-000B	Electrical Components – Flip Top Unit — Non-Powered	.37
EUE2-1331W	Electrical Components – Power and Data	.36
EUE2-C331W	Electrical Components – Power and Data	.36
EUE2-HF0B-1212	Electrical Components – Power, Data and USB	.57
EUE2-HF0B-2110	Electrical Components – Power, Data and USB	.57
EUE2-PF0B-1212	Electrical Components – Power, Data and USB	.45
EUE2-PF0B-2110	Electrical Components – Power, Data and USB	.45
EUE2-PF0B-4000	Electrical Components – Power, Data and USB	.45
EUET-0000-1M3N	Electrical Components – Power Tap — Corded Horizontal and Vertical	.15
EUET-0030-2M3N	Electrical Components – Power Tap — Horizontal	.13
EUET-0030-2M3N	Electrical Components – Power Tap — Vertical	.14
EUET-0030-3M3N	Electrical Components – Power Tap — Horizontal	.13
EUET-0030-3M3N	Electrical Components – Power Tap — Vertical	.14
EUET-0030-4M3N	Electrical Components – Power Tap — Horizontal	.13
EUET-0030-4M3N	Electrical Components – Power Tap — Vertical	.14
EUET-0030-CM3N	Electrical Components – Power Tap — Hardwire	.15
EUG1	Grommets – Flip Top Unit — Hatch	.99
EURT-0000-N001CB	Electrical Components – Data Bezel	.62
EURT-0000-N001CW	Electrical Components – Data Bezel	.62
EURT-0000-N001SB	Electrical Components – Data Bezel	.62
EURT-0000-N001SW	Electrical Components – Data Bezel	.62
EURT-0072-1010	Electrical Components – Bezel Utility Module	.62
EURT-0072-1100	Electrical Components – Bezel Utility Module	.62
HCH-0008	Workstation Accessories – PLACES All-Purpose Hook	.168
HCH-0008-W	Workstation Accessories – PLACES All-Purpose Hook — For Low Profile Wood Top Cap Panels	.168
HCPL-COT1-07	Lighting — Haworth Collection – Table Light	.115
HCPL-COT2-15	Lighting — Haworth Collection – Table Light with Small Panel	.115
HCPL-COT3-30	Lighting — Haworth Collection – Table Light with Large Panel	.115
HCPL-GFT1-13	Lighting — Haworth Collection – Table Light	.116
HCPL-SLF1-47	Lighting — Haworth Collection – Floor Light	.123
HCPL-SLSV-4BP	Lighting — Haworth Collection – Base Pads	.123
HCPL-SLT1-17	Lighting — Haworth Collection – Table Light	.123
HCPL-TTF1-60	Lighting — Haworth Collection – Floor Light	.124
HCPL-TTT1-14	Lighting — Haworth Collection – Table Light	.124
HCPL-TTT2-21	Lighting — Haworth Collection – Table Light	.124
HCPL-TTT3-27	Lighting — Haworth Collection – Table Light	.124
HCPL-UMT2-11	Lighting — Haworth Collection – Audio Lantern	.125
HKMP-1	Adjustable Keyboard Pads – Boogie Board Mouse Pad	.11
HKTC-M	Adjustable Keyboard Pads – Boogie Board Keyboard Tray with Palm Rest and Integrated Mouse Pad	.11
HKTC-N	Adjustable Keyboard Pads – Boogie Board Keyboard Tray with Palm Rest	.11
HKTE-M	Adjustable Keyboard Pads – Boogie Board Keyboard Tray with Palm Rest and Integrated Mouse Pad	.11
HKTE-N	Adjustable Keyboard Pads – Boogie Board Keyboard Tray with Palm Rest	.11

Index

<u>Product Code</u>	<u>Product Description</u>	<u>Page</u>
JAC-18	Workstation Accessories – Pencil Drawer	166
JAG-1	Grommet	98
JAG-2	Grommet	98
JRPY-3948	Recycling Solutions – Recycling Solutions	132
KAIB-0040	Information Display – Information Boards	102
KAIC-0000	Information Display – Horizontal Wall Rail End Caps	103
KAIE-0029	Information Display – Standard Easel	100
KAIE-0072	Information Display – Large Easel	101
KAIH-0000	Information Display – Boards and Accessories – Wall Cleat for Information Boards	102
KAIW-0096	Information Display – Boards and Accessories – Horizontal Wall Rail for Information Boards	102
KFI-00XX-B	Storage Accessories – Drawer Insert	133
KJFI-00XX-D	Storage Accessories – Drawer Insert	133
KU1A-0017	Adjustable Keyboard Pads – Locking Tilt AKP	7
KU1C	CPU Holders – Fixed Mount CPU Holder	12
KU1C	CPU Holders – Fixed Mount CPU Holder	12
KU1D-0000	Workstation Accessories – Adjustable Document Holder	167
KU1F-0000	Workstation Accessories – Adjustable Footrest	167
KU1L-0000-U	Workstation Accessories – Adjustable Laptop Holder	167
KU2A-0017	Adjustable Keyboard Pads – Dial Tilt AKP	7
KU2C-L	CPU Holders – Adjustable CPU Holder	12
KU3A-0023	Adjustable Keyboard Pads – Dial Tilt AKP - Extended Arm	8
KU4A-0023	Adjustable Keyboard Pads – Sit-to-Stand AKP	8
KU5A	Adjustable Keyboard Pads – Thin Profile AKP	10
KU5M-1NNB	Monitor Arms — Haworth – Adjustable Post Arm – for Use with Intuity Benching	129
KU5M-1NNK	Monitor Arms — Haworth – Adjustable Post Arm – for Use with Reside Desking	130
KU5M-1NNN	Monitor Arms — Haworth – Adjustable Post Arm	128
KU5M-2NNB	Monitor Arms — Haworth – Adjustable Post Arm – for Use with Intuity Benching	129
KU5M-2NNK	Monitor Arms — Haworth – Adjustable Post Arm – for Use with Reside Desking	130
KU5M-2NNN	Monitor Arms — Haworth – Adjustable Post Arm	128
KU6M-1NNB	Monitor Arms — Haworth – Extend Arm – For Use with Intuity Benching	129
KU6M-1NNK	Monitor Arms — Haworth – Extend Arm — For Use with Reside Desking	130
KU6M-1NNN	Monitor Arms — Haworth – Extend Arm	128
KU6M-2NNB	Monitor Arms — Haworth – Extend Arm – For Use with Intuity Benching	129
KU6M-2NNK	Monitor Arms — Haworth – Extend Arm — For Use with Reside Desking	130
KU6M-2NNN	Monitor Arms — Haworth – Extend Arm	128
KU6T	Monitor Arms — Haworth – iPad Attachment	131
KUAH-0002	Work Tools – Magnet Hooks	165
KUAH-0003	Work Tools – Magnet Hook	165
KUAK	Work Tools – Accessory Kit	157
KUAM-0411	Work Tools – Magnet Board	165
KUAM-0518	Work Tools – Magnet Board	165
KUAP-0000	Work Tools – Round Peg Magnets	165
KUAR-0403	Belong Work Tools — Accessories – Mirror	165
KUBL-2030-FJ	Work Tools – Blotter	157
KUBT	Work Tools – Base Tray	155
KUCU-0915-BNN	Work Tools – Open C Cubby	154
KUCU-1215-BNS	Work Tools – Open C Cubby	154
KUDP-2420	Workstation Accessories – Pencil + Drawer	166
KUHS-0000-H	Work Tools – Hanging Sorter	156
KULS	Work Tools – Desk Top L-Screen	155
KUP1-0000-CSN	Work Tools — Mounting – Tool Rail — Single Post — C-Clamp or Thru-mount	143
KUP1-0000-USN	Work Tools — Mounting – Tool Rail — Single Post — L-Bracket Mount	145
KUP2-0000-UBI	Work Tools — Mounting – Tool Rail — Single Post Internal/Benching	148

Index

<u>Product Code</u>	<u>Product Description</u>	<u>Page</u>
KUPT-0913-F	Work Tools – Paper Tray — Landscape	156
KUPT-0913-H	Work Tools – Paper Tray — Landscape	156
KUPY	Work Tools — Mounting – Slat, Wall Mount	140
KUR1-0424-PZN	Work Tools — Mounting	141
KUR1-1224-CSN	Work Tools — Mounting – Tool Rail — Horizontal Surface Mount C-Clamp or Thru-Mount	142
KUR1-1224-USE	Work Tools — Mounting – Tool Rail — Single Sided Continuous Benching End	146
KUR1-1224-USI	Work Tools — Mounting – Tool Rail — Internal Single Sided Continuous Benching Application	147
KUR1-1224-USN	Work Tools — Mounting – Tool Rail — Under Horizontal Surface Mount — L-Bracket	144
KUR2-1224-UBI	Work Tools — Mounting – Tool Rail — Internal Continuous Benching Application Only	148
KURB	Recycling Solutions – Recycling/Trash Bin	132
KURD	Recycling Solutions – Recycle Bin Carriage	132
KURS	Work Tools – Desk Top Reference Shelf	155
KURS-0010-H	Work Tools – Reference Shelves	157
KURS-0012-B	Work Tools – Reference Shelves	157
KURS-0019-H	Work Tools – Reference Shelves	157
KUSH-0408-H	Work Tools – Mini Shelf	156
KUSR	Work Tools – Screen Rail	154
KUTB	Work Tools – Structural Screen Tile	153
KUTC-0000-H	Work Tools – Tool Cup	156
KUTS-E	Work Tools – Territory Screen — End-of Run	151
KUTS-L	Work Tools – Territory L-Screen	152
KUTS-S	Work Tools – Territory Screen — Shared	151
KWMF	Wire Management – Wire Management Trough	136
KWT	Wire Management – Wire Management Trough	136
KZTB	Work Tools – Belong Systems Tile — External Mount for use with Compose Panels	153
LBJ1	Lighting — Haworth Collection – Freestanding Lighting	111
LBJ2	Lighting — Haworth Collection – Freestanding Lighting	111
LBJ3	Lighting — Haworth Collection – Mounted Lighting	111
LBJ4	Lighting — Haworth Collection – Mounted Lighting	111
LCC1-1808-NFLC	Lighting — Haworth Collection – Table Light	113
LCC2-2608-NFLC	Lighting — Haworth Collection – Floor Light	113
LCF1-6009	Lighting — Haworth Collection – Floor Light	114
LCT1-1708	Lighting — Haworth Collection – Table Light	114
LL31-2210-NFLC	Lighting — Haworth Collection – Table Light	121
LL32-2210-NGLC	Lighting — Haworth Collection – Grommet Mounted	121
LLC1	Lighting — Haworth Collection – Worksurface Mount	118
LLL1	Lighting — Haworth Collection	117
LLL2	Lighting — Haworth Collection	117
LLL3	Lighting — Haworth Collection	117
LLM1	Lighting — Haworth Collection – Mounted	119
LLM1	Lighting — Haworth Collection – Mounted	119
LLM2	Lighting — Haworth Collection – Mounted	119
LLU2	Lighting — Haworth Collection – Mounted	119
LRF0-5208	Lighting — Haworth Collection – Floor Light	112
RF1-5208	Lighting — Haworth Collection – Floor Light	112
LRT1-1408	Lighting — Haworth Collection – Circa	112
LUPT	Lighting — Haworth Collection – Pixa	122
LUTD-0017-1NULDN	Lighting — Haworth – Reed Premier™ Add-On LED Task Light — For Use with Reed Premier Starter LED Task Lights	109
LUTS-0000	Lighting — Haworth – Reed Premier™ Add-On Occupancy Sensor	109
LUTS-0017-12ULD6	Lighting — Haworth – Reed Premier™ Starter LED Task Light	108
LUTS-0017-19ULD5	Lighting — Haworth – Reed Premier™ Stand-Alone LED Task Light	108
LUV1	Lighting — Haworth – Voyage without Occupancy Sensor	110
LUV2	Lighting — Haworth – Voyage with Occupancy Sensor	110

Index

<u>Product Code</u>	<u>Product Description</u>	<u>Page</u>
MAC-0001	Workstation Accessories – Make-A-Corner	167
NAH-12	Workstation Accessories – PREMISE All Purpose Hooks	168
NAH-12-S	Workstation Accessories – PREMISE All Purpose Hooks	168
NAPY	Work Tools — Mounting – Wall Accessory Slat Pad – For Use with PREMISE	140
NBFS-F	Mobile Screens – Fabric Scrim Insert	127
NBFS-M	Information Display – Markerboard Insert	105
NBFS-X	Mobile Screens – Translucent Insert	127
NECG-V	Wire Management – Vertical Cable Guide	136
NEH-8	Wire Management – Wire Management Loop	135
NEV-1	Wire Management – PREMISE Vertical Wire Manager	137
NEV-2	Wire Management – PREMISE Task Light Cord Manager	138
SCD-19	Workstation Accessories – Steel Center Drawer	166
STP-P26-TH	Pip – Pip	107
TA01-0214	Information Display – Boards and Accessories – Y-Leg Bumper	103
TA01-0217	Wire Management – Cable Column	139
TA01-0220	Grommet	98
TA01-0225	Wire Management – Wire Manager Clips	135
TA01-0228-F	Wire Management – Planes C-Leg Training Table Vertical Wire Manager	137
TA01-0814	Wire Management – Cable Base	139
TA01-1414	Wire Management – Cable Base	139
VZAC-0000-H	Workstation Accessories – Compose All-Purpose Hook	168
VZAC-0000-P	Workstation Accessories – Compose All-Purpose Hook	168
VZAW-0000-V	Wire Management – Compose Task Light Cord Manager	137
WC-17	Wire Management – UniGroup Too, UniGroup and PLACES Task Light Wire Manager	138
WC-6	Wire Management – UniGroup Too, UniGroup and PLACES Wire Manager	138
WQAG	Lighting — Haworth Collection – Grommet — For Use with Brazo Grommet Mounted Light Only	112
WQAG	Grommet	98
WUAC-WSG	Grommets – Grommet	98
WUAW-PNH	Wire Management – Horizontal Wire Management	136
ZUAP-0000-PAN	Electrical Components – Power Tap Bracket — Adjustable	16
ZUAP-0000-PFD	Electrical Components – Power Tap Bracket — Fixed	16
ZUAP-0000-PGH	Electrical Components – Power Tap Bracket with Grommet — Beside Storage Only	16
ZUAP-0000-PUR	Electrical Components – Power Tap Bracket — Under Surface	16

Great Expectations

You have them as a Haworth customer and so do we. And because **we value our customers**, we cover our products with the Haworth North America Product Compatibility and Limited Warranty Policy.

Product Compatibility And Limited Warranty Policy

OUR COMMITMENT TO PRODUCT COMPATIBILITY – INTEGRATED PRODUCT PLATFORMS

As a market leader in the design and manufacture of workspaces that adapt to change, we strive to maintain product compatibility within our various generations of integrated product platforms. This benefits the customer who desires to update or modify their work environment. It also benefits the customer needing to replace a product due to damage or other reasons but which is no longer manufactured or is otherwise unavailable, such as a fabric or finish that is discontinued because of changing market preferences. In both circumstances, we often can provide products with comparable function and performance.

OUR COMMITMENT TO PRODUCT QUALITY – THE HAWORTH NORTH AMERICA LIMITED WARRANTY

To ensure customer satisfaction and peace of mind, we stand behind our products with the Haworth North America Limited Warranty. To review the current version of the limited warranty including its terms and conditions, please go to: www.haworth.com/resources/product-info/warranties or contact Haworth's First Call Center at **800.426.8562**.

WARRANTY REQUESTS OR QUESTIONS

For questions or service requests pertaining to the Haworth Limited Warranty, please contact your Haworth dealer. If you are unsure who your dealer is, please call Haworth's First Call Center at **800.426.8562**.



HAWORTH®

For more information call 800.344.2600 or 616.393.3000.

Haworth is a registered trademark of Haworth, Inc.

©Haworth, Inc. 2018 4.18 Item #1222

haworth.com | haworth-europe.com | haworth-asia.com

Flush Mounted Power

Corded

3-Port:

- (2) Power
- (1) USB

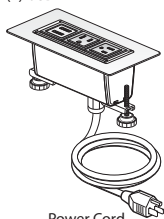

Power Cord

EUB1-PL0B-2100

4-Port:

- (2) Power
- (1) USB
- (1) Data

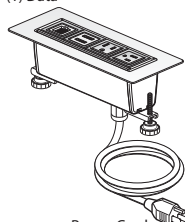

Power Cord

EUB1-PL0B-2110

6-Port:

- (2) Power
- (1) USB
- (1) Data
- (1) Cable Bay

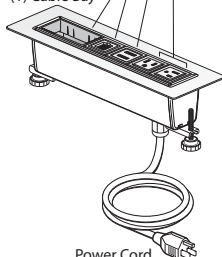

Power Cord

EUB1-PL0B-2112

4-Port:

- (4) Power

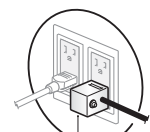
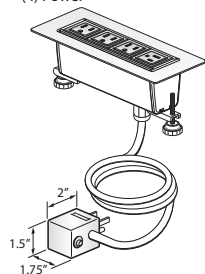

NOTE:
Always Fused Plug when more than 3 power outlets specified.

EUB1-PL0B-4000



Features

- Includes power module with 3, 4 or 6 ports that can be configured with simplex outlets (NEMA-5-15R), USB charging port (with two USB outlets), data ports or cable bay(s) that can accept up to two pull out data/AV cables and mounting hardware.
- Data port accommodate most varieties of field supplied data/AV jacks.
- Corded power module with 15 amp - 12'(3658mm) long cord with plug (NEMA 5-15P).
- USB Charging Port consists of two USB 2.0 style A outlets. 4 Amp (shared) charging capacity.
- Attaches to surface with use of included mounting brackets.
- Flush Mount has an overall housing depth of 4"(102mm) and will extend into mounting surface.
- Color option of black painted bezel with black receptacles or white painted bezel with white receptacles.

To Order, Specify:

- 1) Product number.
(No finish specification required.)

Specification Tips

- **Configuration and quantity of power and data ports cannot be modified in the field.**
- **For use with 120 volt 60 hertz power source only.**
- Requires field installation.
- Requires field cut access hole for power cord/conduit routing.
- Specify AV cables separately.
- Cable Bay requires cables less than 0.3"(7.6mm) diameter.
- Application may require approval of local authority having jurisdiction (AHJ); ensure compliance before placing orders and installation.

Flush Mounted Power

Corded

Top Width	Top Depth	Cord Length	Trim Color	Port Color	Port	Configuration	Number	Price						
Corded														
6 3/4"(171mm)	3"(76mm)	12'(3658mm)	Black	Black	3	1 Power Receptacle, 1 Cable Bay	EUB1-PL0B-1002	\$ 776.71						
						1 Power Receptacle, 2 Data Ports	EUB1-PL0B-1020	776.71						
						1 Power Receptacle, 1 Data Port, 1 USB Charging	EUB1-PL0B-1110	839.73						
						1 Power Receptacle, 2 USB Charging	EUB1-PL0B-1200	902.75						
						2 Power Receptacles, 1 Data Port	EUB1-PL0B-2010	776.71						
						2 Power Receptacles, 1 USB Charging	EUB1-PL0B-2100	839.73						
						3 Power Receptacles	EUB1-PL0B-3000	776.71						
8 1/4"(210mm)	3"(76mm)				4	1 Power Receptacle, 1 Data Port, 1 Cable Bay	EUB1-PL0B-1012	\$ 831.33						
						1 Power Receptacle, 3 Data Ports	EUB1-PL0B-1030	831.33						
						1 Power Receptacle, 1 USB Charging, 1 Cable Bay	EUB1-PL0B-1102	894.35						
						1 Power Receptacle, 3 USB Charging	EUB1-PL0B-1300	1020.39						
						2 Power Receptacles, 1 Cable Bay	EUB1-PL0B-2002	831.33						
						2 Power Receptacles, 2 Data Ports	EUB1-PL0B-2020	831.33						
						2 Power Receptacles, 1 USB Charging, 1 Data Port	EUB1-PL0B-2110	894.35						
						2 Power Receptacles, 2 USB Charging	EUB1-PL0B-2200	957.37						
						3 Power Receptacles, 1 Data Port	EUB1-PL0B-3010	831.33						
						3 Power Receptacles, 1 USB Charging	EUB1-PL0B-3100	894.35						
						4 Power Receptacles	EUB1-PL0B-4000	831.33						
						9 3/4"(248mm)	3"(76mm)				6	1 Power Receptacle, 1 USB Charging, 2 Cable Bays	EUB1-PL0B-1104	\$ 948.97
												1 Power Receptacle, 1 USB Charging, 2 Data Ports, 1 Cable Bay	EUB1-PL0B-1122	948.97
1 Power Receptacle, 1 USB Charging, 4 Data Ports	EUB1-PL0B-1140	948.97												
1 Power Receptacle, 2 USB Charging, 1 Data Port, 1 Cable Bay	EUB1-PL0B-1212	1011.99												
1 Power Receptacle, 2 USB Charging, 3 Data Ports	EUB1-PL0B-1230	1011.99												
1 Power Receptacle, 3 USB Charging, 1 Cable Bay	EUB1-PL0B-1302	1075.01												
1 Power Receptacle, 3 USB Charging, 2 Data Ports	EUB1-PL0B-1320	1075.01												
1 Power Receptacle, 4 USB Charging, 1 Data Port	EUB1-PL0B-1410	1138.03												
2 Power Receptacles, 2 Cable Bays	EUB1-PL0B-2004	885.95												
2 Power Receptacles, 2 Data Ports, 1 Cable Bay	EUB1-PL0B-2022	885.95												
2 Power Receptacles, 4 Data Ports	EUB1-PL0B-2040	885.95												
2 Power Receptacles, 1 USB Charging, 1 Data Port, 1 Cable Bay	EUB1-PL0B-2112	948.97												
2 Power Receptacles, 1 USB Charging, 3 Data Ports	EUB1-PL0B-2130	948.97												
2 Power Receptacles, 2 USB Charging, 1 Cable Bay	EUB1-PL0B-2202	1011.99												
2 Power Receptacles, 2 USB Charging, 2 Data Ports	EUB1-PL0B-2220	1011.99												
2 Power Receptacles, 3 USB Charging, 1 Data Port	EUB1-PL0B-2310	1075.01												
2 Power Receptacles, 4 USB Charging	EUB1-PL0B-2400	1138.03												
3 Power Receptacles, 3 Data Ports	EUB1-PL0B-3030	885.95												
3 Power Receptacles, 1 USB Charging, 1 Cable Bay	EUB1-PL0B-3102	948.97												
3 Power Receptacles, 1 USB Charging, 2 Data Ports	EUB1-PL0B-3120	948.97												
3 Power Receptacles, 2 USB Charging, 1 Data Port	EUB1-PL0B-3210	1011.99												
3 Power Receptacles, 3 USB Charging	EUB1-PL0B-3300	1075.01												
4 Power Receptacles, 1 Cable Bay	EUB1-PL0B-4002	885.95												
4 Power Receptacles, 2 Data Ports	EUB1-PL0B-4020	885.95												
4 Power Receptacles, 1 USB Charging, 1 Data Port	EUB1-PL0B-4110	948.97												
4 Power Receptacles, 2 USB Charging	EUB1-PL0B-4200	1011.99												
5 Power Receptacles, 1 Data Port	EUB1-PL0B-5010	885.95												
5 Power Receptacles, 1 USB Charging	EUB1-PL0B-5100	948.97												
6 Power Receptacles	EUB1-PL0B-6000	885.95												

Flush Mounted Power

Corded

Top Width	Top Depth	Cord Length	Trim Color	Port Color	Port	Configuration	Number	Price						
6 3/4"(171mm)	3"(76mm)	12'(3658mm)	White	White	3	1 Power Receptacle, 1 Cable Bay	EUB1-PL0W-1002	\$ 667.47						
						1 Power Receptacle, 2 Data Ports	EUB1-PL0W-1020	667.47						
						1 Power Receptacle, 1 Data Port, 1 USB Charging	EUB1-PL0W-1110	730.49						
						1 Power Receptacle, 2 USB Charging	EUB1-PL0W-1200	793.51						
						2 Power Receptacles, 1 Data Port	EUB1-PL0W-2010	667.47						
						2 Power Receptacles, 1 USB Charging	EUB1-PL0W-2100	730.49						
						3 Power Receptacles	EUB1-PL0W-3000	667.47						
8 1/4"(210mm)	3"(76mm)				4	1 Power Receptacle, 1 Data Port, 1 Cable Bay	EUB1-PL0W-1012	\$ 722.09						
						1 Power Receptacle, 3 Data Ports	EUB1-PL0W-1030	722.09						
						1 Power Receptacle, 1 USB Charging, 1 Cable Bay	EUB1-PL0W-1102	785.11						
						1 Power Receptacle, 3 USB Charging	EUB1-PL0W-1300	911.15						
						2 Power Receptacles, 1 Cable Bay	EUB1-PL0W-2002	722.09						
						2 Power Receptacles, 2 Data Ports	EUB1-PL0W-2020	722.09						
						2 Power Receptacles, 1 USB Charging, 1 Data Port	EUB1-PL0W-2110	785.11						
						2 Power Receptacles, 2 USB Charging	EUB1-PL0W-2200	848.13						
						3 Power Receptacles, 1 Data Port	EUB1-PL0W-3010	722.09						
						3 Power Receptacles, 1 USB Charging	EUB1-PL0W-3100	785.11						
						4 Power Receptacles	EUB1-PL0W-4000	722.09						
						9 3/4"(248mm)	3"(76mm)				6	1 Power Receptacle, 1 USB Charging, 2 Cable Bays	EUB1-PL0W-1104	\$ 839.73
												1 Power Receptacle, 1 USB Charging, 2 Data Ports, 1 Cable Bay	EUB1-PL0W-1122	839.73
1 Power Receptacle, 1 USB Charging, 4 Data Ports	EUB1-PL0W-1140	839.73												
1 Power Receptacle, 2 USB Charging, 1 Data Port, 1 Cable Bay	EUB1-PL0W-1212	902.75												
1 Power Receptacle, 2 USB Charging, 3 Data Ports	EUB1-PL0W-1230	902.75												
1 Power Receptacle, 3 USB Charging, 1 Cable Bay	EUB1-PL0W-1302	965.77												
1 Power Receptacle, 3 USB Charging, 2 Data Ports	EUB1-PL0W-1320	965.77												
1 Power Receptacle, 4 USB Charging, 1 Data Port	EUB1-PL0W-1410	1028.79												
2 Power Receptacles, 2 Cable Bays	EUB1-PL0W-2004	776.71												
2 Power Receptacles, 2 Data Ports, 1 Cable Bay	EUB1-PL0W-2022	776.71												
2 Power Receptacles, 4 Data Ports	EUB1-PL0W-2040	776.71												
2 Power Receptacles, 1 USB Charging, 1 Data Port, 1 Cable Bay	EUB1-PL0W-2112	839.73												
2 Power Receptacles, 1 USB Charging, 3 Data Ports	EUB1-PL0W-2130	839.73												
2 Power Receptacles, 2 USB Charging, 1 Cable Bay	EUB1-PL0W-2202	902.75												
2 Power Receptacles, 2 USB Charging, 2 Data Ports	EUB1-PL0W-2220	902.75												
2 Power Receptacles, 3 USB Charging, 1 Data Port	EUB1-PL0W-2310	965.77												
2 Power Receptacles, 4 USB Charging	EUB1-PL0W-2400	1028.79												
3 Power Receptacles, 3 Data Ports	EUB1-PL0W-3030	776.71												
3 Power Receptacles, 1 USB Charging, 1 Cable Bay	EUB1-PL0W-3102	839.73												
3 Power Receptacles, 1 USB Charging, 2 Data Ports	EUB1-PL0W-3120	839.73												
3 Power Receptacles, 2 USB Charging, 1 Data Port	EUB1-PL0W-3210	902.75												
3 Power Receptacles, 3 USB Charging	EUB1-PL0W-3300	965.77												
4 Power Receptacles, 1 Cable Bay	EUB1-PL0W-4002	776.71												
4 Power Receptacles, 2 Data Ports	EUB1-PL0W-4020	776.71												
4 Power Receptacles, 1 USB Charging, 1 Data Port	EUB1-PL0W-4110	839.73												
4 Power Receptacles, 2 USB Charging	EUB1-PL0W-4200	902.75												
5 Power Receptacles, 1 Data Port	EUB1-PL0W-5010	776.71												
5 Power Receptacles, 1 USB Charging	EUB1-PL0W-5100	839.73												
6 Power Receptacles	EUB1-PL0W-6000	776.71												

This page intentionally blank

Flush Mounted Power

Hardwire

3-Port:

- (2) Power
- (1) USB

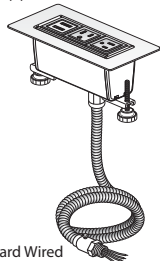

Hard Wired

EUB1-HL0B-2100

4-Port:

- (2) Power
- (1) USB
- (1) Data

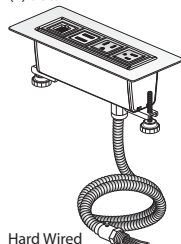

Hard Wired

EUB1-HL0B-2110

6-Port:

- (2) Power
- (1) USB
- (1) Data
- (1) Cable Bay

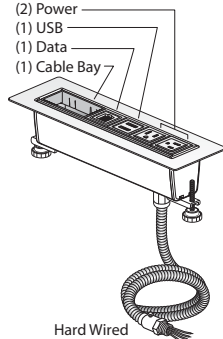

Hard Wired

EUB1-HL0B-2112



Features

- Includes power module with 3, 4 or 6 ports that can be configured with simplex outlets (NEMA-5-15R), USB charging port (with two USB outlets), data ports or cable bay(s) that can accept up to two pull out data/AV cables and mounting hardware.
- Data port accommodate most varieties of field supplied data/AV jacks.
- Hardwired power module with 12'(3658mm) long flexible metal conduit feed, 1/2"(13mm) conduit fitting and wires for hardwire connection.
- USB Charging Port consists of two USB 2.0 style A outlets. 4 Amp (shared) charging capacity.
- Attaches to surface with use of included mounting brackets.
- Flush Mount has an overall housing depth of 4"(102mm) and will extend into mounting surface.
- Color option of black painted bezel with black receptacles or white painted bezel with white receptacles.

To Order, Specify:

- 1) Product number.
(No finish specification required.)

Specification Tips

- **Configuration and quantity of power and data ports cannot be modified in the field.**
- **For use with 120 volt 60 hertz power source only.**
- Requires field installation.
- Requires field cut access hole for power cord/conduit routing.
- Specify AV cables separately.
- Cable Bay requires cables less than 0.3"(7.6mm) diameter.
- Application may require approval of local authority having jurisdiction (AHJ); ensure compliance before placing orders and installation.

Flush Mounted Power

Hardwire

Top Width	Top Depth	Conduit Length	Trim Color	Port Color	Port	Power	USB Charging	Data Port	Cable Bay	Description	Number	Price
Corded												
6 3/4" (171mm)	3" (76mm)	12' (3658mm)	Black	Black	3	1	0	0	2	1 Power Receptacle, 1 Cable Bay	EUB1-HLOB-1002	\$ 849.66
						1	0	2	0	1 Power Receptacle, 2 Data Ports	EUB1-HLOB-1020	849.66
						1	1	1	0	1 Power Receptacle, 1 Data Port, 1 USB Charging	EUB1-HLOB-1110	912.68
						1	2	0	0	1 Power Receptacle, 2 USB Charging	EUB1-HLOB-1200	975.70
						2	0	1	0	2 Power Receptacles, 1 Data Port	EUB1-HLOB-2010	849.66
						2	1	0	0	2 Power Receptacles, 1 USB Charging	EUB1-HLOB-2100	912.68
						3	0	0	0	3 Power Receptacles	EUB1-HLOB-3000	849.66
8 1/4" (210mm)	3" (76mm)				4	1	0	1	2	1 Power Receptacle, 1 Data Port, 1 Cable Bay	EUB1-HLOB-1012	\$ 904.28
						1	0	3	0	1 Power Receptacle, 3 Data Ports	EUB1-HLOB-1030	904.28
						1	1	0	2	1 Power Receptacle, 1 USB Charging, 1 Cable Bay	EUB1-HLOB-1102	967.30
						1	3	0	0	1 Power Receptacle, 3 USB Charging	EUB1-HLOB-1300	1093.34
						2	0	0	2	2 Power Receptacles, 1 Cable Bay	EUB1-HLOB-2002	904.28
						2	0	2	0	2 Power Receptacles, 2 Data Ports	EUB1-HLOB-2020	904.28
						2	1	1	0	2 Power Receptacles, 1 USB Charging, 1 Data Port	EUB1-HLOB-2110	967.30
						2	2	0	0	2 Power Receptacles, 2 USB Charging	EUB1-HLOB-2200	1030.32
						3	0	1	0	3 Power Receptacles, 1 Data Port	EUB1-HLOB-3010	904.28
						3	1	0	0	3 Power Receptacles, 1 USB Charging	EUB1-HLOB-3100	967.30
						4	0	0	0	4 Power Receptacles	EUB1-HLOB-4000	904.28
9 3/4" (248mm)	3" (76mm)				6	1	1	0	4	1 Power Receptacle, 1 USB Charging, 2 Cable Bays	EUB1-HLOB-1104	\$1021.92
						1	1	2	2	1 Power Receptacle, 1 USB Charging, 2 Data Ports, 1 Cable Bay	EUB1-HLOB-1122	1021.92
						1	1	4	0	1 Power Receptacle, 1 USB Charging, 4 Data Ports	EUB1-HLOB-1140	1021.92
						1	2	1	2	1 Power Receptacle, 2 USB Charging, 1 Data Port, 1 Cable Bay	EUB1-HLOB-1212	1084.94
						1	2	3	0	1 Power Receptacle, 2 USB Charging, 3 Data Ports	EUB1-HLOB-1230	1084.94
						1	3	0	2	1 Power Receptacle, 3 USB Charging, 1 Cable Bay	EUB1-HLOB-1302	1147.96
						1	3	2	0	1 Power Receptacle, 3 USB Charging, 2 Data Ports	EUB1-HLOB-1320	1147.96
						1	4	1	0	1 Power Receptacle, 4 USB Charging, 1 Data Port	EUB1-HLOB-1410	1210.98
						2	0	0	4	2 Power Receptacles, 2 Cable Bays	EUB1-HLOB-2004	958.90
						2	0	2	2	2 Power Receptacles, 2 Data Ports, 1 Cable Bay	EUB1-HLOB-2022	958.90
						2	0	4	0	2 Power Receptacles, 4 Data Ports	EUB1-HLOB-2040	958.90
						2	1	1	2	2 Power Receptacles, 1 USB Charging, 1 Data Port, 1 Cable Bay	EUB1-HLOB-2112	1021.92
						2	1	3	0	2 Power Receptacles, 1 USB Charging, 3 Data Ports	EUB1-HLOB-2130	1021.92
						2	2	0	2	2 Power Receptacles, 2 USB Charging, 1 Cable Bay	EUB1-HLOB-2202	1084.94
						2	2	2	0	2 Power Receptacles, 2 USB Charging, 2 Data Ports	EUB1-HLOB-2220	1084.94
						2	3	1	0	2 Power Receptacles, 3 USB Charging, 1 Data Port	EUB1-HLOB-2310	1147.96
						2	4	0	0	2 Power Receptacles, 4 USB Charging	EUB1-HLOB-2400	1210.98
						3	0	3	0	3 Power Receptacles, 3 Data Ports	EUB1-HLOB-3030	958.90
						3	1	0	2	3 Power Receptacles, 1 USB Charging, 1 Cable Bay	EUB1-HLOB-3102	1021.92
						3	1	2	0	3 Power Receptacles, 1 USB Charging, 2 Data Ports	EUB1-HLOB-3120	1021.92
						3	2	1	0	3 Power Receptacles, 2 USB Charging, 1 Data Port	EUB1-HLOB-3210	1084.94
						3	3	0	0	3 Power Receptacles, 3 USB Charging	EUB1-HLOB-3300	1147.96
						4	0	0	2	4 Power Receptacles, 1 Cable Bay	EUB1-HLOB-4002	958.90
						4	0	2	0	4 Power Receptacles, 2 Data Ports	EUB1-HLOB-4020	958.90
						4	1	1	0	4 Power Receptacles, 1 USB Charging, 1 Data Port	EUB1-HLOB-4110	1021.92
						4	2	0	0	4 Power Receptacles, 2 USB Charging	EUB1-HLOB-4200	1084.94
						5	0	1	0	5 Power Receptacles, 1 Data Port	EUB1-HLOB-5010	958.90
						5	1	0	0	5 Power Receptacles, 1 USB Charging	EUB1-HLOB-5100	1021.92
						6	0	0	0	6 Power Receptacles	EUB1-HLOB-6000	958.90

Flush Mounted Power

Hardwire

Top Width	Top Depth	Conduit Length	Trim Color	Port Color	Port	Power	USB Charging	Data Port	Cable Bay	Description	Number	Price
6 3/4" (171mm)	3" (76mm)	12' (3658mm)	White	White	3	1	0	0	2	1 Power Receptacle, 1 Cable Bay	EUB1-HLOW-1002	\$ 740.42
						1	0	2	0	1 Power Receptacle, 2 Data Ports	EUB1-HLOW-1020	740.42
						1	1	1	0	1 Power Receptacle, 1 Data Port, 1 USB Charging	EUB1-HLOW-1110	803.44
						1	2	0	0	1 Power Receptacle, 2 USB Charging	EUB1-HLOW-1200	866.46
						2	0	1	0	2 Power Receptacles, 1 Data Port	EUB1-HLOW-2010	740.42
						2	1	0	0	2 Power Receptacles, 1 USB Charging	EUB1-HLOW-2100	803.44
8 1/4" (210mm)	3" (76mm)				4	1	0	1	2	1 Power Receptacle, 1 Data Port, 1 Cable Bay	EUB1-HLOW-1012	\$ 795.04
						1	0	3	0	1 Power Receptacle, 3 Data Ports	EUB1-HLOW-1030	795.04
						1	1	0	2	1 Power Receptacle, 1 USB Charging, 1 Cable Bay	EUB1-HLOW-1102	858.06
						1	3	0	0	1 Power Receptacle, 3 USB Charging	EUB1-HLOW-1300	984.10
						2	0	0	2	2 Power Receptacles, 1 Cable Bay	EUB1-HLOW-2002	795.04
						2	0	2	0	2 Power Receptacles, 2 Data Ports	EUB1-HLOW-2020	795.04
						2	1	1	0	2 Power Receptacles, 1 USB Charging, 1 Data Port	EUB1-HLOW-2110	858.06
						2	2	0	0	2 Power Receptacles, 2 USB Charging	EUB1-HLOW-2200	921.08
						3	0	1	0	3 Power Receptacles, 1 Data Port	EUB1-HLOW-3010	795.04
						3	1	0	0	3 Power Receptacles, 1 USB Charging	EUB1-HLOW-3100	858.06
						4	0	0	0	4 Power Receptacles	EUB1-HLOW-4000	795.04
9 3/4" (248mm)	3" (76mm)				6	1	1	0	4	1 Power Receptacle, 1 USB Charging, 2 Cable Bays	EUB1-HLOW-1104	\$ 912.68
						1	1	2	2	1 Power Receptacle, 1 USB Charging, 2 Data Ports, 1 Cable Bay	EUB1-HLOW-1122	912.68
						1	1	4	0	1 Power Receptacle, 1 USB Charging, 4 Data Ports	EUB1-HLOW-1140	912.68
						1	2	1	2	1 Power Receptacle, 2 USB Charging, 1 Data Port, 1 Cable Bay	EUB1-HLOW-1212	975.70
						1	2	3	0	1 Power Receptacle, 2 USB Charging, 3 Data Ports	EUB1-HLOW-1230	975.70
						1	3	0	2	1 Power Receptacle, 3 USB Charging, 1 Cable Bay	EUB1-HLOW-1302	1038.72
						1	3	2	0	1 Power Receptacle, 3 USB Charging, 2 Data Ports	EUB1-HLOW-1320	1038.72
						1	4	1	0	1 Power Receptacle, 4 USB Charging, 1 Data Port	EUB1-HLOW-1410	1101.74
						2	0	0	4	2 Power Receptacles, 2 Cable Bays	EUB1-HLOW-2004	849.66
						2	0	2	2	2 Power Receptacles, 2 Data Ports, 1 Cable Bay	EUB1-HLOW-2022	849.66
						2	0	4	0	2 Power Receptacles, 4 Data Ports	EUB1-HLOW-2040	849.66
						2	1	1	2	2 Power Receptacles, 1 USB Charging, 1 Data Port, 1 Cable Bay	EUB1-HLOW-2112	912.68
						2	1	3	0	2 Power Receptacles, 1 USB Charging, 3 Data Ports	EUB1-HLOW-2130	912.68
						2	2	0	2	2 Power Receptacles, 2 USB Charging, 1 Cable Bay	EUB1-HLOW-2202	975.70
						2	2	2	0	2 Power Receptacles, 2 USB Charging, 2 Data Ports	EUB1-HLOW-2220	975.70
						2	3	1	0	2 Power Receptacles, 3 USB Charging, 1 Data Port	EUB1-HLOW-2310	1038.72
						2	4	0	0	2 Power Receptacles, 4 USB Charging	EUB1-HLOW-2400	1101.74
						3	0	3	0	3 Power Receptacles, 3 Data Ports	EUB1-HLOW-3030	849.66
						3	1	0	2	3 Power Receptacles, 1 USB Charging, 1 Cable Bay	EUB1-HLOW-3102	912.68
						3	1	2	0	3 Power Receptacles, 1 USB Charging, 2 Data Ports	EUB1-HLOW-3120	912.68
						3	2	1	0	3 Power Receptacles, 2 USB Charging, 1 Data Port	EUB1-HLOW-3210	975.70
						3	3	0	0	3 Power Receptacles, 3 USB Charging	EUB1-HLOW-3300	1038.72
						4	0	0	2	4 Power Receptacles, 1 Cable Bay	EUB1-HLOW-4002	849.66
4	0	2	0	4 Power Receptacles, 2 Data Ports	EUB1-HLOW-4020	849.66						
4	1	1	0	4 Power Receptacles, 1 USB Charging, 1 Data Port	EUB1-HLOW-4110	912.68						
4	2	0	0	4 Power Receptacles, 2 USB Charging	EUB1-HLOW-4200	975.70						
5	0	1	0	5 Power Receptacles, 1 Data Port	EUB1-HLOW-5010	849.66						
5	1	0	0	5 Power Receptacles, 1 USB Charging	EUB1-HLOW-5100	912.68						
6	0	0	0	6 Power Receptacles	EUB1-HLOW-6000	849.66						

This page intentionally blank

Flush Mounted Power

Spiral Cord for Height Adjustable

3-Port:

- (2) Power
- (1) USB

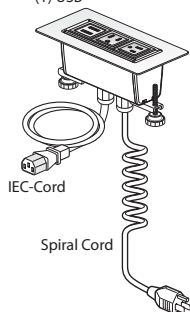

EUB1-SF0B-2100

4-Port:

- (2) Power
- (1) USB
- (1) Data

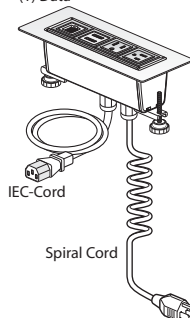

EUB1-SF0B-2110

6-Port:

- (2) Power
- (1) USB
- (1) Data
- (1) Cable Bay

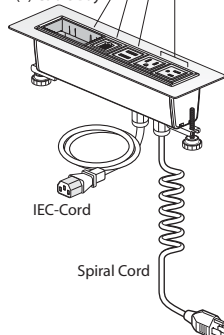

EUB1-SF0B-2112



Features

- Includes power module with 3, 4 or 6 ports that can be configured with simplex outlets (NEMA-5-15R), USB charging port (with two USB outlets), data ports or cable bay(s) that can accept up to two pull out data/AV cables and mounting hardware.
- Data port accommodate most varieties of field supplied data/AV jacks.
- Spiral Cord includes 15 amp plug (NEMA 5-15P) and expands to 12'(3658mm) when stretched.
- Auxiliary 24"(610mm) power cord includes IEC connector (IEC C13) for motor controller.
- USB Charging Port consists of two USB 2.0 style A outlets. 4 Amp (shared) charging capacity.
- Attaches to surface with use of included mounting brackets.
- Flush Mount has an overall housing depth of 4"(102mm) and will extend into mounting surface.
- Color option of black painted bezel with black receptacles or white painted bezel with white receptacles.

To Order, Specify:

- 1) Product number.
(No finish specification required.)

Specification Tips

- **Configuration and quantity of power and data ports cannot be modified in the field.**
- **For use with 120 volt 60 hertz power source only.**
- **For use with Suite, Planes Height Adjustable Tables, Planes Height Adjustable Bench, Hop 120° Benches and 3-Leg Hop Height Adjustable Tables. For 2-Leg Hop Height Adjustable Tables use IEC C6 to IEC C14 adapter.**
- Not for use with cable chain.
- Requires field installation.
- Requires field cut access hole for power cord/conduit routing.
- Specify AV cables separately.
- Cable Bay requires cables less than 0.3"(7.6mm) diameter.
- Application may require approval of local authority having jurisdiction (AHJ); ensure compliance before placing orders and installation.

4-Port:

- (4) Power

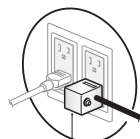
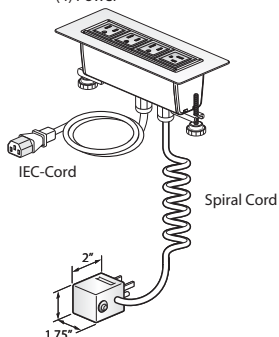

NOTE:

Always Fused Plug when more than 3 power outlets specified.

EUB1-SF0B-4000

Flush Mounted Power

Spiral Cord for Height Adjustable

Top Width	Top Depth	Cord Length	Trim Color	Port Color	Port	Configuration	Number	Price
Corded								
6 3/4"(171mm)	3"(76mm)	10'(3048mm)	Black	Black	3	2 Power Receptacles, 1 Data Port	EUB1-SF0B-2010	\$ 960.23
						2 Power Receptacles, 1 USB Charging	EUB1-SF0B-2100	1023.25
						3 Power Receptacles	EUB1-SF0B-3000	960.23
8 1/4"(210mm)	3"(76mm)				4	2 Power Receptacles, 1 Cable Bay	EUB1-SF0B-2002	1014.85
						2 Power Receptacles, 2 Data Ports	EUB1-SF0B-2020	1014.85
						2 Power Receptacles, 1 USB Charging, 1 Data Port	EUB1-SF0B-2110	1077.87
						2 Power Receptacles, 2 USB Charging	EUB1-SF0B-2200	1140.89
						3 Power Receptacles, 1 Data Port	EUB1-SF0B-3010	1014.85
						3 Power Receptacles, 1 USB Charging	EUB1-SF0B-3100	1077.87
						4 Power Receptacles	EUB1-SF0B-4000	1014.85
						9 3/4"(248mm)	3"(76mm)	
2 Power Receptacles, 2 Data Ports, 1 Cable Bay	EUB1-SF0B-2022	1069.47						
2 Power Receptacles, 4 Data Ports	EUB1-SF0B-2040	1069.47						
2 Power Receptacles, 1 USB Charging, 1 Data Port, 1 Cable Bay	EUB1-SF0B-2112	1132.49						
2 Power Receptacles, 1 USB Charging, 3 Data Ports	EUB1-SF0B-2130	1132.49						
2 Power Receptacles, 2 USB Charging, 1 Cable Bay	EUB1-SF0B-2202	1195.51						
2 Power Receptacles, 2 USB Charging, 2 Data Ports	EUB1-SF0B-2220	1195.51						
2 Power Receptacles, 3 USB Charging, 1 Data Port	EUB1-SF0B-2310	1258.53						
2 Power Receptacles, 4 USB Charging	EUB1-SF0B-2400	1321.55						
3 Power Receptacles, 1 USB Charging, 1 Cable Bay	EUB1-SF0B-3012	1069.47						
3 Power Receptacles, 3 Data Ports	EUB1-SF0B-3030	1069.47						
3 Power Receptacles, 1 USB Charging, 1 Cable Bay	EUB1-SF0B-3102	1132.49						
3 Power Receptacles, 1 USB Charging, 2 Data Ports	EUB1-SF0B-3120	1132.49						
3 Power Receptacles, 2 USB Charging, 1 Data Port	EUB1-SF0B-3210	1195.51						
3 Power Receptacles, 3 USB Charging	EUB1-SF0B-3300	1258.53						
4 Power Receptacles, 1 Cable Bay	EUB1-SF0B-4002	1069.47						
4 Power Receptacles, 2 Data Ports	EUB1-SF0B-4020	1069.47						
4 Power Receptacles, 1 USB Charging, 1 Data Port	EUB1-SF0B-4110	1132.49						
4 Power Receptacles, 2 USB Charging	EUB1-SF0B-4200	1195.51						
5 Power Receptacles, 1 Data Port	EUB1-SF0B-5010	1069.47						
5 Power Receptacles, 1 USB Charging	EUB1-SF0B-5100	1132.49						
6 Power Receptacles	EUB1-SF0B-6000	1069.47						

Flush Mounted Power

Spiral Cord for Height Adjustable

Top Width	Top Depth	Cord Length	Trim Color	Port Color	Port	Configuration	Number	Price
6 3/4"(171mm)	3"(76mm)	10'(3048mm)	White	White	3	2 Power Receptacles, 1 Data Port	EUB1-SFOW-2010	\$ 850.99
						2 Power Receptacles, 1 USB Charging	EUB1-SFOW-2100	914.01
						3 Power Receptacles	EUB1-SFOW-3000	850.99
8 1/4"(210mm)	3"(76mm)				4	2 Power Receptacles, 1 Cable Bay	EUB1-SFOW-2002	\$ 905.61
						2 Power Receptacles, 2 Data Ports	EUB1-SFOW-2020	905.61
						2 Power Receptacles, 1 USB Charging, 1 Data Port	EUB1-SFOW-2110	968.63
						2 Power Receptacles, 2 USB Charging	EUB1-SFOW-2200	1031.65
						3 Power Receptacles, 1 Data Port	EUB1-SFOW-3010	905.61
						3 Power Receptacles, 1 USB Charging	EUB1-SFOW-3100	968.63
						4 Power Receptacles	EUB1-SFOW-4000	905.61
9 3/4"(248mm)	3"(76mm)				6	2 Power Receptacles, 2 Cable Bays	EUB1-SFOW-2004	\$ 960.23
						2 Power Receptacles, 2 Data Ports, 1 Cable Bay	EUB1-SFOW-2022	960.23
						2 Power Receptacles, 4 Data Ports	EUB1-SFOW-2040	960.23
						2 Power Receptacles, 1 USB Charging, 1 Data Port, 1 Cable Bay	EUB1-SFOW-2112	1023.25
						2 Power Receptacles, 1 USB Charging, 3 Data Ports	EUB1-SFOW-2130	1023.25
						2 Power Receptacles, 2 USB Charging, 1 Cable Bay	EUB1-SFOW-2202	1086.27
						2 Power Receptacles, 2 USB Charging, 2 Data Ports	EUB1-SFOW-2220	1086.27
						2 Power Receptacles, 3 USB Charging, 1 Data Port	EUB1-SFOW-2310	1149.29
						2 Power Receptacles, 4 USB Charging	EUB1-SFOW-2400	1212.31
						3 Power Receptacles, 1 USB Charging, 1 Cable Bay	EUB1-SFOW-3012	960.23
						3 Power Receptacles, 3 Data Ports	EUB1-SFOW-3030	960.23
						3 Power Receptacles, 1 USB Charging, 1 Cable Bay	EUB1-SFOW-3102	1023.25
						3 Power Receptacles, 1 USB Charging, 2 Data Ports	EUB1-SFOW-3120	1023.25
						3 Power Receptacles, 2 USB Charging, 1 Data Port	EUB1-SFOW-3210	1086.27
						3 Power Receptacles, 3 USB Charging	EUB1-SFOW-3300	1149.29
						4 Power Receptacles, 1 Cable Bay	EUB1-SFOW-4002	960.23
						4 Power Receptacles, 2 Data Ports	EUB1-SFOW-4020	960.23
						4 Power Receptacles, 1 USB Charging, 1 Data Port	EUB1-SFOW-4110	1023.25
						4 Power Receptacles, 2 USB Charging	EUB1-SFOW-4200	1086.27
						5 Power Receptacles, 1 Data Port	EUB1-SFOW-5010	960.23
5 Power Receptacles, 1 USB Charging	EUB1-SFOW-5100	1023.25						
6 Power Receptacles	EUB1-SFOW-6000	960.23						

Flush Mounted Power

Cord for Height Adjustable

3-Port:

- (2) Power
- (1) USB

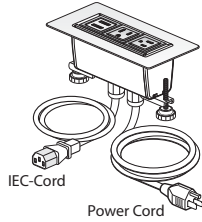

EUB1-SLOB-2100

4-Port:

- (2) Power
- (1) USB
- (1) Data

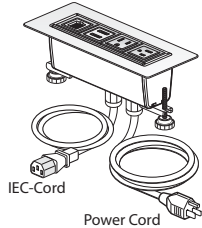

EUB1-SLOB-2110

6-Port:

- (2) Power
- (1) USB
- (1) Data
- (1) Cable Bay

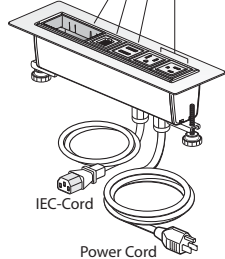

EUB1-SLOB-2112

4-Port:

- (4) Power

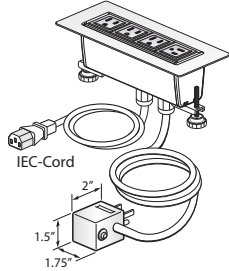

NOTE:
Always Fused Plug
when more than 3
power outlets specified.

EUB1-SLOB-4000



Features

- Includes power module with 3, 4 or 6 ports that can be configured with simplex outlets (NEMA-5-15R), USB charging port (with two USB outlets), data ports or cable bay(s) that can accept up to two pull out data/AV cables and mounting hardware.
- Data port accommodate most varieties of field supplied data/AV jacks.
- Corded power module with 15 amp - 12'(3658mm) long cord with plug (NEMA 5-15P).
- Auxiliary 24"(610mm) power cord includes IEC connector (IEC C13) for motor controller.
- USB Charging Port consists of two USB 2.0 style A outlets. 4 Amp (shared) charging capacity.
- Attaches to surface with use of included mounting brackets.
- Flush Mount has an overall housing depth of 4"(102mm) and will extend into mounting surface.
- Color option of black painted bezel with black receptacles or white painted bezel with white receptacles.

Specification Tips

- **Configuration and quantity of power and data ports cannot be modified in the field.**
- **For use with 120 volt 60 hertz power source only.**
- **For use with Suite, Planes Height Adjustable Tables, Planes Height Adjustable Bench, Hop 120° Benches and 3-Leg Hop Height Adjustable Tables. For 2-Leg Hop Height Adjustable Tables use IEC C6 to IEC C14 adapter.**
- Designed to be used with cable chain.
- Requires field installation.
- Requires field cut access hole for power cord/conduit routing.
- Specify AV cables separately.
- Cable Bay requires cables less than 0.3"(7.6mm) diameter.
- Application may require approval of local authority having jurisdiction (AHJ); ensure compliance before placing orders and installation.

To Order, Specify:

- 1) Product number.
(No finish specification required.)

Flush Mounted Power

Cord for Height Adjustable

Top Width	Top Depth	Cord Length	Trim Color	Port Color	Port	Configuration	Number	Price
Corded								
6 3/4"(171mm)	3"(76mm)	12'(3658mm)	Black	Black	3	2 Power Receptacles, 1 Data Port	EUB1-SLOB-2010	\$1011.58
						2 Power Receptacles, 1 USB Charging	EUB1-SLOB-2100	1074.60
						3 Power Receptacles	EUB1-SLOB-3000	1011.58
8 1/4"(210mm)	3"(76mm)				4	2 Power Receptacles, 1 Cable Bay	EUB1-SLOB-2002	\$1066.20
						2 Power Receptacles, 2 Data Ports	EUB1-SLOB-2020	1066.20
						2 Power Receptacles, 1 USB Charging, 1 Data Port	EUB1-SLOB-2110	1129.22
						2 Power Receptacles, 2 USB Charging	EUB1-SLOB-2200	1192.24
						3 Power Receptacles, 1 Data Port	EUB1-SLOB-3010	1066.20
						3 Power Receptacles, 1 USB Charging	EUB1-SLOB-3100	1129.22
						4 Power Receptacles	EUB1-SLOB-4000	1066.20
9 3/4"(248mm)	3"(76mm)				6	2 Power Receptacles, 2 Cable Bays	EUB1-SLOB-2004	\$1120.82
						2 Power Receptacles, 2 Data Ports, 1 Cable Bay	EUB1-SLOB-2022	1120.82
						2 Power Receptacles, 4 Data Ports	EUB1-SLOB-2040	1120.82
						2 Power Receptacles, 1 USB Charging, 1 Data Port, 1 Cable Bay	EUB1-SLOB-2112	1183.84
						2 Power Receptacles, 1 USB Charging, 3 Data Ports	EUB1-SLOB-2130	1183.84
						2 Power Receptacles, 2 USB Charging, 1 Cable Bay	EUB1-SLOB-2202	1246.86
						2 Power Receptacles, 2 USB Charging, 2 Data Ports	EUB1-SLOB-2220	1246.86
						2 Power Receptacles, 3 USB Charging, 1 Data Port	EUB1-SLOB-2310	1309.88
						2 Power Receptacles, 4 USB Charging	EUB1-SLOB-2400	1372.90
						3 Power Receptacles, 1 USB Charging, 1 Cable Bay	EUB1-SLOB-3012	1120.82
						3 Power Receptacles, 3 Data Ports	EUB1-SLOB-3030	1120.82
						3 Power Receptacles, 1 USB Charging, 1 Cable Bay	EUB1-SLOB-3102	1183.84
						3 Power Receptacles, 1 USB Charging, 2 Data Ports	EUB1-SLOB-3120	1183.84
						3 Power Receptacles, 2 USB Charging, 1 Data Port	EUB1-SLOB-3210	1246.86
						3 Power Receptacles, 3 USB Charging	EUB1-SLOB-3300	1309.88
						4 Power Receptacles, 1 Cable Bay	EUB1-SLOB-4002	1120.82
						4 Power Receptacles, 2 Data Ports	EUB1-SLOB-4020	1120.82
4 Power Receptacles, 1 USB Charging, 1 Data Port	EUB1-SLOB-4110	1183.84						
4 Power Receptacles, 2 USB Charging	EUB1-SLOB-4200	1246.86						
5 Power Receptacles, 1 Data Port	EUB1-SLOB-5010	1120.82						
5 Power Receptacles, 1 USB Charging	EUB1-SLOB-5100	1183.84						
6 Power Receptacles	EUB1-SLOB-6000	1120.82						

Flush Mounted Power

Cord for Height Adjustable

Top Width	Top Depth	Cord Length	Trim Color	Port Color	Port	Configuration	Number	Price
6 3/4"(171mm)	3"(76mm)	12'(3658mm)	White	White	3	2 Power Receptacles, 1 Data Port	EUB1-SLOW-2010	\$ 902.34
						2 Power Receptacles, 1 USB Charging	EUB1-SLOW-2100	965.36
						3 Power Receptacles	EUB1-SLOW-3000	902.34
8 1/4(210mm)	3"(76mm)				4	2 Power Receptacles, 1 Cable Bay	EUB1-SLOW-2002	\$ 956.96
						2 Power Receptacles, 2 Data Ports	EUB1-SLOW-2020	956.96
						2 Power Receptacles, 1 USB Charging, 1 Data Port	EUB1-SLOW-2110	1019.98
						2 Power Receptacles, 2 USB Charging	EUB1-SLOW-2200	1083.00
						3 Power Receptacles, 1 Data Port	EUB1-SLOW-3010	956.96
						3 Power Receptacles, 1 USB Charging	EUB1-SLOW-3100	1019.98
						4 Power Receptacles	EUB1-SLOW-4000	956.96
9 3/4"(248mm)	3"(76mm)				6	2 Power Receptacles, 2 Cable Bays	EUB1-SLOW-2004	\$1011.58
						2 Power Receptacles, 2 Data Ports, 1 Cable Bay	EUB1-SLOW-2022	1011.58
						2 Power Receptacles, 4 Data Ports	EUB1-SLOW-2040	1011.58
						2 Power Receptacles, 1 USB Charging, 1 Data Port, 1 Cable Bay	EUB1-SLOW-2112	1074.60
						2 Power Receptacles, 1 USB Charging, 3 Data Ports	EUB1-SLOW-2130	1074.60
						2 Power Receptacles, 2 USB Charging, 1 Cable Bay	EUB1-SLOW-2202	1137.62
						2 Power Receptacles, 2 USB Charging, 2 Data Ports	EUB1-SLOW-2220	1137.62
						2 Power Receptacles, 3 USB Charging, 1 Data Port	EUB1-SLOW-2310	1200.64
						2 Power Receptacles, 4 USB Charging	EUB1-SLOW-2400	1263.66
						3 Power Receptacles, 1 USB Charging, 1 Cable Bay	EUB1-SLOW-3012	1011.58
						3 Power Receptacles, 3 Data Ports	EUB1-SLOW-3030	1011.58
						3 Power Receptacles, 1 USB Charging, 1 Cable Bay	EUB1-SLOW-3102	1074.60
						3 Power Receptacles, 1 USB Charging, 2 Data Ports	EUB1-SLOW-3120	1074.60
						3 Power Receptacles, 2 USB Charging, 1 Data Port	EUB1-SLOW-3210	1137.62
						3 Power Receptacles, 3 USB Charging	EUB1-SLOW-3300	1200.64
						4 Power Receptacles, 1 Cable Bay	EUB1-SLOW-4002	1011.58
						4 Power Receptacles, 2 Data Ports	EUB1-SLOW-4020	1011.58
4 Power Receptacles, 1 USB Charging, 1 Data Port	EUB1-SLOW-4110	1074.60						
4 Power Receptacles, 2 USB Charging	EUB1-SLOW-4200	1137.62						
5 Power Receptacles, 1 Data Port	EUB1-SLOW-5010	1011.58						
5 Power Receptacles, 1 USB Charging	EUB1-SLOW-5100	1074.60						
6 Power Receptacles	EUB1-SLOW-6000	1011.58						

Ergotron branded products in this price list are covered exclusively by the warranty statement below.

All Ergotron® products will remain free of defects in material and workmanship for a period of five years from the date of receipt of the product, subject to any exclusions and limitations as set forth below.

Ten-year warranty on all LX and MX Ergotron Products, purchased on or after August 1, 2014

Zip Charging Systems: Lifetime material/workmanship; three years electrical components; one year cables (power/Ethernet)

Ten-year warranty on LearnFit Adjustable Standing Desk (24-481-003)

Three-year warranty on all Neo-Flex® Ergotron Products

Original Equipment Manufacturer (OEM) Products resold by Ergotron are warranted by the respective manufacturer

FURTHER EXCLUSIONS AND LIMITATIONS

These warranties do not cover product abuse, modification and failure to adhere to product instructions, improper operations and/or misuse. Ergotron is not responsible for damage arising from failure to follow instructions relating to the product's intended use. Ergotron is not responsible for injury or loss caused by or associated with the installation and/or use of equipment in any manner other than in strict conformance with the instructions set forth in its installation manuals, supplemental assembly and installation instruction sheets, technical bulletins and/or product literature. You will provide Ergotron immediate written notice of any personal injury resulting from the use of Ergotron products.

Ergotron does not warrant damages or defects to the Ergotron product under the following conditions: an Act of God, unauthorized service or repair of the Ergotron products, damage from electrical power problems, usage of parts or components not supplied by Ergotron, failure to follow product instructions and guidelines, unauthorized changes to the Ergotron product, shipping damage (other than original shipment from Ergotron), failure to perform preventative maintenance, or damage caused by peripherals or software or from other external sources.

EXCLUSIVE REMEDY

Warranty Repair: In the event that any Ergotron equipment becomes defective in material or workmanship during the warranty period, Ergotron will determine with you if the product defect is covered under warranty. Ergotron, at its sole discretion, may replace or repair the unit determined to be under warranty at a designated Ergotron location or at your location. The labor costs associated with the repair of the product may be the responsibility of Ergotron if determined to be under warranty. You must receive pre-approval by Ergotron for the labor costs prior to repair or replacement of warranty products. You must contact Ergotron to obtain a Return Material Authorization (RMA) number. An RMA number may be obtained by contacting Ergotron Customer Care online or by telephone within your specific region. Contact information is available to you on the Ergotron web site at www.ergotron.com. Performance of any repair or replacement on product under warranty does not renew or extend the warranty period.

Non-Warranty Repair: You may return a product for repair that is not covered by warranty only if you have received a preapproved RMA number from Ergotron Customer Care. Labor costs and freight charges associated with non-warranty repair will be the sole responsibility of the customer, reseller or installer/integrator. A standard repair fee, specific to the product, is charged for any product that is repaired outside of the warranty period. Repairs on products out of warranty also carry a 90-day warranty, effective the day that you receive the item after repair.

For products that are not covered under warranty, Ergotron offers you the following options:

You may upgrade to a newer, functionally equivalent product at a normal list price

Ergotron will return the product to you

You can request in writing that Ergotron appropriately dispose of the product for you. A fee may apply for this service as designated by local law

Non-Defective Products: You are notified if, after examining and testing a returned product, Ergotron concludes that the product is not defective. The product is returned to you and you would be responsible for the freight charges associated with the return.

WARRANTY DISCLAIMER

Except as expressly set forth in this Limited Warranty and to the greatest extent allowed by law, Ergotron makes no other representations, warranties or conditions, express or implied, including any implied representations, warranties or conditions of merchantability, fitness for a particular purpose, non-infringement, and non-interference. Ergotron does not warrant that your use of the Ergotron product will be uninterrupted or error free. Any implied warranties that may be imposed by law are limited in duration to the Limited Warranty period, to the greatest extent allowed by law. Some states or countries do not allow a limitation on how long an implied warranty lasts or the exclusion or limitation of incidental or consequential damages for consumer products. In such states or countries, some exclusions or limitations of this Limited Warranty may not apply to you. This Limited Warranty is subject to change without notification.

Ergotron devices are not intended to cure, treat, mitigate or prevent any disease.

WARRANTY TRANSFERABILITY

This Limited Warranty is available only to the original end consumer and is non-transferable. For this warranty to be valid, the Ergotron product must have been purchased directly from an authorized distributor, reseller and/or authorized representative of Ergotron.

For additional information reference Ergotron.com or warranty inquiries contact Ergotron at 844-429-9678 or email haworth@Ergotron.com.

Ergotron Limited Warranty Terms and Conditions

©Ergotron Inc.

Effective Date: 1 June 2017

Content is subject to change without notification

Ergotron Keyboard Tray

	Description	Height Adjustment	Number	Price
Keyboard Tray with Mouse Pad	11"(279mm) Track	0" Above/6" Below	169BK	\$439.00
	18.5"(457mm) Track	0" Above/6" Below	UKMCBK	470.00

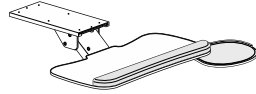

169BK

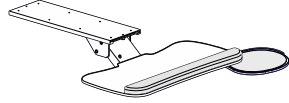

UKMCBK

Features

- Includes: Keyboard tray with mouse pad and attachment hardware.
- Keyboard tray includes integrated foam wrist rest.
- Oval mouse extension pivots out from the right side.
- Height adjustment range: Level with to 6"(152mm) below worksurface.
- Tilt adjustment -20°/ +10°
- Pans 360°.
- Available with 11"(279mm) track or 18.5"(457mm) track.
- Weight capacity: 10 lbs.
- Black only.
- TAA Compliant.

To Order, Specify:

- 1) Product number.

Specification Tips

- Keyboard tray extends 4" from front of worksurface when retracted.
- 11" or 18.5" under surface depth required for track installation.

Neo-Flex Keyboard Tray	Keyboard Tray	0" Above/6" Below	97-582-009	\$239.00
-------------------------------	---------------	-------------------	------------	-----------------

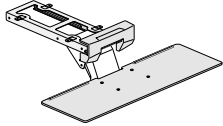

97-582-009

Features

- Includes: Keyboard tray, arm, desk clamp, slide mechanism and mounting hardware.
- Height adjustment range: Level with to 6"(152mm) below worksurface.
- Tilt adjustment +15°
- Fully retracts under worksurface when not in use.
- 26.9"(660mm)W x 8.9"(203mm)D keyboard trays allows room for keyboard and mouse.
- Weight capacity: 3 lbs.
- Keyboard tray extends approximately 9.25"(229mm) from front of surface.
- 15"(381mm) track.
- Black only.



To Order, Specify:

- 1) Product number.

Specification Tips

- Clamps to front edge of worksurface with clamp and one screw or remove clamp and attach under worksurface with four screws.
- Compatible with surfaces 0.75"(0mm) - 1.5"(25mm) thick.
- For use on surfaces with minimum depth of 17".

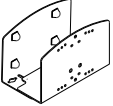
Ergotron CPU Holder

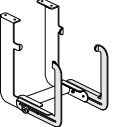
	Description	Number	Price
Small CPU Holder  80-063	Black	80-063-200	\$103.00
	White	80-063-216	103.00
	Features <ul style="list-style-type: none"> Includes: One vertical steel CPU holder, mounting hardware and fasteners. Mounts to any sturdy vertical surface. CPU Holder is 6"(152mm)H x 10"(254mm)D. Accommodates CPUs 1.4"(25mm) to 3.75"(76mm) wide. Weight capacity: 50 lbs. 	To Order, Specify: <ul style="list-style-type: none"> 1) Product number. 	
Universal CPU Holder  97-468	Silver	97-468-202	\$136.00
	White	97-468-216	136.00
	Features <ul style="list-style-type: none"> Includes: One vertical steel CPU holder, mounting hardware and fasteners. Mounts to any sturdy vertical surface. CPU Holder is 6.6"(152mm)H x 10"(254mm)D. Accommodates CPUs 2"(51mm) - 8"(203mm) wide. Weight capacity: 40 lbs. 	To Order, Specify: <ul style="list-style-type: none"> 1) Product number. 	
Cable CPU Holder  80-105-064	Grey/Silver	80-105-064	\$72.00
	Features <ul style="list-style-type: none"> Includes: One size-adjustable CPU holder and hardware. Mounts directly to wall or under worksurface. Size adjusts from 9.4"(229mm) x 2.6"(51mm) to 18"(457mm) x 8.5"(203mm). Unique security fasteners deter theft. Weight capacity: 50 lbs. 	To Order, Specify: <ul style="list-style-type: none"> 1) Product number. 	
CPU SideRack  STSR2GM	Grey Metallic	STSR2GM	\$367.00
	Features <ul style="list-style-type: none"> Includes: One steel CPU SideRack and mounting hardware. Attaches to outside edge of worksurface. Supports CPU width of 4.5"(102mm) - 9.75"(229mm). Weight capacity: 40 lbs. Available in Grey Metallic only. TAA Compliant. 	To Order, Specify: <ul style="list-style-type: none"> 1) Product number. 	

Ergotron Monitor Arm

LX Monitor Arm — Tall Pole

	Description	Number	Price
LX Dual Stacking Arm - Tall Pole Monitor Arm	Polished Aluminum	45-549-026	\$562.00
	White	45-509-216	562.00

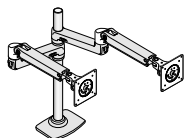

45-549-026
45-509-216

Features

- Includes: Two adjustable height monitor arms, extensions, 22"(559mm) pole, grommet mount, desk clamp and mounting hardware.
- Screen size:
 - Side by Side application; screens 40"(1016mm) wide or smaller.
 - Stacking application; screens 21"(533mm) high or shorter.
- Accommodates monitors from 7-20 pounds per arm. maximum combined weight is 40 pounds.
- Height adjustment range is 13"(330mm).
- Tilts 70° up and 5° down from center.
- Pans 360°.
- Rotates 360°.
- Extends LCDs out up to 25"(635mm).
- Integrated cable management.
- One touch adjustment.

To Order, Specify:

- 1) Product number.

Specification Tips

- Desk clamp mounts on worksurface 0.4"(0mm) - 2.4"(51mm) thick.
- Grommet mount attaches through surface holes 0.31"(0mm) - 2"(51mm) wide and up to 3"(76mm) thick.
- A third or fourth display can be added by ordering the LX Arm, Extension and Collar Kit. When adding a third or fourth monitor the maximum weight capacity per arm is 11 pounds.
- When using LX Arm Extension and Collar Kit with 3 monitors side by side, maximum screen width is 20.7" (526mm). When using LX Arm Extension and Collar kit with 4 monitors side by side, maximum screen width is 13.7" (348mm).

Ergotron Monitor Arm Accessories

For use with LX Monitor Arms

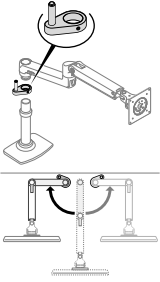
	Description	Number	Price
LX One-Stop Rotational Control Kit 	Silver	97-774-003	\$27.00
	Features <ul style="list-style-type: none"> Includes: Single rotation stop collar, stop post, and hardware. Controls LX arm motion range to prevent extension arm from hitting the wall. 		To Order, Specify: 1) Product number.
	Specification Tips <ul style="list-style-type: none"> Compatible with LX Single Arm, LX Tall Pole Arm, LX Dual Stacking Arm, LX Dual Direct Arm and LX Dual Stacking Tall Pole arm. Not compatible with LX Dual Side by Side Arms or LX Sit-Stand arms. When used on LX Dual Stacking arm a quantity of two is needed. 		

97-774-003

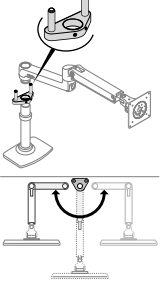
LX Two-Stop Rotational Control Kit 	Silver	98-060-003	\$34.00
	Features <ul style="list-style-type: none"> Includes: Dual rotation stop collar, two stop posts, and hardware. Provides a fixed 180° stop to prevent LX arm extension from hitting the wall. 		To Order, Specify: 1) Product number.
	Specification Tips <ul style="list-style-type: none"> Compatible with LX Single Arm, LX Tall Pole Arm, LX Dual Stacking Arm, LX Dual Direct Arm and LX Dual Stacking Tall Pole arm. Not compatible with LX Dual Side by Side Arms or LX Sit-Stand arms. 		

98-060-003

Ergotron Monitor Arm

MXV Desk Mount

	Description	Number	Price
Single Arm	Polished Aluminum	45-486-026	\$313.00
	White	45-486-216	313.00

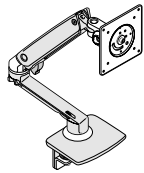

45-486

Features

- Includes: Fully assembled slim profile arm, two-piece desk clamp, and mounting hardware.
- For use with screen 34”(864mm) or smaller.
- Accommodates monitors from 7-20 pounds per arm.
- Height adjustment range is 13”(330mm).
- Tilts 90° backward and 90° forward.
- Rotates 360°.
- Pans 180° at base; 360° between extension and arm. Rotation stop on base can be disengaged at time of installation to increase range to a full 360°.
- Extends LCD monitor out 22.2”(559mm).
- Arm folds back over base into a compact retracted position; perfect for tucking under systems furniture storage shelves or cabinets in space constrained areas.
- Integrated cord management.
- One touch adjustment.

To Order, Specify:

- 1) Product number.

Specification Tips

- Desk clamp mounts on worksurface 0.47”(0mm) - 1.25”(25mm) thick.
- Desk clamp has anti-rotation screws to prevent base from slipping.
- Grommet mount available; separately specified part 98-110.

Dual Arm	Polished Aluminum	45-496-026	\$611.00
	White	45-496-216	611.00

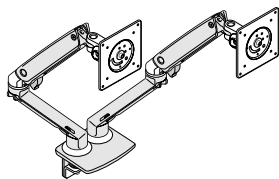

45-496

Features

- Includes: Fully assembled slim profile dual arm, two-piece desk clamp, and mounting hardware.
- For use with screen 24”(610mm) or smaller. Screen size may affect adjustment capability.
- Accommodates monitors from 7-20 pounds.
- Height adjustment range is 13”(330mm).
- Tilts 90° backward and 90° forward.
- Rotates 360°.
- Pans 180° at base; 360° between extension and arm. Rotation stop on base can be disengaged at time of installation to increase range to a full 360°.
- Extends LCD monitor out 22.2”(559mm).
- Arm folds back over base into a compact retracted position; perfect for tucking under systems furniture storage shelves or cabinets in space constrained areas.
- Integrated cord management.
- One touch adjustment.

To Order, Specify:

- 1) Product number.

Specification Tips

- Desk clamp mounts on worksurface .047”(0mm) - 1.25”(25mm) thick.
- Desk clamp has anti-rotation screws to prevent base from slipping.
- Grommet mount available; separately specified part 98-111.

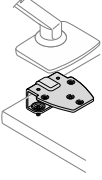
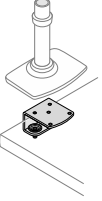
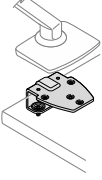
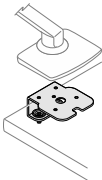

Ergotron Monitor Arm Accessories

Under Mount C-Clamp

	Description	Number	Price
Under Mount C-Clamp for LX Dual Side-by-Side, LX Dual Stacking, LX Desk Mount Tall Pole  98-236-009 98-082	Black	98-236-009	\$52.00
	White	98-082	52.00
Feature <ul style="list-style-type: none"> Includes: Under mount C-clamp and mounting hardware and two extension screws. 		To Order, Specify: <ol style="list-style-type: none"> Product number. 	
Specification Tips <ul style="list-style-type: none"> Compatible with LX Dual Side-by-Side Arm and LX Dual Stacking Arm as well as Single Monitor LX Desk Mount Arm (tall pole). Clamp can slide on from side of worksurface. Installation from the rear requires 1.2"(25mm) from edge of desktop to wall to slide clamp on. Attaches to surface edge 0.5"(0mm) - 1.26"(25mm) thick. For use when mounting monitor arm to Intuity with Access Hatches to avoid understructure interference with the standard two-piece clamp included with the arm. 			
Under Mount C-Clamp for LX Desk Mount Single, LX Dual Direct, and MXV Monitor Arms  98-235-009 98-083	Black	98-235-009	\$52.00
	White	98-083	52.00
Feature <ul style="list-style-type: none"> Includes: Under mount C-clamp and mounting hardware and two extension screws. 		To Order, Specify: <ol style="list-style-type: none"> Product number. 	
Specification Tips <ul style="list-style-type: none"> Compatible with LX Desk Mount Arm, LX Dual Direct Arm and MXV Arms. Clamp can slide on from side of worksurface. Installation from the rear requires 1.2"(25mm)1.2" from edge of desktop to wall to slide clamp on. Attaches to surface edge 0.5"(0mm) - 1.26"(25mm) thick. For use when mounting monitor arm to Intuity with Access Hatches to avoid understructure interference with the standard two-piece clamp included with the arm. 			
Under Mount C-Clamp for use with HX Arms  98-081	White	98-081	\$52.00
	Feature <ul style="list-style-type: none"> Includes: Under mount C-clamp, mounting hardware. 		To Order, Specify: <ol style="list-style-type: none"> Product number.
Specification Tips <ul style="list-style-type: none"> Compatible with HX Desk Single and Dual Monitor Arms. Clamp can slide on from side of worksurface. Installation from the rear requires 1.2"(25mm) from edge of desktop to wall to slide clamp on. Attaches to surface edge 0.5"(0mm) - 1.26"(25mm) thick. For use when mounting monitor arm to Intuity with Access Hatches to avoid understructure interference with the standard two-piece clamp included with the arm. 			
Under Mount C-Clamp for MX Mini Desk Mount Arms  98-084	White	98-084	\$52.00
	Feature <ul style="list-style-type: none"> Includes: Under mount C-clamp and mounting hardware. 		To Order, Specify: <ol style="list-style-type: none"> Product number.
Specification Tips <ul style="list-style-type: none"> Compatible with MX Mini Desk Mount Arm only. Clamp can slide on from side of worksurface. Installation from the rear requires 1.2"(25mm) from edge of desktop to wall to slide clamp on. Attaches to surface edge 0.5"(0mm) - 1.26"(25mm) thick. For use when mounting monitor arm to Intuity with Access Hatches to avoid understructure interference with the standard two-piece clamp included with the arm. 			

Ergotron Monitor Arm Accessories

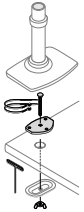
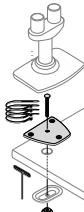
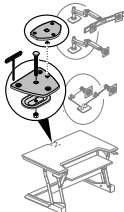
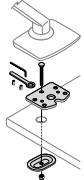
Grommet Mount

	Description	Number	Price
 <p>98-034</p>	Grommet Mount for LX Single and Dual Direct Arms	98-034	\$18.00
	<p>Feature</p> <ul style="list-style-type: none"> Includes: Grommet plate and attachment hardware. <p>Specification Tips</p> <ul style="list-style-type: none"> Compatible with LX Dual Direct Arm and the single monitor LX Desk Mount Arm (standard pole). Mounts through surface 0.31"(0mm) - 2"(51mm) wide and 3"(76mm) thick. 	<p>To Order, Specify:</p> <ol style="list-style-type: none"> Product number. 	
 <p>98-035</p>	Grommet Mount for LX Dual Arm	98-035	\$27.00
	<p>Feature</p> <ul style="list-style-type: none"> Includes: Grommet plate and attachment hardware. <p>Specification Tips</p> <ul style="list-style-type: none"> Compatible with LX Dual Side-by-Side Arm and LX Dual Stacking Arm as well as Single Monitor LX Desk Mount Arm (tall pole). Mounts through surface 0.31"(0mm) - 2"(51mm) wide and 3"(76mm) thick. 	<p>To Order, Specify:</p> <ol style="list-style-type: none"> Product number. 	
 <p>98-017</p>	Grommet Mount for LX Arm on WorkFit-T/TL	Zinc Plated Steel 98-017	\$28.00
	<p>Feature</p> <ul style="list-style-type: none"> Includes: Grommet plate and attachment hardware. <p>Specification Tips</p> <ul style="list-style-type: none"> Compatible with LX Dual Side-by-Side Arm and LX Dual Direct and LX Desk Mount Arm. Mounts through surface 0.31"(0mm) - 2"(51mm) wide and 3"(76mm) thick. Weight capacity: <ul style="list-style-type: none"> -LX Desk Mount Arm - 14 pounds -LX Dual Direct Arm - 4.8 pounds per monitor -LX Dual Side-by-Side Arm - 6 pounds per monitor Weight capacity is limited when mounting LX arms on WorkFit T/TL. 	<p>To Order, Specify:</p> <ol style="list-style-type: none"> Product number. 	
 <p>98-110</p>	Grommet Mount for MXV Single Monitor Arm	98-110	\$19.00
	<p>Feature</p> <ul style="list-style-type: none"> Includes: Grommet plate and attachment hardware. <p>Specification Tips</p> <ul style="list-style-type: none"> Compatible with MXV Single Monitor Arm. Mounts through surface .031"(76mm) - 2"(51mm) wide and 3"(76mm) thick. 	<p>To Order, Specify:</p> <ol style="list-style-type: none"> Product number. 	
 <p>98-111</p>	Grommet Mount for MXV Dual Monitor Arm	98-111	\$29.00
	<p>Feature</p> <ul style="list-style-type: none"> Includes: Grommet plate and attachment hardware. <p>Specification Tips</p> <ul style="list-style-type: none"> Compatible with MXV Dual Monitor Arm. Mounts through surface 0.31"(0mm) - 2"(51mm) wide and 3"(76mm) thick. 	<p>To Order, Specify:</p> <ol style="list-style-type: none"> Product number. 	

Ergotron Monitor Arm Accessories

Top Mount C-Clamp

	Description	Number	Price
Top Mount C-Clamp for LX Single, LX Dual Direct, and MXV Single Monitor Arms	Black	98-237-009	\$55.00
	White	98-121	\$55.00

Top Mount C-Clamp for LX Single, LX Dual Direct, and MXV Single Monitor Arms

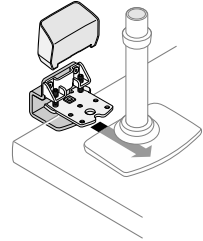

98-237-009
98-121

Feature

- Includes: Top mount C-Clamp and mounting hardware.

Specification Tips

- Compatible with LX Single, LX Dual Direct and MXV single monitor arms.
- Clamp can slide on from side of worksurface. Installation from the rear requires 2.7"(51mm) from edge of desktop to wall to slide clamp on.
- Attaches to surface edge 0.5"(0mm) - 1.26"(25mm) thick.
- Ergonomic installation can be completed from the top of the surface, no crawling under desks necessary.

To Order, Specify:

- Product number.

Top Mount C-Clamp for LX Dual Side-by-Side and Stacking, LX Desk Mount Tall Pole, and MXV Dual Monitor Arms	Black	98-238-009	\$55.00
	White	98-125	\$55.00

Top Mount C-Clamp for LX Dual Side-by-Side and Stacking, LX Desk Mount Tall Pole, and MXV Dual Monitor Arms

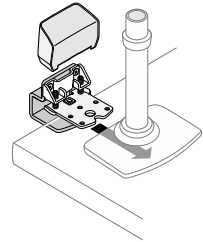

98-238-009
98-125

Feature

- Includes: Top mount C-Clamp and mounting hardware.

Specification Tips

- Compatible with LX Dual Side-by-Side, LX Dual Stacking, LX Desk Mount Tall Pole, and MXV dual monitor arms.
- Clamp can slide on from side of worksurface. Installation from the rear requires 2.7"(51mm) from edge of desktop to wall to slide clamp on.
- Attaches to surface edge 0.5"(0mm) - 1.26"(25mm) thick.
- Ergonomic installation can be completed from the top of the surface, no crawling under desks necessary.

To Order, Specify:

- Product number.

Top Mount C-Clamp for HX Arms	White	98-122	\$55.00
--------------------------------------	-------	--------	---------

Top Mount C-Clamp for HX Arms

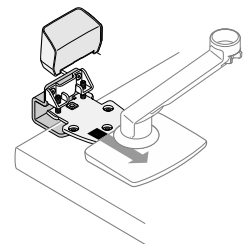

98-122

Feature

- Includes: Top mount C-Clamp and mounting hardware and two extension screws.

Specification Tips

- Compatible with HX Desk Single and Dual Arms and HX triple bow kit.
- Clamp can slide on from side of worksurface. Installation from the rear requires 2.7"(51mm) from edge of desktop to wall to slide clamp on.
- Attaches to surface edge 0.5"(0mm) - 1.26"(25mm) thick.
- Ergonomic installation can be completed from the top of the surface, no crawling under desks necessary.

To Order, Specify:

- Product number.

Top Mount C-Clamp for MX Mini Arms	White	98-126	\$55.00
---	-------	--------	---------

Top Mount C-Clamp for MX Mini Arms

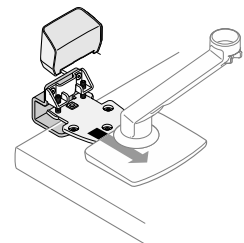

98-126

Feature

- Includes: Top mount C-Clamp and mounting hardware.



Specification Tips

- Compatible with MX Mini Arm only.
- Clamp can slide on from side of worksurface. Installation from the rear requires 2.7"(51mm) from edge of desktop to wall to slide clamp on.
- Attaches to surface edge 0.5"(0mm) - 1.26"(25mm) thick.
- Ergonomic installation can be completed from the top of the surface, no crawling under desks necessary.

To Order, Specify:

- Product number.

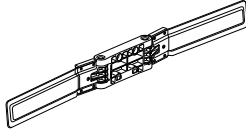
Ergotron Monitor Arm Accessories

	Description	Number	Price
Dual Monitor Double-Hinged Bow	<p>Black</p> <p>Features</p> <ul style="list-style-type: none"> Includes: Double-hinged bow and mounting hardware. For use with screens 25"(635mm) or smaller. Weight capacity is 6-14 pounds each. Capacity may vary depending on WorkFit capacity. Pans 168° from front to back using monitors 18"(457mm) or smaller. Panning motion may be restricted when using screens 19"(483mm) - 25"(635mm) in size. 	98-101-009	\$112.00
 98-101-009	<p>To Order, Specify:</p> <p>1) Product number.</p>		
	<p>Specification Tips</p> <ul style="list-style-type: none"> Compatible with WorkFit-A, WorkFit-S, WorkFit-SR dual workstations. Pivots are not included. Use pivots from current workstation. 		
Monitor Quick Release LCD Bracket	<p>Black</p> <p>Features</p> <ul style="list-style-type: none"> Includes: Bracket, screws and stand-offs. For use with monitors less than 3"(76mm) thick. Bracket weighs 1.2 pounds and is 0.5"(13mm) thick. Weight of the bracket needs to be considered when determining weight capacity of the monitor arm. 	60-589-060	\$33.00
 60-589-060	<p>To Order, Specify:</p> <p>1) Product number.</p>		
Tall-User Kit for Single Display	<p>Black</p> <p>Features</p> <ul style="list-style-type: none"> Includes: Bracket, recess spacer, and screws. Raises monitor 4"(102mm) - 6"(152mm). Screen size dependent on product to which it is attached. 	97-845	\$28.00
 97-845	<p>Specification Tips</p> <ul style="list-style-type: none"> Compatible with WorkFit-S, WorkFit-A and WorkFit-T as well as any VESA mount where portrait/landscape adjustment is locked or not present. Kit adds one pound to the mount weight. De-rate weight capacity of accompanying mount by one pound. Monitor weight should never exceed 29 pounds. 		