

GLASS SLIDING DOOR SYSTEM (Door Weight 286 lbs)

KSPG

SLIDING & FOLDING DOOR HARDWARE

GLASS SLIDING DOOR SYSTEM (DOOR WEIGHT 286 LBS)



Item No.	KSPG
Weight	Max. 130 kg (286 lbs)
Height	Max. 3000 mm (118-1/8")
Glass Thickness	10 or 12 mm

- Sliding door system for single glass door.
- No pre-drilled holes on glass needed for installation.
- Easy height adjustment.
- *Not for resin panels.

■ Door Installation

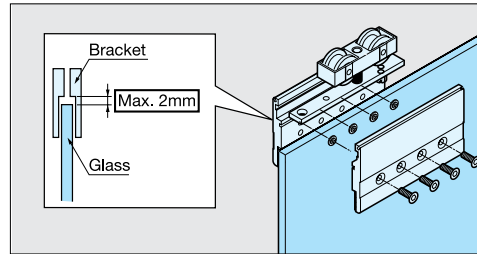

■ Adjustment (Height)

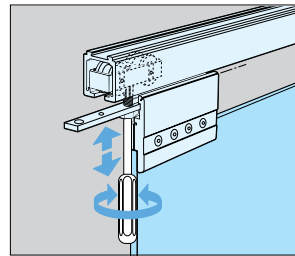

■ Bottom Guide

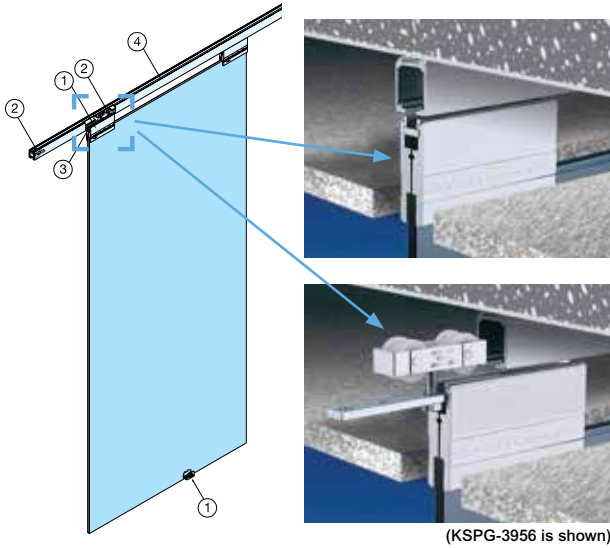
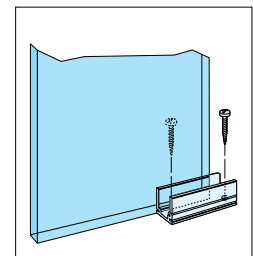

(KSPG-3956 is shown)

■ Dimensions

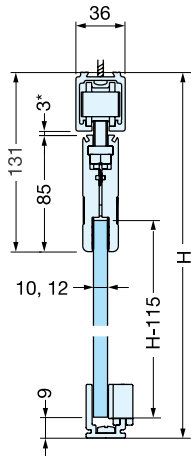

*Must be between 3 mm~5 mm to prevent glass door from falling.

Short Bracket Type

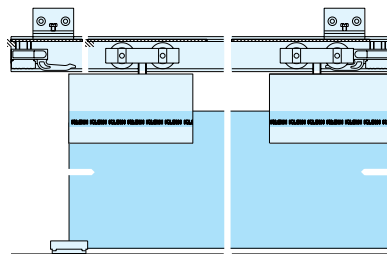

Long Bracket Type (W600, W900, W1200 per bracket)

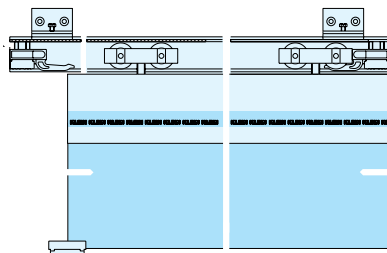

Application Example

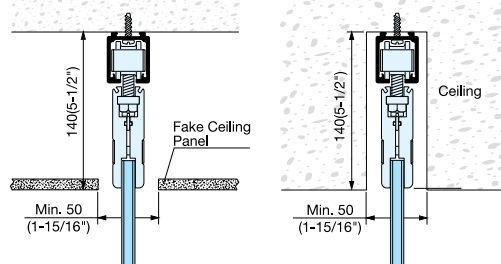

• Short Bracket is designed for application where it can be hidden.

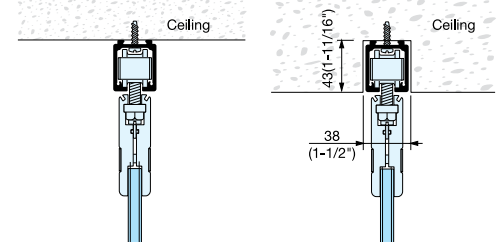

• Long Brackets are designed to cover the top glass edge all the way across.
• Ideal for surface mounting, for application where ceiling space is limited.

Parts Set (per door)		Necessary Parts			
No.	Item No.	Part Name	Quantity	Description 1	Description 2
-	KSPG-3936 (Short Bracket Set)	Glass Bracket	1 set (Select one type)	<ul style="list-style-type: none"> Material Aluminum Finish / Color Anodized *2 pcs per set	<ul style="list-style-type: none"> Kit with short bracket. For 10 mm glass.
	KSPG-3956 (Short Bracket Set)				<ul style="list-style-type: none"> Kit with short bracket. For 12 mm glass.
	KSPG-PE1043 (W600 Bracket Set)				<ul style="list-style-type: none"> Kit with 600 mm bracket. For 10 mm glass.
	KSPG-PE1044 (W600 Bracket Set)				<ul style="list-style-type: none"> Kit with 600 mm bracket. For 12 mm glass.
	KSPG-PE1045 (W900 Bracket Set)				<ul style="list-style-type: none"> Kit with 900 mm bracket. For 10 mm glass.
	KSPG-PE1046 (W900 Bracket Set)				<ul style="list-style-type: none"> Kit with 900 mm bracket. For 12 mm glass.
	KSPG-PE1047 (W1200 Bracket Set)				<ul style="list-style-type: none"> Kit with 1200 mm bracket. For 10 mm glass.
	KSPG-PE1048 (W1200 Bracket Set)				<ul style="list-style-type: none"> Kit with 1200 mm bracket. For 12 mm glass.

Parts Included

No.	Part Name	Quantity	Description
①	Bottom Guide	1 set	<ul style="list-style-type: none"> Material Aluminum, Polyacetal Finish / Color Anodized, White
②	Screw Set	1 set	<ul style="list-style-type: none"> Material Steel Finish / Color Clear Zinc Chromate
③	Roller	2 pcs	<ul style="list-style-type: none"> Material Aluminum, Polyamide Finish / Color Plain, White
	Stopper	2 pcs	<ul style="list-style-type: none"> Material Polyacetal Finish / Color Black
④	Hanging Bracket (for 10 mm Glass)	1 set	<ul style="list-style-type: none"> Material Steel Finish / Color Yellow Zinc Chromate
	Hanging Bracket (for 12 mm Glass)		<ul style="list-style-type: none"> Material Steel Finish / Color Clear Zinc Chromate

Upper Tracks

-	KS-2752	Upper Rail		Necessary quantity	<ul style="list-style-type: none"> Material Aluminum Finish / Color Anodized Length 2000 mm (78-47/64") *Screw hole drilled every 250 mm (10"). *Connecting pin KS-3536 available to align two rails.
---	---------	------------	--	--------------------	---

Optional Parts

-	KS-3531	Angle Bracket (for Upper Rail)		Optional	<ul style="list-style-type: none"> Material Aluminum Finish / Color Anodized *M5×16 screw included.
---	---------	--------------------------------	--	----------	---