

ADJUSTABLE KNUCKLE CATCH

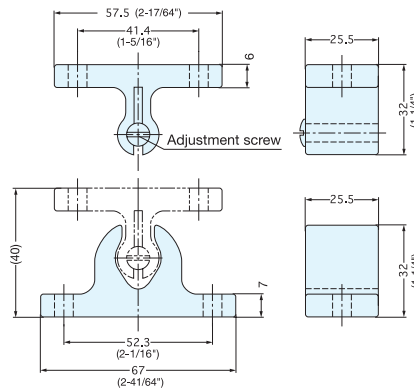

ESO-6732

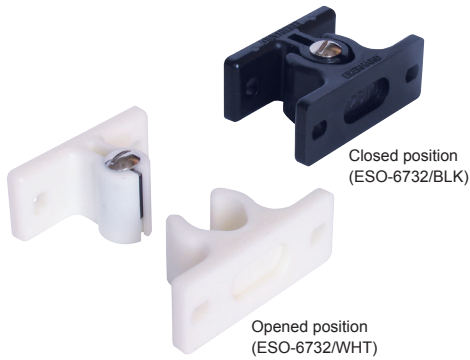

- Grabs and holds doors tightly.
- Strong catch force.
- Catch force is adjustable by turning adjustment screw.

Item No.	Push in Force (kg)	Pulling Force (kg)	Weight (g)	Box (pcs)	Carton (pcs)
ESO-6732/WHT	13~26 (29~57 lbs)	8~20 (18~44 lbs)	42	20	200
ESO-6732/BLK					

Material	Color
Polyamide	White (WHT), Black (BLK)

ROTARY CATCH



6900, 6901

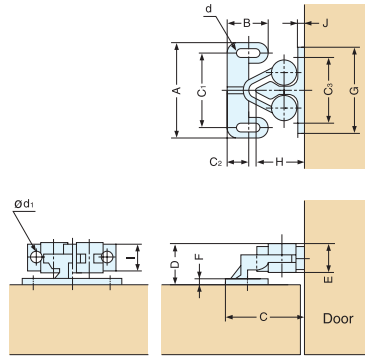
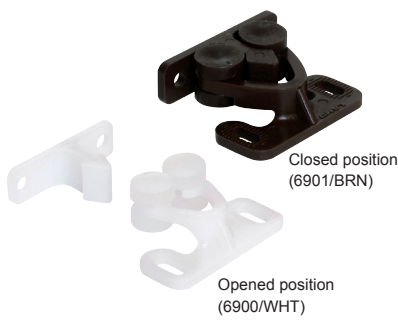

- Grabs and holds doors tightly.

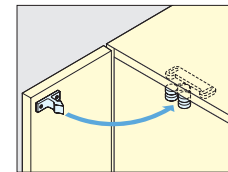

Installation

* Please specify color when ordering.

Part Name	Material	Color
Catch	Polyacetal	White (WHT)
Strike		Brown (BRN)
Roller	Polyethylene	(6901 only)

Item No.	Push in Force (kg)	Pulling Force (kg)	A	B	C	D	E	F	C ₁	C ₂	C ₃	G	H	I	J	d	d ₁	Weight (g)	Box (pcs)	Carton (pcs)
6900/WHT	1.1 (2.4 lbs)	1.6 (3.5 lbs)	29.0 (1-9/64")	12	21.2	11.3	8	2.0	21.5	6.0	20.0	26	13.5	7.5	1.7	3.1×7	3.0	3	100	2000
6901/WHT	2.2 (4.8 lbs)	3.2 (7.0 lbs)	31.3 (1-15/64")	14	27.2	12.6	9	2.3	24.4	7.5	23.6	32	16.5	9.0	2.0		3.1	4		
6901/BRN																				

KNUCKLE CATCH



JC-T50

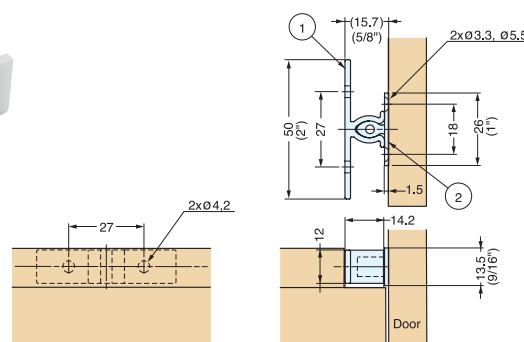
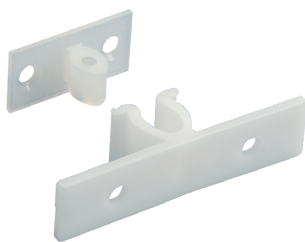

- Grabs and holds doors tightly.

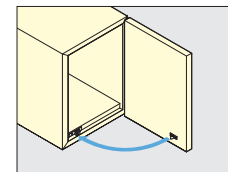

Installation

Item No.	Push in Force (kg)	Pulling Force (kg)	Weight (g)	Box (pcs)	Carton (pcs)
JC-T50	3.3 (6.6 lbs)	3.8 (8.3 lbs)	3	50	500

Part Name	Material	Color
Catch	Polyacetal	White (WHT)
Strike	Polyamide	Natural White