



Sink - Symetrics

Lavatory spout, wall-mounted without drain - platinum matte

Article number: 13 800 980-06 0010



- 7-1/4" Projection
- Fixed spout
- Round aerated stream
- 1-1/2" hole diameter
- Flange 2-3/8" x 2-3/8"
- 1/2" connection
- Plug-in connection mounting
- Water flow rate limited to max. 1.2 gpm
- lead-free
- For Touchfree control please order eSet Touchfree WITH or WITHOUT temperature adjustment



platinum matte

Accessory is required for this item.

Dimensional drawing

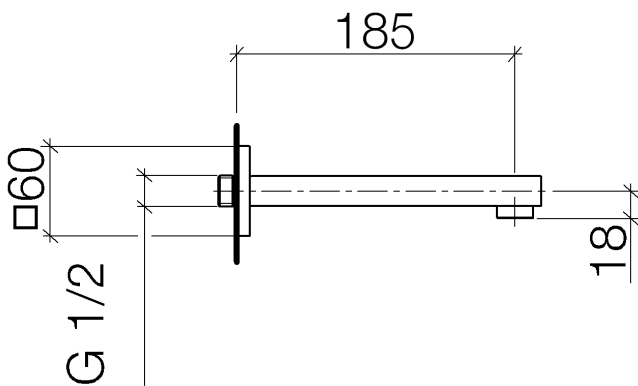

All dimensions in mm / inch = mm x 0,0394



Sink - Symetrics

Lavatory spout, wall-mounted without drain - platinum matte

Article number: 13 800 980-06 0010

Flow rate chart

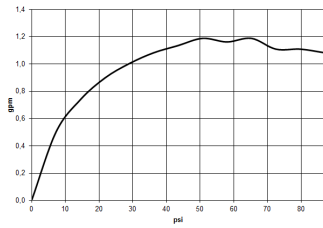

Other surface finishes



polished chrome

13 800 980-00 0010

Other surfaces upon request (extra service)



Sink - Symetrics

Lavatory spout, wall-mounted without drain - platinum matte

Article number: 13 800 980-06 0010

Required article



35 080 970-90 0010

Rough-in adapter -

Exploded drawing

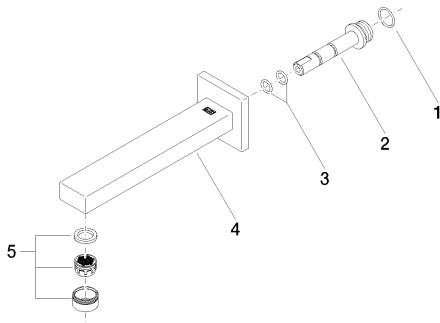

Spare parts list

Number	Item Number	Designation	Number of units
1	09 14 10 053 90	Washer -	1
2	09 24 04 135 90	Nipple -	1
3	09 14 10 008 90	Washer -	1
4	90 11 68 004 00-06	Outlet - platinum matte	1
5	90 23 01 029 05-06	Aerator - platinum matte	1