



DURAFLEX NEON™

SIDE VIEW IP66 OUTDOOR

Key Features

- Energy efficient LED flexible light strip for continuous constant color in linear applications
- Available in top-bend profile for arcing applications or side-bend profile
- Manufactured to specified lengths with factory attached end preps and various connector options for project requirements and efficient power configurations.
- Max continuous length: up to 30' per run (2.8W/ft)
up to 20' per run (4.2W/ft)
- Multiple dimming options available.

Flexible LED luminaire

Energy Efficient LED flexible light for continuous consistent color in outdoor applications. Extremely flexible and adjustable lengths for varied architectural applications.

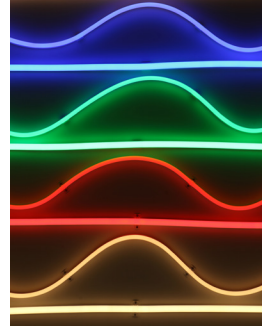

Dimensional Drawings

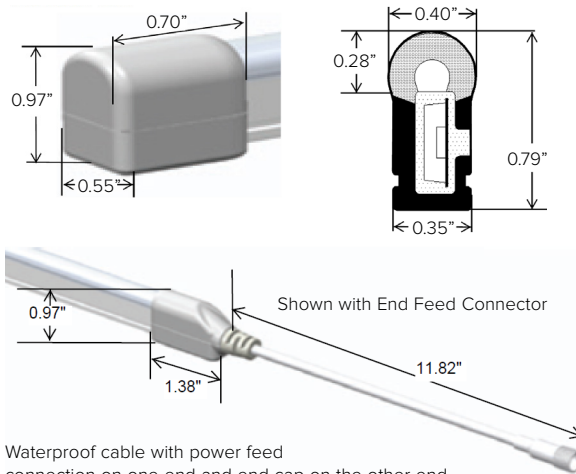

Waterproof cable with power feed connection on one end and end cap on the other end.

Details



Spacing	0.33" OC LED Spacing
LEDs	36 LEDs per foot
Color Temp	Available in 2700°K, 3000°K, 3500°K, 4000°K, Red 630nm, Green 530nm, Blue 470nm, Yellow 590nm, and Orange 605nm.
End Preps	Factory attached end preps available (See Page 2).
Field Cuts	See page 2 for cut zones.
Mounting	2 Mounting Clips options or Aluminum Mounting Channel option available for Installation (See accessories).
Lens Options	Extruded Silicone with Milky White diffusion lens with 180 degree visibility for Top Bend style and 240 degree visibility for Side Bend style.
Installation	Factory manufactured lengths with 12" IP66 connection lead with 12" power feed. To be completed with clip or channel mountings.
Power Supply	Listed Class 2 output, 24 VDC power supply required
Listing	cULus Class 2
Compliance	ROHS compliant
Warranty	3 year warranty

Fixture Data

LED Data

Model	Efficacy* Lm/Ft Lm/Wt	Wt/Ft	Model	Wt/LED	Viewing Angle	Lifespan at 90% drive
Side Bend 3000°K	63	263	Color 2.8W/ft	0.08W	120°	50,000hrs
	71	198	Whites 4.2W/ft	0.13W	120°	50,000hrs

* Meets Title 24 High efficacy rating. * LEDs operating at 90% of LED manufacturers maximum current rating.

Ordering Guide

PRODUCT CODE	PROFILE	WATTAGE	IP RATING	COLOR TEMP	VOLTAGE	+	END PREP	+	MOUNTING	+	POWER SUPPLY
DFN — DuraFlex Neon™	SB — Side Bend	42 — 4.2W/ft (White ONLY)	O — Outdoor IP67	27 — 2700K 30 — 3000K 35 — 3500K 40 — 4000K RD — Red 630nm GR — Green 530nm BL — Blue 470nm YL — Yellow 590nm OR — Orange 605nm	24 — 24 VDC						
		28 — 2.8W/ft (White or Color)		2200K and 2400K available upon request.							

Cut lengths

(Factory manufactured lengths)

Top Bend Profile

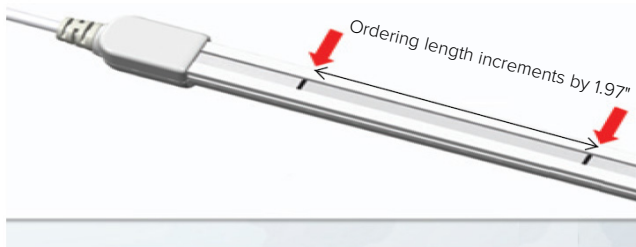

Side Bend Profile

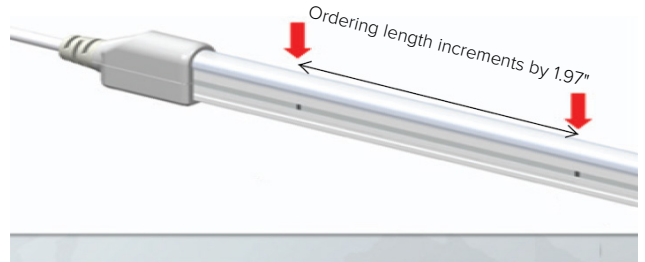

Required End Preps

A



A

DFNSBPWREF

Side Bend End Feed.
Completed with 12" power feed.

B



B

DFNSBPWRSF

Side Bend Side Feed.
Completed with 12" power feed.

C



C

Mounting Accessories

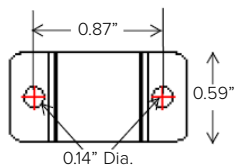
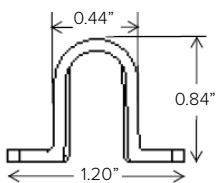
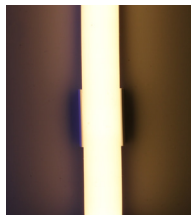

DFNSBCLPCL

Clear Plastic Clip (Package of 10ea) for Side Bend Profile.

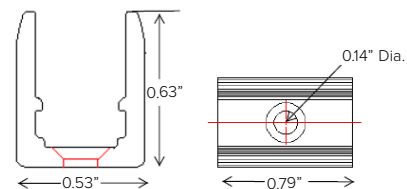
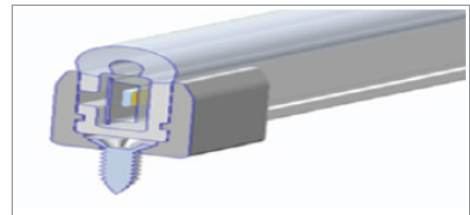

DFNSBCLPAL

Aluminum channel clip (package of 5ea) for side bend profile.



DURAFLEX NEON™

SIDE VIEW IP66 OUTDOOR

Power Supply (REQUIRED)	Type	Wattage	Input/Output Voltage	Dimmable	IP Rating	Output	Dimensions
DMLV40124D	MAGNETIC LOW VOLTAGE TRANSFORMER	40W	120V / 24V	MLV DIMMING 10%	NEMA3R ENCLOSURE	UL CLASS 2	8.13" x 3.93" x 1.59" [†]
DMLV60124D	MAGNETIC LOW VOLTAGE TRANSFORMER	60W	120V / 24V	MLV DIMMING 10%	NEMA3R ENCLOSURE	UL CLASS 2	8.13" x 3.93" x 1.59" [†]
DMLV96124D	MAGNETIC LOW VOLTAGE TRANSFORMER	96W	120V / 24V	MLV DIMMING 10%	NEMA3R ENCLOSURE	UL CLASS 2	8.13" x 3.93" x 1.59" [†]
DMLV192224D	MAGNETIC LOW VOLTAGE TRANSFORMER	192W	120V / 24V	MLV DIMMING 10%	NEMA3R ENCLOSURE	UL CLASS 2	8.00" x 4.15" x 3.41" [†]
DELV40124D	ELECTRONIC LOW VOLTAGE TRANSFORMER	40W	120-277V / 24V	PHASE (120V ONLY) /0-10V DIMMING 10%	IP66 / NEMA4 ENCLOSURE	UL CLASS 2	11" x 4" x 2.21" [†]
DELV60124D	ELECTRONIC LOW VOLTAGE TRANSFORMER	60W	120-277V / 24V	PHASE (120V ONLY) /0-10V DIMMING 10%	IP66 / NEMA4 ENCLOSURE	UL CLASS 2	11" x 4" x 2.21" [†]
DELV96124D	ELECTRONIC LOW VOLTAGE TRANSFORMER	96W	120-277V / 24V	PHASE (120V ONLY) /0-10V DIMMING 10%	IP67 / NEMA4 ENCLOSURE	UL CLASS 2	11" x 4" x 2.21" [†]
DEL60PWM	ELECTRONIC PWM DRIVER STANDALONE, UL LISTED ENCLOSURE PROVIDED BY OTHERS	60W	120-277V / 24V	0-10V/PWM 10%	IP67	UR CLASS 2	5.9" X 2.09" X 1.38"
DEL90PWM	ELECTRONIC PWM DRIVER STANDALONE, UL LISTED ENCLOSURE PROVIDED BY OTHERS	90W	120-277V / 24V	0-10V/PWM 10%	IP67	UR CLASS 2	6.73" X 2.48" X 1.48"
DELX601241CPWM	ELECTRONIC PWM DRIVER	60W	120-277V / 24V	0-10V/PWM 10%	IP67 / NEMA3R ENCLOSURE	UL CLASS 2	10" x 10" x 4" [†]
DELX901241CPWM	ELECTRONIC PWM DRIVER	90W	120-277V / 24V	0-10V/PWM 10%	IP67 / NEMA3R ENCLOSURE	UL CLASS 2	10" x 10" x 4" [†]
DELX1802242CPWM	ELECTRONIC PWM DRIVER	2X90W	120-277V / 24V	0-10V/PWM 10%	IP67 / NEMA3R ENCLOSURE	UL CLASS 2	12" x 12" x 4" [†]
DELX2703243CPWM	ELECTRONIC PWM DRIVER	3X90W	120-277V / 24V	0-10V/PWM 10%	IP67 / NEMA3R ENCLOSURE	UL CLASS 2	12" x 12" x 4" [†]

[†] Dimensions include enclosure with mounting bracket.

* Constant voltage drivers 50/60HZ, voltage regulated with short circuit protection. Operating temperature -40 C- 80° C

* Installation of power supply must be compliant to Class 2 installation standards. Refer to NEC and local building code requirements.

* Consult factory for additional driver options (ie: DMX, DALI, wattage, size, shape, Lutron, ELDO, or others).

TAPE MAXIMUM LENGTH IN FEET PER DRIVER

		Fixture Wattage					
		2.8W	3.0W	3.9W	4.2W	4.4W	8.8W
Driver Wattage	40W	11FT	10FT	8FT	7FT	7FT	3FT
	60W	17FT	16FT	12FT	11FT	10FT	5FT
	96W	27FT	25FT	19FT	17FT	17FT	8FT
	90W	25FT	24FT	18FT	18FT	16FT	8FT
	2X90W	(2) 25FT	(2) 24FT	(2) 18FT	(2) 18FT	(2) 16FT	(2) 8FT
	3X90W	(3) 25FT	(3) 24FT	(3) 18FT	(3) 18FT	(3) 16FT	(3) 8FT
	100W	28FT	26FT	20FT	19FT	18FT	9FT
	2X100	(2) 28FT	(2) 26FT	(2) 20FT	(2) 19FT	(2) 18FT	(2) 9FT

Side-Bend White

