

Seating Specification Guide



Availability

Electronic price list updated with release 188.B (U.S.) and 150.B (Canada), dated August 20, 2018.

Spec News is available on village.steelcase.com. Search Steelcase Marketing Resources (Adstock) and download the current release's Spec News.

Tip: Steelcase Marketing Resources is a new global platform for ordering Steelcase marketing materials that replaces Adstock.

View or download Steelcase Specification Guides at [https://www.steelcase.com/resources/documents?tax-\[doctype\]=spec-guide](https://www.steelcase.com/resources/documents?tax-[doctype]=spec-guide).

Transitional products in this specification guide are **maintained for existing customers only** and are likely to be phased out over time. These products are indicated with a . Products that are scheduled to be culled are indicated with an , followed by the last order entry date.

Surface Materials

The surface materials team has announced the launch of the Finish Library, found at <http://finishlibrary.steelcase.com>.

► For a list of all trademarks, refer to the last page of this specification guide.
© 2018 Steelcase Inc.

This specification guide contains multiple Steelcase and turnstone product lines

which are designed into one specification guide for your convenience. Note that each product may be subject to different pricing terms and conditions.



For Canadian Pricing

Canadian factor can be found at steelcase.com/CADpricing.

Calculate in the following order to avoid rounding errors:

- Multiply the base price and each option by the Canadian factor.
- Round each to the nearest dollar.
- Add base and options for total list price.

Ten Tips: How to Get The Most Out of This Book	2
Steel Seating	
Statement of Line	4
Basics of Ergonomic Seating	16
Basics of Adjustability	20
Additional Resources	25
Work Chairs	27
Collaborative Seating	253
Lounge Seating	315
Multi-Use Chairs	441
Stackable Chairs	493
Surface Materials	503

Wood Seating	
Statement of Line	528
Guidelines for Selecting Appropriate Ergonomic Seating	530
Basics of Adjustability	531
Additional Resources	532
Guest Seating	533
Surface Materials	567

turnstone 1.0	575
Resources	607

Ten Tips: How to Get the Most Out of This Book

Tip 1

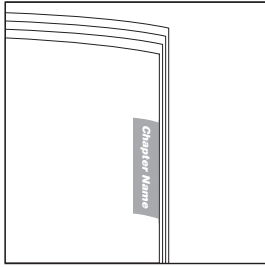

Watch the tabs on the right-hand edges of the pages. They'll always indicate which chapter you are in.

Tip 2

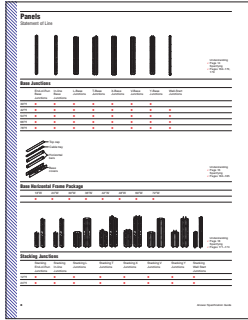

Use the Statement of Line pages for an overview of the available components, their sizes, and page references for additional information. Each *Understanding* chapter includes a statement of line after the table of contents.

Tip 3



Find cross references by looking for page numbers flagged with an arrow.

Tip 4

Study the product detail pages in the *Understanding* section to learn everything an expert knows about specific products. Each product detail page in this section contains the following features, where applicable:

- Product Drawing
- Actual Dimensions
- Product Details
- Connections
- Wiring and Cabling
- Surface Materials
- Application Topics

Product Drawing

shows you what the product looks like and points out important features.

Product Details

gives specific information on the product and how it is used.

Connections

describes how the product is assembled or how it attaches to another product.

Actual Dimensions table lists the dimensions of the product.

Wiring and Cabling details the power and cable-management and cable routing capabilities of the product.

Surface Materials lists what material is used for each part of the product.

Tip 5

Refer to the specifying pages for all the information needed to order a product. Each product specifying page contains a variety of elements to help you complete a specification:

- Product Drawing
- Standard Includes
- Required to Specify
- Options
- Related Products
- Specification Information
 - Dimensions
 - Style Number
 - Price

Standard Includes (under the red or dark grey band) provides a list of what comes standard with the product.

Required to Specify (under the red or dark grey band) itemizes the information that you must provide to order the standard product and the preferred sequence for specification.

Specification Information (under the teal or light grey band) provides product dimensions, style numbers, and prices for the standard product and any surface material choices that are available.

Product Drawing shows you what the product looks like.

Product Drawing shows you what the product looks like.

Standard Includes		Required to Specify	
• Head shell	• Base trim with knockouts (2" W x 2" H) per side	• Panel or cover like number for this product. Refer to page 100.	• See <i>Order Materials</i> , page 72.
• Base trim with knockouts (2" W x 2" H) per side	• The knockouts connecting bars (black paint on)		

Options		Required to Specify	
Surface Materials	• Paint color group 1	• Paint color group 1	Specify panel number
	• Paint color group 2	• Paint color group 2	Specify panel number
	• Paint color group 3	• Paint color group 3	Specify panel number
	• Paint color group 4	• Paint color group 4	Specify panel number
	• Paint color group 5	• Paint color group 5	Specify panel number
	• Paint color group 6	• Paint color group 6	Specify panel number
	• Paint color group 7	• Paint color group 7	Specify panel number
	• Paint color group 8	• Paint color group 8	Specify panel number
	• Paint color group 9	• Paint color group 9	Specify panel number
	• Paint color group 10	• Paint color group 10	Specify panel number
	• Paint color group 11	• Paint color group 11	Specify panel number
	• Paint color group 12	• Paint color group 12	Specify panel number
	• Paint color group 13	• Paint color group 13	Specify panel number
	• Paint color group 14	• Paint color group 14	Specify panel number
	• Paint color group 15	• Paint color group 15	Specify panel number
	• Paint color group 16	• Paint color group 16	Specify panel number
	• Paint color group 17	• Paint color group 17	Specify panel number
	• Paint color group 18	• Paint color group 18	Specify panel number
	• Paint color group 19	• Paint color group 19	Specify panel number
	• Paint color group 20	• Paint color group 20	Specify panel number
	• Paint color group 21	• Paint color group 21	Specify panel number
	• Paint color group 22	• Paint color group 22	Specify panel number
	• Paint color group 23	• Paint color group 23	Specify panel number
	• Paint color group 24	• Paint color group 24	Specify panel number
	• Paint color group 25	• Paint color group 25	Specify panel number
	• Paint color group 26	• Paint color group 26	Specify panel number
	• Paint color group 27	• Paint color group 27	Specify panel number
	• Paint color group 28	• Paint color group 28	Specify panel number
	• Paint color group 29	• Paint color group 29	Specify panel number
	• Paint color group 30	• Paint color group 30	Specify panel number
	• Paint color group 31	• Paint color group 31	Specify panel number
	• Paint color group 32	• Paint color group 32	Specify panel number
	• Paint color group 33	• Paint color group 33	Specify panel number
	• Paint color group 34	• Paint color group 34	Specify panel number
	• Paint color group 35	• Paint color group 35	Specify panel number
	• Paint color group 36	• Paint color group 36	Specify panel number
	• Paint color group 37	• Paint color group 37	Specify panel number
	• Paint color group 38	• Paint color group 38	Specify panel number
	• Paint color group 39	• Paint color group 39	Specify panel number
	• Paint color group 40	• Paint color group 40	Specify panel number
	• Paint color group 41	• Paint color group 41	Specify panel number
	• Paint color group 42	• Paint color group 42	Specify panel number
	• Paint color group 43	• Paint color group 43	Specify panel number
	• Paint color group 44	• Paint color group 44	Specify panel number
	• Paint color group 45	• Paint color group 45	Specify panel number
	• Paint color group 46	• Paint color group 46	Specify panel number
	• Paint color group 47	• Paint color group 47	Specify panel number
	• Paint color group 48	• Paint color group 48	Specify panel number
	• Paint color group 49	• Paint color group 49	Specify panel number
	• Paint color group 50	• Paint color group 50	Specify panel number
	• Paint color group 51	• Paint color group 51	Specify panel number
	• Paint color group 52	• Paint color group 52	Specify panel number
	• Paint color group 53	• Paint color group 53	Specify panel number
	• Paint color group 54	• Paint color group 54	Specify panel number
	• Paint color group 55	• Paint color group 55	Specify panel number
	• Paint color group 56	• Paint color group 56	Specify panel number
	• Paint color group 57	• Paint color group 57	Specify panel number
	• Paint color group 58	• Paint color group 58	Specify panel number
	• Paint color group 59	• Paint color group 59	Specify panel number
	• Paint color group 60	• Paint color group 60	Specify panel number
	• Paint color group 61	• Paint color group 61	Specify panel number
	• Paint color group 62	• Paint color group 62	Specify panel number
	• Paint color group 63	• Paint color group 63	Specify panel number
	• Paint color group 64	• Paint color group 64	Specify panel number
	• Paint color group 65	• Paint color group 65	Specify panel number
	• Paint color group 66	• Paint color group 66	Specify panel number
	• Paint color group 67	• Paint color group 67	Specify panel number
	• Paint color group 68	• Paint color group 68	Specify panel number
	• Paint color group 69	• Paint color group 69	Specify panel number
	• Paint color group 70	• Paint color group 70	Specify panel number
	• Paint color group 71	• Paint color group 71	Specify panel number
	• Paint color group 72	• Paint color group 72	Specify panel number
	• Paint color group 73	• Paint color group 73	Specify panel number
	• Paint color group 74	• Paint color group 74	Specify panel number
	• Paint color group 75	• Paint color group 75	Specify panel number
	• Paint color group 76	• Paint color group 76	Specify panel number
	• Paint color group 77	• Paint color group 77	Specify panel number
	• Paint color group 78	• Paint color group 78	Specify panel number
	• Paint color group 79	• Paint color group 79	Specify panel number
	• Paint color group 80	• Paint color group 80	Specify panel number
	• Paint color group 81	• Paint color group 81	Specify panel number
	• Paint color group 82	• Paint color group 82	Specify panel number
	• Paint color group 83	• Paint color group 83	Specify panel number
	• Paint color group 84	• Paint color group 84	Specify panel number
	• Paint color group 85	• Paint color group 85	Specify panel number
	• Paint color group 86	• Paint color group 86	Specify panel number
	• Paint color group 87	• Paint color group 87	Specify panel number
	• Paint color group 88	• Paint color group 88	Specify panel number
	• Paint color group 89	• Paint color group 89	Specify panel number
	• Paint color group 90	• Paint color group 90	Specify panel number
	• Paint color group 91	• Paint color group 91	Specify panel number
	• Paint color group 92	• Paint color group 92	Specify panel number
	• Paint color group 93	• Paint color group 93	Specify panel number
	• Paint color group 94	• Paint color group 94	Specify panel number
	• Paint color group 95	• Paint color group 95	Specify panel number
	• Paint color group 96	• Paint color group 96	Specify panel number
	• Paint color group 97	• Paint color group 97	Specify panel number
	• Paint color group 98	• Paint color group 98	Specify panel number
	• Paint color group 99	• Paint color group 99	Specify panel number
	• Paint color group 100	• Paint color group 100	Specify panel number

Options (under the black band) lists all the options that apply to the product, their price, and what is required to specify.

Related Products provide specification information for products that are directly related.

Tip 6

Required to Specify

Specify with *Customiz Stain*

Italic typeface on specifying pages usually identifies wording that you should use in your order.

i

Tip 7

To determine how many skins are needed to complete a panel, consult the table at the right.

Tip: Remember to order skins for both sides of the panel buildup.

Watch for tips throughout the text that give you explanations and helpful instructions.

Tip 8

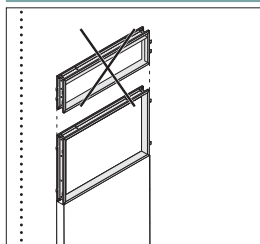

Learn what you cannot do by looking for drawings crossed out with an "X."

Tip 9

Use the surface materials listings in the Surface Materials section of this book to find surface material color numbers.

Tip 10

Style Number	Page
TS7042BL	131
TS7042S	130
TS7048BL	131
TS7048S	130
TS7060BL	131
TS7060S	130
TS7072BL	131

Refer to the style number index when you know a style number and you need to find the page that has more details about the product.

Statement of Line

Work Chairs

Gesture 442 Series

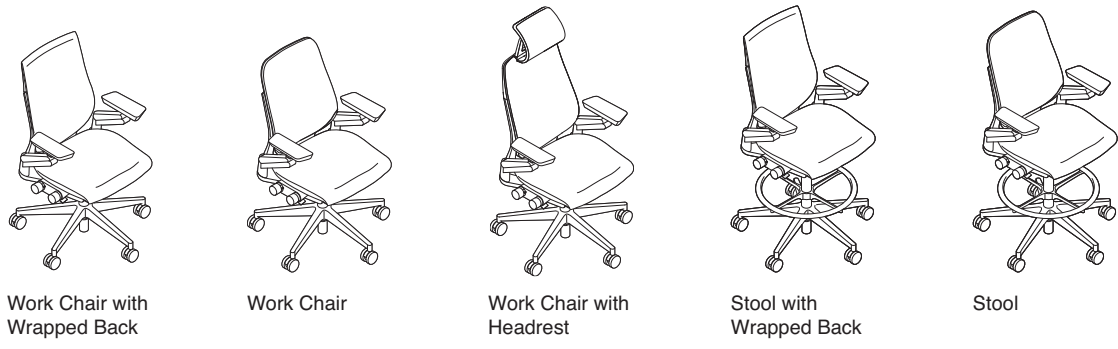

Understanding
▶ Page 30
Specifying
▶ Page 40

Leap 462 Series

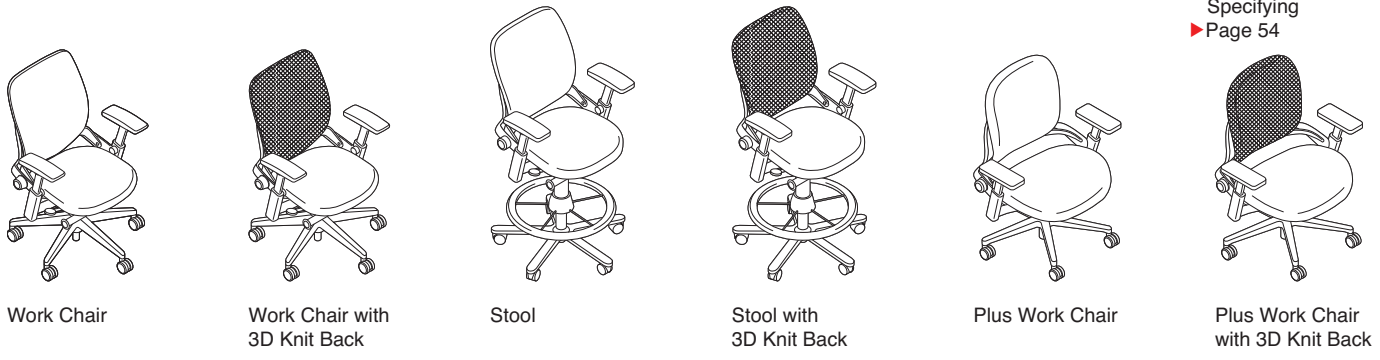

Understanding
▶ Page 48
Specifying
▶ Page 54

Think 465 Series

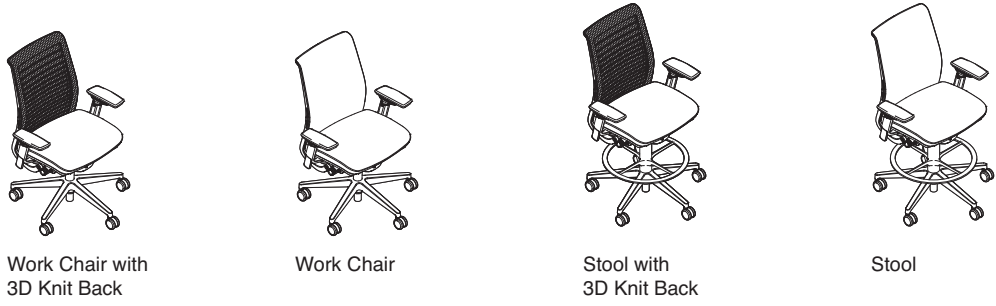

Understanding
▶ Page 78
Specifying
▶ Page 84

Steelcase Series 1

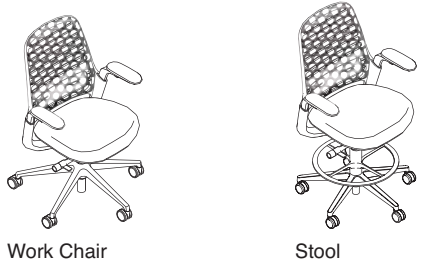

Understanding
▶ Page 94
Specifying
▶ Page 100

Work Chairs, continued

Amia 482 Series



Work Chair



Work Chair with
3D Knit Back



Stool



Stool with
3D Knit Back

- Understanding
- ▶ Page 104
- Specifying
- ▶ Page 110

Reply 466 Series



Work Chair
with mesh back



Work Chair

- Understanding
- ▶ Page 134
- Specifying
- ▶ Page 140

Jersey Series



Work Chair

- Understanding
- ▶ Page 174
- Specifying
- ▶ Page 180

Leap 464 Series WorkLounge



Ribbon Back Frame
WorkLounge

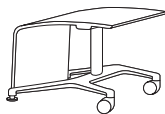

Ottoman

- Understanding
- ▶ Page 190
- Specifying
- ▶ Page 194

Work Chairs, continued

Siento

Understanding
▶ Page 198
Specifying
▶ Page 200

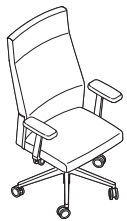

High-Back
Desk Chair with
Fixed T-Arms

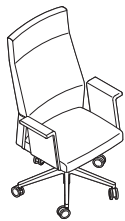

High-Back
Desk Chair with
Enclosed Arms



High-Back
Desk Chair with
Adjustable T-Arms



Mid-Back
Desk Chair with
Fixed T-Arms

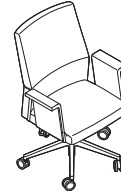

Mid-Back
Desk Chair with
Enclosed Arms



Mid-Back
Desk Chair with
Adjustable T-Arms

Criterion 453 Series

Understanding
▶ Page 206
Specifying
▶ Page 212



High-Back
Work Chair



Mid-Back
Work Chair



High-Back
Stool

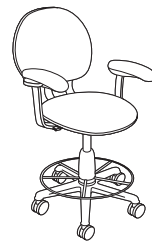

Mid-Back
Stool



Plus High-Back
Work Chair

Cachet 487 Series

Understanding
▶ Page 224
Specifying
▶ Page 228



Swivel-Base
Work Chair



Swivel-Base
Stool

Protégé 433 Series

Understanding
▶ Page 240
Specifying
▶ Page 244



Work Chair
with arms



Work Chair
without arms

Collaborative Seating

SILQ 418 Series

Understanding
▶ Page 256
Specifying
▶ Page 264



SILQ Collaborative Chair with Arms



SILQ Collaborative Chair Armless



SILQ Collaborative Stool with Arms

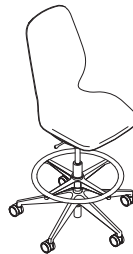

SILQ Collaborative Stool Armless

QiVi 428 Series

Understanding
▶ Page 270
Specifying
▶ Page 276



Collaborative Chair with Arms

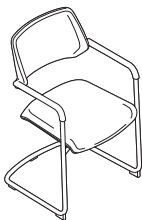

Sled-Base Chair



Collaborative Stool

cobi 434 Series

Understanding
▶ Page 282
Specifying
▶ Page 286



Collaborative Chair with Arms



Collaborative Chair without Arms

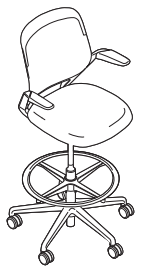

Collaborative Stool with Arms

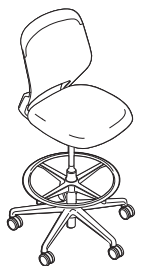

Collaborative Stool without Arms

Collaborative Seating, continued

i2i 416 Series

Understanding
▶ Page 292
Specifying
▶ Page 296



Collaborative Chair



Collaborative Chair with Tablet Arm

Node 480 Series

Understanding
▶ Page 300
Specifying
▶ Page 308



Collaborative Mid-Back Chair

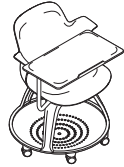

Collaborative Mid-Back Chair with Personal Workspace

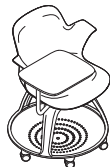

Collaborative Mid-Back Chair with ShareSurface



Collaborative Mid-Back Chair with Swivel-Base



Collaborative Mid-Back Chair with Swivel-Base and Personal Workspace



Collaborative Mid-Back Chair with Swivel-Base and ShareSurface

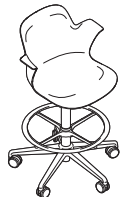

Collaborative Mid-Back Stool with Swivel-Base



Collaborative Chair

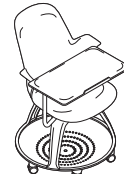

Collaborative Chair with Personal Workspace



Collaborative Chair with ShareSurface



Collaborative Chair with Swivel-Base



Collaborative Chair with Swivel-Base and Personal Workspace



Collaborative Chair with Swivel-Base and ShareSurface



Collaborative Stool with Swivel-Base

Lounge Seating

Brody 488 Series

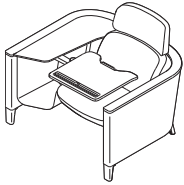
**Brody WorkLounge**

Understanding
 ▶ Page 318
 Specifying
 ▶ Page 334

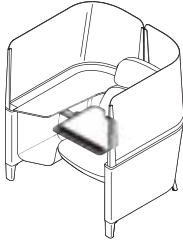
**Brody Privacy Lounge**

Understanding
 ▶ Page 318
 Specifying
 ▶ Page 336

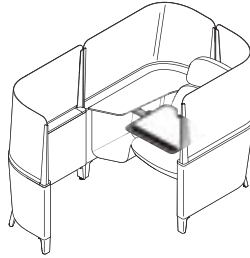
**Brody Privacy Lounge with Extension**

Understanding
 ▶ Page 318
 Specifying
 ▶ Page 338

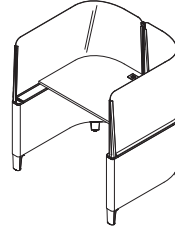
**Brody Privacy Desk**

Understanding
 ▶ Page 328
 Specifying
 ▶ Page 340

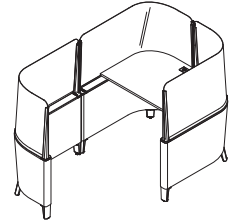
**Brody Privacy Desk with Extension**

Understanding
 ▶ Page 328
 Specifying
 ▶ Page 342

media:scape Lounge

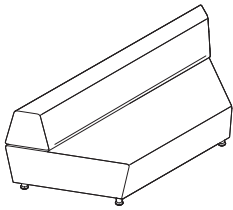
**Straight Lounge**

Understanding
 ▶ Page 346
 Specifying
 ▶ Page 354

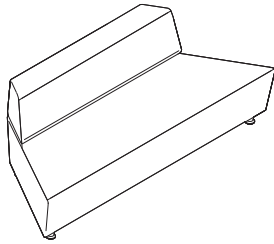
**Straight Inverted Lounge**

Understanding
 ▶ Page 346
 Specifying
 ▶ Page 358

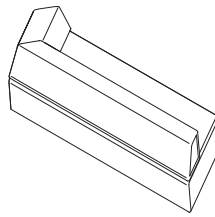
**Corner Lounge, Left Corner**

Understanding
 ▶ Page 346
 Specifying
 ▶ Page 360

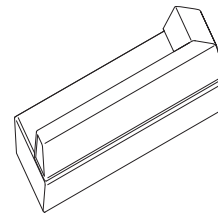
**Corner Lounge, Right Corner**

Understanding
 ▶ Page 346
 Specifying
 ▶ Page 360

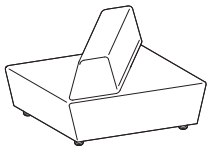
**Reverse Lounge, Reverse Left**

Understanding
 ▶ Page 346
 Specifying
 ▶ Page 364

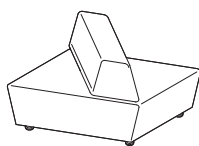
**Reverse Lounge, Reverse Right**

Understanding
 ▶ Page 346
 Specifying
 ▶ Page 364

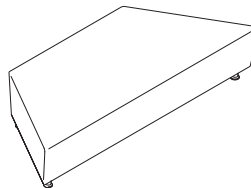
**Backless Lounge**

Understanding
 ▶ Page 346
 Specifying
 ▶ Page 368

Lounge Seating, continued

Umami

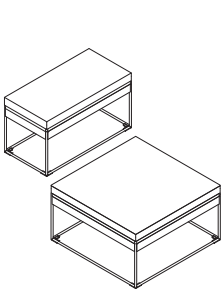

Single Platform
Understanding
▶ Page 372
Specifying
▶ Page 388

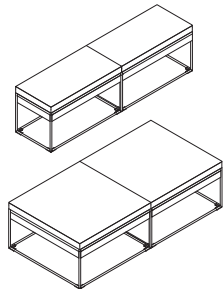

Double Platform
Understanding
▶ Page 372
Specifying
▶ Page 392

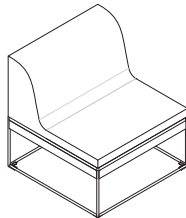

Single, Straight Lounge
Understanding
▶ Page 372
Specifying
▶ Page 396

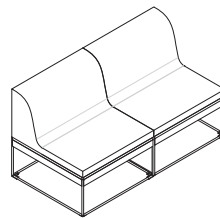

Double, Straight Lounge
Understanding
▶ Page 372
Specifying
▶ Page 398

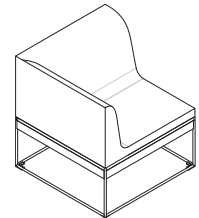

One Arm, Single Lounge
Understanding
▶ Page 372
Specifying
▶ Page 400

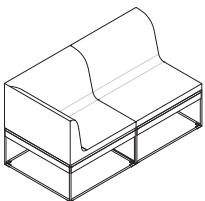

One Arm, Double Lounge
Understanding
▶ Page 372
Specifying
▶ Page 402

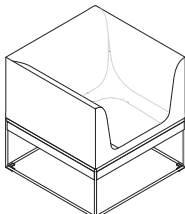

Two Arm, Single Lounge
Understanding
▶ Page 372
Specifying
▶ Page 404

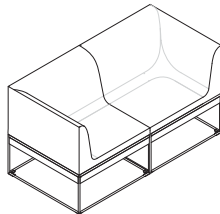

Two Arm, Double Lounge
Understanding
▶ Page 372
Specifying
▶ Page 406

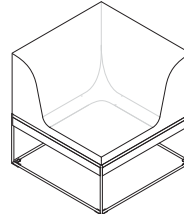

Corner, Single Lounge
Understanding
▶ Page 372
Specifying
▶ Page 408

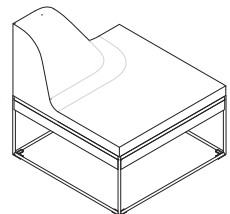

End Cap
Understanding
▶ Page 372
Specifying
▶ Page 410



Standard Screen
Understanding
▶ Page 380
Specifying
▶ Page 412

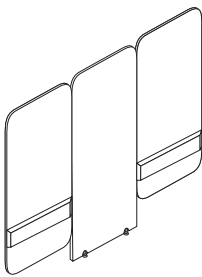

Standard Spanner Screen
Understanding
▶ Page 380
Specifying
▶ Page 418

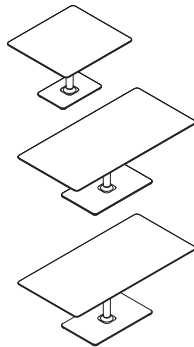

Lagunitas Work Tables
Specifying
▶ Page 424

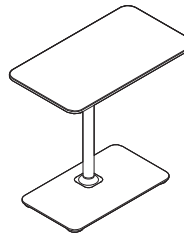

Lagunitas Personal Tables
Specifying
▶ Page 426

Lounge Seating, continued

B-Free

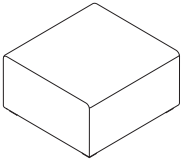

Large Cube
Understanding
▶ Page 428
Specifying
▶ Page 434

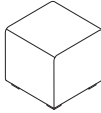

Small Cube
Understanding
▶ Page 428
Specifying
▶ Page 435

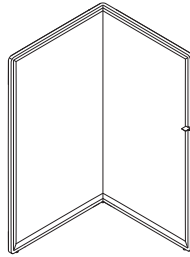

Screens
Understanding
▶ Page 428
Specifying
▶ Page 437

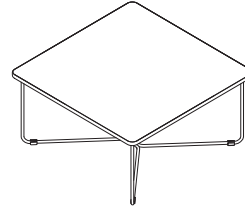

Occasional Tables
Understanding
▶ Page 428
Specifying
▶ Page 439

Statement of Line, continued

Multi-Use Chairs

Reply Series

Understanding
 ▶ Page 134
 Specifying
 ▶ Page 140

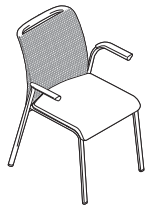

Leg-Base Multi-Use Chair with Mesh Back with Arms

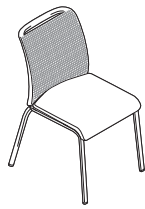

Leg-Base Multi-Use Chair with Mesh Back without Arms

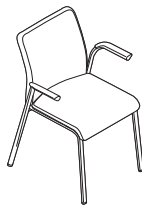

Leg-Base Multi-Use Chair with Standard Upholstery with Arms



Leg-Base Multi-Use Chair with Standard Upholstery without Arms



Sled-Base Multi-Use Chair with Mesh Back with Arms

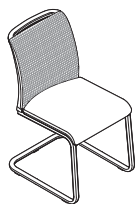

Sled-Base Multi-Use Chair with Mesh Back without Arms



Sled-Base Multi-Use Chair with Standard Upholstery with Arms

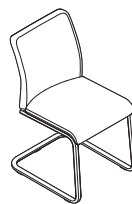

Sled-Base Multi-Use Chair with Standard Upholstery without Arms

*Chairs are available with casters.

Kart Nesting Chairs

Understanding
 ▶ Page 156
 Specifying
 ▶ Page 160



with Arms



Armless

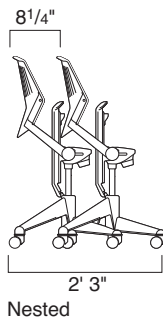

Kart Stools with Casters

Understanding
 ▶ Page 156
 Specifying
 ▶ Page 162



with Arms



Armless

Kart Café Leg-Base Stool

Understanding
 ▶ Page 156
 Specifying
 ▶ Page 164



Multi-Use Chairs, continued

Kart Leg-Base Stacking Chairs



Understanding
 ▶ Page 156
 Specifying
 ▶ Page 166

Kart Jury Base Chairs

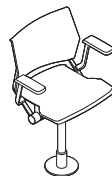

with Arms

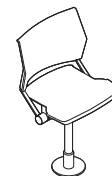

Armless

Understanding
 ▶ Page 156
 Specifying
 ▶ Page 170

Jersey Series

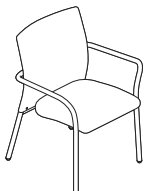

Multi-Use Chair with Arms



Multi-Use Chair without Arms

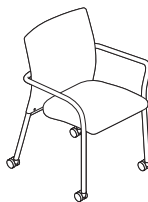

Multi-Use Chair with Arms and with Casters

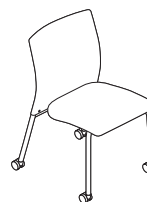

Multi-Use Chair without Arms and with Casters

Understanding
 ▶ Page 174
 Specifying
 ▶ Page 180

Cachet 487 Series

Understanding
 ▶ Page 224
 Specifying
 ▶ Page 228



Leg-Base Multi-Use Chair without Arms



Leg-Base Multi-Use Chair with Flip-Up Arms

Protégé 433 Series

Understanding
 ▶ Pages 240
 Specifying
 ▶ Page 244



Multi-Use Chair with arms



Multi-Use Chair without arms



Sled-Base Multi-Use Chair

Player 475 Series

Understanding
 ▶ Page 444
 Specifying
 ▶ Page 448



Leg-Base* Multi-Use Chair without Arms



Leg-Base* Multi-Use Chair with Arms



Sled-Base Multi-Use Chair without Arms



Sled-Base Multi-Use Chair with Arms



Stool with Arms



Stool without Arms

*Player leg-base chair models also stack.

Multi-Use Chairs, continued

Move 490 Series

Understanding
▶ Page 460
Specifying
▶ Page 464



Multi-Use Chair
without Arms



Multi-Use Chair
without Arms
with Casters



Multi-Use Chair
with Arms



Multi-Use Chair
with Arms and
Casters

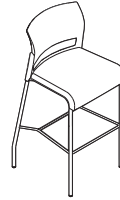

Stool
without Arms



Stool
without Arms
with Casters

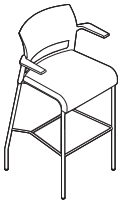

Stool with Arms



Stool with Arms
with Casters

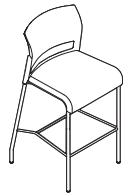

Perching Stool
without Arms

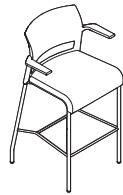

Perching Stool
with Arms

Snodgrass 474 Series

Understanding
▶ Page 480
Specifying
▶ Page 484

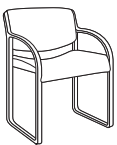

Multi-Use Chair
with Open Back
with Arms



Multi-Use Chair
with Open Back
Armless

Collaborative Seating

Nooi by Wiesner Hager

Understanding
▶ Page 486
Specifying
▶ Page 488



Frame Linking Chair,
Armless



Frame Linking
Chair with Arms



Sled-Base
Chair, Armless



Cafeteria
Chair, Armless



Cafeteria
Chair with Arms



Stools, Armless

Stackable Chairs

Max-Stacker III 477 Series

Understanding
▶ Page 496
Specifying
▶ Page 500



Stackable Chair

Basics of Ergonomic Seating

A well-designed, ergonomically advanced chair that allows a full range of healthy postures throughout the day and can contribute to worker wellness and productivity.

Neck is straight or slightly forward.

Shoulders are relaxed so arms hang naturally.

Back has full contact with the backrest (sit all the way back in your chair).

Elbows and forearms can rest comfortably on the arms of your chair, or on worksurfaces.

Lower back fits into curved lumbar support.

Tension is adjusted so backrest reclines easily, yet provides smooth, even support, and encourages postural change.

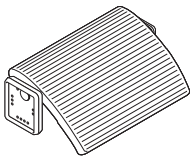

If worksurfaces and keyboard support are not height-adjustable, raise your chair's seat height to achieve the appropriate relationship to your tasks. If this leaves your feet dangling above the floor, use a footrest.

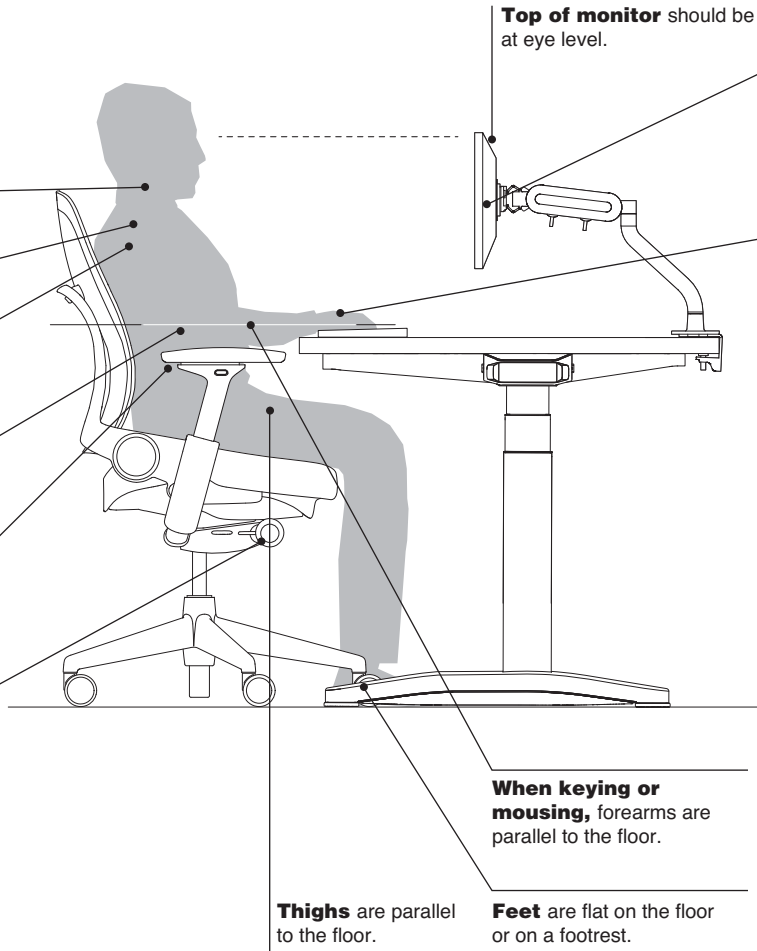

Top of monitor should be at eye level.

Screen is 20 to 30 inches from the eyes. Screen is at eye level slightly lower and directly in front of worker so head is not turned.

Wrists should be straight when keying or mousing, not bent up or down.

ANSI/BIFMA is the American National Standards Institute/Business and Institutional Furniture Manufacturer's Association. All Steelcase furniture meets or exceeds ANSI/BIFMA standards for structural quality. Gesture, Leap, Think, Amia, and Series 1 work chairs, as well as Gesture stool, are all tested and warranted for users up to 400 pounds. All other Steelcase brand work chairs are tested and warranted for users 300 pounds and under. Collaborative chairs tested and warranted for users 300 pounds and under are: QiVi, cobii, i2i, and Node. Move is tested and warranted for users 400 pounds and under. Other multi-use chairs are tested and warranted for users 300 pounds and under: Max Stacker III, Player (armless only), and Jersey. All Steelcase Seating products also follow the ergonomic guidelines established in BIFMA G1-2013.

When keying or mousing, forearms are parallel to the floor.

Thighs are parallel to the floor.

Feet are flat on the floor or on a footrest.

⚠ CAUTION

Regularly inspect for damaged or broken parts and loose fasteners (screws, etc.). If any of these conditions exist, remove from service immediately. Repairs are to be made using only factory authorized parts and methods. Hard wheel casters must be used on carpeted surfaces only. Use on hard surfaces, including floor mats, will affect chair stability. For information on furniture which requires service, call Steelcase toll free at 1.888.783.3522. Failure to follow these instructions could result in property damage or personal injury.

Basic of Ergonomic Seating, continued

BIFMA G1-2013 Ergonomic Guidelines

	BIFMA G1-2013 Requirement	Steelcase Gesture	Steelcase Leap	Steelcase Leap Plus	Steelcase Think	Steelcase Amia
Seat Height	14 ⁸ / ₁₀ "–20 ² / ₁₀ "	14 ¹ / ₂ "–18 ¹ / ₄ " (opt)	14 ¹ / ₂ "–17 ¹ / ₂ " *	15 ¹ / ₂ "–19 ¹ / ₂ "	16 ¹ / ₂ "–21 ¹ / ₂ "	16"–21"
		16"–21"	15 ¹ / ₂ "–20 ¹ / ₂ "		15"–19" (opt)	15"–19" (opt)
		17"–22 ¹ / ₂ " (opt)	17"–24" (opt)		18"–25" (opt)	17"–24" (opt)
					14 ¹ / ₂ "–17 ¹ / ₂ " *	14 ¹ / ₂ "–17 ¹ / ₂ " *
Fixed Seat Depth	16 ³ / ₁₀ " maximum	N.A.	N.A.	N.A.	N.A.	N.A.
Adjustable Seat Depth (if available)	Range must include 16 ³ / ₁₀ "	15 ³ / ₄ "–18 ¹ / ₂ "	15 ³ / ₄ "–18 ³ / ₄ "	16 ³ / ₄ "–18 ³ / ₄ "	15 ¹ / ₂ "–18"	15 ¹ / ₂ "–18 ¹ / ₂ "
Seat Width	19 ² / ₁₀ " minimum if larger than 19 ² / ₁₀ ", the percentile of users supported should be stated	20" 90th percentile female	19 ¹ / ₄ " 90th percentile female	22 ³ / ₄ " 99th percentile female	20 ¹ / ₄ " 90th percentile female	19 ³ / ₈ " 90th percentile female
Seat Pan Angle	0° to 4° Must include some part of the range if adjustable	1° Passive	–1° to 3° Passive	0 to 4°	2° to 6° Passive	–3° to 3° Passive
Angle Between Seat Back and Seat Pan	Fixed: >90° Adjustable: range minimum of 15° within 90° and 120°	98° to 125°	96° to 120°	97° to 114°	98° to 116°	100° to 120°
Lumbar Support	5 ⁹ / ₁₀ " to 9 ⁸ / ₁₀ " Within this range	5 ¹ / ₄ "–9 ¹ / ₄ "	5 ¹ / ₄ "–10 ¹ / ₄ "	6 ¹ / ₂ "–11 ¹ / ₂ "	6"–10 ¹ / ₄ "	6 ¹ / ₄ "–10"
			Adjustable	Adjustable	Adjustable	Adjustable
			Adjustable lumbar and lower back firmness control	Adjustable lumbar and lower back firmness control		
Backrest Width	14 ² / ₁₀ " Minimum at lumbar	16 ¹ / ₄ "	18"	20"	18"	18 ⁷ / ₈ "
Back Height From Seat (mid back and high back)	13 ⁹ / ₁₀ " minimum	24 ¹ / ₁₆ "	25"	24 ¹ / ₂ "	22 ³ / ₄ "	25"
Distance Between Arm Rests	Fixed: 19 ⁴ / ₁₀ " minimum	10 ¹ / ₄ "–22 ¹ / ₂ "	12 ³ / ₄ "–20"	17 ¹ / ₂ "–24 ³ / ₄ "	16 ¹ / ₂ "–21 ¹ / ₄ "	15"–19 ¹ / ₂ "
	Adjustable: include 19 ⁴ / ₁₀ "		Adjustable		Adjustable	Adjustable
Arm Height	7 ⁷ / ₁₀ "–11 ⁴ / ₁₀ "	7 ¹ / ₄ "–11 ¹ / ₂ "	7"–11"	7 ¹ / ₄ "–11 ¹ / ₄ "	7"–11"	7"–11"
			Adjustable		Adjustable	Adjustable
Weight Limit	300 pounds	400 pounds	400 pounds	500 pounds	400 pounds	400 pounds

* Specials

Steelcase Series 1	Steelcase Reply	Steelcase Criterion	Steelcase Jersey	Steelcase Siento	turnstone Crew
16½"-21½"	16"-21"	16"-21"	16"-20½"	16"-21"	16"-21"
14½"-17½"		14½"-17½" *	14½"-17½" *	Fixed: 18" (opt)	
17½"-24½" (opt)				14½"-17½" *	
N.A.	16¾"	16¼"	17"	17½"	18"
15½"-17¾"	Mesh: 16½"-18" Upholstered: 15½"-17"	15¼"-18¼"	16¾"-20"	N.A.	16⅞"-18⅞"
19½" 90th percentile female	18½"	19½" 90th percentile female	20" 90th percentile female	21" 90th percentile female	19½" 90th percentile female
0° to 2° Passive 100° to 124°	2° to 13°	-3° to 8° Adjustable	2° Adjustable	-2° to 0° Passive	3°
	Mesh: 97° to 115° Upholstered: 97° to 113°	97° to 113°	95° to 105°	100° to 114°	96° to 110°
6½"-8¾"	Mesh: 6"-10"	8"-10"	N.A.	9⅛"	2¼"
Adjustable	Adjustable	Adjustable		Fixed	Adjustable
17¼"	17½"	18"	20"	20¾"	19"
21½"	Mesh: 22⅝" Upholstered: 23¼"-25¾"	19½"-21½" (mid back) 22"-24" (high back)	18"	31½" (high back with headrest) 30" (high back) 24" (mid back)	21¼"-23½"
16"-20"	Fixed: 18½"	Fixed: 20"	Fixed: 9"	Fixed: 20½"	12¼"-19½"
Adjustable	Adjustable: 15¾"-19"	Adjustable: 10¾"-18¼" (H,W,P) 12"-20" (W + H)	Adjustable: 13½"-18½"	Adjustable: 12⅜"-19" *	Adjustable
6½"-11½"	7 ¼" - 11"	7"-11"	7"-11"	Fixed: 8"	7"-11"
Adjustable	Adjustable	Adjustable	Adjustable	Adjustable: 6⅔"-9⅑" *	Adjustable
300 pounds	300 pounds	300 pounds	300 pounds	300 pounds	300 pounds

Basics of Adjustability

Steelcase chairs offer varying levels of adjustability to meet the needs of many types of users. Adjustable chairs may offer one or more of these features:

Mechanisms



Natural-glide feature causes the seat to slide forward as the user reclines, keeping the user within his or her vision and reach zone (462, 464).



Advanced swivel-tilt feature incorporates a no front-rise design that allows the seat to remain level even when the user leans back (453, 433).



Synchro-tilt feature means the chair back and seat are synchronized to move in a 2:1 ratio. When the user leans back, the seat rises only half as much, allowing the user's feet to remain flat on the floor (499, 466, 482, Jersey).



Advanced synchro-tilt allows the chair back and seat to move in a 2.8:1 ratio. As the user leans back the seat rises slightly to keep the user's feet on the floor (442).



Weight-activated feature allows for an amount of recline resistance that is directly proportional to the user's weight. The natural-glide feature keeps the user within vision and reach zone (434, 465).



Balanced Action Rocker (BAR) mechanism allows users to recline as the seat flexes. BAR relies on physics to let any user, regardless of posture, height, or weight, find the most comfortable position (487).



Dual-swivel feature allows the back and seat to swivel independently as well as together (416).



360°-swivel feature allows micromovement to stay engaged at fixed height (428, 480).

Seat Adjustments



Pneumatic height adjustment allows the user to remain seated while adjusting the seat height by way of a control button or lever (all work chairs).



Passive seat edge angle allows front edge of seat to drop down while seat angle remains unchanged (442, 462, 499, 465, 482).



Seat angle adjustment allows the user to change the angle of the seat to a forward position (453, Jersey).



Seat depth adjustment allows the user to slide the seat forward or back (442, 462, 453, 465, 466, 482, Jersey).



Gliding seat automatically glides forward and back adjusting to the natural movement of the user's body (428).

Back Adjustments



Lumbar height affords additional lower back support. Grasp lumbar handles and slide up or down to adjust (442, 462, 453, 465, 466, 482).



Lower back firmness changes the amount of firmness user feels in lower back (462, 464).



Upper back tension feature provides an increasing amount of force that increases as the user reclines (462, 464).



Back tension adjustment allows the user to control the amount of resistance felt when leaning back in the chair (all chairs except 487).



Pivoting back automatically follows the natural motion of the user's back as they recline (428).



Your Preference back control includes four settings—weight-activated, boosted, mid-stop, and upright—that allow for personal preference and work styles (465).



Headrest adjustment allows the user to support head and neck in upright or reclined posture (442, 462, 464, 465, 499).



Back height adjustment allows the user to raise or lower the chair back (453, 466).



Variable back stop allows the user to lock the back upright or to preset the range of recline (442, 462, 453, 464).



Core equalizer connects the back and seat to the advanced synchro-tilt and allows appropriate amount of lumbar support in any angle of recline (442).



Upright back lock allows the user to lock the backrest in a full upright position or release it for full recline (433, 466, 482, 499, Jersey, Kart).



Multi-position back lock allows users to recline the back to the desired angle and lock it in place (466).

Arm Adjustments



Arm height adjustment allows the user to move the arms up or down independently (442, 462, 453, 465, 466, 482, 499, Jersey).



Arm width adjustment allows the user to move the arms in or out independently (442, 462, 453, 465, 466, 482, 499, Jersey).



Arm pivot adjustments allows the user to position arm rests as appropriate for the task being performed (442, 462, 453, 465, 466, 482, 499, Jersey).



Arm depth adjustment allows users to get closer to their work by chair arms moving out of the way (442, 462, 465, 466, 482, 499).

Other Features



Foot ring height can be adjusted up or down for user comfort. Cannot be done from seated position (434, 442, 462, 453, 465, 482, 487, Kart).

Basics of Adjustability, continued

Work Chair Adjustability Features						
	Gesture 442 Series ▶ Page 29	Leap 462 Series ▶ Page 47	Leap Plus 462 Series ▶ Page 47	Leap 464 Series WorkLounge ▶ Page 189	Siento 499 Series ▶ Page 197	Criterion 453 Series ▶ Page 205
Mechanisms						
Natural glide		•	•	•		
Weight-activated						
Advanced swivel-tilt						•
Synchro-tilt					•	
Advanced Synchro-tilt	•					
Seat Adjustments						
Pneumatic height	•	•	•	•	•	•
Passive seat edge angle	•	•	•	•	•	
Seat angle						•
Seat depth	•	•	•			•
Back Adjustments						
Lumbar height	•	•	•			•
Lower back firmness		•	•	•		•
Upper back tension		•	•	•		
Back tension	•				•	•
Variable back stop	•	•	•	•		•
Upright back lock	•	•	•	•		
Multi-position back lock						
Core equalizer	•					
Back height						•
Arm Adjustments						
Arm height	•	•	•			•
Arm width	•	•	•			•
Arm pivot	•	•	•			•
Arm depth	•	•	•			
Other Features						
Foot ring height (stool)	•	•				•
Headrest	•	•		•	•*	

*See product understanding pages for additional details.

Work Chair Adjustability Features						
	Think 465 Series ▶ Page 78	Steelcase Series 1 ▶ Page 93	Amia 482 Series ▶ Page 103	Reply 466 Series ▶ Page 133	Jersey Series ▶ Page 173	Criterion Plus 453 Series ▶ Page 205
Mechanisms						
Natural glide						
Weight-activated	●					
Advanced swivel-tilt		●				●
Synchro-tilt			●	●	●	
Advanced Synchro-tilt						
Seat Adjustments						
Pneumatic height	●	●	●	●	●	●
Passive seat edge angle	●		●			
Seat angle		●		●		●
Seat depth		●	●	●	●	●*
Back Adjustments						
Lumbar height	●	●	●	●*		●
Lower back firmness						
Upper back tension						
Back tension	●		●	●	●	●
Variable back stop						
Upright back lock	●		●	●	●	●
Multi-position back lock				●		
Core equalizer						
Back height	●			●*		●
Arm Adjustments						
Arm height	●	●	●	●	●	●
Arm width	●	●	●	●	●	●
Arm pivot		●	●	●	●	
Arm depth		●	●	●		
Other Features						
Foot ring height (stool)		●	●			
Headrest		●**				

*See product understanding pages for additional details.

**Ordered separately as an accessory

Basics of Adjustability, continued

Collaborative/Multi-Use Adjustability Features						
	Cachet 487 Series ▶ Page 223	Protégé 433 Series ▶ Page 239	Qivi 428 Series ▶ Page 269	cobi 434 Series ▶ Page 281	i2i 416 Series ▶ Page 291	Node 480 Series ▶ Page 299
Mechanisms						
Advanced swivel-tilt		•				
Balanced Action Rocker (BAR)	•					
Weight-activated				•		
Dual-swivel					•	
360°-swivel			•			•
Seat Adjustments						
Pneumatic height		•	•	•	•	
Gliding seat			•			
Back Adjustments						
Back tension		•				
Upright back lock		•				
Self adjusting	•		•	•	•	
Pivoting back			•			

Additional Resources

Steelcase seating is supported with an array of informational materials, tools, and software to help you plan efficiently.

Product brochures and planning tools can be ordered through your Steelcase area office by calling 1.800.784.0358 or through the Marketing Resources website at village.steelcase.com.

Printed Materials

Surface Materials Reference Manual

This publication provides:

- An explanation of the surface materials and their categories
- "Available on" matrices
- Vertical surface fabric and seating upholstery selection listing
- Technical data for surface materials
- Surface material care and cleaning instructions

Planning Tools

Quick Ship Guide

This handbook describes all Steelcase, turnstone, and Coalesse products that are available for Rapid2 (ships in 2 days), Rapid5 (ships in 5-7 days), or Coalesse Rapid10 (ships in 10 days).

Computer Tools

Digital Publications

You can access these digital publications at www.steelcase.com or village.steelcase.com.

Electronic Catalog

Accurate sales quotations and purchase orders for Steelcase products are created with specification software that uses Steelcase Electronic Catalog data. Use the data to specify and price style numbers and options for every Steelcase product. The data is updated bimonthly by Steelcase and provided to software programs including: the Hedberg Business System, SmartTools – Steelcase's design and specification software (for more information on SmartTools, please email SmartTools@steelcase.com), the ProjectMatrix Project-Symbols libraries, as well as 20-20 CAP Studio.

Furniture Symbol Graphic Data

Steelcase creates 2D and 3D furniture symbols (with attributes) for planning and initially specifying Steelcase products. This data is incorporated into several add-on software packages that work in either a Microstation or an AutoCAD drafting environment.

More Information

For more information about these and other software tools to help you plan effective work environments, email fsl@steelcase.com.

Seating Product Training

Basic training for Steelcase seating products is available through the Steelcase University website at village.steelcase.com.

Support

Steelcase Capabilities

Steelcase products are distributed, installed, and serviced through a network of more than 600 dealers worldwide. Steelcase is also represented with offices and corporate showrooms in 26 U.S. cities, 4 Canadian cities, and in France, Germany, Great Britain, and Japan. Every Steelcase product meets our exceptionally high standards of quality and durability and comes with the Steelcase assurance of excellence in service.

For assistance, please call your local dealer, the Steelcase Solutions Resource Team, or the Steelcase Solutions Fulfillment Team at 1.888.STEELCASE (1.888.783.3522) or send an email to lineone@steelcase.com.

Call the Steelcase Solutions Resource Team prior to placing an order, when working on a bid, or when you need information about product applications and specifications.

Call the Steelcase Solutions Fulfillment Team if you have submitted an order to Steelcase and you need to speak to your Solutions Fulfillment Team Representative about the order. Also call if you have any post-shipment quality concerns or service parts questions.

For warranty information, please go to <http://www.steelcase.com/warranty/>.

Outside the U.S.A., Canada, Mexico, Puerto Rico, and the U.S. Virgin Islands, call 1.616.247.2500.

For information about Steelcase, the name of your nearest Steelcase dealer, or for product literature, call 1.800.333.9939 or visit our website: www.steelcase.com.

Environmental

Environmental Information

Product Environmental Profiles (PEP) provide key environmental attributes such as certifications, recycled content, recyclability, and potential LEED contributions. To learn more about sustainability at Steelcase, visit www.steelcase.com/sustainability.

Work Chairs

Gesture 442 Series	29
Leap 462 Series	47
Think 465 Series	77
Steelcase Series 1	93
Amia 482 Series	103
Reply 466 Series	133
Jersey Series	173
Leap 464 Series WorkLounge	189
Siento 499 Series	197
Criterion 453 Series	205
Cachet 487 Series	223
Protégé 433 Series	239

Understanding and Specifying Gesture 442 Series Work Chairs

Work Chairs

Highly adjustable task seating offers maximum personalization for fit and comfort for a range of duration and use. By making a series of simple adjustments, you can customize the chair to your body, preferences, and tasks. These chairs provide continuous, stable, comfort, and can be quickly adjusted to support you in upright, and reclining work postures.

- Gesture 442 Series
- Leap 462 Series
- Think 465 Series
- Amia 482 Series
- Reply 466 Series
- Jersey Series
- Leap 464 Series WorkLounge
- Criterion 453 Series

Adjustability Features

- ▶ See page 22 for a comparison to other chairs. **Gesture 442 Series**

Mechanisms

Advanced Synchro-tilt ●

Seat Adjustments

Pneumatic height ●

Passive seat edge angle ●

Seat angle ●

Seat depth ●

Back Adjustments

Back tension ●

Core equalizer ●

Lumbar height ●

Variable back stop ●

Arm Adjustments

Arm height ●

Arm width ●

Arm pivot ●

Arm depth ●

Other Features

Foot ring height (stool) ●

Headrest ●

Product Details

Gesture 442 Series	30
Gesture Upholstery	34
Dimensions	36

Specifying

Gesture 442 Series Value Package Work Chairs	38
Gesture 442 Series Work Chairs	40
Gesture 442 Series Work Chair with Headrest	42
Gesture 442 Series Stools	44

Gesture 442 Series

Gesture is a new sitting experience that is designed for the interface between user and technology, inspired by the movement of the human body, and created for the way we work today.

Back frame, back shell, seat perimeter, arms, and base are standard in black/black or dark/dark color schemes. Polished aluminum base, dark/light, or light/light color schemes are available as options.

Core equalizer provides just the right amount of lumbar support in any angle of recline.

Casters have hard, dual wheels that roll smoothly on carpets. They are 2½" for increased mobility. Soft, dark grey treaded, dual-wheel roll-control casters are available for use on hard floors or mats. Glides are also available as an option.

Tip: Do not roll the chair across asphalt during installation as this may damage the casters.

Variable back stop with four positions is standard.

Back tension requires only 3½ complete turns and accommodates a broader range of users by allowing user to change the rate of increase in force as the chair reclines.

Pneumatic adjustment mechanism is standard. It adjusts with a 5" range. A 3¾" low-range pneumatic seat-height adjustment and a 5½" high-range pneumatic seat-height adjustment are available as options on chairs. Stools have an 8" range.

Seat depth adjusts 2¾" to accommodate various leg lengths.

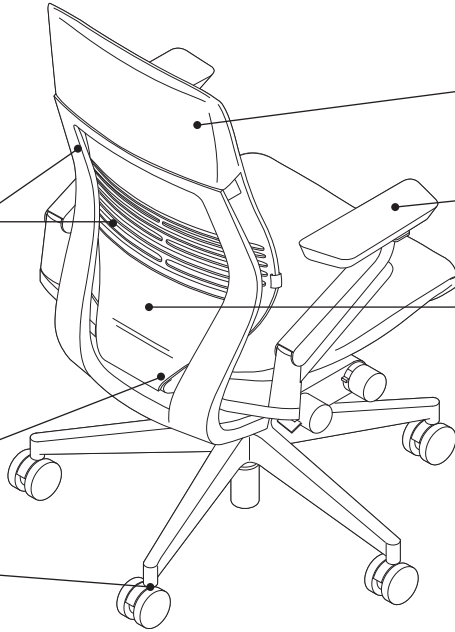

Wrapped upper back upholstery design is available.

360° arm enables 360° of motion to give arm support where it is needed with one release.

3D LiveBack moves with the shape of the user's spine as sitting positions change.

Outer back and outer seat are plastic.

Arm depth can retract 2⅛" to allow user to get closer to worksurface and into tight corners.

Soft arm caps independently pivot 15° inward and 15° outward to accommodate individual user preferences.

Arm width can adjust parallel from 10¼" to 22½" for forearm and elbow support.

Arm height can adjust 4¼" for arm and elbow support.

Passive seat edge angle allows the front edge of the seat to flex 1½" to relieve pressure under the user's thighs.

Seat perimeter is made of flexible elastomer that provides comfort to larger users and allows alternative postures.

Five-arm base is plastic, a polished aluminum base is available as an option.

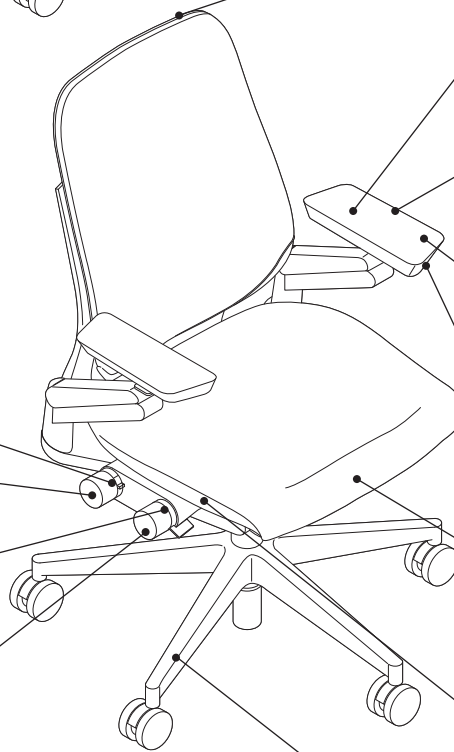

Product Details

Adjustability instructions are included with every chair. Instructions can also be found at www.steelcase.com.

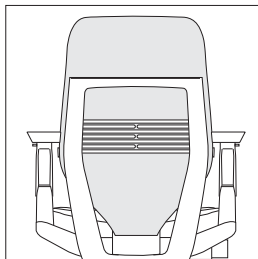

3D LiveBack allows the back to move and conform laterally, sagittally, and torsionally to support individual users.

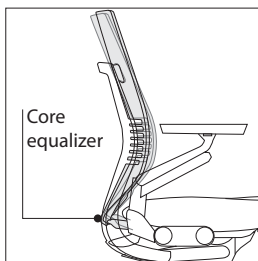

The core equalizer is powered by a torsional spring that adjusts with the angle of the seat and back to provide less lumbar support in a deep recline and more lumbar support in an upright posture.

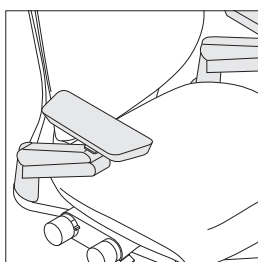

Rectilinear arms with soft caps are standard.

Adjustment Features

Seat Adjustments

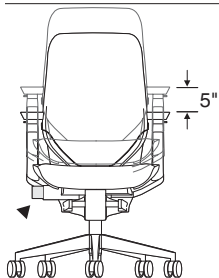

Seat height adjusts pneumatically. To lower, hold handle up while seated. To raise, hold handle up and keep weight off the chair. Range of adjustability is 5", from 16"H to 21"H, and is standard on work chairs. An optional 5 1/2" high-range of adjustability (17"H to 22 1/2"H) and a 3 3/4" low-range (14 1/2"H to 18 1/4"H) are available as an option. Stools are standard with an 8 1/4" range of adjustability (24"H to 32 1/4"H).

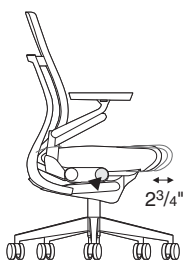

Seat depth adjusts 2 3/4" (15 3/4" to 18 1/2") by rotating dial while seated for an easy fine-tuned fit. This feature is standard on work chairs and stools.

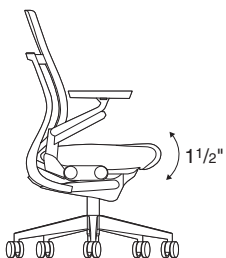

Passive seat edge angle flexes 1 1/2", relieving pressure under the user's thighs. This feature is standard on all work chairs and stools.

Flexible side edges. Comfort goes all the way to edges and requires no adjustment. Perfect for large users and has the ability to side sit.

Adaptive bolstering. The seat has air pockets carefully placed beneath the foam to give consistent comfort and support to a range of users.

Back Adjustments

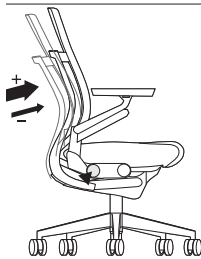

Back tension. Turn the knob forward for more resistance and backward for less resistance. Adjust back tension for appropriate amount of resistance.

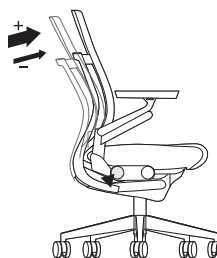

Variable back stop. To lock backrest in upright position, lean forward and flip lever down. Flip lever up to unlock for full-range motion. There are four settings to give just the right angle of recline.

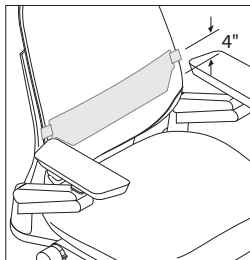

Lumbar height adjusts 4" (5 1/4" to 9 1/4") from seat by grabbing exposed tabs and sliding the lumbar support up or down. This feature is optional on work chairs and stools.

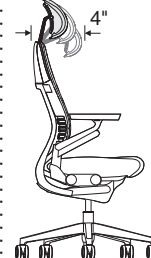
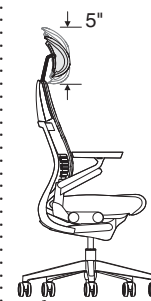

Headrest adjusts 5" vertically and measures 8"H x 10 1/2"W. It tilts 4" forward and the cushion rotates 90°. Plastic shell on the headrest is available in black, merle, or seagull and will match the plastic back shell. Upholstery can match or contrast the seat and back material. It is not available to order separately for installation on existing Gesture chairs. Headrest is available on stools as a special only.

Arm Adjustments

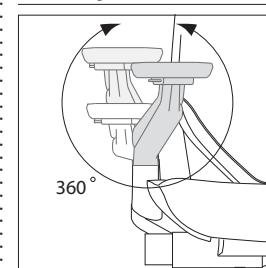

360°-arm. One release enables 360° of motion to give arms support where it is needed. To adjust arm cap position, grasp arm caps and slide in any direction. The 360° provide a great dimensional range for large users and many postures, and ensures proper support when using a range of technology, mobile or fixed.

Gesture 442 Series, continued

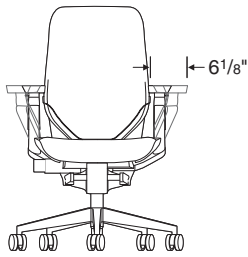

Arm width adjusts parallel 6 1/8" per arm for a total range of 10 1/4" to 22 1/2" between arms.

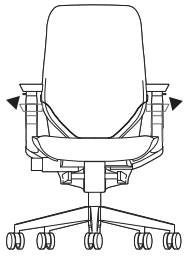

Arm height adjusts independently 4 1/4" (7 1/4"H to 11 1/2"H) to relieve upper back and shoulder fatigue.

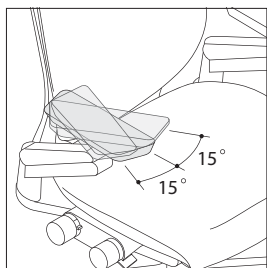

Arms pivot independently 15° inward and 15° outward. Grasp arm and push front to left or right.

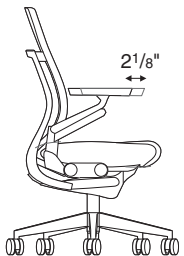

Arm depth adjusts 2 1/8" to enable user to get closer to worksurface.

Other features

Cartoned request on dealer purchase order forces Gesture chairs to ship knocked down in three pieces; the seat and back, the base, and the pneumatic cylinder. This allows for shipment in a smaller carton. Assembly by a qualified dealer installer is required. Assembly instructions are included. This does not apply to Gesture stools. No additional tools are required for assembly.



Armless models are also available.

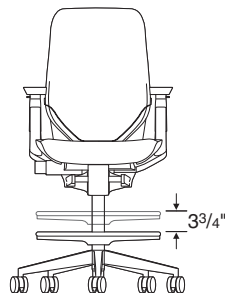

Column and foot ring on stools adjusts by first lifting ring and rotating it counterclockwise to unlock. Then raise or lower ring up to 3 3/4" to desired position before rotating it clockwise to lock.

Surface Materials

▶ See surface materials on page 504 for specific availability or refer to the *Surface Materials Reference Manual* for further information.

Open slats in the back shell will appear as a matching color to the back surface material if specified with Cogent:Connect or 3D Knit. Slats will appear as black if any other seating material is specified.

Upholstery

- Fabric
- Fabric with soil-retardant treatment (option)
- 3D Knit (back and headrest only)
- Leather
- Elmosoft leather
- Select Surfaces leather
- Vinyl
- COM
- COL

Hard components

(back frame, outer back, arm retainer, and base)

- 4799 Platinum
 - 6053 Seagull
 - 6205 Black
 - 6527 Merle
 - 7250 Sterling Dark
 - 8046 Polished Aluminum
- ▶ See color scheme matrix.

Headrest shell is determined by the color scheme.

- 6053 Seagull
- 6205 Black
- 6527 Merle

Stool footing finish is determined by the color scheme.

- 0835 Black (Black/Black, Dark/Dark)
- 4799 Platinum Metallic (Dark/Light, Light/Light)

Arm caps

- Black
- Leather



Polished aluminum base is available.

All Steelcase seating

with standard upholstery fabrics complies with requirements of the State of California Technical Bulletin 117-2013. All standard seating is labeled to be in compliance with California 117-2013.

Programs & Services

▶ See the *Surface Materials Reference Manual* for further detail about programs and services offered for seating.

The Customer's Own Material (COM) Program

offers the opportunity for customers to select fabrics that are not offered through the standard Steelcase surface materials program for use on Steelcase products.

Through the COM program, Steelcase will test your materials for application on Steelcase products. Once approved, you can place your order. Steelcase will facilitate the entire ordering process and give you a production schedule. Steelcase will order the COM fabric directly from the textile manufacturer. For up-to-date information regarding fabric test results for all COM fabrics and details regarding yardage requirements for most Seating lines, visit the COM website. To locate the COM website:

- Visit www.steelcase.com

Soil retardants are treatments that provide long-term soil and stain resistance to a fabric without affecting the shade or the integrity of the fabric. The following Steelcase Textiles are available pre-treated with soil retardant. (You do not need to select the soil-retardant option for these fabrics and incur the upcharge.)

- Jacks
- Link
- Spyder

For information on soil retardant fabrics on Select Surfaces, please refer to the *Surface Materials Reference Manual*.

Soil-retardant treatment is available on all other seating fabrics at an additional upcharge per seating unit. To order this option, please select "Soil-Retardant Treatment" under "Optional Accessories."

For soil-retardant treatment on COMs, please select "Soil-Retardant Treatment" under "Optional Accessories." Minimums or additional yardage may be required. Please contact the vendor directly for specific information. Extended lead times may be necessary for this service.

Contact your Steelcase Solutions Fulfillment Team Representative at 1.888.STEELCASE (1.888.783.3522) or send an email to lineone@steelcase.com.

Dimensions

▶ Page 36

Resources

Online Resources

- ▶ Interactive User Guide available on www.steelcase.com
- ▶ Model sales conversation available on village.steelcase.com
- ▶ Adjustability video available on www.steelcase.com
- ▶ Environmental profiles available on www.steelcase.com/sustainability.

Color Scheme Matrix

Color Scheme	Back Frame	Back Shell /Headrest	Seat Perimeter	Arms	Base	Cylinder
Black/Black	Molded Black-6205	Molded Black-6205	Molded Black-6205	Molded Black-6205	Molded Black-6205 or optional Polished Aluminum-8046	Painted Black-0835
Dark/Dark	Painted Sterling Dark Textured-7250	Molded Merle-6527	Molded Merle-6527	Molded Merle-6527	Painted Sterling Dark Textured-7250 or optional Polished Aluminum-8046	Painted Black-0835
Dark/Light	Painted Platinum Metallic-4799	Molded Merle-6527	Molded Merle-6527	Molded Merle-6527	Painted Platinum Metallic-4799 or optional Polished Aluminum-8046	Painted Platinum Metallic-4799
Light/Light	Painted Platinum Metallic-4799	Molded Seagull -6053	Molded Seagull -6053	Molded Merle-6527	Painted Platinum Metallic-4799 or optional Polished Aluminum-8046	Painted Platinum Metallic-4799

Gesture Upholstery

What Is It?

Fabric, leather, or vinyl-covered back and seat, 3D Knit back.

Standard upholstery design

Cogent: Connect

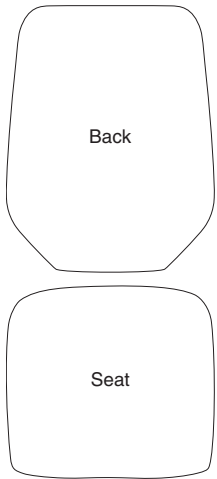

3D Knit on Back only

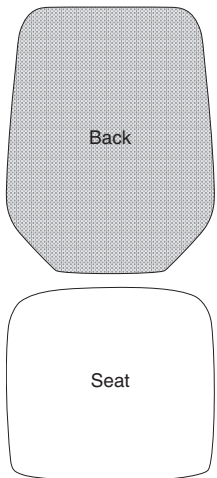

3D Knit back is made up of three layers: the 3D Knit, a solid fabric that matches the 3D Knit color, and the polyurethane cushion that provides exceptional comfort. The seat on these models can be specified with Cogent: Connect fabric colors to match the 3D Knit color, or in any other material.

Stitched upholstery design

Leather, Vinyl, and All Other Fabrics

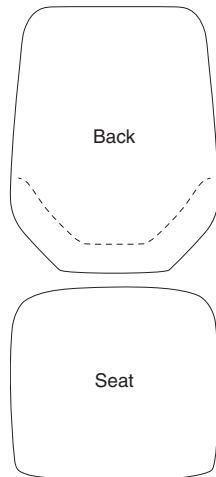

Stitched seams are included on the back cushion of the following:

- Leather
- Vinyl
- Upholstery
- Customer's Own Leather (COL)
- Vinyl
- Select Customer's Own Material/Vinyl (COM)

Pattern alignment at the lumbar seam cannot be guaranteed.

Open slats in the back shell will appear as a matching color to the back surface material if specified with Cogent:Connect or 3D Knit. Slats will appear as black if any other seating material is specified.

Chairs with headrest only

Leather, Vinyl, and All Other Fabrics

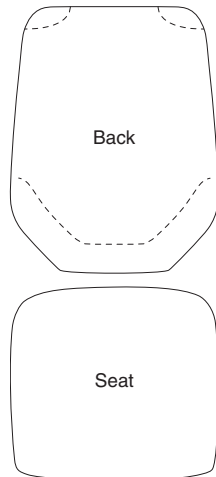

Additional stitched seams in the upper left and right corner of the back cushion on Gesture chairs with headrest are included of the following:

- Leather
- Vinyl
- Upholstery
- Customer's Own Leather (COL)
- Vinyl
- Select Customer's Own Material/Vinyl (COM)

Tip: Fabrics that show a distinct pattern or texture may demonstrate an undesirable contrast at the upper left and right corners of the top of the back.

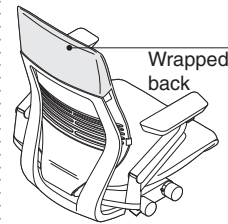
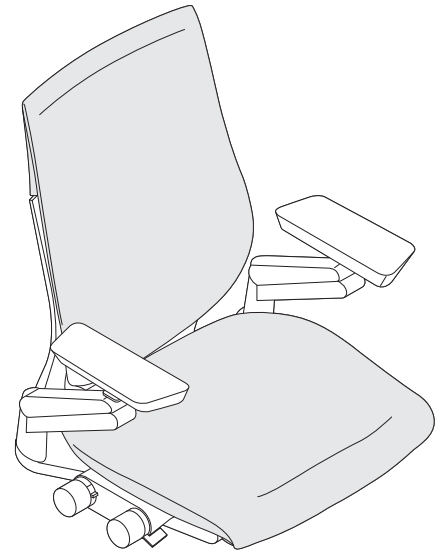

Wrapped upper back is upholstered to the top of the back frame.

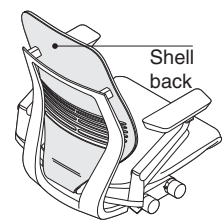

Plastic shell back is fully exposed.

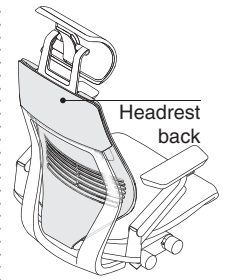

Headrest chair back is upholstered to the top of the back frame.

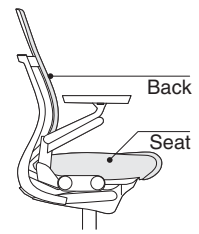

Seat and back cushions can be removed and replaced if damaged.

Dimensions

Gesture 442 Series

Features	Overall Depth	Width	Height	Seat Depth	Functional Seat Depth	Seat Width	Seat Height from Floor	Ring Height from Floor	Back Width	Back Height from Seat
----------	---------------	-------	--------	------------	-----------------------	------------	------------------------	------------------------	------------	-----------------------

Gesture 442 Series

Work Chairs

Adjustable Seat Depth	21" to 23 ⁵ / ₈ "	22 ³ / ₈ " to 34 ⁵ / ₈ "	39 ¹ / ₄ " to 44 ¹ / ₄ "	18 ¹ / ₄ "	15 ³ / ₄ " to 18 ¹ / ₂ "	20"	16" to 21" (14 ¹ / ₂ " to 18 ¹ / ₄ ", 17" to 22 ¹ / ₂ " optional)	N.A.	16 ¹ / ₄ "	24 ¹ / ₁₆ "
-----------------------	---	--	--	----------------------------------	--	-----	---	------	----------------------------------	-----------------------------------

Work Chair with Headrest

Adjustable Seat Depth	21" to 23 ⁵ / ₈ "	22 ³ / ₈ " to 34 ⁵ / ₈ "	47" to 57"	18 ¹ / ₄ "	15 ³ / ₄ " to 18 ¹ / ₂ "	20"	16" to 21" (14 ¹ / ₂ " to 18 ¹ / ₄ ", 17" to 22 ¹ / ₂ " optional)	N.A.	16 ¹ / ₄ "	25 ³ / ₈ "
-----------------------	---	--	------------	----------------------------------	--	-----	---	------	----------------------------------	----------------------------------

Stools

Adjustable Seat Depth	21" to 23 ⁵ / ₈ "	22 ³ / ₈ " to 34 ⁵ / ₈ "	47 ³ / ₈ " to 55 ⁵ / ₈ "	18 ¹ / ₄ "	15 ³ / ₄ " to 18 ¹ / ₂ "	20"	24" to 32 ¹ / ₄ "	10 ¹ / ₄ " to 14"	16 ¹ / ₄ "	24 ¹ / ₁₆ "
-----------------------	---	--	--	----------------------------------	--	-----	---	---	----------------------------------	-----------------------------------

Dimensions were measured with BIFMA CMD (chair-measuring device).

*Seat width at the front of the cushion is 18¹/₄"W.

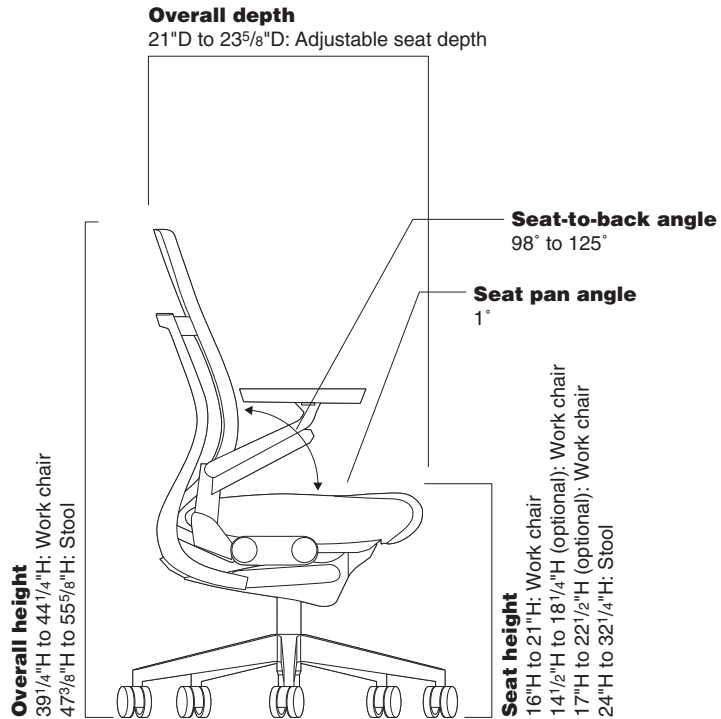
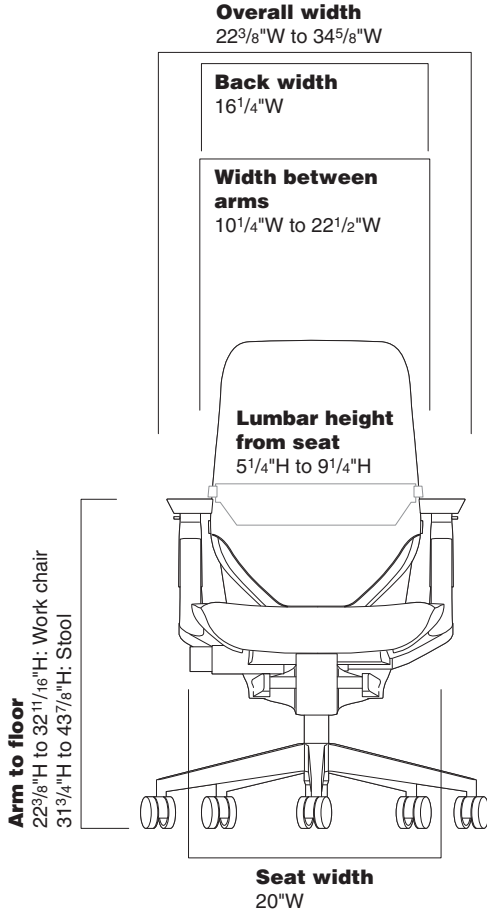

• Back Lumbar Height	• Lumbar Flex Zone	• Width Between Arms	• Width Between Fixed Arms	• Arm to Floor	• Arm Height from Seat	• Arm Cap Pivot Range	• Seat Pan Angle	• Angle Between Seat and Back
Work Chairs								
9¼"	4"	10¼" to 22½"	19"	23⅜" to 32⅛"	7¼" to 11½"	15° inward, 15° outward	1°	98° to 125°
Work Chair with Headrest								
9¼"	4"	10¼" to 22½"	19"	23⅜" to 32⅛"	7¼" to 11½"	15° inward, 15° outward	1°	98° to 125°
Stools								
9¼"	4"	10¼" to 22½"	19"	31¼" to 43⅞"	7¼" to 11½"	15° inward, 15° outward	1°	98° to 125°
:	:	:	:	:	:	:	:	:

Gesture 442 Series Value Package Work Chairs

Tip: Gesture value package work chair offers Gesture chair features at a lower price than when selected individually.

Standard Includes		Required to Specify
<ul style="list-style-type: none"> ▶ Need help? Product details, page 30 	<ul style="list-style-type: none"> • 5" pneumatic seat-height adjustment (16"-21") • 360° independent height-, width-, pivot-, and depth-adjustable arms and soft arm caps: black plastic • Frame, seat shell, outer back, and five-arm base: plastic • 2¾" seat depth adjustment • Standard upholstery design: Cogent: Connect fabric only • 2½" diameter, hard-composition, dual-wheel casters: black 	<ol style="list-style-type: none"> 1 Style number 2 Plastic color scheme for frame, seat shell, outer back, and base (see below under Required Selections) 3 Cogent: Connect color number for upholstery on seat and back 4 Options, if selected (see below) <ul style="list-style-type: none"> ▶ See <i>Surface Materials</i>, page 504.

Required Selections	U.S. Price	Required to Specify
Color Scheme <ul style="list-style-type: none"> • Black/Black • Dark/Dark 	No cost No cost	Specify <i>with black/black color scheme.</i> Specify <i>with dark/dark color scheme.</i>

Options	U.S. Price	Required to Specify
Casters <ul style="list-style-type: none"> • Soft, dark grey treaded, dual-wheel roll-control casters for use on hard floors 	+\$27	Specify <i>with soft roll-control casters.</i>

Specification Information	
<ul style="list-style-type: none"> • Style Number • U.S. Base Price 	

Wrapped Back Chair

442A40V	\$1540
----------------	--------



Shell Back Chair

442A30V	\$1512
----------------	--------



▶ Detailed dimensions, page 36



For Canadian Pricing

Multiply U.S. Price by the Canadian price factor.

▶ See page 1 for details.

Gesture 442 Series Work Chairs

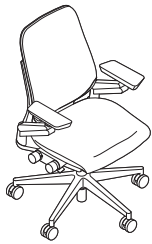

Tip: For more information regarding color schemes, see page 33.

Standard Includes		Required to Specify
<ul style="list-style-type: none"> ▶ Need help? Product details, page 30 	<ul style="list-style-type: none"> • 5" pneumatic seat-height adjustment (16"-21") • 360° independent height-, width-, pivot-, and depth-adjustable arms and soft arm caps: black plastic • Frame, seat shell, outer back, and five-arm base: plastic • 2³/₄" seat depth adjustment • Standard upholstery design on seat: fabric price group 1 • Shell back chair, if selected: fabric price group 1 • Wrapped back chair, if selected: fabric price group 1 • 3D Knit on back only, if selected • 2¹/₂" diameter, hard-composition, dual-wheel casters: black 	<ol style="list-style-type: none"> 1 Style number 2 Plastic color scheme for frame, seat shell, outer back, and base (see below under Required Selections) 3 Fabric color number for upholstery on seat and back, if selected 4 3D Knit color number for upholstery on back, if selected 5 Options, if selected (see below) <ul style="list-style-type: none"> ▶ See <i>Surface Materials</i>, page 504.

Required Selections	U.S. Price	Required to Specify
Color Scheme		
<ul style="list-style-type: none"> • Black/Black • Dark/Dark • Dark/Light • Light/Light 	<ul style="list-style-type: none"> No cost No cost +\$ 43 +\$ 43 	<ul style="list-style-type: none"> Specify with <i>black/black color scheme</i>. Specify with <i>dark/dark color scheme</i>. Specify with <i>dark/light color scheme</i>. Specify with <i>light/light color scheme</i>.

Options	U.S. Price	Required to Specify
Surface Materials		
Contrasting		
<ul style="list-style-type: none"> • Contrasting fabrics 	+\$ 33	Specify with <i>contrasting</i> .
Upholstery on seat		
<ul style="list-style-type: none"> • Fabric price group 1 • Fabric price group 2 • Fabric price group 3 • Fabric price group 4 • Fabric price group 5 • Fabric price group 6 • Fabric price group 7 • Fabric price group 8 • Fabric price group 9 • Fabric price group 10 • Steelcase leather upholstery • Select Surfaces leather price group 1 • Elmosoft leather upholstery • Select Surfaces leather price group 2 • Steelcase vinyl • Customer's Own Material/Vinyl (COM-Sewn) • Customer's Own Leather (COL-Sewn) • Soil-retardant treatment applied to upholstery fabric 	<ul style="list-style-type: none"> No cost +\$ 10 +\$ 27 +\$ 36 +\$ 43 +\$ 53 +\$ 64 +\$ 79 +\$ 97 +\$112 +\$322 +\$322 +\$378 +\$378 +\$ 10 No cost +\$139 +\$ 27 	<ul style="list-style-type: none"> Specify fabric color number. Specify fabric color number. Specify fabric color number. Specify fabric color number. Specify fabric color number. Specify fabric color number. Specify fabric color number. Specify fabric color number. Specify fabric color number. Specify fabric color number. Specify fabric color number. Specify leather color number. ▶ See <i>Surface Materials Reference Manual</i>. Specify Elmosoft leather color number. ▶ See <i>Surface Materials Reference Manual</i>. Specify vinyl color number. ▶ See <i>Surface Materials Reference Manual</i>. Specify leather color number. Specify with <i>soil-retardant treatment</i>.
Upholstery on back		
<ul style="list-style-type: none"> • Fabric price group 1 • Fabric price group 2 • Fabric price group 3 • Fabric price group 4 • Fabric price group 5 • Fabric price group 6 • Fabric price group 7 • Fabric price group 8 • Fabric price group 9 • Fabric price group 10 • 3D Knit • Steelcase leather upholstery • Select Surfaces leather price group 1 • Elmosoft leather upholstery • Select Surfaces leather price group 2 • Steelcase vinyl • Customer's Own Material/Vinyl (COM-Sewn) • Customer's Own Leather (COL-Sewn) • Soil-retardant treatment applied to upholstery fabric 	<ul style="list-style-type: none"> No cost +\$ 10 +\$ 27 +\$ 36 +\$ 43 +\$ 53 +\$ 64 +\$ 79 +\$ 97 +\$112 +\$ 61 +\$322 +\$322 +\$378 +\$378 +\$ 10 No cost +\$139 +\$ 27 	<ul style="list-style-type: none"> Specify fabric color number. Specify fabric color number. Specify fabric color number. Specify fabric color number. Specify fabric color number. Specify fabric color number. Specify fabric color number. Specify fabric color number. Specify fabric color number. Specify fabric color number. Specify 3D Knit fabric color number. Specify leather color number. ▶ See <i>Surface Materials Reference Manual</i>. Specify Elmosoft leather color number. ▶ See <i>Surface Materials Reference Manual</i>. Specify vinyl color number. ▶ See <i>Surface Materials Reference Manual</i>. Specify leather color number. Specify with <i>soil-retardant treatment</i>.

Tip: Seat and back will be a matching textile unless 3D Knit is specified.

▶ Detailed dimensions, page 36



For Canadian Pricing
Multiply U.S. Price by the Canadian price factor.

▶ See page 1 for details.

▶ **Options, continued on next page**

► Options, continued from previous page

Options	U.S. Price	Required to Specify
Surface Materials, continued Polished aluminum base package • Polished aluminum base on chairs	+\$143	Specify with polished aluminum base.
Arms • 360° independent height-, width-, pivot-, and depth-adjustable arms with leather arm caps	+\$170	Specify with 360° independent height-, width-, pivot-, and depth-adjustable arms and select leather color number.
• 360° independent height-, width-, pivot-, and depth-adjustable arms with Elmosoft leather arm caps	+\$199	Specify with 360° independent height-, width-, pivot-, and depth-adjustable arms and select Elmosoft leather color number.
• Fixed arms	-\$100	Specify with fixed arms.
• Armless	-\$285	Specify without arms.
Seat Height • 3 ³ / ₄ " low-range pneumatic seat-height adjustment (14 ¹ / ₂ " to 18 ¹ / ₄ ")	+\$ 61	Specify with low-range pneumatic seat-height adjustment.
• 5 ¹ / ₂ " high-range pneumatic seat-height adjustment (17" to 22 ¹ / ₂ ")	+\$ 61	Specify with high-range pneumatic seat-height adjustment.
Lumbar • Adjustable lumbar support	+\$ 33	Specify with adjustable lumbar height.
Casters • Soft, dark grey treaded, dual-wheel roll-control casters for use on hard floors	+\$ 27	Specify with soft roll-control casters.
Glides • Glides: plastic	+\$ 27	Specify with glides.

Specification Information

• Style	• U.S.
• Number	• Base
•	• Price
•	•
•	•

Wrapped Back Chair

442A40 \$1617

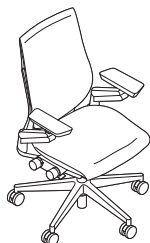

Shell Back Chair

442A30 \$1589



For Canadian Pricing

Multiply U.S. Price by the Canadian price factor.

► See page 1 for details.

Gesture 442 Series Work Chair with Headrest

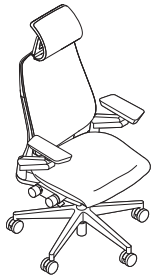

Tip: For more information regarding color schemes, see page 33.

Tip: Headrest upholstery can match or contrast the seat and back upholstery.

Tip: Seat and back will be a matching textile unless 3D Knit is specified.

► Detailed dimensions, page 36



For Canadian Pricing
Multiply U.S. Price by the Canadian price factor.

► See page 1 for details.

Standard Includes		Required to Specify
► Need help? Product details, page 30	<ul style="list-style-type: none"> 5" pneumatic seat-height adjustment (16"–21") 360° independent height-, width-, pivot-, and depth-adjustable arms and soft arm caps: black plastic Frame, seat shell, outer back, and five-arm base: plastic 2¾" seat depth adjustment Standard upholstery design on seat: fabric price group 1 Adjustable headrest, standard upholstery 3D Knit on back and headrest only, if selected 2½" diameter, hard-composition, dual-wheel casters: black 	<ol style="list-style-type: none"> Style number Plastic color scheme for frame, seat shell, outer back, headrest, and base (see below under Required Selections) Fabric color number for upholstery on seat and back, if selected Fabric color number for upholstery on headrest 3D Knit color number for upholstery on back, if selected Options, if selected (see below) <p>► See <i>Surface Materials</i>, page 504.</p>

Required Selections	U.S. Price	Required to Specify
Color Scheme		
• Black/Black	No cost	Specify with <i>black/black color scheme</i> .
• Dark/Dark	No cost	Specify with <i>dark/dark color scheme</i> .
• Dark/Light	+\$ 43	Specify with <i>dark/light color scheme</i> .
• Light/Light	+\$ 43	Specify with <i>light/light color scheme</i> .

Options	U.S. Price	Required to Specify
Surface Materials		
Contrasting		
• Contrasting fabrics	+\$ 33	Specify with <i>contrasting</i> .
Upholstery on seat		
• Fabric price group 1	No cost	Specify fabric color number.
• Fabric price group 2	+\$ 10	Specify fabric color number.
• Fabric price group 3	+\$ 27	Specify fabric color number.
• Fabric price group 4	+\$ 36	Specify fabric color number.
• Fabric price group 5	+\$ 43	Specify fabric color number.
• Fabric price group 6	+\$ 53	Specify fabric color number.
• Fabric price group 7	+\$ 64	Specify fabric color number.
• Fabric price group 8	+\$ 79	Specify fabric color number.
• Fabric price group 9	+\$ 97	Specify fabric color number.
• Fabric price group 10	+\$112	Specify fabric color number.
• Steelcase leather upholstery	+\$322	Specify leather color number.
• Select Surfaces leather price group 1	+\$322	► See <i>Surface Materials Reference Manual</i> . Specify Elmosoft leather color number.
• Elmosoft leather upholstery	+\$378	► See <i>Surface Materials Reference Manual</i> . Specify vinyl color number.
• Select Surfaces leather price group 2	+\$378	► See <i>Surface Materials Reference Manual</i> .
• Steelcase vinyl	+\$ 10	Specify vinyl color number.
• Customer's Own Material/Vinyl (COM-Sewn)	No cost	► See <i>Surface Materials Reference Manual</i> .
• Customer's Own Leather (COL-Sewn)	+\$139	Specify leather color number.
• Soil-retardant treatment applied to upholstery fabric	+\$ 27	Specify with <i>soil-retardant treatment</i> .
Upholstery on back		
• Fabric price group 1	No cost	Specify fabric color number.
• Fabric price group 2	+\$ 10	Specify fabric color number.
• Fabric price group 3	+\$ 27	Specify fabric color number.
• Fabric price group 4	+\$ 36	Specify fabric color number.
• Fabric price group 5	+\$ 43	Specify fabric color number.
• Fabric price group 6	+\$ 53	Specify fabric color number.
• Fabric price group 7	+\$ 64	Specify fabric color number.
• Fabric price group 8	+\$ 79	Specify fabric color number.
• Fabric price group 9	+\$ 97	Specify fabric color number.
• Fabric price group 10	+\$112	Specify fabric color number.
• 3D Knit	+\$ 61	Specify 3D Knit fabric color number.
• Steelcase leather upholstery	+\$322	Specify leather color number.
• Select Surfaces leather price group 1	+\$322	► See <i>Surface Materials Reference Manual</i> . Specify Elmosoft leather color number.
• Elmosoft leather upholstery	+\$378	► See <i>Surface Materials Reference Manual</i> . Specify vinyl color number.
• Select Surfaces leather price group 2	+\$378	► See <i>Surface Materials Reference Manual</i> .
• Steelcase vinyl	+\$ 10	Specify vinyl color number.
• Customer's Own Material/Vinyl (COM-Sewn)	No cost	► See <i>Surface Materials Reference Manual</i> .
• Customer's Own Leather (COL-Sewn)	+\$139	Specify leather color number.
• Soil-retardant treatment applied to upholstery fabric	+\$ 27	Specify with <i>soil-retardant treatment</i> .

► Options, continued on next page

► Options, continued from previous page

Options	U.S. Price	Required to Specify
Surface Materials, continued	Polished aluminum base package	
• Polished aluminum base on chairs	+\$143	Specify with polished aluminum base.
Arms		
• 360° independent height-, width-, pivot-, and depth-adjustable arms with leather arm caps	+\$170	Specify with 360° independent height-, width-, pivot-, and depth-adjustable arms and select leather color number.
• 360° independent height-, width-, pivot-, and depth-adjustable arms with Elmosoft leather arm caps	+\$199	Specify with 360° independent height-, width-, pivot-, and depth-adjustable arms and select Elmosoft leather color number.
• Fixed arms	-\$100	Specify with fixed arms.
• Armless	-\$285	Specify without arms.
Seat Height		
• 3 ³ / ₄ " low-range pneumatic seat-height adjustment (14 ¹ / ₂ " to 18 ¹ / ₄ ")	+\$ 61	Specify with low-range pneumatic seat-height adjustment.
• 5 ¹ / ₂ " high-range pneumatic seat-height adjustment (17" to 22 ¹ / ₂ ")	+\$ 61	Specify with high-range pneumatic seat-height adjustment.
Lumbar		
• Adjustable lumbar support	+\$ 33	Specify with adjustable lumbar height.
Casters		
• Soft, dark grey treaded, dual-wheel roll-control casters for use on hard floors	+\$ 27	Specify with soft roll-control casters.
Glides		
• Glides: plastic	+\$ 27	Specify with glides.

Specification Information

Style Number	U.S. Base Price
442A50	\$1886
:	:



Gesture 442 Series

 **For Canadian Pricing**
Multiply U.S. Price by the Canadian price factor.
► See page 1 for details.

Gesture 442 Series Stools

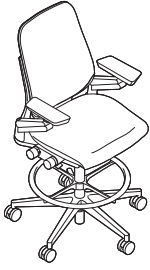

Tip: For more information regarding color schemes, see page 33.

Tip: Seat and back will be a matching textile unless 3D Knit is specified.

► Detailed dimensions, page 36



For Canadian Pricing
Multiply U.S. Price by the Canadian price factor.

► See page 1 for details.

Standard Includes		Required to Specify
► Need help? Product details, page 30	<ul style="list-style-type: none"> • 8 1/4" pneumatic seat-height adjustment (24"–32 1/4") • 360° independent height-, width-, pivot-, and depth-adjustable arms and soft arm caps: black plastic • Frame, seat shell, outer back, and five-arm base: plastic • 2 3/4" seat depth adjustment • Column and 4" adjustable foot ring • Standard upholstery design on seat: fabric price group 1 • Shell back stool, if selected: fabric price group 1 • Wrapped back stool, if selected: fabric price group 1 • 3D Knit on back only, if selected • 2 1/2" diameter, hard-composition, dual-wheel casters: black 	<ol style="list-style-type: none"> 1 Style number 2 Plastic color scheme for frame, seat shell, outer back, and base (see below under Required Selections) 3 Fabric color number for upholstery on seat and back, if selected 4 3D Knit color number for upholstery on back, if selected 5 Options, if selected (see below) <p>► See <i>Surface Materials</i>, page 504.</p>

Required Selections	U.S. Price	Required to Specify
Color Scheme		
• Black/Black	No cost	Specify with <i>black/black color scheme</i> .
• Dark/Dark	No cost	Specify with <i>dark/dark color scheme</i> .
• Dark/Light	+\$ 43	Specify with <i>dark/light color scheme</i> .
• Light/Light	+\$ 43	Specify with <i>light/light color scheme</i> .

Options	U.S. Price	Required to Specify
Surface Materials		
Contrasting		
• Contrasting fabrics	+\$ 33	Specify with <i>contrasting</i> .

Upholstery on seat

• Fabric price group 1	No cost	Specify fabric color number.
• Fabric price group 2	+\$ 10	Specify fabric color number.
• Fabric price group 3	+\$ 27	Specify fabric color number.
• Fabric price group 4	+\$ 36	Specify fabric color number.
• Fabric price group 5	+\$ 43	Specify fabric color number.
• Fabric price group 6	+\$ 53	Specify fabric color number.
• Fabric price group 7	+\$ 64	Specify fabric color number.
• Fabric price group 8	+\$ 79	Specify fabric color number.
• Fabric price group 9	+\$ 97	Specify fabric color number.
• Fabric price group 10	+\$112	Specify fabric color number.
• Steelcase leather upholstery	+\$322	Specify leather color number.
• Select Surfaces leather price group 1	+\$322	► See <i>Surface Materials Reference Manual</i> . Specify Elmosoft leather color number.
• Elmosoft leather upholstery	+\$378	► See <i>Surface Materials Reference Manual</i> . Specify vinyl color number.
• Select Surfaces leather price group 2	+\$378	► See <i>Surface Materials Reference Manual</i> .
• Steelcase vinyl	+\$ 10	
• Customer's Own Material/Vinyl (COM-Sewn)	No cost	
• Customer's Own Leather (COL-Sewn)	+\$139	Specify leather color number.
• Soil-retardant treatment applied to upholstery fabric	+\$ 27	Specify with <i>soil-retardant treatment</i> .

Upholstery on back

• Fabric price group 1	No cost	Specify fabric color number.
• Fabric price group 2	+\$ 10	Specify fabric color number.
• Fabric price group 3	+\$ 27	Specify fabric color number.
• Fabric price group 4	+\$ 36	Specify fabric color number.
• Fabric price group 5	+\$ 43	Specify fabric color number.
• Fabric price group 6	+\$ 53	Specify fabric color number.
• Fabric price group 7	+\$ 64	Specify fabric color number.
• Fabric price group 8	+\$ 79	Specify fabric color number.
• Fabric price group 9	+\$ 97	Specify fabric color number.
• Fabric price group 10	+\$112	Specify fabric color number.
• 3D Knit	+\$ 61	Specify 3D knit fabric color number.
• Steelcase leather upholstery	+\$322	Specify leather color number.
• Select Surfaces leather price group 1	+\$322	► See <i>Surface Materials Reference Manual</i> . Specify Elmosoft leather color number.
• Elmosoft leather upholstery	+\$378	► See <i>Surface Materials Reference Manual</i> . Specify vinyl color number.
• Select Surfaces leather price group 2	+\$378	► See <i>Surface Materials Reference Manual</i> .
• Steelcase vinyl	+\$ 10	
• Customer's Own Material/Vinyl (COM-Sewn)	No cost	
• Customer's Own Leather (COL-Sewn)	+\$139	Specify leather color number.
• Soil-retardant treatment applied to upholstery fabric	+\$ 27	Specify with <i>soil-retardant treatment</i> .

► Options, continued on next page

► Options, continued from previous page

Options	U.S. Price	Required to Specify
Surface Materials, continued Polished aluminum base package • Polished aluminum base on chairs	+\$143	Specify with polished aluminum base.
Arms • 360° independent height-, width-, pivot-, and depth-adjustable arms with leather arm caps • 360° independent height-, width-, pivot-, and depth-adjustable arms with Elmosoft leather arm caps • Fixed arms • Armless	+\$170 +\$199 -\$100 -\$285	Specify with 360° independent height-, width-, pivot-, and depth-adjustable arms and select leather color number. Specify with 360° independent height-, width-, pivot-, and depth-adjustable arms and select Elmosoft leather color number. Specify with fixed arms. Specify without arms.
Lumbar • Adjustable lumbar support	+\$ 33	Specify with adjustable lumbar height.
Casters • Soft, dark grey treaded, dual-wheel roll-control casters for use on hard floors	+\$ 27	Specify with soft roll-control casters.
Glides • Glides: plastic	+\$ 27	Specify with glides.

Specification Information

• Style	• U.S.
• Number	• Base
•	• Price
•	•
•	•

Wrapped Back Stool

442B40	\$1854
•	•
•	•

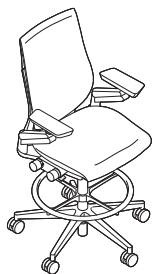

Shell Back Stool

442B30	\$1826
•	•
•	•

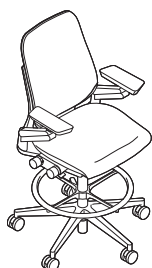

 **For Canadian Pricing**
 Multiply U.S. Price by the Canadian price factor.
 ► See page 1 for details.

Understanding and Specifying Leap 462 Series Work Chairs

Work Chairs

Highly adjustable task seating offers maximum personalization for fit and comfort for a range of duration and use. By making a series of simple adjustments, you can customize the chair to your body, preferences, and tasks. These chairs provide continuous, stable, comfort, and can be quickly adjusted to support you in upright, and reclining work postures.

- Gesture 442 Series
- Leap 462 Series
- Think 465 Series
- Amia 482 Series
- Reply 466 Series
- Jersey Series
- Leap 464 Series WorkLounge
- Criterion 453 Series

Adjustability Features

► See page 22 for a comparison to other chairs.

	Leap 462 Series	Leap Plus
Mechanisms		
Natural glide	●	●
Seat Adjustments		
Pneumatic height	●	●
Passive seat edge angle	●	
Seat depth	●	●
Back Adjustments		
Lumbar height	●	●
Lower back firmness	●	●
Upper back tension	●	●
Variable back stop	●	●
Arm Adjustments		
Arm height	●	●
Arm width	●	●
Arm pivot	●	●
Arm depth	●	●
Other Features		
Foot ring height (stool)	●	

Product Details

Leap 462 Series	48
Leap Upholstery	51
Dimensions	52

Specifying

Value Package

Work Chair	54
------------	----

Platinum Package

Work Chair	56
------------	----

Work Chairs

Upholstery on Back and Seat	58
3D Knit on Back with Upholstery on Seat	62

Stools

Upholstery on Back and Seat	64
3D Knit on Back with Upholstery on Seat	68

Plus Work Chairs

Upholstery on Back and Seat	70
3D Knit on Back and Upholstery on Seat	74

Leap 462 Series

Leap is a high-performance chair for customers who place the highest value on ergonomics, health, and productivity.

Outer back and outer seat are plastic.

LiveBack moves with the shape of the user's spine as sitting positions change.

Lumbar height adjusts 5" to provide additional lower back support. It is standard on all chairs, but may be omitted.

Arm height can adjust independently within a 4" range to help relieve upper back and shoulder fatigue.

Seat depth adjusts within a 3" range to accommodate users of varying leg lengths. Seat depth is standard on all models.

Five-arm base is available in plastic or polished aluminum.

Casters have hard, dual-wheels that roll smoothly on carpets. They are 2½" for increased mobility. Soft, dark grey treaded, dual-wheel roll-control casters are available for use on hard floors or mats. Stools are standard with 2" hard casters. Soft casters are available as an option.

Tip: Do not roll the chair across asphalt during installation as this may damage the casters.

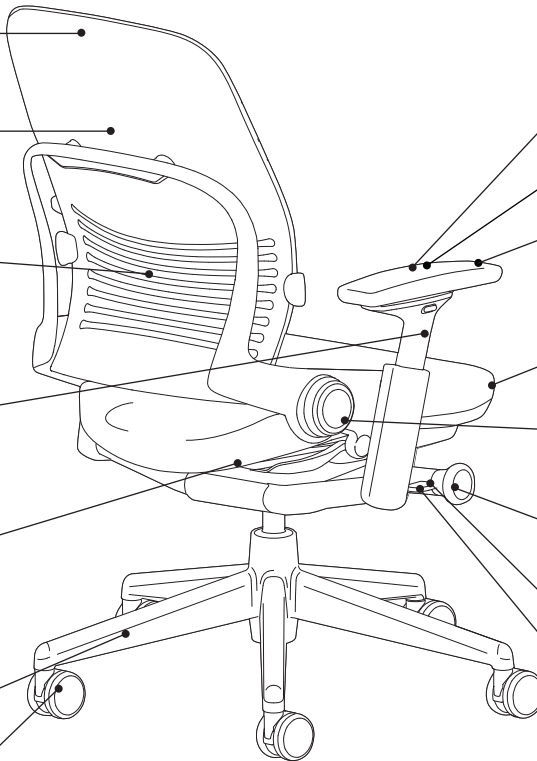

Arm depth can retract 3" to allow user to get closer to worksurface and into tight corners.

Arm width can adjust 4½" overall to provide forearm support.

Arm caps can pivot 30° in and out to accommodate individual user preferences.

Passive seat edge angle allows the front edge of the seat to flex 1½" to relieve pressure under the user's thighs.

Lower back firmness changes the amount of firmness user feels in lower back. Requires only two complete turns.

Upper back force requires only five complete turns and accommodates a broader range of users by allowing user to change the rate of increase in force as the user reclines.

Variable back stop with five positions is standard.

Seat height adjusts within a 5" range with a pneumatic adjustment mechanism. A 7" range is available as an option. Stools have an 8" range.

Product Details

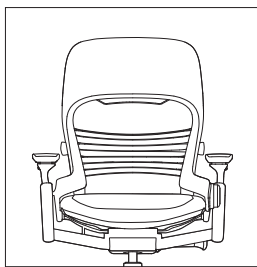

Parallel slats in the Live-Back shell provide extensive flexibility to allow back to conform to individual users.

Leap Plus offers the benefits and functionality of the standard Leap chair, including LiveBack Technology, to users weighing up to 500 pounds.

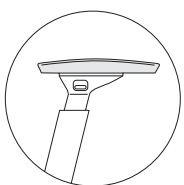

Rectilinear arms with soft caps are standard.

Models are standard with adjustable seats that include seat depth and passive seat edge angle.

Adjustability instructions are included with every chair. Fully adjustable arm models include instructions under the arm cap. Instructions can also be found at www.steelcase.com

Controls under the seat include tactile braille designators.

Cartoned request on your dealer purchase order means Leap chairs will ship knocked down with the chair base separated from the rest of the chair. This allows for shipment in a smaller carton. Assembly instructions are included. This does not apply to Leap stools, Leap Plus, or Leap WorkLounge.

Uncartoned request on your dealer purchase order means Leap chairs will ship fully assembled.

Adjustment Features

Seat Adjustments

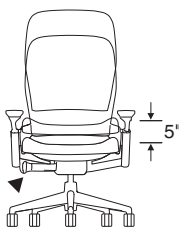

Seat height adjusts pneumatically. To lower, hold handle up while seated. To raise, hold handle up and keep your weight off the chair. Range of adjustability is 5", from 15½"H to 20½"H, and is standard on work chairs. A 7" range of adjustability (17"H to 24"H) is available as an option. Stools are standard with an 8" range of adjustability (22"H to 30"H). Leap Plus is standard with a 4" range of adjustability (15½"H to 19½"H). A 5" range (17½"H to 22½"H) is available as an option.

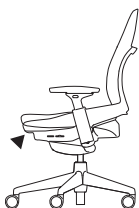

Passive seat edge angle flexes 1½", relieving pressure under the user's thighs. This feature is standard on all work chairs and stools.

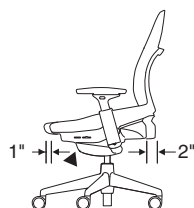

Seat depth adjusts 3" (15¾"-18¾") by pulling handle up. Slide seat forward or back to accommodate various leg lengths. Release handle to lock. This feature is standard on work chairs and stools. Seat depth adjustment range for Leap Plus is 2" (16¾"-18¾").

Back Adjustments

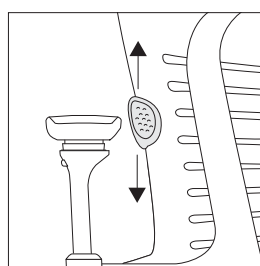

Lumbar height adjusts 5" (5¼" to 10¼" from seat, 6½" to 11½" on Plus chairs) by grabbing exposed tabs and sliding the lumbar support up or down. This feature is standard on work chairs and stools, but may be omitted.

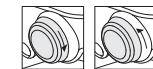
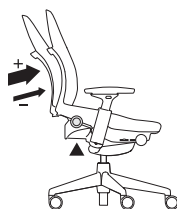

Lower back firmness adjusts by turning knob two complete turns. Forward increases firmness. Backward decreases firmness. This feature is standard on work chairs and stools.

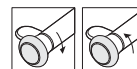
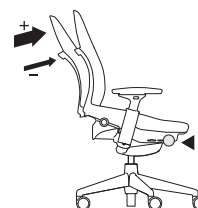

Upper back force adjusts by turning knob five complete turns. Turn knob forward to increase rate of tension; backward to decrease. This feature is standard on work chairs and stools.

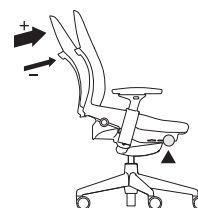

Variable back stop. Rotate handle up or down to set recline angle. Lean back to desired back angle. Five stops are available. This feature is standard on work chairs and stools.
Tip: To stop in upright position, remove weight from back and rotate lever up.

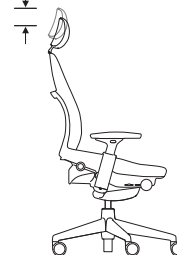

Headrest (option) adjusts 2¼" vertically and adds 6¾" to 9" to the overall height. Plastic shell on the headrest is available in black only. Upholstery is available to match the seat material or black vinyl only. Headrest is not available on stools, Leap models, or when the fire code option (FCS) is selected.

Arm Adjustments

Rectilinear height-, width-, pivot-, and depth-adjustable arms come standard on all arm models of chairs and stools.

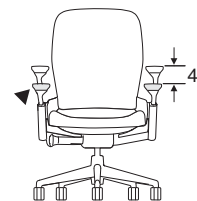

Arm height adjusts independently within a range of 4" (7"-11" from the seat, 7¼"-11¼" on Plus models). Push button on outside and under arm cap in while moving arms up or down. Releasing buttons locks arms in position.

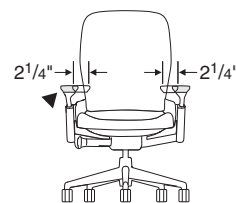

Arm width adjusts 2¼" each independently on chairs with this option. Grasp arm and move in or out.

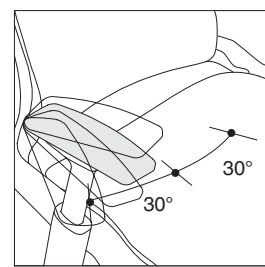

Arms pivot independently 30° inward and outward. Grasp arm and push front to left or right.

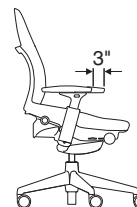

Arm depth adjusts approximately 3" to enable user to get closer to worksurface.

Leap 462 Series, continued

Other Features

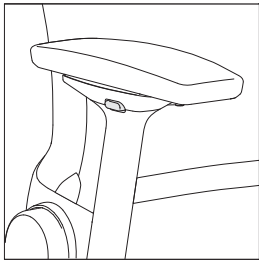

Height-only adjustable arm is also available and adjusts 4".



Armless models are also available.

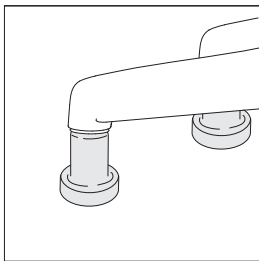

Glides are available as an option, except on chairs with polished aluminum package. Glides ship with chair or stool for field installation and maintain same height as casters.

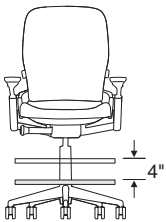

Foot ring height on stools adjusts by first lifting ring and rotating it counter-clockwise to unlock. Then raise or lower ring up to 4" to desired position before rotating it clockwise to lock.

Soft-wheel casters for hard floors are available for specific applications.

Surface Materials

▶ See surface materials on page 504 for specific availability or refer to the *Surface Materials Reference Manual* for further information.

Upholstery

- Fabric
- Fabric with soil-retardant treatment (option)
- 3D Knit (back only)
- Leather
- Elmosoft leather
- Select Surfaces leather
- Vinyl
- COM
- COL

Hard components

(ribbon back frame, outer back, arm retainer, and base)

- 6205 Black
- 6249 Platinum
- 6259 Midnight

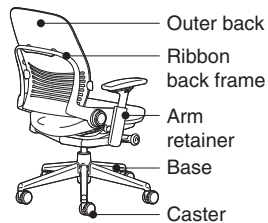

Polished aluminum package

is available on black chairs only. Polished aluminum is applied to ribbon back frame, base, and casters. Stools and Plus models are not available with this package.

Arms

- Black only

Column and foot ring on stools

- 7207 Black only

All Steelcase seating with standard upholstery fabrics complies with requirements of the State of California Technical Bulletin 117-2013. All standard seating is labeled to be in compliance with California 117-2013.

Programs & Services

▶ See the *Surface Materials Reference Manual* for further detail about programs and services offered for seating.

The Customer's Own Material (COM) Program

offers the opportunity for customers to select fabrics that are not offered through the standard Steelcase surface materials program for use on Steelcase products. Through the COM program, Steelcase will test your materials for application on Steelcase products. Once approved, you can place your order. Steelcase will facilitate the entire ordering process and give you a production schedule.

Steelcase will order the COM fabric directly from the textile manufacturer. For up-to-date information regarding fabric test results for all COM fabrics and details regarding yardage requirements for most Seating lines, visit the COM website. To locate the COM website:

- Visit www.steelcase.com

Soil retardants are treatments that provide long-term soil and stain resistance to a fabric without affecting the shade or the integrity of the fabric. The following Steelcase Textiles are available pre-treated with soil retardant. (You do not need to select the soil-retardant option for these fabrics and incur the upcharge.)

- Jacks
- Link
- Spyder

For information on soil retardant fabrics on Select Surfaces, please refer to the *Surface Materials Reference Manual*.

Soil-retardant treatment is available on all other seating fabrics at an additional upcharge per seating unit. To order this option, please select "Soil-Retardant Treatment" under "Optional Accessories."

For soil-retardant treatment on COMs, please select "Soil-Retardant Treatment" under "Optional Accessories." Minimums or additional yardage may be required. Please contact the vendor directly for specific information.

Extended lead times may be necessary for this service.

Contact your Steelcase Solutions Fulfillment Team Representative at 1.888.STEELCASE (1.888.783.3522) or send an email to lineone@steelcase.com.

Fire Codes

▶ See page 517 for upholstery fabrics available for use with FCS modification.

Steelcase offers Fire Code Seating modification (FCS) on some seating models.

The most rigorous fire codes in the nation have been developed in California, and the Steelcase FCS modification is designed to meet those codes. Fire Code Seating (FCS) indicates that a product is constructed to meet the strict fire code requirements of high public occupancy areas such as theaters, meeting rooms, and lobbies. The FCS standards will meet the State of California Bureau of Electronic and Appliance Repair, Home Furnishings, and Thermal Insulation Technical Bulletin 133 (Cal TB 133). Boston adopted the California Bureau of Electronic and Appliance Repair, Home Furnishings, and Thermal Insulation Technical Bulletin TB 133 test standard in 1992.

Local codes may have special requirements for upholstery.

Resources

Printed Materials

- ▶ Leap Brochure (11-0002334)
- ▶ Humantech Case Study (03-0003715)
- ▶ Leap Productivity and Health Impact Study (03-0003716)

Online Resources

- ▶ Interactive User Guide available on www.steelcase.com
- ▶ Leap mini-site (download) available on village.steelcase.com or viewable on www.steelcase.com.
- ▶ Model sales conversation available on village.steelcase.com
- ▶ Leap User Guide available on www.steelcase.com
- ▶ Adjustability video available on www.steelcase.com
- ▶ Leap White Paper Packet available on village.steelcase.com
- ▶ Environmental profiles available on www.steelcase.com/sustainability.

Dimensions

▶ Page 52

Leap Upholstery

What Is It?

Fabric, leather, or vinyl-covered back and seat, 3D Knit back.

Fabric

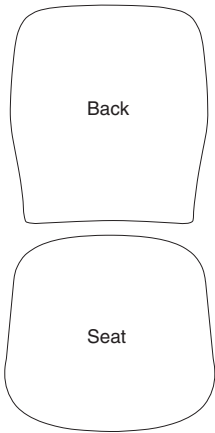

Leather, Vinyl, and Select Fabrics

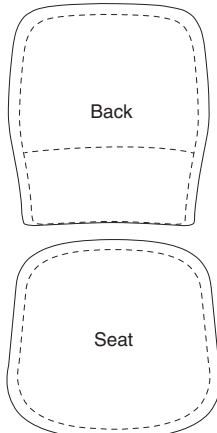

3D Knit Back

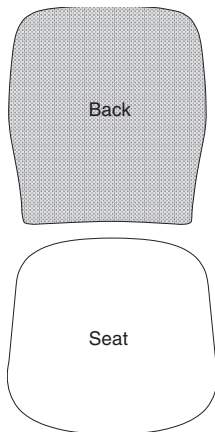

Stitched seams are included on the back cushion and seat cushion of the following:

- Leather
- Customer's Own Leather (COL)
- Vinyl
- Select Customer's Own Material/Vinyl (COM)

Pattern alignment at the lumbar seam cannot be guaranteed.

3D Knit back is made up of three layers: the 3D Knit, a solid fabric that matches the 3D Knit color, and the polyester cushion that provides exceptional comfort. The seat on these models can be specified with Cogent: Connect fabric colors to match the 3D Knit color, or in any other material.

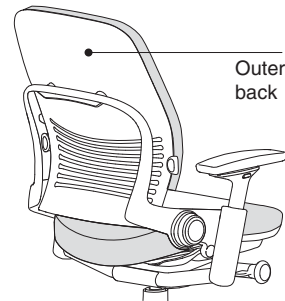

Plastic outer back is fully exposed.

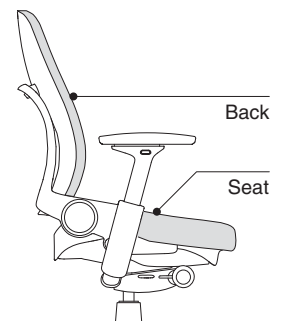

Seat and back cushions can be removed and replaced if damaged.

Dimensions

Leap 462 Series

Features	Overall Depth	Width	Height	Seat Depth	Functional Seat Depth	Seat Width	Seat Height from Floor	Ring Height from Floor	Back Width	Back Height from Seat
Leap 462 Series										
Work Chairs										
Adjustable Seat Depth	21 ³ / ₄ " to 24 ³ / ₄ "	27"	38 ¹ / ₂ " to 43 ¹ / ₂ "	19"	15 ³ / ₄ " to 18 ³ / ₄ "	19 ¹ / ₄ "	15 ¹ / ₂ " to 20 ¹ / ₂ "	N.A.	18"	25"
Stools										
Adjustable Seat Depth	21 ³ / ₄ " to 24 ³ / ₄ "	27"	46" to 54"	19"	15 ³ / ₄ " to 18 ³ / ₄ "	19 ¹ / ₄ "	22" to 30"	N.A.	18"	25"
Plus Work Chairs										
Adjustable Seat Depth	21 ³ / ₄ " to 24 ³ / ₄ "	31 ³ / ₄ "	38 ³ / ₄ " to 42 ¹ / ₂ "	20 ¹ / ₂ "	16 ³ / ₄ " to 18 ³ / ₄ "	22 ³ / ₄ "	15 ¹ / ₂ " to 19 ¹ / ₂ "	6" to 18"	20"	24 ¹ / ₂ "

Dimensions were measured with BIFMA CMD (chair-measuring device).

****Arm width adjustment** is 15"-20", (19³/₄"-24³/₄" for Leap Plus). Arm pivot adjustment adds 2¹/₄" to the minimum width providing a total of 12³/₄"-20" of width between the arms.

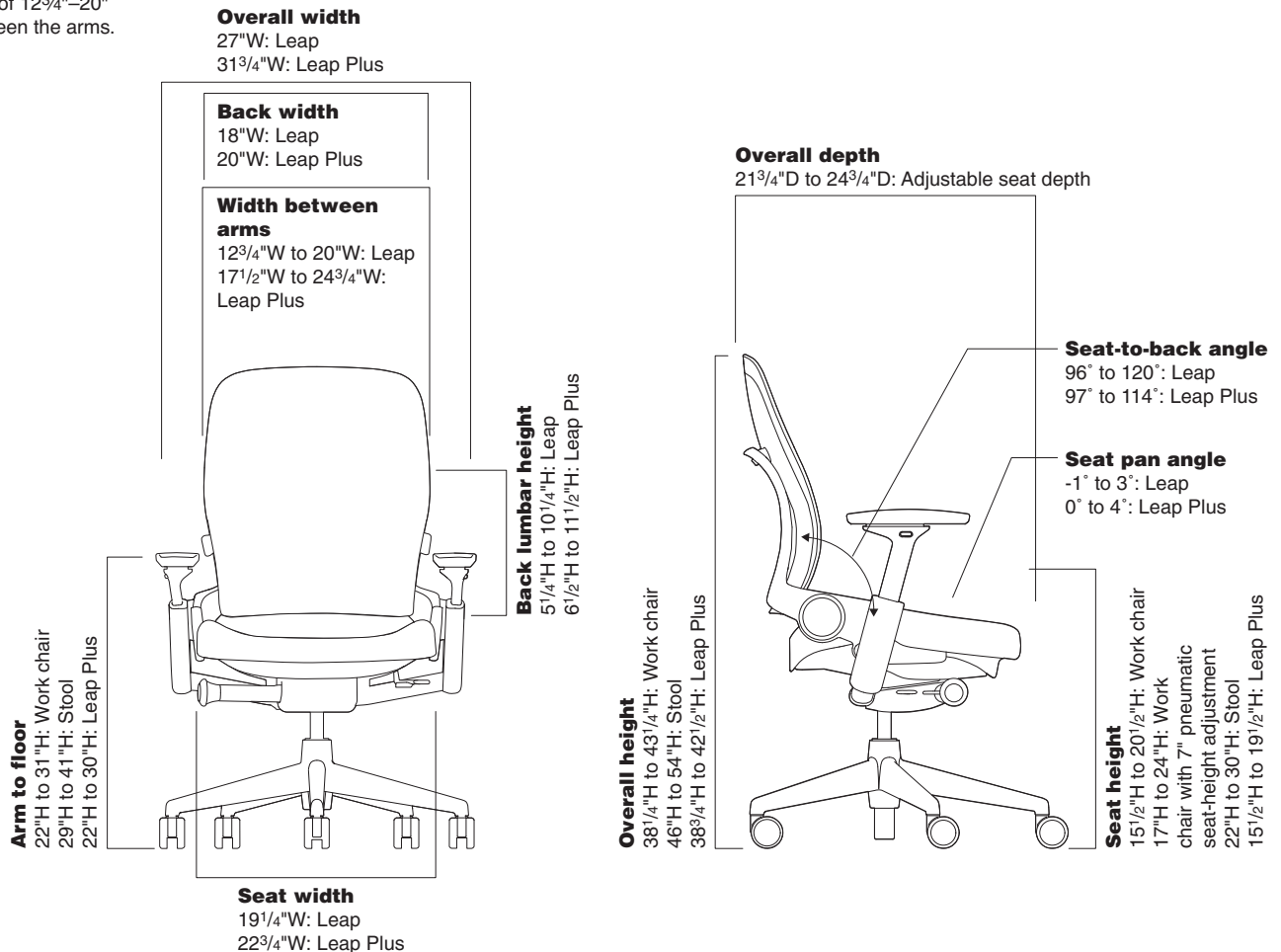

• Back Lumbar Height	• Lumbar Flex Zone	• Width Between Arms	• Arm to Floor	• Arm Height from Seat	• Arm Cap Pivot Range	• Seat Pan Angle	• Angle Between Seat and Back	• Headrest Height Adjustment Range
Work Chairs								
5¼" to 10¼"	5¼" to 10¼"	12¾" to 20"***	22" to 31"	7" to 11"	30°	-1° to 3°	96° to 120°	2¼"
Stools								
5¼" to 10¼"	5¼" to 10¼"	12¾" to 20"***	29" to 41"	7" to 11"	30°	-1° to 3°	96° to 120°	N.A.
Plus Work Chairs								
6½" to 11½"	11¼" to 16¼"	17½" to 24¾"***	22" to 30"	7¼" to 11¼"	30"	0° to 4°	97° to 114°	N.A.

Leap 462 Series Value Package Work Chair

with Buzz2 Upholstery



Tip: Leap value package work chair offers Leap chair features at a lower price than when selected individually.

Standard Includes		Required to Specify
<ul style="list-style-type: none"> ▶ Need help? Product details, page 48 	<ul style="list-style-type: none"> • Upper back force • 5" pneumatic seat-height adjustment • Variable back stop • Lower back firmness • Rectilinear independent height-, width-, pivot- and depth-adjustable arms: black plastic • 3" seat depth adjustment • Passive seat edge angle • Adjustable lumbar • Frame, seat shell, outer back, and five-arm base: black plastic only • Standard upholstery design: Buzz2 fabric only • 2½"-diameter, hard-composition, dual-wheel casters: black 	<ul style="list-style-type: none"> 1 Style number 2 Buzz2 fabric color number for upholstery on seat and back 3 Options, if selected (see below) ▶ See <i>Surface Materials</i>, page 504.

Options	U.S. Price	Required to Specify
Casters <ul style="list-style-type: none"> • Soft, dark grey treaded, dual-wheel roll-control casters for use on hard floors 	+\$27	Specify <i>with soft roll-control casters</i> .

Specification Information	
Style Number	U.S. Base Price
LEAPV2	\$1515

▶ Detailed dimensions, page 52



For Canadian Pricing

Multiply U.S. Price by the Canadian price factor.

▶ See page 1 for details.

Leap 462 Series Value Package Work Chair

with Cogent: Connect Upholstery

Leap 462 Series
Value Package
Work Chair



Tip: Leap value package work chair offers Leap chair features at a lower price than when selected individually.

Standard Includes		Required to Specify
<ul style="list-style-type: none"> ▶ Need help? Product details, page 48 	<ul style="list-style-type: none"> • Upper back force • 5" pneumatic seat-height adjustment • Variable back stop • Lower back firmness • Rectilinear independent height-, width-, pivot- and depth-adjustable arms: black plastic • 3" seat depth adjustment • Passive seat edge angle • Adjustable lumbar • Frame, seat shell, outer back, and five-arm base: black plastic only • Standard upholstery design: Cogent: Connect fabric only • 2½"-diameter, hard-composition, dual-wheel casters: black 	<ol style="list-style-type: none"> 1 Style number 2 Cogent: Connect fabric color number for upholstery on seat and back 3 Options, if selected (see below) <ul style="list-style-type: none"> ▶ See <i>Surface Materials</i>, page 504.

Options	U.S. Price	Required to Specify
Casters <ul style="list-style-type: none"> • Soft, dark grey treaded, dual-wheel roll-control casters for use on hard floors 	+\$27	Specify with soft roll-control casters.

Specification Information	
Style Number	U.S. Base Price
46216179V	\$1516

▶ Detailed dimensions, page 52



For Canadian Pricing
Multiply U.S. Price by the Canadian price factor.
▶ See page 1 for details.

Leap 462 Series Platinum Package Work Chair



Tip: Leap platinum package work chair offers Leap premium performance features at a lower price than when selected individually.

Standard Includes		Required to Specify
<ul style="list-style-type: none"> ▶ Need help? Product details, page 48 	<ul style="list-style-type: none"> • Upper back force • 5" pneumatic seat-height adjustment • Variable back stop • Lower back firmness • Rectilinear independent height-, width-, pivot- and depth-adjustable arms: black plastic • 3" seat depth adjustment • Passive seat edge angle • Adjustable lumbar • Frame, seat shell, outer back, and five-arm base: platinum plastic only • 3D Knit on back only • Standard upholstery design: Cogent: Connect fabric only • 2½"-diameter, hard-composition, dual-wheel casters: black 	<ul style="list-style-type: none"> 1 Style number 2 3D Knit color number for back 3 Cogent: Connect color number for upholstery on seat 4 Options, if selected (see below) ▶ See <i>Surface Materials</i>, page 504.

Options	U.S. Price	Required to Specify
Casters <ul style="list-style-type: none"> • Soft, dark grey treaded, dual-wheel roll-control casters for use on hard floors 	+\$27	Specify <i>with soft roll-control casters</i> .

Specification Information	
Style Number	U.S. Base Price
LEAP3DP	\$1670

▶ Detailed dimensions, page 52



For Canadian Pricing
 Multiply U.S. Price by the Canadian price factor.
 ▶ See page 1 for details.

Leap 462 Series Work Chair

Upholstery on Back and Seat



Standard Includes	Required to Specify
-------------------	---------------------

<p>► Need help? Product details, page 48</p>	<ul style="list-style-type: none"> • Upper back force • 5" pneumatic seat-height adjustment • Variable back stop • Lower back firmness • Rectilinear independent height-, width-, pivot-, and depth- adjustable arms and soft arm caps, if selected: black plastic • Frame, seat shell, outer back, and five-arm base: plastic • 3" seat depth adjustment • Passive seat edge angle • Adjustable lumbar • Standard upholstery design: fabric price group 1 • 2½"-diameter, hard-composition, dual-wheel casters: black 	<ol style="list-style-type: none"> 1 Style number 2 Plastic color for frame, seat shell, outer back, and base 3 Fabric color number for upholstery on seat and back 4 Options, if selected (see below) <p>► See <i>Surface Materials</i>, page 504.</p>
--	---	---

Options	U.S. Price	Required to Specify
---------	------------	---------------------

Surface Materials	Upholstery on seat and back		
	<ul style="list-style-type: none"> • Fabric price group 1 • Fabric price group 2 • Fabric price group 3 • Fabric price group 4 • Fabric price group 5 • Fabric price group 6 • Fabric price group 7 • Fabric price group 8 • Fabric price group 9 • Fabric price group 10 • Steelcase leather upholstery 	<p>No cost</p> <p>+\$ 27</p> <p>+\$ 49</p> <p>+\$ 70</p> <p>+\$ 88</p> <p>+\$109</p> <p>+\$125</p> <p>+\$158</p> <p>+\$194</p> <p>+\$219</p> <p>+\$730</p>	<p>Specify fabric color number.</p> <p>Specify fabric color number.</p> <p>Specify fabric color number.</p> <p>Specify fabric color number.</p> <p>Specify fabric color number.</p> <p>Specify fabric color number.</p> <p>Specify fabric color number.</p> <p>Specify fabric color number.</p> <p>Specify fabric color number.</p> <p>Specify fabric color number.</p> <p>Add suffix S to the style number and specify leather color number.</p> <p>Add suffix S to the style number and specify Select Surfaces leather price group 1.</p> <p>► See <i>Surface Materials Reference Manual</i>. Add suffix S to the style number and specify Elmosoft leather color number.</p> <p>Add suffix S to the style number and specify Select Surfaces leather price group 2.</p> <p>► See <i>Surface Materials Reference Manual</i>. Add suffix S to the style number and specify vinyl color number.</p> <p>► See <i>Surface Materials Reference Manual</i> to specify.</p> <p>Add suffix S to the style number and specify fabric number.</p> <p>Add suffix S to the style number and specify leather color number.</p>
	<ul style="list-style-type: none"> • Select Surfaces leather price group 1 • Elmosoft leather upholstery • Select Surfaces leather price group 2 • Steelcase vinyl • Customer's Own Material (COM) • Customer's Own Material/Vinyl (COM-Sewn) • Customer's Own Leather (COL) 	<p>+\$730</p> <p>+\$845</p> <p>+\$845</p> <p>+\$108</p> <p>No cost</p> <p>+\$ 81</p> <p>+\$366</p>	<p>Add suffix S to the style number and specify leather color number.</p> <p>Add suffix S to the style number and specify Select Surfaces leather price group 1.</p> <p>► See <i>Surface Materials Reference Manual</i>. Add suffix S to the style number and specify Elmosoft leather color number.</p> <p>Add suffix S to the style number and specify Select Surfaces leather price group 2.</p> <p>► See <i>Surface Materials Reference Manual</i>. Add suffix S to the style number and specify vinyl color number.</p> <p>► See <i>Surface Materials Reference Manual</i> to specify.</p> <p>Add suffix S to the style number and specify fabric number.</p> <p>Add suffix S to the style number and specify leather color number.</p>
	Contrasting upholstery on seat and back		
	<ul style="list-style-type: none"> • Contrasting fabrics 	<p>+\$ 33</p>	<p>Add suffix K to the style number and specify fabric color numbers.</p>
	Contrasting upholstery on seat		
	<ul style="list-style-type: none"> • Fabric price group 1 • Fabric price group 2 • Fabric price group 3 • Fabric price group 4 • Fabric price group 5 • Fabric price group 6 • Fabric price group 7 • Fabric price group 8 • Fabric price group 9 • Fabric price group 10 • Steelcase leather upholstery 	<p>No cost</p> <p>+\$ 10</p> <p>+\$ 27</p> <p>+\$ 36</p> <p>+\$ 43</p> <p>+\$ 53</p> <p>+\$ 64</p> <p>+\$ 79</p> <p>+\$ 97</p> <p>+\$112</p> <p>+\$364</p>	<p>Specify fabric color number.</p> <p>Specify fabric color number.</p> <p>Specify fabric color number.</p> <p>Specify fabric color number.</p> <p>Specify fabric color number.</p> <p>Specify fabric color number.</p> <p>Specify fabric color number.</p> <p>Specify fabric color number.</p> <p>Specify fabric color number.</p> <p>Specify fabric color number.</p> <p>Specify fabric color number.</p> <p>Add suffix S to the style number and specify leather color number.</p> <p>Add suffix S to the style number and specify leather color number.</p>
	<ul style="list-style-type: none"> • Select Surfaces leather price group 1 	<p>+\$364</p>	<p>Add suffix S to the style number and specify leather color number.</p>

Tip: Select COMs require sewn application with an additional upcharge. Specify with an **S** suffix.

Tip: Always add suffixes in alphabetical order when specifying options to Leap seating.

► Detailed dimensions, page 52



For Canadian Pricing
Multiply U.S. Price by the Canadian price factor.

► See page 1 for details.

► **Options, continued on next page**

► Options, continued from previous page

	Options	U.S. Price	Required to Specify
Surface Materials, continued	Contrasting upholstery on seat, continued		
	• Elmosoft leather upholstery	+\$420	Add suffix S to the style number and specify leather color number.
	• Select Surfaces leather price group 2	+\$420	Add suffix S to the style number and specify leather color number.
	• Steelcase vinyl	+\$ 52	Add suffix S to the style number and specify vinyl color number.
	• Customer's Own Material (COM)	No cost	► See <i>Surface Materials Reference Manual</i> .
	• Customer's Own Leather (COL)	+\$181	Add suffix S to the style number and specify leather color number.
	• Customer's Own Material/Vinyl (COM-Sewn)	+\$ 42	Add suffix S to the style number and specify vinyl color number.
	Contrasting upholstery on back		
	• Fabric price group 1	No cost	Specify fabric color number.
	• Fabric price group 2	+\$ 17	Specify fabric color number.
	• Fabric price group 3	+\$ 22	Specify fabric color number.
	• Fabric price group 4	+\$ 34	Specify fabric color number.
	• Fabric price group 5	+\$ 45	Specify fabric color number.
	• Fabric price group 6	+\$ 56	Specify fabric color number.
	• Fabric price group 7	+\$ 61	Specify fabric color number.
	• Fabric price group 8	+\$ 79	Specify fabric color number.
	• Fabric price group 9	+\$ 97	Specify fabric color number.
	• Fabric price group 10	+\$107	Specify fabric color number.
	• Steelcase leather upholstery	+\$364	Add suffix S to the style number and specify leather color number.
	• Select Surfaces leather price group 1	+\$364	Add suffix S to the style number and specify leather color number.
	• Elmosoft leather upholstery	+\$423	Add suffix S to the style number and specify leather color number.
	• Select Surfaces leather price group 2	+\$423	Add suffix S to the style number and specify leather color number.
• Steelcase vinyl	+\$ 54	Add suffix S to the style number and specify vinyl color number.	
• Customer's Own Material (COM)	No cost	► See <i>Surface Materials Reference Manual</i> .	
• Customer's Own Leather (COL)	+\$183	Add suffix S to the style number and specify leather color number.	
• Customer's Own Material/Vinyl (COM-Sewn)	+\$ 37	Add suffix S to the style number and specify vinyl color number.	
	Soil-retardant treatment	+\$ 27	Specify <i>with soil-retardant treatment</i> .
	Fire Code Seating (FCS)	+\$ 81	Add suffix F to the style number.
	Polished aluminum package		
	• Polished aluminum package on chairs with arms and 6205 Black frame finish	+\$493	Add suffix C to the style number.
	Platinum		
	• On frame, base, arm retainer, and outer back	+\$ 89	Specify <i>with 6249 Platinum</i> .
Arms	• Height-adjustable arms, soft arm caps	-\$ 94	Specify <i>with height-adjustable arms</i> .
	• Armless	-\$296	Specify <i>without arms</i> .
Seat Height	• 7" pneumatic seat-height adjustment	+\$ 61	Specify <i>with 7" pneumatic seat-height adjustment</i> .
Headrest	• Headrest	+\$243	Specify <i>with headrest</i> .
Lumbar	• Without lumbar	-\$ 60	Specify <i>without lumbar</i> .
Casters	• Soft, dark grey treaded, dual-wheel roll-control casters for use on hard floors	+\$ 27	Specify <i>with soft roll-control casters</i> .
Glides	• Glides: plastic	+\$ 27	Specify <i>with glides</i> .

Tip: Fire Code Seating (FCS) option is available with certain upholstery fabric choices only.
► Page 517

Tip: Fire Code Seating (FCS) option is available on Leap chairs with fully adjustable arms or armless models only.

Tip: Plastic shell on headrest is available in black only.

Tip: Glides are not available on chairs with polished aluminum package.

► Specification Information, on next page

Leap 462 Series Work Chair, Upholstery on Back and Seat

► Options, on previous page

Specification Information



• Style • Number	• U.S. • Base • Price
46216179	\$1584



For Canadian Pricing

Multiply U.S. Price by the Canadian price factor.

► See page 1 for details.

Leap 462 Series Work Chair

3D Knit on Back with Upholstery on Seat



	Standard Includes	Required to Specify
<p>► Need help? Product details, page 48</p>	<ul style="list-style-type: none"> • Upper back force • 5" pneumatic seat-height adjustment • Variable back stop • Lower back firmness • Rectilinear independent height-, width-, pivot-, and depth- adjustable arms and soft arm caps, if selected: black plastic • Frame, seat shell, outer back, and five-arm base: plastic • 3" seat depth adjustment • Passive seat edge angle • Adjustable lumbar • 3D Knit on back only • Standard upholstery design on seat: Fabric price group 1 • 2½"-diameter, hard-composition, dual-wheel casters: black 	<ol style="list-style-type: none"> 1 Style number 2 Plastic color for frame, seat shell, outer back, and base 3 3D Knit color for back 4 Fabric color number for upholstery on seat 5 Options, if selected (see below) <ul style="list-style-type: none"> ► See <i>Surface Materials</i>, page 504.

	Options	U.S. Price	Required to Specify
Surface Materials	Upholstery		
	• Fabric price group 1	No cost	Specify fabric color number.
	• Fabric price group 2	+\$ 10	Specify fabric color number.
	• Fabric price group 3	+\$ 27	Specify fabric color number.
	• Fabric price group 4	+\$ 36	Specify fabric color number.
	• Fabric price group 5	+\$ 43	Specify fabric color number.
	• Fabric price group 6	+\$ 53	Specify fabric color number.
	• Fabric price group 7	+\$ 64	Specify fabric color number.
	• Fabric price group 8	+\$ 79	Specify fabric color number.
	• Fabric price group 9	+\$ 97	Specify fabric color number.
	• Fabric price group 10	+\$112	Specify fabric color number.
	• Steelcase leather upholstery	+\$365	Add suffix S to the style number and specify leather color number.
	• Select Surfaces leather price group 1	+\$365	Add suffix S to the style number and specify Select Surfaces leather price group 1.
• Elmosoft leather upholstery	+\$421	► See <i>Surface Materials Reference Manual</i> . Add suffix S to the style number and specify Elmosoft leather color number.	
• Select Surfaces leather price group 2	+\$421	Add suffix S to the style number and specify Select Surfaces leather price group 2.	
• Steelcase vinyl	+\$ 53	► See <i>Surface Materials Reference Manual</i> . Add suffix S to the style number and specify vinyl color number.	
• Customer's Own Material (COM)	No cost	► See <i>Surface Materials Reference Manual</i> to specify.	
• Customer's Own Material/Vinyl (COM-Sewn)	+\$ 43	Add suffix S to the style number and specify fabric number.	
• Customer's Own Leather (COL)	+\$182	Add suffix S to the style number and specify leather color number.	
• Fire Code Seating (FCS)	+\$ 81	Add suffix F to the style number.	
• Soil-retardant treatment applied to upholstery fabric	+\$ 27	Specify <i>with soil-retardant treatment</i> .	
	Polished aluminum package		
	• Polished aluminum package on chairs with arms and 6205 Black frame finish	+\$493	Add suffix C to the style number.
	Platinum		
	• On frame, base, arm retainer, and outer back	+\$ 89	Specify <i>with 6249 Platinum</i> .
Arms	• Height-adjustable arms, soft arm caps	-\$ 94	Specify <i>with height-adjustable arms</i> .
	• Armless	-\$296	Specify <i>without arms</i> .

Tip: Select COMs require sewn application with an additional upcharge. Specify with an **S** suffix.

Tip: Always add suffixes in alphabetical order when specifying options to Leap seating.

Tip: Fire Code Seating (FCS) option is available with certain upholstery fabric choices only.

► Page 517

Tip: Fire Code Seating (FCS) option is available on Leap chairs with fully adjustable arms or armless models only.

Tip: Glides are not available on chairs with polished aluminum package.

► Detailed dimensions, page 52

► Options, continued on next page

► Options, continued from previous page

Options	U.S. Price	Required to Specify
Seat Height • 7" pneumatic seat-height adjustment	+\$ 61	Specify with 7" pneumatic seat-height adjustment.
Headrest • Headrest	+\$243	Specify with headrest.
Lumbar • Without lumbar	-\$ 60	Specify without lumbar.
Casters • Soft, dark grey treaded, dual-wheel roll-control casters for use on hard floors	+\$ 27	Specify with soft roll-control casters.
Glides • Glides: plastic	+\$ 27	Specify with glides.

Tip: Plastic shell on headrest is available in black only.

Specification Information



• Style • Number	• U.S. • Base • Price
•	•
•	•
•	•

46216189	\$1645
•	•
•	•

Leap 462 Series



For Canadian Pricing
Multiply U.S. Price by the Canadian price factor.
► See page 1 for details.

Leap 462 Series Stool

Upholstery on Back and Seat

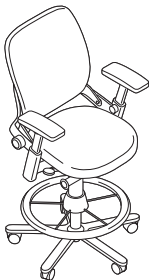

Standard Includes	Required to Specify
<p>► Need help? Product details, page 48</p> <ul style="list-style-type: none"> • Upper back force • 8" pneumatic seat-height adjustment • Variable back stop • Lower back firmness • Passive seat edge angle • Rectilinear independent height-, width-, pivot-, and depth-adjustable arms and soft arm caps, if selected: black plastic • Frame, seat shell, outer back, and five-arm base: plastic • 3" seat depth adjustment • Column and 4" adjustable foot ring: black • Standard upholstery design: fabric price group 1 • 2"-diameter, hard-composition, dual-wheel casters: black 	<ol style="list-style-type: none"> 1 Style number 2 Plastic color for frame, seat shell, outer back, and base 3 Fabric color number for upholstery on seat and back 4 Options, if selected (see below) <ul style="list-style-type: none"> ► See <i>Surface Materials</i>, page 504.

Surface Materials	Options	U.S. Price	Required to Specify
	<p>Upholstery on seat and back</p> <ul style="list-style-type: none"> • Fabric price group 1 • Fabric price group 2 • Fabric price group 3 • Fabric price group 4 • Fabric price group 5 • Fabric price group 6 • Fabric price group 7 • Fabric price group 8 • Fabric price group 9 • Fabric price group 10 • Steelcase leather upholstery • Select Surfaces leather price group 1 • Elmosoft leather upholstery • Select Surfaces leather price group 2 • Steelcase vinyl • Customer's Own Material (COM) • Customer's Own Material/Vinyl (COM-Sewn) • Customer's Own Leather (COL) 	<p>No cost</p> <p>+\$ 27</p> <p>+\$ 49</p> <p>+\$ 70</p> <p>+\$ 88</p> <p>+\$109</p> <p>+\$125</p> <p>+\$158</p> <p>+\$194</p> <p>+\$219</p> <p>+\$730</p> <p>+\$730</p> <p>+\$845</p> <p>+\$845</p> <p>+\$108</p> <p>No cost</p> <p>+\$ 81</p> <p>+\$366</p>	<p>Specify fabric color number.</p> <p>Specify fabric color number.</p> <p>Specify fabric color number.</p> <p>Specify fabric color number.</p> <p>Specify fabric color number.</p> <p>Specify fabric color number.</p> <p>Specify fabric color number.</p> <p>Specify fabric color number.</p> <p>Specify fabric color number.</p> <p>Specify fabric color number.</p> <p>Add suffix S to the style number and specify leather color number.</p> <p>Add suffix S to the style number and specify Select Surfaces leather price group 1.</p> <p>► See <i>Surface Materials Reference Manual</i>. Add suffix S to the style number and specify Elmosoft leather color number.</p> <p>Add suffix S to the style number and specify Select Surfaces leather price group 2.</p> <p>► See <i>Surface Materials Reference Manual</i>. Add suffix S to the style number and specify vinyl color number.</p> <p>► See <i>Surface Materials Reference Manual</i> to specify.</p> <p>Add suffix S to the style number and specify fabric number.</p> <p>Add suffix S to the style number and specify leather color number.</p> <p>Specify with <i>6249 Platinum</i>.</p> <p>Add suffix K to the style number and specify fabric color numbers.</p> <p>Specify fabric color number.</p> <p>Specify fabric color number.</p> <p>Specify fabric color number.</p> <p>Specify fabric color number.</p> <p>Specify fabric color number.</p> <p>Specify fabric color number.</p> <p>Specify fabric color number.</p> <p>Specify fabric color number.</p> <p>Specify fabric color number.</p> <p>Specify fabric color number.</p> <p>Specify fabric color number.</p> <p>Specify fabric color number.</p> <p>Specify fabric color number.</p>
	<p>Platinum</p> <ul style="list-style-type: none"> • On frame, base, arm retainer, and outer back 	<p>+\$ 89</p>	<p>Specify with <i>6249 Platinum</i>.</p>
	<p>Contrasting upholstery on seat and back</p> <ul style="list-style-type: none"> • Contrasting fabrics 	<p>+\$ 33</p>	<p>Add suffix K to the style number and specify fabric color numbers.</p>
	<p>Contrasting upholstery on seat</p> <ul style="list-style-type: none"> • Fabric price group 1 • Fabric price group 2 • Fabric price group 3 • Fabric price group 4 • Fabric price group 5 • Fabric price group 6 • Fabric price group 7 • Fabric price group 8 • Fabric price group 9 • Fabric price group 10 	<p>No cost</p> <p>+\$ 10</p> <p>+\$ 27</p> <p>+\$ 36</p> <p>+\$ 43</p> <p>+\$ 53</p> <p>+\$ 64</p> <p>+\$ 79</p> <p>+\$ 97</p> <p>+\$112</p>	<p>Specify fabric color number.</p> <p>Specify fabric color number.</p> <p>Specify fabric color number.</p> <p>Specify fabric color number.</p> <p>Specify fabric color number.</p> <p>Specify fabric color number.</p> <p>Specify fabric color number.</p> <p>Specify fabric color number.</p> <p>Specify fabric color number.</p> <p>Specify fabric color number.</p> <p>Specify fabric color number.</p>

► Options, continued on next page

*Tip: Select COMs require sewn application with an additional upcharge. Specify with an **S** suffix.*

Tip: Always add suffixes in alphabetical order when specifying options to Leap seating.

Tip: Fire Code Seating (FCS) option is available with certain upholstery fabric choices only.

► Page 517

Tip: Fire Code Seating (FCS) option is available on Leap chairs with fully adjustable arms or armless models only.

► Detailed dimensions, page 52

► Options, continued from previous page

	Options	U.S. Price	Required to Specify
Surface Materials, continued	Contrasting upholstery on seat, continued		
	• Steelcase leather upholstery	+\$364	Add suffix S to the style number and specify leather color number.
	• Select Surfaces leather price group 1	+\$364	Add suffix S to the style number and specify leather color number.
	• Elmosoft leather upholstery	+\$420	Add suffix S to the style number and specify leather color number.
	• Select Surfaces leather price group 2	+\$420	Add suffix S to the style number and specify leather color number.
	• Steelcase vinyl	+\$ 52	Add suffix S to the style number and specify vinyl color number.
	• Customer's Own Material (COM)	No cost	► See <i>Surface Materials Reference Manual</i> .
	• Customer's Own Leather (COL)	+\$181	Add suffix S to the style number and specify leather color number.
	• Customer's Own Material/Vinyl (COM-Sewn)	+\$ 42	Add suffix S to the style number and specify vinyl color number.
	Contrasting upholstery on back		
	• Fabric price group 1	No cost	Specify fabric color number.
	• Fabric price group 2	+\$ 17	Specify fabric color number.
	• Fabric price group 3	+\$ 22	Specify fabric color number.
	• Fabric price group 4	+\$ 34	Specify fabric color number.
• Fabric price group 5	+\$ 45	Specify fabric color number.	
• Fabric price group 6	+\$ 56	Specify fabric color number.	
• Fabric price group 7	+\$ 61	Specify fabric color number.	
• Fabric price group 8	+\$ 79	Specify fabric color number.	
• Fabric price group 9	+\$ 97	Specify fabric color number.	
• Fabric price group 10	+\$107	Specify fabric color number.	
• Steelcase leather upholstery	+\$364	Add suffix S to the style number and specify leather color number.	
• Select Surfaces leather price group 1	+\$364	Add suffix S to the style number and specify leather color number.	
• Elmosoft leather upholstery	+\$423	Add suffix S to the style number and specify leather color number.	
• Select Surfaces leather price group 2	+\$423	Add suffix S to the style number and specify leather color number.	
• Steelcase vinyl	+\$ 54	Add suffix S to the style number and specify vinyl color number.	
• Customer's Own Material (COM)	No cost	► See <i>Surface Materials Reference Manual</i> .	
• Customer's Own Leather (COL)	+\$183	Add suffix S to the style number and specify leather color number.	
• Customer's Own Material/Vinyl (COM-Sewn)	+\$ 37	Add suffix S to the style number and specify vinyl color number.	
	Soil-retardant treatment	+\$ 27	Specify <i>with soil-retardant treatment</i> .
	Fire Code Seating (FCS)	+\$ 81	Add suffix F to the style number.
Arms	• Height-adjustable arms, soft arm caps	-\$ 94	Specify <i>with height-adjustable arms</i> .
	• Armless	-\$296	Specify <i>without arms</i> .
Lumbar	• Without lumbar	-\$ 60	Specify <i>without lumbar</i> .
Casters	• Soft, dark grey treaded, dual-wheel roll-control casters for use on hard floors	+\$ 27	Specify <i>with soft roll-control casters</i> .
Glides	• Glides: plastic	+\$ 27	Specify <i>with glides</i> .

► Specification Information, on next page

**For Canadian Pricing**

Multiply U.S. Price by the Canadian price factor.

► See page 1 for details.

Leap 462 Series Stool Upholstery on Back and Seat

► Options, on previous page

Specification Information



• Style • Number	• U.S. • Base • Price
46267179	\$1825



For Canadian Pricing

Multiply U.S. Price by the Canadian price factor.

► See page 1 for details.

Leap 462 Series Stool

3D Knit on Back with Upholstery on Seat

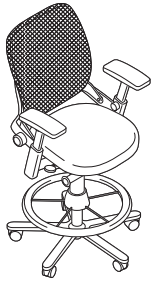

Standard Includes		Required to Specify
<p>► Need help? Product details, page 48</p>	<ul style="list-style-type: none"> • Upper back force • 8" pneumatic seat-height adjustment • Variable back stop • Lower back firmness • Passive seat edge angle • Rectilinear independent height-, width-, pivot-, and depth-adjustable arms and soft arm caps, if selected: black plastic • Frame, seat shell, outer back, and five-arm base: plastic • Column and 4" adjustable foot ring: black • 3D Knit on back only • 3" seat depth adjustment • Adjustable lumbar • Standard upholstery design on seat: fabric price group 1 • 2"-diameter, hard-composition, dual-wheel casters: black 	<ol style="list-style-type: none"> 1 Style number 2 Plastic color for frame, seat shell, outer back, and base 3 3D Knit color for back 4 Fabric color number for upholstery on seat 5 Options, if selected (see below) <ul style="list-style-type: none"> ► See <i>Surface Materials</i>, page 504.

	Options	U.S. Price	Required to Specify
Surface Materials	Upholstery		
	• Fabric price group 1	No cost	Specify fabric color number.
	• Fabric price group 2	+\$ 10	Specify fabric color number.
	• Fabric price group 3	+\$ 27	Specify fabric color number.
	• Fabric price group 4	+\$ 36	Specify fabric color number.
	• Fabric price group 5	+\$ 43	Specify fabric color number.
	• Fabric price group 6	+\$ 53	Specify fabric color number.
	• Fabric price group 7	+\$ 64	Specify fabric color number.
	• Fabric price group 8	+\$ 79	Specify fabric color number.
	• Fabric price group 9	+\$ 97	Specify fabric color number.
	• Fabric price group 10	+\$112	Specify fabric color number.
	• Steelcase leather upholstery	+\$365	Add suffix S to the style number and specify leather color number.
	• Select Surfaces leather price group 1	+\$365	Add suffix S to the style number and specify Select Surfaces leather price group 1. ► See <i>Surface Materials Reference Manual</i> .
• Elmosoft leather upholstery	+\$421	Add suffix S to the style number and specify Elmosoft leather color number.	
• Select Surfaces leather price group 2	+\$421	Add suffix S to the style number and specify Select Surfaces leather price group 2. ► See <i>Surface Materials Reference Manual</i> .	
• Steelcase vinyl	+\$ 53	Add suffix S to the style number and specify vinyl color number. ► See <i>Surface Materials Reference Manual</i> to specify.	
• Customer's Own Material (COM)	No cost	Add suffix S to the style number and specify fabric number.	
• Customer's Own Material/Vinyl (COM-Sewn)	+\$ 43	Add suffix S to the style number and specify leather color number.	
• Customer's Own Leather (COL)	+\$182	Add suffix F to the style number. Specify <i>with soil-retardant treatment</i> .	
• Fire Code Seating (FCS)	+\$ 81		
• Soil-retardant treatment applied to upholstery fabric	+\$ 27		
	Platinum		
	• On frame, base, arm retainer, and outer back	+\$ 89	Specify <i>with 6249 Platinum</i> .
Arms	• Height-adjustable arms, soft arm caps	-\$ 94	Specify <i>with height-adjustable arms</i>
	• Armless	-\$296	Specify <i>without arms</i> .
Lumbar	• Without lumbar	-\$ 60	Specify <i>without lumbar</i> .
Casters	• Soft, dark grey treaded, dual-wheel roll-control casters for use on hard floors	+\$ 27	Specify <i>with soft roll-control casters</i> .
Glides	• Glides: plastic	+\$ 27	Specify <i>with glides</i> .

Tip: Select COMs require sewn application with an additional upcharge. Specify with an **S** suffix.

Tip: Fire Code Seating (FCS) option is available on Leap chairs with fully adjustable arms or armless models only.

Tip: Always add suffixes in alphabetical order when specifying options to Leap seating.

► Detailed dimensions, page 52

Specification Information



• Style • Number	• U.S. • Base • Price
46267189	\$1886

Leap 462 Series



For Canadian Pricing
Multiply U.S. Price by the
Canadian price factor.
▶ See page 1 for details.

Leap Plus 462 Series Work Chair

Upholstery on Back and Seat



Standard Includes	Required to Specify
-------------------	---------------------

- | | | |
|---|---|---|
| <ul style="list-style-type: none"> ▶ Need help? Product details, page 48 | <ul style="list-style-type: none"> • Upper back force • 4" pneumatic seat-height adjustment • Variable back stop • Lower back firmness • Rectilinear independent height-, width-, pivot-, and depth- adjustable arms and soft arm caps, if selected: black plastic • Frame, seat shell, outer back, and five-arm base: plastic • 2" seat depth adjustment • Adjustable lumbar • Standard upholstery design: fabric price group 1 • 2 1/2"-diameter, hard-composition, dual-wheel casters: black | <ol style="list-style-type: none"> 1 Style number 2 Plastic color for frame, seat shell, outer back, and base 3 Fabric color number for upholstery on seat and back 4 Options, if selected (see below) <p>▶ See <i>Surface Materials</i>, page 504.</p> |
|---|---|---|

Surface Materials	Options	U.S. Price	Required to Specify
-------------------	---------	------------	---------------------

Surface Materials	Upholstery on seat and back		
	• Fabric price group 1	No cost	Specify fabric color number.
	• Fabric price group 2	+\$ 27	Specify fabric color number.
	• Fabric price group 3	+\$ 49	Specify fabric color number.
	• Fabric price group 4	+\$ 70	Specify fabric color number.
	• Fabric price group 5	+\$ 88	Specify fabric color number.
	• Fabric price group 6	+\$109	Specify fabric color number.
	• Fabric price group 7	+\$125	Specify fabric color number.
	• Fabric price group 8	+\$158	Specify fabric color number.
	• Fabric price group 9	+\$194	Specify fabric color number.
	• Fabric price group 10	+\$219	Specify fabric color number.
	• Steelcase leather upholstery	+\$730	Add suffix S to the style number and specify leather color number.
	• Select Surfaces leather price group 1	+\$730	Add suffix S to the style number and specify Select Surfaces leather price group 1.
	• Elmosoft leather upholstery	+\$845	▶ See <i>Surface Materials Reference Manual</i> . Add suffix S to the style number and specify Elmosoft leather color number.
	• Select Surfaces leather price group 2	+\$845	Add suffix S to the style number and specify Select Surfaces leather price group 2.
• Steelcase vinyl	+\$108	▶ See <i>Surface Materials Reference Manual</i> . Add suffix S to the style number and specify vinyl color number.	
• Customer's Own Material (COM)	No cost	▶ See <i>Surface Materials Reference Manual</i> to specify.	
• Customer's Own Material/Vinyl (COM-Sewn)	+\$ 81	Add suffix S to the style number and specify fabric number.	
• Customer's Own Leather (COL)	+\$366	Add suffix S to the style number and specify leather color number.	
• Fire Code Seating (FCS)	+\$ 81	Add suffix F to the style number.	
• Soil-retardant treatment applied to upholstery fabric	+\$ 27	Specify <i>with soil-retardant treatment</i> .	

Tip: Select COMs require sewn application with an additional upcharge. Specify with an S suffix.

Tip: Always add suffixes in alphabetical order when specifying options to Leap seating.

Tip: Fire Code Seating (FCS) option is available with certain upholstery fabric choices only.

▶ Page 517

Tip: Fire Code Seating (FCS) option is available on Leap chairs with fully adjustable arms or armless models only.

Contrasting upholstery on seat and back

• Contrasting fabrics	+\$ 33	Add suffix K to the style number and specify fabric color numbers.
-----------------------	--------	---

Contrasting upholstery on seat

• Fabric price group 1	No cost	Specify fabric color number.
• Fabric price group 2	+\$ 10	Specify fabric color number.
• Fabric price group 3	+\$ 27	Specify fabric color number.
• Fabric price group 4	+\$ 36	Specify fabric color number.
• Fabric price group 5	+\$ 43	Specify fabric color number.
• Fabric price group 6	+\$ 53	Specify fabric color number.
• Fabric price group 7	+\$ 64	Specify fabric color number.
• Fabric price group 8	+\$ 79	Specify fabric color number.
• Fabric price group 9	+\$ 97	Specify fabric color number.
• Fabric price group 10	+\$112	Specify fabric color number.

▶ Detailed dimensions, page 52

▶ **Options, continued on next page**

► Options, continued from previous page

Options	U.S. Price	Required to Specify
Surface Materials, continued		
Contrasting upholstery on seat, continued		
• Steelcase leather upholstery	+\$364	Add suffix S to the style number and specify leather color number.
• Select Surfaces leather price group 1	+\$364	Add suffix S to the style number and specify leather color number.
• Elmosoft leather upholstery	+\$420	Add suffix S to the style number and specify leather color number.
• Select Surfaces leather price group 2	+\$420	Add suffix S to the style number and specify leather color number.
• Steelcase vinyl	+\$ 52	Add suffix S to the style number and specify vinyl color number.
• Customer's Own Material (COM)	No cost	► See <i>Surface Materials Reference Manual</i> .
• Customer's Own Leather (COL)	+\$181	Add suffix S to the style number and specify leather color number.
• Customer's Own Material/Vinyl (COM-Sewn)	+\$ 42	Add suffix S to the style number and specify vinyl color number.
Contrasting upholstery on back		
• Fabric price group 1	No cost	Specify fabric color number.
• Fabric price group 2	+\$ 17	Specify fabric color number.
• Fabric price group 3	+\$ 22	Specify fabric color number.
• Fabric price group 4	+\$ 34	Specify fabric color number.
• Fabric price group 5	+\$ 45	Specify fabric color number.
• Fabric price group 6	+\$ 56	Specify fabric color number.
• Fabric price group 7	+\$ 61	Specify fabric color number.
• Fabric price group 8	+\$ 79	Specify fabric color number.
• Fabric price group 9	+\$ 97	Specify fabric color number.
• Fabric price group 10	+\$107	Specify fabric color number.
• Steelcase leather upholstery	+\$364	Add suffix S to the style number and specify leather color number.
• Select Surfaces leather price group 1	+\$364	Add suffix S to the style number and specify leather color number.
• Elmosoft leather upholstery	+\$423	Add suffix S to the style number and specify leather color number.
• Select Surfaces leather price group 2	+\$423	Add suffix S to the style number and specify leather color number.
• Steelcase vinyl	+\$ 54	Add suffix S to the style number and specify vinyl color number.
• Customer's Own Material (COM)	No cost	► See <i>Surface Materials Reference Manual</i> .
• Customer's Own Leather (COL)	+\$183	Add suffix S to the style number and specify leather color number.
• Customer's Own Material/Vinyl (COM-Sewn)	+\$ 37	Add suffix S to the style number and specify vinyl color number.
Soil-retardant treatment	+\$ 27	Specify <i>with soil-retardant treatment</i> .
Fire Code Seating (FCS)	+\$ 81	Add suffix F to the style number.
Platinum		
• On frame, base, arm retainer, and outer back	+\$ 89	Specify <i>with 6249 Platinum</i> .
Arms		
• Height-adjustable arms, soft arm caps	-\$ 94	Specify <i>with height-adjustable arms</i> .
• Armless	-\$296	Specify <i>without arms</i> .
Seat Height		
• 5" pneumatic seat-height adjustment	+\$ 61	Specify <i>with 5" pneumatic seat-height adjustment</i> .
Lumbar		
• Without lumbar	-\$ 60	Specify <i>without lumbar</i> .
Casters		
• Soft, dark grey treaded, dual-wheel roll-control casters for use on hard floors	+\$ 27	Specify <i>with soft roll-control casters</i> .
Glides		
• Glides: plastic	+\$ 27	Specify <i>with glides</i> .

► Specification Information, on next page

**For Canadian Pricing**

Multiply U.S. Price by the Canadian price factor.

► See page 1 for details.

Leap Plus 462 Series Work Chair Upholstery on Back and Seat

► Options, on previous page

Specification Information



• Style • Number	• U.S. • Base • Price
46296179	\$2379



For Canadian Pricing
Multiply U.S. Price by the
Canadian price factor.
► See page 1 for details.

Leap Plus 462 Series Work Chair

3D Knit on Back with Upholstery on Seat



Standard Includes	Required to Specify
-------------------	---------------------

- | | | |
|--|--|--|
| <p>▶ Need help? Product details, page 48</p> | <ul style="list-style-type: none"> • Upper back force • 4" pneumatic seat-height adjustment • Variable back stop • Lower back firmness • Rectilinear independent height-, width-, pivot-, and depth- adjustable arms and soft arm caps, if selected: black plastic • Frame, seat shell, outer back, and five-arm base: plastic • 2" seat depth adjustment • Adjustable lumbar • 3D Knit on back only • Standard upholstery design on seat: Fabric price group 1 • 2½"-diameter, hard-composition, dual-wheel casters: black | <ol style="list-style-type: none"> 1 Style number 2 Plastic color for frame, seat shell, outer back, and base 3 3D Knit color for back 4 Fabric color number for upholstery on seat 5 Options, if selected (see below) <p>▶ See <i>Surface Materials</i>, page 504.</p> |
|--|--|--|

Options	U.S. Price	Required to Specify
---------	------------	---------------------

Surface Materials	Upholstery		
	<ul style="list-style-type: none"> • Fabric price group 1 • Fabric price group 2 • Fabric price group 3 • Fabric price group 4 • Fabric price group 5 • Fabric price group 6 • Fabric price group 7 • Fabric price group 8 • Fabric price group 9 • Fabric price group 10 • Steelcase leather upholstery • Select Surfaces leather price group 1 • Elmosoft leather upholstery • Select Surfaces leather price group 2 • Steelcase vinyl • Customer's Own Material (COM) • Customer's Own Material/Vinyl (COM-Sewn) • Customer's Own Leather (COL) • Fire Code Seating (FCS) • Soil-retardant treatment applied to upholstery fabric 	<p>No cost</p> <p>+\$ 10</p> <p>+\$ 27</p> <p>+\$ 36</p> <p>+\$ 43</p> <p>+\$ 53</p> <p>+\$ 64</p> <p>+\$ 79</p> <p>+\$ 97</p> <p>+\$112</p> <p>+\$365</p> <p>+\$365</p> <p>+\$421</p> <p>+\$421</p> <p>+\$ 53</p> <p>No cost</p> <p>+\$ 43</p> <p>+\$182</p> <p>+\$ 81</p> <p>+\$ 27</p>	<p>Specify fabric color number.</p> <p>Specify fabric color number.</p> <p>Specify fabric color number.</p> <p>Specify fabric color number.</p> <p>Specify fabric color number.</p> <p>Specify fabric color number.</p> <p>Specify fabric color number.</p> <p>Specify fabric color number.</p> <p>Specify fabric color number.</p> <p>Specify fabric color number.</p> <p>Add suffix S to the style number and specify leather color number.</p> <p>Add suffix S to the style number and specify Select Surfaces leather price group 1.</p> <p>▶ See <i>Surface Materials Reference Manual</i>.</p> <p>Add suffix S to the style number and specify Elmosoft leather color number.</p> <p>Add suffix S to the style number and specify Select Surfaces leather price group 2.</p> <p>▶ See <i>Surface Materials Reference Manual</i>.</p> <p>Add suffix S to the style number and specify vinyl color number.</p> <p>▶ See <i>Surface Materials Reference Manual</i> to specify.</p> <p>Add suffix S to the style number and specify fabric number.</p> <p>Add suffix S to the style number and specify leather color number.</p> <p>Add suffix F to the style number.</p> <p>Specify <i>with soil-retardant treatment</i>.</p>
	Platinum		
	<ul style="list-style-type: none"> • On frame, base, arm retainer, and outer back 	+\$ 89	Specify <i>with 6249 Platinum</i> .
	Arms		
	<ul style="list-style-type: none"> • Height-adjustable arms, soft arm caps • Armless 	-\$ 94	Specify <i>with height-adjustable arms</i> .
		-\$296	Specify <i>without arms</i> .
	Seat Height		
	<ul style="list-style-type: none"> • 5" pneumatic seat-height adjustment 	+\$ 61	Specify <i>with 5" pneumatic seat-height adjustment</i> .

Tip: Select COMs require sewn application with an additional upcharge. Specify with an **S** suffix.

Tip: Always add suffixes in alphabetical order when specifying options to Leap seating.

Tip: Fire Code Seating (FCS) option is available with certain upholstery fabric choices only.

▶ Page 517

Tip: Fire Code Seating (FCS) option is available on Leap chairs with fully adjustable arms or armless models only.

▶ Detailed dimensions, page 52

▶ Options, continued on next page

► Options, continued from previous page

	Options	U.S. Price	Required to Specify
Lumbar	• Without lumbar	-\$60	Specify <i>without lumbar</i> .
Casters	• Soft, dark grey treaded, dual-wheel roll-control casters for use on hard floors	+\$27	Specify <i>with soft roll-control casters</i> .
Glides	• Glides: plastic	+\$27	Specify <i>with glides</i> .

Specification Information



• Style • Number	• U.S. • Base • Price
46296189	\$2440



For Canadian Pricing

Multiply U.S. Price by the Canadian price factor.

► See page 1 for details.

Understanding and Specifying Think 465 Series Work Chairs

Product Details

Think 465 Series	78
Think Upholstery	81
Dimensions	82

Specifying

Value Package

Value Package Work Chairs	84
---------------------------	----

Work Chairs

3D Knit with Standard Upholstery on Seat	85
Standard Upholstery on Back and Seat	86

Stools

3D Knit with Standard Upholstery on Seat	88
Standard Upholstery on Back and Seat	90

Work Chairs

Highly adjustable task seating offers maximum personalization for fit and comfort for a range of duration and use. By making a series of simple adjustments, you can customize the chair to your body, preferences, and tasks. These chairs provide continuous, stable, comfort, and can be quickly adjusted to support you in upright, and reclining work postures.

- Gesture 442 Series
- Leap 462 Series
- Think 465 Series
- Amia 482 Series
- Reply 466 Series
- Jersey Series
- Leap 464 Series WorkLounge
- Criterion 453 Series

Adjustability Features

▶ See page 22 for a comparison to other chairs. **Think 465 Series**

Mechanisms

Weight-activated ●

Seat Adjustments

Pneumatic height ●

Passive seat edge angle ●

Seat depth ●

Back Adjustments

Lumbar height ●

Arm Adjustments

Arm height ●

Arm width ●

Arm pivot ●

Arm depth ●

Other Features

Foot ring height (stool) ●

Think 465 Series

Think is for performance based customers who are seeking a progressive aesthetic, intuitive ease of use, and the strongest environmental attributes.

Back frame and seat shell are plastic.

Lumbar height adjusts over 4¼" to provide additional lower back support and is available as an option.

Arm caps can pivot independently 30° in and 30° out to accommodate individual user preferences.

Comfort dial back control provides four settings for the user's personal preference and work style.

Seat height adjusts within a 5" range with a pneumatic adjustment mechanism. A 3" or 7" range is available as an option. Stools have a 10" range.

Casters have hard, dual-wheels that roll smoothly on carpets. They are 2½" for increased mobility. Soft, dark grey treaded, dual-wheel roll-control casters are available for use on hard floors or mats. Glides are also available as an option.

Tip: Do not roll the chair across asphalt during installation as this may damage the casters.



Arm width adjusts 4½" overall to support forearms in neutral position.

Arm height can adjust independently within a 4" range to help relieve upper back and shoulder fatigue.

Arm depth can retract 3" to allow user to get closer to the worksurface and into tight corners.

Passive seat edge angle allows the front edge of the seat to flex 1½" to relieve pressure under the user's thighs.

Seat depth adjusts within a 2½" range to accommodate users of varying leg lengths.

Five-arm base is available in plastic or polished aluminum.

Product Details

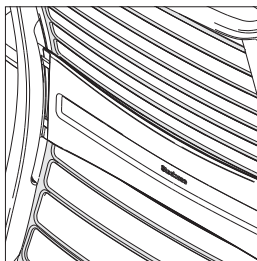

Integrated LiveBack System dynamically supports and follows the movements of the user.

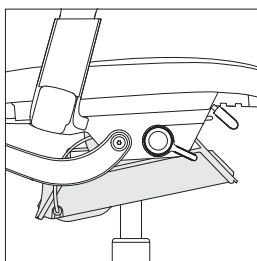

Advanced weight-activated mechanism with a natural fluid motion keeps users oriented to their work.

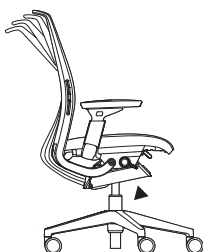

Comfort dial has four settings that allow for the user's personal preference and work style.

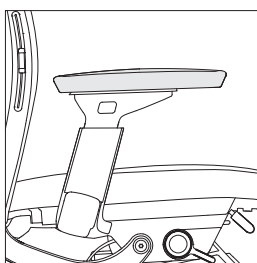

Rectilinear arms with soft caps are standard.

Cartoned request on your dealer purchase order means Think chairs will ship knocked down with the chair base and pneumatic cylinder separated from the rest of the chair. This allows for shipment in a smaller carton. Assembly by a qualified dealer installer is required. *Tip: Assembly instructions are included.*

Uncartoned request on your dealer purchase order means Think chairs will ship fully assembled.

Adjustment Features

Adjustability instructions are included with every chair.

Seat Adjustments

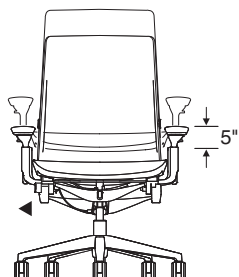

Seat height adjusts pneumatically. To lower, hold handle up while seated. To raise, hold handle up and keep your weight off the chair. Standard range of adjustability is 5" from 16 1/2"H to 21 1/2"H. A 3" range of adjustability (15"H to 18"H), and a 7" range of adjustability (18"H to 25"H) is available as an option. A 10" range of adjustability (22 1/2"H to 32 1/2"H) is available on stools.

Passive seat edge angle relieves pressure under the user's thighs. The passive front seat edge helps properly support the angle of the user's leg and thigh without compromising pelvic support. The front seat edge angle flexes 1 1/2".

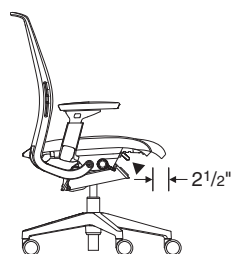

Seat depth adjusts 2 1/2" (15 1/2"-18") by pulling handle up. Slide seat forward or back to accommodate various leg lengths. Release handle to lock.

Back Adjustments

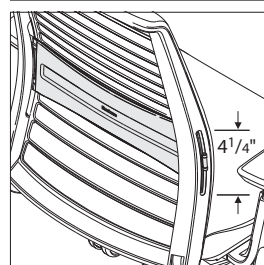

Lumbar height adjusts 4 1/4" (6" to 10 1/4" from seat) by grabbing exposed tabs and sliding the lumbar support up or down. Fixed lumbar height is available as an option on work chairs and stools. The fixed lumbar is positioned 8" from the seat. The adjustment handles are replaced with inserts that fill the lumbar slot in the back frame.



Weight-activated setting

Boosted setting



Mid-stop recline setting

Upright setting

Comfort dial has four settings: (1) weight-activated setting; (2) boosted setting that has approximately 20% more resistance than your body is providing; (3) mid-stop recline setting; and (4) an upright setting.

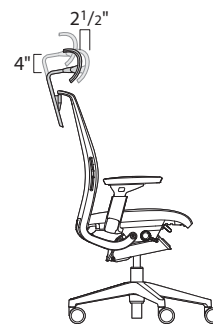

Headrest (option) adjusts 4" vertically and 2 1/2" horizontally (front-to-back) to support the head and neck of the user in both upright and recline postures. The plastic stalk and underside of the headrest will coordinate to match the frame color specified: black, platinum, or seagull. The foam pad of the headrest will always be black. Headrest is not available on stools. Whether ordered initially or at a later date, the headrest ships in its own carton and must be field installed.

Arm Adjustments

Rectilinear height-, width-, pivot-, and depth-adjustable arms come standard on all arm models of chairs and stools.

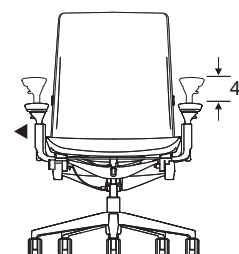

Arm height adjusts independently within a range of 4" (7"-11" from the seat). Push button on outside and under arm cap in while moving arms up or down. Releasing buttons locks arms in position.

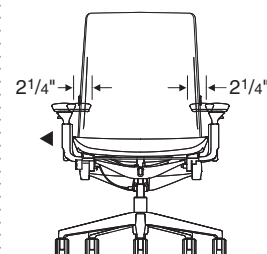

Arm width can be adjusted 2 1/4" each, 4 1/2" overall. Grasp arm cap and move in or out.

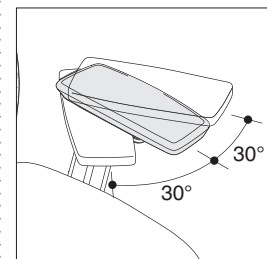

Arms pivot independently, 30° inward and outward. Grasp arm and push front to left or right.

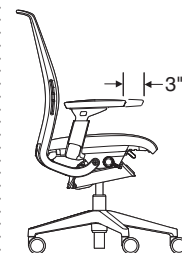

Arm depth adjusts by sliding arm caps back 3". Friction-fit mechanism keeps arms in position.

Think 465 Series, continued

Other Features

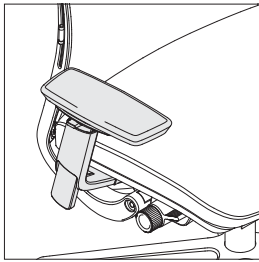

Height-only adjustable arm is also available and adjusts 4".



Armless models are also available.



Coat hanger (option) is field installed. The color will coordinate with the frame of the chair, but will not match the frame exactly. The coat hanger supports up to 10 pounds and is not intended to hold bags or backpacks. This option is not available on stools.

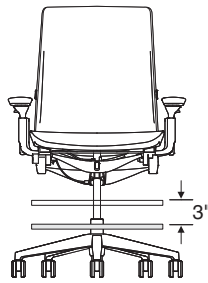

Foot ring height on stools adjusts by rotating it counterclockwise to unlock. Then raise or lower ring to desired position before rotating it clockwise to lock. The foot ring has a diameter of 20".

Soft dual-wheel roll-control casters feature an internal brake that activates when the chair is not under load to reduce shifting when user stands up.

Surface Materials

▶ See surface materials on page 504 for specific availability or refer to the *Surface Materials Reference Manual* for further information.

Upholstery

- Fabric
- Fabric with soil-retardant treatment (option)
- 3D Knit (back only)
- Elmosoft leather
- Select Surfaces leather
- Leather
- Vinyl

Hard components

- All models (back frame, arm retainer, and base)
- 4799 Platinum Metallic
- 6205 Black
- 7243 Seagull

Pneumatic cylinders and stool ring finishes are determined by the frame finish.

- 4799 Platinum Metallic (Platinum and Seagull frame)
- 6205 Black (Black frame)

All Models (adjustment handles, arm pads, arm stalk, casters, glides)

- 6205 Black

Flexors and lumbar finishes are determined by the frame finish.

- 6205 Black (Black Frame)
- 6527 Merle (Platinum and Seagull Frames)

Outer seat shell is determined by the frame finish.

- 6205 Black (Black Frame)
- 6249 Platinum Solid (Platinum and Seagull Frames)

Inner seat shell

- 6205 Black

All seat cushions have a unique sewn construction that is included in the price of the chair.



Stitch detail across the lumbar region of the back cushion will be required on some models with an upholstered backrest. To ensure optimum performance of the Integrated LiveBack System, all Steelcase Select Surfaces, COMs, Leathers, Vinyls, and some standard fabrics will require this sewn detail. The stitch detail is included in the price of the chair.

All Steelcase seating with standard upholstery fabrics complies with requirements of the State of California Technical Bulletin 117-2013. All standard seating is labeled to be in compliance with California 117-2013.

Programs & Services

▶ See *Surface Materials Reference Manual* for further detail about programs and services offered for seating.

The Customer's Own Material (COM) Program

offers the opportunity for customers to select fabrics that are not offered through the standard Steelcase surface materials program for use on Steelcase products. Through the COM program, Steelcase will test your materials for application on Steelcase products. Once approved, you can place your order. Steelcase will facilitate the entire ordering process and give you a production schedule. Steelcase will order the COM fabric directly from the textile manufacturer. For up-to-date information regarding fabric test results for all COM fabrics and details regarding yardage requirements for most seating lines, visit the COM website. To locate the COM website:

- Visit www.steelcase.com

Soil retardants are treatments that provide long-term soil and stain resistance to a fabric without affecting the shade or the integrity of the fabric. The following Steelcase Textiles are available pre-treated with soil retardant. (You do not need to select the soil-retardant option for these fabrics and incur the upcharge.)

- Jacks
- Link
- Spyder

For information on soil retardant fabrics on Select Surfaces, please refer to the *Surface Materials Reference Manual*.

Soil-retardant treatment is available on all other seating fabrics at an additional upcharge per seating unit. To order this option, please select "Soil-Retardant Treatment" under "Optional Accessories."

For soil-retardant treatment on COMs, please select "Soil-Retardant Treatment" under "Optional Accessories." Minimums or additional yardage may be required. Please contact the vendor directly for specific information.

Extended lead times may be necessary for this service.

Contact your Steelcase Solutions Fulfillment Team Representative at 1.888.STEELCASE (1.888.783.3522) or send an email to line-one@steelcase.com.

Fire Codes

▶ See page 517 for upholstery fabrics available for use with FCS modification.

Steelcase offers Fire Code Seating modification (FCS) on some seating models. The most rigorous fire codes in the nation have been developed in California, and the Steelcase FCS modification is designed to meet those codes. Fire Code Seating (FCS) indicates that a product is constructed to meet the strict fire code requirements of high public occupancy areas such as theaters, meeting rooms, and lobbies. The FCS standards will meet the State of California Bureau of Electronic and Appliance Repair, Home Furnishings, and Thermal Insulation Technical Bulletin 133 (Cal TB 133). Boston adopted the California Bureau of Electronic and Appliance Repair, Home Furnishings, and Thermal Insulation Technical Bulletin TB 133 test standard in 1992.

Local codes may have special requirements for upholstery.

Dimensions

▶ Page 82

Think Upholstery

What Is It?

Fabric, leather, or vinyl-covered back and seat, 3D Knit back.

Fabric

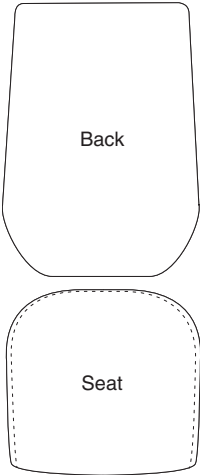

Leather, Vinyl, and Select Other Fabrics

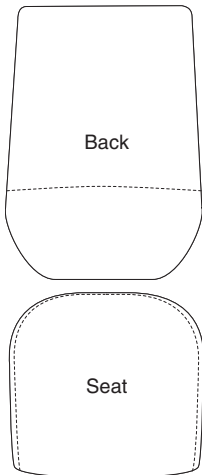

3D Knit on Back only

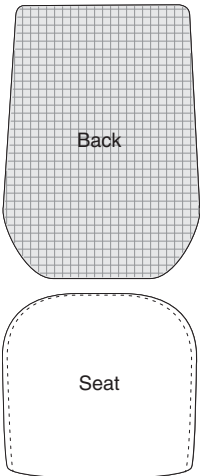

Stitched seams are included on the back cushion and seat cushion of the following:

- Leather
- Vinyl
- Some upholstery
- Customer's Own Leather (COL)
- Vinyl
- Select Customer's Own Material/Vinyl (COM)

Pattern alignment at the lumbar seam cannot be guaranteed.

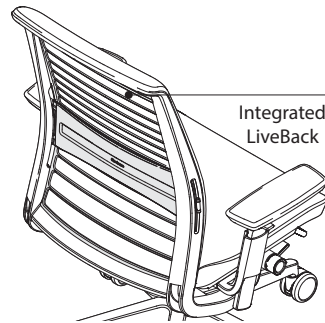

Back flexors are fully exposed.

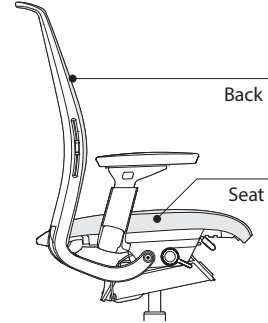

Seat and back assemblies can be removed and replaced if damaged.

3D Knit back with Fire Code option

is made up of three layers: the 3D Knit, a fire code barrier, and a solid fabric that matches the 3D Knit color (which will be visible through the back flexors). The 3D Knit fire code back rest is not transparent.

Dimensions

Think 465 Series

Features	Overall Depth	Width	Height	Seat Depth	Functional Seat Depth	Seat Width	Seat Height from Floor	Ring Height from Floor	Back Width	Back Height from Seat	Lumbar Height from Seat
----------	---------------	-------	--------	------------	-----------------------	------------	------------------------	------------------------	------------	-----------------------	-------------------------

Think 465 Series

Chairs

Arms	22" to 24 1/4"	28 1/2"	37 1/4" to 42"	18 1/2"	15 1/2" to 18"	20 1/4"	16 1/2" to 21 1/2" (15" to 18", 18" to 25" optional)	N.A.	18"	22 3/4"	6" to 10 1/4"
------	----------------	---------	----------------	---------	----------------	---------	--	------	-----	---------	---------------

Stools

Arms	22" to 24 1/4"	28 1/2"	44" to 53 3/4"	18 1/2"	15 1/2" to 18"	20 1/4"	22 1/2" to 32 1/2"	10" to 13"	18"	22 3/4"	6" to 10 1/4"
------	----------------	---------	----------------	---------	----------------	---------	--------------------	------------	-----	---------	---------------

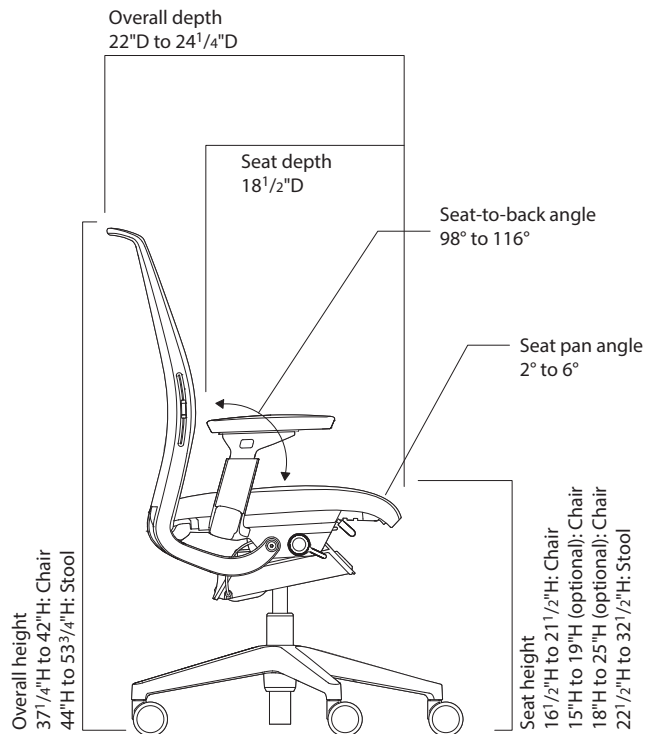
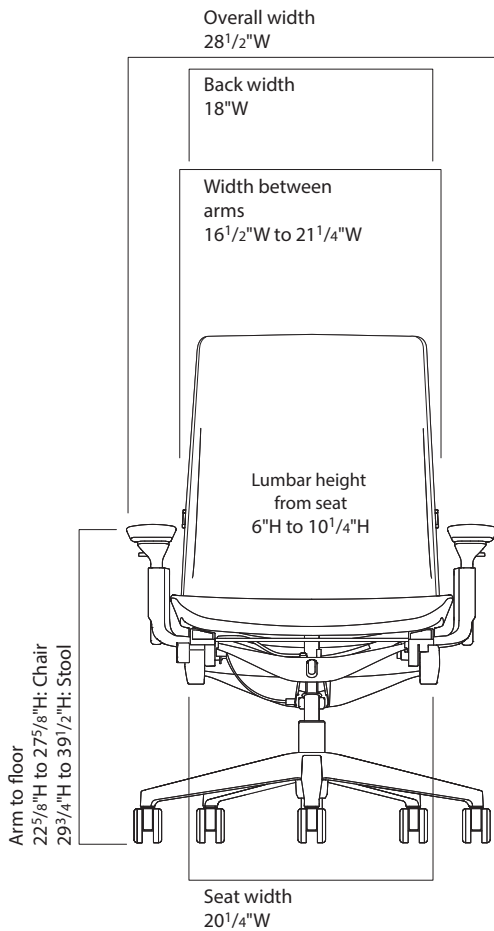

• Width • Between • Adjustable • Arms	• Width • Between • Fixed • Arms	• Arm • to • Floor	• Arm • Height • from • Seat	• Arm • Height • from Seat • for Fixed • Arms	• Arm Cap • Pivot • Range	• Angle • Between • Seat and • Back	• Seat • Pan • Angle	• Headrest • Height • Adjustment • Range
--	---	--------------------------	---------------------------------------	---	---------------------------------	--	----------------------------	---

Chairs

16½" to 21¼" 14" to 21¼" (including pivot)	20½"	22⅝" to 27⅝"	7" to 11"	8¼"	30° inward, 30° outward	98° to 116°	2° to 6°	4"
--	------	--------------	-----------	-----	----------------------------	-------------	----------	----

Stools

16½" to 21¼" 14" to 21¼" (including pivot)	20½"	29¾" to 39½"	7" to 11"	8¼"	30° inward, 30° outward	98° to 116°	2° to 6°	N.A.
--	------	--------------	-----------	-----	----------------------------	-------------	----------	------

Think 465 Series Value Package Work Chairs

Tip: Think value package work chair offers Think chair features at a lower price than when selected individually.

Standard Includes		Required to Specify
<ul style="list-style-type: none"> ▶ Need help? Product details, page 78 	<ul style="list-style-type: none"> • 5" pneumatic seat-height adjustment (16½"-21½") • Passive seat edge angle • Frame, seat shell, and five-arm plastic base: black • 2½" seat depth adjustment • Rectilinear height-, width-, pivot-, and depth-adjustable arms • Adjustable lumbar • 3D Knit color for back, if selected • Standard upholstery design, if selected: Cogent: Connect, Redeem, or Retrieve • 2½"-diameter, hard-composition, dual-wheel casters: black 	<ol style="list-style-type: none"> 1 Style number 2 Plastic color for frame, base, and arm retainer 3 3D Knit color for back, if selected 4 Cogent: Connect, Redeem, or Retrieve color number for upholstery on seat and back, if selected 5 Options, if selected (see below) <ul style="list-style-type: none"> ▶ See <i>Surface Materials</i>, page 504.

Options	U.S. Price	Required to Specify
Casters <ul style="list-style-type: none"> • Soft, dark grey treaded, dual-wheel roll-control casters for use on hard floors 	+\$27	Specify <i>with soft roll-control casters</i> .

Specification Information	
• Style Number	• U.S. Base Price
:	:
:	:
:	:

3D Knit Back with Standard Upholstery on Seat

465A300V \$1238

:

Standard Upholstery on Back and Seat

465A000V \$1179

:



▶ Detailed dimensions, page 82

 **For Canadian Pricing**
 Multiply U.S. Price by the Canadian price factor.
 ▶ See page 1 for details.

Think 465 Series Work Chair

Think 465 Series
Work Chair

3D Knit with Standard Upholstery on Seat



Standard Includes	Required to Specify
<ul style="list-style-type: none"> ▶ Need help? Product details, page 78 • 5" pneumatic seat-height adjustment (16½"-21½") • Passive seat edge angle • Frame, seat shell, and five-arm plastic base: black • 2½" seat depth adjustment • Rectilinear height-, width-, pivot-, and depth-adjustable arms • Adjustable lumbar • 3D Knit on back • Standard upholstery design on seat: fabric price group 1 • 2½"-diameter, hard-composition, dual-wheel casters: black 	<ol style="list-style-type: none"> 1 Style number 2 Plastic color for frame, base, and arm retainer 3 3D Knit color for back 4 Fabric color number for upholstery on seat 5 Options, if selected (see below) <ul style="list-style-type: none"> ▶ See <i>Surface Materials</i>, page 504.

Options	U.S. Price	Required to Specify
Surface Materials <ul style="list-style-type: none"> • Upholstery on seat <ul style="list-style-type: none"> • Fabric price group 1 • Fabric price group 2 • Fabric price group 3 • Fabric price group 4 • Fabric price group 5 • Fabric price group 6 • Fabric price group 7 • Fabric price group 8 • Fabric price group 9 • Fabric price group 10 • Steelcase leather upholstery • Select Surfaces leather price group 1 • Elmosoft leather upholstery • Select Surfaces leather price group 2 • Customer's Own Material (COM) • Soil-retardant treatment applied to upholstery fabric • Frame <ul style="list-style-type: none"> • Platinum • Seagull 	<ul style="list-style-type: none"> No cost +\$ 10 +\$ 25 +\$ 34 +\$ 43 +\$ 53 +\$ 60 +\$ 78 +\$ 96 +\$109 +\$168 +\$168 +\$197 +\$197 No cost +\$ 27 +\$ 54 +\$ 54 	<ul style="list-style-type: none"> Specify fabric color number. Specify fabric color number. Specify fabric color number. Specify fabric color number. Specify fabric color number. Specify fabric color number. Specify fabric color number. Specify fabric color number. Specify fabric color number. Specify fabric color number. Specify fabric color number. Specify leather color number. ▶ See <i>Surface Materials Reference Manual</i>. Specify Elmosoft leather color number. ▶ See <i>Surface Materials Reference Manual</i>. ▶ See <i>Surface Materials Reference Manual</i>. Specify with soil-retardant treatment. Specify with 4799 Platinum. Specify with 7243 Seagull.
Arms <ul style="list-style-type: none"> • Height-adjustable arms • Fixed arms • Armless 	<ul style="list-style-type: none"> -\$ 52 -\$104 -\$266 	<ul style="list-style-type: none"> Specify with height-adjustable arms. Specify with fixed arms. Specify without arms.
Base <ul style="list-style-type: none"> • Polished aluminum base 	<ul style="list-style-type: none"> +\$147 	<ul style="list-style-type: none"> Specify with aluminum base.
Coat Hanger <ul style="list-style-type: none"> • Coat hanger 	<ul style="list-style-type: none"> +\$ 32 	<ul style="list-style-type: none"> Specify with coat hanger.
Seat Height <ul style="list-style-type: none"> • 3" low-range pneumatic seat-height adjustment (15"-18") • 7" high-range pneumatic seat-height adjustment (18"-25") 	<ul style="list-style-type: none"> +\$ 61 +\$ 61 	<ul style="list-style-type: none"> Specify with low-range pneumatic seat-height adjustment. Specify with high-range pneumatic seat-height adjustment.
Headrest <ul style="list-style-type: none"> • Headrest 	<ul style="list-style-type: none"> +\$179 	<ul style="list-style-type: none"> Specify with headrest.
Fire Code Seating <ul style="list-style-type: none"> • Fire code seating (FCS) 	<ul style="list-style-type: none"> +\$ 41 	<ul style="list-style-type: none"> Specify with fire code seating.
Lumbar <ul style="list-style-type: none"> • Fixed lumbar support 	<ul style="list-style-type: none"> -\$ 60 	<ul style="list-style-type: none"> Specify with fixed lumbar height.
Casters <ul style="list-style-type: none"> • Soft, dark grey treaded, dual-wheel roll-control casters for use on hard floors 	<ul style="list-style-type: none"> +\$ 27 	<ul style="list-style-type: none"> Specify with soft roll-control casters.
Glides <ul style="list-style-type: none"> • Glides: plastic 	<ul style="list-style-type: none"> +\$ 27 	<ul style="list-style-type: none"> Specify with glides.

Tip: Coat hanger option is not available on chairs with headrest.

Tip: Plastic shell on headrest is available in black only.

Tip: Fire Code Seating (FCS) option is available with certain upholstery fabric choices only. ▶ Page 517

Tip: Fire Code Seating (FCS) option is available on Think chairs with fully adjustable arms or armless models only.

▶ Detailed dimensions, page 82

Specification Information	
Style Number	U.S. Base Price
465A300	\$1295

Think 465 Series

Think 465 Series Work Chair

Standard Upholstery on Back and Seat



Standard Includes	Required to Specify
<p>► Need help? Product details, page 78</p> <ul style="list-style-type: none"> • 5" pneumatic seat-height adjustment (16½"–21½") • Passive seat edge angle • Frame, seat shell, and five-arm plastic base: black • 2½" seat depth adjustment • Rectilinear height-, width-, pivot-, and depth-adjustable arms • Adjustable lumbar • Standard upholstery design: fabric price group 1 • 2½"-diameter, hard-composition, dual-wheel casters: black 	<ol style="list-style-type: none"> 1 Style number 2 Plastic color for frame, base, and arm retainer 3 Fabric color number for upholstery on seat and back 4 Options, if selected (see below) <p>► See <i>Surface Materials</i>, page 504.</p>

Surface Materials	Options	U.S. Price	Required to Specify
	<p>Contrasting</p> <ul style="list-style-type: none"> • Contrasting fabrics 	+\$ 33	Specify <i>with contrasting</i> .
	<p>Upholstery on seat</p> <ul style="list-style-type: none"> • Fabric price group 1 • Fabric price group 2 • Fabric price group 3 • Fabric price group 4 • Fabric price group 5 • Fabric price group 6 • Fabric price group 7 • Fabric price group 8 • Fabric price group 9 • Fabric price group 10 • Steelcase leather upholstery • Select Surfaces leather price group 1 • Elmosoft leather upholstery • Select Surfaces leather price group 2 • Customer's Own Material (COM) 	No cost +\$ 10 +\$ 25 +\$ 34 +\$ 43 +\$ 53 +\$ 60 +\$ 78 +\$ 96 +\$109 +\$168 +\$168 +\$197 +\$197 No cost	Specify fabric color number. Specify fabric color number. Specify fabric color number. Specify fabric color number. Specify fabric color number. Specify fabric color number. Specify fabric color number. Specify fabric color number. Specify fabric color number. Specify fabric color number. Specify fabric color number. Specify leather color number. ► See <i>Surface Materials Reference Manual</i> . Specify Elmosoft leather color number. ► See <i>Surface Materials Reference Manual</i> . ► See <i>Surface Materials Reference Manual</i> .
	<p>Upholstery on back</p> <ul style="list-style-type: none"> • Fabric price group 1 • Fabric price group 2 • Fabric price group 3 • Fabric price group 4 • Fabric price group 5 • Fabric price group 6 • Fabric price group 7 • Fabric price group 8 • Fabric price group 9 • Fabric price group 10 • Steelcase leather upholstery • Select Surfaces leather price group 1 • Elmosoft leather upholstery • Select Surfaces leather price group 2 • Customer's Own Material (COM) 	No cost +\$ 14 +\$ 27 +\$ 36 +\$ 44 +\$ 55 +\$ 64 +\$ 79 +\$ 97 +\$112 +\$176 +\$176 +\$203 +\$203 No cost	Specify fabric color number. Specify fabric color number. Specify fabric color number. Specify fabric color number. Specify fabric color number. Specify fabric color number. Specify fabric color number. Specify fabric color number. Specify fabric color number. Specify fabric color number. Specify fabric color number. Specify leather color number. Specify leather color number. ► See <i>Surface Materials Reference Manual</i> . Specify Elmosoft leather color number. ► See <i>Surface Materials Reference Manual</i> . ► See <i>Surface Materials Reference Manual</i> .
	<p>Soil retardant</p> <ul style="list-style-type: none"> • Soil-retardant treatment applied to upholstery fabric 	+\$ 27	Specify <i>with soil-retardant treatment</i> .
	<p>Frame</p> <ul style="list-style-type: none"> • Platinum • Seagull 	+\$ 54 +\$ 54	Specify <i>with 4799 Platinum</i> . Specify <i>with 7243 Seagull</i> .
	<p>Arms</p> <ul style="list-style-type: none"> • Height-adjustable arms • Fixed arms • Armless 	–\$ 52 –\$104 –\$266	Specify <i>with height-adjustable arms</i> . Specify <i>with fixed arms</i> . Specify <i>without arms</i> .
	<p>Base</p> <ul style="list-style-type: none"> • Polished aluminum base 	+\$147	Specify <i>with aluminum base</i> .

► Options, continued on next page



For Canadian Pricing

Multiply U.S. Price by the Canadian price factor.

► See page 1 for details.

► Options, continued from previous page

Options	U.S. Price	Required to Specify
Coat Hanger • Coat hanger	+\$ 32	Specify with coat hanger.
Seat Height • 3" low-range pneumatic seat-height adjustment (15"–18")	+\$ 61	Specify with low-range pneumatic seat-height adjustment.
• 7" high-range pneumatic seat-height adjustment (18"–25")	+\$ 61	Specify with high-range pneumatic seat-height adjustment.
Headrest • Headrest	+\$179	Specify with headrest.
Fire Code Seating • Fire code seating (FCS)	+\$ 81	Specify with fire code seating.
Lumbar • Fixed lumbar support	–\$ 60	Specify with fixed lumbar height.
Casters • Soft, dark grey treaded, dual-wheel roll-control casters for use on hard floors	+\$ 27	Specify with soft roll-control casters.
Glides • Glides: plastic	+\$ 27	Specify with glides.

Tip: Coat hanger option is not available on chairs with headrest.

Tip: Plastic shell on headrest is available in black only.

Tip: Fire Code Seating (FCS) option is available with certain upholstery fabric choices only.

► Page 517

Tip: Fire Code Seating (FCS) option is available on Think chairs with fully adjustable arms or armless models only.

► Detailed dimensions, page 82

Specification Information

Style Number	U.S. Base Price
465A000	\$1234
.	.



Think 465 Series

 **For Canadian Pricing**
 Multiply U.S. Price by the Canadian price factor.
 ► See page 1 for details.

Think 465 Series Stool

3D Knit with Standard Upholstery on Seat



Standard Includes		Required to Specify
<p>▶ Need help? Product details, page 78</p>	<ul style="list-style-type: none"> • 10" pneumatic seat-height adjustment (22½"-32½") • Passive seat edge angle • Frame, seat shell, and five-arm base: black • 2½" seat depth adjustment • Rectilinear height-, width-, pivot-, and depth-adjustable arms • Column and adjustable foot ring: black • Adjustable lumbar • 3D Knit on back • Standard upholstery design on seat: fabric price group 1 • 2½"-diameter, hard-composition, dual-wheel casters: black 	<ol style="list-style-type: none"> 1 Style number 2 Plastic color for frame, base, and arm retainer 3 3D Knit color for back 4 Fabric color number for upholstery on seat 5 Options, if selected (see below) <ul style="list-style-type: none"> ▶ See <i>Surface Materials</i>, page 504.

	Options	U.S. Price	Required to Specify
Surface Materials	Upholstery on seat		
	• Fabric price group 1	No cost	Specify fabric color number.
	• Fabric price group 2	+\$ 10	Specify fabric color number.
	• Fabric price group 3	+\$ 25	Specify fabric color number.
	• Fabric price group 4	+\$ 34	Specify fabric color number.
	• Fabric price group 5	+\$ 43	Specify fabric color number.
	• Fabric price group 6	+\$ 53	Specify fabric color number.
	• Fabric price group 7	+\$ 60	Specify fabric color number.
	• Fabric price group 8	+\$ 78	Specify fabric color number.
	• Fabric price group 9	+\$ 96	Specify fabric color number.
	• Fabric price group 10	+\$109	Specify fabric color number.
	• Steelcase leather upholstery	+\$168	Specify leather color number.
	• Select Surfaces leather price group 1	+\$168	▶ See <i>Surface Materials Reference Manual</i> . Specify Elmosoft leather color number.
• Elmosoft leather upholstery	+\$197	▶ See <i>Surface Materials Reference Manual</i> .	
• Select Surfaces leather price group 2	+\$197	▶ See <i>Surface Materials Reference Manual</i> .	
• Customer's Own Material (COM)	No cost	Specify with soil-retardant treatment.	
• Soil-retardant treatment applied to upholstery fabric	+\$ 27		
	Frame		
	• Platinum	+\$ 54	Specify with 4799 Platinum.
	• Seagull	+\$ 54	Specify with 7243 Seagull.
Arms	• Height-adjustable arms	-\$ 52	Specify with height-adjustable arms.
	• Fixed arms	-\$104	Specify with fixed arms.
	• Armless	-\$266	Specify without arms.
Base	• Polished aluminum base	+\$147	Specify with aluminum base.
Fire Code Seating	• Fire code seating (FCS)	+\$ 41	Specify with fire code seating.
Lumbar	• Fixed lumbar support	-\$ 60	Specify with fixed lumbar height.
Casters	• Soft, dark grey treaded, dual-wheel roll-control casters for use on hard floors	+\$ 27	Specify with soft roll-control casters.
Glides	• Glides: plastic	+\$ 27	Specify with glides.

Tip: Fire Code Seating (FCS) option is available with certain upholstery fabric choices only.
▶ Page 517

Tip: Fire Code Seating (FCS) option is available on Think chairs with fully adjustable arms or armless models only.

▶ Detailed dimensions, page 82



For Canadian Pricing

Multiply U.S. Price by the Canadian price factor.

▶ See page 1 for details.

Specification Information

• Style Number	• U.S. Base Price
465B300	\$1547

Think 465 Series Stool

Standard Upholstery on Back and Seat



Standard Includes	Required to Specify
<ul style="list-style-type: none"> ▶ Need help? Product details, page 78 • 10" pneumatic seat-height adjustment (22½"-32½") • Passive seat edge angle • Frame, seat shell, and five-arm base: black • 2½" seat depth adjustment • Rectilinear height-, width-, pivot-, and depth-adjustable arms • Column and adjustable foot ring: black • Adjustable lumbar • Standard upholstery design: fabric price group 1 • 2½"-diameter, hard-composition, dual-wheel casters: black 	<ol style="list-style-type: none"> 1 Style number 2 Plastic color for frame, base, and arm retainer 3 Fabric color number for upholstery on seat and back 4 Options, if selected (see below) <p>▶ See <i>Surface Materials</i>, page 504.</p>

Options	U.S. Price	Required to Specify
Surface Materials <ul style="list-style-type: none"> • Contrasting • Contrasting fabrics 	+\$ 33	Specify <i>with contrasting</i> .
<ul style="list-style-type: none"> • Upholstery on seat • Fabric price group 1 • Fabric price group 2 • Fabric price group 3 • Fabric price group 4 • Fabric price group 5 • Fabric price group 6 • Fabric price group 7 • Fabric price group 8 • Fabric price group 9 • Fabric price group 10 • Steelcase leather upholstery • Select Surfaces leather price group 1 • Elmosoft leather upholstery • Select Surfaces leather price group 2 • Customer's Own Material (COM) 	No cost +\$ 10 +\$ 25 +\$ 34 +\$ 43 +\$ 53 +\$ 60 +\$ 78 +\$ 96 +\$109 +\$168 +\$168 +\$197 +\$197 No cost	Specify fabric color number. Specify fabric color number. Specify fabric color number. Specify fabric color number. Specify fabric color number. Specify fabric color number. Specify fabric color number. Specify fabric color number. Specify fabric color number. Specify fabric color number. Specify fabric color number. Specify leather color number. ▶ See <i>Surface Materials Reference Manual</i> . Specify Elmosoft leather color number. ▶ See <i>Surface Materials Reference Manual</i> . ▶ See <i>Surface Materials Reference Manual</i> .
<ul style="list-style-type: none"> • Upholstery on back • Fabric price group 1 • Fabric price group 2 • Fabric price group 3 • Fabric price group 4 • Fabric price group 5 • Fabric price group 6 • Fabric price group 7 • Fabric price group 8 • Fabric price group 9 • Fabric price group 10 • Steelcase leather upholstery • Select Surfaces leather price group 1 • Elmosoft leather upholstery • Select Surfaces leather price group 2 • Customer's Own Material (COM) 	No cost +\$ 14 +\$ 27 +\$ 36 +\$ 44 +\$ 55 +\$ 64 +\$ 79 +\$ 97 +\$112 +\$176 +\$176 +\$203 +\$203 No cost	Specify fabric color number. Specify fabric color number. Specify fabric color number. Specify fabric color number. Specify fabric color number. Specify fabric color number. Specify fabric color number. Specify fabric color number. Specify fabric color number. Specify fabric color number. Specify fabric color number. Specify leather color number. ▶ See <i>Surface Materials Reference Manual</i> . Specify Elmosoft leather color number. ▶ See <i>Surface Materials Reference Manual</i> . ▶ See <i>Surface Materials Reference Manual</i> .
<ul style="list-style-type: none"> • Soil retardant • Soil-retardant treatment applied to upholstery fabric 	+\$ 27	Specify <i>with soil-retardant treatment</i> .
<ul style="list-style-type: none"> • Frame • Platinum • Seagull 	+\$ 54 +\$ 54	Specify <i>with 4799 Platinum</i> . Specify <i>with 7243 Seagull</i> .

▶ Detailed dimensions, page 82

▶ **Options, continued on next page**



For Canadian Pricing

Multiply U.S. Price by the Canadian price factor.

▶ See page 1 for details.

► Options, continued from previous page

Options	U.S. Price	Required to Specify
Arms		
• Height-adjustable arms	–\$ 52	Specify <i>with height-adjustable arms</i> .
• Fixed arms	–\$104	Specify <i>with fixed arms</i> .
• Armless	–\$266	Specify <i>without arms</i> .
Base		
• Polished aluminum base	+\$147	Specify <i>with aluminum base</i> .
Fire Code Seating		
• Fire code seating (FCS)	+\$ 81	Specify <i>with fire code seating</i> .
Lumbar		
• Fixed lumbar support	–\$ 60	Specify <i>with fixed lumbar height</i> .
Casters		
• Soft, dark grey treaded, dual-wheel roll-control casters for use on hard floors	+\$ 27	Specify <i>with soft roll-control casters</i> .
Glides		
• Glides: plastic	+\$ 27	Specify <i>with glides</i> .

Tip: Fire Code Seating (FCS) option is available with certain upholstery fabric choices only.
► Page 517

Tip: Fire Code Seating (FCS) option is available on Think chairs with fully adjustable arms or armless models only.

Specification Information

Style Number	U.S. Base Price
465B000	\$1486
.	.



► Detailed dimensions, page 82

 **For Canadian Pricing**
Multiply U.S. Price by the Canadian price factor.
► See page 1 for details.

Understanding and Specifying Steelcase Series 1 Work Chairs

Product Details

Steelcase Series 1	94
Dimensions	98

Specifying

Work Chair

3D Microknit with Standard Upholstery on Seat	100
---	-----

Stool

3D Microknit with Standard Upholstery on Seat	101
---	-----

Accessories

	102
--	-----

Work Chairs

Highly adjustable task seating offers maximum personalization for fit and comfort for a range of duration and use. By making a series of simple adjustments, you can customize the chair to your body, preferences, and tasks. These chairs provide continuous, stable, comfort, and can be quickly adjusted to support you in upright, and reclining work postures.

- Gesture 442 Series
- Leap 462 Series
- Think 465 Series
- Amia 482 Series
- Reply 466 Series
- Jersey Series
- Leap 464 Series
- WorkLounge
- Criterion 453 Series

Adjustability Features

► See page 22 for a comparison to other chairs. **Steelcase Series 1**

Mechanisms

Weight-activated ●

Seat Adjustments

Pneumatic height ●

Seat depth ●

Back Adjustments

Lumbar height ●

Arm Adjustments

Arm height ●

Arm width ●

Arm pivot ●

Arm depth ●

Other Features

Foot ring height (stool) ●

Steelcase Series 1

Steelcase Series 1

makes high-quality seating attainable for everyone, everywhere. It delivers performance, style, and choice unprecedented in its class of seating.

Back frame and seat shell are plastic.

Lumbar height adjusts over 2¼" to provide additional lower back support.

Arm caps can pivot independently 40° inward and 40° outward to accommodate individual user preferences.

Seat height adjusts within a 5" range with a pneumatic adjustment mechanism. Short or tall range is available as an option. Stools have a 7¾" range.

Comfort dial back control provides three settings for the user's personal preference and work style.

Casters have hard, dual-wheels that roll smoothly on carpets. They are 2½" for increased mobility. Soft, dual-wheel roll-control casters are available as an option for use on hard floors or chair mats. Glides are also available as an option.

Tip: Do not roll the chair across asphalt during installation as this may damage the casters.

Arm height can adjust independently within a 5" range to help relieve upper back and shoulder fatigue.

Arm width adjusts 4" overall to support forearms in neutral position.

Arm depth can retract 2" to allow user to get closer to the worksurface and into tight corners.

Seat depth adjusts within a 2¼" range to accommodate users of varying leg lengths.

Five-arm base is available in plastic or polished aluminum.

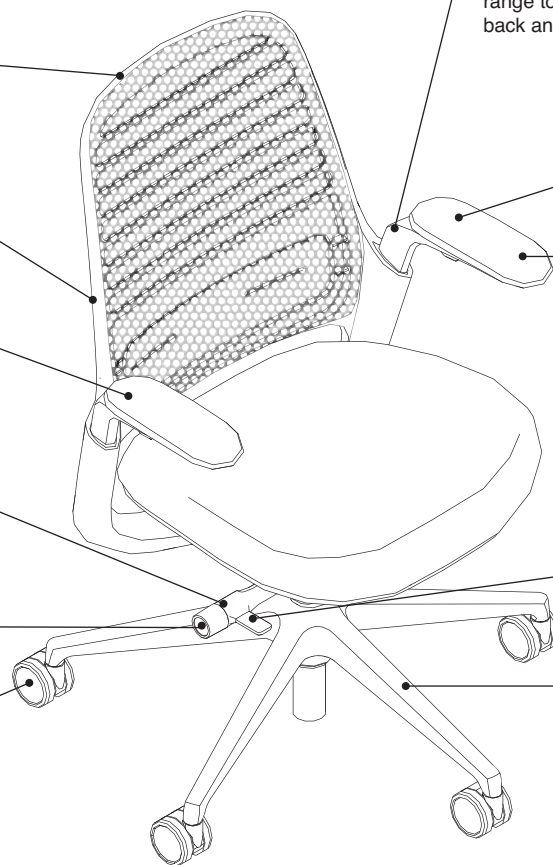

Product Details

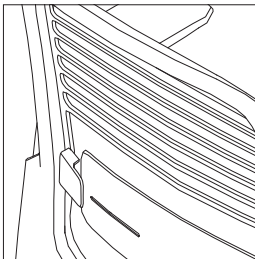

Integrated LiveBack System dynamically supports and follows the movements of the user.

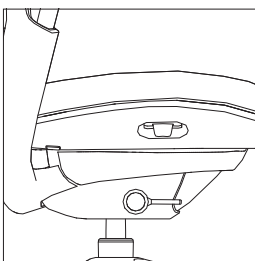

Advanced weight-activated mechanism with a natural fluid motion keeps users oriented to their work.

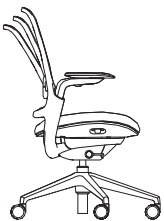

Comfort dial has three settings that allow for the user's personal preference and work style.

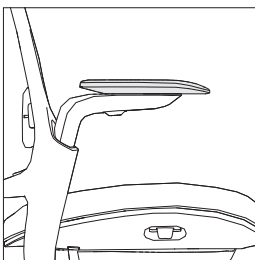

Rectilinear arms with soft caps are standard.

Uncartoned request on your dealer purchase order means Steelcase Series 1 chairs will ship fully assembled.

Cartoned request on the dealer purchase order means Steelcase Series 1 chairs will ship knocked down in seven pieces. This allows for shipment in a smaller carton. Assembly does not require tools.

Tip: Assembly instructions are included on the box.

Adjustment Features

Adjustability instructions are included with every chair.

Seat Adjustments

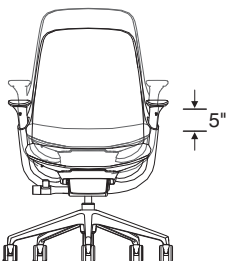

Seat height adjusts pneumatically. To lower, hold handle up while seated. To raise, hold handle up and keep your weight off the chair. Standard range of adjustability is 5" from 16½"H to 21½"H. A short 3¼" range of adjustability (14¾" to 18") and a tall 4¾" range of adjustability (17¼" to 22") is available as an option. A 7¾" range of adjustability (23" to 30¾") is available on stools.

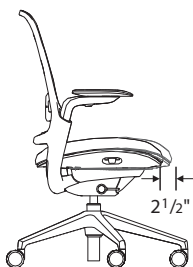

Seat depth adjusts 2½" (15½"–18") by pulling handle up. Slide seat forward or back to accommodate various leg lengths. Release handle to lock.

Back Adjustments

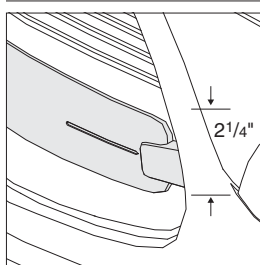

Lumbar height adjusts 2¼" (6½" to 8¾" from seat) by grabbing exposed tabs and sliding the lumbar support up or down.

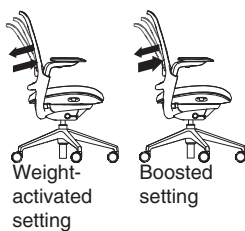

Weight-activated setting

Boosted setting



Upright setting

Comfort dial has three settings: (1) weight-activated setting; (2) boosted setting that has more resistance than your body is providing; and (3) an upright back lock setting.



Headrest accessory adjusts 3" vertically to support the head and neck of the user in both upright and recline postures. The plastic stalk and underside of the headrest will coordinate to match the frame color specified: black or seagull. The foam pad of the headrest is available in eleven 3D Microknit colors. Whether ordered initially or at a later date, the headrest ships in its own carton and must be field installed.

Arm Adjustments

Rectilinear height-, width-, pivot-, and depth-adjustable arms come standard on all arm models of chairs and stools.

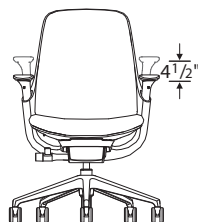

Arm height adjusts independently within a range of 4½" (6½"–11" from the seat). Push button on outside and under arm cap in while moving arms up or down. Releasing buttons locks arms in position.

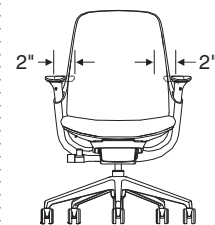

Arm width can be adjusted 2" each, 4" overall. Grasp arm cap and move in or out.

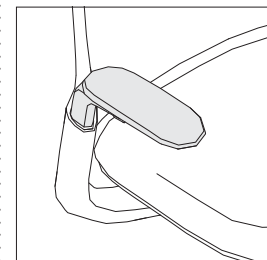

Arms pivot independently, 40° inward and outward. Grasp arm and push front to left or right.

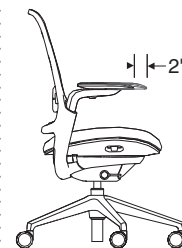

Arm depth adjusts by sliding arm caps back 2". Friction-fit mechanism keeps arms in position.

Steelcase Series 1, continued

Other Features

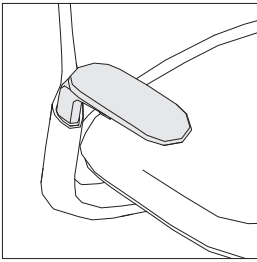

Height-only adjustable arm is also available and adjusts 4 1/2".



Armless models are also available.

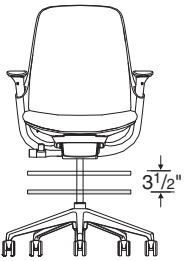

Foot ring height on stools adjusts by rotating it counterclockwise to unlock. Then raise or lower ring to desired position before rotating it clockwise to lock. The foot ring has a diameter of 20".

Soft dual-wheel roll-control casters feature an internal brake that activates when the chair is not under load to reduce shifting when user stands up.

Surface Materials

► See *Surface Materials* on page 504 for specific availability or refer to the *Surface Materials Reference Manual* for further information.

Upholstery

- Fabric
- Fabric with soil-retardant treatment (option)
- 3D Microknit (back and headrest only)
- Elmosoft leather
- Select Surfaces leather
- Leather
- Vinyl

Hard components

- Back frame, stools ring, headrest, and hanger
- 6053 Seagull
 - 6205 Black

Base

- 6053 Seagull
- 6205 Black
- 8046 Polished Aluminum

Pneumatic cylinders

- 6205 Black

Flexors and lumbar finishes are determined by the 3D Microknit color unless specified as contrasting.

Seat shell is determined by the frame finish.

- 6053 Seagull
- 6205 Black

Arms

- 6059 Sterling Dark (on seagull chair)
- 6205 Black (on black chair)

All Steelcase seating with standard upholstery fabrics complies

with requirements of the State of California Technical Bulletin 117-2013. All standard seating is labeled to be in compliance with California 117-2013.

Programs & Services

► See *Surface Materials Reference Manual* for further detail about programs and services offered for seating.

The Customer's Own Material (COM) Program offers the

opportunity for customers to select fabrics that are not offered through the standard Steelcase surface materials program for use on Steelcase products. Through the COM program, Steelcase will test your materials for application on Steelcase products. Once approved, you can place your order. Steelcase will facilitate the entire ordering process and give you a production schedule. Steelcase will order the COM fabric directly from the textile manufacturer. For up-to-date information regarding fabric test results for all COM fabrics and details regarding yardage requirements for most seating lines, visit the COM website. To locate the COM website:

- Visit www.steelcase.com

Soil retardants are treatments that provide long-term soil and stain resistance to a fabric without affecting the shade or the integrity of the fabric. The following Steelcase Textiles are available pre-treated with soil retardant. (You do not need to select the soil-retardant option for these fabrics and incur the upcharge.)

- Jacks
- Link
- Spyder

For information on soil retardant fabrics on Select Surfaces, please refer to the *Surface Materials Reference Manual*.

Soil-retardant treatment is available on all other seating fabrics at an additional upcharge per seating unit. To order this option, please select "Soil-Retardant Treatment" under "Optional Accessories."

For soil-retardant treatment on COMs, please select "Soil-Retardant Treatment" under "Optional Accessories." Minimums or additional yardage may be required. Please contact the vendor directly for specific information.

Extended lead times may be necessary for this service.

Contact your Steelcase Solutions Fulfillment Team Representative at 1.888.STEELCASE (1.888.783.3522) or send an email to lineone@steelcase.com.

Dimensions

► Page 98

Steelcase Series 1 Upholstery

What Is It?

3D Microknit on Back only

Stitched seams are included on the seat cushion of the following:

- Leather
- Vinyl
- Upholstery
- Select Customer's Own Material/Vinyl (COM)

Tip: There are no stitching seams in Cogent:Connect.

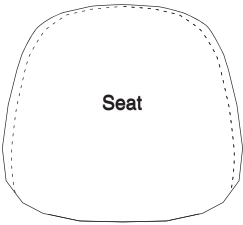

Fabric, leather, or vinyl-covered seat; 3D Microknit back only

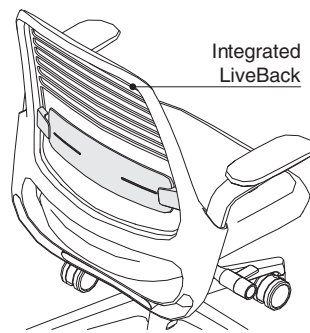
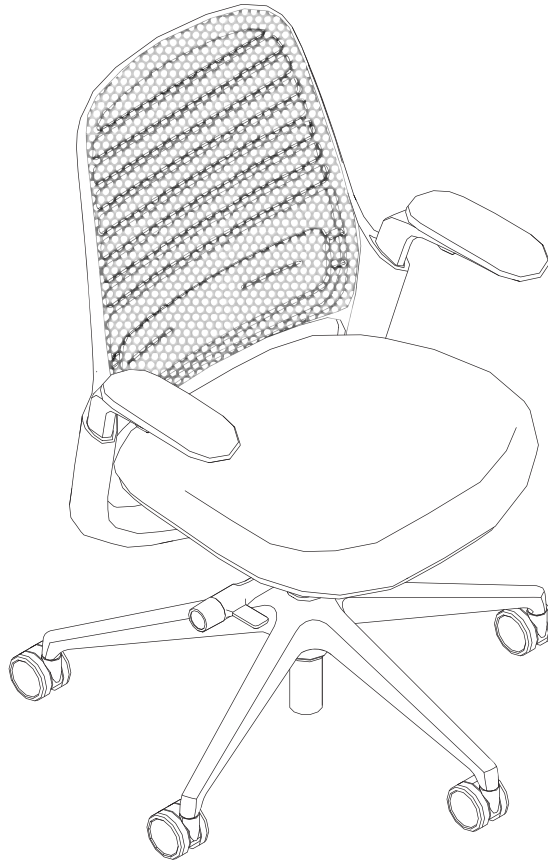

Back flexors are fully exposed. Lumbar and flexor colors always match. Lumbar and flexors will also match the 3D Microknit fabric unless contrasting is selected.

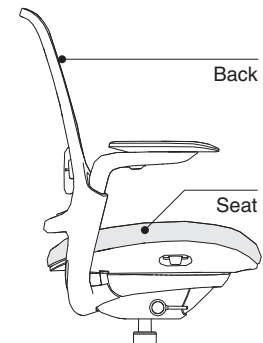

Seat and back assemblies can be removed and replaced if damaged.

Dimensions

Steelcase Series 1

Features	Overall Depth	Width	Height	Seat Depth	Functional Seat Depth	Seat Width	Seat Height from Floor	Ring Height from Floor	Back Width	Back Height from Seat	Lumbar Height from Seat
----------	---------------	-------	--------	------------	-----------------------	------------	------------------------	------------------------	------------	-----------------------	-------------------------

Steelcase Series 1

Chair

Arms	21" to 23 ³ / ₄ "	23 ¹ / ₂ " to 27"	36 ¹ / ₂ " to 41 ¹ / ₄ "	18 ¹ / ₂ "	15 ¹ / ₂ " to 17 ³ / ₄ "	19 ¹ / ₂ "	16 ¹ / ₂ " to 21 ¹ / ₂ " (14 ³ / ₄ " to 18", 17 ¹ / ₄ " to 22" optional)	N.A.	17 ¹ / ₄ "	21 ¹ / ₂ "	6 ¹ / ₂ " to 8 ³ / ₄ "
------	---	---	--	----------------------------------	--	----------------------------------	--	------	----------------------------------	----------------------------------	--

Stool

Arms	21" to 23 ³ / ₄ "	23 ¹ / ₂ " to 27"	42 ¹ / ₄ " to 50"	18 ¹ / ₂ "	15 ¹ / ₂ " to 17 ³ / ₄ "	19 ¹ / ₂ "	23" to 30 ³ / ₄ "	11 ¹ / ₂ " to 15"	17 ¹ / ₄ "	21 ¹ / ₂ "	6 ¹ / ₂ " to 8 ³ / ₄ "
------	---	---	---	----------------------------------	--	----------------------------------	---	---	----------------------------------	----------------------------------	--

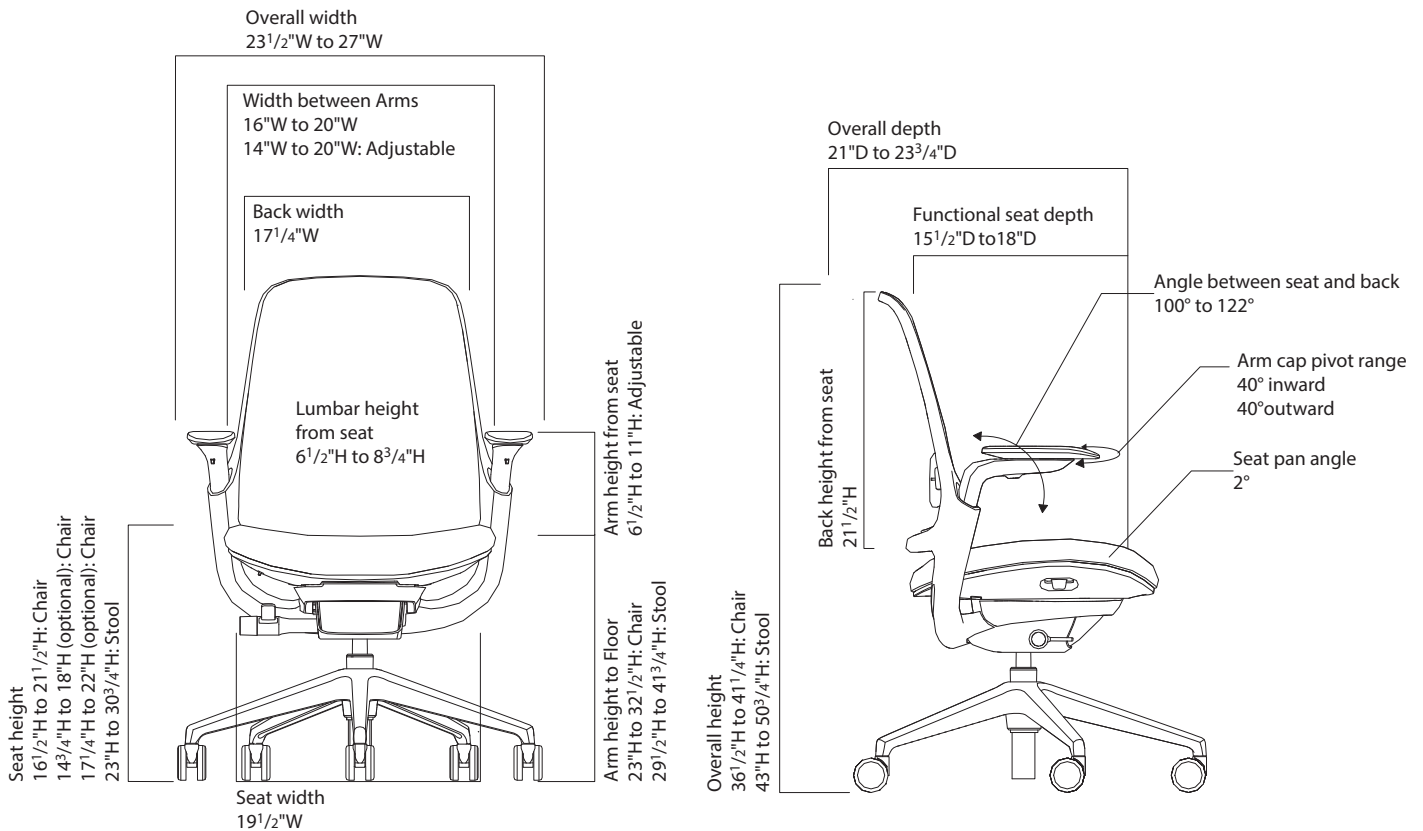

• Width • Between • Adjustable • Arms	• Width • Between • Height- • Adjustable • Arms	• Arm • to • Floor	• Arm • Height • from • Seat	• Arm Cap • Pivot • Range	• Angle • Between • Seat and • Back	• Seat • Pan • Angle	• Headrest • Height • Adjustment • Range
--	---	--------------------------	---------------------------------------	---------------------------------	--	----------------------------	---

Chair

16" to 20½"	19"	23" to 32½"	6½" to 11"	40° outward 40° inward	100° to 122°	2°	3"
-------------	-----	-------------	------------	---------------------------	--------------	----	----

Stool

16" to 20½"	19"	29½" to 41¾"	6½" to 11"	40° outward 40° inward	100° to 122°	2°	3"
-------------	-----	--------------	------------	---------------------------	--------------	----	----

Steelcase Series 1 Work Chair

3D Microknit with Standard Upholstery on Seat



Standard Includes	Required to Specify
-------------------	---------------------

<p>▶ Need help? Product details, page 94</p> <ul style="list-style-type: none"> • 5" pneumatic seat-height adjustment (16½"–21½") • Frame: plastic • Base: plastic • 2½" seat depth adjustment • Rectilinear height-, width-, pivot-, and depth-adjustable arms • Adjustable lumbar • Back: 3D Microknit on back • Standard upholstery design on seat: fabric price group 1 • 2½"-diameter, hard-composition, dual-wheel casters: black only 	<ol style="list-style-type: none"> 1 Style number 2 Plastic color number for frame 6053 Seagull 6205 Black 3 3D Microknit color number for back 4 Fabric color number for upholstery on seat 5 Plastic color number for base: 6053 Seagull (seagull frame only) 6205 Black (black and seagull frame) 6 Options, if selected (see below) ▶ See <i>Surface Materials</i>, page 504.
---	---

Tip: When ordering seagull frame the arms are 6059 Sterling Dark Solid. When ordering black frame, arms are black.

Options	U.S. Price	Required to Specify
---------	------------	---------------------

Surface Materials	Upholstery on seat <ul style="list-style-type: none"> • Fabric price group 1 No cost • Fabric price group 2 +\$ 10 • Fabric price group 3 +\$ 25 • Fabric price group 4 +\$ 34 • Fabric price group 5 +\$ 43 • Fabric price group 6 +\$ 53 • Fabric price group 7 +\$ 60 • Fabric price group 8 +\$ 78 • Fabric price group 9 +\$ 96 • Fabric price group 10 +\$109 • Steelcase leather upholstery +\$168 • Select Surfaces leather price group 1 +\$168 • Elmosoft leather upholstery +\$197 • Select Surfaces leather price group 2 +\$197 • Customer's Own Material (COM) No cost • Soil-retardant treatment applied to upholstery fabric +\$ 27 	Specify fabric color number. Specify fabric color number. Specify fabric color number. Specify fabric color number. Specify fabric color number. Specify fabric color number. Specify fabric color number. Specify fabric color number. Specify fabric color number. Specify fabric color number. Specify fabric color number. Specify leather color number. ▶ See <i>Surface Materials Reference Manual</i> . Specify Elmosoft leather color number. ▶ See <i>Surface Materials Reference Manual</i> . ▶ See <i>Surface Materials Reference Manual</i> . Specify with soil-retardant treatment.
	Back color scheme <ul style="list-style-type: none"> • Contrasting outer back +\$ 10 	Specify with contrasting outer back.
Arms	<ul style="list-style-type: none"> • Height-only adjustable -\$ 10 • Armless -\$ 62 	Specify with height-only adjustable. Specify without arms.
Base	<ul style="list-style-type: none"> • Black No cost • Polished aluminum base +\$132 	Specify with black base. Specify with aluminum base.
Lumbar	<ul style="list-style-type: none"> • Adjustable lumbar No cost • Fixed lumbar No cost 	Specify with adjustable lumbar. Specify with fixed lumbar.
Seat Height	<ul style="list-style-type: none"> • 3¼" low-range pneumatic seat-height adjustment +\$ 60 • 4¾" high-range pneumatic seat-height adjustment +\$ 60 	Specify with short-range pneumatic seat-height adjustment. Specify with tall-range pneumatic seat-height adjustment.
Casters	<ul style="list-style-type: none"> • Soft, dual-wheel roll-control casters for use on hard floors +\$ 27 	Specify with soft roll-control casters.
Glides	<ul style="list-style-type: none"> • Plastic glides +\$ 27 	Specify with glides.

Tip: Base finish matches frame finish, unless seagull frame is selected, then black base is also available.

Tip: Order black base on seagull frame for lowest maintenance.

▶ Detailed dimensions, page 98

Specification Information

Style Number	U.S. Base Price
435A00	\$702

For Canadian Pricing
Multiply U.S. Price by the Canadian price factor.
▶ See page 1 for details.

Steelcase Series 1 Stool

3D Microknit with Standard Upholstery on Seat



Standard Includes	Required to Specify
-------------------	---------------------

- | | | |
|---|--|---|
| <ul style="list-style-type: none"> ▶ Need help? Product details, page 94 | <ul style="list-style-type: none"> • 7¾" pneumatic seat-height adjustment (23"-30¾") • Frame: plastic • Base: plastic • 2¼" seat depth adjustment • Rectilinear height-, width-, pivot-, and depth-adjustable arms • Column and adjustable foot ring: black • Adjustable lumbar • Back: 3D Microknit • Standard upholstery design on seat: fabric price group 1 • 2½"-diameter, hard-composition, dual-wheel casters: black only | <ol style="list-style-type: none"> 1 Style number 2 Plastic color number for frame: 6053 Seagull 6205 Black 3 3D Microknit color number for back 4 Fabric color number for upholstery on seat 5 Plastic color number for base: 6053 Seagull (seagull frame only) 6205 Black (black and seagull frame) 6 Options, if selected (see below) <ul style="list-style-type: none"> ▶ See <i>Surface Materials</i>, page 504. |
|---|--|---|

Tip: When ordering seagull frame the arms are 6059 Sterling Dark Solid. When ordering black frame, arms are black.

Options	U.S. Price	Required to Specify
---------	------------	---------------------

Surface Materials	Upholstery on seat		
	<ul style="list-style-type: none"> • Fabric price group 1 • Fabric price group 2 • Fabric price group 3 • Fabric price group 4 • Fabric price group 5 • Fabric price group 6 • Fabric price group 7 • Fabric price group 8 • Fabric price group 9 • Fabric price group 10 • Steelcase leather upholstery • Select Surfaces leather price group 1 • Elmosoft leather upholstery • Select Surfaces leather price group 2 • Customer's Own Material (COM) • Soil-retardant treatment applied to upholstery fabric 	<ul style="list-style-type: none"> No cost +\$ 10 +\$ 25 +\$ 34 +\$ 43 +\$ 53 +\$ 60 +\$ 78 +\$ 96 +\$109 +\$168 +\$168 +\$197 +\$197 No cost +\$ 27 	<ul style="list-style-type: none"> Specify fabric color number. Specify fabric color number. Specify fabric color number. Specify fabric color number. Specify fabric color number. Specify fabric color number. Specify fabric color number. Specify fabric color number. Specify fabric color number. Specify fabric color number. Specify fabric color number. Specify leather color number. ▶ See <i>Surface Materials Reference Manual</i>. Specify Elmosoft leather color number. ▶ See <i>Surface Materials Reference Manual</i>. ▶ See <i>Surface Materials Reference Manual</i>. Specify with soil-retardant treatment.
	Back color scheme		
	<ul style="list-style-type: none"> • Contrasting outer back 	+\$ 10	Specify with contrasting outer back.
Arms	<ul style="list-style-type: none"> • Height-only adjustable • Armless 	<ul style="list-style-type: none"> -\$ 10 -\$ 62 	<ul style="list-style-type: none"> Specify with height-only adjustable. Specify without arms.
Base	<ul style="list-style-type: none"> • Plastic base • Polished aluminum base 	<ul style="list-style-type: none"> No cost +\$132 	<ul style="list-style-type: none"> Specify plastic color number. Specify with aluminum base.
Lumbar	<ul style="list-style-type: none"> • Adjustable lumbar • Fixed lumbar 	<ul style="list-style-type: none"> No cost No cost 	<ul style="list-style-type: none"> Specify with adjustable lumbar. Specify with fixed lumbar.
Casters	<ul style="list-style-type: none"> • Soft, dual-wheel roll-control casters for use on hard floors 	+\$ 27	Specify with soft roll-control casters.
Glides	<ul style="list-style-type: none"> • Plastic glides 	+\$ 27	Specify with glides.

Tip: Base finish matches frame finish, unless seagull frame is selected, then black base is also available.

Tip: Order black base on seagull frame for lowest maintenance.

Tip: Stool ring is always black for lower cleaning maintenance, even on the seagull frame.

Specification Information	
---------------------------	--

• Style Number	• U.S. Base Price
435B00	\$882

▶ Detailed dimensions, page 98



For Canadian Pricing

Multiply U.S. Price by the Canadian price factor.

▶ See page 1 for details.

Steelcase Series 1

Steelcase Series 1 Accessories

Steelcase Series 1 Headrest

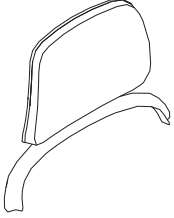

Standard Includes	Required to Specify
-------------------	---------------------

- | | | |
|---|--|--|
| <ul style="list-style-type: none"> ▶ Need help? Product details, page 94 | <ul style="list-style-type: none"> • Headrest frame: plastic • Headrest: 3D Microknit • 3" adjustment range | <ul style="list-style-type: none"> 1 Style number 2 Plastic color number for frame: <ul style="list-style-type: none"> 6053 Seagull 6205 Black 3 3D Microknit color number for headrest <ul style="list-style-type: none"> ▶ See <i>Surface Materials</i>, page 504. |
|---|--|--|

Specification Information	
• Style Number	• U.S. Price

435HEADREST	\$100
-------------	-------

Steelcase Series 1 Hanger

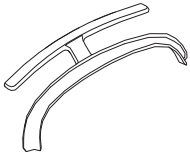

Standard Includes	Required to Specify
-------------------	---------------------

- | | |
|--|---|
| <ul style="list-style-type: none"> • Coat hanger: plastic | <ul style="list-style-type: none"> 1 Style number 2 Plastic color number for coat hanger: <ul style="list-style-type: none"> 6053 Seagull 6205 Black |
|--|---|

Specification Information	
• Style Number	• U.S. Price

435COATHANGER	\$30
---------------	------



For Canadian Pricing

Multiply U.S. Price by the Canadian price factor.

▶ See page 1 for details.

Understanding and Specifying Amia 482 Series Work Chairs

Product Details

Amia 482 Series	104
Amia Upholstery	107
Dimensions	108

Specifying

Value Package

Work Chair	110
------------	-----

Work Chairs

Sewn Leather Upholstery on Back, Seat, and Arm Caps	111
Upholstery on Back and Seat	112
3D Knit on Back with Upholstery on Seat	116
Air Back and Upholstered Seat	118
Air Back with 3D Microknit and Upholstered Seat	120

Stools

Upholstery on Back and Seat	122
3D Knit on Back with Upholstery on Seat	126
Air Back and Upholstered Seat	128
Air Back with 3D Microknit and Upholstered Seat	130

Work Chairs

Highly adjustable task seating offers maximum personalization for fit and comfort for a range of duration and use. By making a series of simple adjustments, you can customize the chair to your body, preferences, and tasks. These chairs provide continuous, stable, comfort, and can be quickly adjusted to support you in upright, and reclining work postures.

- Gesture 442 Series
- Leap 462 Series
- Think 465 Series
- Amia 482 Series
- Reply 466 Series
- Jersey Series
- Leap 464 Series WorkLounge
- Criterion 453 Series

Adjustability Features

► See page 22 for a comparison to other chairs.

Amia 482 Series

Mechanisms

Syncrotilt	●
------------	---

Seat Adjustments

Pneumatic height	●
------------------	---

Passive seat edge angle	●
-------------------------	---

Seat depth	●
------------	---

Back Adjustments

Lumbar height	●
---------------	---

Back tension	●
--------------	---

Back lock	●
-----------	---

Arm Adjustments

Arm height	●
------------	---

Arm width	●
-----------	---

Arm pivot	●
-----------	---

Arm depth	●
-----------	---

Other Features

Foot ring height (stool)	●
--------------------------	---

Amia 482 Series

Amia is for customers seeking a timeless design that incorporates ergonomics and comfort at a value price point.

Outer back and outer seat are plastic. Fully upholstered outer back is available.

LiveLumbar system offers a dialed in spring force in the lumbar region that actively supports the lower back.

Arm height can adjust independently within a 4" range to help relieve upper back and shoulder fatigue.

Seat depth adjusts within a 3" range. Seat depth is standard on all models.

Five-arm base is standard.

Casters have hard, dual-wheels that roll smoothly on carpets. They are 2½" for increased mobility. Soft, dark grey treaded, dual-wheel roll-control casters are available for use on hard floors or mats. Stools are standard with 2" hard casters. Soft casters are available as an option.

Tip: Do not roll the chair across asphalt during installation as this may damage the casters.

Amia Air integrated LiveBack technology automatically creates flexibility and movement within the backrest.

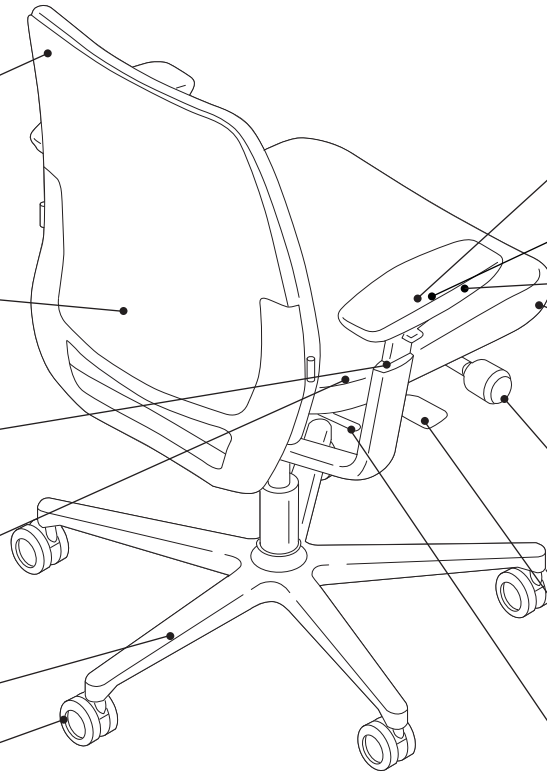

Arm depth can be adjusted approximately 3", enabling individuals to get closer to their work.

Arm width can adjust 4½" overall to provide forearm support.

Arm caps can pivot 30° in and out to accommodate individual user preferences.

Passive seat edge angle allows the front edge of the seat to flex 1½", relieving pressure behind the thighs.

Back tension accommodates a broader range of users by allowing user to change the rate of increase, or decrease, in force as the user reclines.

Seat height adjusts within a 5" range with a pneumatic adjustment mechanism. Stools have an 8" range.

Upright back lock allows the user to lock the back in a full upright position, or release it for full-tilt motion.



Product Details

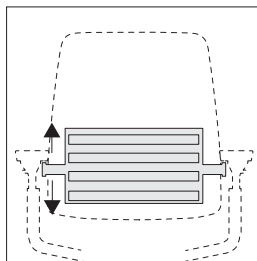

LiveLumbar system allows the user to experience continuous back support with dialed in spring force that can be adjusted to match the users anatomy. Available on standard Amia chairs.

Integrated LiveBack automatically creates flexibility and movement in the backrest to ensure dynamic back support as you recline. A height adjustable lumbar is also available on the Amia Air with 3D Microknit.

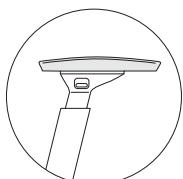

Rectilinear arms with soft caps are standard.

Models are standard with adjustable seats that include seat depth and passive seat edge angle.

Adjustability instructions are included with every chair. Instructions can also be found at www.steelcase.com

Cartoned request on your dealer purchase order means Amia chairs will ship knocked down with the chair back separated from the rest of the chair. This allows for shipment in a smaller carton. Assembly by a qualified dealer installer is required. Assembly instructions are included. This does not apply to Amia stools.

Uncartoned request on your dealer purchase order means Amia chairs will ship fully assembled.

Adjustment Features

Seat Adjustments

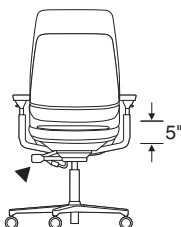

Seat height adjusts pneumatically. To lower, hold handle up while seated. To raise, hold handle up and keep your weight off the chair. Range of adjustability is 5", from 16"H to 21"H, and is standard on work chairs. A lower range of adjustability (15"H to 19"H) is available as an option. A higher range of adjustability (17"H to 24"H) is available as an option. An 8" range of adjustability (23"H to 31"H) is available on stools.

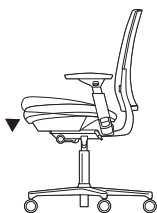

Passive seat edge angle flexes, relieving pressure under the user's thighs. The front flexes 1 1/2". This feature is standard on all work chairs and stools.

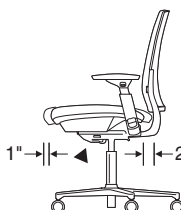

Seat depth adjusts 3" (15 1/2"–18 1/2") by pulling handle up. Slide seat forward or back to accommodate various leg lengths. Release handle to lock. This feature is standard on work chairs and stools.

Back Adjustments

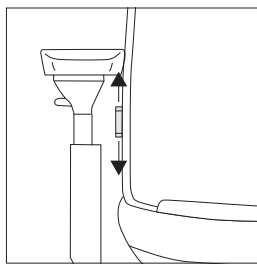

Lumbar height adjusts 3 3/4" (6 1/4" to 10" from seat) by grabbing exposed tabs and sliding the lumbar support up or down. This feature is standard on work chairs and stools.

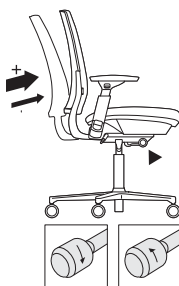

Back tension adjusts by turning knob forward to increase back tension, backward to decrease back tension. This feature is standard on work chairs and stools.

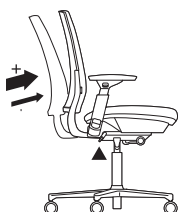

Upright back lock. To release, lean forward and pull toward back. To lock, lean forward and push toward front.

Arm Adjustments

Rectilinear height-, width-, pivot-, and depth-adjustable arms come standard on all arm models of chairs and stools.

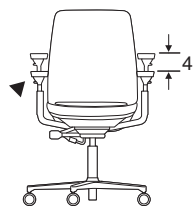

Arm height adjusts independently within a range of 4" (7"–11" from the seat). Push button on outside and under arm cap in while moving arms up or down. Releasing buttons locks arms in position.

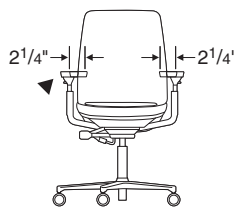

Arm width adjusts 2 1/4" each independently on chairs with this option. Grasp arm and move in or out.

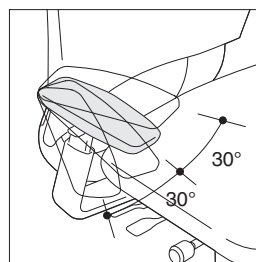

Arms pivot independently 30° inward and outward. Grasp arm and push front to left or right.

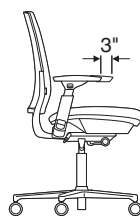

Arm depth adjusts approximately 3" to enable user to get closer to worksurface.

Other Features

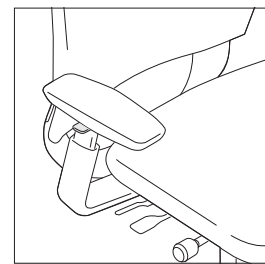

Height-only adjustable arm is also available and adjusts 4".

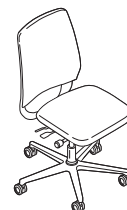

Armless models are also available.

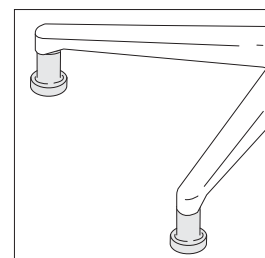

Glides are available as an option. Glides ship with chair or stool for field installation and maintain same height as casters.

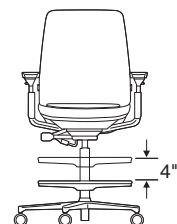

Foot ring height on stools adjusts by first lifting ring and rotating it counter-clockwise to unlock. Then raise or lower ring up to 4" to desired position before rotating it clockwise to lock. The foot ring has a diameter of 20".

Soft-wheel casters for hard floors are available for specific applications.

Surface Materials

▶ See surface materials on page 504 for specific availability or refer to the *Surface Materials Reference Manual* for further information.

Upholstery

- Fabric
- Fabric with soil-retardant treatment (option)
- 3D Knit (back only)
- 3D Microknit (Amia back only)
- Leather
- Elmosoft leather
- Select Surfaces leather
- Customer's Own Leather (COL)
- Select Customer's Own Material/Vinyl (COM)

Hard components

- Back frame, outer back, arm retainer, and base
- 4799 Platinum Metallic
- 6205 Black
- 7243 Seagull
- 7250 Sterling Dark

Outer back, shell, inner back frame, and outer seat shell

- 6527 Merle

Back shell and seat shell only

- 6249 Platinum

Outer back

- Fully upholstered

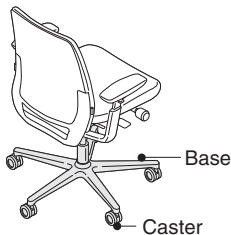

Polished aluminum base and casters

are available on chairs only. Polished aluminum casters approved to 225 pounds only. Stools are not available with this base.

Arm caps

- Black
- Leather

Column and foot ring on stools

- 7207 Black only

All Steelcase seating with standard upholstery fabrics complies with requirements of the State of California Technical Bulletin 117-2013. All standard seating is labeled to be in compliance with California 117-2013.

Programs & Services

▶ See the *Surface Materials Reference Manual* for further detail about programs and services offered for seating.

The Customer's Own Material (COM) Program

offers the opportunity for customers to select fabrics that are not offered through the standard Steelcase surface materials program for use on Steelcase products. Through the COM program, Steelcase will test your materials for application on Steelcase products. Once approved, you can place your order. Steelcase will facilitate the entire ordering process and give you a production schedule. Steelcase will order the COM fabric directly from the textile manufacturer. For up-to-date information regarding fabric test results for all COM fabrics and details regarding yardage requirements for most Seating lines, visit the COM website. To locate the COM website:

- Visit www.steelcase.com

Soil retardants are treatments that provide long-term soil and stain resistance to a fabric without affecting the shade or the integrity of the fabric. The following Steelcase Textiles are available pre-treated with soil retardant. (You do not need to select the soil-retardant option for these fabrics and incur the upcharge.)

- Jacks
- Link
- Spyder

For information on soil retardant fabrics on Select Surfaces, please refer to the *Surface Materials Reference Manual*.

Soil-retardant treatment is available on all other seating fabrics at an additional upcharge per seating unit. To order this option, please select "Soil-Retardant Treatment" under "Optional Accessories."

For soil-retardant treatment on COMs, please select "Soil-Retardant Treatment" under "Optional Accessories." Minimums or additional yardage may be required. Please contact the vendor directly for specific information.

Soil-retardant treatment is available on all other seating fabrics at an additional upcharge per seating unit. To order this option, please select "Soil-Retardant Treatment" under "Optional Accessories."

For soil-retardant treatment on COMs, please select "Soil-Retardant Treatment" under "Optional Accessories." Minimums or additional yardage may be required. Please contact the vendor directly for specific information.

Extended lead times may be necessary for this service.

Contact your Steelcase Solutions Fulfillment Team Representative at 1.888.STEELCASE (1.888.783.3522) or send an email to lineone@steelcase.com.

Fire Codes

▶ See page 517 for upholstery fabrics available for use with FCS modification.

Steelcase offers Fire Code Seating modification (FCS) on some seating models.

The most rigorous fire codes in the nation have been developed in California, and the Steelcase FCS modification is designed to meet those codes. Fire Code Seating (FCS) indicates that a product is constructed to meet the strict fire code requirements of high public occupancy areas such as theaters, meeting rooms, and lobbies. The FCS standards will meet the State of California Bureau of Electronic and Appliance Repair, Home Furnishings, and Thermal Insulation Technical Bulletin 133 (Cal TB 133). Boston adopted the California Bureau of Electronic and Appliance Repair, Home Furnishings, and Thermal Insulation Technical Bulletin TB 133 test standard in 1992.

Local codes may have special requirements for upholstery.

Dimensions

▶ Page 108

Resources

Printed Materials

- ▶ Amia Brochure (11-0002073)
- ▶ Amia User Guide (07-0006468)
- ▶ Amia LiveLumbar card (08-0000111)
- ▶ Innovation Seating Brochure (04-0011870)
- ▶ Alive Seating Story
- ▶ Amia Air Cut Sheet (18-0005529)

Online Resources

- ▶ Interactive User Guide available on www.steelcase.com
- ▶ Amia Model Sales Presentation DVD
- ▶ Amia Design Story video available on www.steelcase.com
- ▶ Adjustability video available on www.steelcase.com
- ▶ Environmental profiles available on www.steelcase.com/sustainability.

Amia Upholstery

What Is It?

Fabric, leather, or vinyl-covered back and seat, 3D Knit back

Fabric

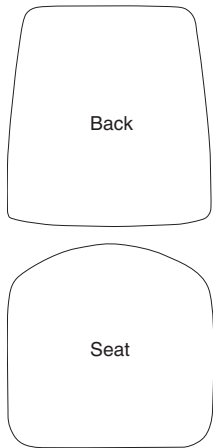

Leather, Vinyl, and Select Fabrics

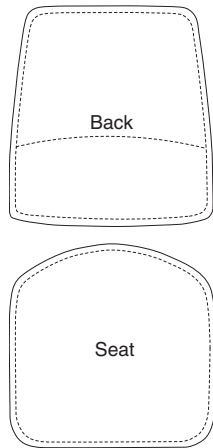

3D Knit and 3D Microknit Back

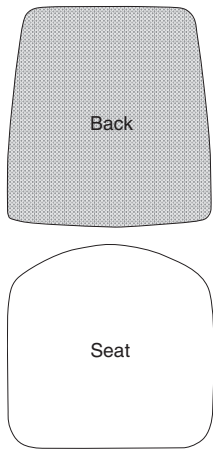

Stitched seams are included on the back cushion and seat cushion of the following:

- Leather
- Elmosoft leather
- Select Surfaces leather
- Customer's Own Leather (COL)
- Vinyl
- Select Customer's Own Material/Vinyl (COM)
- Select Fabrics

Pattern alignment at the lumbar seam cannot be guaranteed.

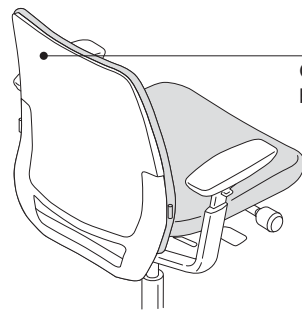
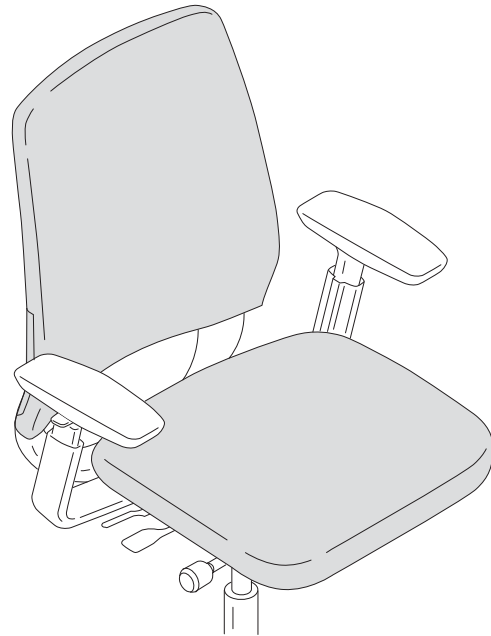

Plastic outer back is fully exposed. Fully upholstered outer back is available.

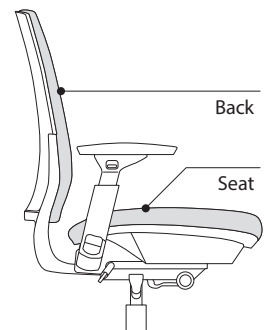

Seat and back cushions can be removed and replaced if damaged.

3D Knit back is made up of three layers: the 3D Knit, a solid fabric that matches the 3D Knit color, and the polyester cushion that provides exceptional comfort. The seat on these models can be specified to match the 3D Knit color or in any other material.

3D Microknit back is available on the Amia Air back version only. A Cogent: Connect fabric can be specified on the seat to color match the 3D Microknit (exception: Seagull). The 3D Microknit can be specified to match or contrast the Amia Air back.

Dimensions

Amia 482 Series

Features	Overall Depth	Width	Height	Seat Depth	Functional Seat Depth	Seat Width	Seat Height from Floor	Ring Height from Floor	Back Width	Back Height from Seat
Amia 482 Series										
Work Chairs										
Adjustable Seat Depth	21 ³ / ₄ " to 24 ³ / ₄ "	26 ⁵ / ₈ "	37 ¹ / ₄ " to 42 ¹ / ₂ "	18 ¹ / ₂ "	15 ¹ / ₂ " to 18 ¹ / ₂ "	19 ³ / ₈ "	16" to 21"	N.A.	18 ⁷ / ₈ "	25"
Stools										
Adjustable Seat Depth	21 ³ / ₄ " to 24 ³ / ₄ "	26 ⁵ / ₈ "	44 ¹ / ₄ " to 52 ¹ / ₂ "	18 ¹ / ₂ "	15 ¹ / ₂ " to 18 ¹ / ₂ "	19 ³ / ₈ "	23" to 31"	10 ¹ / ₄ " to 14 ¹ / ₄ "	18 ⁷ / ₈ "	25"

Dimensions were measured with BIFMA CMD (chair-measuring device).

Arm width adjustment is 15"–19¹/₂". Arm pivot adjustment adds 2³/₄" to the width providing a total of 12¹/₄"–20¹/₂" of width between the arms.

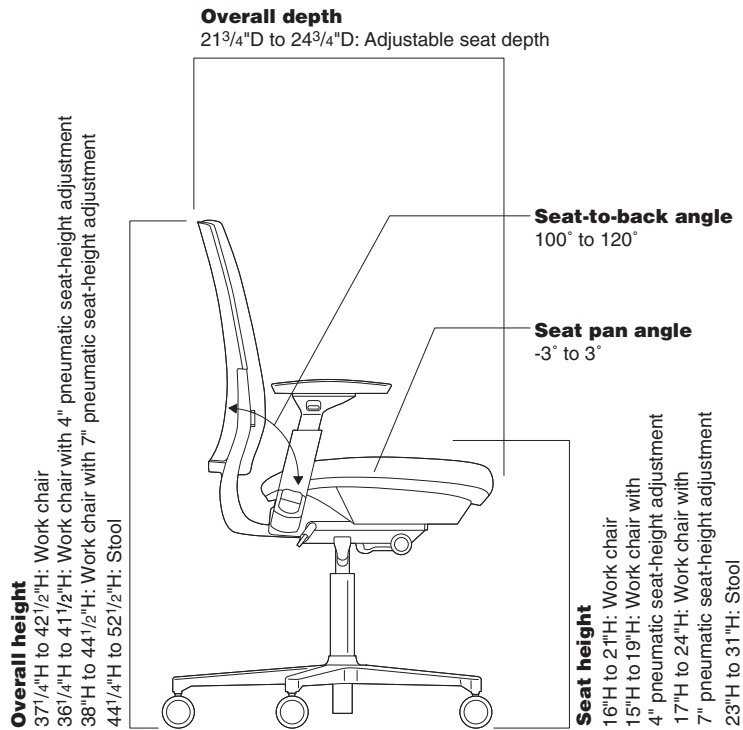
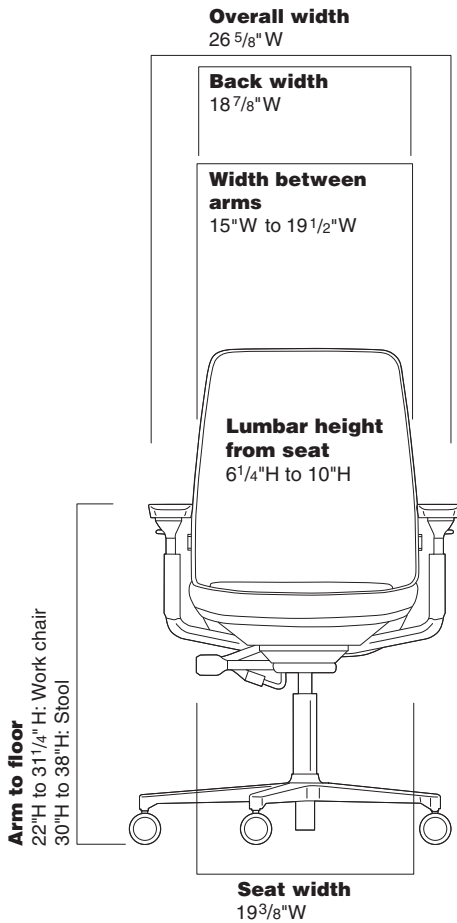

• Back Lumbar Height	• Lumbar Flex Zone	• Width Between Arms	• Arm to Floor	• Arm Height from Seat	• Arm Cap Pivot Range	• Seat Pan Angle	• Angle Between Seat and Back
Work Chairs							
6¼" to 10"	5¼" to 10¼"	15" to 19½"	22" to 32¼"	7" to 11"	30°	-3° to 3°	100° to 120°
Stools							
6¼" to 10"	5¼" to 10¼"	15" to 19½"	30" to 38"	7" to 11"	30°	-3° to 3°	100° to 120°
:	:	:	:	:	:	:	:

Amia 482 Series Value Package Work Chair



Tip: Amia value package work chair offers Amia chair features at a lower price than when selected individually.

Standard Includes		Required to Specify
<ul style="list-style-type: none"> ▶ Need help? Product details, page 104 	<ul style="list-style-type: none"> • Synchro-tilt mechanism • 5" pneumatic seat-height adjustment • Upright back lock • Rectilinear independent height-, width-, pivot-, and depth adjustable arms and soft arm caps: black plastic • 3" seat depth adjustment • Passive seat edge angle • Adjustable lumbar • Frame: black plastic • Seat shell, outer back, and five-arm base: black plastic only • Standard upholstery design: Cogent: Connect fabric only • 2½"-diameter, hard-composition, dual-wheel casters: black 	<ol style="list-style-type: none"> 1 Style number 2 Cogent: Connect fabric color number for upholstery on seat and back 3 Options, if selected (see below) <ul style="list-style-type: none"> ▶ See <i>Surface Materials</i>, page 504.

Options	U.S. Price	Required to Specify
Surface Materials <ul style="list-style-type: none"> • Platinum 	+\$89	Specify with 6249 Platinum.
Casters <ul style="list-style-type: none"> • Soft, dark grey treaded, dual-wheel roll-control casters for use on hard floors 	+\$27	Specify with soft roll-control casters.

Specification Information	
Style Number	U.S. Base Price
4821410V	\$1074
.	.

▶ Detailed dimensions, page 108



For Canadian Pricing
 Multiply U.S. Price by the Canadian price factor.
 ▶ See page 1 for details.

Amia 482 Series Work Chair

Sewn Leather Upholstery on Back, Seat, and Arm Caps



Standard Includes	Required to Specify
<p>▶ Need help? Product details, page 104</p> <ul style="list-style-type: none"> • Synchro-tilt mechanism • 5" pneumatic seat-height adjustment • Upright back lock • Rectilinear independent height-, width-, pivot-, and depth-adjustable arms • Frame and arms: platinum • 3" seat depth adjustment • Five-arm base: polished aluminum • Passive seat edge angle • Adjustable lumbar • Fully upholstered outer back, seat, and arm caps: leather • Sewn upholstery design • 2½"-diameter, hard-composition, dual-wheel casters: polished aluminum 	<ol style="list-style-type: none"> 1 Style number 2 Leather color number for upholstery on back, seat, and arm caps 3 Options, if selected (see below) <p>▶ See <i>Surface Materials</i>, page 504.</p>

Tip: Always add suffixes in alphabetical order when specifying options to Amia seating.

Tip: Fire Code Seating (FCS) option is available with certain upholstery fabric choices only.
▶ Page 517

Tip: Fire Code Seating (FCS) option is available on Amia chairs with fully adjustable arms only.

Tip: Plastic base available with plastic casters only.

Tip: Polished aluminum casters are available on a polished aluminum base only.

▶ Detailed dimensions, page 108



For Canadian Pricing
Multiply U.S. Price by the Canadian price factor.
▶ See page 1 for details.

Options	U.S. Price	Required to Specify
<p>Surface Materials</p> <p>Upholstery</p> <ul style="list-style-type: none"> • Elmosoft leather upholstery +\$ 85 • Select Surfaces leather price group 2 +\$ 85 • Customer's Own Leather (COL) No cost • Fire Code Seating (FCS) +\$ 81 • Soil-retardant treatment applied to upholstery fabric +\$ 27 <p>Frame and arms</p> <ul style="list-style-type: none"> • Black plastic -\$ 89 		<p>Specify Elmosoft leather color number.</p> <p>▶ See <i>Surface Materials Reference Manual</i>. Specify leather color number. Add suffix F to the style number. Specify with soil-retardant treatment.</p>
<p>Base</p> <ul style="list-style-type: none"> • Plastic base -\$218 		Specify with plastic base.
<p>Arms</p> <ul style="list-style-type: none"> • Height-adjustable arms, soft arm caps -\$ 93 		Specify with height-adjustable arms.
<p>Seat Height</p> <ul style="list-style-type: none"> • 4" pneumatic seat-height adjustment +\$ 61 • 7" pneumatic seat-height adjustment +\$ 61 		Specify with 4" pneumatic seat-height adjustment. Specify with 7" pneumatic seat-height adjustment.
<p>Casters</p> <p>Polished aluminum base</p> <ul style="list-style-type: none"> • Soft, dual-wheel casters for use on hard floors: polished aluminum +\$ 27 • Hard, dual-wheel casters for use on soft floors: plastic -\$ 62 • Soft, dark grey treaded, dual-wheel roll-control casters for use on hard floors: plastic -\$ 38 <p>Plastic base</p> <ul style="list-style-type: none"> • Soft, dark grey treaded, dual-wheel roll-control casters for use on hard floors: plastic +\$ 27 		Specify with soft polished aluminum casters. Specify with hard plastic casters. Specify with soft plastic casters. Specify with soft roll-control casters.
<p>Glides</p> <p>Polished aluminum base</p> <ul style="list-style-type: none"> • Glides: plastic -\$ 38 <p>Plastic base</p> <ul style="list-style-type: none"> • Glides: plastic +\$ 27 		Specify with glides. Specify with glides.

Specification Information	
Style Number	U.S. Base Price
4821410LS	\$2249

Amia 482 Series Work Chair

Upholstery on Back and Seat



Standard Includes	Required to Specify
-------------------	---------------------

- | | | |
|--|---|--|
| <ul style="list-style-type: none"> ▶ Need help? Product details, page 104 | <ul style="list-style-type: none"> • Synchro-tilt mechanism • 5" pneumatic seat-height adjustment • Upright back lock • Rectilinear independent height-, width-, pivot-, and depth-adjustable arms and soft arm caps: black plastic • Frame, seat shell, outer back, and five-arm base: plastic • 3" seat depth adjustment • Passive seat edge angle • Adjustable lumbar • Standard upholstery design: fabric price group 1 • 2½"-diameter, hard-composition, dual-wheel casters: black | <ol style="list-style-type: none"> 1 Style number 2 Plastic color for frame, seat shell, outer back, and base 3 Fabric color number for upholstery on seat and back 4 Options, if selected (see below) <ul style="list-style-type: none"> ▶ See <i>Surface Materials</i>, page 504. |
|--|---|--|

Options	U.S. Price	Required to Specify
---------	------------	---------------------

Surface Materials	Upholstery on seat and back	
	<ul style="list-style-type: none"> • Fabric price group 1 No cost • Fabric price group 2 +\$ 27 • Fabric price group 3 +\$ 49 • Fabric price group 4 +\$ 70 • Fabric price group 5 +\$ 88 • Fabric price group 6 +\$109 • Fabric price group 7 +\$125 • Fabric price group 8 +\$158 • Fabric price group 9 +\$194 • Fabric price group 10 +\$219 • Steelcase leather upholstery +\$372 	<p>Specify fabric color number.</p> <p>Specify fabric color number.</p> <p>Specify fabric color number.</p> <p>Specify fabric color number.</p> <p>Specify fabric color number.</p> <p>Specify fabric color number.</p> <p>Specify fabric color number.</p> <p>Specify fabric color number.</p> <p>Specify fabric color number.</p> <p>Specify fabric color number.</p> <p>Add suffix S to the style number and specify leather color number.</p> <p>Add suffix S to the style number and specify Select Surfaces leather price group 1.</p> <p>▶ See <i>Surface Materials Reference Manual</i>.</p> <p>Add suffix S to the style number and specify Elmosoft leather color number.</p> <p>Add suffix S to the style number and specify Select Surfaces leather price group 2.</p> <p>▶ See <i>Surface Materials Reference Manual</i>.</p> <p>Add suffix S to the style number and specify vinyl color number.</p>
	<ul style="list-style-type: none"> • Select Surfaces leather price group 1 +\$372 • Elmosoft leather upholstery +\$428 • Select Surfaces leather price group 2 +\$428 • Steelcase vinyl +\$108 	

Contrasting upholstery on seat and back

• Contrasting fabrics	+\$ 33	Add suffix K to the style number and specify fabric color numbers.
-----------------------	--------	---

Contrasting upholstery on seat

• Fabric price group 1	No cost	Specify fabric color number.
• Fabric price group 2	+\$ 10	Specify fabric color number.
• Fabric price group 3	+\$ 27	Specify fabric color number.
• Fabric price group 4	+\$ 36	Specify fabric color number.
• Fabric price group 5	+\$ 43	Specify fabric color number.
• Fabric price group 6	+\$ 53	Specify fabric color number.
• Fabric price group 7	+\$ 64	Specify fabric color number.
• Fabric price group 8	+\$ 79	Specify fabric color number.
• Fabric price group 9	+\$ 97	Specify fabric color number.
• Fabric price group 10	+\$112	Specify fabric color number.
• Steelcase leather upholstery	+\$188	Add suffix S to the style number and specify leather color number.
• Select Surfaces leather price group 1	+\$188	Add suffix S to the style number and specify leather color number.
• Elmosoft leather upholstery	+\$216	Add suffix S to the style number and specify leather color number.
• Select Surfaces leather price group 2	+\$216	Add suffix S to the style number and specify leather color number.
• Customer's Own Material (COM)	No cost	▶ See <i>Surface Materials Reference Manual</i>

▶ Detailed dimensions, page 108



For Canadian Pricing
 Multiply U.S. Price by the Canadian price factor.
 ▶ See page 1 for details.

▶ **Options, continued on next page**

► Options, continued from previous page

	Options	U.S. Price	Required to Specify
Surface Materials, continued	Contrasting upholstery on back		
	• Fabric price group 1	No cost	Specify fabric color number.
	• Fabric price group 2	+\$ 17	Specify fabric color number.
	• Fabric price group 3	+\$ 22	Specify fabric color number.
	• Fabric price group 4	+\$ 34	Specify fabric color number.
	• Fabric price group 5	+\$ 45	Specify fabric color number.
	• Fabric price group 6	+\$ 56	Specify fabric color number.
	• Fabric price group 7	+\$ 61	Specify fabric color number.
	• Fabric price group 8	+\$ 79	Specify fabric color number.
	• Fabric price group 9	+\$ 97	Specify fabric color number.
	• Fabric price group 10	+\$107	Specify fabric color number.
	• Steelcase leather upholstery	+\$182	Add suffix S to the style number and specify leather color number.
	• Select Surfaces leather price group 1	+\$182	Add suffix S to the style number and specify leather color number.
	• Elmosoft leather upholstery	+\$210	Add suffix S to the style number and specify leather color number.
• Select Surfaces leather price group 2	+\$210	Add suffix S to the style number and specify leather color number.	
• Customer's Own Material (COM)	No cost	► See <i>Surface Materials Reference Manual</i>	
	Soil-retardant treatment	+\$ 27	Specify with soil-retardant treatment.
	Fire Code Seating (FCS)	+\$ 81	Add suffix F to the style number.
	Fully upholstered		
	• Fabric fully upholstered outer back	+\$136	Add suffix U to the style number.
	• Steelcase leather fully upholstered outer back	+\$693	Add suffix SU to the style number and specify leather color number.
	• Select Surfaces leather price group 1 fully upholstered outer back	+\$693	Add suffix SU to the style number and specify Select Surfaces leather price group 1.
			► See <i>Surface Materials Reference Manual</i>
	• Elmosoft leather fully upholstered outer back	+\$777	Add suffix SU to the style number and specify Elmosoft leather color number.
	• Select Surfaces leather price group 2 fully upholstered outer back	+\$777	Add suffix SU to the style number and specify Select Surfaces leather price group 2.
			► See <i>Surface Materials Reference Manual</i>
	• Sewn upholstery	+\$217	Add suffix SU to the style number.
	• Customer's Own Leather (COL) fully upholstered outer back	+\$217	Add suffix SU to the style number.
			► See <i>Surface Materials Reference Manual</i> to specify.
	Platinum		
	• On frame, base, arm retainer, and outer back	+\$ 89	Specify with 6249 Platinum.
	Merle		
	• On outer back and outer seat	+\$ 54	Specify with 6527 Merle.
	Seagull		
	• On frame, base, and arm retainer	+\$ 40	Specify with 6053 Seagull.
Base	• Polished aluminum base	+\$156	Specify with polished aluminum base.
Arms	• Height-adjustable arms, soft arm caps	-\$ 93	Specify with height-adjustable arms.
	• Armless	-\$217	Specify without arms.
Seat Height	• 4" pneumatic seat-height adjustment	+\$ 61	Specify with 4" pneumatic seat-height adjustment.
	• 7" pneumatic seat-height adjustment	+\$ 61	Specify with 7" pneumatic seat-height adjustment.

► Options, continued on next page

Tip: When 6527 Merle is specified, the frame, arm retainer, and base will be 6249 Platinum.

Tip: When 6053 Seagull is specified, the frame, arm retainer, and base will be 6053 Seagull. The outer back shell and outer seat shell will be 6249 Platinum.

**For Canadian Pricing**

Multiply U.S. Price by the Canadian price factor.

► See page 1 for details.

Amia 482 Series Work Chair, Upholstery on Back and Seat, continued

► Options, continued from previous page

	Options	U.S. Price	Required to Specify
Casters	• Soft, dark grey treaded, dual-wheel roll-control casters for use on hard floors	+\$27	Specify <i>with soft roll-control casters</i> .
	• Hard, polished aluminum casters on polished aluminum base for use on soft floors	+\$62	Specify <i>with hard polished aluminum casters</i> .
	• Soft, polished aluminum casters on polished aluminum base for use on hard floors	+\$87	Specify <i>with soft polished aluminum casters</i> .
Glides	• Glides: plastic	+\$27	Specify <i>with glides</i> .

Specification Information

• Style Number	• U.S. Base Price
4821410	\$1103
.	.
.	.



 **For Canadian Pricing**
 Multiply U.S. Price by the Canadian price factor.
 ► See page 1 for details.

Amia 482 Series Work Chair

3D Knit on Back with Upholstery on Seat



Standard Includes		Required to Specify
<p>► Need help? Product details, page 104</p> <ul style="list-style-type: none"> • Synchro-tilt mechanism • 5" pneumatic seat-height adjustment • Upright back lock • Rectilinear independent height-, width-, pivot-, and depth-adjustable arms and soft arm caps: black plastic • Frame, seat shell, outer back, and five-arm base: plastic • 3" seat depth adjustment • Passive seat edge angle • Adjustable lumbar • 3D Knit on back only • Standard upholstery design on seat: fabric price group 1 • 2½"-diameter, hard-composition, dual-wheel casters: black 	<ul style="list-style-type: none"> 1 Style number 2 Plastic color for frame, seat shell, outer back, and base 3 3D Knit color for back 4 Fabric color number for upholstery on seat 5 Options, if selected (see below) <p>► See <i>Surface Materials</i>, page 504.</p>	

	Options	U.S. Price	Required to Specify
Surface Materials	Upholstery		
	• Fabric price group 1	No cost	Specify fabric color number.
	• Fabric price group 2	+\$ 10	Specify fabric color number.
	• Fabric price group 3	+\$ 27	Specify fabric color number.
	• Fabric price group 4	+\$ 36	Specify fabric color number.
	• Fabric price group 5	+\$ 43	Specify fabric color number.
	• Fabric price group 6	+\$ 53	Specify fabric color number.
	• Fabric price group 7	+\$ 64	Specify fabric color number.
	• Fabric price group 8	+\$ 79	Specify fabric color number.
	• Fabric price group 9	+\$ 97	Specify fabric color number.
• Fabric price group 10	+\$112	Specify fabric color number.	
• Steelcase leather upholstery	+\$189	Add suffix S to the style number and specify leather color number.	
• Select Surfaces leather price group 1	+\$189	Add suffix S to the style number and specify Select Surfaces leather price group 1.	
• Elmosoft leather upholstery	+\$217	► See <i>Surface Materials Reference Manual</i> . Add suffix S to the style number and specify Elmosoft leather color number.	
• Select Surfaces leather price group 2	+\$217	Add suffix S to the style number and specify Select Surfaces leather price group 2.	
	• Sewn upholstery	+\$ 43	► See <i>Surface Materials Reference Manual</i> . Add suffix S to the style number.
	• Steelcase vinyl	+\$ 53	Add suffix S to the style number and specify vinyl color number.
	• Customer's Own Material (COM)	No cost	► See <i>Surface Materials Reference Manual</i> to specify.
	• Customer's Own Leather (COL)	+\$ 43	Add suffix S to the style number and specify leather color number.
	• Customer's Own Material/Vinyl (COM-Sewn)	+\$ 43	Add suffix S to the style number and specify vinyl color number.
	• Fire Code Seating (FCS)	+\$ 81	Add suffix F to the style number.
	• Soil-retardant treatment applied to upholstery fabric	+\$ 27	Specify <i>with soil-retardant treatment</i> .
	Platinum		
	• On frame, base, arm retainer, and outer back	+\$ 89	Specify <i>with 6249 Platinum</i> .
	Merle		
	• On outer back and outer seat	+\$ 54	Specify <i>with 6527 Merle</i> .
	Seagull		
	• On frame, base, and arm retainer	+\$ 40	Specify <i>with 6053 Seagull</i> .
Base	• Polished aluminum base	+\$156	Specify <i>with polished aluminum base</i> .
Arms	• Height-adjustable arms, soft arm caps	-\$ 93	Specify <i>with height-adjustable arms</i> .
	• Armless	-\$217	Specify <i>without arms</i> .

► **Options, continued on next page**

Tip: Sewn detail, if selected, is on the seat only.

Tip: Fire Code Seating (FCS) option is available with certain upholstery fabric choices only.
► Page 517

Tip: Fire Code Seating (FCS) option is available on Amia chairs with fully adjustable arms or armless models only.

Tip: When 6527 Merle is specified, the frame, arm retainer, and base will be 6249 Platinum.

Tip: When 6053 Seagull is specified, the frame, arm retainer, and base will be 6053 Seagull. The outer back shell and outer seat shell will be 6249 Platinum.

► Detailed dimensions, page 108

► Options, continued from previous page

Options	U.S. Price	Required to Specify
Seat Height		
• 4" pneumatic seat-height adjustment	+\$61	Specify with 4" pneumatic seat-height adjustment.
• 7" pneumatic seat-height adjustment	+\$61	Specify with 7" pneumatic seat-height adjustment.
Casters		
• Soft, dark grey treaded, dual-wheel roll-control casters for use on hard floors	+\$27	Specify with soft roll-control casters.
• Hard, polished aluminum casters on polished aluminum base for use on soft floors	+\$62	Specify with hard polished aluminum casters.
• Soft, polished aluminum casters on polished aluminum base for use on hard floors	+\$87	Specify with soft polished aluminum casters.
Glides		
• Glides: plastic	+\$27	Specify with glides.

Specification Information

Style Number	U.S. Base Price
4821418	\$1165



For Canadian Pricing
 Multiply U.S. Price by the
 Canadian price factor.
 ► See page 1 for details.

Amia 482 Series Work Chair

Air Back with Upholstery on Seat



Tip: Frame packages include back frame, inner back frame, outer seat shell, arm holsters, and base.

Tip: When merle, platinum, or seagull are selected as frame packages, the outer seat shell and inner back frame default to 7249 Merle plastic.

Tip: Always add suffixes in alphabetical order when specifying options to Amia seating.

► Detailed dimensions, page 108



For Canadian Pricing
Multiply U.S. Price by the Canadian price factor.
► See page 1 for details.

Standard Includes		Required to Specify
► Need help? Product details, page 104	<ul style="list-style-type: none"> • Frame package • Synchro-tilt mechanism • 5" pneumatic seat-height adjustment • Upright back lock • Rectilinear independent height-, width-, pivot-, and depth-adjustable arms and soft arm caps: black plastic • 3" seat depth adjustment • Passive seat edge angle • Air backrest with integrated LiveBack technology • Standard upholstery design on seat: fabric price group 1 • 2½"-diameter, hard-composition, dual-wheel casters: black 	<ol style="list-style-type: none"> 1 Style number 2 Frame package (see below under Required Selections) 3 Fabric color number for upholstery on seat 4 Air back plastic color number 5 Options, if selected (see below) <p>► See <i>Surface Materials</i>, page 504.</p>

Required Selections	U.S. Price	Required to Specify
Frame Package	<ul style="list-style-type: none"> • Black No cost • Merle +\$ 40 • Platinum +\$ 40 • Seagull +\$ 40 	<p>Specify with 6205 Black. Specify with 6527 Merle. Specify with 6249 Platinum. Specify with 6053 Seagull.</p>

Options	U.S. Price	Required to Specify
Surface Materials		
Upholstery		
<ul style="list-style-type: none"> • Fabric price group 1 No cost • Fabric price group 2 +\$ 10 • Fabric price group 3 +\$ 27 • Fabric price group 4 +\$ 36 • Fabric price group 5 +\$ 43 • Fabric price group 6 +\$ 53 • Fabric price group 7 +\$ 64 • Fabric price group 8 +\$ 79 • Fabric price group 9 +\$ 97 • Fabric price group 10 +\$112 • Steelcase leather upholstery +\$189 		<p>Specify fabric color number. Specify fabric color number. Specify fabric color number. Specify fabric color number. Specify fabric color number. Specify fabric color number. Specify fabric color number. Specify fabric color number. Specify fabric color number. Specify fabric color number. Specify fabric color number. Specify fabric color number. Add suffix S to the style number and specify leather color number. Add suffix S to the style number and specify Select Surfaces leather price group 1. ► See <i>Surface Materials Reference Manual</i>. Add suffix S to the style number and specify Elmosoft leather color number. Add suffix S to the style number and specify Select Surfaces leather price group 2. ► See <i>Surface Materials Reference Manual</i>. Add suffix S to the style number. Add suffix S to the style number and specify vinyl color number. ► See <i>Surface Materials Reference Manual</i> to specify. Add suffix S to the style number and specify leather color number. Add suffix S to the style number and specify vinyl color number. Specify with soil-retardant treatment.</p>
<ul style="list-style-type: none"> • Select Surfaces leather price group 1 +\$189 • Elmosoft leather upholstery +\$217 • Select Surfaces leather price group 2 +\$217 • Sewn upholstery +\$ 43 • Steelcase vinyl +\$ 53 • Customer's Own Material (COM) No cost • Customer's Own Leather (COL) +\$ 43 • Customer's Own Material/Vinyl (COM-Sewn) +\$ 43 • Soil-retardant treatment applied to upholstery fabric +\$ 27 		
Base	<ul style="list-style-type: none"> • Polished aluminum base +\$156 	Specify with polished aluminum base.
Arms	<ul style="list-style-type: none"> • Height-adjustable arms, soft arm caps -\$ 93 • Armless -\$217 	Specify with height-adjustable arms. Specify without arms.

► Options, continued on next page

► Options, continued from previous page

Options	U.S. Price	Required to Specify
Seat Height		
• 4" pneumatic seat-height adjustment	+\$61	Specify with 4" pneumatic seat-height adjustment.
• 7" pneumatic seat-height adjustment	+\$61	Specify with 7" pneumatic seat-height adjustment.
Casters		
• Soft, dark grey treaded, dual-wheel roll-control casters for use on hard floors	+\$27	Specify with soft roll-control casters.
• Hard, polished aluminum casters on polished aluminum base for use on soft floors	+\$62	Specify with hard polished aluminum casters.
• Soft, polished aluminum casters on polished aluminum base for use on hard floors	+\$87	Specify with soft polished aluminum casters.
Glides		
• Glides: plastic	+\$27	Specify with glides.

Specification Information

Style Number	U.S. Base Price
4821412	\$944



For Canadian Pricing

Multiply U.S. Price by the Canadian price factor.

► See page 1 for details.

Amia 482 Series Work Chair

Air Back with 3D Microknit and Upholstery on Seat



Standard Includes		Required to Specify
<ul style="list-style-type: none"> ▶ Need help? Product details, page 104 	<ul style="list-style-type: none"> • Frame package • Synchro-tilt mechanism • 5" pneumatic seat-height adjustment • Upright back lock • Rectilinear independent height-, width-, pivot-, and depth-adjustable arms and soft arm caps: black plastic • 3" seat depth adjustment • Passive seat edge angle • Air backrest with integrated LiveBack technology • Adjustable lumbar • 3D Microknit on back only • Standard upholstery design on seat: fabric price group 1 • 2½"-diameter, hard-composition, dual-wheel casters: black 	<ol style="list-style-type: none"> 1 Style number 2 Frame package (see below under Required Selections) 3 Fabric color number for upholstery on seat 4 Air back plastic color number 5 Options, if selected (see below) <ul style="list-style-type: none"> ▶ See <i>Surface Materials</i>, page 504.

Tip: Frame packages include back frame, inner back frame, outer seat shell, arm holsters, and base.

Tip: When merle, platinum, or seagull are selected as frame packages, the outer seat shell and inner back frame default to 7249 Merle plastic.

Tip: Always add suffixes in alphabetical order when specifying options to Amia seating.

Required Selections	U.S. Price	Required to Specify
Frame Package		
• Black	No cost	Specify with 6205 Black.
• Merle	+\$ 40	Specify with 6527 Merle.
• Platinum	+\$ 40	Specify with 6249 Platinum.
• Seagull	+\$ 40	Specify with 6053 Seagull.

Options	U.S. Price	Required to Specify
Surface Materials		
Upholstery		
• Fabric price group 1	No cost	Specify fabric color number.
• Fabric price group 2	+\$ 10	Specify fabric color number.
• Fabric price group 3	+\$ 27	Specify fabric color number.
• Fabric price group 4	+\$ 36	Specify fabric color number.
• Fabric price group 5	+\$ 43	Specify fabric color number.
• Fabric price group 6	+\$ 53	Specify fabric color number.
• Fabric price group 7	+\$ 64	Specify fabric color number.
• Fabric price group 8	+\$ 79	Specify fabric color number.
• Fabric price group 9	+\$ 97	Specify fabric color number.
• Fabric price group 10	+\$112	Specify fabric color number.
• Steelcase leather upholstery	+\$189	Specify fabric color number. Add suffix S to the style number and specify leather color number.
• Select Surfaces leather price group 1	+\$189	Add suffix S to the style number and specify Select Surfaces leather price group 1. ▶ See <i>Surface Materials Reference Manual</i> .
• Elmosoft leather upholstery	+\$217	Add suffix S to the style number and specify Elmosoft leather color number.
• Select Surfaces leather price group 2	+\$217	Add suffix S to the style number and specify Select Surfaces leather price group 2. ▶ See <i>Surface Materials Reference Manual</i> .
• Sewn upholstery	+\$ 43	Add suffix S to the style number.
• Steelcase vinyl	+\$ 53	Add suffix S to the style number and specify vinyl color number.
• Customer's Own Material (COM)	No cost	▶ See <i>Surface Materials Reference Manual</i> to specify.
• Customer's Own Leather (COL)	+\$ 43	Add suffix S to the style number and specify leather color number.
• Customer's Own Material/Vinyl (COM-Sewn)	+\$ 43	Add suffix S to the style number and specify vinyl color number.
• Soil-retardant treatment applied to upholstery fabric	+\$ 27	Specify with soil-retardant treatment.

▶ Detailed dimensions, page 108

Base	• Polished aluminum base	+\$156	Specify with polished aluminum base.
Arms	• Height-adjustable arms, soft arm caps	-\$ 93	Specify with height-adjustable arms.
	• Armless	-\$217	Specify without arms.

▶ Options, continued on next page

 **For Canadian Pricing**
Multiply U.S. Price by the Canadian price factor.
▶ See page 1 for details.

► Options, continued from previous page

	Options	U.S. Price	Required to Specify
Lumbar	• No lumbar	-\$26	Specify <i>with no lumbar</i> .
Seat Height	• 4" pneumatic seat-height adjustment	+\$61	Specify <i>with 4" pneumatic seat-height adjustment</i> .
	• 7" pneumatic seat-height adjustment	+\$61	Specify <i>with 7" pneumatic seat-height adjustment</i> .
Casters	• Soft, dark grey treaded, dual-wheel roll-control casters for use on hard floors	+\$27	Specify <i>with soft roll-control casters</i> .
	• Hard, polished aluminum casters on polished aluminum base for use on soft floors	+\$62	Specify <i>with hard polished aluminum casters</i> .
	• Soft, polished aluminum casters on polished aluminum base for use on hard floors	+\$87	Specify <i>with soft polished aluminum casters</i> .
Glides	• Glides: plastic	+\$27	Specify <i>with glides</i> .

Specification Information

Style Number	U.S. Base Price
4821414	\$999

**For Canadian Pricing**

Multiply U.S. Price by the Canadian price factor.

► See page 1 for details.

Amia 482 Series Stool

Upholstery on Back and Seat

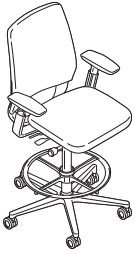

Standard Includes	Required to Specify
-------------------	---------------------

- | | | |
|--|---|---|
| <ul style="list-style-type: none"> ▶ Need help? Product details, page 104 | <ul style="list-style-type: none"> • Synchro-tilt mechanism • 8" pneumatic seat-height adjustment • Upright back lock • Passive seat edge angle • Rectilinear independent height-, width-, pivot-, and depth-adjustable arms and soft arm caps: black plastic • Frame, seat shell, outer back, and five-arm base: plastic • 3" seat depth adjustment • Column and 4" adjustable foot ring: black • Standard upholstery design: fabric price group 1 • 2"-diameter, hard-composition, dual-wheel casters: black • Adjustable lumbar | <ol style="list-style-type: none"> 1 Style number 2 Plastic color for frame, seat shell, outer back, and base 3 Fabric color number for upholstery on seat and back 4 Options, if selected (see below) <ul style="list-style-type: none"> ▶ See <i>Surface Materials</i>, page 504. |
|--|---|---|

Options	U.S. Price	Required to Specify
---------	------------	---------------------

Surface Materials	Upholstery on seat and back	
	<ul style="list-style-type: none"> • Fabric price group 1 No cost • Fabric price group 2 +\$ 27 • Fabric price group 3 +\$ 49 • Fabric price group 4 +\$ 70 • Fabric price group 5 +\$ 88 • Fabric price group 6 +\$109 • Fabric price group 7 +\$125 • Fabric price group 8 +\$158 • Fabric price group 9 +\$194 • Fabric price group 10 +\$219 • Steelcase leather upholstery +\$372 	<p>Specify fabric color number. Specify fabric color number. Specify fabric color number. Specify fabric color number. Specify fabric color number. Specify fabric color number. Specify fabric color number. Specify fabric color number. Specify fabric color number. Specify fabric color number.</p> <p>Add suffix S to the style number and specify leather color number. Add suffix S to the style number and specify Select Surfaces leather price group 1.</p> <p>▶ See <i>Surface Materials Reference Manual</i>. Add suffix S to the style number and specify Elmosoft leather color number. Add suffix S to the style number and specify Select Surfaces leather price group 2.</p> <p>▶ See <i>Surface Materials Reference Manual</i>. Add suffix S to the style number. Add suffix S to the style number and specify vinyl color number.</p> <p>▶ See <i>Surface Materials Reference Manual</i> to specify. Add suffix S to the style number and specify leather color number. Add suffix S to the style number and specify vinyl color number. Add suffix F to the style number. Specify <i>with soil-retardant treatment</i>.</p>
	<ul style="list-style-type: none"> • Select Surfaces leather price group 1 +\$372 • Elmosoft leather upholstery +\$428 • Select Surfaces leather price group 2 +\$428 • Sewn upholstery +\$ 81 • Steelcase vinyl +\$108 • Customer's Own Material (COM) No cost • Customer's Own Leather (COL) +\$ 81 • Customer's Own Material/Vinyl (COM-Sewn) +\$ 81 • Fire Code Seating (FCS) +\$ 81 • Soil-retardant treatment applied to upholstery fabric +\$ 27 	
	Contrasting upholstery on seat and back	
	<ul style="list-style-type: none"> • Contrasting fabrics +\$ 33 	<p>Add suffix K to the style number and specify fabric color numbers.</p>

Tip: Always add suffixes in alphabetical order when specifying options to Amia seating.

Tip: Fire Code Seating (FCS) option is available with certain upholstery fabric choices only.

▶ Page 517

Tip: Fire Code Seating (FCS) option is available on Amia chairs with fully adjustable arms or armless models only.

▶ Detailed dimensions, page 108



For Canadian Pricing

Multiply U.S. Price by the Canadian price factor.

▶ See page 1 for details.

▶ **Options, continued on next page**

► Options, continued from previous page

Options	U.S. Price	Required to Specify
Surface Materials, continued		
Contrasting upholstery on seat		
• Fabric price group 1	No cost	Specify fabric color number.
• Fabric price group 2	+\$ 10	Specify fabric color number.
• Fabric price group 3	+\$ 27	Specify fabric color number.
• Fabric price group 4	+\$ 36	Specify fabric color number.
• Fabric price group 5	+\$ 43	Specify fabric color number.
• Fabric price group 6	+\$ 53	Specify fabric color number.
• Fabric price group 7	+\$ 64	Specify fabric color number.
• Fabric price group 8	+\$ 79	Specify fabric color number.
• Fabric price group 9	+\$ 97	Specify fabric color number.
• Fabric price group 10	+\$112	Specify fabric color number.
• Steelcase leather upholstery	+\$188	Add suffix S to the style number and specify leather color number.
• Select Surfaces leather price group 1	+\$188	Add suffix S to the style number and specify leather color number.
• Elmosoft leather upholstery	+\$216	Add suffix S to the style number and specify leather color number.
• Select Surfaces leather price group 2	+\$216	Add suffix S to the style number and specify leather color number.
• Customer's Own Material (COM)	No cost	► See <i>Surface Materials Reference Manual</i>
Contrasting upholstery on back		
• Fabric price group 1	No cost	Specify fabric color number.
• Fabric price group 2	+\$ 17	Specify fabric color number.
• Fabric price group 3	+\$ 22	Specify fabric color number.
• Fabric price group 4	+\$ 34	Specify fabric color number.
• Fabric price group 5	+\$ 45	Specify fabric color number.
• Fabric price group 6	+\$ 56	Specify fabric color number.
• Fabric price group 7	+\$ 61	Specify fabric color number.
• Fabric price group 8	+\$ 79	Specify fabric color number.
• Fabric price group 9	+\$ 97	Specify fabric color number.
• Fabric price group 10	+\$107	Specify fabric color number.
• Steelcase leather upholstery	+\$182	Add suffix S to the style number and specify leather color number.
• Select Surfaces leather price group 1	+\$182	Add suffix S to the style number and specify leather color number.
• Elmosoft leather upholstery	+\$210	Add suffix S to the style number and specify leather color number.
• Select Surfaces leather price group 2	+\$210	Add suffix S to the style number and specify leather color number.
• Customer's Own Material (COM)	No cost	► See <i>Surface Materials Reference Manual</i>
Soil-retardant treatment	+\$ 27	Specify <i>with soil-retardant treatment</i> .
Fully upholstered		
• Fabric fully upholstered outer back	+\$136	Add suffix U to the style number.
• Steelcase leather fully upholstered outer back	+\$693	Add suffix SU to the style number and specify leather color number.
• Select Surfaces leather price group 1 fully upholstered outer back	+\$693	Add suffix SU to the style number and specify Select Surfaces leather price group 1.
		► See <i>Surface Materials Reference Manual</i> .
• Elmosoft leather fully upholstered outer back	+\$777	Add suffix SU to the style number and specify Elmosoft leather color number.
• Select Surfaces leather price group 2 fully upholstered outer back	+\$777	Add suffix SU to the style number and specify Select Surfaces leather price group 2.
		► See <i>Surface Materials Reference Manual</i> .
• Sewn upholstery	+\$217	Add suffix SU to the style number.
• Customer's Own Leather (COL) fully upholstered outer back	+\$217	Add suffix SU to the style number.
		► See <i>Surface Materials Reference Manual</i> to specify.

► Options, continued on next page

**For Canadian Pricing**

Multiply U.S. Price by the Canadian price factor.

► See page 1 for details.

Amia 482 Series Stool, Upholstery on Back and Seat, continued

► Options, continued from previous page

	Options	U.S. Price	Required to Specify
Surface Materials, continued	Platinum • On frame, base, arm retainer, and outer back	+\$ 89	Specify with 6249 Platinum.
	Merle • On outer back and outer seat	+\$ 54	Specify with 6527 Merle.
	Seagull • On frame, base, and arm retainer	+\$ 40	Specify with 6053 Seagull.
Arms	• Height-adjustable arms, soft arm caps • Armless	-\$ 93 -\$217	Specify with height-adjustable arms. Specify without arms.
Casters	• Soft, dark grey treaded, dual-wheel roll-control casters for use on hard floors	+\$ 27	Specify with soft roll-control casters.
Glides	• Glides: plastic	+\$ 27	Specify with glides.

Tip: When 6527 Merle is specified, the frame, arm retainer, and base will be 6249 Platinum.

Tip: When 6053 Seagull is specified, the frame, arm retainer, and base will be 6053 Seagull. The outer back shell and outer seat shell will be 6249 Platinum.

Specification Information	
• Style Number	• U.S. Base Price
4827410	\$1309
:	:

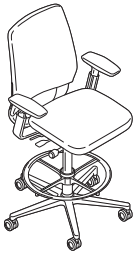

Amia 482 Series Stool

3D Knit on Back with Upholstery on Seat



Standard Includes	Required to Specify
<p>► Need help? Product details, page 104</p> <ul style="list-style-type: none"> • Frame package • Synchro-tilt mechanism • 8" pneumatic seat-height adjustment • Upright back lock • Passive seat edge angle • Rectilinear independent height-, width-, pivot-, and depth-adjustable arms and soft arm caps: black plastic • Frame, seat shell, outer back, and five-arm base: plastic • 3" seat depth adjustment • Column and 4" adjustable foot ring: black • 3D Knit on back only • Standard upholstery design on seat: fabric price group 1 • 2"-diameter, hard-composition, dual-wheel casters: black • Adjustable lumbar 	<ol style="list-style-type: none"> 1 Style number 2 Plastic color for frame, seat shell, outer back, and base 3 3D Knit color for back 4 Fabric color number for upholstery on seat 5 Options, if selected (see below) <p>► See <i>Surface Materials</i>, page 504.</p>

Options	U.S. Price	Required to Specify
<p>Surface Materials</p> <ul style="list-style-type: none"> • Fabric price group 1 • Fabric price group 2 • Fabric price group 3 • Fabric price group 4 • Fabric price group 5 • Fabric price group 6 • Fabric price group 7 • Fabric price group 8 • Fabric price group 9 • Fabric price group 10 • Steelcase leather upholstery • Select Surfaces leather price group 1 • Elmosoft leather upholstery • Select Surfaces leather price group 2 • Sewn upholstery • Steelcase vinyl • Customer's Own Material (COM) • Customer's Own Leather (COL) • Customer's Own Material/Vinyl (COM-Sewn) • Fire Code Seating (FCS) • Soil-retardant treatment applied to upholstery fabric 	<p>No cost</p> <p>+\$ 10</p> <p>+\$ 27</p> <p>+\$ 36</p> <p>+\$ 43</p> <p>+\$ 53</p> <p>+\$ 64</p> <p>+\$ 79</p> <p>+\$ 97</p> <p>+\$112</p> <p>+\$189</p> <p>+\$189</p> <p>+\$217</p> <p>+\$217</p> <p>+\$ 43</p> <p>+\$ 53</p> <p>No cost</p> <p>+\$ 43</p> <p>+\$ 81</p> <p>+\$ 27</p> <hr/> <p>+\$ 89</p> <hr/> <p>+\$ 54</p> <hr/> <p>+\$ 40</p> <hr/> <p>-\$ 93</p> <p>-\$217</p> <hr/> <p>+\$ 27</p> <hr/> <p>+\$ 27</p>	<p>Specify fabric color number.</p> <p>Specify fabric color number.</p> <p>Specify fabric color number.</p> <p>Specify fabric color number.</p> <p>Specify fabric color number.</p> <p>Specify fabric color number.</p> <p>Specify fabric color number.</p> <p>Specify fabric color number.</p> <p>Specify fabric color number.</p> <p>Specify fabric color number.</p> <p>Add suffix S to the style number and specify leather color number.</p> <p>Add suffix S to the style number and specify Select Surfaces leather price group 1.</p> <p>► See <i>Surface Materials Reference Manual</i>. Add suffix S to the style number and specify Elmosoft leather color number.</p> <p>Add suffix S to the style number and specify Select Surfaces leather price group 2.</p> <p>► See <i>Surface Materials Reference Manual</i>. Add suffix S to the style number.</p> <p>Add suffix S to the style number and specify vinyl color number.</p> <p>► See <i>Surface Materials Reference Manual</i> to specify.</p> <p>Add suffix S to the style number and specify leather color number.</p> <p>Add suffix S to the style number and specify vinyl color number.</p> <p>Add suffix F to the style number. Specify <i>with soil-retardant treatment</i>.</p> <hr/> <p>Specify <i>with 6249 Platinum</i>.</p> <hr/> <p>Specify <i>with 6527 Merle</i>.</p> <hr/> <p>Specify <i>with 6053 Seagull</i>.</p> <hr/> <p>Specify <i>with height-adjustable arms</i>. Specify <i>without arms</i>.</p> <hr/> <p>Specify <i>with soft roll-control casters</i>.</p> <hr/> <p>Specify <i>with glides</i>.</p>
<p>Upholstery</p>		
<p>Platinum</p>		
<p>Merle</p>		
<p>Seagull</p>		
<p>Arms</p>		
<p>Casters</p>		
<p>Glides</p>		

Tip: Sewn detail, if selected, is on the seat only.

Tip: Fire Code Seating (FCS) option is available with certain upholstery fabric choices only.
► Page 517

Tip: Fire Code Seating (FCS) option is available on Amia chairs with fully adjustable arms only or armless models only.

Tip: When 6527 Merle is specified, the frame, arm retainer, and base will be 6249 Platinum.

Tip: When 6053 Seagull is specified, the frame, arm retainer, and base will be 6053 Seagull. The outer back shell and outer seat shell will be 6249 Platinum.

► Detailed dimensions, page 108

Specification Information

Style Number	U.S. Base Price
4827418	\$1371



For Canadian Pricing
Multiply U.S. Price by the Canadian price factor.
▶ See page 1 for details.

Amia 482 Series Stool

Air Back with Upholstery on Seat



Standard Includes	Required to Specify
-------------------	---------------------

- | | | |
|--|--|---|
| <ul style="list-style-type: none"> ▶ Need help? Product details, page 104 | <ul style="list-style-type: none"> • Frame package • Synchro-tilt mechanism • 8" pneumatic seat-height adjustment • Upright back lock • Passive seat edge angle • Rectilinear independent height-, width-, pivot-, and depth-adjustable arms and soft arm caps: black plastic • 3" seat depth adjustment • Column and 4" adjustable foot ring: black • Air backrest with integrated LiveBack technology • Standard upholstery design on seat: fabric price group 1 • 2"-diameter, hard-composition, dual-wheel casters: black | <ol style="list-style-type: none"> 1 Style number 2 Frame package (see below under Required Selections) 3 Fabric color number for upholstery on seat 4 Air back plastic color number 5 Options, if selected (see below) <p>▶ See <i>Surface Materials</i>, page 504.</p> |
|--|--|---|

Tip: Frame packages include back frame, inner back frame, outer seat shell, arm holsters, and base.

Tip: When merle, platinum, or seagull are selected as frame packages, the outer seat shell and inner back frame default to 7249 Merle plastic.

Tip: Always add suffixes in alphabetical order when specifying options to Amia seating.

Frame Package	Required Selections	U.S. Price	Required to Specify
---------------	---------------------	------------	---------------------

- | | | |
|---|---|---|
| <ul style="list-style-type: none"> • Black • Merle • Platinum • Seagull | <ul style="list-style-type: none"> No cost +\$ 40 +\$ 40 +\$ 40 | <ul style="list-style-type: none"> Specify with 6205 Black. Specify with 6527 Merle. Specify with 6249 Platinum. Specify with 6053 Seagull. |
|---|---|---|

Surface Materials	Options	U.S. Price	Required to Specify
-------------------	---------	------------	---------------------

- | | | |
|---|---|--|
| <ul style="list-style-type: none"> • Fabric price group 1 • Fabric price group 2 • Fabric price group 3 • Fabric price group 4 • Fabric price group 5 • Fabric price group 6 • Fabric price group 7 • Fabric price group 8 • Fabric price group 9 • Fabric price group 10 • Steelcase leather upholstery | <ul style="list-style-type: none"> No cost +\$ 10 +\$ 27 +\$ 36 +\$ 43 +\$ 53 +\$ 64 +\$ 79 +\$ 97 +\$112 +\$189 | <ul style="list-style-type: none"> Specify fabric color number. Specify fabric color number. Specify fabric color number. Specify fabric color number. Specify fabric color number. Specify fabric color number. Specify fabric color number. Specify fabric color number. Specify fabric color number. Specify fabric color number. Specify fabric color number. Add suffix S to the style number and specify leather color number. Add suffix S to the style number and specify Select Surfaces leather price group 1. ▶ See <i>Surface Materials Reference Manual</i>. Add suffix S to the style number and specify Elmosoft leather color number. Add suffix S to the style number and specify Select Surfaces leather price group 2. ▶ See <i>Surface Materials Reference Manual</i>. Add suffix S to the style number. Add suffix S to the style number and specify vinyl color number. ▶ See <i>Surface Materials Reference Manual</i> to specify. Add suffix S to the style number and specify leather color number. Add suffix S to the style number and specify vinyl color number Specify with soil-retardant treatment. |
| <ul style="list-style-type: none"> • Select Surfaces leather price group 1 • Elmosoft leather upholstery • Select Surfaces leather price group 2 | <ul style="list-style-type: none"> +\$189 +\$217 +\$217 | <ul style="list-style-type: none"> Specify fabric color number. Specify fabric color number. Specify fabric color number. Specify fabric color number. Specify fabric color number. Specify fabric color number. Specify fabric color number. Specify fabric color number. Specify fabric color number. Specify fabric color number. Specify fabric color number. Add suffix S to the style number and specify leather color number. Add suffix S to the style number and specify vinyl color number. ▶ See <i>Surface Materials Reference Manual</i> to specify. Add suffix S to the style number and specify leather color number. Add suffix S to the style number and specify vinyl color number Specify with soil-retardant treatment. |
| <ul style="list-style-type: none"> • Sewn upholstery • Steelcase vinyl | <ul style="list-style-type: none"> +\$ 43 +\$ 53 | <ul style="list-style-type: none"> Specify fabric color number. Specify fabric color number. Specify fabric color number. Specify fabric color number. Specify fabric color number. Specify fabric color number. Specify fabric color number. Specify fabric color number. Specify fabric color number. Specify fabric color number. Specify fabric color number. Add suffix S to the style number and specify leather color number. Add suffix S to the style number and specify vinyl color number Specify with soil-retardant treatment. |
| <ul style="list-style-type: none"> • Customer's Own Material (COM) • Customer's Own Leather (COL) • Customer's Own Material/Vinyl (COM-Sewn) • Soil-retardant treatment applied to upholstery fabric | <ul style="list-style-type: none"> No cost +\$ 43 +\$ 27 | <ul style="list-style-type: none"> Specify fabric color number. Specify fabric color number. Specify fabric color number. Specify fabric color number. Specify fabric color number. Specify fabric color number. Specify fabric color number. Specify fabric color number. Specify fabric color number. Specify fabric color number. Specify fabric color number. Add suffix S to the style number and specify leather color number. Add suffix S to the style number and specify vinyl color number Specify with soil-retardant treatment. |

- | | | |
|--|--|---|
| <ul style="list-style-type: none"> • Height-adjustable arms, soft arm caps • Armless | <ul style="list-style-type: none"> -\$ 93 -\$217 | <ul style="list-style-type: none"> Specify with height-adjustable arms. Specify without arms. |
|--|--|---|

- | | | |
|---|--|---|
| <ul style="list-style-type: none"> • Soft, dark grey treaded, dual-wheel roll-control casters for use on hard floors | <ul style="list-style-type: none"> +\$ 27 | <ul style="list-style-type: none"> Specify with soft roll-control casters. |
|---|--|---|

- | | | |
|---|--|--|
| <ul style="list-style-type: none"> • Glides: plastic | <ul style="list-style-type: none"> +\$ 27 | <ul style="list-style-type: none"> Specify with glides. |
|---|--|--|

▶ Detailed dimensions, page 108



For Canadian Pricing

Multiply U.S. Price by the Canadian price factor.

▶ See page 1 for details.

Specification Information

Style Number	U.S. Base Price
4827412	\$1146



For Canadian Pricing
Multiply U.S. Price by the
Canadian price factor.
▶ See page 1 for details.

Amia 482 Series Stool

Air Back with 3D Microknit and Upholstery on Seat



Standard Includes	Required to Specify
-------------------	---------------------

<p>▶ Need help? Product details, page 104</p> <ul style="list-style-type: none"> • Frame package • Synchro-tilt mechanism • 8" pneumatic seat-height adjustment • Upright back lock • Passive seat edge angle • Rectilinear independent height-, width-, pivot-, and depth-adjustable arms and soft arm caps: black plastic • 3" seat depth adjustment • Column and 4" adjustable foot ring: black • Air backrest with integrated LiveBack technology • Standard upholstery design on seat: fabric price group 1 • 2"-diameter, hard-composition, dual-wheel casters: black 	<ol style="list-style-type: none"> 1 Style number 2 Frame package (see below under Required Selections) 3 Fabric color number for upholstery on seat 4 Air back plastic color number 5 Options, if selected (see below) <p>▶ See <i>Surface Materials</i>, page 504.</p>
--	---

Tip: Frame packages include back frame, inner back frame, outer seat shell, arm holsters, and base.

Tip: When merle, platinum, or seagull are selected as frame packages, the outer seat shell and inner back frame default to 7249 Merle plastic.

Tip: Always add suffixes in alphabetical order when specifying options to Amia seating.

Frame Package	Required Selections	U.S. Price	Required to Specify
---------------	---------------------	------------	---------------------

Frame Package	<ul style="list-style-type: none"> • Black • Merle • Platinum • Seagull 	<p>No cost</p> <p>+\$ 40</p> <p>+\$ 40</p> <p>+\$ 40</p>	<p>Specify with 6205 Black.</p> <p>Specify with 6527 Merle.</p> <p>Specify with 6249 Platinum.</p> <p>Specify with 6053 Seagull.</p>
----------------------	---	--	--

Surface Materials	Options	U.S. Price	Required to Specify
-------------------	---------	------------	---------------------

Surface Materials	Upholstery	<p>No cost</p> <p>+\$ 10</p> <p>+\$ 27</p> <p>+\$ 36</p> <p>+\$ 43</p> <p>+\$ 53</p> <p>+\$ 64</p> <p>+\$ 79</p> <p>+\$ 97</p> <p>+\$112</p> <p>+\$189</p>	<p>Specify fabric color number.</p> <p>Specify fabric color number.</p> <p>Specify fabric color number.</p> <p>Specify fabric color number.</p> <p>Specify fabric color number.</p> <p>Specify fabric color number.</p> <p>Specify fabric color number.</p> <p>Specify fabric color number.</p> <p>Specify fabric color number.</p> <p>Specify fabric color number.</p> <p>Specify fabric color number.</p> <p>Add suffix S to the style number and specify leather color number.</p> <p>Add suffix S to the style number and specify Select Surfaces leather price group 1.</p> <p>▶ See <i>Surface Materials Reference Manual</i>. Add suffix S to the style number and specify Elmosoft leather color number.</p> <p>Add suffix S to the style number and specify Select Surfaces leather price group 2.</p> <p>▶ See <i>Surface Materials Reference Manual</i>. Add suffix S to the style number.</p> <p>Add suffix S to the style number and specify vinyl color number.</p> <p>▶ See <i>Surface Materials Reference Manual</i> to specify.</p> <p>Add suffix S to the style number and specify leather color number.</p> <p>Add suffix S to the style number and specify vinyl color number</p> <p>Specify with <i>soil-retardant treatment</i>.</p>
	<ul style="list-style-type: none"> • Select Surfaces leather price group 1 • Elmosoft leather upholstery • Select Surfaces leather price group 2 • Sewn upholstery • Steelcase vinyl • Customer's Own Material (COM) • Customer's Own Leather (COL) • Customer's Own Material/Vinyl (COM-Sewn) • Soil-retardant treatment applied to upholstery fabric 	<p>+\$189</p> <p>+\$217</p> <p>+\$217</p> <p>+\$ 43</p> <p>+\$ 53</p> <p>No cost</p> <p>+\$ 43</p> <p>+\$ 27</p>	

Arms	Options	U.S. Price	Required to Specify
------	---------	------------	---------------------

Arms	<ul style="list-style-type: none"> • Height-adjustable arms, soft arm caps • Armless 	<p>-\$ 93</p> <p>-\$217</p>	<p>Specify with <i>height-adjustable arms</i>.</p> <p>Specify <i>without arms</i>.</p>
-------------	--	-----------------------------	--

Casters	Options	U.S. Price	Required to Specify
---------	---------	------------	---------------------

Casters	<ul style="list-style-type: none"> • Soft, dark grey treaded, dual-wheel roll-control casters for use on hard floors 	<p>+\$ 27</p>	<p>Specify with <i>soft roll-control casters</i>.</p>
----------------	---	---------------	---

Glides	Options	U.S. Price	Required to Specify
--------	---------	------------	---------------------

Glides	<ul style="list-style-type: none"> • Glides: plastic 	<p>+\$ 27</p>	<p>Specify with <i>glides</i>.</p>
---------------	---	---------------	------------------------------------

▶ Detailed dimensions, page 108



For Canadian Pricing

Multiply U.S. Price by the Canadian price factor.

▶ See page 1 for details.

Specification Information

Style Number	U.S. Base Price
4827414	\$1201



For Canadian Pricing
Multiply U.S. Price by the Canadian price factor.
▶ See page 1 for details.

Understanding and Specifying Reply 466 Series Work Chairs

Product Details

Reply 466 Series	134
Dimensions	138

Specifying

Value Package Work Chairs	140
Swivel-Base Work Chairs	142
Leg-Base Multi-Use Chairs	146
Sled-Base Multi-Use Chairs	150

Work Chairs

Highly adjustable task seating offers maximum personalization for fit and comfort for a range of duration and use. By making a series of simple adjustments, you can customize the chair to your body, preferences, and tasks. These chairs provide continuous, stable, comfort, and can be quickly adjusted to support you in upright, and reclining work postures.

- Gesture 442 Series
- Leap 462 Series
- Think 465 Series
- Amia 482 Series
- Reply 466 Series
- Jersey Series
- Leap 464 Series WorkLounge
- Criterion 453 Series

Adjustability Features

- See page 22 for a comparison to other chairs. **Reply 466 Series**

Mechanisms

Synchro-tilt ●

Seat Adjustments

Pneumatic height ●

Seat depth ●

Back Adjustments

Back height ●

Lumbar height ●

Multi-position back lock ●

Arm Adjustments

Arm height ●

Arm pivot ●

Arm depth ●

Reply 466 Series

Reply is a global family of value-friendly seating designed with unexpected extras.

Back frame and seat shell are plastic.

Back height adjustment on upholstered chairs allows you to raise or lower chair back from a seated position to support your lower back.

Five-arm base is plastic, a polished aluminum base is available as an option.

Arm tube matches the frame finish.

Arm support is coordinated to match the base finish.

Dual-wheel with roll-control casters may be used on soft and hard flooring surfaces.

Back handle on mesh back chairs provides a convenient handhold to easily move the chair.

Arms, when specified, have a textured plastic arm cap.

Lumbar height adjusts 4" to provide additional lower back support and is available as an option on mesh back chairs only.

Arm depth can retract 3" to allow user to get closer to the worksurface and into tight corners.

Arm height can adjust independently within a 3¾" range to help relieve upper back and shoulder fatigue.

Arm caps can pivot independently 18° in and 4° out to accommodate individual user preferences.

Arm width adjusts 1" per arm for a total of 2" overall width adjustment.

Multi-position back lock allows user to recline the back to the desired angle and lock it in place.

Seat depth adjusts within a 1½" range to accommodate users of varying leg lengths.

Seat height adjusts within a 5" range with a pneumatic adjustment mechanism.

Tilt tension adjustment allows you to control the amount of resistance needed for reclining.

Casters have hard, dual-wheels that roll smoothly on carpets. They are 2½" for increased mobility. Soft, dark grey treaded, dual-wheel roll-control casters are available for use on hard floors or mats.

Tip: Do not roll the chair across asphalt during installation as this may damage the casters.

Plastic glides are standard. Optional soft glides are available.

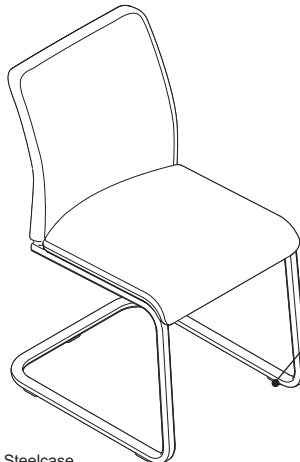
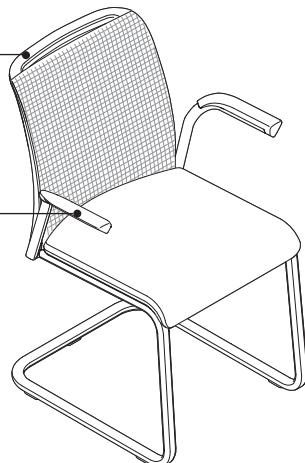
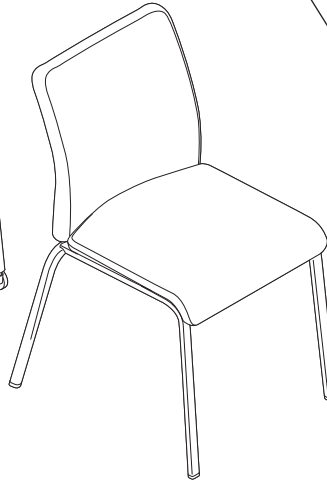
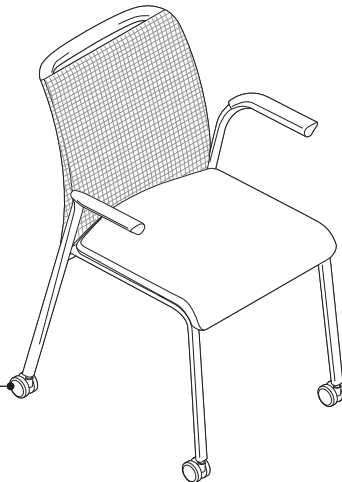

Product Details

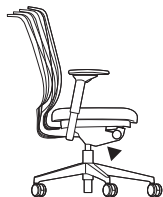

Synchro-tilt mechanism with a natural fluid motion on work chairs keeps users oriented to their work.

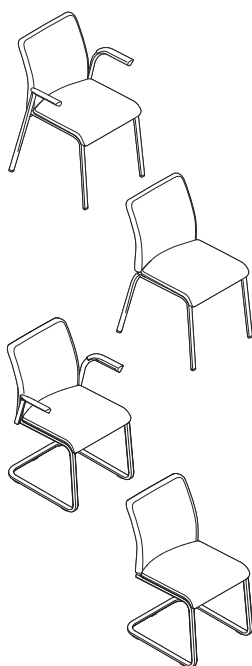

Fixed-height multi-use chairs are available with or without arms.

Cartoned shipment of Reply work chairs is standard. Reply work chairs ship knocked down in a single carton consisting of two components: the base, pneumatic, mechanism, and seat (built up as one component), and the back with the attachment knob. This allows for shipment in a smaller carton. Leg-base multi-use chairs ship two to a carton, when applicable. Assembly by a qualified dealer installer is required for work chairs. Assembly instructions are included. No additional tools are required for assembly.

Uncartoned request means Reply work chairs will ship fully assembled and blanket wrapped.

Stacking density for leg-base multi-use chairs is six on the floor. Arms and casters do not impact the ability to stack.

Adjustment Features

Adjustability instructions are included with every swivel-base chair. Instructions can also be found at www.steelcase.com.

Seat Adjustments

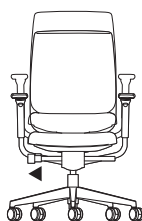

Seat height adjusts pneumatically. To lower, hold handle up while seated. To raise, hold handle up and keep your weight off the chair. Range of adjustability is 5", from 16"H to 21"H.

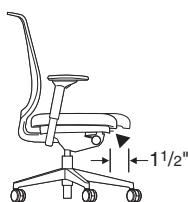

Seat depth adjusts 1 1/2" by pulling handle up. Slide seat forward or back to accommodate various leg lengths. Release handle to lock. Seat depth is a standard feature on work chairs.

Back Adjustments

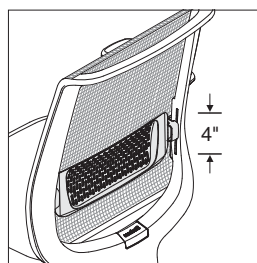

Lumbar height adjusts 4" (6" to 10" from seat) by grabbing exposed tabs and sliding the lumbar support up or down. Available as an option on mesh work chairs only.



Multiple position back lock allows users to recline the back to the desired angle and lock it in place. To lock, recline to desired angle and push back lock handle down. To release, lean forward, lift the handle and apply pressure to the back to disengage the lock.

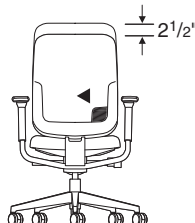

Back height adjusts 2 1/2" (23"—25 1/2") by pressing and holding the control button on the right side of the back, and sliding the back support up or down. Release the control button to lock. This feature is standard on work chairs with upholstered (non-mesh) backs only.

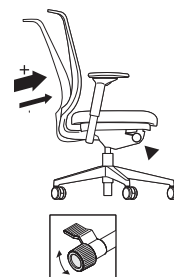

Back tension adjusts by turning knob forward to increase back tension, backward to decrease back tension. This feature is standard on all work chairs.

Arm Adjustments

Height-, pivot-, and depth-adjustable arms are available as an option on Reply task chairs.

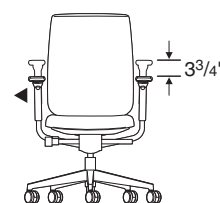

Arm height adjusts independently within a range of 3 3/4" (7 1/2"—11 1/4" from the seat). Push button on outside and under arm cap in while moving arms up or down. Releasing buttons locks arms in position.

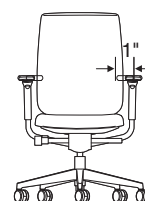

Width maintenance arms adjust 1" each independently on chairs with this option. To adjust, loosen the screw under the arm tube and move to desired position and tighten.

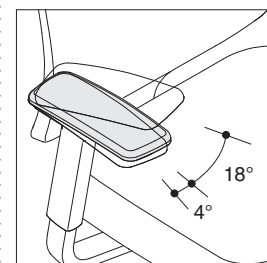

Arms pivot 18° inward and 4° outward on models with adjustable pivot arms. Grasp arm and push front to left or right.

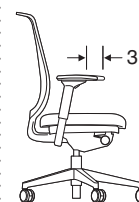

Arm depth adjusts approximately 3" to enable user to get closer to worksurface.

Other Features

Height-only adjustable arm is also available and adjusts 3 3/4".

Soft, dark grey treaded, dual-wheel roll-control casters are available as an option for use on hard floors or mats.

Dual-wheel roll-control casters for use on soft and hard flooring surfaces come standard on leg-base multi-use chairs when specified with casters.

Hard glides come standard on multi-use chairs when specified with glides. Soft glides are available as an option.

Reply 466 Series, continued

Surface Materials

▶ See surface materials on page 504 for specific availability or refer to the *Surface Materials Reference Manual* for further information.

Upholstery

- Fabric
- Fabric with soil-retardant treatment (option)
- Mesh (back only)
- Leather
- Elmosoft leather
- Select Surfaces leather
- Vinyl

Hard components

Chair with swivel-base (frame, outer back, arm cap assembly, and mechanism)

- 6205 Black

Chair with swivel-base and mesh back (frame and arm tube only)

- 6053 Seagull

Chair with swivel-base (arm support and base)

- 6205 Black
- 6249 Platinum
- Polished aluminum (base only)

Chair with multi-use leg-base (outer back, and arm caps)

- 6205 Black

Chair with leg-base or sled-base (metal frame)

- 4799 Platinum
- 7207 Black

Casters

- 6205 Black

Glides

Chair with multi-use leg-base

- 6205 Black

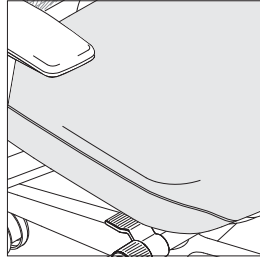

Sewn-upholstery models feature a stitch detail on the sides of the seat and back cushions. Task chairs have an additional stitch across the lumbar region of the back cushion.

Swivel-Base Models

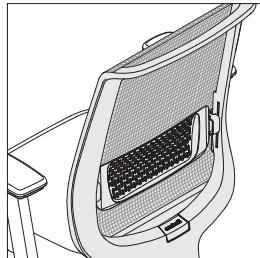

Mesh back on swivel-base models are available with a height-adjustable lumbar option to enhance back support.

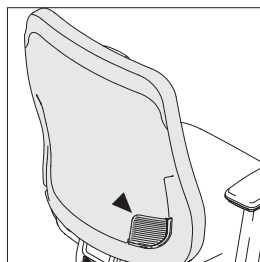

Upholstered back on swivel-base models feature a back-height adjustment that allows you to raise or lower the chair back from a seated position to support your lower back.

Leg-Base and Sled-Base Models

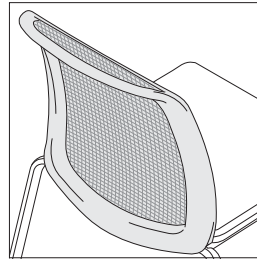

Mesh back frame with handle on leg-base models provides a convenient handhold to easily move the chair.

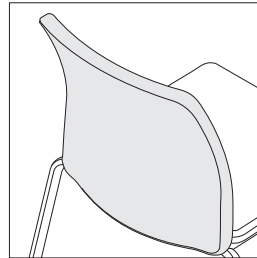

Upholstered backrest on leg-base models features a plastic outer shell.

All Steelcase seating with standard upholstery fabrics complies with requirements of the State of California Technical Bulletin 117-2013. All standard seating is labeled to be in compliance with California 117-2013.

Programs & Services

▶ See *Surface Materials Reference Manual* for further detail about programs and services offered for seating.

The Customer's Own Material (COM) Program

offers the opportunity for customers to select fabrics that are not offered through the standard Steelcase surface materials program for use on Steelcase products. Through the COM program, Steelcase will test your materials for application on Steelcase products. Once approved, you can place your order. Steelcase will facilitate the entire ordering process and give you a production schedule. Steelcase will order the COM fabric directly from the textile manufacturer. For up-to-date information regarding fabric test results for all COM fabrics and details regarding yardage requirements for most Seating lines, visit the COM website. To locate the COM website:

- Visit www.steelcase.com

Soil retardants are treatments that provide long-term soil and stain resistance to a fabric without affecting the shade or the integrity of the fabric. The following Steelcase Textiles are available pre-treated with soil retardant. (You do not need to select the soil-retardant option for these fabrics and incur the upcharge.)

- Jacks
- Link
- Spyder

For information on soil retardant fabrics on Select Surfaces, please refer to the *Surface Materials Reference Manual*.

Soil-retardant treatment is available on all other seating fabrics at an additional upcharge per seating unit. To order this option, please select "Soil-Retardant Treatment" under "Optional Accessories."

For soil-retardant treatment on COMs, please select "Soil-Retardant Treatment" under "Optional Accessories." Minimums or additional yardage may be required. Please contact the vendor directly for specific information.

Extended lead times may be necessary for this service.

Contact your Steelcase Solutions Fulfillment Team Representative at 1.888.STEELCASE (1.888.783.3522) or send an email to line-one@steelcase.com.

Dimensions

▶ Page 138

Resources

Printed Materials

- ▶ Reply Product Brochure (10-0002941)
- ▶ Reply User Guide (10-0002805)

Audiovisual Materials

- ▶ Adjustability video available on www.steelcase.com

Online Resources

- ▶ Environmental profiles available on www.steelcase.com/sustainability.

Dimensions

Reply 466 Series

Features	Overall Depth	Width	Height	Seat Depth	Functional Seat Depth	Seat Width	Seat Height from Floor	Back Width	Back Height from Seat	Lumbar Height from Seat
----------	---------------	-------	--------	------------	-----------------------	------------	------------------------	------------	-----------------------	-------------------------

Reply 466 Series

Swivel-Base Work Chairs

Mesh Back	24" to 25"	26"	37 ³ / ₄ " to 42 ³ / ₄ "	16 ⁷ / ₈ "	16 ¹ / ₂ " to 18"	18 ¹ / ₂ "	16" to 21"	17 ¹ / ₂ "	22 ⁵ / ₈ "	6" to 10"
Upholstered Back and Seat	21 ¹ / ₈ " to 22 ¹ / ₂ "	26"	39 ¹ / ₄ " to 46 ³ / ₄ "	16 ⁷ / ₈ "	15 ¹ / ₂ " to 17"	18 ¹ / ₂ "	16" to 21"	17 ¹ / ₂ "	23 ¹ / ₄ " to 25 ³ / ₄ "	N.A.

Leg-Base Multi-Use Chairs

Mesh Back	23"	23 ¹ / ₄ **	34***	17 ¹ / ₂ "	16"	17 ³ / ₄ "	19***	16 ¹ / ₂ "	17"	9 ¹ / ₂ "
Upholstered	23"	23 ¹ / ₄ **	33***	17 ¹ / ₂ "	17"	17 ³ / ₄ "	19***	16 ³ / ₄ "	17"	8"

Sled-Base Multi-Use Chairs

Mesh Back	23 ¹ / ₂ "	23 ¹ / ₄ "	33 ¹ / ₂ "	17 ¹ / ₂ "	16"	17 ³ / ₄ "	18 ¹ / ₂ "	16 ¹ / ₂ "	17"	9 ¹ / ₂ "
Upholstered	23 ¹ / ₂ "	23 ¹ / ₄ "	32 ¹ / ₂ "	17 ¹ / ₂ "	17"	17 ³ / ₄ "	18 ¹ / ₂ "	16 ³ / ₄ "	17"	8"

*Armless models are 1¹/₄" narrower.

**Dimension is 1/2" less when specified with glides.

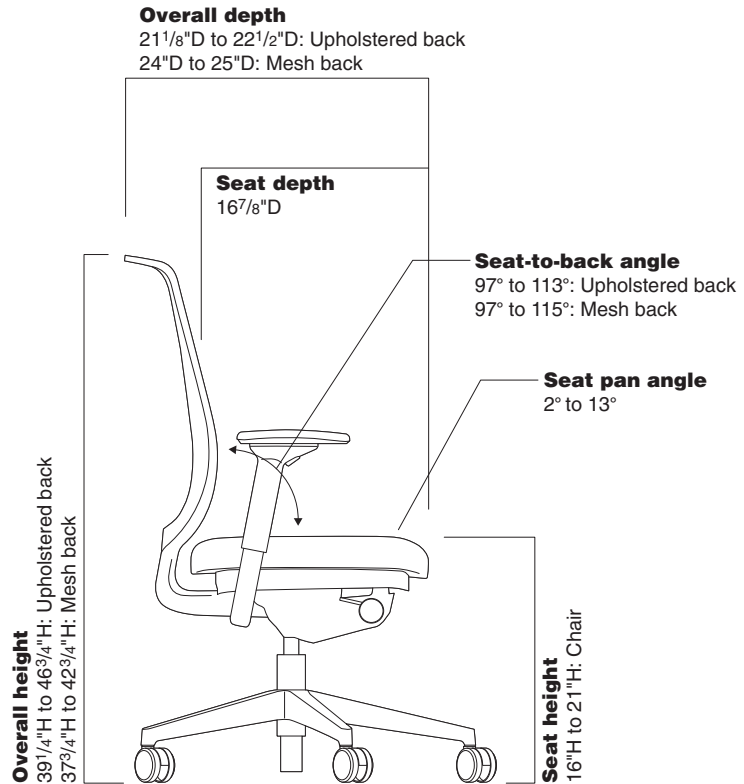
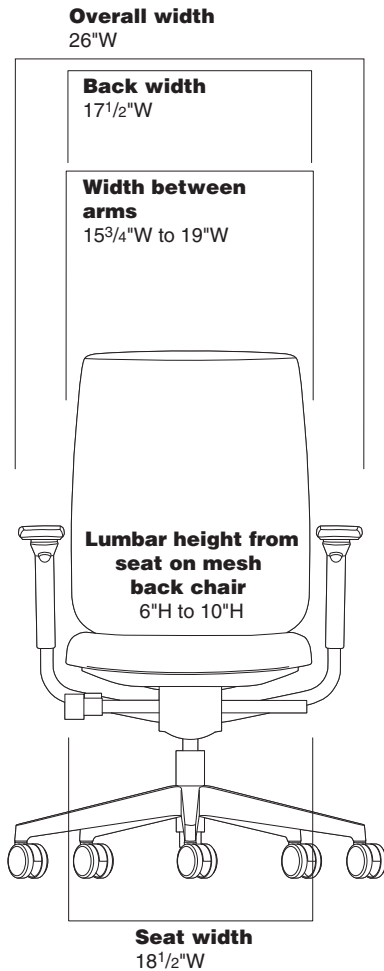

• Width • Between • Arms	• Arm • Height • to Floor	• Arm • Height • from • Seat	• Arm Cap • Pivot • Range	• Angle • Between • Seat and • Back	• Seat • Pan • Angle
--------------------------------	---------------------------------	---------------------------------------	---------------------------------	--	----------------------------

Swivel-Base Work Chairs

15¾" to 19"	23¼" to 32"	7¼" to 11"	18° inward, 4° outward	97° to 115°	2° to 13°
15¾" to 19"	23¼" to 32"	7¼" to 11"	18° inward, 4° outward	97° to 113°	2° to 13°

Leg-Base Multi-Use Chairs

19½"	26¾"***	9"	N.A.	98°	6°
19½"	26¾"***	9"	N.A.	98°	6°

Sled-Base Multi-Use Chairs

19½"	26¼"	9"	N.A.	98°	6°
19½"	26¼"	9"	N.A.	98°	6°

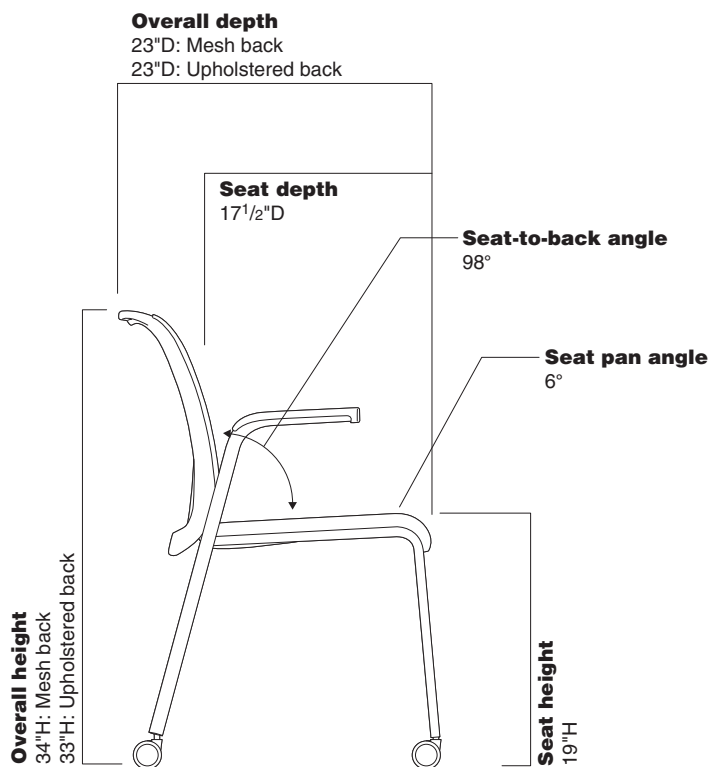
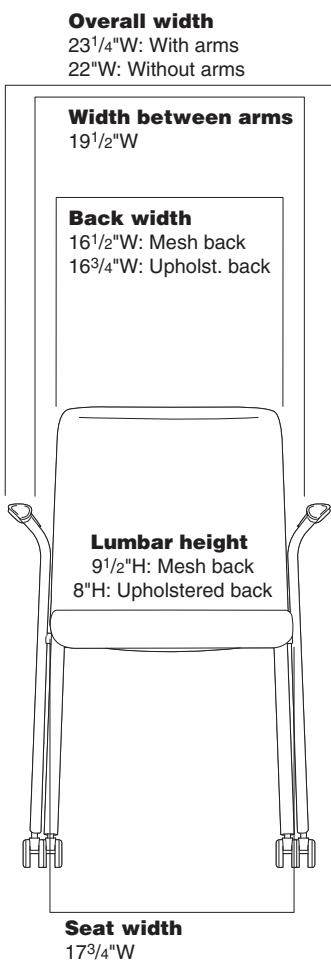

Reply 466 Series Value Package Work Chairs

With Height-, Pivot-, Depth-Adjustable Arms, Mesh Back, and Buzz2 Fabric on Seat



Tip: Reply value package work chairs offer Reply chair features at a lower price than when selected individually.

Standard Includes	Required to Specify
-------------------	---------------------

- | Standard Includes | Required to Specify |
|--|---|
| <ul style="list-style-type: none"> ▶ Need help? Product details, page 134 • Synchro-tilt mechanism • 5" pneumatic seat-height adjustment (16"-21") • Multi-position back lock • Height-, pivot-, depth-adjustable arms • Five-arm plastic base: black • Outer back and seat shell: black plastic only • 1½" seat depth adjustment • Mesh on back • Adjustable lumbar • Standard upholstery design on seat: Buzz2 fabric only • 2½"-diameter, hard-composition, dual-wheel casters: black | <ul style="list-style-type: none"> 1 Style number 2 Mesh color number for back 3 Buzz2 fabric color number for upholstery on seat 4 Options, if selected (see below) ▶ See <i>Surface Materials</i>, page 504. |

Options	U.S. Price	Required to Specify
Surface Materials Frame • Seagull	+\$28	Specify with 6053 Seagull.
Base • Platinum	+\$43	Specify with 4799 Platinum.
Casters • Soft, dark grey treaded, dual-wheel roll-control casters for use on hard floors	+\$27	Specify with soft roll-control casters.

Specification Information

Style Number	U.S. Base Price
466160MTVA	\$900
:	:

For Canadian Pricing
 Multiply U.S. Price by the Canadian price factor.
 ▶ See page 1 for details.

With Height-Adjustable Arms, Mesh Back, and Buzz2 Fabric on Seat



Tip: Reply value package work chairs offer Reply chair features at a lower price than when selected individually.

Standard Includes	Required to Specify
<ul style="list-style-type: none"> ▶ Need help? Product details, page 134 • Synchro-tilt mechanism • 5" pneumatic seat-height adjustment (16"–21") • Multi-position back lock • Height-adjustable arms • Five-arm plastic base: black • Outer back and seat shell: black plastic only • 1½" seat depth adjustment • Mesh on back • Standard upholstery design on seat: Buzz2 fabric only • 2½"-diameter, hard-composition, dual-wheel casters: black 	<ul style="list-style-type: none"> 1 Style number 2 Mesh color number for back 3 Buzz2 fabric color number for upholstery on seat 4 Options, if selected (see below) ▶ See <i>Surface Materials</i>, page 504.

Options	U.S. Price	Required to Specify
Surface Materials <ul style="list-style-type: none"> • Seagull 	+\$28	Specify with 6053 Seagull.
Base <ul style="list-style-type: none"> • Platinum 	+\$43	Specify with 4799 Platinum.
Casters <ul style="list-style-type: none"> • Soft, dark grey treaded, dual-wheel roll-control casters for use on hard floors 	+\$27	Specify with soft roll-control casters.

Specification Information

Style Number	U.S. Base Price
466160MTVB	\$823



For Canadian Pricing

Multiply U.S. Price by the Canadian price factor.

▶ See page 1 for details.

Reply 466 Series Swivel-Base Work Chair

Mesh Back with Standard Upholstery on Seat



Tip: Arms are not included with Reply unless you specify one of the arm options.

Tip: Always add suffixes in alphabetical order when specifying options to Reply seating.

► Detailed dimensions, page 138

Tip: Height-, width-, pivot-, depth-adjustable arms are maintenance width adjustable and are available in black only.

Tip: Frame color includes the frame and arm tube.

Tip: Seagull frame is available with 4799 Platinum arm supports only.

Tip: Black and polished aluminum bases are available with 6205 Black arm supports only. Platinum base is available with 4799 Platinum arm supports only.

Standard Includes	Required to Specify
<ul style="list-style-type: none"> ► Need help? Product details, page 134 • Synchro-tilt mechanism • 5" pneumatic seat-height adjustment (16"-21") • Multi-position back lock • Outer back, seat shell, and five-arm plastic base: plastic • 1½" seat depth adjustment • Mesh on back • Standard upholstery design on seat: fabric price group 1 • 2½"-diameter, hard-composition, dual-wheel casters: black 	<ol style="list-style-type: none"> 1 Style number 2 Plastic color number for frame, arm tube, and base; if specified 3 Mesh color number for back 4 Fabric color number for upholstery on seat 5 Options, if selected (see below) <p>► See <i>Surface Materials</i>, page 504.</p>

Options	U.S. Price	Required to Specify
<p>Surface Materials</p> <p>Upholstery</p> <ul style="list-style-type: none"> • Fabric price group 1 • Fabric price group 2 • Fabric price group 3 • Fabric price group 4 • Fabric price group 5 • Fabric price group 6 • Fabric price group 7 • Fabric price group 8 • Fabric price group 9 • Fabric price group 10 • Steelcase leather upholstery • Select Surfaces leather price group 1 • Elmosoft leather upholstery • Select Surfaces leather price group 2 • Sewn upholstery • Steelcase vinyl • Customer's Own Material (COM) • Customer's Own Leather (COL) • Customer's Own Material/Vinyl (COM-Sewn) • Soil-retardant treatment applied to upholstery fabric 	<ul style="list-style-type: none"> No cost +\$ 10 +\$ 27 +\$ 36 +\$ 43 +\$ 53 +\$ 64 +\$ 79 +\$ 97 +\$112 +\$183 +\$183 +\$214 +\$214 +\$ 43 +\$ 53 No cost +\$ 43 +\$ 43 +\$ 27 	<p>Specify fabric color number.</p> <p>Specify fabric color number.</p> <p>Specify fabric color number.</p> <p>Specify fabric color number.</p> <p>Specify fabric color number.</p> <p>Specify fabric color number.</p> <p>Specify fabric color number.</p> <p>Specify fabric color number.</p> <p>Specify fabric color number.</p> <p>Specify fabric color number.</p> <p>Add suffix S to the style number and specify leather color number.</p> <p>Add suffix S to the style number and specify Select Surfaces leather price group 1.</p> <p>► See <i>Surface Materials Reference Manual</i>. Add suffix S to the style number and specify Elmosoft leather color number.</p> <p>Add suffix S to the style number and specify Select Surfaces leather price group 2.</p> <p>► See <i>Surface Materials Reference Manual</i>. Add suffix S to the style number.</p> <p>Add suffix S to the style number and specify vinyl color number.</p> <p>► See <i>Surface Materials Reference Manual</i> to specify.</p> <p>Add suffix S to the style number and specify leather color number.</p> <p>Add suffix S to the style number and specify vinyl color number.</p> <p>Specify <i>with soil-retardant treatment</i>.</p>
<p>Arms</p> <ul style="list-style-type: none"> • Height-adjustable arms, soft arm caps • Height-, pivot-, depth-adjustable arms • Height-, width-, pivot-, depth-adjustable arms (maintenance width adjustment) 	<ul style="list-style-type: none"> +\$100 +\$147 +\$188 	<p>Specify <i>with height-adjustable arms</i>.</p> <p>Specify <i>with height-, pivot-, depth-adjustable arms</i>.</p> <p>Specify <i>with height-, width-, pivot-, depth-adjustable arms</i>.</p>
<p>Frame</p> <ul style="list-style-type: none"> • Black • Seagull 	<ul style="list-style-type: none"> No cost +\$ 28 	<p>Specify <i>with 6205 Black</i>.</p> <p>Specify <i>with 6053 Seagull</i>.</p>
<p>Base</p> <ul style="list-style-type: none"> • Black • Platinum • Polished aluminum 	<ul style="list-style-type: none"> No cost +\$ 43 +\$153 	<p>Specify <i>with 6205 Black</i>.</p> <p>Specify <i>with 4799 Platinum</i>.</p> <p>Specify <i>with aluminum base</i>.</p>
<p>Lumbar Height</p> <ul style="list-style-type: none"> • 4" travel for additional lumbar support 	<ul style="list-style-type: none"> +\$ 41 	<p>Specify <i>with adjustable lumbar height</i>.</p>
<p>Casters</p> <ul style="list-style-type: none"> • Soft, dark grey treaded, dual-wheel roll-control casters for use on hard floors 	<ul style="list-style-type: none"> +\$ 27 	<p>Specify <i>with soft roll-control casters</i>.</p>

Specification Information

• Style • Number	• U.S. • Base • Price
466160MT	\$733



For Canadian Pricing
Multiply U.S. Price by the
Canadian price factor.
▶ See page 1 for details.

Reply 466 Series Swivel-Base Work Chair

Standard Upholstery on Back and Seat



Tip: Arms are not included with Reply unless you specify one of the arm options.

Standard Includes	Required to Specify
<ul style="list-style-type: none"> ▶ Need help? Product details, page 134 • Synchro-tilt mechanism • 5" pneumatic seat-height adjustment (16"–21") • Multi-position back lock • Outer back, seat shell, and five-arm plastic base: plastic • 1½" seat depth adjustment • 2¼" back-height adjustment • Standard upholstery design on back and seat: fabric price group 1 • 2½"-diameter, hard-composition, dual-wheel casters: black 	<ol style="list-style-type: none"> 1 Style number 2 Plastic color number for base, and arm tube; if specified 3 Fabric color number for upholstery on back and seat 4 Options, if selected (see below) <p>▶ See <i>Surface Materials</i>, page 504.</p>

Surface Materials	Options	U.S. Price	Required to Specify
	Upholstery on seat and back		
	• Fabric price group 1	No cost	Specify fabric color number.
	• Fabric price group 2	+\$ 27	Specify fabric color number.
	• Fabric price group 3	+\$ 49	Specify fabric color number.
	• Fabric price group 4	+\$ 70	Specify fabric color number.
	• Fabric price group 5	+\$ 88	Specify fabric color number.
	• Fabric price group 6	+\$109	Specify fabric color number.
	• Fabric price group 7	+\$125	Specify fabric color number.
	• Fabric price group 8	+\$158	Specify fabric color number.
	• Fabric price group 9	+\$194	Specify fabric color number.
	• Fabric price group 10	+\$219	Specify fabric color number.
	• Steelcase leather upholstery	+\$367	Specify fabric color number. Add suffix S to the style number and specify leather color number.
	• Select Surfaces leather price group 1	+\$367	Add suffix S to the style number and specify Select Surfaces leather price group 1.
	• Elmosoft leather upholstery	+\$427	▶ See <i>Surface Materials Reference Manual</i> . Add suffix S to the style number and specify Elmosoft leather color number.
	• Select Surfaces leather price group 2	+\$427	Add suffix S to the style number and specify Select Surfaces leather price group 2.
	• Sewn upholstery	+\$ 81	▶ See <i>Surface Materials Reference Manual</i> . Add suffix S to the style number.
	• Steelcase vinyl	+\$108	Add suffix S to the style number and specify vinyl color number.
	• Customer's Own Material (COM)	No cost	▶ See <i>Surface Materials Reference Manual</i> to specify.
	• Customer's Own Leather (COL)	+\$ 81	Add suffix S to the style number and specify leather color number.
	• Customer's Own Material/Vinyl (COM-Sewn)	+\$ 81	Add suffix S to the style number and specify vinyl color number.
	Contrasting upholstery on seat and back		
	• Contrasting fabrics	+\$ 33	Add suffix K to the style number and specify fabric color numbers.
	Contrasting upholstery on seat		
	• Fabric price group 1	No cost	Specify fabric color number.
	• Fabric price group 2	+\$ 10	Specify fabric color number.
	• Fabric price group 3	+\$ 27	Specify fabric color number.
	• Fabric price group 4	+\$ 36	Specify fabric color number.
	• Fabric price group 5	+\$ 43	Specify fabric color number.
	• Fabric price group 6	+\$ 53	Specify fabric color number.
	• Fabric price group 7	+\$ 64	Specify fabric color number.
	• Fabric price group 8	+\$ 79	Specify fabric color number.
	• Fabric price group 9	+\$ 97	Specify fabric color number.
	• Fabric price group 10	+\$112	Specify fabric color number.
	• Steelcase leather upholstery	+\$182	Specify fabric color number. Add suffix S to the style number and specify leather color number.
	• Select Surfaces leather price group 1	+\$182	Add suffix S to the style number and specify leather color number.
	• Elmosoft leather upholstery	+\$213	Add suffix S to the style number and specify leather color number.

▶ Detailed dimensions, page 138



For Canadian Pricing

Multiply U.S. Price by the Canadian price factor.

▶ See page 1 for details.

▶ Options, continued on next page

► Options, continued from previous page

	Options	U.S. Price	Required to Specify
Surface Materials, continued	Contrasting upholstery on seat, continued		
	• Select Surfaces leather price group 2	+\$213	Add suffix S to the style number and specify leather color number.
	• Sewn upholstery	+\$ 42	Add suffix S to the style number.
	• Steelcase vinyl	+\$ 52	Add suffix S to the style number and specify vinyl color number.
	• Customer's Own Material (COM)	No cost	► See <i>Surface Materials Reference Manual</i> .
	• Customer's Own Leather (COL)	+\$ 42	Add suffix S to the style number and specify leather color number.
	• Customer's Own Material/Vinyl (COM-Sewn)	+\$ 42	Add suffix S to the style number and specify vinyl color number.
	Contrasting upholstery on back		
	• Fabric price group 1	No cost	Specify fabric color number.
	• Fabric price group 2	+\$ 17	Specify fabric color number.
	• Fabric price group 3	+\$ 22	Specify fabric color number.
	• Fabric price group 4	+\$ 34	Specify fabric color number.
	• Fabric price group 5	+\$ 45	Specify fabric color number.
	• Fabric price group 6	+\$ 56	Specify fabric color number.
	• Fabric price group 7	+\$ 61	Specify fabric color number.
	• Fabric price group 8	+\$ 79	Specify fabric color number.
	• Fabric price group 9	+\$ 97	Specify fabric color number.
	• Fabric price group 10	+\$107	Specify fabric color number.
	• Steelcase leather upholstery	+\$183	Add suffix S to the style number and specify leather color number.
	• Select Surfaces leather price group 1	+\$183	Add suffix S to the style number and specify leather color number.
	• Elmosoft leather upholstery	+\$212	Add suffix S to the style number and specify leather color number.
	• Select Surfaces leather price group 2	+\$212	Add suffix S to the style number and specify leather color number.
	• Sewn upholstery	+\$ 37	Add suffix S to the style number.
	• Steelcase vinyl	+\$ 54	Add suffix S to the style number and specify vinyl color number.
	• Customer's Own Material (COM)	No cost	► See <i>Surface Materials Reference Manual</i> .
	• Customer's Own Leather (COL)	+\$ 37	Add suffix S to the style number and specify leather color number.
	• Customer's Own Material/Vinyl (COM-Sewn)	+\$ 37	Add suffix S to the style number and specify vinyl color number.
	Soil-retardant treatment	+\$ 27	Specify <i>with soil-retardant treatment</i> .
	Platinum		
	• On base, and arm tube	+\$ 89	Specify <i>with 4799 Platinum</i> .
Arms	• Height-adjustable arms, soft arm caps	+\$100	Specify <i>with height-adjustable arms</i> .
	• Height-, pivot-, depth-adjustable arms	+\$147	Specify <i>with height-, pivot-, depth-adjustable arms</i> .
	• Height-, width-, pivot-, depth-adjustable arms (maintenance width adjustment)	+\$188	Specify <i>with height-, width-, pivot-, depth-adjustable arms</i> .
Base	• Polished aluminum base	+\$153	Specify <i>with aluminum base</i> .
Casters	• Soft, dark grey treaded, dual-wheel roll-control casters for use on hard floors	+\$ 27	Specify <i>with soft roll-control casters</i> .

Tip: Outer back, mechanism, and optional arm cap assembly are available in 6205 Black only.

Tip: Height-, width-, pivot-, depth-adjustable arms are maintenance width adjustable and are available in black only.

Specification Information

Style Number	U.S. Base Price
466160MP	\$697

**For Canadian Pricing**

Multiply U.S. Price by the Canadian price factor.

► See page 1 for details.

Reply 466 Series Leg-Base Multi-Use Chairs

Mesh Back with Standard Upholstery on Seat

Standard Includes		Required to Specify
<ul style="list-style-type: none"> ▶ Need help? Product details, page 134 	<ul style="list-style-type: none"> • Frame: paint • Mesh on back • Standard upholstery design on seat: fabric price group 1 • Arm caps, if selected: black 	<ol style="list-style-type: none"> 1 Style number 2 Paint color number for metal frame, and arms; if specified 3 Mesh color number for back 4 Fabric color number for upholstery on seat 5 Options, if selected (see below) <p>▶ See <i>Surface Materials</i>, page 504.</p>

	Options	U.S. Price	Required to Specify
Surface Materials	Upholstery on seat		
	• Fabric price group 1	No cost	Specify fabric color number.
	• Fabric price group 2	+\$ 10	Specify fabric color number.
	• Fabric price group 3	+\$ 27	Specify fabric color number.
	• Fabric price group 4	+\$ 36	Specify fabric color number.
	• Fabric price group 5	+\$ 43	Specify fabric color number.
	• Fabric price group 6	+\$ 53	Specify fabric color number.
	• Fabric price group 7	+\$ 64	Specify fabric color number.
	• Fabric price group 8	+\$ 79	Specify fabric color number.
	• Fabric price group 9	+\$ 97	Specify fabric color number.
	• Fabric price group 10	+\$112	Specify fabric color number.
	• Steelcase leather upholstery	+\$183	Add suffix S to the style number and specify leather color number.
	• Select Surfaces leather price group 1	+\$183	Add suffix S to the style number and specify Select Surfaces leather price group 1. ▶ See <i>Surface Materials Reference Manual</i> .
• Elmosoft leather upholstery	+\$214	Add suffix S to the style number and specify Elmosoft leather color number.	
• Select Surfaces leather price group 2	+\$214	Add suffix S to the style number and specify Select Surfaces leather price group 2. ▶ See <i>Surface Materials Reference Manual</i> .	
• Sewn upholstery	+\$ 43	Add suffix S to the style number.	
• Steelcase vinyl	+\$ 53	Add suffix S to the style number and specify vinyl color number. ▶ See <i>Surface Materials Reference Manual</i> to specify.	
• Customer's Own Material (COM)	No cost	Add suffix S to the style number and specify leather color number.	
• Customer's Own Leather (COL)	+\$ 43	Add suffix S to the style number and specify vinyl color number.	
• Customer's Own Material/Vinyl (COM-Sewn)	+\$ 43	Specify <i>with soil-retardant treatment</i> .	
• Soil-retardant treatment applied to upholstery fabric	+\$ 27		
	Frame		
	• Platinum on frame	+\$ 59	Specify <i>with 4799 Platinum frame</i> .
Casters	• Dual-wheel roll-control casters	+\$ 50	Specify <i>with dual-wheel roll-control casters</i> .
Glides	• Hard glides for use on carpeted floors	No cost	Specify <i>with hard glides</i> .
	• Soft glides for use on non-carpeted floors	+\$ 6	Specify <i>with soft glides</i> .

Tip: Casters or glides must be selected to complete specification of chair.

▶ Detailed dimensions, page 138

 **For Canadian Pricing**
Multiply U.S. Price by the Canadian price factor.
▶ See page 1 for details.

Specification Information

With Arms



Without Arms



• Style • Number	• U.S. Base • Price	• Style • Number	• U.S. Base • Price
466452MT	\$592	466450MT	\$533
:	:	:	:

Reply 466 Series Leg-Base Multi-Use Chairs

Standard Upholstery on Back and Seat

Standard Includes	Required to Specify
<ul style="list-style-type: none"> ▶ Need help? Product details, page 134 • Frame: paint • Standard upholstery design on seat and back: fabric price group 1 • Arm caps, if selected: black 	<ol style="list-style-type: none"> 1 Style number 2 Paint color number for metal frame, and arms; if specified 3 Fabric color number for upholstery on seat and back 4 Options, if selected (see below) <p>▶ See <i>Surface Materials</i>, page 504.</p>

Options	U.S. Price	Required to Specify
Surface Materials		
Upholstery on seat and back		
• Fabric price group 1	No cost	Specify fabric color number.
• Fabric price group 2	+\$ 27	Specify fabric color number.
• Fabric price group 3	+\$ 49	Specify fabric color number.
• Fabric price group 4	+\$ 70	Specify fabric color number.
• Fabric price group 5	+\$ 88	Specify fabric color number.
• Fabric price group 6	+\$109	Specify fabric color number.
• Fabric price group 7	+\$125	Specify fabric color number.
• Fabric price group 8	+\$158	Specify fabric color number.
• Fabric price group 9	+\$194	Specify fabric color number.
• Fabric price group 10	+\$219	Specify fabric color number.
• Steelcase leather upholstery	+\$367	Specify fabric color number. Add suffix S to the style number and specify leather color number.
• Select Surfaces leather price group 1	+\$367	Add suffix S to the style number and specify Select Surfaces leather price group 1. ▶ See <i>Surface Materials Reference Manual</i> .
• Elmosoft leather upholstery	+\$427	Add suffix S to the style number and specify Elmosoft leather color number.
• Select Surfaces leather price group 2	+\$427	Add suffix S to the style number and specify Select Surfaces leather price group 2. ▶ See <i>Surface Materials Reference Manual</i> .
• Sewn upholstery	+\$ 81	Add suffix S to the style number.
• Steelcase vinyl	+\$108	Add suffix S to the style number and specify vinyl color number.
• Customer's Own Material (COM)	No cost	▶ See <i>Surface Materials Reference Manual</i> to specify.
• Customer's Own Leather (COL)	+\$ 81	Add suffix S to the style number and specify leather color number.
• Customer's Own Material/Vinyl (COM-Sewn)	+\$ 81	Add suffix S to the style number and specify vinyl color number.
• Soil-retardant treatment applied to upholstery fabric	+\$ 27	Specify <i>with soil-retardant treatment</i> .
Contrasting upholstery on seat and back		
• Contrasting fabrics	+\$ 33	Add suffix K to the style number and specify fabric color numbers.
Contrasting upholstery on seat		
• Fabric price group 1	No cost	Specify fabric color number.
• Fabric price group 2	+\$ 10	Specify fabric color number.
• Fabric price group 3	+\$ 27	Specify fabric color number.
• Fabric price group 4	+\$ 36	Specify fabric color number.
• Fabric price group 5	+\$ 43	Specify fabric color number.
• Fabric price group 6	+\$ 53	Specify fabric color number.
• Fabric price group 7	+\$ 64	Specify fabric color number.
• Fabric price group 8	+\$ 79	Specify fabric color number.
• Fabric price group 9	+\$ 97	Specify fabric color number.
• Fabric price group 10	+\$112	Specify fabric color number.
• Steelcase leather upholstery	+\$182	Specify fabric color number. Add suffix S to the style number and specify leather color number.
• Select Surfaces leather price group 1	+\$182	Add suffix S to the style number and specify leather color number.
• Elmosoft leather upholstery	+\$213	Add suffix S to the style number and specify leather color number.

▶ Detailed dimensions, page 138



For Canadian Pricing

Multiply U.S. Price by the Canadian price factor.

▶ See page 1 for details.

▶ **Options, continued on next page**

► Options, continued from previous page

	Options	U.S. Price	Required to Specify
Surface Materials, continued	Contrasting upholstery on seat, continued		
	• Select Surfaces leather price group 2	+\$213	Add suffix S to the style number and specify leather color number.
	• Sewn upholstery	+\$ 42	Add suffix S to the style number.
	• Steelcase vinyl	+\$ 52	Add suffix S to the style number and specify vinyl color number.
	• Customer's Own Material (COM)	No cost	► See <i>Surface Materials Reference Manual</i> .
	• Customer's Own Leather (COL)	+\$ 42	Add suffix S to the style number and specify leather color number.
	• Customer's Own Material/Vinyl (COM-Sewn)	+\$ 42	Add suffix S to the style number and specify vinyl color number.
	Contrasting upholstery on back		
	• Fabric price group 1	No cost	Specify fabric color number.
	• Fabric price group 2	+\$ 17	Specify fabric color number.
	• Fabric price group 3	+\$ 22	Specify fabric color number.
	• Fabric price group 4	+\$ 34	Specify fabric color number.
	• Fabric price group 5	+\$ 45	Specify fabric color number.
	• Fabric price group 6	+\$ 56	Specify fabric color number.
	• Fabric price group 7	+\$ 61	Specify fabric color number.
	• Fabric price group 8	+\$ 79	Specify fabric color number.
	• Fabric price group 9	+\$ 97	Specify fabric color number.
	• Fabric price group 10	+\$107	Specify fabric color number.
	• Steelcase leather upholstery	+\$183	Add suffix S to the style number and specify leather color number.
	• Select Surfaces leather price group 1	+\$183	Add suffix S to the style number and specify leather color number.
	• Elmosoft leather upholstery	+\$212	Add suffix S to the style number and specify leather color number.
	• Select Surfaces leather price group 2	+\$212	Add suffix S to the style number and specify leather color number.
	• Sewn upholstery	+\$ 37	Add suffix S to the style number.
	• Steelcase vinyl	+\$ 54	Add suffix S to the style number and specify vinyl color number.
	• Customer's Own Material (COM)	No cost	► See <i>Surface Materials Reference Manual</i> .
	• Customer's Own Leather (COL)	+\$ 37	Add suffix S to the style number and specify leather color number.
	• Customer's Own Material/Vinyl (COM-Sewn)	+\$ 37	Add suffix S to the style number and specify vinyl color number.
	Soil-retardant treatment	+\$ 27	Specify <i>with soil-retardant treatment</i> .
	Frame		
	• Platinum on frame	+\$ 59	Specify <i>with 4799 Platinum frame</i> .
Casters	• Dual-wheel roll-control casters	+\$ 50	Specify <i>with dual-wheel roll-control casters</i> .
Glides	• Hard glides for use on carpeted floors	No cost	Specify <i>with hard glides</i> .
	• Soft glides for use on non-carpeted floors	+\$ 6	Specify <i>with soft glides</i> .

Tip: Casters or glides must be selected to complete specification of chair.

Specification Information

With Arms



• Style Number

466452MH

• U.S. Base Price

\$533

Without Arms



• Style Number

466450MH

• U.S. Base Price

\$474



For Canadian Pricing

Multiply U.S. Price by the Canadian price factor.

► See page 1 for details.

Reply 466 Series Sled-Base Multi-Use Chairs

Mesh Back with Standard Upholstery on Seat



Standard Includes	Required to Specify
<ul style="list-style-type: none"> ▶ Need help? Product details, page 134 • Frame: paint • Mesh on back • Standard upholstery design on seat: fabric price group 1 • Arm caps, if selected: black 	<ol style="list-style-type: none"> 1 Style number 2 Paint color number for metal frame, and arms; if specified 3 Mesh color number for back 4 Fabric color number for upholstery on seat 5 Options, if selected (see below) <p>▶ See <i>Surface Materials</i>, page 504.</p>

Options	U.S. Price	Required to Specify
<p>Surface Materials</p> <p>Upholstery on seat</p> <ul style="list-style-type: none"> • Fabric price group 1 • Fabric price group 2 • Fabric price group 3 • Fabric price group 4 • Fabric price group 5 • Fabric price group 6 • Fabric price group 7 • Fabric price group 8 • Fabric price group 9 • Fabric price group 10 • Steelcase leather upholstery • Select Surfaces leather price group 1 • Elmosoft leather upholstery • Select Surfaces leather price group 2 • Sewn upholstery • Steelcase vinyl • Customer's Own Material (COM) • Customer's Own Leather (COL) • Customer's Own Material/Vinyl (COM-Sewn) • Soil-retardant treatment applied to upholstery fabric <p>Frame</p> <ul style="list-style-type: none"> • Platinum on frame 	<p>No cost</p> <p>+\$ 10</p> <p>+\$ 27</p> <p>+\$ 36</p> <p>+\$ 43</p> <p>+\$ 53</p> <p>+\$ 64</p> <p>+\$ 79</p> <p>+\$ 97</p> <p>+\$112</p> <p>+\$183</p> <p>+\$183</p> <p>+\$214</p> <p>+\$214</p> <p>+\$ 43</p> <p>+\$ 53</p> <p>No cost</p> <p>+\$ 43</p> <p>+\$ 43</p> <p>+\$ 27</p> <p>+\$ 59</p> <p>No cost</p> <p>+\$ 6</p>	<p>Specify fabric color number.</p> <p>Specify fabric color number.</p> <p>Specify fabric color number.</p> <p>Specify fabric color number.</p> <p>Specify fabric color number.</p> <p>Specify fabric color number.</p> <p>Specify fabric color number.</p> <p>Specify fabric color number.</p> <p>Specify fabric color number.</p> <p>Specify fabric color number.</p> <p>Add suffix S to the style number and specify leather color number.</p> <p>Add suffix S to the style number and specify Select Surfaces leather price group 1.</p> <p>▶ See <i>Surface Materials Reference Manual</i>. Add suffix S to the style number and specify Elmosoft leather color number.</p> <p>Add suffix S to the style number and specify Select Surfaces leather price group 2.</p> <p>▶ See <i>Surface Materials Reference Manual</i>. Add suffix S to the style number.</p> <p>Add suffix S to the style number and specify vinyl color number.</p> <p>▶ See <i>Surface Materials Reference Manual</i> to specify.</p> <p>Add suffix S to the style number and specify leather color number.</p> <p>Add suffix S to the style number and specify vinyl color number.</p> <p>Specify <i>with soil-retardant treatment</i>.</p> <p>Specify <i>with 4799 Platinum frame</i>.</p> <p>Specify <i>with hard glides</i>.</p> <p>Specify <i>with soft glides</i>.</p>
<p>Glides</p> <ul style="list-style-type: none"> • Hard glides for use on carpeted floors • Soft glides for use on non-carpeted floors 	<p>No cost</p> <p>+\$ 6</p>	<p>Specify <i>with hard glides</i>.</p> <p>Specify <i>with soft glides</i>.</p>

Tip: Glides must be selected to complete specification of the chair.

▶ Detailed dimensions, page 138

 **For Canadian Pricing**
Multiply U.S. Price by the Canadian price factor.
▶ See page 1 for details.

Specification Information			
With Arms		Without Arms	
			
• Style Number	• U.S. Base Price	• Style Number	• U.S. Base Price
466482MT	\$628	466480MT	\$569

Reply 466 Series Sled-Base Multi-Use Chairs

Standard Upholstery on Back and Seat

Standard Includes	Required to Specify
<ul style="list-style-type: none"> ▶ Need help? Product details, page 134 • Frame: paint • Standard upholstery design on seat and back: fabric price group 1 • Arm caps, if selected: black 	<ol style="list-style-type: none"> 1 Style number 2 Paint color number for metal frame, and arms; if specified 3 Fabric color number for upholstery on seat and back 4 Options, if selected (see below) <p>▶ See <i>Surface Materials</i>, page 504.</p>

Options	U.S. Price	Required to Specify
Surface Materials		
Upholstery on seat and back		
• Fabric price group 1	No cost	Specify fabric color number.
• Fabric price group 2	+\$ 27	Specify fabric color number.
• Fabric price group 3	+\$ 49	Specify fabric color number.
• Fabric price group 4	+\$ 70	Specify fabric color number.
• Fabric price group 5	+\$ 88	Specify fabric color number.
• Fabric price group 6	+\$109	Specify fabric color number.
• Fabric price group 7	+\$125	Specify fabric color number.
• Fabric price group 8	+\$158	Specify fabric color number.
• Fabric price group 9	+\$194	Specify fabric color number.
• Fabric price group 10	+\$219	Specify fabric color number.
• Steelcase leather upholstery	+\$367	Specify fabric color number. Add suffix S to the style number and specify leather color number.
• Select Surfaces leather price group 1	+\$367	Add suffix S to the style number and specify Select Surfaces leather price group 1. ▶ See <i>Surface Materials Reference Manual</i> .
• Elmosoft leather upholstery	+\$427	Add suffix S to the style number and specify Elmosoft leather color number.
• Select Surfaces leather price group 2	+\$427	Add suffix S to the style number and specify Select Surfaces leather price group 2. ▶ See <i>Surface Materials Reference Manual</i> .
• Sewn upholstery	+\$ 81	Add suffix S to the style number.
• Steelcase vinyl	+\$108	Add suffix S to the style number and specify vinyl color number.
• Customer's Own Material (COM)	No cost	▶ See <i>Surface Materials Reference Manual</i> to specify.
• Customer's Own Leather (COL)	+\$ 81	Add suffix S to the style number and specify leather color number.
• Customer's Own Material/Vinyl (COM-Sewn)	+\$ 81	Add suffix S to the style number and specify vinyl color number.
• Soil-retardant treatment applied to upholstery fabric	+\$ 27	Specify <i>with soil-retardant treatment</i> .
Contrasting upholstery on seat and back		
• Contrasting fabrics	+\$ 33	Add suffix K to the style number and specify fabric color numbers.
Contrasting upholstery on seat		
• Fabric price group 1	No cost	Specify fabric color number.
• Fabric price group 2	+\$ 10	Specify fabric color number.
• Fabric price group 3	+\$ 27	Specify fabric color number.
• Fabric price group 4	+\$ 36	Specify fabric color number.
• Fabric price group 5	+\$ 43	Specify fabric color number.
• Fabric price group 6	+\$ 53	Specify fabric color number.
• Fabric price group 7	+\$ 64	Specify fabric color number.
• Fabric price group 8	+\$ 79	Specify fabric color number.
• Fabric price group 9	+\$ 97	Specify fabric color number.
• Fabric price group 10	+\$112	Specify fabric color number.
• Steelcase leather upholstery	+\$182	Specify fabric color number. Add suffix S to the style number and specify leather color number.
• Select Surfaces leather price group 1	+\$182	Add suffix S to the style number and specify leather color number.
• Elmosoft leather upholstery	+\$213	Add suffix S to the style number and specify leather color number.

Tip: Glides must be selected to complete specification of the chair.

▶ Detailed dimensions, page 138





For Canadian Pricing

Multiply U.S. Price by the Canadian price factor.

▶ See page 1 for details.

▶ Options, continued on next page

Options	U.S. Price	Required to Specify
Surface Materials, continued		
Contrasting upholstery on seat, continued		
• Select Surfaces leather price group 2	+\$213	Add suffix S to the style number and specify leather color number. Add suffix S to the style number. Add suffix S to the style number and specify vinyl color number. ▶ See <i>Surface Materials Reference Manual</i> . Add suffix S to the style number and specify leather color number. Add suffix S to the style number and specify vinyl color number.
• Sewn upholstery	+\$ 42	
• Steelcase vinyl	+\$ 52	
• Customer's Own Material (COM)	No cost	
• Customer's Own Leather (COL)	+\$ 42	
• Customer's Own Material/Vinyl (COM-Sewn)	+\$ 42	
Contrasting upholstery on back		
• Fabric price group 1	No cost	Specify fabric color number.
• Fabric price group 2	+\$ 17	Specify fabric color number.
• Fabric price group 3	+\$ 22	Specify fabric color number.
• Fabric price group 4	+\$ 34	Specify fabric color number.
• Fabric price group 5	+\$ 45	Specify fabric color number.
• Fabric price group 6	+\$ 56	Specify fabric color number.
• Fabric price group 7	+\$ 61	Specify fabric color number.
• Fabric price group 8	+\$ 79	Specify fabric color number.
• Fabric price group 9	+\$ 97	Specify fabric color number.
• Fabric price group 10	+\$107	Specify fabric color number.
• Steelcase leather upholstery	+\$183	Add suffix S to the style number and specify leather color number.
• Select Surfaces leather price group 1	+\$183	Add suffix S to the style number and specify leather color number.
• Elmosoft leather upholstery	+\$212	Add suffix S to the style number and specify leather color number.
• Select Surfaces leather price group 2	+\$212	Add suffix S to the style number and specify leather color number.
• Sewn upholstery	+\$ 37	Add suffix S to the style number.
• Steelcase vinyl	+\$ 54	Add suffix S to the style number and specify vinyl color number.
• Customer's Own Material (COM)	No cost	▶ See <i>Surface Materials Reference Manual</i> . Add suffix S to the style number and specify leather color number.
• Customer's Own Leather (COL)	+\$ 37	Add suffix S to the style number and specify vinyl color number.
• Customer's Own Material/Vinyl (COM-Sewn)	+\$ 37	
Soil-retardant treatment		
	+\$ 27	Specify <i>with soil-retardant treatment</i> .
Frame		
• Platinum on frame	+\$ 59	Specify <i>with 4799 Platinum frame</i> .
Glides		
• Hard glides for use on carpeted floors	No cost	Specify <i>with hard glides</i> .
• Soft glides for use on non-carpeted floors	+\$ 6	Specify <i>with soft glides</i> .

Specification Information			
With Arms		Without Arms	
			
• Style Number	• U.S. Base Price	• Style Number	• U.S. Base Price
466482MH	\$569	466480MH	\$510

For Canadian Pricing
Multiply U.S. Price by the Canadian price factor.
▶ See page 1 for details.

Understanding and Specifying Kart Series Multi-Use Chairs

Product Details

Kart Series	156
Dimensions	158

Specifying

Nesting Chairs	160
Stools	162
Café Leg-Base Stools	164
Leg-Base Stacking Chairs	166
Dolly	168
Jury Base Chairs	170

Multi-Use Chairs

Multi-use chairs are suitable for use as occasional seating within team spaces, workstations, offices, or wherever extra seating is required.

- Player 475 Series
- Move 490 Series
- Snodgrass 474 Series

Kart Series

Kart seating collection

offers solutions for classrooms, cafeterias, training rooms, and multipurpose rooms.

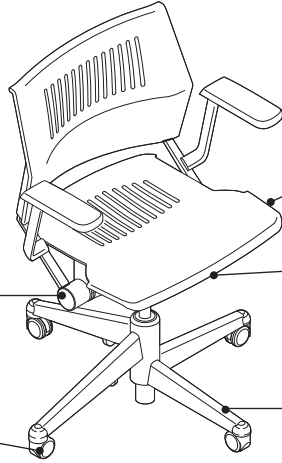

Seat height adjusts within a 5" range with a pneumatic adjustment mechanism.

Casters have hard, dual wheels that roll smoothly on carpets. Soft, dark grey treaded, dual-wheel roll-control casters are available for use on hard floors or mats.

Tip: Do not roll the chair across asphalt during installation as this may damage the casters.

Flip the seat on the nesting chairs and eight Kart chairs can nest in the space of two and a half.

Tilt tension adjustment allows you to control the amount of resistance needed for reclining.

Four-arm base is standard on nesting chairs.

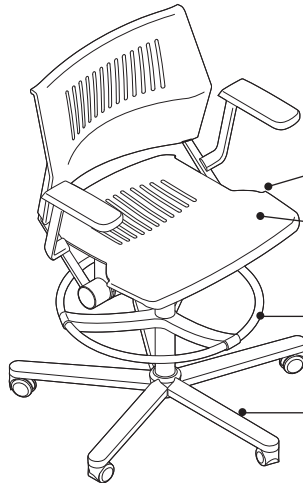

Back lock mechanism allow users to lock the back in an upright position.

Stools do not nest.

Adjustable 19" diameter chrome foot ring.

The stool has a five-arm base.

Arms, glides, and back-seat connection will always be black.

Leg base models are available with arms only.

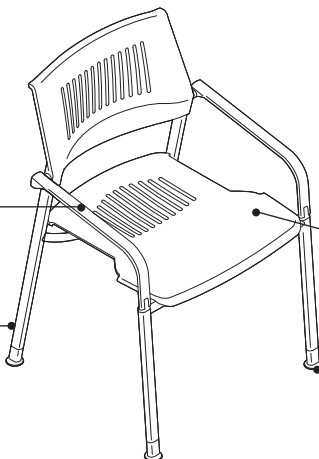

Kart stacking chair stacks six high on the floor.

Glides are standard on stacking chair with the option of hard dual-wheel casters for use on carpets.

Product Details



Nesting chairs and stools with casters are available with or without arms.

Kart is available non-upholstered, upholstered seat only, or upholstered seat and back.

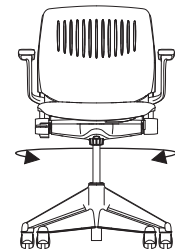

360° swivel motion is locked when in nesting mode (seat up and engaged with base).

Stackability for leg-base models is six high on the floor and ten high on the transport and storage dolly. Leg-base models with casters are not recommended to stack as damage to arms may occur.

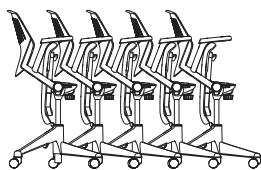

Nesting chairs have the ability to nest eight chairs in the space of two and a half.

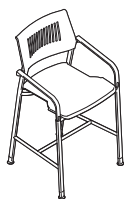

Kart café stools do not stack.

Jury base models are standard with memory return and 180° swivel in black only.

Kart chairs and stools come standard uncartoned. There is an option to have Kart cartoned. Jury base models are available to ship cartoned only.

Adjustment Features

Adjustability instructions are included with every swivel-base chair. Instructions can also be found at www.steelcase.com.

Seat Adjustments

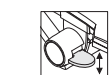
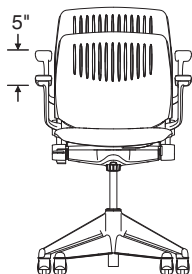

Seat height adjusts pneumatically. To lower, hold handle up while seated. To raise, hold handle up and keep your weight off the chair. Range of adjustability is 5".

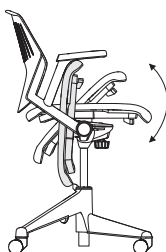

Seat flips on nesting chairs and jury base chairs. Pull the lever under the seat toward the front of the chair and tip the seat up. As the seat releases, the pneumatic lift activates and pushes the chair to its full height position. To lock, spin the chair until the seat engages with the base tooth.

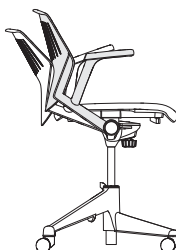

Tilt Tension. To loosen, turn control knob counter-clockwise. To tighten, turn control knob clockwise.

Back Adjustments

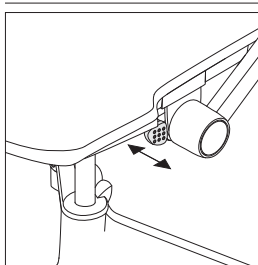

Forward back lock on nesting and stool with casters. Lean forward, pull triangular knob out until it stops.

Foot Ring Adjustments

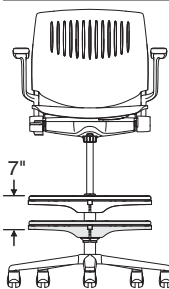

19" chrome foot ring adjusts 8½"H to 15½"H by rotating it left or right.

Other Features

Hard dual-wheel casters for use on soft floors come standard on nesting chairs as well as stools with casters.

Soft dual-wheel casters for hard floors on nesting or five-arm base stools are available for specific applications.

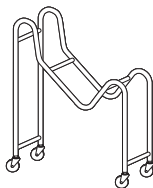

Transport and storage dolly is available to stack, move, and store up to ten chairs with or without arms. Without the dolly, chairs will stack up to six high.

Fully loaded transport dolly measures 40"D x 25"W x 63"H non-upholstered, 68"H upholstered.

Surface Materials

▶ See surface materials on page 504 for specific availability or refer to the *Surface Materials Reference Manual* for further information.

Fabric and leathers will appear loose with comfort wrinkles when upholstered.

Back frame and seat shell are plastic on all Kart models.

Upholstery

- Fabric
- Leather
- Elmosoft Leather

Hard Components

(Base, back supports, and arm support bar)

- Aluminum with paint

(Rub strips, yoke strips, non-upholstered seat, and back)

- Plastic

(Café stool steel frame)

- Paint

Arm Caps

- Black plastic

Foot Ring

- Chrome

Casters

- Black only

Glides

- Standard on café stool and optional on nesting and stools with casters.

Jury Base

- Black

Extra Foam

- Available on nesting and stools with casters.

Programs & Services

▶ See the *Surface Materials Reference Manual* for further detail about programs and services offered for seating.

The Customer's Own Material (COM) Program

offers the opportunity for customers to select fabrics that are not offered through the standard Steelcase surface materials program for use on Steelcase products. Through the COM program, Steelcase will test your materials for application on Steelcase products. Once approved, you can place your order. Steelcase will facilitate the entire ordering process and give you a production schedule. Steelcase will order the COM fabric directly from the textile manufacturer. For up-to-date information regarding fabric test results for all COM fabrics and details regarding yardage requirements for most Seating lines, visit the COM website. To locate the COM website:

- Visit www.steelcase.com

Dimensions

▶ Page 158

Resources

Printed Materials

▶ Kart Brochure

Online Resources

▶ Environmental profiles available on www.steelcase.com/sustainability.

Dimensions

Features	Overall Depth	Width	Height	Seat Depth	Seat Width	Seat Height from Floor	Ring Height from Floor	Back Width	Width Between Arms
----------	---------------	-------	--------	------------	------------	------------------------	------------------------	------------	--------------------

Kart

Nesting Chairs

With arms	22½"	24½"	38"	17¾"	19"	16" to 21"	N.A.	18"	19½"
Without arms	22½"	24½"	38"	17¾"	19"	16" to 21"	N.A.	18"	N.A.

Stools with Casters

With arms	22½"	24½"	44"	17¾"	19"	21" to 28½"	8½" to 15½"	18"	19½"
Without arms	22½"	24½"	44"	17¾"	19"	21" to 28½"	8½" to 15½"	18"	N.A.

Café Leg-Base Stools

With arms	25"	22¼"	46"	18¼"	19¾"	30"	8½" to 15½"	18"	19½"
-----------	-----	------	-----	------	------	-----	-------------	-----	------

Stacking Leg-Base Chairs

With arms	22¾"	22¼"	32⅞"	18¼"	19¾"	17⅞"	N.A.	18"	19½"
-----------	------	------	------	------	------	------	------	-----	------

Jury Base Chairs

With arms	22½"	24½"	36"	17¾"	19"	16½" to 20½"	N.A.	18"	19½"
Without arms	22½"	24½"	36"	17¾"	19"	16½" to 20½"	N.A.	18"	N.A.
With arms—tall range	22½"	24½"	38"	17¾"	19"	19¼" to 23¼"	N.A.	18"	19½"
Without arms—tall range	22½"	24½"	38"	17¾"	19"	19¼" to 23¼"	N.A.	18"	N.A.

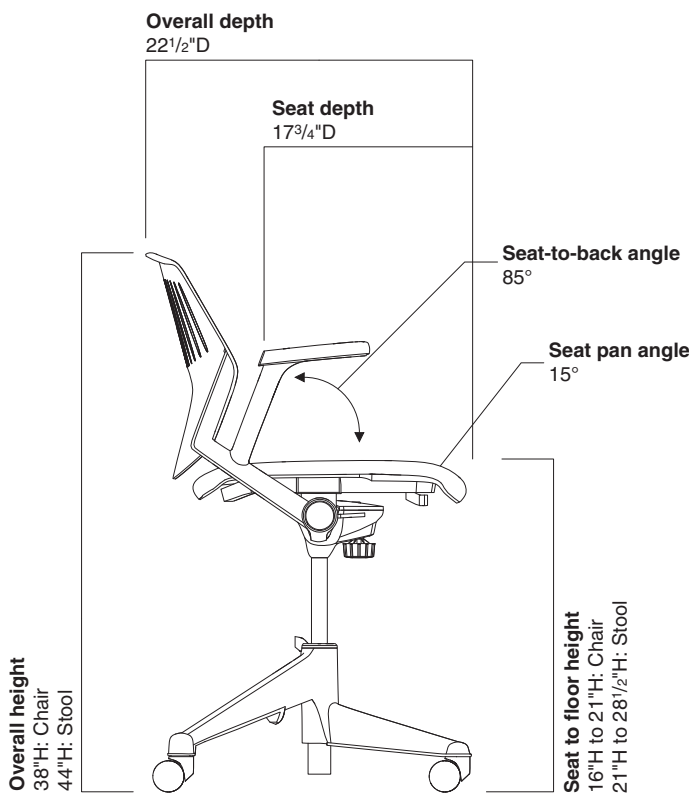
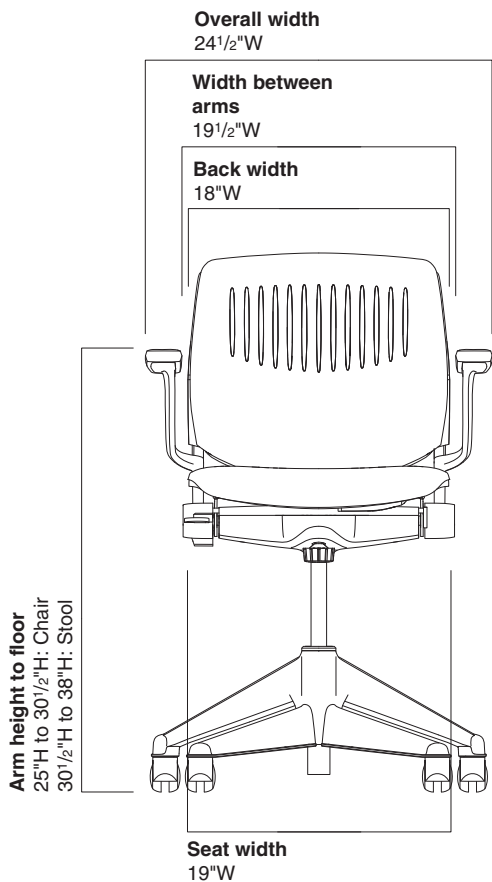

• **Arm Height to Floor**
 • **Angle Between Seat and Back**
 • **Seat Pan Angle**

Nesting Chairs

25 to 30 1/2"	85°	15°
N.A.	85°	15°

Stools with Casters

30 1/2" to 38"	85°	15°
N.A.	85°	15°

Café Leg-Base Stools

38"	85°	15°
-----	-----	-----

Stacking Leg-Base Chairs

26"	85°	15°
-----	-----	-----

Jury Base Chairs

25" to 30 1/2"	85°	15°
N.A.	85°	15°
25" to 30 1/2"	85°	15°
N.A.	85°	15°

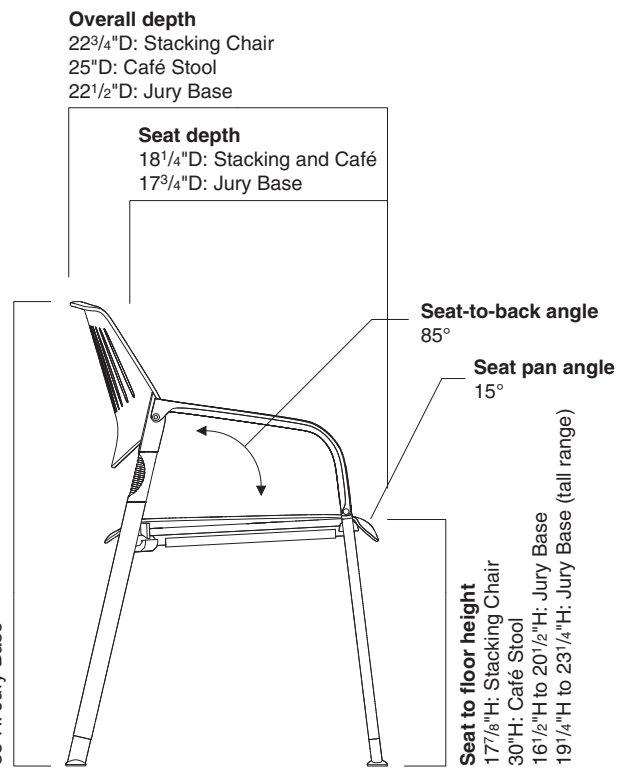
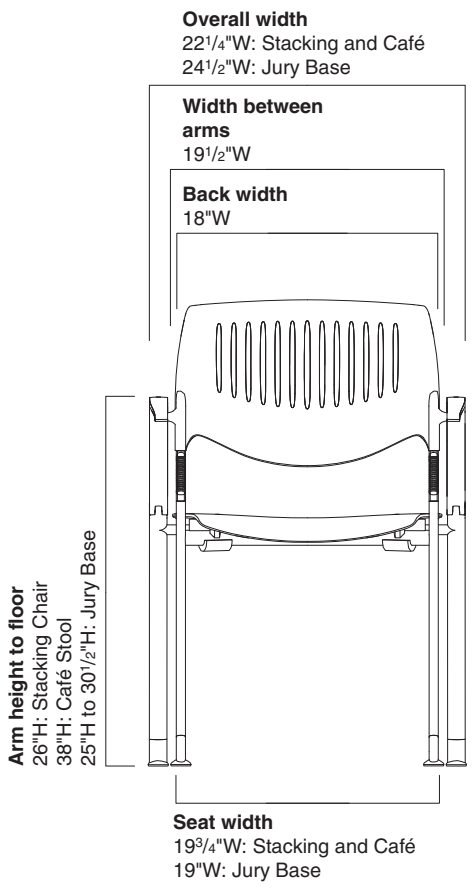

Kart Nesting Chairs



Tip: Fabrics and leathers will appear loose with comfort wrinkles when upholstered.

Tip: For Customer's Own Material or Leather, see necessary requirements, important processing instructions, and ordering information.

▶ See *Surface Materials Reference Manual*.

Standard Includes		Required to Specify
▶ Need help? Product details, page 156	<ul style="list-style-type: none"> • Four-prong Kart nesting base with nylon base tooth: die-cast aluminum with powder coat • Rub strips: injection-molded black polypropylene • Yoke strips: injection-molded black polypropylene • Hard, dual-wheel casters for use on carpet: black plastic • Seat and back: black or gray textured contoured, injection-molded glass-filled Polyurethane • Upholstered seat or upholstered seat and back, if selected: molded urethane foam over injection-molded polypropylene inner shell(s) • Folding seat with self-aligning features • Back supports: one-piece die-cast aluminum • Arms, if selected: die-cast aluminum support bar with black, molded, self-skinning polyurethane arm cap • Pneumatic height adjustment • Tilt tension adjustment • Zero front rise • Forward back lock 	<ol style="list-style-type: none"> 1 Style number 2 Powder coat color number for base 3 Plastic color number for seat and back 4 Fabric or leather color number for upholstery, if selected 5 Options, if selected (see below) <p>▶ See <i>Surface Materials</i>, page 504.</p>

Options	U.S. Price	Required to Specify
Surface Materials		
Non-upholstered chair		
• Plastic	No cost	Specify plastic color number.
Upholstery on seat		
• Fabric price group 1	No cost	Specify fabric color number.
• Fabric price group 2	+\$ 10	Specify fabric color number.
• Fabric price group 3	+\$ 26	Specify fabric color number.
• Fabric price group 4	+\$ 36	Specify fabric color number.
• Fabric price group 5	+\$ 43	Specify fabric color number.
• Fabric price group 6	+\$ 53	Specify fabric color number.
• Fabric price group 7	+\$ 64	Specify fabric color number.
• Fabric price group 8	+\$ 79	Specify fabric color number.
• Fabric price group 9	+\$ 93	Specify fabric color number.
• Fabric price group 10	+\$112	Specify fabric color number.
• Steelcase leather upholstery	+\$ 53	Specify leather color number.
• Elmosoft leather upholstery	+\$106	Specify Elmosoft leather color number.
• Customer's Own Material/Vinyl (COM)	+\$ 42	▶ See <i>Surface Materials Reference Manual</i> to specify.
• Customer's Own Leather (COL)	No cost	▶ See <i>Surface Materials Reference Manual</i> to specify.
Upholstery on seat and back		
• Fabric price group 1	No cost	Specify fabric color number.
• Fabric price group 2	+\$ 22	Specify fabric color number.
• Fabric price group 3	+\$ 50	Specify fabric color number.
• Fabric price group 4	+\$ 72	Specify fabric color number.
• Fabric price group 5	+\$ 87	Specify fabric color number.
• Fabric price group 6	+\$106	Specify fabric color number.
• Fabric price group 7	+\$127	Specify fabric color number.
• Fabric price group 8	+\$159	Specify fabric color number.
• Fabric price group 9	+\$185	Specify fabric color number.
• Fabric price group 10	+\$224	Specify fabric color number.
• Steelcase leather upholstery	+\$106	Specify leather color number.
• Elmosoft leather upholstery	+\$211	Specify Elmosoft leather color number.
• Customer's Own Material (COM)	+\$ 42	▶ See <i>Surface Materials Reference Manual</i> to specify.
• Customer's Own Leather (COL)	No cost	▶ See <i>Surface Materials Reference Manual</i> to specify.
Casters		
• Soft, dark grey treaded, dual-wheel roll-control casters for use on hard floors	+\$ 42	Specify with soft roll-control casters.
Extra Foam		
• Extra foam	+\$ 72	Specify with extra foam.
Glide		
• Glide	+\$ 36	Specify with glides.
Related Products		
• Pouch and leash		▶ Page 161

▶ Detailed dimensions, page 158



For Canadian Pricing

Multiply U.S. Price by the Canadian price factor.

▶ See page 1 for details.

Specification Information

• Style	• U.S.
• Number	• Base
•	• Price
•	•

Non-Upholstered with Arms

126A101	\$ 882
•	•

Non-Upholstered without Arms

126A100	\$ 805
•	•

Upholstered Seat with Arms

126A201S	\$1064
•	•

Upholstered Seat without Arms

126A200S	\$ 987
•	•

Upholstered Seat and Back with Arms

126A201	\$1120
•	•

Upholstered Seat and Back without Arms

126A200	\$1043
•	•



Pouch and Leash for Use on Kart Nesting Chairs

Standard Includes	Required to Specify
<ul style="list-style-type: none"> • Leash to retain up to 10 nested chairs • Pouch to store leash • Pouch attaches to bottom of seat 	Style number

Specification Information

• Style	• U.S.
• Number	• Price
•	•

126900	\$72
•	•

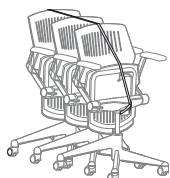

For Canadian Pricing
 Multiply U.S. Price by the Canadian price factor.
 ▶ See page 1 for details.

Kart Stools

with Casters



Tip: Stools do not nest.

Tip: Fabrics and leathers will appear loose with comfort wrinkles when upholstered.

Tip: For Customer's Own Material or Leather, see necessary requirements, important processing instructions, and ordering information. ▶ See *Surface Materials Reference Manual*.

Standard Includes	Required to Specify
<ul style="list-style-type: none"> ▶ Need help? Product details, page 156 • Five-prong base with 25" span: one-piece die-cast aluminum with powder coat color • Telescoping hub cover: black plastic • Adjustable 19" diameter chrome foot ring • Hard, dual-wheel casters for use on carpet: black • Seat and back: black or gray textured contoured, injection-molded glass-filled polypropylene • Upholstered seat or upholstered seat and back, if selected: molded urethane foam over injection-molded polypropylene inner shell(s) • Back supports: one-piece die-cast aluminum • Arms, if selected: die-cast aluminum support bar with black, molded, self-skinning polyurethane arm cap • Pneumatic height adjustment • Tilt tension adjustment • Zero front rise • Forward back lock 	<ol style="list-style-type: none"> 1 Style number 2 Powder coat color number for base 3 Plastic color number for seat and back 4 Fabric or leather color number for upholstery, if selected 5 Options, if selected (see below) <p>▶ See <i>Surface Materials</i>, page 504.</p>

Options	U.S. Price	Required to Specify
Surface Materials Non-upholstered stool <ul style="list-style-type: none"> • Plastic 	No cost	Specify plastic color number.
Upholstery on seat <ul style="list-style-type: none"> • Fabric price group 1 • Fabric price group 2 • Fabric price group 3 • Fabric price group 4 • Fabric price group 5 • Fabric price group 6 • Fabric price group 7 • Fabric price group 8 • Fabric price group 9 • Fabric price group 10 • Steelcase leather upholstery • Elmosoft leather upholstery • Customer's Own Material/Vinyl (COM) • Customer's Own Leather (COL) 	No cost +\$ 10 +\$ 26 +\$ 36 +\$ 43 +\$ 53 +\$ 64 +\$ 79 +\$ 93 +\$112 +\$ 53 +\$106 +\$ 42 No cost	Specify fabric color number. Specify fabric color number. Specify fabric color number. Specify fabric color number. Specify fabric color number. Specify fabric color number. Specify fabric color number. Specify fabric color number. Specify fabric color number. Specify fabric color number. Specify fabric color number. Specify leather color number. Specify Elmosoft leather color number. ▶ See <i>Surface Materials Reference Manual</i> to specify. ▶ See <i>Surface Materials Reference Manual</i> to specify.
Upholstery on seat and back <ul style="list-style-type: none"> • Fabric price group 1 • Fabric price group 2 • Fabric price group 3 • Fabric price group 4 • Fabric price group 5 • Fabric price group 6 • Fabric price group 7 • Fabric price group 8 • Fabric price group 9 • Fabric price group 10 • Steelcase leather upholstery • Elmosoft leather upholstery • Customer's Own Material (COM) • Customer's Own Leather (COL) 	No cost +\$ 22 +\$ 50 +\$ 72 +\$ 87 +\$106 +\$127 +\$159 +\$185 +\$224 +\$106 +\$211 +\$ 42 No cost	Specify fabric color number. Specify fabric color number. Specify fabric color number. Specify fabric color number. Specify fabric color number. Specify fabric color number. Specify fabric color number. Specify fabric color number. Specify fabric color number. Specify fabric color number. Specify fabric color number. Specify leather color number. Specify Elmosoft leather color number. ▶ See <i>Surface Materials Reference Manual</i> to specify. ▶ See <i>Surface Materials Reference Manual</i> to specify.
Casters <ul style="list-style-type: none"> • Soft, dark grey treaded, dual-wheel roll-control casters for use on hard floors 	+\$ 42	Specify with soft roll-control casters.
Extra Foam <ul style="list-style-type: none"> • Extra foam 	+\$ 72	Specify with extra foam.
Glide <ul style="list-style-type: none"> • Glide 	+\$ 36	Specify with glides.

▶ Detailed dimensions, page 158



For Canadian Pricing
 Multiply U.S. Price by the Canadian price factor.
 ▶ See page 1 for details.

Specification Information

• Style	• U.S.
• Number	• Base
•	• Price
•	•

Non-Upholstered with Arms

126B101ST \$1041



Non-Upholstered without Arms

126B100ST \$ 964



Upholstered Seat with Arms

126B201SST \$1223



Upholstered Seat without Arms

126B200SST \$1146



Upholstered Seat and Back with Arms

126B201ST \$1279



Upholstered Seat and Back without Arms

126B200ST \$1202



 **For Canadian Pricing**
 Multiply U.S. Price by the Canadian price factor.
 ▶ See page 1 for details.

Kart Café Leg-Base Stools

With Arms



Tip: Stools do not stack.

Tip: Fabrics and leathers will appear loose with comfort wrinkles when upholstered.

Tip: For Customer's Own Material or Leather, see necessary requirements, important processing instructions, and ordering information. ▶ See *Surface Materials Reference Manual*.

Tip: Arms, glides, and back-seat connection will always be black.

Standard Includes	Required to Specify
<ul style="list-style-type: none"> ▶ Need help? Product details, page 156 • Frame: 16-gauge tubular steel with powder coat color • Flex bars: two black resilient polypropylene flexible connectors in the back frame allow the back to tilt back approximately eight degrees for added comfort • Glides: non-marring, black polypropylene • Seat and back: black textured contoured, injection-molded glass-filled, high-impact polypropylene • Upholstered seat or upholstered seat and back, if selected: resilient, flame-retardant, molded urethane foam over injection-molded polypropylene inner shell(s) 	<ol style="list-style-type: none"> 1 Style number 2 Powder coat color number for base 3 Plastic color number for seat and back 4 Fabric or leather color number for upholstery, if selected 5 Options, if selected (see below) <p>▶ See <i>Surface Materials</i>, page 504.</p>

Options	U.S. Price	Required to Specify
Surface Materials • Plastic	No cost	Specify plastic color number.
Upholstery on seat		
• Fabric price group 1	No cost	Specify fabric color number.
• Fabric price group 2	+\$ 10	Specify fabric color number.
• Fabric price group 3	+\$ 26	Specify fabric color number.
• Fabric price group 4	+\$ 36	Specify fabric color number.
• Fabric price group 5	+\$ 43	Specify fabric color number.
• Fabric price group 6	+\$ 53	Specify fabric color number.
• Fabric price group 7	+\$ 64	Specify fabric color number.
• Fabric price group 8	+\$ 79	Specify fabric color number.
• Fabric price group 9	+\$ 93	Specify fabric color number.
• Fabric price group 10	+\$112	Specify fabric color number.
• Steelcase leather upholstery	+\$ 53	Specify leather color number.
• Elmosoft leather upholstery	+\$106	Specify Elmosoft leather color number.
• Customer's Own Material/Vinyl (COM)	+\$ 42	▶ See <i>Surface Materials Reference Manual</i> to specify.
• Customer's Own Leather (COL)	No cost	▶ See <i>Surface Materials Reference Manual</i> to specify.
Upholstery on seat and back		
• Fabric price group 1	No cost	Specify fabric color number.
• Fabric price group 2	+\$ 22	Specify fabric color number.
• Fabric price group 3	+\$ 50	Specify fabric color number.
• Fabric price group 4	+\$ 72	Specify fabric color number.
• Fabric price group 5	+\$ 87	Specify fabric color number.
• Fabric price group 6	+\$106	Specify fabric color number.
• Fabric price group 7	+\$127	Specify fabric color number.
• Fabric price group 8	+\$159	Specify fabric color number.
• Fabric price group 9	+\$185	Specify fabric color number.
• Fabric price group 10	+\$224	Specify fabric color number.
• Steelcase leather upholstery	+\$106	Specify leather color number.
• Elmosoft leather upholstery	+\$211	Specify Elmosoft leather color number.
• Customer's Own Material (COM)	+\$ 42	▶ See <i>Surface Materials Reference Manual</i> to specify.
• Customer's Own Leather (COL)	No cost	▶ See <i>Surface Materials Reference Manual</i> to specify.

▶ Detailed dimensions, page 158



For Canadian Pricing

Multiply U.S. Price by the Canadian price factor.

▶ See page 1 for details.

Specification Information

• Style	• U.S.
• Number	• Base
•	• Price
•	•

Non-Upholstered

126B111ST	\$656
•	•

Upholstered Seat

126B211SST	\$823
•	•

Upholstered Seat and Back

126B211ST	\$915
•	•

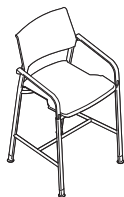
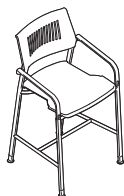
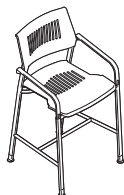

Kart Series

 **For Canadian Pricing**
 Multiply U.S. Price by the Canadian price factor.
 ▶ See page 1 for details.

Kart Leg-Base Stacking Chairs

With Arms



Tip: Chairs stack six high on the floor.

Tip: Fabrics and leathers will appear loose with comfort wrinkles when upholstered.

Tip: For Customer's Own Material or Leather, see necessary requirements, important processing instructions, and ordering information. ▶ See Surface Materials Reference Manual.

Tip: Arms, glides, and back-seat connection will always be black.

Standard Includes		Required to Specify	
▶ Need help? Product details, page 156	<ul style="list-style-type: none"> • Frame: 16-gauge tubular steel with powder coat color • Flex bars: two black resilient polypropylene flexible connectors in the back frame allow the back to tilt back approximately eight degrees for added comfort • Glides: non-marring, black polypropylene • Seat and back: black textured contoured, injection-molded glass-filled, high-impact polypropylene • Upholstered seat or upholstered seat and back, if selected: resilient, flame-retardant, molded urethane foam over injection-molded polypropylene inner shell(s) 	<ol style="list-style-type: none"> 1 Style number 2 Powder coat color number for base 3 Plastic color number for seat and back 4 Fabric or leather color number for upholstery, if selected 5 Options, if selected (see below) <p>▶ See <i>Surface Materials</i>, page 504.</p>	
Surface Materials	Options	U.S. Price	Required to Specify
	Non-upholstered chair <ul style="list-style-type: none"> • Plastic 	No cost	Specify plastic color number.
	Upholstery on seat <ul style="list-style-type: none"> • Fabric price group 1 • Fabric price group 2 • Fabric price group 3 • Fabric price group 4 • Fabric price group 5 • Fabric price group 6 • Fabric price group 7 • Fabric price group 8 • Fabric price group 9 • Fabric price group 10 • Steelcase leather upholstery • Elmosoft leather upholstery • Customer's Own Material/Vinyl (COM) • Customer's Own Leather (COL) 	No cost +\$ 10 +\$ 26 +\$ 36 +\$ 43 +\$ 53 +\$ 64 +\$ 79 +\$ 93 +\$112 +\$ 53 +\$106 +\$ 42 No cost	Specify fabric color number. Specify fabric color number. Specify fabric color number. Specify fabric color number. Specify fabric color number. Specify fabric color number. Specify fabric color number. Specify fabric color number. Specify fabric color number. Specify fabric color number. Specify leather color number. Specify Elmosoft leather color number. ▶ See <i>Surface Materials Reference Manual</i> to specify. ▶ See <i>Surface Materials Reference Manual</i> to specify.
	Upholstery on seat and back <ul style="list-style-type: none"> • Fabric price group 1 • Fabric price group 2 • Fabric price group 3 • Fabric price group 4 • Fabric price group 5 • Fabric price group 6 • Fabric price group 7 • Fabric price group 8 • Fabric price group 9 • Fabric price group 10 • Steelcase leather upholstery • Elmosoft leather upholstery • Customer's Own Material (COM) • Customer's Own Leather (COL) 	No cost +\$ 22 +\$ 50 +\$ 72 +\$ 87 +\$106 +\$127 +\$159 +\$185 +\$224 +\$106 +\$211 +\$ 42 No cost	Specify fabric color number. Specify fabric color number. Specify fabric color number. Specify fabric color number. Specify fabric color number. Specify fabric color number. Specify fabric color number. Specify fabric color number. Specify fabric color number. Specify fabric color number. Specify leather color number. Specify Elmosoft leather color number. ▶ See <i>Surface Materials Reference Manual</i> to specify. ▶ See <i>Surface Materials Reference Manual</i> to specify.
	Casters <ul style="list-style-type: none"> • Hard, dual-wheel casters for use on carpet 	No cost	Add suffix C to the style number.
	Related Products <ul style="list-style-type: none"> • Dolly 		▶ Page 168

▶ Detailed dimensions, page 158



For Canadian Pricing

Multiply U.S. Price by the Canadian price factor.

▶ See page 1 for details.

Specification Information

• Style	• U.S.
• Number	• Base
•	• Price
•	•

Non-Upholstered Seat and Back

126A111	\$458
•	•

Upholstered Seat

126A211S	\$708
•	•

Upholstered Seat and Back

126A211	\$805
•	•



Kart Series

 **For Canadian Pricing**
Multiply U.S. Price by the
Canadian price factor.
▶ See page 1 for details.

Kart Dolly

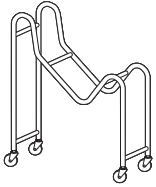

Tip: Holds 10 chairs (40"D x 25"W x 63"H non-upholstered or 68"H upholstered).

Standard Includes	Required to Specify
-------------------	---------------------

▶ Need help? Product details, page 156	• 35"D x 14½"W x 42½"H four-wheel dolly; black Style number
--	--

Specification Information	
---------------------------	--

• Style • Number	• U.S. • Price
793390	\$494
:	:
:	:



For Canadian Pricing

Multiply U.S. Price by the Canadian price factor.

▶ See page 1 for details.

Kart Jury Base Chairs



Tip: Standard seat height range: 16½"H–20½"H.

Tip: Tall seat height range: 19¼"H–23¼"H.

Tip: Kart seat folds up.

Tip: Fabrics and leathers will appear loose with comfort wrinkles when upholstered.

Tip: For Customer's Own Material or Leather, see necessary requirements, important processing instructions, and ordering information. ▶ See *Surface Materials Reference Manual*.

Tip: Jury bases are standard with pneumatic swivel-tilt return mechanism.

Standard Includes	Required to Specify
<ul style="list-style-type: none"> ▶ Need help? Product details, page 156 Jury base with memory return and 180 degree swivel Standard jury base, if selected, is made up of 2½"-diameter column and 8" base plate: 7207 black only Tall jury base, if selected, is made up of 2½"-diameter column and 8" base plate: 7207 black only Seat and back: black textured contoured, injection-molded glass-filled, high-impact polypropylene Upholstered seat or upholstered seat and back, if selected: resilient, flame-retardant, molded urethane foam over injection-molded polypropylene inner shell(s) Folding seat with self-aligning features Arms, if selected; die-cast aluminum support bar with black, molded, self-skinning polyurethane arm cap Pneumatic height adjustment Hardware for floor attachment, not included 	<ol style="list-style-type: none"> 1 Style number 2 Plastic color number for seat and back 3 Fabric or leather color number for upholstery, if selected 4 Options, if selected (see below) <p>▶ See <i>Surface Materials</i>, page 504.</p>

Surface Materials	Options	U.S. Price	Required to Specify
	Non-upholstered chair		
	• Plastic	No cost	Specify plastic color number.
	Upholstery on seat		
	• Fabric price group 1	No cost	Specify fabric color number.
	• Fabric price group 2	+\$ 10	Specify fabric color number.
	• Fabric price group 3	+\$ 26	Specify fabric color number.
	• Fabric price group 4	+\$ 36	Specify fabric color number.
	• Fabric price group 5	+\$ 43	Specify fabric color number.
	• Fabric price group 6	+\$ 53	Specify fabric color number.
	• Fabric price group 7	+\$ 64	Specify fabric color number.
	• Fabric price group 8	+\$ 79	Specify fabric color number.
	• Fabric price group 9	+\$ 93	Specify fabric color number.
	• Fabric price group 10	+\$112	Specify fabric color number.
	• Steelcase leather upholstery	+\$ 53	Specify leather color number.
	• Elmosoft leather upholstery	+\$106	Specify Elmosoft leather color number.
	• Customer's Own Material/Vinyl (COM)	+\$ 42	▶ See <i>Surface Materials Reference Manual</i> to specify.
	• Customer's Own Leather (COL)	No cost	▶ See <i>Surface Materials Reference Manual</i> to specify.
	Upholstery on seat and back		
	• Fabric price group 1	No cost	Specify fabric color number.
	• Fabric price group 2	+\$ 22	Specify fabric color number.
	• Fabric price group 3	+\$ 50	Specify fabric color number.
	• Fabric price group 4	+\$ 72	Specify fabric color number.
	• Fabric price group 5	+\$ 87	Specify fabric color number.
	• Fabric price group 6	+\$106	Specify fabric color number.
	• Fabric price group 7	+\$127	Specify fabric color number.
	• Fabric price group 8	+\$159	Specify fabric color number.
	• Fabric price group 9	+\$185	Specify fabric color number.
	• Fabric price group 10	+\$224	Specify fabric color number.
	• Steelcase leather upholstery	+\$106	Specify leather color number.
	• Elmosoft leather upholstery	+\$211	Specify Elmosoft leather color number.
	• Customer's Own Material (COM)	+\$ 42	▶ See <i>Surface Materials Reference Manual</i> to specify.
	• Customer's Own Leather (COL)	No cost	▶ See <i>Surface Materials Reference Manual</i> to specify.
Extra Foam	• Extra foam	+\$ 72	Specify <i>with extra foam</i> .



For Canadian Pricing

Multiply U.S. Price by the Canadian price factor.

▶ See page 1 for details.

Specification Information

Style Number	U.S. Base Price
--------------	-----------------



Non-Upholstered with Arms

127C101J	\$1139
----------	--------



Non-Upholstered without Arms

127C100J	\$1062
----------	--------



Upholstered Seat with Arms

127C201SJ	\$1321
-----------	--------



Upholstered Seat without Arms

127C200SJ	\$1244
-----------	--------



Upholstered Seat and Back with Arms

127C201J	\$1377
----------	--------

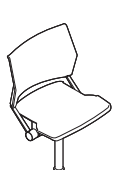

Upholstered Seat and Back without Arms

127C200J	\$1300
----------	--------

► **Specification Information, continued on next page**



For Canadian Pricing
 Multiply U.S. Price by the Canadian price factor.
 ► See page 1 for details.

► Specification Information, continued from previous page

Specification Information

• Style	• U.S.
• Number	• Base
•	• Price
•	•

Non-Upholstered with Arms – Tall

128C101J	\$1139
•	•



Non-Upholstered without Arms – Tall

128C100J	\$1062
•	•

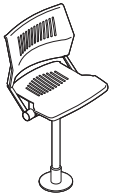

Upholstered Seat with Arms – Tall

128C201SJ	\$1321
•	•

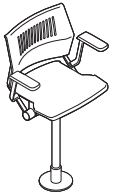

Upholstered Seat without Arms – Tall

128C200SJ	\$1244
•	•

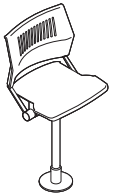

Upholstered Seat and Back with Arms – Tall

128C201J	\$1377
•	•

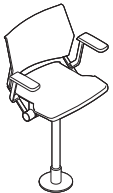

Upholstered Seat and Back without Arms – Tall

128C200J	\$1300
•	•

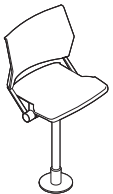

For Canadian Pricing

Multiply U.S. Price by the Canadian price factor.

► See page 1 for details.

Understanding and Specifying Jersey Series Work Chair

Product Details

Jersey Series	174
Dimensions	178

Specifying

Jersey Series Value Package Work Chair	180
Jersey Series Work Chair	182
Jersey Series Multi-Use Chairs	184

Work Chairs

Highly adjustable task seating offers maximum personalization for fit and comfort for a range of duration and use. By making a series of simple adjustments, you can customize the chair to your body, preferences, and tasks. These chairs provide continuous, stable, comfort, and can be quickly adjusted to support you in upright, and reclining work postures.

- Gesture 442 Series
- Leap 462 Series
- Think 465 Series
- Amia 482 Series
- Reply 466 Series
- Jersey Series
- Leap 464 Series WorkLounge
- Criterion 453 Series

Adjustability Features

► See page 22 for a comparison to other chairs.

Jersey Series

Mechanisms

Synchro-tilt	●
--------------	---

Seat Adjustments

Pneumatic height	●
------------------	---

Seat angle	●
------------	---

Seat depth	●
------------	---

Back Adjustments

Back tension	●
--------------	---

Upright back lock	●
-------------------	---

Arm Adjustments

Arm height	●
------------	---

Arm width	●
-----------	---

Arm pivot	●
-----------	---

Jersey Series

Jersey features a double mesh back in a unique ergonomic "S" shape to conform to each user for comfort and support.

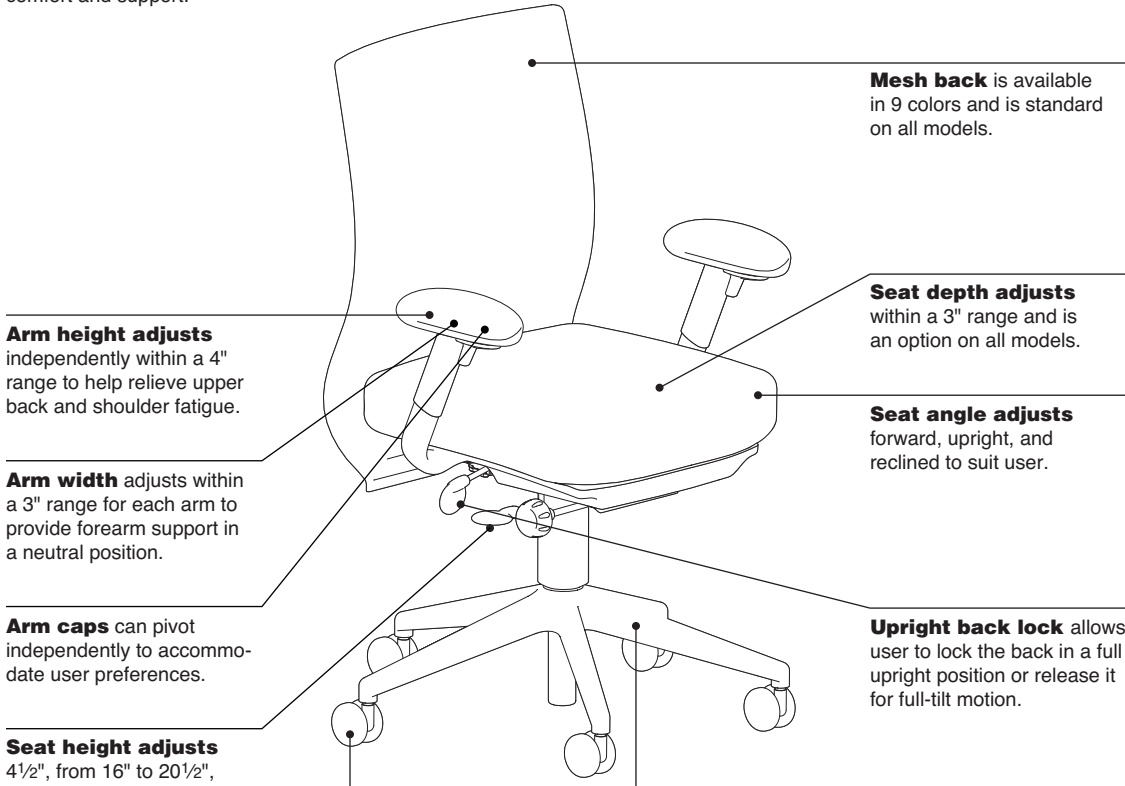

Mesh back is available in 9 colors and is standard on all models.

Seat depth adjusts within a 3" range and is an option on all models.

Seat angle adjusts forward, upright, and reclined to suit user.

Upright back lock allows user to lock the back in a full upright position or release it for full-tilt motion.

Five-arm base is plastic on 6205 Black frame models. Base is aluminum on 4799 Platinum models.

Casters have hard, dual-wheels that roll smoothly on carpets. They are 2½" for increased mobility. Soft, dark grey treaded, dual-wheel roll-control casters are available for use on hard floors or mats.
Tip: Do not roll the chair across asphalt during installation as this may damage the casters.

Arm height adjusts independently within a 4" range to help relieve upper back and shoulder fatigue.

Arm width adjusts within a 3" range for each arm to provide forearm support in a neutral position.

Arm caps can pivot independently to accommodate user preferences.

Seat height adjusts 4½", from 16" to 20½", with a pneumatic adjustment mechanism.

Product Details



Jersey work chairs are available armless, with fixed arms, with height and maintenance width-adjustable arms, and with height-, width-, and pivot-adjustable arms.

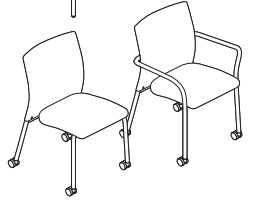
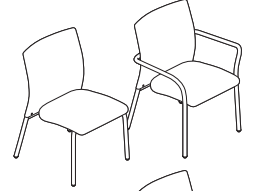

Multi-use chairs are available with or without arms and with or without casters.

Arm cap styles depend on the arm adjustment selected.

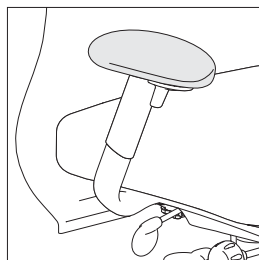

Arm cap on height-, width-, and pivot-adjustable arms.

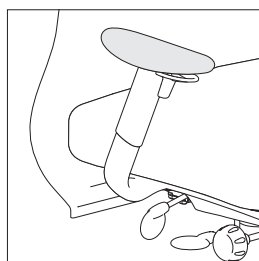

Arm cap on fixed height and maintenance-width-adjustable arms.

Stackability for the Jersey guest chair is four high on the floor. Models with arms are 24¹/₄"W x 28¹/₂"D x 42¹/₂"H. Models without arms are 20⁵/₈"W x 28¹/₂"D x 42¹/₂"H. If stacking dimensions are intended for an enclosure, add 2" to the width and depth, and 1" to the height for clearance.

Adjustment Features

Seat Adjustments

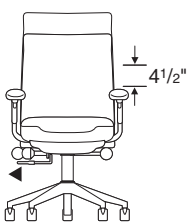

Seat height adjusts pneumatically. To raise chair, lift body weight up, and pull lever up. To lower chair, remain seated and pull lever up.



Seat angle adjustment. Pull lever back and hold, shift seat to desired angle, and release lever to lock.

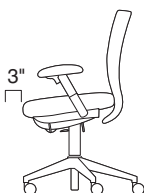

Seat depth adjustment. Pull lever forward and hold, shift seat forward or back, and release lever to lock.

Back Adjustments

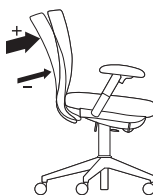

Back tension adjustment. To decrease tension, turn counterclockwise. To increase tension, turn clockwise.



Upright back lock. To release, lean forward and pull toward back. To lock, lean forward and push toward front.

Arm Adjustments

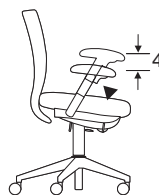

Arm height. Pull trigger up and hold, pull arm up or push down, and release trigger to lock.

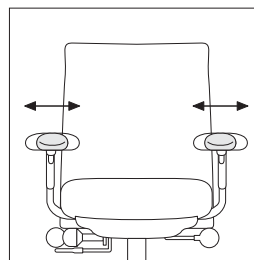

Arm width on rounded telescoping height, width, and pivot arm. Grasp arm caps and move in or out. Arm will stay where positioned.

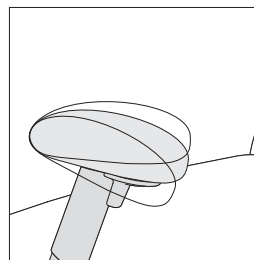

Arms pivot independently, 30° inward and outward. Grasp arm and push front to left or right.

Maintenance arm width adjustment. Loosen and remove screws, slide arm bracket in. Replace and tighten screws.

Surface Materials

► See surface materials on page 504 for specific availability or refer to the *Surface Materials Reference Manual* for further information.

Upholstery

- Mesh on back standard
- Fabric or leather on seat

Hard components

- (base, arms, plastic arm caps, outer seat)
- Black

Platinum frame

- (base and arm uprights) available as an option

Arms

- Black

All Steelcase seating with standard upholstery fabrics

complies with requirements of the State of California Technical Bulletin 117-2013. All standard seating is labeled to be in compliance with California 117-2013.

Programs & Services

▶ See the *Surface Materials Reference Manual* for further detail about programs and services offered for seating.

The Customer's Own Material (COM) Program

offers the opportunity for customers to select fabrics that are not offered through the standard Steelcase surface materials program for use on Steelcase products. Through the COM program, Steelcase will test your materials for application on Steelcase products. Once approved, you can place your order. Steelcase will facilitate the entire ordering process and give you a production schedule. Steelcase will order the COM fabric directly from the textile manufacturer. For up-to-date information regarding fabric test results for all COM fabrics and details regarding yardage requirements for most Seating lines, visit the COM website. To locate the COM website:

- Visit www.steelcase.com

Dimensions

▶ Page 178

Resources

Printed Materials

▶ Jersey Brochure (04-0000161)

Audiovisual Materials

▶ User Guide available on www.steelcase.com

Online Resources

▶ Environmental profiles available on www.steelcase.com/sustainability.

Shipping

Jersey chairs are cartoned assembled only. Uncartoned shipments are not available.

Dimensions

Jersey Series

Features	Overall Depth	Width	Height	Functional Seat Depth	Seat Width	Seat Height from Floor	Back Width	Back Height from Seat
----------	---------------	-------	--------	-----------------------	------------	------------------------	------------	-----------------------

Jersey Series

Work Chairs

Pneumatic	25"	26 ¹ / ₄ "	35 ¹ / ₂ "–40"	17"*	20"	16"–20 ¹ / ₂ "	20"	18"
-----------	-----	----------------------------------	--------------------------------------	------	-----	--------------------------------------	-----	-----

Multi-Use Chairs

4-Leg with Arms	24"	24"	32 ¹ / ₄ "	17"	17 ¹ / ₂ "	17 ¹ / ₂ "	19"	15 ¹ / ₂ "
4-Leg Armless	24"	17 ¹ / ₂ "	32 ¹ / ₄ "	17"	17 ¹ / ₂ "	17 ¹ / ₂ "	19"	15 ¹ / ₂ "

*Models with seat depth adjustment measures 16³/₄"–20".

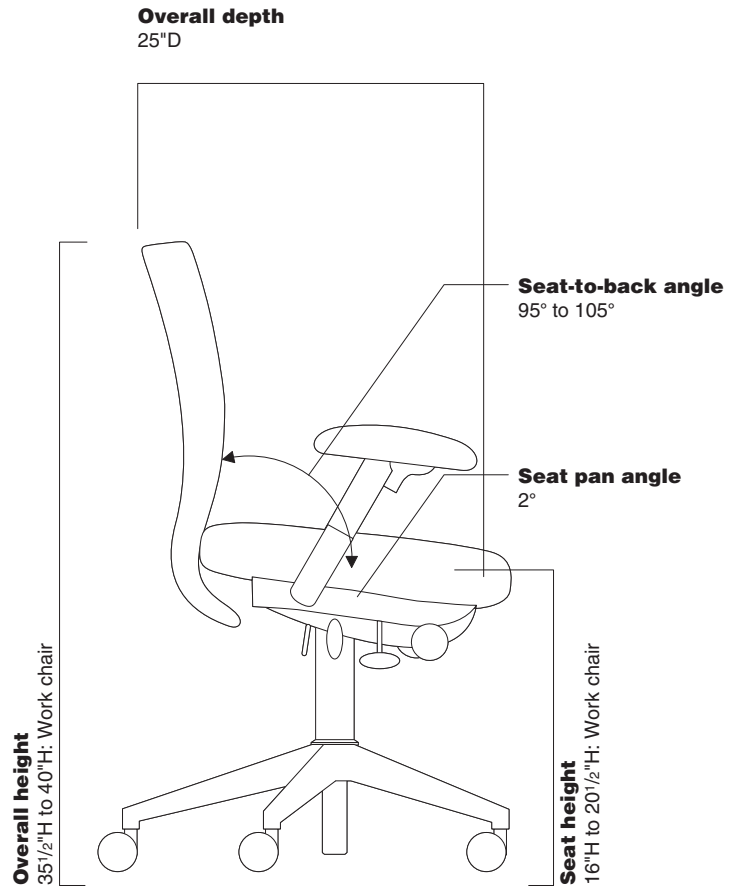
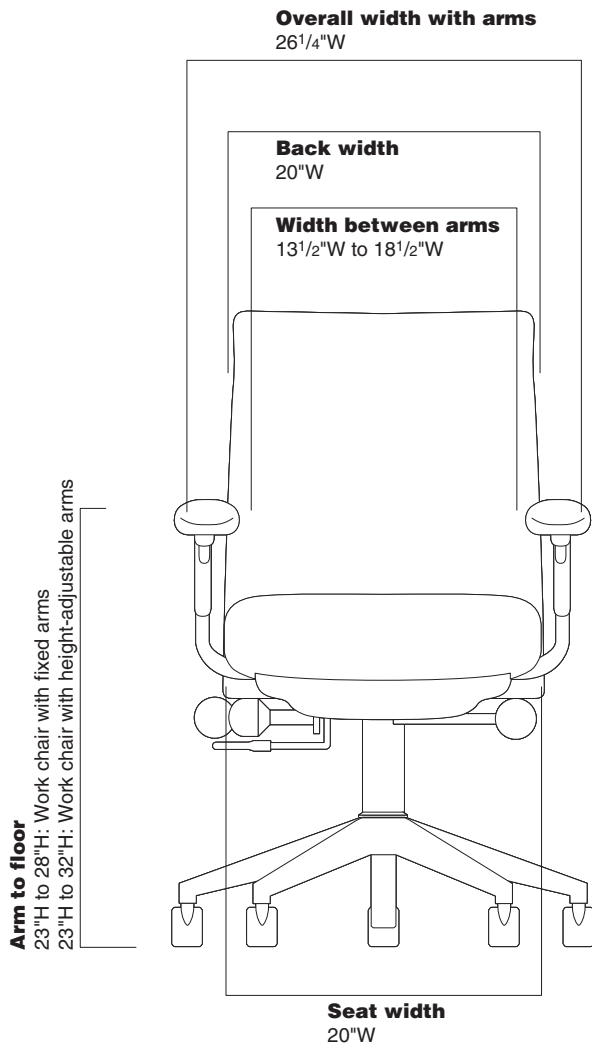

• Width • Between • Arms	• Arm to • Floor • Fixed • Arm	• Arm to • Floor • Height Adj • Arm	• Arm • Height • from Seat • Fixed Arm	• Arm • Height • from Seat • Adj-Height • Arm	• Arm Cap • Pivot • Range	• Seat • Pan • Angle	• Angle • Between • Seat and • Back
--------------------------------	---	--	---	---	---------------------------------	----------------------------	--

Work Chairs

13½"–18½"	23"–28"	23"–32"	9"	7"–11"	30°	2°	95°–105°
-----------	---------	---------	----	--------	-----	----	----------

Multi-Use Chairs

21⅝"	25½"	N.A.	7½"	N.A.	N.A.	2°	N.A.
N.A.	N.A.	N.A.	N.A.	N.A.	N.A.	N.A.	N.A.

Jersey Series Value Package Work Chair T

Black Mesh on Back with Buzz2 Fabric on Seat

Black Plastic Finish on Frame



Tip: This value package allows you to obtain the pre-selected features at a lower price than if specifying as a standard model number.

Tip: Options or substitutions are not available on this value package.

Standard Includes	Required to Specify
-------------------	---------------------

- | | |
|--|--|
| <ul style="list-style-type: none"> ▶ Need help? Product details, page 174 | <ul style="list-style-type: none"> • Deluxe synchro-tilt mechanism: provides seat depth and seat angle • Pneumatic seat-height adjustment • Upright back lock • Tilt tension • Back: T084 Black mesh • Seat: Buzz2 fabric • Height-, width-, and pivot-adjustable arms • Frame: black plastic • 2½" diameter, hard composition, dual-wheel casters: black |
| | <ul style="list-style-type: none"> 1 Style number 2 Buzz2 fabric color number ▶ See <i>Surface Materials</i>, page 504. |

Specification Information	
• Style Number	• U.S. Price
JERSEYV T	\$1136
:	:
:	:

▶ Detailed dimensions, page 178



For Canadian Pricing

Multiply U.S. Price by the Canadian price factor.

▶ See page 1 for details.

T = Transitional product

Jersey Series Work Chair



Standard Includes	Required to Specify
<ul style="list-style-type: none"> ▶ Need help? Product details, page 174 • Synchro-tilt mechanism • Pneumatic height adjustment • Upright back lock • Tilt tension • Back: mesh • Seat: fabric • Five-arm base: reinforced black plastic • 2½" diameter, hard composition, dual-wheel casters: black 	<ol style="list-style-type: none"> 1 Style number 2 Mesh color number for back 3 Fabric color number for seat 4 Options, if selected (see below) <ul style="list-style-type: none"> ▶ See <i>Surface Materials</i>, page 504.

Tip: Leather, Elmosoft leather, COL, vinyl, and COM vinyl materials require a **S** suffix.

Options	U.S. Price	Required to Specify
Surface Materials <ul style="list-style-type: none"> • Jersey black fabric • Fabric price group 1 • Fabric price group 2 • Fabric price group 3 • Fabric price group 4 • Fabric price group 5 • Fabric price group 6 • Fabric price group 7 • Fabric price group 8 • Fabric price group 9 • Fabric price group 10 • Jersey black leather • Steelcase leather upholstery • Select Surfaces leather price group 1 • Elmosoft leather upholstery • Select Surfaces leather price group 2 • Steelcase vinyl • Customer's Own Material (COM) • Customer's Own Leather (COL) • Customer's Own Material/Vinyl (COM-Sewn) 	No cost No cost +\$ 10 +\$ 27 +\$ 36 +\$ 43 +\$ 53 +\$ 64 +\$ 79 +\$ 97 +\$112 +\$102 +\$176 +\$176 +\$203 +\$203 +\$ 10 No cost No cost No cost	Specify <i>with 5011</i> . Specify fabric color number. Specify fabric color number. Specify fabric color number. Specify fabric color number. Specify fabric color number. Specify fabric color number. Specify fabric color number. Specify fabric color number. Specify fabric color number. Specify fabric color number. Add suffix S to the style number and specify <i>with L225</i> . Add suffix S to the style number and specify leather color number. Add suffix S to the style number and specify Select Surfaces leather price group 1. ▶ See <i>Surface Materials Reference Manual</i> . Add suffix S to the style number and specify Elmosoft leather color number. Add suffix S to the style number and specify Select Surfaces leather price group 2. ▶ See <i>Surface Materials Reference Manual</i> . Add suffix S to the style number and specify vinyl color number. ▶ See <i>Surface Materials Reference Manual</i> . Add suffix S to the style number and specify leather color number. Add suffix S to the style number and specify vinyl color number.
Frame and Base <ul style="list-style-type: none"> • 4799 Platinum frame with aluminum base 	+\$ 89	Specify <i>with 4799 Platinum</i> .
Seating Mechanism <ul style="list-style-type: none"> • Deluxe synchro-tilt mechanism: provides seat depth and seat angle 	+\$ 98	Specify <i>with deluxe synchro-tilt mechanism</i> .
Fixed-Height Arms <ul style="list-style-type: none"> • Fixed-height, maintenance width-adjustable arms 	+\$109	Specify <i>with fixed-height, maintenance width-adjustable arms</i> .
Height-Adjustable Arms <ul style="list-style-type: none"> • Height- and maintenance width-adjustable arms 	+\$135	Specify <i>with height- and maintenance width-adjustable arms</i> .
Height-, Width-, and Pivot-Adjustable Arms <ul style="list-style-type: none"> • Height-, width-, and pivot-adjustable arms 	+\$159	Specify <i>with height-, width-, and pivot-adjustable arms</i> .
Castors <ul style="list-style-type: none"> • Soft, dark grey treaded, dual-wheel roll-control casters for use on hard floors 	+\$ 27	Specify <i>with soft roll-control casters</i> .

Tip: Arms, if specified, will match frame color (7207 Black standard, 4799 Platinum optional).

▶ Detailed dimensions, page 178



For Canadian Pricing
Multiply U.S. Price by the Canadian price factor.

▶ See page 1 for details.

Specification Information

• **Style**
• **Number**
•
• **U.S.**
• **Base**
• **Price**

TS38301 ⓘ \$946



Jersey Series



For Canadian Pricing

Multiply U.S. Price by the Canadian price factor.

▶ See page 1 for details.

ⓘ = Transitional product

Jersey Series Multi-Use Chairs

Multi-Use Chair, Fabric, with Glides

Tip: Arms, if specified, will match frame color (7207 Black standard, 4799 Platinum optional).

	Standard Includes	Required to Specify
▶ Need help? Product details, page 174	<ul style="list-style-type: none"> • Back: mesh • Seat: fabric • Arms, if selected: black • Steel four-leg frame: black • Glides: black plastic 	1 Style number 2 Mesh color number for back 3 Fabric color number for seat 4 Options, if selected (see below) ▶ See <i>Surface Materials</i> , page 504.

Tip: Leather, Elmosoft leather, COL, vinyl, and COM vinyl materials require a **S** suffix.

	Options	U.S. Price	Required to Specify
Surface Materials	Seat Upholstery		
	• Jersey black fabric	No cost	Specify with 5011.
	• Fabric price group 1	No cost	Specify fabric color number.
	• Fabric price group 2	+\$ 10	Specify fabric color number.
	• Fabric price group 3	+\$ 27	Specify fabric color number.
	• Fabric price group 4	+\$ 36	Specify fabric color number.
	• Fabric price group 5	+\$ 43	Specify fabric color number.
	• Fabric price group 6	+\$ 53	Specify fabric color number.
	• Fabric price group 7	+\$ 64	Specify fabric color number.
	• Fabric price group 8	+\$ 79	Specify fabric color number.
• Fabric price group 9	+\$ 97	Specify fabric color number.	
• Fabric price group 10	+\$112	Specify fabric color number.	
• Jersey black leather	+\$102	Specify fabric color number.	
• Steelcase leather upholstery	+\$176	Add suffix S to the style number and specify with L225.	
• Select Surfaces leather price group 1	+\$176	Add suffix S to the style number and specify leather color number.	
• Elmosoft leather upholstery	+\$203	Add suffix S to the style number and specify Select Surfaces leather price group 1.	
• Select Surfaces leather price group 2	+\$203	▶ See <i>Surface Materials Reference Manual</i> . Add suffix S to the style number and specify Elmosoft leather color number.	
• Steelcase vinyl	+\$ 10	Add suffix S to the style number and specify Select Surfaces leather price group 2.	
• Customer's Own Material (COM)	No cost	▶ See <i>Surface Materials Reference Manual</i> . Add suffix S to the style number and specify vinyl color number.	
• Customer's Own Leather (COL)	No cost	▶ See <i>Surface Materials Reference Manual</i> . Add suffix S to the style number and specify leather color number.	
• Customer's Own Material/Vinyl (COM-Sewn)	No cost	Add suffix S to the style number and specify vinyl color number.	
Frame	• 4799 Platinum aluminum frame	+\$ 59	Specify with 4799 Platinum.

▶ Detailed dimensions, page 178



For Canadian Pricing

Multiply U.S. Price by the Canadian price factor.

▶ See page 1 for details.

 = Transitional product

Specification Information

• Style	• U.S. Base
• Number	• Price



With Arms

TS38304 	\$585
--	-------



Without Arms

TS38305 	\$537
--	-------

Jersey Series



For Canadian Pricing

Multiply U.S. Price by the Canadian price factor.

▶ See page 1 for details.

 = Transitional product

Multi-Use Chair, Fabric, with Casters **T**

Tip: Arms, if specified, will match frame color (7207 Black standard, 4799 Platinum optional).

Standard Includes	Required to Specify
<ul style="list-style-type: none"> ▶ Need help? Product details, page 174 • Back: mesh • Seat: fabric • Arms, if selected: black • Steel four-leg frame: black • 2½" diameter, hard composition, dual-wheel casters: black 	<ul style="list-style-type: none"> 1 Style number 2 Mesh color number for back 3 Fabric color number for seat 4 Options, if selected (see below) ▶ See <i>Surface Materials</i>, page 504.

Options	U.S. Price	Required to Specify
<p>Surface Materials</p> <ul style="list-style-type: none"> • Jersey black fabric • Fabric price group 1 • Fabric price group 2 • Fabric price group 3 • Fabric price group 4 • Fabric price group 5 • Fabric price group 6 • Fabric price group 7 • Fabric price group 8 • Fabric price group 9 • Fabric price group 10 • Jersey black leather • Steelcase leather upholstery • Select Surfaces leather price group 1 • Elmosoft leather upholstery • Select Surfaces leather price group 2 • Steelcase vinyl • Customer's Own Material (COM) • Customer's Own Leather (COL) • Customer's Own Material/Vinyl (COM-Sewn) 	<ul style="list-style-type: none"> No cost No cost +\$ 10 +\$ 27 +\$ 36 +\$ 43 +\$ 53 +\$ 64 +\$ 79 +\$ 97 +\$112 +\$102 +\$176 +\$176 +\$203 +\$203 +\$ 10 No cost No cost No cost 	<ul style="list-style-type: none"> Specify <i>with 5011</i>. Specify fabric color number. Specify fabric color number. Specify fabric color number. Specify fabric color number. Specify fabric color number. Specify fabric color number. Specify fabric color number. Specify fabric color number. Specify fabric color number. Specify fabric color number. Add suffix S to the style number and specify <i>with L225</i>. Add suffix S to the style number and specify leather color number. Add suffix S to the style number and specify Select Surfaces leather price group 1. ▶ See <i>Surface Materials Reference Manual</i>. Add suffix S to the style number and specify Elmosoft leather color number. Add suffix S to the style number and specify Select Surfaces leather price group 2. ▶ See <i>Surface Materials Reference Manual</i>. Add suffix S to the style number and specify vinyl color number. ▶ See <i>Surface Materials Reference Manual</i>. Add suffix S to the style number and specify leather color number. Add suffix S to the style number and specify vinyl color number.
<p>Frame</p> <ul style="list-style-type: none"> • 4799 Platinum aluminum frame 	<ul style="list-style-type: none"> +\$ 59 	<ul style="list-style-type: none"> Specify <i>with 4799 Platinum</i>.
<p>Casters</p> <ul style="list-style-type: none"> • Soft dual-wheel casters for use on hard floors 	<ul style="list-style-type: none"> +\$ 27 	<ul style="list-style-type: none"> Specify <i>with soft casters</i>.

Tip: Leather, Elmosoft leather, COL, vinyl, and COM vinyl materials require a **S** suffix.

▶ Detailed dimensions, page 178

 **For Canadian Pricing**
 Multiply U.S. Price by the Canadian price factor.
 ▶ See page 1 for details.

T = Transitional product

Specification Information

• Style	• U.S. Base
• Number	• Price

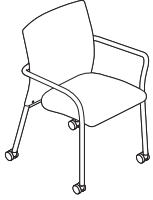

With Arms

TS38308 	\$640
--	-------

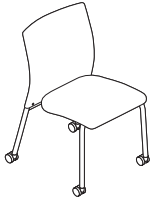

Without Arms

TS38309 	\$596
--	-------

Jersey Series



For Canadian Pricing
Multiply U.S. Price by the
Canadian price factor.
▶ See page 1 for details.

 = Transitional product

Understanding and Specifying Leap 464 Series WorkLounge Work Chairs

Product Details

Leap 464 Series WorkLounge	190
Dimensions	192

Specifying

WorkLounge and Ottoman	194
------------------------	-----

Work Chairs

Highly adjustable task seating offers maximum personalization for fit and comfort for a range of duration and use. By making a series of simple adjustments, you can customize the chair to your body, preferences, and tasks. These chairs provide continuous, stable, comfort, and can be quickly adjusted to support you in upright, and reclining work postures.

- Gesture 442 Series
- Leap 462 Series
- Think 465 Series
- Amia 482 Series
- Reply 466 Series
- Jersey Series
- Leap 464 Series WorkLounge
- Criterion 453 Series

Adjustability Features

► See page 22 for a comparison to other chairs.

Leap 464 Series

Mechanisms

Natural glide	●
---------------	---

Seat Adjustments

Pneumatic height	●
------------------	---

Back Adjustments

Lower back firmness	●
---------------------	---

Upper back tension	●
--------------------	---

Variable back stop	●
--------------------	---

Headrest with flip-up pillow	●
------------------------------	---

Leap 464 Series WorkLounge

WorkLounge—a chair designed especially for people who like to work in a deep, reclined posture.

Outer back is fully upholstered.

Ribbon back frame is standard.

Lower back firmness changes the amount of firmness user feels in lower back. Requires only two complete turns.

Upper back force requires only five complete turns and accommodates a broader range of users by allowing user to change the rate of increase in force as the user reclines.

Variable back stop with five positions is standard.

Seat height adjusts within a 3" range with a pneumatic adjustment mechanism.

Ottoman quickly and easily converts from a footrest to an auxiliary work or laptop table.

Work table, with top up, is 25"H from the floor.

Headrest and flip-up pillow provide neck and head support.

LiveBack moves with the shape of the user's spine as sitting positions change.

Fixed arms have extra padding to provide forearm support and comfort.

Lumbar pillow provides extra comfort and support to the lumbar region.

Extra thick seat cushion provides extra comfort.

Five-arm base is standard with glides. 3" hard or soft casters are available as options.
Tip: Do not roll the chair across asphalt during installation as this may damage the casters.

Polished aluminum is standard on ribbon back frame, arm supports, base, and casters.

Footrest is cushioned and upholstered. Footrest surface is 15"H from the floor.

Polished aluminum is standard on post and four-arm base.

Four-arm base is standard with two glides and two hard, dual-wheel casters.

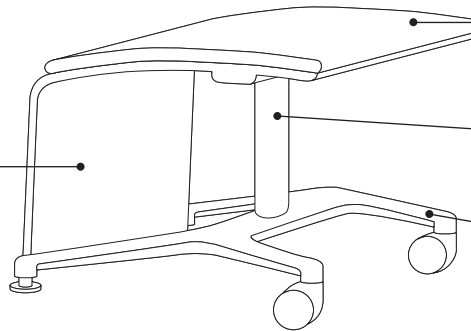
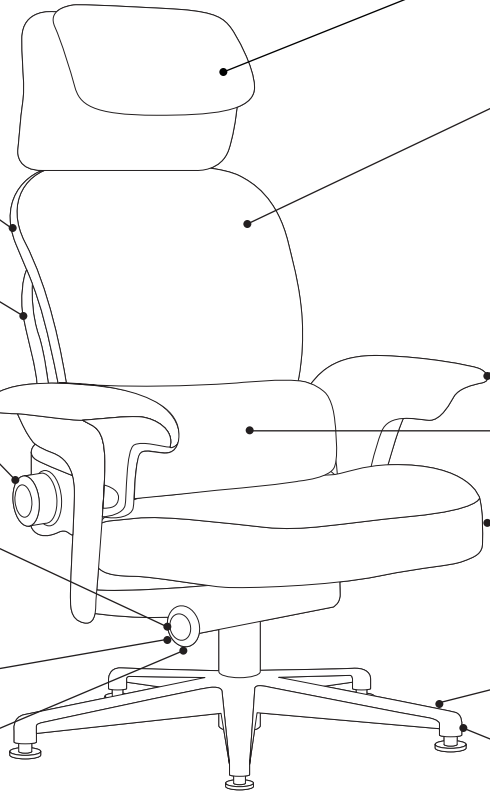

Product Details

Adjustability instructions are included with every chair and ottoman.

Controls under the seat include tactile braille designators.

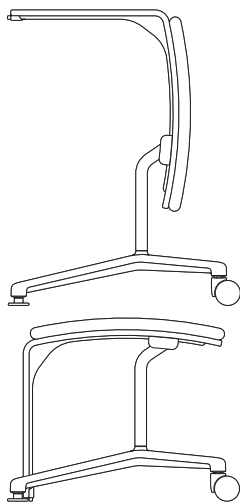

Ottoman easily converts between two positions. With the top up, it is a work or lap-top table; with the top down it is a footrest. Locking pivot mechanism holds each position in place.

Adjustment Features

Seat Adjustments

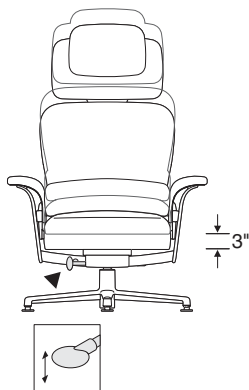

Seat height adjusts pneumatically. To lower, hold handle up while seated. To raise, hold handle up and keep your weight off the chair. This feature is standard. Range of adjustability is 3" from 15"H–18"H with standard glides and 17"H–20"H with optional casters.

Back Adjustments

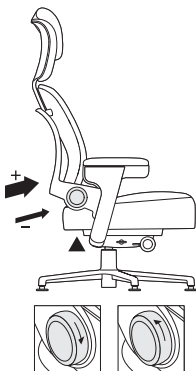

Lower back firmness adjusts by turning knob two complete turns. Forward increases firmness. Backward decreases firmness. This feature is standard.

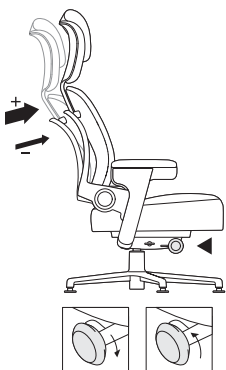

Upper back force adjusts by turning knob five complete turns. Turn knob forward to increase rate of tension; backward to decrease. This feature is standard.

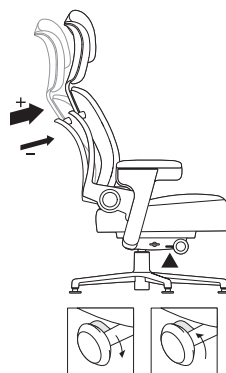

Variable back stop. Rotate handle up or down to set recline angle. Lean back to desired back angle. Five stops are available. This feature is standard.
Tip: To stop in upright position, remove weight from back and rotate lever up.

Other Features

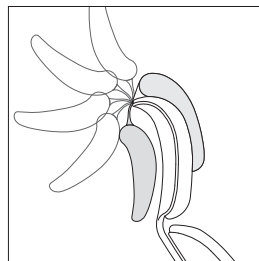

Flip-up pillow can be positioned for use on headrest or placed over the backside of headrest when not in use. This feature is standard.

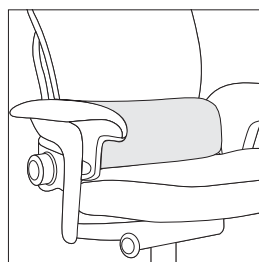

Lumbar pillow is positioned to provide comfort and support to the lumbar region.

Glides are standard.

Casters are optional. 3" polished aluminum hard- or soft-wheel casters are available.

Surface Materials

▶ See surface materials on page 504 for specific availability or refer to the *Surface Materials Reference Manual* for further information.

Upholstery

- Bo Peep fabric
- Elmorustical Leather
- Elmosoft Leather
- Select Surfaces leather

Hard components

- (Seat shell and glides)
- 6205 Black

Polished aluminum

is standard on chair and ottoman. Polished aluminum is applied to ribbon back frame, arm supports, base, and casters of chair. Ottoman has polished aluminum on post and base.

Programs & Services

▶ See the *Surface Materials Reference Manual* for further detail about programs and services offered for seating.

The Customer's Own Material (COM & COL) Program

offers the opportunity for customers to select fabrics and leather that are not offered through the standard Steelcase surface materials program for use on Steelcase products. Avoid pattern fabrics and heavily grained leathers. Through the COM & COL program, Steelcase will test your materials for application on Steelcase products. Once approved, you can place your order. Steelcase will facilitate the entire ordering process and give you a production schedule. Steelcase will order the COM & COL fabric and leather directly from the textile manufacturer. For up-to-date information regarding fabric test results for all COM & COL fabrics and details regarding yardage requirements for most Seating lines, visit the COM website. To locate the COM website:

- Visit www.steelcase.com

Dimensions

▶ Page 192

Resources

Printed Materials

- ▶ Leap Brochure (11-0002334)
- ▶ Humantech Case Study (03-0003715)
- ▶ Leap Productivity and Health Impact Study (03-0003716)

Online Resources

- ▶ Interactive User Guide available on www.steelcase.com
- ▶ Leap mini-site (download) available on village.steelcase.com or viewable on www.steelcase.com.
- ▶ Model sales conversation available on village.steelcase.com
- ▶ Leap User Guide available on www.steelcase.com
- ▶ Adjustability video available on www.steelcase.com
- ▶ Leap White Paper Packet available on village.steelcase.com
- ▶ Environmental profiles available on www.steelcase.com/sustainability.

Dimensions

Leap 464 Series

Features	Overall Depth	Width	Height	Seat Depth	Functional Seat Depth	Seat Width	Seat Height from Floor	Back Width	Back Height from Seat
Leap 464 Series									
WorkLounge									
	26 1/2"	31 1/2"	43 1/2" to 46 1/2" with glides 45 1/2" to 48 1/2" with casters	20 1/2"	18 1/2"	19"	14 1/2" to 17 1/2" with glides 16 1/2" to 19 1/2" with casters	20 1/2"	30"
Ottoman									
	19"	18 1/2"	15"	N.A.	N.A.	16 3/4"	15"	N.A.	N.A.

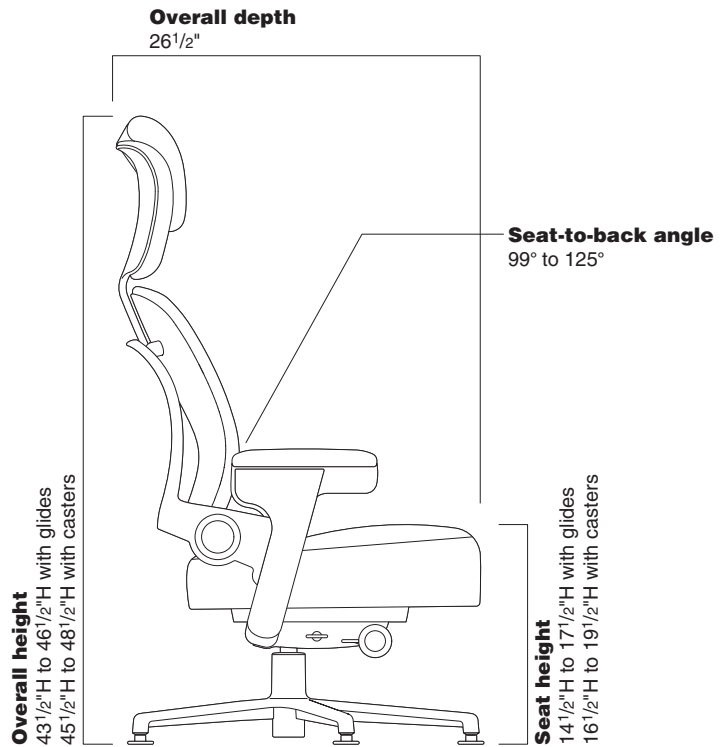
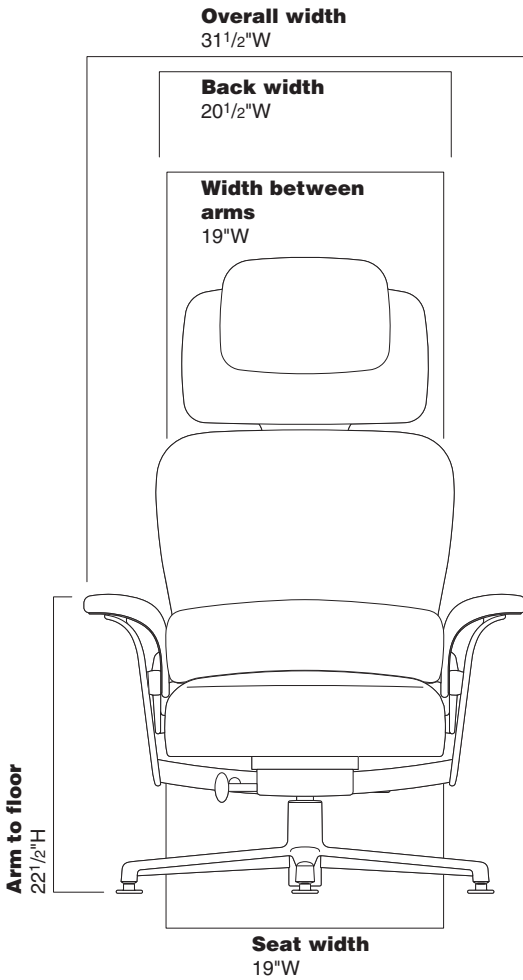

Lumbar Flex Zone	Width Between Arms	Arm to Floor	Arm Height from Seat	Angle Between Seat and Back	Table Height from Floor
------------------	--------------------	--------------	----------------------	-----------------------------	-------------------------

WorkLounge

5¼" to 10¼"	19"	22½"	7¼"	99°–125°	N.A.
-------------	-----	------	-----	----------	------

Ottoman

N.A.	N.A.	N.A.	N.A.	N.A.	25"
------	------	------	------	------	-----

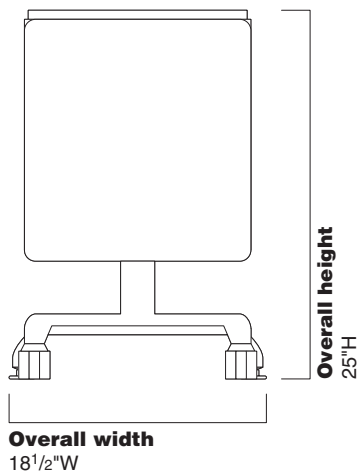
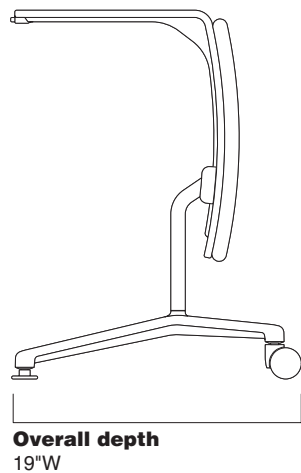
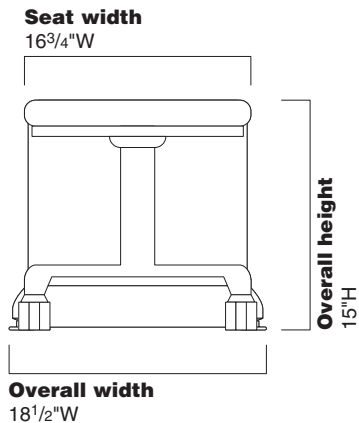
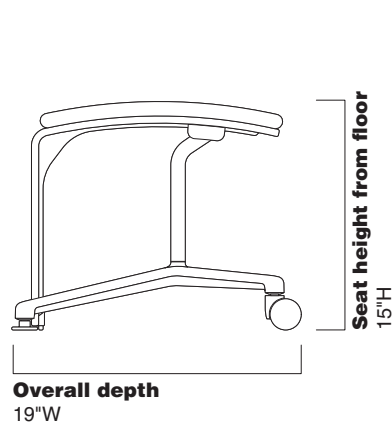

Leap 464 Series WorkLounge and Ottoman

Leap 464 Series WorkLounge

Ribbon Back Frame

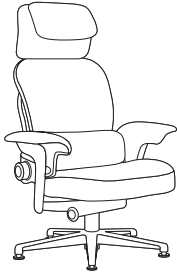

	Standard Includes	Required to Specify
<p>► Need help? Product details, page 190</p>	<ul style="list-style-type: none"> Fully upholstered back, seat, arms, headrest, and flip-up pillow: Bo Peep fabric Upper back force Variable back stop Lower back firmness Lumbar pillow Fixed, non-adjustable arms 3" pneumatic seat-height adjustment Seat and back components: black plastic only Ribbon back frame, arm supports and five-arm base: polished aluminum only Glides: black with stainless steel inserts. 	<ol style="list-style-type: none"> Style number Fabric color number for upholstery on back, seat, arms, headrest, and flip-up pillow Options, if selected (see below) <ul style="list-style-type: none"> ► See <i>Surface Materials</i>, page 504.

	Options	U.S. Price	Required to Specify
Surface Materials	• Bo Peep	No cost	Specify Bo Peep fabric color number. ► See <i>Surface Materials</i> , page 504.
	• Elmorustical Leather	+\$691	Specify with 59DK and leather color number. ► See <i>Surface Materials</i> , page 504.
	• Elmosoft Leather	+\$691	► See <i>Surface Materials</i> , page 504.
	• Select Surfaces leather price group 2	+\$691	► See <i>Surface Materials Reference Manual</i> .
	• Customer's Own Material (COM)	+\$ 38	► See <i>Surface Materials Reference Manual</i> to specify.
	• Customer's Own Leather (COL)	+\$ 38	► See <i>Surface Materials Reference Manual</i> to specify.
Casters	• 3" hard-composition, dual-wheel casters for use on carpet: polished aluminum and black	+\$ 72	Specify with hard casters.
	• 3" soft, dual-wheel casters for use on hard floors: polished aluminum and black	+\$ 72	Specify with soft casters.

Specification Information

Style Number	U.S. Base Price
464LOUNGE	\$3933
.	.
.	.

► Detailed dimensions, page 192



For Canadian Pricing

Multiply U.S. Price by the Canadian price factor.

► See page 1 for details.

Leap 464 Series Ottoman



Standard Includes		Required to Specify
<ul style="list-style-type: none"> ▶ Need help? Product details, page 190 	<ul style="list-style-type: none"> • Upholstery on footrest: Bo Peep fabric • Work table and footrest shell: black plastic only • Post and four-arm base: polished aluminum • Two glides: black with stainless steel inserts • Two 2"-diameter, hard-composition, dual-wheel casters: black 	<ul style="list-style-type: none"> 1 Style number 2 Fabric color number for upholstery on footrest 3 Options, if selected (see below) ▶ See <i>Surface Materials</i>, page 504.

Options	U.S. Price	Required to Specify
Surface Materials		
• Bo Peep	No cost	Specify Bo Peep fabric color number. ▶ See <i>Surface Materials</i> , page 504.
• Elmorustical Leather	+\$158	Specify with 59DK and leather color number. ▶ See <i>Surface Materials</i> , page 504.
• Elmosoft Leather	+\$158	▶ See <i>Surface Materials</i> , page 504.
• Select Surfaces leather price group 2	+\$158	▶ See <i>Surface Materials Reference Manual</i> .
• Customer's Own Material (COM)	+\$ 38	▶ See <i>Surface Materials Reference Manual</i> to specify.
• Customer's Own Leather (COL)	+\$ 38	▶ See <i>Surface Materials Reference Manual</i> to specify.

Specification Information

• Style Number	• U.S. Base Price
464OTTOMAN	\$1174

▶ Detailed dimensions, page 192



For Canadian Pricing

Multiply U.S. Price by the Canadian price factor.

▶ See page 1 for details.

Understanding and Specifying Siento 499 Series Work Chairs

Product Details

Siento 499 Series	198
Dimensions	198

Specifying

Design Package High-Back Executive Chair	200
Executive Desk Chairs	202

Adjustability Features

▶ See page 22 for a comparison to other chairs.

**Siento
499
Series**

Mechanisms

Synchro-tilt ●

Seat Adjustments

Pneumatic height ●

Passive seat edge angle ●

Back Adjustments

Back tension ●

Upright back lock ●

Siento 499 Series

Siento desk chairs, designed in collaboration with Jorge Pensi, merge remarkable ergonomic comfort with a slim and sophisticated executive form.

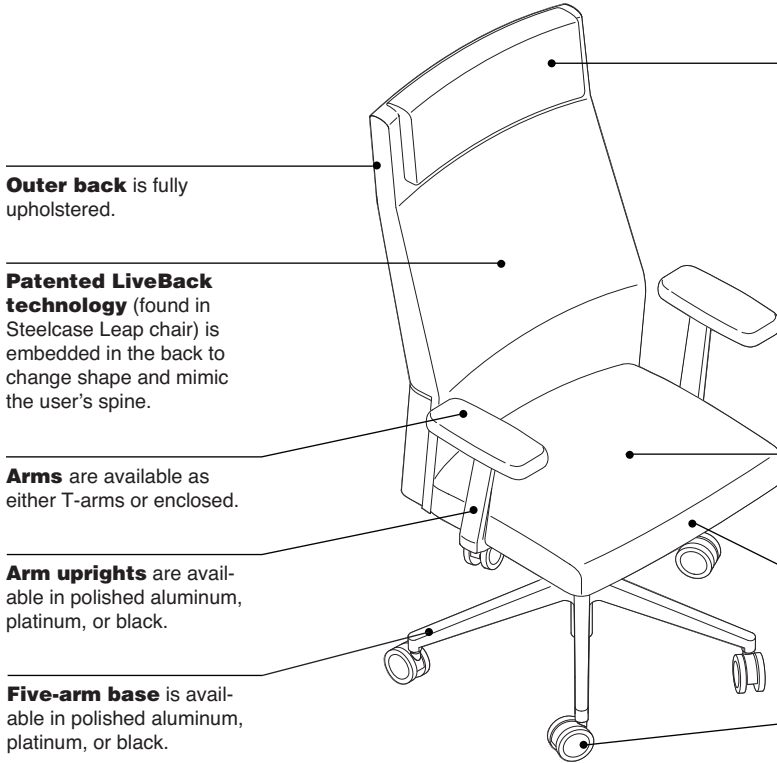

Outer back is fully upholstered.

Patented LiveBack technology (found in Steelcase Leap chair) is embedded in the back to change shape and mimic the user's spine.

Arms are available as either T-arms or enclosed.

Arm uprights are available in polished aluminum, platinum, or black.

Five-arm base is available in polished aluminum, platinum, or black.

Headrest option provides additional head and neck support.

Seat height adjusts from 16" to 21" and is standard with pneumatic adjustment mechanism. Fixed-height option is also available.

Front seat edge flexes naturally to relieve pressure under the user's thighs.

3"- hard dual-wheel casters are provided for use on carpet. Soft dark grey treaded, dual-wheel roll-casters are available for use on hard floors or mats. *Tip: Do not roll the chair across asphalt during installation as this may damage the casters.*

Adjustability Features

- Pneumatic seat-height
- Upright back lock
- Back tension control
- Synchro-tilt mechanism

Product Details

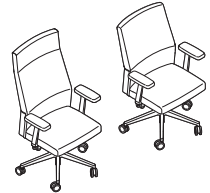

High-back and mid-back desk chairs are available.



Arms are available as T-arms or enclosed. Fixed T-arms are available in urethane or fully upholstered. Adjustable T-arms are available in urethane only. Enclosed arms are always fully upholstered.

All Siento chairs comply with ANSI/HFS and BIFMA standards.

Actual Dimensions

	High-Back Desk Chairs with Headrest	High-Back Desk Chairs without Headrest	Mid-Back Desk Chairs
Overall depth	26"	26"	26"
Overall width—outside of T-arms	27½"	27½"	27½"
Overall width—outside of enclosed arms	29½"	29½"	29½"
Overall height	46¾"–51¾"	46"–51"	40"–45"
Seat depth	17½"	17½"	17½"
Seat width	21"	21"	21"
Back height from seat	31½"	30"	24"
Width between arms	20½"	20½"	20½"
Arm height from seat	8"	8"	8"
Angle between back and seat	100° to 114°	100° to 114°	100° to 114°

Adjustment Features

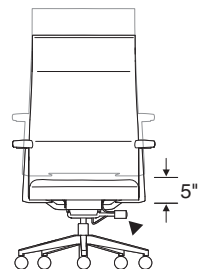

Seat height adjusts pneumatically. To lower, hold handle up while seated. To raise, hold handle up and keep your weight off the chair. Standard range of adjustability is 5" from 16"H to 21"H.

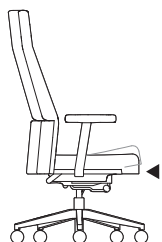

Seat edge flexes, relieving pressure under the user's thighs.

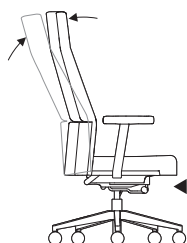

Upright back lock. Flick switch forward to lock; flick switch back to tilt.



Back tension control adjusts by turning knob. Turn knob forward to increase rate of tension, backward to decrease.

Synchro-tilt mechanism provides synchronized back movement while feet remain flat on the floor.

Height-, width-, pivot-, and depth-adjustable arms are available on select models of chairs.

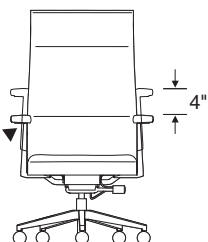

Arm height adjusts independently within a range of 4" (7"-11" from the seat). Push button on outside and under arm cap in while moving arms up or down. Releasing buttons locks arms in position.

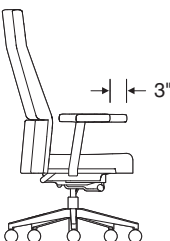

Arm depth adjusts by sliding arm caps back 3". Friction-fit mechanism keeps arms in position.

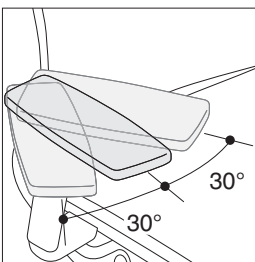

Arms pivot independently, 30° inward and outward

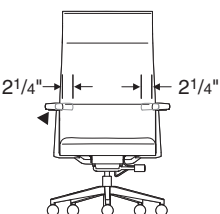

Arm width can be adjusted 2 1/4" each, 4 1/2" overall. Grasp arm cap and move in or out.

Surface Materials

Upholstery

- Fabric
- Fabric with soil-retardant treatment (option)
- Elmosoft leather
- Select Surfaces leather
- COM
- COL

Arms

- Black urethane T-arms
- Upholstered T-arms
- Enclosed upholstered arms

Column

- Black only

Base

- 0835 Black
- 4799 Platinum
- 8046 Polished Aluminum

Casters

- Black wheels with black body on black or platinum base
- Black wheels with polished aluminum body on polished aluminum base

All Steelcase seating with standard upholstery fabrics complies with requirements of the State of California Technical Bulletin 117-2013. All standard seating is labeled to be in compliance with California 117-2013.

Programs & Services

▶ See the *Surface Materials Reference Manual* for further detail about programs and services offered for seating.

The Customer's Own Material (COM & COL) Program

offers the opportunity for customers to select fabrics and leather that are not offered through the standard Steelcase surface materials program for use on Steelcase products.

Avoid pattern fabrics and heavily grained leathers. Through the COM & COL program, Steelcase will test your materials for application on Steelcase products. Once approved, you can place your order. Steelcase will facilitate the entire ordering process and give you a production schedule. Steelcase will order the COM & COL fabric and leather directly from the textile manufacturer. For up-to-date information regarding fabric test results for all COM & COL fabrics and details regarding yardage requirements for most Seating lines, visit the COM website. To locate the COM website:

- Visit www.steelcase.com

Soil retardants are treatments that provide long-term soil and stain resistance to a fabric without affecting the shade or the integrity of the fabric. The following Steelcase Textiles are available pre-treated with soil retardant. (You do not need to select the soil-retardant option for these fabrics and incur the upcharge.)

- Jacks
- Link
- Spyder

For information on soil retardant fabrics on Select Surfaces, please refer to the *Surface Materials Reference Manual*.

Soil-retardant treatment is available on all other seating fabrics at an additional upcharge per seating unit. To order this option, please select "Soil-Retardant Treatment" under "Optional Accessories."

For soil-retardant treatment on COMs, please select "Soil-Retardant Treatment" under "Optional Accessories." Minimums or additional yardage may be required. Please contact the vendor directly for specific information.

Extended lead times may be necessary for this service.

Contact your Steelcase Solutions Fulfillment Team Representative at 1.888.STEELCASE (1.888.783.3522) or send an e-mail to lineone@steelcase.com.

Local codes may have special requirements for upholstery.

Resources

Siento Brochure
Form number 06-0001282

Online Resources

- ▶ Siento User Guide available on www.steelcase.com
- ▶ Environmental profiles available on www.steelcase.com/sustainability.

Siento 499 Series Design Package High-Back Executive Chair



Tip: This design package allows you to obtain the pre-selected features at a lower price than if specifying as a standard model number.

Tip: Options or substitutions are not available on this design package.

Standard Includes	Required to Specify
-------------------	---------------------

- | | | |
|---|--|--|
| <p>▶ Need help? Product details, page 198</p> | <ul style="list-style-type: none"> • Back tension control • 5" pneumatic seat-height adjustment • Upright back lock • Fully upholstered outer back • Front seat edge flex • LiveBack Technology • T-arms: upholstered • Headrest • Upholstery: Elmosoft leather • Five-arm base and arm supports: 8046 Polished Aluminum • Column: black only • 3"-diameter, hard composition, dual-wheel aluminum casters: black wheels with polished aluminum body | <ul style="list-style-type: none"> 1 Style number 2 Elmosoft leather color number <p>▶ See <i>Surface Materials</i>, page 504.</p> |
|---|--|--|

Specification Information	
• Style • Number	• U.S. • Price

499SIENTO	\$3331
-----------	--------

▶ Detailed dimensions, page 198



For Canadian Pricing

Multiply U.S. Price by the Canadian price factor.

▶ See page 1 for details.

Siento 499 Series Executive Desk Chairs



Tip: When a black or platinum painted base is specified, the casters will be black. When a polished aluminum base is specified, the casters will have black wheels with polished aluminum body.

Standard Includes	Required to Specify
-------------------	---------------------

- | | | |
|--|---|---|
| <ul style="list-style-type: none"> ▶ Need help? Product details, page 198 | <ul style="list-style-type: none"> • Back tension control • 5" pneumatic seat-height adjustment • Upright back lock • Front seat edge flex • LiveBack Technology • Fully upholstered outer back • Adjustable arms, if selected: soft black urethane • T-arms, if selected: soft black urethane • Enclosed arms, if selected: fully upholstered • Upholstery: fabric price group 1 • Five-arm base and arm supports: paint or Polished Aluminum • Column: black only • 3"-diameter, hard-composition, dual-wheel casters: black | <ol style="list-style-type: none"> 1 Style number 2 Paint color number for base and arm supports 3 Fabric color number for upholstery 4 Options, if selected (see below) <p>▶ See <i>Surface Materials</i>, page 504.</p> |
|--|---|---|

Options	U.S. Price	Required to Specify
---------	------------	---------------------

Surface Materials	Upholstery		
	<ul style="list-style-type: none"> • Fabric price group 1 • Fabric price group 2 • Fabric price group 3 • Fabric price group 4 • Fabric price group 5 • Fabric price group 6 • Fabric price group 7 • Fabric price group 8 • Fabric price group 9 • Fabric price group 10 • Customer's Own Material (COM) • Customer's Own Leather (COL) 	<ul style="list-style-type: none"> • Steelcase leather upholstery • Select Surfaces leather price group 1 • Elmosoft leather • Select Surfaces leather price group 2 	<ul style="list-style-type: none"> • Sewn upholstery • Soil-retardant treatment applied to upholstery fabric
	T-arms		
	<ul style="list-style-type: none"> • Fully upholstered T-arms 		
	Base and casters		
	<ul style="list-style-type: none"> • 0835 Black base and black casters • 4799 Platinum base and black casters 		
	Seat Height		
	<ul style="list-style-type: none"> • 18" fixed seat height 		
	Headrest		
	<ul style="list-style-type: none"> • Headrest on high-back chairs only 		
	Casters		
	<ul style="list-style-type: none"> • Soft, dark grey treaded, dual-wheel roll-control casters for use on hard floors 		



▶ Detailed dimensions, page 198

Tip: Fully upholstered option is available on fixed T-arm style numbers only.

Tip: When the standard polished aluminum base is specified along with adjustable T-arms, you must specify the finish for arm uprights in either 6205 Black or 6249 Platinum.



Tip: When base and adjustable T-arms are specified in 4799 Platinum, the arm upright will be in 4799 Platinum and the lower section of the arm will be in 6205 Black.

Specification Information

	Fixed T-Arms		Enclosed Upholstered Arms		Adjustable T-Arms	
						
Description	Style Number	U.S. Base Price	Style Number	U.S. Base Price	Style Number	U.S. Base Price

High-Back Chairs

Painted Base	499211	\$1937	499212	\$2191	499213	\$2237
Polished Aluminum Base	499221	\$2320	499222	\$2574	499223	\$2620

	Fixed T-Arms		Enclosed Upholstered Arm		Adjustable T-Arms	
						
Description	Style Number	U.S. Base Price	Style Number	U.S. Base Price	Style Number	U.S. Base Price

Mid-Back Chairs

Painted Base	499111	\$1809	499112	\$2063	499113	\$2109
Polished Aluminum Base	499121	\$2192	499122	\$2446	499123	\$2492

Siento 499 Series



For Canadian Pricing

Multiply U.S. Price by the Canadian price factor.

▶ See page 1 for details.

Understanding and Specifying Criterion 453 Series Work Chairs

Work Chairs

Highly adjustable task seating offers maximum personalization for fit and comfort for a range of duration and use. By making a series of simple adjustments, you can customize the chair to your body, preferences, and tasks. These chairs provide continuous, stable, comfort, and can be quickly adjusted to support you in upright, and reclining work postures.

- Gesture 442 Series
- Leap 462 Series
- Think 465 Series
- Amia 482 Series
- Reply 466 Series
- Jersey Series
- Leap 464 Series WorkLounge
- Criterion 453 Series

Adjustability Features

► See page 22 for a comparison to other chairs.

	Criterion 453	Criterion Plus Series
--	----------------------	------------------------------

Mechanisms

Advanced swivel tilt	●	●
----------------------	---	---

Seat Adjustments

Pneumatic height	●	●
------------------	---	---

Seat angle	●	●
------------	---	---

Seat depth	●	●
------------	---	---

Back Adjustments

Lumbar height	●	●
---------------	---	---

Back tension	●	●
--------------	---	---

Variable back stop	●	
--------------------	---	--

Upright back lock		●
-------------------	--	---

Back height	●	●
-------------	---	---

Arm Adjustments

Arm height	●	●
------------	---	---

Arm width	●	●
-----------	---	---

Arm pivot	●	
-----------	---	--

Other Features

Foot ring height on stool	●	
---------------------------	---	--

Product Details

Criterion 453 Series	206
Criterion Upholstery	209
Dimensions	210

Specifying

High-Back Work Chairs	212
Mid-Back Work Chairs	214
High-Back Stools	216
Mid-Back Stools	218
Plus High-Back Work Chairs	220

Criterion 453 Series

Criterion is a high-performance chair, ideal for users who sit for long periods of time. As one of the world's best-selling chairs with a broad range of adjustments, Criterion meets the long-term comfort needs of today's diverse workforce.

Outer back and outer seat is plastic. Fully upholstered outer back is an option.

Arm height adjusts independently within a 4" range to help relieve upper back and shoulder fatigue.

Seat depth adjusts within a 3" range and is available as an option.

Seat height adjusts within a 5" range with a pneumatic adjustment mechanism.

Five-arm base is standard.

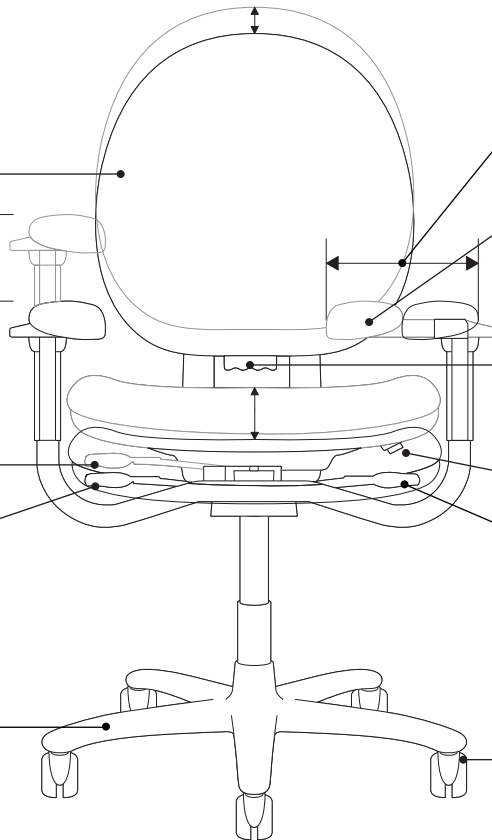

Arm width adjusts within a 4" range for each arm to provide forearm support in neutral position for 5th to 95th percentile office workers.

Arm caps can pivot independently 14° in and 21° out to accommodate individual user preferences.

Back height adjusts up and down within a 2" range to help ensure healthful back posture.

Variable back stop is standard.

Seat angle adjusts forward, upright, and reclined to suit user. Seat angle is standard.

Casters have hard, dual-wheels that roll smoothly on carpets. They are 2 1/8" diameter for increased mobility. Soft, dual-wheel casters are available for use on hard floors or chair mats.
Tip: Do not roll the chair across asphalt during installation as this may damage the casters.

Product Details



Three basic sizes are available—high-back, mid-back, and Plus. All are offered with and without arms. High-back and mid-back are also available as stools.

Criterion features a seat angle adjustment which allows the seat angle to function in a fixed or articulating mode. Variable back stop will lock the back in an upright position or allow the user to set a specific back stop position which the chair will recline to.

Criterion Plus has an upright back lock and offers a wider seat with more space between the arms to accommodate workers who need a larger chair. The Criterion Plus chair is tested to hold up to 400 pounds under normal use.

Upholstery Details



Criterion is standard with a molded upholstered seat and back.



Sewn upholstery can be specified to accommodate vinyl and other high-performance fabrics. Seat and back cushions feature a stitched detail. Specify using an **S** suffix.



Non-sewn seat upholstery can be specified to accommodate vinyl and other high-performance fabrics without a seam on the seat. Back cushion will have stitched detail. Specify using an **X** suffix. This option is available on models with adjustable seat depth only.

Adjustment Features

Seat Adjustments

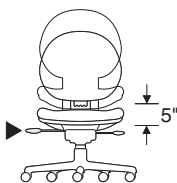

Seat height adjusts pneumatically. To lower, hold handle up while seated. To raise, hold handle up and keep your weight off the chair. Range of adjustability is 5" from 16"H to 21"H.

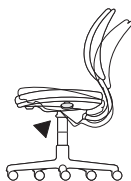

Seat angle adjusts by pulling handle up and shifting your weight to alter seat angle. Release handle to lock. This feature is standard.

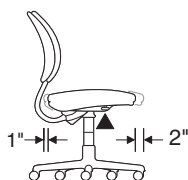

Seat depth adjusts by pulling handle up. Slide seat forward or back to accommodate various leg lengths. Release handle to lock. This feature is optional. For Criterion Plus, seat depth is a maintenance adjustment. The chair has three depth settings: 15", 16⁵/₈", and 18¹/₄". The chair will ship in the 18¹/₄" position.

Back Adjustments

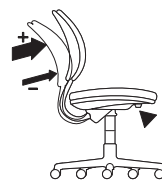

Back tension adjusts by turning knob. Turn knob clockwise to increase tension, counterclockwise to decrease. This feature is standard.

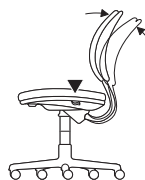

Variable back stop. Hold switch forward to recline. Lean back to desired back angle. Release switch to set tilt range.

Tip: To lock in upright position, remove weight from back and release switch.

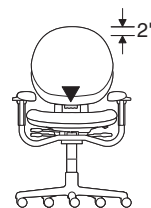

Back height adjusts within a 2" range by pulling handle forward while moving chair back up or down. Release handle to lock chair back in position. This feature is standard.

Arm Adjustments

Arms are available fixed, height- and width-adjustable, and height-, width-, and pivot-adjustable.

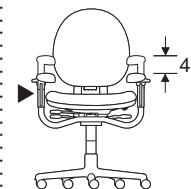

Arm height adjusts independently within a range of 4" on all adjustable arm models. Squeeze triggers in while moving arms up or down. Releasing triggers locks arms in position.

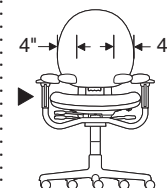

Arm width adjusts independently on chairs with the height- and width-adjustable option. Grasp arm and move in or out. Arm will stay where positioned.

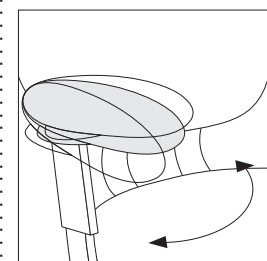

Arms pivot independently on models with height-, width-, and pivot-adjustable arms, 35° inward and outward. Grasp arm and push front to left or right.

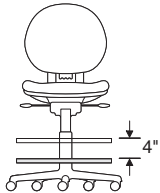
Other Features

Foot ring height on stools adjusts by first lifting ring and rotating it counter-clockwise to unlock. Then raise or lower ring up to 4" to desired position before rotating it clockwise to lock.

Alternative casters and glides are available for specific applications, including soft-wheel casters for hard floors.

Glides are 2"H and interchangeable with casters.

Surface Materials

▶ See surface materials on page 504 for specific availability or refer to the *Surface Materials Reference Manual* for further information.

Upholstery

- Fabric
- Fabric with soil-retardant treatment (option)
- Leather
- Elmosoft leather
- Select Surfaces leather
- Vinyl

Hard components

(base, arms, plastic arm caps, outer back, outer seat, and foot ring)

- Monochromatic color from list of seating plastic color numbers will apply to all hard components.

Outer back and outer seat

- Plastic color to match color of other "hard components"
- Fully upholstered outer back with plastic color outer seat

Arms

- Soft vinyl arm caps to match the plastic color of the other "hard components"

Casters

- Plastic color to match other "hard components"

Foot ring on stools

- Plastic color to match other "hard components"
- 9201 Polished Chrome

Glides

- Stainless steel only

All Steelcase seating with standard upholstery fabrics complies with requirements of the State of California Technical Bulletin 117-2013. All standard seating is labeled to be in compliance with California 117-2013.

Programs & Services

▶ See the *Surface Materials Reference Manual* for further detail about programs and services offered for seating.

The Customer's Own Material (COM) Program

offers the opportunity for customers to select fabrics that are not offered through the standard Steelcase surface materials program for use on Steelcase products. Through the COM program, Steelcase will test your materials for application on Steelcase products. Once approved, you can place your order. Steelcase will facilitate the entire ordering process and give you a production schedule. Steelcase will order the COM fabric directly from the textile manufacturer. For up-to-date information regarding fabric test results for all COM fabrics and details regarding yardage requirements for most Seating lines, visit the COM website. To locate the COM website:

- Visit www.steelcase.com

Soil retardants are treatments that provide long-term soil and stain resistance to a fabric without affecting the shade or the integrity of the fabric. The following Steelcase Textiles are available pre-treated with soil retardant. (You do not need to select the soil-retardant option for these fabrics and incur the upcharge.)

- Jacks
- Link
- Spyder

For information on soil retardant fabrics on Select Surfaces, please refer to the *Surface Materials Reference Manual*.

Soil-retardant treatment is available on all other seating fabrics at an additional upcharge per seating unit. To order this option, please select "Soil-Retardant Treatment" under "Optional Accessories."

For soil-retardant treatment on COMs, please select "Soil-Retardant Treatment" under "Optional Accessories." Minimums or additional yardage may be required. Please contact the vendor directly for specific information.

Extended lead times may be necessary for this service.

Contact your Steelcase Solutions Fulfillment Team Representative at 1.888.STEELCASE (1.888.783.3522) or send an email to line-one@steelcase.com.

Dimensions

▶ Page 210

Resources**Printed Materials**

▶ Criterion Brochure (10-000305)

Online Resources

▶ Adjustability video available on www.steelcase.com

▶ User Guide available on www.steelcase.com

▶ Environmental profiles available on www.steelcase.com/sustainability.

Criterion Upholstery

What Is It?

Fabric, leather, or vinyl-covered back and seat.

Fabric

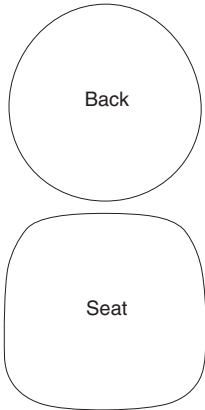

Criterion is standard with a molded upholstered seat and back.

Leather, Vinyl, and Select Fabrics

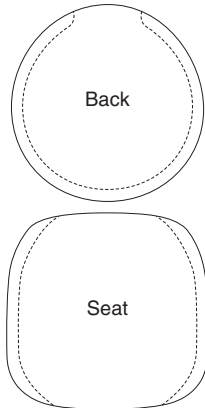

Sewn upholstery can be specified to accommodate vinyl and other high-performance fabrics. Seat and back cushions feature a stitched detail.

- Specify using an **S** suffix.
- Plus models come standard with sewn upholstery.

Non-Sewn Seat

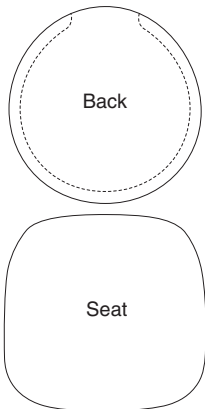

Non-Sewn Seat upholstery can be specified to accommodate vinyl and other high-performance fabrics without a seam on the seat. Back cushion will have stitched detail.

- Specify using an **X** suffix.
- Available only on models with adjustable seat depth.

Pattern alignment at the lumbar seam cannot be guaranteed.

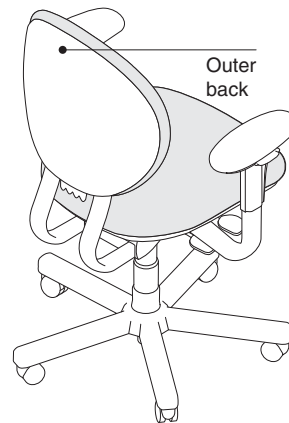
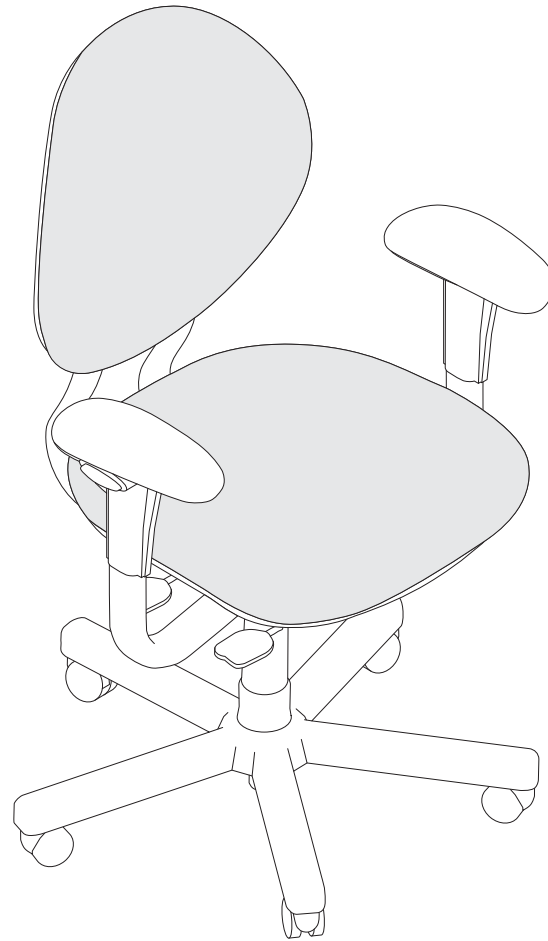

Plastic outer back is fully exposed. Fully upholstered outer back with plastic colored outer seat is available. Plus models are only available with a fully upholstered outer back.

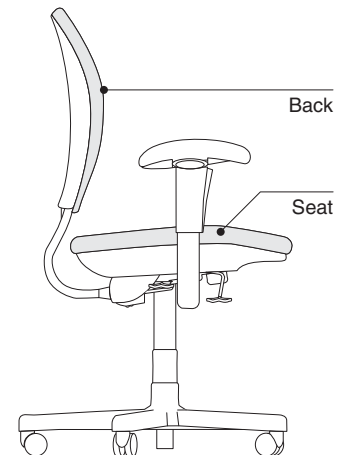

Seat and back cushions can be removed and replaced if damaged.

Dimensions

Criterion 453 Series

Features	Overall Depth	Width	Height	Seat Depth	Functional Seat Depth	Seat Width	Seat Height from Floor	Ring Height from Floor	Back Width	Back Height from Seat
----------	---------------	-------	--------	------------	-----------------------	------------	------------------------	------------------------	------------	-----------------------

Criterion 453 Series

High-Back Work Chairs

22 1/2"–25 1/2"	27 1/2"	37 1/2"–44 1/2"	19 1/2"	16 1/4"*	19 1/2"	16"–21"	N.A.	18"	22"–24"
-----------------	---------	-----------------	---------	----------	---------	---------	------	-----	---------

Mid-Back Work Chairs

22 1/2"–25 1/2"	27 1/2"	34"–41"	19 1/2"	16 1/4"*	19 1/2"	16"–21"	N.A.	18"	19 1/2"–21 1/2"
-----------------	---------	---------	---------	----------	---------	---------	------	-----	-----------------

High-Back Stools

22 1/2"–25 1/2"	27 1/2"	46"–53"	19 1/2"	16 1/4"*	19 1/2"	25"–30"	8 3/4"–12 3/4"	18"	22"–24"
-----------------	---------	---------	---------	----------	---------	---------	----------------	-----	---------

Mid-Back Stools

22 1/2"–25 1/2"	27 1/2"	43"–50"	19 1/2"	16 1/4"*	19 1/2"	25"–30"	8 3/4"–12 3/4"	18"	19 1/2"–21 1/2"
-----------------	---------	---------	---------	----------	---------	---------	----------------	-----	-----------------

Plus High-Back Work Chairs

22 1/2"–25 1/2"	31 1/2"	38"–45"	19 3/4"	18 1/4"***	23"	17"–22"	N.A.	22"	23"–25"
-----------------	---------	---------	---------	------------	-----	---------	------	-----	---------

* Models with adjustable seat depth 15 1/4"–18 1/4". ** Plus models with adjustable seat depth require a maintenance adjustment, see page 207.

Overall width

27 1/2"W: Criterion
31 1/2"W: Criterion Plus

Back width

18"W: Criterion
22"W: Criterion Plus

Width between arms

20"W: Fixed and height-adjustable arms
12"W to 20"W: Width-adjustable arms
10 3/4"W to 18 1/4"W: Height-, width-, and pivot-adjustable arms
15 1/2"W to 23 1/2"W: Criterion Plus

Overall depth

22 1/2"D to 25 1/2"D

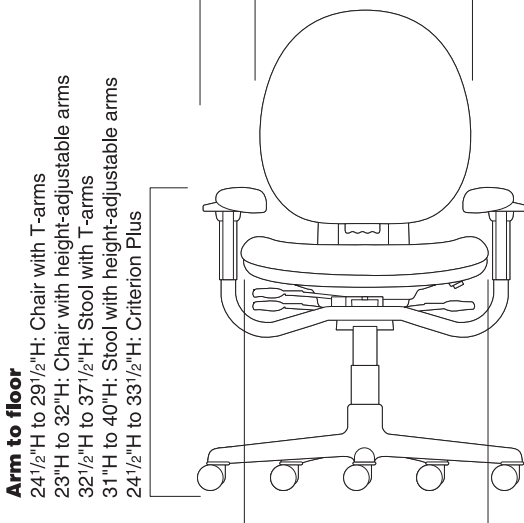

Arm to floor
24 1/2"H to 29 1/2"H: Chair with T-arms
23"H to 32"H: Chair with height-adjustable arms
32 1/2"H to 37 1/2"H: Stool with T-arms
31"H to 40"H: Stool with height-adjustable arms
24 1/2"H to 33 1/2"H: Criterion Plus

Seat width
19 1/2"W: Criterion
23"W: Criterion Plus

Overall height

34"H to 41"H: Mid-back chair
37 1/2"H to 44 1/2"H: High-back chair
43"H to 50"H: Mid-back stool
46"H to 53"H: High-back stool
38"H to 45"H: Criterion Plus

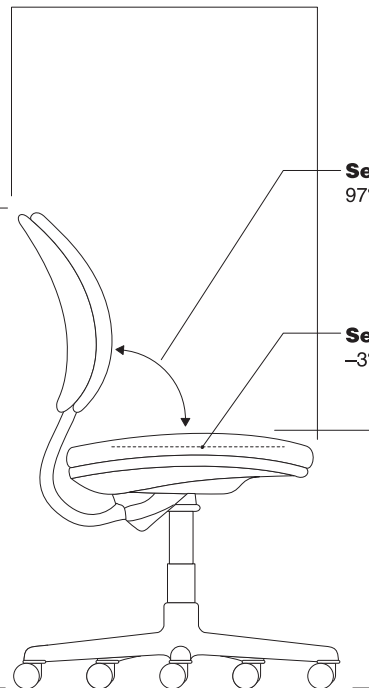

Seat-to-back angle
97° to 113°

Seat pan angle
–3° to 8°

Seat height
16"H to 21"H: High back and mid back
25"H to 30"H: Stool
17"H to 22"H: Criterion Plus

• Back Lumbar Height	• Width Between Fixed-Height Arms	• Width Between Height- and Width-Adjustable Arms	• Width Between Height-, Width-, and Pivot-Adjustable Arms	• Arm to Floor	• Arm Height from Seat	• Arm Cap Pivot Range	• Seat Pan Angle	• Angle Between Seat and Back
----------------------	-----------------------------------	---	--	----------------	------------------------	-----------------------	------------------	-------------------------------

High-Back Work Chairs

8"	20"	12"-20"	10 ³ / ₄ "-18 ¹ / ₄ "	23"-32"	7"-11"	35°	-3°- 8°	97°-113°
----	-----	---------	---	---------	--------	-----	---------	----------

Mid-Back Work Chairs

8"	20"	12"-20"	10 ³ / ₄ "-18 ¹ / ₄ "	23"-32"	7"-11"	35°	-3°- 8°	97°-113°
----	-----	---------	---	---------	--------	-----	---------	----------

High-Back Stools

8"	20"	12"-20"	10 ³ / ₄ "-18 ¹ / ₄ "	31"-40"	7"-11"	35°	-3°- 8°	97°-113°
----	-----	---------	---	---------	--------	-----	---------	----------

Mid-Back Stools

8"	20"	12"-20"	10 ³ / ₄ "-18 ¹ / ₄ "	31"-40"	7"-11"	35°	-3°- 8°	97°-113°
----	-----	---------	---	---------	--------	-----	---------	----------

Plus High-Back Work Chairs

9"	23 ¹ / ₂ "	15 ¹ / ₂ "-23 ¹ / ₂ "	N.A.	24 ¹ / ₂ "-33 ¹ / ₂ "	7 ¹ / ₂ "-11 ¹ / ₂ "	N.A.	1°- 10°	97°-113°
----	----------------------------------	---	------	---	--	------	---------	----------

Criterion 453 Series High-Back Work Chairs

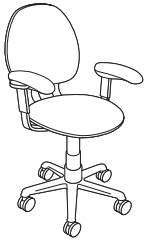

Tip: Always add suffixes in alphabetical order when specifying options to Criterion seating.

Tip: Non-sewn seat upholstery (**X** suffix) is available only on models with adjustable seat depth (**D** suffix).

Standard Includes	Required to Specify
<ul style="list-style-type: none"> ▶ Need help? Product details, page 206 • Back height adjustment • Seat angle adjustment • Variable back stop • Back tension adjustment • Arms, if selected: plastic color to match base • Outer back and outer seat: plastic color • Upholstery: fabric price group 1 • Five-arm base: plastic color • 2½"-diameter, hard composition, dual-wheel casters: black plastic 	<ol style="list-style-type: none"> 1 Style number 2 Plastic color number for base, outer back, outer seat, and arms 3 Fabric color number for upholstery 4 Options, if selected (see below) <p>▶ See <i>Surface Materials</i>, page 504.</p>

Options	U.S. Price	Required to Specify
<p>Surface Materials</p> <ul style="list-style-type: none"> • Fabric price group 1 • Fabric price group 2 • Fabric price group 3 • Fabric price group 4 • Fabric price group 5 • Fabric price group 6 • Fabric price group 7 • Fabric price group 8 • Fabric price group 9 • Fabric price group 10 • Sewn upholstery • Steelcase leather upholstery • Select Surfaces leather price group 1 • Elmosoft leather upholstery • Select Surfaces leather price group 2 • Steelcase vinyl • Non-sewn seat upholstery • Customer's Own Material (COM) • Customer's Own Leather (COL) • Customer's Own Material/Vinyl (COM-Sewn) • Soil-retardant treatment applied to upholstery fabric 	<p>No cost</p> <p>+\$ 27</p> <p>+\$ 49</p> <p>+\$ 70</p> <p>+\$ 88</p> <p>+\$109</p> <p>+\$125</p> <p>+\$158</p> <p>+\$194</p> <p>+\$219</p> <p>+\$ 54</p> <p>+\$696</p> <p>+\$696</p> <p>+\$804</p> <p>+\$804</p> <p>+\$ 81</p> <p>+\$ 99</p> <p>No cost</p> <p>+\$441</p> <p>+\$ 54</p> <p>+\$ 27</p>	<p>Specify fabric color number.</p> <p>Specify fabric color number.</p> <p>Specify fabric color number.</p> <p>Specify fabric color number.</p> <p>Specify fabric color number.</p> <p>Specify fabric color number.</p> <p>Specify fabric color number.</p> <p>Specify fabric color number.</p> <p>Specify fabric color number.</p> <p>Specify fabric color number.</p> <p>Add suffix S to the style number.</p> <p>Add suffix S to the style number and specify leather color number.</p> <p>Add suffix S to the style number and specify Select Surfaces leather price group 1.</p> <p>▶ See <i>Surface Materials Reference Manual</i>. Add suffix S to the style number and specify Elmosoft leather color number.</p> <p>Add suffix S to the style number and specify Select Surfaces leather price group 2.</p> <p>▶ See <i>Surface Materials Reference Manual</i>. Add suffix S to the style number and specify vinyl color number.</p> <p>Add suffix X to the style number.</p> <p>▶ See <i>Surface Materials Reference Manual</i> to specify.</p> <p>Add suffix S to the style number and specify leather color number.</p> <p>Add suffix S to the style number.</p> <p>Specify <i>with soil-retardant treatment</i>.</p>
<p>Fully upholstered</p> <ul style="list-style-type: none"> • Outer back 	<p>+\$115</p>	<p>Add suffix B to the style number.</p>
<p>Casters</p> <ul style="list-style-type: none"> • Soft, dual-wheel casters for use on hard floors 	<p>+\$ 27</p>	<p>Specify <i>with soft casters</i>.</p>
<p>Glides</p> <ul style="list-style-type: none"> • Plastic glide with stainless steel cap 	<p>+\$ 27</p>	<p>Specify <i>with GLD453</i>.</p>

▶ Detailed dimensions, page 210

 **For Canadian Pricing**
 Multiply U.S. Price by the Canadian price factor.
 ▶ See page 1 for details.

Specification Information

Height-, Width-, and Pivot-Adjustable Arms



• Style Number
.....
• U.S. Base Price
.....

Height- and Width-Adjustable Arms



• Style Number
.....
• U.S. Base Price
.....

Soft Arm Caps

Pneumatic

4535331P	\$1579	4535331W	\$1677
-----------------	--------	-----------------	--------

Pneumatic with Adjustable Seat Depth

4535331DP	\$1697	4535331DW	\$1795
------------------	--------	------------------	--------

Fixed-Height Arms



• Style Number
.....
• U.S. Base Price
.....

Without Arms



• Style Number
.....
• U.S. Base Price
.....

Pneumatic

4535331	\$1409	4535301	\$1222
----------------	--------	----------------	--------

Pneumatic with Adjustable Seat Depth

4535331D	\$1527	4535301D	\$1340
-----------------	--------	-----------------	--------

 **For Canadian Pricing**
Multiply U.S. Price by the Canadian price factor.
▶ See page 1 for details.

Criterion 453 Series Mid-Back Work Chairs



Tip: Always add suffixes in alphabetical order when specifying options to Criterion seating.

Tip: Non-sewn seat upholstery (X suffix) is available only on models with adjustable seat depth (D suffix).

Standard Includes		Required to Specify	
<ul style="list-style-type: none"> ▶ Need help? Product details, page 206 	<ul style="list-style-type: none"> • Back height adjustment • Seat angle adjustment • Variable back stop • Back tension adjustment • Arms, if selected: plastic color to match base • Outer back and outer seat: plastic color • Upholstery: fabric price group 1 • Five-arm base: plastic color • 2½"-diameter, hard composition, dual-wheel casters: black plastic 	<ol style="list-style-type: none"> 1 Style number 2 Plastic color number for base, outer back, outer seat, and arms 3 Fabric color number for upholstery 4 Options, if selected (see below) 	<ul style="list-style-type: none"> ▶ See <i>Surface Materials</i>, page 504.
Options	U.S. Price	Required to Specify	
Surface Materials	Upholstery		
	• Fabric price group 1	No cost	Specify fabric color number.
	• Fabric price group 2	+\$ 27	Specify fabric color number.
	• Fabric price group 3	+\$ 49	Specify fabric color number.
	• Fabric price group 4	+\$ 70	Specify fabric color number.
	• Fabric price group 5	+\$ 88	Specify fabric color number.
	• Fabric price group 6	+\$109	Specify fabric color number.
	• Fabric price group 7	+\$125	Specify fabric color number.
	• Fabric price group 8	+\$158	Specify fabric color number.
	• Fabric price group 9	+\$194	Specify fabric color number.
	• Fabric price group 10	+\$219	Specify fabric color number.
	• Sewn upholstery	+\$ 54	Add suffix S to the style number.
	• Steelcase leather	+\$696	Add suffix S to the style number and upholstery specify leather color number.
	• Select Surfaces leather price group 1	+\$696	Add suffix S to the style number and specify Select Surfaces leather price group 1.
	• Elmosoft leather upholstery	+\$804	▶ See <i>Surface Materials Reference Manual</i> . Add suffix S to the style number and specify Elmosoft leather color number.
	• Select Surfaces leather price group 2	+\$804	Add suffix S to the style number and specify Select Surfaces leather price group 2.
	• Steelcase vinyl	+\$ 81	▶ See <i>Surface Materials Reference Manual</i> . Add suffix S to the style number and specify vinyl color number.
	• Non-sewn seat upholstery	+\$ 99	Add suffix X to the style number.
	• Customer's Own Material (COM)	No cost	▶ See <i>Surface Materials Reference Manual</i> to specify.
	• Customer's Own Leather (COL)	+\$441	Add suffix S to the style number and specify leather color number.
	• Customer's Own Material/Vinyl (COM-Sewn)	+\$ 54	Add suffix S to the style number.
	• Soil-retardant treatment applied to upholstery fabric	+\$ 27	Specify <i>with soil-retardant treatment</i> .
	Fully upholstered		
	• Outer back	+\$115	Add suffix B to the style number.
Casters	• Soft, dual-wheel casters for use on hard floors	+\$ 27	Specify <i>with soft casters</i> .
Glides	• Plastic glide with stainless steel cap	+\$ 27	Specify <i>with GLD453</i> .

▶ Detailed dimensions, page 210



For Canadian Pricing

Multiply U.S. Price by the Canadian price factor.

▶ See page 1 for details.

Specification Information

Height-, Width-, and Pivot-Adjustable Arms



• Style
• Number
• U.S.
• Base
• Price

Height- and Width-Adjustable Arms



• Style
• Number
• U.S.
• Base
• Price

Soft Arm Caps

Pneumatic

4535330P	\$1510	4535330W	\$1608
-----------------	--------	-----------------	--------

Pneumatic with Adjustable Seat Depth

4535330DP	\$1628	4535330DW	\$1726
------------------	--------	------------------	--------

Fixed-Height Arms



• Style
• Number
• U.S.
• Base
• Price

Without Arms



• Style
• Number
• U.S.
• Base
• Price

Pneumatic

4535330	\$1340	4535300	\$1153
----------------	--------	----------------	--------

Pneumatic with Adjustable Seat Depth

4535330D	\$1458	4535300D	\$1271
-----------------	--------	-----------------	--------

 **For Canadian Pricing**
Multiply U.S. Price by the Canadian price factor.
▶ See page 1 for details.

Criterion 453 Series High-Back Stools



Standard Includes	Required to Specify
<p>▶ Need help? Product details, page 206</p> <ul style="list-style-type: none"> • Back height adjustment • Seat angle adjustment • Variable back stop • Back tension adjustment • Arms, if selected: plastic color to match base • Outer back and outer seat: plastic color • Upholstery: fabric price group 1 • Five-arm base: plastic color • Adjustable foot ring: plastic color • 2 1/8"-diameter, hard composition, dual-wheel casters: black plastic 	<ol style="list-style-type: none"> 1 Style number 2 Plastic color number for base, foot ring, outer back, outer seat, and arms 3 Fabric color number for upholstery 4 Options, if selected (see below) <p>▶ See <i>Surface Materials</i>, page 504.</p>

Options	U.S. Price	Required to Specify
<p>Surface Materials</p> <p>Upholstery</p> <ul style="list-style-type: none"> • Fabric price group 1 • Fabric price group 2 • Fabric price group 3 • Fabric price group 4 • Fabric price group 5 • Fabric price group 6 • Fabric price group 7 • Fabric price group 8 • Fabric price group 9 • Fabric price group 10 • Sewn upholstery • Steelcase leather upholstery • Select Surfaces leather price group 1 • Elmosoft leather upholstery • Select Surfaces leather price group 2 • Steelcase vinyl • Non-sewn seat upholstery • Customer's Own Material (COM) • Customer's Own Leather (COL) • Customer's Own Material/Vinyl (COM-Sewn) • Soil-retardant treatment applied to upholstery fabric <p>Fully upholstered</p> <ul style="list-style-type: none"> • Outer back <p>Height-adjustable foot ring</p> <ul style="list-style-type: none"> • Polished Chrome foot ring <p>Casters</p> <ul style="list-style-type: none"> • Soft, dual-wheel casters for use on hard floors <p>Glides</p> <ul style="list-style-type: none"> • Plastic glide with stainless steel cap 	<p>No cost</p> <p>+\$ 27</p> <p>+\$ 49</p> <p>+\$ 70</p> <p>+\$ 88</p> <p>+\$109</p> <p>+\$125</p> <p>+\$158</p> <p>+\$194</p> <p>+\$219</p> <p>+\$ 54</p> <p>+\$696</p> <p>+\$696</p> <p>+\$804</p> <p>+\$804</p> <p>+\$ 81</p> <p>+\$ 99</p> <p>No cost</p> <p>+\$441</p> <p>+\$ 54</p> <p>+\$ 27</p> <p>+\$115</p> <p>+\$ 43</p> <p>+\$ 27</p> <p>+\$ 27</p>	<p>Specify fabric color number.</p> <p>Specify fabric color number.</p> <p>Specify fabric color number.</p> <p>Specify fabric color number.</p> <p>Specify fabric color number.</p> <p>Specify fabric color number.</p> <p>Specify fabric color number.</p> <p>Specify fabric color number.</p> <p>Specify fabric color number.</p> <p>Specify fabric color number.</p> <p>Specify fabric color number.</p> <p>Add suffix S to the style number.</p> <p>Add suffix S to the style number and specify leather color number.</p> <p>Add suffix S to the style number and specify Select Surfaces leather price group 1.</p> <p>▶ See <i>Surface Materials Reference Manual</i>. Add suffix S to the style number and specify Elmosoft leather color number.</p> <p>Add suffix S to the style number and specify Select Surfaces leather price group 2.</p> <p>▶ See <i>Surface Materials Reference Manual</i>. Add suffix S to the style number and specify vinyl color number.</p> <p>Add suffix X to the style number.</p> <p>▶ See <i>Surface Materials Reference Manual</i> to specify.</p> <p>Add suffix S to the style number and specify leather color number.</p> <p>Add suffix S to the style number.</p> <p>Specify <i>with soil-retardant treatment</i>.</p> <p>Add suffix B to the style number.</p> <p>Specify <i>with 9201 Polished Chrome foot ring</i>.</p> <p>Specify <i>with soft casters</i>.</p> <p>Specify <i>with GLD453</i>.</p>

Tip: Always add suffixes in alphabetical order when specifying options to Criterion seating.

Tip: Non-sewn seat upholstery (**X** suffix) is available only on models with adjustable seat depth (**D** suffix).

▶ Detailed dimensions, page 210

For Canadian Pricing
 Multiply U.S. Price by the Canadian price factor.
 ▶ See page 1 for details.

Specification Information

Height-, Width-, and Pivot-Adjustable Arms



• **Style Number**
.....
• **U.S. Base Price**
.....

Height- and Width-Adjustable Arms



• **Style Number**
.....
• **U.S. Base Price**
.....

Soft Arm Caps

Pneumatic

4537331P	\$1893	4537331W	\$1991
-----------------	--------	-----------------	--------

Pneumatic with Adjustable Seat Depth

4537331DP	\$2011	4537331DW	\$2109
------------------	--------	------------------	--------

Fixed-Height Arms



• **Style Number**
.....
• **U.S. Base Price**
.....

Without Arms

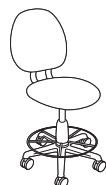

• **Style Number**
.....
• **U.S. Base Price**
.....

Pneumatic

4537331	\$1723	4537301	\$1536
----------------	--------	----------------	--------

Pneumatic with Adjustable Seat Depth

4537331D	\$1841	4537301D	\$1654
-----------------	--------	-----------------	--------



For Canadian Pricing

Multiply U.S. Price by the Canadian price factor.

▶ See page 1 for details.

Criterion 453 Series Mid-Back Stools



Standard Includes	Required to Specify
<ul style="list-style-type: none"> ▶ Need help? Product details, page 206 • Back height adjustment • Seat angle adjustment • Variable back stop • Back tension adjustment • Arms, if selected: plastic color to match base • Outer back and outer seat: plastic color • Upholstery: fabric price group 1 • Five-arm base: plastic color • Adjustable foot ring: plastic color • 2½"-diameter, hard composition, dual-wheel casters: black plastic 	<ol style="list-style-type: none"> 1 Style number 2 Plastic color number for base, foot ring, outer back, outer seat, and arms 3 Fabric color number for upholstery 4 Options, if selected (see below) <p>▶ See <i>Surface Materials</i>, page 504.</p>

Options	U.S. Price	Required to Specify
<p>Surface Materials</p> <p>Upholstery</p> <ul style="list-style-type: none"> • Fabric price group 1 • Fabric price group 2 • Fabric price group 3 • Fabric price group 4 • Fabric price group 5 • Fabric price group 6 • Fabric price group 7 • Fabric price group 8 • Fabric price group 9 • Fabric price group 10 • Sewn upholstery • Steelcase leather upholstery • Select Surfaces leather price group 1 • Elmosoft leather upholstery • Select Surfaces leather price group 2 • Steelcase vinyl • Non-sewn seat upholstery • Customer's Own Material (COM) • Customer's Own Leather (COL) • Customer's Own Material/Vinyl (COM-Sewn) • Soil-retardant treatment applied to upholstery fabric <p>Fully upholstered</p> <ul style="list-style-type: none"> • Outer back <p>Height-adjustable foot ring</p> <ul style="list-style-type: none"> • Polished Chrome foot ring 	<p>No cost</p> <p>+\$ 27</p> <p>+\$ 49</p> <p>+\$ 70</p> <p>+\$ 88</p> <p>+\$109</p> <p>+\$125</p> <p>+\$158</p> <p>+\$194</p> <p>+\$219</p> <p>+\$ 53</p> <p>+\$696</p> <p>+\$696</p> <p>+\$804</p> <p>+\$804</p> <p>+\$ 81</p> <p>+\$ 99</p> <p>No cost</p> <p>+\$441</p> <p>+\$ 54</p> <p>+\$ 27</p> <p>+\$115</p> <p>+\$ 43</p> <p>+\$ 27</p> <p>+\$ 27</p>	<p>Specify fabric color number.</p> <p>Specify fabric color number.</p> <p>Specify fabric color number.</p> <p>Specify fabric color number.</p> <p>Specify fabric color number.</p> <p>Specify fabric color number.</p> <p>Specify fabric color number.</p> <p>Specify fabric color number.</p> <p>Specify fabric color number.</p> <p>Specify fabric color number.</p> <p>Add suffix S to the style number.</p> <p>Add suffix S to the style number and specify leather color number.</p> <p>Add suffix S to the style number and specify Select Surfaces leather price group 1.</p> <p>▶ See <i>Surface Materials Reference Manual</i>. Add suffix S to the style number and specify Elmosoft leather color number.</p> <p>Add suffix S to the style number and specify Select Surfaces leather price group 2.</p> <p>▶ See <i>Surface Materials Reference Manual</i>. Add suffix S to the style number and specify vinyl color number.</p> <p>Add suffix X to the style number.</p> <p>▶ See <i>Surface Materials Reference Manual</i> to specify.</p> <p>Add suffix S to the style number and specify leather color number.</p> <p>Add suffix S to the style number.</p> <p>Specify <i>with soil-retardant treatment</i>.</p> <p>Add suffix B to the style number.</p> <p>Specify <i>with 9201 Polished Chrome foot ring</i>.</p> <p>Specify <i>with soft casters</i>.</p> <p>Specify <i>with GLD453</i>.</p>
<p>Casters</p> <ul style="list-style-type: none"> • Soft, dual-wheel casters for use on hard floors 	<p>+\$ 27</p>	<p>Specify <i>with soft casters</i>.</p>
<p>Glides</p> <ul style="list-style-type: none"> • Plastic glide with stainless steel cap 	<p>+\$ 27</p>	<p>Specify <i>with GLD453</i>.</p>

Tip: Always add suffixes in alphabetical order when specifying options to Criterion seating.

Tip: Non-sewn seat upholstery (**X** suffix) is available only on models with adjustable seat depth (**D** suffix).

▶ Detailed dimensions, page 210



For Canadian Pricing

Multiply U.S. Price by the Canadian price factor.

▶ See page 1 for details.

Specification Information

Height-, Width-, and Pivot-Adjustable Arms



• Style Number
• U.S. Base Price

Height- and Width-Adjustable Arms



• Style Number
• U.S. Base Price

Soft Arm Caps

Pneumatic

4537330P	\$1824	4537330W	\$1922
-----------------	--------	-----------------	--------

Pneumatic with Adjustable Seat Depth

4537330DP	\$1942	4537330DW	\$2040
------------------	--------	------------------	--------

Fixed-Height Arms



• Style Number
• U.S. Base Price

Without Arms

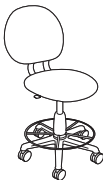

• Style Number
• U.S. Base Price

Pneumatic

4537330	\$1654	4537300	\$1467
----------------	--------	----------------	--------

Pneumatic with Adjustable Seat Depth

4537330D	\$1772	4537300D	\$1585
-----------------	--------	-----------------	--------



For Canadian Pricing
Multiply U.S. Price by the Canadian price factor.
▶ See page 1 for details.

Criterion Plus 453 Series High-Back Work Chairs



Tip: Criterion Plus is available with a fully upholstered outer back only.

Tip: Height-, width-, and pivot-adjustable arms are not available on Criterion Plus.

Standard Includes	Required to Specify
<ul style="list-style-type: none"> ▶ Need help? Product details, page 206 • Back height adjustment • Seat angle adjustment • Manual seat depth adjustment • Back tension adjustment • Upright back lock • Arms, if selected: plastic color to match base • Sewn upholstery • Upholstery: fabric price group 1 • Outer back: upholstery • Outer seat: plastic color • Five-arm base: plastic color • 2½"-diameter, hard composition, dual-wheel casters: black plastic 	<ul style="list-style-type: none"> 1 Style number 2 Plastic color number for base, outer seat, and arms 3 Fabric color number for upholstery 4 Options, if selected (see below) ▶ See <i>Surface Materials</i>, page 504.

Options	U.S. Price	Required to Specify
<p>Surface Materials</p> <p>Upholstery</p> <ul style="list-style-type: none"> • Fabric price group 1 • Fabric price group 2 • Fabric price group 3 • Fabric price group 4 • Fabric price group 5 • Fabric price group 6 • Fabric price group 7 • Fabric price group 8 • Fabric price group 9 • Fabric price group 10 • Steelcase leather upholstery • Select Surfaces leather price group 1 • Elmosoft leather upholstery • Select Surfaces leather price group 2 • Customer's Own Material/Vinyl (COM) • Customer's Own Leather (COL) • Soil-retardant treatment applied to upholstery fabric 	<ul style="list-style-type: none"> No cost +\$ 27 +\$ 49 +\$ 70 +\$ 88 +\$109 +\$125 +\$158 +\$194 +\$219 +\$335 +\$335 +\$385 +\$385 No cost +\$ 38 +\$ 27 	<ul style="list-style-type: none"> Specify fabric color number. Specify fabric color number. Specify fabric color number. Specify fabric color number. Specify fabric color number. Specify fabric color number. Specify fabric color number. Specify fabric color number. Specify fabric color number. Specify fabric color number. Specify fabric color number. Specify leather color number. ▶ See <i>Surface Materials Reference Manual</i>. Specify Elmosoft leather color number. ▶ See <i>Surface Materials Reference Manual</i>. ▶ See <i>Surface Materials Reference Manual</i> to specify. ▶ See <i>Surface Materials Reference Manual</i> to specify. Specify with soil-retardant treatment.
<p>Casters</p> <ul style="list-style-type: none"> • Soft, dual-wheel casters for use on hard floors 	<ul style="list-style-type: none"> +\$ 27 	<ul style="list-style-type: none"> Specify with soft casters.

▶ Detailed dimensions, page 210



For Canadian Pricing

Multiply U.S. Price by the Canadian price factor.

▶ See page 1 for details.

Specification Information

Height- and Width-Adjustable Arms



• Style Number
• U.S. Base Price

Fixed-Height Arms



• Style Number
• U.S. Base Price

Soft Arm Caps

Pneumatic

4539331BW	\$2573	4539331B	\$2378
------------------	--------	-----------------	--------

Without Arms



• Style Number
• U.S. Base Price

Pneumatic

4539301B	\$2191
-----------------	--------



For Canadian Pricing

Multiply U.S. Price by the Canadian price factor.

▶ See page 1 for details.

Understanding and Specifying Cachet 487 Series Work Chairs

Product Details

Cachet 487 Series	224
Dimensions	226

Specifying

Swivel-Base Work Chairs	228
Leg-Base Multi-Use Chairs	230
Swivel-Base Stools	232
Cushion Upholstery Packages	234
Accessories	237

Work Chairs

Cachet offers basic ergonomic comfort for people who have varied tasks and tend to be in and out of the office during the day. Features include adjustable seat height and a unique Balanced-Action Rocker (BAR) mechanism that allows users to recline easily without a manual adjustment. Also featured is the no front-rise seat—in other words, when you lean back, the front edge of the seat doesn't rise up, lifting your legs off the floor and cutting off circulation.

- Protégé 433 Series
- Cachet 487 Series

Adjustability Features

▶ See page 22 for a comparison to other chairs

Cachet 487 Series

Mechanisms

Balanced Action Rocker (BAR)	●
------------------------------	---

Seat Adjustments

Pneumatic height	●
------------------	---

Back Adjustments

Self adjusts	●
--------------	---

Other Features

Foot ring height (stool)	●
--------------------------	---

Cachet 487 Series

Cachet chairs are light-weight, extremely comfortable, multipurpose chairs with a unique Balanced-Action Rocker (BAR) mechanism that allows the chair to recline in response to the user's weight.

Flexible, contoured back and seat have parallel slats that conform to individual users.

Nylon injection-molded tubular frame provides strength with minimal weight.

Plastic glides are standard. Optional soft glides are available.

Balanced-action rocker (BAR) mechanism allows every user to fully recline.

Five-arm base is standard.

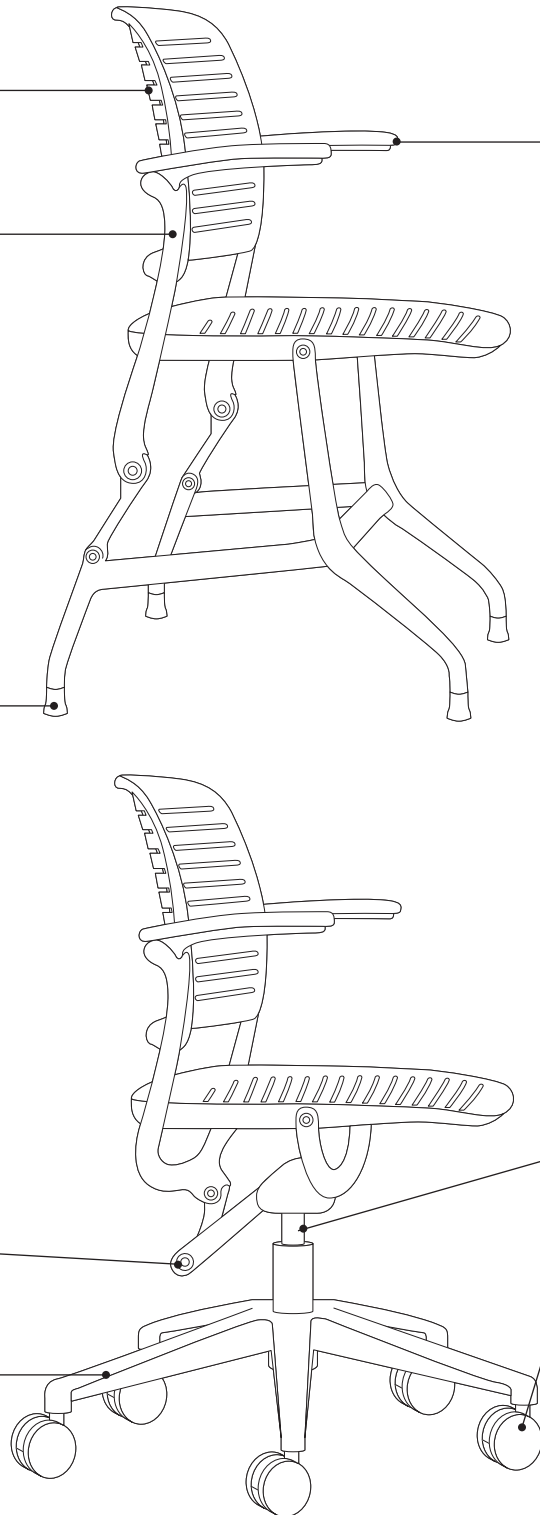

Flip-up arms easily lift to move out of the way or to allow for stacking.

Seat height adjusts within a 5" range (15½"H to 20½"H) with a pneumatic-adjustment mechanism.

Casters have hard, dual-wheels that roll smoothly on carpets. They are 2¾" diameter for increased mobility. Soft, dark grey treaded, dual-wheel roll-control casters are available for use on hard floors and mats.
Tip: Do not roll the chair across asphalt during installation as this may damage the casters.

Product Details



Chair bases are available in three styles—fixed-height four leg, adjustable-height swivel, and adjustable-height stool.

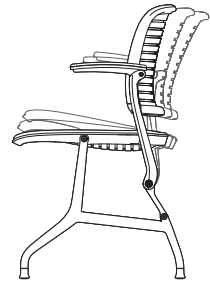

Balanced-action rocker (BAR) mechanism allows the user to recline for optimum comfort.



Upholstered cushions are available for use on chair back and seat. Cushions can be specified for factory installation or ordered separately for field installation. When specified with the chair, cushions are available for seat and back, or seat only. When ordered separately, cushions are available for seat and back, seat only, or back only. The cushions attach to the slats of back and seat.

Tip: You must specify plastic outer back color to match chair.

Soft, dark grey treaded, dual-wheel roll-control casters are available for use on hard floors or mats. Roll-control casters feature an internal brake that activates when the chair is not under load to reduce shifting when user stands up.

Hard plastic glides are standard on leg-base chairs.

Soft felt glides are available as an option for use on non-carpeted surfaces. The soft glide is reversible—soft on one side, hard on the other.

Leg-base chairs stack five high on the floor and 20 high on the dolly. Upholstery does not impact stacking capacity.

Leg-base chairs are available with or without flip-up arms. Chairs with or without arms can be stacked.

Other Features

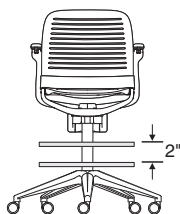

Foot ring height on stools adjusts by first lifting ring and rotating it counter-clockwise to unlock. Then raise or lower ring up to 2" to desired position before rotating it clockwise to lock. The foot ring has a diameter of 20".

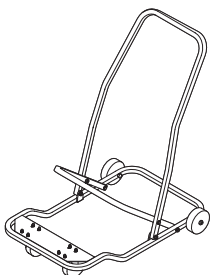

Transport and storage dolly is available to stack, move, and store up to 20 leg-base chairs. Upholstery does not impact stacking capacity. Swivel-base chairs will not stack.

Unloaded transport dolly measures 48"D x 23"W x 38³/₄"H.

Fully loaded transport dolly measures 51"D x 23"W x 78³/₄"H.

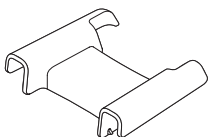

Ganging and alignment device is available to link leg-base chairs together in the field for evenly spaced rows. Chairs can be separated easily. Spacing between chairs linked with alignment device is 2".

Tip: You must specify plastic color of ganging and alignment device to match chairs.

Cachet is recommended for indoor use only.

Surface Materials

► See surface materials on page 504 for specific availability or refer to the *Surface Materials Reference Manual* for further information.

Hard components (frame, flip-up arms, back, seat, and base)

- Swivel and 4-leg chair models available in black, midnight, and ash
- Stool available in black only

Upholstery

- Fabric
- Fabric with soil-retardant treatment (option)
- Leather
- Elmosoft leather
- Select Surfaces leather
- Vinyl

Glides

- Color-matched plastic on leg-base chair
- Color-matched soft plastic on leg-base chair (option)

Casters

- Hard, black plastic wheels on swivel-base chair and stool
- Soft, dual-wheel roll-control black plastic wheels (option)

All Steelcase seating with standard upholstery fabrics complies with requirements of the State of California Technical Bulletin 117-2013. All standard seating is labeled to be in compliance with California 117-2013.

Programs & Services

► See the *Surface Materials Reference Manual* for further detail about programs and services offered for seating.

The Customer's Own Material (COM)

Program offers the opportunity for customers to select fabrics that are not offered through the standard Steelcase surface materials program for use on Steelcase products. Through the COM program, Steelcase will test your materials for application on Steelcase products. Once approved, you can place your order. Steelcase will facilitate the entire ordering process and give you a production schedule. Steelcase will order the COM fabric directly from the textile manufacturer. For up-to-date information regarding fabric test results for all COM fabrics and details regarding yardage requirements for most Seating lines, visit the COM website. To locate the COM website:

- Visit www.steelcase.com

Soil retardants are treatments that provide long-term soil and stain resistance to a fabric without affecting the shade or the integrity of the fabric. The following Steelcase Textiles are available pre-treated with soil retardant. (You do not need to select the soil-retardant option for these fabrics and incur the upcharge.)

- Jacks
- Link
- Spyder

For information on soil retardant fabrics on Select Surfaces, please refer to the *Surface Materials Reference Manual*.

Soil-retardant treatment is available on all other seating fabrics at an additional upcharge per seating unit. To order this option, please select "Soil-Retardant Treatment" under "Optional Accessories."

For soil-retardant treatment on COMs, please select "Soil-Retardant Treatment" under "Optional Accessories." Minimums or additional yardage may be required. Please contact the vendor directly for specific information.

Extended lead times may be necessary for this service.

Contact your Steelcase Solutions Fulfillment Team Representative at 1.888.STEELCASE (1.888.783.3522) or send an email to lineone@steelcase.com.

Local codes may have special requirements for upholstery.

Dimensions

► Page 226

Resources

Printed Materials

► Cachet Product Brochure (08-0001115)

Online Resources

► Environmental profiles available on www.steelcase.com/sustainability.

Dimensions

Cachet 487 Series

Features	Overall Depth	Width	Height	Seat Depth	Functional Seat Depth	Seat Width*	Seat Height from Floor	Ring Height from Floor	Back Width	Back Height from Seat	Back Lumbar Height
Cachet 487 Series											
Leg-Base Multi-Use Chairs											
Fixed-Height	20½"	23"	34¼"	19⅜"	16⅞"	16⅜"	17⅝"	N.A.	18½"	18¾"	8"
Swivel-Base Work Chairs											
Pneumatic	25"	25"	32⅛"–37⅛"	19⅜"	16⅞"	16⅜"	15½"–20½"	N.A.	18½"	18¾"	8"
Stools											
	25"	25"	39"–46"	19⅜"	16⅞"	16⅜"	23"–30"	11¼"–13¼"	18½"	18¾"	8"

* **Seat width dimension** is taken close to the front edge of the seat. The dimension closer to the actual sitting surface is 19".

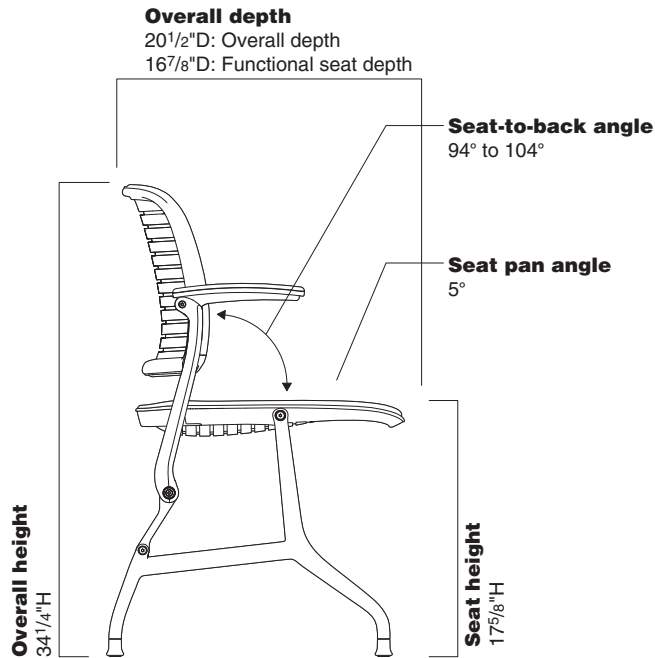
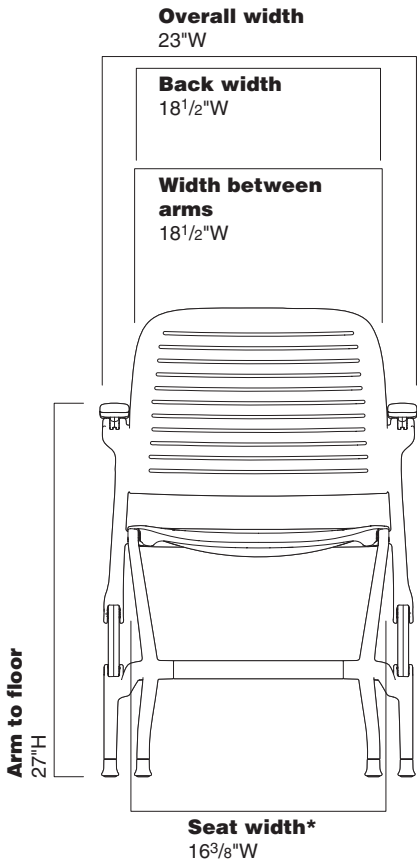

Leg-Base Multi-Use Chair

Width Between Arms	Arm to Floor	Arm Height from Seat	Seat Pan Angle	Angle Between Seat and Back
--------------------	--------------	----------------------	----------------	-----------------------------

Leg-Base Multi-Use Chairs

18½"	27"	10¾"	5°	94°–104°
------	-----	------	----	----------

Swivel-Base Work Chairs

18½"	25"–30"	10¾"	5°	94°–107°
------	---------	------	----	----------

Stools

18½"	33"–40"	10¾"	5°	94°–107°
------	---------	------	----	----------

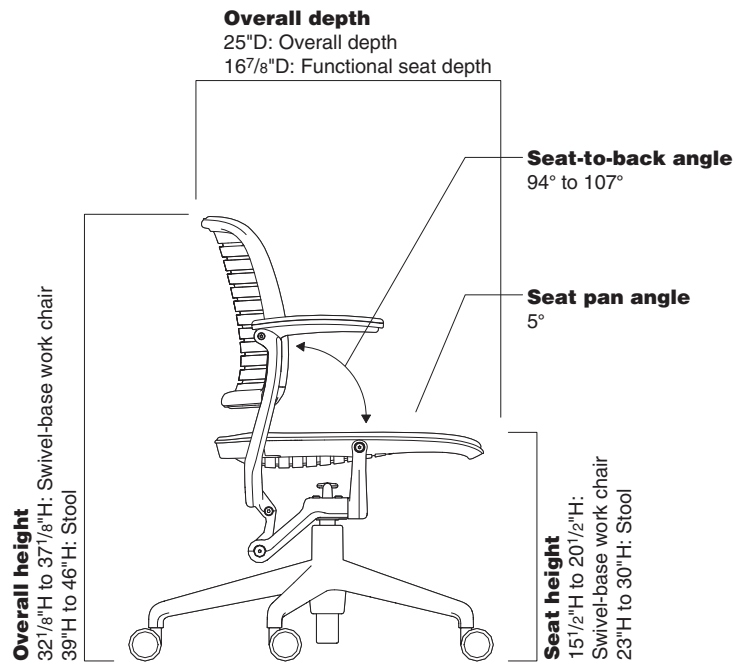
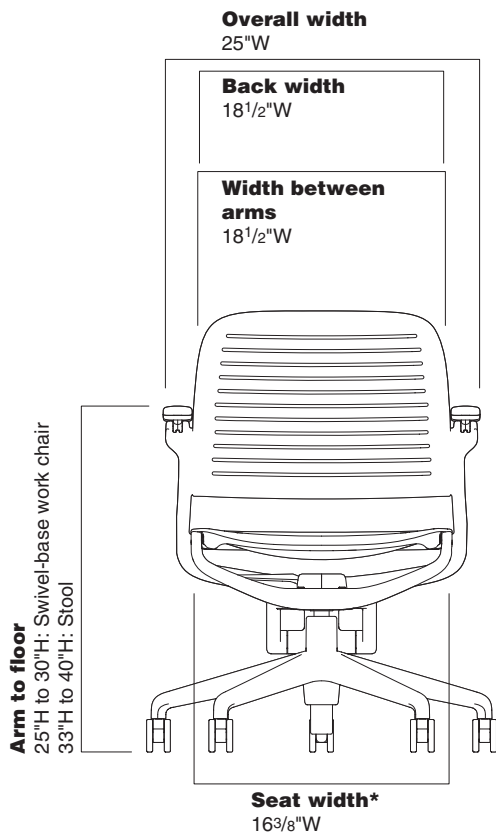

Swivel-Base Work Chair

Cachet 487 Series Swivel-Base Work Chairs



Standard Includes	Required to Specify
-------------------	---------------------

- | | | |
|--|--|--|
| <ul style="list-style-type: none"> ▶ Need help? Product details, page 224 | <ul style="list-style-type: none"> • Balanced-action rocker (BAR) mechanism • Frame, seat, back, flip-up arms, and five-arm base: plastic • 5" pneumatic seat-height adjustment • Upholstery, if selected: fabric price group 1 • 2³/₈" diameter, hard composition, dual-wheel casters: black plastic | <ol style="list-style-type: none"> 1 Style number 2 Plastic color number for frame, seat, back, flip-up arms, and five-arm base 3 Fabric color number for upholstery on seat and back, or seat, if selected 4 Options, if selected (see below) <ul style="list-style-type: none"> ▶ See <i>Surface Materials</i>, page 504. |
|--|--|--|

Options	U.S. Price	Required to Specify
---------	------------	---------------------

Options	U.S. Price	Required to Specify
Surface Materials		
Upholstery on seat		
• Fabric price group 1	No cost	Specify fabric color number.
• Fabric price group 2	+\$ 10	Specify fabric color number.
• Fabric price group 3	+\$ 27	Specify fabric color number.
• Fabric price group 4	+\$ 36	Specify fabric color number.
• Fabric price group 5	+\$ 43	Specify fabric color number.
• Fabric price group 6	+\$ 53	Specify fabric color number.
• Fabric price group 7	+\$ 64	Specify fabric color number.
• Fabric price group 8	+\$ 79	Specify fabric color number.
• Fabric price group 9	+\$ 97	Specify fabric color number.
• Fabric price group 10	+\$112	Specify fabric color number.
• Steelcase leather upholstery	+\$ 94	Specify fabric color number.
• Select Surfaces leather price group 1	+\$ 94	Add suffix S to the style number and specify leather color number.
• Elmosoft leather upholstery	+\$110	Add suffix S to the style number and specify Select Surfaces leather price group 1.
• Select Surfaces leather price group 2	+\$110	▶ See <i>Surface Materials Reference Manual</i> . Add suffix S to the style number and specify Elmosoft leather color number.
• Customer's Own Material (COM)	No cost	Add suffix S to the style number and specify Select Surfaces leather price group 2.
• Customer's Own Leather (COL)	No cost	▶ See <i>Surface Materials Reference Manual</i> to specify.
• Soil-retardant treatment applied to upholstery fabric	+\$ 27	Add suffix S to the style number and specify leather color number.
		▶ See <i>Surface Materials Reference Manual</i> to specify.
		Specify <i>with soil-retardant treatment</i> .
Upholstery on seat and back		
• Fabric price group 1	No cost	Specify fabric color number.
• Fabric price group 2	+\$ 27	Specify fabric color number.
• Fabric price group 3	+\$ 49	Specify fabric color number.
• Fabric price group 4	+\$ 70	Specify fabric color number.
• Fabric price group 5	+\$ 88	Specify fabric color number.
• Fabric price group 6	+\$109	Specify fabric color number.
• Fabric price group 7	+\$125	Specify fabric color number.
• Fabric price group 8	+\$158	Specify fabric color number.
• Fabric price group 9	+\$194	Specify fabric color number.
• Fabric price group 10	+\$219	Specify fabric color number.
• Steelcase leather upholstery	+\$187	Specify fabric color number.
• Select Surfaces leather price group 1	+\$187	Add suffix S to the style number and specify leather color number.
• Elmosoft leather upholstery	+\$218	Add suffix S to the style number and specify Select Surfaces leather price group 1.
• Select Surfaces leather price group 2	+\$218	▶ See <i>Surface Materials Reference Manual</i> . Add suffix S to the style number and specify Elmosoft leather color number.
		Add suffix S to the style number and specify Select Surfaces leather price group 2.
		▶ See <i>Surface Materials Reference Manual</i>

▶ Detailed dimensions, page 226



For Canadian Pricing
Multiply U.S. Price by the Canadian price factor.
▶ See page 1 for details.

▶ Options, continued on next page

► Options, continued from previous page

Options	U.S. Price	Required to Specify
Surface Materials, continued Upholstery on seat and back, continued <ul style="list-style-type: none"> Customer's Own Material (COM) Customer's Own Leather (COL) Soil-retardant treatment applied to upholstery fabric 	<ul style="list-style-type: none"> No cost No cost +\$27 	<ul style="list-style-type: none"> ► See <i>Surface Materials Reference Manual</i> to specify. Add suffix S to the style number and specify leather color number. ► See <i>Surface Materials Reference Manual</i> to specify. Specify <i>with soil-retardant treatment</i>.
Casters <ul style="list-style-type: none"> Soft, dark grey treaded, dual-wheel roll-control casters for use on hard floors: black plastic 	+\$27	Specify <i>with soft roll-control casters</i> .

Specification Information

Without Upholstery



• Style Number
• U.S. Base Price

4871110 \$767

With Upholstered Seat



• Style Number
• U.S. Base Price

4871210 \$917

With Upholstered Seat and Back



• Style Number
• U.S. Base Price

4871211 \$989



For Canadian Pricing

Multiply U.S. Price by the Canadian price factor.

► See page 1 for details.

Cachet 487 Series Leg-Base Multi-Use Chairs

Without Arms or with Flip-Up Arms



Standard Includes	Required to Specify
-------------------	---------------------

- | | | |
|--|---|---|
| <ul style="list-style-type: none"> ▶ Need help? Product details, page 224 | <ul style="list-style-type: none"> Balanced-action rocker (BAR) mechanism Frame, seat, back, and four-leg base: plastic Flip-up arms, if selected: plastic color to match frame, seat, and four-leg base Upholstery, if selected: fabric price group 1 Hard glides: color-matched to frame | <ol style="list-style-type: none"> Style number Plastic color number for frame, seat, back, four-leg base, and flip-up arms, if selected Fabric color number for upholstery on seat and back, or seat, if selected Options, if selected (see below) <ul style="list-style-type: none"> ▶ See <i>Surface Materials</i>, page 504. |
|--|---|---|

Surface Materials	Options	U.S. Price	Required to Specify
-------------------	---------	------------	---------------------

Surface Materials	Upholstery on seat		
	<ul style="list-style-type: none"> Fabric price group 1 Fabric price group 2 Fabric price group 3 Fabric price group 4 Fabric price group 5 Fabric price group 6 Fabric price group 7 Fabric price group 8 Fabric price group 9 Fabric price group 10 Steelcase leather upholstery Select Surfaces leather price group 1 Elmosoft leather upholstery Select Surfaces leather price group 2 Customer's Own Material (COM) Customer's Own Leather (COL) Soil-retardant treatment applied to upholstery fabric 	<ul style="list-style-type: none"> No cost +\$ 10 +\$ 27 +\$ 36 +\$ 43 +\$ 53 +\$ 64 +\$ 79 +\$ 97 +\$112 +\$ 94 +\$ 94 +\$110 +\$110 No cost No cost +\$ 27 	<p>Specify fabric color number.</p> <p>Specify fabric color number.</p> <p>Specify fabric color number.</p> <p>Specify fabric color number.</p> <p>Specify fabric color number.</p> <p>Specify fabric color number.</p> <p>Specify fabric color number.</p> <p>Specify fabric color number.</p> <p>Specify fabric color number.</p> <p>Specify fabric color number.</p> <p>Add suffix S to the style number and specify leather color number.</p> <p>Add suffix S to the style number and specify Select Surfaces leather price group 1.</p> <ul style="list-style-type: none"> ▶ See <i>Surface Materials Reference Manual</i>. Add suffix S to the style number and specify Elmosoft leather color number. Add suffix S to the style number and specify Select Surfaces leather price group 2. ▶ See <i>Surface Materials Reference Manual</i>. ▶ See <i>Surface Materials Reference Manual</i> to specify. Add suffix S to the style number and specify leather color number. ▶ See <i>Surface Materials Reference Manual</i> to specify. Specify <i>with soil-retardant treatment</i>.
	Upholstery on seat and back		
	<ul style="list-style-type: none"> Fabric price group 1 Fabric price group 2 Fabric price group 3 Fabric price group 4 Fabric price group 5 Fabric price group 6 Fabric price group 7 Fabric price group 8 Fabric price group 9 Fabric price group 10 Steelcase leather upholstery Select Surfaces leather price group 1 Elmosoft leather upholstery Select Surfaces leather price group 2 	<ul style="list-style-type: none"> No cost +\$ 27 +\$ 49 +\$ 70 +\$ 88 +\$109 +\$125 +\$158 +\$194 +\$219 +\$187 +\$187 +\$218 +\$218 	<p>Specify fabric color number.</p> <p>Specify fabric color number.</p> <p>Specify fabric color number.</p> <p>Specify fabric color number.</p> <p>Specify fabric color number.</p> <p>Specify fabric color number.</p> <p>Specify fabric color number.</p> <p>Specify fabric color number.</p> <p>Specify fabric color number.</p> <p>Specify fabric color number.</p> <p>Add suffix S to the style number and specify leather color number.</p> <p>Add suffix S to the style number and specify Select Surfaces leather price group 1.</p> <ul style="list-style-type: none"> ▶ See <i>Surface Materials Reference Manual</i>. Add suffix S to the style number and specify Elmosoft leather color number. Add suffix S to the style number and specify Select Surfaces leather price group 2. ▶ See <i>Surface Materials Reference Manual</i>

▶ Detailed dimensions, page 226



For Canadian Pricing

Multiply U.S. Price by the Canadian price factor.

▶ See page 1 for details.

▶ **Options, continued on next page**

► **Options, continued from previous page**

Options	U.S. Price	Required to Specify
Surface Materials, continued Upholstery on seat and back, continued <ul style="list-style-type: none"> Customer's Own Material (COM) Customer's Own Leather (COL) Soil-retardant treatment applied to upholstery fabric 	<ul style="list-style-type: none"> No cost No cost +\$27 	<ul style="list-style-type: none"> ► See <i>Surface Materials Reference Manual</i> to specify. Add suffix S to the style number and specify leather color number. ► See <i>Surface Materials Reference Manual</i> to specify. Specify <i>with soil-retardant treatment</i>.
Glides <ul style="list-style-type: none"> Soft felt glides: color matched to frame 	+\$10	Specify <i>with soft glides</i> .

Specification Information

Without Upholstery



• **Style Number**
• **U.S. Base Price**

With Upholstered Seat



• **Style Number**
• **U.S. Base Price**

With Upholstered Seat and Back



• **Style Number**
• **U.S. Base Price**

Without Arms

4878100 \$460

4878200 \$610

4878201 \$682

Without Upholstery



• **Style Number**
• **U.S. Base Price**

With Upholstered Seat



• **Style Number**
• **U.S. Base Price**

With Upholstered Seat and Back



• **Style Number**
• **U.S. Base Price**

With Flip-Up Arms

4878110 \$582

4878210 \$732

4878211 \$804



For Canadian Pricing

Multiply U.S. Price by the Canadian price factor.

► See page 1 for details.

Cachet 487 Series Swivel-Base Stools



Standard Includes	Required to Specify
-------------------	---------------------

- | | | |
|--|---|---|
| <ul style="list-style-type: none"> ▶ Need help? Product details, page 224 | <ul style="list-style-type: none"> • Balanced-action rocker (BAR) mechanism • Frame, seat, back, flip-up arms, and five-arm base: black plastic • 7¾" pneumatic seat-height adjustment • Upholstery, if selected: fabric price group 1 • 2¾" diameter, hard composition, dual-wheel casters: black plastic | <ol style="list-style-type: none"> 1 Style number 2 Fabric color number for upholstery on seat and back, or seat, if selected 3 Options, if selected (see below) <ul style="list-style-type: none"> ▶ See <i>Surface Materials</i>, page 504. |
|--|---|---|

Options	U.S. Price	Required to Specify
---------	------------	---------------------

Surface Materials	Upholstery on seat		
	<ul style="list-style-type: none"> • Fabric price group 1 • Fabric price group 2 • Fabric price group 3 • Fabric price group 4 • Fabric price group 5 • Fabric price group 6 • Fabric price group 7 • Fabric price group 8 • Fabric price group 9 • Fabric price group 10 • Steelcase leather upholstery 	<ul style="list-style-type: none"> No cost +\$ 10 +\$ 27 +\$ 36 +\$ 43 +\$ 53 +\$ 64 +\$ 79 +\$ 97 +\$112 +\$ 94 	<ul style="list-style-type: none"> Specify fabric color number. Specify fabric color number. Specify fabric color number. Specify fabric color number. Specify fabric color number. Specify fabric color number. Specify fabric color number. Specify fabric color number. Specify fabric color number. Specify fabric color number. Add suffix S to the style number and specify leather color number. Add suffix S to the style number and specify Select Surfaces leather price group 1. ▶ See <i>Surface Materials Reference Manual</i>. Add suffix S to the style number and specify Elmosoft leather color number. Add suffix S to the style number and specify Select Surfaces leather price group 2. ▶ See <i>Surface Materials Reference Manual</i>. ▶ See <i>Surface Materials Reference Manual</i> to specify. Add suffix S to the style number and specify leather color number. ▶ See <i>Surface Materials Reference Manual</i> to specify. Specify <i>with soil-retardant treatment</i>.
	<ul style="list-style-type: none"> • Select Surfaces leather price group 1 • Elmosoft leather upholstery • Select Surfaces leather price group 2 • Customer's Own Material (COM) • Customer's Own Leather (COL) • Soil-retardant treatment applied to upholstery fabric 	<ul style="list-style-type: none"> +\$ 94 +\$110 +\$110 No cost No cost +\$ 27 	
	Upholstery on seat and back		
	<ul style="list-style-type: none"> • Fabric price group 1 • Fabric price group 2 • Fabric price group 3 • Fabric price group 4 • Fabric price group 5 • Fabric price group 6 • Fabric price group 7 • Fabric price group 8 • Fabric price group 9 • Fabric price group 10 • Steelcase leather upholstery 	<ul style="list-style-type: none"> No cost +\$ 27 +\$ 49 +\$ 70 +\$ 88 +\$109 +\$125 +\$158 +\$194 +\$219 +\$187 	<ul style="list-style-type: none"> Specify fabric color number. Specify fabric color number. Specify fabric color number. Specify fabric color number. Specify fabric color number. Specify fabric color number. Specify fabric color number. Specify fabric color number. Specify fabric color number. Specify fabric color number. Add suffix S to the style number and specify leather color number. Add suffix S to the style number and specify Select Surfaces leather price group 1. ▶ See <i>Surface Materials Reference Manual</i> Add suffix S to the style number and specify Elmosoft leather color number. Add suffix S to the style number and specify Select Surfaces leather price group 2. ▶ See <i>Surface Materials Reference Manual</i>
	<ul style="list-style-type: none"> • Select Surfaces leather price group 1 • Elmosoft leather upholstery • Select Surfaces leather price group 2 	<ul style="list-style-type: none"> +\$187 +\$218 +\$218 	

▶ Detailed dimensions, page 226



For Canadian Pricing
 Multiply U.S. Price by the Canadian price factor.
 ▶ See page 1 for details.

▶ **Options, continued on next page**

► Options, continued from previous page

Options	U.S. Price	Required to Specify
Surface Materials <ul style="list-style-type: none"> Customer's Own Material (COM) Customer's Own Leather (COL) Soil-retardant treatment applied to upholstery fabric 	Upholstery on seat and back <ul style="list-style-type: none"> No cost No cost +\$27 	<ul style="list-style-type: none"> ► See <i>Surface Materials Reference Manual</i> to specify. Add suffix S to the style number and specify leather color number. ► See <i>Surface Materials Reference Manual</i> to specify. Specify <i>with soil-retardant treatment</i>.
Casters <ul style="list-style-type: none"> Soft, dark grey treaded, dual-wheel roll-control casters for use on hard floors: black plastic 	+\$27	Specify <i>with soft roll-control casters</i> .

Specification Information

Without Upholstery



Style Number	U.S. Base Price
4877110	\$1090

With Upholstered Seat



Style Number	U.S. Base Price
4877210	\$1240

With Upholstered Seat and Back



Style Number	U.S. Base Price
4877211	\$1312



For Canadian Pricing
 Multiply U.S. Price by the Canadian price factor.
 ► See page 1 for details.

Cushion Upholstery Packages

Cushion Upholstery Package for Back and Seat

For Use on Leg-Base, Swivel, and Stool Models

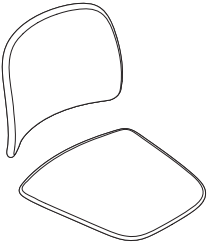

Standard Includes		Required to Specify	
<ul style="list-style-type: none"> • Package of one seat and one back cushion • Cushion upholstery for seat and back: fabric price group 1 • Outer back: plastic to match chair 		<ol style="list-style-type: none"> 1 Style number 2 Fabric color number 3 Specify plastic color of back to match chair 4 Options, if selected (see below) <p>▶ See <i>Surface Materials</i>, page 504.</p>	

	Options	U.S. Price	Required to Specify
Surface Materials	• Fabric price group 1	No cost	Specify fabric color number.
	• Fabric price group 2	+\$ 27	Specify fabric color number.
	• Fabric price group 3	+\$ 49	Specify fabric color number.
	• Fabric price group 4	+\$ 70	Specify fabric color number.
	• Fabric price group 5	+\$ 88	Specify fabric color number.
	• Fabric price group 6	+\$109	Specify fabric color number.
	• Fabric price group 7	+\$125	Specify fabric color number.
	• Fabric price group 8	+\$158	Specify fabric color number.
	• Fabric price group 9	+\$194	Specify fabric color number.
	• Fabric price group 10	+\$219	Specify fabric color number.
	• Steelcase leather upholstery	+\$187	Add suffix S to the style number and specify leather color number.
	• Select Surfaces leather price group 1	+\$187	Add suffix S to the style number and specify Select Surfaces leather price group 1.
	• Elmosoft leather upholstery	+\$218	▶ See <i>Surface Materials Reference Manual</i> . Add suffix S to the style number and specify Elmosoft leather color number.
• Select Surfaces leather price group 2	+\$218	Add suffix S to the style number and specify Select Surfaces leather price group 2.	
• Customer's Own Material (COM)	No cost	▶ See <i>Surface Materials Reference Manual</i> to specify.	
• Customer's Own Leather (COL)	No cost	Add suffix S to the style number and specify leather color number.	
• Soil-retardant treatment	+\$ 27	▶ See <i>Surface Materials Reference Manual</i> . Specify <i>with soil-retardant treatment</i> .	

Specification Information

• Style	• U.S.
• Number	• Base
•	• Price
•	•
•	•

Package of 1 Back Cushion and 1 Seat Cushion

487STBK \$343



For Canadian Pricing

Multiply U.S. Price by the Canadian price factor.

▶ See page 1 for details.

Cushion Upholstery Package for Back

For Use on Leg-Base, Swivel, and Stool Models

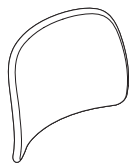

Standard Includes	Required to Specify
-------------------	---------------------

- | | |
|---|--|
| Standard Includes | Required to Specify |
| <ul style="list-style-type: none"> • One back cushion • Cushion upholstery for back: fabric price group 1 • Outer back: plastic to match chair | <ol style="list-style-type: none"> 1 Style number 2 Fabric color number for cushion 3 Specify plastic color of back to match chair 4 Options, if selected (see below) <p>▶ See <i>Surface Materials</i>, page 504.</p> |

Options	U.S. Price	Required to Specify
---------	------------	---------------------

Options	U.S. Price	Required to Specify
Surface Materials		
• Fabric price group 1	No cost	Specify fabric color number.
• Fabric price group 2	+\$ 10	Specify fabric color number.
• Fabric price group 3	+\$ 27	Specify fabric color number.
• Fabric price group 4	+\$ 36	Specify fabric color number.
• Fabric price group 5	+\$ 43	Specify fabric color number.
• Fabric price group 6	+\$ 53	Specify fabric color number.
• Fabric price group 7	+\$ 64	Specify fabric color number.
• Fabric price group 8	+\$ 79	Specify fabric color number.
• Fabric price group 9	+\$ 97	Specify fabric color number.
• Fabric price group 10	+\$112	Specify fabric color number.
• Steelcase leather upholstery	+\$ 94	Add suffix S to the style number and specify leather color number.
• Select Surfaces leather price group 1	+\$ 94	Add suffix S to the style number and specify Select Surfaces leather price group 1.
		▶ See <i>Surface Materials Reference Manual</i> .
• Elmosoft leather upholstery	+\$110	Add suffix S to the style number and specify Elmosoft leather color number.
• Select Surfaces leather price group 2	+\$110	Add suffix S to the style number and specify Select Surfaces leather price group 2.
		▶ See <i>Surface Materials Reference Manual</i> .
• Customer's Own Material (COM)	No cost	▶ See <i>Surface Materials Reference Manual</i> to specify.
• Customer's Own Leather (COL)	No cost	Add suffix S to the style number and specify leather color number.
		▶ See <i>Surface Materials Reference Manual</i> .
• Soil-retardant treatment	+\$ 27	Specify <i>with soil-retardant treatment</i> .

Specification Information

Style Number	U.S. Base Price
487BK	\$190



For Canadian Pricing

Multiply U.S. Price by the Canadian price factor.

▶ See page 1 for details.

Cushion Upholstery Packages, continued

Cushion Upholstery Package for Seat

For Use on Leg-Base, Swivel, and Stool Models

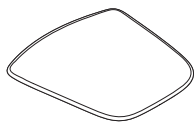

Standard Includes	Required to Specify
<ul style="list-style-type: none"> • One seat cushion • Cushion upholstery for seat: fabric price group 1 	<ul style="list-style-type: none"> 1 Style number 2 Fabric color number for cushion 3 Options, if selected (see below) ▶ See <i>Surface Materials</i>, page 504.

Surface Materials	Options	U.S. Price	Required to Specify
	• Fabric price group 1	No cost	Specify fabric color number.
	• Fabric price group 2	+\$ 10	Specify fabric color number.
	• Fabric price group 3	+\$ 27	Specify fabric color number.
	• Fabric price group 4	+\$ 36	Specify fabric color number.
	• Fabric price group 5	+\$ 43	Specify fabric color number.
	• Fabric price group 6	+\$ 53	Specify fabric color number.
	• Fabric price group 7	+\$ 64	Specify fabric color number.
	• Fabric price group 8	+\$ 79	Specify fabric color number.
	• Fabric price group 9	+\$ 97	Specify fabric color number.
	• Fabric price group 10	+\$112	Specify fabric color number.
	• Steelcase leather upholstery	+\$ 94	Add suffix S to the style number and specify leather color number.
	• Select Surfaces leather price group 1	+\$ 94	Add suffix S to the style number and specify Select Surfaces leather price group 1. ▶ See <i>Surface Materials Reference Manual</i> .
	• Elmosoft leather upholstery	+\$110	Add suffix S to the style number and specify Elmosoft leather color number.
	• Select Surfaces leather price group 2	+\$110	Add suffix S to the style number and specify Select Surfaces leather price group 2. ▶ See <i>Surface Materials Reference Manual</i> .
	• Customer's Own Material (COM)	No cost	▶ See <i>Surface Materials Reference Manual</i> to specify.
	• Customer's Own Leather (COL)	No cost	Add suffix S to the style number and specify leather color number. ▶ See <i>Surface Materials Reference Manual</i> .
	• Soil-retardant treatment	+\$ 27	Specify <i>with soil-retardant treatment</i> .

Specification Information	
• Style Number	• U.S. Base Price
487ST	\$190
:	:
:	:

For Canadian Pricing
 Multiply U.S. Price by the Canadian price factor.
 ▶ See page 1 for details.

Transport and Storage Dolly

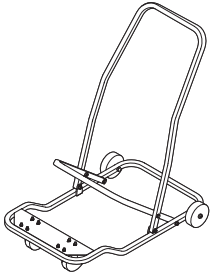

Tip: Transport and storage dolly is for leg-base chairs only.

Standard Includes		Required to Specify
<ul style="list-style-type: none"> ▶ Need help? Product details, page 225 	<ul style="list-style-type: none"> • Transport and storage dolly: black paint only 	<ul style="list-style-type: none"> Style number
Specification Information		
Style Number	U.S. Price	
487D	\$611	
...	...	

Ganging and Alignment Devices

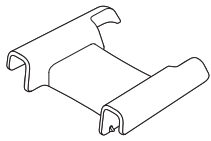

Tip: Ganging and alignment devices are for leg-base chairs only.

Standard Includes		Required to Specify
<ul style="list-style-type: none"> ▶ Need help? Product details, page 225 	<ul style="list-style-type: none"> • Carton of 5 devices: color matched to frame 	<ul style="list-style-type: none"> 1 Style number 2 Plastic color number to match chair ▶ See <i>Surface Materials</i>, page 504.
Specification Information		
Style Number	U.S. Price	
487G	\$61	
...	...	



For Canadian Pricing
Multiply U.S. Price by the Canadian price factor.
▶ See page 1 for details.

Understanding and Specifying Protégé 433 Series Work Chairs

Product Details

Protégé 433 Series	240
Dimensions	242

Specifying

Value Package Work Chair	244
Work Chairs	246
Multi-Use Chairs	248
Sled-Base Multi-Use Chair	250

Work Chairs

Adjustable work chairs offer basic ergonomic comfort for people who have varied tasks and tend to be in and out of the office during the day. Features include adjustable seat height, back tension, and upright back lock. Also featured is the no front-rise seat—in other words, when you lean back, the front edge of the seat doesn't rise up, lifting your legs off the floor and cutting off circulation.

- Protégé 433 Series
- Cachet 487 Series

Adjustability Features

▶ See page 22 for a comparison to other chairs

Protégé 433 Series

Mechanisms

Advanced swivel-tilt	●
----------------------	---

Seat Adjustments

Pneumatic height	●
------------------	---

Back Adjustments

Upright back lock	●
-------------------	---

Back tension	●
--------------	---

Protégé 433 Series

Protégé is an economic, general-use solution with basic ergonomic features. Protégé is stylish, comfortable, and well suited for a wide range of tasks, including moderate computer use.

Outer back is plastic. Fully upholstered outer back is an option.

Five-arm base is standard.

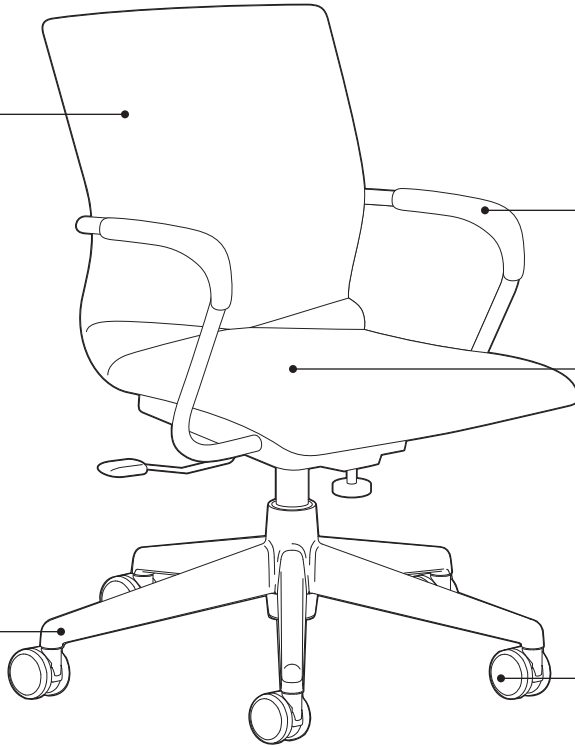

Arms are standard with soft arm caps.

Seat height adjusts with a 5" range from 15"H to 20"H with a pneumatic adjustment mechanism.

Casters have hard, dual-wheels that roll smoothly on carpets. They are 2½" diameter for increased mobility. Soft, dark grey treaded, dual-wheel roll-control casters are for use on hard floors and mats.

Tip: Do not roll the chair across asphalt during installation as this may damage the casters.

Product Details



Work and multi-use chairs are available with or without arms.



Multi-use chair bases are available in two styles: advanced swivel-tilt and sled base.

Adjustment Features

Seat Adjustments

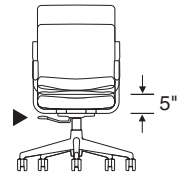

Seat height adjusts pneumatically. To lower, hold handle up while seated. To raise, hold handle up and keep your weight off the chair.

Back Adjustments



Back tension adjusts by turning knob. Turn knob clockwise to increase tension, counterclockwise to decrease.



Upright back lock.
Flick switch forward to lock; flick switch back to tilt.

Surface Materials

► See surface materials on page 504 for specific availability or refer to the *Surface Materials Reference Manual* for further information.

Upholstery

- Fabric
- Fabric with soil-retardant treatment (option)
- Leather
- Elmosoft leather
- Select Surfaces leather
- Vinyl

Base and arms

- 6205 Black
- 6250 Coffee
- 6249 Platinum

Arm caps and outer back shell

- 6205 Black
- 6250 Coffee

Casters

- 6205 Black

Tip: Chairs with a platinum finish will feature a platinum base and arms, and a black outer shell, casters, and arm caps (if specified).

Glides

- Plastic on sled base models

All Steelcase seating with standard upholstery fabrics

complies with requirements of the State of California Technical Bulletin 117-2013. All standard seating is labeled to be in compliance with California 117-2013.

Programs & Services

► See the *Surface Materials Reference Manual* for further detail about programs and services offered for seating.

The Customer's Own Material (COM) Program

offers the opportunity for customers to select fabrics that are not offered through the standard Steelcase surface materials program for use on Steelcase products. Through the COM program, Steelcase will test your materials for application on Steelcase products. Once approved, you can place your order. Steelcase will facilitate the entire ordering process and give you a production schedule. Steelcase will order the COM fabric directly from the textile manufacturer. For up-to-date information regarding fabric test results for all COM fabrics and details regarding yardage requirements for most Seating lines, visit the COM website. To locate the COM website:

- Visit www.steelcase.com

Soil retardants are treatments that provide long-term soil and stain resistance to a fabric without affecting the shade or the integrity of the fabric. The following Steelcase Textiles are available pre-treated with soil retardant. (You do not need to select the soil-retardant option for these fabrics and incur the upcharge.)

- Jacks
- Link
- Spyder

For information on soil retardant fabrics on Select Surfaces, please refer to the *Surface Materials Reference Manual*.

Soil-retardant treatment is available on all other seating fabrics at an additional upcharge per seating unit. To order this option, please select "Soil-Retardant Treatment" under "Optional Accessories."

For soil-retardant treatment on COMs, please select "Soil-Retardant Treatment" under "Optional Accessories." Minimums or additional yardage may be required. Please contact the vendor directly for specific information.

Extended lead times may be necessary for this service.

Contact your Steelcase Solutions Fulfillment Team Representative at 1.888.STEELCASE (1.888.783.3522) or send an email to lineone@steelcase.com.

Dimensions

► Page 242

Resources

Printed Materials

► Protégé Brochure (08-0000160)

Online Resources

► Environmental profiles available on www.steelcase.com/sustainability.

Dimensions

Protégé 433 Series

Features	Overall Depth	Width	Height	Seat Depth	Functional Seat Depth	Seat Width	Seat Height from Floor	Back Width	Back Height from Seat
----------	---------------	-------	--------	------------	-----------------------	------------	------------------------	------------	-----------------------

Protégé 433 Series

Work Chairs

Pneumatic	21 1/4"	24 1/4"	32 3/4"–37 3/4"	17 1/2"	16"	19 1/2"	15"–20"	19"	19 1/4"
-----------	---------	---------	-----------------	---------	-----	---------	---------	-----	---------

Multi-Use Chairs

Fixed Height	21 1/4"	24 1/4"	35 1/4"	17 1/2"	16"	19 1/2"	17 1/4"	19"	19 1/4"
Sled Base	21 1/4"	23"	35"	17 1/2"	16"	19 1/2"	18 1/4"	19"	19 1/4"

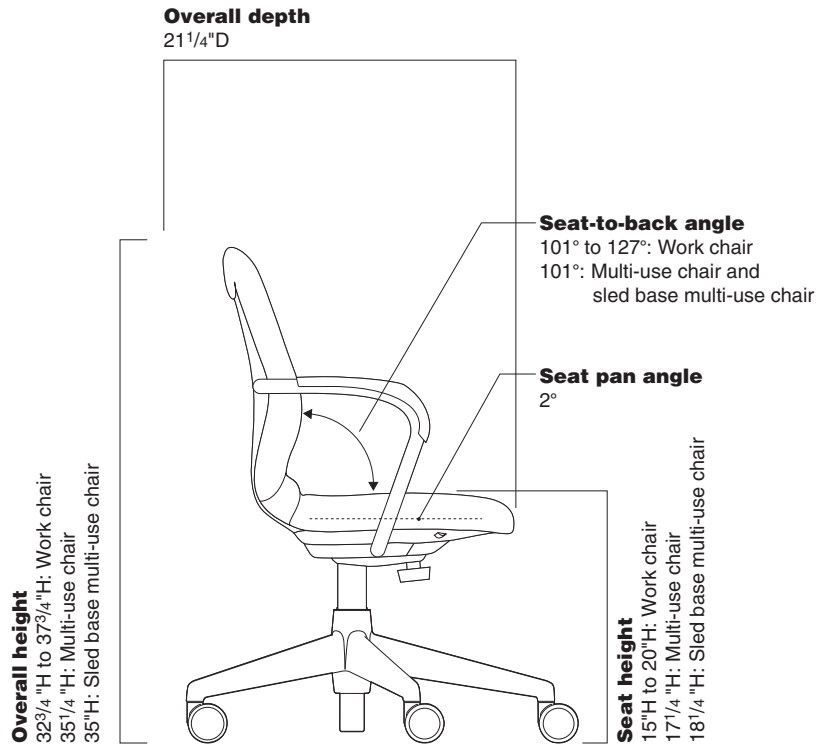
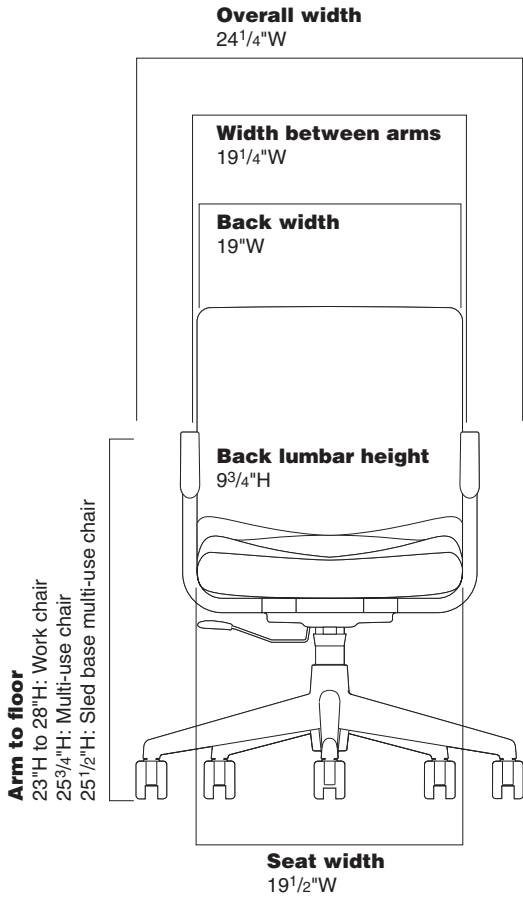

• Back Lumbar Height	• Width Between Arms	• Arm to Floor	• Arm Height from Seat	• Seat Pan Angle	• Angle Between Seat and Back
----------------------	----------------------	----------------	------------------------	------------------	-------------------------------

Work Chairs

9¾"	19¼"	23"-28"	7¾"	2°	101°-127°
-----	------	---------	-----	----	-----------

Multi-Use Chairs

9¾"	19¼"	25¾"	7¾"	2°	101°
-----	------	------	-----	----	------

9¾"	19¼"	25½"	7¾"	2°	101°
-----	------	------	-----	----	------

:	:	:	:	:	:
---	---	---	---	---	---

Protégé 433 Series Value Package Work Chair

Buzz2 Fabric on Seat and Back
 Black Plastic Finish on Frame



Tip: This value package allows you to obtain the pre-selected features at a lower price than if specifying as a standard model number.

Tip: Options or substitutions are not available on this value package.

Standard Includes		Required to Specify
<ul style="list-style-type: none"> ▶ Need help? Product details, page 240 	<ul style="list-style-type: none"> • Advanced swivel-tilt mechanism • Pneumatic seat-height adjustment • Arms with soft arm caps: black plastic • Back tension adjustment • Seat and back: Buzz2 fabric • Five-arm base: black plastic • Frame: black plastic • 2½" diameter, hard composition, dual-wheel casters: black plastic 	<ul style="list-style-type: none"> 1 Style number 2 Buzz2 fabric color number ▶ See <i>Surface Materials</i>, page 504.

Specification Information	
Style Number	U.S. Price
PROTEGEV	\$827
.	.
.	.

▶ Detailed dimensions, page 242

For Canadian Pricing
 Multiply U.S. Price by the Canadian price factor.
 ▶ See page 1 for details.

Protégé 433 Series Work Chairs



Standard Includes	Required to Specify
-------------------	---------------------

- ▶ Need help? Product details, page 240
- Advanced swivel-tilt mechanism
- Arms with soft plastic arm caps, if selected: color to match base
- Back tension adjustment
- Upholstery: fabric price group 1
- Five-arm base: plastic color
- 2½"-diameter, hard composition, dual-wheel casters: black plastic

- 1 Style number
- 2 Plastic color number for base and arms
- 3 Fabric color number for upholstery
- 4 Options, if selected (see below)
- ▶ See *Surface Materials*, page 504.

Surface Materials	Options	U.S. Price	Required to Specify
-------------------	---------	------------	---------------------

Surface Materials	Options	U.S. Price	Required to Specify
	Upholstery		
	• Fabric price group 1	No cost	Specify fabric color number.
	• Fabric price group 2	+\$ 27	Specify fabric color number.
	• Fabric price group 3	+\$ 49	Specify fabric color number.
	• Fabric price group 4	+\$ 70	Specify fabric color number.
	• Fabric price group 5	+\$ 88	Specify fabric color number.
	• Fabric price group 6	+\$ 125	Specify fabric color number.
	• Fabric price group 7	+\$ 176	Specify fabric color number.
	• Fabric price group 8	+\$ 233	Specify fabric color number.
	• Fabric price group 9	+\$ 276	Specify fabric color number.
	• Fabric price group 10	+\$ 321	Specify fabric color number.
	• Steelcase leather upholstery	+\$ 745	Add suffix S to style number and specify leather color number.
	• Select Surfaces leather price group 1	+\$ 745	Add suffix S to the style number and specify Select Surfaces leather price group 1.
			▶ See <i>Surface Materials Reference Manual</i> .
	• Elmosoft leather upholstery	+\$ 860	Add suffix S to the style number and specify Elmosoft leather color number.
	• Select Surfaces leather price group 2	+\$ 860	Add suffix S to the style number and specify Select Surfaces leather price group 2.
			▶ See <i>Surface Materials Reference Manual</i> .
	• Steelcase vinyl	+\$ 108	Add suffix S to style number and specify vinyl color number.
			▶ See <i>Surface Materials Reference Manual</i> to specify.
	• Customer's Own Material (COM)	+\$ 38	Add suffix S to style number.
	• Customer's Own Leather (COL)	+\$ 456	▶ See <i>Surface Materials Reference Manual</i> to specify.
			Add suffix S to style number.
	• Customer's Own Material/Vinyl (COM-Sewn)	+\$ 81	
	• Soil-retardant treatment applied to upholstery fabric	+\$ 27	Specify <i>with soil-retardant treatment</i> .
	Fully upholstered		
	• Fabric fully upholstered outer back and outer seat	+\$ 132	Add suffix U to the style number.
	• Steelcase leather fully upholstered outer back and outer seat	+\$1301	Add suffix SU to the style number and specify leather color number.
	• Select Surfaces leather price group 1 fully upholstered outer back and outer seat	+\$1301	Add suffix SU to the style number and specify Select Surfaces leather price group 1.
			▶ See <i>Surface Materials Reference Manual</i>
	• Elmosoft leather fully upholstered outer back and outer seat	+\$1499	Add suffix SU to the style number and specify Elmosoft leather color number.
	• Select Surfaces leather price group 2 fully upholstered outer back and outer seat	+\$1499	Add suffix SU to the style number and specify Select Surfaces leather price group 2.
			▶ See <i>Surface Materials Reference Manual</i>
	• Customer's Own Leather (COL) fully upholstered outer back and outer seat	+\$ 723	Add suffix SU to the style number.
			▶ See <i>Surface Materials Reference Manual</i> to specify.

Tip: Chairs with a platinum finish will feature a platinum base and arms, and a black outer shell, casters, and arm caps (if specified).

▶ Detailed dimensions, page 242



For Canadian Pricing
 Multiply U.S. Price by the Canadian price factor.
 ▶ See page 1 for details.

▶ Options, continued on next page

► Options, continued from previous page

Options	U.S. Price	Required to Specify
Surface Materials, continued Platinum • On base and arms	+\$89	Specify with 6249 Platinum.
Casters • Soft, dark grey treaded, dual-wheel roll-control casters for use on hard floors	+\$27	Specify with soft roll-control casters.

Specification Information

Arms with Soft Arm Caps



Without Arms



• Style
• Number

• U.S.
• Base
• Price

• Style
• Number

• U.S.
• Base
• Price

Pneumatic

4331223

\$913

4331203

\$825

Pneumatic with Upright Back Lock

4331423

\$975

4331403

\$887



For Canadian Pricing

Multiply U.S. Price by the Canadian price factor.

► See page 1 for details.

Protégé 433 Series Multi-Use Chairs



Standard Includes	Required to Specify
<ul style="list-style-type: none"> ▶ Need help? Product details, page 240 • Fixed height with advanced swivel-tilt mechanism • Arms with soft plastic arm caps, if selected: color to match base • Back tension adjustment • Upholstery: fabric price group 1 • Five-arm base: plastic color • 2½"-diameter, hard composition, dual-wheel casters: black plastic 	<ul style="list-style-type: none"> 1 Style number 2 Plastic color number for base and arms 3 Fabric color number for upholstery 4 Options, if selected (see below) ▶ See <i>Surface Materials</i>, page 504.

Surface Materials	Options	U.S. Price	Required to Specify
	Upholstery		
	• Fabric price group 1	No cost	Specify fabric color number.
	• Fabric price group 2	+\$ 27	Specify fabric color number.
	• Fabric price group 3	+\$ 49	Specify fabric color number.
	• Fabric price group 4	+\$ 70	Specify fabric color number.
	• Fabric price group 5	+\$ 88	Specify fabric color number.
	• Fabric price group 6	+\$ 125	Specify fabric color number.
	• Fabric price group 7	+\$ 176	Specify fabric color number.
	• Fabric price group 8	+\$ 233	Specify fabric color number.
	• Fabric price group 9	+\$ 276	Specify fabric color number.
	• Fabric price group 10	+\$ 321	Specify fabric color number.
	• Steelcase leather upholstery	+\$ 745	Add suffix S to style number and specify leather color number.
	• Select Surfaces leather price group 1	+\$ 745	Add suffix S to the style number and specify Select Surfaces leather price group 1.
	• Elmosoft leather upholstery	+\$ 860	▶ See <i>Surface Materials Reference Manual</i> . Add suffix S to the style number and specify Elmosoft leather color number.
	• Select Surfaces leather price group 2	+\$ 860	Add suffix S to the style number and specify Select Surfaces leather price group 2.
• Steelcase vinyl	+\$ 108	▶ See <i>Surface Materials Reference Manual</i> . Add suffix S to style number and specify vinyl color number.	
• Customer's Own Material (COM)	+\$ 38	▶ See <i>Surface Materials Reference Manual</i> to specify.	
• Customer's Own Leather (COL)	+\$ 456	Add suffix S to style number.	
• Customer's Own Material/Vinyl (COM-Sewn)	+\$ 81	▶ See <i>Surface Materials Reference Manual</i> to specify.	
• Soil-retardant treatment applied to upholstery fabric	+\$ 27	Add suffix S to style number.	
	Fully upholstered		
	• Fabric fully upholstered outer back and outer seat	+\$ 132	Add suffix U to the style number.
	• Steelcase leather fully upholstered outer back and outer seat	+\$1301	Add suffix SU to the style number and specify leather color number.
	• Select Surfaces leather price group 1 fully upholstered outer back and outer seat	+\$1301	Add suffix SU to the style number and specify Select Surfaces leather price group 1.
	• Elmosoft leather fully upholstered outer back and outer seat	+\$1499	▶ See <i>Surface Materials Reference Manual</i> . Add suffix SU to the style number and specify Elmosoft leather color number.
	• Select Surfaces leather price group 2 fully upholstered outer back and outer seat	+\$1499	Add suffix SU to the style number and specify Select Surfaces leather price group 2.
	• Customer's Own Leather (COL) fully upholstered outer back and outer seat	+\$ 723	▶ See <i>Surface Materials Reference Manual</i> to specify.

Tip: Chairs with a platinum finish will feature a platinum base and arms, and a black outer shell, casters, and arm caps (if specified).

▶ Detailed dimensions, page 242



For Canadian Pricing
Multiply U.S. Price by the Canadian price factor.
▶ See page 1 for details.

▶ Options, continued on next page

► Options, continued from previous page

Options	U.S. Price	Required to Specify
Surface Materials, continued Platinum • On base and arms	+ \$89	Specify with 6249 Platinum.
Casters • Soft, dark grey treaded, dual-wheel roll-control casters for use on hard floors	+ \$27	Specify with soft roll-control casters.

Specification Information

Arms with Soft Arm Caps



• Style
• Number

• U.S.
• Base
• Price

Without Arms



• Style
• Number

• U.S.
• Base
• Price

Multi-Use Chairs

Fixed Height		Fixed Height	
4333023	\$887	4333003	\$799
:	:	:	:



For Canadian Pricing

Multiply U.S. Price by the Canadian price factor.

► See page 1 for details.

Protégé 433 Series Sled-Base Multi-Use Chair



Standard Includes		Required to Specify	
<ul style="list-style-type: none"> ▶ Need help? Product details, page 240 	<ul style="list-style-type: none"> • Upholstery: fabric price group 1 • Frame: plastic color • Arms with soft arm caps: plastic • Glides: clear plastic 		<ol style="list-style-type: none"> 1 Style number 2 Plastic color number for base and arms 3 Fabric color number for upholstery 4 Options, if selected (see below) <ul style="list-style-type: none"> ▶ See <i>Surface Materials</i>, page 504.
Surface Materials	Options	U.S. Price	Required to Specify
	Upholstery <ul style="list-style-type: none"> • Fabric price group 1 • Fabric price group 2 • Fabric price group 3 • Fabric price group 4 • Fabric price group 5 • Fabric price group 6 • Fabric price group 7 • Fabric price group 8 • Fabric price group 9 • Fabric price group 10 • Steelcase leather upholstery • Select Surfaces leather price group 1 • Elmosoft leather upholstery • Select Surfaces leather price group 2 • Steelcase vinyl • Customer's Own Material (COM) • Customer's Own Leather (COL) • Customer's Own Material/Vinyl (COM-Sewn) • Soil-retardant treatment applied to upholstery fabric 	No cost +\$ 27 +\$ 49 +\$ 70 +\$ 88 +\$ 125 +\$ 176 +\$ 233 +\$ 276 +\$ 321 +\$ 745 +\$ 745 +\$ 860 +\$ 860 +\$ 108 +\$ 38 +\$ 456 +\$ 81 +\$ 27	Specify fabric color number. Specify fabric color number. Specify fabric color number. Specify fabric color number. Specify fabric color number. Specify fabric color number. Specify fabric color number. Specify fabric color number. Specify fabric color number. Specify fabric color number. Add suffix S to style number and specify leather color number. Add suffix S to the style number and specify Select Surfaces leather price group 1. ▶ See <i>Surface Materials Reference Manual</i> . Add suffix S to the style number and specify Elmosoft leather color number. Add suffix S to the style number and specify Select Surfaces leather price group 2. ▶ See <i>Surface Materials Reference Manual</i> . Add suffix S to style number and specify vinyl color number. ▶ See <i>Surface Materials Reference Manual</i> to specify. Add suffix S to style number. ▶ See <i>Surface Materials Reference Manual</i> to specify. Add suffix S to style number. Specify <i>with soil-retardant treatment</i> .
	Fully upholstered <ul style="list-style-type: none"> • Fabric fully upholstered outer back and outer seat • Steelcase leather fully upholstered outer back and outer seat • Select Surfaces leather price group 1 fully upholstered outer back and outer seat • Elmosoft leather fully upholstered outer back and outer seat • Select Surfaces leather price group 2 fully upholstered outer back and outer seat • Customer's Own Leather (COL) fully upholstered outer back and outer seat 	+\$ 132 +\$1301 +\$1301 +\$1499 +\$1499 +\$ 723	Add suffix U to the style number. Add suffix SU to the style number and specify leather color number. Add suffix SU to the style number and specify Select Surfaces leather price group 1. ▶ See <i>Surface Materials Reference Manual</i> . Add suffix SU to the style number and specify Elmosoft leather color number. Add suffix SU to the style number and specify Select Surfaces leather price group 2. ▶ See <i>Surface Materials Reference Manual</i> . Add suffix SU to the style number. ▶ See <i>Surface Materials Reference Manual</i> to specify.

▶ Detailed dimensions, page 242

▶ Options, continued on next page



For Canadian Pricing

Multiply U.S. Price by the Canadian price factor.

▶ See page 1 for details.

► Options, continued from previous page

Options		U.S. Price	Required to Specify
Surface Materials	Platinum • On sled-base frame	+\$89	Specify with 6249 Platinum.

Specification Information

Style Number	U.S. Base Price
4335023	\$743

Tip: Chairs with a platinum finish will feature a platinum base and arms, and a black outer shell, casters, and arm caps.



For Canadian Pricing
Multiply U.S. Price by the Canadian price factor.
► See page 1 for details.

Collaborative Seating

SILQ 418 Series	255
QiVi 428 Series	269
cobi 434 Series	281
i2i 416 Series	291
Node 480 Series	299

Understanding and Specifying SILQ 418 Series

Product Details

SILQ 418 Series	256
SILQ Upholstery	258
Dimensions	262

Specifying

Collaborative Chair	264
Collaborative Stool	266

Collaborative chairs

Collaborative seating promotes comfort for long periods of time and promotes movement, offers automatic and intuitive adjustments, and supports multiple postures.

- SILQ 418 Series
- QiVi 428 Series
- cobo 434 Series
- i2i 416 Series
- Node 480 Series

Adjustability Features

▶ See page 22 for a comparison to other chairs

SILQ 418 Series

Mechanisms

360°-swivel	●
-------------	---

Seat Adjustments

Pneumatic height	●
------------------	---

Other Features

Foot ring height (stool)	●
--------------------------	---

SILQ 418 Series

SILQ is a breakthrough in seating design that combines innovation, artistry, and performance to create a personal experience by responding to the unique movements of your body.

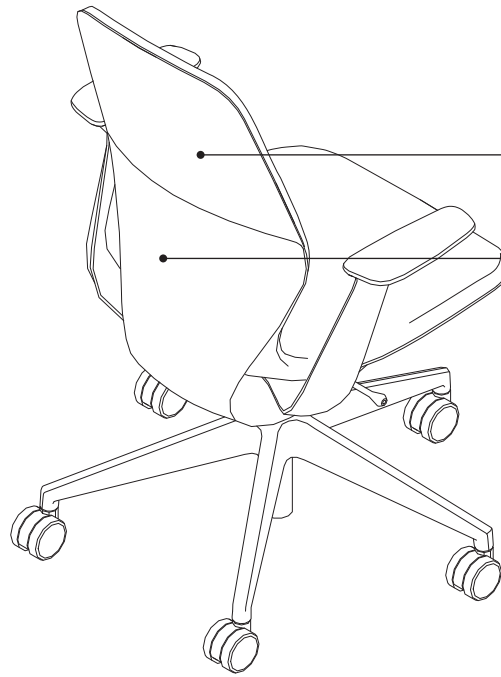

Upper back shell is molded plastic.

Lower shell is painted plastic.

Fabric is applied in the warp vertical direction.

Fixed arms are painted plastic. Arm caps are molded plastic. An armless option is available. Polished aluminum is available as an option.

Seat height adjusts 4⁵/₈" from 16¹/₄"H to 20⁷/₈"H with a pneumatic adjustment mechanism.

Casters have hard, dual-wheels that roll smoothly on carpets. They are 2¹/₂" for increased mobility. Soft, dual-wheel, roll control casters are an option available for use on hard floors or chair mats. Hard glides, hard hubless casters, and soft hubless casters are also available as an option.
Tip: Do not roll the chair across asphalt during installation as this may damage the casters.

Five-arm base is plastic.

Product Details

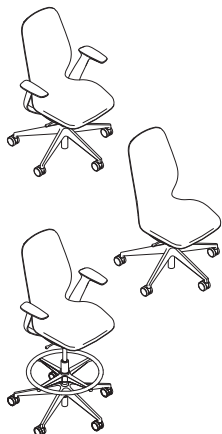

Five-arm base chairs and stools are available with and without arms. Five-arm bases are also available with casters or glides.

Adjustment Features

Adjustability instructions are included with every chair. Instructions can also be found at www.steelcase.com.

Seat Adjustments

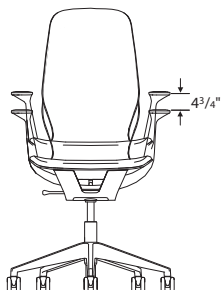

Seat height adjusts pneumatically. To lower, pull lever up while seated. To raise, pull lever up and keep your weight off the chair.

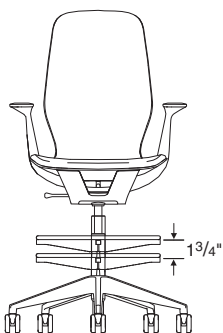

Foot ring height on stools adjusts by first lifting ring and rotating it counter-clockwise to unlock. Then raise or lower ring up to 1 3/4" to desired position before rotating it clockwise to lock. The foot ring has a diameter of 20".

Back Adjustments

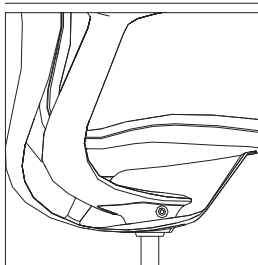

Weight activated compliant system responds to the natural movements of the user's body.

Other features

Hard and soft, hubless roll control wheel casters and hard glides are available as options on the five-arm base.

Cartoned request on dealer purchase order forces SILQ chairs to ship knocked down in three pieces; the seat and back, the base, and the pneumatic cylinder. This request forces SILQ stools to ship knocked down in four pieces; the seat and back, the base, the pneumatic cylinder, and the foot ring. Assembly by a qualified dealer installer is required. Assembly instructions are included.

Surface Materials

▶ See surface materials on page 504 for specific availability or refer to the *Surface Materials Reference Manual* for further information.

Upholstery

- Fabric
- Fabric with soil-retardant treatment (option)
- ▶ See SILQ Resources on Village for list of approved fabrics (<https://village.steelcase.com/docs/DOC-49519>)
- Tip: Fabric on the SILQ 418 Series will only be applied in the warp vertical/down roll direction. This includes all standard Steelcase fabrics, Select Surfaces, and COMs.*
- ▶ See *Fabric Application Direction Guidelines*, page 511.

Hard Components

Upper Shell

- 6053 Seagull
- 6249 Platinum Solid
- 6527 Merle

Lower Shell

- 7245 Carbon Metallic
- 7360 Merle

Arms

- 7243 Seagull
- 7250 Sterling Dark
- 7360 Merle
- 8406 Polished Aluminum

Base

- 6205 Black
- 7243 Seagull
- 7360 Merle
- 8406 Polished Aluminum

Tip: See next page for Color Scheme Matrix.

All Steelcase seating with standard upholstery fabrics complies with requirements of the State of California Technical Bulletin 117-2013. All standard seating is labeled to be in compliance with California 117-2013.

Programs & Services

▶ See the *Surface Materials Reference Manual* for further detail about programs and services offered for seating.

The Customer's Own Material (COM) Program

offers the opportunity for customers to select fabrics that are not offered through the standard Steelcase surface materials program for use on Steelcase products. Through the COM program, Steelcase will test your materials for application on Steelcase products. Once approved, you can place your order. Steelcase will facilitate the entire ordering process and give you a production schedule. Steelcase will order the COM fabric directly from the textile manufacturer. For up-to-date information regarding fabric test results for all COM fabrics and details regarding yardage requirements for most Seating lines, visit the COM website. To locate the COM website:

- Visit www.steelcase.com

Soil retardants are treatments that provide long-term soil and stain resistance to a fabric without affecting the shade or the integrity of the fabric. The following Steelcase Textiles are available pre-treated with soil retardant. (You do not need to select the soil-retardant option for these fabrics and incur the upcharge.)

- Jacks
- Link
- Spyder

For information on soil retardant fabrics on Select Surfaces, please refer to the *Surface Materials Reference Manual*.

Soil-retardant treatment is available on all other seating fabrics at an additional upcharge per seating unit. To order this option, please select "Soil-Retardant Treatment" under "Optional Accessories."

For soil-retardant treatment on COMs, please select "Soil-Retardant Treatment" under "Optional Accessories." Minimums or additional yardage may be required. Please contact the vendor directly for specific information.

Extended lead times may be necessary for this service.

Contact your Steelcase Solutions Fulfillment Team Representative at 1.888.STEELCASE (1.888.783.3522) or send an email to lineone@steelcase.com.

Fire Codes

▶ See page 517 for upholstery fabrics available for use with FCS modification.

Steelcase offers Fire Code Seating modification (FCS) on some seating models. The most rigorous fire codes in the nation have been developed in California, and the Steelcase FCS modification is designed to meet those codes. Fire Code Seating (FCS) indicates that a product is constructed to meet the strict fire code requirements of high public occupancy areas such as theaters, meeting rooms, and lobbies. The FCS standards will meet the State of California Bureau of Electronic and Appliance Repair, Home Furnishings, and Thermal Insulation Technical Bulletin 133 (Cal TB 133). Boston adopted the California Bureau of Electronic and Appliance Repair, Home Furnishings, and Thermal Insulation Technical Bulletin TB 133 test standard in 1992.

Local codes may have special requirements for upholstery.

Color Scheme Matrix

Color Scheme	Upper Back Shell	Lower Back Shell	Arms	Base
Platinum/Merle	Molded Plastic– Platinum Solid 6249	Painted–Textured Merle 7360	Painted–Textured Sterling Dark Solid 7250	Molded Plastic– Black 6205
Seagull/Merle	Molded Plastic– Seagull 6053	Painted–Textured Merle 7360	Painted–Textured Sterling Dark Solid 7250	Painted–Textured Merle 7360
Seagull/Carbon Metallic	Molded Plastic– Seagull 6053	Painted–Textured Carbon Metallic 7245	Painted–Textured Seagull 7243	Painted–Textured Seagull 7243
Merle/Merle	Molded Plastic– Merle 6527	Painted–Textured Merle 7360	Painted–Textured Sterling Dark Solid 7250	Painted–Textured Merls 7360

Tip: Polished aluminum is available as an option on arms and base.

Tip: The polished aluminum arm can be specified with the standard base color.

Tip: The polished aluminum base can be specified with the standard arm color.

Foot Ring (Stools)	Arm Caps	Casters
Plastic-Black 6205	Black 6205	Black 6205
Plastic-Black 6205	Black 6205	Black 6205
Painted-Sterling Dark Solid 7250	Sterling Dark Solid 6059	Sterling Dark Solid 6059
Plastic-Black 6205	Plastic-Black 6205	Plastic-Black 6205

SILQ Upholstery

What Is It?

Fabric, leather, or vinyl-covered back and seat.

Tip: Fabrics on SILQ 418 Series will only be applied in the warp vertical/down roll direction. This fabric application is the opposite direction of the rest of the Steelcase seating portfolio.

Standard upholstery design

Cogent: Connect

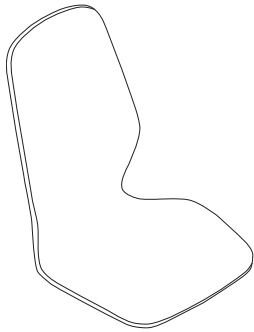

Sewn upholstery design

Vinyl and All Other Fabrics

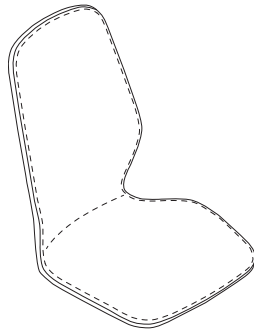

Stitched seams are included across the waist of the chair and along the edges of the chair.

- Vinyl
- Upholstery
- Select Customer's Own Material/Vinyl (COM)

Leather upholstery design

Leather

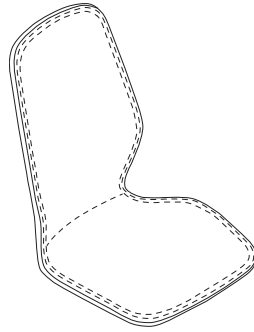

Stitched seams on leather include a single seam across the waist of the chair and a double seam along the edges of the chair.

- Leather
- Select Customer's Own Leather (COL)



Dimensions

SILQ 418 Series

Features	Overall Depth	Width	Height	Seat Depth	Functional Seat Depth	Seat Width	Seat Height from Floor	Ring Height from Floor	Back Width	Back Height from Seat
SILQ 418 Series										
Collaborative Chairs										
	23 1/2"	25 1/2"	37 1/2"-42 1/4"	16 3/4"	16 3/4"	18 3/4"	16 1/4"-20 7/8"	N.A.	14"	23 7/8"
Stools										
	23 1/2"	25 1/2"	44 1/2"-52"	16 3/4"	16 3/4"	18 3/4"	22 7/8"-30 7/8"	11 1/4"-13"	14"	23 7/8"

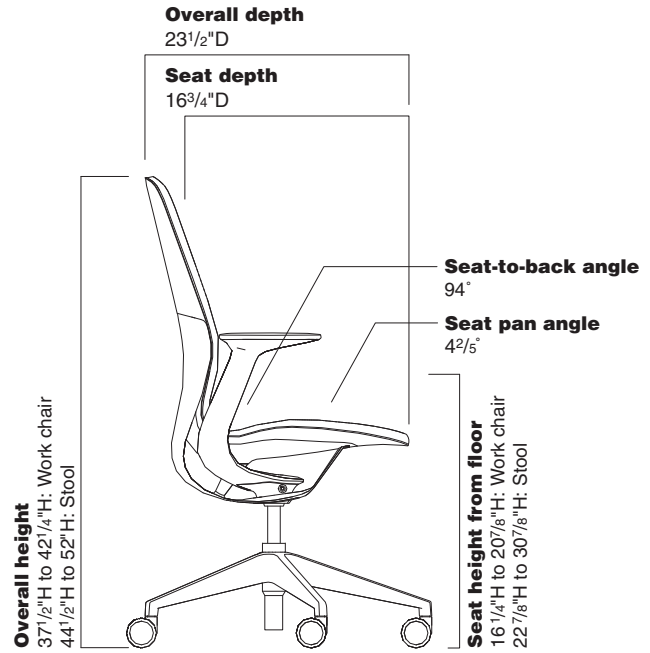
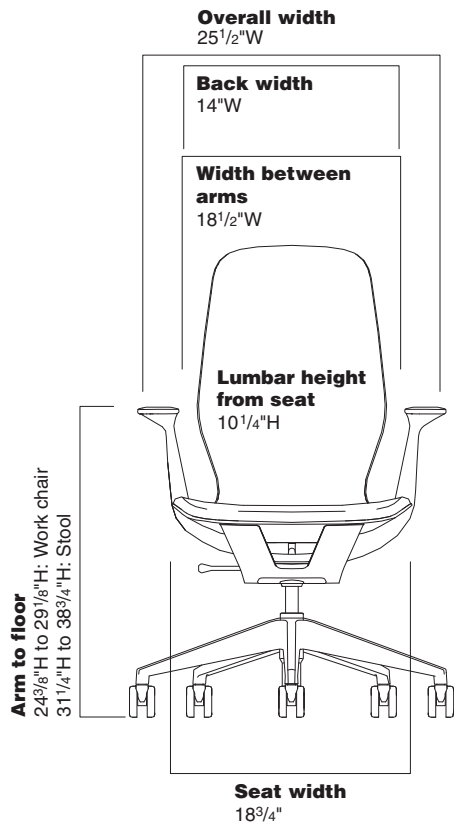

• Back Lumbar Height	• Width Between Arms	• Arm to Floor	• Arm Height from Seat	• Seat Pan Angle	• Angle Between Seat and Back
----------------------	----------------------	----------------	------------------------	------------------	-------------------------------

Collaborative Chairs

10 ¹ / ₄ "	18 ¹ / ₂ "	24 ³ / ₈ "–29 ¹ / ₈ "	9 ¹ / ₄ "	4 ² / ₅ °	94°
----------------------------------	----------------------------------	---	---------------------------------	---------------------------------	-----

Stools

10 ¹ / ₄ "	18 ¹ / ₂ "	31 ¹ / ₄ "–38 ³ / ₄ "	9 ¹ / ₄ "	4 ² / ₅ °	94°
----------------------------------	----------------------------------	---	---------------------------------	---------------------------------	-----

:	:	:	:	:	:
---	---	---	---	---	---

SILQ 418 Series Collaborative Chair



Standard Includes	Required to Specify
-------------------	---------------------

<ul style="list-style-type: none"> ▶ Need help? Product details, page 256 	<ul style="list-style-type: none"> • 4⁵/₈" pneumatic seat-height adjustment (16¹/₄" – 20⁷/₈") • Fixed arms: textured paint • Upper back shell and arm caps: plastic • Lower back shell: textured paint • Five-arm base: plastic • Standard upholstery design on seat: fabric price group 1 • 2¹/₂"-diameter, hard-composition, dual-wheel casters: black 	<ol style="list-style-type: none"> 1 Style number 2 Fabric color number for upholstery on seat 3 Plastic color number for upper back shell and arm caps 4 Paint color number for lower back shell 5 Paint color number for arms 6 Plastic color number for base 7 Options, if selected (see below) <p>▶ See <i>Surface Materials</i>, page 504.</p>
--	--	--

Tip: Fabric on the SILQ 418 Series will only be applied in the warp vertical/down roll direction. This includes all standard Steelcase fabrics, Select Surfaces, and COMs. ▶ See Fabric Application Direction Guidelines, page 511.

Options	U.S. Price	Required to Specify
---------	------------	---------------------

<p>Surface Materials</p>	<p>Upholstery on seat</p> <ul style="list-style-type: none"> • Fabric price group 1 No cost • Fabric price group 2 +\$ 27 • Fabric price group 3 +\$ 49 • Fabric price group 4 +\$ 70 • Fabric price group 5 +\$ 88 • Fabric price group 6 +\$109 • Fabric price group 7 +\$125 • Fabric price group 8 +\$158 • Fabric price group 9 +\$194 • Fabric price group 10 +\$219 • Sewn upholstery +\$100 • Steelcase leather upholstery +\$360 • Select Surfaces leather price group 1 +\$360 • Elmosoft leather +\$414 • Select Surfaces leather price group 2 +\$414 • Steelcase vinyl +\$100 • Customer's Own Material (COM) No cost • Customer's Own Leather (COL) +\$100 • Soil-retardant treatment applied to upholstery fabric +\$ 27 	<p>Specify fabric color number.</p> <p>Specify fabric color number.</p> <p>Specify fabric color number.</p> <p>Specify fabric color number.</p> <p>Specify fabric color number.</p> <p>Specify fabric color number.</p> <p>Specify fabric color number.</p> <p>Specify fabric color number.</p> <p>Specify fabric color number.</p> <p>Specify fabric color number.</p> <p>Add suffix S to the style number and specify fabric color number.</p> <p>Add suffix S to the style number and specify leather color number.</p> <p>Add suffix S to the style number and specify leather color number.</p> <p>▶ See <i>Surface Materials Reference Manual</i>.</p> <p>Add suffix S to the style number and specify Elmosoft leather color number.</p> <p>Add suffix S to the style number and specify leather color number.</p> <p>▶ See <i>Surface Materials Reference Manual</i>.</p> <p>Add suffix S to the style number and specify vinyl color number.</p> <p>▶ See <i>Surface Materials Reference Manual</i>.</p> <p>Add suffix S to style number and specify leather color number.</p> <p>▶ See <i>Surface Materials Reference Manual</i>.</p> <p>Specify <i>with soil-retardant treatment</i>.</p>
<p>Stitch</p>	<ul style="list-style-type: none"> • Light No cost • Dark No cost 	<p>Specify light stitch.</p> <p>Specify dark stitch.</p>
<p>Upper back shell</p>	<ul style="list-style-type: none"> • 6053 Seagull No cost • 6249 Platinum Solid No cost • 6527 Merle No cost 	<p>Specify <i>with 6053 Seagull</i>.</p> <p>Specify <i>with 6249 Platinum Solid</i>.</p> <p>Specify <i>with 6527 Merle</i>.</p>
<p>Lower back shell</p>	<ul style="list-style-type: none"> • 7245 Carbon Metallic No cost • 7360 Merle No cost 	<p>Specify <i>with 7245 Carbon Metallic</i>.</p> <p>Specify <i>with 7360 Merle</i>.</p>
<p>Arms</p>	<ul style="list-style-type: none"> • Armless -\$ 61 • Polished aluminum +\$150 	<p>Specify <i>without arms</i>.</p> <p>Specify <i>with polished aluminum</i>.</p>

▶ **Options, continued on next page**

Tip: Stitch selection will be defaulted on standard leathers.

Tip: Lower back shell and other component finishes have limited selections based on the upper back shell finish selection. ▶ See color scheme matrix, page 258.

Tip: Armless models cannot be modified to have arms after purchase. Conversely, chairs ordered with arms cannot be removed in the field after purchase.

► Options, continued from previous page

Options	U.S. Price	Required to Specify
Base • Polished aluminum	+\$125	Specify <i>with polished aluminum</i> .
Casters • Soft, dark grey treaded, dual-wheel roll-control casters for use on hard floors	+\$ 27	Specify <i>with soft casters</i> .
• Hard, hubless casters	+\$100	Specify <i>with hard, hubless casters</i> .
• Soft, hubless casters	+\$127	Specify <i>with soft, hubless casters</i> .
Glides • Glides	+\$ 27	Specify <i>with glides</i> .

Specification Information

Style Number	U.S. Base Price
418A000	\$989

► Detailed dimensions, page 262



For Canadian Pricing

Multiply U.S. Price by the Canadian price factor.

► See page 1 for details.

SILQ 418 Series Collaborative Stool



Tip: Fabric on the SILQ 418 Series will only be applied in the warp vertical/down roll direction. This includes all standard Steelcase fabrics, Select Surfaces, and COMs. ▶ See Fabric Application Direction Guidelines, page 511.

Tip: Stitch selection will be defaulted on standard leathers.

Tip: Lower back shell and other component finishes have limited selections based on the upper back shell finish selection. ▶ See color scheme matrix, page 258.

Tip: Armless models cannot be modified to have arms after purchase. Conversely, chairs ordered with arms cannot be removed in the field after purchase.

Standard Includes	Required to Specify
<ul style="list-style-type: none"> ▶ Need help? Product details, page 256 • 8" pneumatic seat-height adjustment (22⁷/₈" – 30⁷/₈") • Fixed arms: textured paint • Upper back shell and arm caps: plastic • Lower back shell: textured paint • Five-arm base: plastic • Standard upholstery design on seat: fabric price group 1 • Adjustable foot ring: plastic color • 2"-diameter, hard-composition, dual-wheel casters: black 	<ol style="list-style-type: none"> 1 Style number 2 Fabric color number for upholstery on seat 3 Plastic color number for upper back shell and arm caps 4 Paint color number for lower back shell 5 Paint color number for arms 6 Plastic color number for base 7 Plastic color number for foot ring 8 Options, if selected (see below) <p>▶ See <i>Surface Materials</i>, page 504.</p>

Options	U.S. Price	Required to Specify
Surface Materials <ul style="list-style-type: none"> • Upholstery on seat • Fabric price group 1 • Fabric price group 2 • Fabric price group 3 • Fabric price group 4 • Fabric price group 5 • Fabric price group 6 • Fabric price group 7 • Fabric price group 8 • Fabric price group 9 • Fabric price group 10 • Sewn upholstery • Steelcase leather upholstery • Select Surfaces leather price group 1 • Elmosoft leather • Select Surfaces leather price group 2 • Steelcase vinyl • Customer's Own Material (COM) • Customer's Own Leather (COL) • Soil-retardant treatment applied to upholstery fabric 	<ul style="list-style-type: none"> No cost +\$ 27 +\$ 49 +\$ 70 +\$ 88 +\$109 +\$125 +\$158 +\$194 +\$219 +\$100 +\$360 +\$360 +\$414 +\$414 +\$100 No cost +\$100 +\$ 27 	<ul style="list-style-type: none"> Specify fabric color number. Specify fabric color number. Specify fabric color number. Specify fabric color number. Specify fabric color number. Specify fabric color number. Specify fabric color number. Specify fabric color number. Specify fabric color number. Specify fabric color number. Add suffix S to the style number and specify fabric color number. Add suffix S to the style number and specify leather color number Add suffix S to the style number and specify leather color number. ▶ See <i>Surface Materials Reference Manual</i>. Add suffix S to the style number and specify Elmosoft leather color number. Add suffix S to the style number and specify leather color number. ▶ See <i>Surface Materials Reference Manual</i>. Add suffix S to the style number and specify vinyl color number. ▶ See <i>Surface Materials Reference Manual</i>. Add suffix S to style number and specify leather color number. ▶ See <i>Surface Materials Reference Manual</i>. Specify <i>with soil-retardant treatment</i>.
Stitch <ul style="list-style-type: none"> • Light • Dark 	<ul style="list-style-type: none"> No cost No cost 	<ul style="list-style-type: none"> Specify light stitch. Specify dark stitch.
Upper back shell <ul style="list-style-type: none"> • 6053 Seagull • 6249 Platinum Solid • 6527 Merle 	<ul style="list-style-type: none"> No cost No cost No cost 	<ul style="list-style-type: none"> Specify <i>with 6053 Seagull</i>. Specify <i>with 6249 Platinum Solid</i>. Specify <i>with 6527 Merle</i>.
Lower back shell <ul style="list-style-type: none"> • 7245 Carbon Metallic • 7360 Merle 	<ul style="list-style-type: none"> No cost No cost 	<ul style="list-style-type: none"> Specify <i>with 7245 Carbon Metallic</i>. Specify <i>with 7360 Merle</i>.
Arms <ul style="list-style-type: none"> • Armless • Polished aluminum 	<ul style="list-style-type: none"> -\$ 61 +\$150 	<ul style="list-style-type: none"> Specify <i>without arms</i>. Specify <i>with polished aluminum</i>.

▶ **Options, continued on next page**

► Options, continued from previous page

Options	U.S. Price	Required to Specify
Base • Polished aluminum	+\$125	Specify <i>with polished aluminum</i> .
Casters • Soft, dark grey treaded, dual-wheel roll-control casters for use on hard floors	+\$ 27	Specify <i>with soft casters</i> .
• Hard, hubless casters	+\$100	Specify <i>with hard, hubless casters</i> .
• Soft, hubless casters	+\$127	Specify <i>with soft, hubless casters</i> .
Glides • Glides	+\$ 27	Specify <i>with glides</i> .

Specification Information

Style Number	U.S. Base Price
418B000	\$1193

► Detailed dimensions, page 262



For Canadian Pricing
Multiply U.S. Price by the Canadian price factor.
► See page 1 for details.

Understanding and Specifying QiVi 428 Series

Product Details

QiVi 428 Series	270
Dimensions	274

Specifying

Collaborative Chair	276
Collaborative Stool	277
Sled-Base Multi-Use Chairs	278

Collaborative chairs

Collaborative seating promotes comfort for long periods of time and promotes movement, offers automatic and intuitive adjustments, and supports multiple postures.

- QiVi 428 Series
- cob i 434 Series
- i2i 416 Series
- Node 480 Series

Adjustability Features

▶ See page 22 for a comparison to other chairs

QiVi 428 Series

Mechanisms

360°-swivel	●
-------------	---

Seat Adjustments

Pneumatic height	●
------------------	---

Gliding seat	●
--------------	---

Back Adjustments

Self adjusting	●
----------------	---

Pivoting back	●
---------------	---

Other Features

Foot ring height (stool)	●
--------------------------	---

QiVi 428 Series

QiVi is a family of seating, inspired by collaboration and designed to encourage movement and support various postures. With its pivoting backrest and gliding seat, QiVi adjusts automatically to provide comfort for extended periods of time.

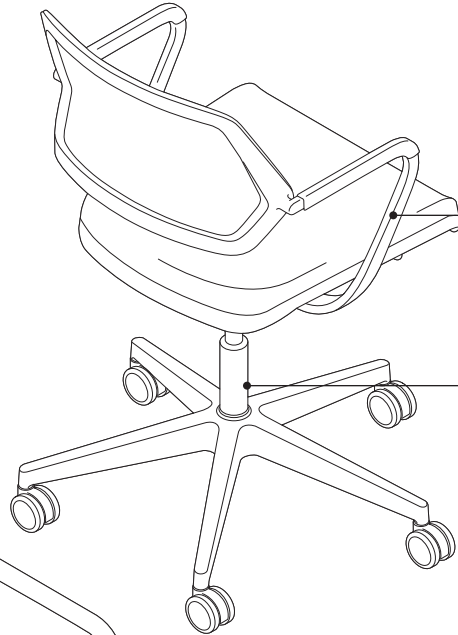

Arms are painted aluminum with a soft touch painted plastic arm cap. Polished aluminum arms are available as an option.

Seat height adjusts 4 1/2" from 17 1/2"H to 22"H with a pneumatic adjustment mechanism.

Back frame, seat shell, and arm caps are plastic and will always coordinate finish color.

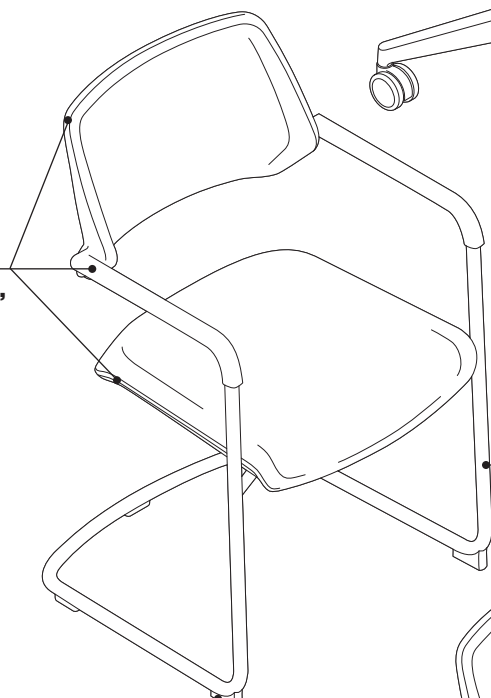

Frame is painted steel with a soft touch painted plastic arm cap. Polished chrome is available as an option.

Pivoting back rotates 15° automatically, encouraging movement and sitting in multiple postures.

Hard plastic glides are standard, soft glides are available as an option.

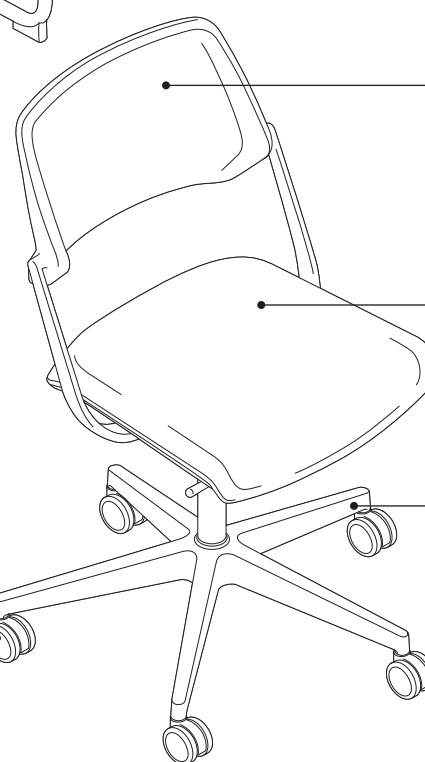

Gliding seat has a 1" range. Movement is automatic and follows the user as they shift postures. A fixed seat is available as an option.

Five-arm base is plastic, a polished aluminum base is available as an option.

Casters have hard, dual-wheels that roll smoothly on carpets. They are 2 1/2" for increased mobility. Soft, dark grey treaded, dual-wheel roll-control casters are available for use on hard floors or mats. Stools are standard with 2" hard casters. Soft casters are available as an option.
Tip: Do not roll the chair across asphalt during installation as this may damage the casters.

Product Details



Five-arm base chairs and stools are available with and without arms.

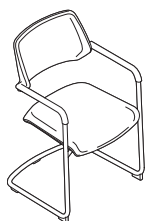

Sled-base is available with arms only.

360° adjustable height swivel mechanism is standard on five-arm base models.

QiVi ships standard assembled and uncartoned. Cartoned shipment is available as an option.

Stacking density for sled-base stacking chairs is three on the floor. Bases on the stacking chairs have a slight bend at the front of each leg.

Adjustment Features

Adjustability instructions are included with every swivel-base chair. Instructions can also be found at www.steelcase.com.

Seat Adjustments

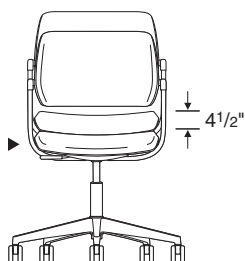

Seat height adjusts pneumatically. To lower, pull lever up while seated. To raise, pull lever up and keep your weight off the chair.

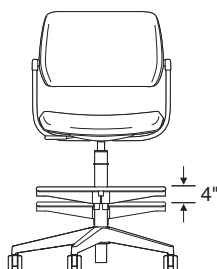

Foot ring height on stools adjusts by first lifting ring and rotating it counter-clockwise to unlock. Then raise or lower ring up to 4" to desired position before rotating it clockwise to lock. The foot ring has a diameter of 20".

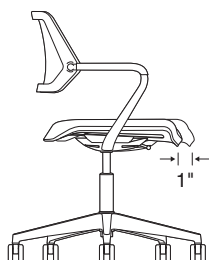

Gliding seat automatically glides forward and back, adjusting to the natural motion of your body. The seat glides within a 1" range and returns to a neutral position when the user leaves the seat. The gliding seat is a standard feature, a fixed seat option is available.

Back Adjustments

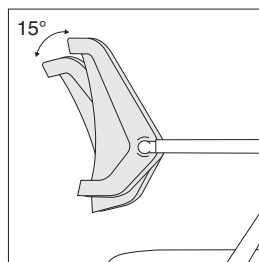

Pivoting back automatically follows the natural motion of your back as you recline, encouraging movement and supporting multiple postures. The backrest pivot range is 15° and will return to the neutral position when the user is not applying pressure to the back.

Other features

Soft wheel casters for hard floors on five-arm base models are available for specific applications.

Hard glides come standard on sled base chairs, soft glides are available as an option.

Surface Materials

▶ See surface materials on page 504 for specific availability or refer to the *Surface Materials Reference Manual* for further information.

Back Upholstery

QiVi Net (back only)

- QN01 Wasabi
- QN02 Licorice
- QN03 Tangerine
- QN04 Graphite
- QN05 Malt
- QN06 Coconut
- QN07 Scarlet
- QN08 Blue Jay
- QN10 Aubergine
- QN11 Peacock
- QN12 Jungle
- QN13 Merlot
- QN14 Honey
- QN15 Lagoon
- QN16 Saffron

Seat Upholstery

- Cogent: Connect fabric
- Fabric
- Fabric with soil-retardant treatment (option)
- Leather
- Elmosoft Leather
- Select Surfaces leather
- Vinyl
- COM
- COL

Tip: Some Steelcase seating fabrics are available with and without a stitched detail on the seat. See seating upholstery matrix for details.

Lux Coatings

QiVi sled-base chairs (base only)

- 4B20 Obsidian
- 4B22 Matte Brass
- 4B23 Burnished Bronze
- 4B24 Night Bronze
- 4B25 Matte Copper

Plastic components

Back frame, seat shell, and arm caps

- 6009 Arctic White
- 6205 Black
- 6249 Platinum

Tip: Only one finish can be selected for all three plastic components.

Base, frame, and arms

- 6205 Black
- 7241 Textured Arctic White
- 4799 Platinum Metallic
- 8046 Polished Aluminum (five-arm only)
- 9201 Polished Chrome (sled only)

Castors and glides

- 6205 Black

Foot ring on stools

- 6205 Black
- 6249 Platinum
- 7241 Arctic White

Tip: Foot ring and cylinder on stool will coordinate to match the base color.

All Steelcase seating with standard upholstery fabrics

complies with requirements of the State of California Technical Bulletin 117-2013. All standard seating is labeled to be in compliance with California 117-2013.

Programs & Services

▶ See the *Surface Materials Reference Manual* for further detail about programs and services offered for seating.

The Customer's Own Material (COM) Program

offers the opportunity for customers to select fabrics that are not offered through the standard Steelcase surface materials program for use on Steelcase products. Through the COM program, Steelcase will test your materials for application on Steelcase products. Once approved, you can place your order. Steelcase will facilitate the entire ordering process and give you a production schedule. Steelcase will order the COM fabric directly from the textile manufacturer. For up-to-date information regarding fabric test results for all COM fabrics and details regarding yardage requirements for most Seating lines, visit the COM website. To locate the COM website:

- Visit www.steelcase.com

QiVi 428 Series, continued

Soil retardants are treatments that provide long-term soil and stain resistance to a fabric without affecting the shade or the integrity of the fabric. The following Steelcase Textiles are available pre-treated with soil retardant. (You do not need to select the soil-retardant option for these fabrics and incur the upcharge.)

- Jacks
- Link
- Spyder

For information on soil retardant fabrics on Select Surfaces, please refer to the *Surface Materials Reference Manual*.

Soil-retardant treatment is available on all other seating fabrics at an additional upcharge per seating unit. To order this option, please select "Soil-Retardant Treatment" under "Optional Accessories."

For soil-retardant treatment on COMs, please select "Soil-Retardant Treatment" under "Optional Accessories." Minimums or additional yardage may be required. Please contact the vendor directly for specific information.

Extended lead times may be necessary for this service.

Contact your Steelcase Solutions Fulfillment Team Representative at 1.888.STEELCASE (1.888.783.3522) or send an email to lineone@steelcase.com.

Fire Codes

▶ See page 517 for upholstery fabrics available for use with FCS modification.

Steelcase offers Fire Code Seating modification (FCS) on some seating models.

The most rigorous fire codes in the nation have been developed in California, and the Steelcase FCS modification is designed to meet those codes. Fire Code Seating (FCS) indicates that a product is constructed to meet the strict fire code requirements of high public occupancy areas such as theaters, meeting rooms, and lobbies. The FCS standards will meet the State of California Bureau of Electronic and Appliance Repair, Home Furnishings, and Thermal Insulation Technical Bulletin 133 (Cal TB 133). Boston adopted the California Bureau of Electronic and Appliance Repair, Home Furnishings, and Thermal Insulation Technical Bulletin TB 133 test standard in 1992.

Local codes may have special requirements for upholstery.

Dimensions

▶ Page 274

Resources

Printed Materials

- ▶ QiVi Brochure (13-0000592)
- ▶ QiVi User Guide (13-0000217)

Online Resources

- ▶ QiVi technical animation available on SteelcaseTV YouTube channel
- ▶ QiVi Commercial available on SteelcaseTV YouTube channel
- ▶ Environmental profiles available on www.steelcase.com/sustainability.

Dimensions

QiVi 428 Series

Features	Overall Depth	Width	Height	Seat Depth	Functional Seat Depth	Seat Width	Seat Height from Floor	Ring Height from Floor	Back Width	Back Height from Seat
QiVi 428 Series										
Collaborative Chairs										
	22 ¹ / ₁₆ "	*22 ¹ / ₂ "	33 ¹ / ₄ "–38 ¹ / ₈ "	19 ⁷ / ₈ "	18 ¹ / ₂ "	18 ¹ / ₂ "	17 ¹ / ₂ "–22"	N.A.	18"	16 ¹ / ₂ "
Sled-Base Chairs										
	22 ¹ / ₈ "	22 ¹ / ₁₆ "	34"	19 ⁷ / ₈ "	18 ¹ / ₂ "	18 ¹ / ₂ "	18 ¹ / ₂ "	N.A.	18"	16 ¹ / ₂ "
Stools										
	22 ¹ / ₁₆ "	*22 ¹ / ₂ "	38 ¹ / ₄ "–46 ¹ / ₂ "	19 ⁷ / ₈ "	18 ¹ / ₂ "	18 ¹ / ₂ "	22"–30 ¹ / ₄ "	10 ¹ / ₂ "–14 ¹ / ₂ "	18"	16 ¹ / ₂ "

*Overall width does not include the base.
The diameter of the chair with the five-arm base is 26".

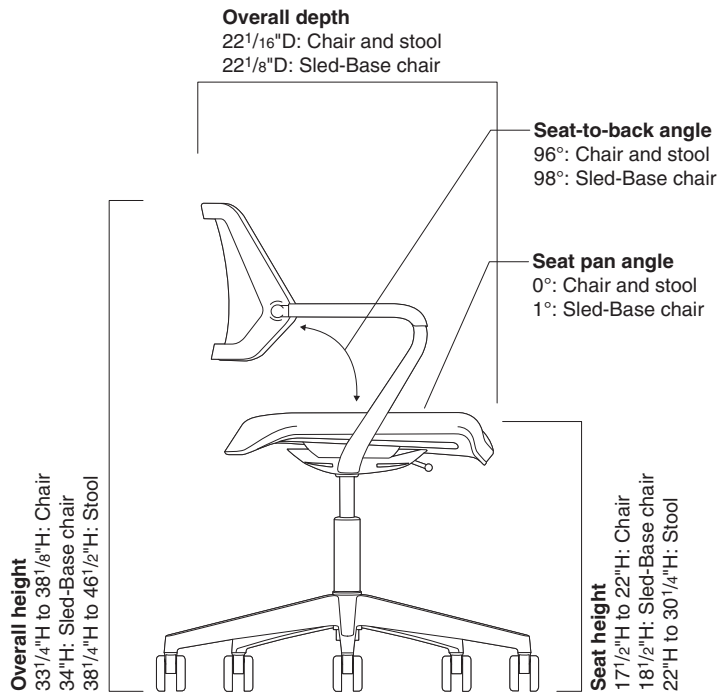
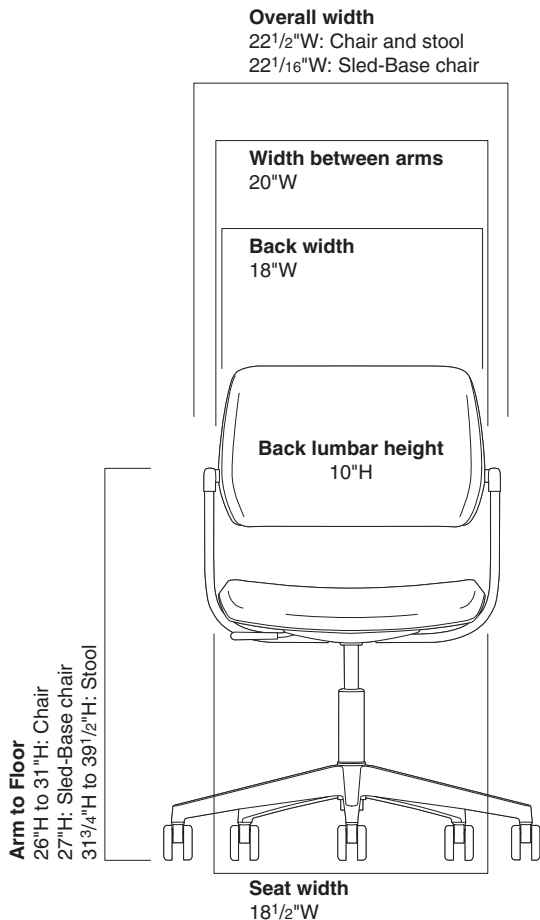

• Back Lumbar Height	• Width Between Arms	• Arm to Floor	• Arm Height from Seat	• Seat Pan Angle	• Angle Between Seat and Back
----------------------	----------------------	----------------	------------------------	------------------	-------------------------------

Collaborative Chairs

10"	20"	26"-31"	8½"	0°	96°
-----	-----	---------	-----	----	-----

Sled-Base Chairs

10"	20"	27"	8½"	1°	98°
-----	-----	-----	-----	----	-----

Stools

10"	20"	31¾"-39½"	8½"	0°	96°
-----	-----	-----------	-----	----	-----

:	:	:	:	:	:
---	---	---	---	---	---

QiVi 428 Series Collaborative Chair

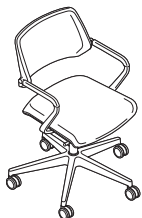

Standard Includes	Required to Specify
-------------------	---------------------

<p>► Need help? Product details, page 270</p> <ul style="list-style-type: none"> • 4 1/2" pneumatic seat-height adjustment (17 1/2" to 22") • Arms, if selected: 6205 black plastic to match base • Seat shell, outer back, and soft touch arm caps: plastic • Five-arm base: 6205 black plastic • QiVi Net upholstery on back • 15° pivoting backrest • Standard upholstery design on seat: fabric price group 1 • 1" gliding seat • 2 1/2"-diameter, hard-composition, dual-wheel casters: black 	<ol style="list-style-type: none"> 1 Style number 2 Plastic color number for base 3 Plastic color number for seat shell, outer back shell, and arm caps, if selected 4 QiVi Net color number for upholstery on back 5 Fabric color number for upholstery on seat 6 Options, if selected (see below) <p>► See <i>Surface Materials</i>, page 504.</p>
---	--

Options	U.S. Price	Required to Specify
---------	------------	---------------------

<p>Surface Materials</p> <ul style="list-style-type: none"> • Fabric price group 1 • Fabric price group 2 • Fabric price group 3 • Fabric price group 4 • Fabric price group 5 • Fabric price group 6 • Fabric price group 7 • Fabric price group 8 • Fabric price group 9 • Fabric price group 10 • Steelcase leather upholstery • Select Surfaces leather price group 1 • Elmosoft leather upholstery • Select Surfaces leather price group 2 • Sewn upholstery • Steelcase vinyl • Customer's Own Material (COM) • Customer's Own Leather (COL) • Customer's Own Material/Vinyl (COM-Sewn) • Fire Code Seating (FCS) • Soil-retardant treatment applied to upholstery fabric 	<p>Upholstery on seat</p> <ul style="list-style-type: none"> No cost No cost +\$ 27 +\$ 36 +\$ 43 +\$ 53 +\$ 64 +\$ 79 +\$ 97 +\$112 +\$225 +\$225 +\$254 +\$254 +\$ 43 +\$ 43 No cost +\$ 43 +\$ 43 +\$ 41 +\$ 27 	<p>Required to Specify</p> <p>Specify fabric color number. Specify fabric color number. Specify fabric color number. Specify fabric color number. Specify fabric color number. Specify fabric color number. Specify fabric color number. Specify fabric color number. Specify fabric color number. Specify fabric color number. Specify fabric color number. Add suffix S to the style number and specify leather color number. Add suffix S to the style number and specify Select Surfaces leather price group 1. ► See <i>Surface Materials Reference Manual</i>. Add suffix S to the style number and specify Elmosoft leather color number. Add suffix S to the style number and specify Select Surfaces leather price group 2. ► See <i>Surface Materials Reference Manual</i>. Add suffix S to the style number. Add suffix S to the style number and specify vinyl color number. ► See <i>Surface Materials Reference Manual</i>. Add suffix S to the style number and specify leather color number. Add suffix S to the style number and specify vinyl color number. Add suffix F to style number. Specify <i>with soil-retardant treatment</i>.</p> <p>Specify <i>with 6009 Arctic White</i>. Specify <i>with 4799 Platinum Metallic</i>. Specify <i>with polished aluminum</i>. Specify Lux Coatings color number.</p> <p>Specify <i>without arms</i>.</p> <p>Specify <i>with fixed seat</i>.</p> <p>Specify <i>with soft roll-control casters</i>.</p>
<p>Base</p> <ul style="list-style-type: none"> • Arctic white • Platinum metallic • Polished aluminum • Lux Coatings 	<ul style="list-style-type: none"> +\$ 59 +\$ 59 +\$135 +\$221 	<p>Specify <i>with 6009 Arctic White</i>. Specify <i>with 4799 Platinum Metallic</i>. Specify <i>with polished aluminum</i>. Specify Lux Coatings color number.</p>
<p>Arms</p> <ul style="list-style-type: none"> • Armless 	<ul style="list-style-type: none"> -\$ 68 	<p>Specify <i>without arms</i>.</p>
<p>Gliding Seat</p> <ul style="list-style-type: none"> • Fixed seat 	<ul style="list-style-type: none"> -\$ 35 	<p>Specify <i>with fixed seat</i>.</p>
<p>Casters</p> <ul style="list-style-type: none"> • Soft, dark grey treaded, dual-wheel roll-control casters for use on hard floors 	<ul style="list-style-type: none"> +\$ 27 	<p>Specify <i>with soft roll-control casters</i>.</p>

Tip: Always add suffixes in alphabetical order when specifying options to QiVi seating.

Tip: Fire Code Seating (FCS) option is available with certain upholstery fabric choices only.
► Page 517

► Detailed dimensions, page 274



For Canadian Pricing
Multiply U.S. Price by the Canadian price factor.
► See page 1 for details.

Specification Information	
Style Number	U.S. Base Price

428510	\$894
--------	-------

Qivi 428 Series Collaborative Stool



Standard Includes	Required to Specify
<p>▶ Need help? Product details, page 270</p> <ul style="list-style-type: none"> • 8¼" pneumatic seat-height adjustment (22" to 30¼") • Arms, if selected: 6205 black plastic to match base • Seat shell, outer back, and soft touch arm caps: plastic • Five-arm base: 6205 black plastic • Qivi Net upholstery on back • 15° pivoting backrest • Standard upholstery design on seat: Fabric price group 1 • 1" gliding seat • Adjustable foot ring: plastic color • 2"-diameter, hard-composition, dual-wheel casters: black 	<ol style="list-style-type: none"> 1 Style number 2 Plastic color number for base and foot ring 3 Plastic color number for seat shell, outer back shell, and arm caps, if selected 4 Qivi Net color number for upholstery on back 5 Fabric color number for upholstery on seat 6 Options, if selected (see below) <p>▶ See <i>Surface Materials</i>, page 504.</p>

Tip: Always add suffixes in alphabetical order when specifying options to Qivi seating.

Tip: Fire Code Seating (FCS) option is available with certain upholstery fabric choices only.
▶ Page 517

Options	U.S. Price	Required to Specify
<p>Surface Materials</p> <p>Upholstery on seat</p> <ul style="list-style-type: none"> • Fabric price group 1 • Fabric price group 2 • Fabric price group 3 • Fabric price group 4 • Fabric price group 5 • Fabric price group 6 • Fabric price group 7 • Fabric price group 8 • Fabric price group 9 • Fabric price group 10 • Steelcase leather upholstery • Select Surfaces leather price group 1 • Elmosoft leather upholstery • Select Surfaces leather price group 2 • Sewn upholstery • Steelcase vinyl • Customer's Own Material (COM) • Customer's Own Leather (COL) • Customer's Own Material/Vinyl (COM-Sewn) • Fire Code Seating (FCS) • Soil-retardant treatment applied to upholstery fabric 	<p>No cost</p> <p>No cost</p> <p>+\$ 27</p> <p>+\$ 36</p> <p>+\$ 43</p> <p>+\$ 53</p> <p>+\$ 64</p> <p>+\$ 79</p> <p>+\$ 97</p> <p>+\$112</p> <p>+\$225</p> <p>+\$225</p> <p>+\$254</p> <p>+\$254</p> <p>+\$ 43</p> <p>+\$ 43</p> <p>No cost</p> <p>+\$ 43</p> <p>+\$ 43</p> <p>+\$ 41</p> <p>+\$ 27</p>	<p>Specify fabric color number.</p> <p>Specify fabric color number.</p> <p>Specify fabric color number.</p> <p>Specify fabric color number.</p> <p>Specify fabric color number.</p> <p>Specify fabric color number.</p> <p>Specify fabric color number.</p> <p>Specify fabric color number.</p> <p>Specify fabric color number.</p> <p>Specify fabric color number.</p> <p>Add suffix S to the style number and specify leather color number.</p> <p>Add suffix S to the style number and specify Select Surfaces leather price group 1.</p> <p>▶ See <i>Surface Materials Reference Manual</i>. Add suffix S to the style number and specify Elmosoft leather color number.</p> <p>Add suffix S to the style number and specify Select Surfaces leather price group 2.</p> <p>▶ See <i>Surface Materials Reference Manual</i>. Add suffix S to the style number.</p> <p>Add suffix S to the style number and specify vinyl color number.</p> <p>▶ See <i>Surface Materials Reference Manual</i>. Add suffix S to the style number and specify leather color number.</p> <p>Add suffix S to the style number and specify vinyl color number.</p> <p>Add suffix F to style number.</p> <p>Specify <i>with soil-retardant treatment</i>.</p> <p>Specify <i>with 6009 Arctic White</i>.</p> <p>Specify <i>with 4799 Platinum Metallic</i>.</p> <p>Specify Lux Coatings color number.</p> <p>Specify <i>without arms</i>.</p> <p>Specify <i>with fixed seat</i>.</p> <p>Specify <i>with soft roll-control casters</i>.</p>
<p>Base</p> <ul style="list-style-type: none"> • Arctic white • Platinum metallic • Lux Coatings 	<p>+\$ 59</p> <p>+\$ 59</p> <p>+\$221</p>	<p>Specify <i>with 6009 Arctic White</i>.</p> <p>Specify <i>with 4799 Platinum Metallic</i>.</p> <p>Specify Lux Coatings color number.</p>
<p>Arms</p> <ul style="list-style-type: none"> • Armless 	<p>-\$ 68</p>	<p>Specify <i>without arms</i>.</p>
<p>Gliding Seat</p> <ul style="list-style-type: none"> • Fixed seat 	<p>-\$ 35</p>	<p>Specify <i>with fixed seat</i>.</p>
<p>Casters</p> <ul style="list-style-type: none"> • Soft, dark grey treaded, dual-wheel roll-control casters for use on hard floors 	<p>+\$ 27</p>	<p>Specify <i>with soft roll-control casters</i>.</p>

Specification Information	
Style Number	U.S. Base Price
428710	\$1249

▶ Detailed dimensions, page 274

For Canadian Pricing
Multiply U.S. Price by the Canadian price factor.
▶ See page 1 for details.

Qivi 428 Series

QiVi 428 Series Sled-Base Multi-Use Chairs

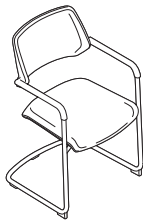

Standard Includes	Required to Specify
<ul style="list-style-type: none"> ▶ Need help? Product details, page 270 • Frame: 6205 black plastic to match base • Base, seat shell, outer back, and soft touch arm caps: plastic • QiVi Net upholstery on back • 15° pivoting backrest • Standard upholstery design on seat: fabric price group 1 • 1" gliding seat 	<ol style="list-style-type: none"> 1 Style number 2 Plastic color number for base 3 Plastic color number for, seat shell, outer back shell, and arm caps, if selected 4 QiVi Net color number for upholstery on back 5 Fabric color number for upholstery on seat 6 Options, if selected (see below) <p>▶ See <i>Surface Materials</i>, page 504.</p>

Options	U.S. Price	Required to Specify
<p>Surface Materials</p> <p>Upholstery on seat</p> <ul style="list-style-type: none"> • Fabric price group 1 • Fabric price group 2 • Fabric price group 3 • Fabric price group 4 • Fabric price group 5 • Fabric price group 6 • Fabric price group 7 • Fabric price group 8 • Fabric price group 9 • Fabric price group 10 • Steelcase leather upholstery • Select Surfaces leather price group 1 • Elmosoft leather upholstery • Select Surfaces leather price group 2 • Sewn upholstery • Steelcase vinyl • Customer's Own Material (COM) • Customer's Own Leather (COL) • Customer's Own Material/Vinyl (COM-Sewn) • Fire Code Seating (FCS) • Soil-retardant treatment applied to upholstery fabric 	<ul style="list-style-type: none"> No cost No cost +\$ 27 +\$ 36 +\$ 43 +\$ 53 +\$ 64 +\$ 79 +\$ 97 +\$112 +\$225 +\$225 +\$254 +\$254 +\$ 43 +\$ 43 No cost +\$ 43 +\$ 43 +\$ 41 +\$ 27 	<p>Specify fabric color number.</p> <p>Specify fabric color number.</p> <p>Specify fabric color number.</p> <p>Specify fabric color number.</p> <p>Specify fabric color number.</p> <p>Specify fabric color number.</p> <p>Specify fabric color number.</p> <p>Specify fabric color number.</p> <p>Specify fabric color number.</p> <p>Specify fabric color number.</p> <p>Specify fabric color number.</p> <p>Add suffix S to the style number and specify leather color number.</p> <p>Add suffix S to the style number and specify Select Surfaces leather price group 1.</p> <p>▶ See <i>Surface Materials Reference Manual</i>. Add suffix S to the style number and specify Elmosoft leather color number.</p> <p>Add suffix S to the style number and specify Select Surfaces leather price group 2.</p> <p>▶ See <i>Surface Materials Reference Manual</i>. Add suffix S to the style number.</p> <p>Add suffix S to the style number and specify vinyl color number.</p> <p>▶ See <i>Surface Materials Reference Manual</i>. Add suffix S to the style number and specify leather color number.</p> <p>Add suffix S to the style number and specify vinyl color number.</p> <p>Add suffix F to style number.</p> <p>Specify <i>with soil-retardant treatment</i>.</p> <hr/> <p>Specify <i>with 6009 Arctic White</i>.</p> <p>Specify <i>with 4799 Platinum Metallic</i>.</p> <p>Specify Lux Coatings color number.</p> <p>Specify <i>with polished chrome</i>.</p> <hr/> <p>Specify <i>with fixed seat</i>.</p> <hr/> <p>Specify <i>with hard glides</i>.</p> <p>Specify <i>with soft glides</i>.</p>
<p>Base</p> <ul style="list-style-type: none"> • Arctic white • Platinum metallic • Lux Coatings • Polished chrome 	<ul style="list-style-type: none"> +\$ 59 +\$ 59 +\$129 +\$163 	
<p>Gliding Seat</p> <ul style="list-style-type: none"> • Fixed seat 	<ul style="list-style-type: none"> -\$ 35 	
<p>Glides</p> <ul style="list-style-type: none"> • Hard glides for use on carpeted floors • Soft glides for use on non-carpeted floors 	<ul style="list-style-type: none"> No cost +\$ 6 	

Tip: Always add suffixes in alphabetical order when specifying options to QiVi seating.

Tip: Fire Code Seating (FCS) option is available with certain upholstery fabric choices only.
▶ Page 517

▶ See page 271 for a list of Lux Coatings finish numbers.

▶ Detailed dimensions, page 274



For Canadian Pricing

Multiply U.S. Price by the Canadian price factor.

▶ See page 1 for details.

Specification Information

• Style	• U.S.
• Number	• Base
•	• Price
•	•

Sled-Base

428310	\$730
•	•

Stacking Sled-Base

428910	\$730
•	•

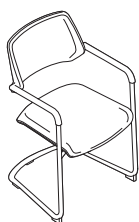
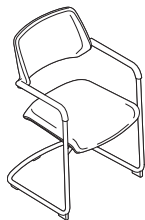

 **For Canadian Pricing**
Multiply U.S. Price by the
Canadian price factor.
▶ See page 1 for details.

Understanding and Specifying cobi 434 Series Collaborative Chairs

Product Details

cobi 434 Series	282
Dimensions	284

Specifying

Collaborative Chairs	286
Swivel-Base Stools	288

Collaborative chairs

Collaborative seating promotes comfort for long periods of time and promotes movement, offers automatic and intuitive adjustments, and supports multiple postures.

- QiVi 428 Series
- cob i 434 Series
- i2i 416 Series
- Node 480 Series

Adjustability Features

▶ See page 22 for a comparison to other chairs

cobi 434 Series

Mechanisms

Weight-activated	●
------------------	---

Seat Adjustments

Pneumatic height	●
------------------	---

Back Adjustments

Self adjusting	●
----------------	---

Other Features

Foot ring height (stool)	●
--------------------------	---

cobi 434 Series

cobi is collaborative seating for teams that helps people move freely, change postures, and stay energized and comfortable.

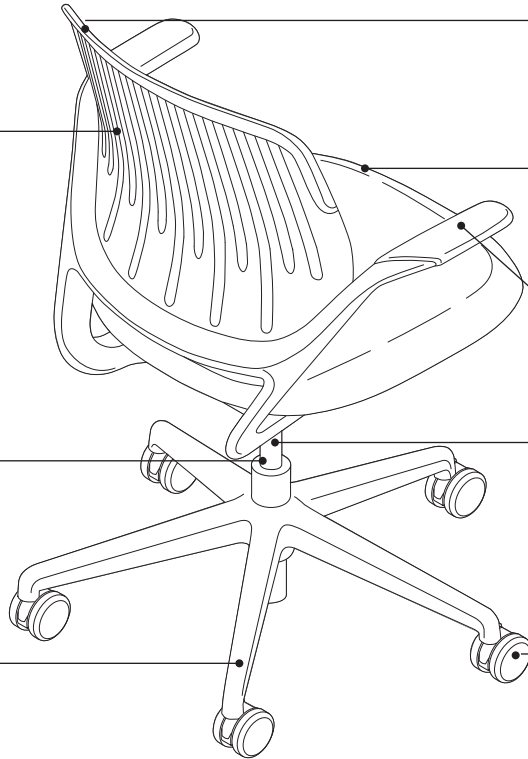

Flexing fingers in back offer support while moving and conforming to the user.

Weight-activated mechanism provides support by automatically responding to the users movements.

Five-arm base is standard.

Flexible top edge allows for multiple postures while maintaining support and comfort.

Flexible seat edge on all 3-sides supports multiple postures while relieving thigh pressure.

Arms are constructed of a soft durable rubber compound.

Seat height adjusts with a 5" range from 15½"H to 20½"H with a pneumatic adjustment mechanism.

Casters have hard, dual-wheels that roll smoothly on carpets. They are 2½" for increased mobility. Soft, dark grey treaded, dual-wheel roll-control casters are available for use on hard floors or mats. Stools are standard with 2" hard casters. Soft casters are available as an option.
Tip: Do not roll the chair across asphalt during installation as this may damage the casters.

Product Details



Chairs and stools are available with or without arms.



Weight-activated mechanism provides individual support without a tension control by intuitively sensing and supporting the users center of gravity.

cobi ships standard assembled and uncartoned. A cartoned request on a dealer purchase order forces cobi chairs to ship unassembled with the chair seat, back, and cylinder separated from the base. This allows for shipment in a smaller carton. Assembly by a qualified dealer installer is required. Assembly instructions are included. No additional tools are required for assembly.

Adjustment Features

Seat Adjustments

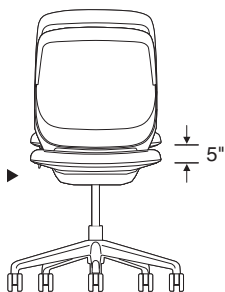

Seat height adjusts pneumatically. To lower, pull lever up while seated. To raise, pull lever up and keep your weight off the chair.

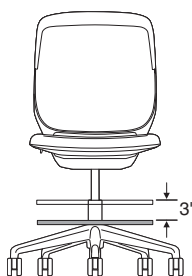

Foot ring height on stools adjusts by first lifting ring and rotating it counter-clockwise to unlock. Then raise or lower ring up to 3" to desired position before rotating it clockwise to lock. The foot ring has a diameter of 20".

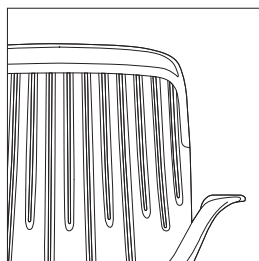

Flexing fingers in back promote movement and provide support for a wide range of postures.

Soft roll-control caster option features an internal brake that activates when the chair is not under load to reduce shifting when user stands up.

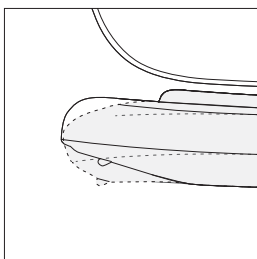

Flexing seat edge on all 3-sides supports multiple postures while relieving thigh pressure.

Surface Materials

► See surface materials on page 504 for specific availability or refer to the *Surface Materials Reference Manual* for further information.

Back Upholstery

- Connect 3D (back only)

Seat Upholstery

- Cogent: Connect (seat only)
- Fabric
- Fabric with soil-retardant treatment (option)
- Leather
- Elmosoft leather
- Select Surfaces leather
- Vinyl
- COM
- COL

All seat upholstery except standard Cogent: Connect requires a sewn application. Specify with an **S** suffix.

Outer Back

- 6009 Arctic White
- 6205 Black
- 6249 Platinum
- 6295 Near Black

Arm Caps, Top Edge, and Casters

- 6205 Black
- 6249 Platinum

Tip: Frame, base, and cylinder will default to match outer back color.

Tip: If black or near black are specified on the outer back, the arm caps, top edge, and casters will be 6205 black. If platinum or arctic white are specified on the outer back, the arm caps, top edge, and casters will be 6249 platinum.

Glides

- Black plastic

Foot ring on stools

- 6205 Black
- 6249 Platinum

Tip: Foot ring on stool will coordinate to match outer back color.

All Steelcase seating with standard upholstery fabrics complies with requirements of the State of California Technical Bulletin 117-2013. All standard seating is labeled to be in compliance with California 117-2013.

Programs & Services

► See the *Surface Materials Reference Manual* for further detail about programs and services offered for seating.

The Customer's Own Material (COM) Program

offers the opportunity for customers to select fabrics that are not offered through the standard Steelcase surface materials program for use on Steelcase products. Through the COM program, Steelcase will test your materials for application on Steelcase products. Once approved, you can place your order. Steelcase will facilitate the entire ordering process and give you a production schedule. Steelcase will order the COM fabric directly from the textile manufacturer. For up-to-date information regarding fabric test results for all COM fabrics and details regarding yardage requirements for most Seating lines, visit the COM website. To locate the COM website:

- Visit www.steelcase.com

Soil retardants are treatments that provide long-term soil and stain resistance to a fabric without affecting the shade or the integrity of the fabric. The following Steelcase Textiles are available pre-treated with soil retardant. (You do not need to select the soil-retardant option for these fabrics and incur the upcharge.)

- Jacks
- Link
- Spyder

For information on soil retardant fabrics on Select Surfaces, please refer to the *Surface Materials Reference Manual*.

Soil-retardant treatment is available on all other seating fabrics at an additional upcharge per seating unit. To order this option, please select "Soil-Retardant Treatment" under "Optional Accessories."

For soil-retardant treatment on COMs, please select "Soil-Retardant Treatment" under "Optional Accessories." Minimums or additional yardage may be required. Please contact the vendor directly for specific information.

Extended lead times may be necessary for this service.

Contact your Steelcase Solutions Fulfillment Team Representative at 1.888.STEELCASE (1.888.783.3522) or send an email to lineone@steelcase.com.

Fire Codes

► See page 517 for upholstery fabrics available for use with FCS modification.

Steelcase offers Fire Code Seating modification (FCS) on some seating models. The most rigorous fire codes in the nation have been developed in California, and the Steelcase FCS modification is designed to meet those codes. Fire Code Seating (FCS) indicates that a product is constructed to meet the strict fire code requirements of high public occupancy areas such as theaters, meeting rooms, and lobbies. The FCS standards will meet the State of California Bureau of Electronic and Appliance Repair, Home Furnishings, and Thermal Insulation Technical Bulletin 133 (Cal TB 133). Boston adopted the California Bureau of Electronic and Appliance Repair, Home Furnishings, and Thermal Insulation Technical Bulletin TB 133 test standard in 1992.

Local codes may have special requirements for upholstery.

Dimensions

► Page 284

Resources

Printed Materials

- **cobi Brochure** (09-0000049)
- **cobi User Guide** (10-0002706)

Online Resources

- **Come Together** (PDF) available on www.steelcase.com
- **Collaborative Seating Design** video available on www.steelcase.com
- **Environmental profiles** available on www.steelcase.com/sustainability.

Dimensions

cobi 434 Series

Features	Overall Depth	Width	Height	Seat Depth	Functional Seat Depth	Seat Width	Seat Height from Floor	Ring Height from Floor	Back Width	Back Height from Seat
cobi 434 Series										
Collaborative Chairs										
	23 ¹ / ₄ "	24 ³ / ₄ "	34"-39"	19 ¹ / ₂ "	17 ⁷ / ₈ "	18 ³ / ₄ "	15 ¹ / ₂ "-20 ¹ / ₂ "	N.A.	18"	19 ¹ / ₂ "
Stools										
	23 ¹ / ₄ "	24 ³ / ₄ "	40"-50"	19 ¹ / ₂ "	17 ⁷ / ₈ "	18 ³ / ₄ "	21"-31"	11 ¹ / ₄ "-14 ¹ / ₄ "	18"	19 ¹ / ₂ "

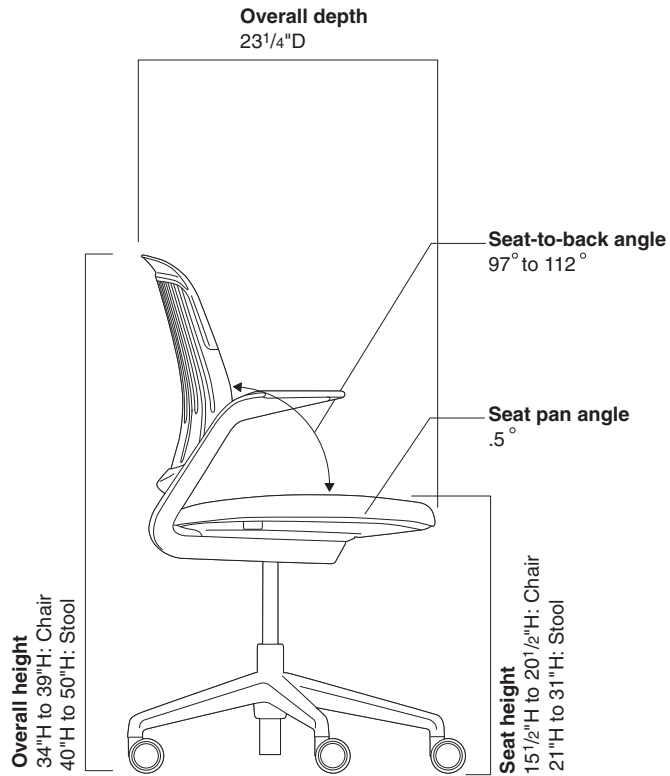
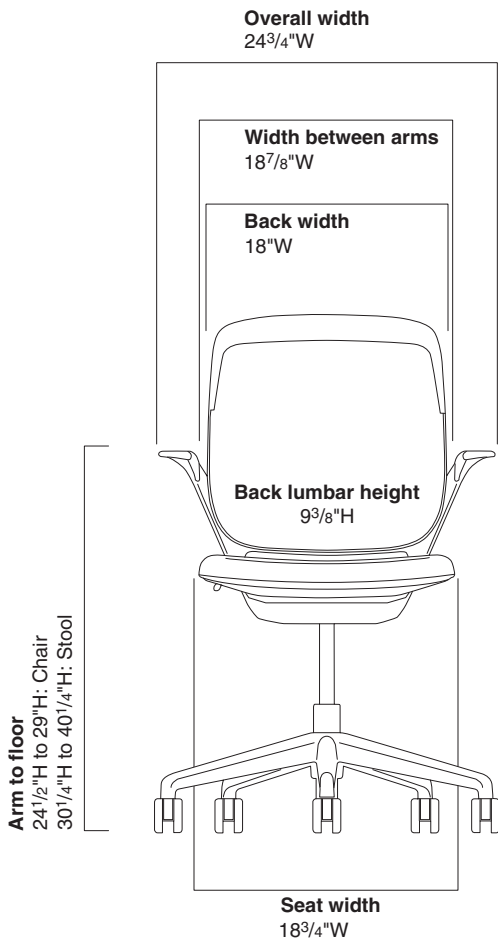

• Back Lumbar Height	• Width Between Arms	• Arm to Floor	• Arm Height from Seat	• Seat Pan Angle	• Angle Between Seat and Back
----------------------	----------------------	----------------	------------------------	------------------	-------------------------------

Collaborative Chairs

9 ³ / ₈ "	18 ⁷ / ₈ "	24 ¹ / ₄ "–29"	8 ⁷ / ₈ "	.5°	97°–112°
---------------------------------	----------------------------------	--------------------------------------	---------------------------------	-----	----------

Stools

9 ³ / ₈ "	18 ⁷ / ₈ "	30 ¹ / ₄ "–40 ¹ / ₄ "	8 ⁷ / ₈ "	.5°	97°–112°
---------------------------------	----------------------------------	---	---------------------------------	-----	----------

: : : : :

cobi 434 Series Collaborative Chairs



Standard Includes	Required to Specify
<ul style="list-style-type: none"> ▶ Need help? Product details, page 282 • Weight-activated mechanism • 5" pneumatic seat-height adjustment • Fixed arms, if selected: plastic to match outer back • Back upholstery: Connect 3D • Seat upholstery: Cogent: Connect • Frame, outer back, and five-arm base: Black • 2½"-diameter, hard composition, dual-wheel casters: black plastic 	<ol style="list-style-type: none"> 1 Style number 2 Plastic color number for outer back 3 Connect 3D color number for back 4 Cogent: Connect color number for upholstery on seat 5 Options, if selected (see below) <ul style="list-style-type: none"> ▶ See <i>Surface Materials</i>, page 504.

*Tip: All seat upholstery except standard Cogent: Connect requires a sewn application. Specify with an **S** suffix.*

Tip: Always add suffixes in alphabetical order when specifying options to cobi seating.

Options	U.S. Price	Required to Specify
Surface Materials <ul style="list-style-type: none"> • Upholstery • Fabric price group 1 • Fabric price group 2 • Fabric price group 3 • Fabric price group 4 • Fabric price group 5 • Fabric price group 6 • Fabric price group 7 • Fabric price group 8 • Fabric price group 9 • Fabric price group 10 • Steelcase leather upholstery • Select Surfaces leather price group 1 • Elmosoft leather upholstery • Select Surfaces leather price group 2 • Sewn Upholstery • Steelcase vinyl • Customer's Own Material (COM) • Customer's Own Leather (COL) • Customer's Own Material/Vinyl (COM-Sewn) • Fire Code Seating (FCS) • Soil-retardant treatment applied to upholstery fabric 	<ul style="list-style-type: none"> No cost No cost +\$ 27 +\$ 36 +\$ 43 +\$ 53 +\$ 64 +\$ 79 +\$ 97 +\$112 +\$225 +\$225 +\$254 +\$254 +\$ 43 +\$ 43 +\$ 43 +\$ 43 +\$113 +\$ 27 	<ul style="list-style-type: none"> Add suffix S to the style number and specify fabric color number. Add suffix S to the style number and specify fabric color number. Add suffix S to the style number and specify fabric color number. Add suffix S to the style number and specify fabric color number. Add suffix S to the style number and specify fabric color number. Add suffix S to the style number and specify fabric color number. Add suffix S to the style number and specify fabric color number. Add suffix S to the style number and specify fabric color number. Add suffix S to the style number and specify fabric color number. Add suffix S to the style number and specify fabric color number. Add suffix S to the style number and specify fabric color number. Add suffix S to the style number and specify leather color number. Add suffix S to the style number and specify Select Surfaces leather price group 1. ▶ See <i>Surface Materials Reference Manual</i>. Add suffix S to the style number and specify Elmosoft leather color number. Add suffix S to the style number and specify Select Surfaces leather price group 2. ▶ See <i>Surface Materials Reference Manual</i>. Add suffix S to the style number and specify fabric color number. Add suffix S to the style number and specify vinyl color number. Add suffix S to the style number and specify fabric color number. Add suffix S to the style number and specify leather color number. Add suffix S to the style number and specify vinyl color number. Add suffix F to the style number. Specify with <i>soil-retardant treatment</i>.
<ul style="list-style-type: none"> • Outer back • Arctic white • Platinum • Near black 	<ul style="list-style-type: none"> +\$ 89 +\$ 89 +\$ 89 	<ul style="list-style-type: none"> Specify with <i>6009 Arctic White</i>. Specify with <i>6249 Platinum</i>. Specify with <i>6295 Near Black</i>.
<ul style="list-style-type: none"> • Casters • Soft, dark grey treaded, dual-wheel roll-control casters for use on hard floors 	<ul style="list-style-type: none"> +\$ 27 	<ul style="list-style-type: none"> Specify with <i>soft roll-control casters</i>.
<ul style="list-style-type: none"> • Glides • Glides: black plastic 	<ul style="list-style-type: none"> +\$ 27 	<ul style="list-style-type: none"> Specify with <i>glides</i>.

Tip: Fire Code Seating (FCS) option is available with certain upholstery fabric choices only.
▶ Page 517

Tip: Arm caps, top edge, and casters default to coordinate and match outer back color.

▶ Detailed dimensions, page 284

Specification Information

**Arms with
Soft Arm Caps**



• Style
• Number

• U.S.
• Base
• Price

434111

\$796

Without Arms



• Style
• Number

• U.S.
• Base
• Price

434110

\$734

cobi 434 Series



For Canadian Pricing

Multiply U.S. Price by the Canadian price factor.

▶ See page 1 for details.

cobi 434 Series Swivel-Base Stools

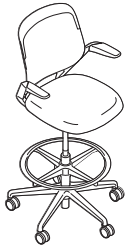

Standard Includes	Required to Specify
<ul style="list-style-type: none"> ▶ Need help? Product details, page 282 • Weight-activated mechanism • 10" pneumatic seat-height adjustment • Fixed arms, if selected: plastic to match outer back • Adjustable foot ring: black • Back upholstery: Connect 3D • Seat upholstery: Cogent: Connect • Frame, outer back, and five-arm base: black • 2½"-diameter, hard composition, dual-wheel casters: black plastic 	<ol style="list-style-type: none"> 1 Style number 2 Plastic color number for outer back 3 Connect 3D color number for back 4 Cogent: Connect color number for upholstery on seat 5 Options, if selected (see below) <ul style="list-style-type: none"> ▶ See <i>Surface Materials</i>, page 504.

*Tip: All seat upholstery except standard Cogent: Connect requires a sewn application. Specify with an **S** suffix.*

Tip: Always add suffixes in alphabetical order when specifying options to cobi seating.

Options	U.S. Price	Required to Specify
<p>Surface Materials</p> <p>Upholstery</p> <ul style="list-style-type: none"> • Fabric price group 1 • Fabric price group 2 • Fabric price group 3 • Fabric price group 4 • Fabric price group 5 • Fabric price group 6 • Fabric price group 7 • Fabric price group 8 • Fabric price group 9 • Fabric price group 10 • Steelcase leather upholstery • Select Surfaces leather price group 1 • Elmosoft leather upholstery • Select Surfaces leather price group 2 • Sewn Upholstery • Steelcase vinyl • Customer's Own Material/Vinyl (COM) • Customer's Own Leather (COL) • Fire Code Seating (FCS) • Soil-retardant treatment applied to upholstery fabric <p>Outer back</p> <ul style="list-style-type: none"> • Arctic white • Platinum • Near black 	<ul style="list-style-type: none"> No cost No cost +\$ 27 +\$ 36 +\$ 43 +\$ 53 +\$ 64 +\$ 79 +\$ 97 +\$112 +\$225 +\$225 +\$254 +\$254 +\$ 43 +\$ 43 +\$ 43 +\$ 43 +\$113 +\$ 27 +\$136 +\$136 +\$136 	<p>Add suffix S to the style number and specify fabric color number.</p> <p>Add suffix S to the style number and specify fabric color number.</p> <p>Add suffix S to the style number and specify fabric color number.</p> <p>Add suffix S to the style number and specify fabric color number.</p> <p>Add suffix S to the style number and specify fabric color number.</p> <p>Add suffix S to the style number and specify fabric color number.</p> <p>Add suffix S to the style number and specify fabric color number.</p> <p>Add suffix S to the style number and specify fabric color number.</p> <p>Add suffix S to the style number and specify fabric color number.</p> <p>Add suffix S to the style number and specify fabric color number.</p> <p>Add suffix S to the style number and specify fabric color number.</p> <p>Add suffix S to the style number and specify fabric color number.</p> <p>Add suffix S to the style number and specify fabric color number.</p> <p>Add suffix S to the style number and specify leather color number.</p> <p>Add suffix S to the style number and specify Select Surfaces leather price group 1.</p> <p>▶ See <i>Surface Materials Reference Manual</i>. Add suffix S to the style number and specify Elmosoft leather color number.</p> <p>Add suffix S to the style number and specify Select Surfaces leather price group 2.</p> <p>▶ See <i>Surface Materials Reference Manual</i>. Add suffix S to the style number and specify fabric color number.</p> <p>Add suffix S to the style number and specify vinyl color number.</p> <p>Add suffix S to the style number and specify fabric color number.</p> <p>Add suffix S to the style number and specify leather color number.</p> <p>Add suffix F to the style number. Specify <i>with soil-retardant treatment</i>.</p> <p>Specify <i>with 6009 Arctic White</i>.</p> <p>Specify <i>with 6249 Platinum</i>.</p> <p>Specify <i>with 6295 Near Black</i>.</p>
<p>Casters</p> <ul style="list-style-type: none"> • Soft, dark grey treaded, dual-wheel roll-control casters for use on hard floors 	<ul style="list-style-type: none"> +\$ 27 	<p>Specify <i>with soft roll-control casters</i>.</p>
<p>Glides</p> <ul style="list-style-type: none"> • Glides: black plastic 	<ul style="list-style-type: none"> +\$ 27 	<p>Specify <i>with glides</i>.</p>

Tip: Fire Code Seating (FCS) option is available with certain upholstery fabric choices only.

▶ Page 517

Tip: Arm caps, top edge, and casters default to coordinate and match outer back color.

▶ Detailed dimensions, page 284

Specification Information

**Arms with
Soft Arm Caps**



• Style
• Number

434711

• U.S.
• Base
• Price

\$1111

Without Arms



• Style
• Number

434710

• U.S.
• Base
• Price

\$1049

cobi 434 Series



For Canadian Pricing

Multiply U.S. Price by the Canadian price factor.

▶ See page 1 for details.

Understanding and Specifying i2i 416 Series

Collaborative Chairs and Collaborative Lounge Table

Product Details

i2i 416 Series	292
Dimensions	294

Specifying

Collaborative Chairs	296
Collaborative Lounge Table	297

Collaborative Chairs

Collaborative seating promotes comfort for long periods of time and promotes movement, offers automatic and intuitive adjustments, and supports multiple postures.

- QiVi 428 Series
- cobī 434 Series
- i2i 416 Series
- Node 480 Series

Adjustability Features

▶ See page 22 for a comparison to other chairs

i2i 416 Series

Mechanisms

Dual-swivel	●
-------------	---

Back Adjustments

Self adjusting	●
----------------	---

i2i 416 Series

i2i is collaborative seating that helps people move freely, change postures, and stay energized and comfortable.

Upholstery specified is applied to seat and arms.

Flexing fingers form the back and offer support while moving and conforming to your body.

Dual-swivel mechanism allows the back and seat to swivel independently as well as together.

Four-arm base is standard in polished aluminum.

Glides are standard with the static base.

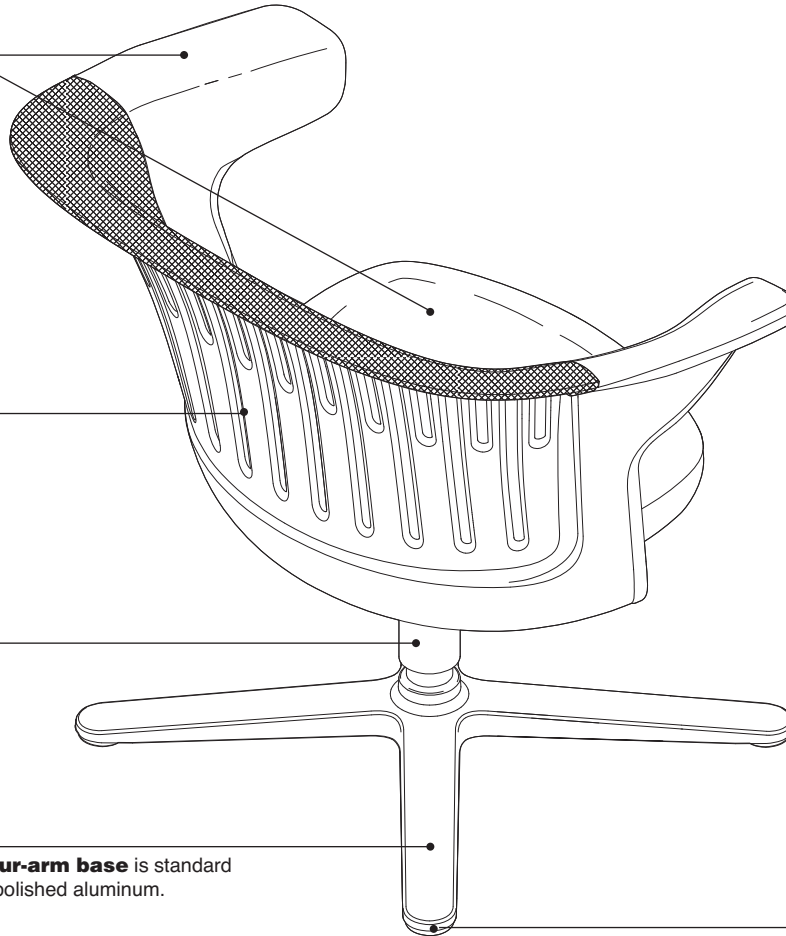

Product Details

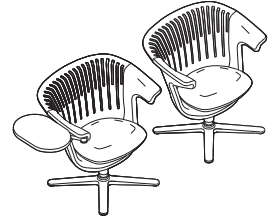

Chairs are available with or without tablet arm.

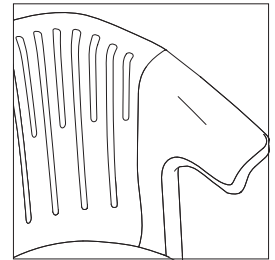

Flexing fingers in the back promote movement and provide support in a variety of postures.

Dual-swivel mechanism allows the back and seat to swivel independently as well as together.

Tablet arm attaches on the right side of the chair with a dual pivot function providing a range of motion that allows the tablet area to accommodate both left and right handed users. It provides a work-surface 12¹/₄"D x 18"W. The tablet ships separately and requires field assembly and installation.

Adjustment Features

Swivel-return cylinder option has a built in memory and will return to the fixed position when the user leaves the chair.

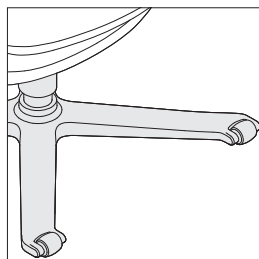

Mobile base includes two rollers on the front arms of the base that allow the chair to be moved easily.

Surface Materials

▶ See surface materials on page 504 for specific availability or refer to the *Surface Materials Reference Manual* for further information.

Back Upholstery

- 3D Knit (back only)

Seat and Arm Upholstery

- Cogent: Connect (seat and arm only)
- Fabric
- Fabric with soil-retardant treatment (option)
- Leather
- Elmosoft leather
- Select Surfaces leather
- Vinyl
- COM
- COL

Cogent: Connect maximizes quality and comfort on i2i. The selected upholstery will be applied to the seat and arms. It is standard with a sewn application.

Frame

- 6009 Arctic White
- 6249 Platinum
- 6295 Near Black

Tablet Arm

- Laminate
- Veneer

The laminate surface is available with a black edge only. The veneer surface has a self edge. The tablet ships separately and requires field assembly and installation.

Glides

- Black plastic

Rollers

- Optional rollers on mobile base are available in dark fusion only.

All Steelcase seating with standard upholstery fabrics complies with requirements of the State of California Technical Bulletin 117-2013. All standard seating is labeled to be in compliance with California 117-2013.

Programs & Services

▶ See the *Surface Materials Reference Manual* for further detail about programs and services offered for seating.

The Customer's Own Material (COM) Program

offers the opportunity for customers to select fabrics that are not offered through the standard Steelcase surface materials program for use on Steelcase products. Through the COM program, Steelcase will test your materials for application on Steelcase products. Once approved, you can place your order. Steelcase will facilitate the entire ordering process and give you a production schedule. Steelcase will order the COM fabric directly from the textile manufacturer. For up-to-date information regarding fabric test results for all COM fabrics and details regarding yardage requirements for most Seating lines, visit the COM website. To locate the COM website:

- Visit www.steelcase.com

Soil retardants are treatments that provide long-term soil and stain resistance to a fabric without affecting the shade or the integrity of the fabric. The following Steelcase Textiles are available pre-treated with soil retardant. (You do not need to select the soil-retardant option for these fabrics and incur the upcharge.)

- Jacks
- Link
- Spyder

For information on soil retardant fabrics on Select Surfaces, please refer to the *Surface Materials Reference Manual*.

Soil-retardant treatment is available on all other seating fabrics at an additional upcharge per seating unit. To order this option, please select "Soil-Retardant Treatment" under "Optional Accessories."

For soil-retardant treatment on COMs, please select "Soil-Retardant Treatment" under "Optional Accessories." Minimums or additional yardage may be required. Please contact the vendor directly for specific information.

Extended lead times may be necessary for this service.

Contact your Steelcase Solutions Fulfillment Team Representative at 1.888.STEELCASE (1.888.783.3522) or send an email to lineone@steelcase.com.

Dimensions

▶ Page 294

Resources

Printed Materials

▶ i2i Brochure (08-0001013)

Online Resources

▶ Come Together (PDF) available on www.steelcase.com

▶ Collaborative Seating video available on www.steelcase.com

▶ Environmental profiles available on www.steelcase.com/sustainability.

Dimensions

i2i 416 Series

• Features	• Overall Depth	Width	Height	• Seat Depth	• Functional Seat Depth	• Seat Width	• Seat Height from Floor	• Back Height from Seat	• Back Lumbar Height
i2i 416 Series									
Collaborative Chairs									
	25"	32½"	31⅛"	17½"	17¼"	19"	17½"	17¼"	9¼"

Dimensions were measured with BIFMA CMD (chair-measuring device).

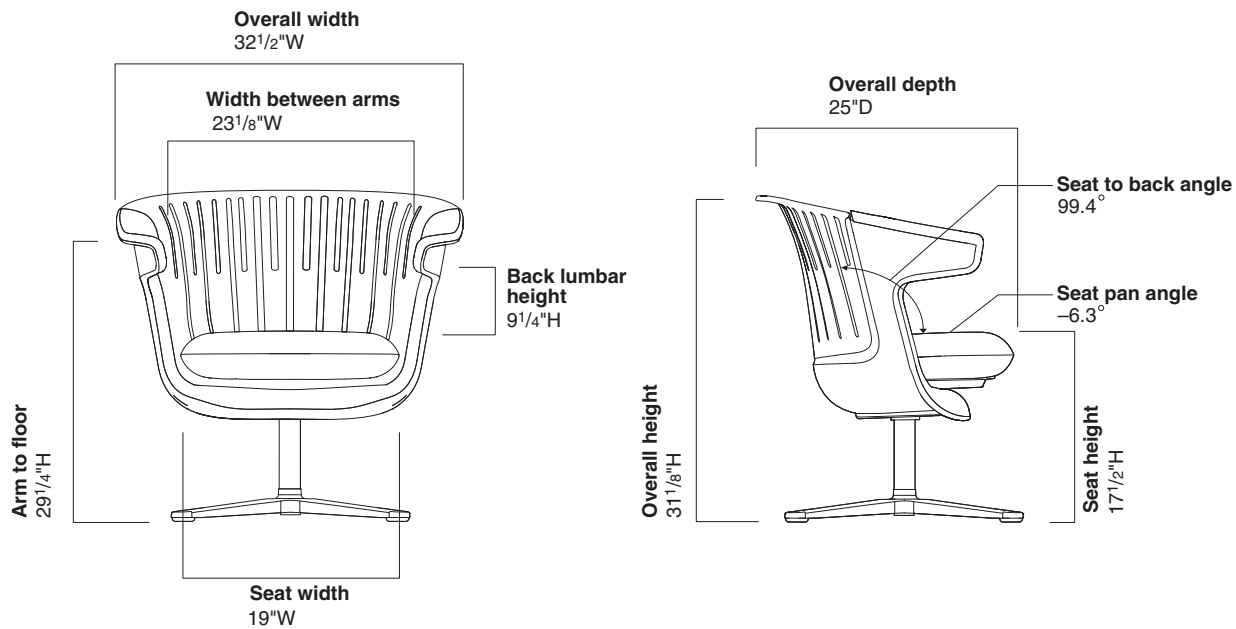

•Width •Between •Arms	•Arm •to •Floor	•Seat •Pan •Angle	•Angle •Between •Seat and •Back
-----------------------------	-----------------------	-------------------------	--

Collaborative Chairs

23 ¹ / ₈ "	29 ¹ / ₄ "	-6.3°	99.4°
:	:	:	:

Collaborative Chairs

i2i 416 Series

Standard Includes	Required to Specify
<ul style="list-style-type: none"> ▶ Need help? Product details, page 292 • Back: near black • Static base with dual-swivel mechanism: polished aluminum • Back upholstery: 3D Knit • Seat and arms: sewn upholstery • Tablet arm, if selected: laminate • Glides: black plastic 	<ol style="list-style-type: none"> 1 Style number 2 Plastic color number for frame 3 3D Knit color number for back 4 Fabric color number for upholstery on seat and arms 5 Laminate color number for tablet arm, if selected 6 Options, if selected (see below) <p>▶ See <i>Surface Materials</i>, page 504.</p>

Tip: Cogent: Connect maximizes quality and comfort on the seat and arms on i2i.

Options	U.S. Price	Required to Specify
<p>Surface Materials</p> <ul style="list-style-type: none"> • Fabric price group 1 • Fabric price group 2 • Fabric price group 3 • Fabric price group 4 • Fabric price group 5 • Fabric price group 6 • Fabric price group 7 • Fabric price group 8 • Fabric price group 9 • Fabric price group 10 • Steelcase leather upholstery • Select Surfaces leather price group 1 • Elmosoft leather • Select Surfaces leather price group 2 • Steelcase vinyl • Customer's Own Material/Vinyl (COM) • Customer's Own Leather (COL) • Soil-retardant treatment applied to upholstery fabric 	<ul style="list-style-type: none"> No cost No cost +\$ 50 +\$ 71 +\$ 90 +\$111 +\$128 +\$161 +\$198 +\$223 +\$371 +\$371 +\$428 +\$428 No cost +\$ 43 +\$ 43 +\$ 27 	<ul style="list-style-type: none"> Specify fabric color number. Specify fabric color number. Specify fabric color number. Specify fabric color number. Specify fabric color number. Specify fabric color number. Specify fabric color number. Specify fabric color number. Specify fabric color number. Specify fabric color number. Specify leather color number. <p>▶ See <i>Surface Materials Reference Manual</i>. Specify Elmosoft leather color number.</p> <p>▶ See <i>Surface Materials Reference Manual</i>. Specify vinyl color number.</p> <p>See <i>Surface Materials Reference Manual</i> to specify.</p> <p>See <i>Surface Materials Reference Manual</i> to specify.</p> <p>Specify with soil-retardant treatment.</p>
<p>Back Shell</p> <ul style="list-style-type: none"> • Arctic White • Platinum 	<ul style="list-style-type: none"> +\$ 91 +\$ 91 	<ul style="list-style-type: none"> Specify with 6009 Arctic White. Specify with 6249 Platinum.
<p>Base</p> <ul style="list-style-type: none"> • Mobile base 	<ul style="list-style-type: none"> +\$ 60 	<ul style="list-style-type: none"> Specify with mobile base.
<p>Cylinder</p> <ul style="list-style-type: none"> • Swivel with return 	<ul style="list-style-type: none"> +\$ 60 	<ul style="list-style-type: none"> Specify with swivel return.
<p>Tablet Arm</p> <ul style="list-style-type: none"> • Wood veneer 	<ul style="list-style-type: none"> +\$241 	<ul style="list-style-type: none"> Specify with wood veneer.

Tip: For list of wood veneer options available on tablet arm, see page 505.

Specification Information

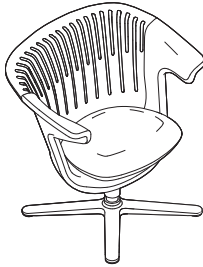
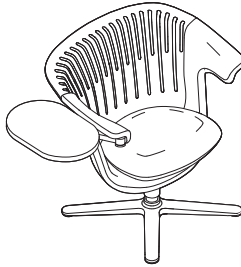
		With tablet arm	
• Style Number	• U.S. Base Price	• Style Number	• U.S. Base Price
 416911	 \$2231	 416911T	 \$2477

▶ Detailed dimensions, page 294

 **For Canadian Pricing**
 Multiply U.S. Price by the Canadian price factor.
 ▶ See page 1 for details.

Collaborative Lounge Table

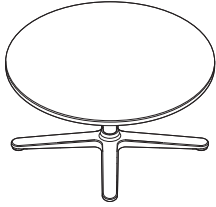

Standard Includes	Required to Specify
<ul style="list-style-type: none"> ▶ Need help? See <i>c:scape Specification Guide</i> for details. • Table: High-Pressure Laminate surface with 3 mm plastic edge profile • Base: Polished Aluminum 	<ul style="list-style-type: none"> 1 Style number 2 Laminate color number for table 3 Plastic color number for edge on laminate surface 4 Options, if selected (see below) ▶ See <i>c:scape Specification Guide</i>.

Surface Materials	Options	U.S. Price	Required to Specify
	High-Pressure Laminate surface		
	• Open Line laminate	+\$ 71 plus cost of laminate	▶ See <i>Surface Materials Reference Manual</i> .
	Wood veneer surface		
	• Wood veneer surface with matching 3 mm edge profile	+\$421	Specify <i>with wood veneer</i> and indicate wood color number.
	• Premium wood 2	+\$450	Specify <i>with wood veneer</i> and indicate Premium wood 2 color number.
	• Premium wood 3	+\$518	Specify <i>with wood veneer</i> and indicate Premium wood 3 color number.
	• Customiz stain	No cost	Specify <i>with Customiz stain</i> .
	• Full-fill finish	+\$ 29	▶ See <i>Surface Materials Reference Manual</i> . Specify full-fill finish number.

Specification Information			
Dimensions		Style Number	U.S. Base Price
Diameter	Height		
32"	16"	CQCT1632	\$1453

Product on this page is *c:scape*, not seating. It is included here to simplify your planning. Remember that systems has different pricing terms than seating products.

 **For Canadian Pricing**
 Multiply U.S. Price by the Canadian price factor.
 ▶ See page 1 for details.

IZI 416 Series

Understanding and Specifying Node 480 Series Collaborative Chairs

Product Details

Node 480 Series	300
Planning with Node	303
Dimensions	306

Specifying

Collaborative Chairs	308
Mid-Back Collaborative Chairs	310
Collaborative Stool	312
Mid-Back Collaborative Stool	313

Collaborative Chairs

Collaborative seating promotes comfort for long periods of time and promotes movement, offers automatic and intuitive adjustments, and supports multiple postures.

- QiVi 428 Series
- cobī 434 Series
- i2i 416 Series
- Node 480 Series

Adjustability Features

▶ See page 22 for a comparison to other chairs

Node 480 Series

Mechanisms

360°-swivel



Node 480 Series

Node is a collaborative seating line that accommodates multiple environments including classrooms, clinical settings, and other learning environments. Node supports multiple teaching and learning modes, freedom to change postures, and optional storage.

One piece polypropylene contoured shell is designed for easy maintenance and cleaning.

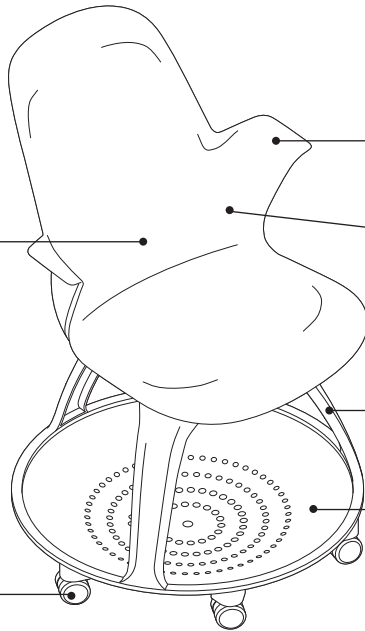

Arms are designed to support arms, side-sitting postures, and serve as a backpack hook.

Flexible and contoured seat shell supports comfort by allowing many postures.

360°-swivel mechanism is standard.

Backpack storage area is standard.

Casters have hard, dual wheels that roll smoothly on carpets. Soft dual-wheel casters are available for use on hard floors.

Tip: Do not roll the chair across asphalt during installation as this may damage the casters.

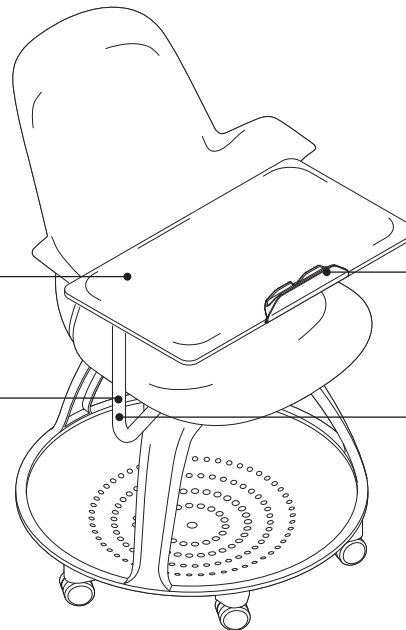

Personal worksurface moves independently of seat shell and base.

Tablet stand is available on all personal worksurfaces and supports tablets and smart phones.

Personal worksurface is depth adjustable for large and small users and allows for ingress/egress.

Personal worksurface is mounted on the right but appropriate for both right- and left-hand users.

ShareSurface is designed to support collaboration with its uniquely designed surface that pivots and rotates 360°.

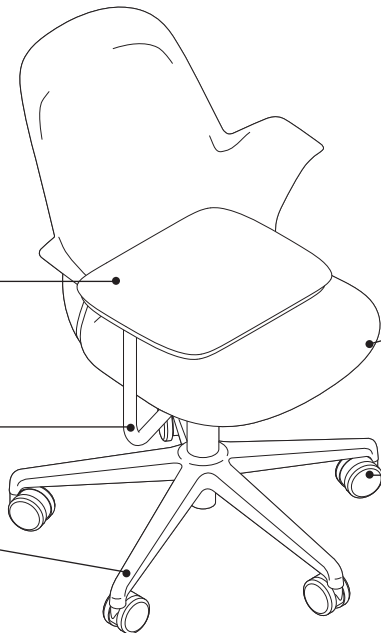

ShareSurface is non-handed and swings from right to left to optimize sharing technology.

Seat height adjusts with a 5¼" range with a pneumatic adjustment mechanisms on five-arm base chairs. Chairs with a personal worksurface or Share-Surface adjusts with a 4" range. Stools have a 8½" range. A 7½" range is available as an option.

Five-arm base is standard.

Hard, dual wheel casters are standard for use on carpets. Soft, dark grey treaded, dual-wheel roll-control casters are available for use on hard floors or mats.

Product Details



Chairs and stools are available with high-back and mid-back shells. Chairs are available with a tripod base, tripod base with personal worksurface or Share-Surface, five-arm base with pneumatic adjustment, and five-arm base with pneumatic adjustment with personal worksurface or Share-Surface. Stools are available with five-arm base only.

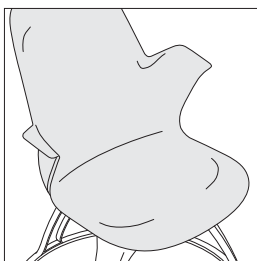

Flexing seat shell and arms promotes movement and supports multiple postures. Integrated arms support user's arms, side posture, and act as a backpack hook.

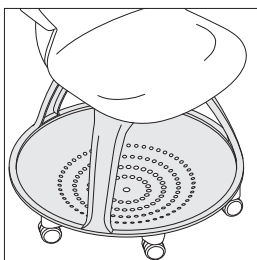

Tripod base reclaims the space under the seat. The space is 1.7 cu/ft. and allows for backpacks or personal belongings to be stored, and serves as a footrest.

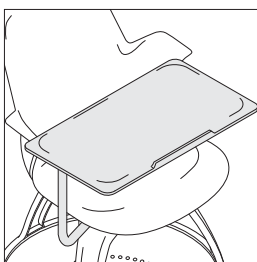

Personal worksurface is mounted on user's right, and designed to accommodate left- and right-handed users. It is 12"D x 22¹/₄"W and features a safety stop to help prevent belongings and laptops from easily sliding off back edge.

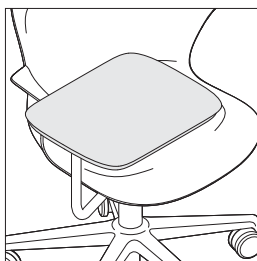

ShareSurface is mounted to the underside of the seat and moves from right to left at 138° to accommodate left- and right-handed users. The ShareSurface is 12"D x 14¹/₂"W. The surface swivels 360° around a 1¹/₂" pivot to maximize comfort and collaboration.

Node tripod, with or without worksurface, and Node five-arm base chairs with worksurface ships standard unassembled and cartoned with the seat shell separated from the base. This allows for shipment in a smaller carton. Five-arm base chairs without worksurface and stools ship two to a carton. Assembly by a qualified Steelcase dealer installer is required. Assembly instructions are available at www.steelcase.com. No tools required for assembly.

Adjustment Features

360° fixed height swivel mechanism on tripod base models allows students to remain oriented to instructor, presentation materials, and other students.

360° adjustable height swivel mechanism is standard on five-arm base models.

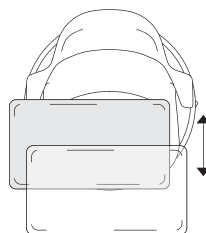

Personal worksurface depth adjustment range is 7¹/₄" to 15". Measurement is from lumbar to worksurface.

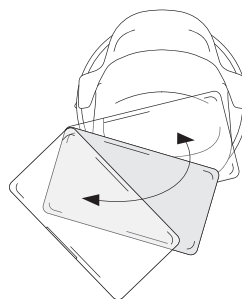

Personal worksurface pivot range is 48°.

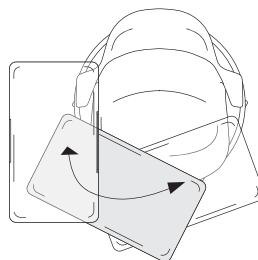

Personal worksurface center pivot is 100°. The center pivot range is measured from the closest position to the furthest position from the user.

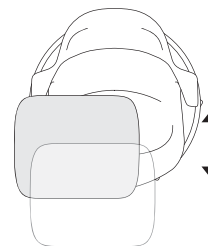

ShareSurface depth adjustment range is 11¹/₄" to 16⁵/₈". Measurement is from lumbar to worksurface.

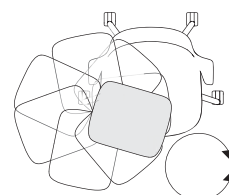

ShareSurface swivels 360° around a 1¹/₂" pivot for inputting data or sharing information.

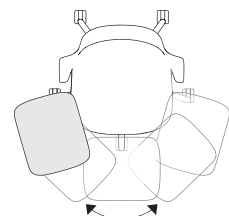

ShareSurface arm swings right to left at 138°. The two-pivot mechanism for the surface allows the surface to pivot right to left, allowing users to collaborate or move the surface out of the way for easy ingress and egress.

Node 480 Series, continued

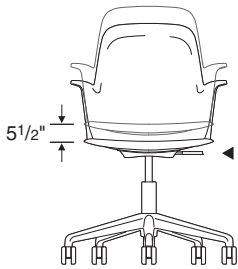

Seat height adjusts pneumatically. To lower, pull lever up while seated. To raise, pull lever up and keep your weight off the chair. Range of adjustability is 5 1/4" from 16"H to 21 3/16"H, a 3 3/4" range (17 1/8"H to 20 3/4"H) is available on chairs with a worksurface. Stools are standard with an 8 1/2" range of adjustability (23 1/16"H to 31 3/8"H). A 7 1/2" range of adjustability (18 1/2"H to 26 7/16"H) is available as an option.

Glides are available as an option. Glides ship assembled on the chair or stool and maintain same height as casters.

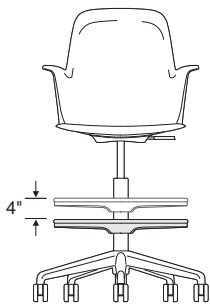

Foot ring height on stools adjusts by first lifting ring and rotating it counterclockwise to unlock. Then raise or lower ring up to 4" to desired position before rotating it clockwise to lock. The foot ring has a diameter of 20".

Soft, dual-wheel roll-control casters for hard floors are available on five-arm base chairs and stools only.

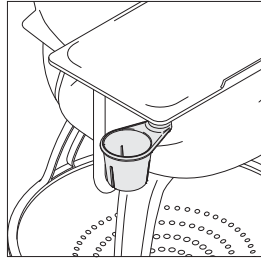

Cup holder is available as an option on Node chairs with personal worksurfaces. It is retractable under the worksurface when not in use. *Tip: Cup holder is not available on Node chairs with ShareSurface.*

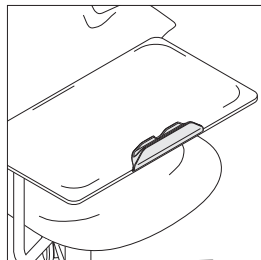

Tablet stand is available on Node chairs with personal worksurfaces. The stand supports tablets and smart phones in both portrait and landscape positions, making content easy to view and freeing up space on the worksurface for other materials. It can be field or factory installed. *Tip: Devices are not secure in tablet stand when Node is moved.* *Tip: Tablet stand is not available on Node chairs with ShareSurface.*

Surface Materials

▶ See surface materials on page 504 for specific availability or refer to the *Surface Materials Reference Manual* for further information.

Seat Shell

Price Group 1

- Plastics
- 6009 Arctic White
 - 6059 Sterling Dark Solid
 - 6205 Black
 - 6249 Platinum Solid
 - 6259 Midnight
 - 6332 Citron
 - 6333 Picasso
 - 6334 Flash
 - 6335 Wasabi
 - 6336 Jazz
 - 6337 Element
 - 6338 Chili Red
 - 6BD8 Snow
 - 6BD9 Carbon Flat
 - 6BE1 Ore

Price Group 2

- Signature Plastics
- 6BC1 Crimson
 - 6BC2 Purple
 - 6BC3 Green
 - 6BC4 Burgundy
 - 6BC5 Blue
 - 6BC6 Orange
 - 6BC7 Brown
 - 6BC8 Gold
 - 6BC9 Red
 - 6BD1 Aubergine
 - 6BD2 Peacock
 - 6BD3 Jungle
 - 6BD4 Merlot
 - 6BD5 Honey
 - 6BD6 Lagoon
 - 6BD7 Saffron

Tripod Base

- 6249 Platinum Solid
- 6295 Near Black
- 6337 Element

Five-arm Base

- 6205 Black
- 6249 Platinum Solid
- 6337 Element

Personal Worksurface and ShareSurface

- 6053 Seagull
- 6249 Platinum Solid
- 6295 Near Black
- 6337 Element
- 6654 Sand

Paint for Metal

- 0835 Black
- 4750 Champagne Metallic
- 4799 Platinum Metallic

Casters

- Black

Glides

- Black plastic (five-arm base)
- Sterling Dark Solid (tripod base)

Cup Holder

- Sterling Dark Solid

Tablet Stand

- Sterling Dark Solid

Fire Code Seating (FCS) option is available. ▶ See *Surface Materials*, page 518.

Steelcase offers Fire Code Seating modification (FCS) on some seating models. The most rigorous fire codes in the nation have been developed in California, and the Steelcase FCS modification is designed to meet those codes. Fire Code Seating (FCS) indicates that a product is constructed to meet the strict fire code requirements of high public occupancy areas such as theaters, meeting rooms, and lobbies. The FCS standards will meet the State of California Bureau of Electronic and Appliance Repair, Home Furnishings, and Thermal Insulation Technical Bulletin 133 (Cal TB 133). Boston adopted the California Bureau of Electronic and Appliance Repair, Home Furnishings, and Thermal Insulation Technical Bulletin TB 133 test standard in 1992.

Dimensions

▶ Page 306

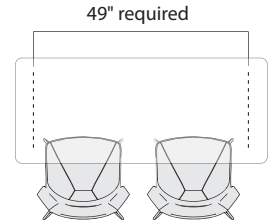

The backpack storage area and overall chair width require 23 3/4" of continuous floor space when used with tables. The minimum distance between table bases is 49" to allow two chairs to be pushed under the worksurface. This does not apply to five-arm basemodels.

Resources

Printed Materials

- ▶ Node Brochure (10-0002733)
- ▶ Node with ShareSurface Brochure (16-0000238)

Online Resources

- ▶ Node Higher Ed Classroom Case Study available at www.steelcase.com
- ▶ Node High School Classroom Case Study available at www.steelcase.com
- ▶ Indiana University Node video available at www.steelcase.com
- ▶ Node Student video available at www.steelcase.com
- ▶ Environmental profiles available on www.steelcase.com/sustainability.

Planning with Node

For Classroom Environments

Pedagogy, technology and space, when carefully considered and intentionally designed, can establish new protocols for advanced learning solutions.

Planning Tips

- 1 Illustrate multiple modes for each drawing to:
 - a) ensure enough space is available for each reconfiguration
 - b) allow the user to understand what's possible
 - c) ensure that sight lines are maintained when the furniture is moved
 - d) confirm that jurisdictional codes are followed for each layout (eg: International Building Code, American Disability Act, etc.)
- 2 Give permission to act differently by including wall guard and enough space to move, supporting simultaneous multi-modal activities.
- 3 Provide both analogue and digital tools in the solution such as whiteboards, personal whiteboards, interactive whiteboards or media:scape.
- 4 Address the needs of classroom and personal storage for both students and teachers. Incorporate this information into each mode to ensure space is adequate.
- 5 Include zones for mentoring, assessment, and/or coaching for teacher-to-student and/or student-to-student interaction.
- 6 Annotate the drawings with design principles to confirm they are being addressed.

Lecture Mode

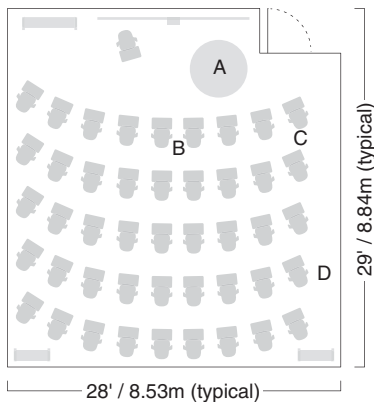

Group Mode

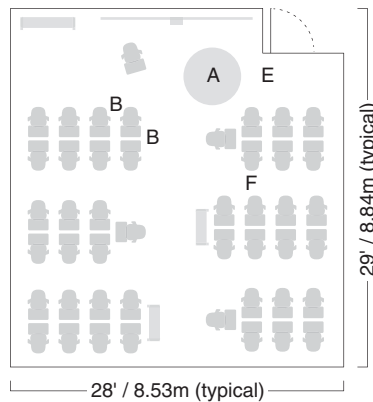

Discussion Mode

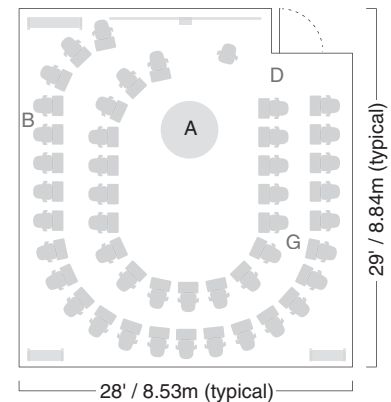

This example: 18* sq. ft. or 1.68 sq. meters per person. *For K-12 applications,
 ▶ See Table 1004.1.1 Maximum Floor Area Allowances per Occupant, 2009 International Building Code.

- Ⓐ — 60"/1.52m (ADA)
- Ⓑ — 12"/0.3m
- Ⓒ — 18"-24"/0.46-0.61m (aisle)
- Ⓓ — 36"/0.91m (egress)
- Ⓔ — 60"/1.52m (egress)
- Ⓕ — 38"/0.97m (aisle)
- Ⓖ — 18"-36"/0.46-0.91m (aisle)

Planning with Node

For Healthcare Environments

Clinicians, patients, family, technology, and space should be carefully considered and intentionally designed to create impactful and meaningful healthcare experiences.

Planning Tips

- 1 Demonstrate ability for a clinician to perform three key behaviors:
 - a) input information using a mobile device
 - b) share information with the patient and family member
 - c) connect with patient by moving surface aside for physical exam
- 2 Encourage customers to think differently about other objects within the exam space to encourage collaboration and mutual participation with all participants.
- 3 Provide both analogue and digital capabilities for teaching and learning with the clinician, patient, and family member.
- 4 Optimize real estate by considering a chair-based exam for many exam room applications.

Wellbeing Hub

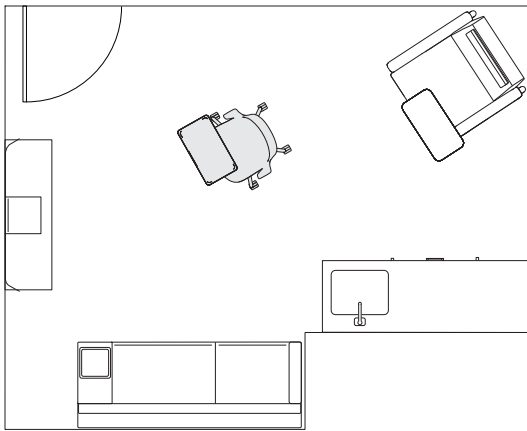

Room Dimensions: 13'11" x 11'3"

Wellbeing hubs offers a blended space to perform a physical exam and consultative experience.

Retail Exam Space

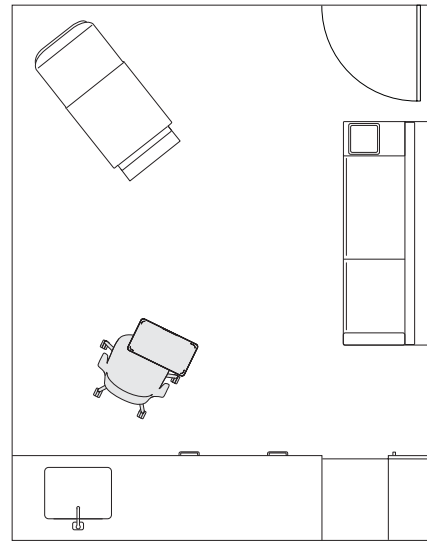

Room Dimensions: 9'6" x 12'

Retail exam spaces maximize real estate by accommodating the physical exam, consultative experience, and clinician work area.

▶ See *Table 1004.1.1 Maximum Floor Area Allowances per Occupant, 2009 International Building Code.*

Planning Tips, continued

Pediatric Exam Space

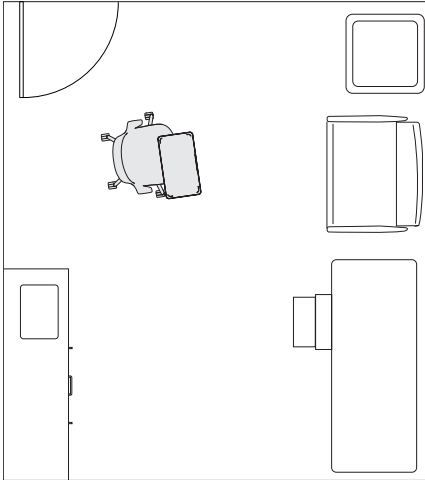

Room Dimensions: 11'6" x 10'

Pediatric exam spaces are about building trust and connection by accommodating clinicians, parents, and children with a more consultative experience.

► See *Table 1004.1.1 Maximum Floor Area Allowances per Occupant, 2009 International Building Code.*

Dimensions

Node 480 Series

Features	Overall Depth	Width	Height	Seat Depth	Seat Width	Seat Height from Floor	Ring Height from Floor	Width Between Arms
Node 480 Series								
Tripod Base Collaborative Chair								
	25"	23 ³ / ₄ "	35"	16 ¹ / ₂ "	19 ¹ / ₂ "	18 ¹ / ₄ "	N.A.	20 ¹ / ₈ "
Five-Arm Base Collaborative Chair								
	24 ³ / ₄ "	25 ³ / ₄ "	32 ⁵ / ₈ " to 37 ³ / ₄ "	16 ¹ / ₂ "	19 ¹ / ₂ "	15 ⁵ / ₈ " to 20 ³ / ₄ "	N.A.	20 ¹ / ₈ "
Tripod Base Mid-Back Collaborative Chair								
	23 ³ / ₄ "	23 ³ / ₄ "	31 ¹ / ₄ "	15 ¹ / ₂ "	19 ¹ / ₄ "	18 ¹ / ₄ "	N.A.	20 ¹ / ₈ "
Five-Arm Base Mid-Back Collaborative Chair								
	23 ¹ / ₂ "	25 ³ / ₄ "	28 ⁷ / ₈ " to 34"	15 ¹ / ₂ "	19 ¹ / ₄ "	15 ⁵ / ₈ " to 20 ³ / ₄ "	N.A.	20 ¹ / ₈ "
Five-Arm Base Stool								
	24 ³ / ₄ "	25 ³ / ₄ "	40 ⁷ / ₈ " to 48 ¹ / ₄ "	16 ¹ / ₂ "	19 ¹ / ₂ "	23 ⁵ / ₈ " to 31 ³ / ₈ "	11 ¹ / ₂ " to 15 ¹ / ₂ "	20 ¹ / ₈ "
Five-Arm Base Mid-Back Stool								
	23 ¹ / ₂ "	25 ³ / ₄ "	37 ¹ / ₈ " to 44 ¹ / ₂ "	15 ¹ / ₂ "	19 ¹ / ₄ "	23 ⁵ / ₈ " to 31 ³ / ₈ "	11 ¹ / ₂ " to 15 ¹ / ₂ "	20 ¹ / ₈ "

*Personal worksurface and ShareSurface height from floor on tripod base chairs is 28¹/₂".

*Personal worksurface and Sharesurface height from floor on five-arm base chairs is 27³/₁₆" to 30¹³/₁₆".

*Personal worksurface measures 22¹/₂"W x 12"D and has a depth adjustment range of 7¹/₄" to 15".

*ShareSurface measures 14¹/₂"W x 12"D and rotates 360° around a 1¹/₂" pivot.

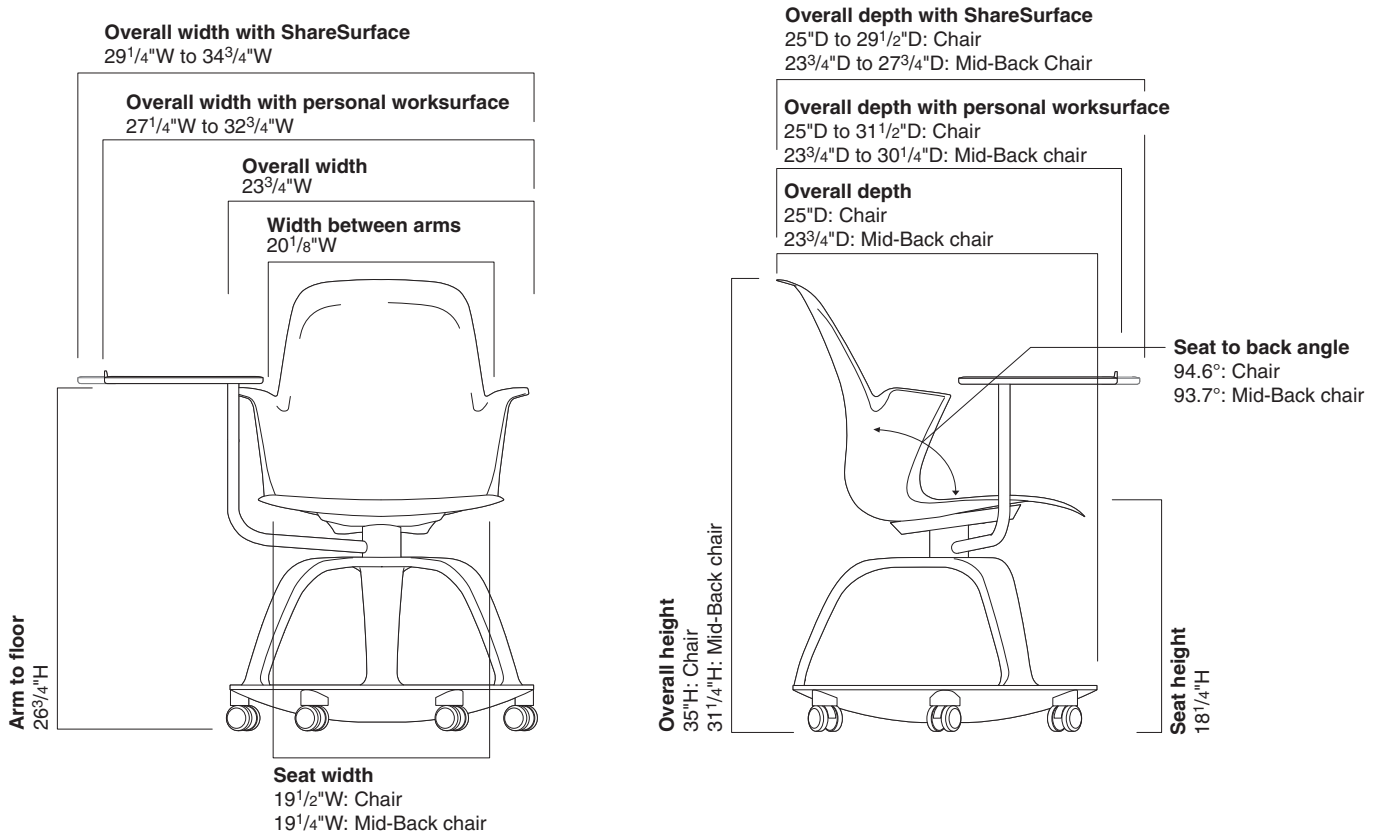

• Arm to Floor
• Angle Between Seat and Back

Tripod Base Collaborative Chair

26³/₄" 94.6°

Five-Arm Base Collaborative Chair

24¹/₈" to 29¹/₄" 94.6°

Tripod Base Mid-Back Collaborative Chair

26³/₄" 93.7°

Five-Arm Base Mid-Back Collaborative Chair

24¹/₈" to 29¹/₄" 93.7°

Five-Arm Base Stool

27" to 35" 94.6°

Five-Arm Base Mid-Back Stool

27" to 35" 93.7°

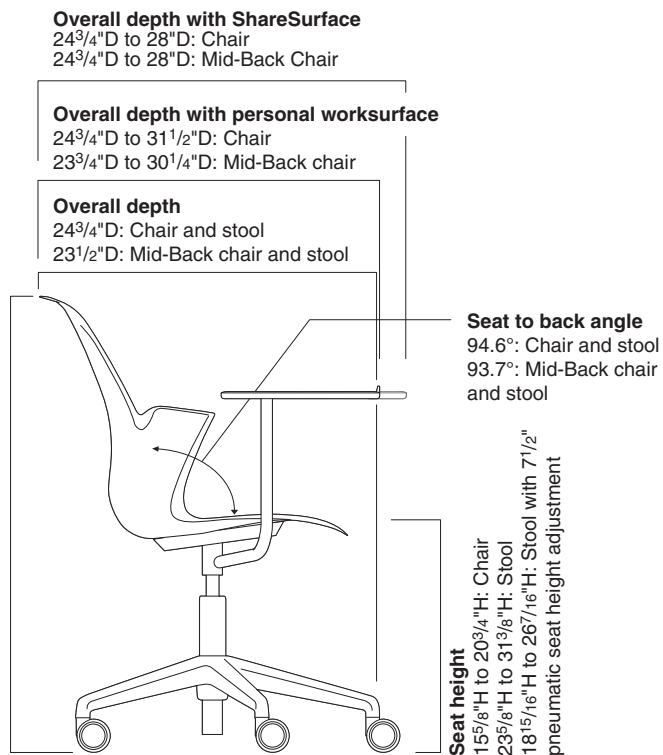
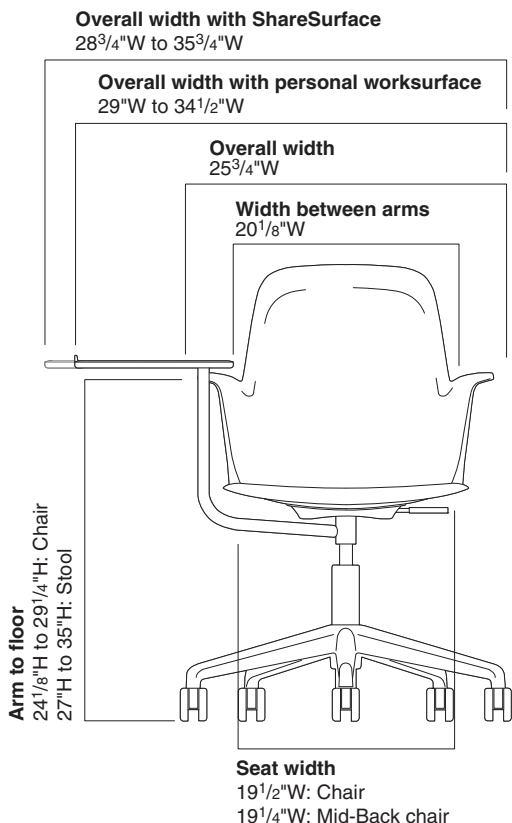

Node 480 Series Collaborative Chairs

With Tripod Base

Standard Includes		Required to Specify
<ul style="list-style-type: none"> ▶ Need help? Product details, page 300 	<ul style="list-style-type: none"> • Seat shell: plastic • Tripod base: plastic • Storage tray: sterling dark solid • Metal components: 0835 Black paint • Swivel seat • Worksurface, if selected: plastic • Hard casters 	<ol style="list-style-type: none"> 1 Style number 2 Plastic color number for seat shell 3 Plastic color number for tripod base 4 Paint color number for metal components 5 Plastic color number for personal worksurface, if selected 6 Options, if selected (see below) <ul style="list-style-type: none"> ▶ See <i>Surface Materials</i>, page 504.

Options	U.S. Price	Required to Specify	
Surface Materials			
Platinum or Champagne Metallic metal components			
• On 480110 and 480170	+\$10	Specify with 4799 Platinum or 4750 Champagne Metallic.	
• On 480120	+\$25	Specify with 4799 Platinum or 4750 Champagne Metallic.	
Seat shell			
• Plastic price group 1	No cost	Specify color number.	
• Plastic price group 2	+\$29	▶ See <i>Surface Materials</i> , page 504. Specify color number.	
• Fire Code Seating (FCS)	+\$82	▶ See <i>Surface Materials</i> , page 504. Add suffix F to style number.	
Cup Holder	• On 480120	+\$36	Specify with cup holder.
Tablet Stand	• On 480120	+\$36	Specify with tablet stand.
Casters	• Soft casters	+\$33	Specify with soft casters.
Glides	• Glides: sterling dark solid	+\$27	Specify with glides.

Tip: Fire Code Seating (FCS) option is available with certain plastic color choices only.
▶ Page 517

Tip: Cup holder is available on Node models with personal worksurface only.

Tip: ShareSurface is not available with cup holder or tablet stand option.

▶ Detailed dimensions, page 306

Specification Information	
• Style Number	• U.S. Base Price
•	•
•	•
•	•

Without Personal Worksurface

480110 \$473

•

With Personal Worksurface

480120 \$708

•

With ShareSurface

480170 \$750

•

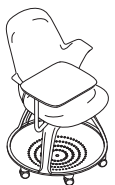
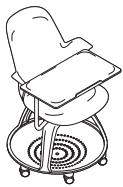

Node 480 Series Collaborative Chairs

With Five-Arm Base

Standard Includes	Required to Specify
<ul style="list-style-type: none"> ▶ Need help? Product details, page 300 • Seat shell: plastic • Five-arm base: plastic • Metal components: 0835 Black paint • Swivel seat • 5¼" pneumatic seat-height adjustment • Hard casters 	<ol style="list-style-type: none"> 1 Style number 2 Plastic color number for seat shell 3 Plastic color number for five-arm base 4 Options, if selected (see below) <ul style="list-style-type: none"> ▶ See <i>Surface Materials</i>, page 504.

Options	U.S. Price	Required to Specify
Surface Materials <ul style="list-style-type: none"> • Plastic price group 1 • Plastic price group 2 • Fire Code Seating (FCS) 	No cost +\$29 +\$82	Specify color number. ▶ See <i>Surface Materials</i> , page 504. Specify color number. ▶ See <i>Surface Materials</i> , page 504. Add suffix F to style number.
Base <ul style="list-style-type: none"> • Platinum on 480130 and 480180 • Element on 480130 • Platinum on 480150 • Element on 480150 	+\$35 +\$35 +\$39 +\$39	Specify with 6249 Platinum. Specify with 6337 Element. Specify with 6249 Platinum. Specify with 6337 Element.
Cup Holder <ul style="list-style-type: none"> • On 480150 	+\$36	Specify with cup holder.
Tablet Stand <ul style="list-style-type: none"> • On 480150 	+\$36	Specify with tablet stand.
Casters <ul style="list-style-type: none"> • Soft, dark grey treaded, dual-wheel roll-control casters for use on hard floors 	+\$27	Specify with soft roll-control casters.
Glides <ul style="list-style-type: none"> • Glides: black plastic 	+\$27	Specify with glides.

Tip: Fire Code Seating (FCS) option is available with certain plastic color choices only.
▶ Page 517

Tip: Metal components will match plastic color for base.

Tip: Cup holder is available on Node models with personal worksurface only.

Tip: ShareSurface is not available with cup holder or tablet stand option.

▶ Detailed dimensions, page 306

Specification Information	
Style Number	U.S. Base Price

Without Personal Worksurface

480130 \$426

With Personal Worksurface

480150 \$708

With ShareSurface

480180 \$750

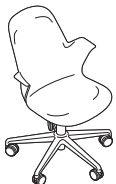

For Canadian Pricing
Multiply U.S. Price by the Canadian price factor.
▶ See page 1 for details.

Node 480 Series Mid-Back Collaborative Chairs

With Tripod Base

Standard Includes		Required to Specify
<ul style="list-style-type: none"> ▶ Need help? Product details, page 300 	<ul style="list-style-type: none"> • Seat shell: plastic • Tripod base: plastic • Storage tray: sterling dark solid • Metal components: 0835 Black paint • Swivel seat • Worksurface, if selected: plastic • Hard casters 	<ol style="list-style-type: none"> 1 Style number 2 Plastic color number for seat shell 3 Plastic color number for tripod base 4 Paint color number for metal components 5 Plastic color number for personal work-surface, if selected 6 Options, if selected (see below) <ul style="list-style-type: none"> ▶ See <i>Surface Materials</i>, page 504.

Options	U.S. Price	Required to Specify	
Surface Materials			
Platinum or Champagne Metallic metal components			
• On 480210 and 480270	+\$10	Specify with 4799 Platinum or 4750 Champagne Metallic.	
• On 480220	+\$25	Specify with 4799 Platinum or 4750 Champagne Metallic.	
Seat shell			
• Plastic price group 1	No cost	Specify color number. ▶ See <i>Surface Materials</i> , page 504.	
• Plastic price group 2	+\$29	Specify color number. ▶ See <i>Surface Materials</i> , page 504.	
• Fire Code Seating (FCS)	+\$82	Add suffix F to the style number.	
Cup Holder	• On 480220	+\$36	Specify with cup holder.
Tablet Stand	• On 480220	+\$36	Specify with tablet stand.
Casters	• Soft, dark grey treaded, dual-wheel roll-control casters for use on hard floors	+\$33	Specify with soft roll-control casters.
Glides	• Glides: sterling dark solid	+\$27	Specify with glides.

Tip: Fire Code Seating (FCS) option is available with certain upholstery fabric choices only.
▶ Page 517

Tip: Cup holder is available on Node models with personal work-surfaces only.

Tip: ShareSurface is not available with cup holder or tablet stand option.

▶ Detailed dimensions, page 306

Specification Information	
Style Number	U.S. Base Price

Without Personal Worksurface

480210 \$473

With Personal Worksurface

480220 \$708

With ShareSurface

480270 \$750

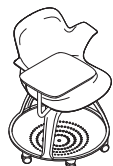

Node 480 Series Mid-Back Collaborative Chairs

With Five-Arm Base

Standard Includes	Required to Specify
<ul style="list-style-type: none"> ▶ Need help? Product details, page 300 • Seat shell: plastic • Five-arm base: plastic • Metal components: 0835 Black paint • Swivel seat • 5¼" pneumatic seat-height adjustment • Hard casters 	<ol style="list-style-type: none"> 1 Style number 2 Plastic color number for seat shell 3 Plastic color number for five-arm base 4 Options, if selected (see below) <ul style="list-style-type: none"> ▶ See <i>Surface Materials</i>, page 504.

Options	U.S. Price	Required to Specify
Surface Materials <ul style="list-style-type: none"> • Seat shell • Plastic price group 1 • Plastic price group 2 • Fire Code Seating (FCS) 	<ul style="list-style-type: none"> No cost +\$29 +\$82 	<ul style="list-style-type: none"> Specify color number. ▶ See <i>Surface Materials</i>, page 504. Specify color number. ▶ See <i>Surface Materials</i>, page 504. Add suffix F to style number.
Base <ul style="list-style-type: none"> • Platinum on 480230 and 480280 • Element on 480230 • Platinum on 480250 and 480280 • Element on 480250 	<ul style="list-style-type: none"> +\$35 +\$35 +\$39 +\$39 	<ul style="list-style-type: none"> Specify with 6249 Platinum. Specify with 6337 Element. Specify with 6249 Platinum. Specify with 6337 Element.
Cup Holder <ul style="list-style-type: none"> • On 480250 	<ul style="list-style-type: none"> +\$36 	<ul style="list-style-type: none"> Specify with cup holder.
Tablet Stand <ul style="list-style-type: none"> • On 480250 	<ul style="list-style-type: none"> +\$36 	<ul style="list-style-type: none"> Specify with tablet stand.
Casters <ul style="list-style-type: none"> • Soft, dark grey treaded, dual-wheel roll-control casters for use on hard floors 	<ul style="list-style-type: none"> +\$27 	<ul style="list-style-type: none"> Specify with soft roll-control casters.
Glides <ul style="list-style-type: none"> • Glides: black plastic 	<ul style="list-style-type: none"> +\$27 	<ul style="list-style-type: none"> Specify with glides.

Tip: Fire Code Seating (FCS) option is available with certain plastic color choices only.
▶ Page 517

Tip: Metal components will match plastic color for base.

Tip: Cup holder is available on Node models with personal worksurface only.

Tip: ShareSurface is not available with cup holder or tablet stand option.

▶ Detailed dimensions, page 306

Specification Information	
Style Number	U.S. Base Price

Without Personal Worksurface

480230	\$426

With Personal Worksurface

480250	\$708

With ShareSurface

480280	\$750



For Canadian Pricing
Multiply U.S. Price by the Canadian price factor.
▶ See page 1 for details.

Node 480 Series Collaborative Stool

With Five-Arm Base

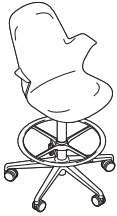

Tip: Metal components will match plastic color for base.

Tip: Fire Code Seating (FCS) option is available with certain plastic color choices only.

▶ Page 517

Standard Includes		Required to Specify
▶ Need help? Product details, page 300	<ul style="list-style-type: none"> • Seat shell: plastic • Five-arm base: plastic • Metal components: 0835 Black paint • Swivel seat • 8½" pneumatic seat-height adjustment • Hard casters 	<ol style="list-style-type: none"> 1 Style number 2 Plastic color number for seat shell 3 Plastic color number for five-arm base 4 Options, if selected (see below) <p>▶ See <i>Surface Materials</i>, page 504.</p>

	Options	U.S. Price	Required to Specify
Surface Materials	Seat shell		
	• Plastic price group 1	No cost	Specify color number. ▶ See <i>Surface Materials</i> , page 504.
	• Plastic price group 2	+\$ 29	Specify color number.
	• Fire Code Seating (FCS)	+\$ 82	▶ See <i>Surface Materials</i> , page 504. Add suffix F to style number.
Seat-Height	• 7½" pneumatic seat-height adjustment	No cost	Specify with 7" pneumatic seat-height adjustment.
Base	• Platinum	+\$102	Specify with 6249 Platinum.
	• Element	+\$102	Specify with 6337 Element.
Casters	• Soft, dark grey treaded, dual-wheel roll-control casters for use on hard floors	+\$ 27	Specify with soft roll-control casters.

Specification Information	
• Style Number	• U.S. Base Price
480140	\$628
.	.

▶ Detailed dimensions, page 306



For Canadian Pricing

Multiply U.S. Price by the Canadian price factor.

▶ See page 1 for details.

Node 480 Series Mid-Back Collaborative Stool

With Five-Arm Base

Node 480 Series Mid-Back Collaborative Stool

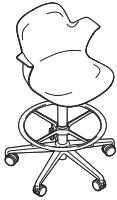

Tip: Fire Code Seating (FCS) option is available with certain upholstery fabric choices only.
▶ Page 517

Tip: Metal components will match plastic color for base.

Standard Includes		Required to Specify
▶ Need help? Product details, page 300	<ul style="list-style-type: none"> • Seat shell: plastic • Five-arm base: plastic • Metal components: 0835 Black paint • Swivel seat • 8½" pneumatic seat-height adjustment • Hard casters 	<ol style="list-style-type: none"> 1 Style number 2 Plastic color number for seat shell 3 Plastic color number for five-arm base 4 Options, if selected (see below) <p>▶ See <i>Surface Materials</i>, page 504.</p>

	Options	U.S. Price	Required to Specify
Surface Materials	Seat shell <ul style="list-style-type: none"> • Plastic price group 1 • Plastic price group 2 • Fire Code Seating (FCS) 	No cost +\$ 29 +\$ 82	Specify color number. ▶ See <i>Surface Materials</i> , page 504. Specify color number. ▶ See <i>Surface Materials</i> , page 504. Add suffix F to style number.
Seat-Height	<ul style="list-style-type: none"> • 7½" pneumatic seat-height adjustment 	No cost	Specify with 7" pneumatic seat-height adjustment.
Base	<ul style="list-style-type: none"> • Platinum • Element 	+\$102 +\$102	Specify with 6249 Platinum. Specify with 6337 Element.
Casters	<ul style="list-style-type: none"> • Soft, dark grey treaded, dual-wheel roll-control casters for use on hard floors 	+\$ 27	Specify with soft roll-control casters.

Specification Information	
Style Number	U.S. Base Price
480240	\$628
.	.

▶ Detailed dimensions, page 306



For Canadian Pricing
 Multiply U.S. Price by the Canadian price factor.
 ▶ See page 1 for details.

Lounge Seating

Brody 488 Series	317
media:scape Lounge	345
Umami	371
B-Free	427

Understanding and Specifying Brody 488 Series

Product Details

Brody Lounge 488 Series	318
Brody Lounge Dimensions	324
Brody Lounge Application Tips	326
Brody Desk 488 Series	328
Brody Desk Dimensions	331
Brody Desk Application Tips	332

Specifying

Brody WorkLounge	334
Brody Privacy Lounge	336
Brody Privacy Lounge with Extension	338
Brody Privacy Desk	340
Brody Privacy Desk with Extension	342
Brody Footrest	344

Brody Lounge 488 Series

Brody is a destination for focus. Every detail has been designed with focus in mind, creating a place where people can escape while still having access to the tools, information, and people they need to be most productive.

Screen alignment clip ensures privacy screens remain aligned.

Side surface is a laminate surface and creates space to spread work out.

Screw covers allow for easier assembly of screens to the stanchion and lower surround.

Caddy provides accessible storage close-at-hand for personal belongings.

Power is conveniently located inside Brody to accommodate mobile devices.

Lower surround is upholstery wrapped and creates a barrier around the workspace.

dash mini LED light is available to provide additional light when needed.

Screens offer additional privacy and shield from distractions.

Seat back was designed with LiveLumbar to provide support in a variety of working postures.

Personal worksurface tilts to ergonomically support a user's wrists for keyboarding while also allowing the screen to rise up to eye level, reducing neck strain.

Seat has adaptive bolstering which creates comfort pockets designed to support every user.

Open cavity beneath seat provides storage space for footrest.

Footrest provides support in lounge postures.

Leveling glides on foot adjust 1 1/2" for uneven floors.

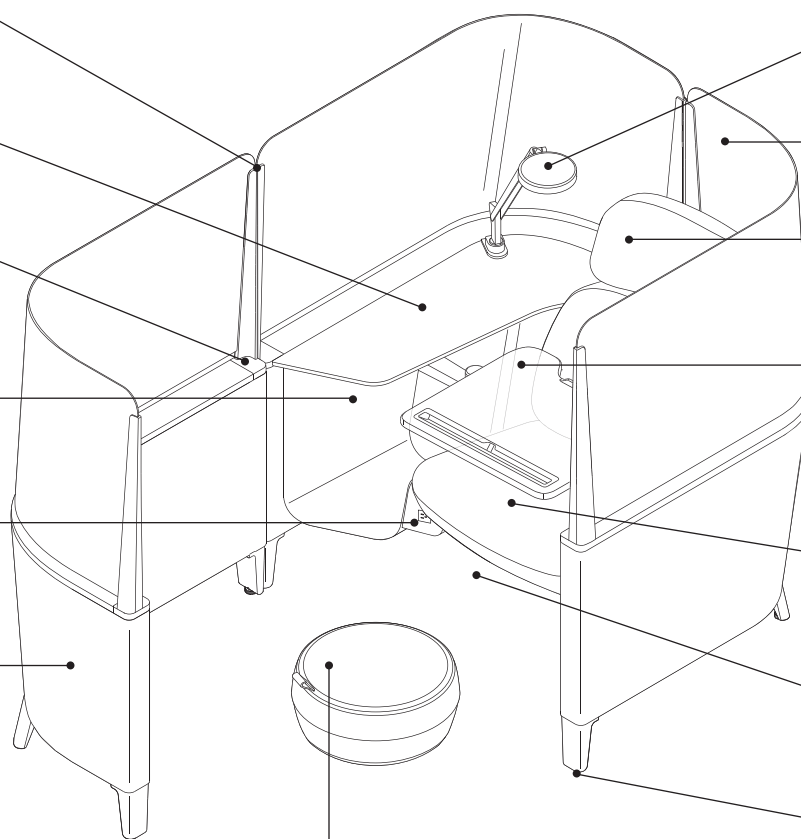

Product Details

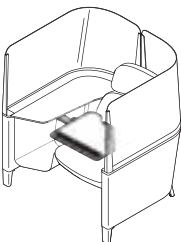
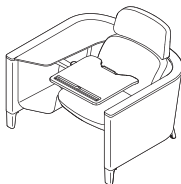

Brody is available with and without screens.

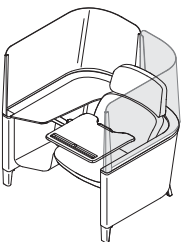

Screens on privacy lounge with extension can only be omitted on the opposite side of where the side surface is located.

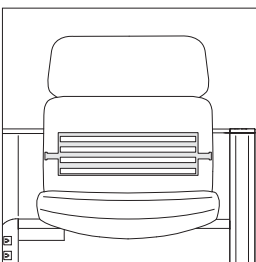

LiveLumbar offers a dialed in spring force in the lumbar region that actively supports the lower back.

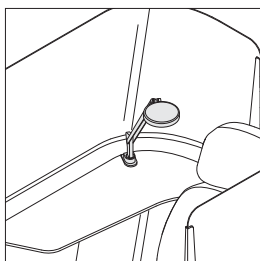

dash mini LED light is available if power has been specified and can be field installed.

dash mini LED light adjusts 19⁷/₈"H from the side surface. The base and head pivot 360°.

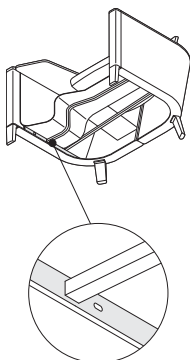

Footrest can be tethered to the frame. There is a small slot on the frame designed for a Kensington lock.

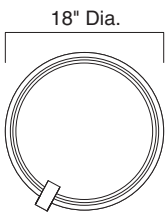

Footrest has plastic base and an overall height of 10"H and a diameter of 18".

Integrated loop on footrest allows for easy repositioning of the footrest in the workspace. It is 13³/₄"W x 2" long and can be used to tether the footrest to the frame.

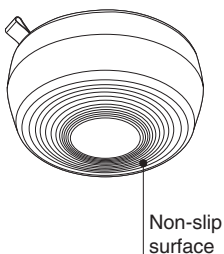

Footrest base is domed in the middle, allowing it to move to adapt to user preferences.

Bottom of footrest has a non-slip surface toward the outside to prevent sliding.

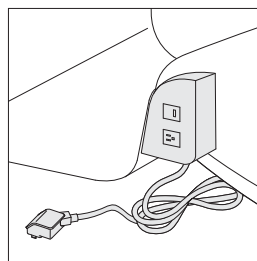

Proprietary low-profile plug can only be used with the Thread system and will not interface with existing receptacles. In order to achieve ADA compliance for connectors in an egress location, we developed our own plug design.

Note: Always consult your local inspector prior to purchasing the Thread system to ensure all local codes and ordinances are satisfied since local regulations may supersede those spelled out in the National Electric Code.

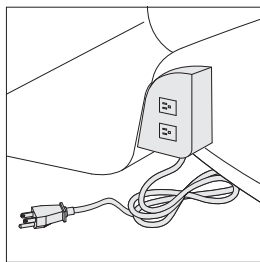

Two NEMA outlets

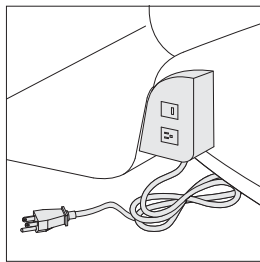

One NEMA, one USB outlet

Power is standard with two three-prong NEMA outlets. It is available with one three-prong NEMA outlet and one USB 2.0 (2.1 amp) outlet as an option. The cord is 10' long and is available with either a standard three-prong NEMA plug for use with standard receptacles or with Steelcase's proprietary Thread low-profile plug for use with one-door and two-door low-profile connectors.

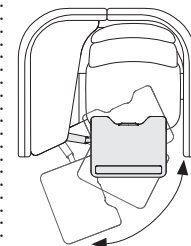

Personal workspace swivels 125 degrees in and out to allow easy entry and exit.

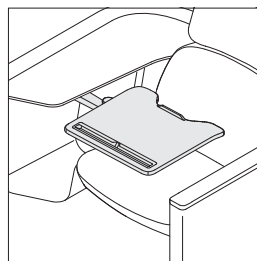

Personal workspace has a cut out to hold technology like smart phones and tablets. The workspace measures 16⁵/₈"D x 18¹/₄"W and is 26⁷/₈"H from the floor.

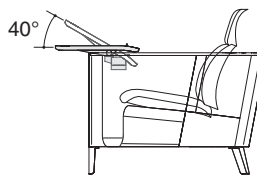

Personal workspace tilts up to 40-degrees allowing users to bring work to eye level.

Brody Lounge 488 Series, continued

Surface Materials

▶ See surface materials on page 504 for specific availability or refer to the *Surface Materials Reference Manual* for further information.

Seat upholstery

- Fabric
- Vinyl
- Leather
- Elmosoft Leather
- Select Surfaces leather
- COL
- COM

Screen

- Arcylic – 6559 Satin Ice
- Buzz2 fabric
- COM

Tip: COM selections are strictly limited. Please reference the COM page at www.steelcase.com to make your selections.

Lower surround upholstery

- Fabric
- COM

Tip: The standard application direction of fabric on the lower surround is warp horizontal. Standard Steelcase fabrics were designed for this application direction.

Upper footrest

- Fabric
- Vinyl
- Leather
- Elmosoft Leather
- Select Surfaces leather
- Plastic
- COL
- COM

Tip: Consider fabrics appropriate for high-wear environments for the upper footrest.

Lower footrest

- 6053 Seagull
- 6059 Sterling Dark

Trim

- Fabric
- Plastic
- COM

Light

- 4231 Arctic White
- 4710 Low Gloss Black
- 4799 Platinum
- Accent paint (option)

Side surface

- 2410 Graphite Walnut
- 2511 Winter on Maple
- 2535 Virginia Walnut
- 2536 Blackwood
- 2883 Seagull
- 2HAT Acacia

Storage caddy, lower surround trim, seat shell, personal worksurface, personal worksurface arm, screen brackets, power, frame, foot, and back of caddy finishes can be found on the color scheme matrix.

▶ See page 33

Programs & Services

▶ See the *Surface Materials Reference Manual* for further detail about programs and services offered for seating.

The Customer's Own Material (COM) Program

offers the opportunity for customers to select fabrics that are not offered through the standard Steelcase surface materials program for use on Steelcase products. Through the COM program, Steelcase will test your materials for application on Steelcase products. Once approved, you can place your order. Steelcase will facilitate the entire ordering process and give you a production schedule. Steelcase will order the COM fabric directly from the textile manufacturer. For up-to-date information regarding fabric test results for all COM fabrics and details regarding yardage requirements for most Seating lines, visit the COM website. To locate the COM website:

- Visit www.steelcase.com

Soil retardants are treatments that provide long-term soil and stain resistance to a fabric without affecting the shade or the integrity of the fabric. The following Steelcase Textiles are available pre-treated with soil retardant. (You do not need to select the soil-retardant option for these fabrics and incur the upcharge.)

- Jacks
- Link
- Spyder

For information on soil retardant fabrics on Select Surfaces, please refer to the *Surface Materials Reference Manual*.

Soil-retardant treatment is available on all other seating fabrics at an additional upcharge per seating unit. To order this option, please select "Soil-Retardant Treatment" under "Optional Accessories."

For soil-retardant treatment on COMs, please select "Soil-Retardant Treatment" under "Optional Accessories." Minimums or additional yardage may be required. Please contact the vendor directly for specific information.

Extended lead times may be necessary for this service.

Contact your Steelcase Solutions Fulfillment Team Representative at 1.888.STEELCASE (1.888.783.3522) or send an email to lineone@steelcase.com.

Dimensions

▶ Page 324

Resources**Printed Materials**

▶ Brody WorkLounge Brochure (15-0000167)

Brody Lounge 488 Series, continued

Color Scheme Matrix

Color Scheme	Foot	Screen Brackets	Frame	Lower Surround Trim	Seat Shell
Light	Seagull 7243	Seagull 7243	Merle 7360	Seagull 6053	Platinum Solid 6249
Medium	Platinum Metallic 4799	Platinum Metallic 4799	Merle 7360	Platinum Solid 6249	Sterling Dark Solid 6059
Dark	Sterling Dark 7250	Sterling Dark 7250	Merle 7360	Sterling Dark Solid 6059	Sterling Dark Solid 6059
Matte Copper	Matte Copper 4B25	Matte Copper 4B25	Merle 7360	Sterling Dark Solid 6059	Sterling Dark Solid 6059
Matte Brass	Matte Brass 4B22	Matte Brass 4B22	Merle 7360	Sterling Dark Solid 6059	Sterling Dark Solid 6059
Burnished Bronze	Burnished Bronze 4B23	Burnished Bronze 4B23	Merle 7360	Sterling Dark Solid 6059	Sterling Dark Solid 6059
Night Bronze	Night Bronze 4B24	Night Bronze 4B24	Merle 7360	Sterling Dark Solid 6059	Sterling Dark Solid 6059
Obsidian	Obsidian 4B20	Obsidian 4B20	Merle 7360	Sterling Dark Solid 6059	Sterling Dark Solid 6059

Tip: If an upholstered screen is specified, then the screen clips will always be aluminum.

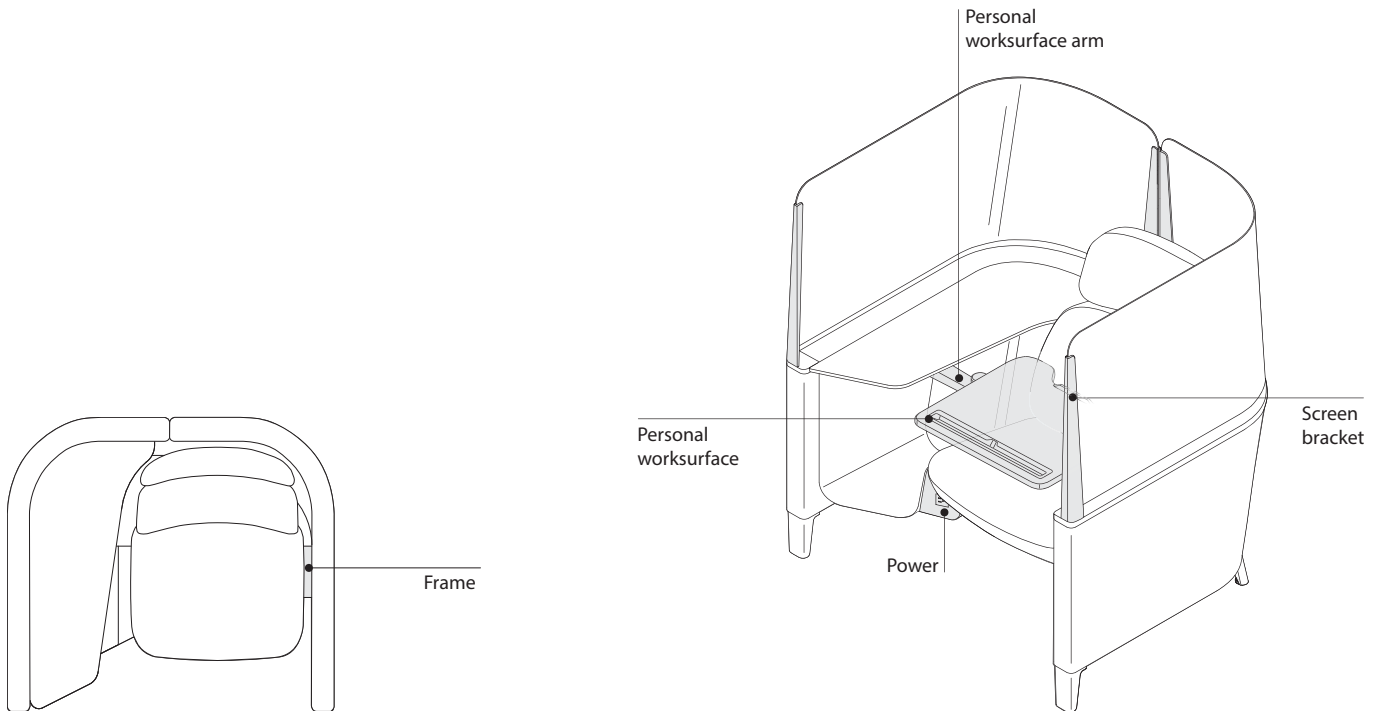

Color Scheme Matrix

Color Scheme	Personal Worksurface	Personal Worksurface Arm	Caddy	Back of Caddy	Power
Light	Seagull 6053	Platinum Metallic 4799	Seagull 6053	Merle 6527	Merle 6527
Medium	Platinum Solid 6249	Platinum Metallic 4799	Merle 6527	Merle 6527	Merle 6527
Dark	Sterling Dark Solid 6059	Sterling Dark 7250	Sterling Dark Solid 6059	Merle 6527	Merle 6527
Matte Copper	Sterling Dark Solid 6059	Matte Copper 4B25	Sterling Dark Solid 6059	Merle 6527	Merle 6527
Matte Brass	Sterling Dark Solid 6059	Matte Brass 4B22	Sterling Dark Solid 6059	Merle 6527	Merle 6527
Burnished Bronze	Sterling Dark Solid 6059	Burnished Bronze 4B23	Sterling Dark Solid 6059	Merle 6527	Merle 6527
Night Bronze	Sterling Dark Solid 6059	Night Bronze 4B24	Sterling Dark Solid 6059	Merle 6527	Merle 6527
Obsidian	Sterling Dark Solid 6059	Obsidian 4B20	Sterling Dark Solid 6059	Merle 6527	Merle 6527

Brody 488 Series

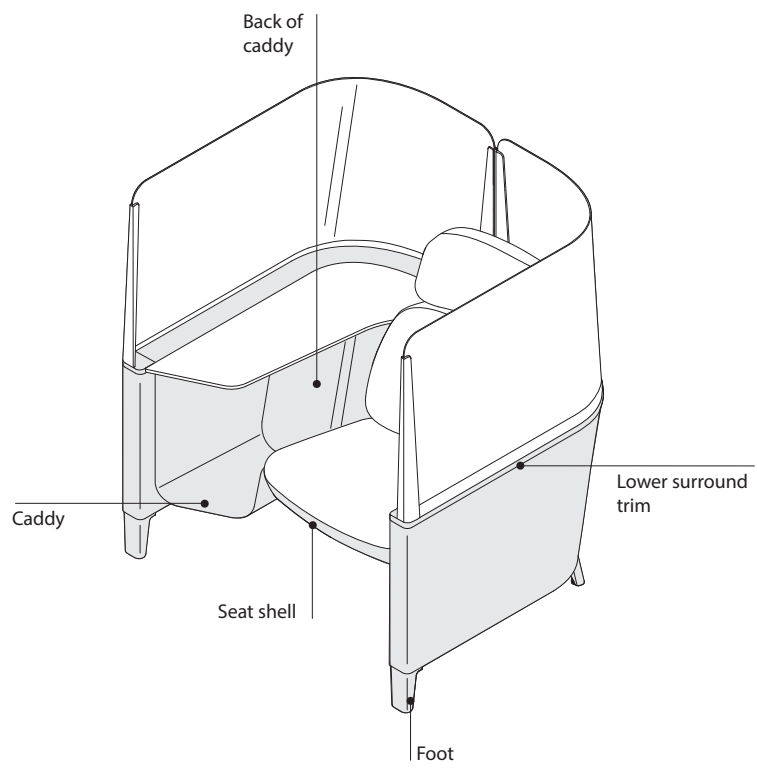

Dimensions

Brody Lounge 488 Series

Features	Overall Depth	Width	Height	Seat Depth	Functional Seat Depth	Seat Width	Seat Height from Floor	Back Width	Lumbar Height from Floor	Lower Surround Height from Floor
Brody WorkLounge 488 Series										
WorkLounge	36 ¹ / ₁₀ "	42 ¹³ / ₁₆ "	36"	21 ⁵ / ₈ "	19 ⁷ / ₈ "	22 ⁵ / ₈ "	16 ⁷ / ₈ "	21 ⁷ / ₈ "	18 ³ / ₈ "	25"
Privacy Lounge	36 ¹ / ₁₀ "	42 ¹³ / ₁₆ "	48 ¹ / ₂ "	21 ⁵ / ₈ "	19 ⁷ / ₈ "	22 ⁵ / ₈ "	16 ⁷ / ₈ "	21 ⁷ / ₈ "	18 ³ / ₈ "	25"
Privacy Lounge with Extension	72 ¹ / ₄ "	42 ¹³ / ₁₆ "	48 ¹ / ₂ "	21 ⁵ / ₈ "	19 ⁷ / ₈ "	22 ⁵ / ₈ "	16 ⁷ / ₈ "	21 ⁷ / ₈ "	18 ³ / ₈ "	25"

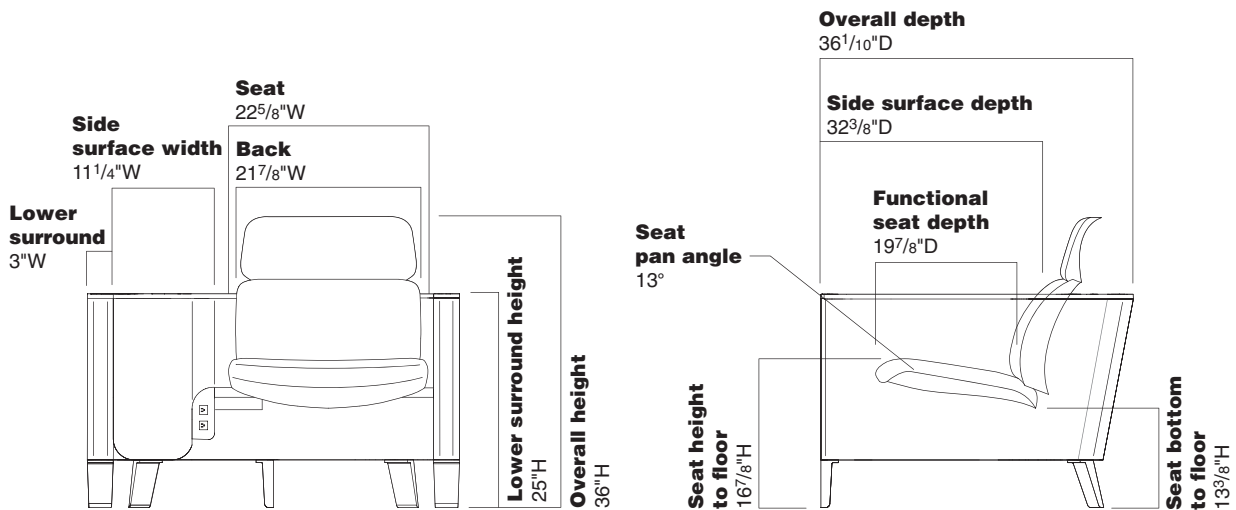

• Lower Surround Trim Width	• Screen Height	• Side Surface Depth	• Side Surface Width	• Side Surface Height from Floor	• Angle Between Seat and Back	• Seat Pan Angle	• Caddy	• Weight Acrylic Screen	• Weight Fabric Screen
3"	N.A.	32 ³ / ₈ "	11 ¹ / ₄ "	25"	99°	13°	14 ¹ / ₄ "D x 10"W x 17 ³ / ₈ "H	119 lbs*	119 lbs*
3"	23 ¹ / ₂ "	32 ³ / ₈ "	11 ¹ / ₄ "	25"	99°	13°	14 ¹ / ₄ "D x 10"W x 17 ³ / ₈ "H	135 lbs	161 lbs
3"	23 ¹ / ₂ "	32 ³ / ₈ "	11 ¹ / ₄ "	25"	99°	13°	14 ¹ / ₄ "D x 10"W x 17 ³ / ₈ "H	169 lbs	208 lbs

Brody 488 Series

*WorkLounge does not come with screens.
The WorkLounge base weight is displayed.

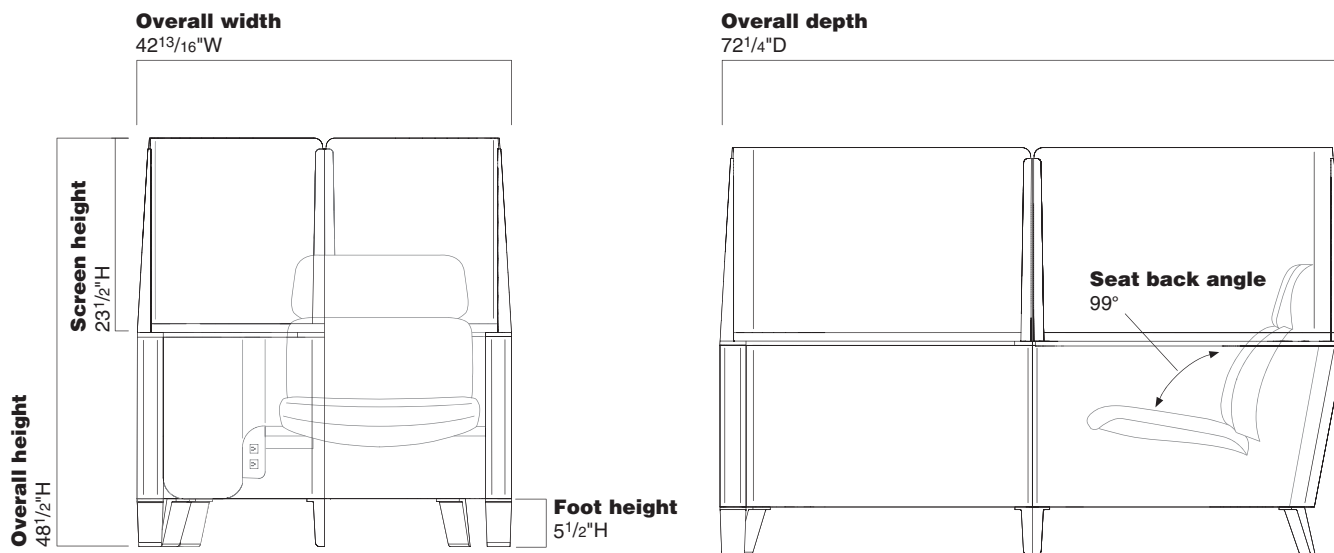

Brody Lounge Application Tips

Application Topics

Consider Brody embedded in five zones:

- Private individual focus area
- At thresholds to the neighborhood
- Along transition paths
- As supplement to the primary workstation
- Working lounge areas

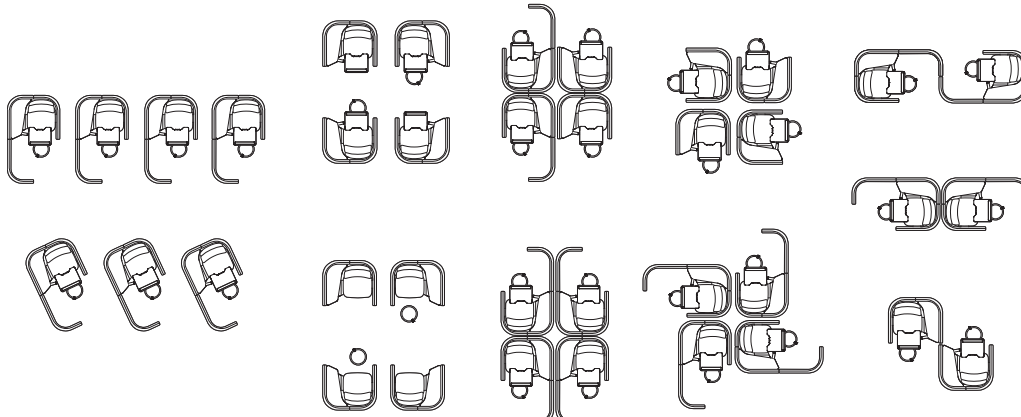

Parallel:
Side-by-Side/Angled

Booth

Clover

Pin Wheel

Yin Yang

Tip: Individual Brody units do not connect with brackets.

Brody Desk 488 Series

Brody is a destination for focus. Every detail has been designed with focus in mind, creating a place where people can escape while still having access to the tools, information, and people they need to be most productive.

Worksurface is available in laminate or veneer and creates space to spread work out.

dash mini LED light is available to provide additional light when needed.

Power is conveniently integrated into the worksurface.

Screens offer additional privacy and shield from distractions.

Lower surround is upholstery wrapped and creates a barrier around the workspace.

Leveling glides on foot adjust 1 1/2" for uneven floors.

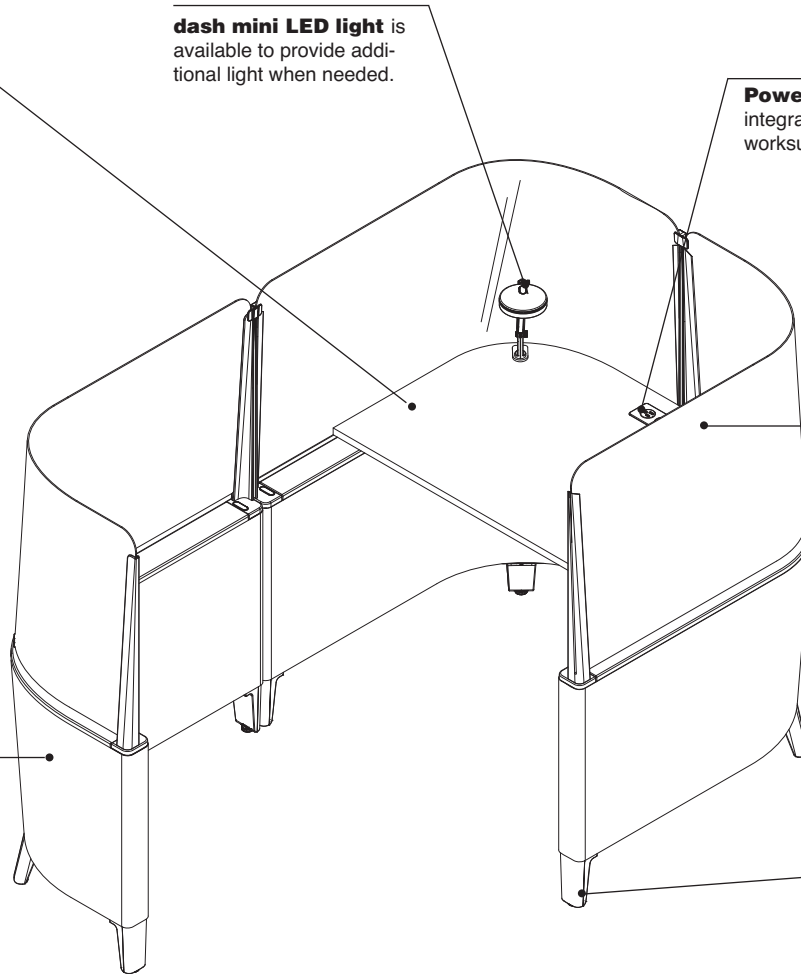

Product Details

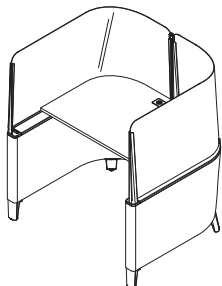

Brody desk always comes standard with screens.

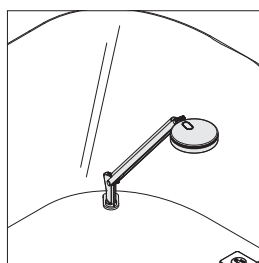

dash mini LED light is available if power has been specified and can be field installed.

dash mini LED light adjusts 19⁷/₈"H from the worksurface. The base and head pivot 360°.

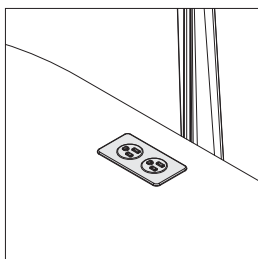

Two NEMA outlets

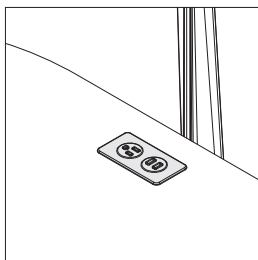

One NEMA, one USB outlet

Power is standard with two three-prong NEMA outlets. It is available with one three-prong NEMA outlet and one USB 2.0 (2.1 amp) outlet as an option. The cord is 10' long and is available with either a standard three-prong NEMA plug for use with standard receptacles or with Steelcase's proprietary Thread low-profile plug for use with one-door and two-door low-profile connectors.

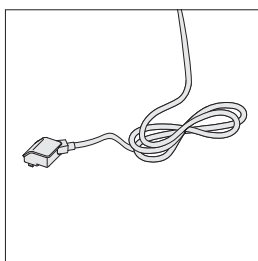

Proprietary low-profile plug

can only be used with the Thread system and will not interface with existing receptacles. In order to achieve ADA compliance for connectors in an egress location, we developed our own plug design.

Note: Always consult your local inspector prior to purchasing the Thread system to ensure all local codes and ordinances are satisfied since local regulations may supersede those spelled out in the National Electric Code.

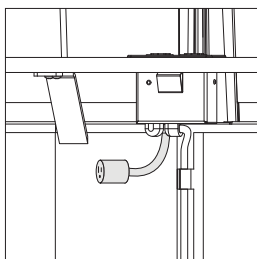

Power includes one convenience outlet standard below the worksurface to power the available dash mini LED light and retain a single power cord out.

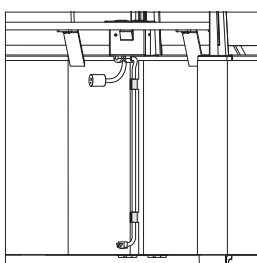

Wire management clips come standard with Brody desk to manage the power cord to the floor.

Surface Materials

► See surface materials on page 504 for specific availability or refer to the *Surface Materials Reference Manual* for further information.

Screen

- Acrylic – 6559 Satin Ice
- Buzz2 fabric
- COM

Tip: COM selections are strictly limited. Please reference the COM page at www.steelcase.com to make your selections.

Lower surround upholstery

- Fabric
- COM

Tip: The standard application direction of fabric on the lower surround is warp horizontal. Standard Steelcase fabrics were designed for this application direction.

Trim

- Fabric
- Plastic
- COM

Light

- 4231 Arctic White
- 4710 Low Gloss Black
- 4799 Platinum
- Accent paint (option)

Power

- 4799 Platinum Metallic
- 7243 Seagull
- 7250 Sterling Dark Solid

Worksurface

- Laminate
- Veneer

Lower surround trim, screen brackets, frame, and foot finishes can be found on the color scheme matrix.

► See page 330

Programs & Services

► See the *Surface Materials Reference Manual* for further detail about programs and services offered for seating.

The Customer's Own Material (COM) Program

offers the opportunity for customers to select fabrics that are not offered through the standard Steelcase surface materials program for use on Steelcase products. Through the COM program, Steelcase will test your materials for application on Steelcase products. Once approved, you can place your order. Steelcase will facilitate the entire ordering process and give you a production schedule. Steelcase will order the COM fabric directly from the textile manufacturer. For up-to-date information regarding fabric test results for all COM fabrics and details regarding yardage requirements for most Seating lines, visit the COM website. To locate the COM website:

- Visit www.steelcase.com

Dimensions

► Page 331

Color Scheme Matrix

Color Scheme	Foot	Screen Brackets	Frame	Lower Surround Trim
Light	Seagull 7243	Seagull 7243	Merle 7360	Seagull 6053
Medium	Platinum Metallic 4799	Platinum Metallic 4799	Merle 7360	Platinum Solid 6249
Dark	Sterling Dark 7250	Sterling Dark 7250	Merle 7360	Sterling Dark Solid 6059
Matte Copper	Matte Copper 4B25	Matte Copper 4B25	Merle 7360	Sterling Dark Solid 6059
Matte Brass	Matte Brass 4B22	Matte Brass 4B22	Merle 7360	Sterling Dark Solid 6059
Burnished Bronze	Burnished Bronze 4B23	Burnished Bronze 4B23	Merle 7360	Sterling Dark Solid 6059
Night Bronze	Night Bronze 4B24	Night Bronze 4B24	Merle 7360	Sterling Dark Solid 6059
Obsidian	Obsidian 4B20	Obsidian 4B20	Merle 7360	Sterling Dark Solid 6059

Tip: If an upholstered screen is specified, then the screen clips will always be aluminum.

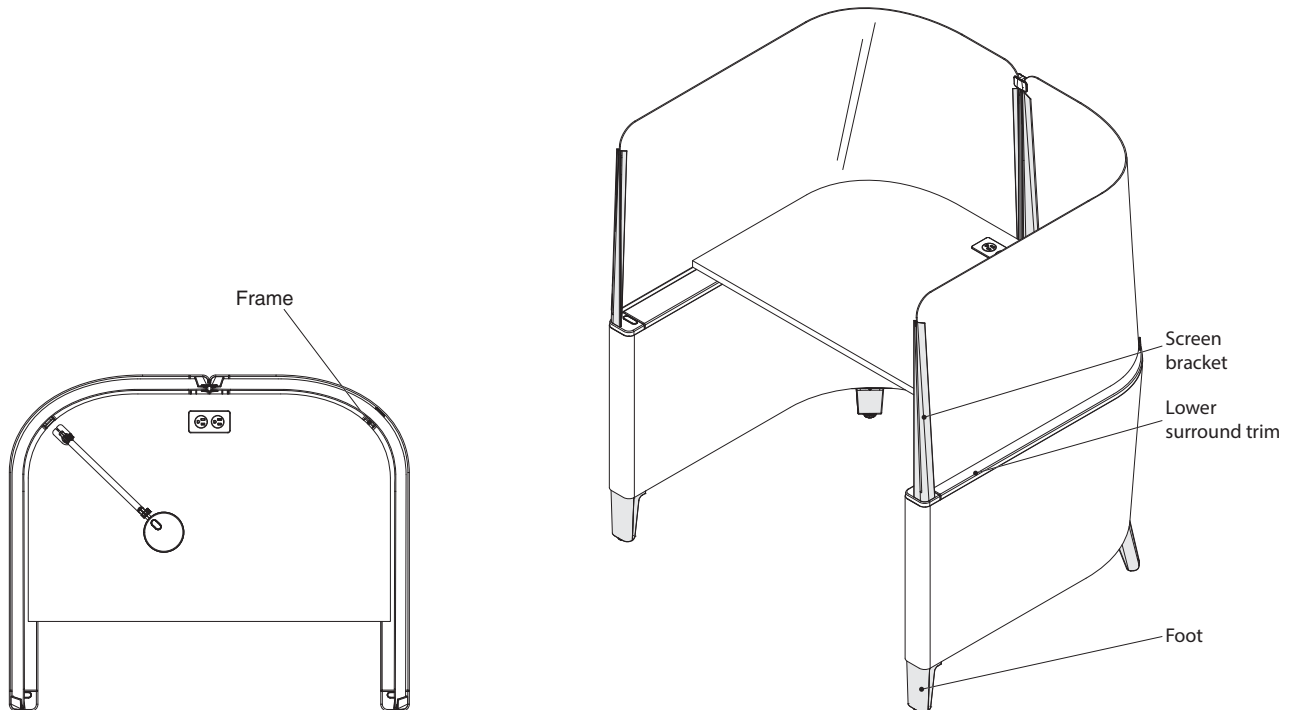

Dimensions

Brody Desk 488 Series

Features	Overall Depth	Width	Height	Lower Surround Trim Width	Screen Height	Worksurface Depth	Worksurface Width	Worksurface Height from Floor
Brody Desk 488 Series								
Privacy Desk								
	36 ¹ / ₈ "	43"	48 ¹ / ₂ "	3"	23 ¹ / ₂ "	24 ¹ / ₂ "	39"	28 ¹ / ₂ "
Privacy Desk with Extension								
	72 ¹ / ₄ "	43"	48 ¹ / ₂ "	3"	23 ¹ / ₂ "	24 ¹ / ₂ "	39"	28 ¹ / ₂ "

Brody 488 Series

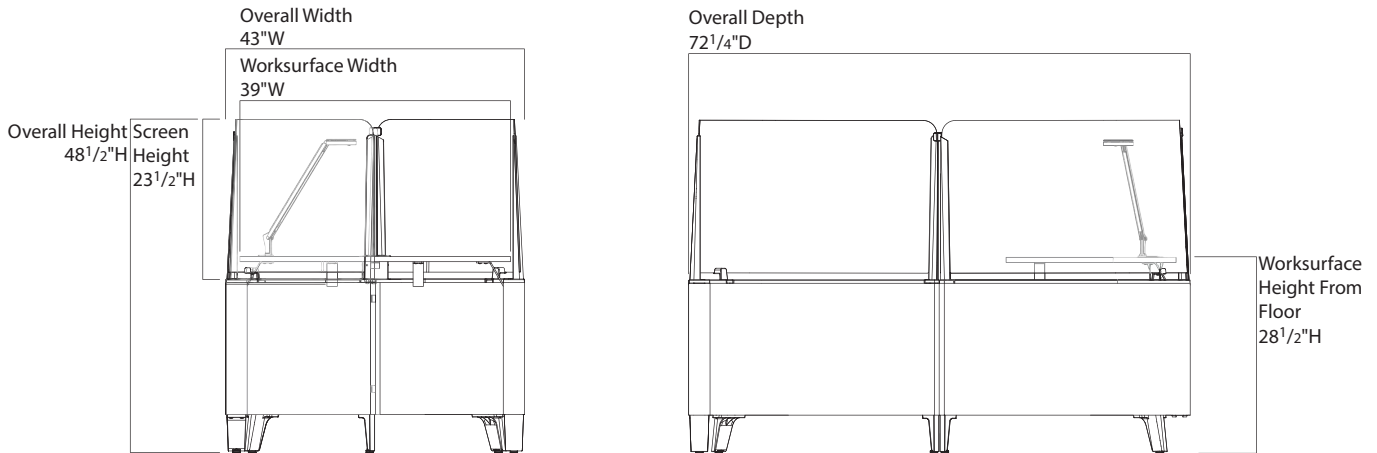
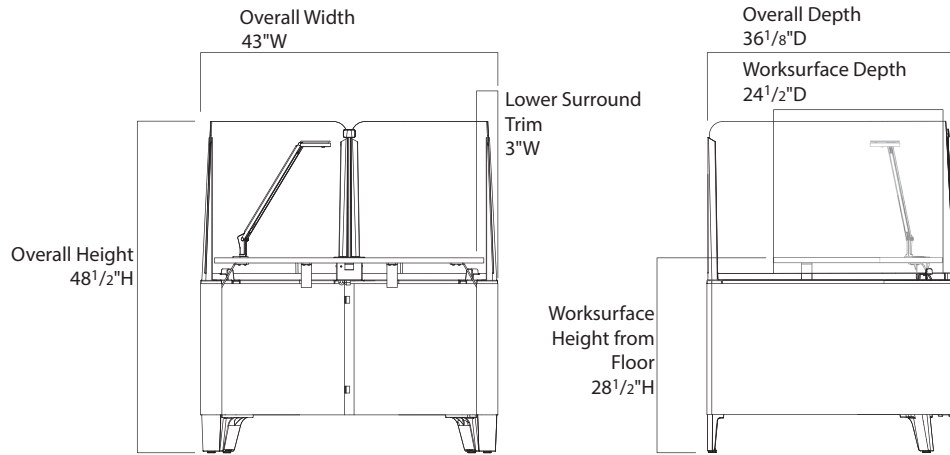

Brody Desk Application Tips

Application Topics

Consider Brody embedded in five zones:

- Private individual focus area
- At thresholds to the neighborhood
- Along transition paths
- As supplement to the primary workstation

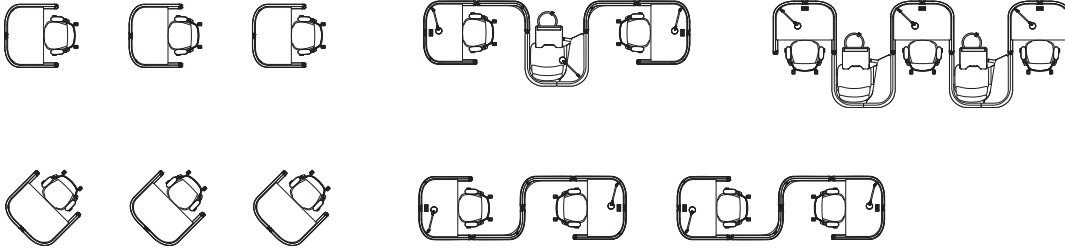

Parallel:
Side-by-Side/Angled

Booth

Clover

Pin Wheel

Yin Yang

Tip: Individual Brody units do not connect with brackets.

Brody WorkLounge

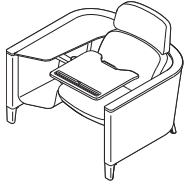

Tip: Illustration above shows right-hand worklounge.

Tip: For more information regarding color schemes, see page 320.

Tip: Handedness is determined by the side surface location. If specified as right-hand, the side surface and storage will be on the user's right (as seated).

Tip: The trim is the top edge of the lower surround. If fabric trim is selected, the upholstery will match the upholstery specified on the lower surround.

► Detailed dimensions, page 324



For Canadian Pricing
Multiply U.S. Price by the Canadian price factor.
► See page 1 for details.

Standard Includes	Required to Specify
<p>► Need help? Product details, page 318</p> <ul style="list-style-type: none"> • Lower surround: fabric price group 1 • Seat: fabric price group 1 • Side surface: laminate • Personal worksurface: plastic defaulted by color scheme • NEMA three prong power outlet: plastic defaulted by color scheme • Caddy: paint defaulted by color scheme 	<ol style="list-style-type: none"> 1 Style number 2 Color scheme (see below under Required Selections) 3 Left- or right-hand configuration (see below under Required Selections) 4 Fabric color number for upholstery on lower surround 5 Fabric color number for upholstery on seat 6 Laminate for side surface 7 Options, if selected (see below) <p>► See <i>Surface Materials</i>, page 504.</p>

Required Selections	U.S. Price	Required to Specify
<p>Color Scheme</p> <p>WorkLounge</p> <ul style="list-style-type: none"> • Light • Medium • Dark • Matte copper • Matte brass • Burnished bronze • Night bronze • Obsidian 	<p>No cost</p> <p>No cost</p> <p>No cost</p> <p>+\$368</p> <p>+\$368</p> <p>+\$368</p> <p>+\$368</p> <p>+\$368</p>	<p>Specify with <i>light color scheme</i>.</p> <p>Specify with <i>medium color scheme</i>.</p> <p>Specify with <i>dark color scheme</i>.</p> <p>Specify with <i>matte copper color scheme</i>.</p> <p>Specify with <i>matte brass color scheme</i>.</p> <p>Specify with <i>burnished bronze color scheme</i>.</p> <p>Specify with <i>night bronze color scheme</i>.</p> <p>Specify with <i>obsidian color scheme</i>.</p>
<p>Handedness</p> <ul style="list-style-type: none"> • Left • Right 	<p>No cost</p> <p>No cost</p>	<p>Specify with <i>left-hand side surface and storage location</i>.</p> <p>Specify with <i>right-hand side surface and storage location</i>.</p>

Options	U.S. Price	Required to Specify
<p>Surface Materials</p> <p>Upholstery on lower surround</p> <ul style="list-style-type: none"> • Fabric price group 1 • Fabric price group 2 • Fabric price group 3 • Fabric price group 4 • Fabric price group 5 • Fabric price group 6 • Fabric price group 7 • Fabric price group 8 • Fabric price group 9 • Fabric price group 10 • Customer's Own Material (COM) 	<p>No cost</p> <p>+\$ 48</p> <p>+\$ 91</p> <p>+\$128</p> <p>+\$161</p> <p>+\$200</p> <p>+\$228</p> <p>+\$288</p> <p>+\$354</p> <p>+\$403</p> <p>No cost</p>	<p>Specify fabric color number.</p> <p>Specify fabric color number.</p> <p>Specify fabric color number.</p> <p>Specify fabric color number.</p> <p>Specify fabric color number.</p> <p>Specify fabric color number.</p> <p>Specify fabric color number.</p> <p>Specify fabric color number.</p> <p>Specify fabric color number.</p> <p>Specify fabric color number.</p> <p>► See <i>Surface Materials Reference Manual</i>.</p>
<p>Trim</p> <ul style="list-style-type: none"> • Plastic • Fabric to match lower surround 	<p>No cost</p> <p>+\$270</p>	<p>Specify with <i>plastic trim</i>.</p> <p>Specify with <i>fabric trim</i>.</p>
<p>Upholstery on trim</p> <ul style="list-style-type: none"> • Fabric price group 1 • Fabric price group 2 • Fabric price group 3 • Fabric price group 4 • Fabric price group 5 • Fabric price group 6 • Fabric price group 7 • Fabric price group 8 • Fabric price group 9 • Fabric price group 10 • Customer's Own Material (COM) 	<p>No cost</p> <p>+\$ 18</p> <p>+\$ 33</p> <p>+\$ 46</p> <p>+\$ 58</p> <p>+\$ 73</p> <p>+\$ 83</p> <p>+\$104</p> <p>+\$129</p> <p>+\$146</p> <p>No cost</p>	<p>Specify fabric color number.</p> <p>Specify fabric color number.</p> <p>Specify fabric color number.</p> <p>Specify fabric color number.</p> <p>Specify fabric color number.</p> <p>Specify fabric color number.</p> <p>Specify fabric color number.</p> <p>Specify fabric color number.</p> <p>Specify fabric color number.</p> <p>Specify fabric color number.</p>

► Options, continued on next page

► Options, continued from previous page

Options	U.S. Price	Required to Specify
Surface Materials, continued	Upholstery on seat	
	• Fabric price group 1	No cost
	• Fabric price group 2	+\$ 27
	• Fabric price group 3	+\$ 49
	• Fabric price group 4	+\$ 70
	• Fabric price group 5	+\$ 88
	• Fabric price group 6	+\$109
	• Fabric price group 7	+\$125
	• Fabric price group 8	+\$158
	• Fabric price group 9	+\$194
	• Fabric price group 10	+\$219
	• Steelcase leather upholstery	+\$291
	• Select Surfaces leather price group 1	+\$291
	• Elmosoft leather upholstery	+\$347
	• Select Surfaces leather price group 2	+\$347
	• Steelcase vinyl	+\$ 27
	• Customer's Own Material (COM)	No cost
	• Customer's Own Leather (COL)	+\$ 79
	• Soil-retardant treatment applied to upholstery fabric	+\$ 27
		Specify fabric color number. Specify fabric color number. Specify fabric color number. Specify fabric color number. Specify fabric color number. Specify fabric color number. Specify fabric color number. Specify fabric color number. Specify fabric color number. Specify fabric color number. Specify leather color number. ► See <i>Surface Materials Reference Manual</i> . Specify Elmosoft leather color number. ► See <i>Surface Materials Reference Manual</i> . Specify vinyl color number. ► See <i>Surface Materials Reference Manual</i> . Specify leather color number. Specify <i>with soil-retardant treatment</i> .
Personal Worksurface	• Omit personal worksurface	-\$485
		Specify <i>with no worksurface</i> .
Power	• Omit power	-\$296
	• Thread low profile plug	+\$ 28
	• One USB 2.0 outlet and one NEMA three-prong outlet	+\$100
		Specify <i>with no power</i> . Specify <i>with Thread low profile plug</i> . Specify <i>with USB and standard NEMA three-prong outlet</i> .
dash mini LED light	• Paint price group 1	+\$453
	• Paint price group 3	+\$483
		Specify <i>with light</i> and indicate paint color number. Specify <i>with light</i> and indicate paint color number. ► See <i>Surface Materials Reference Manual</i> .
Related Products	• Footrest	► Page 344

Tip: The light option is only available if power has been specified.

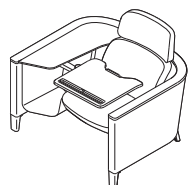

Specification Information

Style Number	U.S. Base Price
488WO	\$3204

**For Canadian Pricing**

Multiply U.S. Price by the Canadian price factor.

► See page 1 for details.

Brody Privacy Lounge

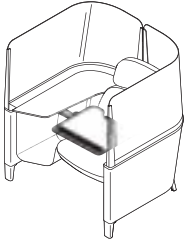

Tip: Illustration above shows right-hand privacy lounge.

Tip: For more information regarding color schemes, see page 320.

Tip: Handedness is determined by the side surface location. If specified as right-hand the side surface and storage will be on the user's right (as seated).

Tip: The trim is the top edge of the lower surround. If fabric trim is selected, the upholstery will match the upholstery specified on the lower surround.

► Detailed dimensions, page 324



For Canadian Pricing
Multiply U.S. Price by the Canadian price factor.
► See page 1 for details.

Standard Includes	Required to Specify
<p>► Need help? Product details, page 318</p> <ul style="list-style-type: none"> • Lower surround: fabric price group 1 • Screens: 6559 Satin Ice acrylic • Seat: fabric price group 1 • Side surface: laminate • Personal worksurface: plastic defaulted by color scheme • NEMA three prong power outlet: plastic defaulted by color scheme • Caddy: paint defaulted by color scheme 	<ol style="list-style-type: none"> 1 Style number 2 Color scheme (see below under Required Selections) 3 Left- or right-hand configuration (see below under Required Selections) 4 Fabric color number for upholstery on lower surround 5 Fabric color number for upholstery on seat 6 Laminate for side surface 7 Options, if selected (see below) <p>► See <i>Surface Materials</i>, page 504.</p>

Required Selections	U.S. Price	Required to Specify
<p>Color Scheme</p> <p>Privacy lounge</p> <ul style="list-style-type: none"> • Light No cost • Medium No cost • Dark No cost • Matte copper +\$368 • Matte brass +\$368 • Burnished bronze +\$368 • Night bronze +\$368 • Obsidian +\$368 		<p>Specify with <i>light color scheme</i>.</p> <p>Specify with <i>medium color scheme</i>.</p> <p>Specify with <i>dark color scheme</i>.</p> <p>Specify with <i>matte copper color scheme</i>.</p> <p>Specify with <i>matte brass color scheme</i>.</p> <p>Specify with <i>burnished bronze color scheme</i>.</p> <p>Specify with <i>night bronze color scheme</i>.</p> <p>Specify with <i>obsidian color scheme</i>.</p>
<p>Handedness</p> <ul style="list-style-type: none"> • Left No cost • Right No cost 		<p>Specify with <i>left-hand side surface and storage location</i>.</p> <p>Specify with <i>right-hand side surface and storage location</i>.</p>

Options	U.S. Price	Required to Specify
<p>Surface Materials</p> <p>Upholstery on lower surround</p> <ul style="list-style-type: none"> • Fabric price group 1 No cost • Fabric price group 2 +\$ 48 • Fabric price group 3 +\$ 91 • Fabric price group 4 +\$128 • Fabric price group 5 +\$161 • Fabric price group 6 +\$200 • Fabric price group 7 +\$228 • Fabric price group 8 +\$288 • Fabric price group 9 +\$354 • Fabric price group 10 +\$403 • Customer's Own Material (COM) No cost 		<p>Specify fabric color number.</p> <p>Specify fabric color number.</p> <p>Specify fabric color number.</p> <p>Specify fabric color number.</p> <p>Specify fabric color number.</p> <p>Specify fabric color number.</p> <p>Specify fabric color number.</p> <p>Specify fabric color number.</p> <p>Specify fabric color number.</p> <p>Specify fabric color number.</p> <p>► See <i>Surface Materials Reference Manual</i>.</p>
<p>Trim</p> <ul style="list-style-type: none"> • Plastic No cost • Fabric to match lower surround +\$270 		<p>Specify with <i>plastic trim</i>.</p> <p>Specify with <i>fabric trim</i>.</p>
<p>Upholstery on trim</p> <ul style="list-style-type: none"> • Fabric price group 1 No cost • Fabric price group 2 +\$ 18 • Fabric price group 3 +\$ 33 • Fabric price group 4 +\$ 46 • Fabric price group 5 +\$ 58 • Fabric price group 6 +\$ 73 • Fabric price group 7 +\$ 83 • Fabric price group 8 +\$104 • Fabric price group 9 +\$129 • Fabric price group 10 +\$146 • Customer's Own Material (COM) No cost 		<p>Specify fabric color number.</p> <p>Specify fabric color number.</p> <p>Specify fabric color number.</p> <p>Specify fabric color number.</p> <p>Specify fabric color number.</p> <p>Specify fabric color number.</p> <p>Specify fabric color number.</p> <p>Specify fabric color number.</p> <p>Specify fabric color number.</p> <p>Specify fabric color number.</p> <p>Specify fabric color number.</p>

► Options, continued on next page

► Options, continued from previous page

	Options	U.S. Price	Required to Specify
Surface Materials, continued	Upholstery on seat		
	• Fabric price group 1	No cost	Specify fabric color number.
	• Fabric price group 2	+\$ 27	Specify fabric color number.
	• Fabric price group 3	+\$ 49	Specify fabric color number.
	• Fabric price group 4	+\$ 70	Specify fabric color number.
	• Fabric price group 5	+\$ 88	Specify fabric color number.
	• Fabric price group 6	+\$109	Specify fabric color number.
	• Fabric price group 7	+\$125	Specify fabric color number.
	• Fabric price group 8	+\$158	Specify fabric color number.
	• Fabric price group 9	+\$194	Specify fabric color number.
	• Fabric price group 10	+\$219	Specify fabric color number.
	• Steelcase leather upholstery	+\$291	Specify leather color number.
	• Select Surfaces leather price group 1	+\$291	► See <i>Surface Materials Reference Manual</i> . Specify Elmosoft leather color number.
	• Elmosoft leather upholstery	+\$347	► See <i>Surface Materials Reference Manual</i> . Specify vinyl color number.
	• Select Surfaces leather price group 2	+\$347	► See <i>Surface Materials Reference Manual</i> . Specify leather color number.
• Steelcase vinyl	+\$ 27	Specify <i>with soil-retardant treatment</i> .	
• Customer's Own Material (COM)	No cost		
• Customer's Own Leather (COL)	+\$ 79		
• Soil-retardant treatment applied to upholstery fabric	+\$ 27		
	Screen type		
	• Acrylic	No cost	Specify <i>with 6559 Satin Ice acrylic</i> .
	• Fabric – 1 screen	+\$215	Specify <i>with fabric screen</i> .
	• Fabric – 2 screens	+\$430	Specify <i>with fabric screens</i> .
	Upholstery on screen		
	• Fabric price group 1	No cost	Specify fabric color number.
	• Fabric price group 2	+\$ 31	Specify fabric color number.
	• Fabric price group 3	+\$ 58	Specify fabric color number.
	• Fabric price group 4	+\$ 81	Specify fabric color number.
	• Fabric price group 5	+\$102	Specify fabric color number.
	• Fabric price group 6	+\$127	Specify fabric color number.
	• Fabric price group 7	+\$145	Specify fabric color number.
	• Fabric price group 8	+\$183	Specify fabric color number.
	• Fabric price group 9	+\$226	Specify fabric color number.
	• Fabric price group 10	+\$256	Specify fabric color number.
	• Customer's Own Material (COM)	No cost	► See <i>Surface Materials Reference Manual</i> .
Omit Screen	• Omit right screen	–\$404	Specify <i>with left screen location only</i> .
	• Omit left screen	–\$404	Specify <i>with right screen location only</i> .
Personal Worksurface	• Omit personal worksurface	–\$485	Specify <i>with no worksurface</i> .
Power	• Omit power	–\$296	Specify <i>with no power</i> .
	• Thread low profile plug	+\$ 28	Specify <i>with Thread low profile plug</i> .
	• One USB 2.0 outlet and one NEMA three-prong outlet	+\$100	Specify <i>with USB and standard NEMA three-prong outlet</i> .
dash mini LED light	• Paint price group 1	+\$453	Specify <i>with light</i> and indicate paint color number.
	• Paint price group 3	+\$483	Specify <i>with light</i> and indicate paint color number.
			► See <i>Surface Materials Reference Manual</i> .
Related Products	• Footrest		► Page 344

Tip: When omitting one fabric screen on a privacy lounge, the upholstery upcharge will be reduced by one half.

Tip: Buzz2 is the only Steelcase vertical upholstery group available on fabric screens.

Tip: COM selections are strictly limited, please reference the COM page at www.steelcase.com to make your selections.

Tip: When omitting a screen, only the screen opposite the side surface can be omitted.

Tip: The light option is only available if power has been specified.

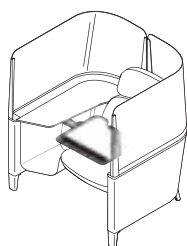

Specification Information

Style Number	U.S. Base Price
488WP	\$4119

Brody Privacy Lounge with Extension

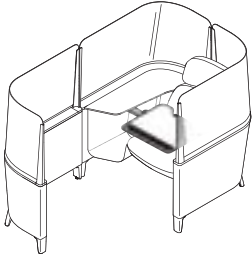

Tip: Illustration above shows right-hand privacy lounge with extension.

Tip: For more information regarding color schemes, see page 320.

Tip: Handedness is determined by the side surface location. If specified as right-hand the side surface and storage will be on the user's right (as seated).

Tip: The trim is the top edge of the lower surround. If fabric trim is selected, the upholstery will match the upholstery specified on the lower surround.

► Detailed dimensions, page 324



For Canadian Pricing
Multiply U.S. Price by the Canadian price factor.
► See page 1 for details.

Standard Includes	Required to Specify
-------------------	---------------------

- | | |
|--|---|
| <ul style="list-style-type: none"> ► Need help? Product details, page 318 • Lower surround: fabric price group 1 • Screens: 6559 Satin Ice acrylic • Seat: fabric price group 1 • Side surface: laminate • Personal worksurface: plastic defaulted by color scheme • NEMA three prong power outlet: plastic defaulted by color scheme • Caddy: paint defaulted by color scheme | <ol style="list-style-type: none"> 1 Style number 2 Color scheme (see below under Required Selections) 3 Left- or right-hand configuration (see below under Required Selections) 4 Fabric color number for upholstery on lower surround 5 Fabric color number for upholstery on seat 6 Laminate for side surface 7 Options, if selected (see below) <p>► See <i>Surface Materials</i>, page 504.</p> |
|--|---|

Required Selections	U.S. Price	Required to Specify
---------------------	------------	---------------------

Color Scheme	Privacy lounge with extension	
	<ul style="list-style-type: none"> • Light No cost • Medium No cost • Dark No cost • Matte copper +\$368 • Matte brass +\$368 • Burnished bronze +\$368 • Night bronze +\$368 • Obsidian +\$368 	<p>Specify with <i>light color scheme</i>.</p> <p>Specify with <i>medium color scheme</i>.</p> <p>Specify with <i>dark color scheme</i>.</p> <p>Specify with <i>matte copper color scheme</i>.</p> <p>Specify with <i>matte brass color scheme</i>.</p> <p>Specify with <i>burnished bronze color scheme</i>.</p> <p>Specify with <i>night bronze color scheme</i>.</p> <p>Specify with <i>obsidian color scheme</i>.</p>

Handedness	<ul style="list-style-type: none"> • Left No cost • Right No cost 	<p>Specify with <i>left-hand side surface and storage location</i>.</p> <p>Specify with <i>right-hand side surface and storage location</i>.</p>
-------------------	---	--

Options	U.S. Price	Required to Specify
---------	------------	---------------------

Surface Materials	Upholstery on lower surround	
	<ul style="list-style-type: none"> • Fabric price group 1 No cost • Fabric price group 2 +\$ 79 • Fabric price group 3 +\$149 • Fabric price group 4 +\$209 • Fabric price group 5 +\$263 • Fabric price group 6 +\$327 • Fabric price group 7 +\$374 • Fabric price group 8 +\$472 • Fabric price group 9 +\$580 • Fabric price group 10 +\$659 • Customer's Own Material (COM) No cost 	<p>Specify fabric color number.</p> <p>Specify fabric color number.</p> <p>Specify fabric color number.</p> <p>Specify fabric color number.</p> <p>Specify fabric color number.</p> <p>Specify fabric color number.</p> <p>Specify fabric color number.</p> <p>Specify fabric color number.</p> <p>Specify fabric color number.</p> <p>Specify fabric color number.</p> <p>► See <i>Surface Materials Reference Manual</i></p>

	Trim	
	<ul style="list-style-type: none"> • Plastic No cost • Fabric to match lower surround +\$405 	<p>Specify with <i>plastic trim</i>.</p> <p>Specify with <i>fabric trim</i>.</p>

	Upholstery on trim	
	<ul style="list-style-type: none"> • Fabric price group 1 No cost • Fabric price group 2 +\$ 28 • Fabric price group 3 +\$ 49 • Fabric price group 4 +\$ 70 • Fabric price group 5 +\$ 88 • Fabric price group 6 +\$110 • Fabric price group 7 +\$126 • Fabric price group 8 +\$158 • Fabric price group 9 +\$194 • Fabric price group 10 +\$220 • Customer's Own Material (COM) No cost 	<p>Specify fabric color number.</p> <p>Specify fabric color number.</p> <p>Specify fabric color number.</p> <p>Specify fabric color number.</p> <p>Specify fabric color number.</p> <p>Specify fabric color number.</p> <p>Specify fabric color number.</p> <p>Specify fabric color number.</p> <p>Specify fabric color number.</p> <p>Specify fabric color number.</p> <p>Specify fabric color number.</p>

► Options, continued on next page

► Options, continued from previous page

	Options	U.S. Price	Required to Specify
Surface Materials, continued	Upholstery on seat		
	• Fabric price group 1	No cost	Specify fabric color number.
	• Fabric price group 2	+\$ 27	Specify fabric color number.
	• Fabric price group 3	+\$ 49	Specify fabric color number.
	• Fabric price group 4	+\$ 70	Specify fabric color number.
	• Fabric price group 5	+\$ 88	Specify fabric color number.
	• Fabric price group 6	+\$109	Specify fabric color number.
	• Fabric price group 7	+\$125	Specify fabric color number.
	• Fabric price group 8	+\$158	Specify fabric color number.
	• Fabric price group 9	+\$194	Specify fabric color number.
	• Fabric price group 10	+\$219	Specify fabric color number.
	• Steelcase leather upholstery	+\$291	Specify leather color number.
	• Select Surfaces leather price group 1	+\$291	► See <i>Surface Materials Reference Manual</i> .
	• Elmosoft leather upholstery	+\$347	Specify Elmosoft leather color number.
	• Select Surfaces leather price group 2	+\$347	► See <i>Surface Materials Reference Manual</i> .
• Steelcase vinyl	+\$ 27	Specify vinyl color number.	
• Customer's Own Material (COM)	No cost	► See <i>Surface Materials Reference Manual</i> .	
• Customer's Own Leather (COL)	+\$ 79	Specify leather color number.	
• Soil-retardant treatment applied to upholstery fabric	+\$ 27	Specify <i>with soil-retardant treatment</i> .	
	Screen type		
	• Acrylic	No cost	Specify <i>with 6559 Satin Ice acrylic</i> .
	• Fabric – 2 screens	+\$430	Specify <i>with fabric screens</i> .
	• Fabric – 3 screens	+\$645	Specify <i>with fabric screens</i> .
	Upholstery on screen		
	• Fabric price group 1	No cost	Specify fabric color number.
	• Fabric price group 2	+\$ 31	Specify fabric color number.
	• Fabric price group 3	+\$ 58	Specify fabric color number.
	• Fabric price group 4	+\$ 81	Specify fabric color number.
	• Fabric price group 5	+\$102	Specify fabric color number.
	• Fabric price group 6	+\$127	Specify fabric color number.
	• Fabric price group 7	+\$145	Specify fabric color number.
	• Fabric price group 8	+\$183	Specify fabric color number.
	• Fabric price group 9	+\$226	Specify fabric color number.
	• Fabric price group 10	+\$256	Specify fabric color number.
	• Customer's Own Material (COM)	No cost	► See <i>Surface Materials Reference Manual</i> .
	Omit Screen		
	• Omit right screen	–\$404	Specify <i>with left screen location only</i> .
	• Omit left screen	–\$404	Specify <i>with right screen location only</i> .
	Personal Worksurface		
	• Omit personal worksurface	–\$485	Specify <i>with no worksurface</i> .
	Power		
	• Omit power	–\$296	Specify <i>with no power</i> .
	• Thread low profile plug	+\$ 28	Specify <i>with Thread low profile plug</i> .
	• One USB 2.0 outlet and one NEMA three-prong outlet	+\$100	Specify <i>with USB and standard NEMA three-prong outlet</i> .
	dash mini LED light		
	• Paint price group 1	+\$453	Specify <i>with light</i> and indicate paint color number.
	• Paint price group 3	+\$483	Specify <i>with light</i> and indicate paint color number.
			► See <i>Surface Materials Reference Manual</i> .
	Related Products		► Page 344

Tip: When omitting one fabric screen on a privacy lounge with extension, the upholstery upcharge will be reduced by one third.

Tip: Buzz2 is the only Steelcase vertical upholstery group available on fabric screens.

Tip: COM selections are strictly limited, please reference the COM page at www.steelcase.com to make your selections.

Tip: When omitting a screen, only the screen opposite the side surface can be omitted.

Tip: The light option is only available if power has been specified.

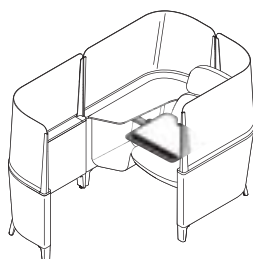

Specification Information	
Style Number	U.S. Base Price
488WE	\$5562

Brody Privacy Desk

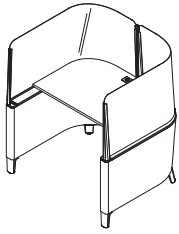

Standard Includes	Required to Specify
<ul style="list-style-type: none"> ▶ Need help? Product details, page 328 • Lower surround: fabric price group 1 • Screens: 6559 Satin Ice acrylic • Worksurface: High-Pressure Laminate • Edge: plastic • NEMA three prong power outlet: paint • Wire management clips 	<ol style="list-style-type: none"> 1 Style number 2 Color scheme (see below under Required Selections) 3 Fabric color number for upholstery on lower surround 4 High-Pressure Laminate color number for worksurface 5 Plastic color number for worksurface edge 6 Paint color number for power outlet 7 Options, if selected (see below) <ul style="list-style-type: none"> ▶ See <i>Surface Materials</i>, page 504.

Tip: For more information regarding color schemes, see page 330.

Color Scheme	Required Selections	U.S. Price	Required to Specify
	• Light	No cost	Specify <i>with light color scheme</i> .
	• Medium	No cost	Specify <i>with medium color scheme</i> .
	• Dark	No cost	Specify <i>with dark color scheme</i> .
	• Matte copper	+\$368	Specify <i>with matte copper color scheme</i> .
	• Matte brass	+\$368	Specify <i>with matte brass color scheme</i> .
	• Burnished bronze	+\$368	Specify <i>with burnished bronze color scheme</i> .
	• Night bronze	+\$368	Specify <i>with night bronze color scheme</i> .
	• Obsidian	+\$368	Specify <i>with obsidian color scheme</i> .

Options	U.S. Price	Required to Specify
Surface Materials High-Pressure Laminate worksurface <ul style="list-style-type: none"> • Open Line laminate 	+\$ 71 plus cost of laminate	▶ See <i>Surface Materials Reference Manual</i> .
Wood veneer worksurface <ul style="list-style-type: none"> • Wood veneer • Premium wood 2 • Premium wood 3 • Customiz stain • Full-fill finish 	+\$750 +\$798 +\$919 No cost +\$789	Specify <i>with wood veneer</i> and indicate wood color number. Specify Premium wood 2 finish number. Specify Premium wood 3 finish number. Specify <i>with Customiz stain</i> . ▶ See <i>Surface Materials Reference Manual</i> . Specify full-fill finish number.
Upholstery on lower surround <ul style="list-style-type: none"> • Fabric price group 1 • Fabric price group 2 • Fabric price group 3 • Fabric price group 4 • Fabric price group 5 • Fabric price group 6 • Fabric price group 7 • Fabric price group 8 • Fabric price group 9 • Fabric price group 10 • Customer's Own Material (COM) 	No cost +\$ 48 +\$ 91 +\$128 +\$161 +\$200 +\$228 +\$288 +\$354 +\$403 No cost	Specify fabric color number. Specify fabric color number. Specify fabric color number. Specify fabric color number. Specify fabric color number. Specify fabric color number. Specify fabric color number. Specify fabric color number. Specify fabric color number. Specify fabric color number. Specify fabric color number. ▶ See <i>Surface Materials Reference Manual</i> .

▶ Options, continued on next page



For Canadian Pricing

Multiply U.S. Price by the Canadian price factor.

▶ See page 1 for details.

► Options, continued from previous page

	Options	U.S. Price	Required to Specify
Surface Materials, continued	Trim		
	• Plastic	No cost	Specify <i>with plastic trim</i> .
	• Fabric to match lower surround	+\$270	Specify <i>with fabric trim</i> .
	Upholstery on trim		
	• Fabric price group 1	No cost	Specify fabric color number.
	• Fabric price group 2	+\$ 18	Specify fabric color number.
	• Fabric price group 3	+\$ 33	Specify fabric color number.
	• Fabric price group 4	+\$ 46	Specify fabric color number.
	• Fabric price group 5	+\$ 58	Specify fabric color number.
	• Fabric price group 6	+\$ 73	Specify fabric color number.
• Fabric price group 7	+\$ 83	Specify fabric color number.	
• Fabric price group 8	+\$104	Specify fabric color number.	
• Fabric price group 9	+\$129	Specify fabric color number.	
• Fabric price group 10	+\$146	Specify fabric color number.	
• Customer's Own Material (COM)	No cost	► See <i>Surface Materials Reference Manual</i> .	
	Screen type		
	• Acrylic	No cost	Specify <i>with 6559 Satin Ice acrylic</i> .
	• Fabric	+\$430	Specify <i>with fabric screens</i> .
	Upholstery on screen		
	• Fabric price group 1	No cost	Specify fabric color number.
	• Fabric price group 2	+\$ 31	Specify fabric color number.
	• Fabric price group 3	+\$ 58	Specify fabric color number.
	• Fabric price group 4	+\$ 81	Specify fabric color number.
	• Fabric price group 5	+\$102	Specify fabric color number.
	• Fabric price group 6	+\$127	Specify fabric color number.
	• Fabric price group 7	+\$145	Specify fabric color number.
	• Fabric price group 8	+\$183	Specify fabric color number.
	• Fabric price group 9	+\$226	Specify fabric color number.
	• Fabric price group 10	+\$256	Specify fabric color number.
	• Customer's Own Material (COM)	No cost	► See <i>Surface Materials Reference Manual</i> .
	Power		
	• Omit power	-\$296	Specify <i>with no power</i> .
	• Thread low profile plug	+\$ 28	Specify <i>with Thread low profile plug</i> and indicate paint color number.
	• One USB 2.0 outlet and one NEMA three-prong outlet	+\$100	Specify <i>with USB and standard NEMA three-prong outlet</i> and indicate paint color number.
	dash mini LED light		
	• Paint price group 1	+\$453	Specify <i>with light</i> and indicate paint color number.
	• Paint price group 3	+\$483	Specify <i>with light</i> and indicate paint color number.
			► See <i>Surface Materials Reference Manual</i> .
	Related Products		
	• Steelcase Series 1 chairs		► Page 100
	• QiVi chairs		► Page 276
	• Cobi chairs		► Page 286

Tip: The trim is the top edge of the lower surround. If fabric trim is selected, the upholstery will match the upholstery specified on the lower surround.

Tip: Buzz2 is the only Steelcase verical upholstery group available on fabric screens.

Tip: COM selections are strictly limited, please reference the COM page at www.steelcase.com to make your selections.

Tip: The light option is only available if power has been specified.

Specification Information

Style Number	U.S. Base Price
488BD	\$3706

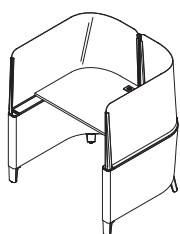

Brody Privacy Desk with Extension

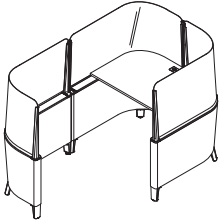

Tip: Illustration above shows privacy desk with extension, enter right.

Tip: For more information regarding color schemes, see page 330.

Tip: Extension opening is determined by where the user enters Brody desk unit.

Standard Includes	Required to Specify
<ul style="list-style-type: none"> ▶ Need help? Product details, page 328 • Lower surround: fabric price group 1 • Screens: 6559 Satin Ice acrylic • Worksurface: High-Pressure Laminate • Edge: plastic • NEMA three prong power outlet: paint • Wire management clips 	<ol style="list-style-type: none"> 1 Style number 2 Color scheme (see below under Required Selections) 3 Extension opening (see below under Required Selections) 4 Fabric color number for upholstery on lower surround 5 High-Pressure Laminate color number for worksurface 6 Plastic color number for worksurface edge 7 Paint color number for power outlet 8 Options, if selected (see below) <p>▶ See <i>Surface Materials</i>, page 504.</p>

Color Scheme	Required Selections	U.S. Price	Required to Specify
	• Light	No cost	Specify with <i>light color scheme</i> .
	• Medium	No cost	Specify with <i>medium color scheme</i> .
	• Dark	No cost	Specify with <i>dark color scheme</i> .
	• Matte copper	+\$368	Specify with <i>matte copper color scheme</i> .
	• Matte brass	+\$368	Specify with <i>matte brass color scheme</i> .
	• Burnished bronze	+\$368	Specify with <i>burnished bronze color scheme</i> .
	• Night bronze	+\$368	Specify with <i>night bronze color scheme</i> .
	• Obsidian	+\$368	Specify with <i>obsidian color scheme</i> .

Extension Opening	Required Selections	U.S. Price	Required to Specify
	• Enter left	No cost	Specify with <i>enter left</i> .
	• Enter right	No cost	Specify with <i>enter right</i> .

Surface Materials	Options	U.S. Price	Required to Specify
	High-Pressure Laminate worksurface		<p>▶ See <i>Surface Materials Reference Manual</i>.</p> <hr/> <p>Specify with <i>wood veneer</i> and indicate wood color number.</p> <p>Specify Premium wood 2 finish number.</p> <p>Specify Premium wood 3 finish number.</p> <p>Specify with <i>Customiz stain</i>.</p> <p>▶ See <i>Surface Materials Reference Manual</i>.</p> <p>Specify full-fill finish number.</p>
	Wood veneer worksurface		
	• Open Line laminate	+\$ 71 plus cost of laminate	
	• Wood veneer	+\$750	
	• Premium wood 2	+\$798	
	• Premium wood 3	+\$919	
	• Customiz stain	No cost	
	• Full-fill finish	+\$789	
	Upholstery on lower surround		
	• Fabric price group 1	No cost	
	• Fabric price group 2	+\$ 79	
	• Fabric price group 3	+\$149	
• Fabric price group 4	+\$209		
• Fabric price group 5	+\$263		
• Fabric price group 6	+\$327		
• Fabric price group 7	+\$374		
• Fabric price group 8	+\$472		
• Fabric price group 9	+\$580		
• Fabric price group 10	+\$659		
• Customer's Own Material (COM)	No cost		

▶ Options, continued on next page



For Canadian Pricing
 Multiply U.S. Price by the Canadian price factor.
 ▶ See page 1 for details.

► Options, continued from previous page

Options	U.S. Price	Required to Specify
Surface Materials, continued	Trim <ul style="list-style-type: none"> • Plastic • Fabric to match lower surround 	No cost +\$405 Specify <i>with plastic trim</i> . Specify <i>with fabric trim</i> .
	Upholstery on trim <ul style="list-style-type: none"> • Fabric price group 1 • Fabric price group 2 • Fabric price group 3 • Fabric price group 4 • Fabric price group 5 • Fabric price group 6 • Fabric price group 7 • Fabric price group 8 • Fabric price group 9 • Fabric price group 10 • Customer's Own Material (COM) 	No cost +\$ 28 +\$ 49 +\$ 70 +\$ 88 +\$110 +\$126 +\$158 +\$194 +\$220 No cost Specify fabric color number. Specify fabric color number. Specify fabric color number. Specify fabric color number. Specify fabric color number. Specify fabric color number. Specify fabric color number. Specify fabric color number. Specify fabric color number. Specify fabric color number. Specify fabric color number. Specify fabric color number. ► See <i>Surface Materials Reference Manual</i> .
	Screen type <ul style="list-style-type: none"> • Acrylic • Fabric 	No cost +\$645 Specify <i>with 6559 Satin Ice acrylic</i> . Specify <i>with fabric screens</i> .
	Upholstery on screen <ul style="list-style-type: none"> • Fabric price group 1 • Fabric price group 2 • Fabric price group 3 • Fabric price group 4 • Fabric price group 5 • Fabric price group 6 • Fabric price group 7 • Fabric price group 8 • Fabric price group 9 • Fabric price group 10 • Customer's Own Material (COM) 	No cost +\$ 31 +\$ 58 +\$ 81 +\$102 +\$127 +\$145 +\$183 +\$226 +\$256 No cost Specify fabric color number. Specify fabric color number. Specify fabric color number. Specify fabric color number. Specify fabric color number. Specify fabric color number. Specify fabric color number. Specify fabric color number. Specify fabric color number. Specify fabric color number. Specify fabric color number. Specify fabric color number. ► See <i>Surface Materials Reference Manual</i> .
	Power <ul style="list-style-type: none"> • Omit power • Thread low profile plug • One USB 2.0 outlet and one NEMA three-prong outlet 	-\$296 +\$ 28 +\$100 Specify <i>with no power</i> . Specify <i>with Thread low profile plug</i> and indicate paint color number. Specify <i>with USB and standard NEMA three-prong outlet</i> and indicate paint color number.
	dash mini LED light <ul style="list-style-type: none"> • Paint price group 1 • Paint price group 3 	+\$453 +\$483 Specify <i>with light</i> and indicate paint color number. Specify <i>with light</i> and indicate paint color number. ► See <i>Surface Materials Reference Manual</i> .
	Related Products <ul style="list-style-type: none"> • Steelcase Series 1 chairs • QiVi chairs • Cobi chairs 	► Page 100 ► Page 276 ► Page 286

Tip: The trim is the top edge of the lower surround. If fabric trim is selected, the upholstery will match the upholstery specified on the lower surround.

Tip: Buzz2 is the only Steelcase verical upholstery group available on fabric screens.

Tip: COM selections are strictly limited, please reference the COM page at www.steelcase.com to make your selections.

Tip: The light option is only available if power has been specified.

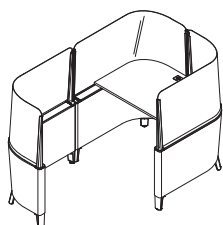

Specification Information	
• Style Number	• U.S. Base Price
488BDE	\$5149

Brody 488 Series

Brody Footrest



Standard Includes	Required to Specify
<ul style="list-style-type: none"> ▶ Need help? Product details, page 318 • Lower footrest: plastic • Upper footrest: fabric price group 1 	<ol style="list-style-type: none"> 1 Style number 2 Fabric color number for upper footrest 3 Plastic color number for lower footrest: 6053 Seagull 6059 Sterling Dark 4 Options, if selected (see below) <ul style="list-style-type: none"> ▶ See <i>Surface Materials</i>, page 504.

Options	U.S. Price	Required to Specify
Surface Materials Upholstery on upper footrest <ul style="list-style-type: none"> • Fabric price group 1 • Fabric price group 2 • Fabric price group 3 • Fabric price group 4 • Fabric price group 5 • Fabric price group 6 • Fabric price group 7 • Fabric price group 8 • Fabric price group 9 • Fabric price group 10 • Steelcase leather upholstery • Select Surfaces leather price group 1 • Elmosoft leather upholstery • Select Surfaces leather price group 2 • Steelcase vinyl • Customer's Own Material (COM) • Customer's Own Leather (COL) • Soil-retardant treatment applied to upholstery fabric 	No cost +\$ 18 +\$ 33 +\$ 46 +\$ 58 +\$ 73 +\$ 83 +\$104 +\$129 +\$146 +\$195 +\$195 +\$231 +\$231 +\$ 18 No cost +\$ 38 +\$ 27	Specify fabric color number. Specify fabric color number. Specify fabric color number. Specify fabric color number. Specify fabric color number. Specify fabric color number. Specify fabric color number. Specify fabric color number. Specify fabric color number. Specify fabric color number. Specify leather color number. <ul style="list-style-type: none"> ▶ See <i>Surface Materials Reference Manual</i>. Specify Elmosoft leather color number. ▶ See <i>Surface Materials Reference Manual</i>. Specify vinyl color number. ▶ See <i>Surface Materials Reference Manual</i>. Specify leather color number. Specify <i>with soil-retardant treatment</i> .
Plastic on upper footrest <ul style="list-style-type: none"> • Plastic 	+\$ 67	Specify <i>with 6527 Merle</i> .
Related Products <ul style="list-style-type: none"> • Brody 		<ul style="list-style-type: none"> ▶ Pages 334–338

Specification Information	
Style Number	U.S. Base Price
488FR	\$326



For Canadian Pricing

Multiply U.S. Price by the Canadian price factor.

▶ See page 1 for details.

Understanding and Specifying media:scape Lounge Seating

Product Details

media:scape Lounge	346
Dimensions	350
Canopy and Ledge Surface Material Relationships	352

Specifying

Straight Lounge	354
Straight Inverted Lounge	358
Corner Lounge	360
Reverse Lounge	364
Backless Lounge	368

media:scape Lounge

media:scape lounge creates collaborative work settings designed to support small teams of four to six people.
► Specifying, page 354

media:scape lounge offers seven lounge pieces: straight, straight inverted, backless, right corner, left corner, reverse left, and reverse right. The lounge is designed to be easily reconfigured in many different ways to accommodate multiple settings. There are three different fabric orientations to choose from.

Due to the geometric shapes, it is recommended to use one of the standard fabrics, vinyls, leather, or a non-patterned COM or COL. The use of solid fabrics is recommended with media:scape lounge settings. Steelcase will not pattern match fabrics which have a distinct repeating pattern.

Tip: Canopy and ledge back panels are not available in full-fill or flat cut.

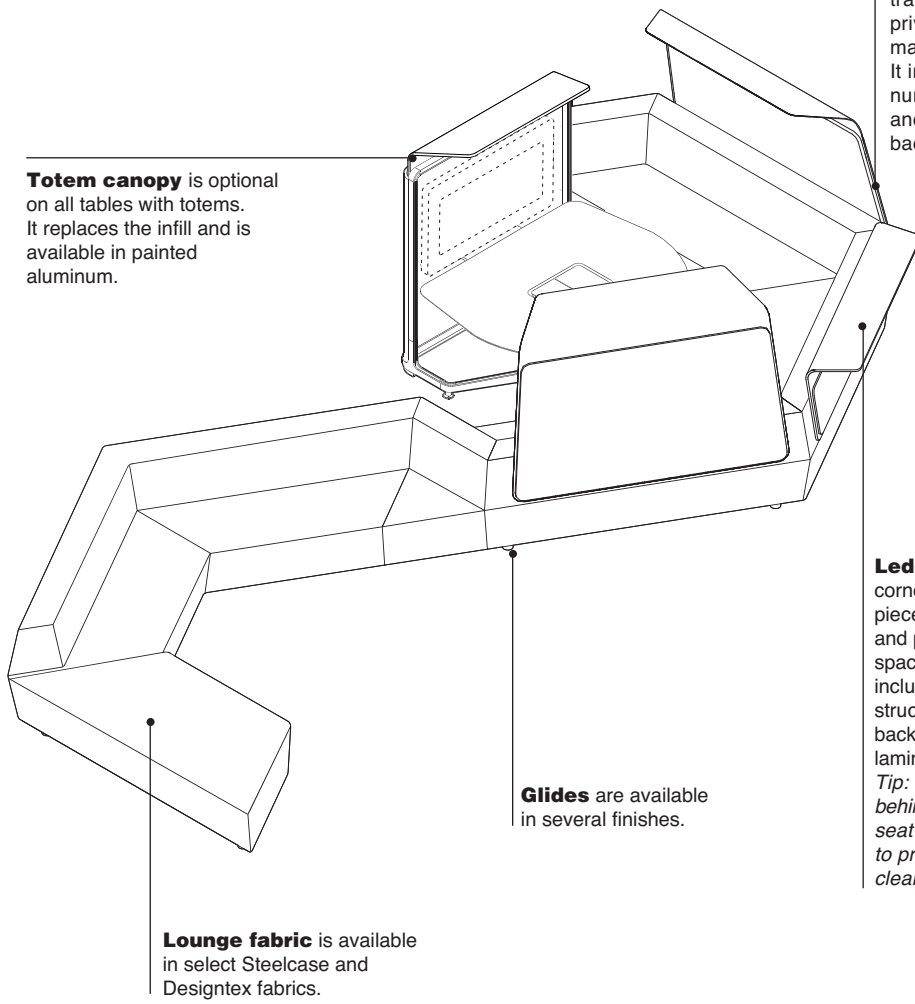

Totem canopy is optional on all tables with totems. It replaces the infill and is available in painted aluminum.

Lounge fabric is available in select Steelcase and Designtex fabrics.

Glides are available in several finishes.

Lounge canopy is optional on all corner and straight lounge pieces. It transforms the degree of privacy providing an intimate and protected setting. It includes a painted aluminum structure, fabric panel, and a laminate or veneer back panel.

Ledge is optional on all corner and straight lounge pieces. It acts as a surface and provides additional space for collaboration. It includes a painted aluminum structure, laminate or veneer back panel, and an optional laminate or veneer topper.
Tip: If specifying seating behind the ledge, maximum seat height should be 31" to provide appropriate leg clearance.

Upholstery Orientations

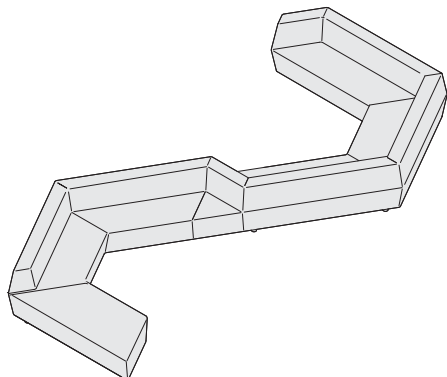

Same - The entire lounge is one fabric.

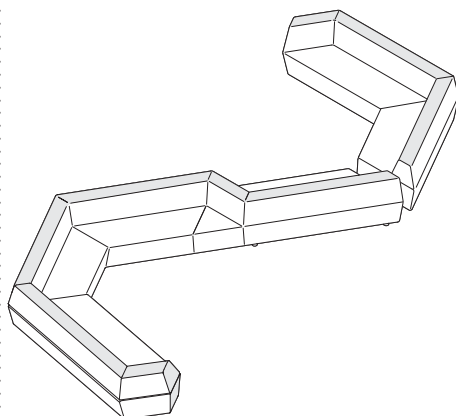

Edge - The top of the lounge is one fabric, along with the end of the corner unit. The remaining sides are a second fabric.

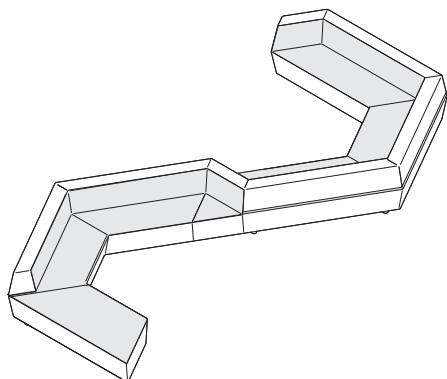

Front seat and back - The seat surface and the front of the back is one fabric and all other panels are a second fabric. The reveal on the back of the lounge is the same fabric as the seat surface and the front of the back.

Product Details

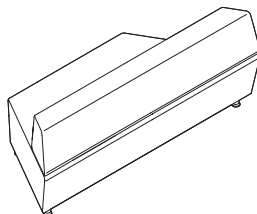

Straight lounge has a straight back which tapers to the front of the seat.

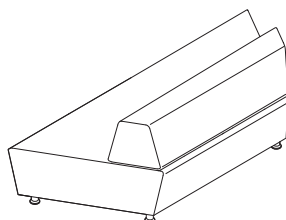

Straight inverted lounge has a straight back. It tapers from front to the back of the seat.

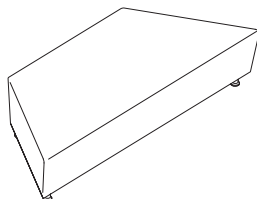

Backless lounge is the same shape as the straight lounge and tapers to the front of the seat.

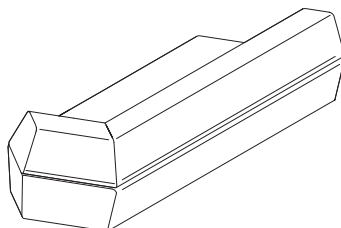

Left corner lounge is left-handed in a seated position.

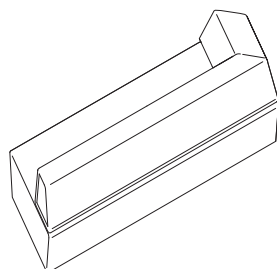

Right corner lounge is right-handed in a seated position.

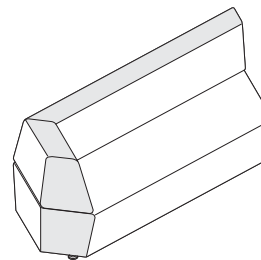

The end of the corner lounges will have the same fabric as the top when edge upholstery is specified.

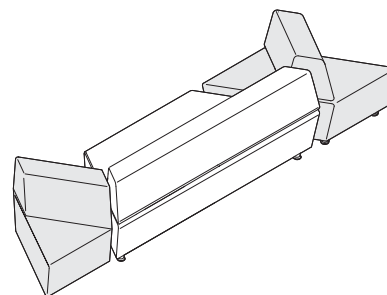

Reverse lounges are either right-handed or left-handed and provide the ability to transition seating from one side of an application to the other. They can be applied in either angled or straight applications.

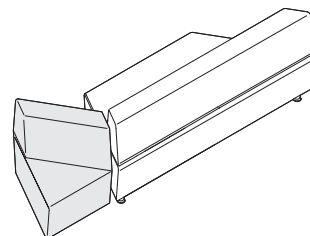

Reverse left, when fitted next to a straight lounge, provides an angle similar to the corner left.

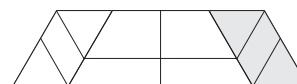
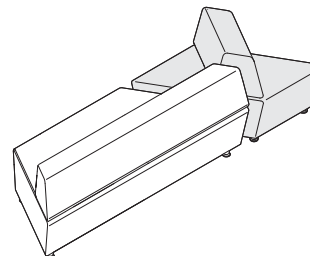

Reverse right, when fitted next to a straight lounge, provides an angle similar to the corner right.

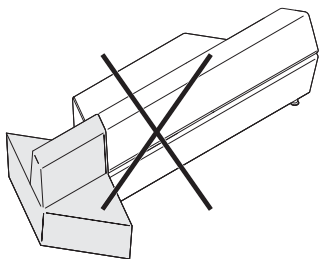

Reverse lounges, that are specified with incorrect handed orientation will not align with other lounge pieces.

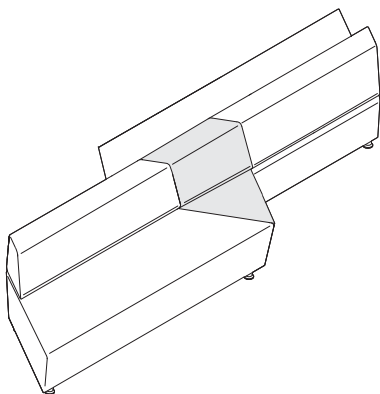

Use a reverse left to transition seating from one side of the application to the other and have seating on the left hand side.

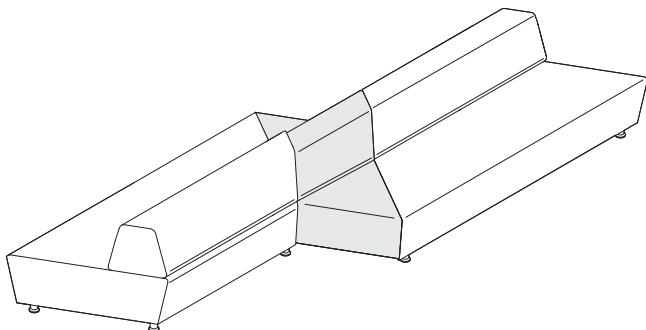

Use a reverse right to transition seating from one side of an application to the other and have seating on the right side.

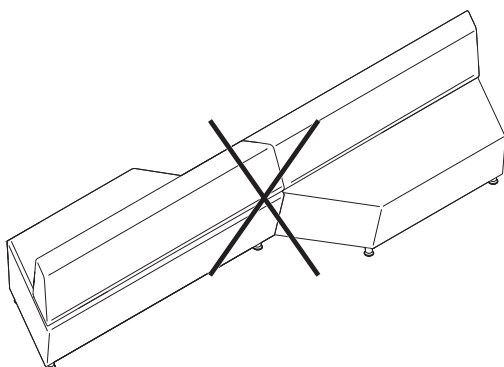

A reverse lounge piece must be used to transition seating from one side of an application to another. Attempting to transition seating without a reverse will prohibit adjacent lounges from being ganged together.

Surface Materials

Upholstery

- Steelcase or Designtex fabric
- Fabric with soil-retardant treatment (option)
- Leather
- ▶ See *Surface Materials*, page 504.

Tip: Thread color that is associated with the more dominant fabric will be used throughout the upholstery. Therefore, with the multiple upholstery option, the thread may be a contrasting color.

Glides

- 4140 Arctic White Gloss
- 4799 Platinum
- 4803 Near Black Metallic
- 8046 Polished Aluminum

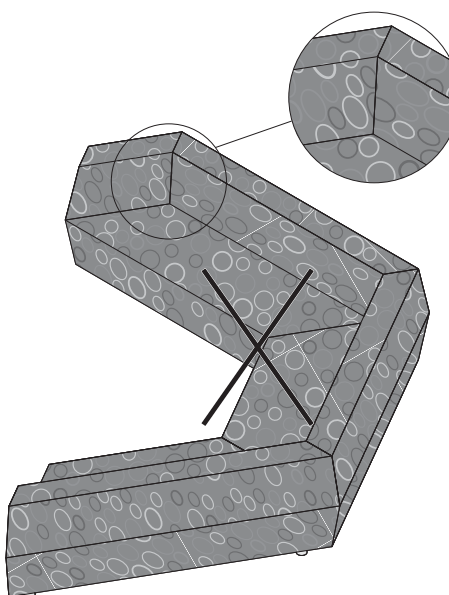

Solid non-repeat fabrics are recommended for media:scape lounge because of the unique geometric shapes. When patterned fabrics are selected, patterns are not matched.

Programs & Services

- ▶ See the *Surface Materials Reference Manual* for further detail about programs and services offered for seating.

The Customer's Own Material (COM & COL) Program offers the opportunity for customers to select fabrics and leather that are not offered through the standard Steelcase surface materials program for use on Steelcase products. Avoid pattern fabrics and heavily grained leathers. Through the COM & COL program, Steelcase will test your materials for application on Steelcase products. Once approved, you can place your order. Steelcase will facilitate the entire ordering process and give you a production schedule. Steelcase will order the COM & COL fabric and leather directly from the textile manufacturer. For up-to-date information regarding fabric test results for all COM & COL fabrics and details regarding yardage requirements for most Seating lines, visit the COM website. To locate the COM website:

- Visit www.steelcase.com

Soil retardants are treatments that provide long-term soil and stain resistance to a fabric without affecting the shade or the integrity of the fabric. The following Steelcase Textiles are available pre-treated with soil retardant. (You do not need to select the soil-retardant option for these fabrics and incur the upcharge.)

- Jacks
- Link
- Spyder

For information on soil retardant fabrics on Select Surfaces, please refer to the *Surface Materials Reference Manual*.

Soil-retardant treatment is available on all other seating fabrics at an additional upcharge per seating unit. To order this option, please select "Soil-Retardant Treatment" under "Optional Accessories".

For soil-retardant treatment on COMs, please select "Soil-Retardant Treatment" under "Optional Accessories." Minimums or additional yardage may be required. Please contact the vendor directly for specific information.

Extended lead times may be necessary for this service.

Contact your Steelcase Solutions Fulfillment Team Representative at 1.888.STEELCASE (1.888.783.3522) or send an email to lineone@steelcase.com.

Dimensions

media:scape Lounge

Features	Overall Width	Back Width	Front Width	Overall Depth	Seat Depth	Overall Height	Seat Height from Floor	Back Height
media:scape Lounge								
Straight	80"	80"	42"	33"	21"	29"	16"	13"
Straight Inverted	80"	42"	80"	33"	21"	29"	16"	13"
Backless	80"	80"	42"	33"	33"	16"	16"	13"
Corner (left, right)	92"	80"	66"	33"	21"	29"	16"	13"
Reverse (left, right)	43"	24"	24"	33"	21"	29"	16"	13"

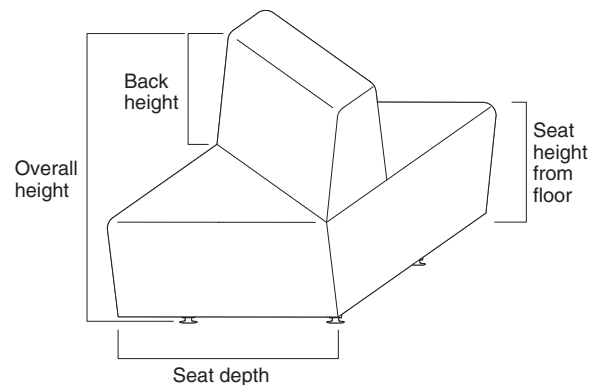
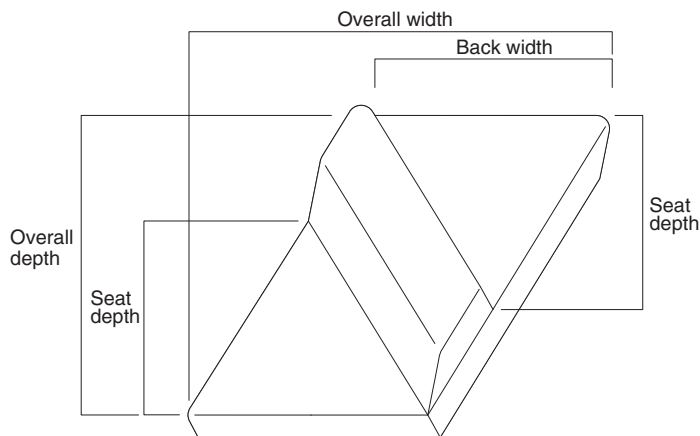
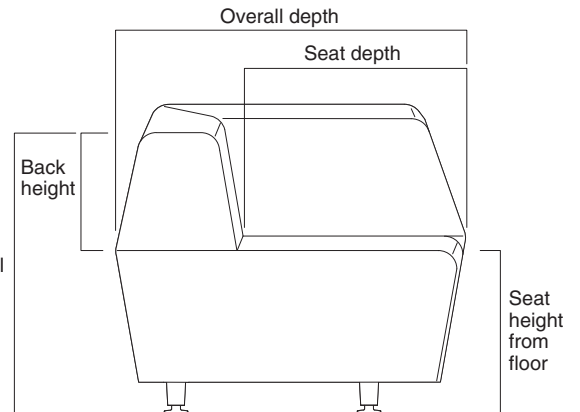
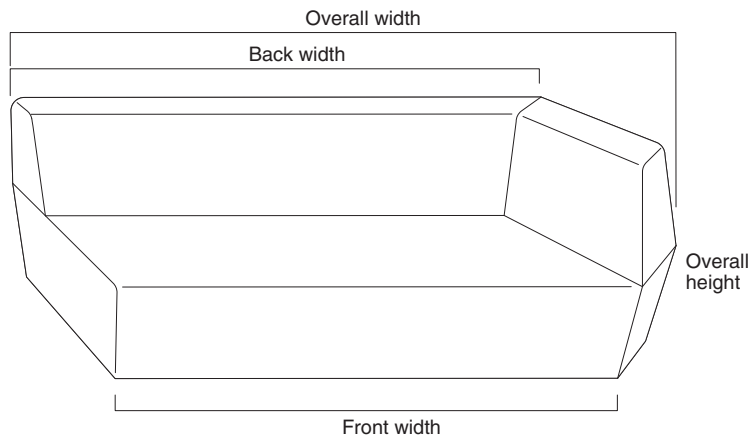
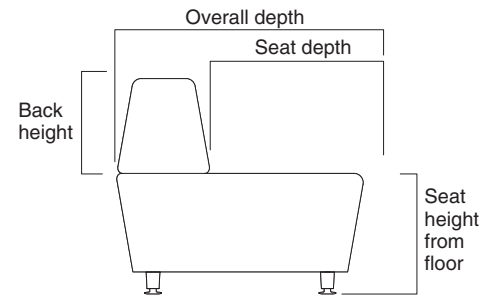
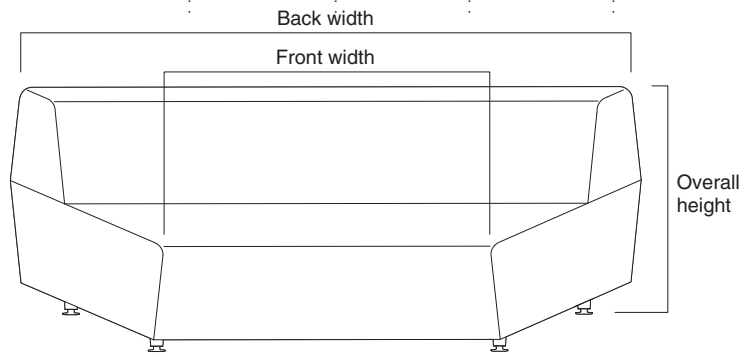

Ledge

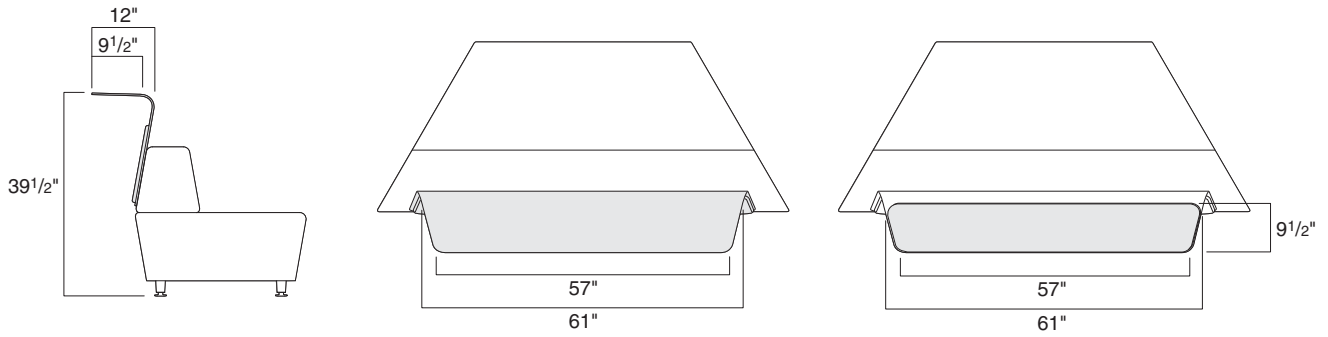

Canopy

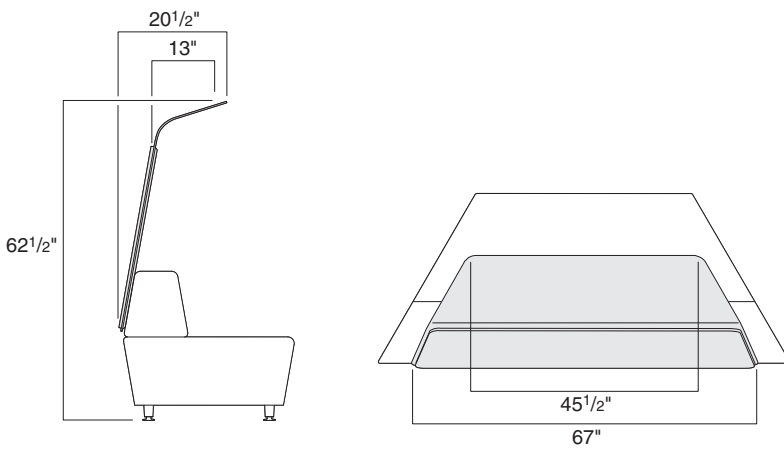

media:scape
Lounge

Canopy and Ledge Surface Material Relationships

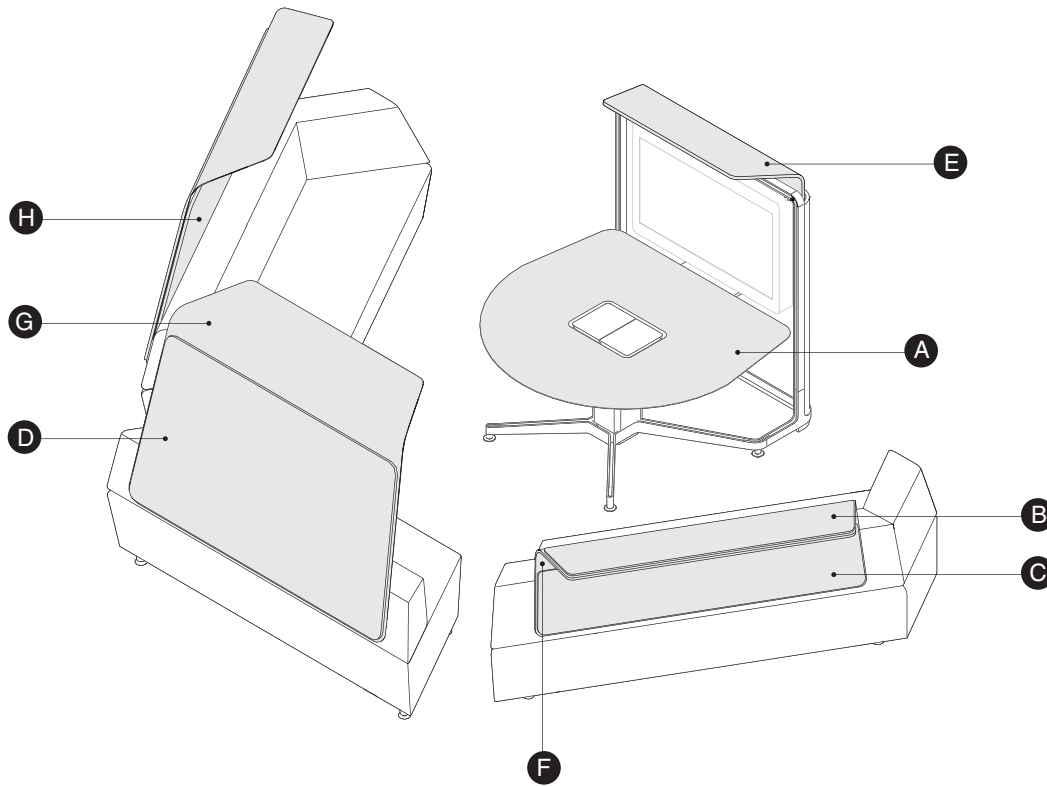

Recommended Components

	Laminate/ Veneer	Painted Aluminum	Connect 3D Fabric
A	Table top	E	Totem canopy infill
B	Topper	F	Ledge
C	Ledge back panel	G	Canopy
D	Canopy back panel		H
			Canopy fabric panel

Straight Lounge

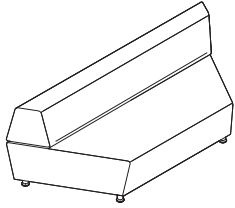

Standard Includes	Required to Specify
<ul style="list-style-type: none"> ▶ Need help? Product details, page 346 • Straight lounge: fabric • Aluminum feet: paint • Ganging brackets 	<ol style="list-style-type: none"> 1 Style number 2 Fabric color number for upholstery 3 Paint color number for feet: <ul style="list-style-type: none"> 4140 Arctic White Gloss 4799 Platinum Metallic 4803 Near Black Metallic 4 Options, if selected (see below) <ul style="list-style-type: none"> ▶ See <i>Surface Materials</i>, page 504.

Surface Materials	Options	U.S. Price	Required to Specify
	Soil-Retardant Treatment <ul style="list-style-type: none"> • Soil-retardant treatment applied to upholstery fabric 	+\$ 48	Specify <i>with soil-retardant treatment</i> .
	Same upholstery on all surfaces <ul style="list-style-type: none"> • Fabric price group 1 • Fabric price group 2 • Fabric price group 3 • Fabric price group 4 • Fabric price group 5 • Fabric price group 6 • Fabric price group 7 • Fabric price group 8 • Fabric price group 9 • Fabric price group 10 • Leather 	No cost +\$ 32 +\$ 122 +\$ 304 +\$ 517 +\$ 791 +\$1127 +\$1462 +\$1797 +\$2070 +\$2313	Specify fabric color number. Specify fabric color number. Specify fabric color number. Specify fabric color number. Specify fabric color number. Specify fabric color number. Specify fabric color number. Specify fabric color number. Specify fabric color number. Specify fabric color number. Specify leather color number.
	Edge upholstery: Upholstery on edge <ul style="list-style-type: none"> • Fabric price group 1 • Fabric price group 2 • Fabric price group 3 • Fabric price group 4 • Fabric price group 5 • Fabric price group 6 • Fabric price group 7 • Fabric price group 8 • Fabric price group 9 • Fabric price group 10 • Leather 	No cost +\$ 3 +\$ 10 +\$ 32 +\$ 52 +\$ 79 +\$ 114 +\$ 146 +\$ 180 +\$ 208 +\$ 231	Specify fabric color number. Specify fabric color number. Specify fabric color number. Specify fabric color number. Specify fabric color number. Specify fabric color number. Specify fabric color number. Specify fabric color number. Specify fabric color number. Specify fabric color number. Specify leather color number.
	One upholstery on all surfaces except edge <ul style="list-style-type: none"> • Fabric price group 1 • Fabric price group 2 • Fabric price group 3 • Fabric price group 4 • Fabric price group 5 • Fabric price group 6 • Fabric price group 7 • Fabric price group 8 • Fabric price group 9 • Fabric price group 10 • Leather 	No cost +\$ 30 +\$ 111 +\$ 273 +\$ 467 +\$ 712 +\$1014 +\$1314 +\$1616 +\$1863 +\$2082	Specify fabric color number. Specify fabric color number. Specify fabric color number. Specify fabric color number. Specify fabric color number. Specify fabric color number. Specify fabric color number. Specify fabric color number. Specify fabric color number. Specify fabric color number. Specify leather color number.

▶ Options, continued on next page

Tip: If selecting edge upholstery option, first select the fabric for the edge, then select the fabric for all other surfaces.

 **For Canadian Pricing**
 Multiply U.S. Price by the Canadian price factor.
 ▶ See page 1 for details.

► Options, continued from previous page

	Options	U.S. Price	Required to Specify
Surface Materials	Front seat and back upholstery:		
	Upholstery on front seat and back		
	• Fabric price group 1	No cost	Specify fabric color number.
	• Fabric price group 2	+\$ 10	Specify fabric color number.
	• Fabric price group 3	+\$ 48	Specify fabric color number.
	• Fabric price group 4	+\$ 122	Specify fabric color number.
	• Fabric price group 5	+\$ 208	Specify fabric color number.
	• Fabric price group 6	+\$ 317	Specify fabric color number.
	• Fabric price group 7	+\$ 451	Specify fabric color number.
	• Fabric price group 8	+\$ 585	Specify fabric color number.
	• Fabric price group 9	+\$ 719	Specify fabric color number.
	• Fabric price group 10	+\$ 828	Specify fabric color number.
	• Leather	+\$ 925	Specify leather color number.
	Upholstery on all surfaces except front seat and back		
	• Fabric price group 1	No cost	Specify fabric color number.
	• Fabric price group 2	+\$ 16	Specify fabric color number.
	• Fabric price group 3	+\$ 73	Specify fabric color number.
	• Fabric price group 4	+\$ 182	Specify fabric color number.
	• Fabric price group 5	+\$ 309	Specify fabric color number.
	• Fabric price group 6	+\$ 475	Specify fabric color number.
• Fabric price group 7	+\$ 676	Specify fabric color number.	
• Fabric price group 8	+\$ 877	Specify fabric color number.	
• Fabric price group 9	+\$1078	Specify fabric color number.	
• Fabric price group 10	+\$1242	Specify fabric color number.	
• Leather	+\$1388	Specify leather color number.	
COM / COL			
• Customer's Own Material (COM)	+\$ 37	► See <i>Surface Materials Reference Manual</i> .	
• Customer's Own Leather (COL)	+\$ 122	► See <i>Surface Materials Reference Manual</i> .	
Glide			
• Polished Aluminum	+\$ 57	Specify <i>with 8046 Polished Aluminum</i> .	
Canopy	• Canopy	+\$2804	Specify <i>with canopy</i> .
Paint			
• Paint price group 1	No cost	Specify paint color number.	
• Paint price group 2	+\$ 46	Specify paint color number.	
• Paint price group 3	+\$ 138	Specify paint color number.	
Fabric			
• Connect 3D	No cost	Specify fabric color number.	
Laminate back panel			
• High-Pressure Laminate	No cost	Specify laminate color.	
• Edge	No cost	Specify plastic color number.	
Wood back panel			
• Wood veneer	+\$ 357	Specify <i>with wood veneer</i> and indicate wood color number.	
• Premium wood 2	+\$ 437	Specify Premium wood 2 finish number.	
• Premium wood 3	+\$ 639	Specify Premium wood 3 finish number.	
• Customiz stain on wood	No cost	Specify <i>with Customiz stain</i> .	
		► See <i>Surface Materials Reference Manual</i> .	

► Options, continued on next page

Tip: If selecting front seat and back upholstery option, first select the fabric for the front of the back and seat, then select the fabric for all other surfaces.

Tip: To add a ledge or canopy to an existing media:scape lounge, please see the Service Parts section of the Steelcase Product Reference website.

Tip: Ledge and canopy back panels are not available in full-fill or flat cut veneer.

For Canadian Pricing
Multiply U.S. Price by the Canadian price factor.
► See page 1 for details.

Straight Lounge, continued

► Options, continued from previous page

	Options	U.S. Price	Required to Specify
Ledge	• Ledge	+\$2396	Specify <i>with ledge</i> .
	Paint		
	• Paint price group 1	No cost	Specify paint color number.
	• Paint price group 2	+\$ 30	Specify paint color number.
	• Paint price group 3	+\$ 87	Specify paint color number.
	Laminate back panel		
	• High-Pressure Laminate	No cost	Specify laminate color.
	• Edge	No cost	Specify plastic color number.
	Wood back panel		
	• Wood veneer	+\$ 157	Specify <i>with wood veneer</i> and indicate wood color number.
• Premium wood 2	+\$ 192	Specify Premium wood 2 finish number.	
• Premium wood 3	+\$ 278	Specify Premium wood 3 finish number.	
• Customiz stain on wood	No cost	Specify <i>with Customiz stain</i> . ► See <i>Surface Materials Reference Manual</i> .	
Ledge with Topper	• Ledge with topper	+\$2803	Specify <i>with ledge with topper</i> .
	Paint		
	• Paint price group 1	No cost	Specify paint color number.
	• Paint price group 2	+\$ 30	Specify paint color number.
	• Paint price group 3	+\$ 87	Specify paint color number.
	Laminate back panel		
	• High-Pressure Laminate	No cost	Specify laminate color.
	• Edge	No cost	Specify plastic color number.
	Wood back panel		
	• Wood veneer	+\$ 157	Specify <i>with wood veneer</i> and indicate wood color number.
	• Premium wood 2	+\$ 192	Specify Premium wood 2 finish number.
	• Premium wood 3	+\$ 278	Specify Premium wood 3 finish number.
	• Customiz stain on wood	No cost	Specify <i>with Customiz stain</i> . ► See <i>Surface Materials Reference Manual</i> .
	Laminate topper		
	• High-Pressure Laminate	No cost	Specify laminate color.
	• Edge	No cost	Specify plastic color number.
Wood topper			
• Wood veneer	+\$ 91	Specify <i>with wood veneer</i> and indicate wood color number.	
• Premium wood 2	+\$ 115	Specify Premium wood 2 finish number.	
• Premium wood 3	+\$ 171	Specify Premium wood 3 finish number.	
• Customiz stain on wood	No cost	Specify <i>with Customiz stain</i> . ► See <i>Surface Materials Reference Manual</i> .	
• Full-fill finish on wood	+\$ 24	Specify <i>with full-finish</i> and select wood color number.	

**For Canadian Pricing**

Multiply U.S. Price by the Canadian price factor.

► See page 1 for details.

Specification Information

• Style	• U.S.
• Number	• Base
•	• Price
•	•

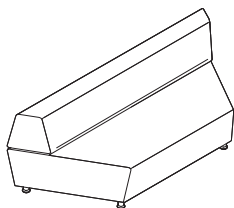

Same Upholstery

MLSTS	\$2993
•	•

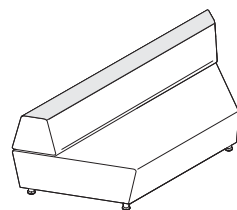

Multiple Upholstery - Edge

MLSTE	\$2993
•	•

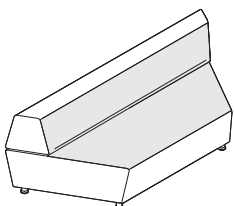

Multiple Upholstery - Front Seat and Back

MLSTF	\$2993
•	•



For Canadian Pricing

Multiply U.S. Price by the Canadian price factor.

▶ See page 1 for details.

Straight Inverted Lounge

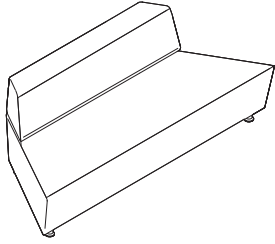

► Need help?
Product details,
page 346

Standard Includes

- Straight inverted lounge: fabric
- Aluminum feet: paint
- Ganging brackets

Required to Specify

- 1 Style number
- 2 Fabric color number for upholstery
- 3 Paint color number for feet:
 - 4140 Arctic White Gloss
 - 4799 Platinum Metallic
 - 4803 Near Black Metallic
- 4 Options, if selected (see below)
 - See *Surface Materials*, page 504.

	Options	U.S. Price	Required to Specify
Surface Materials	Soil-Retardant Treatment		
	• Soil-retardant treatment applied to upholstery fabric	+\$ 48	Specify <i>with soil-retardant treatment</i> .
	Same upholstery on all surfaces		
	• Fabric price group 1	No cost	Specify fabric color number.
	• Fabric price group 2	+\$ 32	Specify fabric color number.
	• Fabric price group 3	+\$ 91	Specify fabric color number.
	• Fabric price group 4	+\$ 213	Specify fabric color number.
	• Fabric price group 5	+\$ 365	Specify fabric color number.
	• Fabric price group 6	+\$ 549	Specify fabric color number.
	• Fabric price group 7	+\$ 761	Specify fabric color number.
	• Fabric price group 8	+\$1005	Specify fabric color number.
	• Fabric price group 9	+\$1249	Specify fabric color number.
	• Fabric price group 10	+\$1432	Specify fabric color number.
	• Leather	+\$1675	Specify leather color number.
	Edge upholstery: Upholstery on edge		
	• Fabric price group 1	No cost	Specify fabric color number.
	• Fabric price group 2	+\$ 3	Specify fabric color number.
	• Fabric price group 3	+\$ 8	Specify fabric color number.
	• Fabric price group 4	+\$ 24	Specify fabric color number.
	• Fabric price group 5	+\$ 37	Specify fabric color number.
	• Fabric price group 6	+\$ 54	Specify fabric color number.
	• Fabric price group 7	+\$ 77	Specify fabric color number.
	• Fabric price group 8	+\$ 101	Specify fabric color number.
	• Fabric price group 9	+\$ 125	Specify fabric color number.
	• Fabric price group 10	+\$ 144	Specify fabric color number.
	• Leather	+\$ 169	Specify leather color number.
	Upholstery on all surfaces except edge		
	• Fabric price group 1	No cost	Specify fabric color number.
	• Fabric price group 2	+\$ 30	Specify fabric color number.
	• Fabric price group 3	+\$ 82	Specify fabric color number.
	• Fabric price group 4	+\$ 192	Specify fabric color number.
	• Fabric price group 5	+\$ 330	Specify fabric color number.
	• Fabric price group 6	+\$ 493	Specify fabric color number.
	• Fabric price group 7	+\$ 686	Specify fabric color number.
	• Fabric price group 8	+\$ 904	Specify fabric color number.
	• Fabric price group 9	+\$1125	Specify fabric color number.
	• Fabric price group 10	+\$1290	Specify fabric color number.
	• Leather	+\$1510	Specify leather color number.

► Options, continued on next page

Tip: If selecting edge upholstery option, first select the fabric for the edge, then select the fabric for all other surfaces.



For Canadian Pricing

Multiply U.S. Price by the Canadian price factor.

► See page 1 for details.

► Options, continued from previous page

Tip: If selecting front seat and back upholstery option, first select the fabric for the front of the back and seat, then select the fabric for all other surfaces.

Options	U.S. Price	Required to Specify
Surface Materials	Front seat and back upholstery: Upholstery on front seat and back	
• Fabric price group 1	No cost	Specify fabric color number.
• Fabric price group 2	+\$ 10	Specify fabric color number.
• Fabric price group 3	+\$ 37	Specify fabric color number.
• Fabric price group 4	+\$ 85	Specify fabric color number.
• Fabric price group 5	+\$ 146	Specify fabric color number.
• Fabric price group 6	+\$ 219	Specify fabric color number.
• Fabric price group 7	+\$ 304	Specify fabric color number.
• Fabric price group 8	+\$ 402	Specify fabric color number.
• Fabric price group 9	+\$ 500	Specify fabric color number.
• Fabric price group 10	+\$ 573	Specify fabric color number.
• Leather	+\$ 670	Specify leather color number.
	Upholstery on all surfaces except front seat and back	
• Fabric price group 1	No cost	Specify fabric color number.
• Fabric price group 2	+\$ 16	Specify fabric color number.
• Fabric price group 3	+\$ 54	Specify fabric color number.
• Fabric price group 4	+\$ 127	Specify fabric color number.
• Fabric price group 5	+\$ 219	Specify fabric color number.
• Fabric price group 6	+\$ 330	Specify fabric color number.
• Fabric price group 7	+\$ 457	Specify fabric color number.
• Fabric price group 8	+\$ 603	Specify fabric color number.
• Fabric price group 9	+\$ 749	Specify fabric color number.
• Fabric price group 10	+\$ 858	Specify fabric color number.
• Leather	+\$1005	Specify leather color number.
	COM / COL	
• Customer's Own Material (COM)	+\$ 37	► See <i>Surface Materials Reference Manual</i> .
• Customer's Own Leather (COL)	+\$ 122	► See <i>Surface Materials Reference Manual</i> .
	Glide	
• Polished Aluminum	+\$ 57	Specify with 8046 Polished Aluminum.

Specification Information

Style Number	U.S. Base Price

Same Upholstery

MLSIS	\$2870
-------	--------

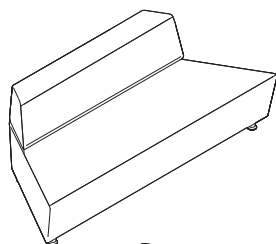

Multiple Upholstery - Edge

MLSIE	\$2870
-------	--------

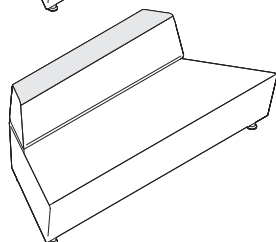

Multiple Upholstery - Front Seat and Back

MLSIF	\$2870
-------	--------

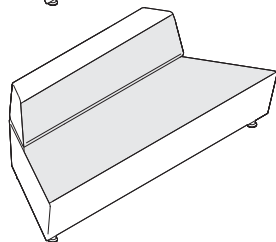

Corner Lounge

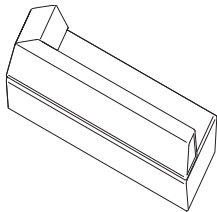

Standard Includes	Required to Specify
-------------------	---------------------

- | | | |
|--|---|--|
| <ul style="list-style-type: none"> ▶ Need help? Product details, page 346 | <ul style="list-style-type: none"> • Corner lounge: fabric • Aluminum feet: paint • Ganging brackets | <ol style="list-style-type: none"> 1 Style number 2 Fabric color number for upholstery 3 Paint color number for feet: <ul style="list-style-type: none"> 4140 Arctic White Gloss 4799 Platinum Metallic 4803 Near Black Metallic 4 Options, if selected (see below) <ul style="list-style-type: none"> ▶ See <i>Surface Materials</i>, page 504. |
|--|---|--|

Surface Materials	Options	U.S. Price	Required to Specify
-------------------	---------	------------	---------------------

Soil-Retardant Treatment	<ul style="list-style-type: none"> • Soil-retardant treatment applied to upholstery fabric 	+\$ 58	Specify <i>with soil-retardant treatment</i> .
---------------------------------	---	--------	--

Same upholstery on all surfaces

<ul style="list-style-type: none"> • Fabric price group 1 • Fabric price group 2 • Fabric price group 3 • Fabric price group 4 • Fabric price group 5 • Fabric price group 6 • Fabric price group 7 • Fabric price group 8 • Fabric price group 9 • Fabric price group 10 • Leather 	<ul style="list-style-type: none"> No cost +\$ 61 +\$ 213 +\$ 336 +\$ 579 +\$ 914 +\$1279 +\$1644 +\$2009 +\$2344 +\$2588 	<ul style="list-style-type: none"> Specify fabric color number. Specify fabric color number. Specify fabric color number. Specify fabric color number. Specify fabric color number. Specify fabric color number. Specify fabric color number. Specify fabric color number. Specify fabric color number. Specify fabric color number. Specify leather color number.
--	--	---

Edge upholstery: Upholstery on edge

<ul style="list-style-type: none"> • Fabric price group 1 • Fabric price group 2 • Fabric price group 3 • Fabric price group 4 • Fabric price group 5 • Fabric price group 6 • Fabric price group 7 • Fabric price group 8 • Fabric price group 9 • Fabric price group 10 • Leather 	<ul style="list-style-type: none"> No cost +\$ 5 +\$ 24 +\$ 35 +\$ 59 +\$ 91 +\$ 127 +\$ 164 +\$ 202 +\$ 235 +\$ 261 	<ul style="list-style-type: none"> Specify fabric color number. Specify fabric color number. Specify fabric color number. Specify fabric color number. Specify fabric color number. Specify fabric color number. Specify fabric color number. Specify fabric color number. Specify fabric color number. Specify fabric color number. Specify leather color number.
--	---	---

Upholstery on all surfaces except edge

<ul style="list-style-type: none"> • Fabric price group 1 • Fabric price group 2 • Fabric price group 3 • Fabric price group 4 • Fabric price group 5 • Fabric price group 6 • Fabric price group 7 • Fabric price group 8 • Fabric price group 9 • Fabric price group 10 • Leather 	<ul style="list-style-type: none"> No cost +\$ 54 +\$ 192 +\$ 302 +\$ 520 +\$ 821 +\$1151 +\$1480 +\$1809 +\$2110 +\$2331 	<ul style="list-style-type: none"> Specify fabric color number. Specify fabric color number. Specify fabric color number. Specify fabric color number. Specify fabric color number. Specify fabric color number. Specify fabric color number. Specify fabric color number. Specify fabric color number. Specify fabric color number. Specify leather color number.
--	--	---

▶ Options, continued on next page

Tip: If selecting edge upholstery option, first select the fabric for the edge, then select the fabric for all other surfaces.



For Canadian Pricing

Multiply U.S. Price by the Canadian price factor.

▶ See page 1 for details.

► Options, continued from previous page

Tip: If selecting front seat and back upholstery option, first select the fabric for the front of the back and seat, then select the fabric for all other surfaces.

	Options	U.S. Price	Required to Specify
Surface Materials	Front seat and back upholstery:		
	Upholstery on front seat and back		
	• Fabric price group 1	No cost	Specify fabric color number.
	• Fabric price group 2	+\$ 26	Specify fabric color number.
	• Fabric price group 3	+\$ 85	Specify fabric color number.
	• Fabric price group 4	+\$ 133	Specify fabric color number.
	• Fabric price group 5	+\$ 231	Specify fabric color number.
	• Fabric price group 6	+\$ 365	Specify fabric color number.
	• Fabric price group 7	+\$ 512	Specify fabric color number.
	• Fabric price group 8	+\$ 659	Specify fabric color number.
	• Fabric price group 9	+\$ 804	Specify fabric color number.
	• Fabric price group 10	+\$ 938	Specify fabric color number.
	• Leather	+\$1036	Specify leather color number.
	Upholstery on all surfaces except front seat and back		
	• Fabric price group 1	No cost	Specify fabric color number.
	• Fabric price group 2	+\$ 37	Specify fabric color number.
	• Fabric price group 3	+\$ 127	Specify fabric color number.
	• Fabric price group 4	+\$ 202	Specify fabric color number.
	• Fabric price group 5	+\$ 346	Specify fabric color number.
	• Fabric price group 6	+\$ 549	Specify fabric color number.
	• Fabric price group 7	+\$ 768	Specify fabric color number.
	• Fabric price group 8	+\$ 986	Specify fabric color number.
• Fabric price group 9	+\$1206	Specify fabric color number.	
• Fabric price group 10	+\$1407	Specify fabric color number.	
• Leather	+\$1553	Specify leather color number.	
COM / COL			
• Customer's Own Material (COM)	+\$ 37	► See <i>Surface Materials Reference Manual</i> .	
• Customer's Own Leather (COL)	+\$ 122	► See <i>Surface Materials Reference Manual</i> .	
Glide			
• Polished Aluminum	+\$ 57	Specify with 8046 Polished Aluminum	
Canopy	• Canopy	+\$2804	Specify with canopy.
	Paint		
	• Paint price group 1	No cost	Specify paint color number.
	• Paint price group 2	+\$ 46	Specify paint color number.
	• Paint price group 3	+\$ 138	Specify paint color number.
	Fabric		
	• Connect 3D	No cost	Specify fabric color number.
	Laminate back panel		
	• High-Pressure Laminate	No cost	Specify laminate color.
	• Edge	No cost	Specify plastic color number.
Wood back panel			
• Wood veneer	+\$ 357	Specify with wood veneer and indicate wood color number.	
• Premium wood 2	+\$ 437	Specify Premium wood 2 finish number.	
• Premium wood 3	+\$ 639	Specify Premium wood 3 finish number.	
• Customiz stain on wood	No cost	Specify with Customiz stain.	
		► See <i>Surface Materials Reference Manual</i> .	

Tip: To add a ledge or canopy to an existing media:scape lounge, please see the Service Parts section of the Steelcase Product Reference website.

Tip: Ledge and canopy back panels are not available in full-fill or flat cut veneer.

► Options, continued on next page

**For Canadian Pricing**

Multiply U.S. Price by the Canadian price factor.

► See page 1 for details.

► Options, continued from previous page

	Options	U.S. Price	Required to Specify
Ledge	• Ledge	+\$2396	Specify <i>with ledge</i> .
	Paint		
	• Paint price group 1	No cost	Specify paint color number.
	• Paint price group 2	+\$ 30	Specify paint color number.
	• Paint price group 3	+\$ 87	Specify paint color number.
	Laminate back panel		
	• High-Pressure Laminate	No cost	Specify laminate color.
	• Edge	No cost	Specify plastic color number.
	Wood back panel		
	• Wood veneer	+\$ 157	Specify <i>with wood veneer</i> and indicate wood color number.
• Premium wood 2	+\$ 192	Specify Premium wood 2 finish number.	
• Premium wood 3	+\$ 278	Specify Premium wood 3 finish number.	
• Customiz stain on wood	No cost	Specify <i>with Customiz stain</i> . ► See <i>Surface Materials Reference Manual</i> .	
Ledge with Topper	• Ledge with topper	+\$2803	Specify <i>with ledge with topper</i> .
	Paint		
	• Paint price group 1	No cost	Specify paint color number.
	• Paint price group 2	+\$ 30	Specify paint color number.
	• Paint price group 3	+\$ 87	Specify paint color number.
	Laminate back panel		
	• High-Pressure Laminate	No cost	Specify laminate color.
	• Edge	No cost	Specify plastic color number.
	Wood back panel		
	• Wood veneer	+\$ 157	Specify <i>with wood veneer</i> and indicate wood color number.
	• Premium wood 2	+\$ 192	Specify Premium wood 2 finish number.
	• Premium wood 3	+\$ 278	Specify Premium wood 3 finish number.
	• Customiz stain on wood	No cost	Specify <i>with Customiz stain</i> . ► See <i>Surface Materials Reference Manual</i> .
	Laminate topper		
	• High-Pressure Laminate	No cost	Specify laminate color.
• Edge	No cost	Specify plastic color number.	
Wood topper			
• Wood veneer	+\$ 91	Specify <i>with wood veneer</i> and indicate wood color number.	
• Premium wood 2	+\$ 115	Specify Premium wood 2 finish number.	
• Premium wood 3	+\$ 171	Specify Premium wood 3 finish number.	
• Customiz stain on wood	No cost	Specify <i>with Customiz stain</i> . ► See <i>Surface Materials Reference Manual</i> .	
• Full-fill finish on wood	+\$ 24	Specify full-finish and select wood color number.	

**For Canadian Pricing**

Multiply U.S. Price by the Canadian price factor.

► See page 1 for details.

Specification Information

• Style Number	• U.S. Base Price	• Style Number	• U.S. Base Price
----------------	-------------------	----------------	-------------------

Same Upholstery

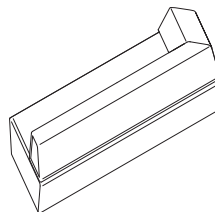
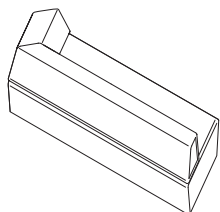

Left Corner

Right Corner

MLLCS \$3663

MLRCS \$3663

Multiple Upholstery - Edge

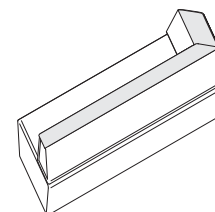
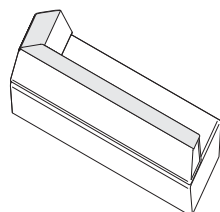

Left Corner

Right Corner

MLLCE \$3663

MLRCE \$3663

Multiple Upholstery - Front Seat and Back

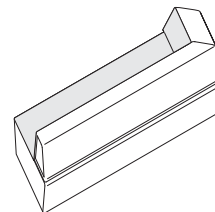
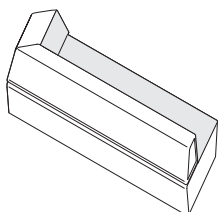

Left Corner

Right Corner

MLLCF \$3663

MLRCF \$3663



For Canadian Pricing

Multiply U.S. Price by the Canadian price factor.

▶ See page 1 for details.

Reverse Lounge

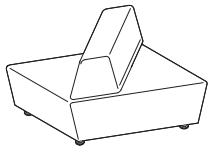

Standard Includes	Required to Specify
<ul style="list-style-type: none"> ▶ Need help? Product details, page 346 • Reverse media:scape lounge: fabric • Aluminum feet: paint • Ganging brackets 	<ol style="list-style-type: none"> 1 Style number 2 Fabric color number for upholstery 3 Paint color number for feet: <ul style="list-style-type: none"> 4140 Arctic White Gloss 4799 Platinum Metallic 4803 Near Black Metallic 4 Options, if selected (see below) <ul style="list-style-type: none"> ▶ See <i>Surface Materials</i>, page 504.

Surface Materials	Options	U.S. Price	Required to Specify
	Soil-Retardant Treatment <ul style="list-style-type: none"> • Soil-retardant treatment applied to upholstery fabric 	+\$ 35	Specify <i>with soil-retardant treatment</i> .
	Same upholstery on all surfaces <ul style="list-style-type: none"> • Fabric price group 1 • Fabric price group 2 • Fabric price group 3 • Fabric price group 4 • Fabric price group 5 • Fabric price group 6 • Fabric price group 7 • Fabric price group 8 • Fabric price group 9 • Fabric price group 10 • Leather 	No cost +\$ 32 +\$ 91 +\$ 182 +\$ 304 +\$ 457 +\$ 609 +\$ 791 +\$ 974 +\$1127 +\$1370	Specify fabric color number. Specify fabric color number. Specify fabric color number. Specify fabric color number. Specify fabric color number. Specify fabric color number. Specify fabric color number. Specify fabric color number. Specify fabric color number. Specify fabric color number. Specify leather color number.
	Edge upholstery: Upholstery on edge <ul style="list-style-type: none"> • Fabric price group 1 • Fabric price group 2 • Fabric price group 3 • Fabric price group 4 • Fabric price group 5 • Fabric price group 6 • Fabric price group 7 • Fabric price group 8 • Fabric price group 9 • Fabric price group 10 • Leather 	No cost +\$ 3 +\$ 8 +\$ 16 +\$ 32 +\$ 46 +\$ 61 +\$ 79 +\$ 97 +\$ 114 +\$ 138	Specify fabric color number. Specify fabric color number. Specify fabric color number. Specify fabric color number. Specify fabric color number. Specify fabric color number. Specify fabric color number. Specify fabric color number. Specify fabric color number. Specify fabric color number. Specify leather color number.
	Upholstery on all surfaces except edge <ul style="list-style-type: none"> • Fabric price group 1 • Fabric price group 2 • Fabric price group 3 • Fabric price group 4 • Fabric price group 5 • Fabric price group 6 • Fabric price group 7 • Fabric price group 8 • Fabric price group 9 • Fabric price group 10 • Leather 	No cost +\$ 30 +\$ 82 +\$ 164 +\$ 273 +\$ 413 +\$ 549 +\$ 712 +\$ 877 +\$1014 +\$1235	Specify fabric color number. Specify fabric color number. Specify fabric color number. Specify fabric color number. Specify fabric color number. Specify fabric color number. Specify fabric color number. Specify fabric color number. Specify fabric color number. Specify fabric color number. Specify leather color number.

▶ Options, continued on next page

Tip: If selecting edge upholstery option, first select the fabric for the edge, then select the fabric for all other surfaces.



For Canadian Pricing

Multiply U.S. Price by the Canadian price factor.

▶ See page 1 for details.

► Options, continued from previous page

Options	U.S. Price	Required to Specify
Surface Materials		
Front seat and back upholstery:		
Upholstery on front seat and back		
• Fabric price group 1	No cost	Specify fabric color number.
• Fabric price group 2	+\$ 10	Specify fabric color number.
• Fabric price group 3	+\$ 37	Specify fabric color number.
• Fabric price group 4	+\$ 73	Specify fabric color number.
• Fabric price group 5	+\$122	Specify fabric color number.
• Fabric price group 6	+\$182	Specify fabric color number.
• Fabric price group 7	+\$244	Specify fabric color number.
• Fabric price group 8	+\$317	Specify fabric color number.
• Fabric price group 9	+\$390	Specify fabric color number.
• Fabric price group 10	+\$451	Specify fabric color number.
• Leather	+\$549	Specify leather color number.
Upholstery on all surfaces except front seat and back		
• Fabric price group 1	No cost	Specify fabric color number.
• Fabric price group 2	+\$ 16	Specify fabric color number.
• Fabric price group 3	+\$ 54	Specify fabric color number.
• Fabric price group 4	+\$111	Specify fabric color number.
• Fabric price group 5	+\$182	Specify fabric color number.
• Fabric price group 6	+\$273	Specify fabric color number.
• Fabric price group 7	+\$365	Specify fabric color number.
• Fabric price group 8	+\$475	Specify fabric color number.
• Fabric price group 9	+\$585	Specify fabric color number.
• Fabric price group 10	+\$676	Specify fabric color number.
• Leather	+\$821	Specify leather color number.
COM / COL		
• Customer's Own Material (COM)	+\$ 37	► See <i>Surface Materials Reference Manual</i> .
• Customer's Own Leather (COL)	+\$122	► See <i>Surface Materials Reference Manual</i> .
Glide		
• Polished Aluminum	+\$ 57	Specify with 8046 Polished Aluminum.

► Specification Information, on next page

Tip: If selecting front seat and back upholstery option, first select the fabric for the front of the back and seat, then select the fabric for all other surfaces.

**For Canadian Pricing**

Multiply U.S. Price by the Canadian price factor.

► See page 1 for details.

► Options, on previous page

Specification Information

• Style Number	• U.S. Base Price	• Style Number	• U.S. Base Price
----------------	-------------------	----------------	-------------------

Same Upholstery

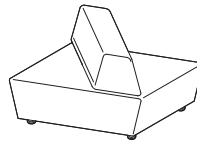
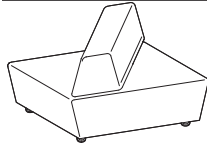

Reverse Left

Reverse Right

MLRLS \$1405

MLRRS \$1405

Multiple Upholstery - Edge

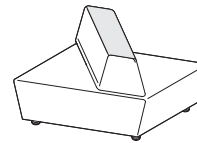
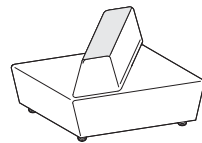

Reverse Left

Reverse Right

MLRLE \$1405

MLRRE \$1405

Multiple Upholstery - Front Seat and Back

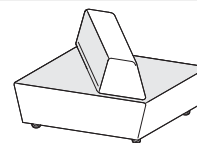
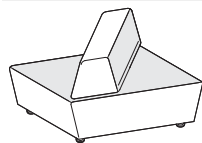

Reverse Left

Reverse Right

MLRLF \$1405

MLRRF \$1405



For Canadian Pricing

Multiply U.S. Price by the Canadian price factor.

► See page 1 for details.

Backless Lounge

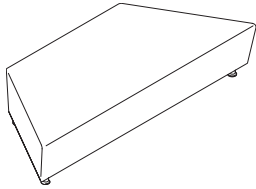

Standard Includes	Required to Specify
<ul style="list-style-type: none"> ▶ Need help? Product details, page 346 • Backless lounge: fabric • Aluminum feet: paint • Ganging brackets 	<ol style="list-style-type: none"> 1 Style number 2 Fabric color number for upholstery 3 Paint color number for feet: <ul style="list-style-type: none"> 4140 Arctic White Gloss 4799 Platinum Metallic 4803 Near Black Metallic 4 Options, if selected (see below) <ul style="list-style-type: none"> ▶ See <i>Surface Materials</i>, page 504.

Surface Materials	Options	U.S. Price	Required to Specify
	Soil-Retardant Treatment		
	• Soil-retardant treatment applied to upholstery fabric	+\$ 35	Specify <i>with soil-retardant treatment</i> .
	Same upholstery on all surfaces		
	• Fabric price group 1	No cost	Specify fabric color number.
	• Fabric price group 2	+\$ 32	Specify fabric color number.
	• Fabric price group 3	+\$ 91	Specify fabric color number.
	• Fabric price group 4	+\$ 213	Specify fabric color number.
	• Fabric price group 5	+\$ 365	Specify fabric color number.
	• Fabric price group 6	+\$ 549	Specify fabric color number.
	• Fabric price group 7	+\$ 761	Specify fabric color number.
	Front upholstery: Upholstery on seat surface		
	• Fabric price group 1	No cost	Specify fabric color number.
	• Fabric price group 2	+\$ 10	Specify fabric color number.
	• Fabric price group 3	+\$ 37	Specify fabric color number.
	• Fabric price group 4	+\$ 85	Specify fabric color number.
	• Fabric price group 5	+\$ 146	Specify fabric color number.
	• Fabric price group 6	+\$ 219	Specify fabric color number.
	• Fabric price group 7	+\$ 304	Specify fabric color number.
	• Fabric price group 8	+\$ 402	Specify fabric color number.
	• Fabric price group 9	+\$ 500	Specify fabric color number.
	Upholstery on all surfaces except seat surface		
	• Fabric price group 1	No cost	Specify fabric color number.
	• Fabric price group 2	+\$ 16	Specify fabric color number.
	• Fabric price group 3	+\$ 54	Specify fabric color number.
	• Fabric price group 4	+\$ 127	Specify fabric color number.
	• Fabric price group 5	+\$ 219	Specify fabric color number.
	• Fabric price group 6	+\$ 330	Specify fabric color number.
	• Fabric price group 7	+\$ 457	Specify fabric color number.
	• Fabric price group 8	+\$ 603	Specify fabric color number.
	• Fabric price group 9	+\$ 749	Specify fabric color number.
	COM / COL		
	• Customer's Own Material (COM)	+\$ 37	▶ See <i>Surface Materials Reference Manual</i> .
	• Customer's Own Leather (COL)	+\$ 122	▶ See <i>Surface Materials Reference Manual</i> .
	Glide		
	• Polished Aluminum	+\$ 57	Specify <i>with 8046 Polished Aluminum</i> .

Tip: If selecting front upholstery option, first select the fabric for the surface, then select the fabric for all other surfaces.

For Canadian Pricing
 Multiply U.S. Price by the Canadian price factor.
 ▶ See page 1 for details.

Specification Information

• Style	• U.S.
• Number	• Base
•	• Price
•	•

Same Upholstery

MLBBS	\$1893
•	•

Multiple Upholstery - Front Seat

MLBBF	\$1893
•	•

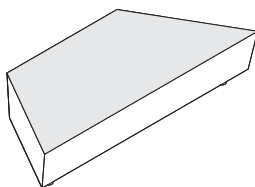
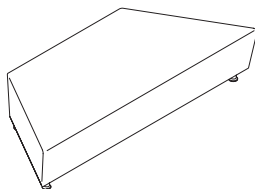

For Canadian Pricing

Multiply U.S. Price by the Canadian price factor.

▶ See page 1 for details.

Understanding and Specifying Umami Lounge Seating

Product Details

Umami	372
Thought Starters	382
Dimensions	386

Specifying

Platforms	388
Lounges	396
Screens	412
Tables	424

Umami

Umami, with its flexible, modular design, can be used to create spaces that are unique to organizations and individuals. Multiple materials are used to promote variation and encourage creativity and self-expression. Integrated power, tables, and screens support the ability to perform in an open environment or in solitude.

► Specifying, pages 388-426

Umami screens are available in two heights for different privacy needs.

Integrated tables are available in two shapes and can be optioned on lounges and platforms.

Lounge seating is upholstered and attaches to other seating or platforms. Different styles allow for a variety of configurations and applications.

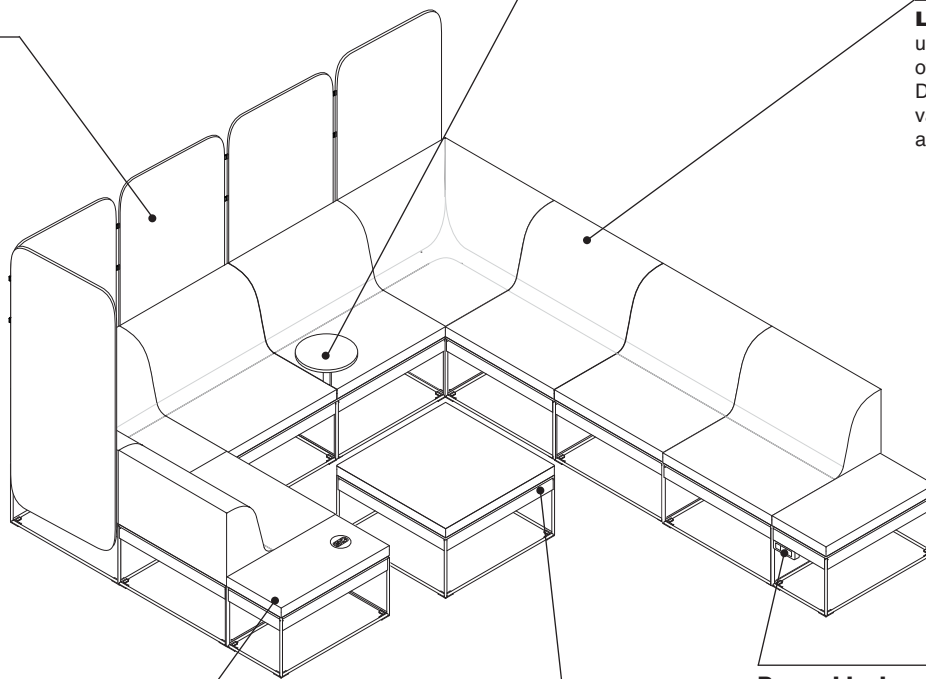

Platforms are available in different sizes with multiple materials available. They can be attached to lounge seating or other platforms to create tables or benches.

Fascia will match the top of the seat or platform unless the contrasting option is selected.

Power block can be attached below the frame anywhere along the lounge or platform. Power can also be integrated on single platforms with laminate or veneer tops (platform table power option).

Product Details

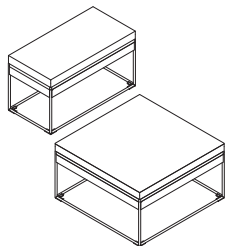

Single platforms come in 15"D x 30"W or 30"D x 30"W sizes. They are available in upholstery, laminate, or wood veneer.

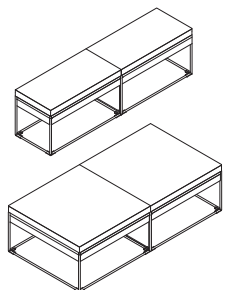

Double platforms come in 15"D x 60"W or 30"D x 60"W sizes. They are available in upholstery only.

Platforms can be ganged together or ganged to lounge seating.

When selecting contrasting option on platforms with depth of 15", the 15"D sides are the left and right sides. The front is either the 30"W side (if single platform), or 60"W side (if double platform).

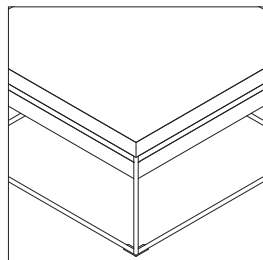

Glides come standard on the bottom of platform frame.

Lounges are available in five different shapes:

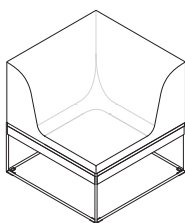
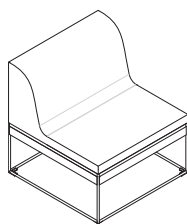

Corner lounge

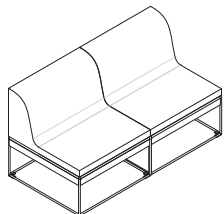

Straight lounge - single or double

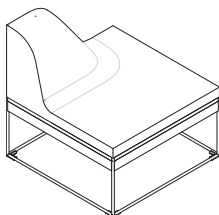

End cap lounge

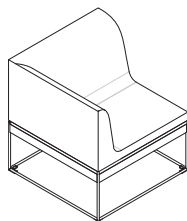

One arm lounge - single or double

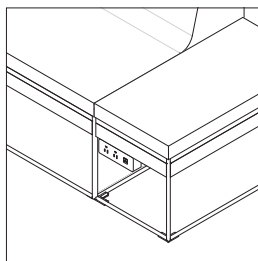

Lounge and platforms gang together with two bolts.

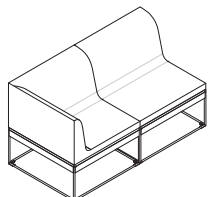

Screens are available at installed heights of 48" or 60".

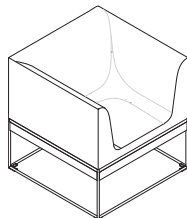

Two arm lounge - single or double



Standard screens come in widths of 15" or 30".

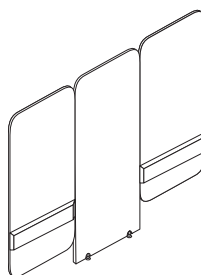

Spanner screens span across two lounge frames and an open space to create a cabin type application. They come in widths of 90" or 105". 90"W spanner screens come with (3) 30"W screens. 105"W spanner screens come with (2) 30"W screens and (1) 45"W center screen.

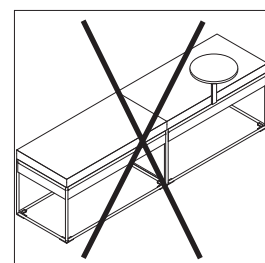

Tables may not be specified on 15"D x 30"W or 15"D x 60"W platforms.

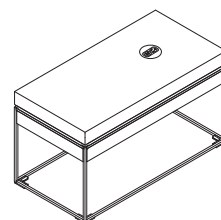

Platform table power can only be optioned on single platforms with laminate or veneer tops. It will be located at the center back of the platform top.

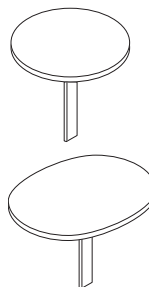

Round or pill tables can only be optioned on straight single, straight double, one arm double, and end cap lounge. Tables can be optioned on all upholstered top platforms except for 15"D x 30"W single platform and 15"D x 60"W double platform.

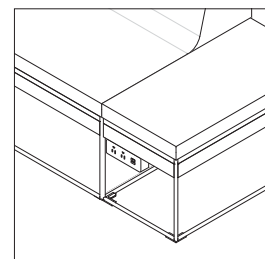

Power blocks can be installed anywhere along the bottom of the fascia on any platform or lounge.

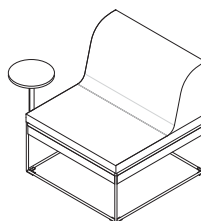

Tables are optioned as table left or table right (based on user sitting in lounge). Table right is shown above.

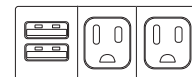

Power blocks and platform table power options come with three power or two power, one USB.

Umami, continued

Surface Materials

The fascia will match the top surface unless the contrasting option is specified.

If top of platform is fabric, the fascia cannot be a hard surface. It can only be upholstery.

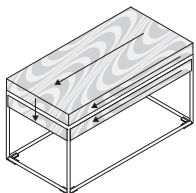

Fascia grain direction will always match the sides of the platforms when selecting hard surfaces. On 15"D platforms, the grain is a waterfall on 15" sides.

When a platform has a hard surface and either laminate or veneer is selected, only monolithic and contrasting fascia options are available. Contrasting sides is not an option.

Only one contrasting surface option is available on each product. This includes fascia which is considered a contrasting surface. If more than one contrasting option is desired, please contact a specials representative.

When contrasting fascia is selected, the fascia will be contrasting from the tops.

Single platform

- Top and fascia
- Laminate
- Veneer
- Open Line laminate
- Customiz stain
- Fabric
- Vinyl
- Elmosoft leather
- COL
- COM

- Frame
- Paint
- Lux Coatings
- Accent paints
- PerfectMatch paint

Double platform

- Top and fascia
- Fabric
- Vinyl
- Elmosoft leather
- COL
- COM

- Frame
- Paint
- Lux Coatings
- Accent paints
- PerfectMatch paint

Lounge

- Top and fascia
- Fabric
- Vinyl
- Elmosoft leather
- COL
- COM

- Frame
- Paint
- Lux Coatings
- Accent paints
- PerfectMatch paint

Screen

- Fabric
- COM

Screen Clips

- 6053 Seagull
- 6527 Merle

Power block (option)

- Black

Platform table power

- (option)
- Silver

Round and pill**table** (option)

- Top
- Laminate

Support

- Paint

Solid, non-repeat fabrics are recommended for Umami lounge, platform, and screens. Steelcase will not pattern match fabrics which have a distinct repeating pattern (stripes, vertical repeats, etc). This includes pattern matching on the single unit but also pattern matching from one component to another. If pattern matching is of concern it is recommended to use one of the standard Steelcase fabrics, vinyls, or non-patterned COM/COL.

Programs & Services

For more information on accent paints, Lux Coatings, PerfectMatch program, and Select Surfaces program, please refer to the *Surface Materials Reference Manual*.

The Customer's Own Material (COM) Program

offers the opportunity for customers to select fabrics that are not offered through the standard Steelcase surface materials program for use on Steelcase products. Through the COM program, Steelcase will test your materials for application on Steelcase products. Once approved, you can place your order. Steelcase will facilitate the entire ordering process and give you a production schedule. Steelcase will order the COM fabric directly from the textile manufacturer. For up-to-date information regarding fabric test results for all COM fabrics and details regarding yardage requirements for most Seating lines, visit the COM website. To locate the COM website:

- Visit www.steelcase.com

Contact your Steelcase Solutions Fulfillment Team Representative at 1.888.STEELCASE (1.888.783.3522) or send an email to lineone@steelcase.com.

Umami

Materiality

Umami screens can have contrasting fabrics on the inside and outside of the screen as long as they are in the same fabric family.

Spanner screens can have fabric applied vertically only.

Double platforms are available in upholstery only.

If the top of the platform is upholstered, the fascia must be upholstered.

If top of platform is a hard surface, the fascia may be upholstered, laminate, or veneer.

When optioning contrasting fascia, the fascia will be contrasting around the entire frame (all four sides).

Lounge seating fascia can only be ordered in upholstery. No hard surfaces on lounge or lounge fascia.

Round or pill table tops are available in two laminates only (2HMG Merle and 2883 Seagull).

Integrated round or pill tables can only be optioned onto lounges or upholstered platforms.

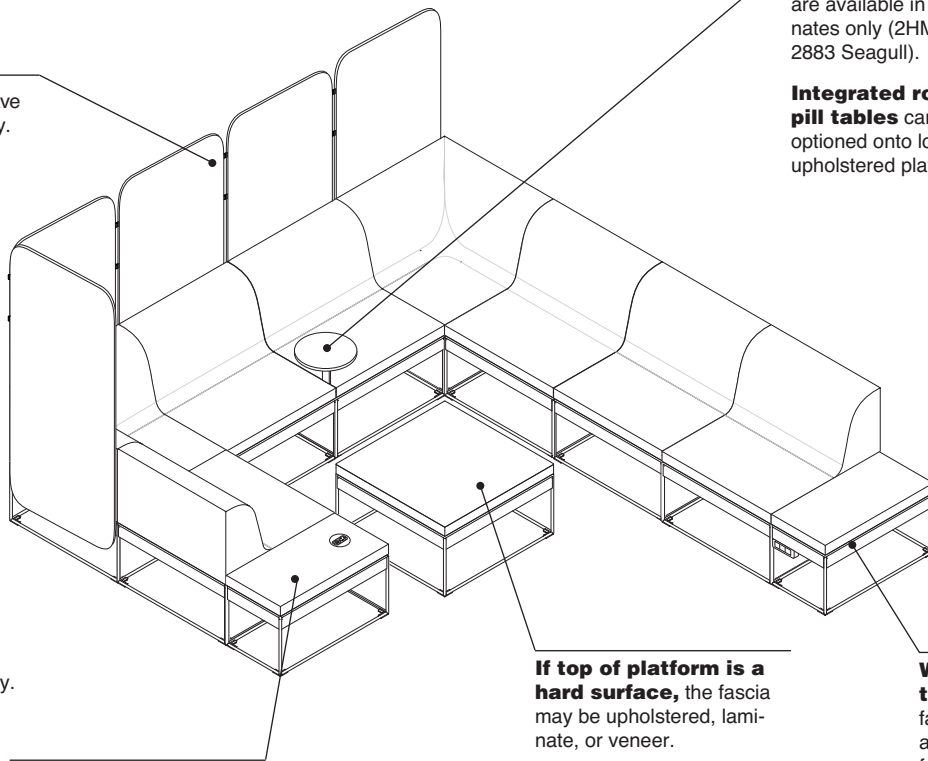

Contrasting Details

Single Platforms and Lounges

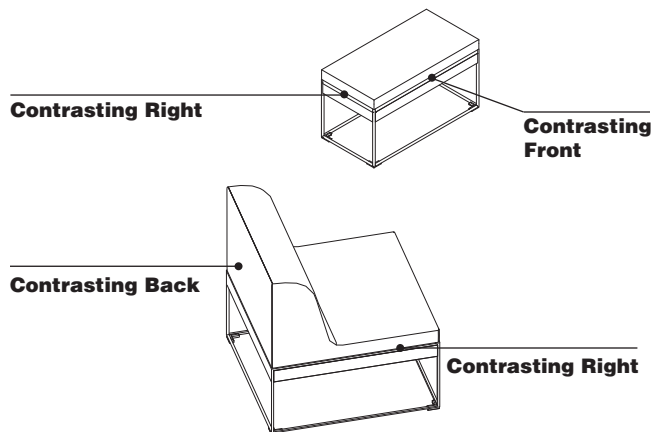

Single Platforms and Lounges

- Contrasting Front
- Contrasting Back
- Contrasting Front and Back
- Contrasting Left
- Contrasting Right
- Contrasting Left and Right

Only one contrasting selection can be made on each product. This includes contrasting fascia.

When a platform has a hard surface and either laminate or veneer is selected, only monolithic and contrasting fascia options are available. Contrasting sides is not an option.

Double Platforms and Lounges

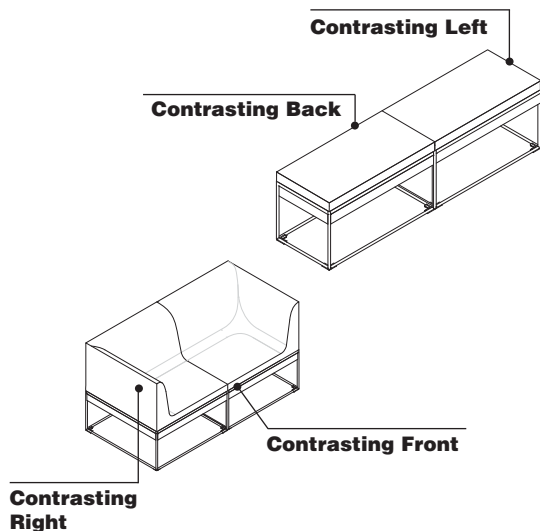

On 15"D platforms, the front is the 30"W or 60"W side. The left and right sides are 15"D.

Double Platforms and Lounges

- Contrasting Front
- Contrasting Back
- Contrasting Front and Back
- Contrasting Left
- Contrasting Right
- Contrasting Left and Right
- Contrasting Seam
- Contrasting Seam, Left and Right

Only one contrasting selection can be made on each product. This includes contrasting fascia.

Corner Lounge only

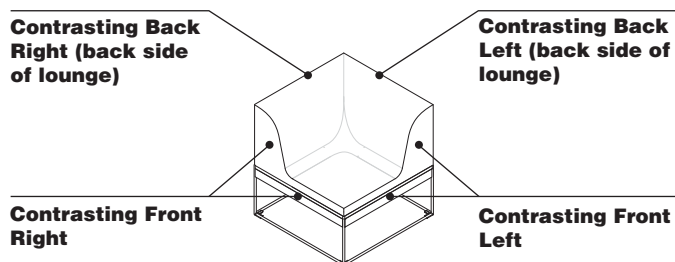

Corner Lounge only

- Contrasting Front Right and Front Left
- Contrasting Back Right and Back Left

Only one contrasting selection can be made on each product. This includes contrasting fascia.

Umami

Pill and Round Tables

Pill and round tables

are options added as table left or table right (optioned based on user sitting in lounge).

Pill and round tables

can be optioned on select platforms with upholstered top or on lounge products.

Round tables are 10" in diameter. Pill tables are 10" by 13 1/2".



The post (support) of the table is available in paint.



Table tops are available in 2883 Seagull and 2HMG Merle only.

Locations of round or pill tables are shown below.

Single Platforms

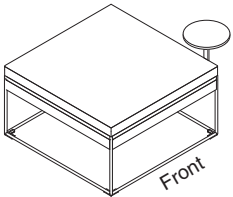

Left location

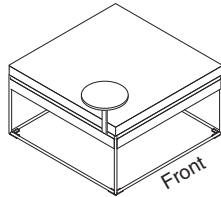

Right location

Round and pill tables cannot be attached to a 15"D x 30"W or 15"D x 60"W platform.

Double Platforms

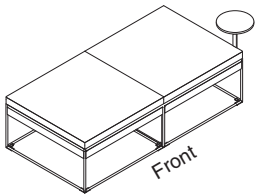

Left location

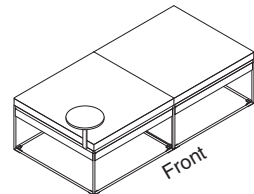

Right location

Round and pill tables cannot be attached to a 15"D x 60"W platform.

Straight Single Lounge

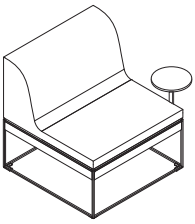

Left location

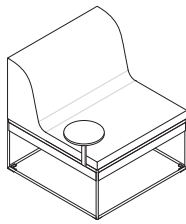

Right location

Round and pill tables cannot be attached to one arm single, two arm single, or corner lounge.

End Cap

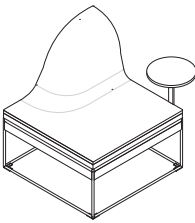

Left location

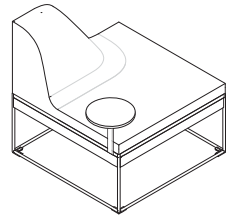

Right location

Straight Double Lounge

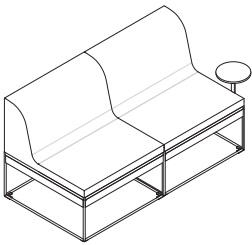

Left location

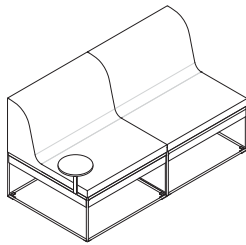

Right location

Round and pill tables cannot be attached to two arm double lounge.

One Arm Double Lounge

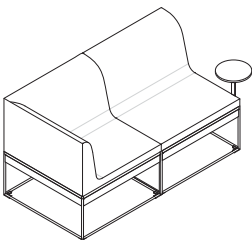

Left location

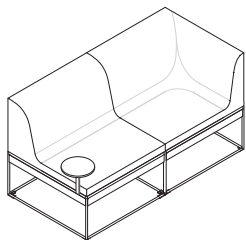

Right location

Umami

Screens

Standard screens are installed at 48" and 60" high.

Screens are available as standard fabric covered.

Each screen will come with one or two clips in merle or seagull that attach screens together.

Screen clips come in two types: straight or corner.

Standard come in 15" and 30" widths.

Fabrics on the screens can be ordered as contrasting. When ordering contrasting, fabrics must be in same fabric family.

Screens cannot be placed in between platforms and lounge seating.

Screens cannot be placed on the front of any platform or lounge seating.

30"W screen can only be put on a 15"D x 30"W platform if the platform is attached to another platform or lounge.

30"W screens can be placed on a 30"D platform/lounge or two 15"D platforms.

Spanner screens come in 90" and 105" widths and the center screen goes completely to the floor. They are not allowed to be attached to a platform or end cap lounge.

90"W spanner screens can only be attached to the side of two lounge chairs. They cannot be attached to an end cap lounge or platform.

15"W screens can go on an end of a lounge for partial privacy. In this case, an upholstered fascia must be added.

Two 15"W screens will not fit on a 30"D platform or lounge.

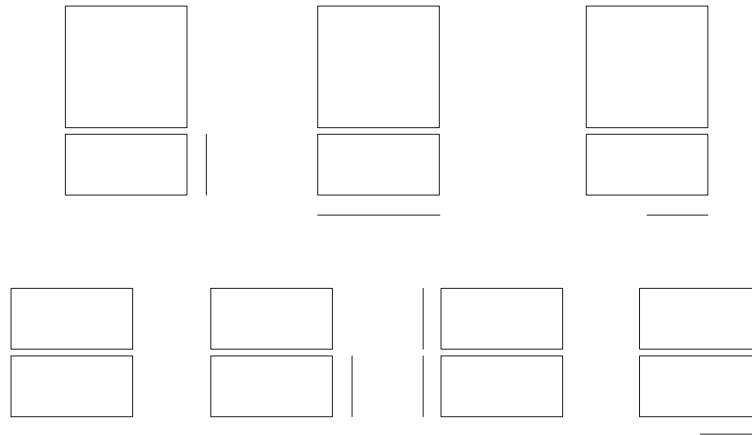
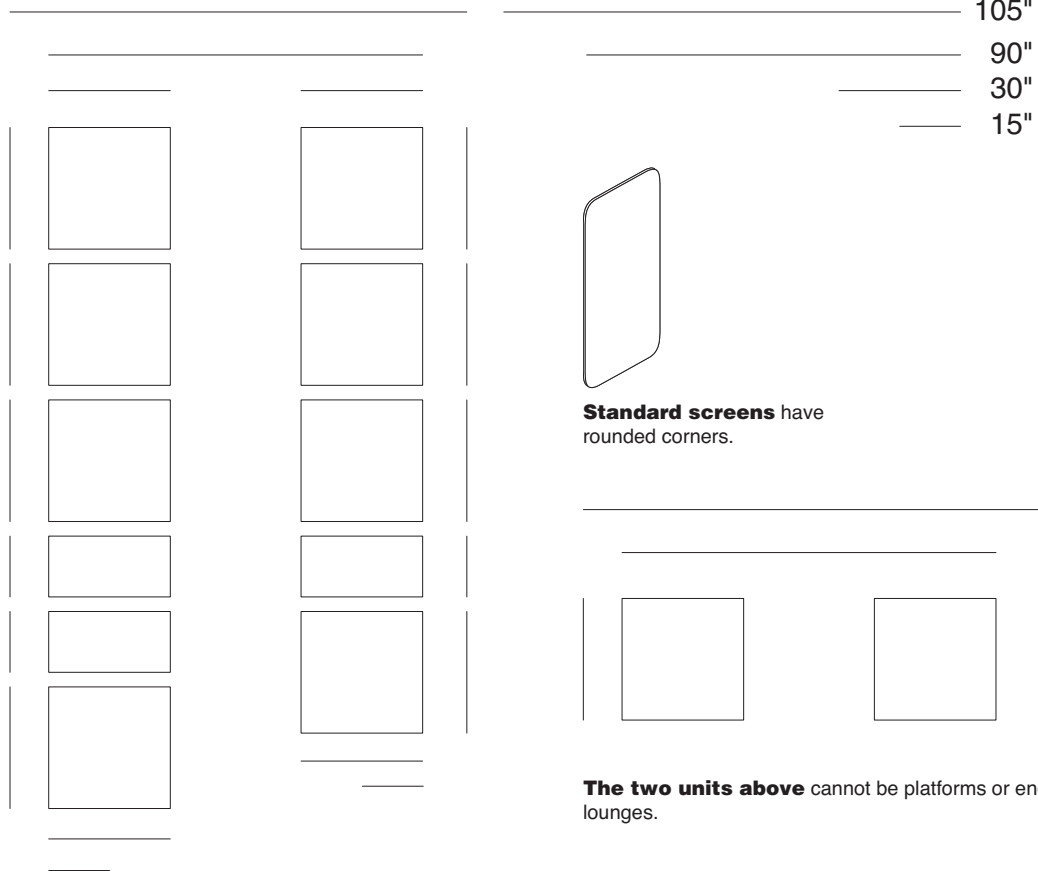

15"W and 30"W screens are only allowed on 15"D x 30"W frames in the shown above configurations.

Tip: When placing a 15"D screen on a 30"W frame, a fascia must be specified.

The following applications are not allowed:

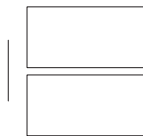
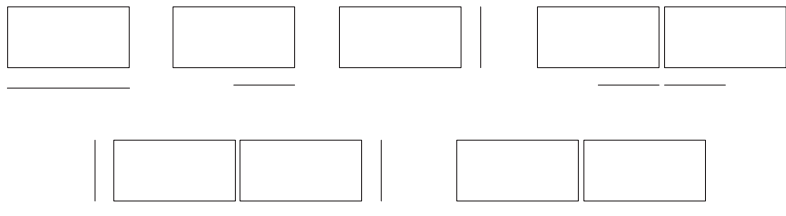

15"W screens cannot span two 15"D x 30"W units.

Specifications above are not allowed for stability reasons.

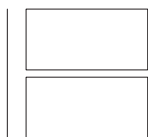

30"W screens cannot span two 15"D x 30"W units.

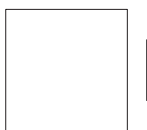

15"W screens cannot be mounted in the center of a 30"D x 30"W unit.

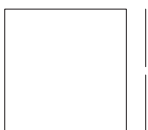

Two 15"W screens cannot be mounted to a 30"W unit.

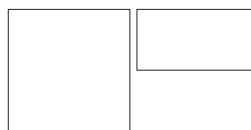

15"D units cannot be ganged to a 30"W frame on the 15"D side.

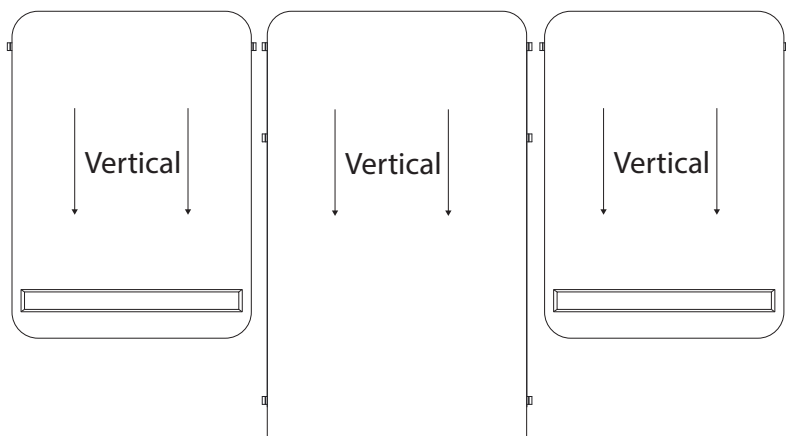

Fabrics can only be applied vertically on spanner screens. If you want other screens to match spanner screens, make sure to specify vertical application on standard screens.

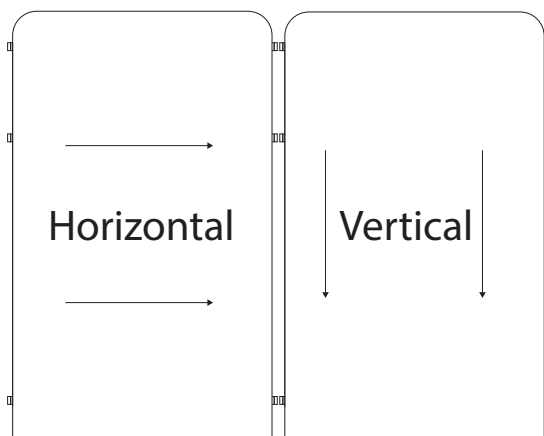

Fabrics can be applied either vertically or horizontally on standard screens.

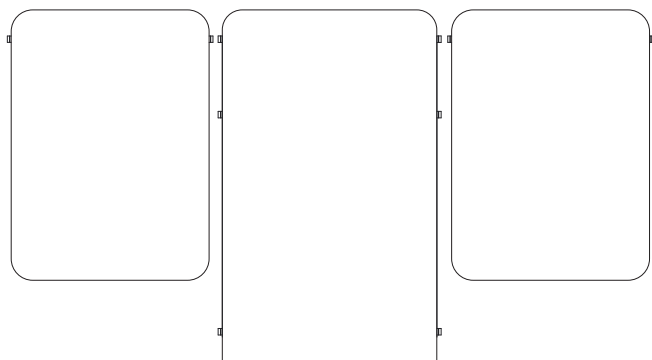

90"W spanner screens will come with three 30"W screens. The center screen will go completely to the floor.

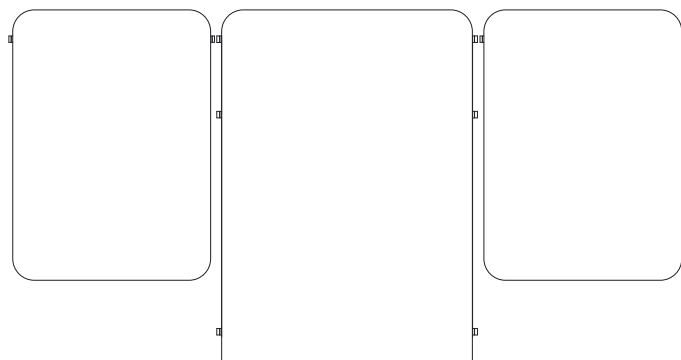

105"W spanner screens will come with two 30"W screens on the ends and a 45"W center screen. The center screen will go completely to the floor.

Thought Starters

Umami

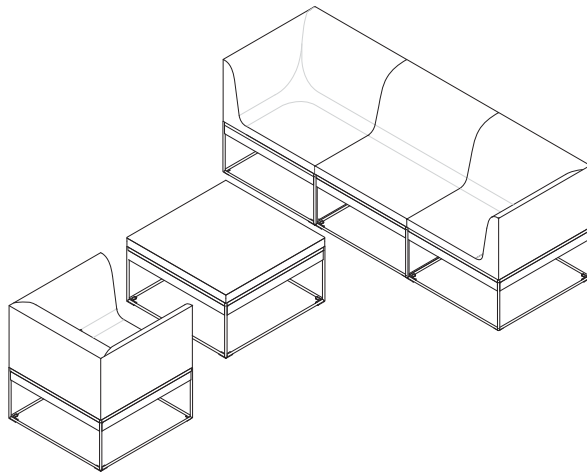

Quantity	Style Number	Description	Options	Page for Ordering
1	STLLNG2AR1	Two Arms, Single Lounge		▶ Page 404
1	STLLNGAR2	One Arm, Double Lounge	Right Arm	▶ Page 402
1	STLLNGAR1	One Arm, Single Lounge	Left Arm	▶ Page 400
1	STLPLTF1	Single Platform	30"D x 30"W	▶ Page 388

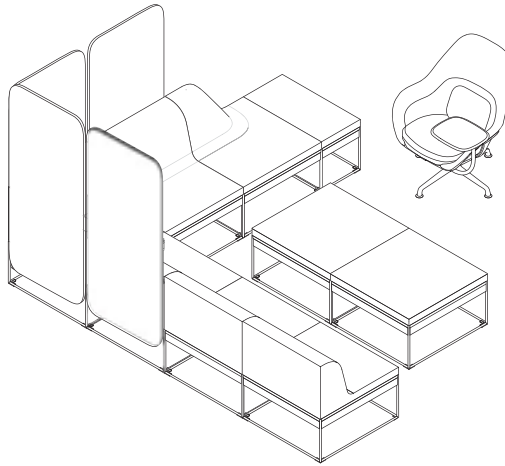

Quantity	Style Number	Description	Options	Page for Ordering
1	STLLNGST2	Straight, Double Lounge		▶ Page 398
1	STLLNGCR1	Corner, Single Lounge		▶ Page 408
2	STLLNGST1	Straight, Single Lounge		▶ Page 396
1	STLLNGEC	End Cap Lounge		▶ Page 410
1	STLPLTF1	Single Platform	15"D x 30"W	▶ Page 388
1	STLPLTF2	Double Platform	30"D x 60"W	▶ Page 392
4	STLSCRPL	Standard Screen	30"W x 48"H	▶ Page 412
1	COW713	SW_1 High-Back Collaborative Lounge Chair	Left Tablet	▶ See <i>Coalesse Seating and Outdoor Specification Guide</i> .

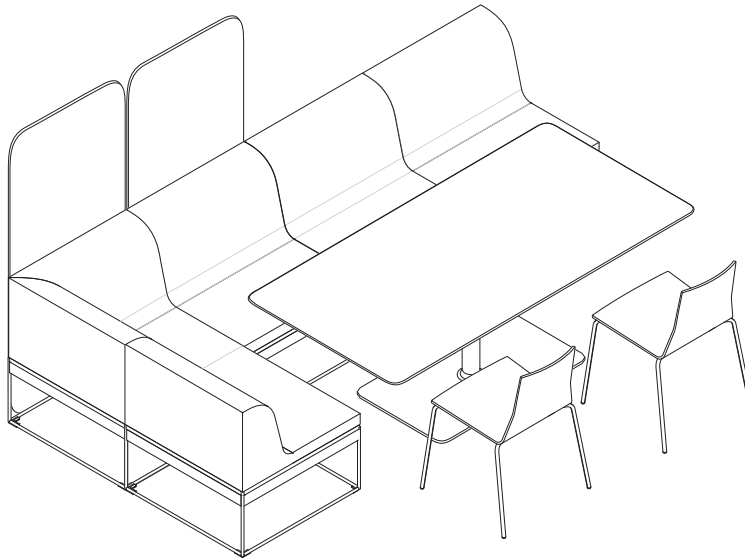

Quantity	Style Number	Description	Options	Page for Ordering
1	STLLNGST2	Straight, Double Lounge	Single	▶ Page 398
1	STLLNGCR1	Corner, Single Lounge		▶ Page 408
1	STLLNGST1	Straight, Single Lounge		▶ Page 396
1	COLAGTRECT	Lagunitas Work Table	36"D x 72"W	▶ Page 422
2	STLSCRPL	Standard Screen	30"W x 48"H	▶ Page 412
2	COSFZCH	Montara650 Chair		▶ See <i>Coalesse Seating and Outdoor Specification Guide</i> .

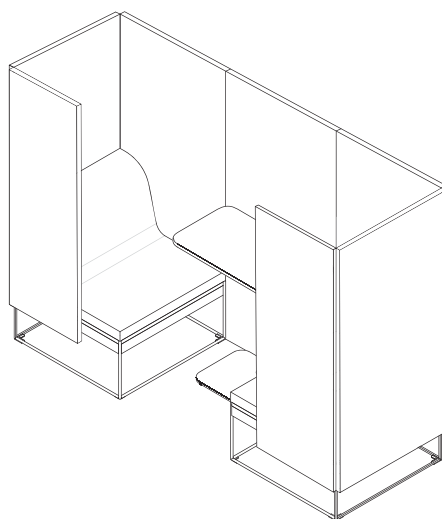

Quantity	Style Number	Description	Options	Page for Ordering
2	STLLNGST1	Straight, Single Lounge		▶ Page 396
1	COLAGTRECT	Lagunitas Work Table	24"D x 36"W	▶ Page 422
2	STLSCRPL	Standard Screen	60"W x 60"H	▶ Page 412
2	STLSCRPL	Standard Screen	15"W x 60"H, 15"H fascia	▶ Page 412
1	STLSCRPLS	Spanner Screen	90"W x 60"H	▶ Page 418

Dimensions

Umami

Features	Overall Depth	Width	Height	Seat Depth	Seat Height from Floor	Installed Screen Height
Umami						
Platform						
Small - Single	15"	30"	16 ¹ / ₂ "	N.A.	N.A.	N.A.
Small - Double	15"	60"	16 ¹ / ₂ "	N.A.	N.A.	N.A.
Large - Single	30"	30"	16 ¹ / ₂ "	N.A.	N.A.	N.A.
Large - Double	30"	60"	16 ¹ / ₂ "	N.A.	N.A.	N.A.
Lounge						
Lounge Seating, Single	30"	30"	31"	17 ¹ / ₄ "	16 ¹ / ₂ "	N.A.
Lounge Seating, Double	30"	60"	31"	17 ¹ / ₄ "	16 ¹ / ₂ "	N.A.
Screen						
Standard	5/8"	15"	36 ¹ / ₂ "	N.A.	N.A.	48"
	5/8"	30"	36 ¹ / ₂ "	N.A.	N.A.	48"
	5/8"	15"	48 ¹ / ₂ "	N.A.	N.A.	60"
	5/8"	30"	48 ¹ / ₂ "	N.A.	N.A.	60"
Standard Spanner	5/8"	90"	48"	N.A.	N.A.	48"
	5/8"	105"	48"	N.A.	N.A.	48"
	5/8"	90"	60"	N.A.	N.A.	60"
	5/8"	105"	60"	N.A.	N.A.	60"

Umami

Single Platform

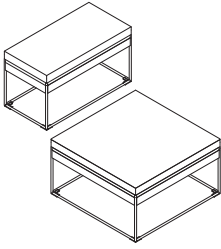

Tip: On 15"D platforms, the front is the 30"W side. When selecting contrasting left or right, the 15"D sides are the contrasting sides.

Tip: When contrasting fascia is selected, the fascia will be contrasting from the top.

Tip: Only a single material scheme can be selected. For example, both contrasting fascia and contrasting front cannot be selected together. If more than one material scheme is desired, contact a specials representative.

Tip: When a platform has a hard surface and either laminate or veneer is selected, only monolithic and contrasting fascia options are available. Contrasting sides is not an option.

Standard Includes	Required to Specify
<ul style="list-style-type: none"> ▶ Need help? Product details, page 372 • Top: fabric price group 1 or laminate • Fascia: monolithic, matches top • Frame: paint price group 1 • Glides • Ships fully assembled • Attachment package 	<ol style="list-style-type: none"> 1 Style number 2 Fabric or laminate color number for top 3 Paint color number for frame 4 Platform size (see below under Required Selections) 5 Material scheme (see below under Required Selections) 6 Options, if selected (see below) <p>▶ See <i>Surface Materials</i>, page 504.</p>

Platform Size	Required Selections	U.S. Price	Required to Specify
	15"D x 30"W 30"D x 30"W	Prices at right Prices at right	Specify with 15"D. Specify with 30"D.
Material Scheme	<ul style="list-style-type: none"> • Monolithic • Contrasting fascia • Contrasting front • Contrasting back • Contrasting left • Contrasting right • Contrasting front and back • Contrasting left and right 	<ul style="list-style-type: none"> No cost No cost No cost No cost No cost No cost No cost No cost 	<ul style="list-style-type: none"> Specify with <i>monolithic</i>. Specify with <i>contrasting fascia</i>. Specify with <i>contrasting front</i>. Specify with <i>contrasting back</i>. Specify with <i>contrasting left</i>. Specify with <i>contrasting right</i>. Specify with <i>contrasting front and back</i>. Specify with <i>contrasting left and right</i>.

Surface Materials	Options	U.S. Price	Required to Specify
	Top finish for 15"D x 30"W		
	<ul style="list-style-type: none"> • Fabric price group 1 • Fabric price group 2 • Fabric price group 3 • Fabric price group 4 • Fabric price group 5 • Fabric price group 6 • Fabric price group 7 • Fabric price group 8 • Fabric price group 9 • Fabric price group 10 • Elmosoft leather upholstery • Steelcase vinyl • Customer's Own Material (COM) • Customer's Own Leather (COL) • Laminate • Open Line Laminate (OLL) • Veneer price group 1 • Veneer price group 2 • Veneer price group 3 • Customiz stain 	<ul style="list-style-type: none"> No cost +\$ 20 +\$ 29 +\$ 40 +\$ 50 +\$ 62 +\$ 71 +\$ 91 +\$111 +\$126 +\$266 +\$ 19 No cost +\$ 52 No cost +\$ 71 +\$327 +\$371 +\$475 +\$327 	<ul style="list-style-type: none"> Specify fabric color number. Specify fabric color number. Specify fabric color number. Specify fabric color number. Specify fabric color number. Specify fabric color number. Specify fabric color number. Specify fabric color number. Specify fabric color number. Specify fabric color number. Specify Elmosoft leather color number. Specify vinyl color number. ▶ See <i>Surface Materials Reference Manual</i>. Specify leather color number. Specify laminate color number. ▶ See <i>Surface Materials Reference Manual</i>. Specify wood veneer finish number. Specify wood veneer finish number. Specify wood veneer finish number. Specify with <i>Customiz stain</i>.

▶ Options, continued on next page



For Canadian Pricing

Multiply U.S. Price by the Canadian price factor.

▶ See page 1 for details.

► Options, continued from previous page

Options	U.S. Price	Required to Specify
Surface Materials, continued	Top finish for 30"D x 30"W	
• Fabric price group 1	No cost	Specify fabric color number.
• Fabric price group 2	+\$ 26	Specify fabric color number.
• Fabric price group 3	+\$ 48	Specify fabric color number.
• Fabric price group 4	+\$ 68	Specify fabric color number.
• Fabric price group 5	+\$ 85	Specify fabric color number.
• Fabric price group 6	+\$105	Specify fabric color number.
• Fabric price group 7	+\$122	Specify fabric color number.
• Fabric price group 8	+\$153	Specify fabric color number.
• Fabric price group 9	+\$188	Specify fabric color number.
• Fabric price group 10	+\$214	Specify fabric color number.
• Elmosoft leather upholstery	+\$451	Specify Elmosoft leather color number.
• Steelcase vinyl	+\$ 26	Specify vinyl color number.
• Customer's Own Material (COM)	No cost	► See <i>Surface Materials Reference Manual</i> .
• Customer's Own Leather (COL)	+\$ 77	Specify leather color number.
• Laminate	No cost	Specify laminate color number.
• Open Line laminate (OLL)	+\$ 71	► See <i>Surface Materials Reference Manual</i> .
• Veneer price group 1	+\$561	Specify wood veneer finish number.
• Veneer price group 2	+\$632	Specify wood veneer finish number.
• Veneer price group 3	+\$810	Specify wood veneer finish number.
• Customiz stain	+\$561	Specify with <i>Customiz stain</i> .
	Frame finish	
• Paint price group 1	No cost	Specify paint color number.
• Paint price group 2	+\$ 52	Specify paint color number.
• Paint price group 3	+\$110	Specify paint color number.
• Lux Coatings	+\$206	Specify Lux Coatings color number.
Contrasting Material Scheme	Contrasting fascia finish, if contrasting fascia selected on platforms with upholstered tops	
• Fabric price group 1	No cost	Specify fabric color number.
• Fabric price group 2	+\$ 20	Specify fabric color number.
• Fabric price group 3	+\$ 29	Specify fabric color number.
• Fabric price group 4	+\$ 40	Specify fabric color number.
• Fabric price group 5	+\$ 50	Specify fabric color number.
• Fabric price group 6	+\$ 62	Specify fabric color number.
• Fabric price group 7	+\$ 71	Specify fabric color number.
• Fabric price group 8	+\$ 91	Specify fabric color number.
• Fabric price group 9	+\$111	Specify fabric color number.
• Fabric price group 10	+\$126	Specify fabric color number.
• Elmosoft leather upholstery	+\$266	Specify Elmosoft leather color number.
• Steelcase vinyl	+\$ 19	Specify vinyl color number.
• Customer's Own Material (COM)	No cost	► See <i>Surface Materials Reference Manual</i> .
• Customer's Own Leather (COL)	+\$ 52	Specify with <i>contrasting</i> and specify leather color number.
	Contrasting fascia finish, if contrasting fascia selected on platforms with laminate or veneer tops	
• Laminate	No cost	Specify laminate color number.
• Open Line laminate (OLL)	+\$ 71	► See <i>Surface Materials Reference Manual</i> .
• Veneer price group 1	+\$327	Specify wood veneer finish number
• Veneer price group 2	+\$371	Specify wood veneer finish number.
• Veneer price group 3	+\$475	Specify wood veneer finish number.
• Customiz stain	+\$327	Specify with <i>Customiz stain</i> .
	Contrasting sides, if contrasting side selected	
• Fabric price group 1	No cost	Specify fabric color number.
• Fabric price group 2	+\$ 10	Specify fabric color number.
• Fabric price group 3	+\$ 15	Specify fabric color number.
• Fabric price group 4	+\$ 21	Specify fabric color number.
• Fabric price group 5	+\$ 26	Specify fabric color number.
• Fabric price group 6	+\$ 30	Specify fabric color number.
• Fabric price group 7	+\$ 34	Specify fabric color number.
• Fabric price group 8	+\$ 39	Specify fabric color number.
• Fabric price group 9	+\$ 49	Specify fabric color number.
• Fabric price group 10	+\$ 57	Specify fabric color number.

Tip: Contrasting sides are only allowed on fabric platforms.



For Canadian Pricing
Multiply U.S. Price by the Canadian price factor.
► See page 1 for details.

► Options, continued on next page

Umami

Umami, Single Platform, continued

► Options, continued from previous page

Options	U.S. Price	Required to Specify
Contrasting Material Scheme, continued	• Contrasting sides, if contrasting side selected, continued	
	• Elmosoft leather upholstery	+ \$123
	• Steelcase vinyl	+ \$ 8
	• Customer's Own Material (COM)	No cost
	• Customer's Own Leather (COL)	+ \$ 26
	• Laminate	+ \$ 41
	• Open Line laminate (OLL)	+ \$ 71
	• Veneer price group 1	+ \$114
	• Veneer price group 2	+ \$129
	• Veneer price group 3	+ \$167
	• Cusomiz stain	+ \$114
		Specify Elmosoft leather color number. Specify vinyl color number. ► See <i>Surface Materials Reference Manual</i> . Specify leather color number. Specify laminate color number. ► See <i>Surface Materials Reference Manual</i> . Specify wood veneer finish number. Specify wood veneer finish number. Specify wood veneer finish number. Specify <i>with Customiz stain</i> .
Tables (on platform with upholstered top)	Table type (on 30"D x 30"W platform only)	
	• No table	No cost
	• Round table	+ \$368
	• Pill table	+ \$368
		Specify <i>with no table</i> . Specify <i>with round table</i> and select color number. Specify <i>with pill table</i> and select color number.
	Table location	
	• Table left	No cost
	• Table right	No cost
		Specify <i>with table left</i> . Specify <i>with table right</i> .
	Table support finish	
	• Paint group 1	No cost
	• Paint group 2	+ \$ 15
	• Paint group 3	+ \$ 28
	• Lux Coatings	+ \$ 41
		Specify paint color number. Specify paint color number. Specify paint color number. Specify Lux Coatings color number.
Power Configuration	Power type	
	• No power	No cost
	• Platform table power	+ \$294
	• Power block	+ \$347
		Specify <i>with no power</i> . Specify <i>with platform table power</i> . Specify <i>with power block</i> .
	Power configuration for platform table power	
	• Two power	No cost
	• One power, one USB	+ \$123
		Specify <i>with 2 power</i> . Specify <i>with 1 power, 1 USB</i> .
	Power configuration for power block	
	• Three power	No cost
	• Two power, one USB	+ \$123
		Specify <i>with 3 power</i> . Specify <i>with 2 power, 1 USB</i> .
	Power plug type	
	• Standard NEMA 5–15 3 prong	No cost
	• Low profile plug	+ \$ 28
		Specify <i>with NEMA</i> . Specify <i>with low profile plug</i> .
	Tamper resistant	
	• No tamper resistant	No cost
	• Tamper resistant	+ \$ 21
		Specify <i>with no tamper resistant</i> . Specify <i>with tamper resistant</i> .

Tip: Platform table power is located at the center back of platform top.

Tip: Platform table power is only available on platforms with laminate or veneer tops.

Tip: Power is provided by a 72" power cord.

**For Canadian Pricing**

Multiply U.S. Price by the Canadian price factor.

► See page 1 for details.

Specification Information

• Dimensions		• Style • Number	U.S. Base Prices	
• W	• H		• 15"D	• 30"D
30"	16½"	STLPLTF1	\$1071	\$1392

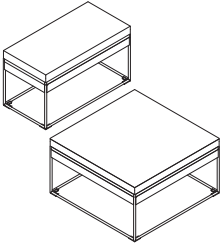

 **For Canadian Pricing**
 Multiply U.S. Price by the
 Canadian price factor.
 ▶ See page 1 for details.

Umami

Double Platform

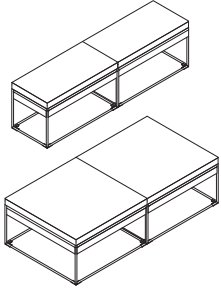

Tip: On 15"D platforms, the front is the 60"W side. When selecting contrasting left or right, the 15"D sides are the contrasting sides

Tip: Only a single material scheme can be selected. For example, both contrasting fascia and contrasting front cannot be selected together. If more than one material scheme is desired, contact a specials representative.

Standard Includes	Required to Specify
<ul style="list-style-type: none"> ▶ Need help? Product details, page 372 • Top: fabric price group 1 • Fascia: monolithic, matches top • Frame: paint price group 1 • Glides • Ships fully assembled • Attachment package 	<ol style="list-style-type: none"> 1 Style number 2 Fabric color number for top 3 Paint color number for frame 4 Platform size (see below under Required Selections) 5 Material scheme (see below under Required Selections) 6 Options, if selected (see below) <p>▶ See <i>Surface Materials</i>, page 504.</p>

Required Selections	U.S. Price	Required to Specify
Platform Size <ul style="list-style-type: none"> • 15"D x 60"W • 30"D x 60"W 	<ul style="list-style-type: none"> Prices at right Prices at right 	<ul style="list-style-type: none"> Specify with 15"D. Specify with 30"D.
Material Scheme <ul style="list-style-type: none"> • Monolithic • Contrasting fascia • Contrasting front • Contrasting back • Contrasting left • Contrasting right • Contrasting front and back • Contrasting left and right • Contrasting seam • Contrasting seam, left and right 	<ul style="list-style-type: none"> No cost No cost No cost No cost No cost No cost No cost No cost No cost No cost 	<ul style="list-style-type: none"> Specify with <i>monolithic</i>. Specify with <i>contrasting fascia</i>. Specify with <i>contrasting front</i>. Specify with <i>contrasting back</i>. Specify with <i>contrasting left</i>. Specify with <i>contrasting right</i>. Specify with <i>contrasting front and back</i>. Specify with <i>contrasting left and right</i>. Specify with <i>contrasting seam</i>. Specify with <i>contrasting seam, left and right</i>.

Options	U.S. Price	Required to Specify
Surface Materials <p>Top finish for 15"D x 60"W</p> <ul style="list-style-type: none"> • Fabric price group 1 • Fabric price group 2 • Fabric price group 3 • Fabric price group 4 • Fabric price group 5 • Fabric price group 6 • Fabric price group 7 • Fabric price group 8 • Fabric price group 9 • Fabric price group 10 • Elmosoft leather upholstery • Steelcase vinyl • Customer's Own Material (COM) • Customer's Own Leather (COL) <p>Top finish for 30"D x 60"W</p> <ul style="list-style-type: none"> • Fabric price group 1 • Fabric price group 2 • Fabric price group 3 • Fabric price group 4 • Fabric price group 5 • Fabric price group 6 • Fabric price group 7 • Fabric price group 8 • Fabric price group 9 • Fabric price group 10 • Elmosoft leather upholstery • Steelcase vinyl • Customer's Own Material (COM) • Customer's Own Leather (COL) 	<ul style="list-style-type: none"> No cost +\$ 35 +\$ 52 +\$ 72 +\$ 91 +\$111 +\$128 +\$163 +\$200 +\$227 +\$478 +\$ 33 No cost +\$ 93 <ul style="list-style-type: none"> No cost +\$ 49 +\$ 92 +\$129 +\$163 +\$200 +\$231 +\$291 +\$358 +\$407 +\$856 +\$ 46 No cost +\$103 	<ul style="list-style-type: none"> Specify fabric color number. Specify fabric color number. Specify fabric color number. Specify fabric color number. Specify fabric color number. Specify fabric color number. Specify fabric color number. Specify fabric color number. Specify fabric color number. Specify fabric color number. Specify Elmosoft leather color number. Specify vinyl color number. <p>▶ See <i>Surface Materials Reference Manual</i>. Specify leather color number.</p> <ul style="list-style-type: none"> Specify fabric color number. Specify fabric color number. Specify fabric color number. Specify fabric color number. Specify fabric color number. Specify fabric color number. Specify fabric color number. Specify fabric color number. Specify fabric color number. Specify fabric color number. Specify Elmosoft leather color number. Specify vinyl color number. <p>▶ See <i>Surface Materials Reference Manual</i>. Specify leather color number.</p>

▶ Options, continued on next page

For Canadian Pricing
 Multiply U.S. Price by the Canadian price factor.
 ▶ See page 1 for details.

► Options, continued from previous page

	Options	U.S. Price	Required to Specify	
Surface Materials, continued	Frame finish			
	• Paint price group 1	No cost	Specify paint color number.	
	• Paint price group 2	+\$ 88	Specify paint color number.	
	• Paint price group 3	+\$187	Specify paint color number.	
	• Lux Coatings	+\$412	Specify Lux Coatings color number.	
Contrasting Material Scheme	Contrasting fascia finish, if contrasting fascia selected			
	• Fabric price group 1	No cost	Specify fabric color number.	
	• Fabric price group 2	+\$ 31	Specify fabric color number.	
	• Fabric price group 3	+\$ 46	Specify fabric color number.	
	• Fabric price group 4	+\$ 64	Specify fabric color number.	
	• Fabric price group 5	+\$ 80	Specify fabric color number.	
	• Fabric price group 6	+\$ 99	Specify fabric color number.	
	• Fabric price group 7	+\$113	Specify fabric color number.	
	• Fabric price group 8	+\$145	Specify fabric color number.	
	• Fabric price group 9	+\$178	Specify fabric color number.	
	• Fabric price group 10	+\$201	Specify fabric color number.	
	• Elmosoft leather upholstery	+\$424	Specify Elmosoft leather color number.	
	• Steelcase vinyl	+\$ 30	Specify vinyl color number.	
	• Customer's Own Material (COM)	No cost	► See <i>Surface Materials Reference Manual</i> .	
	• Customer's Own Leather (COL)	+\$ 82	Specify leather color number.	
		Contrasting sides finish, if contrasting side selected		
		• Fabric price group 1	No cost	Specify fabric color number.
	• Fabric price group 2	+\$ 20	Specify fabric color number.	
	• Fabric price group 3	+\$ 29	Specify fabric color number.	
	• Fabric price group 4	+\$ 40	Specify fabric color number.	
	• Fabric price group 5	+\$ 50	Specify fabric color number.	
	• Fabric price group 6	+\$ 62	Specify fabric color number.	
	• Fabric price group 7	+\$ 71	Specify fabric color number.	
	• Fabric price group 8	+\$ 91	Specify fabric color number.	
	• Fabric price group 9	+\$111	Specify fabric color number.	
	• Fabric price group 10	+\$126	Specify fabric color number.	
	• Elmosoft leather upholstery	+\$266	Specify Elmosoft leather color number.	
	• Steelcase vinyl	+\$ 19	Specify color number.	
	• Customer's Own Material (COM)	No cost	► See <i>Surface Materials Reference Manual</i> .	
	• Customer's Own Leather (COL)	+\$ 52	Specify leather color number .	
Tables	Table type (on 30"D x 60"W platform only)			
	• No table	No cost	Specify <i>with no table</i>	
	• Round table	+\$368	Specify <i>with round table</i> and select color number.	
	• Pill table	+\$368	Specify <i>with pill table</i> and select color number.	
	Table location			
	• Table left	No cost	Specify <i>with table left</i> .	
	• Table right	No cost	Specify <i>with table right</i> .	
	Table support finish			
	• Paint group 1	No cost	Specify paint color number.	
	• Paint group 2	+\$ 15	Specify paint color number.	
	• Paint group 3	+\$ 28	Specify paint color number.	
	• Lux Coatings	+\$ 41	Specify Lux Coatings color number.	

► Options, continued on next page

Tip: Contrasting sides are only allowed on fabric platforms.

**For Canadian Pricing**

Multiply U.S. Price by the Canadian price factor.

► See page 1 for details.

Umami, Double Platform, continued

► Options, continued from previous page

Tip: Power is provided by a 72" power cord.

Options	U.S. Price	Required to Specify
Power Configuration <ul style="list-style-type: none"> Power type No power Power block Two power blocks 	No cost +\$347 +\$694	Specify with no power. Specify with power block. Specify with two power blocks.
Outlet configuration <ul style="list-style-type: none"> Three power Two power, one USB 	No cost +\$123	Specify with 3 power. Specify with 2 power, 1 USB.
Power plug type <ul style="list-style-type: none"> Standard NEMA 5-15 3 prong Low profile plug 	No cost +\$ 28	Specify with NEMA. Specify with low profile plug.
Tamper resistant <ul style="list-style-type: none"> No tamper resistant Tamper resistant 	No cost +\$ 21	Specify with no tamper resistant. Specify with tamper resistant.

Specification Information

Dimensions		Style Number	U.S. Base Prices	
W	H		15"D	30"D
60"	16½"	STLPLTF2	\$1571	\$2042

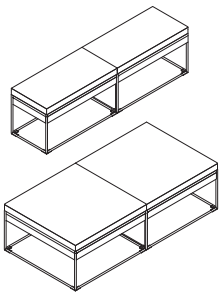

 **For Canadian Pricing**
 Multiply U.S. Price by the Canadian price factor.
 ► See page 1 for details.



Umami Straight Lounge

Single

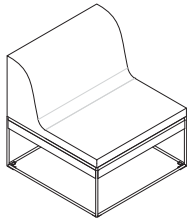

Tip: Only a single material scheme can be selected. For example, both contrasting fascia and contrasting front cannot be selected together. If more than one material scheme is desired, contact a specials representative.

Standard Includes	Required to Specify
<ul style="list-style-type: none"> ▶ Need help? Product details, page 372 • Seat upholstery: fabric price group 1 • Fascia: monolithic, matches top • Frame: paint price group 1 • Ships fully assembled • Attachment package 	<ol style="list-style-type: none"> 1 Style number 2 Fabric color number for seat 3 Paint color number for frame 4 Material scheme (see below under Required Selections) 5 Options, if selected (see below) <p>▶ See <i>Surface Materials</i>, page 504.</p>

Material Scheme	Required Selections	U.S. Price	Required to Specify
	<ul style="list-style-type: none"> • Monolithic • Contrasting fascia • Contrasting front • Contrasting back • Contrasting left • Contrasting right • Contrasting front and back • Contrasting left and right 	<ul style="list-style-type: none"> No cost No cost No cost No cost No cost No cost No cost No cost 	<ul style="list-style-type: none"> Specify <i>with monolithic</i>. Specify <i>with contrasting fascia</i>. Specify <i>with contrasting front</i>. Specify <i>with contrasting back</i>. Specify <i>with contrasting left</i>. Specify <i>with contrasting right</i>. Specify <i>with contrasting front and back</i>. Specify <i>with contrasting left and right</i>.

Surface Materials	Options	U.S. Price	Required to Specify
	<p>Seat finish</p> <ul style="list-style-type: none"> • Fabric price group 1 • Fabric price group 2 • Fabric price group 3 • Fabric price group 4 • Fabric price group 5 • Fabric price group 6 • Fabric price group 7 • Fabric price group 8 • Fabric price group 9 • Fabric price group 10 • Elmosoft leather upholstery • Steelcase vinyl • Customer's Own Material (COM) • Customer's Own Leather (COL) • Soil-retardant treatment applied to upholstery fabric 	<ul style="list-style-type: none"> No cost +\$ 49 +\$ 92 +\$129 +\$163 +\$200 +\$231 +\$291 +\$358 +\$407 +\$856 +\$ 49 No cost +\$103 +\$ 27 	<ul style="list-style-type: none"> Specify fabric color number. Specify fabric color number. Specify fabric color number. Specify fabric color number. Specify fabric color number. Specify fabric color number. Specify fabric color number. Specify fabric color number. Specify fabric color number. Specify fabric color number. Specify Elmosoft leather color number. Specify vinyl color number. ▶ See <i>Surface Materials Reference Manual</i>. Specify leather color number. Specify <i>with soil-retardant treatment</i>.
	<p>Frame finish</p> <ul style="list-style-type: none"> • Paint price group 1 • Paint price group 2 • Paint price group 3 • Lux Coatings 	<ul style="list-style-type: none"> No cost +\$ 52 +\$110 +\$206 	<ul style="list-style-type: none"> Specify paint color number. Specify paint color number. Specify paint color number. Specify Lux Coatings color number.

Contrasting Material Scheme	Contrasting fascia finish, if contrasting fascia selected	U.S. Price	Required to Specify
	<ul style="list-style-type: none"> • Fabric price group 1 • Fabric price group 2 • Fabric price group 3 • Fabric price group 4 • Fabric price group 5 • Fabric price group 6 • Fabric price group 7 • Fabric price group 8 • Fabric price group 9 • Fabric price group 10 • Elmosoft leather upholstery • Steelcase vinyl • Customer's Own Material (COM) • Customer's Own Leather (COL) 	<ul style="list-style-type: none"> No cost +\$ 20 +\$ 29 +\$ 40 +\$ 50 +\$ 62 +\$ 71 +\$ 91 +\$111 +\$126 +\$266 +\$ 19 No cost +\$ 52 	<ul style="list-style-type: none"> Specify fabric color number. Specify fabric color number. Specify fabric color number. Specify fabric color number. Specify fabric color number. Specify fabric color number. Specify fabric color number. Specify fabric color number. Specify fabric color number. Specify fabric color number. Specify Elmosoft leather color number. Specify vinyl color number. ▶ See <i>Surface Materials Reference Manual</i>. Specify leather color number.

▶ Options, continued on next page



For Canadian Pricing

Multiply U.S. Price by the Canadian price factor.

▶ See page 1 for details.

► Options, continued from previous page

Options	U.S. Price	Required to Specify
Contrasting Material Scheme, continued		
Contrasting sides finish, if contrasting side selected		
• Fabric price group 1	No cost	Specify fabric color number.
• Fabric price group 2	+\$ 20	Specify fabric color number.
• Fabric price group 3	+\$ 29	Specify fabric color number.
• Fabric price group 4	+\$ 40	Specify fabric color number.
• Fabric price group 5	+\$ 50	Specify fabric color number.
• Fabric price group 6	+\$ 62	Specify fabric color number.
• Fabric price group 7	+\$ 71	Specify fabric color number.
• Fabric price group 8	+\$ 91	Specify fabric color number.
• Fabric price group 9	+\$111	Specify fabric color number.
• Fabric price group 10	+\$126	Specify fabric color number.
• Elmosoft leather upholstery	+\$266	Specify Elmosoft leather color number.
• Steelcase vinyl	+\$ 19	Specify vinyl color number.
• Customer's Own Material (COM)	No cost	► See <i>Surface Materials Reference Manual</i> .
• Customer's Own Leather (COL)	+\$ 52	Specify leather color number.
Tables		
Table type		
• No table	No cost	Specify <i>with no table</i> .
• Round table	+\$368	Specify <i>with round table</i> and select color number.
• Pill table	+\$368	Specify <i>with pill table</i> and select color number.
Table location		
• Table left	No cost	Specify <i>with table left</i> .
• Table right	No cost	Specify <i>with table right</i> .
Table support finish		
• Paint price group 1	No cost	Specify paint color number.
• Paint price group 2	+\$ 15	Specify paint color number.
• Paint price group 3	+\$ 28	Specify paint color number.
• Lux Coatings	+\$ 41	Specify Lux Coatings color number.
Power Configuration		
Power type		
• No power	No cost	Specify <i>with no power</i> .
• Power block	+\$347	Specify <i>with power block</i> .
Outlet configuration		
• Three power	No cost	Specify <i>with 3 power</i> .
• Two power, one USB	+\$123	Specify <i>with 2 power, 1 USB</i> .
Power plug type		
• Standard NEMA 5–15 3 prong	No cost	Specify <i>with NEMA</i> .
• Low profile plug	+\$ 28	Specify <i>with low profile plug</i> .
Tamper resistant		
• No tamper resistant	No cost	Specify <i>with no tamper resistant</i> .
• Tamper resistant	+\$ 21	Specify <i>with tamper resistant</i> .

Tip: Platform table power is located at the center back of platform top.

Tip: Power is provided by a 72" power cord.

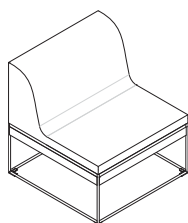

Specification Information				
• Dimensions			• Style	• U.S.
D	W	H	Number	Base Price
30"	30"	31"	STLLNGST1	\$2010

Umami Straight Lounge

Double

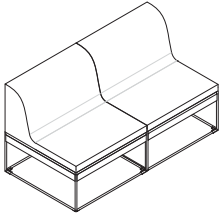

Tip: Only a single material scheme can be selected. For example, both contrasting fascia and contrasting front cannot be selected together. If more than one material scheme is desired, contact a specials representative.

Standard Includes	Required to Specify
-------------------	---------------------

- | | | |
|--|---|---|
| <ul style="list-style-type: none"> ▶ Need help? Product details, page 372 | <ul style="list-style-type: none"> • Seat upholstery: fabric price group 1 • Fascia: monolithic, matches top • Frame: paint price group 1 • Ships ready to assemble • Attachment package | <ol style="list-style-type: none"> 1 Style number 2 Fabric color number for seat 3 Paint color number for frame 4 Material scheme (see below under Required Selections) 5 Options, if selected (see below) <ul style="list-style-type: none"> ▶ See <i>Surface Materials</i>, page 504. |
|--|---|---|

Material Scheme	Required Selections	U.S. Price	Required to Specify
-----------------	---------------------	------------	---------------------

- | | | | |
|------------------------|--|--|--|
| Material Scheme | <ul style="list-style-type: none"> • Monolithic • Contrasting fascia • Contrasting front • Contrasting back • Contrasting left • Contrasting right • Contrasting front and back • Contrasting left and right • Contrasting seam • Contrasting seam, left and right | <ul style="list-style-type: none"> No cost No cost No cost No cost No cost No cost No cost No cost No cost No cost | <ul style="list-style-type: none"> Specify with <i>monolithic</i>. Specify with <i>contrasting fascia</i>. Specify with <i>contrasting front</i>. Specify with <i>contrasting back</i>. Specify with <i>contrasting left</i>. Specify with <i>contrasting right</i>. Specify with <i>contrasting front and back</i>. Specify with <i>contrasting left and right</i>. Specify with <i>contrasting seam</i>. Specify with <i>contrasting seam, left and right</i>. |
|------------------------|--|--|--|

Surface Materials	Options	U.S. Price	Required to Specify
-------------------	---------	------------	---------------------

- | | | | | |
|--------------------------|---------------------|--|--|--|
| Surface Materials | Seat finish | <ul style="list-style-type: none"> • Fabric price group 1 • Fabric price group 2 • Fabric price group 3 • Fabric price group 4 • Fabric price group 5 • Fabric price group 6 • Fabric price group 7 • Fabric price group 8 • Fabric price group 9 • Fabric price group 10 • Elmosoft leather upholstery • Steelcase vinyl • Customer's Own Material (COM) • Customer's Own Leather (COL) | <ul style="list-style-type: none"> No cost +\$ 89 +\$ 165 +\$ 232 +\$ 293 +\$ 359 +\$ 415 +\$ 524 +\$ 645 +\$ 732 +\$1541 +\$ 89 No cost +\$ 185 | <ul style="list-style-type: none"> Specify fabric color number. Specify fabric color number. Specify fabric color number. Specify fabric color number. Specify fabric color number. Specify fabric color number. Specify fabric color number. Specify fabric color number. Specify fabric color number. Specify fabric color number. Specify Elmosoft leather color number. Specify vinyl color number. ▶ See <i>Surface Materials Reference Manual</i>. Specify leather color number. |
| | Frame finish | <ul style="list-style-type: none"> • Paint price group 1 • Paint price group 2 • Paint price group 3 • Lux Coatings | <ul style="list-style-type: none"> No cost +\$ 88 +\$ 187 +\$ 412 | <ul style="list-style-type: none"> Specify paint color number. Specify paint color number. Specify paint color number. Specify Lux Coatings color number. |

Contrasting Material Scheme	Contrasting fascia finish, if contrasting fascia selected	U.S. Price	Required to Specify
-----------------------------	---	------------	---------------------

- | | | | |
|------------------------------------|--|---|--|
| Contrasting Material Scheme | <ul style="list-style-type: none"> • Fabric price group 1 • Fabric price group 2 • Fabric price group 3 • Fabric price group 4 • Fabric price group 5 • Fabric price group 6 • Fabric price group 7 • Fabric price group 8 • Fabric price group 9 • Fabric price group 10 • Elmosoft leather upholstery • Steelcase vinyl • Customer's Own Material (COM) • Customer's Own Leather (COL) | <ul style="list-style-type: none"> No cost +\$ 31 +\$ 46 +\$ 64 +\$ 80 +\$ 99 +\$ 113 +\$ 145 +\$ 178 +\$ 201 +\$ 424 +\$ 30 No cost +\$ 82 | <ul style="list-style-type: none"> Specify fabric color number. Specify fabric color number. Specify fabric color number. Specify fabric color number. Specify fabric color number. Specify fabric color number. Specify fabric color number. Specify fabric color number. Specify fabric color number. Specify fabric color number. Specify Elmosoft leather color number. Specify vinyl color number. ▶ See <i>Surface Materials Reference Manual</i>. Specify leather color number. |
|------------------------------------|--|---|--|

▶ Options, continued on next page



For Canadian Pricing

Multiply U.S. Price by the Canadian price factor.

▶ See page 1 for details.

► Options, continued from previous page

Options	U.S. Price	Required to Specify
Contrasting Material Scheme, continued		
Contrasting sides finish, if contrasting side selected		
• Fabric price group 1	No cost	Specify fabric color number.
• Fabric price group 2	+\$ 26	Specify fabric color number.
• Fabric price group 3	+\$ 48	Specify fabric color number.
• Fabric price group 4	+\$ 68	Specify fabric color number.
• Fabric price group 5	+\$ 85	Specify fabric color number.
• Fabric price group 6	+\$105	Specify fabric color number.
• Fabric price group 7	+\$122	Specify fabric color number.
• Fabric price group 8	+\$153	Specify fabric color number.
• Fabric price group 9	+\$188	Specify fabric color number.
• Fabric price group 10	+\$214	Specify fabric color number.
• Elmosoft leather upholstery	+\$451	Specify Elmosoft leather color number.
• Steelcase vinyl	+\$ 26	Specify vinyl color number.
• Customer's Own Material (COM)	No cost	► See <i>Surface Materials Reference Manual</i> .
• Customer's Own Leather (COL)	+\$ 77	Specify leather color number.
Tables		
Table type		
• No table	No cost	Specify <i>with no table</i> .
• Round table	+\$368	Specify <i>with round table</i> and select color number.
• Pill table	+\$368	Specify <i>with pill table</i> and select color number.
Table location		
• Table left	No cost	Specify <i>with table left</i> .
• Table right	No cost	Specify <i>with table right</i> .
Table support finish		
• Paint price group 1	No cost	Specify paint color number.
• Paint price group 2	+\$ 15	Specify paint color number.
• Paint price group 3	+\$ 28	Specify paint color number.
• Lux Coatings	+\$ 41	Specify Lux Coatings color number.
Power Configuration		
Power type		
• No power	No cost	Specify <i>with no power</i> .
• Power block	+\$347	Specify <i>with power block</i> .
• Two power blocks	+\$694	Specify <i>with two power blocks</i> .
Outlet configuration		
• Three power	No cost	Specify <i>with 3 power</i> .
• Two power, one USB	+\$123	Specify <i>with 2 power, 1 USB</i> .
Power plug type		
• Standard NEMA 5–15 3 prong	No cost	Specify <i>with NEMA</i> .
• Low profile plug	+\$ 28	Specify <i>with low profile plug</i> .
Tamper resistant		
• No tamper resistant	No cost	Specify <i>with no tamper resistant</i> .
• Tamper resistant	+\$ 21	Specify <i>with tamper resistant</i> .

Tip: Power is provided by a 72" power cord.

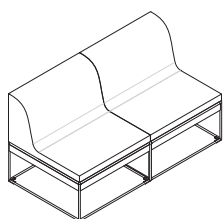

Specification Information				
Dimensions			Style	U.S. Base Price
D	W	H	Number	
30"	60"	31"	STLLNGST2	\$2907

Umami

Umami Lounge

One Arm, Single

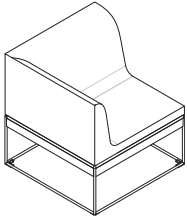

Tip: Only a single material scheme can be selected. For example, both contrasting fascia and contrasting front cannot be selected together. If more than one material scheme is desired, contact a specials representative.

Standard Includes	Required to Specify
<ul style="list-style-type: none"> ▶ Need help? Product details, page 372 • Seat upholstery: fabric price group 1 • Fascia: monolithic, matches top • Frame: paint price group 1 • Ships fully assembled • Attachment package 	<ol style="list-style-type: none"> 1 Style number 2 Fabric color number for seat 3 Paint color number for frame 4 Material scheme (see below under Required Selections) 5 Arm Position (see below under Required Selections) 6 Options, if selected (see below) <ul style="list-style-type: none"> ▶ See <i>Surface Materials</i>, page 504.

	Required Selections	U.S. Price	Required to Specify
Material Scheme	<ul style="list-style-type: none"> • Monolithic • Contrasting fascia • Contrasting front • Contrasting back • Contrasting left • Contrasting right • Contrasting front and back • Contrasting left and right 	<ul style="list-style-type: none"> No cost No cost No cost No cost No cost No cost No cost No cost 	<ul style="list-style-type: none"> Specify <i>with monolithic</i>. Specify <i>with contrasting fascia</i>. Specify <i>with contrasting front</i>. Specify <i>with contrasting back</i>. Specify <i>with contrasting left</i>. Specify <i>with contrasting right</i>. Specify <i>with contrasting front and back</i>. Specify <i>with contrasting left and right</i>.
Arm Position	<ul style="list-style-type: none"> • Left arm • Right arm 	<ul style="list-style-type: none"> No cost No cost 	<ul style="list-style-type: none"> Specify <i>with left arm</i>. Specify <i>with right arm</i>.

	Options	U.S. Price	Required to Specify
Surface Materials	<p>Seat finish</p> <ul style="list-style-type: none"> • Fabric price group 1 • Fabric price group 2 • Fabric price group 3 • Fabric price group 4 • Fabric price group 5 • Fabric price group 6 • Fabric price group 7 • Fabric price group 8 • Fabric price group 9 • Fabric price group 10 • Elmosoft leather upholstery • Steelcase vinyl • Customer's Own Material (COM) • Customer's Own Leather (COL) <p>Frame finish</p> <ul style="list-style-type: none"> • Paint price group 1 • Paint price group 2 • Paint price group 3 • Lux Coatings 	<ul style="list-style-type: none"> No cost +\$ 55 +\$101 +\$142 +\$179 +\$219 +\$253 +\$320 +\$394 +\$448 +\$856 +\$ 55 No cost +\$103 No cost +\$ 52 +\$110 +\$206 	<ul style="list-style-type: none"> Specify fabric color number. Specify fabric color number. Specify fabric color number. Specify fabric color number. Specify fabric color number. Specify fabric color number. Specify fabric color number. Specify fabric color number. Specify fabric color number. Specify fabric color number. Specify Elmosoft leather color number. Specify vinyl color number. ▶ See <i>Surface Materials Reference Manual</i>. Specify leather color number. Specify paint color number. Specify paint color number. Specify paint color number. Specify Lux Coatings color number.

▶ Options, continued on next page



For Canadian Pricing

Multiply U.S. Price by the Canadian price factor.

▶ See page 1 for details.

► Options, continued from previous page

Options	U.S. Price	Required to Specify
Contrasting Material Scheme		
Contrasting fascia finish, if contrasting fascia selected		
• Fabric price group 1	No cost	Specify fabric color number.
• Fabric price group 2	+\$ 20	Specify fabric color number.
• Fabric price group 3	+\$ 29	Specify fabric color number.
• Fabric price group 4	+\$ 40	Specify fabric color number.
• Fabric price group 5	+\$ 50	Specify fabric color number.
• Fabric price group 6	+\$ 62	Specify fabric color number.
• Fabric price group 7	+\$ 71	Specify fabric color number.
• Fabric price group 8	+\$ 91	Specify fabric color number.
• Fabric price group 9	+\$111	Specify fabric color number.
• Fabric price group 10	+\$126	Specify fabric color number.
• Elmosoft leather upholstery	+\$266	Specify Elmosoft leather color number.
• Steelcase vinyl	+\$ 19	Specify vinyl color number.
• Customer's Own Material (COM)	No cost	► See <i>Surface Materials Reference Manual</i> .
• Customer's Own Leather (COL)	+\$ 52	Specify leather color number.
Contrasting sides finish, if contrasting side selected		
• Fabric price group 1	No cost	Specify fabric color number.
• Fabric price group 2	+\$ 20	Specify fabric color number.
• Fabric price group 3	+\$ 29	Specify fabric color number.
• Fabric price group 4	+\$ 40	Specify fabric color number.
• Fabric price group 5	+\$ 50	Specify fabric color number.
• Fabric price group 6	+\$ 62	Specify fabric color number.
• Fabric price group 7	+\$ 71	Specify fabric color number.
• Fabric price group 8	+\$ 91	Specify fabric color number.
• Fabric price group 9	+\$111	Specify fabric color number.
• Fabric price group 10	+\$126	Specify fabric color number.
• Elmosoft leather upholstery	+\$266	Specify Elmosoft leather color number.
• Steelcase vinyl	+\$ 19	Specify vinyl color number.
• Customer's Own Material (COM)	No cost	► See <i>Surface Materials Reference Manual</i> .
• Customer's Own Leather (COL)	+\$ 52	Specify leather color number.
Power Configuration		
Power type		
• No power	No cost	Specify <i>with no power</i> .
• Power block	+\$347	Specify <i>with power block</i> .
Outlet configuration		
• Three power	No cost	Specify <i>with 3 power</i> .
• Two power, one USB	+\$123	Specify <i>with 2 power, 1 USB</i> .
Power plug type		
• Standard NEMA 5–15 3 prong	No cost	Specify <i>with NEMA</i> .
• Low profile plug	+\$ 28	Specify <i>with low profile plug</i> .
Tamper resistant		
• No tamper resistant	No cost	Specify <i>with no tamper resistant</i> .
• Tamper resistant	+\$ 21	Specify <i>with tamper resistant</i> .

Tip: Power is provided by a 72" power cord.

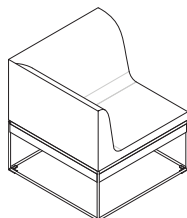

Specification Information				
• Dimensions			• Style	• U.S.
D	W	H	Number	Base Price
30"	30"	31"	STLLNGAR1	\$2616

Umami

Umami Lounge

One Arm, Double

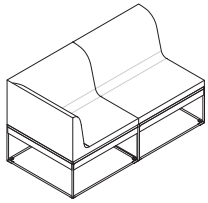

Tip: Only a single material scheme can be selected. For example, both contrasting fascia and contrasting front cannot be selected together. If more than one material scheme is desired, contact a specials representative.

Tip: Arm positions are determined based on user sitting in seat. For example, specify right arm if you want an arm on your right side while sitting.

Standard Includes	Required to Specify
<ul style="list-style-type: none"> ▶ Need help? Product details, page 372 • Seat upholstery: fabric price group 1 • Fascia: monolithic, matches top • Frame: paint price group 1 • Ships ready to assemble • Attachment package 	<ol style="list-style-type: none"> 1 Style number 2 Fabric color number for seat 3 Paint color number for frame 4 Material scheme (see below under Required Selections) 5 Arm position (see below under Required Selections) 6 Options, if selected (see below) <p>▶ See <i>Surface Materials</i>, page 504.</p>

Required Selections	U.S. Price	Required to Specify
Material Scheme <ul style="list-style-type: none"> • Monolithic • Contrasting fascia • Contrasting front • Contrasting back • Contrasting left • Contrasting right • Contrasting front and back • Contrasting left and right • Contrasting seam • Contrasting seam, left and right 	<ul style="list-style-type: none"> No cost No cost No cost No cost No cost No cost No cost No cost No cost No cost 	<ul style="list-style-type: none"> Specify <i>with monolithic</i>. Specify <i>with contrasting fascia</i>. Specify <i>with contrasting front</i>. Specify <i>with contrasting back</i>. Specify <i>with contrasting left</i>. Specify <i>with contrasting right</i>. Specify <i>with contrasting front and back</i>. Specify <i>with contrasting left and right</i>. Specify <i>with contrasting seam</i>. Specify <i>with contrasting seam, left and right</i>.
Arm Position <ul style="list-style-type: none"> • Left arm • Right arm 	<ul style="list-style-type: none"> No cost No cost 	<ul style="list-style-type: none"> Specify <i>with left arm</i>. Specify <i>with right arm</i>.

Options	U.S. Price	Required to Specify
Surface Materials <p>Seat finish</p> <ul style="list-style-type: none"> • Fabric price group 1 • Fabric price group 2 • Fabric price group 3 • Fabric price group 4 • Fabric price group 5 • Fabric price group 6 • Fabric price group 7 • Fabric price group 8 • Fabric price group 9 • Fabric price group 10 • Elmosoft leather upholstery • Steelcase vinyl • Customer's Own Material (COM) • Customer's Own Leather (COL) <p>Frame finish</p> <ul style="list-style-type: none"> • Paint price group 1 • Paint price group 2 • Paint price group 3 • Lux Coatings 	<ul style="list-style-type: none"> No cost +\$ 98 +\$ 181 +\$ 255 +\$ 322 +\$ 396 +\$ 457 +\$ 577 +\$ 710 +\$ 805 +\$1541 +\$ 98 No cost +\$ 185 No cost +\$ 88 +\$ 187 +\$ 412 	<ul style="list-style-type: none"> Specify fabric color number. Specify fabric color number. Specify fabric color number. Specify fabric color number. Specify fabric color number. Specify fabric color number. Specify fabric color number. Specify fabric color number. Specify fabric color number. Specify fabric color number. Specify Elmosoft leather color number. Specify vinyl color number. ▶ See <i>Surface Materials Reference Manual</i>. Specify leather color number. Specify paint color number. Specify paint color number. Specify paint color number. Specify Lux Coatings color number.

Contrasting Material Scheme	Contrasting fascia finish, if contrasting fascia selected	Required to Specify
<ul style="list-style-type: none"> • Fabric price group 1 • Fabric price group 2 • Fabric price group 3 • Fabric price group 4 • Fabric price group 5 • Fabric price group 6 • Fabric price group 7 • Fabric price group 8 • Fabric price group 9 • Fabric price group 10 • Elmosoft leather upholstery • Steelcase vinyl • Customer's Own Material (COM) • Customer's Own Leather (COL) 	<ul style="list-style-type: none"> No cost +\$ 31 +\$ 46 +\$ 64 +\$ 80 +\$ 99 +\$ 113 +\$ 145 +\$ 178 +\$ 201 +\$ 424 +\$ 30 No cost +\$ 82 	<ul style="list-style-type: none"> Specify fabric color number. Specify fabric color number. Specify fabric color number. Specify fabric color number. Specify fabric color number. Specify fabric color number. Specify fabric color number. Specify fabric color number. Specify fabric color number. Specify fabric color number. Specify Elmosoft leather color number. Specify vinyl color number. ▶ See <i>Surface Materials Reference Manual</i>. Specify leather color number.

▶ Options, continued on next page



For Canadian Pricing

Multiply U.S. Price by the Canadian price factor.

▶ See page 1 for details.

► Options, continued from previous page

Options	U.S. Price	Required to Specify
Contrasting Material Scheme, continued		
Contrasting sides finish, if contrasting side selected		
• Fabric price group 1	No cost	Specify fabric color number.
• Fabric price group 2	+\$ 26	Specify fabric color number.
• Fabric price group 3	+\$ 48	Specify fabric color number.
• Fabric price group 4	+\$ 68	Specify fabric color number.
• Fabric price group 5	+\$ 85	Specify fabric color number.
• Fabric price group 6	+\$105	Specify fabric color number.
• Fabric price group 7	+\$122	Specify fabric color number.
• Fabric price group 8	+\$153	Specify fabric color number.
• Fabric price group 9	+\$188	Specify fabric color number.
• Fabric price group 10	+\$214	Specify fabric color number.
• Elmosoft leather upholstery	+\$451	Specify Elmosoft leather color number.
• Steelcase vinyl	+\$ 26	Specify vinyl color number.
• Customer's Own Material (COM)	No cost	► See <i>Surface Materials Reference Manual</i> .
• Customer's Own Leather (COL)	+\$ 77	Specify leather color number.
Tables		
Table type		
• No table	No cost	Specify <i>with no table</i> .
• Round table	+\$368	Specify <i>with round table</i> and select color number.
• Pill table	+\$368	Specify <i>with pill table</i> and select color number.
Table location		
• Table left	No cost	Specify <i>with table left</i> .
• Table right	No cost	Specify <i>with table right</i> .
Table support finish		
• Paint group 1	No cost	Specify paint color number.
• Paint group 2	+\$ 15	Specify paint color number.
• Paint group 3	+\$ 28	Specify paint color number.
• Lux Coatings	+\$ 41	Specify Lux Coatings color number.
Power Configuration		
Power type		
• No power	No cost	Specify <i>with no power</i> .
• Power block	+\$347	Specify <i>with power block</i> .
• Two power blocks	+\$694	Specify <i>with power blocks</i> .
Outlet configuration		
• Three power	No cost	Specify <i>with 3 power</i> .
• Two power, one USB	+\$123	Specify <i>with 2 power, 1 USB</i> .
Power plug type		
• Standard NEMA 5–15 3 prong	No cost	Specify <i>with NEMA</i> .
• Low profile plug	+\$ 28	Specify <i>with low profile plug</i> .
Tamper resistant		
• No tamper resistant	No cost	Specify <i>with no tamper resistant</i> .
• Tamper resistant	+\$ 21	Specify <i>with tamper resistant</i> .

Tip: Power is provided by a 72" power cord.

Specification Information

• Dimensions			• Style	• U.S.
D	W	H	Number	Base Price
30"	60"	31"	STLLNGAR2	\$3513

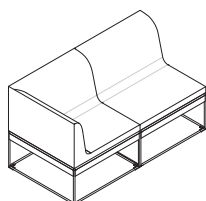

Umami Lounge

Two Arms, Single

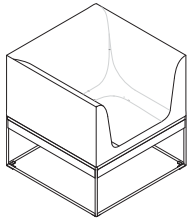

Tip: Only a single material scheme can be selected. For example, both contrasting fascia and contrasting front cannot be selected together. If more than one material scheme is desired, contact a specials representative.

Standard Includes	Required to Specify
<ul style="list-style-type: none"> ▶ Need help? Product details, page 372 • Seat upholstery: fabric price group 1 • Fascia: monolithic, matches top • Frame: paint price group 1 • Ships fully assembled • Attachment package 	<ol style="list-style-type: none"> 1 Style number 2 Fabric color number for seat 3 Paint color number for frame 4 Material scheme (see below under Required Selections) 5 Options, if selected (see below) <ul style="list-style-type: none"> ▶ See <i>Surface Materials</i>, page 504.

Required Selections	U.S. Price	Required to Specify
Material Scheme <ul style="list-style-type: none"> • Monolithic • Contrasting fascia • Contrasting front • Contrasting back • Contrasting left • Contrasting right • Contrasting front and back • Contrasting left and right 	<ul style="list-style-type: none"> No cost No cost No cost No cost No cost No cost No cost No cost 	<ul style="list-style-type: none"> Specify <i>with monolithic</i>. Specify <i>with contrasting fascia</i>. Specify <i>with contrasting front</i>. Specify <i>with contrasting back</i>. Specify <i>with contrasting left</i>. Specify <i>with contrasting right</i>. Specify <i>with contrasting front and back</i>. Specify <i>with contrasting left and right</i>.

Options	U.S. Price	Required to Specify
Surface Materials <p>Seat finish</p> <ul style="list-style-type: none"> • Fabric price group 1 • Fabric price group 2 • Fabric price group 3 • Fabric price group 4 • Fabric price group 5 • Fabric price group 6 • Fabric price group 7 • Fabric price group 8 • Fabric price group 9 • Fabric price group 10 • Elmosoft leather upholstery • Steelcase vinyl • Customer's Own Material (COM) • Customer's Own Leather (COL) <p>Frame finish</p> <ul style="list-style-type: none"> • Paint price group 1 • Paint price group 2 • Paint price group 3 • Lux Coatings 	<ul style="list-style-type: none"> No cost +\$ 60 +\$110 +\$155 +\$196 +\$240 +\$277 +\$350 +\$431 +\$488 +\$856 +\$ 60 No cost +\$103 	<ul style="list-style-type: none"> Specify fabric color number. Specify fabric color number. Specify fabric color number. Specify fabric color number. Specify fabric color number. Specify fabric color number. Specify fabric color number. Specify fabric color number. Specify fabric color number. Specify fabric color number. Specify Elmosoft leather color number. Specify vinyl color number. ▶ See <i>Surface Materials Reference Manual</i>. Specify leather color number. <ul style="list-style-type: none"> Specify paint color number. Specify paint color number. Specify paint color number. Specify Lux Coatings color number.

▶ Options, continued on next page



For Canadian Pricing

Multiply U.S. Price by the Canadian price factor.

▶ See page 1 for details.

► Options, continued from previous page

Options	U.S. Price	Required to Specify
Contrasting Material Scheme		
Contrasting fascia finish, if contrasting fascia selected		
• Fabric price group 1	No cost	Specify fabric color number.
• Fabric price group 2	+\$ 20	Specify fabric color number.
• Fabric price group 3	+\$ 29	Specify fabric color number.
• Fabric price group 4	+\$ 40	Specify fabric color number.
• Fabric price group 5	+\$ 50	Specify fabric color number.
• Fabric price group 6	+\$ 62	Specify fabric color number.
• Fabric price group 7	+\$ 71	Specify fabric color number.
• Fabric price group 8	+\$ 91	Specify fabric color number.
• Fabric price group 9	+\$111	Specify fabric color number.
• Fabric price group 10	+\$126	Specify fabric color number.
• Elmosoft leather upholstery	+\$266	Specify Elmosoft leather color number.
• Steelcase vinyl	+\$ 19	Specify vinyl color number.
• Customer's Own Material (COM)	No cost	► See <i>Surface Materials Reference Manual</i> .
• Customer's Own Leather (COL)	+\$ 52	Specify leather color number.
Contrasting sides finish, if contrasting side selected		
• Fabric price group 1	No cost	Specify fabric color number.
• Fabric price group 2	+\$ 20	Specify fabric color number.
• Fabric price group 3	+\$ 29	Specify fabric color number.
• Fabric price group 4	+\$ 40	Specify fabric color number.
• Fabric price group 5	+\$ 50	Specify fabric color number.
• Fabric price group 6	+\$ 62	Specify fabric color number.
• Fabric price group 7	+\$ 71	Specify fabric color number.
• Fabric price group 8	+\$ 91	Specify fabric color number.
• Fabric price group 9	+\$111	Specify fabric color number.
• Fabric price group 10	+\$126	Specify fabric color number.
• Elmosoft leather upholstery	+\$266	Specify Elmosoft leather color number.
• Steelcase vinyl	+\$ 19	Specify vinyl color number.
• Customer's Own Material (COM)	No cost	► See <i>Surface Materials Reference Manual</i> .
• Customer's Own Leather (COL)	+\$ 52	Specify leather color number.
Power Configuration		
Power type		
• No power	No cost	Specify <i>with no power</i> .
• Power block	+\$347	Specify <i>with power block</i> .
Outlet configuration		
• Three power	No cost	Specify <i>with 3 power</i> .
• Two power, one USB	+\$123	Specify <i>with 2 power, 1 USB</i> .
Power plug type		
• Standard NEMA 5–15 3 prong	No cost	Specify <i>with NEMA</i> .
• Low profile plug	+\$ 28	Specify <i>with low profile plug</i> .
Tamper resistant		
• No tamper resistant	No cost	Specify <i>with no tamper resistant</i> .
• Tamper resistant	+\$ 21	Specify <i>with tamper resistant</i> .

Tip: Power is provided by a 72" power cord.

Specification Information

• Dimensions			• Style	• U.S.
D	W	H	Number	Base Price
30"	30"	31"	STLLNG2AR1	\$3222

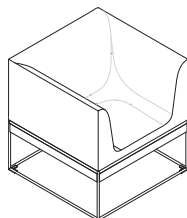

Umami

Umami Lounge

Two Arms, Double

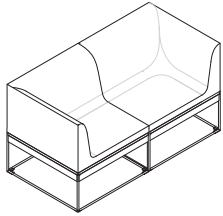

Tip: Only a single material scheme can be selected. For example, both contrasting fascia and contrasting front cannot be selected together. If more than one material scheme is desired, contact a specials representative.

Standard Includes	Required to Specify
<ul style="list-style-type: none"> ▶ Need help? Product details, page 372 • Seat upholstery: fabric price group 1 • Fascia: monolithic, matches top • Frame: paint price group • Ships ready to assemble • Attachment package 	<ol style="list-style-type: none"> 1 Style number 2 Fabric color number for seat 3 Paint color number for frame 4 Material scheme (see below under Required Selections) 5 Options, if selected (see below) <ul style="list-style-type: none"> ▶ See <i>Surface Materials</i>, page 504.

Required Selections	U.S. Price	Required to Specify
Material Scheme <ul style="list-style-type: none"> • Monolithic • Contrasting fascia finish • Contrasting front • Contrasting back • Contrasting left • Contrasting right • Contrasting front and back • Contrasting left and right • Contrasting seam • Contrasting seam, left and right 	<ul style="list-style-type: none"> No cost No cost No cost No cost No cost No cost No cost No cost No cost No cost 	<ul style="list-style-type: none"> Specify <i>with monolithic</i>. Specify <i>with contrasting fascia</i>. Specify <i>with contrasting front</i>. Specify <i>with contrasting back</i>. Specify <i>with contrasting left</i>. Specify <i>with contrasting right</i>. Specify <i>with contrasting front and back</i>. Specify <i>with contrasting left and right</i>. Specify <i>with contrasting seam</i>. Specify <i>with contrasting seam, left and right</i>.

Options	U.S. Price	Required to Specify
Surface Materials <p>Seat finish</p> <ul style="list-style-type: none"> • Fabric price group 1 • Fabric price group 2 • Fabric price group 3 • Fabric price group 4 • Fabric price group 5 • Fabric price group 6 • Fabric price group 7 • Fabric price group 8 • Fabric price group 9 • Fabric price group 10 • Elmosoft leather upholstery • Steelcase vinyl • Customer's Own Material (COM) • Customer's Own Leather (COL) <p>Frame finish</p> <ul style="list-style-type: none"> • Paint price group 1 • Paint price group 2 • Paint price group 3 • Lux Coatings 	<ul style="list-style-type: none"> No cost +\$ 107 +\$ 198 +\$ 278 +\$ 351 +\$ 432 +\$ 499 +\$ 629 +\$ 775 +\$ 879 +\$1541 +\$ 107 No cost +\$ 185 No cost +\$ 88 +\$ 187 +\$ 412 	<ul style="list-style-type: none"> Specify fabric color number. Specify fabric color number. Specify fabric color number. Specify fabric color number. Specify fabric color number. Specify fabric color number. Specify fabric color number. Specify fabric color number. Specify fabric color number. Specify fabric color number. Specify Elmosoft leather color number. Specify vinyl color number. ▶ See <i>Surface Materials Reference Manual</i>. Specify leather color number. Specify paint color number. Specify paint color number. Specify paint color number. Specify Lux Coatings color number.

▶ Options, continued on next page



For Canadian Pricing

Multiply U.S. Price by the Canadian price factor.

▶ See page 1 for details.

► Options, continued from previous page

Options	U.S. Price	Required to Specify
Contrasting Material Scheme		
Contrasting fascia finish, if contrasting fascia selected		
• Fabric price group 1	No cost	Specify fabric color number.
• Fabric price group 2	+\$ 31	Specify fabric color number.
• Fabric price group 3	+\$ 46	Specify fabric color number.
• Fabric price group 4	+\$ 64	Specify fabric color number.
• Fabric price group 5	+\$ 80	Specify fabric color number.
• Fabric price group 6	+\$ 99	Specify fabric color number.
• Fabric price group 7	+\$113	Specify fabric color number.
• Fabric price group 8	+\$145	Specify fabric color number.
• Fabric price group 9	+\$178	Specify fabric color number.
• Fabric price group 10	+\$201	Specify fabric color number.
• Elmosoft leather upholstery	+\$424	Specify Elmosoft leather color number.
• Steelcase vinyl	+\$ 30	Specify vinyl color number.
• Customer's Own Material (COM)	No cost	► See <i>Surface Materials Reference Manual</i> .
• Customer's Own Leather (COL)	+\$ 82	Specify leather color number.
Contrasting sides finish, if contrasting side selected		
• Fabric price group 1	No cost	Specify fabric color number.
• Fabric price group 2	+\$ 26	Specify fabric color number.
• Fabric price group 3	+\$ 48	Specify fabric color number.
• Fabric price group 4	+\$ 68	Specify fabric color number.
• Fabric price group 5	+\$ 85	Specify fabric color number.
• Fabric price group 6	+\$105	Specify fabric color number.
• Fabric price group 7	+\$122	Specify fabric color number.
• Fabric price group 8	+\$153	Specify fabric color number.
• Fabric price group 9	+\$188	Specify fabric color number.
• Fabric price group 10	+\$214	Specify fabric color number.
• Elmosoft leather upholstery	+\$451	Specify Elmosoft leather color number.
• Steelcase vinyl	+\$ 26	Specify vinyl color number.
• Customer's Own Material (COM)	No cost	► See <i>Surface Materials Reference Manual</i> .
• Customer's Own Leather (COL)	+\$ 77	Specify leather color number.
Power Configuration		
Power type		
• No power	No cost	Specify <i>with no power</i> .
• Power block	+\$347	Specify <i>with power block</i> .
• Two power blocks	+\$694	Specify <i>with two power blocks</i> .
Outlet configuration		
• Three power	No cost	Specify <i>with 3 power</i> .
• Two power, one USB	+\$123	Specify <i>with 2 power, 1 USB</i> .
Power plug type		
• Standard NEMA 5–15 3 prong	No cost	Specify <i>with NEMA</i> .
• Low profile plug	+\$ 28	Specify <i>with low profile plug</i> .
Tamper resistant		
• No tamper resistant	No cost	Specify <i>with no tamper resistant</i> .
• Tamper resistant	+\$ 21	Specify <i>with tamper resistant</i> .

Tip: Power is provided by a 72" power cord.

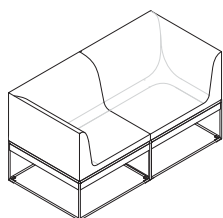

Specification Information				
• Dimensions			• Style	• U.S.
D	W	H	Number	Base Price
30"	60"	31"	STLLNG2AR2	\$4119

Umami

Umami Lounge

Corner, Single

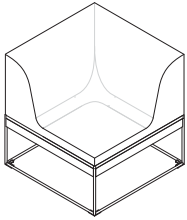

Tip: Only a single material scheme can be selected. For example, both contrasting fascia and contrasting front cannot be selected together. If more than one material scheme is desired, contact a specials representative.

Standard Includes	Required to Specify
<ul style="list-style-type: none"> ▶ Need help? Product details, page 372 • Seat upholstery: fabric price group 1 • Fascia: monolithic, matches top • Frame: paint price group 1 • Ships fully assembled • Attachment package 	<ol style="list-style-type: none"> 1 Style number 2 Fabric color number for seat 3 Paint color number for frame 4 Material scheme (see below under Required Selections) 5 Options, if selected (see below) <p>▶ See <i>Surface Materials</i>, page 504.</p>

Required Selections	U.S. Price	Required to Specify
Material Scheme <ul style="list-style-type: none"> • Monolithic • Contrasting fascia • Contrasting front left • Contrasting front right • Contrasting back left • Contrasting back right • Contrasting front left and right • Contrasting back left and right 	<ul style="list-style-type: none"> No cost No cost No cost No cost No cost No cost No cost No cost 	<ul style="list-style-type: none"> Specify <i>with monolithic</i>. Specify <i>with contrasting fascia</i>. Specify <i>with contrasting front left</i>. Specify <i>with contrasting front right</i>. Specify <i>with contrasting back left</i>. Specify <i>with contrasting back right</i>. Specify <i>with contrasting front left and right</i>. Specify <i>with contrasting back left and right</i>.

Options	U.S. Price	Required to Specify
Surface Materials <p>Seat finish</p> <ul style="list-style-type: none"> • Fabric price group 1 • Fabric price group 2 • Fabric price group 3 • Fabric price group 4 • Fabric price group 5 • Fabric price group 6 • Fabric price group 7 • Fabric price group 8 • Fabric price group 9 • Fabric price group 10 • Elmosoft leather upholstery • Steelcase vinyl • Customer's Own Material (COM) • Customer's Own Leather (COL) <p>Frame finish</p> <ul style="list-style-type: none"> • Paint price group 1 • Paint price group 2 • Paint price group 3 • Lux Coatings 	<ul style="list-style-type: none"> No cost +\$ 55 +\$101 +\$142 +\$179 +\$219 +\$253 +\$320 +\$394 +\$448 +\$856 +\$ 55 No cost +\$103 No cost +\$ 52 +\$110 +\$206 	<ul style="list-style-type: none"> Specify fabric color number. Specify fabric color number. Specify fabric color number. Specify fabric color number. Specify fabric color number. Specify fabric color number. Specify fabric color number. Specify fabric color number. Specify fabric color number. Specify fabric color number. Specify Elmosoft leather color number. Specify vinyl color number. ▶ See <i>Surface Materials Reference Manual</i>. Specify leather color number. Specify paint color number. Specify paint color number. Specify paint color number. Specify Lux Coatings color number.

▶ Options, continued on next page



For Canadian Pricing

Multiply U.S. Price by the Canadian price factor.

▶ See page 1 for details.

► Options, continued from previous page

Options	U.S. Price	Required to Specify
Contrasting Material Scheme		
Contrasting fascia finish, if contrasting fascia selected		
• Fabric price group 1	No cost	Specify fabric color number.
• Fabric price group 2	+\$ 20	Specify fabric color number.
• Fabric price group 3	+\$ 29	Specify fabric color number.
• Fabric price group 4	+\$ 40	Specify fabric color number.
• Fabric price group 5	+\$ 50	Specify fabric color number.
• Fabric price group 6	+\$ 62	Specify fabric color number.
• Fabric price group 7	+\$ 71	Specify fabric color number.
• Fabric price group 8	+\$ 91	Specify fabric color number.
• Fabric price group 9	+\$111	Specify fabric color number.
• Fabric price group 10	+\$126	Specify fabric color number.
• Elmosoft leather upholstery	+\$266	Specify Elmosoft leather color number.
• Steelcase vinyl	+\$ 19	Specify vinyl color number.
• Customer's Own Material (COM)	No cost	► See <i>Surface Materials Reference Manual</i> .
• Customer's Own Leather (COL)	+\$ 52	Specify leather color number.
Contrasting sides finish, if contrasting side selected		
• Fabric price group 1	No cost	Specify fabric color number.
• Fabric price group 2	+\$ 20	Specify fabric color number.
• Fabric price group 3	+\$ 29	Specify fabric color number.
• Fabric price group 4	+\$ 40	Specify fabric color number.
• Fabric price group 5	+\$ 50	Specify fabric color number.
• Fabric price group 6	+\$ 62	Specify fabric color number.
• Fabric price group 7	+\$ 71	Specify fabric color number.
• Fabric price group 8	+\$ 91	Specify fabric color number.
• Fabric price group 9	+\$111	Specify fabric color number.
• Fabric price group 10	+\$126	Specify fabric color number.
• Elmosoft leather upholstery	+\$266	Specify Elmosoft leather color number.
• Steelcase vinyl	+\$ 19	Specify vinyl color number.
• Customer's Own Material (COM)	No cost	► See <i>Surface Materials Reference Manual</i> .
• Customer's Own Leather (COL)	+\$ 52	Specify leather color number.
Power Configuration		
Power type		
• No power	No cost	Specify <i>with no power</i> .
• Power block	+\$347	Specify <i>with power block</i> .
Outlet configuration		
• Three power	No cost	Specify <i>with 3 power</i> .
• Two power, one USB	+\$123	Specify <i>with 2 power, 1 USB</i> .
Power plug type		
• Standard NEMA 5–15 3 prong	No cost	Specify <i>with NEMA</i> .
• Low profile plug	+\$ 28	Specify <i>with low profile plug</i> .
Tamper resistant		
• No tamper resistant	No cost	Specify <i>with no tamper resistant</i> .
• Tamper resistant	+\$ 21	Specify <i>with tamper resistant</i> .

Tip: Power is provided by a 72" power cord.

Specification Information

• Dimensions			• Style	• U.S.
D	W	H	Number	Base Price
30"	30"	31"	STLLNGCR1	\$2616

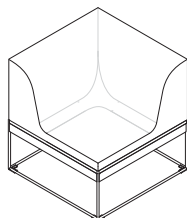

Umami

Umami Lounge

End Cap

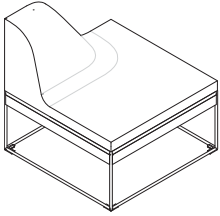

Tip: The end cap position is determined based on the end of a lounge run that you are ganging the end cap to. For example, if attaching to the right end of a lounge run, it would be a right position end cap.

Tip: Only a single material scheme can be selected. For example, both contrasting fascia and contrasting front cannot be selected together. If more than one material scheme is desired, contact a specials representative.

Standard Includes	Required to Specify
<ul style="list-style-type: none"> ▶ Need help? Product details, page 372 • Seat upholstery: fabric price group 1 • Fascia: monolithic, matches top • Frame: paint price group 1 • Ships fully assembled • Attachment package 	<ol style="list-style-type: none"> 1 Style number 2 Fabric color number for seat 3 Paint color number for frame 4 Material scheme (see below under Required Selections) 5 Arm position (see below under Required Selections) 6 Options, if selected (see below) <p>▶ See <i>Surface Materials</i>, page 504.</p>

Required Selections	U.S. Price	Required to Specify
Material Scheme <ul style="list-style-type: none"> • Monolithic • Contrasting fascia • Contrasting front • Contrasting back • Contrasting left • Contrasting right • Contrasting front and back • Contrasting left and right 	<ul style="list-style-type: none"> No cost No cost No cost No cost No cost No cost No cost No cost 	<ul style="list-style-type: none"> Specify with <i>monolithic</i>. Specify with <i>contrasting fascia</i>. Specify with <i>contrasting front</i>. Specify with <i>contrasting back</i>. Specify with <i>contrasting left</i>. Specify with <i>contrasting right</i>. Specify with <i>contrasting front and back</i>. Specify with <i>contrasting left and right</i>.
Arm Position <ul style="list-style-type: none"> • Left arm • Right arm 	<ul style="list-style-type: none"> No cost No cost 	<ul style="list-style-type: none"> Specify with <i>left arm</i>. Specify with <i>right arm</i>.

Options	U.S. Price	Required to Specify
Surface Materials <p>Seat finish</p> <ul style="list-style-type: none"> • Fabric price group 1 • Fabric price group 2 • Fabric price group 3 • Fabric price group 4 • Fabric price group 5 • Fabric price group 6 • Fabric price group 7 • Fabric price group 8 • Fabric price group 9 • Fabric price group 10 • Elmosoft leather upholstery • Steelcase vinyl • Customer's Own Material (COM) • Customer's Own Leather (COL) <p>Frame finish</p> <ul style="list-style-type: none"> • Paint price group 1 • Paint price group 2 • Paint price group 3 • Lux Coatings 	<ul style="list-style-type: none"> No cost +\$ 55 +\$101 +\$142 +\$179 +\$219 +\$253 +\$320 +\$394 +\$448 +\$856 +\$ 55 No cost +\$103 No cost +\$ 52 +\$110 +\$206 	<ul style="list-style-type: none"> Specify fabric color number. Specify fabric color number. Specify fabric color number. Specify fabric color number. Specify fabric color number. Specify fabric color number. Specify fabric color number. Specify fabric color number. Specify fabric color number. Specify fabric color number. Specify Elmosoft leather color number. Specify vinyl color number. ▶ See <i>Surface Materials Reference Manual</i>. Specify leather color number. Specify paint color number. Specify paint color number. Specify paint color number. Specify Lux Coatings color number.

Contrasting Material Scheme	Contrasting fascia finish, if contrasting fascia selected	Required to Specify
<ul style="list-style-type: none"> • Fabric price group 1 • Fabric price group 2 • Fabric price group 3 • Fabric price group 4 • Fabric price group 5 • Fabric price group 6 • Fabric price group 7 • Fabric price group 8 • Fabric price group 9 • Fabric price group 10 • Elmosoft leather upholstery • Steelcase vinyl • Customer's Own Material (COM) • Customer's Own Leather (COL) 	<ul style="list-style-type: none"> No cost +\$ 20 +\$ 29 +\$ 40 +\$ 50 +\$ 62 +\$ 71 +\$ 91 +\$111 +\$126 +\$266 +\$ 19 No cost +\$ 52 	<ul style="list-style-type: none"> Specify fabric color number. Specify fabric color number. Specify fabric color number. Specify fabric color number. Specify fabric color number. Specify fabric color number. Specify fabric color number. Specify fabric color number. Specify fabric color number. Specify fabric color number. Specify Elmosoft leather color number. Specify vinyl color number. ▶ See <i>Surface Materials Reference Manual</i>. Specify leather color number.

▶ Options, continued on next page

For Canadian Pricing
 Multiply U.S. Price by the Canadian price factor.
 ▶ See page 1 for details.

► Options, continued from previous page

Options	U.S. Price	Required to Specify
Contrasting Material Scheme, continued		
Contrasting sides finish, if contrasting side selected		
• Fabric price group 1	No cost	Specify fabric color number.
• Fabric price group 2	+\$ 20	Specify fabric color number.
• Fabric price group 3	+\$ 29	Specify fabric color number.
• Fabric price group 4	+\$ 40	Specify fabric color number.
• Fabric price group 5	+\$ 50	Specify fabric color number.
• Fabric price group 6	+\$ 62	Specify fabric color number.
• Fabric price group 7	+\$ 71	Specify fabric color number.
• Fabric price group 8	+\$ 91	Specify fabric color number.
• Fabric price group 9	+\$111	Specify fabric color number.
• Fabric price group 10	+\$126	Specify fabric color number.
• Elmosoft leather upholstery	+\$266	Specify Elmosoft leather color number.
• Steelcase vinyl	+\$ 19	Specify vinyl color number.
• Customer's Own Material (COM)	No cost	► See <i>Surface Materials Reference Manual</i> .
• Customer's Own Leather (COL)	+\$ 52	Specify leather color number.
Tables		
Table type		
• No table	No cost	Specify <i>with no table</i> .
• Round table	+\$368	Specify <i>with round table</i> and select color number.
• Pill table	+\$368	Specify <i>with pill table</i> and select color number.
Table location		
• Table left	No cost	Specify <i>with table left</i> .
• Table right	No cost	Specify <i>with table right</i> .
Table support finish		
• Paint price group 1	No cost	Specify paint color number.
• Paint price group 2	+\$ 15	Specify paint color number.
• Paint price group 3	+\$ 28	Specify paint color number.
• Lux Coatings	+\$ 41	Specify Lux Coatings color number.
Power Configuration		
Power type		
• No power	No cost	Specify <i>with no power</i> .
• Power block	+\$347	Specify <i>with power block</i> .
Outlet configuration		
• Three power	No cost	Specify <i>with 3 power</i> .
• Two power, one USB	+\$123	Specify <i>with 2 power, 1 USB</i> .
Power plug type		
• Standard NEMA 5–15 3 prong	No cost	Specify <i>with NEMA</i> .
• Low profile plug	+\$ 28	Specify <i>with low profile plug</i> .
Tamper resistant		
• No tamper resistant	No cost	Specify <i>with no tamper resistant</i> .
• Tamper resistant	+\$ 21	Specify <i>with tamper resistant</i> .

Tip: Power is provided by a 72" power cord.

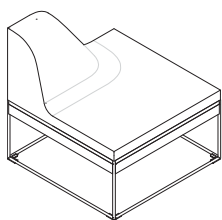

Specification Information				
Dimensions			Style	U.S.
D	W	H	Number	Base Price
30"	30"	31"	STLLNGEC	\$2616

Umami

Umami Screens

Standard Screens



Standard Includes	Required to Specify
<ul style="list-style-type: none"> ▶ Need help? Product details, page 380 • Screen: fabric price group 1 • Plastic clips for attachment to other screen (one clip for 48"H screens and two clips for 60"H screens) • Ships full assembled 	<ol style="list-style-type: none"> 1 Style number 2 Size of screen (see below under Required Selections) 3 Screen clips (see below under Required Selections) 4 Fascia (see below under Required Selections) 5 Fabric direction (see below under Required Selections) 6 Fabric color number for screen 7 Options, if selected (see below) <p>▶ See <i>Surface Materials</i>, page 504.</p>

Tip: Specify straight clip if end of run and no additional clips required.

Tip: Fascia must be specified when 15"W screen is being placed on a 30" platform/lounge frame.

Tip: If user is seated on the lounge, the side that the 15"W screen will be applied on is the handedness of the fascia. If fascia needs to be applied to the left side of the lounge, then specify fascia left.

▶ See screen application rules for additional details, page 380.

	Required Selections	U.S. Price	Required to Specify
Size of Screen	<ul style="list-style-type: none"> • 15"W x 48"H • 30"W x 48"H • 15"W x 60"H • 30"W x 60"H 	<p>Prices at right</p> <p>Prices at right</p> <p>Prices at right</p> <p>Prices at right</p>	<p>Specify <i>with 15"W x 48"H</i>.</p> <p>Specify <i>with 30"W x 48"H</i>.</p> <p>Specify <i>with 15"W x 60"H</i>.</p> <p>Specify <i>with 30"W x 60"H</i>.</p>
Screen Clips	<ul style="list-style-type: none"> • Straight • Corner 	<p>No cost</p> <p>No cost</p>	<p>Specify <i>with straight clip</i>.</p> <p>Specify <i>with corner clip</i>.</p>
Fascia (if 15"W screen selected)	<ul style="list-style-type: none"> • No fascia • Fascia left • Fascia right 	<p>No cost</p> <p>+\$ 63</p> <p>+\$ 63</p>	<p>Specify <i>with no fascia</i>.</p> <p>Specify <i>with fascia left</i> and select fabric color number for fascia.</p> <p>Specify <i>with fascia right</i> and select fabric color number for fascia.</p>
Fabric Direction	<ul style="list-style-type: none"> • Horizontal • Vertical 	<p>No cost</p> <p>No cost</p>	<p>Specify <i>with horizontal direction</i>.</p> <p>Specify <i>with vertical direction</i>.</p>

	Options	U.S. Price	Required to Specify
Surface Materials 15"W x 48"H	<p>Non-contrasting</p> <ul style="list-style-type: none"> • Fabric price group 1 • Fabric price group 2 • Fabric price group 3 • Fabric price group 4 • Fabric price group 5 • Fabric price group 6 • Fabric price group 7 • Fabric price group 8 • Fabric price group 9 • Fabric price group 10 • Customer's Own Material (COM) 	<p>No cost</p> <p>+\$ 24</p> <p>+\$ 46</p> <p>+\$ 66</p> <p>+\$ 78</p> <p>+\$ 92</p> <p>+\$110</p> <p>+\$140</p> <p>+\$170</p> <p>+\$192</p> <p>No cost</p>	<p>Specify fabric color number.</p> <p>Specify fabric color number.</p> <p>Specify fabric color number.</p> <p>Specify fabric color number.</p> <p>Specify fabric color number.</p> <p>Specify fabric color number.</p> <p>Specify fabric color number.</p> <p>Specify fabric color number.</p> <p>Specify fabric color number.</p> <p>Specify fabric color number.</p> <p>Specify fabric color number.</p> <p>▶ See <i>Surface Materials Reference Manual</i>.</p>

▶ Options, continued on next page



For Canadian Pricing

Multiply U.S. Price by the Canadian price factor.

▶ See page 1 for details.

► Options, continued from previous page

Tip: Fabrics must be in the same fabric family when specifying contrasting fabrics.

Options	U.S. Price	Required to Specify
Surface Materials 15"W x 48"H, continued		
Contrasting fabrics Inside of screen		
• Fabric price group 1	No cost	Specify <i>with contrasting</i> and select fabric color number for inside of screen.
• Fabric price group 2	+\$12	Specify <i>with contrasting</i> and select fabric color number for inside of screen.
• Fabric price group 3	+\$23	Specify <i>with contrasting</i> and select fabric color number for inside of screen.
• Fabric price group 4	+\$33	Specify <i>with contrasting</i> and select fabric color number for inside of screen.
• Fabric price group 5	+\$39	Specify <i>with contrasting</i> and select fabric color number for inside of screen.
• Fabric price group 6	+\$46	Specify <i>with contrasting</i> and select fabric color number for inside of screen.
• Fabric price group 7	+\$55	Specify <i>with contrasting</i> and select fabric color number for inside of screen.
• Fabric price group 8	+\$70	Specify <i>with contrasting</i> and select fabric color number for inside of screen.
• Fabric price group 9	+\$85	Specify <i>with contrasting</i> and select fabric color number for inside of screen.
• Fabric price group 10	+\$96	Specify <i>with contrasting</i> and select fabric color number for inside of screen.
• Customer's Own Material (COM)	No cost	► See <i>Surface Materials Reference Manual</i> .
Outside of screen		
• Fabric price group 1	No cost	Specify <i>with contrasting</i> and select fabric color number for outside of screen.
• Fabric price group 2	+\$12	Specify <i>with contrasting</i> and select fabric color number for outside of screen.
• Fabric price group 3	+\$23	Specify <i>with contrasting</i> and select fabric color number for outside of screen.
• Fabric price group 4	+\$33	Specify <i>with contrasting</i> and select fabric color number for outside of screen.
• Fabric price group 5	+\$39	Specify <i>with contrasting</i> and select fabric color number for outside of screen.
• Fabric price group 6	+\$46	Specify <i>with contrasting</i> and select fabric color number for outside of screen.
• Fabric price group 7	+\$55	Specify <i>with contrasting</i> and select fabric color number for outside of screen.
• Fabric price group 8	+\$70	Specify <i>with contrasting</i> and select fabric color number for outside of screen.
• Fabric price group 9	+\$85	Specify <i>with contrasting</i> and select fabric color number for outside of screen.
• Fabric price group 10	+\$96	Specify <i>with contrasting</i> and select fabric color number for outside of screen.
• Customer's Own Material (COM)	No cost	► See <i>Surface Materials Reference Manual</i> .

► Options, continued on next page

**For Canadian Pricing**

Multiply U.S. Price by the Canadian price factor.

► See page 1 for details.

Umami Screens, Standard Screens, continued

► Options, continued from previous page

	Options	U.S. Price	Required to Specify
Surface Materials, 30"W x 48"H	Non-contrasting		
	• Fabric price group 1	No cost	Specify fabric color number.
	• Fabric price group 2	+\$ 48	Specify fabric color number.
	• Fabric price group 3	+\$ 86	Specify fabric color number.
	• Fabric price group 4	+\$126	Specify fabric color number.
	• Fabric price group 5	+\$146	Specify fabric color number.
	• Fabric price group 6	+\$178	Specify fabric color number.
	• Fabric price group 7	+\$206	Specify fabric color number.
	• Fabric price group 8	+\$264	Specify fabric color number.
	• Fabric price group 9	+\$324	Specify fabric color number.
	• Fabric price group 10	+\$362	Specify fabric color number.
	• Customer's Own Material (COM)	No cost	► See <i>Surface Materials Reference Manual</i> .
	Contrasting fabrics		
	Inside of screen		
	• Fabric price group 1	No cost	Specify <i>with contrasting</i> and select fabric color number for inside of screen.
	• Fabric price group 2	+\$ 24	Specify <i>with contrasting</i> and select fabric color number for inside of screen.
	• Fabric price group 3	+\$ 43	Specify <i>with contrasting</i> and select fabric color number for inside of screen.
	• Fabric price group 4	+\$ 63	Specify <i>with contrasting</i> and select fabric color number for inside of screen.
	• Fabric price group 5	+\$ 73	Specify <i>with contrasting</i> and select fabric color number for inside of screen.
	• Fabric price group 6	+\$ 89	Specify <i>with contrasting</i> and select fabric color number for inside of screen.
	• Fabric price group 7	+\$103	Specify <i>with contrasting</i> and select fabric color number for inside of screen.
	• Fabric price group 8	+\$132	Specify <i>with contrasting</i> and select fabric color number for inside of screen.
	• Fabric price group 9	+\$162	Specify <i>with contrasting</i> and select fabric color number for inside of screen.
	• Fabric price group 10	+\$181	Specify <i>with contrasting</i> and select fabric color number for inside of screen.
	• Customer's Own Material (COM)	No cost	► See <i>Surface Materials Reference Manual</i> .
	Outside of screen		
	• Fabric price group 1	No cost	Specify <i>with contrasting</i> and select fabric color number for outside of screen.
	• Fabric price group 2	+\$ 24	Specify <i>with contrasting</i> and select fabric color number for outside of screen.
	• Fabric price group 3	+\$ 43	Specify <i>with contrasting</i> and select fabric color number for outside of screen.
	• Fabric price group 4	+\$ 63	Specify <i>with contrasting</i> and select fabric color number for outside of screen.
	• Fabric price group 5	+\$ 73	Specify <i>with contrasting</i> and select fabric color number for outside of screen.
	• Fabric price group 6	+\$ 89	Specify <i>with contrasting</i> and select fabric color number for outside of screen.
	• Fabric price group 7	+\$103	Specify <i>with contrasting</i> and select fabric color number for outside of screen.
	• Fabric price group 8	+\$132	Specify <i>with contrasting</i> and select fabric color number for outside of screen.
	• Fabric price group 9	+\$162	Specify <i>with contrasting</i> and select fabric color number for outside of screen.
	• Fabric price group 10	+\$181	Specify <i>with contrasting</i> and select fabric color number for outside of screen.
	• Customer's Own Material (COM)	No cost	► See <i>Surface Materials Reference Manual</i> .

Tip: Fabrics must be in the same fabric family when specifying contrasting fabrics.

► Options, continued on next page

**For Canadian Pricing**

Multiply U.S. Price by the Canadian price factor.

► See page 1 for details.

► Options, continued from previous page

Options	U.S. Price	Required to Specify
Surface Materials, 15"W x 60"H		
Non-contrasting		
• Fabric price group 1	No cost	Specify fabric color number.
• Fabric price group 2	+\$ 28	Specify fabric color number.
• Fabric price group 3	+\$ 52	Specify fabric color number.
• Fabric price group 4	+\$ 76	Specify fabric color number.
• Fabric price group 5	+\$ 88	Specify fabric color number.
• Fabric price group 6	+\$108	Specify fabric color number.
• Fabric price group 7	+\$124	Specify fabric color number.
• Fabric price group 8	+\$160	Specify fabric color number.
• Fabric price group 9	+\$196	Specify fabric color number.
• Fabric price group 10	+\$218	Specify fabric color number.
• Customer's Own Material (COM)	No cost	► See <i>Surface Materials Reference Manual</i> .
Contrasting fabrics		
Inside of screen		
• Fabric price group 1	No cost	Specify <i>with contrasting</i> and select fabric color number for inside of screen.
• Fabric price group 2	+\$ 14	Specify <i>with contrasting</i> and select fabric color number for inside of screen.
• Fabric price group 3	+\$ 26	Specify <i>with contrasting</i> and select fabric color number for inside of screen.
• Fabric price group 4	+\$ 38	Specify <i>with contrasting</i> and select fabric color number for inside of screen.
• Fabric price group 5	+\$ 44	Specify <i>with contrasting</i> and select fabric color number for inside of screen.
• Fabric price group 6	+\$ 54	Specify <i>with contrasting</i> and select fabric color number for inside of screen.
• Fabric price group 7	+\$ 62	Specify <i>with contrasting</i> and select fabric color number for inside of screen.
• Fabric price group 8	+\$ 80	Specify <i>with contrasting</i> and select fabric color number for inside of screen.
• Fabric price group 9	+\$ 98	Specify <i>with contrasting</i> and select fabric color number for inside of screen.
• Fabric price group 10	+\$109	Specify <i>with contrasting</i> and select fabric color number for inside of screen.
• Customer's Own Material (COM)	No cost	► See <i>Surface Materials Reference Manual</i> .
Outside of screen		
• Fabric price group 1	No cost	Specify <i>with contrasting</i> and select fabric color number for outside of screen.
• Fabric price group 2	+\$ 14	Specify <i>with contrasting</i> and select fabric color number for outside of screen.
• Fabric price group 3	+\$ 26	Specify <i>with contrasting</i> and select fabric color number for outside of screen.
• Fabric price group 4	+\$ 38	Specify <i>with contrasting</i> and select fabric color number for outside of screen.
• Fabric price group 5	+\$ 44	Specify <i>with contrasting</i> and select fabric color number for outside of screen.
• Fabric price group 6	+\$ 54	Specify <i>with contrasting</i> and select fabric color number for outside of screen.
• Fabric price group 7	+\$ 62	Specify <i>with contrasting</i> and select fabric color number for outside of screen.
• Fabric price group 8	+\$ 80	Specify <i>with contrasting</i> and select fabric color number for outside of screen.
• Fabric price group 9	+\$ 98	Specify <i>with contrasting</i> and select fabric color number for outside of screen.
• Fabric price group 10	+\$109	Specify <i>with contrasting</i> and select fabric color number for outside of screen.
• Customer's Own Material (COM)	No cost	► See <i>Surface Materials Reference Manual</i> .

Tip: Fabrics must be in the same fabric family when specifying contrasting fabrics.

► Options, continued on next page

**For Canadian Pricing**

Multiply U.S. Price by the Canadian price factor.

► See page 1 for details.

Umami Screens, Standard Screens, continued

► Options, continued from previous page

	Options	U.S. Price	Required to Specify
Surface Materials, 30"W x 60"H	Non-contrasting		
	• Fabric price group 1	No cost	Specify fabric color number.
	• Fabric price group 2	+\$ 54	Specify fabric color number.
	• Fabric price group 3	+\$ 98	Specify fabric color number.
	• Fabric price group 4	+\$144	Specify fabric color number.
	• Fabric price group 5	+\$168	Specify fabric color number.
	• Fabric price group 6	+\$202	Specify fabric color number.
	• Fabric price group 7	+\$236	Specify fabric color number.
	• Fabric price group 8	+\$302	Specify fabric color number.
	• Fabric price group 9	+\$370	Specify fabric color number.
	• Fabric price group 10	+\$416	Specify fabric color number.
	• Customer's Own Material (COM)	No cost	► See <i>Surface Materials Reference Manual</i> .
		Contrasting fabrics	
	Inside of screen		
	• Fabric price group 1	No cost	Specify <i>with contrasting</i> and select fabric color number for inside of screen.
	• Fabric price group 2	+\$ 27	Specify <i>with contrasting</i> and select fabric color number for inside of screen.
	• Fabric price group 3	+\$ 49	Specify <i>with contrasting</i> and select fabric color number for inside of screen.
	• Fabric price group 4	+\$ 72	Specify <i>with contrasting</i> and select fabric color number for inside of screen.
	• Fabric price group 5	+\$ 84	Specify <i>with contrasting</i> and select fabric color number for inside of screen.
	• Fabric price group 6	+\$101	Specify <i>with contrasting</i> and select fabric color number for inside of screen.
	• Fabric price group 7	+\$118	Specify <i>with contrasting</i> and select fabric color number for inside of screen.
	• Fabric price group 8	+\$151	Specify <i>with contrasting</i> and select fabric color number for inside of screen.
	• Fabric price group 9	+\$185	Specify <i>with contrasting</i> and select fabric color number for inside of screen.
	• Fabric price group 10	+\$208	Specify <i>with contrasting</i> and select fabric color number for inside of screen.
	• Customer's Own Material (COM)	No cost	► See <i>Surface Materials Reference Manual</i> .
	Outside of screen		
	• Fabric price group 1	No cost	Specify <i>with contrasting</i> and select fabric color number for outside of screen.
	• Fabric price group 2	+\$ 27	Specify <i>with contrasting</i> and select fabric color number for outside of screen.
	• Fabric price group 3	+\$ 49	Specify <i>with contrasting</i> and select fabric color number for outside of screen.
	• Fabric price group 4	+\$ 72	Specify <i>with contrasting</i> and select fabric color number for outside of screen.
	• Fabric price group 5	+\$ 84	Specify <i>with contrasting</i> and select fabric color number for outside of screen.
	• Fabric price group 6	+\$101	Specify <i>with contrasting</i> and select fabric color number for outside of screen.
	• Fabric price group 7	+\$118	Specify <i>with contrasting</i> and select fabric color number for outside of screen.
	• Fabric price group 8	+\$151	Specify <i>with contrasting</i> and select fabric color number for outside of screen.
	• Fabric price group 9	+\$185	Specify <i>with contrasting</i> and select fabric color number for outside of screen.
	• Fabric price group 10	+\$208	Specify <i>with contrasting</i> and select fabric color number for outside of screen.
	• Customer's Own Material (COM)	No cost	► See <i>Surface Materials Reference Manual</i> .

Tip: Fabrics must be in the same fabric family when specifying contrasting fabrics.

**For Canadian Pricing**

Multiply U.S. Price by the Canadian price factor.

► See page 1 for details.

Specification Information

• Dimensions • Depth	• Style • Number	U.S. Base Prices			
		• 15"W x 48"H	• 30"W x 48"H	• 15"W x 60"H	• 30"W x 60"H
5/8"	STLSCRPL	\$391	\$459	\$547	\$643
.



 **For Canadian Pricing**
 Multiply U.S. Price by the
 Canadian price factor.
 ▶ See page 1 for details.

Umami Screens

Spanner Screens

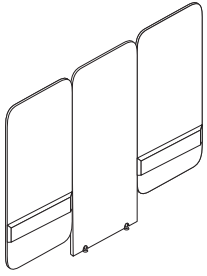

Tip: Spanner screens are not allowed to be attached to a platform or end cap lounge.

Tip: Specify straight clip if end of run and no additional clips required.

Tip: Fabrics will only be applied vertically on spanner screens.

Tip: If you want other screens to match spanner screens, make sure to specify vertical application on standard screens.

► See screen application rules for additional details, page 380.

Tip: Fabrics must be in the same fabric family when specifying contrasting fabrics.

Standard Includes	Required to Specify
<ul style="list-style-type: none"> ► Need help? Product details, page 380 • Three 30"W screens, if 90"W selected: fabric price group 1 • Two 30"W screens and one 45"W center screen, if 105"W selected: fabric price group 1 • Plastic clips for attachment to other screen (one clip for 48"H screens and two clips for 60"H screens) • Ships full assembled 	<ol style="list-style-type: none"> 1 Style number 2 Size of screen (see below under Required Selections) 3 Screen clips (see below under Required Selections) 4 Fabric direction (see below under Required Selections) 5 Fabric color number for screen 6 Options, if selected (see below) <p>► See <i>Surface Materials</i>, page 504.</p>

Required Selections	U.S. Price	Required to Specify
Size of Screen <ul style="list-style-type: none"> • 90"W x 48"H • 105"W x 48"H • 90"W x 60"H • 105"W x 60"H 	<ul style="list-style-type: none"> Prices at right Prices at right Prices at right Prices at right 	<ul style="list-style-type: none"> Specify with 90"W x 48"H. Specify with 105"W x 48"H. Specify with 90"W x 60"H. Specify with 105"W x 60"H

Screen Clips <ul style="list-style-type: none"> • Straight • Corner 	<ul style="list-style-type: none"> No cost No cost 	<ul style="list-style-type: none"> Specify with straight clip. Specify with corner clip.
--	--	--

Options	U.S. Price	Required to Specify
Surface Materials 90"W x 48"H <ul style="list-style-type: none"> • Non-contrasting • Fabric price group 1 • Fabric price group 2 • Fabric price group 3 • Fabric price group 4 • Fabric price group 5 • Fabric price group 6 • Fabric price group 7 • Fabric price group 8 • Fabric price group 9 • Fabric price group 10 • Customer's Own Material (COM) 	<ul style="list-style-type: none"> No cost +\$ 74 +\$136 +\$198 +\$234 +\$278 +\$328 +\$420 +\$512 +\$574 No cost 	<ul style="list-style-type: none"> Specify fabric color number. Specify fabric color number. Specify fabric color number. Specify fabric color number. Specify fabric color number. Specify fabric color number. Specify fabric color number. Specify fabric color number. Specify fabric color number. Specify fabric color number. Specify fabric color number. <p>► See <i>Surface Materials Reference Manual</i>.</p>

<ul style="list-style-type: none"> • Contrasting fabrics Inside of screen • Fabric price group 1 • Fabric price group 2 • Fabric price group 3 • Fabric price group 4 • Fabric price group 5 • Fabric price group 6 • Fabric price group 7 • Fabric price group 8 • Fabric price group 9 • Fabric price group 10 • Customer's Own Material (COM) 	<ul style="list-style-type: none"> No cost +\$ 37 +\$ 68 +\$ 99 +\$117 +\$139 +\$164 +\$210 +\$256 +\$287 No cost 	<ul style="list-style-type: none"> Specify with contrasting and select fabric color number for inside of screen. Specify with contrasting and select fabric color number for inside of screen. Specify with contrasting and select fabric color number for inside of screen. Specify with contrasting and select fabric color number for inside of screen. Specify with contrasting and select fabric color number for inside of screen. Specify with contrasting and select fabric color number for inside of screen. Specify with contrasting and select fabric color number for inside of screen. Specify with contrasting and select fabric color number for inside of screen. Specify with contrasting and select fabric color number for inside of screen. Specify with contrasting and select fabric color number for inside of screen. Specify with contrasting and select fabric color number for inside of screen. <p>► See <i>Surface Materials Reference Manual</i>.</p>
---	--	---

► Options, continued on next page



For Canadian Pricing
 Multiply U.S. Price by the Canadian price factor.
 ► See page 1 for details.

► Options, continued from previous page

	Options	U.S. Price	Required to Specify
Surface Materials 90"W x 48"H, continued	Outside of screen		
	• Fabric price group 1	No cost	Specify <i>with contrasting</i> and select fabric color number for outside of screen.
	• Fabric price group 2	+\$ 37	Specify <i>with contrasting</i> and select fabric color number for outside of screen.
	• Fabric price group 3	+\$ 68	Specify <i>with contrasting</i> and select fabric color number for outside of screen.
	• Fabric price group 4	+\$ 99	Specify <i>with contrasting</i> and select fabric color number for outside of screen.
	• Fabric price group 5	+\$ 117	Specify <i>with contrasting</i> and select fabric color number for outside of screen.
	• Fabric price group 6	+\$ 139	Specify <i>with contrasting</i> and select fabric color number for outside of screen.
	• Fabric price group 7	+\$ 164	Specify <i>with contrasting</i> and select fabric color number for outside of screen.
	• Fabric price group 8	+\$ 210	Specify <i>with contrasting</i> and select fabric color number for outside of screen.
	• Fabric price group 9	+\$ 256	Specify <i>with contrasting</i> and select fabric color number for outside of screen.
	• Fabric price group 10	+\$ 287	Specify <i>with contrasting</i> and select fabric color number for outside of screen.
	• Customer's Own Material (COM)	No cost	► See <i>Surface Materials Reference Manual</i> .
105"W x 48"H	Non-contrasting		
	• Fabric price group 1	No cost	Specify fabric color number.
	• Fabric price group 2	+\$ 142	Specify fabric color number.
	• Fabric price group 3	+\$ 260	Specify fabric color number.
	• Fabric price group 4	+\$ 376	Specify fabric color number.
	• Fabric price group 5	+\$ 438	Specify fabric color number.
	• Fabric price group 6	+\$ 532	Specify fabric color number.
	• Fabric price group 7	+\$ 618	Specify fabric color number.
	• Fabric price group 8	+\$ 792	Specify fabric color number.
	• Fabric price group 9	+\$ 970	Specify fabric color number.
	• Fabric price group 10	+\$1088	Specify fabric color number.
	• Customer's Own Material (COM)	No cost	► See <i>Surface Materials Reference Manual</i> .
	Contrasting fabrics		
	Inside of screen		
	• Fabric price group 1	No cost	Specify <i>with contrasting</i> and select fabric color number for inside of screen.
	• Fabric price group 2	+\$ 71	Specify <i>with contrasting</i> and select fabric color number for inside of screen.
	• Fabric price group 3	+\$ 130	Specify <i>with contrasting</i> and select fabric color number for inside of screen.
	• Fabric price group 4	+\$ 188	Specify <i>with contrasting</i> and select fabric color number for inside of screen.
	• Fabric price group 5	+\$ 219	Specify <i>with contrasting</i> and select fabric color number for inside of screen.
	• Fabric price group 6	+\$ 266	Specify <i>with contrasting</i> and select fabric color number for inside of screen.
	• Fabric price group 7	+\$ 309	Specify <i>with contrasting</i> and select fabric color number for inside of screen.
	• Fabric price group 8	+\$ 396	Specify <i>with contrasting</i> and select fabric color number for inside of screen.
	• Fabric price group 9	+\$ 485	Specify <i>with contrasting</i> and select fabric color number for inside of screen.
	• Fabric price group 10	+\$ 544	Specify <i>with contrasting</i> and select fabric color number for inside of screen.
	• Customer's Own Material (COM)	No cost	► See <i>Surface Materials Reference Manual</i> .

Tip: Fabrics must be in the same fabric family when specifying contrasting fabrics.

► Options, continued on next page

**For Canadian Pricing**

Multiply U.S. Price by the Canadian price factor.

► See page 1 for details.

Umami Screens, Spanner Screens, continued

► Options, continued from previous page

	Options	U.S. Price	Required to Specify
Surface Materials, 105"W x 48"H continued	Outside of screen		
	• Fabric price group 1	No cost	Specify <i>with contrasting</i> and select fabric color number for outside of screen.
	• Fabric price group 2	+\$ 71	Specify <i>with contrasting</i> and select fabric color number for outside of screen.
	• Fabric price group 3	+\$130	Specify <i>with contrasting</i> and select fabric color number for outside of screen.
	• Fabric price group 4	+\$188	Specify <i>with contrasting</i> and select fabric color number for outside of screen.
	• Fabric price group 5	+\$219	Specify <i>with contrasting</i> and select fabric color number for outside of screen.
	• Fabric price group 6	+\$266	Specify <i>with contrasting</i> and select fabric color number for outside of screen.
	• Fabric price group 7	+\$309	Specify <i>with contrasting</i> and select fabric color number for outside of screen.
	• Fabric price group 8	+\$396	Specify <i>with contrasting</i> and select fabric color number for outside of screen.
	• Fabric price group 9	+\$485	Specify <i>with contrasting</i> and select fabric color number for outside of screen.
	• Fabric price group 10	+\$544	Specify <i>with contrasting</i> and select fabric color number for outside of screen.
	• Customer's Own Material (COM)	No cost	► See <i>Surface Materials Reference Manual</i> .
90"W x 60"H	Non-contrasting		
	• Fabric price group 1	No cost	Specify fabric color number.
	• Fabric price group 2	+\$ 86	Specify fabric color number.
	• Fabric price group 3	+\$154	Specify fabric color number.
	• Fabric price group 4	+\$228	Specify fabric color number.
	• Fabric price group 5	+\$266	Specify fabric color number.
	• Fabric price group 6	+\$322	Specify fabric color number.
	• Fabric price group 7	+\$370	Specify fabric color number.
	• Fabric price group 8	+\$482	Specify fabric color number.
	• Fabric price group 9	+\$588	Specify fabric color number.
	• Fabric price group 10	+\$656	Specify fabric color number.
	• Customer's Own Material (COM)	No cost	► See <i>Surface Materials Reference Manual</i> .
	Contrasting fabrics		
	Inside of screen		
	• Fabric price group 1	No cost	Specify <i>with contrasting</i> and select fabric color number for inside of screen.
	• Fabric price group 2	+\$ 43	Specify <i>with contrasting</i> and select fabric color number for inside of screen.
	• Fabric price group 3	+\$ 77	Specify <i>with contrasting</i> and select fabric color number for inside of screen.
	• Fabric price group 4	+\$114	Specify <i>with contrasting</i> and select fabric color number for inside of screen.
	• Fabric price group 5	+\$133	Specify <i>with contrasting</i> and select fabric color number for inside of screen.
	• Fabric price group 6	+\$161	Specify <i>with contrasting</i> and select fabric color number for inside of screen.
	• Fabric price group 7	+\$185	Specify <i>with contrasting</i> and select fabric color number for inside of screen.
	• Fabric price group 8	+\$241	Specify <i>with contrasting</i> and select fabric color number for inside of screen.
	• Fabric price group 9	+\$294	Specify <i>with contrasting</i> and select fabric color number for inside of screen.
	• Fabric price group 10	+\$328	Specify <i>with contrasting</i> and select fabric color number for inside of screen.
	• Customer's Own Material (COM)	No cost	► See <i>Surface Materials Reference Manual</i> .

Tip: Fabrics must be in the same fabric family when specifying contrasting fabrics.

► Options, continued on next page

**For Canadian Pricing**

Multiply U.S. Price by the Canadian price factor.

► See page 1 for details.

► Options, continued from previous page

	Options	U.S. Price	Required to Specify
Surface Materials, 90"W x 60"H continued	Outside of screen		
	• Fabric price group 1	No cost	Specify <i>with contrasting</i> and select fabric color number for outside of screen.
	• Fabric price group 2	+\$ 43	Specify <i>with contrasting</i> and select fabric color number for outside of screen.
	• Fabric price group 3	+\$ 77	Specify <i>with contrasting</i> and select fabric color number for outside of screen.
	• Fabric price group 4	+\$ 114	Specify <i>with contrasting</i> and select fabric color number for outside of screen.
	• Fabric price group 5	+\$ 133	Specify <i>with contrasting</i> and select fabric color number for outside of screen.
	• Fabric price group 6	+\$ 161	Specify <i>with contrasting</i> and select fabric color number for outside of screen.
	• Fabric price group 7	+\$ 185	Specify <i>with contrasting</i> and select fabric color number for outside of screen.
	• Fabric price group 8	+\$ 241	Specify <i>with contrasting</i> and select fabric color number for outside of screen.
	• Fabric price group 9	+\$ 294	Specify <i>with contrasting</i> and select fabric color number for outside of screen.
	• Fabric price group 10	+\$ 328	Specify <i>with contrasting</i> and select fabric color number for outside of screen.
	• Customer's Own Material (COM)	No cost	► See <i>Surface Materials Reference Manual</i> .
105"W x 60"H	Non-contrasting		
	• Fabric price group 1	No cost	Specify fabric color number.
	• Fabric price group 2	+\$ 160	Specify fabric color number.
	• Fabric price group 3	+\$ 296	Specify fabric color number.
	• Fabric price group 4	+\$ 432	Specify fabric color number.
	• Fabric price group 5	+\$ 506	Specify fabric color number.
	• Fabric price group 6	+\$ 606	Specify fabric color number.
	• Fabric price group 7	+\$ 710	Specify fabric color number.
	• Fabric price group 8	+\$ 908	Specify fabric color number.
	• Fabric price group 9	+\$1112	Specify fabric color number.
	• Fabric price group 10	+\$1248	Specify fabric color number.
	• Customer's Own Material (COM)	No cost	► See <i>Surface Materials Reference Manual</i> .
	Contrasting fabrics		
	Inside of screen		
	• Fabric price group 1	No cost	Specify <i>with contrasting</i> and select fabric color number for inside of screen.
	• Fabric price group 2	+\$ 80	Specify <i>with contrasting</i> and select fabric color number for inside of screen.
	• Fabric price group 3	+\$ 148	Specify <i>with contrasting</i> and select fabric color number for inside of screen.
	• Fabric price group 4	+\$ 216	Specify <i>with contrasting</i> and select fabric color number for inside of screen.
	• Fabric price group 5	+\$ 253	Specify <i>with contrasting</i> and select fabric color number for inside of screen.
	• Fabric price group 6	+\$ 303	Specify <i>with contrasting</i> and select fabric color number for inside of screen.
	• Fabric price group 7	+\$ 355	Specify <i>with contrasting</i> and select fabric color number for inside of screen.
	• Fabric price group 8	+\$ 454	Specify <i>with contrasting</i> and select fabric color number for inside of screen.
	• Fabric price group 9	+\$ 556	Specify <i>with contrasting</i> and select fabric color number for inside of screen.
	• Fabric price group 10	+\$ 624	Specify <i>with contrasting</i> and select fabric color number for inside of screen.
	• Customer's Own Material (COM)	No cost	► See <i>Surface Materials Reference Manual</i> .

Tip: Fabrics must be in the same fabric family when specifying contrasting fabrics.

► Options, continued on next page

**For Canadian Pricing**

Multiply U.S. Price by the Canadian price factor.

► See page 1 for details.



Lagunitas Work Tables

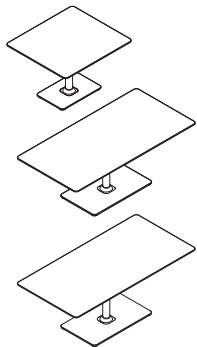

Tip: Wood veneer tables have matching wood veneer edges.

Standard Includes	Required to Specify
<ul style="list-style-type: none"> Table top: laminate price group 1 with 3 mm flat plastic edge Base: paint price group 1 or group 2 Ships ready to assemble 	<ol style="list-style-type: none"> Style number Size of screen (see below under Required Selections) Laminate color number for table top Plastic edge color number for laminate table Paint color number for base Options, if selected (see below) <p>▶ See <i>Surface Materials</i>, page 504.</p>

Required Selections	U.S. Price	Required to Specify
Size		
• 30"W x 24"D	Prices at right	Specify with 30"W x 24"D.
• 36"W x 24"D	Prices at right	Specify with 36"W x 24"D.
• 40"W x 36"D	Prices at right	Specify with 40"W x 36"D.
• 48"W x 36"D	Prices at right	Specify with 48"W x 36"D.
• 57"W x 36"D	Prices at right	Specify with 57"W x 36"D.
• 72"W x 36"D	Prices at right	Specify with 72"W x 36"D.

Options	U.S. Price	Required to Specify
Surface Materials		
Top		
• Laminate price group 1	Prices at right	Specify laminate color number.
• Laminate price group 2	Prices at right	Specify laminate color number.
• Veneer price group 1	Prices at right	Specify wood veneer finish number.
• Veneer price group 2	Prices at right	Specify wood veneer finish number.
• Customiz stain	No cost	Specify with <i>Customiz stain</i> .
		▶ See <i>Coalesse Surface Materials Reference Guide</i> .

Base		
• Paint price group 1	No cost	Specify paint color number.
• Paint price group 2	No cost	Specify paint color number.
• Paint price group 3	+\$ 77	Specify paint color number.
		▶ See <i>Coalesse Surface Materials Reference Guide</i> .

Power		
Power module (two receptacles)		
• One power module in silver finish (center only)	+\$273	Specify with <i>power module, with two power</i> .
USB power module (one USB port/one power receptable)		
• One USB power module in silver finish (center only)	+\$381	Specify with <i>USB power module, with one power/one USB</i> .
3" metal grommet		
• One metal grommet in anodized silver finish (center only)	+\$ 83	Specify with <i>3" metal grommet</i> .
Power Pod grommet		
• One Power Pod grommet in 6025 Milk or 6000 Black plastic finish (center only)	+\$ 54	Specify with <i>Power Pod grommet</i> and select color number.



For Canadian Pricing

Multiply U.S. Price by the Canadian price factor.

▶ See page 1 for details.

Specification Information							
Style Number	Dimensions			U.S. Base Prices			
	D	W	H	Flat Plastic Edge on Laminate Top		Flat Wood Edge on Wood Top	
				Group 1	Group 2	Group 1	Group 2
COLAGTRECT	24"	30"	26"	\$1636	\$1710	\$3021	\$3210
	24"	36"	26"	\$1746	\$1825	\$3153	\$3358
	36"	40"	26"	\$1854	\$1942	\$3695	\$3935
	36"	48"	26"	\$2292	\$2399	\$4023	\$4309
	36"	57"	26"	\$2402	\$2515	\$4187	\$4488
	36"	72"	26"	\$2786	\$2917	\$4680	\$5005



For Canadian Pricing

Multiply U.S. Price by the Canadian price factor.

► See page 1 for details.

Lagunitas Personal Table

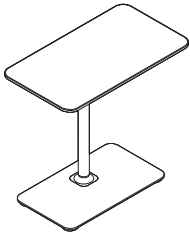

Standard Includes	Required to Specify
<ul style="list-style-type: none"> Table top: laminate price group 1 with 3 mm flat plastic edge Base: paint price group 1 Four non adjustable glides Ships ready to assemble 	<ol style="list-style-type: none"> Style number Laminate color number for table top Plastic edge color number for laminate table Paint color number for base Options, if selected (see below) <p>▶ See <i>Surface Materials</i>, page 504.</p>

Options	U.S. Price	Required to Specify
<p>Surface Materials</p> <p>Top</p> <ul style="list-style-type: none"> Laminate price group 1 Laminate price group 2 Fusion fabric wrapped 	<p>No cost</p> <p>+\$ 33</p> <p>+\$270</p>	<p>Specify laminate color number.</p> <p>Specify laminate color number.</p> <p>Specify <i>with Fusion fabric</i> and select color number.</p>
<p>Base</p> <ul style="list-style-type: none"> Paint price group 1 Paint price group 2 Paint price group 3 	<p>No cost</p> <p>No cost</p> <p>+\$ 52</p>	<p>Specify paint color number.</p> <p>Specify paint color number.</p> <p>Specify paint color number.</p>

Specification Information				
• Dimensions			• Style	• U.S.
D	W	H	Number	Base Price
13"	24"	25"	COLAGTP	\$655



For Canadian Pricing
 Multiply U.S. Price by the Canadian price factor.
 ▶ See page 1 for details.

Understanding and Specifying B-Free Lounge Seating

Product Details

B-Free	428
Thought Starters	430

Specifying

Large Cube	434
Small Cube	435
Ganging Brackets	436
Screens	437
Screen Magnets	438
Occasional Tables	439

B-Free

B-Free leverages ancillary spaces to create informal and convenient workspaces where teams can collaborate. A variety of casual seating and table options allows workers to quickly connect, while subtle screens promote concentration. Its modular and flexible design allows for spaces that support both individual and group work.

B-Free screens are made of knit material and are available in several colors. Screens come in small and large sizes with left or right applications. Magnets allow screens to connect to one another and/or connect to the large cube.

Occasional tables are available in coffee and corner configurations. They can be placed in between cubes, in front of cubes, on the side of cubes as an end table, or act as a corner piece with a screen configuration.

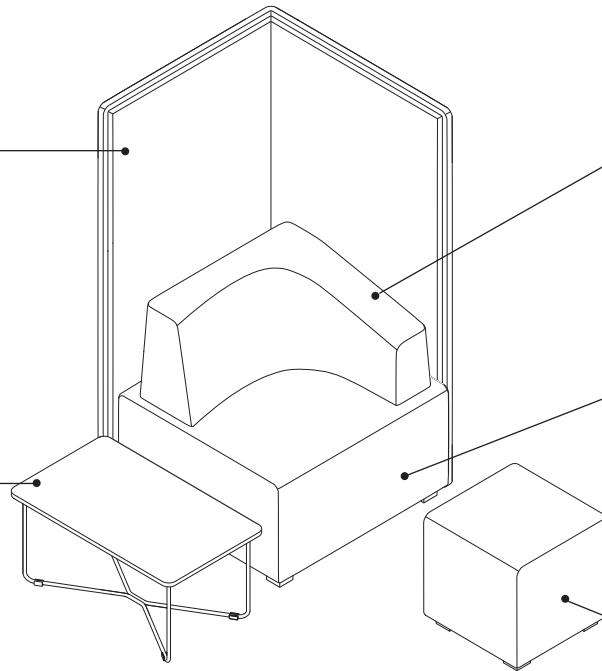

Top block is available on large cube with either a straight application or a corner left or right application. Shown is a corner left application. Top block is contoured and sculpted to provide comfort for multiple postures.

Large cubes can be standalone units or ganged together with other large cube units.

Small cube can be used as a seat or an ottoman. It can be specified with glides or casters.

Actual Dimensions

	Depth	Width	Height	Seat Depth
Large cube	29½"	31"	17⅛"	N.A.
Large cube with top block	29½"	31"	31½"	19"
Small cube	16¾"	16¾"	17⅛"	N.A.
Screen (small)	30½"	32"	59"	N.A.
Screen (large)	30½"	40⅞"	59"	N.A.
Coffee table	29½"	17¾"	15⅛"	N.A.
Corner table	29½"	29½"	15⅛"	N.A.

Product Details

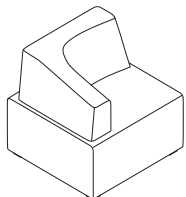

Corner left and right options on large cube integrate as armrests. The backrest is shaped to “wrap” around the user, providing greater lumbar support.



Ganging brackets are discreet and allow cubes to be well aligned when attached together.

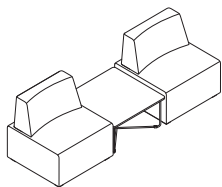

The corner occasional table can be used as a corner piece and/or to bridge together two large cubes. It also fits perfectly next to the cube and inside of the privacy screen, or works well out front.

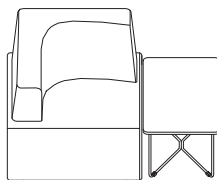

The coffee occasional table fits perfectly next to the cube and works well out in front of the cube.

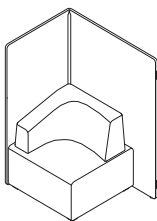

Left and right screens are decided based on the perspective of the user sitting on a cube in front of a large screen. The small side of the screen is on the arm side of the cube. The large side of the screen goes behind the cube. Shown above is a large, right screen application.

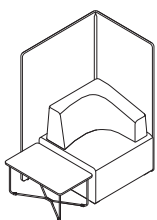

The large screen surrounds the cube and part of a coffee table.

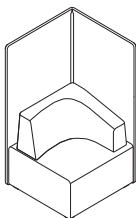

The small screen fits perfectly around the cube.

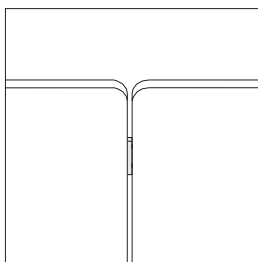

Screen to screen magnets come in a pair and attach two screens together.

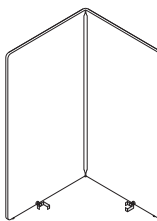

Screen to large cube magnets come in a pair and attach to the bottom of the screen and to the bottom of the large cube.

Surface Materials

Cube and top block

- Fabric
- Vinyl
- Leather
- Elmosoft leather
- Select Surfaces leather
- COL
- COM

Occasional tables

- Top
- Laminate
- Veneer

- Base
- Paint

Screen

- B-Free Knit:

Steelcase Surfaces

- 5Y58 Light Grey
- 5Y99 Dark Grey

Select Surfaces

- 0096 White
- 1274 Sky
- 1280 Ice
- 1288 Teal Blue
- 2111 Tangerine
- 2121 Paprika
- 5306 Leaf
- 5313 Chartreuse
- 5314 Lime
- 7273 Silver
- 8172 Currant
- 8179 Red Mittens
- 8180 Hot Pink

Tip: Warranty and availability of these colors vary and are at the discretion of the supplier.

For more information on Select Surfaces, please refer to the *Surface Materials Reference Manual*.

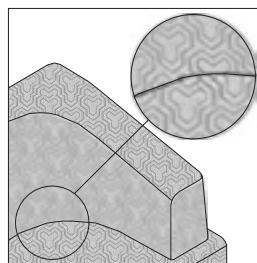

Solid, non-repeat fabrics are recommended for B-Free lounge settings because of the unique geometric shapes. Steelcase will not pattern match fabrics which have a distinct repeating pattern. It is recommended to use one of the standard fabrics, vinyls, leathers, or non-patterned COM/COL.

Programs & Services

▶ See the *Surface Materials Reference Manual* for further detail about programs and services offered for seating.

The Customer’s Own Material (COM) Program

offers the opportunity for customers to select fabrics that are not offered through the standard Steelcase surface materials program for use on Steelcase products. Through the COM program, Steelcase will test your materials for application on Steelcase products. Once approved, you can place your order. Steelcase will facilitate the entire ordering process and give you a production schedule. Steelcase will order the COM fabric directly from the textile manufacturer. For up-to-date information regarding fabric test results for all COM fabrics and details regarding yardage requirements for most Seating lines, visit the COM website. To locate the COM website:

- Visit www.steelcase.com

Soil retardants are treatments that provide long-term soil and stain resistance to a fabric without affecting the shade or the integrity of the fabric. The following Steelcase Textiles are available pre-treated with soil retardant. (You do not need to select the soil-retardant option for these fabrics and incur the upcharge.)

- Jacks
- Link
- Spyder

For information on soil retardant fabrics on Select Surfaces, please refer to the *Surface Materials Reference Manual*.

Soil-retardant treatment is available on all other seating fabrics at an additional upcharge per seating unit. To order this option, please select “Soil-Retardant Treatment” under “Optional Accessories.”

For soil-retardant treatment on COMs, please select “Soil-Retardant Treatment” under “Optional Accessories.” Minimums or additional yardage may be required. Please contact the vendor directly for specific information. Extended lead times may be necessary for this service.

Contact your Steelcase Solutions Fulfillment Team Representative at 1.888.STEELCASE (1.888.783.3522) or send an email to lineone@steelcase.com.

Thought Starters

B-Free

Individual (Left Application)

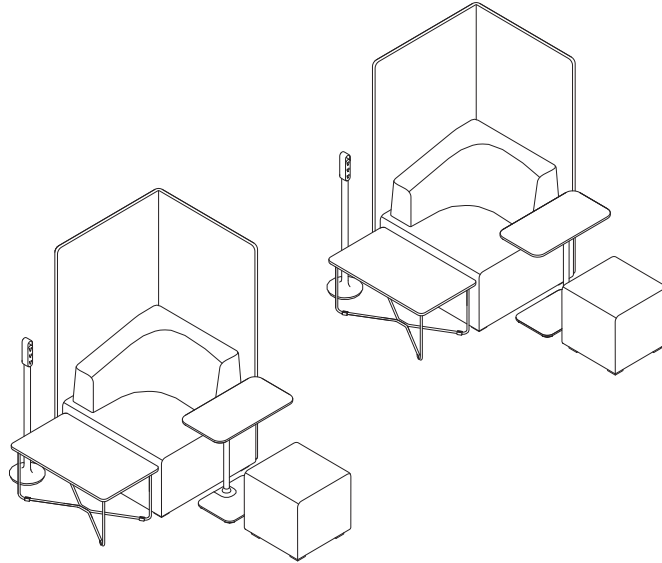

Quantity	Style Number	Description	Options	Page for Ordering
2	N3LCUBEL	Large cube	Corner right	▶ Page 434
2	N3LCUBES	Small cube		▶ Page 435
2	N3LSCREEN	Small screen	Connecting magnets, cube	▶ Page 437
2	N3LTABLECF	Coffee table		▶ Page 439
2	COLAGTP	Lagunitas personal table		▶ See <i>Coalesse Tables, Storage, and Accessories Specification Guide</i> .
2	PFLHUB	Thread power hub		▶ See <i>Architectural Solutions Specification Guide</i> .

Dyadic

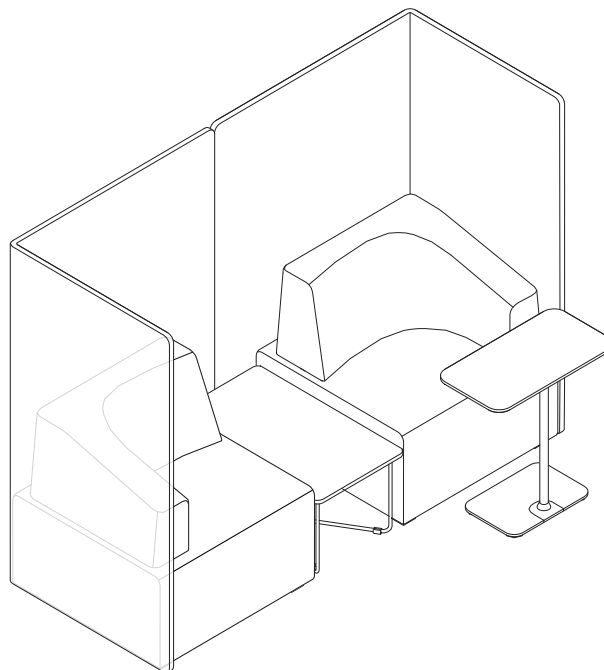

Units	Style Number	Description	Options	Page for Ordering
1	N3LCUBEL	Large cube	Corner left	▶ Page 434
1	N3LCUBEL	Large cube	Corner right	▶ Page 434
1	N3LSCREEN	Large screen	Large screen, left application, connecting magnets, cube	▶ Page 437
1	N3LSCREEN	Large screen	Large screen, right application, connecting magnets, cube	▶ Page 437
1	N3LTABLECF	Coffee table		▶ Page 439
1	COLAGTP	Lagunitas personal table		▶ See <i>Coalesse Tables, Storage, and Accessories Specification Guide</i> .

Group Lounge 1

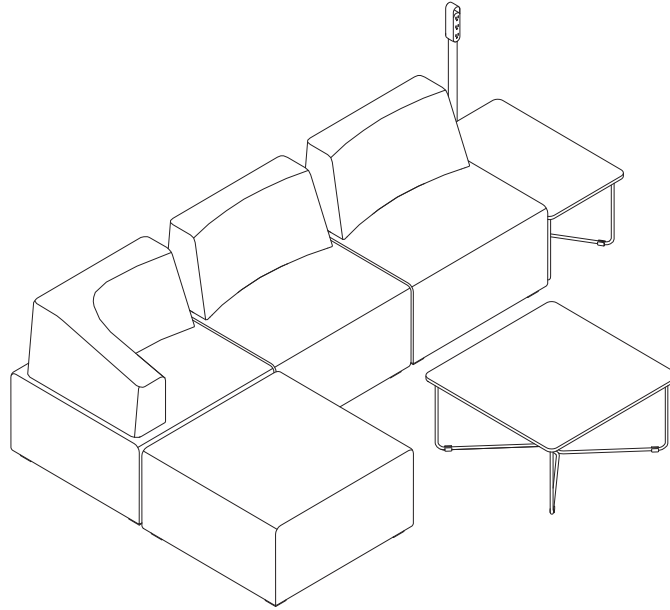

Units	Style Number	Description	Options	Page for Ordering
1	N3LCUBEL	Large cube	Corner right	▶ Page 434
1	N3LCUBEL	Large cube		▶ Page 434
2	N3LCUBEL	Large cube	Straight	▶ Page 434
1	N3LGA	Brackets		▶ Page 436
1	N3LTABLECF	Coffee table		▶ Page 439
1	N3LTABLECR	Corner table		▶ Page 439
1	PFLHUB	Thread power hub		▶ See <i>Architectural Solutions Specification Guide</i> .

Group Lounge 2

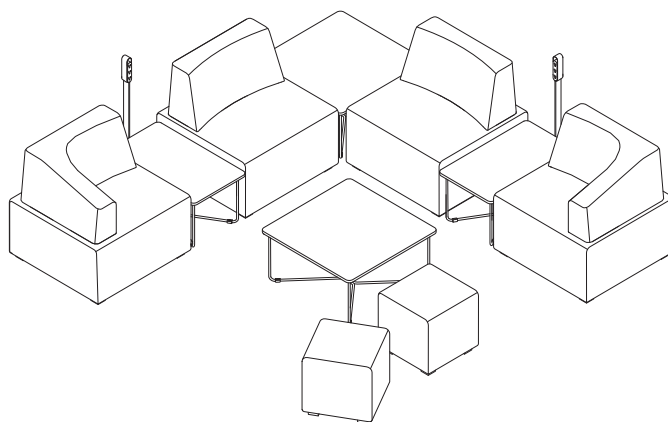

Units	Style Number	Description	Options	Page for Ordering
1	N3LCUBEL	Large cube	Corner left	▶ Page 434
1	N3LCUBEL	Large cube	Corner right	▶ Page 434
2	N3LCUBEL	Large cube	Straight	▶ Page 434
2	N3LCUBES	Small cube		▶ Page 435
2	N3LTABLECF	Coffee table		▶ Page 439
2	N3LTABLECR	Corner table		▶ Page 439
2	PFLHUB	Thread power hub		▶ See <i>Architectural Solutions Specification Guide</i> .

B-Free Large Cube

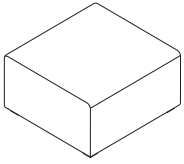

Tip: Large cube with top block has a height of 31 1/2".

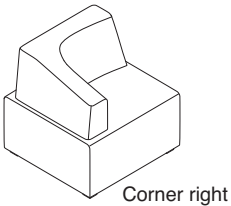
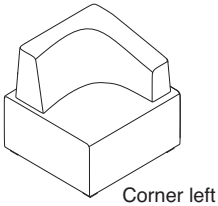
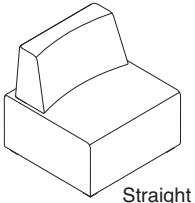

Tip: Cubes do not ship with ganging brackets. Ganging brackets, N3LGA, need to be ordered separately.

▶ See page 436

Standard Includes	Required to Specify
-------------------	---------------------

▶ Need help? Product details, page 428	<ul style="list-style-type: none"> • Large cube: fabric • Plastic, hard glides • Shipped fully assembled 	1 Style number 2 Fabric color number for cube 3 Top block, see below under Required Selections 4 Options, if selected (see below) ▶ See <i>Surface Materials</i> , page 504.
--	---	--

Required Selections	U.S. Price	Required to Specify
---------------------	------------	---------------------

Top Block	<ul style="list-style-type: none"> • No top block • Straight • Corner left • Corner right 	No cost +\$515 +\$567 +\$567
		Specify <i>with no top block</i> . Specify <i>with straight top block</i> . Specify <i>with corner left top block</i> . Specify <i>with corner right top block</i> .

Options	U.S. Price	Required to Specify
---------	------------	---------------------

Surface Materials	Cube	
	<ul style="list-style-type: none"> • Fabric price group 1 • Fabric price group 2 • Fabric price group 3 • Fabric price group 4 • Fabric price group 5 • Fabric price group 6 • Fabric price group 7 • Fabric price group 8 • Fabric price group 9 • Fabric price group 10 • Steelcase vinyl • Steelcase leather upholstery • Select Surfaces leather price group 1 • Elmosoft leather upholstery • Select Surfaces leather price group 2 • Customers Own Material (COM) • Customers Own Leather (COL) • Soil-retardant treatment applied to upholstery fabric 	No cost +\$ 47 +\$ 89 +\$125 +\$157 +\$195 +\$222 +\$281 +\$346 +\$392 +\$ 41 +\$639 +\$639 +\$830 +\$830 No cost +\$ 77 +\$ 27
		Specify fabric color number. Specify fabric color number. Specify fabric color number. Specify fabric color number. Specify fabric color number. Specify fabric color number. Specify fabric color number. Specify fabric color number. Specify fabric color number. Specify vinyl color number. Specify leather color number. ▶ See <i>Surface Materials Reference Manual</i> . Specify Elmosoft leather color number. ▶ See <i>Surface Materials Reference Manual</i> . ▶ See <i>Surface Materials Reference Manual</i> . ▶ See <i>Surface Materials Reference Manual</i> . Specify <i>with soil-retardant treatment</i> .

Options	U.S. Price	Required to Specify
---------	------------	---------------------

	Top Block	
	<ul style="list-style-type: none"> • Fabric price group 1 • Fabric price group 2 • Fabric price group 3 • Fabric price group 4 • Fabric price group 5 • Fabric price group 6 • Fabric price group 7 • Fabric price group 8 • Fabric price group 9 • Fabric price group 10 • Steelcase vinyl • Steelcase leather upholstery • Select Surfaces leather price group 1 • Elmosoft leather upholstery • Select Surfaces leather price group 2 • Customers Own Material (COM) • Customers Own Leather (COL) • Soil-retardant treatment applied to upholstery fabric 	No cost +\$ 26 +\$ 48 +\$ 68 +\$ 85 +\$105 +\$122 +\$153 +\$188 +\$214 +\$ 26 +\$361 +\$361 +\$469 +\$469 No cost +\$ 77 +\$ 27
		Specify fabric color number. Specify fabric color number. Specify fabric color number. Specify fabric color number. Specify fabric color number. Specify fabric color number. Specify fabric color number. Specify fabric color number. Specify fabric color number. Specify vinyl color number. Specify leather color number. ▶ See <i>Surface Materials Reference Manual</i> . Specify Elmosoft leather color number. ▶ See <i>Surface Materials Reference Manual</i> . ▶ See <i>Surface Materials Reference Manual</i> . ▶ See <i>Surface Materials Reference Manual</i> . Specify <i>with soil-retardant treatment</i> .

Glide	<ul style="list-style-type: none"> • Soft glide 	+\$ 6 Specify <i>with soft glides</i> .
--------------	--	--

Specification Information				
---------------------------	--	--	--	--

Dimensions			Style	U.S. Base
D	W	H	Number	Price
29 1/2"	31"	17 1/8"	N3LCUBEL	\$1000

For Canadian Pricing
 Multiply U.S. Price by the Canadian price factor.
 ▶ See page 1 for details.

B-Free Small Cube

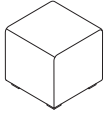

Standard Includes	Required to Specify
-------------------	---------------------

<ul style="list-style-type: none"> ▶ Need help? Product details, page 428 • Small cube: fabric • Plastic, hard glides 	<ol style="list-style-type: none"> 1 Style number 2 Fabric color number for cube 3 Options, if selected (see below) <p>▶ See <i>Surface Materials</i>, page 504.</p>
--	---

Options	U.S. Price	Required to Specify
---------	------------	---------------------

<p>Surface Materials</p> <ul style="list-style-type: none"> • Fabric price group 1 • Fabric price group 2 • Fabric price group 3 • Fabric price group 4 • Fabric price group 5 • Fabric price group 6 • Fabric price group 7 • Fabric price group 8 • Fabric price group 9 • Fabric price group 10 • Steelcase vinyl • Steelcase leather upholstery • Select Surfaces leather price group 1 • Elmosoft leather upholstery • Select Surfaces leather price group 2 • Customers Own Material (COM) • Customers Own Leather (COL) • Soil-retardant treatment applied to upholstery fabric 	<p>Cube</p> <ul style="list-style-type: none"> No cost +\$ 26 +\$ 48 +\$ 68 +\$ 85 +\$105 +\$122 +\$153 +\$188 +\$214 +\$ 26 +\$361 +\$361 +\$469 +\$469 No cost +\$ 77 +\$ 27 	<ul style="list-style-type: none"> Specify fabric color number. Specify fabric color number. Specify fabric color number. Specify fabric color number. Specify fabric color number. Specify fabric color number. Specify fabric color number. Specify fabric color number. Specify fabric color number. Specify vinyl color number. Specify leather color number. ▶ See <i>Surface Materials Reference Manual</i>. Specify Elmosoft leather color number. ▶ See <i>Surface Materials Reference Manual</i>. ▶ See <i>Surface Materials Reference Manual</i>. ▶ See <i>Surface Materials Reference Manual</i>. Specify <i>with soil-retardant treatment</i>.
<p>Casters/Glides</p> <ul style="list-style-type: none"> • Soft glides • Soft casters • Hard casters 	<ul style="list-style-type: none"> +\$ 6 +\$ 27 +\$ 52 	<ul style="list-style-type: none"> Specify <i>with soft glides</i>. Specify <i>with soft casters</i>. Specify <i>with hard casters</i>.

Specification Information				
Dimensions			Style	U.S.
D	W	H	Number	Base Price

16¾"	16¾"	17⅛"	N3LCUBES	\$510
:	:	:	:	:



For Canadian Pricing
 Multiply U.S. Price by the Canadian price factor.
 ▶ See page 1 for details.

B-Free Ganging Brackets

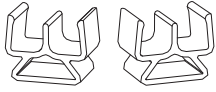

Standard Includes	Required to Specify
-------------------	---------------------

- | | | |
|--|---|--|
| <ul style="list-style-type: none"> ▶ Need help? Product details, page 429 | <ul style="list-style-type: none"> • 10 ganging brackets | <ul style="list-style-type: none"> ▶ Style number |
|--|---|--|

Related Products

- | | |
|--|--|
| <ul style="list-style-type: none"> • B-Free large cube • B-Free small cube | <ul style="list-style-type: none"> ▶ Page 434 ▶ Page 435 |
|--|--|

Specification Information

• Style Number	• U.S. Price
N3LGA	\$20



For Canadian Pricing
 Multiply U.S. Price by the Canadian price factor.
 ▶ See page 1 for details.

B-Free Screens

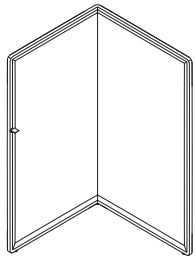

Tip: Small, right application screen is pictured above.

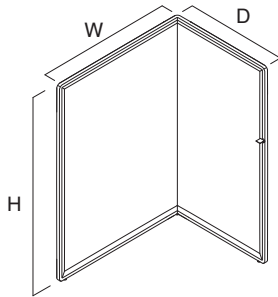

Tip: Large, left application screen is pictured above.

Standard Includes	Required to Specify
-------------------	---------------------

- | | | |
|--|--|--|
| <ul style="list-style-type: none"> ▶ Need help? Product details, page 428 | <ul style="list-style-type: none"> • Screen: steel tubular frame with a polyester cover: knit • Plastic, adjustable glides | <ul style="list-style-type: none"> 1 Style number 2 Knit color number for screen 3 Options, if selected (see below) |
|--|--|--|

Options	U.S. Price	Required to Specify
---------	------------	---------------------

Screen Width	<ul style="list-style-type: none"> • Small (32"W) • Large (40⁷/₈"W) 	Prices below Prices below	Specify <i>with small screen</i> . Specify <i>with large screen</i> .
Application	<ul style="list-style-type: none"> • Left application • Right application 	No cost No cost	Specify <i>with left application</i> . Specify <i>with right application</i> .
Connecting Magnets	<ul style="list-style-type: none"> • No connecting magnets • Connecting magnets, screen • Connecting magnets, cube • Connecting magnets, screen and cube 	No cost +\$27 +\$53 +\$79	Specify <i>with no magnets</i> . Specify <i>with screen magnets</i> . Specify <i>with cube magnets</i> . Specify <i>with screen and cube magnets</i> .

Specification Information				
• Dimensions		• Style Number	• U.S. Base Prices	
D	H		Small 32"W	Large 40 ⁷ / ₈ "W

30 ¹ / ₂ "	59"	N3LSCREEN	\$969	\$1022
:	:	:	:	:



For Canadian Pricing
 Multiply U.S. Price by the Canadian price factor.
 ▶ See page 1 for details.

B-Free Screen Magnets

Standard Includes	Required to Specify
<ul style="list-style-type: none"> Need help? Product details, page 428 • Pair of magnets 	Style number

Specification Information	
Style Number	U.S. Price

Screen to Screen

N3LMAGSS \$26

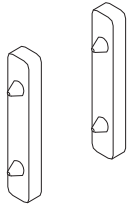

Screen to Large Cube

N3LMAGSC \$51

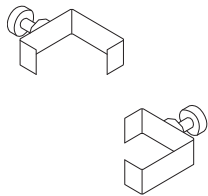

 **For Canadian Pricing**
 Multiply U.S. Price by the Canadian price factor.
 ▶ See page 1 for details.

B-Free Occasional Tables

Standard Includes	Required to Specify
<ul style="list-style-type: none"> ▶ Need help? Product details, page 428 • Table: High-Pressure Laminate surface with plastic edge profile • 12 mm steel wire and 1½ mm thick steel tube base: paint • Fitted with four merle plastic glides clipped onto the framework • Shipped ready to assemble 	<ol style="list-style-type: none"> 1 Style number 2 Laminate color number for table 3 Paint color number for base 4 Options, if selected (see below) <ul style="list-style-type: none"> ▶ See <i>Surface Materials</i>, page 504.

Options	U.S. Price	Required to Specify
Surface Materials High-Pressure Laminate Surface <ul style="list-style-type: none"> • Open Line laminate Wood Veneer Surface <ul style="list-style-type: none"> • Wood veneer • Premium wood 2 • Premium wood 3 • Customiz stain • Full-fill finish 	<ul style="list-style-type: none"> + \$ 71 +\$550 +\$621 +\$799 +\$550 +\$621 	<ul style="list-style-type: none"> ▶ See <i>Surface Materials Reference Manual</i>. Specify wood veneer finish number. Specify Premium wood 2 finish number. Specify Premium wood 3 finish number. Specify <i>with Customiz stain</i>. Specify full-fill finish number.
Base <ul style="list-style-type: none"> • Paint price group 1 • Paint price group 2 	<ul style="list-style-type: none"> No cost +\$ 53 	<ul style="list-style-type: none"> Specify paint color number. Specify paint color number.

Specification Information				
• Dimensions			• Style	• U.S.
D	W	H	Number	Base Price
•••	•••	•••	•••	•••

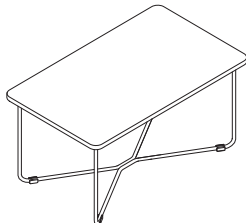

Coffee Table				
29½"	17¾"	15⅛"	N3LTABLECF	\$500
•••	•••	•••	•••	•••

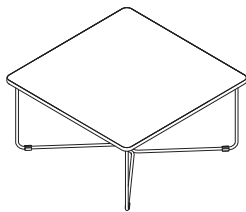

Corner Table				
29½"	29½"	15⅛"	N3LTABLECR	\$600
•••	•••	•••	•••	•••

 **For Canadian Pricing**
 Multiply U.S. Price by the Canadian price factor.
 ▶ See page 1 for details.

B-Free

Multi-Use Chairs

Reply 466 Series	133
Kart Series	155
Jersey Series	173
Cachet 487 Series	223
Protégé 433 Series	239
Player 475 Series	443
Move 490 Series	459
Snodgrass 474 Series	479
Nooi by Wiesner Hager	485

Understanding and Specifying Player 475 Series Multi-Use Chairs

Product Details

Player 475 Series	444
Dimensions	446

Specifying

Leg-Base Multi-Use Chairs	448
Sled-Base Multi-Use Chairs	452
Leg-Base Stools	456
Accessories	458

Multi-Use Chairs

Multi-use chairs are suitable for use as occasional seating within team spaces, workstations, offices, or wherever extra seating is required.

- Player 475 Series
- Move 490 Series
- Snodgrass 474 Series

Player 475 Series

Player chairs are guest chairs that also stack. Strength features in the back, arms, and back legs make Player a logical choice for high-traffic areas, and its simple, classic design complements a broad range of work settings.

Back and seat, including outer back, are fully upholstered. High-back and thick-seat options are available.

Arms slope downward and will easily clear the front edge of a worksurface or table. Arms are available in smooth or textured finish.

Steel frame is monochromatic.

Plastic glides with a hard plastic insert are standard.

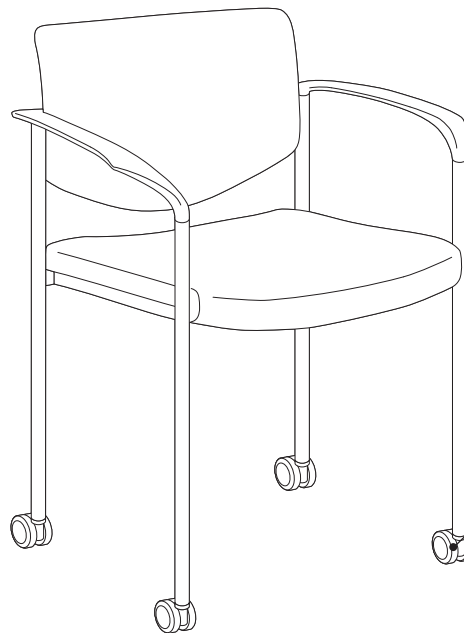
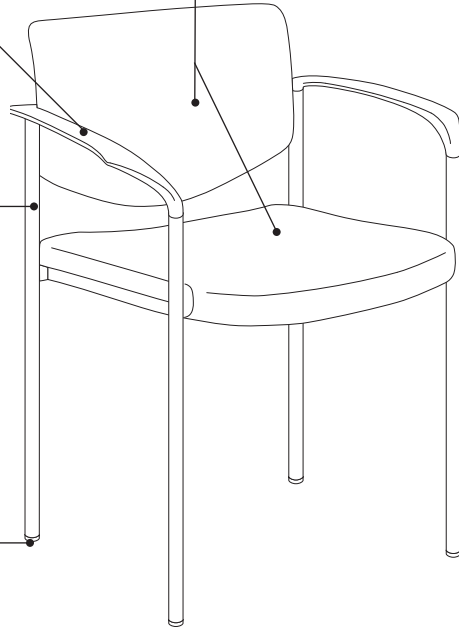

Casters have hard, dual wheels that roll smoothly on carpets. They are 2" in diameter for increased mobility. Soft, dual-wheel casters are available for use on hard floor or chair mats. Casters available in black only.
Tip: Do not roll the chair across asphalt during installation as this may damage the casters.

Product Details

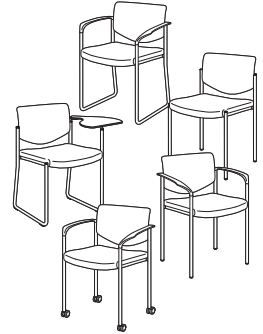

Chair models are available with a leg-base or a sled-base. Stools are available with a leg-base. The leg base arms are available with casters. Chairs and stools are available with several features such as arms, tablet arms, high back, and thick seat.

Stackability for leg-base models is six high on the floor and eight high on the transport and storage dolly. Leg-base models with casters are not recommended to stack as damage to arms may occur. Sled-base models, stools, and chairs with tablet arms will not stack.

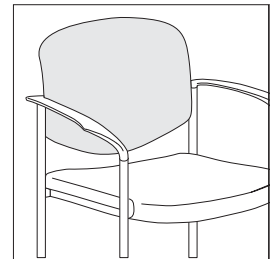

High-back option, available on all Player chairs and stools, adds 2½" to back height. Top edge is slightly rounded. Stackability is not affected.

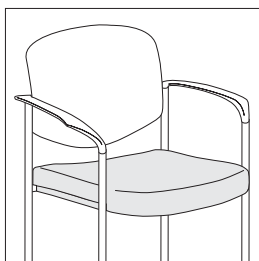

Thick-seat option, available on all Player chairs and stools, increases the thickness of the seat cushion by approximately 1/2". Stackability is not affected.

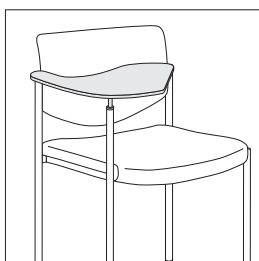

Tablet arm is available right hand and left hand and is shipped knocked down (K.D.). Tablet arm tilts for easy entrance and exit from chair. Tablet arm measures 25 1/2" x 13 1/2". Tablet arm is not available to order separately for installation on existing chairs.

Plastic glides, with hard plastic inserts on leg-base Player chairs, are recommended for carpeted surfaces only.

Soft felt glides are available on Player chairs for non-carpeted surfaces.

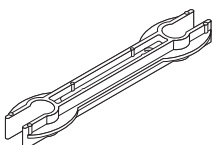

Alignment device is available to temporarily link chairs together for evenly spaced rows. Chairs can be unlinked easily. Spacing between chairs linked with alignment device is 5 7/8".

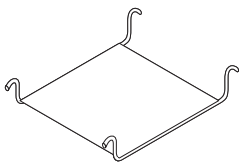

Ganging device is available to link chairs on a more permanent basis. It attaches to the chair's side frame. Spacing between chairs linked with the ganging device is approximately 9".

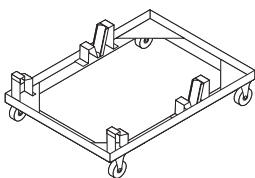

Transport and storage dolly is available to stack, move, and store up to eight chairs with or without arms. Without the dolly, chairs will stack up to six high. Sled-base models, stools, and chairs with tablet arms will not stack.

Fully loaded transport dolly measures 32 3/4"D x 25 1/2"W x 55 3/4"H.

Surface Materials

► See surface materials on page 504 for specific availability or refer to the *Surface Materials Reference Manual* for further information.

Upholstery

- Fabric
- Fabric with soil-retardant treatment (option)
- Vinyl

Hard components (arms, frames, and sled base)

- Monochromatic color from list of seating plastic color numbers can be applied to all hard components.

Arms

- Smooth plastic
- Textured plastic

Tablet arms

- Laminate

Casters

- Black only

Glides

- Plastic with hard plastic inserts come standard on leg-base multi-use chairs when specified with glides. Soft glides are available as an option.

All Steelcase seating with standard upholstery fabrics complies with requirements of the State of California Technical Bulletin 117-2013. All standard seating is labeled to be in compliance with California 117-2013.

Programs & Services

► See the *Surface Materials Reference Manual* for further detail about programs and services offered for seating.

The Customer's Own Material (COM) Program

offers the opportunity for customers to select fabrics that are not offered through the standard Steelcase surface materials program for use on Steelcase products. Through the COM program, Steelcase will test your materials for application on Steelcase products. Once approved, you can place your order. Steelcase will facilitate the entire ordering process and give you a production schedule. Steelcase will order the COM fabric directly from the textile manufacturer. For up-to-date information regarding fabric test results for all COM fabrics and details regarding yardage requirements for most Seating lines, visit the COM website. To locate the COM website:

- Visit www.steelcase.com

Soil retardants are treatments that provide long-term soil and stain resistance to a fabric without affecting the shade or the integrity of the fabric. The following Steelcase Textiles are available pre-treated with soil retardant. (You do not need to select the soil-retardant option for these fabrics and incur the upcharge.)

- Jacks
- Link
- Spyder

For information on soil retardant fabrics on Select Surfaces, please refer to the *Surface Materials Reference Manual*.

Soil-retardant treatment is available on all other seating fabrics at an additional upcharge per seating unit. To order this option, please select "Soil-Retardant Treatment" under "Optional Accessories."

For soil-retardant treatment on COMs, please select "Soil-Retardant Treatment" under "Optional Accessories." Minimums or additional yardage may be required. Please contact the vendor directly for specific information.

Extended lead times may be necessary for this service.

Contact your Steelcase Solutions Fulfillment Team Representative at 1.888.STEELCASE (1.888.783.3522) or send an email to lineone@steelcase.com.

Dimensions

► Page 446

Resources

Printed Materials

► Player Brochure (08-0001468)

Online Resources

► Environmental profiles available on www.steelcase.com/sustainability.

Dimensions

Player 475 Series

• Features	• Overall Depth	Width	Height	• Seat Depth	• Functional Seat Depth	• Seat Width	• Seat Height from Floor	• Footrest Height from Floor	• Back Width
Player 475 Series									
Leg-Base Chair with Arms									
	21¼"	25½"	30¼"	19¾"	17½"	18¼"	18¼"	N.A.	18½"
Leg-Base Chair without Arms									
	21¼"	20"	30¼"	19¾"	17½"	18¼"	18¼"	N.A.	18½"
Sled-Base Chair with Arms									
	21¼"	25½"	30¼"	19¾"	17½"	18¼"	18"	N.A.	18½"
Sled-Base Chair without Arms									
	21¼"	20"	30¼"	19¾"	17½"	18¼"	18"	N.A.	18½"
Leg-Base Stool with Arms									
	21¼"	25½"	42"	19¾"	17½"	18¼"	29½"	11⅞"	18½"
Leg-Base Stool without Arms									
	21¼"	20"	42"	19¾"	17½"	18¼"	29½"	11⅞"	18½"

• Back • Height • from • Seat	• Back • Lumbar • Height	• Width • Between • Arms	• Arm • to • Floor	• Arm • Height • from • Seat	• Seat • Pan • Angle	• Angle • Between • Seat and • Back
--	--------------------------------	--------------------------------	--------------------------	---------------------------------------	----------------------------	--

Leg-Base Chair with Arms

13 ³ / ₄ "	7 ¹ / ₄ "	20 ¹ / ₂ "	25 ¹ / ₄ "	8 ³ / ₈ "	4°	95°
----------------------------------	---------------------------------	----------------------------------	----------------------------------	---------------------------------	----	-----

Leg-Base Chair without Arms

13 ³ / ₄ "	7 ¹ / ₄ "	N.A.	N.A.	N.A.	4°	95°
----------------------------------	---------------------------------	------	------	------	----	-----

Sled-Base Chair with Arms

13 ³ / ₄ "	7 ¹ / ₄ "	20 ¹ / ₂ "	25 ¹ / ₄ "	8 ³ / ₈ "	4°	95°
----------------------------------	---------------------------------	----------------------------------	----------------------------------	---------------------------------	----	-----

Sled-Base Chair without Arms

13 ³ / ₄ "	7 ¹ / ₄ "	N.A.	N.A.	N.A.	4°	95°
----------------------------------	---------------------------------	------	------	------	----	-----

Leg-Base Stool with Arms

13 ³ / ₄ "	7 ¹ / ₄ "	20 ¹ / ₂ "	36 ¹ / ₂ "	8 ³ / ₈ "	4°	95°
----------------------------------	---------------------------------	----------------------------------	----------------------------------	---------------------------------	----	-----

Leg-Base Stool without Arms

13 ³ / ₄ "	7 ¹ / ₄ "	N.A.	N.A.	N.A.	4°	95°
----------------------------------	---------------------------------	------	------	------	----	-----

⋮ ⋮ ⋮ ⋮ ⋮ ⋮ ⋮

Player 475 Series Leg-Base Multi-Use Chairs

With Open Arms or without Arms



Tip: Color choices are limited for chairs with textured plastic arms.

▶ Page 518

Tip: To price a chair without contrasting fabrics, add upholstery on seat and upholstery on back prices together.

Standard Includes	Required to Specify
<ul style="list-style-type: none"> ▶ Need help? Product details, page 444 • Frame: monochromatic color • Arms, if selected: plastic color to match frame color • Upholstery: fabric price group 1 • Glides, if selected: plastic with hard plastic inserts • Hard composition, dual-wheel casters, if selected; black 	<ol style="list-style-type: none"> 1 Style number 2 Monochromatic color number from seating plastic colors for frame 3 Fabric color number for upholstery 4 Options, if selected (see below) <p>▶ See <i>Surface Materials</i>, page 504.</p>

Options	U.S. Price	Required to Specify
Surface Materials		
Upholstery on seat <ul style="list-style-type: none"> • Fabric price group 1 • Fabric price group 2 • Fabric price group 3 • Fabric price group 4 • Fabric price group 5 • Fabric price group 6 • Fabric price group 7 • Fabric price group 8 • Fabric price group 9 • Fabric price group 10 • Customer's Own Material/ Vinyl (COM) 	No cost +\$ 13 +\$ 25 +\$ 35 +\$ 43 +\$ 62 +\$ 88 +\$116 +\$138 +\$161 +\$ 19	Specify fabric color number. Specify fabric color number. Specify fabric color number. Specify fabric color number. Specify fabric color number. Specify fabric color number. Specify fabric color number. Specify fabric color number. Specify fabric color number. Specify fabric color number. ▶ See <i>Surface Materials Reference Manual</i> .
Upholstery on back <ul style="list-style-type: none"> • Fabric price group 1 • Fabric price group 2 • Fabric price group 3 • Fabric price group 4 • Fabric price group 5 • Fabric price group 6 • Fabric price group 7 • Fabric price group 8 • Fabric price group 9 • Fabric price group 10 • Customer's Own Material/ Vinyl (COM) 	No cost +\$ 13 +\$ 25 +\$ 35 +\$ 44 +\$ 63 +\$ 89 +\$116 +\$138 +\$161 +\$ 20	Specify fabric color number. Specify fabric color number. Specify fabric color number. Specify fabric color number. Specify fabric color number. Specify fabric color number. Specify fabric color number. Specify fabric color number. Specify fabric color number. Specify fabric color number. ▶ See <i>Surface Materials Reference Manual</i> .
Soil-Retardant Treatment <ul style="list-style-type: none"> • Soil-retardant treatment applied to upholstery fabric 	+\$ 27	Specify <i>with soil-retardant treatment</i> .
Platinum <ul style="list-style-type: none"> • Platinum frame 	+\$ 59	Specify <i>with 6249 Platinum</i> .
Back and Seat <ul style="list-style-type: none"> • High back • Thick seat 	+\$ 40 +\$ 40	Specify <i>with high back</i> . Specify <i>with thick seat</i> .
Glides <ul style="list-style-type: none"> • Soft felt glides for use on non-carpeted floors 	+\$ 6	Specify <i>with soft glides</i> .
Casters <ul style="list-style-type: none"> • Soft, dual-wheel casters for use on hard floors 	+\$ 27	Specify <i>with soft casters</i> .

▶ Detailed dimensions, page 446



For Canadian Pricing

Multiply U.S. Price by the Canadian price factor.

▶ See page 1 for details.

Specification Information

• Style	• U.S.
• Number	• Base
•	• Price
•	•

Smooth Plastic Arms

With Glides

475412M	\$422
•	•

With Casters

475412MC	\$477
•	•

Textured Plastic Arms

With Glides

475415M	\$422
•	•

With Casters

475415MC	\$477
•	•

Without Arms

With Glides

475410M	\$385
•	•



Tip: Player without arms is only available with glides. Casters are not available.

For Canadian Pricing
Multiply U.S. Price by the Canadian price factor.
▶ See page 1 for details.

Player 475 Series Leg-Base Multi-Use Chairs

With Tablet Arm



Tip: To price a chair without contrasting fabrics, add upholstery on seat and upholstery on back prices together.

Standard Includes		Required to Specify	
<ul style="list-style-type: none"> ▶ Need help? Product details, page 444 	<ul style="list-style-type: none"> • Frame: monochromatic color • Tablet arm: laminate • Upholstery: fabric price group 1 • Glides: plastic with hard plastic inserts 	<ol style="list-style-type: none"> 1 Style number 2 Monochromatic color number from seating plastic colors for frame 3 Fabric color number for upholstery 4 Laminate color number for tablet arm 5 Options, if selected (see below) 	<ul style="list-style-type: none"> ▶ See <i>Surface Materials</i>, page 504.

Options	U.S. Price	Required to Specify
Surface Materials		
Upholstery on seat		
• Fabric price group 1	No cost	Specify fabric color number.
• Fabric price group 2	+\$ 13	Specify fabric color number.
• Fabric price group 3	+\$ 25	Specify fabric color number.
• Fabric price group 4	+\$ 35	Specify fabric color number.
• Fabric price group 5	+\$ 43	Specify fabric color number.
• Fabric price group 6	+\$ 62	Specify fabric color number.
• Fabric price group 7	+\$ 88	Specify fabric color number.
• Fabric price group 8	+\$116	Specify fabric color number.
• Fabric price group 9	+\$138	Specify fabric color number.
• Fabric price group 10	+\$161	Specify fabric color number.
• Customer's Own Material/ Vinyl (COM)	+\$ 19	▶ See <i>Surface Materials Reference Manual</i> .
Upholstery on back		
• Fabric price group 1	No cost	Specify fabric color number.
• Fabric price group 2	+\$ 13	Specify fabric color number.
• Fabric price group 3	+\$ 25	Specify fabric color number.
• Fabric price group 4	+\$ 35	Specify fabric color number.
• Fabric price group 5	+\$ 44	Specify fabric color number.
• Fabric price group 6	+\$ 63	Specify fabric color number.
• Fabric price group 7	+\$ 89	Specify fabric color number.
• Fabric price group 8	+\$116	Specify fabric color number.
• Fabric price group 9	+\$138	Specify fabric color number.
• Fabric price group 10	+\$161	Specify fabric color number.
• Customer's Own Material/ Vinyl (COM)	+\$ 20	▶ See <i>Surface Materials Reference Manual</i> .
Soil-Retardant Treatment		
• Soil-retardant treatment applied to upholstery fabric	+\$ 27	Specify <i>with soil-retardant treatment</i> .
Platinum		
• Platinum frame	+\$ 59	Specify <i>with 6249 Platinum</i> .
Back and Seat		
• High back	+\$ 40	Specify <i>with high back</i> .
• Thick seat	+\$ 40	Specify <i>with thick seat</i> .
Glides		
• Soft felt glides for use on non-carpeted floors	+\$ 6	Specify <i>with soft glides</i> .

▶ Detailed dimensions, page 446



For Canadian Pricing

Multiply U.S. Price by the Canadian price factor.

▶ See page 1 for details.

Specification Information

• Style • Number • •	• U.S. • Base • Price •
-------------------------------	----------------------------------



Right-Hand Tablet Arm

475410MTR \$599



Left-Hand Tablet Arm

475410MTL \$599



For Canadian Pricing
Multiply U.S. Price by the
Canadian price factor.
▶ See page 1 for details.

Player 475 Series Sled-Base Multi-Use Chairs

With Open Arms or without Arms



Tip: Color choices are limited for chairs with textured plastic arms.

▶ Page 518

Tip: To price a chair without contrasting fabrics, add upholstery on seat and upholstery on back prices together.

Standard Includes	Required to Specify
<ul style="list-style-type: none"> ▶ Need help? Product details, page 444 • Frame: monochromatic color • Arms, if selected: plastic color to match frame color • Upholstery: fabric price group 1 • Glides: plastic with hard plastic inserts 	<ol style="list-style-type: none"> 1 Style number 2 Monochromatic color number from seating plastic colors for frame 3 Fabric color number for upholstery 4 Options, if selected (see below) <p>▶ See <i>Surface Materials</i>, page 504.</p>

Options	U.S. Price	Required to Specify
<p>Surface Materials</p>		
<p>Upholstery on seat</p> <ul style="list-style-type: none"> • Fabric price group 1 • Fabric price group 2 • Fabric price group 3 • Fabric price group 4 • Fabric price group 5 • Fabric price group 6 • Fabric price group 7 • Fabric price group 8 • Fabric price group 9 • Fabric price group 10 • Customer's Own Material/ Vinyl (COM) 	<ul style="list-style-type: none"> No cost +\$ 13 +\$ 25 +\$ 35 +\$ 43 +\$ 62 +\$ 88 +\$116 +\$138 +\$161 +\$ 19 	<ul style="list-style-type: none"> Specify fabric color number. Specify fabric color number. Specify fabric color number. Specify fabric color number. Specify fabric color number. Specify fabric color number. Specify fabric color number. Specify fabric color number. Specify fabric color number. Specify fabric color number. ▶ See <i>Surface Materials Reference Manual</i>.
<p>Upholstery on back</p> <ul style="list-style-type: none"> • Fabric price group 1 • Fabric price group 2 • Fabric price group 3 • Fabric price group 4 • Fabric price group 5 • Fabric price group 6 • Fabric price group 7 • Fabric price group 8 • Fabric price group 9 • Fabric price group 10 • Customer's Own Material/ Vinyl (COM) 	<ul style="list-style-type: none"> No cost +\$ 13 +\$ 25 +\$ 35 +\$ 44 +\$ 63 +\$ 89 +\$116 +\$138 +\$161 +\$ 20 	<ul style="list-style-type: none"> Specify fabric color number. Specify fabric color number. Specify fabric color number. Specify fabric color number. Specify fabric color number. Specify fabric color number. Specify fabric color number. Specify fabric color number. Specify fabric color number. Specify fabric color number. ▶ See <i>Surface Materials Reference Manual</i>.
<p>Soil-Retardant Treatment</p> <ul style="list-style-type: none"> • Soil-retardant treatment applied to upholstery fabric 	<ul style="list-style-type: none"> +\$ 27 	<ul style="list-style-type: none"> Specify <i>with soil-retardant treatment</i>.
<p>Platinum</p> <ul style="list-style-type: none"> • Platinum frame 	<ul style="list-style-type: none"> +\$ 59 	<ul style="list-style-type: none"> Specify <i>with 6249 Platinum</i>.
<p>Back and Seat</p> <ul style="list-style-type: none"> • High back • Thick seat 	<ul style="list-style-type: none"> +\$ 40 +\$ 40 	<ul style="list-style-type: none"> Specify <i>with high back</i>. Specify <i>with thick seat</i>.
<p>Glides</p> <ul style="list-style-type: none"> • Soft felt glides for use on non-carpeted floors 	<ul style="list-style-type: none"> +\$ 6 	<ul style="list-style-type: none"> Specify <i>with soft glides</i>.

▶ Detailed dimensions, page 446



For Canadian Pricing

Multiply U.S. Price by the Canadian price factor.

▶ See page 1 for details.

Specification Information

• Style	• U.S.
• Number	• Base
•	• Price
•	•



Smooth Plastic Arms

475482M	\$542
•	•



Textured Plastic Arms

475485M	\$542
•	•



Without Arms

475480M	\$505
•	•



For Canadian Pricing
Multiply U.S. Price by the
Canadian price factor.
▶ See page 1 for details.

Player 475 Series Sled-Base Multi-Use Chairs

With Tablet Arm



Tip: To price a chair without contrasting fabrics, add upholstery on seat and upholstery on back prices together.

Standard Includes		Required to Specify	
<ul style="list-style-type: none"> ▶ Need help? Product details, page 444 	<ul style="list-style-type: none"> • Frame: monochromatic color • Tablet arm: laminate • Upholstery: fabric price group 1 • Glides: plastic with hard plastic inserts 	<ol style="list-style-type: none"> 1 Style number 2 Monochromatic color number from seating plastic colors for frame 3 Fabric color number for upholstery 4 Laminate color number for tablet arm 5 Options, if selected (see below) 	<ul style="list-style-type: none"> ▶ See <i>Surface Materials</i>, page 504.

Options	U.S. Price	Required to Specify
Surface Materials		
Upholstery on seat <ul style="list-style-type: none"> • Fabric price group 1 • Fabric price group 2 • Fabric price group 3 • Fabric price group 4 • Fabric price group 5 • Fabric price group 6 • Fabric price group 7 • Fabric price group 8 • Fabric price group 9 • Fabric price group 10 • Customer's Own Material/ Vinyl (COM) 	<ul style="list-style-type: none"> No cost +\$ 13 +\$ 25 +\$ 35 +\$ 43 +\$ 62 +\$ 88 +\$116 +\$138 +\$161 +\$ 19 	<ul style="list-style-type: none"> Specify fabric color number. Specify fabric color number. Specify fabric color number. Specify fabric color number. Specify fabric color number. Specify fabric color number. Specify fabric color number. Specify fabric color number. Specify fabric color number. Specify fabric color number. ▶ See <i>Surface Materials Reference Manual</i>.
Upholstery on back <ul style="list-style-type: none"> • Fabric price group 1 • Fabric price group 2 • Fabric price group 3 • Fabric price group 4 • Fabric price group 5 • Fabric price group 6 • Fabric price group 7 • Fabric price group 8 • Fabric price group 9 • Fabric price group 10 • Customer's Own Material/ Vinyl (COM) 	<ul style="list-style-type: none"> No cost +\$ 13 +\$ 25 +\$ 35 +\$ 44 +\$ 63 +\$ 89 +\$116 +\$138 +\$161 +\$ 20 	<ul style="list-style-type: none"> Specify fabric color number. Specify fabric color number. Specify fabric color number. Specify fabric color number. Specify fabric color number. Specify fabric color number. Specify fabric color number. Specify fabric color number. Specify fabric color number. Specify fabric color number. ▶ See <i>Surface Materials Reference Manual</i>.
Soil-Retardant Treatment <ul style="list-style-type: none"> • Soil-retardant treatment applied to upholstery fabric 	<ul style="list-style-type: none"> +\$ 27 	<ul style="list-style-type: none"> Specify <i>with soil-retardant treatment</i>.
Platinum <ul style="list-style-type: none"> • Platinum frame 	<ul style="list-style-type: none"> +\$ 59 	<ul style="list-style-type: none"> Specify <i>with 6249 Platinum</i>.
Back and Seat <ul style="list-style-type: none"> • High back • Thick seat 	<ul style="list-style-type: none"> +\$ 40 +\$ 40 	<ul style="list-style-type: none"> Specify <i>with high back</i>. Specify <i>with thick seat</i>.
Glides <ul style="list-style-type: none"> • Soft felt glides for use on non-carpeted floors 	<ul style="list-style-type: none"> +\$ 6 	<ul style="list-style-type: none"> Specify <i>with soft glides</i>.

▶ Detailed dimensions, page 446



For Canadian Pricing

Multiply U.S. Price by the Canadian price factor.

▶ See page 1 for details.

Specification Information

• Style • Number	• U.S. • Base • Price



Right-Hand Tablet Arm

475480MTR	\$719



Left-Hand Tablet Arm

475480MTL	\$719



For Canadian Pricing
 Multiply U.S. Price by the
 Canadian price factor.
 ▶ See page 1 for details.

Player 475 Series Leg-Base Stools



Tip: Color choices are limited for chairs with textured plastic arms.

▶ Page 518

Tip: To price a chair without contrasting fabrics, add upholstery on seat and upholstery on back prices together.

Standard Includes	Required to Specify
<ul style="list-style-type: none"> ▶ Need help? Product details, page 444 • Frame: monochromatic color • Arms, if selected: plastic color to match frame color • Upholstery: fabric price group 1 • Glides: plastic with hard plastic inserts 	<ol style="list-style-type: none"> 1 Style number 2 Monochromatic color number from seating plastic colors for frame 3 Fabric color number for upholstery 4 Options, if selected (see below) <p>▶ See <i>Surface Materials</i>, page 504.</p>

Options	U.S. Price	Required to Specify
Surface Materials		
Upholstery on seat <ul style="list-style-type: none"> • Fabric price group 1 • Fabric price group 2 • Fabric price group 3 • Fabric price group 4 • Fabric price group 5 • Fabric price group 6 • Fabric price group 7 • Fabric price group 8 • Fabric price group 9 • Fabric price group 10 • Customer's Own Material/ Vinyl (COM) 	No cost +\$ 13 +\$ 25 +\$ 35 +\$ 43 +\$ 62 +\$ 88 +\$116 +\$138 +\$161 +\$ 19	Specify fabric color number. Specify fabric color number. Specify fabric color number. Specify fabric color number. Specify fabric color number. Specify fabric color number. Specify fabric color number. Specify fabric color number. Specify fabric color number. Specify fabric color number. Specify fabric color number. ▶ See <i>Surface Materials Reference Manual</i> .
Upholstery on back <ul style="list-style-type: none"> • Fabric price group 1 • Fabric price group 2 • Fabric price group 3 • Fabric price group 4 • Fabric price group 5 • Fabric price group 6 • Fabric price group 7 • Fabric price group 8 • Fabric price group 9 • Fabric price group 10 • Customer's Own Material/ Vinyl (COM) 	No cost +\$ 13 +\$ 25 +\$ 35 +\$ 44 +\$ 63 +\$ 89 +\$116 +\$138 +\$161 +\$ 20	Specify fabric color number. Specify fabric color number. Specify fabric color number. Specify fabric color number. Specify fabric color number. Specify fabric color number. Specify fabric color number. Specify fabric color number. Specify fabric color number. Specify fabric color number. Specify fabric color number. ▶ See <i>Surface Materials Reference Manual</i> .
Soil-Retardant Treatment <ul style="list-style-type: none"> • Soil-retardant treatment applied to upholstery fabric 	+\$ 27	Specify <i>with soil-retardant treatment</i> .
Platinum <ul style="list-style-type: none"> • Platinum frame 	+\$ 59	Specify <i>with 6249 Platinum</i> .
Back and Seat <ul style="list-style-type: none"> • High back • Thick seat 	+\$ 40 +\$ 40	Specify <i>with high back</i> . Specify <i>with thick seat</i> .
Glides <ul style="list-style-type: none"> • Soft felt glides for use on non-carpeted floors 	+\$ 6	Specify <i>with soft glides</i> .

▶ Detailed dimensions, page 446



For Canadian Pricing

Multiply U.S. Price by the Canadian price factor.

▶ See page 1 for details.

Specification Information

• Style • Number	• U.S. • Base • Price
---------------------	-----------------------------



Smooth Plastic Arms

475712M	\$723
----------------	-------



Textured Plastic Arms

475715M	\$723
----------------	-------



Without Arms

475710M	\$686
----------------	-------



For Canadian Pricing
Multiply U.S. Price by the
Canadian price factor.
▶ See page 1 for details.

Player 475 Series Accessories

Alignment Device

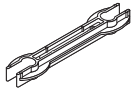

Tip: One pair is required to align two chairs.

Standard Includes

- Alignment device: black paint only
- Package of 5 pairs

Required to Specify

Style number

Specification Information

• Style • Number	• U.S. • Price
475A	\$81

Ganging Device

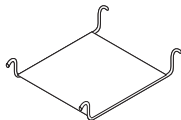

Tip: Use one ganging device for every two chairs.

Standard Includes

- Ganging device: black paint only
- Package of 2

Required to Specify

Style number

Specification Information

• Style • Number	• U.S. • Price
475G	\$101

Transport and Storage Dolly

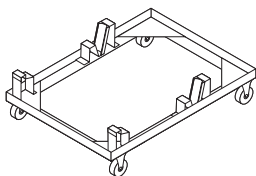

Standard Includes

- Transport and storage dolly: black paint only

Required to Specify

Style number

Specification Information

• Style • Number	• U.S. • Price
475D	\$337



For Canadian Pricing

Multiply U.S. Price by the Canadian price factor.

► See page 1 for details.

Understanding and Specifying Move 490 Series Multi-Use Chairs

Product Details

Move 490 Series	460
Dimensions	462

Specifying

Value Package Multi-Use Chairs and Stools	464
Multi-Use Chairs	466
Multi-Use Stools	470
Perching Stools	474
Accessories	477

Multi-Use Chairs

Multi-use chairs are suitable for use as occasional seating within team spaces, workstations, offices, or wherever extra seating is required.

- Player 475 Series
- Move 490 Series
- Snodgrass 474 Series

Move 490 Series

Move chairs are guest chairs that also stack. Live dynamic seat, open cantilever arm design, light weight, and strength make Move a logical choice for multipurpose areas. Move's simple design complements a broad range of work settings.

Arms are cantilevered and will easily clear the front edge of a worksurface or table. The open cantilever design of the arms allows alternative postures and sitting positions.

Steel frame is monochromatic.

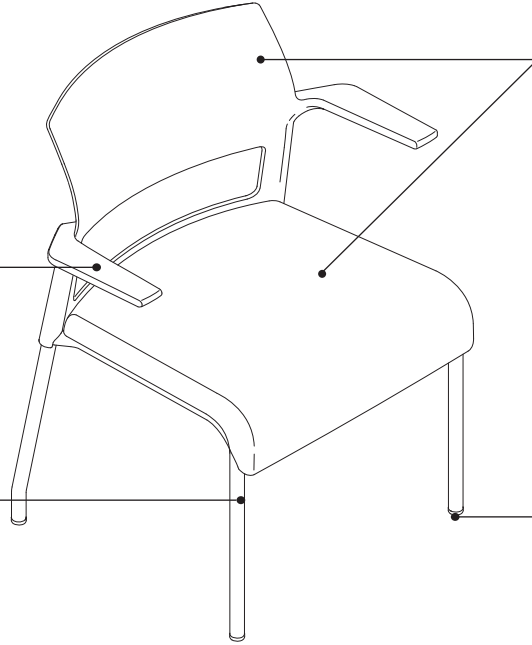

Seat and back are available in plastic or with an upholstered cushion.

Plastic glides have a hard plastic insert.

Upholstered back is available on selected styles.

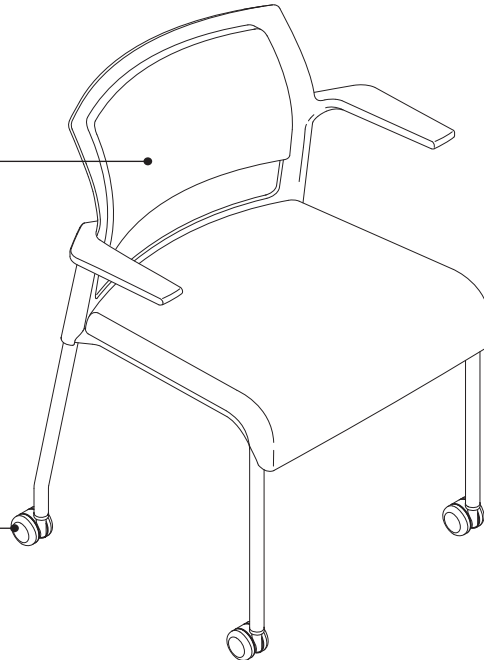

Casters have hard, dual wheels that roll smoothly on carpets. Soft, dual-wheel casters are available for use on hard floor or chair mats. Casters are available in black only.

Tip: Do not roll the chair across asphalt during installation as this may damage the casters.

Product Details

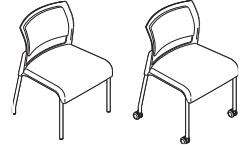
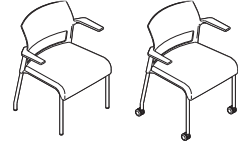

Chairs and stools have a leg-base and are available with glides or casters, and with or without arms.

Stackability for leg base chair models is five high on the floor. Stools do not stack.

Plastic glides with hard plastic inserts are recommended for carpeted surfaces.

Soft felt glides for use on non-carpeted surfaces are available as an option.

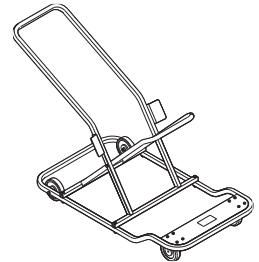

Transport and storage dolly is available to stack, move, and store up to 10 chairs.

Unloaded transport dolly measures 58½"D x 25½"W x 37½"H.

Fully loaded transport dolly measures 58½"D x 25½"W x 58½"H.

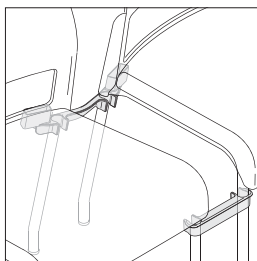

Ganging and alignment device is available to link leg-base chairs together in the field for evenly spaced rows. Chairs can be separated easily. Spacing between chairs linked with alignment device is 4" for chairs with no arms and 7" for chairs with arms.



Move wall saver is available to prevent the back of the chair from making contact with the wall.

Surface Materials

► See surface materials on page 504 for specific availability or refer to the *Surface Materials Reference Manual* for further information.

Frame

- 0835 Black
- 4799 Platinum Metallic
- 7239 Midnight

Arms

- Plastic

Back shell and seat

Price Group 1

- Plastics
- 6009 Arctic White
 - 6059 Sterling Dark Solid
 - 6205 Black
 - 6249 Platinum Solid
 - 6259 Midnight
 - 6332 Citron
 - 6333 Picasso
 - 6334 Flash
 - 6335 Wasabi
 - 6336 Jazz
 - 6337 Element
 - 6338 Chili Red
 - 6BD8 Snow
 - 6BD9 Carbon Flat
 - 6BE1 Ore

Price Group 2

- Signature Plastics
- 6BC1 Crimson
 - 6BC2 Purple
 - 6BC3 Green
 - 6BC4 Burgundy
 - 6BC5 Blue
 - 6BC6 Orange
 - 6BC7 Brown
 - 6BC8 Gold
 - 6BC9 Red
 - 6BD1 Aubergine
 - 6BD2 Peacock
 - 6BD3 Jungle
 - 6BD4 Merlot
 - 6BD5 Honey
 - 6BD6 Lagoon
 - 6BD7 Saffron

Upholstery

- Fabric
- Fabric with soil retardant treatment (option)
- Leather
- Elmosoft leather
- Select Surfaces leather
- Vinyl

Casters

- Black only

Glides

- Plastic with hard plastic inserts come standard on multi-use chairs when specified with glides. Soft glides are available as an option.

Wall saver

- 6644 Fusion Dark only

All Steelcase seating with standard upholstery fabrics complies with requirements of the State of California Technical Bulletin 117-2013. All standard seating is labeled to be in compliance with California 117-2013.

Programs & Services

► See the *Surface Materials Reference Manual* for further detail about programs and services offered for seating.

Select Surfaces

For information on products within Select Surfaces, including accent paints, Signature plastics, and fabrics from Designtex, Gabriel, Kvadrat, and Pollack, please refer to the *Surface Materials Reference Manual* or visit www.steelcase.com/selectsurfaces.

Custom Surfaces

The Customer's Own Material (COM)

Program offers the opportunity for customers to select fabrics that are not offered through the standard Steelcase surface materials program for use on Steelcase products. Through the COM program, Steelcase will test your materials for application on Steelcase products. Once approved, you can place your order. Steelcase will facilitate the entire ordering process and give you a production schedule. Steelcase will order the COM fabric directly from the textile manufacturer. For up-to-date information regarding fabric test results for all COM fabrics and details regarding yardage requirements for most Seating lines, visit the COM website. To locate the COM website:

- Visit www.steelcase.com

Soil retardants are treatments that provide long-term soil and stain resistance to a fabric without affecting the shade or the integrity of the fabric. The following Steelcase Textiles are available pre-treated with soil retardant. (You do not need to select the soil-retardant option for these fabrics and incur the upcharge.)

- Jacks
- Link
- Spyder

For information on soil retardant fabrics on Select Surfaces, please refer to the *Surface Materials Reference Manual*.

Soil-retardant treatment is available on all other seating fabrics at an additional upcharge per seating unit. To order this option, please select "Soil-Retardant Treatment" under "Optional Accessories."

For soil-retardant treatment on COMs, please select "Soil-Retardant Treatment" under "Optional Accessories." Minimums or additional yardage may be required. Please contact the vendor directly for specific information.

Extended lead times may be necessary for this service.

Contact your Steelcase Solutions Fulfillment Team Representative at 1.888.STEELCASE (1.888.783.3522) or send an email to lineone@steelcase.com.

Fire Codes

► See page 517 for upholstery fabrics available for use with FCS modification.

Steelcase offers Fire Code Seating modification (FCS) on some seating models. The most rigorous fire codes in the nation have been developed in California, and the Steelcase FCS modification is designed to meet those codes. Fire Code Seating (FCS) indicates that a product is constructed to meet the strict fire code requirements of high public occupancy areas such as theaters, meeting rooms, and lobbies. The FCS standards will meet the State of California Bureau of Electronic and Appliance Repair, Home Furnishings, and Thermal Insulation Technical Bulletin 133 (Cal TB 133). Boston adopted the California Bureau of Electronic and Appliance Repair, Home Furnishings, and Thermal Insulation Technical Bulletin TB 133 test standard in 1992.

Local codes may have special requirements for upholstery.

Dimensions

► Page 462

Resources

Printed Materials

► Move Brochure (10-0002807)

Online Resources

► Environmental profiles available on www.steelcase.com/sustainability.

Dimensions

Move 490 Series

Features	Overall Depth	Width	Height	Seat Depth	Functional Seat Depth	Seat Width	Seat Height from Floor	Back Width	Back Height from Seat
Move 490 Series									
Chair with Arms									
	20 ¹ / ₄ "	25 ³ / ₄ "	31 ¹ / ₂ "	18 ¹ / ₂ "	16 ⁷ / ₈ "	19"	18 ¹ / ₂ "	19"	15 ¹ / ₄ "
Plastic Chair with Arms									
	20 ¹ / ₄ "	25 ³ / ₄ "	31 ¹ / ₂ "	18 ¹ / ₂ "	16 ⁷ / ₈ "	18 ¹ / ₄ "	18"	19"	15 ¹ / ₂ "
Chair without Arms									
	20 ¹ / ₄ "	21"	31 ¹ / ₂ "	18 ¹ / ₂ "	16 ⁷ / ₈ "	19"	18 ¹ / ₂ "	19"	15 ¹ / ₄ "
Plastic Chair without Arms									
	20 ¹ / ₄ "	21"	31 ¹ / ₂ "	18 ¹ / ₂ "	16 ⁷ / ₈ "	18 ¹ / ₄ "	18"	19"	15 ¹ / ₂ "
Stool with Arms									
	20 ¹ / ₄ "	25 ³ / ₄ "	42 ¹ / ₂ "	18 ¹ / ₂ "	16 ⁷ / ₈ "	19"	29 ¹ / ₂ "	19"	15 ¹ / ₄ "
Plastic Stool with Arms									
	20 ¹ / ₄ "	25 ³ / ₄ "	42 ¹ / ₂ "	18 ¹ / ₂ "	16 ⁷ / ₈ "	18 ¹ / ₄ "	29"	19"	15 ¹ / ₂ "
Stool without Arms									
	20 ¹ / ₄ "	21"	42 ¹ / ₂ "	18 ¹ / ₂ "	16 ⁷ / ₈ "	19"	29 ¹ / ₂ "	19"	15 ¹ / ₄ "
Plastic Stool without Arms									
	20 ¹ / ₄ "	21"	42 ¹ / ₂ "	18 ¹ / ₂ "	16 ⁷ / ₈ "	18 ¹ / ₄ "	29"	19"	15 ¹ / ₂ "
Perching Stool with Arms									
	20 ¹ / ₄ "	25 ³ / ₄ "	40"	18 ¹ / ₂ "	16 ⁷ / ₈ "	19"	27"	19"	15 ¹ / ₄ "
Plastic Perching Stool with Arms									
	20 ¹ / ₄ "	25 ³ / ₄ "	40"	18 ¹ / ₂ "	16 ⁷ / ₈ "	18 ¹ / ₄ "	26 ¹ / ₂ "	19"	15 ¹ / ₂ "
Perching Stool without Arms									
	20 ¹ / ₄ "	21"	40"	18 ¹ / ₂ "	16 ⁷ / ₈ "	19"	27"	19"	15 ¹ / ₄ "
Plastic Perching Stool without Arms									
	20 ¹ / ₄ "	21"	40"	18 ¹ / ₂ "	16 ⁷ / ₈ "	18 ¹ / ₄ "	26 ¹ / ₂ "	19"	15 ¹ / ₂ "

• Back Lumbar Height	• Width Between Arms	• Arm to Floor	• Arm Height from Seat	• Seat Pan Angle	• Angle Between Seat and Back
----------------------	----------------------	----------------	------------------------	------------------	-------------------------------

Chair with Arms

10"	20½"	25¾"	8¾"	5°	95°
-----	------	------	-----	----	-----

Plastic Chair with Arms

10"	20½"	25¾"	8¾"	4°	96°
-----	------	------	-----	----	-----

Chair without Arms

10"	N.A.	N.A.	N.A.	5°	95°
-----	------	------	------	----	-----

Plastic Chair without Arms

10"	N.A.	N.A.	N.A.	4°	96°
-----	------	------	------	----	-----

Stool with Arms

10"	20½"	36¾"	8¾"	5°	95°
-----	------	------	-----	----	-----

Plastic Stool with Arms

10"	20½"	25¾"	8¾"	4°	96°
-----	------	------	-----	----	-----

Stool without Arms

10"	N.A.	N.A.	N.A.	5°	95°
-----	------	------	------	----	-----

Plastic Stool without Arms

10"	N.A.	N.A.	N.A.	4°	96°
-----	------	------	------	----	-----

Perching Stool with Arms

10"	20½"	34¼"	8¾"	5°	95°
-----	------	------	-----	----	-----

Plastic Perching Stool with Arms

10"	20½"	34¼"	8¾"	4°	96°
-----	------	------	-----	----	-----

Perching Stool without Arms

10"	N.A.	N.A.	N.A.	5°	95°
-----	------	------	------	----	-----

Plastic Perching Stool without Arms

10"	N.A.	N.A.	N.A.	4°	96°
-----	------	------	------	----	-----

⋮ ⋮ ⋮ ⋮ ⋮ ⋮

Move 490 Series Value Package Multi-Use Chairs and Stools

Buzz2 Fabric on Seat with Black on Frame and Back Shell

Tip: Value package chairs allow you to obtain pre-selected features at a lower price than if specifying as a standard model number.

Tip: Options or substitutions are not available on this value package.

Standard Includes	Required to Specify
<ul style="list-style-type: none"> ▶ Need help? Product details, page 460 • Frame: 0835 Black paint • Back shell: 6205 Black plastic • Seat: Buzz2 fabric • Arms, if selected: 6205 Black plastic • Glides, if selected: plastic with hard plastic inserts • Hard, dual-wheel casters, if selected: black 	<ul style="list-style-type: none"> 1 Style number 2 Buzz2 fabric color number for seat 3 Options, if selected (see below) ▶ See <i>Surface Materials</i>, page 504.

Options	U.S. Price	Required to Specify
Surface Materials <ul style="list-style-type: none"> • Fire Code Seating (FCS) 	+\$81	Add suffix F to the style number.

Specification Information	
<ul style="list-style-type: none"> • Style Number • U.S. Base Price 	

Chairs without Arms

With Glides

490410V \$295

.....

With Casters

490410VC \$348

.....

Chairs with Arms

With Glides

490412V \$357

.....

With Casters

490412VC \$410

.....

▶ **Specification Information, continued on next page**



▶ Detailed dimensions, page 462

 **For Canadian Pricing**
 Multiply U.S. Price by the Canadian price factor.
 ▶ See page 1 for details.

► Specification Information, continued from previous page

Specification Information

• Style • Number	• U.S. • Base • Price

Stools without Arms

With Glides

490710V	\$538
----------------	-------

With Casters

490710VC	\$591
-----------------	-------

Stools with Arms

With Glides

490712V	\$600
----------------	-------

With Casters

490712VC	\$653
-----------------	-------

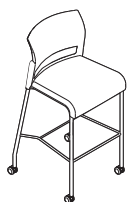
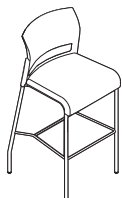

For Canadian Pricing

Multiply U.S. Price by the Canadian price factor.

► See page 1 for details.

Move 490 Series Multi-Use Chairs



Standard Includes	Required to Specify
<p>▶ Need help? Product details, page 460</p> <ul style="list-style-type: none"> • Frame: 0835 Black paint • Back shell: plastic • Seat shell, if selected: plastic • Upholstery, if selected: fabric price group 1 • Arms, if selected: plastic to match back shell • Glides, if selected: plastic with hard plastic inserts • Hard, dual-wheel casters, if selected: black 	<ol style="list-style-type: none"> 1 Style number 2 Paint color number for frame 3 Plastic color number for back shell 4 Plastic color number for seat shell, if selected 5 Fabric color number for upholstery on seat and back, or seat, if selected 6 Options, if selected (see below) <p>▶ See <i>Surface Materials</i>, page 504.</p>

Surface Materials	Options	U.S. Price	Required to Specify
	Plastic on seat shell		
	• Plastic price group 1	No cost	Specify color number. ▶ See <i>Surface Materials</i> , page 504.
	• Plastic price group 2	+\$ 23	Specify color number. ▶ See <i>Surface Materials</i> , page 504.
	Plastic on back shell		
	• Plastic price group 1	No cost	Specify color number. ▶ See <i>Surface Materials</i> , page 504.
	• Plastic price group 2	+\$ 23	Specify color number. ▶ See <i>Surface Materials</i> , page 504.
	Upholstery on seat and back		
	• Fabric price group 1	No cost	Specify fabric color number.
	• Fabric price group 2	+\$ 27	Specify fabric color number.
	• Fabric price group 3	+\$ 49	Specify fabric color number.
• Fabric price group 4	+\$ 70	Specify fabric color number.	
• Fabric price group 5	+\$ 88	Specify fabric color number.	
• Fabric price group 6	+\$125	Specify fabric color number.	
• Fabric price group 7	+\$176	Specify fabric color number.	
• Fabric price group 8	+\$233	Specify fabric color number.	
• Fabric price group 9	+\$276	Specify fabric color number.	
• Fabric price group 10	+\$321	Specify fabric color number.	
• Steelcase leather upholstery	+\$182	Specify leather color number.	
• Select Surfaces leather price group 1	+\$182	▶ See <i>Surface Materials Reference Manual</i> . Specify Elmosoft leather color number.	
• Elmosoft leather upholstery	+\$211	▶ See <i>Surface Materials Reference Manual</i> .	
• Select Surfaces leather price group 2	+\$211	▶ See <i>Surface Materials Reference Manual</i> .	
• Customer's Own Material/Vinyl (COM)	No cost	▶ See <i>Surface Materials Reference Manual</i> . Specify leather color number.	
• Customer's Own Leather (COL)	No cost		
	Contrasting upholstery on seat and back		
	• Contrasting fabrics	+\$ 33	Add suffix K to the style number and specify fabric color numbers.
	Contrasting upholstery on seat		
	• Fabric price group 1	No cost	Specify fabric color number.
	• Fabric price group 2	+\$ 10	Specify fabric color number.
	• Fabric price group 3	+\$ 27	Specify fabric color number.
	• Fabric price group 4	+\$ 36	Specify fabric color number.
	• Fabric price group 5	+\$ 43	Specify fabric color number.
	• Fabric price group 6	+\$ 53	Specify fabric color number.
	• Fabric price group 7	+\$ 64	Specify fabric color number.
• Fabric price group 8	+\$ 79	Specify fabric color number.	
• Fabric price group 9	+\$ 97	Specify fabric color number.	
• Fabric price group 10	+\$112	Specify fabric color number.	
• Steelcase leather upholstery	+\$ 91	Specify leather color number.	
• Select Surfaces leather price group 1	+\$ 91	▶ See <i>Surface Materials Reference Manual</i> . Specify Elmosoft leather color number.	
• Elmosoft leather upholstery	+\$106	▶ See <i>Surface Materials Reference Manual</i> .	
• Select Surfaces leather price group 2	+\$106	▶ See <i>Surface Materials Reference Manual</i> .	
• Customer's Own Material/Vinyl (COM)	No cost	▶ See <i>Surface Materials Reference Manual</i> . Specify leather color number.	
• Customer's Own Leather (COL)	No cost		

▶ Detailed dimensions, page 462



For Canadian Pricing

Multiply U.S. Price by the Canadian price factor.

▶ See page 1 for details.

▶ Options, continued on next page

► Options, continued from previous page

Options	U.S. Price	Required to Specify
Surface Materials, continued		
Contrasting upholstery on back		
• Fabric price group 1	No cost	Specify fabric color number.
• Fabric price group 2	+\$ 17	Specify fabric color number.
• Fabric price group 3	+\$ 22	Specify fabric color number.
• Fabric price group 4	+\$ 34	Specify fabric color number.
• Fabric price group 5	+\$ 45	Specify fabric color number.
• Fabric price group 6	+\$ 72	Specify fabric color number.
• Fabric price group 7	+\$112	Specify fabric color number.
• Fabric price group 8	+\$154	Specify fabric color number.
• Fabric price group 9	+\$179	Specify fabric color number.
• Fabric price group 10	+\$209	Specify fabric color number.
• Steelcase leather upholstery	+\$ 91	Add suffix S to the style number and specify leather color number.
• Select Surfaces leather price group 1	+\$ 91	Add suffix S to the style number and specify leather color number.
• Elmosoft leather upholstery	+\$105	Add suffix S to the style number and specify leather color number.
• Select Surfaces leather price group 2	+\$105	Add suffix S to the style number and specify leather color number.
• Customer's Own Material/Vinyl (COM)	No cost	► See <i>Surface Materials Reference Manual</i> .
• Customer's Own Leather (COL)	No cost	Specify leather color number.
• Fire Code Seating (FCS)	+\$ 81	Add suffix F to the style number.
Soil-retardant treatment		
	+\$ 27	Specify <i>with soil-retardant treatment</i> .
Frame		
• 7239 Midnight	No cost	Specify <i>with 7239 Midnight</i> .
• 4799 Platinum Metallic	+\$ 59	Specify <i>with 4799 Platinum Metallic</i> .
Glides		
• Soft felt glides for use on non-carpeted floors	+\$ 6	Specify <i>with soft glides</i> .
Casters		
• Soft, dual-wheel casters for use on hard floors	+\$ 27	Specify <i>with soft casters</i> .

Specification Information

Style Number	U.S. Base Price

Upholstered Seat without Arms

With Glides

490410	\$310
--------	-------

With Casters

490410C	\$363
---------	-------

► Specification Information, continued on next page



Tip: Plastic finish number must be specified for both seat and back on plastic styles.

► Specification Information, continued from previous page

Specification Information

• Style • Number • • •	• U.S. • Base • Price • •
------------------------------------	---------------------------------------

Upholstered Back and Seat without Arms

With Glides

490410U	\$372
•	•

With Casters

490410UC	\$425
•	•

Plastic Back and Seat without Arms

With Glides

490410P	\$244
•	•

With Casters

490410CP	\$297
•	•

Upholstered Seat with Arms

With Glides

490412	\$372
•	•

With Casters

490412C	\$425
•	•

► Specification Information, continued on next page



Tip: Plastic finish number must be specified for both seat and back on plastic styles.



For Canadian Pricing

Multiply U.S. Price by the Canadian price factor.

► See page 1 for details.

► Specification Information, continued from previous page

Specification Information

• Style • Number • •	• U.S. • Base • Price •
-------------------------------	----------------------------------

Upholstered Back and Seat with Arms

With Glides

490412U	\$434
----------------	-------

With Casters

490412UC	\$487
-----------------	-------

Plastic Back and Seat with Arms

With Glides

490412P	\$306
----------------	-------

With Casters

490412CP	\$359
-----------------	-------



Tip: Plastic finish number must be specified for both seat and back on plastic styles.



For Canadian Pricing
 Multiply U.S. Price by the Canadian price factor.
 ► See page 1 for details.

Move 490 Series Multi-Use Stools

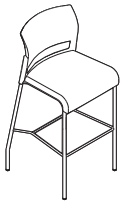

Standard Includes	Required to Specify
<ul style="list-style-type: none"> ▶ Need help? Product details, page 460 • Frame: 0835 Black paint • Back shell: plastic • Seat shell, if selected: plastic • Upholstery, if selected: fabric price group 1 • Arms, if selected: plastic to match back shell • Glides, if selected: plastic with hard plastic inserts • Hard, dual-wheel casters, if selected: black 	<ol style="list-style-type: none"> 1 Style number 2 Paint color number for frame 3 Plastic color number for back shell 4 Plastic color number for seat shell, if selected 5 Fabric color number for upholstery on seat and back, or seat, if selected 6 Options, if selected (see below) <ul style="list-style-type: none"> ▶ See <i>Surface Materials</i>, page 504.

Surface Materials	Options	U.S. Price	Required to Specify
	Plastic on seat shell		
	• Plastic price group 1	No cost	Specify color number. ▶ See <i>Surface Materials</i> , page 504.
	• Plastic price group 2	+\$ 23	Specify color number. ▶ See <i>Surface Materials</i> , page 504.
	Plastic on back shell		
	• Plastic price group 1	No cost	Specify color number. ▶ See <i>Surface Materials</i> , page 504.
	• Plastic price group 2	+\$ 23	Specify color number. ▶ See <i>Surface Materials</i> , page 504.
	Upholstery on seat and back		
	• Fabric price group 1	No cost	Specify fabric color number.
	• Fabric price group 2	+\$ 27	Specify fabric color number.
	• Fabric price group 3	+\$ 49	Specify fabric color number.
• Fabric price group 4	+\$ 70	Specify fabric color number.	
• Fabric price group 5	+\$ 88	Specify fabric color number.	
• Fabric price group 6	+\$125	Specify fabric color number.	
• Fabric price group 7	+\$176	Specify fabric color number.	
• Fabric price group 8	+\$233	Specify fabric color number.	
• Fabric price group 9	+\$276	Specify fabric color number.	
• Fabric price group 10	+\$321	Specify fabric color number.	
• Steelcase leather upholstery	+\$182	Specify leather color number.	
• Select Surfaces leather price group 1	+\$182	▶ See <i>Surface Materials Reference Manual</i> . Specify Elmosoft leather color number.	
• Elmosoft leather upholstery	+\$211	▶ See <i>Surface Materials Reference Manual</i> .	
• Select Surfaces leather price group 2	+\$211	▶ See <i>Surface Materials Reference Manual</i> .	
• Customer's Own Material/Vinyl (COM)	No cost	▶ See <i>Surface Materials Reference Manual</i> . Specify leather color number.	
• Customer's Own Leather (COL)	No cost		
	Contrasting upholstery on seat and back		
	• Contrasting fabrics	+\$ 33	Add suffix K to the style number and specify fabric color numbers.
	Contrasting upholstery on seat		
	• Fabric price group 1	No cost	Specify fabric color number.
	• Fabric price group 2	+\$ 10	Specify fabric color number.
	• Fabric price group 3	+\$ 27	Specify fabric color number.
	• Fabric price group 4	+\$ 36	Specify fabric color number.
	• Fabric price group 5	+\$ 43	Specify fabric color number.
	• Fabric price group 6	+\$ 53	Specify fabric color number.
	• Fabric price group 7	+\$ 64	Specify fabric color number.
	• Fabric price group 8	+\$ 79	Specify fabric color number.
	• Fabric price group 9	+\$ 97	Specify fabric color number.
	• Fabric price group 10	+\$112	Specify fabric color number.
	• Steelcase leather upholstery	+\$ 91	Specify leather color number.
	• Select Surfaces leather price group 1	+\$ 91	▶ See <i>Surface Materials Reference Manual</i> . Specify Elmosoft leather color number.
	• Elmosoft leather upholstery	+\$106	▶ See <i>Surface Materials Reference Manual</i> .
	• Select Surfaces leather price group 2	+\$106	▶ See <i>Surface Materials Reference Manual</i> .
	• Customer's Own Material/Vinyl (COM)	No cost	▶ See <i>Surface Materials Reference Manual</i> . Specify leather color number.
• Customer's Own Leather (COL)	No cost		

▶ Detailed dimensions, page 462



For Canadian Pricing

Multiply U.S. Price by the Canadian price factor.

▶ See page 1 for details.

▶ Options, continued on next page

► Options, continued from previous page

Options	U.S. Price	Required to Specify	
Surface Materials, continued			
Contrasting upholstery on back			
• Fabric price group 1	No cost	Specify fabric color number.	
• Fabric price group 2	+\$ 17	Specify fabric color number.	
• Fabric price group 3	+\$ 22	Specify fabric color number.	
• Fabric price group 4	+\$ 34	Specify fabric color number.	
• Fabric price group 5	+\$ 45	Specify fabric color number.	
• Fabric price group 6	+\$ 72	Specify fabric color number.	
• Fabric price group 7	+\$112	Specify fabric color number.	
• Fabric price group 8	+\$154	Specify fabric color number.	
• Fabric price group 9	+\$179	Specify fabric color number.	
• Fabric price group 10	+\$209	Specify fabric color number.	
• Steelcase leather upholstery	+\$ 91	Add suffix S to the style number and specify leather color number.	
• Select Surfaces leather price group 1	+\$ 91	Add suffix S to the style number and specify leather color number.	
• Elmosoft leather upholstery	+\$105	Add suffix S to the style number and specify leather color number.	
• Select Surfaces leather price group 2	+\$105	Add suffix S to the style number and specify leather color number.	
• Customer's Own Material/Vinyl (COM)	No cost	► See <i>Surface Materials Reference Manual</i> .	
• Customer's Own Leather (COL)	No cost	Specify leather color number.	
Fire Code Seating (FCS)	+\$ 81	Add suffix F to the style number.	
Soil-retardant treatment	+\$ 27	Specify <i>with soil-retardant treatment</i> .	
Frame			
• 7239 Midnight	No cost	Specify <i>with 7239 Midnight</i> .	
• 4799 Platinum Metallic	+\$ 59	Specify <i>with 4799 Platinum Metallic</i> .	
Glides	• Soft felt glides for use on non-carpeted floors	+\$ 6	Specify <i>with soft glides</i> .
Casters	• Soft, dual-wheel casters for use on hard floors	+\$ 27	Specify <i>with soft casters</i> .

Specification Information

Style Number	U.S. Base Price
.....

Upholstered Seat without Arms

With Glides

490710	\$553
.....

With Casters

490710C	\$606
.....

► Specification Information, continued on next page

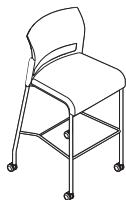
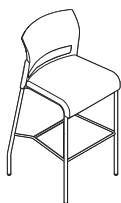
**For Canadian Pricing**

Multiply U.S. Price by the Canadian price factor.

► See page 1 for details.

► Specification Information, continued from previous page

Specification Information

• Style	• U.S.
• Number	• Base
•	• Price

Upholstered Back and Seat without Arms

With Glides

490710U	\$615
----------------	-------

With Casters

490710UC	\$668
-----------------	-------

Plastic Back and Seat without Arms

With Glides

490710P	\$479
----------------	-------

With Casters

490710CP	\$532
-----------------	-------

Upholstered Seat with Arms

With Glides

490712	\$615
---------------	-------

With Casters

490712C	\$668
----------------	-------

► Specification Information, continued on next page

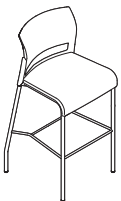
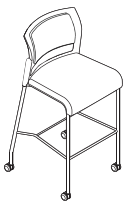
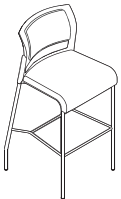

Tip: Plastic finish number must be specified for both seat and back on plastic styles.

► Specification Information, continued from previous page

Specification Information

Style Number	U.S. Base Price
--------------	-----------------

Upholstered Back and Seat with Arms

With Glides

490712U	\$677
---------	-------

With Casters

490712UC	\$730
----------	-------

Plastic Back and Seat with Arms

With Glides

490712P	\$541
---------	-------

With Casters

490712CP	\$594
----------	-------

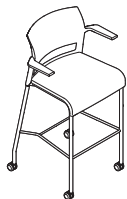
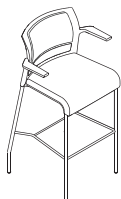

Tip: Plastic finish number must be specified for both seat and back on plastic styles.



For Canadian Pricing

Multiply U.S. Price by the Canadian price factor.

► See page 1 for details.

Move 490 Series Perching Stools

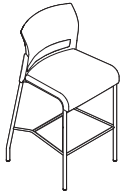

Tip: Move 490 Series stools do not stack.

Standard Includes	Required to Specify
<ul style="list-style-type: none"> ▶ Need help? Product details, page 460 • Frame: 0835 Black paint • Back shell: plastic • Seat shell, if selected: plastic • Upholstery, if selected: fabric price group 1 • Arms, if selected: plastic to match back shell • Glides, if selected: plastic with hard plastic inserts 	<ol style="list-style-type: none"> 1 Style number 2 Paint color number for frame 3 Plastic color number for back shell 4 Plastic color number for seat shell, if selected 5 Fabric color number for upholstery on seat, if selected 6 Options, if selected (see below) <p>▶ See <i>Surface Materials</i>, page 504.</p>

Surface Materials	Options	U.S. Price	Required to Specify
	Plastic on seat shell		
	• Plastic price group 1	No cost	Specify color number. ▶ See <i>Surface Materials</i> , page 504.
	• Plastic price group 2	+\$ 23	Specify color number. ▶ See <i>Surface Materials</i> , page 504.
	Plastic on back shell		
	• Plastic price group 1	No cost	Specify color number. ▶ See <i>Surface Materials</i> , page 504.
	• Plastic price group 2	+\$ 23	Specify color number. ▶ See <i>Surface Materials</i> , page 504.
	Upholstery on seat and back		
	• Fabric price group 1	No cost	Specify fabric color number.
	• Fabric price group 2	+\$ 27	Specify fabric color number.
	• Fabric price group 3	+\$ 49	Specify fabric color number.
	• Fabric price group 4	+\$ 70	Specify fabric color number.
	• Fabric price group 5	+\$ 88	Specify fabric color number.
• Fabric price group 6	+\$125	Specify fabric color number.	
• Fabric price group 7	+\$176	Specify fabric color number.	
• Fabric price group 8	+\$233	Specify fabric color number.	
• Fabric price group 9	+\$276	Specify fabric color number.	
• Fabric price group 10	+\$321	Specify fabric color number.	
• Steelcase leather upholstery	+\$182	Specify leather color number.	
• Select Surfaces leather price group 1	+\$182	▶ See <i>Surface Materials Reference Manual</i> . Specify Elmosoft leather color number.	
• Elmosoft leather upholstery	+\$211	▶ See <i>Surface Materials Reference Manual</i> .	
• Select Surfaces leather price group 2	+\$211	▶ See <i>Surface Materials Reference Manual</i> .	
• Customer's Own Material/Vinyl (COM)	No cost	▶ See <i>Surface Materials Reference Manual</i> . Specify leather color number.	
• Customer's Own Leather (COL)	No cost		
	Contrasting upholstery on seat and back		
	• Contrasting fabrics	+\$ 33	Add suffix K to the style number and specify fabric color numbers.
	Contrasting upholstery on seat		
	• Fabric price group 1	No cost	Specify fabric color number.
	• Fabric price group 2	+\$ 10	Specify fabric color number.
	• Fabric price group 3	+\$ 27	Specify fabric color number.
	• Fabric price group 4	+\$ 36	Specify fabric color number.
	• Fabric price group 5	+\$ 43	Specify fabric color number.
	• Fabric price group 6	+\$ 53	Specify fabric color number.
	• Fabric price group 7	+\$ 64	Specify fabric color number.
	• Fabric price group 8	+\$ 79	Specify fabric color number.
	• Fabric price group 9	+\$ 97	Specify fabric color number.
• Fabric price group 10	+\$112	Specify fabric color number.	
• Steelcase leather upholstery	+\$ 91	Specify leather color number.	
• Select Surfaces leather price group 1	+\$ 91	▶ See <i>Surface Materials Reference Manual</i> . Specify Elmosoft leather color number.	
• Elmosoft leather upholstery	+\$106	▶ See <i>Surface Materials Reference Manual</i> .	
• Select Surfaces leather price group 2	+\$106	▶ See <i>Surface Materials Reference Manual</i> .	
• Customer's Own Material/Vinyl (COM)	No cost	▶ See <i>Surface Materials Reference Manual</i> . Specify leather color number.	
• Customer's Own Leather (COL)	No cost		

▶ Detailed dimensions, page 462



For Canadian Pricing

Multiply U.S. Price by the Canadian price factor.

▶ See page 1 for details.

▶ Options, continued on next page

► Options, continued from previous page

Options	U.S. Price	Required to Specify
Surface Materials, continued		
Contrasting upholstery on back		
• Fabric price group 1	No cost	Specify fabric color number.
• Fabric price group 2	+\$ 17	Specify fabric color number.
• Fabric price group 3	+\$ 22	Specify fabric color number.
• Fabric price group 4	+\$ 34	Specify fabric color number.
• Fabric price group 5	+\$ 45	Specify fabric color number.
• Fabric price group 6	+\$ 72	Specify fabric color number.
• Fabric price group 7	+\$112	Specify fabric color number.
• Fabric price group 8	+\$154	Specify fabric color number.
• Fabric price group 9	+\$179	Specify fabric color number.
• Fabric price group 10	+\$209	Specify fabric color number.
• Steelcase leather upholstery	+\$ 91	Add suffix S to the style number and specify leather color number.
• Select Surfaces leather price group 1	+\$ 91	Add suffix S to the style number and specify leather color number.
• Elmosoft leather upholstery	+\$105	Add suffix S to the style number and specify leather color number.
• Select Surfaces leather price group 2	+\$105	Add suffix S to the style number and specify leather color number.
• Customer's Own Material/Vinyl (COM)	No cost	► See <i>Surface Materials Reference Manual</i> .
• Customer's Own Leather (COL)	No cost	Specify leather color number.
Fire Code Seating (FCS)		
	+\$ 81	Add suffix F to the style number.
Soil-retardant treatment		
	+\$ 27	Specify <i>with soil-retardant treatment</i> .
Frame		
• 7239 Midnight	No cost	Specify <i>with 7239 Midnight</i> .
• 4799 Platinum Metallic	+\$ 59	Specify <i>with 4799 Platinum Metallic</i> .
Glides		
• Soft felt glides for use on non-carpeted floors	+\$ 6	Specify <i>with soft glides</i> .

Specification Information

Style Number	U.S. Base Price

Upholstered Seat without Arms

490510	\$553

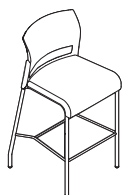

Upholstered Back and Seat without Arms

490510U	\$615

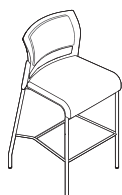

► Specification Information, continued on next page

Tip: Plastic finish number must be specified for both seat and back on plastic styles.

For Canadian Pricing
Multiply U.S. Price by the Canadian price factor.
► See page 1 for details.

► Specification Information, continued from previous page

Specification Information

• Style • Number • • •	• U.S. • Base • Price • •
------------------------------------	---------------------------------------

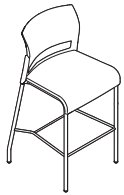

Plastic Back and Seat without Arms

490510P	\$479
•	•



Upholstered Seat with Arms

490512	\$615
•	•

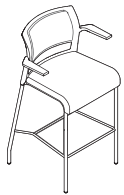

Upholstered Back and Seat with Arms

490512U	\$677
•	•



Plastic Back and Seat with Arms

490512P	\$541
•	•

Tip: Plastic finish number must be specified for both seat and back on plastic styles.

 **For Canadian Pricing**
 Multiply U.S. Price by the Canadian price factor.
 ► See page 1 for details.

Ganging and Alignment Device

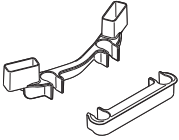

Tip: One pair is required to align two chairs. The 4" device is used for armless chairs and the 7" device is used for chairs with arms.

Standard Includes

- Alignment device: black plastic only
- Package of two

Required to Specify

Style number

Specification Information

• Style Number	• Width	• U.S. Price
490GA4	4"	\$40
490GA7	7"	\$40
•	•	•

Transport and Storage Dolly

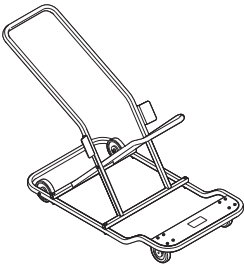

Standard Includes

- Transport and storage dolly: black paint only

Required to Specify

Style number

Specification Information

• Style Number	• U.S. Price
490D	\$781
•	•

Wall Saver



Tip: Wall saver package is for use on Move chair styles only.

Tip: One pair is required for each chair.

Standard Includes

- Package of four
- Plastic: 6644 Fusion Dark only

Required to Specify

Style number

Specification Information

• Style Number	• Width	• U.S. Price
490WS	4"	\$53
•	•	•



For Canadian Pricing

Multiply U.S. Price by the Canadian price factor.

► See page 1 for details.

Understanding and Specifying Snodgrass 474 Series Multi-Use Chairs

Understanding Snodgrass 474 Series

Snodgrass 474 Series	480
Dimensions	482

Specifying Snodgrass 474 Series

Multi-Use Chairs	484
------------------	-----

Multi-Use Chairs

Multi-use chairs are suitable for use as occasional seating within team spaces, workstations, offices, or wherever extra seating is required.

- Player 475 Series
- Move 490 Series
- Snodgrass 474 Series

Snodgrass 474 Series

Snodgrass, designed by Warren Snodgrass, offers guest and occasional seating of classic simplicity. With a choice of metal or wood frames, Snodgrass has enduring design that is always in style.

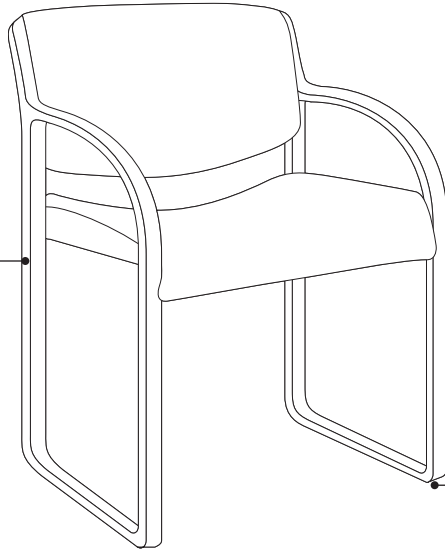

Frame is available in monochromatic colors or wood veneer.

Glides are clear plastic.

Product Details

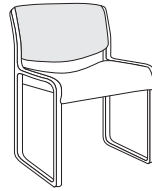

One back shape is available, open back.

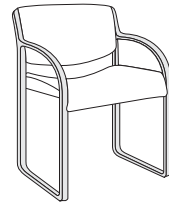

Open arms are available on monochromatic and wood models. Armless chairs are available monochromatic only.

Surface Materials

▶ See surface materials on page 504 for specific availability or refer to the *Surface Materials Reference Manual* for further information.

Upholstery

- Fabric
- Fabric with soil retardant treatment (option)
- Leather
- Elmosoft leather
- Select Surfaces leather
- Vinyl

Frame

- Monochromatic color from list of seating plastic color numbers can be applied to the frame.
- Wood

Tip: Frames are constructed of solid maple. Finishes applied to maple will match the color of stains applied to oak, walnut, or cherry, but will not show the same natural grain.

Glides

- Clear plastic

All Steelcase seating with standard upholstery fabrics

complies with requirements of the State of California Technical Bulletin 117-2013. All standard seating is labeled to be in compliance with California 117-2013.

Programs & Services

▶ See the *Surface Materials Reference Manual* for further detail about programs and services offered for seating.

The Customer's Own Material (COM) Program

offers the opportunity for customers to select fabrics that are not offered through the standard Steelcase surface materials program for use on Steelcase products. Through the COM program, Steelcase will test your materials for application on Steelcase products. Once approved, you can place your order. Steelcase will facilitate the entire ordering process and give you a production schedule. Steelcase will order the COM fabric directly from the textile manufacturer. For up-to-date information regarding fabric test results for all COM fabrics and details regarding yardage requirements for most Seating lines, visit the COM website. To locate the COM website:

- Visit www.steelcase.com

Soil retardants are treatments that provide long-term soil and stain resistance to a fabric without affecting the shade or the integrity of the fabric. The following Steelcase Textiles are available pre-treated with soil retardant. (You do not need to select the soil-retardant option for these fabrics and incur the upcharge.)

- Jacks
- Link
- Spyder

For information on soil retardant fabrics on Select Surfaces, please refer to the *Surface Materials Reference Manual*.

Soil-retardant treatment is available on all other seating fabrics at an additional upcharge per seating unit. To order this option, please select "Soil-Retardant Treatment" under "Optional Accessories."

For soil-retardant treatment on COMs, please select "Soil-Retardant Treatment" under "Optional Accessories." Minimums or additional yardage may be required. Please contact the vendor directly for specific information.

Soil-retardant treatment is available on all other seating fabrics at an additional upcharge per seating unit. To order this option, please select "Soil-Retardant Treatment" under "Optional Accessories."

For soil-retardant treatment on COMs, please select "Soil-Retardant Treatment" under "Optional Accessories." Minimums or additional yardage may be required. Please contact the vendor directly for specific information.

Extended lead times may be necessary for this service.

Contact your Steelcase Solutions Fulfillment Team Representative at 1.888.STEELCASE (1.888.783.3522) or send an email to lineone@steelcase.com.

Dimensions

▶ Page 482

Resources

Printed Materials

- ▶ Snodgrass Brochure (11-0002246)
- ▶ Wood Solutions Overview Brochure (09-0000206)

Online Resources

- ▶ Environmental profiles available on www.steelcase.com/sustainability.

Dimensions

Snodgrass 474 Series

• Features	• Overall Depth	Width	Height	• Seat Depth	• Functional Seat Depth	• Seat Width	• Seat Height from Floor	• Back Width	• Back Height from Seat
------------	-----------------	-------	--------	--------------	-------------------------	--------------	--------------------------	--------------	-------------------------

Snodgrass 474 Series

Chair with Open Loop Arms

	23½"	22¾"	31½"	21"	17½"	20"	18¼"	20"	14¼"
--	------	------	------	-----	------	-----	------	-----	------

Chair without Arms

	23½"	22¾"	31½"	21"	17½"	20"	18¼"	20"	14¼"
--	------	------	------	-----	------	-----	------	-----	------

⋮ ⋮ ⋮ ⋮ ⋮ ⋮ ⋮ ⋮ ⋮ ⋮

• Back Lumbar Height	• Width Between Arms	• Arm to Floor	• Arm Height from Seat	• Seat Pan Angle	• Angle Between Seat and Back
----------------------	----------------------	----------------	------------------------	------------------	-------------------------------

Chair with Open Loop Arms

7"	20"	25¼"	7"	5°	103°
----	-----	------	----	----	------

Chair without Arms

7"	20"	25¼"	7"	5°	103°
----	-----	------	----	----	------

Snodgrass 474 Series Multi-Use Chairs

Standard Includes	Required to Specify
<ul style="list-style-type: none"> ▶ Need help? Product details, page 480 • Frame and arms, if selected: monochromatic color, or wood veneer • Upholstery: fabric price group 1 • Glides: clear plastic 	<ol style="list-style-type: none"> 1 Style number 2 Fabric color number for upholstery 3 Monochromatic color number from seating plastic colors for frame, if applicable 4 Wood veneer color number for frame, if applicable 5 Options, if selected (see below) <ul style="list-style-type: none"> ▶ See <i>Surface Materials</i>, page 504.

Options	U.S. Price	Required to Specify
Surface Materials Upholstery <ul style="list-style-type: none"> • Fabric price group 1 • Fabric price group 2 • Fabric price group 3 • Fabric price group 4 • Fabric price group 5 • Fabric price group 6 • Fabric price group 7 • Fabric price group 8 • Fabric price group 9 • Fabric price group 10 • Leather price group • Select Surfaces leather price group 1 • Elmosoft leather upholstery • Select Surfaces leather price group 2 • Customer's Own Material (COM) or Customer's Own Leather (COL) • Soil-retardant treatment applied to upholstery fabric 	No cost +\$ 27 +\$ 49 +\$ 70 +\$ 88 +\$109 +\$125 +\$158 +\$194 +\$219 +\$564 +\$564 +\$652 +\$652 +\$ 38 +\$ 27	Specify fabric color number. Specify fabric color number. Specify fabric color number. Specify fabric color number. Specify fabric color number. Specify fabric color number. Specify fabric color number. Specify fabric color number. Specify fabric color number. Specify leather color number. ▶ See <i>Surface Materials Reference Manual</i> . Specify Elmosoft leather color number. ▶ See <i>Surface Materials Reference Manual</i> . ▶ See <i>Surface Materials Reference Manual</i> . Specify <i>with soil-retardant treatment</i> .
Frame <ul style="list-style-type: none"> • Customiz stain on wood 	No cost	Specify <i>with Customiz stain</i> . ▶ See <i>Surface Materials Reference Manual</i> .

Specification Information

Open Loop Arms with Open Back



• Style Number

• U.S. Base Price

Armless with Open Back



• Style Number

• U.S. Base Price

Monochromatic

474419M \$ 900

474410M \$856

Wood

474419W \$1198

▶ Detailed dimensions, page 482



For Canadian Pricing

Multiply U.S. Price by the Canadian price factor.

▶ See page 1 for details.

Understanding and Specifying Nooi by Wiesner Hager Multi-Use Chairs

Product Details

Nooi by Wiesner Hager **486**

Specifying

Nooi Frame Linking Chairs **488**
Nooi Sled-Base Chair **490**
Nooi Cafeteria Chairs **491**
Nooi Stools **492**

Nooi by Wiesner
Hager

Multi-Use Chairs

Multi-use chairs are suitable for use as occasional seating within team spaces, workstations, offices, or wherever extra seating is required.

- Player 475 Series
- Move 490 Series
- Snodgrass 474 Series

Nooi by Wiesner Hager

Nooi chairs by Wiesner Hager are multi-use chairs that can also stack. Nooi's sophisticated design and versatile statement of line provides choice and control in a broad range of spaces.

Arms are available on select styles.

Seat and back are one integrated plastic shell. The interior shell is textured, while the exterior shell is high gloss, enhancing the product design.

Glides are available in hard and soft options.

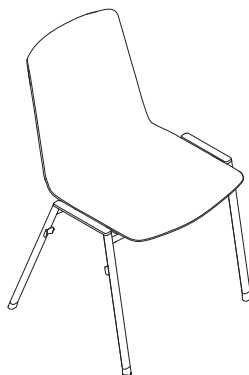
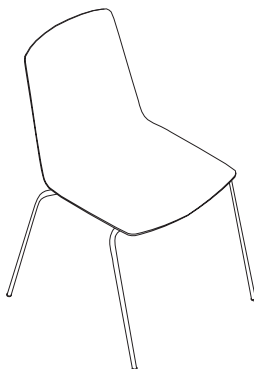
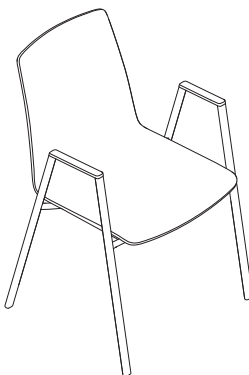
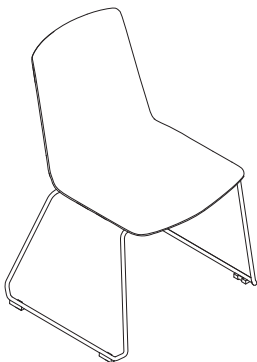
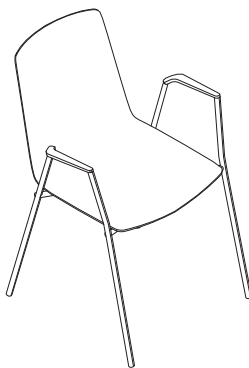
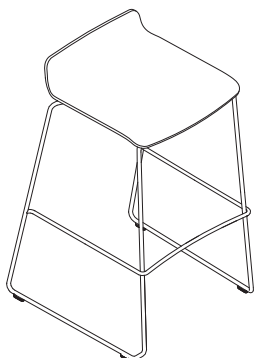

Product Details

Stackability varies by style number. See specific style number product page for details.

Hard glides are required for carpeted surfaces and soft glides are required for non-carpeted surfaces.

Surface Materials

Frame

- 0835 Black
- 4242 Milk
- 4799 Platinum Metallic
- 4H04 Chrome

Arm pad cover

- WH95 Black
- WH96 White

Frame cover

- WH95 Black
- WH96 White

Shell

- WH69 White/Light Green
- WH71 White/Mocca Anthracite
- WH72 Black/Black
- WH73 White/White
- WH74 Mocca Anthracite/Mocca Anthracite
- WH75 White/Light Blue
- WH76 White/Yellow
- WH77 White/Terra
- WH78 White/Warm Grey
- WH79 White/Black

Tip: The first color listed for each finish number represents the interior textured shell color. The color listed after the backslash for each finish number represents the exterior high-gloss shell color.

Nooi Frame Linking Chairs by Wiesner Hager



Tip: The first color indicates the interior textured shell color. The color after the backslash indicates the exterior high-gloss shell color.

Tip: Hard glides are required for carpeted surfaces and soft glides are required for non-carpeted surfaces.

Standard Includes	Required to Specify
<ul style="list-style-type: none"> ▶ Need help? Product details, page 486 • Shell: plastic price group 1 • Frame color: paint price group 1 • Frame cover, if armless chair is selected: plastic price group 1 • Arm pad cover, if chair with arms is selected: plastic price group 1 	<ol style="list-style-type: none"> 1 Style number 2 Plastic color number for shell 3 Paint color number for frame 4 Plastic color number for arm pad cover, if selected 5 Plastic color number for frame cover, if selected 6 Options, if selected (see below)

Surface Materials	Options	U.S. Price	Required to Specify
	Shell		
	• WH69 White/Light Green	No cost	Specify with WH69 White/Light Green.
	• WH71 White/Mocca Anthracite	No cost	Specify with WG71 White/Mocca Anthracite.
	• WH72 Black/Black	No cost	Specify with WH72 Black/Black.
	• WH73 White/White	No cost	Specify with WH73 White/White.
	• WH74 Mocca Anthracite/Mocca Anthracite	No cost	Specify with WH74 Mocca Anthracite/Mocca Anthracite.
	• WH75 White/Light Blue	No cost	Specify with WH75 White/Light Blue.
	• WH76 White/Yellow	No cost	Specify with WH76 White/Yellow.
	• WH77 White/Terra	No cost	Specify with WH77 White/Terra.
	• WH78 White/Warm Grey	No cost	Specify with WH78 White/Warm Grey.
	• WH79 White/Black	No cost	Specify with WH79 White/Black.
		Frame color on WHG6600	
	• 0835 Black	No cost	Specify with 0835 Black.
	• 4242 Milk	No cost	Specify with 4242 Milk.
	• 4799 Platinum Metallic	+\$15	Specify with 4799 Platinum Metallic.
	• WH04 Chrome	+\$50	Specify with WH04 Chrome.
	Frame color on WHG6602		
	• 0835 Black	No cost	Specify with 0835 Black.
	• 4242 Milk	No cost	Specify with 4242 Milk.
	• 4799 Platinum Metallic	+\$15	Specify with 4799 Platinum Metallic.
	• WH04 Chrome	+\$75	Specify with WH04 Chrome.
	Frame cover on WHG6600		
	• WH95 Black	No cost	Specify with WH95 Black.
	• WH96 Milk	No cost	Specify with WH96 Milk.
	Arm pad cover on WHG6602		
	• WH95 Black	No cost	Specify with WH95 Black.
	• WH96 Milk	No cost	Specify with WH96 Milk.
	Glides		
	• Hard	No cost	Specify with hard glides.
	• Soft	No cost	Specify with soft glides.

 **For Canadian Pricing**
 Multiply U.S. Price by the Canadian price factor.
 ▶ See page 1 for details.

Specification Information

• Style • Number	• U.S. • Base • Price
•	•
•	•



Frame Linking Chair, Armless

WHG6600 \$500



Frame Linking Chair with Arms

WHG6602 \$550

Nooi by Wiesner
Hager

 **For Canadian Pricing**
Multiply U.S. Price by the
Canadian price factor.
▶ See page 1 for details.

Nooi Sled-Base Chair by Wiesner Hager

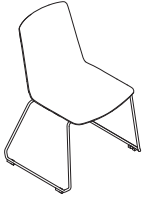

Tip: The first color indicates the interior, textured shell color. The color after the backslash indicates the exterior, high-gloss shell color.

Tip: Hard glides are required for carpeted surfaces and soft glides are required for non-carpeted surfaces.

Standard Includes		Required to Specify
<ul style="list-style-type: none"> ▶ Need help? Product details, page 486 	<ul style="list-style-type: none"> • Shell: plastic price group 1 • Frame color: paint price group 1 	<ol style="list-style-type: none"> 1 Style number 2 Plastic color number for shell 3 Paint color number for frame 4 Options, if selected (see below)

Options	U.S. Price	Required to Specify
Surface Materials		
Shell		
• WH69 White/Light Green	No cost	Specify with WH69 White/Light Green.
• WH71 White/Mocca Anthracite	No cost	Specify with WG71 White/Mocca Anthracite.
• WH72 Black/Black	No cost	Specify with WH72 Black/Black.
• WH73 White/White	No cost	Specify with WH73 White/White.
• WH74 Mocca Anthracite/Mocca Anthracite	No cost	Specify with WH74 Mocca Anthracite/Mocca Anthracite.
• WH75 White/Light Blue	No cost	Specify with WH75 White/Light Blue.
• WH76 White/Yellow	No cost	Specify with WH76 White/Yellow.
• WH77 White/Terra	No cost	Specify with WH77 White/Terra.
• WH78 White/Warm Grey	No cost	Specify with WH78 White/Warm Grey.
• WH79 White/Black	No cost	Specify with WH79 White/Black.
Frame color		
• 0835 Black	No cost	Specify with 0835 Black.
• 4242 Milk	No cost	Specify with 4242 Milk.
• 4799 Platinum Metallic	+\$15	Specify with 4799 Platinum Metallic.
• WH04 Chrome	+\$50	Specify with WH04 Chrome.
Glides		
• Hard	No cost	Specify with hard glides.
• Soft	No cost	Specify with soft glides.

Specification Information	
Style Number	U.S. Base Price
WHG6604	\$450

 **For Canadian Pricing**
 Multiply U.S. Price by the Canadian price factor.
 ▶ See page 1 for details.

Nooi Cafeteria Chairs by Wiesner Hager

Nooi Cafeteria Chairs by
Wiesner Hager

Standard Includes	Required to Specify
<ul style="list-style-type: none"> ▶ Need help? Product details, page 486 • Shell: plastic price group 1 • Frame color: paint price group 1 • Arm pad cover, if chair with arms is selected: plastic price group 1 	<ol style="list-style-type: none"> 1 Style number 2 Plastic color number for shell 3 Paint color number for frame 4 Plastic color number for plastic, if selected 5 Options, if selected (see below)

Tip: The first color indicates the interior, textured shell color. The color after the backslash indicates the exterior, high-gloss shell color.

Surface Materials	Options	U.S. Price	Required to Specify	
	Shell			
	• WH69 White/Light Green	No cost	Specify with WH69 White/Light Green.	
	• WH71 White/Mocca Anthracite	No cost	Specify with WG71 White/Mocca Anthracite.	
	• WH72 Black/Black	No cost	Specify with WH72 Black/Black.	
	• WH73 White/White	No cost	Specify with WH73 White/White.	
	• WH74 Mocca Anthracite/Mocca Anthracite	No cost	Specify with WH74 Mocca Anthracite/Mocca Anthracite.	
	• WH75 White/Light Blue	No cost	Specify with WH75 White/Light Blue.	
	• WH76 White/Yellow	No cost	Specify with WH76 White/Yellow.	
	• WH77 White/Terra	No cost	Specify with WH77 White/Terra.	
	• WH78 White/Warm Grey	No cost	Specify with WH78 White/Warm Grey.	
	• WH79 White/Black	No cost	Specify with WH79 White/Black.	
	Frame color			
	• 0835 Black	No cost	Specify with 0835 Black.	
	• 4242 Milk	No cost	Specify with 4242 Milk.	
	• 4799 Platinum Metallic	+\$15	Specify with 4799 Platinum Metallic.	
	Arm pad cover on WHG6608			
	• WH95 Black	No cost	Specify with WH95 Black.	
	• WH95 Milk	No cost	Specify with WH96 Milk.	
	Glides	• Hard	No cost	Specify with hard glides.
		• Soft	No cost	Specify with soft glides.

Tip: Hard glides are required for carpeted surfaces and soft glides are required for non-carpeted surfaces.

Specification Information	
Style Number	U.S. Base Price

Cafeteria Chair, Armless

WHG6606 \$400

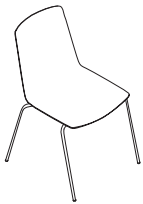

Cafeteria Chair with Arms

WHG6608 \$450



Nooi by Wiesner Hager

Nooi Stools by Wiesner Hager



Tip: The first color indicates the interior, textured shell color. The color after the backslash indicates the exterior, high-gloss shell color.

Tip: Hard glides are required for carpeted surfaces and soft glides are required for non-carpeted surfaces.

Standard Includes		Required to Specify
<ul style="list-style-type: none"> ▶ Need help? Product details, page 486 	<ul style="list-style-type: none"> • Shell: plastic price group 1 • Frame color: paint price group 1 	<ol style="list-style-type: none"> 1 Style number 2 Plastic color number for shell 3 Paint color number for frame 4 Options, if selected (see below)

Options	U.S. Price	Required to Specify
Surface Materials		
Shell		
• WH69 White/Light Green	No cost	Specify with WH69 White/Light Green.
• WH71 White/Mocca Anthracite	No cost	Specify with WG71 White/Mocca Anthracite.
• WH72 Black/Black	No cost	Specify with WH72 Black/Black.
• WH73 White/White	No cost	Specify with WH73 White/White.
• WH74 Mocca Anthracite/Mocca Anthracite	No cost	Specify with WH74 Mocca Anthracite/Mocca Anthracite.
• WH75 White/Light Blue	No cost	Specify with WH75 White/Light Blue.
• WH76 White/Yellow	No cost	Specify with WH76 White/Yellow.
• WH77 White/Terra	No cost	Specify with WH77 White/Terra.
• WH78 White/Warm Grey	No cost	Specify with WH78 White/Warm Grey.
• WH79 White/Black	No cost	Specify with WH79 White/Black.
Frame color		
• 0835 Black	No cost	Specify with 0835 Black.
• 4242 Milk	No cost	Specify with 4242 Milk.
• 4799 Platinum Metallic	+\$15	Specify with 4799 Platinum Metallic.
• WH04 Chrome	+\$75	Specify with WH04 Chrome.
Glides		
• Hard	No cost	Specify with hard glides.
• Soft	No cost	Specify with soft glides.

Specification Information	
• Style Number	• U.S. Base Price
•	•
•	•

Bar-Height Stool	
WHG6625	\$625
•	•

Café-Height Stool	
WHG6626	\$600
•	•

 **For Canadian Pricing**
 Multiply U.S. Price by the Canadian price factor.
 ▶ See page 1 for details.

Stackable Chairs

Max-Stacker III 477 Series

495

Understanding and Specifying Max-Stacker III 477 Series Stackable Chair

Product Details

Max-Stacker III 477 Series	496
Dimensions	498

Specifying

Stackable Chair	500
Accessories	501

Stackable Chairs

Stackable chairs offer flexibility and ease of use in classrooms, auditoriums, or wherever extra seating is required.

- Max-Stacker III 477 Series
- Player 475 Series
Leg-Base Chairs

Max-Stacker III 477 Series

Max-Stacker III is a stacking chair perfect for high traffic areas. With a new texture and an updated finish offering, it fits into any environment.

Tablet arms and bookracks are available factory or field installed.

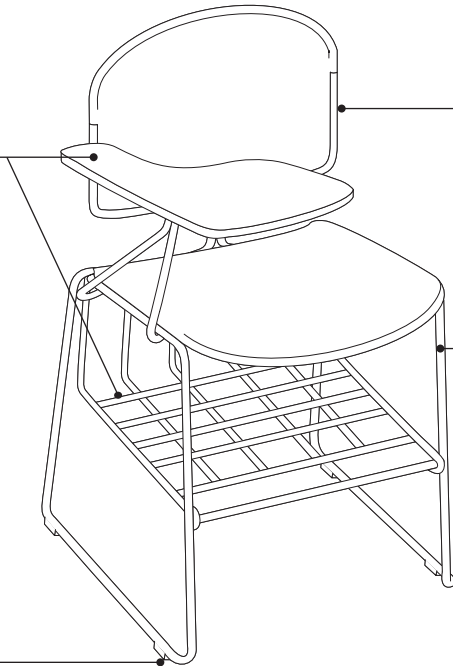

Shell is available in flexible, contoured plastic.

Two-piece wire-rod frame is $\frac{7}{16}$ " diameter carbon steel for strength and durability.

Plastic glides are standard. Soft felt glides, optional, are recommended for use on non-carpeted floors.

Product Details

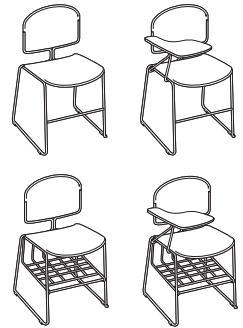

Four configurations are available—chairs without arms, chairs with bookracks, chairs with tablet arms, and chairs with a combination of bookrack and tablet arm.

Max-Stacker III can stack up to 12 chairs high when stacked on the floor.

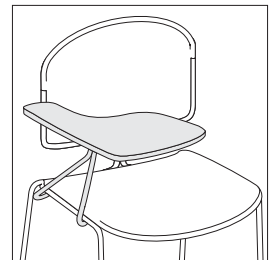

Tablet arms provide a writing surface that is $12\frac{1}{2}$ "D x $11\frac{3}{8}$ "W. They are available in left- or right-hand models.

Clearance between tablet arm and seat is $7\frac{1}{4}$ "H. Tablet arm tilts for easy entrance and exit from chair.

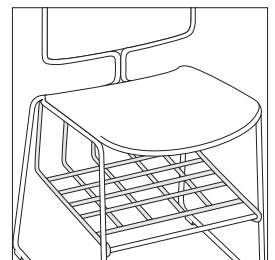

Bookrack is available factory or field installed for convenient storage of notebooks and purses.

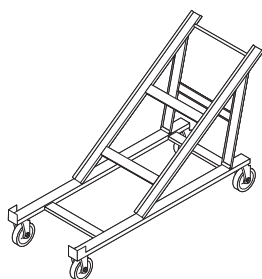

Transport and storage dolly is available to stack, move, and store up to 45 chairs. Chairs with book-racks and tablet arms cannot be stacked.

Unloaded transport dolly measures 55"D x 22"W x 37½"H.

Fully loaded transport dolly measures 57"D x 22"W x 68½"H.

Without transport dolly stack can be up to 12 chairs high.

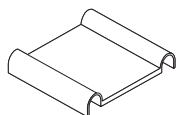

Alignment device is available to temporarily link chairs together in the field for evenly spaced rows. Chairs can be unlinked easily. Spacing between chairs linked with alignment device is 2¼".

Surface Materials

▶ See surface materials on page 504 for specific availability or refer to the *Surface Materials Reference Manual* for further information.

Hard components (frame)

- 4799 Platinum Metallic
- 7000 Black
- 7239 Midnight
- 9201 Polished Chrome

Lux Coatings

- 4B20 Obsidian
- 4B22 Matte Brass
- 4B23 Burnished Bronze
- 4B24 Night Bronze
- 4B25 Matte Copper

Shell

Price Group 1

- Plastics
- 6009 Arctic White
 - 6059 Sterling Dark Solid
 - 6205 Black
 - 6249 Platinum Solid
 - 6259 Midnight
 - 6332 Citron
 - 6333 Picasso
 - 6334 Flash
 - 6335 Wasabi
 - 6336 Jazz
 - 6337 Element
 - 6338 Chili Red
 - 6BD8 Snow
 - 6BD9 Carbon Flat
 - 6BE1 Ore

Price Group 2

- Signature Plastics
- 6BC1 Crimson
 - 6BC2 Purple
 - 6BC3 Green
 - 6BC4 Burgundy
 - 6BC5 Blue
 - 6BC6 Orange
 - 6BC7 Brown
 - 6BC8 Gold
 - 6BC9 Red
 - 6BD1 Aubergine
 - 6BD2 Peacock
 - 6BD3 Jungle
 - 6BD4 Merlot
 - 6BD5 Honey
 - 6BD6 Lagoon
 - 6BD7 Saffron

Bookrack

- Coated to match the frame color on seating coated models
- 9201 Polished Chrome on Polished Chrome models
- 4B20 Obsidian
- 4B22 Matte Brass
- 4B23 Burnished Bronze
- 4B24 Night Bronze
- 4B25 Matte Copper

Tablet arms

- Laminate

Glides

- Clear plastic
- Soft

Programs & Services

▶ See the *Surface Materials Reference Manual* for further detail about programs and services offered for seating.

Dimensions

▶ Page 498

Resources

Printed Materials

▶ Max-Stacker Brochure (11-0002245)

Online Resources

▶ Environmental profiles available on www.steelcase.com/sustainability.

Dimensions

Max-Stacker III 477 Series

• Features	• Overall Depth	Width	Height	• Seat Depth	• Functional Seat Depth	• Seat Width	• Seat Height from Floor	• Back Width	• Back Height from Seat	• Back Lumbar Height
Max-Stacker III 477 Series										
	21½"	20"	30¼"	17¾"	16¾"	18¼"	17½"	18¼"	14¾"	9½"

•Width •Between •Arms	•Arm •to •Floor	•Arm •Height •from •Seat	•Seat •Pan •Angle	•Angle •Between •Seat and •Back
-----------------------------	-----------------------	-----------------------------------	-------------------------	--

N.A.	N.A.	N.A.	8°	93°
------	------	------	----	-----

Max-Stacker III 477 Series Stackable Chair



Standard Includes	Required to Specify
<p>► Need help? Product details, page 496</p> <ul style="list-style-type: none"> • Frame: 7000 Black paint • Shell: plastic • Tablet arm, if selected: laminate • Bookrack, if selected: high-wear coating or 9201 Polished Chrome • Glides: plastic 	<ol style="list-style-type: none"> 1 Style number 2 Seating coating color number for frame 3 Plastic color number for shell 4 Laminate color number for tablet arm, if selected (see below under Required Selections) 5 High-wear coating or 9201 Polished Chrome for bookrack, if selected (see below under Required Selections) 6 Options, if selected (see below) <p>► See <i>Surface Materials</i>, page 504.</p>

Required Selections	U.S. Price	Required to Specify
<p>Tablet</p> <ul style="list-style-type: none"> • No tablet • Tablet left • Tablet right 	<p>No cost +\$163 +\$163</p>	<p>Specify <i>with no tablet</i>. Specify <i>with tablet arm left</i> and select laminate color number. Specify <i>with tablet arm right</i> and select laminate color number.</p>
<p>Bookrack</p> <ul style="list-style-type: none"> • No bookrack • Bookrack 	<p>No cost +\$ 98</p>	<p>Specify <i>with no bookrack</i>. Specify <i>with bookrack</i> and select color number.</p>

Options	U.S. Price	Required to Specify
<p>Surface Materials</p> <p>Frame</p> <ul style="list-style-type: none"> • 7239 Midnight • 4799 Platinum Metallic • 9201 Polished Chrome • Lux Coatings 	<p>No cost +\$ 32 +\$ 32 +\$ 62</p>	<p>Specify <i>with 7239 Midnight</i>. Specify <i>with 4799 Platinum Metallic</i>. Specify <i>with 9201 Polished Chrome</i>. Specify Lux Coatings color number. ► See <i>Surface Materials</i>, page 504.</p>
<p>Shell</p> <ul style="list-style-type: none"> • Plastic price group 1 • Plastic price group 2 	<p>No cost +\$ 28</p>	<p>Specify color number. ► See <i>Surface Materials</i>, page 504. Specify color number. ► See <i>Surface Materials</i>, page 504.</p>
<p>Glides</p> <ul style="list-style-type: none"> • Soft glides for use on non-carpeted floors 	<p>+\$ 6</p>	<p>Specify <i>with soft glides</i>.</p>

Specification Information

Style Number	U.S. Base Price
477100	\$219

► Detailed dimensions, page 498



For Canadian Pricing

Multiply U.S. Price by the Canadian price factor.

► See page 1 for details.

Tablet Arm Assembly

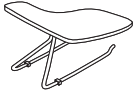

Standard Includes		Required to Specify	
<ul style="list-style-type: none"> • Tablet arm frame: paint price group 1 • Tablet arm worksurface: laminate 		<ol style="list-style-type: none"> 1 Style number 2 Laminate color number 3 Paint color number for tablet arm frame 4 Options, if selected (see below) 	
Surface Materials	Options	U.S. Price	Required to Specify
	Frame <ul style="list-style-type: none"> • Paint price group 1 • 4799 Platinum Metallic • 9201 Polished Chrome • Lux Coatings 	No cost +\$32 +\$32 +\$62	Specify paint color number. Specify <i>with 4799 Platinum Metallic</i> . Specify <i>with 9201 Polished Chrome</i> . Specify Lux Coatings color number. ▶ See <i>Surface Materials</i> , page 504.

Specification Information	
Style Number	U.S. Base Price
Right-Hand	
472TAR	\$169
Left-Hand	
472TAL	\$169

Bookrack Assembly



Standard Includes		Required to Specify	
<ul style="list-style-type: none"> • Bookrack assembly: paint price group 1 		<ol style="list-style-type: none"> 1 Style number 2 Paint color number for bookrack 3 Options, if selected (see below) 	
Surface Materials	Options	U.S. Price	Required to Specify
	<ul style="list-style-type: none"> • Paint price group 1 • 4799 Platinum Metallic • 9201 Polished Chrome • Lux Coatings 	No cost +\$32 +\$32 +\$62	Specify paint color number. Specify <i>with 4799 Platinum Metallic</i> . Specify <i>with 9201 Polished Chrome</i> . Specify Lux Coatings color number. ▶ See <i>Surface Materials</i> , page 504.

Specification Information	
Style Number	U.S. Base Price
472BR	\$102



For Canadian Pricing
 Multiply U.S. Price by the Canadian price factor.
 ▶ See page 1 for details.

Alignment Device

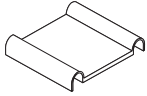

Standard Includes		Required to Specify
<ul style="list-style-type: none"> • Carton of 12 alignment devices: black plastic only 		Style number
Specification Information		
• Style Number	• U.S. Price	
472G	\$39	

Transport and Storage Dolly

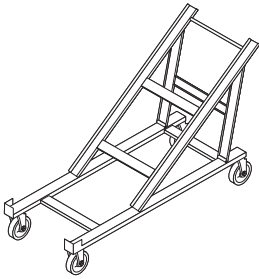

Standard Includes		Required to Specify
<ul style="list-style-type: none"> • Transport and storage dolly: black paint only 		Style number
Specification Information		
• Style Number	• U.S. Price	
473D	\$560	



For Canadian Pricing

Multiply U.S. Price by the Canadian price factor.

► See page 1 for details.

Surface Materials

Surface Materials	504
Fabric Application Direction Guidelines	511
Seating Upholstery Matrix	514
Fire Code Seating Upholstery Matrix	517
Color Availability Matrix	518
Special Features	526

Surface Materials

This listing includes all the surface material choices that are available for the products in this specification guide.

Resources

For more information about surface materials, refer to the following resources:

Additional surface materials specification tools are available to assist you in the specification process—the Surface Materials Binders.

The global surface materials palette is a core collection of finishes that is available across multiple geographies (Americas/ EMEA – Europe, Middle East, and Africa/APAC – Asia Pacific) and on global product lines, where applicable. For a list of finishes included in the offering, see the *Surface Materials Reference Manual*. Additional details, like product approvals by geography and finish number conversions, can also be found in the *Surface Materials Reference Manual* or see www.steelcase.com/surface-materials.

Surface Materials

Binders include:

- Surface Materials Reference Manual
- A complete set of swatch cards for hard surfaces, vertical surface fabrics, and seating upholstery

Plastic

Steelcase Surfaces

Not every plastic color is available on every plastic component.

► Refer to the *Color Availability Matrix* on page 518 before specifying.

Applies to:

- B-Free table edges
- See *Surface Materials Reference Manual*.

6000	Black
6001	Coffee
6009	Arctic White
6034	Natural Cherry
6036	Medium Cherry
6037	Winter on Maple
6038	Blonde on Maple
6041	Natural Walnut
6045	Medium Mahogany on Walnut E
6052	Milk
6053	Seagull
6213	Acacia
6219	Clear Oak
6231	Graphite Walnut
6234	Clear Cherry
6237	Clear Maple
6242	Virginia Walnut
6243	Blackwood
6245	Clear Walnut
6246	Warm Oak E
6249	Platinum Solid
6271	Plywood
6527	Merle
6615	Grey V5
6619	Ice E
6631	Cream
6635	Dawn E
6636	Mist
6654	Sand
6655	Warm White
6676	Marbled Maple
6677	Chocolate Walnut
6678	Marbled Cherry
6689	Brushed Silver E
6694	Slate
6695	Midnight
6697	Fog
6698	Fieldstone
6703	Ash Wenge
6704	Storm Wenge
6705	Bisque Wenge
6706	Clay Wenge
6707	Ash Noce
6708	Bisque Noce
6709	Clay Noce
6710	Storm Noce

Select Surfaces

6T02	Fawn Cypress
6T03	Weathered Char
6T04	Saddle Oak
6T05	Veranda Teak
6T06	Persian Cherry
6T07	Walnut Heights

Tip: Light color plastic edges are susceptible to degradation due to normal wear and tear. Staining (e.g., ball point pen or clothing dyes such as blue jeans) and dirt effects are more pronounced in light colors and are not considered defects.

Applies to:

- Kart
- 6052 Milk
- 6053 Seagull
- 6205 Black
- 6248 Midnight Brown
- 6249 Platinum Solid
- 6259 Midnight
- 6527 Merle

Applies to:

- Umami screen clips
- 6053 Seagull
- 6527 Merle

Applies to:

- Max-Stacker III 477 Series
- Move 490 Series
- Node 480 Series

Price Group 1

Plastics

6009	Arctic White
6059	Sterling Dark Solid
6205	Black
6249	Platinum Solid
6259	Midnight
6332	Citron
6333	Picasso
6334	Flash
6335	Wasabi
6336	Jazz
6337	Element
6338	Chili Red
6BD8	Snow
6BD9	Carbon Flat
6BE1	Ore

Price Group 2

Signature Plastics

6BC1	Crimson
6BC2	Purple
6BC3	Green
6BC4	Burgundy
6BC5	Blue
6BC6	Orange
6BC7	Brown
6BC8	Gold
6BC9	Red
6BD1	Aubergine
6BD2	Peacock
6BD3	Jungle
6BD4	Merlot
6BD5	Honey
6BD6	Lagoon
6BD7	Saffron

Seating Coating

Steelcase Surfaces

Applies to:

- Max-Stacker III 477 Series
- 7000 Black

Paint

Steelcase Surfaces

Applies to:

- Jersey Series work chairs
- 4799 Platinum Metallic

Applies to:

- Jersey Series guest chairs
- 4799 Platinum Metallic
- 7207 Black

Applies to:

- Siento 499 Series chairs
- Move 490 Series chair frames
- 0835 Black **E**
- 4799 Platinum Metallic
- 7239 Midnight

Applies to:

- cobI 434 Series chairs
- 0835 Black **E**
- 4799 Platinum Metallic
- 4803 Near Black Metallic

Applies to:

- Node 480 Series chairs
- 0835 Black **E**
- 4750 Champagne Metallic
- 4799 Platinum Metallic

Applies to:

- Gesture 442 Series chairs
- 7250 Sterling Dark Solid

Applies to:

- Max-Stacker III 477 Series
- 4799 Platinum Metallic
- 7239 Midnight

Applies to:

- Think 465 Series
- 4799 Platinum Metallic
- 7243 Seagull

Applies to:

- Brody 488 Series
- 4799 Platinum Metallic
- 7243 Seagull
- 7250 Sterling Dark
- 7360 Merle

Applies to:

- Kart
- 4799 Platinum Metallic
- 7207 Black

Applies to:

- Umami
- 4144 Black Gloss
- 4242 Milk
- 4728 Nickel
- 4750 Champagne Metallic
- 4798 Sterling Metallic
- 4799 Platinum Metallic
- 4803 Near Black Metallic
- 7207 Black
- 7246 Midnight Metallic
- 7360 Merle

Applies to:

- B-Free tables
- 4140 Arctic White Gloss
- 4144 Black Gloss
- 4728 Nickel
- 4750 Champagne Metallic
- 4798 Sterling Metallic
- 4799 Platinum Metallic
- 4803 Near Black Metallic
- 4B20 Obsidian
- 4B22 Matte Brass
- 4B23 Burnished Bronze
- 4B24 Night Bronze
- 4B25 Matte Copper
- 7207 Black
- 7241 Arctic White
- 7246 Midnight Metallic
- 7360 Merle

Applies to:

- Brody dash mini LED light
- 4231 Arctic White
- 4710 Low Gloss Black
- 4799 Platinum Metallic

Select Surfaces

Price Group 3

Accent paint

Accent paints allow you to choose from a pre-matched color palette of trend driven colors. Refer to the *Surface Materials Reference Manual* for more information.

Applies to:

- Brody 488 Series
- Max-Stacker III 477 Series
- QiVi 428 Series chairs (Sled base only)
- Umami

Lux Coatings

4B20	Obsidian
4B22	Matte Brass
4B23	Burnished Bronze
4B24	Night Bronze
4B25	Matte Copper

Accessory Paint

Steelcase Surfaces

Applies to:

- cobI 434 Series chairs
- 4140 Arctic White Gloss

Metal

Steelcase Surfaces

Metal finishes are not available on every chair. ► Refer to the *Color Availability Matrix* on page 518 before specifying.

8046	Polished Aluminum
9201	Polished Chrome

E = Established

Laminate

Steelcase Surfaces

Not every laminate color is available on every chair.
 ▶ Refer to the *Color Availability Matrix* on page 518 before specifying.

2406	Clear Cherry
2409	Clear Maple
2410	Graphite Walnut
2412	Natural Cherry
2422	Medium Cherry
2511	Winter on Maple
2535	Virginia Walnut
2536	Blackwood
2538	Clear Walnut
2539	Warm Oak E
2714	Natural Walnut
2722	Cream
2730	Arctic White
2746	Black
2759	Warm White
2772	Medium Mahogany on Walnut E
2811	Mist
2883	Seagull
2884	Milk
2885	Dune
2HAT	Acacia

Tip: Some wood veneer finishes and woodgrain laminates share the same name. Because of the difference in materials, veneers and laminates of the same name are not an exact match but do coordinate with each other.

Applies to:

- Umami round and pill table tops

2883	Seagull
2HMG	Merle

High-Pressure Laminate

Applies to:

- Brody 488 Series desks
- Umami platform

2406	Clear Cherry
2409	Clear Maple
2410	Graphite Walnut
2412	Natural Cherry
2422	Medium Cherry
2511	Winter on Maple
2535	Virginia Walnut
2536	Blackwood
2538	Clear Walnut
2539	Warm Oak E
2592	Blonde on Maple
2612	Marbled Maple
2614	Chocolate Walnut
2615	Marbled Cherry V2
2714	Natural Walnut
2772	Medium Mahogany on Walnut E
2HAK	Clear Oak
2HAN	Ash Noce
2HAT	Acacia
2HAW	Ash Wenge
2HBN	Bisque Noce
2HBW	Bisque Wenge
2HCN	Clay Noce
2HCW	Clay Wenge
2HSN	Storm Noce
2HSW	Storm Wenge

E = Established

Fiber Laminate

2850	Vanadium Fiber
2851	Rhyme Fiber E
2852	Tungsten Fiber
2854	Vellum Fiber
2859	Novell Fiber
2860	Granite Fiber
2861	Coconut Fiber
2862	Stucco Fiber

Micro Laminate

2920	Marl Micro
2921	Gypsum Micro
2922	Clay Micro
2923	Shadow Micro E

Patina Laminate

2870	Blonde Bronze Patina
2871	Blackened Bronze Patina
2873	Instant Iron Patina

Solid Laminate

2722	Cream E
2730	Arctic White
2746	Black
2759	Warm White E
2811	Mist E
2883	Seagull
2884	Milk
2885	Dune
2HMG	Merle

Speckle Laminate

2820	Coffee Speckle E
2822	Woodrose Speckle E
2823	Driftwood Speckle
2824	Smoke Speckle
2825	Vanadium Speckle

Select Surfaces

High-Pressure Laminate

Applies to:

- Brody 488 Series desks
- i2i tablet arms
- media:scape lounge
- B-Free
- Umami platform

Tip: B-Free tables are available in many laminates.

▶ See *Surface Materials Reference Manual*.

Textured Woodgrain Laminate

2TH2	Fawn Cypress
2TH3	Weathered Char
2TH4	Saddle Oak
2TH5	Veranda Teak
2TH6	Persian Cherry
2TH7	Walnut Heights

Custom Surfaces

Open Line Laminate (OLL)

Applies to:

- Brody 488 Series desks
- Umami platform

This service allows you to order non-standard laminate at an additional processing fee of \$71 U.S. per unit, plus the cost of the laminate.

When processing orders for Open Line Laminate, specify 2900 in the laminate finish field and enter the OLL manufacturer information. Enter the required edge finish as you would a standard laminate.

Tip: Standard laminates being used in the Open Line Laminate Program to obtain a different edge detail will be charged the Open Line laminate upcharge; however, no additional charges for the laminate will be applied.

Laminate Approval and Material Requirements

To confirm whether a particular laminate has already been tested for use on a specific Steelcase product or to determine material square foot requirements:

- Visit www.steelcase.com

For additional information, refer to the *Steelcase Surface Materials Reference Manual*.

Wood

Steelcase Surfaces

Veneer

Veneers are matched for proper balance and consistency. Veneers are available quarter cut, except for Oak, which is rift cut. Refer to the *Surface Materials Reference Manual* for descriptions of each cut.

Open-pore finish is a medium gloss finish that leaves the wood grain texture visible to the eye and distinguishable to the touch.

Applies to:

- Brody 488 Series desks
- i2i tablet arms
- media:scape lounge
- B-Free
- Umami platform

Flat-cut open-pore finish choices

3062	FC/OP Graphite Walnut
3402	FC/OP Clear Cherry (Aged)
3412	FC/OP Natural Cherry E
3422	FC/OP Medium Cherry
3522	FC/OP Clear Maple*
3572	FC/OP Amber on Maple E
3582	FC/OP Winter on Maple
3592	FC/OP Blonde on Maple
3702	FC/OP Clear Walnut
3712	FC/OP Natural Walnut
3722	FC/OP Dark Mahogany on Walnut
3752	FC/OP Medium Walnut
3762	FC/OP Dark Walnut
3772	FC/OP Medium Mahogany on Walnut

Surface Materials, continued

Quarter-cut open-pore finish choices

- 3042 QC/OP Ash
- 3222 QC/OP Clear Maple
- 3272 QC/OP Amber on Maple **E**
- 3292 QC/OP Blonde on Maple
- 3302 QC/OP Clear Walnut
- 3312 QC/OP Natural Walnut
- 3322 QC/OP Dark Mahogany on Walnut
- 3352 QC/OP Medium Walnut
- 3362 QC/OP Dark Walnut
- 3372 QC/OP Medium Mahogany on Walnut
- 3382 QC/OP Graphite Walnut

Rift-cut open-pore finish choices

- 3602 RC/OP Desert Oak
- 3612 RC/OP Warm Oak **E**
- 3692 RC/OP Espresso Oak

Applies to:

- Brody 488 Series desks
- i2i tablet arms
- media:scape lounge
- B-Free

Full-fill finish is a medium-gloss finish that completely fills the grain texture, yet allows the grain pattern to be seen. The wood has a lustrous, satiny look, and it is smooth to the touch. This finish is available on worksurfaces only.

Flat-cut full-fill finish choices

- 3064 FC/FF Graphite Walnut
- 3404 FC/FF Clear Cherry (Aged)
- 3414 FC/FF Natural Cherry **E**
- 3424 FC/FF Medium Cherry
- 3524 FC/FF Clear Maple*
- 3544 FC/FF Blonde on Maple
- 3564 FC/FF Linseed/Maple E
- 3574 FC/FF Amber on Maple **E**
- 3704 FC/FF Clear Walnut
- 3714 FC/FF Natural Walnut
- 3724 FC/FF Dark Mahogany on Walnut
- 3754 FC/FF Medium Walnut
- 3764 FC/FF Dark Walnut
- 3774 FC/FF Medium Mahogany on Walnut

Quarter-cut full-fill finish choices

- 3224 QC/FF Clear Maple*
- 3274 QC/FF Amber on Maple **E**
- 3294 QC/FF Blonde on Maple
- 3304 QC/FF Clear Walnut
- 3314 QC/FF Natural Walnut
- 3324 QC/FF Dark Mahogany on Walnut
- 3354 QC/FF Medium Walnut
- 3364 QC/FF Dark Walnut
- 3374 QC/FF Medium Mahogany on Walnut
- 3384 QC/FF Graphite Walnut

Rift-cut full-fill finish choices

- 3604 RC/FF Desert Oak
- 3614 RC/FF Warm Oak **E**
- 3694 RC/FF Espresso Oak

* To ensure an understanding of the color ranges and characteristic variations of natural veneer, a sign-off sheet is required prior to orders being accepted for this clearcoat finish. The sign-off sheet is available through Steelcase advertising stock. Please use form number 09-0000756 for 3042, form number 05-0001370 for 3222 and 3224.

E = Established

Applies to:

- Snodgrass 474 Series chair frames

Tip: Frames are constructed of solid maple. Finishes applied to maple will match the color of stains applied to oak, walnut, or cherry, but will not show the same natural grain. Composite color finishes will match the color of composites on veneered surfaces, but will not have the same grain pattern.

Wood Seating Color Choices

- 3062 Graphite Walnut
- 3402 Clear Cherry (Aged)
- 3412 Natural Cherry **E**
- 3422 Medium Cherry
- 3522 Clear Maple*
- 3572 Amber on Maple **E**
- 3592 Blonde on Maple
- 3602 Desert Oak
- 3612 Warm Oak **E**
- 3692 Espresso Oak
- 3702 Clear Walnut
- 3712 Natural Walnut
- 3722 Dark Mahogany on Walnut
- 3752 Medium Walnut
- 3762 Dark Walnut
- 3772 Medium Mahogany on Walnut

**To ensure an understanding of the color ranges and characteristic variations of natural veneer, a sign-off sheet is required prior to orders being accepted for this clear-coat finish. The sign-off sheet is available through Steelcase advertising stock. Form number 05-0001370.*

Applies to:

- i2i tablet arms
- 3062 Graphite Walnut
- 3222 Clear Maple*
- 3272 Amber on Maple **E**
- 3292 Blonde on Maple
- 3302 Desert Oak
- 3312 Natural Walnut
- 3322 Dark Mahogany on Walnut
- 3352 Medium Walnut
- 3362 Dark Walnut
- 3372 Medium Mahogany on Walnut
- 3382 Graphite Walnut
- 3402 Clear Cherry (Aged)
- 3412 Natural Cherry **E**
- 3422 Medium Cherry
- 3522 Clear Maple
- 3572 Amber on Maple **E**
- 3592 Blonde on Maple
- 3602 Desert Oak
- 3612 Warm Oak **E**
- 3692 Espresso Oak
- 3702 Clear Walnut
- 3712 Natural Walnut
- 3722 Dark Mahogany on Walnut
- 3752 Medium Walnut
- 3762 Dark Walnut
- 3772 Medium Mahogany on Walnut

Premium Veneers

A selection of Premium veneers in this collection are available on most Steelcase brand products. The collection will be available as close to standard leadtimes as possible. However, because adequate supplies of veneer and solids must be secured, all orders will be scheduled individually. Leadtimes will vary based on Premium veneer and Premium solids availability at the time the order is placed. The collection is Graded-In as Wood Group 2 and Wood Group 3, and supported like standard veneers to make ordering easy. Please see the Steelcase surface materials section on village.steelcase.com for sample information and product line availability. All premium veneers are in clear-coat.

Available on:

- Brody 488 Series desks
- i2i tablet arms
- Snodgrass
- Collaborative lounge table
- B-Free
- media:scape lounge
- Umami platform

Quarter-cut open-pore finish choices

- Wood Group 2**
- 3032 QC/OP Dark Thin Line Bamboo
 - 3052 QC/OP Ribbon Sapele

Wood Group 3

- 3832 QC/OP Figured Anegre
- 3842 QC/OP Figured Makore

Tip: Full-fill finish is not available on premium veneers as a standard.

**To ensure an understanding of the color ranges and characteristic variations of natural veneer, a sign-off sheet is required prior to orders being accepted for this clear-coat finish. The sign-off sheet is available through Steelcase advertising stock. Please use form number 09-0000755 for 3032, form number 09-0000757 for 3052, form number 09-0000758 for 3832, and form number 09-0000759 for 3842.*

**To ensure an understanding of the color ranges and characteristic variations of natural veneer, a sign-off sheet is required prior to orders being accepted for this clear-coat finish. The sign-off sheet is available through Steelcase advertising stock. Form number 05-0001370.*

Select Surfaces

For information on products within Select Surfaces, including accent paints and fabrics from Designtex, Gabriel, Kvadrat, and Pollack, please refer to the *Surface Materials Reference Manual* or visit www.steelcase.com/surface-materials under the Select Surfaces section.

Applies to:

- Collaborative lounge table
- i2i tablet arm
- media:scape lounge
- Snodgrass 474 Series chair frames
- Umami platform

Natural Veneer

Natural veneer is available in the Select Surfaces offering. Natural veneer may have extended leadtimes. Place your order as you normally would for any other finish, calling out the appropriate finish code. Natural veneers are Graded-In as Wood Group 1 pricing.

The following finishes are available through the natural veneer offering:

Flat-cut open-pore finish choices

- 35A2 FC/OP Blanch Maple
- 37A2 FC/OP Thunder Walnut

Quarter-cut open-pore finish choices

- 32A2 QC/OP Blanch Maple
- 33A2 QC/OP Thunder Walnut

Rift-cut open-pore finish choices

- 36A2 RC/OP Volcanic Oak

Applies to:

- Collaborative lounge table
- i2i tablet arm
- media:scape lounge
- Snodgrass 474 Series chair frames
- Umami platform

Planked Veneer

Planked veneer is available in the Select Surfaces offering. Planked veneer may have extended leadtimes. Place your order as you normally would for any other finish, calling out the appropriate finish code.

Ⓜ = Established

The following finishes are available through the planked veneer offering:

Wood Group 1

- 3P41 OP Planked Cherry
- 3P51 OP Planked Maple
- 3P61 OP Planked Oak
- 3P71 OP Planked Walnut

Tip: Known for its uniqueness, planked veneer has intentional and natural variations that include, but are not limited to: character marks, grain pattern, color, and natural color aging.

Applies to:

- Umami platform
- Snodgrass 474 Series chair frames

Composite Veneer

Composite veneers are an engineered wood intended to create specific grain patterns and characteristics. They are pre-stained and finished with Steelcase's Clarity water-borne UV topcoat, which protects the environment while providing durability and clarity. Only open-pore finishes are available on composite wood. Composite veneer and matching edge bands are available on most Steelcase brand products. Composites, for use as a solid nosing substitute, are not available. Steelcase does not recommend mixing composite veneers with natural solid nosings because composite and natural wood grain and color matching are rarely compatible. Composite veneers are Graded-In as Wood Group 1 pricing.

Tip: Known for their color consistency, composite veneers feature a clear coat finish. Because the veneers are sourced in large lots, overall color within a specific purchase order should have minimal color inconsistency. However, composite customers should know that colors may vary slightly from dye lot to dye lot. This inconsistency may be noticed when replacement pieces are ordered that may be from different dye lots, or when a new project phase is installed. Also note that composite veneers tend to fade and lighten over time, especially with sun exposure.

Flat-cut open-pore finish choices

- 3JDX FC/OP Oak Composite
- 3JFX FC/OP Maple Composite
- 3JHX FC/OP Cherry Composite
- 3JJX FC/OP Walnut Composite

Applies to:

- Umami platform

Quarter-cut open-pore finish choices

- 3F8X QC/OP European Walnut Composite
- 3GAX QC/OP Gold Teak Composite
- 3GFX QC/OP Rosewood Composite
- 3GGX QC/OP Zebrano Composite
- 3HGX QC/OP Oak Composite
- 3HVX QC/OP Walnut Composite
- 3JEX QC/OP Maple Composite
- 3JGX QC/OP Cherry Composite
- 3ZNX QC/OP Night Composed Oak Composite

Tip: Composite veneers are not available on tapered edge worksurfaces on Impact style numbers.

Tip: Be conscious if mixing the flat cut and the quarter cut in composites, as there may be large variation in color.

Custom Surfaces

Customiz stain is a service that allows you to create your own stain colors and finishes on standard veneer. Customiz stain color is available on all product lines that offer wood veneer.

A \$500 stain-matching fee applies on CUSTOMIZ requests (Exception: The \$500 fee does not apply on matches to Coalesse standard finishes or for a low-gloss finish request on a standard color). The \$500 fee covers the cost of formulating the Customiz color finish and applies regardless of whether or not an order for product is placed.

In addition, an approval form must be signed to indicate customer acceptance of Customiz match. A \$1,500 initiation fee will be charged prior to first order entry. This initiation fee activates the finish for unlimited use on any Steelcase product for an 18 month time period. After the 18 month time period has lapsed, the Customiz finish may be reactivated for another 18 months for a \$1,000 fee at any point within five years after the \$1,500 initiation fee was paid. If the finish is not reactivated within five years after the \$1,500 initiation fee was paid, the finish will be culled and the customer will need to pay the \$1,500 initiation fee again. All style number related Customiz charges products are no cost as of April 2014, with the exception of Umami platform and B-Free table. The matching and initiation fees are not discountable.

Customiz stain takes 10 days to formulate. Consult the *Surface Materials Reference Manual* for more information. Custom veneers are also available and must be quoted by Steelcase specials group. Customiz stain on custom veneers takes 2 to 4 weeks to formulate.

Requirements and information on ordering a Customiz stain color are found in the *Surface Materials Reference Manual*.

► See *c:scape Specification Guide* for the complete surface materials list for the i2i collaborative lounge table.

Applies to:

- Leap 464 Series WorkLounge
- 12011 Light Grey
- 22679 Beige
- 33286 Rust
- 43236 Camel
- 43632 Honey
- 48059 Field Green
- 53301 Red Brown
- 55057 Crimson
- 55063 Flame
- 93287 Charbrown
- 93327 Loam
- 97054 Twilight
- 98953 Mist Green
- 99991 Ebony

Screen

Applies to:

- B-Free screens

Steelcase Surfaces

Price Group 1

B-Free Knit

- 5Y58 Light Grey
- 5Y99 Dark Grey

Select Surfaces

Price Group 1

B-Free Knit

- 0096 White
- 1274 Sky
- 1280 Ice
- 1288 Teal Blue
- 2111 Tangerine
- 2121 Paprika
- 5306 Leaf
- 5313 Chartreuse
- 5314 Lime
- 7273 Silver
- 8172 Currant
- 8179 Red Mittens
- 8180 Hot Pink

Applies to:

- Umami screen

Steelcase Surfaces

Price Group 1

- Buzz2
- Jacks Ⓜ
- Link
- Playground Ⓜ
- New Black: Bruce
- New Black: Henry

Price Group 2

- Chainmail
- Cogent: Connect
- Cogent: Trails
- Spyder Ⓜ
- New Black: Harley
- New Black: Jack
- New Black: James

Price Group 3

- Billiard Multi-Use by Designtex
- Redeem
- Retrieve

Surface Materials, continued

Mesh**Steelcase Surfaces**

Applies to:
• Jersey Series

Jersey Mesh

T084 Black
T085 Grey
T086 White
T087 Yellow
T088 Orange **E**
T089 Red **E**
T090 Green **E**
T091 Blue
T094 Cardinal **E**

Applies to
• Reply Series

Reply Air Mesh

AR01 Grey
AR02 Black
AR03 White
AR04 Red
AR05 Royal Blue
AR06 Apple Green
AR07 Orange
AR08 Bright Purple
AR09 Sable
AR13 Aubergine
AR14 Peacock
AR15 Jungle
AR16 Merlot
AR17 Honey
AR18 Lagoon
AR19 Saffron

3D Knit**Steelcase Surfaces**

Applies to:
• i2i 416 Series
• Leap 462 Series
• Think 465 Series
• Amia 482 Series
5054 Canary
5059 Sailor
5064 Licorice
5065 Coconut
5066 Malt
5067 Root Beer
5089 Royal Blue
5090 Wasabi
5091 Maya Blue
5092 Graphite
5093 Nickel
5094 Tangerine
5095 Scarlet
5096 Turmeric/Honey
5097 Concord
5098 Blue Jay
5560 Aubergine
5561 Peacock
5562 Jungle
5563 Merlot
5564 Lagoon
5565 Saffron

E = Established

3D Microknit**Steelcase Surfaces**

Applies to:
• Steelcase Series 1
5T20 Nickel
5T21 Licorice
5T22 Royal Blue
5T23 Blue Jay
5T24 Scarlet
5T25 Malt
5T26 Wasabi
5T27 Tangerine
5T28 Concord
5T29 Graphite
5T30 Canary

Connect 3D**Steelcase Surfaces**

Applies to:
• cob1 434 Series
5014 Royal Blue
5015 Coconut
5016 Turmeric/Honey
5017 Tangerine
5018 Scarlet
5019 Concord
5020 Maya Blue
5021 Blue Jay
5023 Wasabi
5024 Nickel
5025 Graphite
5026 Licorice
5027 Malt
5028 Root Beer
5030 Sailor
5036 Canary
5532 Aubergine
5533 Peacock
5534 Jungle
5535 Merlot
5536 Lagoon
5537 Saffron

Seating Upholstery

Not every upholstery is available on every chair.
▶ Refer to the *Steelcase Upholstery Matrix* on page 514 before specifying.

Steelcase Surfaces**Price Group 1****Buzz2**

5F01 Camel **E**
5F03 Tomato
5F04 Red **E**
5F05 Burgundy
5F06 Sky **E**
5F07 Blue
5F08 Navy
5F10 Grape **E**
5F11 Eggplant **E**
5F15 Stone
5F16 Grey
5F17 Black
5G50 Dunegrass
5G51 Sable
5G52 Barley
5G53 Sunrise
5G54 Carrot
5G55 Pumpkin
5G56 Timber
5G57 Rouge
5G58 Chocolate
5G59 Meadow
5G60 Ivy
5G61 Cyan
5G62 Atlantic
5G63 Crocus
5G64 Alpine
5G65 Tornado

Jacks

5B61 Taupe **E**
5B63 Camel **E**
5B64 Pewter **E**
5B70 Midnight **E**

Link

5A20 Burgundy
5A23 Green
5A24 Blue
5A25 Navy
5A26 Purple
5A27 Black
5A28 Ocean
5A30 Chamois

New Black

5J10 New Black: Bruce
5J11 New Black: Henry
Tip: New Black upholstery has color numbers in both price group 1 and price group 2.

Playground **E**

5F28 Claret
5F29 Chile
5F30 Amber
5F31 Nut
5F32 Blade
5F33 Stone
5F34 Sky
5F35 Navy
5F36 Huckleberry
5F37 Charcoal

Price Group 2**Chainmail**

5550 Cotton
5551 Space
5552 Silver Dollar
5553 Volcano
5554 Orange Crush
5555 Tricycle
5556 Geranium
5557 Banana
5558 Margarita
5559 Lagoon

Cogent: Connect

5S15 Coconut
5S16 Turmeric/Honey
5S17 Tangerine
5S18 Scarlet
5S19 Concord
5S20 Maya Blue
5S21 Blue Jay
5S23 Wasabi
5S24 Nickel
5S25 Graphite
5S26 Licorice
5S27 Malt
5S28 Root Beer
5S93 Blueprint
5S94 Lizard/Jungle
5S95 Sailor
5S96 Quicksilver
5S97 Nugget
5S98 Canary
5S99 Lipstick/Merlot
5SD0 Royal Blue
5SD1 Aubergine
5SD2 Peacock
5SD3 Lagoon
5SD4 Saffron

Cogent: Geode Vertical

5S38 Oyster **E**
5S41 Sesame **E**

Cogent: Trails

5S29 Bronzite
5S85 Agate
5S86 Lapis
5S87 Malachite
5S88 Quartz
5S90 Tiger Eye
5S91 Travertine
5S92 Topaz

New Black

5J08 New Black: Jack
5J09 New Black: James
5J12 New Black: Harley
Tip: New Black upholstery has color numbers in both price group 1 and price group 2.

Nitelights

5F58 Hazelnut
5F61 Earth
5F62 Shore
5F63 Moss
5F65 Regal Blue
5F66 Stone
5F67 Moon

Seating Vinyl **E**

5801 Topaz
5805 Foggy Night
5809 Black
5810 Forest
5812 Navy
5813 Currant
5814 Leaf
5815 Seaside
5817 Pebble
5818 Spice
5819 Thistle
5820 Coffee
5822 Iris

Spyder

5B01 Foggy Night **E**
5B04 Peri **E**

Stand In

5621 Sleet
5622 Lunar
5623 Cyclone
5624 Eclipse
5625 Powder
5626 Chardonnay
5627 Graham
5628 Sediment
5629 Allspice
5630 Apple
5631 Lava
5632 Cayenne
5633 Plantain
5634 Parsley
5635 Scallion
5636 Atlantis
5691 Orca
5740 Burlap
5741 Porter
5742 Tusk
5743 Putty
5744 Blueberry
5745 Chartreuse
5746 Mango
5747 Sedona
5748 Juniper
5749 Peanut

Price Group 3**Billiard Multi-Use by Designtex**

5H10 Bone
5H11 Poppy
5H12 Tangelo
5H13 Citron
5H14 Avocado
5H15 Hunter
5H16 Indigo
5H17 Mallard
5H18 Teak
5H19 Cumulus
5H20 Pewter
5H21 Gunmetal
5H22 Ink

Gaja — Cradle to Cradle Certified™ Silver

5W40	Black
5W41	Pepper
5W42	Pearl Grey
5W43	Crimson
5W44	Ink
5W45	Night Blue
5W46	Petrol
5W47	Greige
5W48	Sepia
5W49	Umbur
5W50	Java
5W51	Camellia Red
5W52	Emerald
5W53	Snow Pea
5W54	Olive
5W55	Light Blue
5W56	Maroon
5W57	Black Raspberry
5W58	Spruce
5W59	Apple Green
5W60	Deep Blue
5W61	Chili Pepper
5W62	Daffodil

Imperma

TM01	Toffee
TM02	Pigeon
TM03	Fossil
TM04	Poppyseed
TM05	Auburn
TM06	Cumin
TM07	Marble
TM08	Cliff
TM09	Tarragon
TM10	Pesto
TM11	Wave
TM12	Niagara
TM13	Tuscan
TM14	Peppercorn

Redeem

TM50	Brick
TM51	Yolk
TM52	Cinnamon
TM53	Daisy
TM54	Pine
TM55	Water
TM56	Dill
TM57	Lavender
TM58	Mallard
TM59	Caramel
TM60	Greyhound
TM61	Mocha
TM62	Iceberg
TM63	Chestnut
TM64	Granite
TM65	Cashmere
TM66	Barnwood

Retrieve

TM30	Kelly
TM31	Lake
TM32	Gala
TM33	Papaya
TM34	Dandelion
TM35	Curry
TM36	Lilac
TM37	Submarine
TM38	Driftwood
TM39	Bistro
TM40	Quarry
TM41	Mohair
TM42	Shadow
TM43	Seal
TM44	Chalk

Texel

TM20	Angora
TM21	Grist
TM22	Galaxy
TM23	Terracotta
TM24	Nude
TM25	Field
TM26	Haze

Price Group 5**Bo Peep**

5G66	Pita
5G67	Bone
5G68	Safari
5G69	Brown Sugar
5G70	Chocolate Chip
5G71	Candlelight
5G72	Honey Mustard
5G73	Marmalade
5G74	Picnic
5G75	Pinot
5G76	Bloom
5G77	Grapevine
5G78	Firefly
5G79	Artichoke
5G80	Serpent
5G81	Carolina
5G82	Blue Bonnet
5G83	Nautical
5G84	Gravel
5G85	Sharkskin
5G86	Kohl

Remix

RE01	Rust
RE02	Pumpkin
RE03	Pebble
RE04	Dark Chocolate
RE05	Beige
RE06	Linen Beige
RE07	Hazelnut
RE08	Concrete Grey
RE09	Sky Blue
RE10	Blue Jean
RE11	Ivy Green
RE12	Primavera Yellow
RE13	Night Blue

Silk

5L30	Butterscotch
5L31	Dijon
5L32	Seaweed
5L33	Boysenberry
5L34	Vermillion
5L35	Marina
5L36	Heather Blue
5L37	Blue Raspberry
5L38	Cauldron
5L39	Flaxen

Price Group 6**Brisa**

BR01	Black Onyx
BR04	Truffle
BR06	Ash
BR07	Sage
BR08	Celery
BR09	Sterling Blue
BR10	Night Navy
BR11	Cambridge Blue
BR12	Abyss
BR13	Canyon
BR14	Pompeian Red
BR15	Salsa
BR16	Cinnabar
BR17	Aztec
BR18	New Sand
BR19	Cream
BR20	White
BR21	Moccasin
BR22	Buckskin
BR23	Prairie

Price Group 7**Steelcut Trio**

TR01	Mist Grey
TR02	Stone Grey
TR03	Cassonade Beige
TR04	Nutmeg Beige
TR06	Licorice Black
TR07	Mustard Yellow
TR08	Red Currant
TR11	Ice Blue
TR14	Blue Jay Mix
TR15	Brown Frost

Leather Price Group**Steelcase Leather**

L107	Black
L207	Mahogany
L220	Soapstone
L221	Rocky

Almosoft Leather Price Group**Almosoft Leather**

L110	Maritime Blue
L111	Midnight Blue
L112	Ebony
L113	Gunmetal
L114	Mica
L115	Dove Grey
L116	Plum Pleasure
L122	Truffle
L128	Red Birch
L132	Violet
L133	Espresso
L134	Ruby
L135	Scarlet
L138	Bourbon
L139	Cinder
L140	Garnet
L143	Pecan
L144	Chamois
L146	Russet
L147	Saddle
L151	White
L709	Sugar
L711	Parchment
L712	Buff
L716	Khaki
L717	Cameo
L721	Rock
L722	Desert
L723	Storm
L725	Teal
L727	Egyptian Blue
L728	Bright Blue
L730	Hunter
L736	Lemon
L737	Sunshine
L738	Drama
L740	Dazzle
L743	Forest Green
L744	Turtle
L745	Grass
L746	Envy
L747	Cigar
L748	Light Chocolate
L749	Beaver
L750	Bluffstone
L751	Sienna
L752	Oxblood
L753	Dough
L754	Acorn
L755	Peanut Butter
L756	Quinoa
L757	Dark Sand
L758	Mustard
L759	Amber Orange
L760	Bengal
L761	Periwinkle
L762	Canvas
L763	Macadamia
L764	True Blue
L765	Storm Blue
L766	Powder Blue
L767	Blush
L768	Tropical
L769	Mauve
L770	Cadet
L771	Powder Mint
L772	Timberwolf
L773	Chalice
L774	Oil
L775	Coyote

Select Surfaces

For information on products within Select Surfaces, including accent paints, Signature plastics, and fabrics from Designtex, Gabriel, Kvadrat, and Pollack, please refer to the *Surface Materials Reference Manual* or visit www.steelcase.com/surface-materials under the Select Surfaces section.

Custom Surfaces**Price Group COM (Customer's Own Material)****Fabric Approval and Yardage**

To confirm whether a particular COM material has already been tested for use on a specific Steelcase product or to determine actual yardage requirements:

- Visit www.steelcase.com

For additional information regarding Customer's Own Material, call (1.888.783.3522) or send an email to line-one@steelcase.com.

Vertical Surface Fabric

Applies to:

- Brody

Vertical upholstery is not available on all upholstered surfaces.

► See the Vertical Surface Fabric Matrix in *Surface Materials Reference Manual*.

Steelcase Surfaces**Price Group 1**

Boccie
Buzz2

Price Group 2

Bariolage
Cogent: Geode Vertical
Fresco

Price Group 6

Brisa

Tip: Brisa is available on Brody WorkLounge and Brody Privacy Lounge only.

Custom Surfaces

**Price Group COM
(Customer's Own
Material)**

**Fabric Approval and
Yardage**

To confirm whether a particular COM material has already been tested for use on a specific Steelcase product or to determine actual yardage requirements:

- Visit www.steelcase.com

E = Established

Fabric Application Direction Guidelines

What is the issue?

Some textiles are simple and look the same regardless of how you apply them to a product. Many other fabrics are patterned, textured, or have luster that will have a distinctly different appearance if applied in different directions on chairs. Because of these differences, and the fact that there are limits to how some fabrics can be applied to Steelcase products, it is important to understand fabric application direction standards at Steelcase in order to avoid being disappointed.

Talking about direction

Fabrics come on rolls. The long yarns that run down the length of the roll are called the "warp" yarns. These yarns are used to define the direction you are viewing the fabric as it is applied to a chair. Fabric directionality is determined by how the fabric comes off the roll. It is NOT determined by the way the pattern looks on the product (i.e., horizontal stripes do not mean the fabric was applied warp horizontal—it could have been applied warp vertical).

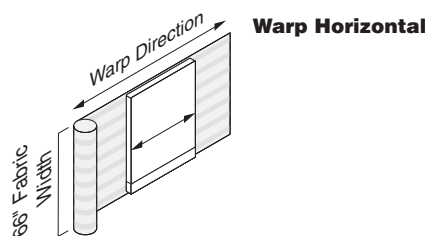

In the example below, the fabric is applied warp horizontal although the stripes appear vertical.

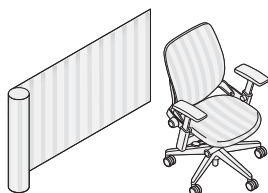

Warp horizontal application is the standard application direction for most Steelcase fabrics on Steelcase seating products. Horizontal application means that as you view the chair in its upright position, the warp yarns of the fabric are running in the horizontal direction.

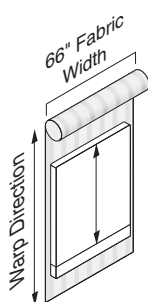

Warp Vertical

Warp vertical application is the standard application direction for SILQ 418 Series. Vertical application means that as you view the chair in its upright position, the warp yarns are running in the vertical direction.

► See page 511, *Fabric Application Direction for Systems, Casegoods, and Architecture* matrix, for details on these exceptions.

Steelcase is not responsible for charges associated with replacement or reupholstery of products due to incorrect specifications.



The combination of most seating products (warp horizontal) with SILQ 418 (warp vertical) will result in the fabric patterns running in opposite directions.

To remedy this situation, the following options are available:

- Use non-directional fabric. Only a small selection of fabrics are non-directional.
- Use fabrics that have standard warp vertical application direction.
- Specify warp vertical application on fabrics that are standard warp horizontal.

Tip: If you require warp vertical and it is not the standard, you must specify the warp vertical option on every line in the order.

Warp Horizontal (Railroaded)

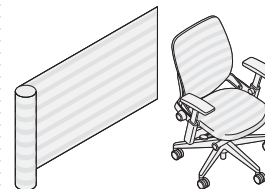

Railroaded means the same thing as *warp horizontal* and is often used when talking about chairs. *Across roll* is another term for running the fabric in this direction.



Warp Vertical (Woven Way)

Woven way means the same thing as *warp vertical* and is often used when talking about chairs. *Down roll* is another term for running the fabric in this direction.

What determines fabric direction?

Standard default directions exist for all products. You may specify a fabric to be cut in a specific direction if the product allows it to be applied. The purchase order must clearly state the application direction if it is other than standard. Refer to the following tables for the standard directions.

Tip: If you are changing the application direction of fabric, yardage requirements may increase resulting in an additional upcharge. This upcharge will be applied to the purchase order.

Why do dealers have to specify fabric application direction?

Sometimes COM fabrics have patterns that look awkward or inappropriate if they are applied in the standard direction. Therefore, it is critical to know how the pattern is run on the roll to ensure that Steelcase builds and ships each order to the customer's expectation. Some examples are shown here.



Incorrect?



Correct?



Incorrect?



Correct?



Incorrect?



Correct?



Incorrect?



Correct?

- Steelcase does not know which way your customer wants to see these patterns on their furniture.
- Dealers must specify application direction on all COM orders.

Swatch directions

All Steelcase fabric swatches and samples are shown in the warp horizontal direction. If you hold any fabric sample in the orientation shown below, the fabric will be in the warp-horizontal direction.

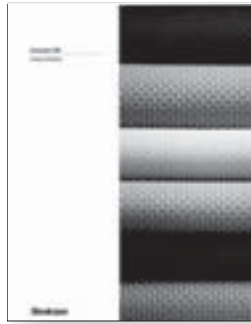

Swatch card

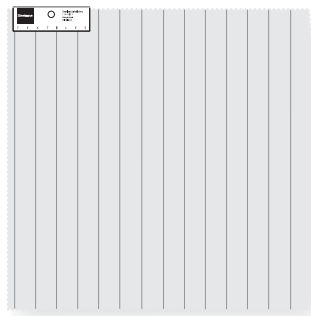

Memo sample

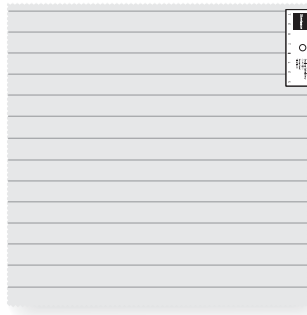

To see how a fabric will look if it is applied warp vertical, turn it 90°.

Tip: Fabric direction on samples from COM vendors may vary by product. Most textile companies will swatch their fabrics in a warp vertical (woven way, down roll) direction. Some exceptions might be made to address patterns especially with stripes. Typically, when a fabric is swatched in a warp horizontal (railroad or across roll) direction, the direction is noted on the swatch card or fabric sample. If in doubt of a fabric direction, we encourage you to contact the textile vendor for clarification.

Fabric Application Direction for Seating

Fabric	Standard Application Direction	Tips
Steelcase Textiles Upholstery	Railroaded (warp horizontal)	Fabrics on SILQ 418 Series will only be applied in the warp vertical/down roll direction, this includes all standard Steelcase fabrics, Select Surfaces, and COMs.
Select Surfaces-Designtex	Varies by fabric Dealers must specify desired fabric application direction on all select surfaces orders.	Confirm test results and application direction on COM website and <i>Designtex.com</i> prior to ordering.
Select Surfaces-Gabriel	Varies by fabric Dealers must specify desired fabric application direction on all select surfaces orders.	Confirm test results and application direction on COM website and <i>Gabriel.dk</i> prior to ordering.
Select Surfaces-Kvadrat	Varies by fabric Dealers must specify desired fabric application direction on all select surfaces orders.	Confirm test results and application direction on COM website and <i>Kvadrat.dk</i> prior to ordering.
Select Surfaces-Pollack	Warp vertical Dealers must specify desired fabric application direction on all select surfaces orders.	Confirm test results and application direction on COM website and <i>Pollackassociates.com</i> prior to ordering.
COM Fabrics	Varies by fabric Dealers must specify desired fabric application direction on all COM orders.	The most common COM application direction for seating is warp vertical. Confirm test results and application direction on COM website and your textile vendor's site prior to entering COM orders.
COM Vinyls	Varies by fabric Dealers must specify desired fabric application direction on all COM orders.	Most solid vinyls are commonly applied in the warp horizontal application direction.

Seating Upholstery Matrix

Legend

- = Not available
- = Available
- = Available with exceptions
- Ⓢ = Established
- EL = Elmosoft leather
- L = Leather
- ▶ See specification pages for details.
- *Gaja – Cradle to Cradle Certified™ Silver

	Price Group	Amia 482 Series - 3D Knit - Standard	Amia 482 Series - Standard	Amia 482 Series - 3D Knit - Sewn	Amia 482 Series - Sewn	B-Free Lounge	Basic Cushion	Brody 488 Series Worklounge - Seat	Brody 488 Series Worklounge - Lower Surround & Trim	Brody 488 Series Privacy Lounge - Seat	Brody 488 Series Privacy Lounge - Lower Surround & Trim	Brody 488 Series Privacy Lounge - Screen	Brody 488 Series Privacy Lounge with Extension - Seat	Brody 488 Series Privacy Lounge with Extension - Lower Surround & Trim	Brody 488 Series Privacy Lounge with Extension - Screen	Brody 488 Series Footrest	Cachet 487 Series - Standard	cobi 434 Series - Connect 3D - Standard	cobi 434 Series - Connect 3D - Sewn	Criterion 453 Series - Standard, Molded	Criterion 453 Series - Standard, Plus	Criterion 453 Series - Sewn	Criterion 453 Series - Sewn Back, Non-Sewn Seat	c:scape Screens	c:scape Cushion Tops	Divisio Side Screen	FrameOne
3D Knit	NA	■	•	•	■	•	•	•	•	•	•	•	•	•	•	•	•	•	•	•	•	•	•	•	•	•	•
3D Microknit	NA	•	•	•	•	•	•	•	•	•	•	•	•	•	•	•	•	•	•	•	•	•	•	•	•	•	•
Billiard Multi-Use by DesignTex	3	■	■	■	■	■	■	■	■	■	■	■	■	■	■	■	■	■	■	■	■	■	■	■	■	■	■
Bo Peep	5	■	■	•	•	■	■	■	■	■	■	■	■	■	■	■	■	■	■	■	■	■	■	■	■	■	■
Brisa	6	■	■	■	■	■	■	■	■	■	■	■	■	■	■	■	■	■	■	■	■	■	■	■	■	■	■
Buzz2	1	■	■	■	■	■	■	■	■	■	■	■	■	■	■	■	■	■	■	■	■	■	■	■	■	■	■
Chainmail	2	■	■	•	•	■	■	■	■	■	■	■	■	■	■	■	■	■	■	■	■	■	■	■	■	■	■
Cogent: Connect	2	■	■	•	•	■	■	■	■	■	■	■	■	■	■	■	■	■	■	■	■	■	■	■	■	■	■
Cogent: Geode Vertical Ⓢ	2	■	■	•	•	■	■	■	■	■	■	■	■	■	■	■	■	■	■	■	■	■	■	■	■	■	■
Cogent: Trails	2	■	■	•	•	■	■	■	■	■	■	■	■	■	■	■	■	■	■	■	■	■	■	■	■	■	■
Connect 3D	NA	•	•	•	•	•	•	•	•	•	•	•	•	•	•	•	•	•	•	•	•	•	•	•	•	•	•
Elmosoft Leather	EL	■	•	■	■	■	■	■	■	■	■	■	■	■	■	■	■	■	■	■	■	■	■	■	■	■	■
Gaja*	3	■	■	■	■	■	■	■	■	■	■	■	■	■	■	■	■	■	■	■	■	■	■	■	■	■	■
Imperma	3	■	■	•	•	■	■	■	■	■	■	■	■	■	■	■	■	■	■	■	■	■	■	■	■	■	■
Jacks Ⓢ	1	■	■	■	■	■	■	■	■	■	■	■	■	■	■	■	■	■	■	■	■	■	■	■	■	■	■
Jersey Black	NA	•	•	•	•	•	•	•	•	•	•	•	•	•	•	•	•	•	•	•	•	•	•	•	•	•	•
Steelcase Leather	L	■	•	■	■	■	■	■	■	■	■	■	■	■	■	■	■	■	■	■	■	■	■	■	■	■	■
Link	1	■	■	■	■	■	■	■	■	■	■	■	■	■	■	■	■	■	■	■	■	■	■	■	■	■	■
New Black: Bruce	1	■	■	■	■	■	■	■	■	■	■	■	■	■	■	■	■	■	■	■	■	■	■	■	■	■	■
New Black: Harley	2	■	■	■	■	■	■	■	■	■	■	■	■	■	■	■	■	■	■	■	■	■	■	■	■	■	■
New Black: Henry	1	■	■	■	■	■	■	■	■	■	■	■	■	■	■	■	■	■	■	■	■	■	■	■	■	■	■
New Black: Jack	2	■	■	■	■	■	■	■	■	■	■	■	■	■	■	■	■	■	■	■	■	■	■	■	■	■	■
New Black: James	2	■	■	■	■	■	■	■	■	■	■	■	■	■	■	■	■	■	■	■	■	■	■	■	■	■	■
Nitelights	2	■	■	•	•	■	■	■	■	■	■	■	■	■	■	■	■	■	■	■	■	■	■	■	■	■	■
Playground Ⓢ	1	■	■	•	•	■	■	■	■	■	■	■	■	■	■	■	■	■	■	■	■	■	■	■	■	■	■
Redeem	3	■	■	■	■	■	■	■	■	■	■	■	■	■	■	■	■	■	■	■	■	■	■	■	■	■	■
Remix	5	■	■	■	■	■	■	■	■	■	■	■	■	■	■	■	■	■	■	■	■	■	■	■	■	■	■
Reply Air Mesh	NA	•	•	•	•	•	•	•	•	•	•	•	•	•	•	•	•	•	•	•	•	•	•	•	•	•	•
Retrieve	3	■	■	■	■	■	■	■	■	■	■	■	■	■	■	■	■	■	■	■	■	■	■	■	■	■	■
Seating Vinyl Ⓢ	2	■	•	■	■	■	■	■	■	■	■	■	■	■	■	■	■	■	■	■	■	■	■	■	■	■	■
Silk	5	■	■	■	■	■	■	■	■	■	■	■	■	■	■	■	■	■	■	■	■	■	■	■	■	■	■
Spyder Ⓢ	2	■	■	•	•	■	■	■	■	■	■	■	■	■	■	■	■	■	■	■	■	■	■	■	■	■	■
Stand In	2	■	•	■	■	■	■	■	■	■	■	■	■	■	■	■	■	■	■	■	■	■	■	■	■	■	■
Steelcut Trio	7	■	■	■	■	■	■	■	■	■	■	■	■	■	■	■	■	■	■	■	■	■	■	■	■	■	■
Texel	3	■	■	•	•	■	■	■	■	■	■	■	■	■	■	■	■	■	■	■	■	■	■	■	■	■	■

Amia 482 Series sewn version models with leather or vinyl require an "S" suffix which features an additional stitch detail across the lumbar region on the back cushion. Vinyl is not available on models with upholstered outer back.

Brody 488 Series vertical fabrics can be found in the *Vertical Surface Fabric Matrix* in the *Surface Materials Reference Manual*.

Legend

- = Not available
- = Available
- = Available with exceptions
- ⓔ = Established
- EL = Elmosoft leather
- L = Leather
- ▶ See specification pages for details.
- *Gaja – Cradle to Cradle Certified™ Silver

	Price Group	Gesture 442 Series - Non-Sewn	Gesture 442 Series - Sewn	Gesture 442 Series - 3D Knit - Non-Sewn	i2i 416 Series - 3D Knit - Sewn	Jersey 383 Series - Standard	Jersey 383 Series - Sewn	Kart	Leap 462 Series - 3D Knit - Standard	Leap 462 Series - Standard	Leap Plus 462 Series - 3D Knit - Standard	Leap Plus 462 Series - Standard	Leap 462 Series - 3D Knit - Sewn	Leap 462 Series - Sewn	Leap Plus 462 Series - 3D Knit - Sewn	Leap Plus 462 Series - Sewn	Leap 464 WorkLounge and Ottoman Series - Standard	Max-Stacker III 477 Series	media:scape kiosk	media:scape Lounge	Mobile Ped Cushion Tops - 9000, Avenir, and Context	Move 490 Series - Standard	Player 475 Series - Standard	Protégé 433 Series - Standard	Protégé 433 Series - Sewn	QIVI 428 Series - QIVI Net - Standard	QIVI 428 Series - QIVI Net - Sewn
3D Knit	NA	•	■	■	•	•	•	•	•	•	•	■	•	■	■	•	•	•	•	•	•	•	•	•	•	•	•
3D Microknit	NA	•	•	•	•	•	•	•	•	•	•	•	•	•	•	•	•	•	•	•	•	•	•	•	•	•	•
Billiard Multi-Use by DesignTex	3	•	■	■	■	■	•	■	■	■	■	■	•	•	•	•	•	•	•	■	■	■	■	■	■	■	■
Bo Peep	5	•	■	■	■	■	•	■	■	■	■	■	•	•	•	•	•	•	•	■	■	■	■	■	■	■	■
Brisa	6	•	■	■	■	■	•	■	■	■	■	■	•	•	•	•	•	•	•	■	■	■	■	■	■	■	■
Buzz2	1	•	■	■	■	■	•	■	■	■	■	■	•	•	•	•	•	•	•	■	■	■	■	■	■	■	■
Chainmail	2	•	■	■	■	■	•	■	■	■	■	■	•	•	•	•	•	•	•	■	■	■	■	■	■	■	■
Cogent: Connect	2	■	■	■	■	■	•	■	■	■	■	■	•	•	•	•	•	•	•	■	■	■	■	■	■	■	■
Cogent: Geode Vertical ⓔ	2	•	■	■	■	■	•	■	■	■	■	■	•	•	•	•	•	•	•	■	■	■	■	■	■	■	■
Cogent: Trails	2	•	■	■	■	■	•	■	■	■	■	■	•	•	•	•	•	•	•	■	■	■	■	■	■	■	■
Connect 3D	NA	•	•	•	•	•	•	•	•	•	•	•	•	•	•	•	•	•	•	•	•	•	•	•	•	•	•
Elmosoft Leather	EL	•	■	■	■	■	•	■	■	■	■	■	•	•	•	•	•	•	•	■	■	■	■	■	■	■	■
Gaja*	3	•	■	■	■	■	•	■	■	■	■	■	•	•	•	•	•	•	•	■	■	■	■	■	■	■	■
Imperma	3	•	■	■	■	■	•	■	■	■	■	■	•	•	•	•	•	•	•	■	■	■	■	■	■	■	■
Jacks ⓔ	1	•	■	■	■	■	•	■	■	■	■	■	•	•	•	•	•	•	•	■	■	■	■	■	■	■	■
Jersey Black	NA	•	•	•	•	■	■	•	•	•	•	•	•	•	•	•	•	•	•	•	•	•	•	•	•	•	•
Steelcase Leather	L	•	■	■	■	■	•	■	■	■	■	■	•	•	•	•	•	•	•	■	■	■	■	■	■	■	■
Link	1	•	■	■	■	■	•	■	■	■	■	■	•	•	•	•	•	•	•	■	■	■	■	■	■	■	■
New Black: Bruce	1	■	■	■	■	■	•	■	■	■	■	■	•	•	•	•	•	•	•	■	■	■	■	■	■	■	■
New Black: Harley	2	■	■	■	■	■	•	■	■	■	■	■	•	•	•	•	•	•	•	■	■	■	■	■	■	■	■
New Black: Henry	1	■	■	■	■	■	•	■	■	■	■	■	•	•	•	•	•	•	•	■	■	■	■	■	■	■	■
New Black: Jack	2	■	■	■	■	■	•	■	■	■	■	■	•	•	•	•	•	•	•	■	■	■	■	■	■	■	■
New Black: James	2	■	■	■	■	■	•	■	■	■	■	■	•	•	•	•	•	•	•	■	■	■	■	■	■	■	■
Nitelights	2	•	■	■	■	■	•	■	■	■	■	■	•	•	•	•	•	•	•	■	■	■	■	■	■	■	■
Playground ⓔ	1	•	■	■	■	■	•	■	■	■	■	■	•	•	•	•	•	•	•	■	■	■	■	■	■	■	■
Redeem	3	•	■	■	■	■	•	■	■	■	■	■	•	•	•	•	•	•	•	■	■	■	■	■	■	■	■
Remix	5	•	■	■	■	■	•	■	■	■	■	■	•	•	•	•	•	•	•	■	■	■	■	■	■	■	■
Reply Air Mesh	NA	•	•	•	•	■	•	•	•	•	•	•	•	•	•	•	•	•	•	•	•	•	•	•	•	•	•
Retrieve	3	•	■	■	■	■	•	■	■	■	■	■	•	•	•	•	•	•	•	■	■	■	■	■	■	■	■
Seating Vinyl ⓔ	2	•	■	■	■	■	•	■	■	■	■	■	•	•	•	•	•	•	•	■	■	■	■	■	■	■	■
Silk	5	■	■	■	■	■	•	■	■	■	■	■	•	•	•	•	•	•	•	■	■	■	■	■	■	■	■
Spyder ⓔ	2	•	■	■	■	■	•	■	■	■	■	■	•	•	•	•	•	•	•	■	■	■	■	■	■	■	■
Stand In	2	•	■	■	■	■	•	■	■	■	■	■	•	•	•	•	•	•	•	■	■	■	■	■	■	■	■
Steelcut Trio	7	•	■	■	■	■	•	■	■	■	■	■	•	•	•	•	•	•	•	■	■	■	■	■	■	■	■
Texel	3	•	■	■	■	■	•	■	■	■	■	■	•	•	•	•	•	•	•	■	■	■	■	■	■	■	■

3D Knit upholstery available only on models with 3D Knit back.
Leap 464 Series WorkLounge is standard with Bo Peep. Elmorustical leather is an option.

Surface Materials

Seating Upholstery Matrix, continued

Legend

- = Not available
- = Available
- = Available with exceptions
- Ⓢ = Established
- EL = Elmosoft leather
- L = Leather
- ▶ See specification pages for details.
- *Gaja — Cradle to Cradle Certified™ Silver
- Tip: *SILQ 418 Series will only take warped vertical fabrics. This includes all standard Steelcase fabrics, Select Surfaces, and COMs.*

	Price Group	Reply 466 Series Work Chair; Uph Seat-Mesh Back	Reply 466 Series Multi-Use Side Chair; Uph Seat-Mesh Back	Reply 466 Series Work chair; Uph Seat-Uph Back	Reply 466 Series Multi-Use Side Chair; Uph Seat-Uph Back	Reply 466 Series Work Chair - Sewn Seat-Mesh Back	Reply 466 Series Multi-Use Side Chair; Sewn Seat-Mesh Back	Reply 466 Series Work Chair; Sewn Seat-Sewn Back	Reply 466 Series Multi-Use Side Chair; Sewn Seat-Sewn Back	Siento 499 Series - Sewn	SILQ 418 Series - Standard	SILQ 418 Series - Sewn	Snodgrass 474 Series - Standard	Steelcase Series 1	Think 465 Series - 3D Knit Back, Sewn Seat	Think 465 Series - Uph Back, Sewn Seat	Think 465 Series - Sewn Back, Sewn Seat	Umami	Universal Ped Cushion Tops - Standard, RPM and RPX	Universal Lateral Cushion Tops - RPDC, 2 Seam	Universal Lateral Cushion Tops - RPDC, 4 Seam	Universal Privacy Modesty Screen
3D Knit	NA	•	•	•	•	•	•	•	•	•	•	•	•	•	•	•	•	•	•	•	•	•
3D Microknit	NA	•	•	•	•	•	•	•	•	•	•	•	•	•	•	•	•	•	•	•	•	•
Billiard Multi-Use by DesignTex	3	■	■	■	■	•	•	•	•	■	■	■	■	■	■	■	■	■	■	■	■	■
Bo Peep	5	■	■	■	■	•	•	•	•	■	■	■	■	■	■	■	■	■	■	■	■	■
Brisa	6	■	•	•	•	•	■	■	■	■	■	■	■	■	■	■	■	■	■	■	■	■
Buzz2	1	■	■	■	■	•	•	•	•	■	■	■	■	■	■	■	■	■	■	■	■	■
Chainmail	2	■	■	■	■	•	•	•	•	■	■	■	■	■	■	■	■	■	■	■	■	■
Cogent: Connect	2	■	■	■	■	•	•	•	•	■	■	■	■	■	■	■	■	■	■	■	■	■
Cogent: Geode Vertical Ⓢ	2	■	•	■	•	•	•	•	•	■	■	■	■	■	■	■	■	■	■	■	■	■
Cogent: Trails	2	•	•	•	•	•	•	•	•	■	■	■	■	■	■	■	■	■	■	■	■	■
Connect 3D	NA	•	•	•	•	•	•	•	•	•	•	•	•	•	•	•	•	•	•	•	•	•
Elmosoft Leather	EL	■	•	•	•	•	■	■	■	■	■	■	■	■	■	■	■	■	■	■	■	■
Gaja*	3	■	■	■	■	•	•	•	•	■	■	■	■	■	■	■	■	■	■	■	■	■
Imperma	3	■	•	•	•	•	•	•	•	■	■	■	■	■	■	■	■	■	■	■	■	■
Jacks Ⓢ	1	■	■	■	■	•	•	•	•	■	■	■	■	■	■	■	■	■	■	■	■	■
Jersey Black	NA	•	•	•	•	•	•	•	•	•	•	•	•	•	•	•	•	•	•	•	•	•
Steelcase Leather	L	■	•	•	•	•	■	■	■	■	■	■	■	■	■	■	■	■	■	■	■	■
Link	1	■	■	■	■	•	•	•	•	■	■	■	■	■	■	■	■	■	■	■	■	■
New Black: Bruce	1	■	■	■	■	•	•	•	•	■	■	■	■	■	■	■	■	■	■	■	■	■
New Black: Harley	2	■	■	■	■	•	•	•	•	■	■	■	■	■	■	■	■	■	■	■	■	■
New Black: Henry	1	■	■	■	■	•	•	•	•	■	■	■	■	■	■	■	■	■	■	■	■	■
New Black: Jack	2	■	■	■	■	•	•	•	•	■	■	■	■	■	■	■	■	■	■	■	■	■
New Black: James	2	■	■	■	■	•	•	•	•	■	■	■	■	■	■	■	■	■	■	■	■	■
Nitelights	2	•	■	•	■	•	•	•	•	■	■	■	■	■	■	■	■	■	■	■	■	■
Playground Ⓢ	1	■	■	■	■	•	•	•	•	■	■	■	■	■	■	■	■	■	■	■	■	■
Redeem	3	■	■	■	■	•	•	•	•	■	■	■	■	■	■	■	■	■	■	■	■	■
Remix	5	■	■	■	■	•	•	•	•	■	■	■	■	■	■	■	■	■	■	■	■	■
Reply Air Mesh	NA	■	■	■	■	■	■	■	■	•	•	•	•	•	•	•	•	•	•	•	•	•
Retrieve	3	■	■	■	■	•	•	•	•	■	■	■	■	■	■	■	■	■	■	■	■	■
Seating Vinyl Ⓢ	2	■	•	•	•	•	■	■	■	■	■	■	■	■	■	■	■	■	■	■	■	■
Silk	5	■	■	■	■	•	•	•	•	■	■	■	■	■	■	■	■	■	■	■	■	■
Spyder	2	■	■	■	■	•	•	•	•	■	■	■	■	■	■	■	■	■	■	■	■	■
Stand In	2	■	•	•	•	•	■	■	■	■	■	■	■	■	■	■	■	■	■	■	■	■
Steelcut Trio	7	■	■	■	■	•	•	•	•	■	■	■	■	■	■	■	■	■	■	■	■	■
Texel	3	■	•	•	•	•	•	•	•	■	■	■	■	■	■	■	■	■	■	■	■	■

Fire Code Seating Upholstery Matrix

The following matrix lists each seating line and denotes fabrics that are available, available with exceptions, and not available. For further detail regarding exceptions, see the specific chapter within the *Seating Specification Guide* or the *Surface Materials Reference Manual*.

Seating Upholstery: Availability of Fire Code Treatment

Legend

- = Not available
- = Available
- = Available with exceptions
- ◻ = Untested
- ⓔ = Established
- EL = Elmosoft leather
- L = Leather
- ▶ See specification pages for details.
- *Gaja — Cradle to Cradle Certified™ Silver

	Price Group	Amia 482 Series - 3D Knit	Amia 482 Series	Amia 482 Series - 3D Knit, Sewn	Amia 482 Series - Sewn	cobi 434 Series - Connect 3D	cobi 434 Series - Connect 3D, Sewn	Gesture 442 Series - Non-Sewn	Gesture 442 Series - Sewn	Gesture 442 Series - 3D Knit, Non-Sewn	Jersey 383 Series	Jersey 383 Series - Sewn	Leap 462 Series - 3D Knit	Leap 462 Series	Leap Plus 462 Series - 3D Knit	Leap Plus 462 Series	Leap 462 Series - 3D Knit, Sewn	Leap 462 Series - Sewn	Leap Plus 462 Series - 3D Knit - Sewn	Leap Plus 462 Series - Sewn	Leap 464 WorkLounge and Ottoman Series	Move 490 Series	QIVI 428 Series - QIVI Net	QIVI 428 Series - QIVI Net, Sewn	Think 465 Series - 3D Knit Back, Sewn Seat	Think 465 Series - Uph Back, Sewn Seat	Think 465 Series - Sewn Back, Sewn Seat
Billiard Multi-Use by DesignTex	3	■	■	•	◻	•	■	•	•	◻	•	•	■	■	■	■	•	•	•	•	•	■	■	■	■	•	
Bo Peep	5	■	■	•	◻	•	■	•	•	◻	•	•	■	■	■	■	•	•	•	•	•	◻	■	■	■	•	
Brisa	6	■	■	•	◻	•	■	•	•	◻	•	•	■	■	■	■	•	•	•	•	•	■	■	■	■	•	
Buzz2	1	■	■	•	◻	•	■	•	•	◻	•	•	■	■	■	■	•	•	•	•	•	■	■	■	■	•	
Chainmail	2	■	■	•	◻	•	■	•	•	◻	•	•	■	■	■	■	•	•	•	•	•	■	■	■	■	•	
Cogent: Connect	2	■	■	•	◻	■	•	•	•	◻	•	•	■	■	■	■	•	•	•	•	•	■	■	■	■	•	
Cogent: Geode Vertical	2	■	■	•	◻	•	■	•	•	◻	•	•	■	■	■	■	•	•	•	•	•	■	■	■	■	•	
Cogent: Trails	2	■	■	•	◻	•	■	•	•	◻	•	•	■	■	■	■	•	•	•	•	•	■	■	■	■	•	
Connect 3D	NA	•	•	•	•	•	•	•	•	•	•	•	•	•	•	•	•	•	•	•	•	•	•	•	•	•	
Elmosoft Leather	EL	■	■	•	◻	•	■	•	•	◻	•	•	■	■	■	■	•	•	•	•	•	■	■	■	■	•	
Gaja*	3	■	■	•	◻	•	■	•	•	◻	•	•	■	■	■	■	•	•	•	•	•	■	■	■	■	•	
Imperma	3	■	■	•	◻	•	■	•	•	◻	•	•	■	■	■	■	•	•	•	•	•	■	■	■	■	•	
Jacks	1	■	■	•	◻	•	■	•	•	◻	•	•	■	■	■	■	•	•	•	•	•	■	■	■	■	•	
Steelcase Leather	L	■	■	•	◻	•	■	•	•	◻	•	•	■	■	■	■	•	•	•	•	•	■	■	■	■	•	
Link	1	■	■	•	◻	•	■	•	•	◻	•	•	■	■	■	■	•	•	•	•	•	■	■	■	■	•	
Nitelights	2	■	■	•	◻	•	■	•	•	◻	•	•	■	■	■	■	•	•	•	•	•	■	■	■	■	•	
Playground	1	■	■	•	◻	•	■	•	•	◻	•	•	■	■	■	■	•	•	•	•	•	■	■	■	■	•	
Redeem	3	■	■	•	◻	•	■	•	•	◻	•	•	■	■	■	■	•	•	•	•	•	■	■	■	■	•	
Remix	5	■	■	•	◻	•	■	•	•	◻	•	•	■	■	■	■	•	•	•	•	•	■	■	■	■	•	
Reply Air Mesh	NA	•	•	•	•	•	•	•	•	•	•	•	•	•	•	•	•	•	•	•	•	•	•	•	•	•	
Retrieve	3	■	■	•	◻	•	■	•	•	◻	•	•	■	■	■	■	•	•	•	•	•	■	■	■	■	•	
Seating Vinyl	2	■	■	•	◻	•	■	•	•	◻	•	•	■	■	■	■	•	•	•	•	•	■	■	■	■	◻	
Spyder	2	■	■	•	◻	•	■	•	•	◻	•	•	■	■	■	■	•	•	•	•	•	■	■	■	■	•	
Stand In	2	■	■	•	◻	•	■	•	•	◻	•	•	■	■	■	■	•	•	•	•	•	■	■	■	■	◻	
Steelcut Trio	7	■	■	•	◻	•	■	•	•	◻	•	•	■	■	■	■	•	•	•	•	•	■	■	■	■	•	
Texel	3	■	■	•	◻	•	■	•	•	◻	•	•	■	■	■	■	•	•	•	•	•	■	■	■	■	•	

Amia 482 models meet fire code requirements only when specified with fully adjustable arms or armless.
cobi 434 Series fire code models are available in the following Connect 3D colors only: 5021 Blue Jay, 5023 Wasabi, 5025 Graphite, 5026 Licorice, 5027 Malt, and 5028 Root Beer.
Move models meet fire code requirements only when specified with 6205 Black or 6249 Platinum Solid plastic.
3D Knit upholstery is available only on models with 3D Knit back.
Leap 462 models meet fire code requirements only when specified with fully adjustable arms or armless.
Think 465 models meet fire code requirements only when specified with fully adjustable arms or armless. Models specified with vinyl meet firecode requirements only when specified armless.

Surface Materials

Color Availability Matrix

Legend

- = Not available
- = Available
- = Available with exceptions
- Ⓢ = Established
- ▶ See specification pages for details.

		Plastic																					
		6009	6052	6053	6059	6205	6248	6249	6250	6256	6259	6295	6296	6302	6332	6333	6334	6335	6336	6337	6338	6527	6654
		Arctic White	Milk	Seagull	Sterling Dark Solid	Black	Midnight Brown	Platinum Solid	Coffee	Graphite	Midnight	Near Black	Sterling	Baltic	Citron	Picasso	Flash	Wasabi	Jazz	Element	Chili Red	Merle	Sand
Amia 482 Series	Base and frame	•	•	•	•	■	•	■	•	•	•	•	•	•	•	•	•	•	•	•	•	■	•
	Outer seat and back	•	•	•	•	■	•	■	•	•	•	•	•	•	•	•	•	•	•	•	•	■	•
	Arms	•	•	•	•	■	•	•	•	•	•	•	•	•	•	•	•	•	•	•	•	■	•
	Stool base and frame	•	•	•	•	■	•	•	•	•	•	•	•	•	•	•	•	•	•	•	•	•	•
	Stool foot ring	•	•	•	•	■	•	•	•	•	•	•	•	•	•	•	•	•	•	•	•	•	•
Brody 488 WorkLounge	Foot and screen brackets	•	•	•	•	•	•	•	•	•	•	•	•	•	•	•	•	•	•	•	•	•	•
	Frame, power, and caddy	•	•	•	•	•	•	•	•	•	•	•	•	•	•	•	•	•	•	•	•	•	•
	Back of caddy	•	•	•	•	•	•	•	•	•	•	•	•	•	•	•	•	•	•	•	•	•	•
	Lower surround trim	•	•	■	■	•	•	■	•	•	•	•	•	•	•	•	•	•	•	•	•	•	•
	Seat shell	•	•	•	■	•	•	■	•	•	•	•	•	•	•	•	•	•	•	•	•	•	•
	Personal worksurface	•	•	■	■	•	•	■	•	•	•	•	•	•	•	•	•	•	•	•	•	•	•
	Personal worksurface arm	•	•	•	•	•	•	•	•	•	•	•	•	•	•	•	•	•	•	•	•	•	•
	Side surface	•	•	•	•	•	•	•	•	•	•	•	•	•	•	•	•	•	•	•	•	•	•
Brody 488 Desk	Foot and screen brackets	•	•	•	•	•	•	•	•	•	•	•	•	•	•	•	•	•	•	•	•	•	•
	Frame	•	•	•	•	•	•	•	•	•	•	•	•	•	•	•	•	•	•	•	•	•	•
	Lower surround trim	•	•	■	■	•	•	■	•	•	•	•	•	•	•	•	•	•	•	•	•	•	•
	Power	•	•	•	•	•	•	•	•	•	•	•	•	•	•	•	•	•	•	•	•	•	•
Cachet 487 Series	Swivel and 4-leg frame	•	•	•	•	■	•	•	•	•	■	•	•	•	•	•	•	•	•	•	•	•	•
	Stool frame	•	•	•	•	■	•	•	•	•	•	•	•	•	•	•	•	•	•	•	•	•	•
cobi 434 Series	Base and back frame	•	•	•	•	■	•	•	•	•	•	•	•	•	•	•	•	•	•	•	•	•	•
	Arm caps, top edge, and casters	•	•	•	•	■	•	■	•	•	•	•	•	•	•	•	•	•	•	•	•	•	•
	Outer back	■	•	•	•	■	•	■	•	•	•	■	•	•	•	•	•	•	•	•	•	•	•
Foot ring	•	•	•	•	■	•	■	•	•	•	•	•	•	•	•	•	•	•	•	•	•	•	•
Criterion 453 Series	Base, arms, outer seat, and back	•	•	•	•	■	•	•	□	□	•	•	•	•	•	•	•	•	•	•	•	•	•
	Foot ring	•	•	•	•	■	•	•	□	□	•	•	•	•	•	•	•	•	•	•	•	•	•
Gesture 442 Series	Base	•	•	•	•	■	•	•	•	•	•	•	•	•	•	•	•	•	•	•	•	•	•
	Arms	•	•	•	•	■	•	•	•	•	•	•	•	•	•	•	•	•	•	•	•	■	•
	Seat perimeter, back shell, and headrest	•	•	■	•	■	•	•	•	•	•	•	•	•	•	•	•	•	•	•	•	■	•
	Back frame	•	•	•	•	■	•	•	•	•	•	•	•	•	•	•	•	•	•	•	•	•	•
i2i 416 Series	Outer back	■	•	•	•	•	•	■	•	•	•	■	•	•	•	•	•	•	•	•	•	•	•
	Base and cylinder	•	•	•	•	•	•	•	•	•	•	•	•	•	•	•	•	•	•	•	•	•	•
	Tablet arm	•	•	•	•	•	•	•	•	•	•	•	•	•	•	•	•	•	•	•	•	•	•
Jersey Series	Work chair	•	•	•	•	•	•	•	•	•	•	•	•	•	•	•	•	•	•	•	•	•	•
	Guest chair	•	•	•	•	•	•	•	•	•	•	•	•	•	•	•	•	•	•	•	•	•	•
Kart	Base, back supports, and arm support bar	•	•	•	•	•	•	•	•	•	•	•	•	•	•	•	•	•	•	•	•	•	•
	Back frame and seat shell	•	■	■	•	■	•	■	•	•	■	•	•	•	•	•	•	•	•	•	•	■	•
	Arm caps and casters	•	•	•	•	■	•	•	•	•	•	•	•	•	•	•	•	•	•	•	•	•	•
	Stool foot ring	•	•	•	•	•	•	•	•	•	•	•	•	•	•	•	•	•	•	•	•	•	•
Leap 462 Series	Base and ribbon frame	•	•	•	•	■	•	■	•	•	■	•	•	•	•	•	•	•	•	•	•	•	•
	Outer seat and back	•	•	•	•	■	•	■	•	•	■	•	•	•	•	•	•	•	•	•	•	•	•
	Arms	•	•	•	•	■	•	•	•	•	•	•	•	•	•	•	•	•	•	•	•	•	•
	Stool base and ribbon frame	•	•	•	•	■	•	■	•	•	■	•	•	•	•	•	•	•	•	•	•	•	•
	Stool foot ring	•	•	•	•	■	•	•	•	•	•	•	•	•	•	•	•	•	•	•	•	•	•
Leap 464 WorkLounge	Back frame, arm supports, and base	•	•	•	•	•	•	•	•	•	•	•	•	•	•	•	•	•	•	•	•	•	•

		6BD8 Snow	6BD9 Carbon Flat	6BE1 Ore																								
Metal																												
		8046 Polished Aluminum		9201 Polished Chrome																								
Accessory Paint																												
		4140 Arctic White Gloss																										
Paint																												
		0835 Black		4146 Champagne Matte		4750 Champagne Metallic		4799 Platinum Metallic		4803 Near Black Metallic		7207 Black		7239 Midnight		7241 Arctic White		7243 Seagull		7250 Sterling Dark		7360 Merle						
Lux Coatings— Select Surfaces																												
		4B20 Obsidian		4B22 Matte Brass		4B23 Burnished Bronze		4B24 Night Bronze		4B25 Matte Copper																		
Seating Coating																												
		7000 Black																										

Color Availability Matrix, continued

- Legend**
- = Not available
 - = Available
 - = Available with exceptions
 - E = Established
 - ▶ See specification pages for details.

		Laminate	2406	2409	2410	2412	2422	2511	2535	2536	2538	2539	2714	2722	2730	2746	2759	2772	2811	2883	2884	2885	2HAT	
Amia 482 Series	Base and frame	•	•	•	•	•	•	•	•	•	•	•	•	•	•	•	•	•	•	•	•	•	•	•
	Outer seat and back	•	•	•	•	•	•	•	•	•	•	•	•	•	•	•	•	•	•	•	•	•	•	•
	Arms	•	•	•	•	•	•	•	•	•	•	•	•	•	•	•	•	•	•	•	•	•	•	•
	Stool base and frame	•	•	•	•	•	•	•	•	•	•	•	•	•	•	•	•	•	•	•	•	•	•	•
	Stool foot ring	•	•	•	•	•	•	•	•	•	•	•	•	•	•	•	•	•	•	•	•	•	•	•
Brody 488 WorkLounge	Foot and screen brackets	•	•	•	•	•	•	•	•	•	•	•	•	•	•	•	•	•	•	•	•	•	•	•
	Frame, power, and caddy	•	•	•	•	•	•	•	•	•	•	•	•	•	•	•	•	•	•	•	•	•	•	•
	Back of caddy	•	•	•	•	•	•	•	•	•	•	•	•	•	•	•	•	•	•	•	•	•	•	•
	Lower surround trim	•	•	•	•	•	•	•	•	•	•	•	•	•	•	•	•	•	•	•	•	•	•	•
	Seat shell	•	•	•	•	•	•	•	•	•	•	•	•	•	•	•	•	•	•	•	•	•	•	•
	Personal worksurface	•	•	•	•	•	•	•	•	•	•	•	•	•	•	•	•	•	•	•	•	•	•	•
	Personal worksurface arm	•	•	•	•	•	•	•	•	•	•	•	•	•	•	•	•	•	•	•	•	•	•	•
Side surface	•	•	■	•	•	■	■	■	•	•	•	•	•	•	•	•	•	•	•	■	•	•	■	
Brody 488 Desk	Foot and screen brackets	•	•	•	•	•	•	•	•	•	•	•	•	•	•	•	•	•	•	•	•	•	•	•
	Frame	•	•	•	•	•	•	•	•	•	•	•	•	•	•	•	•	•	•	•	•	•	•	•
	Lower surround trim	•	•	•	•	•	•	•	•	•	•	•	•	•	•	•	•	•	•	•	•	•	•	•
Cachet 487 Series	Swivel and 4-leg frame	•	•	•	•	•	•	•	•	•	•	•	•	•	•	•	•	•	•	•	•	•	•	•
	Stool frame	•	•	•	•	•	•	•	•	•	•	•	•	•	•	•	•	•	•	•	•	•	•	•
cobi 434 Series	Base and back frame	•	•	•	•	•	•	•	•	•	•	•	•	•	•	•	•	•	•	•	•	•	•	•
	Arm caps, top edge, and casters	•	•	•	•	•	•	•	•	•	•	•	•	•	•	•	•	•	•	•	•	•	•	•
	Outer back	•	•	•	•	•	•	•	•	•	•	•	•	•	•	•	•	•	•	•	•	•	•	•
Foot ring	•	•	•	•	•	•	•	•	•	•	•	•	•	•	•	•	•	•	•	•	•	•	•	•
Criterion 453 Series	Base, arms, outer seat, and back	•	•	•	•	•	•	•	•	•	•	•	•	•	•	•	•	•	•	•	•	•	•	•
	Foot ring	•	•	•	•	•	•	•	•	•	•	•	•	•	•	•	•	•	•	•	•	•	•	•
Gesture 442 Series	Base	•	•	•	•	•	•	•	•	•	•	•	•	•	•	•	•	•	•	•	•	•	•	•
	Arms	•	•	•	•	•	•	•	•	•	•	•	•	•	•	•	•	•	•	•	•	•	•	•
	Seat perimeter, back shell, and headrest	•	•	•	•	•	•	•	•	•	•	•	•	•	•	•	•	•	•	•	•	•	•	•
	Back frame	•	•	•	•	•	•	•	•	•	•	•	•	•	•	•	•	•	•	•	•	•	•	•
i2i 416 Series	Outer back	•	•	•	•	•	•	•	•	•	•	•	•	•	•	•	•	•	•	•	•	•	•	•
	Base and cylinder	•	•	•	•	•	•	•	•	•	•	•	•	•	•	•	•	•	•	•	•	•	•	•
	Tablet arm	•	•	•	•	•	■	•	•	•	•	•	•	•	■	■	•	•	•	■	•	■	•	•
Jersey Series	Work chair	•	•	•	•	•	•	•	•	•	•	•	•	•	•	•	•	•	•	•	•	•	•	•
	Guest chair	•	•	•	•	•	•	•	•	•	•	•	•	•	•	•	•	•	•	•	•	•	•	•
Kart	Base, back supports, and arm support bar	•	•	•	•	•	•	•	•	•	•	•	•	•	•	•	•	•	•	•	•	•	•	•
	Back frame and seat shell	•	•	•	•	•	•	•	•	•	•	•	•	•	•	•	•	•	•	•	•	•	•	•
	Arm caps and casters	•	•	•	•	•	•	•	•	•	•	•	•	•	•	•	•	•	•	•	•	•	•	•
	Stool foot ring	•	•	•	•	•	•	•	•	•	•	•	•	•	•	•	•	•	•	•	•	•	•	•
Leap 462 Series	Base and ribbon frame	•	•	•	•	•	•	•	•	•	•	•	•	•	•	•	•	•	•	•	•	•	•	•
	Outer seat and back	•	•	•	•	•	•	•	•	•	•	•	•	•	•	•	•	•	•	•	•	•	•	•
	Arms	•	•	•	•	•	•	•	•	•	•	•	•	•	•	•	•	•	•	•	•	•	•	•
	Stool base and ribbon frame	•	•	•	•	•	•	•	•	•	•	•	•	•	•	•	•	•	•	•	•	•	•	•
	Stool foot ring	•	•	•	•	•	•	•	•	•	•	•	•	•	•	•	•	•	•	•	•	•	•	•
Leap 464 WorkLounge	Back frame, arm supports, and base	•	•	•	•	•	•	•	•	•	•	•	•	•	•	•	•	•	•	•	•	•	•	•

- **FCS models for Amia, Leap, and Think** meet fire code requirements only when specified with fully adjustable arms or armless.
- **FCS models for Criterion** are available with 6205 Black plastic only.
- **FCS models for Gesture** are available with black/black color scheme only.
- **FCS models for Move** are available with 6205 Black or 6249 Platinum Solid plastic only.
- **FCS models for i2i** are available with 6249 Platinum Solid or 6295 Near Black plastic only.
- **FCS models for Node** are available with 6205 Black, 6259 Midnight, 6335 Wasabi, or 6336 Jazz only.

Color Availability Matrix, continued

Legend

- = Not available
- = Available
- = Available with exceptions
- Ⓢ = Established
- ▶ See specification pages for details.

		Paint, cont.				Lux Coatings-Select Surfaces					Seating Coating	7000 Black	Laminate	Other Finishes											
		7239	7241	7243	7250	4B20	4B22	4B23	4B24	4B25	7000	2406	2409	2410	2412	2422	2511	2538	2539	2714	2722	2730	2746		
		Midnight	Arctic White	Seagull	Sterling Dark	Obsidian	Matte Brass	Burnished Bronze	Night Bronze	Matte Copper	Black	Clear Cherry	Clear Maple	Graphite Walnut	Natural Cherry	Medium Cherry	Winter on Maple	Clear Walnut	Warm Oak Ⓢ	Natural Walnut	Cream	Arctic White	Black		
Max-Stacker 477 Series	Frame and bookrack	■	•	•	•	■	■	■	■	■	■	•	•	•	•	•	•	•	•	•	•	•	•	•	
	Seat and back	•	•	•	•	•	•	•	•	•	•	•	•	•	•	•	•	•	•	•	•	•	•	•	
	Tablet arm	•	•	•	•	•	•	•	•	•	•	■	■	■	■	■	■	■	■	■	■	■	■	■	
Move 490 Series	Frame	•	•	•	•	•	•	•	•	•	•	•	•	•	•	•	•	•	•	•	•	•	•	•	
	Back shell and arms	•	•	•	•	•	•	•	•	•	•	•	•	•	•	•	•	•	•	•	•	•	•	•	
Node 480 Series	Shell	•	•	•	•	•	•	•	•	•	•	•	•	•	•	•	•	•	•	•	•	•	•	•	
	Personal worksurface	•	•	•	•	•	•	•	•	•	•	•	•	•	•	•	•	•	•	•	•	•	•	•	
	Tripod base	•	•	•	•	•	•	•	•	•	•	•	•	•	•	•	•	•	•	•	•	•	•	•	
Player 475 Series	Stool base	•	•	•	•	•	•	•	•	•	•	•	•	•	•	•	•	•	•	•	•	•	•	•	
	Frame on chairs with smooth arms	•	•	•	•	•	•	•	•	•	•	•	•	•	•	•	•	•	•	•	•	•	•	•	
	Smooth arms	•	•	•	•	•	•	•	•	•	•	•	•	•	•	•	•	•	•	•	•	•	•	•	
	Frame on chairs with textured arms	•	•	•	•	•	•	•	•	•	•	•	•	•	•	•	•	•	•	•	•	•	•	•	
Protégé 433 Series	Textured arms	•	•	•	•	•	•	•	•	•	•	•	•	•	•	•	•	•	•	•	•	•	•	•	
	Tablet arm	•	•	•	•	•	•	•	•	•	•	•	•	•	•	•	•	•	•	•	■	■	■	■	
	Base, arms, and sled base	•	•	•	•	•	•	•	•	•	•	•	•	•	•	•	•	•	•	•	•	•	•	•	
	Arm caps and outer back shell	•	•	•	•	•	•	•	•	•	•	•	•	•	•	•	•	•	•	•	•	•	•	•	
QiVi 428 Series	Casters	•	•	•	•	•	•	•	•	•	•	•	•	•	•	•	•	•	•	•	•	•	•	•	
	Back frame, seat shell, and arm caps	•	•	•	•	□	□	□	□	□	•	•	•	•	•	•	•	•	•	•	•	•	•	•	
	Base	•	•	•	•	•	•	•	•	•	•	•	•	•	•	•	•	•	•	•	•	•	•	•	
	Frame	•	•	•	•	•	•	•	•	•	•	•	•	•	•	•	•	•	•	•	•	•	•	•	
	Stool foot ring	•	■	•	•	•	•	•	•	•	•	•	•	•	•	•	•	•	•	•	•	•	•	•	
	Stool base	•	■	•	•	•	•	•	•	•	•	•	•	•	•	•	•	•	•	•	•	•	•	•	
Reply 466 Series	Base and arm support	•	•	•	•	•	•	•	•	•	•	•	•	•	•	•	•	•	•	•	•	•	•	•	
	Frame, outer back, arm caps, arm tube, and casters	•	•	•	•	•	•	•	•	•	•	•	•	•	•	•	•	•	•	•	•	•	•	•	
Steelcase Series 1	Arms	•	•	•	•	•	•	•	•	•	•	•	•	•	•	•	•	•	•	•	•	•	•	•	
	Base	•	•	•	•	•	•	•	•	•	•	•	•	•	•	•	•	•	•	•	•	•	•	•	
	Frame	•	•	•	•	•	•	•	•	•	•	•	•	•	•	•	•	•	•	•	•	•	•	•	
	Lumbar and flexor	•	•	•	•	•	•	•	•	•	•	•	•	•	•	•	•	•	•	•	•	•	•	•	
Siento 499 Serie	Base and arm supports	•	•	•	•	•	•	•	•	•	•	•	•	•	•	•	•	•	•	•	•	•	•	•	
Snodgrass 474 Series	Frame	•	•	•	•	•	•	•	•	•	•	•	•	•	•	•	•	•	•	•	•	•	•	•	
Think 465 Series	Base	•	•	■	•	•	•	•	•	•	•	•	•	•	•	•	•	•	•	•	•	•	•	•	
	Frame and arm supports	•	•	■	•	•	•	•	•	•	•	•	•	•	•	•	•	•	•	•	•	•	•	•	
	Stool frame and arm supports	•	•	■	•	•	•	•	•	•	•	•	•	•	•	•	•	•	•	•	•	•	•	•	
	Stool foot ring	•	•	•	•	•	•	•	•	•	•	•	•	•	•	•	•	•	•	•	•	•	•	•	
	Stool base	•	•	■	•	•	•	•	•	•	•	•	•	•	•	•	•	•	•	•	•	•	•	•	

Special Features

This chart provides general guidelines about some of the types of special features that are available.

Legend

- = Not available
- = Available
- S = Standard Offering
- DO = Available in Design Options
- ▶ See specification pages for details.

	Different fabric on seat and back	Headrest	Sewn seam using vinyl or leather	Thicker seat cushion	Special seat height *	Special seat height base assemblies for field installation	Stool base	Jury base	Glides	Soft roll-control casters (specified with chair/stool)	Field-installed roll-control casters	Braking or reverse braking casters (specified with chair/stool)	Field-installed reverse-braking casters	High-performance arm	Oversized tablet arm	Corporate logo	Narrow arm width
Amia 482 Series	■	•	S	■	■	•	S	■	S	DO	DO	■	DO	S	•	•	•
Cachet 487 Series	■	•	•	■	■	■	S	■	•	S	S	DO	DO	•	•	•	•
cobi 434 Series	■	•	S	•	•	•	S	■	S	•	•	■	•	•	•	•	•
Criterion 453 Series	■	•	S	■	DO	■	S	•	S	DO	DO	DO	•	S	•	•	•
Gesture 442 Series	■	S	•	•	•	•	•	•	•	•	•	•	•	•	•	•	•
i2i 416 Series	■	•	•	•	•	•	•	•	S	•	•	•	•	•	•	•	•
Jersey Series	S	•	•	•	■	■	•	■	S	•	•	•	•	S	•	•	•
Kart	•	•	•	■	■	•	S	S	■	■	•	•	•	•	•	•	•
Leap 462 Series	■	S	S	■	DO	■	S	■	S	DO	DO	■	DO	S	•	■	DO
Leap 464 Series WorkLounge	■	S	•	■	■	•	•	•	S	•	•	•	•	•	•	•	•
Max-Stacker III 477 Series	•	•	•	•	•	•	•	•	S	•	•	•	•	•	•	•	•
Move 490 Series	■	•	•	•	•	•	S	•	S	•	•	•	•	•	•	•	•
Player 475 Series	■	•	S	•	•	•	•	•	S	•	•	•	•	•	•	•	•
Protégé 433 Series	•	•	•	■	■	■	■	•	■	■	DO	■	•	•	•	•	•
Reply 466 Series	■	•	•	•	•	■	•	•	S	■	DO	•	•	•	•	•	•
Siento 499 Series	■	■	S	•	■	•	•	•	■	•	•	•	•	■	•	•	•
Snodgrass 474 Series	■	•	•	•	•	•	•	•	S	•	•	•	•	•	•	•	•
Think 465 Series	■	S	S	•	■	•	S	■	S	S	S	■	DO	S	•	■	•
turnstone 1.0																	
à la carte Series	S	•	•	•	•	•	S	■	S	•	•	•	•	•	•	•	•
Crew Series	■	•	S	•	■	•	S	•	S	•	DO	•	•	•	•	•	•
Jacket Series	S	•	•	•	•	•	•	•	•	•	•	•	•	•	•	•	•
Uno Series	S	•	•	•	•	•	S	■	S	•	•	•	•	•	•	•	•

Design Options is a collection of commonly ordered Specials. Products in Design Options have a special quote number already assigned so it's not necessary to go through the normal E-quote process.

For individual quote information, or special requests not listed above, please submit an RFQ request form. The form may be accessed at the following: village.steelcase.com, search Specials RFQ.

*Maximum seat height is 33".
Minimum seat height is 14½" with 3" travel.

Statement of Line

Guest Seating

Alcove

- Understanding
- ▶ Page 534
- Specifying
- ▶ Page 536

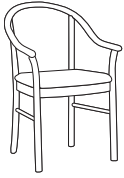

Guest Chair with Open Arms

Collaboration

- Understanding
- ▶ Page 538
- Specifying
- ▶ Page 540

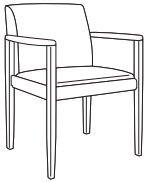

Open

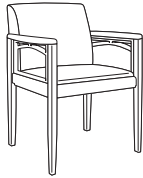

Arcade

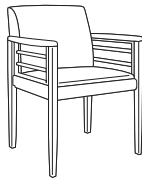

Ladder

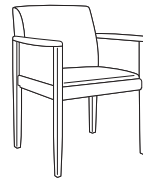

Upholstered Insert

Tip: All Collaboration guest chairs are available with plain wood arms.

Escapade

- Understanding
- ▶ Page 542
- Specifying
- ▶ Page 544



Guest Chair with Wood Slat Back



Guest Chair with Upholstered Back

Guest Seating, continued

Mingle

Understanding
 ▶ Page 546
 Specifying
 ▶ Page 548

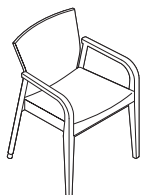

Guest Chair

Oriana

Understanding
 ▶ Page 550
 Specifying
 ▶ Page 552

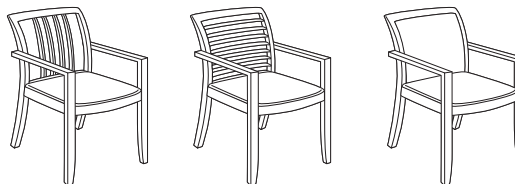

Vertical
 Slat-Back
 Guest Chair

Horizontal
 Slat-Back
 Guest Chair

Fully
 Upholstered
 Back Guest
 Chair

Sawyer

Understanding
 ▶ Page 554
 Specifying
 ▶ Page 555

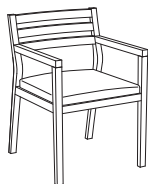

Guest Chair

Snodgrass 474 Series

Understanding
 ▶ Page 556
 Specifying
 ▶ Page 557

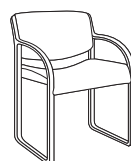

Guest Chair with
 Open Back and
 Open Arms

Terrazzo

Understanding
 ▶ Page 558
 Specifying
 ▶ Page 560

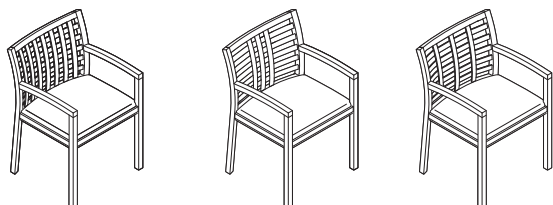

Guest Chair with
 Square Lattice Back

Guest Chair with
 Macintosh Lattice
 Back

Guest Chair with
 Horizontal Lattice
 Back

Topaz

Understanding
 ▶ Page 562
 Specifying
 ▶ Page 564

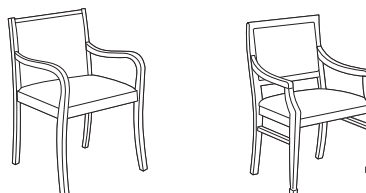

Guest Chair with
 Closed Back

Guest Chair with
 Open Back

Guidelines for Selecting Appropriate Ergonomic Seating

<p>General-Use</p>	<p>High</p> <p>General-Use Seating</p> <p>Group Communicating Group Collaborating</p> <p>Interaction</p> <p>High-Performance Seating</p> <p>Individual Processing (task intensive) Individual Analyzing/Creating (multi-task)</p> <p>Low</p>	<ul style="list-style-type: none"> • Short periods of sitting • Moderate computer use • In some cases, a general-use chair can be used for short-term, individual analyzing/creating. 	
<p>High-Performance</p>	<p>Low</p> <p>Autonomy</p> <p>High</p>	<ul style="list-style-type: none"> • Long periods of sitting • Heavy computer use • The more repetitive the task (individual processing work), the more critical it is to have a high-performance chair with full adjustability. 	
<p>Executive</p>	<p>Executive Seating</p>	<p>Today's executive is an active participant, not just a delegator. Image is very important in the executive suite, but time at the computer must also be a consideration. Whether image or ergonomics drive the choice, this range of seating is diverse to provide the perfect chair for any executive work setting.</p>	<ul style="list-style-type: none"> • Design that acknowledges image • Aesthetics and detailing that suit the setting • Ergonomic features matched to the kinds of work
<p>Guest</p>	<p>Guest Seating</p>	<p>Guest seating must be adaptable to many roles: as side chairs, pulled up to the conference table, in the learning center, in the private office, or in high-traffic areas where long use-life is essential. Guest seating is not intended for long periods of seated work, but must provide short-term comfort and have a welcoming, comfortable look.</p>	<ul style="list-style-type: none"> • A style in harmony with the other furniture • A scale that suits the environment • A durability that fits the intended use
<p>Stackable</p>	<p>Stackable Seating</p>	<p>Stackable seating is used when occasional, transportable, easy-to-store seating is needed. Whether used as side chairs, meeting chairs, in classrooms, or cafeterias, the challenge is to maintain an excellent aesthetic combined with great strength even though the chairs are light in scale for portability.</p>	<ul style="list-style-type: none"> • Durability for high-volume, high-traffic use • Light weight for easy stacking and moving • Extra features if needed, such as tablet arms, bookracks, glides, transport and storage dollies, and ganging or alignment devices.
<p>Lounge</p>	<p>Lounge Seating</p>	<p>Lounge seating is often multiple and is found throughout the organization from reception areas to executive offices. Lounge seating is the "first impression seating," critical to an organization's image.</p>	<ul style="list-style-type: none"> • Durability related to level of use • A design that looks right in multiples • Size, scale, and appearance that suits the environment

Steelcase chairs offer varying levels of adjustability to meet the needs of many types of users. Adjustable chairs may offer one or more of these features:

Mechanisms



Swivel feature allows the user to rotate the seat 360 degrees in either direction.
(All)

Seat Adjustments



Pneumatic-height adjustment allows the user to remain seated while adjusting the seat height by way of a control button or lever.
(All)

Back Adjustments



Back-tension adjustment allows the user to control the amount of resistance felt when leaning back in the chair.
(All)

Additional Resources

Wood seating products

are supported with an array of informational materials, tools, and software to help you plan an installation efficiently.

Product brochures and planning tools

can be ordered through your Steelcase area office by calling 1.800.784.0358 or through the Marketing Resources website at village.steelcase.com.

Product Brochures

The following publications focus on wood seating in greater detail:

Seating Overview

Form number 06-0000890

Alcove

Form number S3012

Collaboration

Form number S11078

Escapade

Form number S11074

Mingle

Form number S10880

Oriana

Form number S11079

Siento

Form number 06-0001282

Terrazzo

Form number S10886

Topaz

Form number S11077

Steelcase Inc. Corporate Capabilities Brochure

This publication offers a concise overview of Steelcase including insights into the attitudes and commitments that make the corporation unique. In addition, the brochure provides an illustrated listing of all the products and services offered and international activities are described.

Printed Materials

Surface Materials Reference Manual

This publication provides:

- An explanation of the surface materials and their categories
- "Available on" matrices
- Vertical surface fabric and seating upholstery selection listing
- Technical data for surface materials
- Surface material care and cleaning instructions

Planning Tools

Quick Ship Guide

This handbook describes all Steelcase, turnstone, and Coalesse products that are available for Rapid2 (ships in 2 days), Rapid5 (ships in 5-7 days), or Coalesse Rapid10 (ships in 10 days).

Computer Tools

Electronic Catalog

Accurate sales quotations and purchase orders for Steelcase products are created with specification software that uses Steelcase Electronic Catalog data. Use the data to specify and price style numbers and options for every Steelcase product. The data is updated bimonthly by Steelcase and provided to software programs including: the Hedberg Business System, SmartTools—Steelcase's design and specification software (for more information on SmartTools, please email SmartTools@steelcase.com), the ProjectMatrix ProjectSystems libraries, as well as 20-20 CAP Studio.

Furniture Symbol Graphic Data

Steelcase creates 2D and 3D furniture symbols (with attributes) for planning and initially specifying Steelcase products. This data is incorporated into several add-on software packages that work in either a Microstation or an AutoCAD drafting environment.

For more information about these and other software tools to help you plan effective work environments, please email fsl@steelcase.com.

Support

Steelcase Capabilities

Steelcase products are distributed, installed, and serviced through a network of more than 600 dealers worldwide. Steelcase is also represented with offices and corporate showrooms in 26 U.S. cities, 4 Canadian cities, and in France, Germany, Great Britain, and Japan. Every Steelcase product meets our exceptionally high standards of quality and durability and comes with the Steelcase assurance of excellence in service.

For assistance,

please call your local dealer, the Steelcase Solutions Resource Team, or the Steelcase Solutions Fulfillment Team at 1.888.STEELCASE (1.888.783.3522) or send an e-mail to lineone@steelcase.com.

Call the Steelcase Solutions Resource Team prior to placing an order, when working on a bid, or when you need information about product applications and specifications.

Call the Steelcase Solutions Fulfillment Team if you have submitted an order to Steelcase and you need to speak to your Solutions Fulfillment Team Representative about the order. Also call if you have any post-shipment quality concerns or service parts questions.

For warranty information, please go to <http://www.steelcase.com/warranty/>.

Outside the U.S.A., Canada, Mexico, Puerto Rico, and the U.S. Virgin Islands, call 1.616.247.2500.

For information about Steelcase, the name of your nearest Steelcase dealer, or for product literature, call 1.800.333.9939 or visit our website: www.steelcase.com.

Guest Seating

Alcove	534
Collaboration	538
Escapade	542
Mingle	546
Oriana	550
Sawyer	554
Snodgrass	556
Terrazzo	558
Topaz	562

Alcove

Alcove is a contemporary guest chair with upholstered seat and back.

Frame is European beech wood.

Back and seat are fully upholstered.

Arms are one-piece solid wood construction and form a gentle curve to provide comfortable seating.

Upholstered seat features a webbed panel construction.

Stretcher rails provide additional support.

Legs are solid wood.

Glides are 1/2" in diameter.

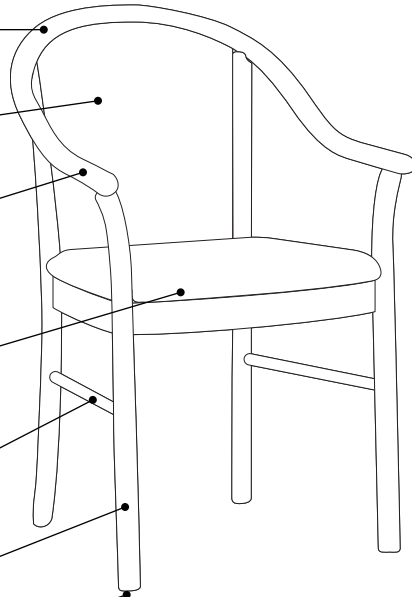

Surface Materials

Upholstery

- Fabric
- Fabric with soil-retardant treatment (option)
- Leather
- COM
- COL

Frame

- European Beech
- Tip: Wood finishes applied to beech will match the color of stains applied to oak, walnut, or cherry but will not have the same natural grain.*

Glides

- Stainless steel only

Wood touch-up kits

- Available in specific finishes for field repairs
- ▶ Page 570

All Steelcase seating with standard upholstery fabrics complies with requirements of the State of California Technical Bulletin 117. All standard seating is labeled to be in compliance with California 117.

Programs & Services

▶ See the *Surface Materials Reference Manual* for further detail about programs and services offered for seating.

The Customer's Own Material (COM & COL) Program

offers the opportunity for customers to select fabrics and leather that are not offered through the standard Steelcase surface materials program for use on Steelcase products. Avoid pattern fabrics and heavily grained leathers. Through the COM & COL program, Steelcase will test your materials for application on Steelcase products. Once approved, you can place your order. Steelcase will facilitate the entire ordering process and give you a production schedule. Steelcase will order the COM & COL fabric and leather directly from the textile manufacturer. For up-to-date information regarding fabric test results for all COM & COL fabrics and details regarding yardage requirements for most Seating lines, visit the COM website. To locate the COM website:

- Visit www.steelcase.com

Soil retardants are treatments that provide long-term soil and stain resistance to a fabric without affecting the shade or the integrity of the fabric. The following Steelcase Textiles are available pre-treated with soil retardant. (You do not need to select the soil-retardant option for these fabrics and incur the upcharge.)

- Jacks
- Link
- Spyder

For information on soil retardant fabrics on Select Surfaces, please refer to the *Surface Materials Reference Manual*.

Soil-retardant treatment is available on all other seating fabrics at an additional upcharge per seating unit. To order this option, please select "Soil-Retardant Treatment" under "Optional Accessories."

Actual Dimensions

Overall depth	22"
Overall width	22½"
Overall height	34"
Seat depth	16¼"
Seat width	16"
Back width	15½"
Back height	17"
Width between arms	16½"
Seat to floor height	18"
Arm height from floor	25"

For soil-retardant treatment on COMs, please select "Soil-Retardant Treatment" under "Optional Accessories." Minimums or additional yardage may be required. Please contact the vendor directly for specific information.

Extended lead times may be necessary for this service.

Contact your Steelcase Solutions Fulfillment Team Representative at 1.888.STEELCASE (1.888.783.3522) or send an e-mail to lineone@steelcase.com.

Alcove Brochure
Form number S3012

Resources

Quick Ship Guide

Alcove Guest Chair

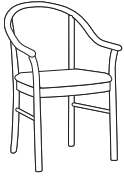

Standard Includes	Required to Specify
-------------------	---------------------

- | | | |
|--|---|--|
| ▶ Need help?
Product details,
page 534 | <ul style="list-style-type: none"> • Frame: European Beech • Upholstery: fabric price group 1 • 1/2"-diameter glides: stainless steel only | <ol style="list-style-type: none"> 1 Style number 2 Wood color number for frame 3 Fabric color number for upholstery 4 Options, if selected (see below) ▶ See <i>Surface Materials</i> , page 568. |
|--|---|--|

Options	U.S. Price	Required to Specify
---------	------------	---------------------

Surface Materials	Upholstery on seat and back	
	<ul style="list-style-type: none"> • Fabric price group 1 No cost • Fabric price group 2 +\$ 27 • Fabric price group 3 +\$ 56 • Fabric price group 4 +\$ 88 • Fabric price group 5 +\$109 • Fabric price group 6 +\$125 • Fabric price group 7 +\$158 • Fabric price group 8 +\$202 • Fabric price group 9 +\$250 • Fabric price group 10 +\$328 • Leather price group +\$470 • Customer's Own Material (COM) +\$ 16 • Customer's Own Leather (COL) +\$ 16 	Specify fabric color number. Specify fabric color number. Specify fabric color number. Specify fabric color number. Specify fabric color number. Specify fabric color number. Specify fabric color number. Specify fabric color number. Specify fabric color number. Specify fabric color number. Specify leather color number. ▶ See <i>Surface Materials Reference Manual</i> . ▶ See <i>Surface Materials Reference Manual</i> .
	Contrasting upholstery on seat and back	
	<ul style="list-style-type: none"> • Contrasting fabrics +\$ 33 	Add suffix K to the style number and specify fabric color numbers.
	Contrasting upholstery on seat	
	<ul style="list-style-type: none"> • Fabric price group 1 No cost • Fabric price group 2 +\$ 13 • Fabric price group 3 +\$ 28 • Fabric price group 4 +\$ 44 • Fabric price group 5 +\$ 54 • Fabric price group 6 +\$ 62 • Fabric price group 7 +\$ 79 • Fabric price group 8 +\$101 • Fabric price group 9 +\$125 • Fabric price group 10 +\$164 • Leather price group +\$235 • Customer's Own Material (COM) +\$ 8 • Customer's Own Leather (COL) +\$ 8 	Specify fabric color number. Specify fabric color number. Specify fabric color number. Specify fabric color number. Specify fabric color number. Specify fabric color number. Specify fabric color number. Specify fabric color number. Specify fabric color number. Specify fabric color number. Specify leather color number. ▶ See <i>Surface Materials Reference Manual</i> . ▶ See <i>Surface Materials Reference Manual</i> .
	Contrasting upholstery on back	
	<ul style="list-style-type: none"> • Fabric price group 1 No cost • Fabric price group 2 +\$ 14 • Fabric price group 3 +\$ 28 • Fabric price group 4 +\$ 44 • Fabric price group 5 +\$ 55 • Fabric price group 6 +\$ 63 • Fabric price group 7 +\$ 79 • Fabric price group 8 +\$101 • Fabric price group 9 +\$125 • Fabric price group 10 +\$164 • Leather price group +\$235 • Customer's Own Material (COM) +\$ 8 • Customer's Own Leather (COL) +\$ 8 	Specify fabric color number. Specify fabric color number. Specify fabric color number. Specify fabric color number. Specify fabric color number. Specify fabric color number. Specify fabric color number. Specify fabric color number. Specify fabric color number. Specify fabric color number. Specify leather color number. ▶ See <i>Surface Materials Reference Manual</i> . ▶ See <i>Surface Materials Reference Manual</i> .
	<ul style="list-style-type: none"> • Soil-retardant treatment applied to upholstery fabric +\$ 27 	Specify <i>with soil-retardant treatment</i> .
	Frame	
	<ul style="list-style-type: none"> • Customiz stain on wood No cost 	Specify <i>with Customiz stain</i> . ▶ See <i>Surface Materials Reference Manual</i> .

▶ **Specification Information, on next page**

Tip: Wood finishes applied to beech will match the color of stains applied to oak, walnut, or cherry but will not have the same natural grain.

► Options, on previous page

Specification Information

• Style • Number	• U.S. • Base • Price
G20	\$742



Alcove



For Canadian Pricing

Multiply U.S. Price by the Canadian price factor.

► See page 1 for details.

Collaboration

Collaboration guest chairs, designed by Dennie Pimental and John Duffy, have a classic design that is ideal for conference room, reception area, and dining room seating, or as guest seating in a workstation. Several arm inserts are available to create different visual details.

Inserts can match or contrast with frame color.

Back and seat are fully upholstered.

Upholstered seat features a webbed panel construction.

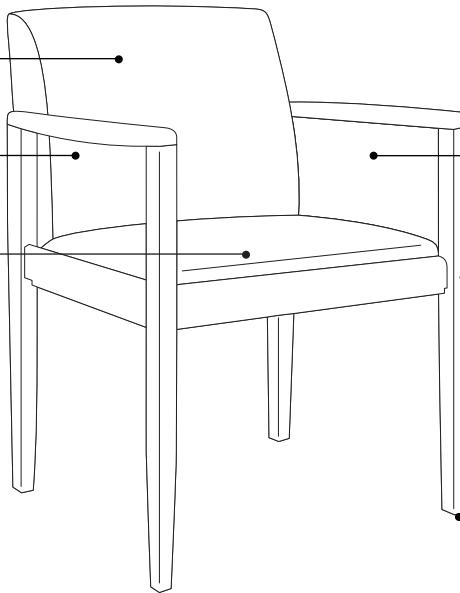

Arms may be enclosed with upholstery or European Beech inserts, or left open.

Frame is European Beech.

Glides are 1/2" diameter.

Actual Dimensions

Overall depth	24 1/4"
Overall width	22 1/2"
Overall height	31 1/2"
Seat depth	17"
Seat width	18 3/4"
Back width	18 3/4"
Back height	13 3/4"
Width between arms	18 3/4"
Seat to floor height	18"
Arm height from floor	25 1/2"

Product Details

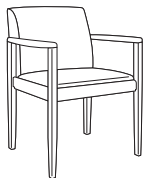

Open-arm chair is the simplest variation in the Collaboration family.



Arcade chair inserts introduce an arched motif.

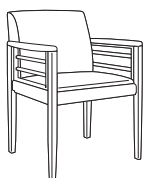

Ladder chair inserts establish a strong horizontal direction.

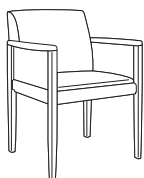

Upholstered inserts enclose the arms with fabric-covered panels.

All inserts are factory-installed.

All chairs are available with plain hardwood arms.

Surface Materials

Upholstery

- Fabric
- Fabric with soil-retardant treatment (option)
- Leather
- COM
- COL

Frame

- European Beech
- Tip: Wood finishes applied to European Beech will match the color of stains applied to oak, walnut, or cherry but will not show the same natural grain.*
- Customiz stain (option)

Inserts

- Upholstery
- European Beech
- Customiz stain (option)

Glides

- Stainless steel only

Wood touch-up kits

- Available in specific finishes for field repairs
- ▶ Page 570

All Steelcase seating with standard upholstery fabrics

complies with requirements of the State of California Technical Bulletin 117. All standard seating is labeled to be in compliance with California 117.

Programs & Services

▶ See the *Surface Materials Reference Manual* for further detail about programs and services offered for seating.

The Customer's Own Material (COM & COL) Program

offers the opportunity for customers to select fabrics and leather that are not offered through the standard Steelcase surface materials program for use on Steelcase products. Avoid pattern fabrics and heavily grained leathers. Through the COM & COL program, Steelcase will test your materials for application on Steelcase products. Once approved, you can place your order. Steelcase will facilitate the entire ordering process and give you a production schedule. Steelcase will order the COM & COL fabric and leather directly from the textile manufacturer. For up-to-date information regarding fabric test results for all COM & COL fabrics and details regarding yardage requirements for most Seating lines, visit the COM website. To locate the COM website:

- Visit www.steelcase.com

Soil retardants are treatments that provide long-term soil and stain resistance to a fabric without affecting the shade or the integrity of the fabric. The following Steelcase Textiles are available pre-treated with soil retardant. (You do not need to select the soil-retardant option for these fabrics and incur the upcharge.)

- Jacks
- Link
- Spyder

For information on soil retardant fabrics on Select Surfaces, please refer to the *Surface Materials Reference Manual*.

Soil-retardant treatment is available on all other seating fabrics at an additional upcharge per seating unit. To order this option, please select "Soil-Retardant Treatment" under "Optional Accessories."

For soil-retardant treatment on COMs, please select "Soil-Retardant Treatment" under "Optional Accessories." Minimums or additional yardage may be required. Please contact the vendor directly for specific information.

Extended lead times may be necessary for this service.

Contact your Steelcase Solutions Fulfillment Team Representative at 1.888.STEELCASE (1.888.783.3522) or send an e-mail to lineone@steelcase.com.

Resources

Collaboration Brochure
Form number S11078

Chairs for People at Work
Form number S11347

Quick Ship Guide

Collaboration Guest Chairs

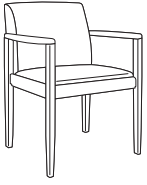

Standard Includes	Required to Specify
<ul style="list-style-type: none"> ▶ Need help? Product details, page 538 • Frame: European Beech • Upholstery on seat and back: fabric price group 1 • Inserts, if selected: upholstery or European Beech • Glides: stainless steel only 	<ol style="list-style-type: none"> 1 Style number 2 Fabric color number for upholstery 3 Wood color number for frame 4 Wood color number for inserts, if selected 5 Options, if selected (see below) <p>▶ See <i>Surface Materials</i>, page 568.</p>

Options	U.S. Price	Required to Specify	
Surface Materials	Upholstery on seat and back		
<ul style="list-style-type: none"> • Fabric price group 1 • Fabric price group 2 • Fabric price group 3 • Fabric price group 4 • Fabric price group 5 • Fabric price group 6 • Fabric price group 7 • Fabric price group 8 • Fabric price group 9 • Fabric price group 10 • Leather price group • Customer's Own Material (COM) • Customer's Own Leather (COL) 	<ul style="list-style-type: none"> No cost +\$ 27 +\$ 56 +\$ 88 +\$125 +\$180 +\$213 +\$313 +\$402 +\$490 +\$470 +\$ 34 +\$ 34 	<ul style="list-style-type: none"> Specify fabric color number. Specify fabric color number. Specify fabric color number. Specify fabric color number. Specify fabric color number. Specify fabric color number. Specify fabric color number. Specify fabric color number. Specify fabric color number. Specify fabric color number. Specify leather color number. ▶ See <i>Surface Materials Reference Manual</i>. ▶ See <i>Surface Materials Reference Manual</i>. 	
	Contrasting upholstery on seat and back		
<ul style="list-style-type: none"> • Contrasting fabrics 	<ul style="list-style-type: none"> +\$ 33 	<ul style="list-style-type: none"> Add suffix K to the style number and specify fabric color numbers. 	
	Contrasting upholstery on seat		
<ul style="list-style-type: none"> • Fabric price group 1 • Fabric price group 2 • Fabric price group 3 • Fabric price group 4 • Fabric price group 5 • Fabric price group 6 • Fabric price group 7 • Fabric price group 8 • Fabric price group 9 • Fabric price group 10 • Leather price group • Customer's Own Material (COM) • Customer's Own Leather (COL) 	<ul style="list-style-type: none"> No cost +\$ 13 +\$ 28 +\$ 44 +\$ 62 +\$ 90 +\$106 +\$156 +\$201 +\$245 +\$235 +\$ 17 +\$ 17 	<ul style="list-style-type: none"> Specify fabric color number. Specify fabric color number. Specify fabric color number. Specify fabric color number. Specify fabric color number. Specify fabric color number. Specify fabric color number. Specify fabric color number. Specify fabric color number. Specify fabric color number. Specify leather color number. ▶ See <i>Surface Materials Reference Manual</i>. ▶ See <i>Surface Materials Reference Manual</i>. 	
	Contrasting upholstery on back		
<ul style="list-style-type: none"> • Fabric price group 1 • Fabric price group 2 • Fabric price group 3 • Fabric price group 4 • Fabric price group 5 • Fabric price group 6 • Fabric price group 7 • Fabric price group 8 • Fabric price group 9 • Fabric price group 10 • Leather price group • Customer's Own Material (COM) • Customer's Own Leather (COL) 	<ul style="list-style-type: none"> No cost +\$ 14 +\$ 28 +\$ 44 +\$ 63 +\$ 90 +\$107 +\$157 +\$201 +\$245 +\$235 +\$ 17 +\$ 17 	<ul style="list-style-type: none"> Specify fabric color number. Specify fabric color number. Specify fabric color number. Specify fabric color number. Specify fabric color number. Specify fabric color number. Specify fabric color number. Specify fabric color number. Specify fabric color number. Specify fabric color number. Specify leather color number. ▶ See <i>Surface Materials Reference Manual</i>. ▶ See <i>Surface Materials Reference Manual</i>. 	
	<ul style="list-style-type: none"> • Soil-retardant treatment applied to upholstery fabric 	<ul style="list-style-type: none"> +\$ 27 	<ul style="list-style-type: none"> Specify <i>with soil-retardant treatment</i>.
	Frame		
<ul style="list-style-type: none"> • Customiz stain on wood 	<ul style="list-style-type: none"> No cost 	<ul style="list-style-type: none"> Specify <i>with Customiz stain</i>. ▶ See <i>Surface Materials Reference Manual</i>. 	

▶ **Specification Information, on next page**

Tip: Wood finishes applied to beech will match the color of stains applied to oak, walnut, or cherry but will not have the same natural grain.

► Options, on previous page

Specification Information

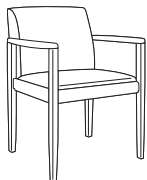

Open



Description	Style Number	U.S. Base Price
Wood arms	120	\$ 953

Arcade Insert



Description	Style Number	U.S. Base Price
Wood arms	120D	\$1056

Ladder Insert



Description	Style Number	U.S. Base Price
Wood arms	120L	\$1056

Upholstered Insert



Description	Style Number	U.S. Base Price
Wood arms	120U	\$1056

Collaboration



For Canadian Pricing
 Multiply U.S. Price by the Canadian price factor.
 ► See page 1 for details.

Escapade

Escapade contemporary guest chairs are available with upholstered or wood slat backs.

Frame is European beech wood.

Back is fully upholstered front and back or with vertical wood slats.

Stretcher rails provide additional support.

Legs are solid wood.

Glides are 1/2" in diameter.

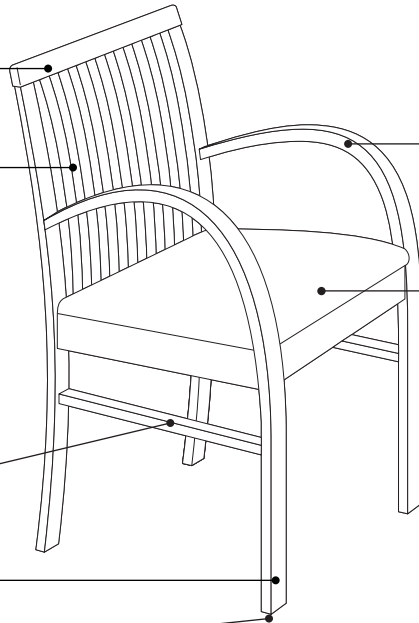

Arms have an open arch that flows into the front legs. Finger joint is used in construction.

Upholstered seat features a webbed panel construction.

Product Details

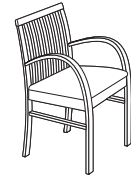
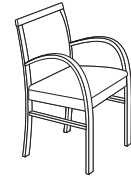

Two models are available—upholstered back or vertical-slat wood back.

Surface Materials

Upholstery

- Fabric
- Fabric with soil-retardant treatment (option)
- Leather
- COM
- COL

Frame

- European Beech
- Tip: Wood finishes applied to beech will match the color of stains applied to oak, walnut, or cherry but will not have the same natural grain.*

Glides

- Stainless steel only

Wood touch-up kits

- Available in specific finishes for field repairs
- ▶ Page 570

All Steelcase seating with standard upholstery fabrics

complies with requirements of the State of California Technical Bulletin 117. All standard seating is labeled to be in compliance with California 117.

Actual Dimensions

Overall depth	22 1/2"
Overall width	23 1/2"
Overall height	35"
Seat depth	17 1/2"
Seat width	21 1/2"
Back width	20 1/4"
Back height	16 3/4"
Width between arms	19"
Seat to floor height	18 1/4"
Arm height from floor	28 1/2"

Programs & Services

▶ See the *Surface Materials Reference Manual* for further detail about programs and services offered for seating.

The Customer's Own Material (COM & COL) Program

offers the opportunity for customers to select fabrics and leather that are not offered through the standard Steelcase surface materials program for use on Steelcase products. Avoid pattern fabrics and heavily grained leathers. Through the COM & COL program, Steelcase will test your materials for application on Steelcase products. Once approved, you can place your order. Steelcase will facilitate the entire ordering process and give you a production schedule. Steelcase will order the COM & COL fabric and leather directly from the textile manufacturer. For up-to-date information regarding fabric test results for all COM & COL fabrics and details regarding yardage requirements for most Seating lines, visit the COM website. To locate the COM website:

- Visit www.steelcase.com

Soil retardants are treatments that provide long-term soil and stain resistance to a fabric without affecting the shade or the integrity of the fabric. The following Steelcase Textiles are available pre-treated with soil retardant. (You do not need to select the soil-retardant option for these fabrics and incur the upcharge.)

- Jacks
- Link
- Spyder

For information on soil retardant fabrics on Select Surfaces, please refer to the *Surface Materials Reference Manual*.

Soil-retardant treatment is available on all other seating fabrics at an additional upcharge per seating unit. To order this option, please select "Soil-Retardant Treatment" under "Optional Accessories."

For soil-retardant treatment on COMs, please select "Soil-Retardant Treatment" under "Optional Accessories." Minimums or additional yardage may be required. Please contact the vendor directly for specific information.

Extended lead times may be necessary for this service.

Contact your Steelcase Solutions Fulfillment Team Representative at 1.888.STEELCASE (1.888.783.3522) or send an e-mail to lineone@steelcase.com.

Resources

Escapade Brochure

Form number S11074

Chairs for People at Work

Form number S11347

Quick Ship Guide

Escapade Guest Chairs

Standard Includes		Required to Specify
▶ Need help? Product details, page 542	<ul style="list-style-type: none"> • Frame: European Beech • Slat back, if selected: European Beech • Upholstery for seat and cushioned back, if selected: fabric price group 1 • ½"-diameter glides: stainless steel only 	1 Style number 2 Wood color number for frame 3 Fabric color number for upholstery 4 Options, if selected (see below) ▶ See <i>Surface Materials</i> , page 568.

Options	U.S. Price	Required to Specify
Surface Materials		
Upholstery on seat and back		
• Fabric price group 1	No cost	Specify fabric color number.
• Fabric price group 2	+\$ 27	Specify fabric color number.
• Fabric price group 3	+\$ 56	Specify fabric color number.
• Fabric price group 4	+\$ 88	Specify fabric color number.
• Fabric price group 5	+\$125	Specify fabric color number.
• Fabric price group 6	+\$180	Specify fabric color number.
• Fabric price group 7	+\$213	Specify fabric color number.
• Fabric price group 8	+\$313	Specify fabric color number.
• Fabric price group 9	+\$402	Specify fabric color number.
• Fabric price group 10	+\$490	Specify fabric color number.
• Leather price group for slat-back chair	+\$250	Specify leather color number.
• Leather price group for upholstered-back chair	+\$470	Specify leather color number.
• Customer's Own Material (COM)	+\$ 34	▶ See <i>Surface Materials Reference Manual</i> .
• Customer's Own Leather (COL)	+\$ 34	▶ See <i>Surface Materials Reference Manual</i> .
Contrasting upholstery on seat and back		
• Contrasting fabrics	+\$ 33	Add suffix K to the style number and specify fabric color numbers.
Contrasting upholstery on seat		
• Fabric price group 1	No cost	Specify fabric color number.
• Fabric price group 2	+\$ 13	Specify fabric color number.
• Fabric price group 3	+\$ 28	Specify fabric color number.
• Fabric price group 4	+\$ 44	Specify fabric color number.
• Fabric price group 5	+\$ 62	Specify fabric color number.
• Fabric price group 6	+\$ 90	Specify fabric color number.
• Fabric price group 7	+\$106	Specify fabric color number.
• Fabric price group 8	+\$156	Specify fabric color number.
• Fabric price group 9	+\$201	Specify fabric color number.
• Fabric price group 10	+\$245	Specify fabric color number.
• Leather price group	+\$235	Specify leather color number.
• Customer's Own Material (COM)	+\$ 17	▶ See <i>Surface Materials Reference Manual</i> .
• Customer's Own Leather (COL)	+\$ 17	▶ See <i>Surface Materials Reference Manual</i> .
Contrasting upholstery on back		
• Fabric price group 1	No cost	Specify fabric color number.
• Fabric price group 2	+\$ 14	Specify fabric color number.
• Fabric price group 3	+\$ 28	Specify fabric color number.
• Fabric price group 4	+\$ 44	Specify fabric color number.
• Fabric price group 5	+\$ 63	Specify fabric color number.
• Fabric price group 6	+\$ 90	Specify fabric color number.
• Fabric price group 7	+\$107	Specify fabric color number.
• Fabric price group 8	+\$157	Specify fabric color number.
• Fabric price group 9	+\$201	Specify fabric color number.
• Fabric price group 10	+\$245	Specify fabric color number.
• Leather price group	+\$235	Specify leather color number.
• Customer's Own Material (COM)	+\$ 17	▶ See <i>Surface Materials Reference Manual</i> .
• Customer's Own Leather (COL)	+\$ 17	▶ See <i>Surface Materials Reference Manual</i> .
• Soil-retardant treatment applied to upholstery fabric	+\$ 27	Specify <i>with soil-retardant treatment</i> .
Frame		
• Customiz stain on wood	No cost	Specify <i>with Customiz stain</i> . ▶ See <i>Surface Materials Reference Manual</i> .

▶ **Specification Information, on next page**

Tip: Wood finishes applied to beech will match the color of stains applied to oak, walnut, or cherry but will not have the same natural grain.

► Options, on previous page

Specification Information

Chair with Wood Slat Back



• Style
• Number

• U.S.
• Base
• Price

G23

\$1148

Chair with Upholstered Cushioned Back



• Style
• Number

• U.S.
• Base
• Price

G22

\$1086



For Canadian Pricing

Multiply U.S. Price by the Canadian price factor.

► See page 1 for details.

Mingle

Mingle guest chairs, designed by Bill Schacht and Lynda Chesser, have a tailored appearance that is sophisticated and pure in design, yet simple in scale. Mingle's design addresses a broad set of applications from an open plan systems environment to a closed office setting.

Exposed maple plywood back panel

provides enhanced lumbar support to achieve a high level of comfort.

Upholstered seat

features a webbed-panel construction.

Back legs and seat frame

are metal for additional strength and durability. Legs are standard in black. Nickel powdercoat is available as an option.

Foot cap is standard with nickel finish.

Arms taper to flow into front legs.

Glides are 1/2" diameter on front legs and 1" diameter on back legs.

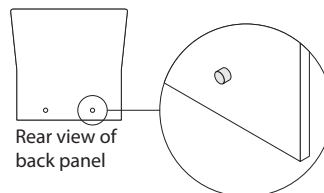
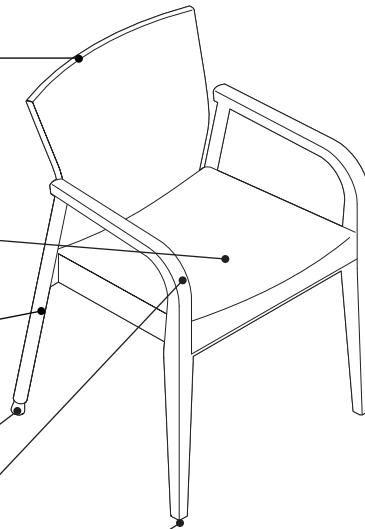

Rear view of back panel

Metal button fasteners located at bottom of back panel secure seat and back attachment while providing an additional element of design.

Actual Dimensions

Overall depth	22 ¹ / ₈ "
Overall width	22 ¹ / ₄ "
Overall height	32"
Seat depth	17 ¹ / ₂ "
Seat width	17 ⁷ / ₈ "
Back width	17 ¹ / ₄ "
Back height	14"
Width between arms	19"
Seat to floor height	17 ¹ / ₂ "
Arm height from floor	25 ¹ / ₂ "

Surface Materials

Seat

- Fabric
- Fabric with soil-retardant treatment (option)
- Leather
- COM
- COL

Back legs

- Black
- Nickel (option)

Back, arms, and front legs

- Maple plywood
- Customiz stain (option)

Metal button fasteners

- Nickel color only

Foot caps on back legs

- Nickel color only

Glides

- Stainless steel on front legs
- Nylon on back legs

Wood touch-up kits

- Available in specific finishes for field repairs
- ▶ Page 570

All Steelcase seating with standard upholstery fabrics

complies with requirements of the State of California Technical Bulletin 117. All standard seating is labeled to be in compliance with California 117.

Programs & Services

▶ See the *Surface Materials Reference Manual* for further detail about programs and services offered for seating.

The Customer's Own Material (COM & COL) Program

offers the opportunity for customers to select fabrics and leather that are not offered through the standard Steelcase surface materials program for use on Steelcase products. Avoid pattern fabrics and heavily grained leathers. Through the COM & COL program, Steelcase will test your materials for application on Steelcase products. Once approved, you can place your order. Steelcase will facilitate the entire ordering process and give you a production schedule. Steelcase will order the COM & COL fabric and leather directly from the textile manufacturer. For up-to-date information regarding fabric test results for all COM & COL fabrics and details regarding yardage requirements for most Seating lines, visit the COM website. To locate the COM website:

- Visit www.steelcase.com

Soil retardants are treatments that provide long-term soil and stain resistance to a fabric without affecting the shade or the integrity of the fabric. The following Steelcase Textiles are available pre-treated with soil retardant. (You do not need to select the soil-retardant option for these fabrics and incur the upcharge.)

- Jacks
- Link
- Spyder

For information on soil retardant fabrics on Select Surfaces, please refer to the *Surface Materials Reference Manual*.

Soil-retardant treatment is available on all other seating fabrics at an additional upcharge per seating unit. To order this option, please select "Soil-Retardant Treatment" under "Optional Accessories."

For soil-retardant treatment on COMs, please select "Soil-Retardant Treatment" under "Optional Accessories." Minimums or additional yardage may be required. Please contact the vendor directly for specific information.

Extended lead times may be necessary for this service.

Contact your Steelcase Solutions Fulfillment Team Representative at 1.888.STEELCASE (1.888.783.3522) or send an e-mail to lineone@steelcase.com.

Resources

Mingle Brochure
Form number S10880

Mingle Guest Chair

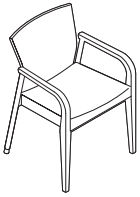

Standard Includes	Required to Specify
<ul style="list-style-type: none"> ▶ Need help? Product details, page 546 • Back, arms, and front legs: maple • Back legs: black • Upholstery: fabric price group 1 • Glides: stainless steel on front legs, nylon on back legs 	<ul style="list-style-type: none"> 1 Style number 2 Wood color number for frame 3 Fabric color number for upholstery 4 Options, if selected (see below) ▶ See <i>Surface Materials</i>, page 568.

Options	U.S. Price	Required to Specify
<p>Surface Materials</p> <p>Upholstery</p> <ul style="list-style-type: none"> • Fabric price group 1 • Fabric price group 2 • Fabric price group 3 • Fabric price group 4 • Fabric price group 5 • Fabric price group 6 • Fabric price group 7 • Fabric price group 8 • Fabric price group 9 • Fabric price group 10 • Leather price group • Customer's Own Material (COM) • Customer's Own Leather (COL) • Soil-retardant treatment applied to upholstery fabric 	<ul style="list-style-type: none"> No cost +\$ 27 +\$ 56 +\$ 88 +\$109 +\$125 +\$158 +\$202 +\$250 +\$328 +\$250 +\$ 16 +\$ 16 +\$ 27 	<ul style="list-style-type: none"> Specify fabric color number. Specify fabric color number. Specify fabric color number. Specify fabric color number. Specify fabric color number. Specify fabric color number. Specify fabric color number. Specify fabric color number. Specify fabric color number. Specify fabric color number. Specify leather color number. ▶ See <i>Surface Materials Reference Manual</i>. ▶ See <i>Surface Materials Reference Manual</i>. Specify <i>with soil-retardant treatment</i>.
<p>Frame</p> <ul style="list-style-type: none"> • Customiz stain on wood 	<ul style="list-style-type: none"> No cost 	<ul style="list-style-type: none"> Specify <i>with Customiz stain</i>. ▶ See <i>Surface Materials Reference Manual</i>.
<p>Legs</p> <ul style="list-style-type: none"> • Nickel 	<ul style="list-style-type: none"> +\$ 31 	<ul style="list-style-type: none"> Specify <i>with 7026 Nickel</i>.

Specification Information	
Style Number	U.S. Base Price
MNGLB	\$1091
.	.
.	.

For Canadian Pricing
 Multiply U.S. Price by the Canadian price factor.
 ▶ See page 1 for details.



Oriana

Oriana, designed by David Jenkins, is an interpretation of early ladder-back and slat-back seating designs. Its classic styling is suitable for both transitional and contemporary interiors.

Back is available in three design variations.

Arms are open.

Frame is European Beech.

Upholstered seat features a webbed panel construction.

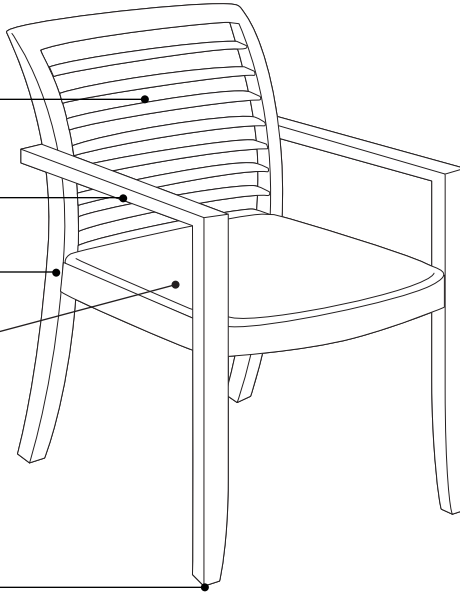

Glides are 1/2" diameter.

Actual Dimensions

Overall depth	23 ⁷ / ₈ "
Overall width	23 ¹ / ₄ "
Overall height	34 ³ / ₈ "
Seat depth	17 ⁷ / ₈ "
Seat width	20"
Back width	18"
Back height	15 ⁵ / ₈ "
Width between arms	19"
Seat to floor height	18 ³ / ₄ "
Arm height from floor	25 ³ / ₈ "

Product Details

Back is available with horizontal slats, vertical slats, or closed upholstered construction.

Surface Materials

Upholstery

- Fabric
- Fabric with soil-retardant treatment (option)
- Leather
- COM
- COL

Frame

- European Beech
- *Tip: Wood finishes applied to European Beech will match the color of stains applied to oak, walnut, or cherry but will not show the same natural grain.*
- Customiz stain (option)

Glides

- Stainless steel only

Wood touch-up kits

- Available in specific finishes for field repairs
- ▶ Page 570

All Steelcase seating with standard upholstery fabrics

complies with requirements of the State of California Technical Bulletin 117. All standard seating is labeled to be in compliance with California 117.

Programs & Services

▶ See the *Surface Materials Reference Manual* for further detail about programs and services offered for seating.

The Customer's Own Material (COM & COL) Program

offers the opportunity for customers to select fabrics and leather that are not offered through the standard Steelcase surface materials program for use on Steelcase products. Avoid pattern fabrics and heavily grained leathers. Through the COM & COL program, Steelcase will test your materials for application on Steelcase products. Once approved, you can place your order. Steelcase will facilitate the entire ordering process and give you a production schedule. Steelcase will order the COM & COL fabric and leather directly from the textile manufacturer. For up-to-date information regarding fabric test results for all COM & COL fabrics and details regarding yardage requirements for most Seating lines, visit the COM website. To locate the COM website:

- Visit www.steelcase.com

Soil retardants

are treatments that provide long-term soil and stain resistance to a fabric without affecting the shade or the integrity of the fabric. The following Steelcase Textiles are available pre-treated with soil retardant. (You do not need to select the soil-retardant option for these fabrics and incur the upcharge.)

- Jacks
- Link
- Spyder

For information on soil retardant fabrics on Select Surfaces, please refer to the *Surface Materials Reference Manual*.

Soil-retardant treatment is available on all other seating fabrics at an additional upcharge per seating unit. To order this option, please select "Soil-Retardant Treatment" under "Optional Accessories."

For soil-retardant treatment on COMs, please select "Soil-Retardant Treatment" under "Optional Accessories." Minimums or additional yardage may be required. Please contact the vendor directly for specific information.

Extended lead times may be necessary for this service.

Contact your Steelcase Solutions Fulfillment Team Representative at 1.888.STEELCASE (1.888.783.3522) or send an e-mail to lineone@steelcase.com.

Resources

Oriana Brochure
Form number S11079

Oriana Guest Chairs



Standard Includes		Required to Specify
<ul style="list-style-type: none"> ▶ Need help? Product details, page 550 	<ul style="list-style-type: none"> • Frame: European Beech • Upholstery: fabric price group 1 • Glides: stainless steel only 	<ol style="list-style-type: none"> 1 Style number 2 Fabric color number for upholstery 3 Wood color number for frame 4 Options, if selected (see below) <ul style="list-style-type: none"> ▶ See <i>Surface Materials</i>, page 568.
Options	U.S. Price	Required to Specify
Surface Materials		
Upholstery on seat and back		
<ul style="list-style-type: none"> • Fabric price group 1 • Fabric price group 2 • Fabric price group 3 • Fabric price group 4 • Fabric price group 5 • Fabric price group 6 • Fabric price group 7 • Fabric price group 8 • Fabric price group 9 • Fabric price group 10 • Leather price group for slat-back chair • Leather price group for upholstered-back chair • Customer's Own Material (COM) • Customer's Own Leather (COL) 	<ul style="list-style-type: none"> No cost +\$ 27 +\$ 56 +\$ 88 +\$125 +\$180 +\$213 +\$313 +\$402 +\$490 +\$250 +\$470 +\$ 34 +\$ 34 	<ul style="list-style-type: none"> Specify fabric color number. Specify fabric color number. Specify fabric color number. Specify fabric color number. Specify fabric color number. Specify fabric color number. Specify fabric color number. Specify fabric color number. Specify fabric color number. Specify fabric color number. Specify leather color number. Specify leather color number. ▶ See <i>Surface Materials Reference Manual</i>. ▶ See <i>Surface Materials Reference Manual</i>.
Contrasting upholstery on seat and back		
<ul style="list-style-type: none"> • Contrasting fabrics 	<ul style="list-style-type: none"> +\$ 33 	<ul style="list-style-type: none"> Add suffix K to the style number and specify fabric color numbers.
Contrasting upholstery on seat		
<ul style="list-style-type: none"> • Fabric price group 1 • Fabric price group 2 • Fabric price group 3 • Fabric price group 4 • Fabric price group 5 • Fabric price group 6 • Fabric price group 7 • Fabric price group 8 • Fabric price group 9 • Fabric price group 10 • Leather price group • Customer's Own Material (COM) • Customer's Own Leather (COL) 	<ul style="list-style-type: none"> No cost +\$ 13 +\$ 28 +\$ 44 +\$ 62 +\$ 90 +\$106 +\$156 +\$201 +\$245 +\$235 +\$ 17 +\$ 17 	<ul style="list-style-type: none"> Specify fabric color number. Specify fabric color number. Specify fabric color number. Specify fabric color number. Specify fabric color number. Specify fabric color number. Specify fabric color number. Specify fabric color number. Specify fabric color number. Specify fabric color number. Specify leather color number. ▶ See <i>Surface Materials Reference Manual</i>. ▶ See <i>Surface Materials Reference Manual</i>.
Contrasting upholstery on back		
<ul style="list-style-type: none"> • Fabric price group 1 • Fabric price group 2 • Fabric price group 3 • Fabric price group 4 • Fabric price group 5 • Fabric price group 6 • Fabric price group 7 • Fabric price group 8 • Fabric price group 9 • Fabric price group 10 • Leather price group • Customer's Own Material (COM) • Customer's Own Leather (COL) 	<ul style="list-style-type: none"> No cost +\$ 14 +\$ 28 +\$ 44 +\$ 63 +\$ 90 +\$107 +\$157 +\$201 +\$245 +\$235 +\$ 17 +\$ 17 	<ul style="list-style-type: none"> Specify fabric color number. Specify fabric color number. Specify fabric color number. Specify fabric color number. Specify fabric color number. Specify fabric color number. Specify fabric color number. Specify fabric color number. Specify fabric color number. Specify fabric color number. Specify leather color number. ▶ See <i>Surface Materials Reference Manual</i>. ▶ See <i>Surface Materials Reference Manual</i>.
<ul style="list-style-type: none"> • Soil-retardant treatment applied to upholstery fabric 	<ul style="list-style-type: none"> +\$ 27 	<ul style="list-style-type: none"> Specify <i>with soil-retardant treatment</i>.
Frame		
<ul style="list-style-type: none"> • Customiz stain on wood 	<ul style="list-style-type: none"> No cost 	<ul style="list-style-type: none"> Specify <i>with Customiz stain</i>. ▶ See <i>Surface Materials Reference Manual</i>.

▶ **Specification Information, on next page**

Tip: Wood finishes applied to beech will match the color of stains applied to oak, walnut, or cherry but will not have the same natural grain.

► Options, on previous page

Specification Information

Vertical Slat Back



• Style
• Number
• U.S.
• Base
• Price

0202 \$1470

Horizontal Slat Back



• Style
• Number
• U.S.
• Base
• Price

0204 \$1470

Fully Upholstered Back



• Style
• Number
• U.S.
• Base
• Price

0205 \$1415



For Canadian Pricing

Multiply U.S. Price by the Canadian price factor.

► See page 1 for details.

Sawyer

Sawyer, clean lines and simple forms create this solid wood guest chair. Contemporary, durable, and perfect for private offices and public spaces.

Back has horizontal wood slots.

Frame is European beech wood.

Upholstered seat features a webbed panel construction.

Glides are 1/2" diameter.

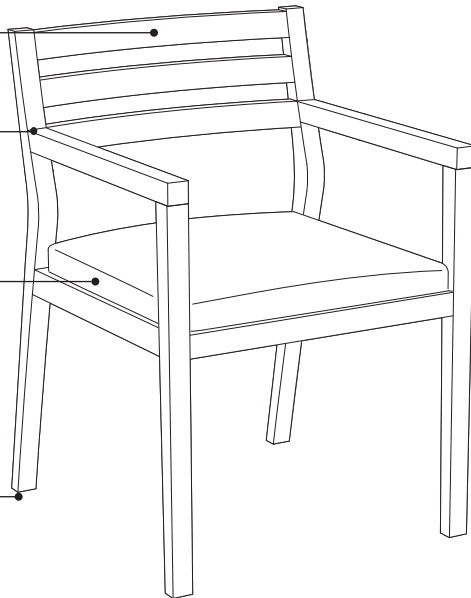

Glides

- Stainless steel only

Wood touch-up kits

- Available in specific finishes for field repairs
- ▶ Page 570

All Steelcase seating with standard upholstery fabrics

complies with requirements of the State of California Technical Bulletin 117. All standard seating is labeled to be in compliance with California 117.

Programs & Services

- ▶ See the *Surface Materials Reference Manual* for further detail about programs and services offered for seating.

The Customer's Own Material (COM & COL) Program

offers the opportunity for customers to select fabrics and leather that are not offered through the standard Steelcase surface materials program for use on Steelcase products. Avoid pattern fabrics and heavily grained leathers. Through the COM and COL program, Steelcase will test your materials for application on Steelcase products. Once approved, you can place your order. Steelcase will facilitate the entire ordering process and give you a production schedule. Steelcase will order the COM and COL fabric and leather directly from the textile manufacturer.

For up-to-date information regarding fabric test results for all COM and COL fabrics and details regarding yardage requirements for most Seating lines, visit the COM website. To locate the COM website:

- Visit www.steelcase.com

Surface Materials

Upholstery

- Fabric
- Fabric with soil-retardant treatment (option)
- Leather
- COM
- COL

Frame

- European Beech
- Tip: Wood finishes applied to beech will match the color of stains applied to oak, walnut, or cherry but will not show the same natural grain.*

Soil retardants are treatments that provide longterm soil and stain resistance to a fabric without affecting the shade or the integrity of the fabric. The following Steelcase Textiles are available pre-treated with soil retardant. (You do not need to select the soil retardant option for these fabrics and incur the upcharge.)

- Jacks
- Link
- Spyder

For information on soil retardant fabrics on Select Surfaces, please refer to the *Surface Materials Reference Manual*.

Soil-retardant treatment is available on all other seating fabrics at an additional upcharge per seating unit. To order this option, please select "Soil-Retardant Treatment" under "Optional Accessories."

For soil-retardant treatment on COMs, please select "Soil-Retardant Treatment" under "Optional Accessories." Minimums or additional yardage may be required. Please contact the vendor directly for specific information.

Extended lead times may be necessary for this service.

Contact your Steelcase Solutions Fulfillment Team Representative at 1.888.STEELCASE (1.888.783.3522) or send an e-mail to lineone@steelcase.com.

Actual Dimensions

Overall depth	22½"
Overall width	22½"
Overall height	32½"
Seat depth	18"
Seat width	19⅜"
Back width	22¼"
Back height	15⅜"
Back lumbar height	7"
Width between arms	19½"
Seat-to-floor height	18⅝"
Arm height from floor	26½"

Sawyer Wood Guest Chair



Tip: Due to natural variations in wood, finished products may vary in color texture and grain.

Tip: Wood color 3522 Clear is a clear coat. Therefore, the natural variations in European beech will be visible.

Tip: 3522 Clear coordinates with Marbled Maple laminate.

Tip: Wood finishes applied to beech will match the color of stains applied to oak, walnut, or cherry but will not have the same natural grain.

Standard Includes		Required to Specify
<ul style="list-style-type: none"> ▶ Need help? Product details, page 554 	<ul style="list-style-type: none"> • Upholstered seat: fabric price group 1 • Webbed panel construction seat for added comfort • Frame: wood (European beech) • Back with horizontal slats • Glides 	<ol style="list-style-type: none"> 1 Style number 2 Fabric color number for upholstery 3 Wood color number for frame 4 Options, if selected (see below) <ul style="list-style-type: none"> ▶ See <i>Surface Materials</i>, page 568.

Options	U.S. Price	Required to Specify
Surface Materials		
Upholstery <ul style="list-style-type: none"> • Fabric price group 1 • Fabric price group 2 • Fabric price group 3 • Fabric price group 4 • Fabric price group 5 • Fabric price group 6 • Fabric price group 7 • Fabric price group 8 • Fabric price group 9 • Fabric price group 10 • Customer's Own Material (COM) • Leather price group • Customer's Own Leather (COL) 	<ul style="list-style-type: none"> No cost +\$ 10 +\$ 27 +\$ 36 +\$ 43 +\$ 53 +\$ 64 +\$ 79 +\$ 97 +\$112 +\$ 38 +\$297 +\$ 37 	<ul style="list-style-type: none"> Specify fabric color number. Specify fabric color number. Specify fabric color number. Specify fabric color number. Specify fabric color number. Specify fabric color number. Specify fabric color number. Specify fabric color number. Specify fabric color number. Specify fabric color number. ▶ See <i>Surface Materials Reference Manual</i>. Add suffix L to style number and specify leather color number. Add suffix L to style number and specify leather color number. ▶ See <i>Surface Materials Reference Manual</i>.

Specification Information	
• Style Number	• U.S. Base Price
TS37602	\$619

 **For Canadian Pricing**
 Multiply U.S. Price by the Canadian price factor.
 ▶ See page 1 for details.

Snodgrass

Snodgrass, designed by Warren Snodgrass, offers guest and occasional seating of classic simplicity. Snodgrass has enduring design that is always in style.

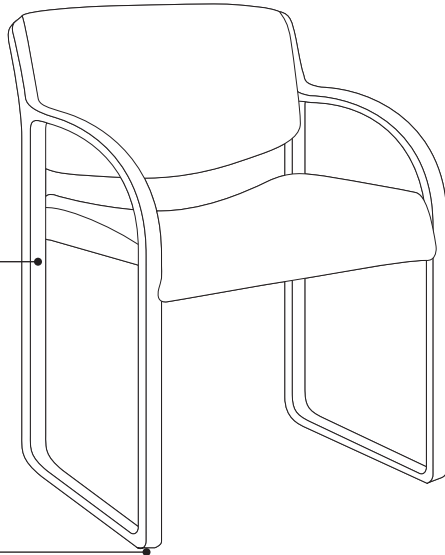

Frame is available in wood veneer.

Glides are clear plastic.

Actual Dimensions

Overall depth	23½"
Overall width	22¾"
Overall height	31½"
Seat depth	21"
Functional seat depth	17½"
Seat width	20"
Back width	20"
Back height	14¼"
Back lumbar height	7"
Width between arms	20"
Seat-to-floor height	18¼"
Arm height from floor	25¼"
Arm height from seat	7"
Seat pan angle	5°
Angle between seat and back	103°

Product Details

One back shape is available, open back.

One arm style—open is available.

Surface Materials

▶ See surface materials on page 568 for specific availability or refer to the *Surface Materials Reference Manual* for further information.

Upholstery

- Fabric
- Fabric with soil retardant treatment (option)
- Vinyl
- Leather
- Select Surfaces leather
- COM
- COL

Frame

- 9201 Polished Chrome
- Wood

Tip: Frames are constructed of solid maple. Finishes applied to maple will match the color of stains applied to oak, walnut, or cherry, but will not show the same natural grain.

Glides

- Clear plastic

Wood touch-up kits

- Available in specific finishes for field repairs
- ▶ Page 570

All Steelcase seating with standard upholstery fabrics

complies with requirements of the State of California Technical Bulletin 117. All standard seating is labeled to be in compliance with California 117.

Programs & Services

▶ See the *Surface Materials Reference Manual* for further detail about programs and services offered for seating.

The Customer's Own Material (COM & COL) Program

offers the opportunity for customers to select fabrics and leather that are not offered through the standard Steelcase surface materials program for use on Steelcase products. Avoid pattern fabrics and heavily grained leathers. Through the COM & COL program, Steelcase will test your materials for application on Steelcase products. Once approved, you can place your order. Steelcase will facilitate the entire ordering process and give you a production schedule. Steelcase will order the COM & COL fabric and leather directly from the textile manufacturer. For up-to-date information regarding fabric test results for all COM & COL fabrics and details regarding yardage requirements for most Seating lines, visit the COM website. To locate the COM website:

- Visit www.steelcase.com

Soil retardants are treatments that provide long-term soil and stain resistance to a fabric without affecting the shade or the integrity of the fabric. The following Steelcase Textiles are available pre-treated with soil retardant. (You do not need to select the soil-retardant option for these fabrics and incur the upcharge.)

- Jacks
- Link
- Spyder

For information on soil retardant fabrics on Select Surfaces, please refer to the *Surface Materials Reference Manual*.

Soil-retardant treatment is available on all other seating fabrics at an additional upcharge per seating unit. To order this option, please select "Soil-Retardant Treatment" under "Optional Accessories."

For soil-retardant treatment on COMs, please select "Soil-Retardant Treatment" under "Optional Accessories." Minimums or additional yardage may be required. Please contact the vendor directly for specific information.

Extended lead times may be necessary for this service.

Contact your Steelcase Solutions Fulfillment Team Representative at 1.888.STEELCASE (1.888.783.3522) or send an e-mail to lineone@steelcase.com.

Resources

Snodgrass Brochure
Form number (S11006)

Snodgrass Guest Chair

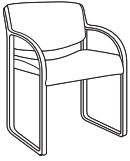

Standard Includes	Required to Specify
-------------------	---------------------

- | | |
|--|---|
| <ul style="list-style-type: none"> ▶ Need help? Product details, page 556 • Frame and arms: wood veneer • Upholstery: fabric price group 1 • Glides: clear plastic | <ul style="list-style-type: none"> 1 Style number 2 Fabric color number for upholstery 3 Wood veneer color number for frame 4 Options, if selected (see below) ▶ See <i>Surface Materials</i>, page 568. |
|--|---|

Options	U.S. Price	Required to Specify
---------	------------	---------------------

Surface Materials	Upholstery <ul style="list-style-type: none"> • Fabric price group 1 • Fabric price group 2 • Fabric price group 3 • Fabric price group 4 • Fabric price group 5 • Fabric price group 6 • Fabric price group 7 • Fabric price group 8 • Fabric price group 9 • Fabric price group 10 • Leather price group • Select Surfaces leather price group 1 • Elmosoft leather price group • Select Surfaces leather price group 2 • Customer's Own Material (COM) • Customer's Own Leather (COL) • Soil-retardant treatment applied to upholstery fabric 	<ul style="list-style-type: none"> No cost +\$ 27 +\$ 49 +\$ 70 +\$ 88 +\$109 +\$125 +\$158 +\$194 +\$219 +\$564 +\$564 +\$652 +\$652 +\$ 38 +\$ 38 +\$ 27
	Frame	<ul style="list-style-type: none"> • Customiz stain on wood
		<ul style="list-style-type: none"> Specify fabric color number. Specify fabric color number. Specify fabric color number. Specify fabric color number. Specify fabric color number. Specify fabric color number. Specify fabric color number. Specify fabric color number. Specify fabric color number. Specify fabric color number. Specify leather color number. ▶ See <i>Surface Materials Reference Manual</i>. Specify Elmosoft leather color number. ▶ See <i>Surface Materials Reference Manual</i>. ▶ See <i>Surface Materials Reference Manual</i>. ▶ See <i>Surface Materials Reference Manual</i>. Specify with soil-retardant treatment.
		<ul style="list-style-type: none"> No cost Specify with <i>Customiz stain</i>. ▶ See <i>Surface Materials Reference Manual</i>.

Specification Information	
---------------------------	--

<ul style="list-style-type: none"> • Style Number • • • 	<ul style="list-style-type: none"> • U.S. Base Price • • •
--	---

Open Loop Arms with Open Back - Wood

474419W	\$1198
•	•

For Canadian Pricing
 Multiply U.S. Price by the Canadian price factor.
 ▶ See page 1 for details.

Terrazzo

Terrazzo guest chairs, designed by Brian Kane, have a classic and simple styling appropriate for a broad range of applications. A family of factory-installed back designs are available to create a variety of visual statements.

Lattice inserts are available in three designs. Slats are bowed to provide enhanced lumbar support.

Frame is European Beech.

Arms are arched to correspond with the curvature of the chair's back and are gently raised at the front to assist in entering and rising from the chair.

Seat is fully upholstered and features a webbed-panel construction.

Glides are 1/2" diameter.

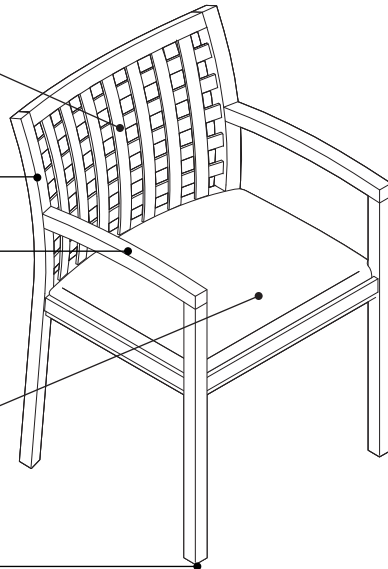

Product Details

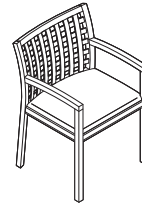

Square lattice back creates a strong grid-like pattern.

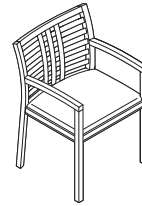

Macintosh lattice back introduces a distinctive vertical space.

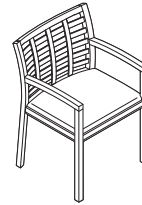

Horizontal lattice back divides the space with horizontal elements.

Surface Materials

Seat

- Vinyl
- Fabric
- Fabric with soil-retardant treatment (option)
- Leather
- COM
- COL

Frame and back slats

- European Beech
- Tip: Wood finishes applied to beech will match the color of stains applied to oak, walnut, or cherry but will not show the same natural grain.*
- Customiz stain (option)

Glides

- Stainless steel only

Wood touch-up kits

- Available in specific finishes for field repairs
- ▶ Page 570

All Steelcase seating with standard upholstery fabrics

complies with requirements of the State of California Technical Bulletin 117. All standard seating is labeled to be in compliance with California 117.

Actual Dimensions

Overall depth	21 ³ / ₄ "
Overall width	21 ¹ / ₄ "
Overall height	32 ¹ / ₄ "
Seat depth	17 ⁷ / ₈ "
Seat width	20"
Back width	21 ¹ / ₄ "
Back height	14"
Width between arms	18 ³ / ₄ "
Seat to floor height	18 ¹ / ₄ "
Arm height from floor	25 ¹ / ₄ "

Programs & Services

► See the *Surface Materials Reference Manual* for further detail about programs and services offered for seating.

The Customer's Own Material (COM & COL) Program

offers the opportunity for customers to select fabrics and leather that are not offered through the standard Steelcase surface materials program for use on Steelcase products. Avoid pattern fabrics and heavily grained leathers. Through the COM & COL program, Steelcase will test your materials for application on Steelcase products. Once approved, you can place your order. Steelcase will facilitate the entire ordering process and give you a production schedule. Steelcase will order the COM & COL fabric and leather directly from the textile manufacturer. For up-to-date information regarding fabric test results for all COM & COL fabrics and details regarding yardage requirements for most Seating lines, visit the COM website. To locate the COM website:

- Visit www.steelcase.com

Soil retardants are treatments that provide long-term soil and stain resistance to a fabric without affecting the shade or the integrity of the fabric. The following Steelcase Textiles are available pre-treated with soil retardant. (You do not need to select the soil-retardant option for these fabrics and incur the upcharge.)

- Jacks
- Link
- Spyder

For information on soil retardant fabrics on Select Surfaces, please refer to the *Surface Materials Reference Manual*.

Soil-retardant treatment is available on all other seating fabrics at an additional upcharge per seating unit. To order this option, please select "Soil-Retardant Treatment" under "Optional Accessories."

For soil-retardant treatment on COMs, please select "Soil-Retardant Treatment" under "Optional Accessories." Minimums or additional yardage may be required. Please contact the vendor directly for specific information.

Extended lead times may be necessary for this service.

Contact your Steelcase Solutions Fulfillment Team Representative at 1.888.STEELCASE (1.888.783.3522) or send an e-mail to lineone@steelcase.com.

Resources

Terrazzo Brochure
Form number S10886



Chairs for People at Work
Form number S11347

Terrazzo Guest Chairs

Standard Includes		Required to Specify
<ul style="list-style-type: none"> ▶ Need help? Product details, page 558 	<ul style="list-style-type: none"> Upholstery on seat: fabric price group 1 Frame: European Beech Lattice slats: European Beech Glides: stainless steel only 	<ul style="list-style-type: none"> 1 Style number 2 Fabric color number for upholstery 3 Wood color number for frame 4 Options, if selected (see below) ▶ See <i>Surface Materials</i>, page 568.

Tip: Wood finishes applied to beech will match the color of stains applied to oak, walnut, or cherry but will not have the same natural grain.

Options	U.S. Price	Required to Specify
Surface Materials	Upholstery <ul style="list-style-type: none"> Fabric price group 1: No cost Fabric price group 2: +\$ 27 Fabric price group 3: +\$ 56 Fabric price group 4: +\$ 88 Fabric price group 5: +\$109 Fabric price group 6: +\$125 Fabric price group 7: +\$158 Fabric price group 8: +\$202 Fabric price group 9: +\$250 Fabric price group 10: +\$328 Leather price group: +\$250 Customer's Own Material (COM): +\$ 16 Customer's Own Leather (COL): +\$ 16 Soil-retardant treatment applied to upholstery fabric: +\$ 27 	<ul style="list-style-type: none"> Specify fabric color number. Specify fabric color number. Specify fabric color number. Specify fabric color number. Specify fabric color number. Specify fabric color number. Specify fabric color number. Specify fabric color number. Specify fabric color number. Specify fabric color number. Specify leather color number. ▶ See <i>Surface Materials Reference Manual</i>. ▶ See <i>Surface Materials Reference Manual</i>. Specify with soil-retardant treatment.
Frame <ul style="list-style-type: none"> Customiz stain on wood 	<ul style="list-style-type: none"> No cost 	<ul style="list-style-type: none"> Specify with <i>Customiz stain</i>. ▶ See <i>Surface Materials Reference Manual</i>.

Specification Information					
Square Lattice Back		Macintosh Lattice Back		Horizontal Lattice Back	
					
• Style Number	• U.S. Base Price	• Style Number	• U.S. Base Price	• Style Number	• U.S. Base Price
TERR1	\$1107	TERR2	\$1107	TERR3	\$1107

 **For Canadian Pricing**
 Multiply U.S. Price by the Canadian price factor.
 ▶ See page 1 for details.



Topaz

Topaz offers two chair styles to complement traditional and transitional office environments.

Frame is European Beech.

Back is upholstered and framed in wood. It is available either open or closed.

Arms are open. They are available with either a rectilinear or curvilinear design. Finger joint is used in construction.

Upholstered seat features a webbed panel construction.

Legs are solid wood. Front legs on open back model are carved for traditional detail.

Glides are 1/2" in diameter.

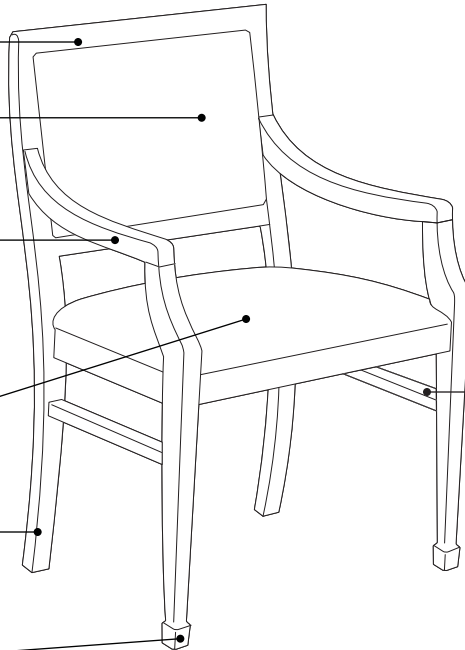

Stretcher rails on open back model provide added support.

Product Details

Two models are available—open back or closed back.

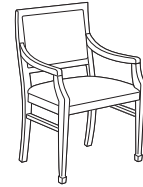

Open-back models have rectilinear arms, carved detail on the front legs, and stretcher rails.

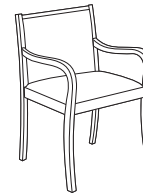

Closed-back models have curvilinear arms that flow into the front legs.

Surface Materials

Upholstery

- Vinyl
- Fabric
- Fabric with soil-retardant treatment (option)
- Leather
- COM
- COL

Frame

- European Beech
- Tip: Wood finishes applied to beech will match the color of stains applied to oak, walnut, or cherry but will not have the same natural grain.*

Glides

- Stainless steel only

Wood touch-up kits

- Available in specific finishes for field repairs
- ▶ Page 570

All Steelcase seating with standard upholstery fabrics complies with requirements of the State of California Technical Bulletin 117. All standard seating is labeled to be in compliance with California 117.

Actual Dimensions

	Closed Back	Open Back
Overall depth	21"	23 ³ / ₄ "
Overall width	22 ¹ / ₄ "	23 ¹ / ₄ "
Overall height	32 ¹ / ₂ "	35 ¹ / ₂ "
Seat depth	16"	18"
Seat width	21"	21"
Back width	20 ¹ / ₂ "	19 ¹ / ₂ "
Back height	14 ¹ / ₂ "	17 ³ / ₄ "
Width between arms	19 ¹ / ₂ "	19 ¹ / ₂ "
Seat to floor height	18 ¹ / ₄ "	18 ¹ / ₄ "
Arm height from floor	25 ¹ / ₄ "	25 ¹ / ₂ "

Programs & Services

► See the *Surface Materials Reference Manual* for further detail about programs and services offered for seating.

The Customer's Own Material (COM & COL) Program

offers the opportunity for customers to select fabrics and leather that are not offered through the standard Steelcase surface materials program for use on Steelcase products. Avoid pattern fabrics and heavily grained leathers. Through the COM & COL program, Steelcase will test your materials for application on Steelcase products. Once approved, you can place your order. Steelcase will facilitate the entire ordering process and give you a production schedule. Steelcase will order the COM & COL fabric and leather directly from the textile manufacturer. For up-to-date information regarding fabric test results for all COM & COL fabrics and details regarding yardage requirements for most Seating lines, visit the COM website. To locate the COM website:

- Visit www.steelcase.com

Soil retardants are treatments that provide long-term soil and stain resistance to a fabric without affecting the shade or the integrity of the fabric. The following Steelcase Textiles are available pre-treated with soil retardant. (You do not need to select the soil-retardant option for these fabrics and incur the upcharge.)

- Jacks
- Link
- Spyder

For information on soil retardant fabrics on Select Surfaces, please refer to the *Surface Materials Reference Manual*.

Soil-retardant treatment is available on all other seating fabrics at an additional upcharge per seating unit. To order this option, please select "Soil-Retardant Treatment" under "Optional Accessories."

For soil-retardant treatment on COMs, please select "Soil-Retardant Treatment" under "Optional Accessories." Minimums or additional yardage may be required. Please contact the vendor directly for specific information.

Extended lead times may be necessary for this service.

Contact your Steelcase Solutions Fulfillment Team Representative at 1.888.STEELCASE (1.888.783.3522) or send an e-mail to lineone@steelcase.com.

Resources

Topaz Brochure

Form number S11077

Chairs for People at Work

Form number S11347

Quick Ship Guide

Topaz Guest Chairs

Standard Includes		Required to Specify
<ul style="list-style-type: none"> ▶ Need help? Product details, page 562 	<ul style="list-style-type: none"> • Frame: European Beech • Upholstery: fabric price group 1 • ½"-diameter glides: stainless steel only 	<ol style="list-style-type: none"> 1 Style number 2 Wood color number for frame 3 Fabric color number for upholstery 4 Options, if selected (see below) <ul style="list-style-type: none"> ▶ See <i>Surface Materials</i>, page 568.

Options	U.S. Price	Required to Specify
Surface Materials		
Upholstery on seat and back		
• Fabric price group 1	No cost	Specify fabric color number.
• Fabric price group 2	+\$ 27	Specify fabric color number.
• Fabric price group 3	+\$ 56	Specify fabric color number.
• Fabric price group 4	+\$ 88	Specify fabric color number.
• Fabric price group 5	+\$109	Specify fabric color number.
• Fabric price group 6	+\$125	Specify fabric color number.
• Fabric price group 7	+\$158	Specify fabric color number.
• Fabric price group 8	+\$202	Specify fabric color number.
• Fabric price group 9	+\$250	Specify fabric color number.
• Fabric price group 10	+\$328	Specify fabric color number.
• Leather price group	+\$470	Specify leather color number.
• Customer's Own Material (COM)	+\$ 16	▶ See <i>Surface Materials Reference Manual</i> .
• Customer's Own Leather (COL)	+\$ 16	▶ See <i>Surface Materials Reference Manual</i> .
Contrasting upholstery on seat and back		
• Contrasting fabrics	+\$ 33	Add suffix K to the style number and specify fabric color numbers.
Contrasting upholstery on seat		
• Fabric price group 1	No cost	Specify fabric color number.
• Fabric price group 2	+\$ 13	Specify fabric color number.
• Fabric price group 3	+\$ 28	Specify fabric color number.
• Fabric price group 4	+\$ 44	Specify fabric color number.
• Fabric price group 5	+\$ 54	Specify fabric color number.
• Fabric price group 6	+\$ 62	Specify fabric color number.
• Fabric price group 7	+\$ 79	Specify fabric color number.
• Fabric price group 8	+\$101	Specify fabric color number.
• Fabric price group 9	+\$125	Specify fabric color number.
• Fabric price group 10	+\$164	Specify fabric color number.
• Leather price group	+\$235	Specify leather color number.
• Customer's Own Material (COM)	+\$ 8	▶ See <i>Surface Materials Reference Manual</i> .
• Customer's Own Leather (COL)	+\$ 8	▶ See <i>Surface Materials Reference Manual</i> .
Contrasting upholstery on back		
• Fabric price group 1	No cost	Specify fabric color number.
• Fabric price group 2	+\$ 14	Specify fabric color number.
• Fabric price group 3	+\$ 28	Specify fabric color number.
• Fabric price group 4	+\$ 44	Specify fabric color number.
• Fabric price group 5	+\$ 55	Specify fabric color number.
• Fabric price group 6	+\$ 63	Specify fabric color number.
• Fabric price group 7	+\$ 79	Specify fabric color number.
• Fabric price group 8	+\$101	Specify fabric color number.
• Fabric price group 9	+\$125	Specify fabric color number.
• Fabric price group 10	+\$164	Specify fabric color number.
• Leather price group	+\$235	Specify leather color number.
• Customer's Own Material (COM)	+\$ 8	▶ See <i>Surface Materials Reference Manual</i> .
• Customer's Own Leather (COL)	+\$ 8	▶ See <i>Surface Materials Reference Manual</i> .
• Soil-retardant treatment applied to upholstery fabric	+\$ 27	Specify <i>with soil-retardant treatment</i> .
Frame		
• Customiz stain on wood	No cost	Specify <i>with Customiz stain</i> .
▶ See <i>Surface Materials Reference Manual</i> .		

Tip: Wood finishes applied to beech will match the color of stains applied to oak, walnut, or cherry but will not have the same natural grain.

▶ **Specification Information, on next page**

► Options, on previous page

Specification Information

Chair with Open Back



• **Style Number**
 • **U.S. Base Price**

G24 \$947

Chair with Closed Back



• **Style Number**
 • **U.S. Base Price**

G26 \$883

Topaz



For Canadian Pricing

Multiply U.S. Price by the Canadian price factor.

► See page 1 for details.

Surface Materials

Surface Materials	568
Wood Seating Upholstery Matrix	571
Wood Color Availability Matrix	572
Guidelines for Directional Fabrics	574

Surface Materials

This listing includes all the surface material choices that are available for the products in this specification guide.

Resources

For more information about surface materials, refer to the following resources:

Additional surface materials specification tools are available to assist you in the specification process—the Surface Materials Binders.

The global surface materials palette is a core collection of finishes that is available across multiple geographies (Americas/EMEA – Europe, Middle East, and Africa/APAC – Asia Pacific) and on global product lines, where applicable. For a list of finishes included in the offering, see the *Surface Materials Reference Manual*. Additional details, like product approvals by geography and finish number conversions, can also be found in the *Surface Materials Reference Manual* or see www.steelcase.com/surface-materials

Surface Materials Binders

- Surface Materials Reference Manual
- A complete set of swatch cards for hard surfaces, vertical surface fabrics, and seating upholstery

Metal

Select Surfaces

4798	Sterling Metallic
7026	Nickel
7207	Black
8046	Polished Aluminum
9201	Polished Chrome

Paint

Steelcase Surfaces

0835	Black
4799	Platinum Metallic
7207	Black

Wood

► See *Wood Color Availability Matrix* on page 572 for color availability by product line and wood species.
Tip: The wood used in the construction of chairs is either maple or European beech. Wood finishes applied to maple or beech will match the color of stains applied to oak, walnut, or cherry, but will not have the same natural grain. Composite color finishes will match the color of composites on veneered surfaces, but will not have the same grain pattern.

Select Surfaces

For information on products within Select Surfaces, including accent paints and fabrics from Designtex, Gab-riel, Kvadrat, and Pollack, please refer to the *Surface Materials Reference Manual* or visit www.steelcase.com/surface-materials under the Select Surfaces section.

- Applies to:
- Collaborative lounge table
 - i2i tablet arm
 - media:scape lounge
 - Snodgrass 474 Series chair frames

Natural Veneer

Natural veneer is available in the Select Surfaces offering. Natural veneer may have extended leadtimes. Place your order as you normally would for any other finish, calling out the appropriate finish code. Natural veneers are Graded-In as Wood Group 1 pricing.

The following finishes are available through the natural veneer offering:

Flat-cut open-pore finish choices

35A2	FC/OP Blanch Maple
37A2	FC/OP Thunder Walnut

Quarter-cut open-pore finish choices

32A2	QC/OP Blanch Maple
33A2	QC/OP Thunder Walnut

Rift-cut open-pore finish choices

36A2	RC/OP Volcanic Oak
------	--------------------

Steelcase Surfaces

Wood Seating color choices

3062	Graphite Walnut
3402	Clear Cherry (Aged)
3412	Natural Cherry E
3422	Medium Cherry
3522	Clear Maple*
3572	Amber on Maple E
3592	Blonde on Maple
3602	Desert Oak
3612	Warm Oak E
3692	Espresso Oak
3702	Clear Walnut
3712	Natural Walnut
3722	Dark Mahogany on Walnut
3752	Medium Walnut
3762	Dark Walnut
3772	Medium Mahogany on Walnut
3JDX	Oak Composite
3JFX	Maple Composite
3JHX	Cherry Composite
3JJX	Walnut Composite
3ZNX	Night Cerused Oak Composite

*To ensure an understanding of the color ranges and characteristic variations of natural veneer, a sign-off sheet is required prior to orders being accepted for this clear-coat finish. The sign-off sheet is available through Steelcase advertising stock. Form number 05-0001370

Custom Surfaces

Customiz stain is a service that allows you to create your own stain colors and finishes on standard veneer. Customiz stain color is available on all product lines that offer wood veneer.

A \$500 stain-matching fee applies on CUSTOMIZ requests (Exception: The \$500 fee does not apply on matches to Coalesse standard finishes or for a low-gloss finish request on a standard color). The \$500 fee covers the cost of formulating the Customiz color finish and applies regardless of whether or not an order for product is placed.

In addition, an approval form must be signed to indicate customer acceptance of Customiz match. A \$1,500 initiation fee will be charged prior to first order entry. This initiation fee activates the finish for unlimited use on any Steelcase product for an 18 month time period. After the 18 month time period has lapsed, the Customiz finish may be reactivated for another 18 months for a \$1,000 fee at any point within five years after the \$1,500 initiation fee was paid. If the finish is not reactivated within five years after the \$1,500 initiation fee was paid, the finish will be culled and the customer will need to pay the \$1,500 initiation fee again. All style number related Customiz charges products are no cost as of April 2014. The matching and initiation fees are not discountable.

Customiz stain takes 10 days to formulate. Consult the *Surface Materials Reference Manual* for more information. Custom veneers are also available and must be quoted by Steelcase specials group. Customiz stain on custom veneers takes 2 to 4 weeks to formulate.

Requirements and information on ordering a Customiz stain color are found in the *Surface Materials Reference Manual*.

Upholstery

Steelcase Surfaces

Price Group 1

Buzz2

5F01	Camel E
5F03	Tomato
5F04	Red E
5F05	Burgundy
5F06	Sky E
5F07	Blue
5F08	Navy
5F10	Grape E
5F11	Eggplant E
5F15	Stone
5F16	Grey
5F17	Black
5G50	Dunegrass
5G51	Sable
5G52	Barley
5G53	Sunrise
5G54	Carrot
5G55	Pumpkin
5G56	Timber
5G57	Rogue
5G58	Chocolate
5G59	Meadow
5G60	Ivy
5G61	Cyan
5G62	Atlantic
5G63	Crocus
5G64	Alpine
5G65	Tornado

Jacks

5B61	Taupe E
5B63	Camel E
5B64	Pewter E
5B70	Midnight E

Link

5A20	Burgundy
5A23	Green
5A24	Blue
5A25	Navy
5A26	Purple
5A27	Black
5A28	Ocean
5A30	Chamois

New Black

5J10 New Black: Bruce
 5J11 New Black: Henry
Tip: New Black upholstery has color numbers in both price group 1 and price group 2.

Playground

5F28	Claret E
5F29	Chile E
5F30	Amber E
5F31	Nut E
5F32	Blade E
5F33	Stone E
5F34	Sky E
5F35	Navy E
5F36	Huckleberry E
5F37	Charcoal E

E = Established

Price Group 2**Chainmail**

5550 Cotton
 5551 Space
 5552 Silver Dollar
 5553 Volcano
 5554 Orange Crush
 5555 Tricycle
 5556 Geranium
 5557 Banana
 5558 Margarita
 5559 Lagoon

Cogent: Connect

5S15 Coconut
 5S16 Turmeric/Honey
 5S17 Tangerine
 5S18 Scarlet
 5S19 Concord
 5S20 Maya Blue
 5S21 Blue Jay
 5S23 Wasabi
 5S24 Nickel
 5S25 Graphite
 5S26 Licorice
 5S27 Malt
 5S28 Root Beer
 5S93 Blueprint
 5S94 Lizard/Jungle
 5S95 Sailor
 5S96 Quicksilver
 5S97 Nugget
 5S98 Canary
 5S99 Lipstick/Merlot
 5SD0 Royal Blue
 5SD1 Aubergine
 5SD2 Peacock
 5SD3 Lagoon
 5SD4 Saffron

Cogent: Geode Vertical E

5S38 Oyster
 5S41 Sesame

Cogent: Trails

5S29 Bronzite
 5S85 Agate
 5S86 Lapis
 5S87 Malachite
 5S88 Quartz
 5S90 Tiger Eye
 5S91 Travertine
 5S92 Topaz

New Black

5J08 New Black: Jack
 5J09 New Black: James
 5J12 New Black: Harley
Tip: New Black upholstery has color numbers in both price group 1 and price group 2.

E = Established

Nitelights

5F58 Hazelnut
 5F61 Earth
 5F62 Shore
 5F63 Moss
 5F65 Regal Blue
 5F66 Stone
 5F67 Moon

Seating Vinyl E

5801 Topaz
 5805 Foggy Night
 5809 Black
 5810 Forest
 5812 Navy
 5813 Currant
 5814 Leaf
 5815 Seaside
 5817 Pebble
 5818 Spice
 5819 Thistle
 5820 Coffee
 5822 Iris

Spyder

5B01 Foggy Night **E**
 5B04 Peri **E**

Stand In

5621 Sleet
 5622 Lunar
 5623 Cyclone
 5624 Eclipse
 5625 Powder
 5626 Chardonnay
 5627 Graham
 5628 Sediment
 5629 Allspice
 5630 Apple
 5631 Lava
 5632 Cayenne
 5633 Plantain
 5634 Parsley
 5635 Scallion
 5636 Atlantis
 5691 Orca
 5740 Burlap
 5741 Porter
 5742 Tusk
 5743 Putty
 5744 Blueberry
 5745 Chartreuse
 5746 Mango
 5747 Sedona
 5748 Juniper
 5749 Peanut

Price Group 3**Billiard Multi-Use by Designtex**

5H10 Bone
 5H11 Poppy
 5H12 Tangelo
 5H13 Citron
 5H14 Avocado
 5H15 Hunter
 5H16 Indigo
 5H17 Mallard
 5H18 Teak
 5H19 Cumulus
 5H20 Pewter
 5H21 Gunmetal
 5H22 Ink

Gaja — Cradle to Cradle Certified™ Silver

5W40 Black
 5W41 Pepper
 5W42 Pearl Grey
 5W43 Crimson
 5W44 Ink
 5W45 Night Blue
 5W46 Petrol
 5W47 Greige
 5W48 Sepia
 5W49 Umber
 5W50 Java
 5W51 Camellia Red
 5W52 Emerald
 5W53 Snow Pea
 5W54 Olive
 5W55 Light Blue
 5W56 Maroon
 5W57 Black Raspberry
 5W58 Spruce
 5W59 Apple Green
 5W60 Deep Blue
 5W61 Chili Pepper
 5W62 Daffodil

Imperma

TM01 Toffee
 TM02 Pigeon
 TM03 Fossil
 TM04 Poppyseed
 TM05 Auburn
 TM06 Cumin
 TM07 Marble
 TM08 Cliff
 TM09 Tarragon
 TM10 Pesto
 TM11 Wave
 TM12 Niagara
 TM13 Tuscan
 TM14 Peppercorn

Redeem

TM50 Brick
 TM51 Yolk
 TM52 Cinnamon
 TM53 Daisy
 TM54 Pine
 TM55 Water
 TM56 Dill
 TM57 Lavender
 TM58 Mallard
 TM59 Caramel
 TM60 Greyhound
 TM61 Mocha
 TM62 Iceberg
 TM63 Chestnut
 TM64 Granite
 TM65 Cashmere
 TM66 Barnwood

Retrieve

TM30 Kelly
 TM31 Lake
 TM32 Gala
 TM33 Papaya
 TM34 Dandelion
 TM35 Curry
 TM36 Lilac
 TM37 Submarine
 TM38 Driftwood
 TM39 Bistro
 TM40 Quarry
 TM41 Mohair
 TM42 Shadow
 TM43 Seal
 TM44 Chalk

Texel

TM20 Angora
 TM21 Grist
 TM22 Galaxy
 TM23 Terracotta
 TM24 Nude
 TM25 Field
 TM26 Haze

Price Group 5**Bo Peep**

5G66 Pita
 5G67 Bone
 5G68 Safari
 5G69 Brown Sugar
 5G70 Chocolate Chip
 5G71 Candlelight
 5G72 Honey Mustard
 5G73 Marmalade
 5G74 Picnic
 5G75 Pinot
 5G76 Bloom
 5G77 Grapevine
 5G78 Firefly
 5G79 Artichoke
 5G80 Serpent
 5G81 Carolina
 5G82 Blue Bonnet
 5G83 Nautical
 5G84 Gravel
 5G85 Sharkskin
 5G86 Kohl

Remix

RE01 Rust
 RE02 Pumpkin
 RE03 Pebble
 RE04 Dark Chocolate
 RE05 Beige
 RE06 Linen Beige
 RE07 Hazelnut
 RE08 Concrete Grey
 RE09 Sky Blue
 RE10 Blue Jean
 RE11 Ivy Green
 RE12 Primavera Yellow
 RE13 Night Blue

Silk

5L30 Butterscotch
 5L31 Dijon
 5L32 Seaweed
 5L33 Boysenberry
 5L34 Vermillion
 5L35 Marina
 5L36 Heather Blue
 5L37 Blue Raspberry
 5L38 Cauldron
 5L39 Flaxen

Price Group 6**Brisa**

BR01 Black Onyx
 BR04 Truffle
 BR06 Ash
 BR07 Sage
 BR08 Celery
 BR09 Sterling Blue
 BR10 Night Navy
 BR11 Cambridge Blue
 BR12 Abyss
 BR13 Canyon
 BR14 Pompeian Red
 BR15 Salsa
 BR16 Cinnabar
 BR17 Aztec
 BR18 New Sand
 BR19 Cream
 BR20 White
 BR21 Moccasin
 BR22 Buckskin
 BR23 Prairie

Price Group 7**Steelcut Trio**

TR01 Mist Grey
 TR02 Stone Grey
 TR03 Cassonade Beige
 TR04 Nutmeg Beige
 TR06 Licorice Black
 TR07 Mustard Yellow
 TR08 Red Currant
 TR11 Ice Blue
 TR14 Blue Jay Mix
 TR15 Brown Frost

Leather Price Group**Steelcase Leather**

L107 Black
 L207 Mahogany
 L220 Soapstone
 L221 Rocky

Surface Materials, continued

Elmosoft Leather Price Group**Elmosoft Leather**

L110 Maritime Blue
 L111 Midnight Blue
 L112 Ebony
 L113 Gunmetal
 L114 Mica
 L115 Dove Grey
 L116 Plum Pleasure
 L122 Truffle
 L128 Red Birch
 L132 Violet
 L133 Espresso
 L134 Ruby
 L135 Scarlet
 L138 Bourbon
 L139 Cinder
 L140 Garnet
 L143 Pecan
 L144 Chamois
 L146 Russet
 L147 Saddle
 L151 White
 L709 Sugar
 L711 Parchment
 L712 Buff
 L716 Khaki
 L717 Cameo
 L721 Rock
 L722 Desert
 L723 Storm
 L725 Teal
 L727 Egyptian Blue
 L728 Bright Blue
 L730 Hunter
 L736 Lemon
 L737 Sunshine
 L738 Drama
 L740 Dazzle
 L743 Forest Green
 L744 Turtle
 L745 Grass
 L746 Envy
 L747 Cigar
 L748 Light Chocolate
 L749 Beaver
 L750 Bluffstone
 L751 Sienna
 L752 Oxblood
 L753 Dough
 L754 Acorn
 L755 Peanut Butter
 L756 Quinoa
 L757 Dark Sand
 L758 Mustard
 L759 Amber Orange
 L760 Bengal
 L761 Periwinkle
 L762 Canvas
 L763 Macadamia
 L764 True Blue
 L765 Storm Blue
 L766 Powder Blue
 L767 Blush
 L768 Tropical
 L769 Mauve
 L770 Cadet
 L771 Powder Mint
 L772 Timberwolf
 L773 Chalice
 L774 Oil
 L775 Coyote

Select Surfaces

For information on products within Select Surfaces, including accent paints and fabrics from Designtex, Gabriel, Kvadrat, and Pollack, please refer to the *Surface Materials Reference Manual* or visit www.steelcase.com/surface-materials under the Select Surface section.

Custom Surfaces**Price Group COM (Customer's Own Material)****Fabric Approval and Yardage**

To confirm whether a particular COM material has already been tested for use on a specific Steelcase product or to determine actual yardage requirements:

- Visit www.steelcase.com

For additional information regarding Customer's Own Material, call 1.888.STEELCASE.

How to Order Wood Touch-Up Kits

Order wood finish touch-up kits from J. Kaltz Co. Specify the desired Steelcase finish code (i.e. 3422). Each kit, priced at \$9.98, contains one brush tip marker and one fil-stick. A minimum order of \$15 is required. Shipping, estimated at approximately \$5 per kit, is extra. Dealer will be charged directly. No additional discounts apply.

Place orders as follows:

- Phone: 616.942.6070
- Web: <http://jkaltzco.com>
- Email: susan.bothwell@jkaltzco.com

Orders placed before noon Eastern Standard Time will ship the same day via standard ground shipping and will arrive in three to five days. Express shipment is not available due to the combustible nature of the materials.

Wood Seating Upholstery Matrix

Not every fabric is available on every chair. This matrix gives an overview of the upholstery fabrics that can be specified on each seating product line.

Legend

- = Not available
- = Available
- = Available with exceptions
- E** = Established
- ▶ See specification guide for details.
- *Gaja — Cradle to Cradle Certified™ Silver

	Price Group	Alcove	Collaboration	Escapade	Mingle	Mobile Ped Cushion Top - EE, Lateral Tops/2 Seam	Mobile Ped Cushion Top - EE, Lateral Tops/4 Seam	Oriana	Sawyer	Siento	Snodgrass	Terrazzo	Topaz
Billiard Multi-Use by DesignTex	3	■	■	■	■	■	•	■	■	■	■	■	■
Bo Peep	5	■	■	■	■	■	•	■	■	■	■	■	■
Brisa	6	■	■	■	■	•	■	■	■	■	■	■	■
Buzz2	1	■	■	■	■	•	■	■	■	■	■	■	■
Chainmail	2	■	■	■	■	■	•	■	■	■	■	■	■
Cogent: Connect	2	■	■	■	■	•	■	■	■	■	■	■	■
Cogent: Geode Vertical E	2	■	■	■	■	■	•	■	■	•	■	■	■
Cogent: Trails	2	■	■	■	■	■	•	■	■	■	■	■	■
Elmosoft Leather	EL	•	•	•	•	•	■	•	•	■	■	•	•
Gaja*	3	■	■	■	■	■	•	■	■	■	■	■	■
Imperma	3	■	■	■	■	■	•	■	■	■	■	■	■
Jacks E	1	■	■	■	■	■	•	■	■	■	■	■	■
Steelcase Leather	L	■	■	■	■	•	■	■	■	■	■	■	■
Link	1	■	■	■	■	■	•	■	■	■	■	■	■
New Black: Bruce	1	■	■	■	■	■	■	■	■	■	■	■	■
New Black: Harley	2	■	■	■	■	■	■	■	■	■	■	■	■
New Black: Henry	1	■	■	■	■	■	■	■	■	■	■	■	■
New Black: Jack	2	■	■	■	■	■	■	■	■	■	■	■	■
New Black: James	2	■	■	■	■	■	■	■	■	■	■	■	■
Nitelights	2	■	■	■	■	■	•	■	■	■	■	■	■
Playground E	1	■	■	■	■	■	•	■	■	■	■	■	■
Redeem	3	■	■	■	■	■	•	■	■	■	■	■	■
Remix	5	■	■	■	■	■	•	■	■	■	■	■	■
Reply Air Mesh	NA	■	■	■	•	■	■	■	•	•	•	■	■
Retrieve	3	■	■	■	■	■	•	■	■	■	■	■	■
Seating Vinyl E	2	•	•	•	•	•	■	•	■	•	■	■	•
Silk	5	■	■	■	■	■	■	■	■	■	■	■	■
Spyder E	2	■	■	■	■	■	•	■	■	•	■	■	■
Stand In	2	•	•	•	•	•	■	•	■	•	■	■	•
Steelcut Trio	7	■	■	■	■	■	•	■	■	•	■	■	■
Texel	3	■	■	■	■	■	•	■	■	■	■	■	■

Tip: Certain fabrics and leathers appear loose with comfort wrinkles when upholstered.

Wood Color Availability Matrix

Not every wood color is available on every seating component. This matrix gives an overview of which wood colors can be specified for each seating component.

		Species or type of wood	3062 Graphite Walnut	3402 Clear Cherry (Aged)	3412 Natural Cherry E	3422 Medium Cherry	3522 Clear Maple**	3572 Amber on Maple E	3592 Blonde on Maple	3602 Desert Oak	3612 Warm Oak E	3692 Espresso Oak	3702 Clear Walnut	3712 Natural Walnut	3722 Dark Mahogany on Walnut	3752 Medium Walnut	3762 Dark Walnut	3772 Medium Mahogany on Walnut
Alcove	Frame	European Beech	■	■	■	■	•	■	■	■	■	■	■	■	■	■	■	■
Collaboration	Frame and inserts	European Beech	■	■	■	■	■	■	■	■	■	■	■	■	■	■	■	■
Escapade	Frame	European Beech	■	■	■	■	•	■	■	■	■	■	■	■	■	■	■	■
Mingle	Legs, back, and arms	Maple	■	■	■	■	■	■	■	■	■	■	■	■	■	■	■	■
Oriana	Frame	European Beech	■	■	■	■	■	■	■	■	■	■	■	■	■	■	■	■
Sawyer	Frame	European Beech	■	■	■	■	■	■	■	■	■	■	■	■	■	■	■	■
Snodgrass	Frame and arms	Maple	■	■	■	■	■	■	■	■	■	■	■	■	■	■	■	■
Terrazzo	Frame and back slats	European Beech	■	■	■	■	•	■	■	■	■	■	■	■	■	■	■	■
Topaz	Frame and arms	European Beech	■	■	■	■	•	■	■	■	■	■	■	■	■	■	■	■

► Wood Color Availability Matrix, continued

Tip: The wood used in the construction of chairs is either maple or European beech. Wood finishes applied to maple or beech will match the color of stains applied to oak, walnut, or cherry, but will not have the same natural grain. Composite color finishes will match the color of composites on veneered surfaces, but will not have the same grain pattern.

***To ensure an understanding of the color ranges and characteristic variations of natural veneer, a sign-off sheet is required prior to orders being accepted for this clear-coat finish. The sign-off sheet is available through Steelcase advertising stock. Form number 05-0001370*

Tip: 3522 Clear Maple is a clear coat. Therefore, the natural variations in wood (maple or European beech) will be visible.

Tip: Due to natural variations in wood, finish products may vary in color, texture and grain.

Legend

- = Not available
- = Available
- = Available with exceptions
- E** = Established
- See specification guide for details.

Wood Color Availability Matrix, continued

Not every wood color is available on every seating component. This matrix gives an overview of which wood colors can be specified for each seating component.

			Composite Veneers													Natural Veneers				
			Wood Group 1													Wood Group 1				
		Species or type of wood	3F8X QC/OP European Walnut Composite	3GAX QC/OP Gold Teak Composite	3GFX QC/OP Rosewood Composite	3GGX QC/OP Zebrano Composite	3HGX QC/OP Oak Composite	3HVX QC/OP Walnut Composite	3JDX FC/OP Oak Composite	3JEX QC/OP Maple Composite	3JFX FC/OP Maple Composite	3JGX QC/OP Cherry Composite	3JHX FC/OP Cherry Composite	3JLX FC/OP Walnut Composite	3ZNX QC/OP Night Cerused Oak Composite	35A2 FC/OP Blanch Maple	37A2 FC/OP Thunder Walnut	32A2 QC/OP Blanch Maple	33A2 QC/OP Thunder Walnut	36A2 RC/OP Volcanic Oak
Alcove	Frame	European Beech	•	•	•	•	•	•	■	•	■	•	■	■	•	■	■	•	•	•
Collaboration	Frame and inserts	European Beech	•	•	•	•	•	•	■	•	■	•	■	■	•	■	■	•	•	•
Escapade	Frame	European Beech	•	•	•	•	•	•	■	•	■	•	■	■	•	■	■	•	•	•
Mingle	Legs, back, and arms	Maple	•	•	•	•	•	•	■	•	■	•	■	■	•	■	■	•	•	•
Oriana	Frame	European Beech	•	•	•	•	•	•	■	•	■	•	■	■	•	■	■	•	•	•
Sawyer	Frame	European Beech	•	•	•	•	•	•	■	•	■	•	■	■	•	■	■	•	•	•
Snodgrass	Frame and arms	Maple	•	•	•	•	•	•	■	•	■	•	■	■	•	■	■	•	•	•
Terrazzo	Frame and back slats	European Beech	•	•	•	•	•	•	■	•	■	•	■	■	•	■	■	•	•	•
Topaz	Frame and arms	European Beech	•	•	•	•	•	•	■	•	■	•	■	■	•	■	■	•	•	•

Tip: The wood used in the construction of chairs is either maple or European beech. Wood finishes applied to maple or beech will match the color of stains applied to oak, walnut, or cherry, but will not have the same natural grain. Composite color finishes will match the color of composites on veneered surfaces, but will not have the same grain pattern.

Tip: Due to natural variations in wood, finish products may vary in color, texture and grain.

Legend

- = Not available
- = Available
- = Available with exceptions
- ⓔ = Established
- ▶ See specification guide for details.

Guidelines for Directional Fabrics

What is the issue?

Some textiles are plain and look the same regardless of which direction the fabric is applied to the product. But many customers prefer fabrics that have patterns that give a clear direction to the textile. Because there are limits to how directional fabrics can be applied to panels and chairs, it is important to understand directional fabrics to avoid being disappointed.

Talking about direction

Fabrics come on rolls. The long threads that run parallel to the length of the roll are called the warp. The perpendicular threads that run parallel to the width of the roll are called the filling.

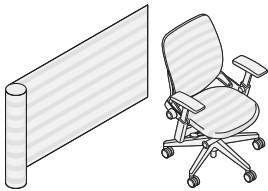

Railroaded means the height dimension of the product is perpendicular to the warp of the fabric; *warp horizontal* and *across roll* are other terms for running the fabric in this direction. All Steelcase standard fabrics are railroaded. The yardage requirements for railroaded cutting are calculated using the width of the fabric, quantity ordered, style of chair(s), and pattern repeat.

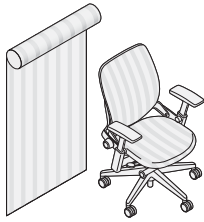

Woven way means the height dimension of the product is parallel to the warp of the fabric; *warp vertical* and *down roll* are other terms for running the fabric in this direction. The yardage requirements for woven way cutting are calculated using the width of the fabric, quantity ordered, and style of chair(s).

What determines fabric direction?

The width of the roll of fabric and the techniques that are used to apply it to the product can both determine the direction. Standard default direction for seating products with Steelcase standard fabrics is railroaded. No exceptions are possible. COM fabrics are standard woven way. You may specify a COM fabric to be cut in a specific direction if the product allows it to be applied. The purchase order must clearly state the cutting direction if it is other than standard.

Tip: If you are changing the cutting direction of fabric, yardage requirements may increase, resulting in an additional upcharge. This upcharge will be applied to the purchase order.

► See *Yardage Requirements* in the *Surface Materials Reference Manual* for specific information.

If you have any questions regarding cutting direction guidelines, please call the Steelcase Solutions Resource Team at 1.888. STEELCASE or 1.888.783.3522. You can also find this information on our website:

- Visit www.steelcase.com

COM pattern exceptions

Sometimes COM fabrics have patterns that look awkward or inappropriate if they are applied in the standard direction (woven way). Those cases are addressed with these two pattern exception rules.



Incorrect

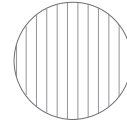

Correct



Incorrect

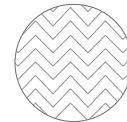

Correct

1

Fabrics with stripes or flame stitch will be applied so that the patterns are vertical.



Incorrect



Correct



Incorrect







Correct

2

Fabrics with patterns of people, vines, or flower arrangements will be applied so that the pattern is vertical.

turnstone 1.0 Seating

	
Statement of Line	576
	
Product Details	
Seating Dimensions	578
Seating Mechanisms and Adjustability Features Defined	583
Adjustability Overview	584
	
Specifying	
Performance Seating	
Crew	586
Jacket	591
à la carte	592
Multipurpose/Guest Seating	
Uno	596
	
Surface Materials	599

This specification guide contains multiple Steelcase and turnstone product lines which are designed into one specification guide for your convenience. Note that each product may be subject to different pricing terms and conditions.

Statement of Line

Crew



Task Chair with Arms
▶ Page 586



Task Chair without Arms
▶ Page 586



Stool with Arms
▶ Page 586

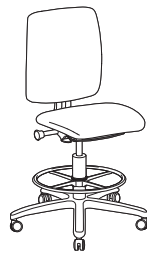

Stool without Arms
▶ Page 586



Guest Chair with Arms
▶ Page 588



Guest Chair without Arms
▶ Page 588

Jacket



Desk Chair
▶ Page 591

à la carte



Mid-Back Task Chair with Modified Round Back
▶ Page 592



Mid-Back Task Chair with Round Back
▶ Page 592



High-Back Task Chair with Round Back
▶ Page 592



Mid-Back Task Chair with Square Back
▶ Page 592



High-Back Task Chair with Square Back
▶ Page 592



Mid-Back Stool with Modified Round Back
▶ Page 592



Mid- or High-Back Stool with Round Back
▶ Page 592

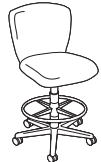

Mid- or High-Back Stool with Square Back
▶ Page 592



Guest Chair with Round Back
▶ Page 594

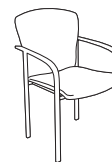

Guest Chair with Square Back
▶ Page 594

Uno



Multi-Purpose
High-Back Chair
▶ Page 596

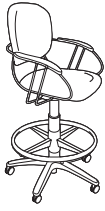

Multi-Purpose
High-Back Stool
▶ Page 596



Multi-Purpose
Mid-Back Chair
▶ Page 596

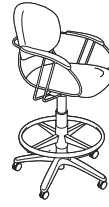

Multi-Purpose
Mid-Back Stool
▶ Page 596

Seating Dimensions

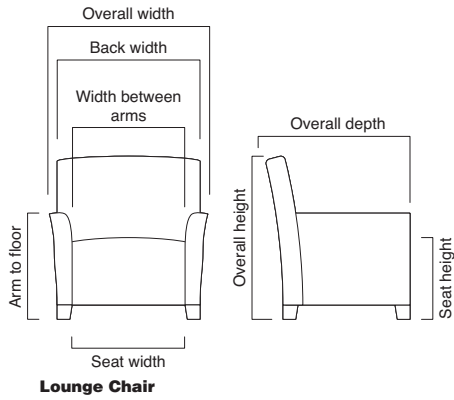
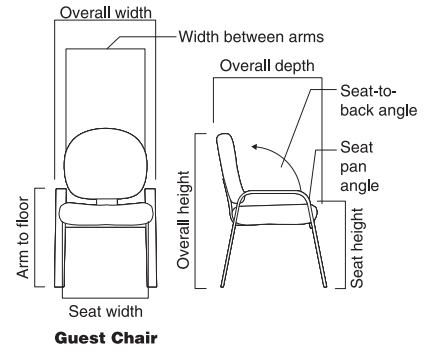
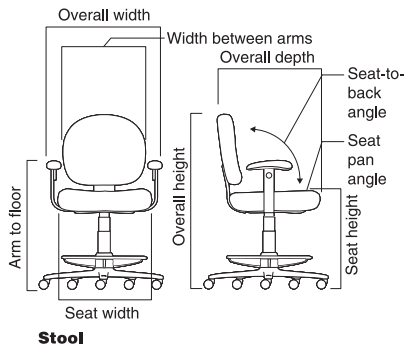
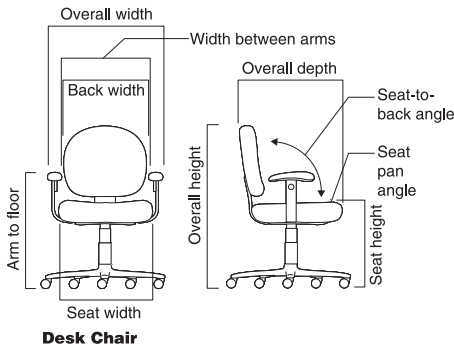

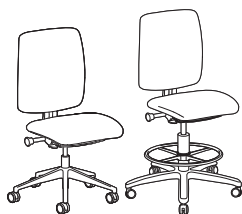

TS30801, TS30802, TS30803
Crew full-back desk chair
Armless

Overall depth	26"
Overall width	26½"
Overall height	39⅝"–44⅝"
Functional seat depth	18"
Functional seat depth on chairs with adjustable seat depth	16⅞"–18⅞"
Seat width	19½"
Seat height from floor	16"–21"
Back width	19"
Back height from seat	21¼"–23½"
Seat pan angle	3°
Angle between seat and back	96°–110°

Stool

Seat height from floor	22¼"–32½"
Foot ring diameter	20"
Foot ring height	8¼"–12"



TS30811, TS30812, TS30813, TS30821, TS30822, TS30823, TS30831, TS30832, TS30833
Crew full-back desk chair
With arms

Overall depth	26"
Overall width	26½"
Overall height	39⅝"–44⅝"
Functional seat depth	18"
Functional seat depth on chairs with adjustable seat depth	16⅞"–18⅞"
Seat width	19½"
Seat height from floor	16"–21"
Back width	19"
Back height from seat	21¼"–23½"
Seat pan angle	3°
Angle between seat and back	96°–110°

Fixed-height T-arms

Width between arms	17¾"–19½"
Arm cap width	3½"
Arm cap length	9"
Arm height from seat	9"

Height- and width-adjustable T-arms

Width between arms	17¾"–19½"
Arm cap width	3½"
Arm cap length	9"
Arm height from seat	7"–11"

Height- and width-adjustable pivot T-arms

Width between arms	12¼"–19½"
Arm cap pivot	35°
Arm cap width	4½"
Arm cap length	10"
Arm height from seat	7"–11"

Stool

Seat height from floor	22¼"–32½"
Foot ring diameter	20"
Foot ring height	8¼"–12"



TS30805, TS30806
Crew guest chair
Armless

Overall depth	24"
Overall width	23"
Overall height	32"
Functional seat depth	18¼"
Seat width	19"
Seat height from floor	18½"
Back width	20"
Back height from seat	15½"

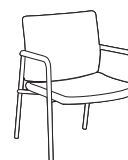

TS30807, TS30808
Crew guest chair
With arms

Overall depth	24"
Overall width	23"
Overall height	32"
Functional seat depth	18¼"
Seat width	19"
Seat height from floor	18½"
Back width	20"
Back height from seat	15½"
Width between arms	20"
Arm rest width	7⅞"
Arm rest length	7⅞"
Arm-to-floor	25"
Arm height from seat	7¼"

Seating Dimensions, continued



TS31301
Jacket desk chair
Synchro-tilt mechanism

Overall depth	25"
Overall width	27"
Overall height	37½"-40½"
Functional seat depth	19"
Seat width	20"
Seat height from floor	17½"-20½"
Back width	21½"
Back height from seat	21½"
Width between arms	20"
Arm cap width	3½"
Arm cap length	9½"
Arm height from seat	7½"-9½"
Arm-to-floor	25"-30"
Angle between seat and back	98°-105°



TS30101
à la carte task chair
Modified round mid-back
Armless
Swivel mechanism

Overall depth	24½"-27"
Overall width	27"
Overall height	32"-39"
Functional seat depth	16½"-18½"
Seat width	20½"
Seat height from floor	15¾"-20¾"
Back width	19¼"
Back height from seat	17"
Seat pan angle	0°
Seat pan angle on chairs with swivel-tilt mechanism	0°-9°
Seat pan angle on chairs with synchro-tilt mechanism	3°-13°
Angle between seat and back	96°
Angle between seat and back on chairs with swivel-tilt mechanism	95°-108°
Angle between seat and back on chairs with synchro-tilt mechanism	95°-115°

Arm Options

Fixed T-arms with curved caps

Width between arms	18¼"-20¾"
Arm cap width	3"
Arm cap length	8"
Arm height from seat	8½"

Height- and width-adjustable T-arms with curved caps

Width between arms	18¼"-20¾"
Arm cap width	3"
Arm cap length	8"
Arm height from seat	7"-10"

Width-adjustable C-arms

Width between arms	18"-20"
Arm cap width	2¼"
Arm cap length	15"
Arm height from seat	8"

Stool Option

Overall height	37"-49"
Seat height from floor	22½"-32½"
Foot ring diameter	20"
Foot ring height	8"-11"



TS30102
à la carte task chair
Round mid-back
Armless
Swivel mechanism

Overall depth	24"-27"
Overall width	27"
Overall height	32"-39"
Functional seat depth	16½"-18½"
Seat width	20½"
Seat height from floor	15¾"-20¾"
Back width	19"
Back height from seat	17"-19"
Seat pan angle	0°
Seat pan angle on chairs with swivel-tilt mechanism	0°-9°
Seat pan angle on chairs with synchro-tilt mechanism	0°-9°
Angle between seat and back	98°
Angle between seat and back on chairs with swivel-tilt mechanism	98°-124°
Angle between seat and back on chairs with synchro-tilt mechanism	100°-134°

Arm Options

Fixed T-arms with curved caps

Width between arms	18"-20½"
Arm cap width	3"
Arm cap length	8"
Arm height from seat	8"

Height- and width-adjustable T-arms with curved caps

Width between arms	18"-20½"
Arm cap width	3"
Arm cap length	8"
Arm height from seat	7"-10"

Width-adjustable C-arms

Width between arms	18"-20½"
Arm cap width	2¼"
Arm cap length	15"
Arm height from seat	8"

Stool Option

Overall height	37"-49"
Seat height from floor	22½"-32½"
Foot ring diameter	20"
Foot ring height	8"-11"



TS30103
à la carte task chair
Round high-back
Armless
Swivel mechanism

Overall depth	24"-27"
Overall width	27"
Overall height	34"-41"
Functional seat depth	16½"-18½"
Seat width	20½"
Seat height from floor	15¾"-20¾"
Back width	19½"
Back height from seat	20"-22"
Seat pan angle	0°
Seat pan angle on chairs with swivel-tilt mechanism	0°-9°
Seat pan angle on chairs with synchro-tilt mechanism	0°-9°
Angle between seat and back	98°
Angle between seat and back on chairs with swivel-tilt mechanism	98°-124°
Angle between seat and back on chairs with synchro-tilt mechanism	100°-134°

Arm Options

Fixed T-arms with curved caps

Width between arms	18"-20½"
Arm cap width	3"
Arm cap length	8"
Arm height from seat	8"

Height- and width-adjustable T-arms with curved caps

Width between arms	18"-20½"
Arm cap width	3"
Arm cap length	8"
Arm height from seat	7"-10"

Width-adjustable C-arms

Width between arms	18"-20½"
Arm cap width	2¼"
Arm cap length	15"
Arm height from seat	8"

Stool Option

Overall height	37"-49"
Seat height from floor	22½"-32½"
Foot ring diameter	20"
Foot ring height	8"-11"



TS30105
à la carte task chair
Square mid-back
Armless
Swivel mechanism

Overall depth	24"-27"
Overall width	27"
Overall height	32"-39"
Functional seat depth	16½"-18½"
Seat width	20½"
Seat height from floor	15¾"-20¾"
Back width	19"
Back height from seat	17"-19"
Seat pan angle	0°
Seat pan angle on chairs with swivel-tilt mechanism	0°-9°
Seat pan angle on chairs with synchro-tilt mechanism	0°-9°
Angle between seat and back	98°
Angle between seat and back on chairs with swivel-tilt mechanism	98°-124°
Angle between seat and back on chairs with synchro-tilt mechanism	100°-134°

Arm Options

Fixed T-arms with curved caps

Width between arms	18"-20½"
Arm cap width	3"
Arm cap length	8"
Arm height from seat	8"

Height- and width-adjustable T-arms with curved caps

Width between arms	18"-20½"
Arm cap width	3"
Arm cap length	8"
Arm height from seat	7"-10"

Width-adjustable C-arms

Width between arms	18"-20½"
Arm cap width	2¼"
Arm cap length	15"
Arm height from seat	8"

Stool Option

Overall height	37"-49"
Seat height from floor	22½"-32½"
Foot ring diameter	20"
Foot ring height	8"-11"

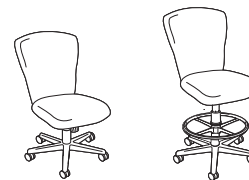

TS30106
à la carte task chair
Square high-back
Armless
Swivel mechanism

Overall depth	24"-27"
Overall width	27"
Overall height	34"-41"
Functional seat depth	16½"-18½"
Seat width	20½"
Seat height from floor	15¾"-20¾"
Back width	20"
Back height from seat	20"-22"
Seat pan angle	0°
Seat pan angle on chairs with swivel-tilt mechanism	0°-9°
Seat pan angle on chairs with synchro-tilt mechanism	0°-9°
Angle between seat and back	98°
Angle between seat and back on chairs with swivel-tilt mechanism	98°-124°
Angle between seat and back on chairs with synchro-tilt mechanism	100°-134°

Arm Options

Fixed T-arms with curved caps

Width between arms	18"-20½"
Arm cap width	3"
Arm cap length	8"
Arm height from seat	8"

Height- and width-adjustable T-arms with curved caps

Width between arms	18"-20½"
Arm cap width	3"
Arm cap length	8"
Arm height from seat	7"-10"

Width-adjustable C-arms

Width between arms	18"-20½"
Arm cap width	2¼"
Arm cap length	15"
Arm height from seat	8"

Stool Option

Overall height	37"-49"
Seat height from floor	22½"-32½"
Foot ring diameter	20"
Foot ring height	8"-11"

Seating Dimensions, continued

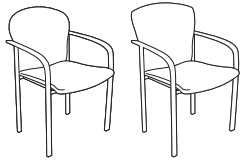

TS30104, TS30107
à la carte guest chair
Mid-back

Overall depth	21"
Overall width	22"
Overall height	32 ³ / ₄ "
Functional seat depth	16 ¹ / ₄ "
Seat width	19"
Seat height from floor	17 ¹ / ₂ "
Back width	19 ¹ / ₄ "
Back height from seat	18"
Width between arms	19 ¹ / ₂ "
Arm-to-floor	25 ¹ / ₂ "
Arm height from seat	7 ³ / ₄ "
Seat pan angle	0°
Angle between seat and back	100°



TS31101
Uno multi-purpose chair
Mid-back

Fixed arms
Swivel mechanism

Overall depth	23"
Overall width	25"
Overall height	31 ¹ / ₂ "–36 ¹ / ₂ "
Functional seat depth	19"
Seat width	18 ¹ / ₄ "
Seat height from floor	15 ¹ / ₂ "–20 ¹ / ₂ "
Back width	17 ¹ / ₂ "
Back height from seat	18"
Width between arms	18 ¹ / ₂ "
Arm cap width	3"
Arm cap length	12"
Arm-to-floor	23"–28"
Arm height from seat	7 ¹ / ₂ "
Seat pan angle	5°
Angle between seat and back	92°

Stool Option

Overall height	37 ¹ / ₂ "–45"
Seat height from floor	23 ¹ / ₂ "–33 ³ / ₄ "
Foot ring diameter	20"
Foot ring height	8 ¹ / ₄ "–12"



TS31102
Uno multi-purpose chair
High-back
Fixed arms
Swivel mechanism

Overall depth	23"
Overall width	25"
Overall height	34 ³ / ₄ "–39 ³ / ₄ "
Functional seat depth	19"
Seat width	18 ¹ / ₄ "
Seat height from floor	15 ¹ / ₂ "–20 ¹ / ₂ "
Back width	18"
Back height from seat	21 ¹ / ₂ "
Width between arms	18 ¹ / ₂ "
Arm cap width	3"
Arm cap length	12"
Arm-to-floor	23"–28"
Arm height from seat	7 ¹ / ₂ "
Seat pan angle	5°
Angle between seat and back	92°

Stool Option

Overall height	41 ¹ / ₂ "–49"
Seat height from floor	23 ¹ / ₂ "–33 ³ / ₄ "
Foot ring diameter	20"
Foot ring height	8 ¹ / ₄ "–12"

Seating Mechanisms and Adjustability Features Defined

Seating Mechanisms



Swivel Mechanism
Chair swivels 360°. Seat and back stay in a fixed position (no recline).



Swivel-Tilt Mechanism
Chair swivels 360°. Back and seat recline in unison.



Synchro-Tilt Mechanism
Chair swivels 360°. Back and seat move together but at different angles. For every 2 degrees of back recline, the seat angle tilts 1 degree.

Adjustability Features



Adjustable Back Height
Allows the user to position the back up or down.



Adjustable Foot Ring
Allows the user to position the stool foot ring up or down.



Adjustable Seat Depth
Allows the user to change the distance between the front edge of the seat and the chair back.



Adjustable Seat Depth via the Back
Allows the user to change the distance between the front edge of the seat and the chair back via the maintenance back adjustment.



Lumbar Height Adjustment
Allows the user to raise or lower the lumbar support.



Pneumatic Height Adjustment
Allows the user to raise or lower the chair with one lever from a seated position.



Seat Angle Adjustment
Allows the user to position and lock the seat angle in a variety of positions.



Tilt Tension
Allows the user to vary the amount of recline resistance.



Upright Back Lock
Allows the user to lock the back in the upright position.



Variable Back Stop
Allows the user to stop the back recline at various points.



Variable Back Lock
Allows the user to locate and lock the back in a variety of positions.

Adjustability Overview

Tip: Your chair may not include all the adjustments shown.

Style Number	Reference Number
TS30801	1
TS30802	1
TS30803	1
TS30811	1
TS30812	1
TS30813	1
TS30821	1
TS30822	1
TS30823	1
TS30831	1
TS30832	1
TS30833	1
TS31301	2
TS31901	7
TS31902	7
à la carte	3
à la carte	Options: 4, 5

1 Crew

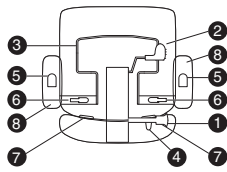

- 1 Tilt tension**
To decrease tension, turn counterclockwise.
To increase tension, turn clockwise.
- 2 Pneumatic height adjustment**
To raise chair, lift body weight up and pull lever up. To lower chair, remain seated and pull lever out.
- 3 Adjustable seat depth**
Lift lever up and hold, shift seat forward or back, and release lever to lock. Available on models TS30802, TS30812, and TS30822 only.
- 4 Upright back lock**
To release, lean forward and flip lever up. To lock, lean forward and flip lever down.
- 5 Arm height**
Pull trigger up and hold, pull arm up or push down, and release trigger.
- 6 Arm width**
Push toggle down to release and adjust arms in or out. Push toggle up to lock.
- 7 Back height**
While seated, pull levers inward, raise or lower back into position, and release lever.
- 8 Height-, width-, and pivot-adjustable arm**
Press button under arm caps to adjust height. Grasp arm caps to slide width in and out, and to pivot.

2 Jacket

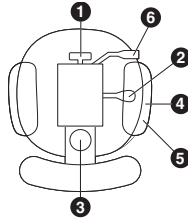

- 1 Tilt tension**
To decrease tension, turn counterclockwise.
To increase tension, turn clockwise.
- 2 Pneumatic height adjustment**
To raise chair, lift body weight up and pull lever up. To lower chair, remain seated and pull lever up.
- 3 Adjustable seat depth via the back**
Loosen bolt, adjust back in or out to desired position, and retighten knob.
- 4 Height-adjustable arms**
To raise arm, lift arm to desired height. To lower arm, lift arm to its highest position and then lower to bottom.
- 5 Maintenance width-adjustable arms**
Loosen screws under arm bracket, adjust arm in or out, tighten screws.
- 6 Upright back lock**
To lock back in upright position, lean forward and push lever back. To release back lock, lean forward and push lever forward.

3 à la carte

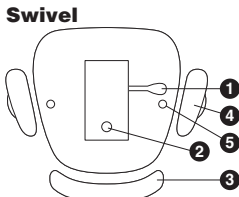

- 1 Pneumatic height adjustment**
To raise chair, lift body weight up and pull lever up. To lower chair, remain seated and pull lever up.
- 2 Seat depth adjustment via the back**
Loosen bolt and adjust back in or out to desired position. Retighten bolt.
- 3 Adjustable back height**
Grab chair back with both hands and slowly pull up to desired height. To lower back, pull up to highest position, and back will drop to lowest position. Reset mechanism by pushing down firmly, then adjust upward.
- 4 Height-adjustable arms**
Squeeze trigger under arm cap and raise or lower arm to desired height. Release trigger.
- 5 Maintenance width-adjustable arms**
Loosen screws under arm bracket, adjust arm in or out, tighten screws.

4 à la carte

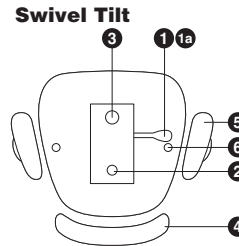

- 1 Pneumatic height adjustment**
To raise chair, lift body weight up and pull lever up. To lower chair, remain seated and pull lever up.
- 1 Upright back lock**
While in the upright position, push the lever in and the chair will not tilt; pull it out and the chair can tilt.
- 2 Seat depth adjustment via the back**
Loosen bolt and adjust back in or out to desired position. Retighten bolt.
- 3 Tilt tension**
To decrease tension, turn counterclockwise.
To increase tension, turn clockwise.
- 4 Adjustable back height**
Grab chair back with both hands and slowly pull up to desired height. To lower back, pull up to highest position, and back will drop to lowest position. Reset mechanism by pushing down firmly, then adjust upward.
- 5 Height-adjustable arms**
Squeeze trigger under arm cap and raise or lower arm to desired height. Release trigger.
- 6 Maintenance width-adjustable arms**
Loosen screws under arm bracket, adjust arm in or out, tighten screws.

5 à la carte

Synchro Tilt

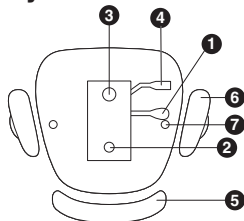

1 Pneumatic height adjustment

To raise chair, lift body weight up and pull lever up. To lower chair, remain seated and pull lever up.

2 Seat depth adjustment via the back

Loosen bolt and adjust back in or out to desired position. Retighten bolt.

3 Tilt tension

To decrease tension, turn counterclockwise.
To increase tension, turn clockwise.

4 Upright back lock

To lock back in upright position, lean forward and push lever back.
To release back lock, lean forward and push lever forward.

5 Adjustable back height

Grab chair back with both hands and slowly pull up to desired height.
To lower back, pull up to highest position, and back will drop to lowest position. Reset mechanism by pushing down firmly, then adjust upward.

6 Height-adjustable arms

Squeeze trigger under arm cap and raise or lower arm to desired height. Release trigger.

7 Maintenance width-adjustable arms

Loosen screws under arm bracket, adjust arm in or out, tighten screws.

Crew

Task Chairs and Stools with Foot Rings



Tip: Hard dual-wheel casters are for use on carpet. Use on hard surfaces, including floor mats, will affect chair stability and may result in personal injury.

Tip: Leather (L suffix) uses a sewn upholstery process on the seat which produces a stitched detail.

Tip: Vinyl specified with a V suffix uses a sewn upholstery process on the seat which produces a stitched detail. Vinyl specified without a suffix is a non-sewn, seamless upholstery.

Tip: Arms, if specified, will match base.

Standard Includes	Required to Specify
<ul style="list-style-type: none"> • Synchro-tilt mechanism • Pneumatic seat height • Upright back lock • Tilt tension • Back height adjustment • Upholstered seat and inner back: fabric price group 1 • Outer back: black plastic • Five-arm base: black plastic • Width-adjustable arms, if arms selected: 0835 Black • Adjustable foot ring on stools only: 9201 Polished Chrome • Hard dual-wheel casters: black • Shipped ready to assemble with no tools required 	<ul style="list-style-type: none"> 1 Style number 2 Fabric color number for upholstery 3 Options, if selected (see below) ▶ See <i>Surface Materials</i>, page 600.

	Options	U.S. Price	Required to Specify
Surface Materials	Upholstery		
	• Fabric price group 1	No cost	Specify fabric color number.
	• Fabric price group 2	+\$ 27	Specify fabric color number.
	• Fabric price group 3	+\$ 49	Specify fabric color number.
	• Fabric price group 4	+\$ 70	Specify fabric color number.
	• Fabric price group 5	+\$ 88	Specify fabric color number.
	• Fabric price group 6	+\$109	Specify fabric color number.
	• Fabric price group 7	+\$125	Specify fabric color number.
	• Fabric price group 8	+\$158	Specify fabric color number.
	• Fabric price group 9	+\$194	Specify fabric color number.
• Fabric price group 10	+\$219	Specify fabric color number.	
• Leather price group	+\$571	Add suffix L to style number and specify leather color number.	
• Sewn Vinyl	+\$108	Add suffix V to style number and specify vinyl color number.	
• Customer's Own Material/Vinyl (COM)	+\$ 38	▶ See <i>Understanding Customer's Own Material (COM)</i> , page 604.	
• Customer's Own Leather (COL)	+\$ 81	Add suffix L to style number and specify leather color number.	
Outer back			
• Upholstered outer back	+\$106	Add suffix U to the style number.	
Base on task chairs			
• Aluminum base: 4799 Platinum	+\$ 62	Specify <i>with 4799 Platinum</i> .	
Casters	• Soft dual-wheel casters for use on hard floors	No cost	Specify <i>with soft casters</i> .
	Glides	• Non-marring plastic glides	+\$ 33

For Canadian Pricing
 Multiply U.S. Price by the Canadian price factor.
 ▶ See page 1 for details.

Specification Information

• **Style**
• **Number**
•
• **U.S.**
• **Base**
• **Price**



Tip: Arms, if specified, will match base.

Full-Back Task Chairs

Armless

TS30801 \$ 656

With Fixed-Height T-Arms

TS30811 \$ 752

With Height- and Width-Adjustable T-Arms

TS30821 \$ 791

With Height-, Width-, and Pivot-Adjustable Arms

TS30831 \$ 860



Tip: Arms, if specified, will match base.

Full-Back Task Chairs with Seat Depth

Armless

TS30802 \$ 728

With Fixed-Height T-Arms

TS30812 \$ 824

With Height- and Width-Adjustable T-Arms

TS30822 \$ 863

With Height-, Width-, and Pivot-Adjustable Arms

TS30832 \$ 932

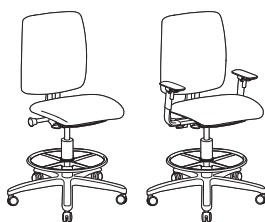

Tip: Arms and base available in black only.

Full-Back Task Stools

Armless

TS30803 \$ 825

With Fixed-Height T-Arms

TS30813 \$ 921

With Height- and Width-Adjustable T-Arms

TS30823 \$ 960

With Height-, Width-, and Pivot-Adjustable Arms

TS30833 \$1029

turnstone 1.0

For Canadian Pricing
Multiply U.S. Price by the Canadian price factor.
▶ See page 1 for details.

Guest Chairs



Tip: Hard dual-wheel casters are for use on carpet. Use on hard surfaces, including floor mats, will affect chair stability and may result in personal injury.

*Tip: When specifying wood back and leather seat, specify suffix **W** before suffix **L**. Example: TS30805WL.*

*Tip: When specifying wood back and vinyl seat, specify suffix **W** before suffix **V**. Example: TS30806WV.*

Standard Includes	Required to Specify
<ul style="list-style-type: none"> Upholstered seat and back: fabric price group 1 Steel four-leg frame: 7207 Black Hard dual-wheel casters or glides: black Shipped fully assembled Stacks four high 	<ul style="list-style-type: none"> 1 Style number 2 Fabric color number for upholstery 3 Options, if selected (see below) ▶ See <i>Surface Materials</i>, page 600.

Surface Materials	Options	U.S. Price	Required to Specify
	Single upholstery fabric		
	• Fabric price group 1	No cost	Specify fabric color number.
	• Fabric price group 2	+\$ 27	Specify fabric color number.
	• Fabric price group 3	+\$ 49	Specify fabric color number.
	• Fabric price group 4	+\$ 70	Specify fabric color number.
	• Fabric price group 5	+\$ 88	Specify fabric color number.
	• Fabric price group 6	+\$109	Specify fabric color number.
	• Fabric price group 7	+\$125	Specify fabric color number.
	• Fabric price group 8	+\$158	Specify fabric color number.
	• Fabric price group 9	+\$194	Specify fabric color number.
	• Fabric price group 10	+\$219	Specify fabric color number.
	• Leather price group	+\$475	Specify fabric color number. Add suffix L to style number and specify leather color number.
	• Vinyl	+\$ 27	Add suffix V to style number and specify vinyl color number.
	• Customer's Own Material/Vinyl (COM)	+\$ 38	▶ See <i>Understanding Customer's Own Material (COM)</i> , page 604.
	Upholstery on chair with wood back		
	• Fabric price group 1	No cost	Specify fabric color number.
	• Fabric price group 2	+\$ 10	Specify fabric color number.
	• Fabric price group 3	+\$ 27	Specify fabric color number.
	• Fabric price group 4	+\$ 36	Specify fabric color number.
	• Fabric price group 5	+\$ 43	Specify fabric color number.
	• Fabric price group 6	+\$ 53	Specify fabric color number.
	• Fabric price group 7	+\$ 64	Specify fabric color number.
	• Fabric price group 8	+\$ 79	Specify fabric color number.
	• Fabric price group 9	+\$ 97	Specify fabric color number.
	• Fabric price group 10	+\$112	Specify fabric color number.
	• Leather price group	+\$169	Specify fabric color number. Add suffix L to style number and specify leather color number.
	• Vinyl	+\$ 10	Add suffix V to style number and specify vinyl color number.
	• Customer's Own Material/Vinyl (COM)	+\$ 38	▶ See <i>Understanding Customer's Own Material (COM)</i> , page 604.

▶ **Options, continued on next page**



For Canadian Pricing

Multiply U.S. Price by the Canadian price factor.

▶ See page 1 for details.

► Options, continued from previous page

	Options	U.S. Price	Required to Specify
Surface Materials (continued)	Multiple upholstery fabric		
	• Different fabric on seat and back ► See below and at right.	+\$ 68	Add suffix M to chair style number and select fabric color number for: ① Seat ② Back <i>Example: TS30805M with T015 on seat and T016 on back.</i>
	① Fabric on seat		Specify fabric color number.
	• Fabric price group 1	No cost	Specify fabric color number.
	• Fabric price group 2	+\$ 10	Specify fabric color number.
	• Fabric price group 3	+\$ 27	Specify fabric color number.
	• Fabric price group 4	+\$ 36	Specify fabric color number.
	• Fabric price group 5	+\$ 43	Specify fabric color number.
	• Fabric price group 6	+\$ 53	Specify fabric color number.
	• Fabric price group 7	+\$ 64	Specify fabric color number.
	• Fabric price group 8	+\$ 79	Specify fabric color number.
	• Fabric price group 9	+\$ 97	Specify fabric color number.
	• Fabric price group 10	+\$112	Specify fabric color number.
	• Customer's Own Material (COM)	+\$ 38	► See <i>Understanding Customer's Own Material (COM)</i> , page 604.
	② Fabric on back		Specify fabric color number.
	• Fabric price group 1	No cost	Specify fabric color number.
	• Fabric price group 2	+\$ 10	Specify fabric color number.
	• Fabric price group 3	+\$ 27	Specify fabric color number.
	• Fabric price group 4	+\$ 36	Specify fabric color number.
	• Fabric price group 5	+\$ 43	Specify fabric color number.
	• Fabric price group 6	+\$ 53	Specify fabric color number.
	• Fabric price group 7	+\$ 64	Specify fabric color number.
	• Fabric price group 8	+\$ 79	Specify fabric color number.
	• Fabric price group 9	+\$ 97	Specify fabric color number.
	• Fabric price group 10	+\$112	Specify fabric color number.
	• Customer's Own Material (COM)	+\$ 38	► See <i>Understanding Customer's Own Material (COM)</i> , page 604.
	Frame		
	• Steel frame: 4799 Platinum	+\$ 30	Specify <i>with 4799 Platinum</i> .
	Back		
	• Wood back	+\$129	Add suffix W to style number and specify wood color number.
	Caster		
	• Soft dual-wheel casters for use on hard floors	No cost	Specify <i>with soft casters</i> .

Tip: Arms, if specified, will match frame.

► Specification Information, on next page

**For Canadian Pricing**

Multiply U.S. Price by the Canadian price factor.

► See page 1 for details.

► Options, on previous page

Specification Information

• Style • Number • •	• U.S. • Base • Price •
-------------------------------	----------------------------------

Armless Guest Chairs

With Glides

TS30805 \$408

With Casters

TS30806 \$444

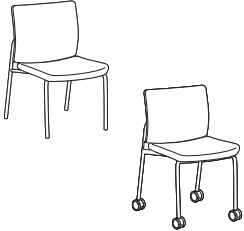

Guest Chairs with Arms

With Glides

TS30807 \$455

With Casters

TS30808 \$491

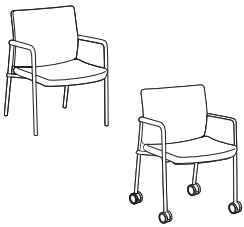

For Canadian Pricing
 Multiply U.S. Price by the
 Canadian price factor.
 ► See page 1 for details.

Desk Chair X4/19



Tip: Jacket cover on back is removable. Additional covers can be ordered separately.
▶ See below.

Tip: Hard dual-wheel casters are for use on carpet. Use on hard surfaces, including floor mats, will affect chair stability and may result in personal injury.

Standard Includes	Required to Specify
<ul style="list-style-type: none"> • Synchro-tilt mechanism • Pneumatic height adjustment • Tilt tension • Adjustable seat depth via the back • Height- and maintenance width-adjustable arms • Leather chair • Five-arm base: reinforced black plastic • Hard dual-wheel casters: black • Shipped ready to assemble • Meets Cal. 116 and 117 requirements 	<ol style="list-style-type: none"> 1 Style number 2 Upholstery color number for seat: L305 Brown Leather T802 Black Leather T803 Port Leather 3 Upholstery color number for back: L305 Brown Leather T802 Black Leather T803 Port Leather 4 Options, if selected (see below)

Options	U.S. Price	Required to Specify
Surface Materials Upholstery <ul style="list-style-type: none"> • Customer's Own Material (COM) on seat • Customer's Own Material (COM) on back 	<ul style="list-style-type: none"> +\$ 16 +\$ 16 	<ul style="list-style-type: none"> ▶ See <i>Understanding Customer's Own Material (COM)</i>, page 604. ▶ See <i>Understanding Customer's Own Material (COM)</i>, page 604.
Base <ul style="list-style-type: none"> • Polished Aluminum base 	+\$149	Specify with Polished Aluminum base.
Casters <ul style="list-style-type: none"> • Soft dual-wheel casters for use on hard floors 	No cost	Specify with soft casters.

Specification Information	
Style Number	U.S. Base Price
TS31301 X4/19	\$1007

Jacket Cover X4/19



Standard Includes	Required to Specify
<ul style="list-style-type: none"> • Removable back slip-cover • Meets Cal. 116 and 117 requirements 	<ol style="list-style-type: none"> 1 Style number 2 Upholstery color number for back: L305 Brown Leather T802 Black Leather T803 Port Leather 3 Options, if selected (see below)

Options	U.S. Price	Required to Specify
Surface Materials Upholstery <ul style="list-style-type: none"> • Customer's Own Material (COM) on back 	+\$16	▶ See <i>Understanding Customer's Own Material (COM)</i> , page 604.

Specification Information	
Style Number	U.S. Base Price
TS31302 X4/19	\$183

 **For Canadian Pricing**
Multiply U.S. Price by the Canadian price factor.
▶ See page 1 for details.

X 4/19 = Last order entry
April 14, 2019
Steelcase
August 2018

Task Chairs **T**



Tip: Arms are not included with à la carte chairs unless you specify one of the arm options.

Tip: Hard dual-wheel casters are for use on carpet. Use on hard surfaces, including floor mats, will affect chair stability and may result in personal injury.

Tip: Bolt under seat allows for adjustable seat depth via the back.

Tip: When specifying multiple COM fabrics, indicate all surfaces where COM applies.

Example: TS30101M with Designtex 1234 on seat and Designtex 5678 on back

Standard Includes **Required to Specify**

- Swivel mechanism
- Pneumatic height adjustment
- Adjustable seat depth via the back
- Upholstered seat, back, and outer back: fabric price group 1
- Five-arm base: reinforced black plastic
- Hard dual-wheel casters: black
- Shipped ready to assemble

- 1 Style number
- 2 Fabric color number for upholstery
- 3 Options, if selected (see below)
- ▶ See *Surface Materials*, page 600.

Options **U.S. Price** **Required to Specify**

Surface Materials

Single upholstery fabric

- Fabric price group 1 No cost
- Fabric price group 2 +\$ 27
- Fabric price group 3 +\$ 49
- Fabric price group 4 +\$ 70
- Fabric price group 5 +\$ 88
- Fabric price group 6 +\$109
- Fabric price group 7 +\$125
- Fabric price group 8 +\$158
- Fabric price group 9 +\$194
- Fabric price group 10 +\$219
- Customer's Own Material (COM) +\$ 38

- Specify fabric color number.
- Specify fabric color number.
- Specify fabric color number.
- Specify fabric color number.
- Specify fabric color number.
- Specify fabric color number.
- Specify fabric color number.
- Specify fabric color number.
- Specify fabric color number.
- Specify fabric color number.
- ▶ See *Understanding Customer's Own Material (COM)*, page 604.

Multiple upholstery fabrics

- Different fabric on seat and back +\$ 68
- ▶ See below.

- Add suffix **M** to chair style number and select fabric color number for:
- 1 Seat
- 2 Back
- Example: TS30101M with T015 on seat and T016 on back.

1 Fabric on seat

- Fabric price group 1 No cost
- Fabric price group 2 +\$ 10
- Fabric price group 3 +\$ 27
- Fabric price group 4 +\$ 36
- Fabric price group 5 +\$ 43
- Fabric price group 6 +\$ 53
- Fabric price group 7 +\$ 64
- Fabric price group 8 +\$ 79
- Fabric price group 9 +\$ 97
- Fabric price group 10 +\$112
- Customer's Own Material (COM) +\$ 16

- Specify fabric color number.
- Specify fabric color number.
- Specify fabric color number.
- Specify fabric color number.
- Specify fabric color number.
- Specify fabric color number.
- Specify fabric color number.
- Specify fabric color number.
- Specify fabric color number.
- Specify fabric color number.
- ▶ See *Understanding Customer's Own Material (COM)*, page 604.

2 Fabric on back

- Fabric price group 1 No cost
- Fabric price group 2 +\$ 10
- Fabric price group 3 +\$ 27
- Fabric price group 4 +\$ 36
- Fabric price group 5 +\$ 43
- Fabric price group 6 +\$ 53
- Fabric price group 7 +\$ 64
- Fabric price group 8 +\$ 79
- Fabric price group 9 +\$ 97
- Fabric price group 10 +\$112
- Customer's Own Material (COM) +\$ 16

- Specify fabric color number.
- Specify fabric color number.
- Specify fabric color number.
- Specify fabric color number.
- Specify fabric color number.
- Specify fabric color number.
- Specify fabric color number.
- Specify fabric color number.
- Specify fabric color number.
- Specify fabric color number.
- ▶ See *Understanding Customer's Own Material (COM)*, page 604.

▶ **Options, continued on next page**





For Canadian Pricing

Multiply U.S. Price by the Canadian price factor.

▶ See page 1 for details.

T = Transitional product

► Options, continued from previous page

Options	U.S. Price	Required to Specify
Adjustable Back Height • Adjustable back height on chair without modified backs	+\$ 50	Specify with adjustable back height.
Seating Mechanism • Swivel-tilt: tilt, tilt tension, and upright back lock • Synchro-tilt: tilt, tilt tension, and upright back lock	+\$ 83 +\$164	Specify with swivel-tilt. Specify with synchro-tilt.
Fixed T-Arms  Curved • Curved arm caps: black only	+\$ 97	Specify with fixed T-arms with curved arm caps.
Height- and Maintenance Width-Adjustable T-Arms  Curved • Curved arm caps: black only	+\$149	Specify with height- and width-adjustable with curved arm caps.
Maintenance Width-Adjustable C-Arms • Width-adjustable C-arms: black only	+\$139	Specify with width-adjustable C-arms.
Stool Kit • Stool kit available on chairs with standard swivel mechanism only. Not available on chairs with optional seating mechanisms. Includes taller pneumatic height and chrome foot ring.	+\$167	Specify with stool kit.
Casters • Soft, dual-wheel casters for use on hard floors	No cost	Specify with soft casters.
Glides • Non-marring plastic glides	No cost	Specify with glides.

Arm Options

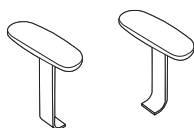

Fixed T-arms

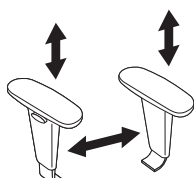

Height- and width-adjustable T-arms

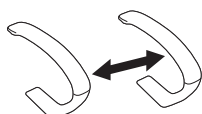

Width-adjustable C-arms

Tip: Adjustable back height option is not available on TS30101.



Specification Information

Style Number	U.S. Base Price
.....

Modified Round-Back Task Chair

Mid-Back

TS30101  \$356

Round-Back Task Chairs

Mid-Back

TS30102  \$372

High-Back

TS30103  \$458

Square-Back Task Chairs

Mid-Back

TS30105  \$372

High-Back

TS30106  \$458

 = Transitional product

Guest Chairs 



Standard Includes **Required to Specify**

- Mid-back
- Steel four-leg frame with open arms: 7207 Black
- Upholstered seat, back, and outer back: fabric price group 1
- Glides: plastic
- Shipped fully assembled
- Chairs can stack four high

- 1 Style number
- 2 Fabric color number for upholstery
- 3 Options, if selected (see below)
- ▶ See *Surface Materials*, page 600.

Options **U.S. Price** **Required to Specify**

Surface Materials

Single upholstery fabric

- | | |
|---------------------------------|---------|
| • Fabric price group 1 | No cost |
| • Fabric price group 2 | +\$ 27 |
| • Fabric price group 3 | +\$ 49 |
| • Fabric price group 4 | +\$ 70 |
| • Fabric price group 5 | +\$ 88 |
| • Fabric price group 6 | +\$109 |
| • Fabric price group 7 | +\$125 |
| • Fabric price group 8 | +\$158 |
| • Fabric price group 9 | +\$194 |
| • Fabric price group 10 | +\$219 |
| • Customer's Own Material (COM) | +\$ 38 |

- Specify fabric color number.
- Specify fabric color number.
- Specify fabric color number.
- Specify fabric color number.
- Specify fabric color number.
- Specify fabric color number.
- Specify fabric color number.
- Specify fabric color number.
- Specify fabric color number.
- Specify fabric color number.
- ▶ See *Understanding Customer's Own Material (COM)*, page 604.

Multiple upholstery fabrics

- Different fabric on seat and back +\$ 68
- ▶ See below.

- Add suffix **M** to chair style number and select fabric color number for:
- 1 Seat
- 2 Back
- Example: TS30104M with T015 on seat and T016 on back.*

1 Fabric on seat

- | | |
|---------------------------------|---------|
| • Fabric price group 1 | No cost |
| • Fabric price group 2 | +\$ 10 |
| • Fabric price group 3 | +\$ 27 |
| • Fabric price group 4 | +\$ 36 |
| • Fabric price group 5 | +\$ 43 |
| • Fabric price group 6 | +\$ 53 |
| • Fabric price group 7 | +\$ 64 |
| • Fabric price group 8 | +\$ 79 |
| • Fabric price group 9 | +\$ 97 |
| • Fabric price group 10 | +\$112 |
| • Customer's Own Material (COM) | +\$ 16 |

- Specify fabric color number.
- Specify fabric color number.
- Specify fabric color number.
- Specify fabric color number.
- Specify fabric color number.
- Specify fabric color number.
- Specify fabric color number.
- Specify fabric color number.
- Specify fabric color number.
- Specify fabric color number.
- ▶ See *Understanding Customer's Own Material (COM)*, page 604.

2 Fabric on back

- | | |
|---------------------------------|---------|
| • Fabric price group 1 | No cost |
| • Fabric price group 2 | +\$ 10 |
| • Fabric price group 3 | +\$ 27 |
| • Fabric price group 4 | +\$ 36 |
| • Fabric price group 5 | +\$ 43 |
| • Fabric price group 6 | +\$ 53 |
| • Fabric price group 7 | +\$ 64 |
| • Fabric price group 8 | +\$ 79 |
| • Fabric price group 9 | +\$ 97 |
| • Fabric price group 10 | +\$112 |
| • Customer's Own Material (COM) | +\$ 16 |

- Specify fabric color number.
- Specify fabric color number.
- Specify fabric color number.
- Specify fabric color number.
- Specify fabric color number.
- Specify fabric color number.
- Specify fabric color number.
- Specify fabric color number.
- Specify fabric color number.
- Specify fabric color number.
- ▶ See *Understanding Customer's Own Material (COM)*, page 604.

Tip: When specifying multiple COM fabrics, indicate all surfaces where COM applies.
Example: TS30104M with Designtex 1234 on seat and Designtex 5678 on back

For Canadian Pricing
 Multiply U.S. Price by the Canadian price factor.
 ▶ See page 1 for details.

 = Transitional product

Specification Information

• Style • Number	• U.S. • Base • Price



Round-Back Guest Chair

TS30104  \$390



Square-Back Chair

TS30107  \$390



For Canadian Pricing

Multiply U.S. Price by the Canadian price factor.

▶ See page 1 for details.

 = Transitional product

Uno

Multi-Purpose Chairs



Tip: Frame is available in black only.

Tip: Hard dual-wheel casters are for use on carpet. Use on hard surfaces, including floor mats, will affect chair stability and may result in personal injury.

Tip: When specifying multiple COM fabrics, indicate all surfaces where COM applies.
Example: TS31101M with Designtex 1234 on seat and Designtex 5678 on back

Standard Includes	Required to Specify
<ul style="list-style-type: none"> Hammock-style support Swivel mechanism Pneumatic height adjustment Upholstered seat and back: fabric price group 1 Outer back: black plastic Five-arm base: reinforced black plastic Hard dual-wheel casters: black Stool ring, if selected: black paint Shipped ready to assemble with no tools required 	<ul style="list-style-type: none"> 1 Style number 2 Fabric color number for upholstery 3 Options, if selected (see below) ▶ See <i>Surface Materials</i>, page 600.

Surface Materials	Options	U.S. Price	Required to Specify
	Single upholstery fabric		
	<ul style="list-style-type: none"> Fabric price group 1 Fabric price group 2 Fabric price group 3 Fabric price group 4 Fabric price group 5 Fabric price group 6 Fabric price group 7 Fabric price group 8 Fabric price group 9 Fabric price group 10 Leather price group Customer's Own Material (COM) Customer's Own Leather (COL) 	<ul style="list-style-type: none"> No cost +\$ 27 +\$ 49 +\$ 70 +\$ 88 +\$109 +\$125 +\$158 +\$194 +\$219 +\$283 +\$ 38 +\$ 64 	<ul style="list-style-type: none"> Specify fabric color number. Specify fabric color number. Specify fabric color number. Specify fabric color number. Specify fabric color number. Specify fabric color number. Specify fabric color number. Specify fabric color number. Specify fabric color number. Specify fabric color number. Specify fabric color number. Specify leather color number. ▶ See <i>Understanding Customer's Own Material (COM)</i>, page 604. Specify leather color number.

	Multiple upholstery fabric		
	<ul style="list-style-type: none"> Different fabric on seat and back 	<ul style="list-style-type: none"> +\$ 68 	<ul style="list-style-type: none"> Add suffix M to chair style number and select fabric color number for: ① Seat ② Back Example: TS31101M with T015 on seat and T016 on back. Specify fabric color number. Specify fabric color number. Specify fabric color number. Specify fabric color number. Specify fabric color number. Specify fabric color number. Specify fabric color number. Specify fabric color number. Specify fabric color number. Specify fabric color number. Specify leather color number. ▶ See <i>Understanding Customer's Own Material (COM)</i>, page 604. Specify leather color number.
	<ul style="list-style-type: none"> ① Fabric on seat Fabric price group 1 Fabric price group 2 Fabric price group 3 Fabric price group 4 Fabric price group 5 Fabric price group 6 Fabric price group 7 Fabric price group 8 Fabric price group 9 Fabric price group 10 Leather price group Customer's Own Material (COM) Customer's Own Leather (COL) 	<ul style="list-style-type: none"> No cost +\$ 10 +\$ 27 +\$ 36 +\$ 43 +\$ 53 +\$ 64 +\$ 79 +\$ 97 +\$112 +\$142 +\$ 16 +\$ 33 	

▶ Options, continued on next page



For Canadian Pricing
Multiply U.S. Price by the Canadian price factor.
▶ See page 1 for details.

► Options, continued from previous page

Options	U.S. Price	Required to Specify	
Surface Materials (continued)	② Fabric on back <ul style="list-style-type: none"> Fabric price group 1 Fabric price group 2 Fabric price group 3 Fabric price group 4 Fabric price group 5 Fabric price group 6 Fabric price group 7 Fabric price group 8 Fabric price group 9 Fabric price group 10 Leather price group Customer's Own Material (COM) Customer's Own Leather (COL) 	No cost +\$ 10 +\$ 27 +\$ 36 +\$ 43 +\$ 53 +\$ 64 +\$ 79 +\$ 97 +\$112 +\$142 +\$ 16 +\$ 33	Specify fabric color number. Specify fabric color number. Specify fabric color number. Specify fabric color number. Specify fabric color number. Specify fabric color number. Specify fabric color number. Specify fabric color number. Specify fabric color number. Specify fabric color number. Specify fabric color number. Specify leather color number. ► See <i>Understanding Customer's Own Material (COM)</i> , page 604. Specify leather color number.
Stool Kit	<ul style="list-style-type: none"> Stool kit with swivel mechanism 	+\$207	Specify <i>with stool kit</i> .
Casters	<ul style="list-style-type: none"> Soft dual-wheel casters for use on hard floors 	No cost	Specify <i>with soft casters</i> .
Glides	<ul style="list-style-type: none"> Non-marring plastic glides 	+\$ 33	Specify <i>with glides</i> .

Specification Information

Style Number	U.S. Base Price

Mid-Back Multi-Purpose Chair

TS31101 \$576



High-Back Multi-Purpose Chair

TS31102 \$670



turnstone 1.0

 **For Canadian Pricing**
 Multiply U.S. Price by the Canadian price factor.
 ► See page 1 for details.

turnstone 1.0

Surface Materials

Surface Materials	600
Seating Upholstery Matrix	602
Understanding Customer's Own Material (COM)	604
Maintenance and Cleaning	606

Surface Materials

Paint

Steelcase Surfaces

Applies to:

- Crew guest chair

7207 Black

Applies to:

- Crew arms

0835 Black **E**

Applies to:

- Crew base, arms, and frame

4799 Platinum Metallic

Plastic

Steelcase Surfaces

Applies to:

- Crew task chair outer back and base

6205 Black

Wood

Steelcase Surfaces

Applies to:

- Crew guest wood back

3412 Natural Cherry **E**
3522 Clear Maple
3762 Dark Walnut

Tip: Due to natural variations in wood, finished products may vary in color, texture and grain.

Tip: Established finishes are available for delivery in 15 business days.

E = Established

Upholstery

Not every upholstery is available on every chair.
▶ Refer to the *Steelcase Upholstery Matrix* on page 514 before specifying.

Steelcase Surfaces

Price Group 1

Buzz2

5F01 Camel **E**
5F03 Tomato
5F04 Red **E**
5F05 Burgundy
5F06 Sky **E**
5F07 Blue
5F08 Navy
5F10 Grape **E**
5F11 Eggplant **E**
5F15 Stone
5F16 Grey
5F17 Black
5G50 Dunegrass
5G51 Sable
5G52 Barley
5G53 Sunrise
5G54 Carrot
5G55 Pumpkin
5G56 Timber
5G57 Rouge
5G58 Chocolate
5G59 Meadow
5G60 Ivy
5G61 Cyan
5G62 Atlantic
5G63 Crocus
5G64 Alpine
5G65 Tornado

Jacks

5B61 Taupe **E**
5B63 Camel **E**
5B64 Pewter **E**
5B70 Midnight **E**

Link

5A20 Burgundy
5A23 Green
5A24 Blue
5A25 Navy
5A26 Purple
5A27 Black
5A28 Ocean
5A30 Chamois

New Black

5J10 New Black: Bruce
5J11 New Black: Henry
Tip: New Black upholstery has color numbers in both price group 1 and price group 2.

Playground **E**

5F28 Claret
5F29 Chile
5F30 Amber
5F31 Nut
5F32 Blade
5F33 Stone
5F34 Sky
5F35 Navy
5F36 Huckleberry
5F37 Charcoal

Price Group 2

Chainmail

5550 Cotton
5551 Space
5552 Silver Dollar
5553 Volcano
5554 Orange Crush
5555 Tricycle
5556 Geranium
5557 Banana
5558 Margarita
5559 Lagoon

Cogent: Connect

5S15 Coconut
5S16 Turmeric/Honey
5S17 Tangerine
5S18 Scarlet
5S19 Concord
5S20 Maya Blue
5S21 Blue Jay
5S23 Wasabi
5S24 Nickel
5S25 Graphite
5S26 Licorice
5S27 Malt
5S28 Root Beer
5S93 Blueprint
5S94 Lizard/Jungle
5S95 Sailor
5S96 Quicksilver
5S97 Nugget
5S98 Canary
5S99 Lipstick/Merlot
5SD0 Royal Blue
5SD1 Aubergine
5SD2 Peacock
5SD3 Lagoon
5SD4 Saffron

Cogent: Geode Vertical **E**

5S38 Oyster
5S41 Sesame

Cogent: Trails

5S29 Bronzite
5S85 Agate
5S86 Lapis
5S87 Malachite
5S88 Quartz
5S90 Tiger Eye
5S91 Travertine
5S92 Topaz

New Black

5J08 New Black: Jack
5J09 New Black: James
5J12 New Black: Harley
Tip: New Black upholstery has color numbers in both price group 1 and price group 2.

Nitelights

5F58 Hazelnut
5F61 Earth
5F62 Shore
5F63 Moss
5F65 Regal Blue
5F66 Stone
5F67 Moon

Seating Vinyl **E**

5801 Topaz
5805 Foggy Night
5809 Black
5810 Forest
5812 Navy
5813 Currant
5814 Leaf
5815 Seaside
5817 Pebble
5818 Spice
5819 Thistle
5820 Coffee
5822 Iris

Spyder

5B01 Foggy Night **E**
5B04 Peri **E**

Stand In

5621 Sleet
5622 Lunar
5623 Cyclone
5624 Eclipse
5625 Powder
5626 Chardonnay
5627 Graham
5628 Sediment
5629 Allspice
5630 Apple
5631 Lava
5632 Cayenne
5633 Plantain
5634 Parsley
5635 Scallion
5636 Atlantis
5691 Orca
5740 Burlap
5741 Porter
5742 Tusk
5743 Putty
5744 Blueberry
5745 Chartreuse
5746 Mango
5747 Sedona
5748 Juniper
5749 Peanut

Price Group 3

Billiard Multi-Use

by Designtex

5H10 Bone
5H11 Poppy
5H12 Tangelo
5H13 Citron
5H14 Avocado
5H15 Hunter
5H16 Indigo
5H17 Mallard
5H18 Teak
5H19 Cumulus
5H20 Pewter
5H21 Gunmetal
5H22 Ink

Gaja — Cradle to Cradle Certified™ Silver

5W40 Black
5W41 Pepper
5W42 Pearl Grey
5W43 Crimson
5W44 Ink
5W45 Night Blue
5W46 Petrol
5W47 Greige
5W48 Sepia
5W49 Umber
5W50 Java
5W51 Camellia Red
5W52 Emerald
5W53 Snow Pea
5W54 Olive
5W55 Light Blue
5W56 Maroon
5W57 Black Raspberry
5W58 Spruce
5W59 Apple Green
5W60 Deep Blue
5W61 Chili Pepper
5W62 Daffodil

Imperma

TM01 Toffee
TM02 Pigeon
TM03 Fossil
TM04 Poppyseed
TM05 Auburn
TM06 Cumin
TM07 Marble
TM08 Cliff
TM09 Tarragon
TM10 Pesto
TM11 Wave
TM12 Niagara
TM13 Tuscan
TM14 Peppercorn

Redeem

TM50 Brick
 TM51 Yolk
 TM52 Cinnamon
 TM53 Daisy
 TM54 Pine
 TM55 Water
 TM56 Dill
 TM57 Lavender
 TM58 Mallard
 TM59 Caramel
 TM60 Greyhound
 TM61 Mocha
 TM62 Iceberg
 TM63 Chestnut
 TM64 Granite
 TM65 Cashmere
 TM66 Barnwood

Retrieve

TM30 Kelly
 TM31 Lake
 TM32 Gala
 TM33 Papaya
 TM34 Dandelion
 TM35 Curry
 TM36 Lilac
 TM37 Submarine
 TM38 Driftwood
 TM39 Bistro
 TM40 Quarry
 TM41 Mohair
 TM42 Shadow
 TM43 Seal
 TM44 Chalk

Texel

TM20 Angora
 TM21 Grist
 TM22 Galaxy
 TM23 Terracotta
 TM24 Nude
 TM25 Field
 TM26 Haze

Price Group 5**Bo Peep**

5G66 Pita
 5G67 Bone
 5G68 Safari
 5G69 Brown Sugar
 5G70 Chocolate Chip
 5G71 Candlelight
 5G72 Honey Mustard
 5G73 Marmalade
 5G74 Picnic
 5G75 Pinot
 5G76 Bloom
 5G77 Grapevine
 5G78 Firefly
 5G79 Artichoke
 5G80 Serpent
 5G81 Carolina
 5G82 Blue Bonnet
 5G83 Nautical
 5G84 Gravel
 5G85 Sharkskin
 5G86 Kohl

Remix

RE01 Rust
 RE02 Pumpkin
 RE03 Pebble
 RE04 Dark Chocolate
 RE05 Beige
 RE06 Linen Beige
 RE07 Hazelnut
 RE08 Concrete Grey
 RE09 Sky Blue
 RE10 Blue Jean
 RE11 Ivy Green
 RE12 Primavera Yellow
 RE13 Night Blue

Silk

5L30 Butterscotch
 5L31 Dijon
 5L32 Seaweed
 5L33 Boysenberry
 5L34 Vermillion
 5L35 Marina
 5L36 Heather Blue
 5L37 Blue Raspberry
 5L38 Cauldron
 5L39 Flaxen

Price Group 6**Brisa**

BR01 Black Onyx
 BR04 Truffle
 BR06 Ash
 BR07 Sage
 BR08 Celery
 BR09 Sterling Blue
 BR10 Night Navy
 BR11 Cambridge Blue
 BR12 Abyss
 BR13 Canyon
 BR14 Pompeian Red
 BR15 Salsa
 BR16 Cinnabar
 BR17 Aztec
 BR18 New Sand
 BR19 Cream
 BR20 White
 BR21 Moccasin
 BR22 Buckskin
 BR23 Prairie

Price Group 7**Steelcut Trio**

TR01 Mist Grey
 TR02 Stone Grey
 TR03 Cassonade Beige
 TR04 Nutmeg Beige
 TR06 Licorice Black
 TR07 Mustard Yellow
 TR08 Red Currant
 TR11 Ice Blue
 TR14 Blue Jay Mix
 TR15 Brown Frost

Leather Price Group**Steelcase Surfaces**

Applies to:

- Crew and Uno
- L107 Black
- L207 Mahogany
- L220 Soapstone
- L221 Rocky

turnstone Leather**Steelcase Surfaces**

Applies to:

- Jacket
- L305 Brown
- T802 Black

Select Surfaces

For information on products within Select Surfaces, including accent paints and fabrics from Designtex, Gabriel, Kvadrat, and Pollack, please refer to the *Surface Materials Reference Manual* or visit www.steelcase.com/surface-materials under the Select Surface section.

Custom Surfaces**Customers' Own Material (COM) Program**

The Customers' Own Material (COM) program offers the opportunity for customers to select fabrics that are not offered through the standard Steelcase surface materials program for use on Steelcase products. Once approved, you can place your order. Steelcase will facilitate the entire ordering process and give you a production schedule. Steelcase will order the COM fabric directly from the textile manufacturer. For up-to-date information regarding fabric test results for all COM fabrics and details regarding yardage requirements for most seating lines, visit the COM website on www.steelcase.com. COMs are not covered under the Steelcase warranty.

Soil Retardants

Soil retardants are treatments that provide long-term soil and stain resistance to a fabric without affecting the shade or the integrity of the fabric. The following Steelcase Textiles and turnstone Collection by Designtex fabrics are available pre-treated with soil retardant:

- Link

For information on soil retardant fabrics on select surfaces, please refer to the *Surface Materials Reference Manual*.

Seating Upholstery Matrix

Legend

- = Not available
- = Available
- = Available with exceptions
- ▨ = COM approved
- Ⓢ = Established
- ▶ See specification guide for details.
- *Gaja — Cradle to Cradle Certified™ Silver

Products that are missing from the matrix are not available with these surface materials.

	Price Group	á la carte - Standard, Task	á la carte - Standard, Guest	Crew - Standard, Task, Plastic Back	Crew - Standard, Task, Upholstered Back	Crew - Standard, Guest, Upholstered Back	Crew - Standard, Guest, Wood Back	Jacket - Standard	Pedestal Seat Cushion - Standard	Uno - Standard	Uno - Standard, High Back
Billiard Multi-Use by DesignTex	3	■	■	■	■	■	■	▨	■	■	■
Bo Peep	5	■	■	■	■	■	■	▨	■	■	■
Brisa	6	■	■	■	•	■	■	▨	■	■	■
Buzz2	1	■	■	■	■	■	■	▨	■	■	■
Chainmail	2	■	■	■	■	■	■	▨	■	■	■
Cogent: Connect	2	■	■	■	■	■	■	▨	■	■	■
Cogent: Geode Vertical Ⓢ	2	•	•	■	■	•	•	▨	■	■	■
Cogent: Trails	2	■	■	■	■	■	■	▨	■	■	■
Gaja*	3	■	■	■	■	■	■	▨	■	■	■
Imperma	3	■	■	■	■	■	■	▨	■	■	■
Jacks Ⓢ	1	■	■	■	■	■	■	▨	■	■	■
turnstone Leather	NA	•	•	•	•	•	•	■	•	•	•
Steelcase Leather	L	▨	▨	■	■	■	■	▨	▨	■	■
Link	1	■	■	■	■	■	■	▨	■	■	■
New Black: Bruce	1	■	■	■	■	■	■	•	■	■	■
New Black: Harley	2	■	■	■	■	■	■	•	■	■	■
New Black: Henry	1	■	■	■	■	■	■	•	■	■	■
New Black: Jack	2	■	■	■	■	■	■	•	■	■	■
New Black: James	2	■	■	■	■	■	■	•	■	■	■
Nitelights	2	■	■	■	■	■	■	▨	■	■	■
Playground Ⓢ	1	■	■	■	■	■	■	▨	■	■	■
Redeem	3	■	■	■	■	■	■	▨	■	■	■
Remix	5	■	■	■	■	■	■	▨	■	■	■
Reply Air Mesh	NA	■	■	■	■	■	■	■	■	•	•
Retrieve	3	■	■	■	■	■	■	▨	■	■	■
Seating Vinyl Ⓢ	2	■	■	■	•	■	■	•	•	■	■
Silk	5	■	■	■	■	■	■	▨	■	■	■
Spyder Ⓢ	2	■	■	■	■	■	■	•	■	■	■
Stand In	2	■	■	■	■	■	■	•	■	■	■
Steelcut Trio	7	■	■	■	■	■	■	▨	■	■	■
Texel	3	■	■	■	■	■	■	▨	■	■	■

Tip: All Steelcase Textiles Price Group 3 upholstery requires an additional leadtime of two or more weeks.

Tip: For the most up to date availability information, please visit www.steelcase.com/surface-materials.

Understanding Customer's Own Material (COM)

The Customer's Own Material (COM) program allows customers to select textiles that are not offered through the standard Surface Materials program for use on turnstone products.

The COM process consists of seven steps: COM website, Testing/Approval, Steelcase to Purchase Service, Pricing, Cutting Direction, Yardage Requirements, and the Purchase Orders.

COM Website

- COM Website features application test results for all COM, Designtex Graded-In, Options Collection and Classics Collection fabrics. The website allows you to calculate yardage requirements for most turnstone seating and systems products.
- Access the COM website at: www.steelcase.com.
- Or call 1.888.STEELCASE (1.888.783.3522) or send an e-mail to line-one@steelcase.com.

Application Testing/Approval

- Confirm that the selected COM has been tested and approved for application on a specific product by checking the COM website at: www.steelcase.com.

COM Application Testing or "approved for application" means the COM fabric has been reviewed for manufacturability using the standard manufacturing techniques to achieve acceptable appearance per Steelcase quality standards.

COM fabric performance, including durability, pilling, color fastness, stretch, splitting, fraying, etc. is not tested by Steelcase. Therefore, COMs are not covered by the Steelcase Warranty. Each COM vendor is responsible for all warranty claims related to fabric performance.

Steelcase reserves the right to reject or reverse any COM approval that does not meet the manufacturing requirements in actual production. COM approval may be rejected or reversed because not all application testing is based on actual production conditions and because some materials vary in fabrication.

- If the COM is approved, you may continue the order process.
- If the COM has failed, you must reselect a fabric.
- If the COM is not listed, that means Steelcase has not tested that fabric on our products.

Helpful hint: Seating vinyl and leather do not require testing. Customer's own vinyl is available on all seating products that accept Steelcase standard vinyl.

- If your material has not been tested, then send yardage (4.5 yards for seating, 2 yards for vertical surfaces) and submit a completed COM Application Testing Request form to:
Steelcase Inc.
Attn: COM Testing
Door 305
4060 Eastern Avenue
Grand Rapids, MI 49508
- To ensure rapid processing, please use the electronic COM Application Testing Request form found on the COM website under the "How To Test" tab **or** fax a copy of the COM Testing Request form from the *Surface Materials Reference Manual* to 616.698.4700. **All information on the form is required in order to complete testing. COM tests cannot be performed if information is incomplete. Contact your requested fabric vendor for any missing information.**
- Test results will be returned (by fax or e-mail) in four working days from receipt of fabric and completed form.

COM materials that are approved for application to panel systems might require UL approval after application test approval. UL approval does involve fees and extended lead times.

All vertical surface COMs tested and approved with a content of 100% polyester meet a minimum of class C/UL1286. If class A or B fire rating is indicated, a burn test must be performed. All vertical surface COMs with a blended fabric construction require a UL burn test. For further UL information, contact a COM Consultant at 616.475.2426.

Steelcase to Purchase Service

The COM program also includes a service to purchase approved COM for our customers for use on turnstone products. Steelcase will facilitate the ordering, scheduling and shipment of COM directly from the suppliers. There are no additional charges for this service.

Steelcase is the only party that may purchase COM for all turnstone products.

In some instances, not all colors in a fabric family are approved. You will be informed of these instances before Steelcase purchases the fabric.

If for some reason the fabric must be ordered directly from the supplier, contact your Steelcase Solutions Fulfillment Team Representative for approval and instructions prior to purchase. The only time the customer can purchase fabric is for testing.

COM Pricing

- Confirm COM is tested and approved.
- Use the COM or COL (Customer's Own Leather) price group found under Surface Materials Options within each product spec guide.
- Calculate yardage required by using the COM Calculator found on the COM website at www.steelcase.com.
- Or call 1.888.STEELCASE (1.888.783.3522) or send an e-mail to line-one@steelcase.com.
Helpful tip: Fabric width, repeat and product quantity and style number are required in order to calculate yardage accurately.
- Add the cost of the fabric to the COM or COL price group.
- The cost of the COM will be shown as a separate line on the acknowledgement.

COM vendors require fabric purchases in half or full yard increments. Therefore, Steelcase will round all final yardage calculations to the half yard.

COL (Customer's Own Leather) is calculated by the square foot, but purchased in hide. The customer is responsible for purchasing the minimum hide requirement.

Base price of chair includes standard fabrics. Steelcase will not allow credit or deduct the cost of the standard fabric when a COM fabric is selected in its place.

Steelcase cannot be held responsible for costs incurred when a COM supplier ships a COM fabric that does not meet Steelcase application standards or for costs incurred for late deliveries when a COM supplier commits to shipping a COM fabric for manufacturing by a specific date and misses that date.

COM Warranty

Steelcase standard warranty does not apply to Designtex or any other COM vendor's fabric.

- Designtex and other COM suppliers are responsible for color consistency within commercial tolerances, abrasion resistance, UV stability, and resistance to soiling and perspiration. These fabrics or vinyls are subject to policies regarding appearance, behavior, and durability that have been established by the fabric supplier. The customer's remedy for a fabric defect is limited to the replacement of the fabric by the supplier. Durability, performance, and fabric defects of COM fabrics are not guaranteed by Steelcase.

Cutting Direction

SEATING:

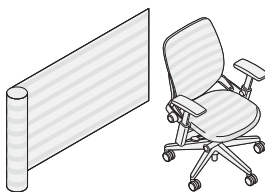

Warp horizontal

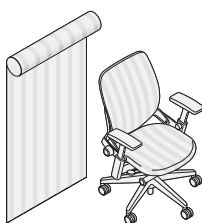

Warp vertical

• Dealers must specify fabric application direction on all COM orders.

- COMs for seating are most often applied in the warp vertical (downroll, woven way) direction. Some exceptions include patterns with stripes, fabrics that are sampled in the warp horizontal (railroad, across roll) direction, and solid vinyls.

▶ See Cutting Direction Guidelines in the *Surface Materials Reference Manual* for more information.

VERTICAL SURFACES:

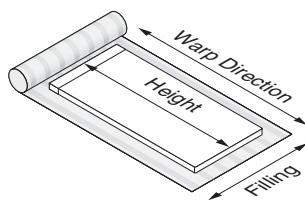

Warp vertical

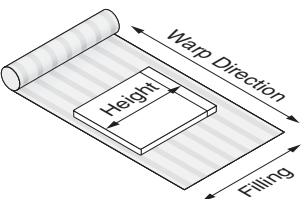

Warp horizontal

• Dealers must specify fabric application direction on all COM orders.

- The cutting direction of COMs on vertical surfaces varies by product and sometimes by style number. Please check the COM website for the approved cutting direction for your particular COM.

▶ See Cutting Direction Guidelines in the *Surface Materials Reference Manual* for more information.

Steelcase cannot guarantee pattern repeat match from product to product. Steelcase also cannot guarantee pattern repeat match within each product listed. (i.e., seat and back, arms to back, etc.)

COM Yardage Requirements

- For the most accurate yardage requirements, visit the Calculator found on the COM website or call 1.888.STEELCASE (1.888.783.3522) or send an e-mail to lineone@steelcase.com.
- The Calculator on the COM website provides the same yardage requirements used by Steelcase purchasing.

Yardage requirements will change depending on:

- width of fabric
- fabric repeat
- cutting direction
- product style number
- quantity of products being manufactured

- COM vinyl requires upholstering in the railroad cutting direction. Please visit our website or call 1.888.STEELCASE (1.888.783.3522) or send an e-mail to lineone@steelcase.com for yardage requirements.

- Certain fabric treatments and backings require additional yardage or yardage minimums. Please contact the supplier for specific information.

- COM fabric vendors require fabric purchases in half- or full-yard increments, and the Steelcase COM calculator will automatically round all final yardage calculations to the half yard.

- Steelcase is the only party who may purchase COMs.

Maintenance and Cleaning

Inspecting and cleaning. Have your chair's upholstery, finishes, controls, base, and other moving parts inspected and cleaned at least once a year.

Cleaning painted and plastic surfaces. Finishes should be cleaned with water and/ or a non-abrasive cleaner (such as Formula 409® and Fantastik®).

Maintaining upholstery. Use a vacuum cleaner for regular cleaning. Periodic professional dry cleaning is recommended. Do not steam clean.

Removing excess stains or heavy soil. Soak up excess stain with a cloth. Do not dry the stain completely or it may set. For most water-soluble stains (coffee, fruit juice, washable ink), use an upholstery cleaning solution (such as Bissell® upholstery shampoo or Guardsman Fabri-Kleen® products) and follow directions on package. For oil-borne stains, use a dry cleaning solution at room temperature (never hot) and let solution work into the stain. Use quick, light strokes to brush the stain with a soft bristle brush. Work from outside toward the center to prevent rings. Soak up remaining dry cleaning solution, then sponge the fabric with cool water. Let fabric dry completely; then vacuum thoroughly. If stain is still visible, repeat procedure. Several light applications of cleaning solution are more effective and less damaging than one heavy application.

Formula 409 is a registered trademark of Clorox company. Fantastik is a registered trademark of Dow Consumer Products, Inc. Fabri-Kleen is a registered trademark of Guardsman Chemical. All other marks are marks of their respective owners.

Resources

Style Number Index

608

Style Number Index

Style Number	Page	Description	Style Number	Page	Description
0202	553	Oriana Guest Chair	434710	289	cobi 434 Work Stool
0204	553	Oriana Guest Chair	434711	289	cobi 434 Work Stool/Arm
0205	553	Oriana Guest Chair	435A00	100	Steelcase Series 1 Work Chair
120	541	Collaboration Guest Chair	435B00	101	Steelcase Series 1 Stool
120D	541	Collaboration Guest Chair	435COATHANGER	102	Steelcase Series 1 Hanger
120L	541	Collaboration Guest Chair	435HEADREST	102	Steelcae Series 1 Headrest
120U	541	Collaboration Guest Chair	442A30	41	Gesture 442 Shell Bck Chair
126900	161	Kart Accessory	442A30V	38	Gesture 442 Series Value Pkg Work Chair
126A100	161	Kart Nesting Chair	442A40	41	Gesture 442 Wrapped Bck Chair
126A101	161	Kart Nesting Chair	442A40V	38	Gesture 442 Series Value Pkg Work Chairs
126A111	167	Kart Leg-Base Stacking Chair	442A50	43	Gesture 442 Series Chr w/Headrest
126A200	161	Kart Nesting Chair	442B30	45	Gesture 442 Shell Bck Stool
126A200S	161	Kart Nesting Chair	442B40	45	Gesture 442 Wrapped Bck Stool
126A201	161	Kart Nesting Chair	4535300	215	Criterion 453 MidBk Work Chair
126A201S	161	Kart Nesting Chair	4535300D	215	Criterion 453 MidBk Work Chair
126A211	167	Kart Leg-Base Stacking Chair	4535301	213	Criterion 453 HiBk Work Chair
126A211S	167	Kart Leg-Base Stacking Chair	4535301D	213	Criterion 453 HiBk Work Chair
126B100ST	163	Kart Stool	4535301D	213	Criterion 453 HiBk Work Chair
126B101ST	163	Kart Stool	4535330	215	Criterion 453 MidBk Work Chair
126B111ST	165	Kart Café Leg-Base Stool	4535330D	215	Criterion 453 MidBk Work Chair
126B200SST	163	Kart Stool	4535330DP	215	Criterion 453 MidBk Work Chair
126B200ST	163	Kart Stool	4535330DW	215	Criterion 453 MidBk Work Chair
126B201SST	163	Kart Stool	4535330P	215	Criterion 453 MidBk Work Chair
126B201ST	163	Kart Stool	4535330W	215	Criterion 453 MidBk Work Chair
126B211SST	165	Kart Café Leg-Base Stool	4535331	213	Criterion 453 HiBk Work Chair
126B211ST	165	Kart Café Leg-Base Stool	4535331D	213	Criterion 453 HiBk Work Chair
127C100J	171	Kart Jury Base Chair	4535331DP	213	Criterion 453 HiBk Work Chair
127C101J	171	Kart Jury Base Chair	4535331DW	213	Criterion 453 HiBk Work Chair
127C200J	171	Kart Jury Base Chair	4535331P	213	Criterion 453 HiBk Work Chair
127C200SJ	171	Kart Jury Base Chair	4535331W	213	Criterion 453 HiBk Work Chair
127C201J	171	Kart Jury Base Chair	4537300	219	Criterion 453 MidBk Stool
127C201SJ	171	Kart Jury Base Chair	4537300D	219	Criterion 453 MidBk Stool
128C100J	172	Kart Jury Base Chair	4537301	217	Criterion 453 HiBk Stool
128C101J	172	Kart Jury Base Chair	4537301D	217	Criterion 453 HiBk Stool
128C200J	172	Kart Jury Base Chair	4537330	219	Criterion 453 MidBk Stool
128C200SJ	172	Kart Jury Base Chair	4537330D	219	Criterion 453 MidBk Stool
128C201J	172	Kart Jury Base Chair	4537330DP	219	Criterion 453 MidBk Stool
128C201SJ	172	Kart Jury Base Chair	4537330DW	219	Criterion 453 MidBk Stool
416911	296	i2i 416 Work Chair	4537330P	219	Criterion 453 MidBk Stool
416911T	296	i2i 416 Work Chair/Tab	4537330W	219	Criterion 453 MidBk Stool
418A000	265	SILQ 418 Series Chair	4537331	217	Criterion 453 HiBk Stool
418B000	267	SILQ 418 Series Stool	4537331D	217	Criterion 453 HiBk Stool
428310	279	Qivi 428 Sled-Base Multi-Use Chair	4537331DP	217	Criterion 453 HiBk Stool
428510	276	Qivi 428 Collab Chair	4537331DW	217	Criterion 453 HiBk Stool
428710	277	Qivi 428 Collab Stool	4537331P	217	Criterion 453 HiBk Stool
428910	279	Qivi 428 Sled-Base Multi-Use Chair	4537331W	217	Criterion 453 HiBk Stool
4331203	247	Protégé 433 Work Chair	4539301B	221	Criterion Plus 453 HiBk Work Chair
4331223	247	Protégé 433 Work Chair	4539331B	221	Criterion Plus 453 HiBk Work Chair
4331403	247	Protégé 433 Work Chair	4539331BW	221	Criterion Plus 453 HiBk Work Chair
4331423	247	Protégé 433 Work Chair	46216179	60	Leap 462 Work Chair
4333003	249	Protégé 433 Guest Chair	46216179V	55	Leap 462 Series Value Package Work Chair
4333023	249	Protégé 433 Guest Chair	46216189	63	Leap 462 Work Chair
4335023	251	Protégé 433 Sled-Base Guest Chair	46267179	66	Leap 462 Stool
434110	287	cobi 434 Work Chair	46267189	69	Leap 462 Stool
434111	287	cobi 434 Work Chair/Arm	46296179	72	Leap Plus 462 Work Chair
			46296189	75	Leap Plus 462 Work Chair

Style Number	Page	Description	Style Number	Page	Description
464LOUNGE	194	Leap 464 WorkLounge	480220	310	Node 480 Series MidBk Collab Chair
464OTTOMAN	195	Leap 464 Ottoman	480230	311	Node 480 Series MidBk Collab Chair
465A000	87	Think 465 Series Work Chair	480240	313	Node 480 Series MidBk Collab Stool
465A000V	84	Think 465 Series Value Package Work Chairs	480250	311	Node 480 Series MidBk Collab Chair
465A300	85	Think 465 Series Work Chair	480270	310	Node 480 Series MidBk Collab Chair
465A300V	84	Think 465 Series Value Package Work Chairs	480280	311	Node 480 Series MidBk Collab Chair
465B000	91	Think 465 Series Stool	4821410	114	Amia 482 Series Work Chair
465B300	88	Think 465 Series Stool	4821410LS	111	Amia 482 Series Work Chair
466160MP	145	Reply 466 Series Work Chair	4821410V	110	Amia 482 Series Value Package Work Chair
466160MT	143	Reply 466 Series Work Chair	4821412	119	Amia 482 Series Air Back Work Chair
466160MTVA	140	Reply 466 Value Pkg Wrk Chair	4821414	121	Amia 482 Series Air Back Work Chair
466160MTVB	141	Reply 466 Value Pkg Wrk Chair	4821418	117	Amia 482 Series Chair
466450MH	149	Reply 466 Series Leg-Base Multi-Use Chair	4827410	124	Amia 482 Series Stool
466450MT	147	Reply 466 Series Leg-Base Multi-Use Chair	4827412	129	Amia 482 Series Air Back Stool
466452MH	149	Reply 466 Series Leg-Base Multi-Use Chair	4827414	131	Amia 482 Series Air Back Stool
466452MT	147	Reply 466 Series Leg-Base Multi-Use Chair	4827418	127	Amia 482 Series Stool
466480MH	153	Reply 466 Series Sled-Base Multi-Use Chair	4871110	229	Cachet 487 Swivel-Base
466480MT	150	Reply 466 Series Sled-Base Multi-Use Chair	4871210	229	Cachet 487 Swivel-Base
466482MH	153	Reply 466 Series Sled-Base Multi-Use Chair	4871211	229	Cachet 487 Swivel-Base
466482MT	150	Reply 466 Series Sled-Base Multi-Use Chair	4877110	233	Cachet 487 Stool
472BR	501	Max-Stkr 472 Bkrack Assy	4877210	233	Cachet 487 Stool
472G	502	Max-Stkr 472 Alignment Device	4877211	233	Cachet 487 Stool
472TAL	501	Max-Stkr 472 Tablet Arm Assy	4878100	231	Cachet 487 Leg-Base
472TAR	501	Max-Stkr 472 Tablet Arm Assy	4878110	231	Cachet 487 Leg-Base
473D	502	Max-Stkr Trans/Strg Dolly	4878200	231	Cachet 487 Leg-Base
474410M	484	Snodgrass 474 Series Chair	4878201	231	Cachet 487 Leg-Base
474419M	484	Snodgrass 474 Series Chair	4878210	231	Cachet 487 Leg-Base
474419W	484, 557	Snodgrass 474 Guest Chair	4878211	231	Cachet 487 Leg-Base
475410M	449	Player 475 Leg-Base Multi-Purp Chair	487BK	235	Cachet 487 Cushion Upholstery Pkg
475410MTL	451	Player 475 Leg-Base Multi-Purp Chair	487D	237	Cachet 487 Transport/Strg Dolly
475410MTR	451	Player 475 Leg-Base Multi-Purp Chair	487G	237	Cachet 487 Ganging/Alignment Device
475412M	449	Player 475 Leg-Base Multi-Purp Chair	487ST	236	Cachet 487 Cushion Upholstery Pkg
475412MC	449	Player 475 Leg-Base Multi-Purp Chair	487STBK	234	Cachet 487 Cushion Upholstery Pkg
475415M	449	Player 475 Leg-Base Multi-Purp Chair	488BD	341	Brody Privacy Desk
475415MC	449	Player 475 Leg-Base	488BDE	343	Brody Privacy Desk with Extension
475480M	453	Player 475 Sled-Base	488FR	344	Brody Footrest
475480MTL	455	Player 475 Sled-Base	488WE	339	Brody Privacy Lounge with Extension
475480MTR	455	Player 475 Sled-Base	488WO	335	Brody WorkLounge
475482M	453	Player 475 Sled-Base	488WP	337	Brody Privacy Lounge
475485M	453	Player 475 Sled-Base	490410	467	Move 490
475710M	457	Player 475 Leg-Base Stool	490410C	467	Move 490
475712M	457	Player 475 Leg-Base Stool	490410CP	468	Move 490
475715M	457	Player 475 Leg-Base Stool	490410P	468	Move 490
475A	458	Player 475 Alignment Device	490410U	468	Move 490
475D	458	Player 475 Transport/Strg Dolly	490410UC	468	Move 490
475G	458	Player 475 Ganging Device	490410V	464	Move 490
477100	500	Max-Stacker III 477 Series Stackable Chair	490410VC	464	Move 490
480110	308	Node 480 Series Work Chair	490412	468	Move 490
480120	308	Node 480 Series Work Chair	490412C	468	Move 490
480130	309	Node 480 Series Collaborative Chair	490412CP	469	Move 490
480140	312	Node 480 Series Collaborative Stool	490412P	469	Move 490
480150	309	Node 480 Series Collaborative Chair	490412U	469	Move 490
480170	308	Node 480 Series Collaborative Chair	490412UC	469	Move 490
480180	309	Node 480 Series Collaborative Chair	490412V	464	Move 490
480210	310	Node 480 Series MidBk Collab Chair	490412VC	464	Move 490

Style Number Index, continued

Style Number	Page	Description
490510	475	Move 490 Perching Stool
490510P	476	Move 490 Perching Stool
490510U	475	Move 490 Perching Stool
490512	476	Move 490 Perching Stool
490512P	476	Move 490 Perching Stool
490512U	476	Move 490 Perching Stool
490710	471	Move 490
490710C	471	Move 490
490710CP	472	Move 490
490710P	472	Move 490
490710U	472	Move 490
490710UC	472	Move 490
490710V	465	Move 490 Value Pkg
490710VC	465	Move 490 Value Pkg
490712	472	Move 490
490712C	472	Move 490
490712CP	473	Move 490
490712P	473	Move 490
490712U	473	Move 490
490712UC	473	Move 490
490712V	465	Move 490 Value Pkg
490712VC	465	Move 490 Value Pkg
490D	477	Move Transport/Storage Dolly
490GA4	477	Move Ganging/Alignment Device
490GA7	477	Move Ganging/Alignment Device
490WS	477	Wall Saver
499111	203	Siento Mid-Back Desk Chair
499112	203	Siento Mid-Back Desk Chair
499113	203	Siento Mid-Back Desk Chair
499121	203	Siento Mid-Back Desk Chair
499122	203	Siento Mid-Back Desk Chair
499123	203	Siento Mid-Back Desk Chair
499211	203	Siento High-Back Desk Chair
499212	203	Siento High-Back Desk Chair
499213	203	Siento High-Back Desk Chair
499221	203	Siento High-Back Desk Chair
499222	203	Siento High-Back Desk Chair
499223	203	Siento High-Back Desk Chair
499SIENTO	200	Siento Design Pkg High-Back Chair
793390	168	Kart Stack Dolly
COLAGTP	426	Lagunitas Personal Table
COLAGRECT	425	Lagunitas Work Table
CQCT1632	297	Collaborative Lounge Table
G20	537	Alcove Guest Chair
G22	545	Escapade Guest Chair
G23	545	Escapade Guest Chair
G24	565	Topaz Guest Chair
G26	565	Topaz Guest Chair
JERSEYV	180	Jersey Series Value Work Chair
LEAP3DP	56	Leap 462 Platinum Pkg Wrk Chair
LEAPV2	54	Leap 462 Work Chair
MLBBF	369	Backless Lounge
MLBBS	369	Backless Lounge
MLLCE	363	Corner Lounge
MLLCF	363	Corner Lounge

Style Number	Page	Description
MLLCS	363	Corner Lounge
MLRCE	363	Corner Lounge
MLRCF	363	Corner Lounge
MLRCS	363	Corner Lounge
MLRLE	366	Reverse Lounge
MLRLF	366	Reverse Lounge
MLRLS	366	Reverse Lounge
MLRRE	366	Reverse Lounge
MLRRF	366	Reverse Lounge
MLRRS	366	Reverse Lounge
MLSIE	359	Straight Inverted Lounge
MLSIF	359	Straight Inverted Lounge
MLSIS	359	Straight Inverted Lounge
MLSTE	357	Straight Lounge
MLSTF	357	Straight Lounge
MLSTS	357	Straight Lounge
MNGLB	548	Mingle Guest Chair
N3LCUBEL	434	B-Free Large Cube
N3LCUBES	435	B-Free Small Cube
N3LGA	436	B-Free Ganging Brackets
N3LMAGSC	438	B-Free Screen to Cube Magnets
N3LMAGSS	438	B-Free Screen to Screen Magnets
N3LSCREEN	437	B-Free Screen
N3LTABLECF	439	B-Free Occasional Coffee Table
N3LTABLECR	439	B-Free Occasional Corner Table
PROTEGEV	244	Protégé 433 Value Work Chair
STLLNG2AR1	405	Umami Lounge, Two Arms, Single
STLLNG2AR2	407	Umami Lounge, Two Arms, Double
STLLNGAR1	401	Umami Lounge, One Arm, Single
STLLNGAR2	403	Umami Lounge, One Arm, Double
STLLNGCR1	409	Umami Lounge, Corner, Single
STLLNGEC	411	Umami Lounge, End Cap
STLLNGST1	397	Umami Straight Lounge, Single
STLLNGST2	399	Umami Straight Lounge, Double
STLPLTF1	391	Umami Single Platform
STLPLTF2	394	Umami Double Platform
STLSCRPL	417	Umami Screens, Standard
STLSCRPLS	422	Umami Screens, Spanner Screens
TERR1	560	Terrazzo Guest Chair
TERR2	560	Terrazzo Guest Chair
TERR3	560	Terrazzo Guest Chair
TS30101	593	à la carte Chair
TS30102	593	à la carte Chair
TS30103	593	à la carte Chair
TS30104	595	à la carte Chair
TS30105	593	à la carte Chair
TS30106	593	à la carte Chair
TS30107	595	à la carte Chair
TS30801	587	Crew Chair
TS30802	587	Crew Chair
TS30803	587	Crew Stool
TS30805	590	Crew Chair
TS30806	590	Crew Chair
TS30807	590	Crew Chair
TS30808	590	Crew Chair

Style Number	Page	Description
TS30811	587	Crew Chair
TS30812	587	Crew Chair
TS30813	587	Crew Stool
TS30821	587	Crew Chair
TS30822	587	Crew Chair
TS30823	587	Crew Stool
TS30831	587	Crew Chair
TS30832	587	Crew Chair
TS30833	587	Crew Stool
TS31101	597	Uno Chair
TS31102	597	Uno Chair
TS31301	591	Jacket Chair
TS31302	591	Jacket Cover
TS37602	555	Sawyer Chair
TS38301	183	Jersey Chair
TS38304	185	Jersey Chair
TS38305	185	Jersey Chair
TS38308	187	Jersey Chair
TS38309	187	Jersey Chair
WHG6600	489	Nooi Linking Chair, Armless
WHG6602	489	Nooi Linking Chair, Arms
WHG6604	490	Nooi Sled-Based Chair
WHG6606	491	Nooi Cafeteria Chair, Armless
WHG6608	491	Nooi Cafeteria Chair, Arms
WHG6625	492	Nooi Bar-Height Stool
WHG6626	492	Nooi Cafe-Height Stool

Trademark List

- ® The following are registered trademarks for products of Steelcase Inc. or one of its related corporate entities: 4 o'clock, 900 Series, à la carte, Airtouch, Ally, Amia, Answer, Archipelago, Avenir, Ballet, Bix, Brayton International, Cachet, Canopy, Canto, Chancellor, Coalesse, Confidante, Context, Convene, CopyCam, Criterion, Crushed Can, Currency, dash, Designtex, Details, Detour, Drive, Elective Elements, Ellipse, Ember Chrome, Emerge, E-Table 2, FYI, Garland, Gentry, Ginkgo Biloba, Groupwork, Ideo, Jacket, Jenny, Jersey, Kart, Kick, LaCosta, Leap, Let's B, LiveBack, Max-Stacker, media:scape, Metro, Migrations, Mitra, Montage, Nurture, Oriana, Parade, Pathways, PCT, Permiso, Player, Portal, Power Pincher, Progeny, Protégé, R2, Rally, Relevant, Reply, Rizzi Arc, Sensor, Series 9000, Siento, Sieste, Sine, Softcare, Springboard, Steelcase, Steelcase Design Partnership, Stella, Stow Davis, Swathmore, TeamWork, Technique, Texpress, Think, Thunder, Topo, Train, turnstone, Underline, Unison, Vecta, Viridian, Walden, Wernld, and X-Stack.
- ® The following registered trademarks are under license from AWI Licensing Company, Dover, DE: SoundScapes, DuraBrite, BioBlock, and Armstrong.
- ® The following registered trademarks are under license from Byrne Electrical, Rockford, MI: Interport, Mini-Port, Axil Z, and Ellora.
- ® The following is a registered trademark of DuPont, Wilmington, DE: Corian.
- ® The following is a registered trademark of Genlyte Thomas Company, Louisville, KY: Lightolier.
- ® The following is a registered trademark of Hilti Corporation, FL-9494 Schaan, Principality of Liechtenstein: Hilti.
- ® The following is a registered trademark of Leviton Manufacturing Company, Little Neck, NY: Decora.
- ® The following is a registered trademark of Mechanical Plastics Corp, Elmsford, NY: Toggler.
- ® The following is a registered trademark of Microsoft Corporation, Redmond, WA: Microsoft.
- ® The following is a registered trademark of Panduit Corporation, Lockport, IL: Panduit.
- ® The following is a registered trademark of Trav (Press), Cuneo, Italy: Assisa.
- ® The following is a registered trademark of Virtual Ink, Boston, MA: mimioActive.
- ® The following registered trademarks are under license from Wilkhahn Furniture Products: Avera, Senzo, Versal, and Wilkhahn FS.

- ® The following is a registered trademark of Wilsonart International, Temple, TX: Chemsurf.
- ® The following is a registered trademark of Wiremold, West Hartford, CT: Wiremold.
- ® The following is a registered trademark of EMU Group S.P.A., Perugia, Italy: Emu.
- ™ The following are trademarks for products of Steelcase Inc. or one of its related corporate entities: Access, Active/Passive Shelf, Ainsley, Akira, Alcove, Alerion, Alight, Amaris, American Elect, American Tradition, ap40, Arbor, Arriva, Asana, Ascot, Aspekt, Astor, Await, Bassline, B-Free, Bira, Bivi, Bixby, Bottomline, Brody, Brook, Buoy, Burton, c:scape, Calla, Calm, Camber, Campfire, Capa, Cappuccino, Cesar, Chester, Chord, Circa, Clarendon, Classic Rectangular, Clipper, cobì, Collaboration, Community, Company, Convey, Cortex, Coupe, Crea, Crew, Cura, Cypress, Davenport, Dearborn, Deck, Déjà, Denizen, Denska, Derby, Divisio, Donovan, Dune, Duo, Echo, Edge, Elsna, Empath, Empress, Enea, èno, EnSync, Enviro, Escapade, Exchange, Exponents, Field, Flat Top, FlexFrame, Flip Top, Flute, Folio, FrameOne, FreeFlow, Frontier, Galilei, Gesture, Ginger, Ginkgo, Go Wall, Grip, Groove, Hatchback, Hawthorne, Hitch, Host Collection, Hosu, Huddleboard, i2i, Impact, Indy, InfoLink, IOS, I-Solve, Jack, Jarrah, Jetty, Juice, Kami, Kast, Kathryn, Lagunitas, Lark, L'Attitude, LearnLab, Leela, LessThanFive, Lincoln, Linden, LiveSeat, Loria, Lyric, Malibu, Malibu Too, Mansfield, Marathon, Martini, Mason, Masque, Migration, Millbrae, Mineral, Mingle, Mystic, Mystic Metal, Mystic Wood, Montara650, Montreal, Move, Nadia, Neighbor, nesso, Nickel, Nikko, Nod, Node, Norfolk, Ology, Ontrak, Oom, Opus, Orchid, Outlook Collection, Ovation, Paloma, Paperflo, Parliment, Pasio, Passerelle, Patriarch, Payback, Peek, Pile File, Pisa, Pool, Potrero415, PUCK, QiVi, Quba, Rave, Reed, Regard, Relay, Reunion, Ripple, Riser, Rocco, Rocky, RoomWizard, Runner, Satellite, Sawyer, ScapeSeries, Senti, Sentinel, Senza, Sequoia, Session, ShareLink, Shield, Shortcut, Sidewalk, SILQ, Skylar, Slumber, Smoke, Snug, Soft Leaf, Sonata, Sorrel, SOTO, Southside, Stationkits, Steelcase Series, Stiletto, Surprise!, Surround, Switch, Symphony, Sync, TagWizard, Tava, TeamStudio, TeamTheater, Tenaro, Terrazzo, Theorem, Thread, Topaz, Touchdown, Tour, Tower Too, Trees, Trillium, Trolley, tX2, U-Free, Umami, Underscore, Uno, V.I.A., Verb, Verge, Victor2, Visalia, Waldorf, Woodruff, Workspring, and X-tenz.
- ™ The following is a trademark of Microsoft Corporation, Redmond, WA: Windows.
- ™ The following is a trademark of Rodman Industries, Inc., Oconomowoc, WI: ResinCore1.
- ™ The following is a trademark of Ultrafabrics, LLC, Elmsford, NY: Ultraleather.

- ™ The following trademarks are under license from Wilkhahn Furniture products: Cana, Linus, Logon, Picto, Range, Stitz, Thema, Timetable, and Tubis.
- ™ The following trademark is used under license from Cradle to Cradle Products Innovation Institute, Oakland, CA: Cradle to Cradle Certified.
- ™ The following trademarks are under license from Walter Knoll: Andoo, Bob, Lazlo, Lox, Ribbon, and Together.
- ™ The following trademarks are under license from PP Möbler: Bar and Flag Halyard.
- ™ The following trademarks are under license from Viccarbe: Davos, Holy Day, Last Minute, RS, and Wrapp.
- ™ The following trademarks are under license from Carl Hansen: Elbow, Paddle, Shell, Wing, and Wishbone.
- ™ The following trademarks are under license from Cambridge Sound Management, LLC, Cambridge, MA: QtPro Soundmasking, Qt Quiet Technology, and Sonet Qt.
- ™ The following is a trademark of Electri-Cable Assemblies, Shelton, CT: Interact.
- ™ The following is a trademark of Clestra Hauserman: IRYS.
- ™ The following is a trademark of Wiesner-Hager Möbel GmbH: Nooi.
- ™ The following are trademarks of PolyVision: a³, e³, Motif, and PolyVision.

Trademarks used here in are the property of Steelcase, Inc. or of their respective owners.