

SA927 09250/USH

# Panels and Accessories



# gypsum products













# Gypsum Panels & Accessories

## Introduction

In January 2000, USG introduced a revolutionary reformulation of its SHEETROCK Brand Gypsum Panels. The improved panels—manufactured using a patent-pending technology developed by USG’s Research Center—are easier to install than conventional wallboard products and perform better under a variety of conditions. Reformulated SHEETROCK Brand Gypsum Panels can be applied more quickly than regular wallboard and their improved performance characteristics reduce the frequency of callbacks. The end result is savings—of labor, of time, and of money.

Naturally, SHEETROCK Brand Gypsum Panels from USG continue to offer all of the benefits that have made them synonymous with drywall. Those advantages include crack resistance, ease of decoration, and fire protection (see USG’s *Construction Selector*, publication SA100, for specific fire-resistance ratings). SHEETROCK Brand Panels are available in a number of specialized forms for various applications and are complemented by the industry’s broadest line of accessories, adhesives, and joint treatment systems. More than 50 strategically located operating plants produce or stock the gypsum panels described here.

## Where to use Sheetrock Brand Gypsum Panels

		Interior Walls										
		Single layer					Double layer					
		Over existing walls	Masonry (furred)	Wood framing	Steel framing	Masonry & concrete (direct)	Masonry (furred)		Wood framing		Steel framing	
							Base	Finish	Base	Finish	Base	Finish
Regular	1/4"	X							X		X	
	3/8"	X							X	X		
	1/2"		X	X	X	X	X	X	X	X	X	X
ULTRACODE												
	3/4"				X						X	X
FIRECODE												
	5/8"		X	X	X		X	X	X	X	X	X
FIRECODE C												
	1/2"		X	X	X		X	X	X	X	X	X
	5/8"		X	X	X		X	X	X	X	X	X
Foil-Back <sup>(1)</sup>												
	3/8"											
	1/2" & 5/8"											
Water-Resistant <sup>(2)</sup>												
	1/2" & 5/8"			X	X	X		X		X		X
Interior Ceiling Board												
	1/2"											
Exterior Ceiling Board												
	1/2" & 5/8"											
Vinyl Covered Panels												
	1/2" & 5/8"	X	X	X	X	X		X		X		X
Abuse Resistant												
	1/2" & 5/8"		X	X	X	X	X	X	X	X	X	X
Gypsum Sheathing												
	1/2" & 5/8"											

(1) Not recommended in hot-humid climates. (2) Recommended as a base for ceramic or other tile. Also available in FIRECODE and FIRECODE C Cores. (3) Not recommended as a base for ceramic tile or as a base layer for SHEETROCK Brand Vinyl-Faced Gypsum Panels double-layer systems. (4) 20 ga. steel recommended.

<b>Improved Score and Snap</b>	Reformulated SHEETROCK Brand Gypsum Panels snap more cleanly for smoother edges with less rasping, reducing preparation time.
<b>Improved Handling</b>	The reformulated board's strength makes it easier to carry and hang, reducing the tendency to flex that can result in accidental (and sometimes hidden) core breakage.
<b>Improved Flatness</b>	SHEETROCK Brand Gypsum Panels remain flat during storage. When properly stored on spacers, the panels will not warp or become wavy. Flat board is easier to apply, easier to finish, and results in a better final appearance.
<b>Improved Bond</b>	Better bond of the face-paper to the core means fewer blisters, better-looking board, easier finishing, and a better final appearance.
<b>Improved Performance</b>	Reformulated SHEETROCK Brand Gypsum Panels stand up to varied climatic conditions, resisting warping and sagging even when subjected to heat and humidity. The result is a better final appearance that will last over time.

Interior of Exterior Walls								Ceilings							
Single layer			Double layer				Single layer		Double layer				Acoustical base		
Masonry (furred)	Wood or steel framing	Rigid insulation board	Masonry (furred)		Wood or steel framing		Over existing ceiling	Wood framing	Steel framing	Wood framing		Steel framing		Over suspended metal grillage	Over channel
			Base	Finish	Base	Finish				Base	Finish	Base	Finish		
				X		X	X								
				X		X	X	X			X	X			
X	X	X	X	X	X	X	X	X	X	X	X	X	X	X	X
X	X			X	X	X	X		X	X	X	X	X	X	X
X	X			X	X	X	X		X	X	X	X	X	X	X
				X <sup>(3)</sup>		X <sup>(3)</sup>			X		X				
X	X			X <sup>(3)</sup>		X <sup>(3)</sup>			X	X	X		X		
X	X	X													
									X	X					
									X	X					
X	X	X	X	X	X	X	X		X	X	X	X	X	X	X
<b>Exterior of Exterior Walls</b>															
X	X	X	X	X	X	X	X								

## Gypsum Panels & Accessories

### General Limitations

- 1 Exposure to excessive or continuous moisture and extreme temperatures should be avoided. Gypsum board is not recommended in solar heating systems where board will be in contact with surfaces exceeding 125 °F (52 °C).
- 2 Must be adequately protected against wetting when used as a base for ceramic wall tile (see foil-back panel limitation). Use SHEETROCK Brand Gypsum Panels—Water Resistant, or DUROCK Brand Cement Board, for this purpose.
- 3 Maximum spacing of framing members: 1/2" and 5/8" gypsum panels are designed for use on framing centers up to 24"; 1/4" and 3/8" panels on centers up to 16" (but neither is intended for single-layer application). In both walls and ceilings when 1/2" or 5/8" gypsum panels are applied across framing on 24" centers and joints reinforced, blocking is not required. Neither 3/8" nor 1/4" SHEETROCK Brand Gypsum Panels are recommended for use on steel framing as base for water-based texturing materials. When a water-based texture is used on ceilings with framing 24" o.c., 5/8" gypsum panels, 1/2" FIRECODE C core panels, or 1/2" SHEETROCK Brand Interior Ceiling Panels—Sag-Resistant should be used to prevent sag.
- 4 Application of SHEETROCK Brand Gypsum Panels over 3/4" wood furring applied across framing is not recommended since the relative flexibility of the furring under impact of the hammer tends to loosen nails already driven. Furring should be 2" x 2" minimum (may be nom. 1" x 4" if panels are to be screw-attached).
- 5 The application of gypsum panels over an insulating blanket that has first been installed continuously across the face of the framing members is not recommended. Blankets should be recessed and the blanket flanges attached to sides of studs or joists.
- 6 To prevent objectionable sag in new gypsum panel ceilings, the weight of overlaid unsupported insulation should not exceed 1.3 psf for 1/2" thick panels with frame spacing 24" o.c.; 2.2 psf for 1/2" panels on 16" o.c. framing (or 1/2" SHEETROCK Brand Interior Ceiling Panels—Sag-Resistant on 24" o.c. framing) and 5/8" panels 24" o.c.; 3/8" thick panels must not be overlaid with unsupported insulation. A vapor retarder should be installed in exterior ceilings, and the plenum or attic space should be properly vented.

During periods of cold or damp weather when an independent vapor retarder is installed on ceilings behind the gypsum board, it is important to install the ceiling insulation before or immediately after installing the ceiling board. Failure to follow this procedure may result in moisture condensation on the back side of the gypsum board, causing the board to sag.

Water-based textures, interior finishing materials and high ambient humidity conditions can produce sag in gypsum ceiling panels if adequate vapor and moisture control is not provided. The following precautions must be observed to minimize sagging of ceiling panels:

  - a) Where vapor retarder is required in cold weather conditions, the temperature of the gypsum ceiling panels and vapor retarder must remain above the interior air dew point temperature during and after the installation of panels and finishing materials.
  - b) The interior space must be adequately ventilated and air circulation must be provided to remove water vapor from the structure.

Most sag problems are caused by the condensation of water within the gypsum panel. The placement of vapor retarders, insulation levels and ventilation requirements will vary by location and climate and should be reviewed by a qualified engineer if in question.
- 7 To produce final intended results, certain recommendations regarding surface preparation, painting products and systems must be adhered to for satisfactory performance. Refer to Good Design Practices and Architectural Specifications.
- 8 Precautions should be taken against creating a double vapor retarder by using gypsum panels as a base for highly water vapor-resistant coverings when the wall already contains a vapor retarder. Moreover, do not create a vapor retarder by such wall coverings on the interior side of exterior walls of air-conditioned buildings in hot-humid climates where conditions dictate a vapor retarder location near the exterior side of the wall. Such conditions require assessment by a qualified mechanical engineer.
- 9 Adhesives for attaching vinyl-faced gypsum panels to studs must be marked for application with vinyl-faced gypsum panels. Compliance with ASTM C557 does not ensure that the adhesive was tested for compatibility with vinyl-faced gypsum panels.
- 10 In order to avoid yellow staining and show-through of stud adhesives onto the surfaces of the gypsum panels and delamination of the vinyls on vinyl-faced gypsum panels caused by the adhesive, solvent-based gypsum panel stud adhesives should not contain acetone, heptane, hexane, toluene or xylene.

### Technical Data

SHEETROCK Brand Gypsum Panels comply with ASTM C36. Thermal coefficient of expansion (unrestrained): 9.0 x 10<sup>-6</sup> in. per in. per deg. F (40-100 °F); hygrometric coefficient of expansion (unrestrained): 7.2 x 10<sup>-6</sup> in. per in. per % r.h. (5%-90% r.h.). Surface burning characteristics: flame spread 15, smoke developed 0.

<p><b>Interior Gypsum Panel Products</b></p>	<p><b>SHEETROCK Brand Gypsum Panels</b></p>	<p>Have long edges tapered on the face side to form a shallow channel for joint reinforcement. Made in the three thicknesses shown below for specific purposes.</p> <ul style="list-style-type: none"> <li>—1/2", for single-layer application in new residential construction and remodeling.</li> <li>—3/8", lightweight, applied principally in the double wall system over wood framing and in repair and remodel work.</li> <li>—1/4", a lightweight, low-cost utility gypsum panel, used as base layer for improving sound control in double-layer steel and wood stud partitions and for use over old wall and ceiling surfaces. Also for forming curved surfaces with short radii.</li> </ul> <p>Width: 4'; length: 8', 9', 10', 12' or 14' (except 1/4", available in 8' and 10' lengths only); edges: tapered; finish: natural-finish face paper, suitable for paint or other decoration.</p>																																								
<p><b>SHEETROCK Brand Gypsum Panels, SW Edge</b></p>		<p>Have an exclusive tapered rounded edge design to help minimize ridging or beading and other joint imperfections and help compensate for extremes of temperature and humidity during construction. The SW system produces a stronger joint than regular gypsum panels.</p> <p>This is accomplished by pre-filling gypsum panel joints with SHEETROCK Brand Setting-Type (DURABOND) or Lightweight Setting-Type (EASY SAND) Joint Compound formulations which chemically harden, providing maximum bond and minimum shrinkage. No more compound is required than with regular panels. Taping and other application procedures are conventional.</p> <p>Except for the rounded edge, SW Panels are tapered like, and otherwise identical to, regular tapered-edge gypsum panels. Made in 1/2" and 5/8" thicknesses.</p>																																								
<p><b>SHEETROCK Brand Gypsum Panels, ULTRACODE Core</b></p>		<p>Made 3/4" thick, provide 1, 2, 3 and 4 hr. fire ratings with fewer layers of gypsum panels than are usually required when used in approved designs. Because fewer layers are needed, ULTRACODE Core panels provide reduced labor costs and reduced material costs. Also provide added abuse-resistance. Width: 4'; lengths: 8', 9', 10' or 12'; edge: tapered; finish: manila face paper, suitable for paint or other decoration. Refer to SA923 for complete information.</p>																																								
<p><b>SHEETROCK Brand 1/4" Flexible Gypsum Panels</b></p>		<p>Bend to fit tight curves without wetting. These 1/4" panels are much more flexible than standard SHEETROCK Brand panels of the same thickness, making them ideal for use anywhere a tight radius is required. SHEETROCK Brand Flexible Gypsum Panels permit quick and easy construction of curved walls, arches and stairways. They are also lightweight and fire resistant.</p> <table border="1" data-bbox="545 1131 1546 1358"> <thead> <tr> <th colspan="6">Minimum Bending Radii of SHEETROCK Brand 1/4" Flexible Gypsum Panels</th> </tr> <tr> <th rowspan="2">Application</th> <th rowspan="2">Condition</th> <th colspan="2">Lengthwise</th> <th colspan="2">Widthwise</th> </tr> <tr> <th>Bend Radii</th> <th>Max. Stud Spacing</th> <th>Bend Radii</th> <th>Max. Stud Spacing</th> </tr> </thead> <tbody> <tr> <td>Inside (concave)</td> <td>Dry*</td> <td>24"</td> <td>9" o.c.</td> <td>12"</td> <td>9" o.c.</td> </tr> <tr> <td>Inside (concave)</td> <td>Wet</td> <td>20"</td> <td>9" o.c.</td> <td>10"</td> <td>6" o.c.</td> </tr> <tr> <td>Outside (convex)</td> <td>Dry*</td> <td>24"</td> <td>9" o.c.</td> <td>12"</td> <td>6" o.c.</td> </tr> <tr> <td>Outside (convex)</td> <td>Wet</td> <td>15"</td> <td>6" o.c.</td> <td>7"</td> <td>6" o.c.</td> </tr> </tbody> </table> <p>*At 70° F and 50% RH.</p>	Minimum Bending Radii of SHEETROCK Brand 1/4" Flexible Gypsum Panels						Application	Condition	Lengthwise		Widthwise		Bend Radii	Max. Stud Spacing	Bend Radii	Max. Stud Spacing	Inside (concave)	Dry*	24"	9" o.c.	12"	9" o.c.	Inside (concave)	Wet	20"	9" o.c.	10"	6" o.c.	Outside (convex)	Dry*	24"	9" o.c.	12"	6" o.c.	Outside (convex)	Wet	15"	6" o.c.	7"	6" o.c.
Minimum Bending Radii of SHEETROCK Brand 1/4" Flexible Gypsum Panels																																										
Application	Condition	Lengthwise		Widthwise																																						
		Bend Radii	Max. Stud Spacing	Bend Radii	Max. Stud Spacing																																					
Inside (concave)	Dry*	24"	9" o.c.	12"	9" o.c.																																					
Inside (concave)	Wet	20"	9" o.c.	10"	6" o.c.																																					
Outside (convex)	Dry*	24"	9" o.c.	12"	6" o.c.																																					
Outside (convex)	Wet	15"	6" o.c.	7"	6" o.c.																																					
<p><b>Bending of SHEETROCK Brand Gypsum Panels<sup>(1)</sup></b></p>		<p>Regular gypsum panels may also be bent. For comparison, the radii are given in the table that follows.</p> <table border="1" data-bbox="545 1444 1546 1627"> <thead> <tr> <th colspan="6">Bending radii with dry panels</th> </tr> <tr> <th colspan="2">Panel thickness</th> <th colspan="2">Panel applied with long dimension perpendicular to framing</th> <th colspan="2">Panel applied with long dimension parallel to framing</th> </tr> <tr> <th>in.</th> <th>mm</th> <th>ft.</th> <th>m</th> <th>ft.</th> <th>m</th> </tr> </thead> <tbody> <tr> <td>1/4</td> <td>6.4</td> <td>5<sup>(2)</sup></td> <td>1.5</td> <td>15</td> <td>4.6</td> </tr> <tr> <td>3/8</td> <td>9.5</td> <td>7-1/2</td> <td>2.3</td> <td>25</td> <td>7.6</td> </tr> <tr> <td>1/2</td> <td>12.7</td> <td>20<sup>(2)</sup></td> <td>6.1</td> <td>—</td> <td>—</td> </tr> </tbody> </table> <p>(1) For steel-framed systems and bending with wetted panels, see folder SA923. (2) Bending two 1/4" pieces successively permits radii shown for 1/4" panels.</p> <p><b>Note:</b> By moistening the face and back paper thoroughly prior to application, and replacing in the stack for at least one hour, the panel may be bent to still shorter radii. When the panel dries thoroughly, it will regain its original hardness.</p>	Bending radii with dry panels						Panel thickness		Panel applied with long dimension perpendicular to framing		Panel applied with long dimension parallel to framing		in.	mm	ft.	m	ft.	m	1/4	6.4	5 <sup>(2)</sup>	1.5	15	4.6	3/8	9.5	7-1/2	2.3	25	7.6	1/2	12.7	20 <sup>(2)</sup>	6.1	—	—				
Bending radii with dry panels																																										
Panel thickness		Panel applied with long dimension perpendicular to framing		Panel applied with long dimension parallel to framing																																						
in.	mm	ft.	m	ft.	m																																					
1/4	6.4	5 <sup>(2)</sup>	1.5	15	4.6																																					
3/8	9.5	7-1/2	2.3	25	7.6																																					
1/2	12.7	20 <sup>(2)</sup>	6.1	—	—																																					
<p><b>SHEETROCK Brand Gypsum Panels, FIRECODE Core</b></p>		<p>Made 5/8" thick, combine all the advantages of regular panels with additional resistance to fire. Comply with ASTM C36 for a Type X gypsum board and meet the definition of a Type X gypsum board for fire-rated assemblies in the Gypsum Association Fire Resistance Design Manual. Width: 4'; length: 8', 9', 10', 12' or 14'; edges: SW tapered or tapered; finish: natural-finish face paper, suitable for paint, wallpaper or other decoration.</p>																																								
<p><b>SHEETROCK Brand Gypsum Panels, FIRECODE C Core</b></p>		<p>Made in 5/8" and 1/2" thicknesses, provide improved fire protection over standard FIRECODE panels due to additives that enhance the integrity of the core under fire exposure. Comply with Type X requirements.</p> <p>Systems using these gypsum panels have qualified for fire ratings of up to 4 hours in walls, 3 hours in ceilings, 4 hours for column protection. See Construction Selector for variations.</p>																																								

## Gypsum Panels & Accessories

**Limitations:** (also refer to General Limitations, page 4): (1) In order to attain fire-resistance ratings, the construction of the partition and/or floor and ceiling assemblies must conform to the system designs as tested at the indicated fire testing facilities (see System Folders). (2) Max. frame member spacing: 24" o.c.

### SHEETROCK Brand Gypsum Panel Application and Frame Spacing

Thickness	Approx. panel weight psf	Location	Application method	Max. frame spacing o.c.
3/8" <sup>(1)</sup>	1.4	ceilings <sup>(2)(3)(5)</sup>	perpendicular	16"
3/8" <sup>(1)</sup>	1.4	sidewalls <sup>(5)</sup>	perpendicular or parallel	16"
1/2"	1.8	ceilings	parallel <sup>(3)(6)</sup> perpendicular	16" 24" <sup>(4)</sup>
1/2"	1.8	sidewalls	perpendicular or parallel	24"
5/8"	2.3	ceilings	parallel <sup>(3)</sup> perpendicular	16" 24"
5/8"	2.3	sidewalls	perpendicular or parallel	24"

(1) For wood framing only. Also see general limitations, page 4. (2) Not recommended below unheated spaces. (3) Not recommended if water-based texturing material is to be applied. (4) Max. spacing 16" if water-based texturing material is to be applied. If 1/2" SHEETROCK Brand Interior Gypsum Ceiling Board is used, max. spacing is 24". (5) Not intended for single-layer application. (6) When using 1/2" SHEETROCK Brand Interior Brand Ceiling Panels (Sag-Resistant), panels may be applied parallel to framing members.

### SHEETROCK Brand Gypsum Panels, Foil-Back

Are made by laminating special kraft-backed aluminum foil to back surface of regular or SW tapered panels with FIRECODE and FIRECODE C cores as indicated above. Effective as a vapor retarder for walls and ceilings when applied with foil surface next to the framing in single-layer application or as the base layer in multi-layer systems. SHEETROCK Brand Gypsum Panels, Foil-Back, provide a water vapor retarder to help prevent interior moisture from entering wall and ceiling spaces. In tests per ASTM E96 (desiccant method), 1/2" foil-back panels showed a vapor permeance of 0.06 perm.

These panels are designed for interior use with furred masonry, wood or steel framing. In air conditioned buildings in climates having sustained high outside temperature and humidity, a qualified mechanical engineer should determine vapor retarder location.

**Limitations:** Not recommended as a base for ceramic or other tile or as base layer for SHEETROCK Brand Vinyl-Faced Gypsum Panels or other highly moisture-resistant wall coverings. Also not to be used in hot, humid climates such as the Southern Atlantic and Gulf Coast areas.

**Sizes:** 3/8", 1/2" and 5/8" thick. Sizes, edges and finish: same as for base panels.

### SHEETROCK Brand Gypsum Panels, Water-Resistant

Are a proven water-resistant base for the adhesive application of ceramic and plastic tile and plastic-faced wall panels for areas not subjected to constant moisture and humidity. Made water-resistant all the way through: (1) multi-layered face and back paper are chemically treated to combat penetration of moisture; (2) the gypsum core is made water-resistant with a special composition. The panel is easily recognized by its distinctive green face.

Available in 1/2" and 5/8" thickness; in 1/2" FIRECODE C Core and 5/8" FIRECODE Core. Surface burning characteristics: flame spread 20, smoke developed 0. Comply with ASTM C630. Width: 4'; length: 8', 10' or 12'; edges: tapered; finish: green treated paper, suitable for receiving tile, paint or wallpaper.

**Limitations:** Ceiling framing must be 12" o.c. for 1/2" thick water-resistant panels, and not more than 16" o.c. for 5/8" thick water-resistant panels. Not recommended for single-layer resilient attachment where tile is to be applied or in remodeling unless applied directly to studs. Panels should not be installed over a vapor retarder or on a wall acting as a vapor retarder unless it will not be tiled or finished with an impervious paint. Store in an enclosed shelter and protect from exposure to the elements. Panels are not intended for use in areas subject to constant moisture such as interior swimming pools, gang showers and commercial food processing; DUROCK Brand Cement Boards are recommended for these uses (see Folder SA932).

### SHEETROCK Brand Abuse-Resistant Gypsum Panels

Offer greater resistance to surface indentation and through-penetration than standard SHEETROCK Brand Gypsum Panels. SHEETROCK Brand Abuse-Resistant Panels are a low-cost alternative to other systems for partitions that require greater impact resistance. The regular and fire-resistant gypsum core is encased in heavy natural-finish paper on the face side and strong liner paper on the back side. The face paper is folded around the long edges to reinforce and protect the core, and the ends are square cut and finished smooth. Long edges of panels are tapered, allowing joints to be reinforced and concealed with a U.S. Gypsum joint treatment system. 1/2" SHEETROCK Brand Abuse-Resistant Gypsum Panels (available in 8'-12' lengths) are recommended for residential construction as an upgrade to standard drywall. 5/8" SHEETROCK Brand FIRECODE Abuse-Resistant Gypsum Panels (available in 8'-12' lengths) are recommended for commercial and institutional construction where greater indentation resistance and through-penetration resistance are required.

<b>SHEETROCK Brand Vinyl-Faced Gypsum Panels</b>	Are conventional gypsum panels with factory-applied vinyl facings in coordinated decorator colors. Used for predecorated permanent partitions, relocatable partitions or in remodeling. Not recommended as a finish layer over foil-back gypsum panels or on exterior walls in hot and humid climates unless suitable vapor control is provided by mechanical engineer. See Technical Folder SA928 for descriptions and specifications.
<b>SHEETROCK Brand Gypsum Coreboard</b>	Has a 1" thick gypsum core encased in strong, gray paper on both sides. It is used in laminated gypsum partitions with additional layers of gypsum panels applied to the coreboard to complete the wall assembly. Manufactured with "V" T&G edges for use in solid partitions or with square edges and prescored 6" to 8" o.c. Coreboard strips are then easily snapped and separated from this master unit. Thickness: 1"; width: 24"; edges: "V" T&G or square; length: 8', 9', 10' and 12' (prescored—7'8" lengths only); finish: gray paper, unsuitable as exposed surface. (Special order availability prevails in some markets.) Meets ASTM C442.
<b>SHEETROCK Brand Gypsum Liner Panels</b>	Have a special 1" thick gypsum core for added fire resistance and multi-layered green paper facings that are treated to resist moisture penetration. Used in Shaft Wall Partitions (see Folder SA926), Area Separation Fire Walls/Party Walls (see Folder SA925), High-Attenuation Double Wall Systems (see Folder SA923) and High Performance Floor Ceiling Assemblies (see SA924). Panels have beveled edges, are 1" thick and 24" wide, and are available in lengths up to 16' (14' in some markets). Meets ASTM C442.
<b>SHEETROCK Brand Interior Gypsum Ceiling Board, Sag-Resistant</b>	A 1/2" thick panel, supports water-based spray texture paints and insulation like 5/8" thick board but with in-place construction costs that are less. Special gypsum core contains additives which increase sag-resistance. Lightweight for easy handling. Surface burning characteristics: flame spread 15, smoke developed 0. Recognized by NER 458 code compliance document. <b>Sizes:</b> Thickness: 1/2"; width: 4'; lengths: 8' and 12'; edges: tapered. Meets ASTM C36.
<b>IMPERIAL Brand Gypsum Base</b>	A large size, rigid base for the economical application of veneer plasters. The panels are large enough to be installed like drywall, and have a distinctive blue face paper that provides the qualities desirable for veneer plaster applications. Available in both regular core and foil-back versions, 1/2" and 5/8" thick, 4' wide, in 8' to 14' lengths. Complies with ASTM C588, and has a gypsum core UL Classified as noncombustible per ASTM E136.
<b>IMPERIAL Brand Gypsum Base, FIRECODE and FIRECODE C Cores</b>	Combines the advantages of regular IMPERIAL Brand Gypsum Base with additional resistance to fire. IMPERIAL Brand Gypsum Base, FIRECODE Core, is 5/8" thick and provides Type X fire-resistance performance. IMPERIAL Brand Gypsum Base, FIRECODE C Core, is available 1/2" and 5/8" thick, and provides the highest levels of fire-resistant performance. Available 4' wide in lengths from 8' to 14'.
<b>IMPERIAL Brand Gypsum Base, ULTRACODE Core</b>	Offers the benefits of regular IMPERIAL Brand Gypsum Base in a thickness ideal for achieving fire-rated veneer-plaster systems with the fewest layers of base. Complies with ASTM C588 and has a gypsum core UL Classified as noncombustible per ASTM E136. Available 4' wide in 8' to 14' lengths.
<b>IMPERIAL Brand Gypsum Base, Abuse-Resistant</b>	Combines the advantages of regular IMPERIAL Brand Gypsum Base with increased resistance to indentation, impact, and abrasion. The 1/2" version has a regular gypsum core; the 5/8" and 3/4" FIRECODE versions provide Type X fire-resistant performance. The 3/4" thick panels also have mesh reinforcement for added abuse resistance. All comply with ASTM C588 and have gypsum cores UL Classified as noncombustible per ASTM E136. Available 1/2", 5/8", and 3/4" thick, 4' wide, in 8' to 14' lengths.
<b>IMPERIAL Brand Gypsum Ceiling Base, Sag-Resistant</b>	This specially formulated rigid base for gypsum veneer plasters provides enhanced sag resistance, even under conditions of high heat and humidity (up to 90% r.h.). Complies with ASTM C588 and has a gypsum core UL Classified as noncombustible per ASTM E136. Available 1/2" thick, 4' wide, in 8' to 14' lengths. The foil-back version has a bright aluminum foil backing which meets HUD requirements for a vapor retarder. Available only in certain regions; consult your USG representative for additional information.

## Gypsum Panels & Accessories

<b>Exterior Gypsum Panel Products</b>	<b>SHEETROCK Brand Exterior Gypsum Ceiling Board</b>	<p>Is a weather- and sag-resistant board designed for the soffit side of eaves, canopies and carports and other commercial and residential exterior applications with indirect weather exposure. It is noncombustible, is simply scored and snapped for quick application, and offers excellent paintability. Surface burning characteristics: flame spread 20, smoke developed 0. Meets ASTM C931.</p> <p>Installed conventionally in wood and steel-framed soffits; batten strips or mouldings used over butt joints or treated joints; backing strips required for small vent openings. Has beige, water-repellent face paper.</p> <p><b>Sizes:</b> Thickness: 1/2"; width: 4'; lengths: 8' and 12'; edges: SW tapered. Also available 5/8" thick with FIRECODE core which is suitable for fire-rated assemblies.</p>
	<b>SHEETROCK Brand Gypsum Sheathing</b>	<p>Is a fire-resistant gypsum board, with water-resistant gypsum core encased in specially formulated black water repellent paper on both sides and long edges. Its weather resistance, water repellence, fire resistance and low applied cost make it suitable for use in exterior curtain wall construction; also a popular choice for wood-framed garden apartments and light commercial buildings (see Folder SA924 for application and specifications). Surface burning characteristics: flame spread 20, smoke developed 0. Meets ASTM C79. Available 24" wide, 8' length with V-shaped T&amp;G long edges and 48" wide, 8' and 9' lengths with square edges. Thickness: 1/2" Regular and 5/8" FIRECODE core sheathing boards.</p>
	<b>GYP-LAP Gypsum Sheathing</b>	<p>Is a weather- and fire-resistant board used in exterior curtain walls and in frame construction (see Folder SA924). Surface burning characteristics: flame spread 20, smoke developed 0. Lightweight board has noncombustible gypsum core clad in water-repellent paper on face and back surfaces. Meets ASTM C79. Available in western U.S., 1/2" thick, 24" wide, 8' length with V-shaped T&amp;G long edges and 48" wide, 8' length with square edges. Also available: 5/8" thick FIRECODE core sheathing board.</p>
<b>Paper-Faced Sheathing Limitations</b>		<ol style="list-style-type: none"> <li>1 Sheathing may be stored outside for up to one month, but must be stored off the ground and have protective covering.</li> <li>2 Maximum stud spacing is 24" o.c.</li> <li>3 When applied to a structure, sheathing must not be left exposed to the elements for more than one month unless the procedure as outlined in limitation 8 is followed.</li> <li>4 The gypsum sheathing must be covered with a weather-resistant barrier (#15 felt or equivalent).</li> <li>5 Exterior finish systems applied over gypsum paper-faced sheathing must be applied with mechanical fasteners through the sheathing into the wall framing. Alternative methods of application are not endorsed and their performance and that of the substrate are solely the responsibility of the specifier. Direct application of paint, texture finishes and coatings over gypsum sheathing is not recommended.</li> <li>6 For in-place exposure up to six months, all gaps resulting from cuts, corners, joints and machine end cuts of the sheathing should be filled with exterior caulk at time of erection.</li> <li>7 For curtain wall construction, cover gypsum paper-faced sheathing with No. 15 asphalt felt within 30 days of sheathing erection. Felt should be applied horizontally with 2" overlap and immediately anchored with metal lath, masonry ties or corrosion-resistant screws or staples.</li> <li>8 Sheathing for exterior ceilings and soffits is not recommended unless covered with metal lath and exterior stucco.</li> </ol>



# Gypsum Panels & Accessories

## Paper Faced Metal Bead and Trim

### SHEETROCK Brand Paper Faced Metal Bead and Trim

For faster, easier installation and superior product performance, reducing callbacks. With the Tape On products, nailing is not required. As a result, installation and corner alignment are easier, and nail pops from wood shrinkage are eliminated. Paper tape covering assures excellent adhesion of finish; provides superior resistance to edge cracking and chipping, despite the stresses of normal building movement and everyday wear and tear.

#### SHEETROCK Brand Paper Faced Metal Outside Corner, Tape On Bead (B1W, B1XW EL, B1 Super Wide)



Use for 90° outside corners. Suitable for use on any thickness of wallboard.

#### SHEETROCK Brand Paper Faced Metal Outside Corner (Micro Bead)



Reduced bead height results in less use of joint compound. Wider 1"x1" flanges provide easier installation on all cut edges.

#### SHEETROCK Brand Paper Faced Metal Offset Outside Corner, Tape On Bead (B1 OS)

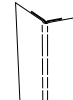

Designed for 135° corners. Offset bead is designed to give a true offset corner with a smaller bead height for less compound fill. Can be used on any thickness of wallboard.

#### SHEETROCK Brand Paper Faced Metal Offset Inside Corner, Tape On Trim (B2)



Designed to form a true inside (90°) corner. For use with any thickness of wallboard.

#### SHEETROCK Brand Paper Faced Metal 3/4" Bullnose Outside Corner, Tape On Bead (SLOC)

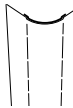

Installs easily to form a smooth rounded outside corner. The 3/4" radius can be used for 1/2" or 5/8" drywall panels.

#### SHEETROCK Brand Paper Faced Metal Offset Inside Corner, Tape On Trim (B2 OS)



Designed for a 135° offset angle on inside corners. For use on any thickness of wallboard.

#### SHEETROCK Brand Paper Faced Metal Bullnose Offset Outside Corner Tape On Bead (SLOC OS)



Designed for bay window offsets. Use to create a rounded 135° offset outside corner.

#### SHEETROCK Brand Paper Faced Metal Inner Cove, Tape On Trim (SLIC)

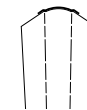

Used to create a smooth, rounded inside corner. The 3/4" radius trim is suitable for 1/2" or 5/8" drywall.

#### SHEETROCK Brand Paper Faced Metal 1-1/2" Bullnose Outside Corner, Tape On Bead (Danish)



Similar to the SLOC series except for a 1-1/2" radius. Can be used for 1/2" or 5/8" drywall.

#### SHEETROCK Brand Paper Faced Offset Metal Inner Cove, Tape On Trim (SLIC OS)

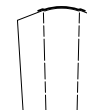

A tape on bullnose trim for 135° inside offset corners. Creates a straight inside cove that is guaranteed not to crack for the lifetime of the structure.

#### SHEETROCK® Brand Paper Faced Metal 3/4" Bullnose Outside Corner Nail On Bead (Santa Fe)

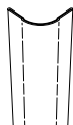

An economical alternative for bullnose corners. Forms a smooth, rounded outside corner. Can be used on any thickness of drywall panels.

#### SHEETROCK Brand Paper Faced Metal "L" Shaped Tape On Trim (B4 Series)

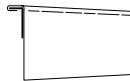

Use where wallboard abuts suspended ceilings, beams, plaster, masonry, and concrete walls, as well as untrimmed door and window jambs.

#### SHEETROCK® Brand Paper Faced Metal 1/2" Outside Corner Tape On Bead (Baby Bull)

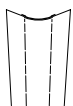

Smaller radius forms a smooth, rounded outside corner. Can be used on 1/2" or 5/8" thick drywall panels.

#### SHEETROCK Brand Paper Faced Metal Reveal Tape On Trim (Reveal NB)

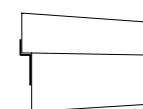

Reduced bead height results in less use of joint compound. This modified tape-on "L" trim solves a variety of problems associated with reveal details on soffits, wall areas, ceilings, lightboxes, and other interior architectural components. B4 Reveal features a paper flange on both trim legs. The additional paper flange eliminates the need to caulk the edge of reveal details, providing a far cleaner and straighter line. Available only in No Bead.

#### SHEETROCK Brand Paper Faced Metal "J" Shaped Tape On Trim (B9)



Tape on "J" trim completely surrounds the rough edge of the wallboard, providing a strong and clean corner. Tape on application eliminates frustration with nailing and nail shrink-back. Can be used for finishing off bifold closet doors, as well as under all door and window encasements, and to finish rough drywall ends.

# Gypsum Panels & Accessories

## Metal Bead and Trim

### Metal Bead

Provides protection for external corners.

#### Expanded Flange Corner Bead

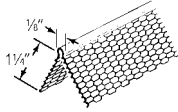

Galvanized steel external corner reinforcement with 1/16" grounds and 1-1/4" wide fine-mesh expanded flanges. Nailed to framing through panels or stapled to panels. Provides superior key for joint compounds and eliminates shadowing and edge cracking.

#### DUR-A-BEAD Corner Bead

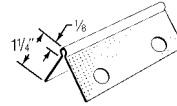

Part of the family of SHEETROCK Brand Metal Products. All-metal galvanized steel reinforcement, protects external corners. Concealed with United States Gypsum Company joint compounds for a smooth, finished corner. Provides superior joint compound adhesion. Available in flange width: No. 103 1-1/4" x 1-1/4".

#### SPEED BEAD Corner Bead

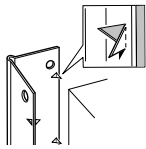

SHEETROCK Brand Metal Corner Bead (SPEED BEAD) is made with metal barbs that grip wallboard faces, minimizing the need for nails or screws and eliminating nail pops. Applies with hand pressure or rubber mallet. Avoids edge deformation and wallboard fracturing.

### Metal Trim

Provides protection and neat finished edges to gypsum panels at window and door jambs, ceiling angles and intersections where panels abut other materials. Nailed through the channel and panels into the framing or jamb. These components eliminate need for precision cutting and mitering. Finish with joint compound (except 400 series trims).

#### L-Trim & J-Trim

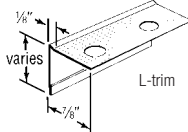
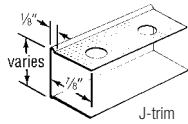

Galvanized steel casing, includes No. 200-A J-shaped channel in 1/2" and 5/8" sizes; No. 200-B L-shaped angle edge trim without back flange to simplify application, in 1/2" and 5/8" sizes.

#### Expanded Flange L-Trim & J-Trim

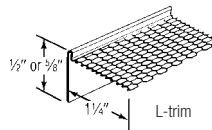
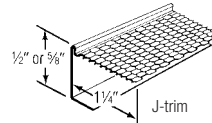

Expanded-flange trim used to provide edge protection at cased openings and ceilings or wall intersections. Includes 801-B J-shaped and 801-B L-shaped trim, both 1/2" and 5/8" sizes.

#### J-Stop

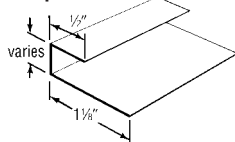

Reveal type galvanized steel trim, requires no finishing compound, includes No. 401 in 1/2", No. 402 in 5/8" size.

## Accessories

### Zinc Control Joint No. 093

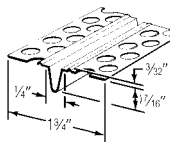

Relieves stresses of expansion and contraction across the joint in large ceiling and wall areas. Made from roll-formed zinc with a tape-protected 1/4" opening 7/16" deep. Length: 10'. Limitation: where sound and/or fire ratings are prime considerations, an adequate seal must be provided behind the control joint.

## Plastic Trim Accessories

### USG Rigid Vinyl Trim (RP Series)

Vinyl plastic in Almond and Ash Blue. Available for 1/2" and 5/8" thick panels; lengths: 8', 9', 10'; shapes: RP-2 Inside Corner, RP-4 End Cap, RP-5 Snap-on Corner, RP-7 Snap-on Batten, RP-46 Ceiling Drive-In Trim. RPV series trims also available factory-laminated to match SHEETROCK Brand Vinyl-Faced Gypsum Panels.

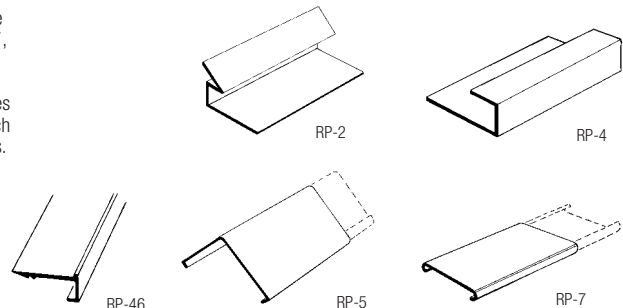

# Gypsum Panels & Accessories

## Metal Channels and Furring Accessories

### Metal Furring Channels

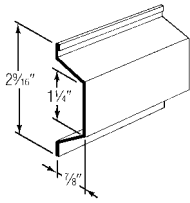

Hat-shaped channels for ceiling and wall furring. Roll-formed from two gauges of corrosion-resistant steel. DWC-25 for screw attachment of 1/2" and 5/8" gypsum panels. DWC-20 for greater spans and load-carrying capacity in ceiling applications. Products comply with ASTM C645. Face width: 1-1/4"; depth: 7/8"; length: 12'.

### Cold-Rolled Channels

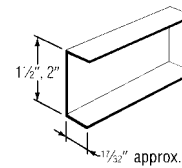
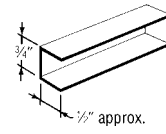

Made of 16 ga. steel, used for furring and in suspended ceilings and partitions. Available either galvanized or black asphaltum painted. Sizes: 3/4", with 1/2" flange; 1-1/2" and 2" with 17/32" flange. Length: 16' and 20'.

### RC-1 Resilient Channel

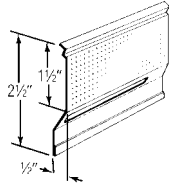

Part of the family of SHEETROCK Brand Metal Products. Corrosion-resistant steel channel for resilient attachment of gypsum panels to wood and steel framing. Reduces sound transmission through wood and steel framed partition and floor-ceiling assemblies. Width: 2-1/2"; depth: 1/2"; length: 12'. Limitation: not for use beneath highly flexible floor joists; should be attached to walls or ceilings with 1-1/4" coarse thread or drywall steel screws; not suitable for use with more than 2 layers 5/8" thick gypsum panels.

### Metal Angles

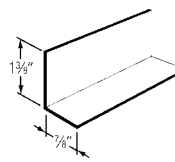

1-3/8" x 7/8" corrosion-resistant steel angle sections used as runners to secure and brace 1" coreboard in laminated gypsum partitions. 2-1/2" x 2-1/2" size made for High Attenuation Double Wall Systems. Length: 10'.

### Z-Furring Channels

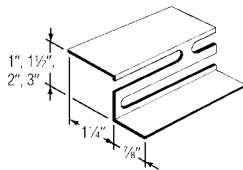

Mechanically attach THERMAFIBER, mineral and rigid foam insulations and SHEETROCK Brand Gypsum Panels to interior surfaces of monolithic concrete and masonry walls. Also for attaching insulation and gypsum panels to interiors of existing walls and ceilings. Made of corrosion-resistant steel; furring depths: 1", 1-1/2", 2", 3"; length: 8'6".

### Metal Furring Channel Clips



Made of galvanized wire for attaching DWC-25 Metal Furring Channels to 1-1/2" cold-rolled channels. Installed on alternate sides of carrying channels; where clips cannot be alternated, wire tying recommended.

## Shaft Wall Framing Members

### USG Steel J-Runners

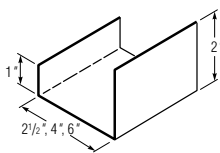

Used at floor and ceiling in shaft wall assemblies and for special stud framing, made with unequal legs in 2-1/2", 4" and 6" widths; styles: 2-1/2", 24, 20 ga.; 4", 20, 24 ga.; 6", 24, 20 ga.; length: 10'.

### USG Steel E-Studs

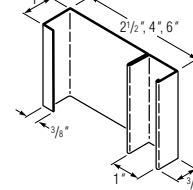

Used singly for cavity shaft walls to cap partition or both sides of closure panel; widths: 2-1/2", 4" and 6"; styles: 2-1/2", 25, 20 ga.; 4", 25, 20 ga.; 6", 25, 20 ga.; lengths as required.

### USG Steel C-H Studs

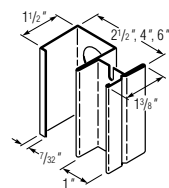

Rigid, roll-formed sections for cavity shaft walls shaped to engage 1" liner panels. Widths: 2-1/2" and 4"; styles: 2-1/2", 25, 22, 20 ga.; 4", 25, 20 ga.; 6", 20 ga., lengths as required.

### USG Steel Jamb Struts

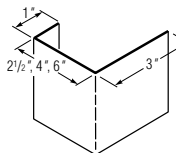

Used in jamb framing for fire-rated shaft elevator door frames. Widths: 2-1/2", 4" and 6"; style: 2-1/2", 20 ga.; 4", 20 ga.; 6", 20 ga.; length: 10'.

## Area Separation Fire Wall/Party Wall Framing Members

### USG Steel H-Studs

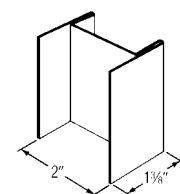

Slide over and engage edges of adjacent liner panels for solid area separation walls. Width: 2"; gauge: 25; length: 8' to 16'.

### USG Steel CR-Runners

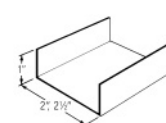

For solid area separation walls: 2" width, 25 ga., 10' length.

## Gypsum Panels & Accessories

<b>Insulation</b>	<b>THERMAFIBER Insulation</b>	A mineral fiber product ideal for improving sound control in partition and floor-ceiling constructions.
	<b>Sound Attenuation Fire Blankets (SAFB)</b>	Paperless, semi-rigid mineral fiber mats designed to improve STC ratings when installed in steel stud partitions and wood-frame construction. Fire-resistant Fire Safety FS-15 Blankets are used to provide noncombustible exterior wall furring and steel stud curtain wall assemblies. They are open-faced and require separate vapor retarder (see Folder SA707).
<b>Adhesives and Acoustical Sealant</b>	<b>Drywall Adhesives</b>	<p>Make an important contribution to gypsum panel attachment where the finest room interiors are desired. Their use greatly reduces the nail or screw fastening otherwise required, thus saving labor on spotting and sanding—also minimizes nail pops and other fastener imperfections.</p> <p>For laminating gypsum panels in multi-layer fire-rated or non-rated partitions and ceilings use <b>SHEETROCK Brand Setting-Type (DURABOND)</b> or <b>Lightweight Setting-Type (EASY SAND) Joint Compounds</b>—dry powder products, applied by spreader, requiring mixing and temporary fastening, or <b>SHEETROCK Brand All Purpose or Taping Joint Compound Ready-Mixed</b>. These compounds provide tight bond when dry yet permit adjustment of panels after contact.</p> <p>Recommended adhesives for non-fire-rated construction are a solvent-based stud adhesive which meets ASTM C557 and is compatible with vinyl or vinyl-faced gypsum panels, or a rubber-based construction adhesive for subfloors and plywood construction which meets ASTM C557 and American Plywood Association Performance Standard AFG-01. Laminating and liquid contact adhesives are also commercially available. These adhesives bridge minor irregularities in the base or framing, make it easier to form true joints and level surfaces. Stud adhesives add strength to an assembly, reduce fasteners required, help eliminate loose panels and nail pops. Adhesives should not contain acetone, heptane, hexane, toluene or xylene.</p>
	<b>SHEETROCK Brand Acoustical Sealant</b>	A highly elastic, water-base caulking for sound-rated partition and ceiling systems and sealing exterior walls to reduce infiltration. Non-bleeding and staining, pumpable and easily applied in beads. Provides excellent adherence to most surfaces, permanent flexibility and lasting seal. Surface burning characteristics: flame spread 0, smoke developed 0. Meets ASTM C919 and ASTM C834.

### Assembly ratings with and without Acoustical Sealant.



## Gypsum Panels & Accessories

### USG Fire Stop System

FIRECODE Compound, THERMAFIBER SMOKE SEAL Compound, FIRECODE Acrylic Firestop Sealant (regular and Type SA), FIRECODE IA Intumescent Acrylic Firestop Sealant

USG has a variety of materials available for use in the wide range of USG Fire Stop Systems it offers. These products fall into the categories of mortar-type materials, caulk materials and intumescent-type materials. FIRECODE Compound is a mortar-type material; it is applied in wet form and allowed to set or harden. It provides a stronger firestop than other materials. FIRECODE Compound is typically used in walls, floors and curtain wall slab-edge conditions where strength and economy are required. USG has three caulk materials: THERMAFIBER SMOKE SEAL Compound and FIRECODE Acrylic Firestop Sealant are applied from a caulk gun and typically used for floor and wall penetrations where movement is anticipated and flexibility is a requirement. These products are applied from a caulk gun and provide a flexible firestop. FIRECODE SA Acrylic Firestop Spray Sealant is a spray-type caulk material typically used to provide a low installed cost solution in firestopping dynamic joints in head of wall designs. In cases where an intumescent material is required, U. S. Gypsum offers FIRECODE IA Intumescent Acrylic Firestop Sealant which is usually applied by caulk gun. Intumescent-type materials greatly expand when exposed to high temperatures. These materials are only necessary when the integrity of the penetrants is compromised by high temperature, such as in PVC (plastic) pipe or some insulated pipes. Refer to SA727, USG Fire Stop Systems, for information on the systems offered for fire protection of through-penetrations and head-of-wall construction joints using these products.

### Joint Treatment Systems

Today's complete United States Gypsum Company joint treatment line includes both ready-mixed and powder products in drying and setting types. In addition to conventional joint finishing and fastener spotting, certain products are designed for repairing cracks, patching, spackling, back-blocking, texturing and for laminating gypsum panels in double-layer systems. These joint compounds meet ASTM C475.

For estimating purposes: for 1,000 sq. ft. of surface area to be finished, approximately 370 lin. ft. of tape and 83 lb. of conventional drying-type powders, 67 lb. of lightweight drying-type powders, 72 lb. of conventional setting-type powders, 52 lb. of lightweight setting-type powders, 138 lb. of conventional weight ready-mixed type or 9.4 gallons of lightweight ready-mixed joint compound are required.

### Joint Treatment Limitations

- 1 United States Gypsum Company joint compounds are not compatible with and should not be intermixed with any other compounds.
- 2 For interior use only—except SHEETROCK Brand Setting-Type (DURABOND) and Lightweight Setting-Type (EASY SAND) Joint Compounds, which may be used for treating joints of SHEETROCK Brand Exterior Gypsum Ceiling Board; not recommended for laminating—except SHEETROCK Brand Setting-Type (DURABOND) and Lightweight Setting-Type (EASY SAND) Joint Compounds, and SHEETROCK Brand All Purpose and Taping Joint Compounds Ready-Mixed.
- 3 Protect bagged and cartoned products against wetting; protect ready-mixed products from freezing and extreme heat.
- 4 Each compound coat must be dry before the next is applied—except SHEETROCK Brand Setting-Type (DURABOND) and Lightweight Setting-Type (EASY SAND) Joint Compounds—and completed joint treatment must be thoroughly dry before decorating.
- 5 Only SHEETROCK Brand Setting-Type (DURABOND) and Lightweight Setting-Type (EASY SAND) Joint Compounds are recommended for treating joints of SHEETROCK Brand Gypsum Panels, Water-Resistant, to be covered with ceramic or plastic tile (do not use other compounds).
- 6 Prior to using any epoxy coating over any surface treated with joint compound, consult the epoxy coating manufacturer and follow manufacturer's specific recommendations regarding the preparation or suitability of substrates for the epoxy coating. Many epoxy coatings exert significant shear stress on the substrate as the strong epoxy film shrinks while curing/drying. This stress can cause the bond of the joint compound to fail, resulting in delamination problems.

### Joint Tapes

#### SHEETROCK Brand Joint Tape

A strong, cross-fibered paper tape with minimal longitudinal stretch and superior tensile strength. Lightly precreased for corner application.

#### SHEETROCK BRAND Joint Tape—Heavy

Special fiber paper tape offers exceptional strength and crack-resistance in drywall joint treatment. High tensile strength resists stretching, tearing, and distortion. Roughened surface provides superior bond; accurately center-creased to improve corner treatment. Meets ASTM C475.

## Gypsum Panels & Accessories

<p><b>SHEETROCK Brand Fiberglass Drywall Tape</b></p>	<p>Made with a unique cross-fiberglass construction to provide greater drywall joint strength than conventional fiberglass leno-weave mesh tapes. Self-adhesive tape goes on quickly—eliminates bedding coat and provides smooth finished joints in only two coats. For first coat over tape, setting-type joint compound is used; for second coat, setting-type or drying-type (ready-mixed or powder) joint compounds may be used. Tape is also ideal for patching small holes and cracks.</p>
<p><b>Ready-Mixed Compounds</b></p>	<p>SHEETROCK Brand Ready-Mixed Joint Compounds are non-asbestos, vinyl-based formulations specially premixed to a creamy, smooth consistency. They offer excellent slip and bond, easy workability. Joint finishing is fast, easy and smooth, reducing labor costs and improving appearance and quality of the job. Meet ASTM C475. Limitation: protect wet joints and container from freezing.</p>
<p><b>SHEETROCK Brand Taping Joint Compound Ready-Mixed</b></p>	<p>A high-performance product for embedding tape; also used for laminating.</p>
<p><b>SHEETROCK Brand Topping Joint Compound Ready-Mixed</b></p>	<p>A low-shrinkage, easily applied and sanded product recommended for second and third coats over ready-mixed taping and all purpose compounds. Also used for simple hand-applied texturing in some markets; check suitability of formula in your area with local sales office. Not suitable for embedding tape or as first coat over metal corners, trim and fasteners.</p>
<p><b>SHEETROCK Brand All Purpose Joint Compound Ready-Mixed</b></p>	<p>Used for embedding, finishing, simple hand-applied texturing, laminating and skim coating. Combines single package convenience with good taping and topping characteristics. Recommended for repairing cracks in interior plaster and masonry not subject to moisture.</p>
<p><b>SHEETROCK Brand Lightweight All Purpose Joint Compound Ready-Mixed (PLUS 3)</b></p>	<p>Offers all benefits of a conventional product. Exclusive advantages: weighs up to 35% less, requires only two coats over metal bead and fasteners, gives exceptional ease of sanding. This all purpose, single package product provides tight bond, superior slip and workability, good crack resistance and low shrinkage.</p>
<p><b>SHEETROCK Brand All Purpose Joint Compound, Ready-Mixed (MIDWEIGHT)</b></p>	<p>High-performance all-purpose compound offers superior working qualities and good open time. Weighs up to 15% less than conventional-weight compounds; is easier working and sanding, and provides lower shrinkage for metal bead, trim, and fastener concealment. Also ideal for embedding tape and for filling, leveling, and finishing over gypsum panel joints, fasteners, bead and trim.</p>
<p><b>Vinyl-Base Powder Joint Compounds</b></p>	<p>SHEETROCK Brand Powder Joint Compounds are top-quality, non-asbestos, conventionally drying-type products providing easy mixing, smooth application and ample working time. For embedding tape, for fill coats and finishing over drywall joints, corner bead, trim and fasteners, and for simple hand-applied texture finishes. Meet ASTM C475.</p>
<p><b>SHEETROCK Brand Taping Joint Compound</b></p>	<p>For embedding tape and for first fill coat on metal beads, trim, fasteners; also for patching plaster cracks. Outstanding bond and resistance to tape cracking.</p>
<p><b>SHEETROCK Brand Topping Joint Compound</b></p>	<p>A smooth-sanding material for second and third coats over taping compound or all purpose compound. Produces excellent feathering and superior finishing.</p>
<p><b>SHEETROCK Brand All Purpose Joint Compound</b></p>	<p>Incorporates good taping and topping characteristics in a single product. For use where finest results of the specialized compounds (above) are not necessary. Also has good hand-texturing properties.</p>
<p><b>SHEETROCK Brand Lightweight All Purpose Joint Compound (AP LITE)</b></p>	<p>Weights 20% less than conventional compounds; offers lower shrinkage, better crack resistance, easier mixing, application and sanding.</p>

## Gypsum Panels & Accessories

### SHEETROCK Brand Setting-Type (DURABOND) and Lightweight Setting-Type (EASY SAND) Joint Compounds

These setting-type powder products were developed to provide faster finishing of drywall interiors, even under slow drying conditions. Rapid chemical hardening and low shrinkage permit same-day finishing and usually next-day decoration. Features exceptional bond; virtually unaffected by humidity extremes. Ideal for laminating double-layer systems, particularly fire-rated assemblies, and for adhering gypsum panels to above-grade concrete surfaces. May be used for surface texturing and for filling, smoothing and finishing interior above-grade concrete. Fill cracks and holes and level any offsets and voids to the same level as adjacent surfaces with compound. Apply in as many coats as are needed to provide a crack-free fill without edge joinings that show through decoration. Do not use setting-type joint compounds for thin, tight skim coat applications because the compounds will be susceptible to drying out before chemically setting, resulting in potential bond failure. Also used to treat joints in exterior gypsum ceiling board and to embed tape and fill beads in veneer finish systems when any of the following conditions exist: rapid drying conditions due to low humidity, high temperature and excessive evaporation; metal framing is specified; 24" o.c. wood frame spacing and a single layer gypsum base veneer system is specified (5/8" base with one-coat veneer finish and 1/2" or 5/8" base with two-coat veneer finish). Required as prefill material for SHEETROCK Brand Gypsum Panels, SW Edge. Recommended for filling joints of SHEETROCK Brand Gypsum Panels, Water-Resistant, and treating fastener heads in areas to receive ceramic or plastic tile. Also used extensively for touch-up and patching.

**Limitations:** SHEETROCK Brand Setting-Type Joint Compounds (DURABOND) are difficult to sand after drying and must be smoothed before complete setting. Not to be applied over moist surfaces or surfaces likely to become moist, on below-grade surfaces, or on surfaces subject to moisture exposure, pitting or popping.

### SHEETROCK Brand Setting-Type Joint Compound (DURABOND)

In addition to the above applications, these compounds are also ideal for repairing surface damaged areas in handball and racquetball court walls finished with STRUCTO-BASE and STRUCTO-GAUGE Gypsum Plasters. Also use for repair of STRUCTOCORE Security Wall system. Offers varied setting times of 20 to 30 min., 30 to 80 min., 85 to 130 min., 180 to 240 min. and 240 to 360 min.

### SHEETROCK Brand Lightweight Setting-Type Joint Compound (EASY SAND)

Weighs 25% less than conventional setting-type compounds for easier handling, faster application and improved productivity on the job. Provides sanding ease similar to a ready-mixed, all purpose joint compound. Offers varied setting times of 8 to 12 min., 20 to 30 min., 30 to 80 min., 85 to 130 min., 180 to 240 min. and 240 to 360 min.

### Prime Coat

#### SHEETROCK Brand First Coat

A flat latex basecoat paint formulated to provide a superior first (prime) coat over interior gypsum board and concrete surfaces. Equalizes differences between the porosity and texture variations of gypsum board face paper and finished joint compound to minimize decorating problems such as "joint banding." Applies with brush, roller or spray equipment. Dries to a white finish in less than 30 minutes; topcoat within an hour. Not intended as a final coating—should be overpainted when dry.

### Concrete Finishing Compound

#### COVER COAT Compound

A vinyl-base product, designed for filling and smoothing monolithic concrete ceilings and columns located above grade—no extra bonding agent needed. Supplied in ready-mixed form (sand can be added), easily applied with drywall tools in two or more coats. Dries to a fine white surface usually making further decoration unnecessary on ceilings.

**Limitations:** Not to be applied over moist surfaces or surfaces likely to become moist (by condensation or otherwise); on ceiling areas below grade; on surfaces which project outside the building, or on other areas which might be subject to moisture, freezing, efflorescence, pitting or popping. Not washable unpainted.

### Texture Finishes

United States Gypsum Company also produces the industry's broadest line of texture finishes to provide distinctive appearance and surface decoration to gypsum panel walls and ceilings. A full line of both ready-to-use and powder products is offered to create fine, medium or coarse simulated acoustic textures, sand finishes and interesting spatter, spatter/knockdown, "orange peel" or light to medium stipples. For available texture products, often applied by the same trade which finishes gypsum drywall, refer to *Textures* Folder SA933.

## Gypsum Panels & Accessories

### Decorative Interior Finish System

USG Decorative Interior Finish System is a gypsum-based finish system that puts color and texture together on interior drywall or basecoat plaster surfaces in a single application. The finish surface can be semi-smooth or finished with nearly any texture you can imagine. System is applied with a trowel, similar to veneer plaster. The system is less expensive to use and apply than other specialty colored finish materials. Colors can be mixed using a standard tint machine and COLORTREND 888 Universal Machine Colorants. USG recommends using only COLORTREND 888 Universal Machine Colorants. Colorants from other manufacturers are not recommended since they may not be compatible with USG materials, they may cause color variations and they may interfere with the intended product application. We recommend only the use of COLORTREND 888 Universal Machine Colorants, the basic USG color formulas with these colorants and custom colors created using the COLORTREND AMBIANCE Fan Deck Selector.

For standard colors using COLORTREND 888 Universal Machine Colorants, the formula selected will produce a five-gallon batch size. To create a custom color, select a color and formula from the fan deck and color formula book that represents a color somewhat darker than the color you desire as the finished, dried, surface color. Note that the shade of finished colors is dependent on many factors. Each color formula yields a slightly different degree of color lightness compared to the color swatch depicted in the fan deck selector. The texture applied and the consistency of the mixed mortar also effect the appearance of the finished surface, and therefore the color. Even the plaster product chosen (DIAMOND Brand Interior Finish, IMPERIAL Brand Basecoat Plaster, DIAMOND Brand Veneer Basecoat Plaster or IMPERIAL Brand Finish Plaster) for the mix can vary the resulting shade. Depending on these factors, the final dried finish can be up to several shades lighter than the color swatch depicted in the fan deck selector. Note also that when wet, the wet mixed mortar appears darker than the selected color swatch, but will lighten in color when set and dry.

For complete information on selecting and applying the appropriate system over drywall, plaster or an existing substrate, see P797 (drywall), P808 (existing substrate) and P809 (plaster).

#### Preparation

Embed tape over drywall joints and apply one coat of joint compound over joints, fasteners and beads/trims. Pretreat joint treated surfaces with SHEETROCK Brand Wall Covering Primer to minimize absorption differences between joint compound and face paper. After primer has dried, apply USG Plaster Bonder—Clear to all wall and ceiling surfaces.

#### Mixing

USG Decorative Interior Finish usually consists of DIAMOND Brand Interior Finish mixed with colorants and water, but IMPERIAL Basecoat Plaster, DIAMOND Brand Veneer Basecoat Plaster or IMPERIAL Brand Finish Plaster also may be used. Mix in 5-gal. pail (14" high, 10-1/4" bottom, 11-1/4" top). Use 6-1/2" of water per batch for DIAMOND Brand Interior Finish, 4-1/2" for DIAMOND Brand Veneer Basecoat Plaster, 4" for IMPERIAL Brand Basecoat Plaster, and 5" for IMPERIAL Brand Finish Plaster. Add the predetermined amount of colorant (COLORTREND Formula) to the water. The plaster is added to the water in three stages. First, fill the bucket with plaster and stir lightly with an on-and-off action using a 450 RPM 1/2" drill and blade-type (joint compound) mixing paddle. Add plaster to the top of the bucket and repeat stirring with on-and-off action. Add plaster a third time and mix completely, ensuring that no colored water splashes out of mixing container. Mix approximately 40-45 lbs. of DIAMOND Brand Interior Finish with the water, or 60 lbs. of DIAMOND Brand Veneer Basecoat Plaster or IMPERIAL Brand Basecoat Plaster, or 50 lbs. of IMPERIAL Brand Finish Plaster. These quantities should fill the container to about 1 to 1-1/2 inches from its top. Finish should be slightly thicker than normal. To ensure color uniformity, each batch must be mixed exactly the same way, by volume and to the same fluidity in a volume-specific container.

#### Application

Each wall or ceiling must be covered in a continuous application, always continuing joinings of separate mixes prior to either mix setting. Work walls and vaulted ceilings from top to bottom; ceilings from angle to angle. For one-coat semi-smooth texture, apply plaster in random, 1' to 2' strokes at a nominal 1/16" to 1/8" thickness, leaving lap marks as desired. After approx. 20 minutes from initial application, draw a trowel, held almost flat, lightly over the surface with short strokes in various directions. Trowel again as initial set begins (approx. 45 minutes). And again during final set to achieve the degree of burnishing desired. For two-coat heavy texture, apply first coat to a nominal thickness of approx. 1/8", covering the entire surface. When surface has firmed slightly, apply second coat in short strokes as described above. Two-coat thickness can vary from 1/8" to 1/4". Additional troweling of second coat should be as described above for one-coat finish.

#### Sealing

After finish has set and dried (approx. 24 hr.), apply USG Decorative Finish Sealer and maintain min. 55° F ( 13° C) temperature. Do not shake or box-mix sealer. Apply using brush, roller or sprayer with 0.015" to 0.023" tip. Initially, sealer will appear milky, but will dry clear and colorless. Immediately wipe any drips or puddles from the surface while still wet with a clean, dry cloth.



## Gypsum Panels & Accessories

<b>Wood Framing Requirements</b>	<ol style="list-style-type: none"> <li>1 Framework should meet the minimum requirements of local building codes.</li> <li>2 Framing members should be straight, true, of uniform dimension, and framing should be properly aligned.</li> <li>3 All framing lumber should be of a good grade for the intended use, and 2" x 4" nominal size or larger should bear the grade mark of a recognized inspection agency.</li> <li>4 All framing lumber should have a moisture content not in excess of 19% at time of gypsum panel application.</li> <li>5 Do not attach panels to extremely soft framing members.</li> </ol> <p>Failure to observe these minimum framing requirements, which are applicable to screw, nail and adhesive attachment, will materially increase the possibility of fastener failure and surface distortion, due to warping or dimensional changes.</p> <p>Framing should approach in-service moisture content as closely as possible. Allow the building, after it is enclosed, to stand as long as possible prior to the application of the gypsum panels.</p>
<b>Good Design Practices</b>	<p>This section is an overview of design, application, installation and safety concerns that should be addressed when USG's products and systems are used at professional construction sites or at home in do-it-yourself projects. This section is not intended to be a comprehensive review but instead outline some major issues. No attempt is made at completeness. We recommend that architects and contractors seek the assistance of safety professionals, especially at the professional construction site, because there are many factors to be considered that are not included here. In addition, for more detailed information and references, please refer to Chapter 13 of the USG Gypsum Construction Handbook, Centennial Edition.</p>
<b>1 Specifications</b>	<p>The following comments and recommendations cover basic specifications for normal job requirements and are intended as minimum guide specifications which can be adapted to specific projects and conditions. These specifications are not intended to cover every possible design or job condition, but rather to assist in preparation of specifications.</p>
<b>2 Related Systems</b>	<p>Description, details and specifications on various systems are covered in these pertinent USG Corporation folders:</p> <ul style="list-style-type: none"> <li>SA700 USG Exterior Systems</li> <li>SA707 THERMAFIBER Life-Safety Fire Containment Systems</li> <li>SA727 USG Fire Stop Systems</li> <li>SA923 Drywall/Steel Framed Systems</li> <li>SA924 Drywall/Wood Framed Systems</li> <li>SA925 USG Area Separation Fire Wall/Party Wall Systems</li> <li>SA926 USG Cavity Shaft Wall Systems</li> <li>SA932 DUROCK Brand Cement Board Systems</li> <li>SA933 SHEETROCK Brand Textures and Finishing Products</li> </ul>
<b>3 Protection</b>	<p>Light gauge metal components such as steel studs and runners, furring channels and resilient channels should be given adequate protection in the warehouse and on the jobsite against rusting caused by moisture. In marine areas such as the Caribbean, Florida and the Gulf Coast where chloride and sea salt are present in combination with excessively high humidity, use of components which offer increased protection against corrosion is recommended.</p>
<b>4 Shadowing and Spotting</b>	<p>Temperature differentials on the interior surface of exterior walls may result in collection of airborne dirt on the colder surface areas. Consequently accumulated dirt in the form of shadowing and spotting may occur at locations of fasteners or framing where surface temperatures usually are lowest. This is a natural phenomenon which occurs through no fault of the products.</p> <p>Where temperature, humidity and soiling conditions are expected to cause objectionable shadowing and spotting, one of the following alternatives should be considered:</p> <ol style="list-style-type: none"> <li><b>A</b> The interior facing of SHEETROCK Brand Gypsum Panels, Foil-Back, should be furred from the exterior wall studs using a base layer of panels screw-attached to the studs and horizontally applied metal furring channels spaced 24" o.c.</li> <li><b>B</b> On exterior masonry walls, install rigid or semi-rigid insulation between Z-Furring channels affixed to the interior side of wall and finish with SHEETROCK Brand Gypsum Panels, Foil-Back.</li> <li><b>C</b> For maximum resistance to shadowing and spotting, a separate free-standing wall construction is recommended using studs that are independent of the exterior wall.</li> </ol>
<b>5 Painting Systems</b>	<p>For satisfactory results, painting products and systems should be used which comply with recommendations and requirements in Appendixes of ASTM C840.</p>

## Gypsum Panels & Accessories

		<p>For priming and decorating with paint, texture or wall covering, follow manufacturer's directions for materials used. All surfaces, including applied joint compound, must be thoroughly dry, dust-free, and not glossy. Prime with SHEETROCK Brand First Coat or with an undiluted, interior latex flat paint with high-solids content. Allow to dry before decorating.</p> <p>To improve fastener concealment, where gypsum panel walls and ceilings will be subjected to severe artificial or natural side lighting and be decorated with a gloss paint (egg shell, semi-gloss or gloss), the gypsum panel surface should be skim coated with joint compound to equalize suction and texture differences between the drywall face paper and the finished joint compound before painting.</p>
	<b>6 Note</b>	United States Gypsum Company reserves the right to make changes or improvements in the design of all cataloged items without notice and without obligation to incorporate these changes or improvements in items already manufactured.
	<b>7 Additional Information</b>	See United States Gypsum Company technical folders in this series and in Sweet's General Building File.
<b>Part 1: General</b>	<b>1.1 Scope</b>	Specify to meet project requirements.
	<b>1.2 Qualifications</b>	<p>All material described in this Folder manufactured by or for United States Gypsum Company shall be installed in accordance with its current printed directions.</p> <p>All studs, runners and other accessories identified as USG or SHEETROCK Brand products in this catalog are marketed by United States Gypsum Company as integral components of our gypsum board systems. Upon request United States Gypsum Company will provide certification that these products conform to the applicable Company and ASTM standards as well as meet the performance values identified herein.</p>
	<b>1.3 Delivery and Storage of Materials</b>	All materials shall be delivered in their original unopened packages and stored in an enclosed shelter providing protection from damage and exposure to the elements. Damaged or deteriorated materials shall be removed from the premises. <b>Warning:</b> Store all SHEETROCK Brand Gypsum Panels flat. Panels are heavy and can fall over, causing serious injury or death. Do not move unless authorized.
	<b>1.4 Environmental Conditions</b>	In cold weather and during gypsum panel joint finishing, temperatures within the building shall be maintained within the range of 55 to 70 °F (13 to 21 °C). Adequate ventilation shall be provided to carry off excess moisture.
<b>Part 2: Products</b>	<b>2.1 Materials</b>	<p><b>A Interior Panels</b></p> <ul style="list-style-type: none"> <li>– Gypsum Panels (in lengths as long as practical to minimize number of joints): SHEETROCK Brand (Regular, SW Edge, FIRECODE Core, FIRECODE C Core, ULTRACODE Core) Gypsum Panels (thickness). SHEETROCK Brand Foil-Back (Regular, SW Edge, FIRECODE Core, FIRECODE C Core) Gypsum Panels (thickness). SHEETROCK Brand Water-Resistant (Regular, FIRECODE Core, FIRECODE C Core) Gypsum Panels (thickness). SHEETROCK Brand Flexible Gypsum Panels. SHEETROCK Brand Abuse-Resistant Gypsum Panels (Regular, FIRECODE Core) SHEETROCK Brand Vinyl-Faced Gypsum Panels (type) (pattern) (thickness).</li> <li>– Gypsum Liner Panels: SHEETROCK Brand Gypsum (Liner Panel) (length).</li> <li>– Interior Ceiling Board: SHEETROCK Brand Interior Gypsum Ceiling Board (length).</li> </ul> <p><b>B Exterior Panels</b></p> <ul style="list-style-type: none"> <li>– Gypsum Sheathing: (SHEETROCK Brand Gypsum Sheathing, GYP-LAP Gypsum Sheathing) (FIRECODE) (size) (thickness).</li> <li>– Exterior Ceiling Board: SHEETROCK Brand Exterior Gypsum Ceiling Board (thickness).</li> </ul> <p><b>C USG Cavity Shaft Wall &amp; Area Separation Fire/Party Wall</b></p> <ul style="list-style-type: none"> <li>– Cavity-Type Area Separation Wall Materials: USG Steel CR-Runners (style), USG Steel C-H Studs and E-Studs (style), USG Aluminum Breakaway Clip.</li> <li>– Cavity Shaft Wall Materials: USG Steel J-Runners (style), USG Steel C-H Studs (style), USG Steel E-Studs (style), USG Steel Jamb Struts (style).</li> <li>– Solid-Type Area Separation Wall Materials: USG Steel CR-Runners (style), USG Steel H-Studs (style), USG Aluminum Breakaway Clip.</li> </ul> <p><b>D Furring Accessories</b></p> <ul style="list-style-type: none"> <li>– Metal Furring Materials: (Metal Furring Channels and Clips) (Adjustable Wall Furring Brackets) (Cold-Rolled Channels 3/4" or 1-1/2") (Z-Furring Channels).</li> <li>– Resilient Channels: RC-1 Resilient Channel or equivalent.</li> </ul>

## Gypsum Panels & Accessories

- E Fasteners**
- Drywall Screws: size: (3/8")(7/16")(1/2")(1")(1-1/4")(1-1/2")(1-5/8")(2")(2-1/4")(2-1/2")(3") style: (framing—Type S or S-12)(drywall—Type S)(self-drilling—Type S-12)(laminating—Type G)(coarse thread—Type W) head: (bugle)(pan)(trim)(pancake)(low-profile)(mod. truss head) coating: (reg)(corrosion-resistant).
  - Drywall Nails: (length)(type)(conforming with ASTM C514)(as specified in fire-resistive construction).
- F Adhesives**
- Drywall Adhesives: (SHEETROCK Brand Setting-Type (DURABOND) or Lightweight Setting-Type (EASY SAND) Joint Compound 210 or 90) (SHEETROCK Brand All Purpose or Taping Joint Compound Ready-Mixed).
- G Insulation**
- THERMAFIBER Sound Attenuation Fire Blankets (thickness)(width).
- H Trim Accessories**
- SHEETROCK Brand Paper Faced Metal Bead and Trim**
- Corner Reinforcement: outside corners (B1W, B1XWEL, B1 Super Wide), inside corners (B2, SLIC), and bull-nose corners (SLOC, Danish and Santa Fe) in various lengths.
  - Trim: “L” (B4 SERIES) and “J” (B9) shapes and reveal in various lengths.
- Metal Bead and Trim**
- Corner Reinforcement: DUR-A-BEAD® Corner Bead No. 103, 800 and Speed Bead in various lengths.
  - Trim: 200 A and 200 B in 1/2" and 5/8", 401 or 402, 801 A and 802 B in 1/2" or 5/8" in various lengths..
- Corner Angles**
- Metal Angles: 2-1/2" x 2-1/2" x 24 ga. Corrosion-resistant steel, lengths as required.
- Control Joint**
- Zinc Control Joint No. 093.
- I Plastic Trim Mouldings**
- Plastic Trim: (RP or RPV Series), Vinyl Trim.
- J Finishing Products**
- Joint Treatment: SHEETROCK Brand Joint Tape. SHEETROCK Brand Fiberglass Drywall Tape (must use a setting-type joint compound for first coat over tape). SHEETROCK Brand Setting-Type (DURABOND) or Lightweight Setting-Type (EASY SAND) Joint Compound (20, 45, 90, 210, 300). SHEETROCK Brand Joint Compound (Taping, Topping, All Purpose). SHEETROCK Brand Lightweight All Purpose Joint Compound (AP LITE). SHEETROCK Brand Ready-Mixed Joint Compound (Taping, Topping, All Purpose, Multi-Purpose). SHEETROCK Brand Lightweight All Purpose Joint Compound Ready-Mixed (PLUS 3). SHEETROCK Brand All Purpose Joint Compound, Ready-Mixed (MIDWEIGHT).
  - Concrete Finishing Compound: (SHEETROCK Brand Setting-Type (DURABOND) or Lightweight Setting-Type (EASY SAND) Joint Compound) (COVER COAT Compound) (as ready-mixed) (with sand additive).
- K Firestop**
- Firestop Materials: FIRECODE Compound, THERMAFIBER SMOKE SEAL Compound, FIRECODE Acrylic Firestop Sealant, FIRECODE SA Acrylic Firestop Sealant, FIRECODE IA Intumescent Acrylic Firestop Sealant.
- L Acoustical Sealant**
- Sealant: SHEETROCK Brand Acoustical Sealant.
- M Decorating**
- Prime Coat: SHEETROCK Brand First Coat.
- Decorative Colored Finish System: USG Decorative Interior Finish System.

### Part 3: Execution

#### 3.1 Gypsum Panel Application

##### 3.1.1 Basic Single-Layer System, Treated Joints

- A** Position all ends and edges of all gypsum panels over framing members, except when joints are at right angles to framing members as in perpendicular application or when end joints are backblocked.
- B** Apply gypsum panels first to the ceiling and then to the walls. Extend ceiling board into corners and make firm contact with top plate. To minimize end joints, use panels of maximum practical lengths. Fit ends and edges closely, but not forced together. Stagger end joints in successive courses with joints on opposite sides of a partition placed on different studs.
- C** Attach panels to framing supports by: (Standard Single Nailing Method) (Adhesive Application) (Double Nailing Method) (Power-driven Screws). Space fasteners not less than 3/8" from edges and ends of panels and drive as recommended for specified fastening method. Drive fasteners in field of panels first, working toward ends and edges. Hold panel in firm contact with framing while driving fasteners. Drive fastener heads slightly below surface of gypsum panels in a uniform dimple without breaking face paper.

## Gypsum Panels & Accessories

	<p><b>D</b> Cut ends, edges, scribe or make cutouts within field of panels in a workmanlike manner. Gypsum board should be cut to size utilizing a knife and a straight edge. A power saw should be used only if it is equipped with a dust collection device.</p> <p><b>E</b> Install trim at all internal and external angles formed by the intersection of either panel surfaces or other surfaces. Apply corner bead to all vertical or horizontal external corners in accordance with manufacturer's directions. (Multilayer systems: see pertinent United States Gypsum Company System Folders.)</p> <p><b>3.1.2 SHEETROCK Brand Gypsum Panels—Water Resistant</b> (see United States Gypsum Company Folder SA924.)</p> <p><b>3.1.3 Lamination of Gypsum Panels to Interior Monolithic Concrete and Unit Masonry</b></p> <p><b>A</b> The masonry or concrete shall be clean, smooth and dry prior to application. If wood base is to be used, attach wood nailer to wall before lamination is started.</p> <p><b>B</b> Cut face panels to allow continuous clearance (1/8" to 1/4") at floor. Apply SHEETROCK Brand Setting-Type (DURABOND) or Lightweight Setting-Type (EASY SAND) Joint Compound, or SHEETROCK Brand All Purpose or Taping Joint Compound Ready-Mixed at center and near each panel edge in strips consisting of 4 beads, 3/8" wide x 1/2" high and spaced 1-1/2" to 2" o.c. Position panels vertically over wall surface, press into place and provide temporary support until adhesive is hardened.</p> <p><b>C</b> Install trim at all intersections of panel surfaces with other surfaces.</p> <p><b>D</b> Lamination to interiors below grade or directly to interior surfaces of exterior walls, and lamination where exposure to moisture is extreme or continuous, are not recommended.</p>
<b>3.2 RC-1 Resilient Channel Erection (or equivalent)</b>	(See specifications in Systems Folders SA923 and SA924.)
<b>3.3 Steel Stud and Runner Erection</b>	(See specifications in Systems Folder SA923.)
<b>3.4 Metal Furring Channel Erection</b>	(See specifications in Systems Folder SA923.)
<b>3.5 USG High Performance Floor/Ceiling Erection</b>	(See specifications in Systems Folder SA924.)
<b>3.6 USG Area Separation Wall Erection</b>	(See specifications in Systems Folder SA925.)
<b>3.7 USG Cavity Shaft Wall Erection</b>	(See specifications in Systems Folder SA926.)
<b>3.8 Control Joint Installation</b>	Attach Zinc Control Joint No. 093 with Bostitch 9/16" "G" staples or equal spaced not over 6" apart in each flange. Cut end joints square and align for neat fit. Remove protective tape when joint treatment is completed.
<b>3.9 Fastener and Adhesive Application</b>	<p><b>3.9.1 Drywall Screws:</b> Power-drive with an electric screw gun so screwheads provide a slight depression below surface of gypsum panels without breaking face paper. Do not drive screws closer than 3/8" from edges and ends of gypsum panels.</p> <p><b>3.9.2 Nails:</b> Drive nails with heads slightly below gypsum panel surface in a uniform dimple 1/32" deep formed by crowned face of hammer. Drive nails no closer than 3/8" from edges and ends of panel.</p> <p><b>3.9.3 Adhesive</b> Mix and apply in accordance with manufacturer's directions, and as follows:</p> <p><b>A</b> Apply SHEETROCK Brand Setting-Type (DURABOND) or Lightweight Setting-Type (EASY SAND) Joint Compound in the prescribed manner to back of face panels to be laminated. Laminate face panels to (base layer panels) (coreboard) using moderate pressure and temporary nailing or shoring to ensure adequate bond.</p> <p><b>B</b> Apply stud adhesive in a continuous 3/8" bead at center of attachment to face of framing members. Where two gypsum panels meet on a framing member, apply two parallel beads on face of framing at panel joints. Do not apply adhesive to members such as bridging, diagonal bracing, etc., into which no supplemental fasteners will be driven. Immediately following contact of panel to adhesive, apply necessary fasteners 16" o.c. around</p>

## Gypsum Panels & Accessories

perimeter of panel, 3/8" away from edges and ends. On ceilings only, apply one temporary field fastener per framing member at mid-width of board; remove after 24 hours. With predecorated panels pre-bowed and applied vertically, use permanent fasteners only at top and bottom of panel.

- C** Apply laminating adhesive in strips to center and along both edges of gypsum face panel. Apply strips with a notched metal spreader having four 1/4" x 1/4" minimum notches spaced max. 2" o.c. Position face panels against base panels; fasten at top and bottom (vertical application) as required. For laminated ceilings, space fasteners 16" o.c. along edges and ends, with one permanent field fastener per framing member installed at mid-width of panel. Press panel into place with firm pressure to ensure bond; press again within 24 hr. if necessary.
- D** Apply liquid contact adhesive with a short nap paint roller to cover both contact surfaces according to adhesive manufacturer's directions. Let adhesive air dry to the touch. Apply panels as soon as possible after drying occurs. On walls, fasten 16" o.c. at top and bottom (vertical application) as required. In ceiling lamination, apply permanent supplementary fasteners at each corner of panel, and along edges spaced max. 48" o.c. Press panel into place with firm pressure to ensure bond.
- E** Apply construction adhesive in continuous 3/8" beads to framing. On walls, apply a continuous adhesive bead to center of studs to within 6" of board perimeter. At panel joints, apply two adhesive beads—one at a time—as each panel is installed. Do not apply adhesive at inside corners or to top and bottom plates, bridging, bracing and fire stops. Apply no more adhesive than can be covered in 15 min. Set panel in place, fasten 16" o.c. along top and bottom of panel and impact by hand along stud.

### 3.10 Pre-Fill Application

- A** Mix SHEETROCK Brand Setting-Type (DURABOND) or Lightweight Setting-Type (EASY SAND) Joint Compound according to directions on bag. Do not overmix, or use extremely cold water or cold joint compound.
- B** Pre-fill all "V"-grooves formed by abutting tapered eased edges of SHEETROCK Brand Gypsum Panels, SW Edge, with SHEETROCK Brand Setting-Type (DURABOND) or Lightweight Setting-Type (EASY SAND) Joint Compound using a flexible 5" or 6" joint finishing knife or Ames Pre-Fill Tool. Fill "V" joint flush and wipe off excess compound beyond the "V" groove, leaving a clear depression to receive tape. Allow pre-fill to harden prior to the next application (tape or embedding coat).

### 3.11 Interior Joint System Application

#### 3.11.1 SHEETROCK Brand Joint Tape

- A** Mix joint compound in strict accordance with manufacturer's recommendations.
- B** Apply joint compound in a thin uniform layer to all joints and angles to be reinforced. Immediately apply SHEETROCK Brand Joint Tape centered over joint and seated into compound. Sufficient compound—approx. 1/64" to 1/32"—must remain under the tape to provide proper bond. Follow immediately with a thin skim coat to embed tape, but not to function as a second coat. Fold and embed tape properly in all interior angles to provide a true angle. The tape or embedding coat must be thoroughly dry prior to application of second coat. (Exception: DURABOND Setting-Type and EASY SAND Lightweight Setting-Type Joint Compounds need only have hardened prior to application of next coat.)
- C** Apply second coat of joint compound over embedding coat, filling panel taper flush with surface; cover tape and feather out at least 2" beyond first coat. On joints with no taper, cover the tape and feather out at least 4" on either side of tape. Allow second coat to dry thoroughly prior to application of finish coat. (Exception: DURABOND Setting-Type and EASY SAND Lightweight Setting-Type Joint Compounds need only have hardened prior to second coat application.)
- D** Spread finish coat evenly over and extend at least 2" beyond second coat on all joints and feather to a smooth uniform finish. Do not allow finished joint to protrude beyond plane of the surface. Apply a finish coat to cover tape and taping compound at all tapered angles and provide a true angle. Where necessary, sand lightly between coats and following the final application of compound to provide a smooth surface ready for decoration. When sanding take care not to roughen face paper.

#### 3.11.2 SHEETROCK Brand Fiberglass Drywall Tape

- A** Mix joint compound in strict accordance with manufacturer's recommendations.
- B** Center and apply SHEETROCK Brand Fiberglass Drywall Tape directly over joint, pressing tape firmly so that it adheres evenly to surface. To eliminate wrinkles and ensure maximum bond, press entire length of tape with drywall knife. Avoid overlapping tape at intersections. Cut tape with drywall knife.
- C** Cover with a layer of SHEETROCK Brand Setting-Type (DURABOND) or Lightweight Setting-Type (EASY SAND) Joint Compound, forcing compound through the tape with a drywall knife/trowel to completely fill and level the joint. Failure to completely fill the joint may result in cracking. Let dry and sand lightly as required.
- D** Apply second coat of SHEETROCK Brand Setting-Type (DURABOND) or Lightweight Setting-Type (EASY SAND) Joint Compound, or SHEETROCK Brand Drying-Type Joint Compound (powder or ready-mixed), feathering approximately 2" beyond first coat. Let dry and sand lightly as required.

## Gypsum Panels & Accessories

<p><b>3.12</b> <b>Finishing Fasteners</b></p>	<p>Apply a setting-type, or all-purpose or lightweight all-purpose compound to fastener depressions as the first coat. Follow with a minimum of two additional coats of topping or all-purpose compound, leaving all depressions level with the surface. (Exception: Setting-type and lightweight all-purpose joint compounds need only one additional coat.)</p>
<p><b>3.13</b> <b>Finishing Bead and Trim</b></p>	<p><b>3.13.1 SHEETROCK Brand Paper Faced Metal Drywall Bead and Trim</b></p> <p><b>A</b> Apply compound to both sides of corner, extending 2" on each side for outer corners, 1-1/2" for inside corners. Cut bead to desired length; align tight to ceiling and press firmly with fingers along length of corner to set. Do not bend bead. Run taping knife over corner at a 45° angle with even pressure. Remove excess compound using knife to eliminate air bubbles under paper. Allow to dry.</p> <p><b>B</b> For outer corners, apply another coat of compound to both sides, feathering out 5" to 6" on each side. Let dry; sand lightly as necessary. For inner corners, apply fill coat to one side, feathering out 1". Let dry. Apply fill coat to other side using same procedure. Let dry. Sand lightly where necessary.</p> <p><b>C</b> For outer corner, apply finishing coat, feathering 8" from nose of bead. Draw knife along one side of bead with one edge resting on nose of bead and other on surface of wallboard. Repeat for other side. Let dry. Sand and prime. For inner corners, apply finishing coat to one side, feathering 1" past previous coat. Let dry. Apply finishing coat to other side. Let dry. Sand and prime.</p> <p><b>3.13.2 Other Bead and Trim</b></p> <p><b>A</b> Apply first coat to all bead and trim and properly feather out from ground to plane of surface. Compound must thoroughly dry prior to application of second coat. (Exception: SHEETROCK Brand Setting-Type (DURABOND) and Lightweight Setting-Type (EASY SAND) Joint Compounds need only have hardened prior to application of next coat.)</p> <p><b>B</b> Apply second coat in same manner as first coat, extending compound slightly beyond face of panel. Compound must be thoroughly dry prior to application of finish coat. (Exception: Setting-type joint compounds need only have hardened prior to application of next coat.)</p> <p><b>C</b> Apply finish coat to all bead and trim, extending compound slightly beyond the second coat and properly feathering from ground to plane of surface. (Exception: Only two coats of SHEETROCK Brand Setting-Type (DURABOND) or Lightweight Setting-Type (EASY SAND) Joint Compound or SHEETROCK Brand All Purpose Joint Compound Ready-Mixed (PLUS 3) are needed.) When dry, sand finish as necessary to provide a flat smooth surface ready for decoration. When sanding, take care not to roughen face paper.</p>
<p><b>3.14</b> <b>Exterior Joint System Application</b></p>	<p><b>A</b> Mix SHEETROCK Brand Setting-Type (DURABOND) or Lightweight Setting-Type (EASY SAND) Joint Compound according to directions on the bag. Do not overmix, nor use in temperatures below 45 °F.</p> <p><b>B</b> Prefill joints of SHEETROCK Brand Exterior Gypsum Ceiling Board with SHEETROCK Brand Setting-Type (DURABOND) or Lightweight Setting-Type (EASY SAND) Joint Compound. After prefill has hardened, embed SHEETROCK Brand Joint Tape centered over joint. When compound has hardened, immediately apply fill coat.</p> <p><b>C</b> Apply SHEETROCK Brand Setting-Type (DURABOND) or Lightweight Setting-Type (EASY SAND) Joint Compound over flanges of Zinc Control Joints, metal beads and trim. Spot fastener heads.</p> <p><b>D</b> After fill coat has hardened, apply finishing coat of SHEETROCK Brand Setting-Type (DURABOND) or Lightweight Setting-Type (EASY SAND) Joint Compound. Completely cover all joints, angles, beads, control joints and fasteners. <b>Note:</b> After SHEETROCK Brand Setting-Type (DURABOND) or Lightweight Setting-Type (EASY SAND) Joint Compound has dried, apply one coat oil-based primer-sealer and one coat exterior oil or latex paint over entire surface.</p>
<p><b>3.15</b> <b>Filling and Finishing Interior Concrete</b></p>	<p><b>A</b> Concrete surfaces shall be clean, smooth, dry and free from contaminants and exposed metal protected with a rust-inhibitive primer and allowed to dry.</p> <p><b>B</b> Fill offsets and voids with a SHEETROCK Brand Setting-Type (DURABOND) or Lightweight Setting-Type (EASY SAND) Joint Compound.</p> <p><b>C</b> Mix (COVER COAT Compound) (SHEETROCK Brand Setting-Type (DURABOND) or Lightweight Setting-Type (EASY SAND) Joint Compound) according to manufacturer's directions and apply to concrete (ceilings) (columns) before interior partitions are erected. Coordinate application of corner bead on angles and corners as required, embedding and covering both flanges with a smooth fill of compound 3" to 4" wide. Apply sufficient coats to obtain a smooth surface. If SHEETROCK Brand Setting-Type Joint Compound (DURABOND) is used, and if an easier sanding surface is desired, then apply a skim coat of COVER COAT Compound over entire surface. After compound has dried, sand to a smooth surface suitable for decoration.</p>

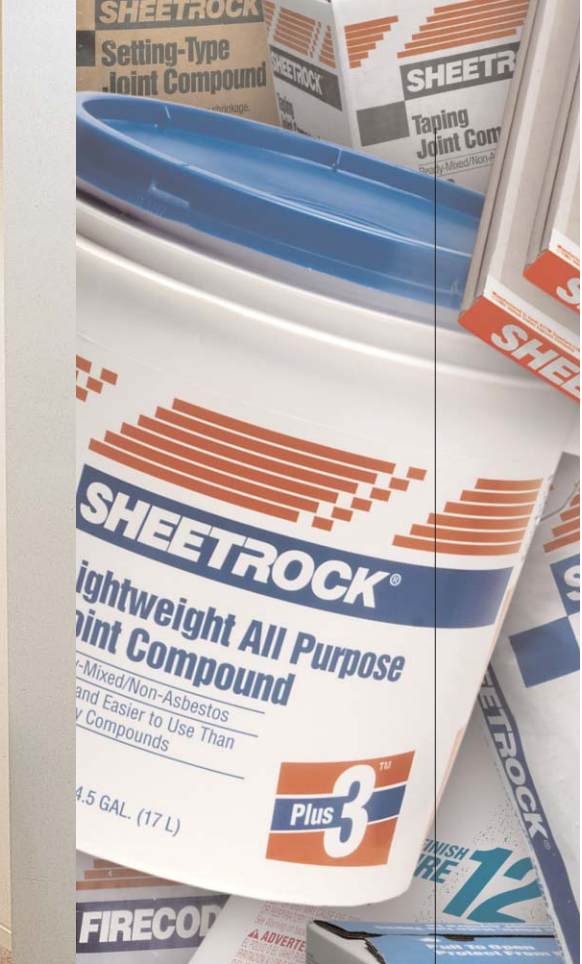

**Technical Service**  
**800 USG.4YOU**

**Website**  
**www.usg.com**

**Samples/Literature**  
**888 874.2450**

**Samples/Literature E-mail**  
**samplit@usg.com**

**Samples/Literature/Fax**  
**888 874.2348**

**Customer Service**  
**800 950.3839**

These samples show colors that are as close as possible to actual products. Colors are checked by spectrophotometric analysis according to the "L.a.b." chromaticity coordinates system. Color-matching of coatings is within normally accepted commercial tolerance.

**Note**  
All products described here may not be available in all geographic markets. Consult your local sales office or representative for information.

**Trademarks**  
The following are trademarks of USG Interiors, Inc. or a related company: CELEBRATION, COLOR SOLUTIONS, COMPASSO, CURVATURA, PANZ, USG.

**Notice**  
We shall not be liable for incidental and consequential damages, directly or indirectly sustained, nor for any loss caused by application of these goods not in accordance with current printed instructions or for other than the intended use.

Our liability is expressly limited to replacement of defective goods. Any claim shall be deemed waived unless made in writing to us within thirty (30) days from date it was or reasonably should have been discovered.

**Safety First!**  
Follow good safety and industrial hygiene practices during handling and installing of all products and systems. Take necessary precautions and wear the appropriate personal protective equipment as needed. Read material safety data sheets and related literature on products before specification and/or installation.



Manufactured by  
United States Gypsum Company  
125 South Franklin Street  
Chicago, IL 60606

© 2002, USG Corporation  
SA927/rev. 3-02  
Printed in U.S.A.