

CO-OP MEETING SPACES

designed by qdesign



SIN #711-16

GENERAL PRODUCT FEATURES:

- Excluding the back and seat cushions, fabric upholstery will always be railroaded.
- All models standard with 2" high black plinth base only.
- Tables, accent tier and shelf available in Maple, Walnut and White Oak wood species.
- All standard and custom wood finishes available.
- For custom wood finishes (to tables, accent tier and/or shelf), please add one-time upcharge of \$400 List per color per order.
- Laminate available in all Arcadia standard laminates.
- Custom laminates available, contact Customer Service for pricing.
- Unless specified, wood grain direction will run horizontally on accent tier and lengthwise on all tables.
- Table bases and shelf support posts available in standard and premium metal finishes.
- For premium metal finishes, please refer to applicable sections for upcharge amounts.
- When specifying electrical or overhead LED light fixture, cord exit grommet placement must be specified as well as power source location, as applicable. Refer to power units on page 8 for placement specifications.
- **All units with the exception of single modules and 3-sided models, must be either floor mounted (hardware provided) or weighted with sandbags (50 lbs. per side for lounge models and 150 lbs. each side for love seat units).**
- **DISCLAIMER: ARCADIA CANNOT BE HELD RESPONSIBLE IF FLOOR MOUNTING OR WEIGHTS ARE NOT UTILIZED FOR INSTALLATION.**
- Please refer to pages 43-54 for multi-tone yardage requirements and applicable pricing.
- Field-assembly required for all seating models with canopy, units with integrated tables and wall-mount panels, as well as linking tables, cantilever tables and shelf.
- Mounting hardware provided for linking tables, cantilever tables and shelf.
- Linking tables, cantilever tables and shelf cannot be retro-fit to seating units previously ordered. Please include layout to ensure units are mounted to the appropriate side of seating models.

INTEGRATED TABLE, FREE-STANDING TABLE, CANTILEVER TABLE AND SHELF EDGE DETAIL:

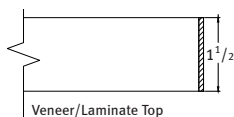

- Table/shelf with veneer top, wood edge finish will match top finish color, unless otherwise specified.
- Table/shelf with Arcadia standard laminate top, self edge is standard, unless otherwise specified (laminate applied to edge).

STANDARD FINISH COLORS (FOR TABLE SUPPORT POST, SHELF POST AND FREE-STANDING TABLE BASE):

#82 Graphite	#91 Chrome
#95 Satin Black	#90 Metallic Silver

PREMIUM FINISH COLORS (FOR TABLE SUPPORT POST, SHELF POST AND FREE-STANDING TABLE BASE):

#77 Sunshine	#89 Granny Smith
#80 Clementine	#94 Cotton
#83 Metallic Champagne	#98 Pacific
#87 Poppy	#99 Glossy Black
#88 Pink Flamingo	

CO-OP MEETING SPACES

designed by qdesign



SIN #711-16

SINGLE MODULE PRODUCT FEATURES:

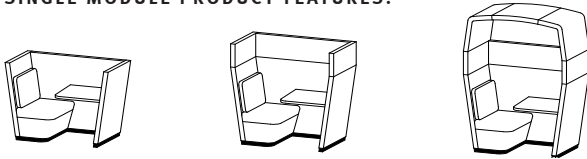

- Public free-standing, private free-standing and private free-standing with full canopy offered.
- Accent tier panel available in upholstery, veneer, laminate or whiteboard material. Refer to Accent Tier product features section (page 5) for information.
- Modules come standard with 27" high integrated table.
- Integrated table available in Maple, Walnut and White Oak veneer, as well as laminate selections.
- Overhead recessed LED swivel light available on full canopy models. Single fixture measures 2⁵/₈" in diameter and draws 3 watts. Features touch-controlled power button next to seat back cushion.
- Power units available on front and side of seating units and on tables. Position must be specified, in addition to cord exit grommet placement and power source location, as applicable.

PUBLIC THREE-SIDED UNIT PRODUCT FEATURES:

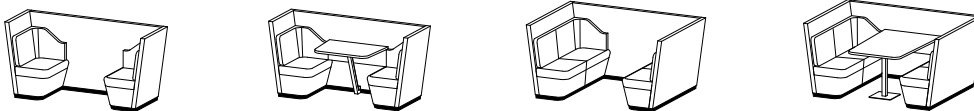

- Lounge and love seat models, measuring 43¹/₂" in height.
- Offered with, and without, 27" high integrated table.
- Integrated table available in Maple, Walnut and White Oak veneer, as well as laminate selections.
- Table support post available in standard and premium metal finishes.
- Power units available on front and side of seating units and on tables. Position must be specified, in addition to cord exit grommet placement and power source location, as applicable.

PRIVATE THREE-SIDED UNIT PRODUCT FEATURES:

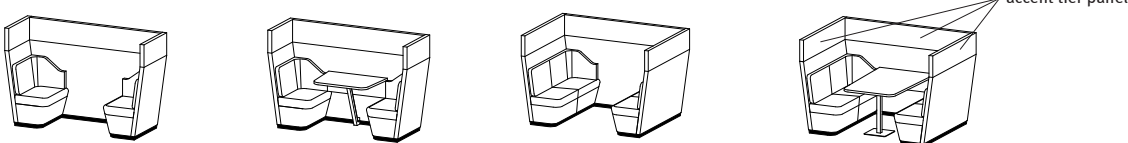

- Single Modules, Lounge and love seat models, measuring 56³/₄" in height.
- Accent tier panel available in upholstery, veneer, laminate or whiteboard material. Refer to Accent Tier product features section (page 5) for information.
- Offered with, and without, 27" high integrated table.
- Integrated table available in Maple, Walnut and White Oak veneer as well as laminate selections.
- Table support post available in standard and premium metal finishes.
- Power units available on front and side of seating units and on tables. Position must be specified, in addition to cord exit grommet placement and power source location, as applicable.
- Monitor-ready mounting option includes a PB5 table-mounted power unit. Monitor and mount not included. Refer to page 8 for standard grommet locations.

CO-OP MEETING SPACES

designed by qdesign



SIN #711-16

PRIVATE THREE-SIDED UNIT WITH CANOPY PRODUCT FEATURES:

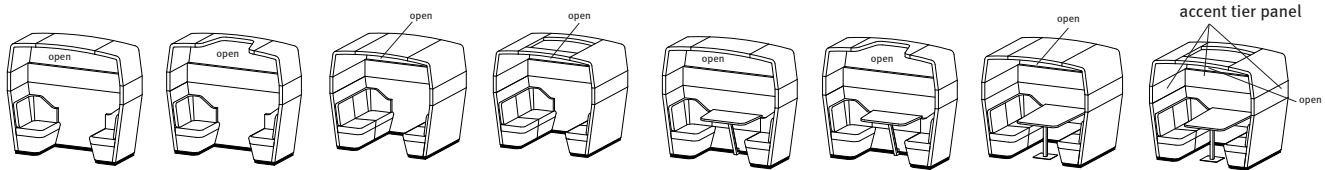

- Lounge and love seat models, measuring 88¹/₂" in height, available with full, partial or open canopy.
- **Note: Canopy not available with polyurethane or vinyl upholstery.**
- Accent tier panel available in upholstery, veneer, laminate or whiteboard material. Refer to Accent Tier product features section (page 5).
- Offered with, and without, 27" high integrated table.
- Integrated table available in Maple, Walnut and White Oak veneer, as well as laminate selections.
- Table support post available in standard and premium metal finishes.
- Overhead recessed LED swivel light available on full canopy models. Measuring 2⁵/₈" in diameter and drawing 3 watts each, lounge units come with one fixture, and love seats come with two fixtures. Features touch-controlled power button on right or left side of seats, please specify location.
- Cantilever table and shelf available on love seat models only. Refer to individual product features section for information.
- Power units available on front and side of seating units and on tables.
- When specifying electrical or overhead LED light fixture, cord exit grommet placement must be specified, as well as power source location, as applicable.
- Optional linking table (to place between two private love seat units) and storage cubby (for use in side-to-side applications) ordered separately. Refer to individual product features section for information.
- Monitor-ready mounting option includes a PB5 table-mounted power unit. Monitor and mount not included. Refer to page 8 for standard grommet locations.

BOOTH PRODUCT FEATURES:

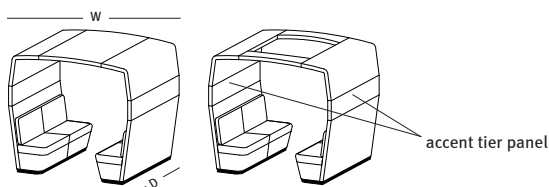

- Available in 60" and 72" depths, measuring 88¹/₂" in height, with full or open canopy.
- **Note: Canopy not available with polyurethane or vinyl upholstery.**
- Accent tier panel available in upholstery, veneer, laminate or whiteboard material. Refer to Accent Tier product features section (page 5).
- Overhead recessed LED swivel light available on full canopy models. Comes with two fixtures, measuring 2⁵/₈" in diameter and drawing 3 watts each. Features touch-controlled power button on right or left side of seats, please specify location.
- Power units available on front and side of seating units.
- When specifying electrical or overhead LED light fixture, cord exit grommet placement must be specified, as well as power source location, as applicable.
- Optional cantilever table and shelf available. Refer to individual product features section for information.
- Optional linking table (to place between two private love seat units) and storage cubby (for use in back-to-back applications) ordered separately. Refer to individual product features section for information.
- Free-standing tables ordered separately.

CO-OP MEETING SPACES

designed by qdesign



SIN #711-16

STAND-ALONE PANEL WITH TABLE PRODUCT FEATURES:

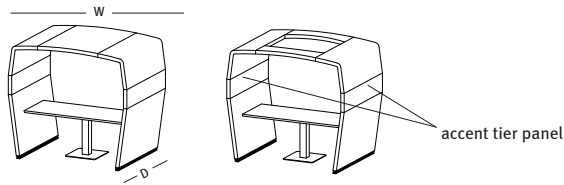

- Available in 60" and 72" depths, measuring 88¹/₂" in height, with full or open canopy.
- **Note: Canopy not available with polyurethane or vinyl upholstery.**
- Accent tier panel available in upholstery, veneer, laminate or whiteboard material. Refer to Accent Tier product features section (page 5).
- Table available at 27", 29" or 39" heights, in varying depths.
- Table available in Maple, Walnut and White Oak veneer, as well as laminate selections.
- Table column dimensions: 4³/₄" x 4³/₄".
- Table base plate dimensions: 22" x 22".
- Table column and base plate available in standard and premium metal finishes.
- Overhead recessed LED swivel light available on full canopy models. Comes with two fixtures, measuring 2⁵/₈" in diameter and drawing 3 watts each. Features touch-controlled power button on right or left side of seats, please specify location.
- Optional cantilever table and shelf available. Refer to individual product features section for information.
- Optional linking table (to place between two private love seat units) and storage cubby (for use in back-to-back applications) ordered separately. Refer to individual product features section for information.
- Optional power units mounted to center of table as standard.
- When specifying electrical or overhead LED light fixture, cord exit grommet placement must be specified, as well as power source location, as applicable.

CO-OP MEETING SPACES

designed by qdesign



SIN #711-16

WALL-MOUNT PANEL PRODUCT FEATURES:

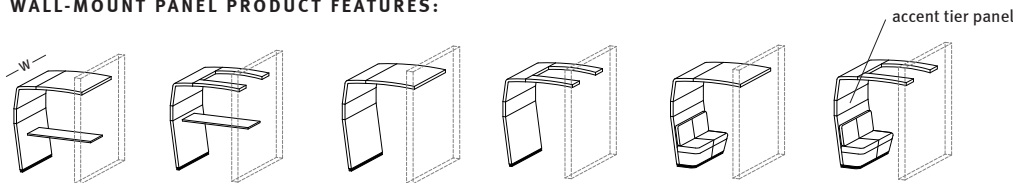

- Available in 60" and 72" widths, measuring 88¹/₂" in height, with full or open canopy.
- Note: Canopy not available with polyurethane or vinyl upholstery.**
- Panel available with suspended table, connected love seat or by itself.
- Panel by itself must be floor-mounted, hardware included.
- Panel with connected love seat must be either floor-mounted or weighted with sandbags. Hardware included for floor-mounting. Optional sandbags can be ordered separately.
- Suspended table available at 27", 29" or 39" heights, in varying depths.
- Accent tier panel available in upholstery, veneer, laminate or whiteboard material. Refer to Accent Tier product features below.
- Overhead recessed LED swivel light available on panel with suspended table or panel with love seat. Comes with two fixtures, measuring 2⁵/₈" in diameter and drawing 3 watts each. Features touch-controlled power button on right or left side of seat/table, please specify location.
- Optional cantilever table and shelf available. Refer to individual product features section for information.
- Optional linking table (to place between two private love seat units) and storage cubby (for use in back-to-back applications) ordered separately. Refer to individual product features section for information.
- Optional power units mounted to center of table as standard. Also available on front and side of seating unit.
- When specifying electrical or overhead LED light fixture, cord exit grommet placement must be specified, as well as power source location, as applicable.
- Unit is affixed to wall with provided mounting hardware.

ACCENT TIER PRODUCT FEATURES:

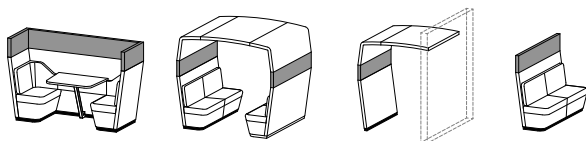

- Veneer panels available in Maple, Walnut and White Oak wood species and feature horizontal grain direction only.
- Laminate and whiteboard panels also available and will be applied to both sides as standard.
- Veneer, laminate and whiteboard can be intermixed (interior and exterior accent tier panel does not have to be the same material). List model number with applicable interior surface material code first, followed by exterior surface material code (e.g. #6512-WB-V represents unit with whiteboard on the interior and veneer on the exterior).
- Note: upholstery accent tier panel must be upholstered on both interior and exterior of units (cannot mix materials).
- Solid wood end caps to match accent tier finish, unless otherwise specified. When intermixing materials, end cap finish must be specified.
- Note: wood grain on solid wood end caps will run vertically.

CO-OP MEETING SPACES

designed by qdesign



SIN #711-16

LINKING TABLE PRODUCT FEATURES:

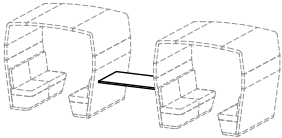

- Linking table can be mounted between any 60" and 72" wide seating or wall panel units.
- 29" and 39" mounted heights.
- Available in 30" and 36" depths, in lengths of 60" and 72".
- Tables available in Maple, Walnut and White Oak veneer, as well as laminate selections.
- Optional power units mounted to center of table as standard.
- When specifying electrical, cord exit grommet placement must be specified on the applicable seating unit, as well as power source location, as applicable.

CANTILEVER TABLE PRODUCT FEATURES:

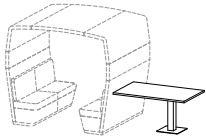

- Cantilever table can be affixed to any 60" and 72" wide seating or wall panel unit.
- 29" and 39" table heights.
- Available in 30" and 36" depths, in lengths of 60" and 72".
- Tables available in Maple, Walnut and White Oak veneer, as well as laminate selections. Refer to General Product Features on page 1 for edge detail specifications.
- Table column dimensions: 4³/₄" x 4³/₄". Table base plate dimensions: 22" x 22".
- Column and base plate available in standard and premium metal finishes.
- Optional power units mounted to center of table as standard.
- When specifying electrical, cord exit grommet placement must be specified on the applicable seating unit, as well as power source location, as applicable.

STORAGE CUBBY PRODUCT FEATURES:

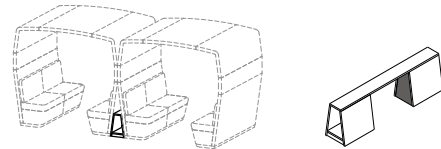

- Double-sided unit fits between tapered spaces of back-to-back 60" and 72" wide models.
- 60" and 72" lengths available.
- Available in Maple, Walnut and White Oak veneer, as well as laminate selections.
- Inside clearance, per cubby: 6" wide at the top, 10" wide at the bottom and 14¹/₄" high.
- Ships separately.

CO-OP MEETING SPACES

designed by qdesign



SIN #711-16

SHELF PRODUCT FEATURES:

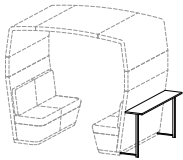

- Shelf available on all 60" and 72" wide models.
- Available in 30" and 40" heights.
- Shelf depth is 12" with 150 lbs. maximum weight allowance.
- Available in Maple, Walnut and White Oak veneer, as well as laminate selections. Refer to General Product Features on page 1 for edge detail specifications.
- Shelf support posts available in standard and premium metal finishes.
- Ships separately and requires field-assembly.

STAND-ALONE SEATING UNIT PRODUCT FEATURES:

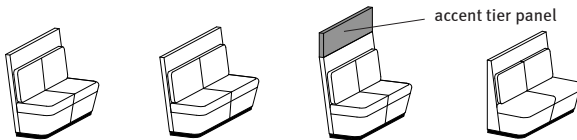

- Available in 60" and 72" widths, with 43¹/₂" and 56³/₄" heights.
- 90-degree back models also offered.
- Accent tier panel on 56³/₄" high models available in upholstery, veneer, laminate or whiteboard material. Refer to Accent Tier product features section (page 5).
- Power units available on front and side of seating units. Position must be specified, in addition to cord exit grommet placement and power source location, as applicable.
- Optional storage cubby available. Refer to individual product features section for information. Not offered on 90-degree back models.

BACK-TO-BACK MODELS PRODUCT FEATURES:

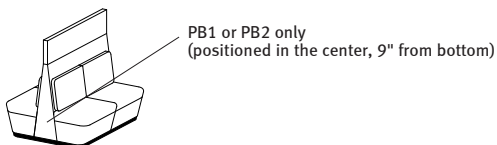

- Available in 60" and 72" widths, with 43¹/₂" and 56³/₄" heights.
- Accent tier panel on 56³/₄" high models available in upholstery, veneer, laminate or whiteboard material. Refer to Accent Tier product features section (page 5).
- Power units available on front and side of seating units. Only PB1 and PB2 units can be used for center-side panel placement. Position must be specified, in addition to cord exit grommet placement and power source location, as applicable.
- Accessories not available.

SHIPPING:

- All seating models ship blanket-wrap as standard.
- If cartoning is required, a 5% upcharge (based on the COM List Price), will be added to each applicable product. Please contact Customer Service for additional information and assistance with cartoning requirements as needed.

CO-OP MEETING SPACES

designed by qdesign



SIN #711-16

POWER UNITS:

- PB1, PB2 and PB3 units available for placement below seats, as well as on integrated, connected, cantilever and linking tables.
- PB1 and PB2 dimensions: 5³/₄" W x 2¹/₂" D
- PB3 dimensions: 6¹/₂" W x 2¹/₂" D
- Metallic silver or white finish with 108" electrical cord.
- UL listed.
- PB1 unit features one outlet and two USB charging ports.
- PB2 unit features two outlets.
- PB3 unit features two outlets and two USB charging ports.
- PP1, PP2 and PP3 Portal Power units also available for integrated, suspended, cantilever and linking tables only.
- PB5 power unit (for monitor-ready mounting only) includes two outlets, two USB charging ports and one HDMI jack.
- **Cord exit grommet position must always be specified as well as power source location, as applicable.**



PB1

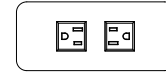

PB2

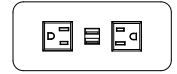

PB3

STANDARD POWER UNIT PLACEMENT, SEATING UNITS:

- Drawings reflect the general standard locations for electrical unit placement.
- For custom placements, please contact Customer Service.

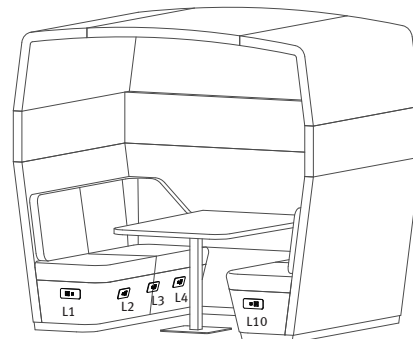
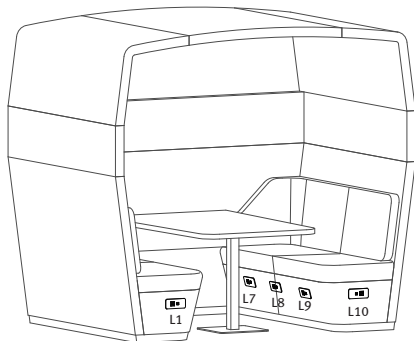
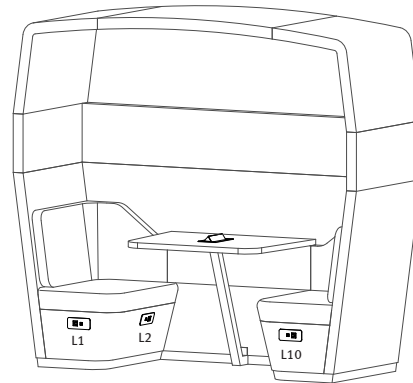
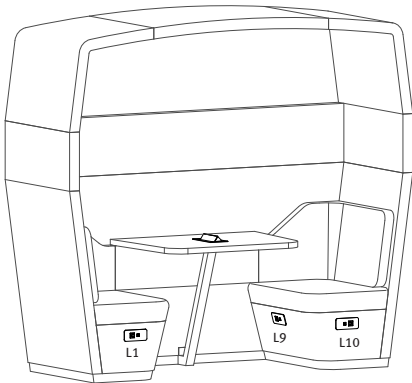

CO-OP MEETING SPACES

designed by qdesign



SIN #711-16

STANDARD POWER UNIT PLACEMENT, SEATING UNITS (CONTINUED):

- Drawings reflect the general standard locations for electrical unit placement.
- For custom placements, please contact Customer Service.

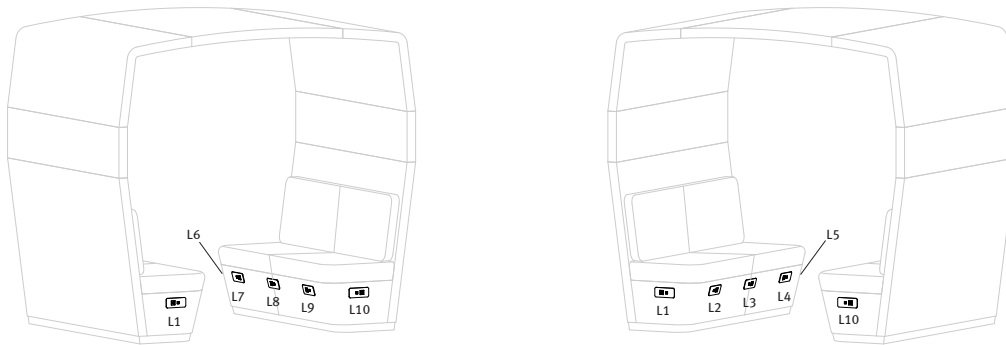

OVERHEAD LED LIGHT FIXTURE AND BUTTON POSITION:

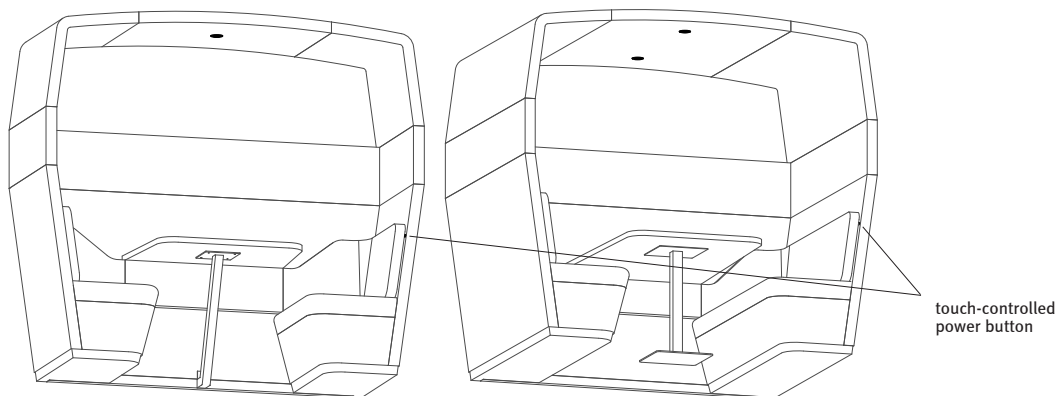

CO-OP MEETING SPACES

designed by qdesign



SIN #711-16

STANDARD CORD EXIT LOCATION

- Please reference the appropriate grommet exit code location when specifying electrical or overhead LED light fixture.
- G7 and G8 locations are for tv/monitor integration (both required). Maximum tv/monitor size is 42".
- For custom placements, please contact Customer Service.

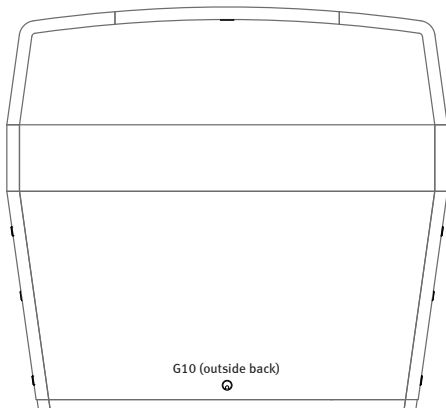
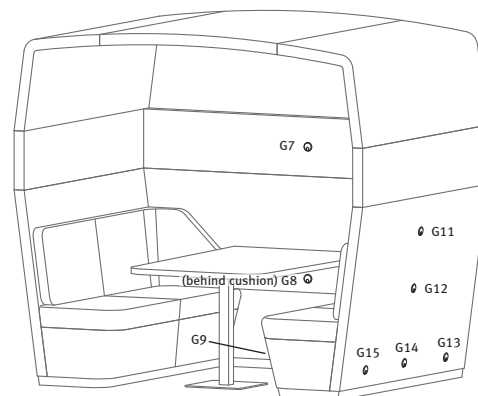
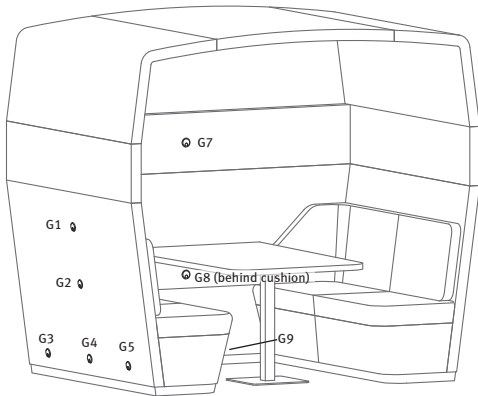

NOTES:

- Fully upholstered seating models with black plinth base. Refer to page 2 for product details.
- When specifying electrical or over-head LED light fixture, cord exit grommet position must be specified as well as power source location, as applicable.

SPECIFY:

- Model number
- Upholstery selection
- Table top and edge wood species
- Table top and edge wood finish
- Table post finish
- Options, as applicable

ORDERING EXAMPLE:

#6514-65TA-PB1-W

Public Single Work Module
Power Band 1 Unit, White
Table Placement

CO-OP
MEETING SPACES

designed by qdesign

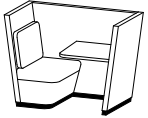
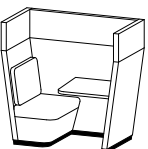
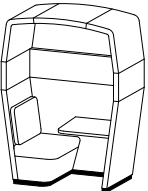

SIN #711-16

MODEL NUMBER	PRODUCT SPECIFICATIONS	FABRIC GRADES								
		COM	1	2	3	4	5	6	7	8
6514-65TA 	Public Single Work Module, Left Side Seated, as Facing W 58 ¹ / ₂ D 30 H 43 ¹ / ₂ Seat Height 18 Inside Seat Width 27 ¹ / ₂ Inside Seat Depth 19 11 ¹ / ₂ yds. 195 lbs. TB 133, add \$552 List	4082	4703	4853	5117	5382	5635	5899	6141	6405
6515-65TA 	Private Single Work Module, Left Side Seated, as Facing W 58 ¹ / ₂ D 30 H 56 ³ / ₄ Seat Height 18 Inside Seat Width 27 ¹ / ₂ Inside Seat Depth 19 15 ¹ / ₂ yds. 220 lbs. TB 133, add \$744 List	5393	6230	6432	6788	7145	7486	7842	8168	8524
6516-65TA 	Private Single Work Module, Full Canopy, Left Side Seated, as Facing W 58 ¹ / ₂ D 30 H 79 ¹ / ₂ Seat Height 18 Inside Seat Width 27 ¹ / ₂ Inside Seat Depth 19 20 ¹ / ₂ yds. 280 lbs. TB 133, add \$984 List	6938	8045	8312	8783	9255	9706	10177	10608	11079

OPTIONS (XXXX - REFERS TO LOUNGE MODEL NUMBER)

MODEL	DESCRIPTION	LIST
XXXX-MB02	Moisture Barrier, Seats Only	95
XXXX-LED1	LED Light (one fixture, full canopy only)	350

FOR PLACEMENT BELOW SEATS AND/OR INTEGRATED TABLE

XXXX-PB1-S	Power Band 1 (one power, two USB), Silver	413
XXXX-PB1-W	Power Band 1 (one power, two USB), White	413
XXXX-PB2-S	Power Band 2 (dual power), Silver	322
XXXX-PB2-W	Power Band 2 (dual power), White	322
XXXX-PB3-S	Power Band 3 (dual power, two USB), Silver	429
XXXX-PB3-W	Power Band 3 (dual power, two USB), White	429

FOR INTEGRATED TABLES ONLY, 4" X 4" FROM CORNER

XXXX-PP1	Portal Power 1 (one power, one data)	612
XXXX-PP2	Portal Power 2 (dual power)	542
XXXX-PP3	Portal Power 3 (one power, two USB)	643

CO-OP MEETING SPACES

designed by qdesign



SIN #711-16

NOTES:

- Seating models with accent tier. Refer to page 5 for product details.
- Accent tier available in Maple, Walnut and White Oak veneer (-V), laminate (-L) and whiteboard material (-WB). Please specify code for interior and exterior material selections.
- When specifying electrical or over-head LED light fixture, cord exit grommet position must be specified as well as power source location, as applicable.

SPECIFY:

1. Model number
2. Accent tier finish, interior
3. Accent tier finish, exterior
4. Upholstery selection
5. Table and edge wood species
6. Table and edge wood finish
7. Table post finish
8. Options, as applicable

ORDERING EXAMPLE:

#6516-V-V-65TA-PB1-S

Private Single Work Module
Veneer Accent Tier, Interior
Veneer Accent Tier, Exterior
Power Band 1 Unit, Silver
Seat Placement

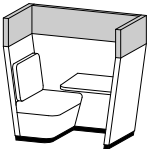
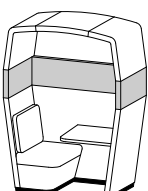
MODEL NUMBER	PRODUCT SPECIFICATIONS	FABRIC GRADES								
		COM	1	2	3	4	5	6	7	8
6515-(-)-(-)-65TA 	Private Single Work Module, Non-Upholstered Accent Tier, Left Side Seated, as Facing W 58 ¹ / ₂ D 30 H 56 ³ / ₄ Seat Height 18 Inside Seat Width 27 ¹ / ₂ Inside Seat Depth 19 11 ¹ / ₂ yds. 280 lbs. TB 133, add \$552 List	6818	7439	7589	7853	8118	8371	8635	8877	9141
6516-(-)-(-)-65TA 	Private Single Work Module, Full Canopy, Non-Upholstered Accent Tier, Left Side Seated, as Facing W 58 ¹ / ₂ D 30 H 79 ¹ / ₂ Seat Height 18 Inside Seat Width 27 ¹ / ₂ Inside Seat Depth 19 16 ¹ / ₂ yds. 280 lbs. TB 133, add \$792 List	8363	9254	9469	9848	10228	10591	10970	11317	11696

OPTIONS (XXXX - REFERS TO LOUNGE MODEL NUMBER)

MODEL	DESCRIPTION	LIST
XXXX-MB02	Moisture Barrier, Seats Only	95
XXXX-LED1	LED Light (one fixture, full canopy only)	350

FOR PLACEMENT BELOW SEATS

XXXX-PB1-S	Power Band 1 (one power, two USB), Silver	413
XXXX-PB1-W	Power Band 1 (one power, two USB), White	413
XXXX-PB2-S	Power Band 2 (dual power), Silver	322
XXXX-PB2-W	Power Band 2 (dual power), White	322
XXXX-PB3-S	Power Band 3 (dual power, two USB), Silver	429
XXXX-PB3-W	Power Band 3 (dual power, two USB), White	429

FOR INTEGRATED TABLES ONLY, 4" X 4" FROM CORNER

XXXX-PP1	Portal Power 1 (one power, one data)	612
XXXX-PP2	Portal Power 2 (dual power)	542
XXXX-PP3	Portal Power 3 (one power, two USB)	643

NOTES:

- Fully upholstered seating models with black plinth base. Refer to pages 2 for product details.
- When specifying electrical or over-head LED light fixture, cord exit grommet position must be specified as well as power source location, as applicable.

SPECIFY:

- Model number
- Accent tier finish, interior
- Accent tier finish, exterior
- Upholstery selection
- Table and edge wood species
- Table and edge wood finish
- Table post finish
- Options, as applicable

ORDERING EXAMPLE:

#6518-65TA-PB1-W

Private Single Work Module
Power Band 1 Unit, White
Table Placement

CO-OP
MEETING SPACES

designed by qdesign



SIN #711-16

MODEL NUMBER	PRODUCT SPECIFICATIONS	FABRIC GRADES								
		COM	1	2	3	4	5	6	7	8
6517-65TA 	Public Single Work Module, Right Side Seated, as Facing W 58 ¹ / ₂ D 30 H 43 ¹ / ₂ Seat Height 18 Inside Seat Width 27 ¹ / ₂ Inside Seat Depth 19 11 ¹ / ₂ yds. 195 lbs. TB 133, add \$xxx List	4082	4703	4853	5117	5382	5635	5899	6141	6405
6518-65TA 	Private Single Work Module, Right Side Seated, as Facing W 58 ¹ / ₂ D 30 H 56 ³ / ₄ Seat Height 18 Inside Seat Width 27 ¹ / ₂ Inside Seat Depth 19 15 ¹ / ₂ yds. 220 lbs. TB 133, add \$744 List	5393	6230	6432	6788	7145	7486	7842	8168	8524
6519-65TA 	Private Single Work Module, Full Canopy, Right Side Seated, as Facing W 58 ¹ / ₂ D 30 H 79 ¹ / ₂ Seat Height 18 Inside Seat Width 27 ¹ / ₂ Inside Seat Depth 19 20 ¹ / ₂ yds. 280 lbs. TB 133, add \$984 List	6938	8045	8312	8783	9255	9706	10177	10608	11079

OPTIONS (XXXX - REFERS TO LOUNGE MODEL NUMBER)

MODEL	DESCRIPTION	LIST
XXXX-MB02	Moisture Barrier, Seats Only	95
XXXX-LED1	LED Light (one fixture, full canopy only)	350

FOR PLACEMENT BELOW SEATS

XXXX-PB1-S	Power Band 1 (one power, two USB), Silver	413
XXXX-PB1-W	Power Band 1 (one power, two USB), White	413
XXXX-PB2-S	Power Band 2 (dual power), Silver	322
XXXX-PB2-W	Power Band 2 (dual power), White	322
XXXX-PB3-S	Power Band 3 (dual power, two USB), Silver	429
XXXX-PB3-W	Power Band 3 (dual power, two USB), White	429

FOR INTEGRATED TABLES ONLY, 4" X 4" FROM CORNER

XXXX-PP1	Portal Power 1 (one power, one data)	612
XXXX-PP2	Portal Power 2 (dual power)	542
XXXX-PP3	Portal Power 3 (one power, two USB)	643

CO-OP MEETING SPACES

designed by qdesign



SIN #711-16

NOTES:

- Seating models with accent tier. Refer to page 5 for product details.
- Accent tier available in Maple, Walnut and White Oak veneer (-V), laminate (-L) and whiteboard material (-WB). Please specify code for interior and exterior material selections.
- When specifying electrical or over-head LED light fixture, cord exit grommet position must be specified as well as power source location, as applicable.

SPECIFY:

1. Model number
2. Accent tier finish, interior
3. Accent tier finish, exterior
4. Upholstery selection
5. Table and edge wood species
6. Table and edge wood finish
7. Table post finish
8. Options, as applicable

ORDERING EXAMPLE:

#6519-V-WB-65TA-PB1-W
Private Single Work Module Veneer Accent Tier, Interior Whiteboard Accent Tier, Exterior Power Band 1 Unit, White Table Placement

MODEL NUMBER PRODUCT SPECIFICATIONS FABRIC GRADES

		COM	1	2	3	4	5	6	7	8
6518-(-)-(-)-65TA	Private Single Work Module, Non-Upholstered Accent Tier, Right Side Seated, as Facing W 58 ¹ / ₂ D 30 H 56 ³ / ₄ Seat Height 18 Inside Seat Width 27 ¹ / ₂ Inside Seat Depth 19 11 ¹ / ₂ yds. 280 lbs. TB 133, add \$552 List	6818	7439	7589	7853	8118	8371	8635	8877	9141
6519-(-)-(-)-65TA	Private Single Work Module, Full Canopy, Non-Upholstered Accent Tier, Right Side Seated, as Facing W 58 ¹ / ₂ D 30 H 79 ¹ / ₂ Seat Height 18 Inside Seat Width 27 ¹ / ₂ Inside Seat Depth 19 16 ¹ / ₂ yds. 280 lbs. TB 133, add \$792 List	8363	9254	9469	9848	10228	10591	10970	11317	11696

OPTIONS (XXXX - REFERS TO LOUNGE MODEL NUMBER)

MODEL	DESCRIPTION	LIST
XXXX-MB02	Moisture Barrier, Seats Only	95
XXXX-LED1	LED Light (one fixture, full canopy only)	350

FOR PLACEMENT BELOW SEATS

XXXX-PB1-S	Power Band 1 (one power, two USB), Silver	413
XXXX-PB1-W	Power Band 1 (one power, two USB), White	413
XXXX-PB2-S	Power Band 2 (dual power), Silver	322
XXXX-PB2-W	Power Band 2 (dual power), White	322
XXXX-PB3-S	Power Band 3 (dual power, two USB), Silver	429
XXXX-PB3-W	Power Band 3 (dual power, two USB), White	429

FOR INTEGRATED TABLES ONLY, 4" X 4" FROM CORNER

XXX-PP1	Portal Power 1 (one power, one data)	612
XXXX-PP2	Portal Power 2 (dual power)	542
XXXX-PP3	Portal Power 3 (one power, two USB)	643

NOTES:

- Fully upholstered seating models with black plinth base. Refer to pages 2-3 for product details.
- For units with integrated table, please refer to page 17.
- When specifying electrical or over-head LED light fixture, cord exit grommet position must be specified as well as power source location, as applicable.

SPECIFY:

1. Model number
2. Upholstery selection
3. Options, as applicable

ORDERING EXAMPLE:

#6512-PB1-S

Private Lounge w/Full Canopy
Power Band 1 Unit, Silver

**CO-OP
MEETING SPACES**

designed by qdesign

SIN #711-16

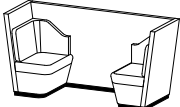
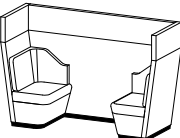
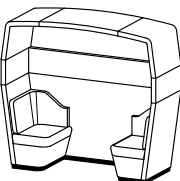
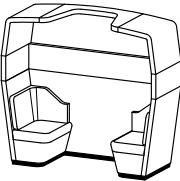
MODEL NUMBER	PRODUCT SPECIFICATIONS	FABRIC GRADES								
		COM	1	2	3	4	5	6	7	8
6510 	Public Lounge Unit W 88 ¹ / ₂ D 30 H 43 ¹ / ₂ Seat Height 18 Inside Seat Width 25 ¹ / ₂ Inside Seat Depth 19 15 ¹ / ₄ yds. 290 lbs. TB 133, add \$732 List	4349	5173	5371	5722	6073	6408	6759	7079	7430
6511 	Private Lounge Unit W 88 ¹ / ₂ D 30 H 56 ³ / ₄ Seat Height 18 Inside Seat Width 25 ¹ / ₂ Inside Seat Depth 19 20 yds. 351 lbs. TB 133, add \$960 List	5661	6741	7001	7461	7921	8361	8821	9241	9701
6512 	Private Lounge Unit with Full Canopy W 88 ¹ / ₂ D 30 H 80 ¹ / ₄ Seat Height 18 Inside Seat Width 25 ¹ / ₂ Inside Seat Depth 19 25 ¹ / ₂ yds. 416 lbs. TB 133, add \$1224 List	7213	8590	8922	9508	10095	10656	11242	11778	12364
6513 	Private Lounge Unit with Partial Canopy W 88 ¹ / ₂ D 30 H 80 ¹ / ₄ Seat Height 18 Inside Seat Width 25 ¹ / ₂ Inside Seat Depth 19 25 ¹ / ₂ yds. 411 lbs. TB 133, add \$1200 List	7254	8604	8929	9504	10079	10629	11204	11729	12304

OPTIONS (XXXX - REFERS TO LOUNGE MODEL NUMBER)

MODEL	DESCRIPTION	LIST
XXXX-MB06	Moisture Barrier, Seats Only	190
XXXX-LED1	LED Light (one fixture, full canopy only)	350

FOR PLACEMENT BELOW SEATS

XXXX-PB1-S	Power Band 1 (one power, two USB), Silver	412
XXXX-PB1-W	Power Band 1 (one power, two USB), White	412
XXXX-PB2-S	Power Band 2 (dual power), Silver	322
XXXX-PB2-W	Power Band 2 (dual power), White	322
XXXX-PB3-S	Power Band 3 (dual power, two USB), Silver	429
XXXX-PB3-W	Power Band 3 (dual power, two USB), White	429

CO-OP MEETING SPACES

designed by qdesign

NOTES:

- Seating models with accent tier. Refer to page 5 for product details.
- For units with integrated table, please refer to page 18.
- Accent tier available in Maple, Walnut and White Oak veneer (-V), laminate (-L) and whiteboard material (-WB). Please specify code for interior and exterior material selections.
- Standard with black plinth base.
- When specifying electrical or over-head LED light fixture, cord exit grommet position must be specified as well as power source location, as applicable.

SPECIFY:

1. Model number
2. Accent tier finish, interior
3. Accent tier finish, exterior
4. Upholstery selection
5. Options, as applicable

ORDERING EXAMPLE:

#6513-V-V-MB03
Private Lounge w/Partial Canopy
Veneer Accent Tier, Interior
Veneer Accent Tier, Exterior
Moisture Barrier

SIN #711-16

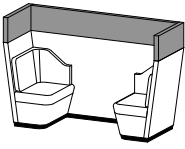
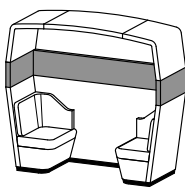
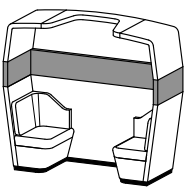
MODEL NUMBER	PRODUCT SPECIFICATIONS	FABRIC GRADES								
		COM	1	2	3	4	5	6	7	8
<p>Specify Interior Material Code, Followed by Exterior Material Code V = Veneer L = Laminate WB = Whiteboard</p>										
<p>6511-()-()</p> 	<p>Private Lounge Unit Non-Upholstered Accent Tier W 88¹/₂ D 30 H 56³/₄ Seat Height 18 Inside Seat Width 25¹/₂ Inside Seat Depth 19 15¹/₄ yds. 360 lbs. TB 133, add \$732 List</p>	7083	7907	8105	8456	8807	9142	9493	9813	10164
<p>6512-()-()</p> 	<p>Private Lounge Unit with Full Canopy Non-Upholstered Accent Tier W 88¹/₂ D 30 H 80¹/₄ Seat Height 18 Inside Seat Width 25¹/₂ Inside Seat Depth 19 20³/₄ yds. 425 lbs. TB 133, add \$996 List</p>	8636	9757	10027	10504	10981	11438	11915	12351	12828
<p>6513-()-()</p> 	<p>Private Lounge Unit with Partial Canopy Non-Upholstered Accent Tier W 88¹/₂ D 30 H 80¹/₄ Seat Height 18 Inside Seat Width 25¹/₂ Inside Seat Depth 19 20³/₄ yds. 420 lbs. TB 133, add \$996 List</p>	8676	9797	10067	10544	11021	11478	11955	12391	12868

OPTIONS (XXXX - REFERS TO LOUNGE MODEL NUMBER)

MODEL	DESCRIPTION	LIST
XXXX-MB06	Moisture Barrier, Seats Only	190
XXXX-LED1	LED Light (one fixture, full canopy only)	350

FOR PLACEMENT BELOW SEATS

XXXX-PB1-S	Power Band 1 (one power, two USB), Silver	412
XXXX-PB1-W	Power Band 1 (one power, two USB), White	412
XXXX-PB2-S	Power Band 2 (dual power), Silver	322
XXXX-PB2-W	Power Band 2 (dual power), White	322
XXXX-PB3-S	Power Band 3 (dual power, two USB), Silver	429
XXXX-PB3-W	Power Band 3 (dual power, two USB), White	429

NOTES:

- Fully upholstered seating models with integrated table. Refer to pages 2-3 for product details.
- Standard with black plinth base.
- 27" high integrated table available in Maple, Walnut and White Oak veneer as well as laminate selections.
- When specifying electrical or over-head LED light fixture, cord exit grommet position must be specified as well as power source location, as applicable.

SPECIFY:

- Model number
- Upholstery selection
- Table top and edge wood species
- Table top and edge wood finish
- Table post finish
- Options, as applicable

ORDERING EXAMPLE:

#6510-65TS-PP1

Public Lounge w/Table
Portal Power 1 Unit, Table Placement

CO-OP MEETING SPACES

designed by qdesign

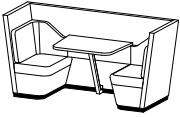
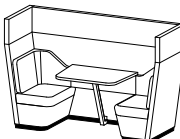
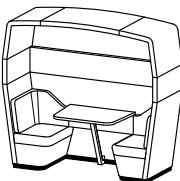
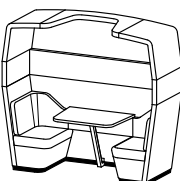

SIN #711-16

MODEL NUMBER	PRODUCT SPECIFICATIONS	FABRIC GRADES								
		COM	1	2	3	4	5	6	7	8
6510-65TS 	Public Lounge Unit with Integrated Table W 88 ¹ / ₂ D 30 H 43 ¹ / ₂ Seat Height 18 Inside Seat Width 25 ¹ / ₂ Inside Seat Depth 19 16 ¹ / ₄ yds. 327 lbs. TB 133, add \$780 List	5462	6340	6551	6925	7299	7656	8030	8371	8745
6511-65TS 	Private Lounge Unit with Integrated Table W 88 ¹ / ₂ D 30 H 56 ³ / ₄ Seat Height 18 Inside Seat Width 25 ¹ / ₂ Inside Seat Depth 19 21 yds. 388 lbs. TB 133, add \$1008 List	6774	7908	8181	8664	9147	9609	10092	10533	11016
6512-65TS 	Private Lounge Unit with Full Canopy and Integrated Table W 88 ¹ / ₂ D 30 H 80 ¹ / ₄ Seat Height 18 Inside Seat Width 25 ¹ / ₂ Inside Seat Depth 19 26 ¹ / ₂ yds. 453 lbs. TB 133, add \$1272 List	8326	9757	10102	10711	11321	11904	12513	13070	13679
6513-65TS 	Private Lounge Unit with Partial Canopy and Integrated Table W 88 ¹ / ₂ D 30 H 80 ¹ / ₄ Seat Height 18 Inside Seat Width 25 ¹ / ₂ Inside Seat Depth 19 26 ¹ / ₂ yds. 448 lbs. TB 133, add \$1272 List	8367	9798	10143	10752	11362	11945	12554	13111	13720

OPTIONS (XXXX - REFERS TO LOUNGE MODEL NUMBER)

MODEL	DESCRIPTION	LIST
XXXX-MB06	Moisture Barrier, Seats Only	190
XXXX-LED1	LED Light (one fixture, full canopy only)	350
XXXX-PF03	Premium Finish, Table Post	110

FOR PLACEMENT BELOW SEATS AND/OR CENTER OF INTEGRATED TABLES

XXXX-PB1-S	Power Band 1 (one power, two USB), Silver	413
XXXX-PB1-W	Power Band 1 (one power, two USB), White	413
XXXX-PB2-S	Power Band 2 (dual power), Silver	322
XXXX-PB2-W	Power Band 2 (dual power), White	322
XXXX-PB3-S	Power Band 3 (dual power, two USB), Silver	429
XXXX-PB3-W	Power Band 3 (dual power, two USB), White	429

FOR INTEGRATED TABLES ONLY, CENTERED 5" FROM BACK

XXXX-PP1	Portal Power 1 (one power, one data)	612
XXXX-PP2	Portal Power 2 (dual power)	542
XXXX-PP3	Portal Power 3 (one power, two USB)	643

CO-OP MEETING SPACES

designed by qdesign

NOTES:

- Seating models with accent tier. Refer to page 5 for product details.
- Accent tier available in Maple, Walnut and White Oak veneer (-V), laminate (-L) and whiteboard material (-WB). Please specify code for interior and exterior material selections.
- Standard with black plinth base.
- 27" high integrated table available in Maple, Walnut and White Oak veneer as well as laminate selections.
- When specifying electrical or over-head LED light fixture, cord exit grommet position must be specified as well as power source location, as applicable.

SPECIFY:

1. Model number
2. Accent tier finish, interior
3. Accent tier finish, exterior
4. Upholstery selection
5. Table and edge wood species
6. Table and edge wood finish
7. Table post finish
8. Options, as applicable

ORDERING EXAMPLE:

#6512-WB-WB-65TS-PF03
Private Lounge w/Full Canopy and Table
Whiteboard Accent Tier, Interior
Whiteboard Accent Tier, Exterior
Table Post Premium Finish

SIN #711-16

MODEL NUMBER	PRODUCT SPECIFICATIONS	FABRIC GRADES								
		COM	1	2	3	4	5	6	7	8
Specify Interior Material Code, Followed by Exterior Material Code V = Veneer L = Laminate WB = Whiteboard										
6511-(-)-(-)-65TS	Private Lounge Unit with Integrated Table Non-Upholstered Accent Tier W 88 ¹ / ₂ D 30 H 56 ³ / ₄ Seat Height 18 Inside Seat Width 25 ¹ / ₂ Inside Seat Depth 19 16 ¹ / ₄ yds. 397 lbs. TB 133, add \$780 List	8197	9075	9286	9660	10034	10391	10765	11106	11480
6512-(-)-(-)-65TS	Private Lounge Unit with Full Canopy and Integrated Table, Non-Upholstered Accent Tier W 88 ¹ / ₂ D 30 H 80 ¹ / ₄ Seat Height 18 Inside Seat Width 25 ¹ / ₂ Inside Seat Depth 19 21 ³ / ₄ yds. 462 lbs. TB 133, add \$1044 List	9748	10923	11206	11706	12206	12685	13185	13642	14142
6513-(-)-(-)-65TS	Private Lounge Unit with Partial Canopy and Integrated Table, Non-Upholstered Accent Tier W 88 ¹ / ₂ D 30 H 80 ¹ / ₄ Seat Height 18 Inside Seat Width 25 ¹ / ₂ Inside Seat Depth 19 21 ³ / ₄ yds. 457 lbs. TB 133, add \$1044 List	9789	10964	11247	11747	12247	12726	13226	13683	14183

OPTIONS (XXXX - REFERS TO LOUNGE MODEL NUMBER)

MODEL	DESCRIPTION	LIST
XXXX-MB06	Moisture Barrier, Seats Only	190
XXXX-LED1	LED Light (one fixture, full canopy only)	350
XXXX-PF03	Premium Finish, Table Post	110

FOR PLACEMENT BELOW SEATS AND/OR CENTER OF INTEGRATED TABLES

XXXX-PB1-S	Power Band 1 (one power, two USB), Silver	413
XXXX-PB1-W	Power Band 1 (one power, two USB), White	413
XXXX-PB2-S	Power Band 2 (dual power), Silver	322
XXXX-PB2-W	Power Band 2 (dual power), White	322
XXXX-PB3-S	Power Band 3 (dual power, two USB), Silver	429
XXXX-PB3-W	Power Band 3 (dual power, two USB), White	429

FOR INTEGRATED TABLES ONLY, CENTERED 5" FROM BACK

XXX-PP1	Portal Power 1 (one power, one data)	612
XXXX-PP2	Portal Power 2 (dual power)	542
XXXX-PP3	Portal Power 3 (one power, two USB)	643

NOTES:

- Fully upholstered seating models with black plinth base. Refer to pages 2-3 for product details.
- For units with integrated table, please refer to page 21.
- When specifying electrical or over-head LED light fixture, cord exit grommet position must be specified as well as power source location, as applicable.

SPECIFY:

- Model number
- Upholstery selection
- Options, as applicable

ORDERING EXAMPLE:

#6520-PB1-W

Public Love Seat
Power Band 1 Unit, White

CO-OP
MEETING SPACES

designed by qdesign

SIN #711-16

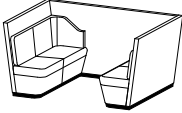
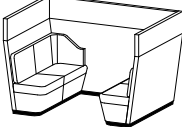
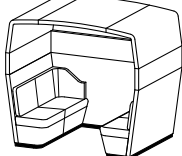
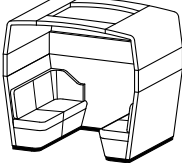
MODEL NUMBER	PRODUCT SPECIFICATIONS	FABRIC GRADES								
		COM	1	2	3	4	5	6	7	8
6520 	Public Love Seat Unit W 88 ¹ / ₂ D 60 H 43 ¹ / ₂ Seat Height 18 Inside Seat Width 55 ¹ / ₄ Inside Seat Depth 19 23 ¹ / ₄ yds. 480 lbs. TB 133, add \$1116 List	5503	6759	7061	7596	8131	8642	9177	9665	10200
6521 	Private Love Seat Unit W 88 ¹ / ₂ D 60 H 56 ³ / ₄ Seat Height 18 Inside Seat Width 55 ¹ / ₄ Inside Seat Depth 19 30 yds. 535 lbs. TB 133, add \$1440 List	7068	8688	9078	9768	10458	11118	11808	12438	13128
6522 	Private Love Seat Unit with Full Canopy W 88 ¹ / ₂ D 60 H 80 ¹ / ₄ Seat Height 18 Inside Seat Width 55 ¹ / ₄ Inside Seat Depth 19 41 ¹ / ₂ yds. 665 lbs. TB 133, add \$1992 List	9241	11482	12022	12976	13931	14844	15798	16670	17624
6523 	Private Love Seat with Open Canopy W 88 ¹ / ₂ D 60 H 80 ¹ / ₄ Seat Height 18 Inside Seat Width 55 ¹ / ₄ Inside Seat Depth 19 39 ³ / ₄ yds. 639 lbs. TB 133, add \$1908 List	9297	11444	11961	12875	13789	14664	15578	16413	17327

OPTIONS (XXXX - REFERS TO LOVE SEAT NUMBER)

MODEL	DESCRIPTION	LIST	OPTIONAL ACCESSORIES	PAGE REFERENCE
XXXX-MB07	Moisture Barrier, Seats Only	290	Shelf	page 39
XXXX-LED2	LED Light (two fixtures, full canopy only)	500	Linking Table	page 40
XXXX-MR5	Monitor Ready Mounting (includes PB5 table-mounted power unit)	665	Cantilever Table	page 40
			Storage Cubby	page 41

FOR PLACEMENT BELOW SEATS

XXXX-PB1-S	Power Band 1 (one power, two USB), Silver	413
XXXX-PB1-W	Power Band 1 (one power, two USB), White	413
XXXX-PB2-S	Power Band 2 (dual power), Silver	322
XXXX-PB2-W	Power Band 2 (dual power), White	322
XXXX-PB3-S	Power Band 3 (dual power, two USB), Silver	429
XXXX-PB3-W	Power Band 3 (dual power, two USB), White	429

CO-OP MEETING SPACES

designed by qdesign

NOTES:

- Seating models with accent tier. Refer to page 5 for product details.
- For units with integrated table, please refer to page 22.
- Accent tier available in Maple, Walnut and White Oak veneer (-V), laminate (-L) and whiteboard material (-WB). Please specify code for interior and exterior material selections.
- Standard with black plinth base.
- When specifying electrical or over-head LED light fixture, cord exit grommet position must be specified as well as power source location, as applicable.

SPECIFY:

1. Model number
2. Accent tier finish, interior
3. Accent tier finish, exterior
4. Upholstery selection
5. Options, as applicable

ORDERING EXAMPLE:

#6523-V-WB-PB3-S
 Private Love Seat w/Open Canopy
 Veneer Accent Tier, Interior
 Whiteboard Accent Tier, Exterior
 Power Band 3 Unit, Silver

SIN #711-16

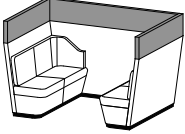
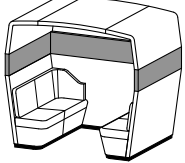
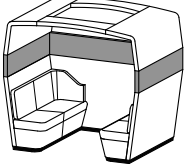
MODEL NUMBER	PRODUCT SPECIFICATIONS	FABRIC GRADES								
		COM	1	2	3	4	5	6	7	8
<p>Specify Interior Material Code, Followed by Exterior Material Code V = Veneer L = Laminate WB = Whiteboard</p>										
<p>6521-()-()</p> 	<p>Private Love Seat Unit Non-Upholstered Accent Tier W 88¹/₂ D 60 H 56³/₄ Seat Height 18 Inside Seat Width 55¹/₄ Inside Seat Depth 19 23¹/₄ yds. 550 lbs. TB 133, add \$1116 List</p>	9373	10629	10931	11466	12001	12512	13047	13535	14070
<p>6522-()-()</p> 	<p>Private Love Seat Unit with Full Canopy, Non-Upholstered Accent Tier W 88¹/₂ D 60 H 80¹/₄ Seat Height 18 Inside Seat Width 55¹/₄ Inside Seat Depth 19 34³/₄ yds. 680 lbs. TB 133, add \$1668 List</p>	11546	13423	13875	14674	15473	16238	17037	17767	18566
<p>6523-()-()</p> 	<p>Private Love Seat Unit with Open Canopy, Non-Upholstered Accent Tier W 88¹/₂ D 60 H 80¹/₄ Seat Height 18 Inside Seat Width 55¹/₄ Inside Seat Depth 19 33 yds. 654 lbs. TB 133, add \$1584 List</p>	11603	13385	13814	14573	15332	16058	16817	17510	18269

OPTIONS (XXXX - REFERS TO LOUNGE MODEL NUMBER)

MODEL	DESCRIPTION	LIST	OPTIONAL ACCESSORIES	PAGE REFERENCE
XXXX-MB07	Moisture Barrier, Seats Only	290	Shelf	page 39
XXXX-LED2	LED Light (two fixtures, full canopy only)	500	Linking Table	page 40
XXXX-MR5	Monitor Ready Mounting (includes PB5 table-mounted power unit)	665	Cantilever Table Storage Cubby	page 40 page 41

FOR PLACEMENT BELOW SEATS

XXXX-PB1-S	Power Band 1 (one power, two USB), Silver	412
XXXX-PB1-W	Power Band 1 (one power, two USB), White	412
XXXX-PB2-S	Power Band 2 (dual power), Silver	322
XXXX-PB2-W	Power Band 2 (dual power), White	322
XXXX-PB3-S	Power Band 3 (dual power, two USB), Silver	429
XXXX-PB3-W	Power Band 3 (dual power, two USB), White	429

NOTES:

- Fully upholstered seating models with integrated table. Refer to pages 2-3 for product details.
- Standard with black plinth base.
- 27" high integrated table available in Maple, Walnut and White Oak veneer as well as laminate selections.
- Table support post dimensions include 2" x 2" column and 14" x 14" base plate.
- When specifying electrical or over-head LED light fixture, cord exit grommet position must be specified as well as power source location, as applicable.

SPECIFY:

- Model number
- Upholstery selection
- Table top and edge wood species
- Table top and edge wood finish
- Table post finish
- Options, as applicable

ORDERING EXAMPLE:

#6521-65TL-PB3-S

Private Love Seat with Table
Power Band 3 Unit, Silver
Seat Placement

CO-OP
MEETING SPACES

designed by qdesign

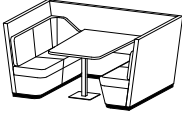
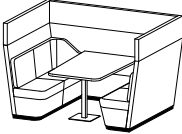
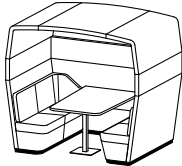
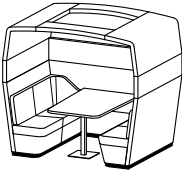

SIN #711-16

MODEL NUMBER	PRODUCT SPECIFICATIONS	FABRIC GRADES								
		COM	1	2	3	4	5	6	7	8
6520-65TL 	Public Love Seat Unit with Integrated Table W 88 ¹ / ₂ D 60 H 43 ¹ / ₂ Seat Height 18 Inside Seat Width 55 ¹ / ₄ Inside Seat Depth 19 24 ¹ / ₄ yds. 547 lbs. TB 133, add \$1164 List	7722	9032	9347	9905	10463	10996	11554	12063	12621
6521-65TL 	Private Love Seat Unit with Integrated Table W 88 ¹ / ₂ D 60 H 56 ³ / ₄ Seat Height 18 Inside Seat Width 55 ¹ / ₄ Inside Seat Depth 19 31 yds. 622 lbs. TB 133, add \$1488 List	9288	10962	11365	12078	12791	13473	14186	14837	15550
6522-65TL 	Private Love Seat Unit with Full Canopy and Integrated Table W 88 ¹ / ₂ D 60 H 80 ¹ / ₄ Seat Height 18 Inside Seat Width 55 ¹ / ₄ Inside Seat Depth 19 42 ¹ / ₂ yds. 752 lbs. TB 133, add \$2040 List	11460	13755	14308	15285	16263	17198	18175	19068	20045
6523-65TL 	Private Love Seat with Open Canopy and Integrated Table W 88 ¹ / ₂ D 60 H 80 ¹ / ₄ Seat Height 18 Inside Seat Width 55 ¹ / ₄ Inside Seat Depth 19 40 ³ / ₄ yds. 726 lbs. TB 133, add \$1956 List	11516	13717	14247	15184	16121	17018	17955	18811	19748

OPTIONS (XXXX - REFERS TO LOVE SEAT NUMBER)

MODEL	DESCRIPTION	LIST	OPTIONAL ACCESSORIES	PAGE REFERENCE
XXXX-MB07	Moisture Barrier, Seats Only	290	Shelf	page 39
XXXX-LED2	LED Light (two fixtures, full canopy only)	500	Linking Table	page 40
XXXX-MR5	Monitor Ready Mounting (includes PB5 table-mounted power unit)	665	Cantilever Table	page 40
XXXX-PF03	Premium Finish, Table Post	110	Storage Cubby	page 41

FOR PLACEMENT BELOW SEATS AND/OR CENTER OF INTEGRATED TABLES

XXXX-PB1-S	Power Band 1 (one power, two USB), Silver	413
XXXX-PB1-W	Power Band 1 (one power, two USB), White	413
XXXX-PB2-S	Power Band 2 (dual power), Silver	322
XXXX-PB2-W	Power Band 2 (dual power), White	322
XXXX-PB3-S	Power Band 3 (dual power, two USB), Silver	429
XXXX-PB3-W	Power Band 3 (dual power, two USB), White	429

FOR INTEGRATED TABLES ONLY, CENTERED 5" FROM BACK

XXXX-PP1	Portal Power 1 (one power, one data)	612
XXXX-PP2	Portal Power 2 (dual power)	542
XXXX-PP3	Portal Power 3 (one power, two USB)	643

CO-OP MEETING SPACES

designed by qdesign

NOTES:

- Seating models with accent tier. Refer to page 5 for product details.
- Accent tier available in Maple, Walnut and White Oak veneer (-V), laminate (-L) and whiteboard material (-WB). Please specify code for interior and exterior material selections.
- Standard with black plinth base.
- 27" high integrated table available in Maple, Walnut and White Oak veneer as well as laminate selections.
- Table support post dimensions include 2" x 2" column and 14" x 14" base plate.

SPECIFY:

1. Model number
2. Accent tier finish, interior
3. Accent tier finish, exterior
4. Upholstery selection
5. Table wood species
6. Table wood finish
7. Table post finish
8. Options, as applicable

ORDERING EXAMPLE:

#6523-L-L-65TL-PF03-PP1
Private Love Seat w/Open Canopy and Table
Laminate Accent Tier, Interior
Laminate Accent Tier, Exterior
Table Post Premium Finish
Portal Power 1 Unit, Table Placement

SIN #711-16

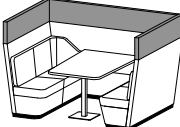
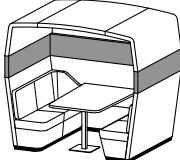
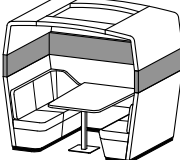
MODEL NUMBER	PRODUCT SPECIFICATIONS	FABRIC GRADES								
		COM	1	2	3	4	5	6	7	8
<p>Specify Interior Material Code, Followed by Exterior Material Code V = Veneer L = Laminate WB = Whiteboard</p>										
<p>6521-(-)-65TL</p> 	<p>Private Love Seat Unit with Integrated Table Non-Upholstered Accent Tier W 88¹/₂ D 60 H 56³/₄ Seat Height 18 Inside Seat Width 55¹/₄ Inside Seat Depth 19 24¹/₄ yds. 562 lbs. TB 133, add \$1164 List</p>	11592	12902	13217	13775	14333	14866	15424	15933	16491
<p>6522-(-)-65TL</p> 	<p>Private Love Seat Unit with Full Canopy and Integrated Table, Non-Upholstered Accent Tier W 88¹/₂ D 60 H 80¹/₄ Seat Height 18 Inside Seat Width 55¹/₄ Inside Seat Depth 19 35³/₄ yds. 637 lbs. TB 133, add \$1716 List</p>	13766	15697	16162	16984	17806	18593	19415	20166	20988
<p>6523-(-)-65TL</p> 	<p>Private Love Seat Unit with Open Canopy and Integrated Table, Non-Upholstered Accent Tier W 88¹/₂ D 60 H 80¹/₄ Seat Height 18 Inside Seat Width 55¹/₄ Inside Seat Depth 19 34 yds. 741 lbs. TB 133, add \$1632 List</p>	13822	15658	16100	16882	17664	18412	19194	19908	20690

OPTIONS (XXXX - REFERS TO LOVE SEAT MODEL NUMBER)

MODEL	DESCRIPTION	LIST	OPTIONAL ACCESSORIES	PAGE REFERENCE
XXXX-MB07	Moisture Barrier, Seats Only	290	Shelf	page 39
XXXX-LED2	LED Light (two fixtures, full canopy only)	500	Linking Table	page 40
XXXX-MR5	Monitor Ready Mounting (includes PB5 table-mounted power unit)	665	Cantilever Table	page 40
XXXX-PF03	Premium Finish, Table Post	110	Storage Cubby	page 41

FOR PLACEMENT BELOW SEATS AND/OR CENTER OF INTEGRATED TABLES

XXXX-PB1-S	Power Band 1 (one power, two USB), Silver	413
XXXX-PB1-W	Power Band 1 (one power, two USB), White	413
XXXX-PB2-S	Power Band 2 (dual power), Silver	322
XXXX-PB2-W	Power Band 2 (dual power), White	322
XXXX-PB3-S	Power Band 3 (dual power, two USB), Silver	429
XXXX-PB3-W	Power Band 3 (dual power, two USB), White	429

FOR INTEGRATED TABLES ONLY, CENTERED 5" FROM BACK

XXX-PP1	Portal Power 1 (one power, one data)	612
XXXX-PP2	Portal Power 2 (dual power)	542
XXXX-PP3	Portal Power 3 (one power, two USB)	643

NOTES:

- Fully upholstered seating models with black plinth base. Refer to page 3 for product details.
- When specifying electrical or over-head LED light fixture, cord exit grommet position must be specified as well as power source location, as applicable.

SPECIFY:

- Model number
- Upholstery selection
- Options, as applicable

ORDERING EXAMPLE:

#6532-LED2-PB1-S

60" D Love Seat, Full Canopy
Overhead LED Light
Power Band 1 Unit, Silver
Seat Placement

CO-OP
MEETING SPACES

designed by qdesign

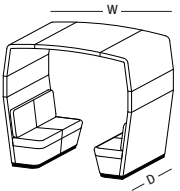
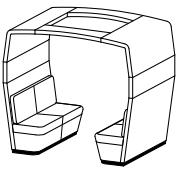
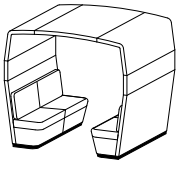
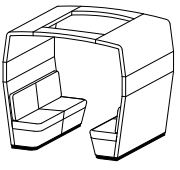

SIN #711-16

MODEL NUMBER	PRODUCT SPECIFICATIONS	FABRIC GRADES								
		COM	1	2	3	4	5	6	7	8
6532 	60" D Booth with Full Canopy W 88 ¹ / ₂ D 60 H 80 ¹ / ₄ Seat Height 18 Inside Seat Width 60 Inside Seat Depth 19 34 yds. 496 lbs. TB 133, add \$1632 List	7484	9320	9762	10544	11326	12074	12856	13570	14352
6533 	60" D Booth with Open Canopy W 88 ¹ / ₂ D 60 H 80 ¹ / ₄ Seat Height 18 Inside Seat Width 60 Inside Seat Depth 19 32 ¹ / ₄ yds. 470 lbs. TB 133, add \$1548 List	7540	9282	9701	10443	11185	11894	12636	13313	14055
6534 	72" D Booth with Full Canopy W 88 ¹ / ₂ D 72 H 80 ¹ / ₄ Seat Height 18 Inside Seat Width 60 Inside Seat Depth 19 39 yds. 594 lbs. TB 133, add \$1872 List	9002	11108	11615	12512	13409	14267	15164	15983	16880
6535 	72" D Booth with Open Canopy W 88 ¹ / ₂ D 72 H 80 ¹ / ₄ Seat Height 18 Inside Seat Width 60 Inside Seat Depth 19 36 ¹ / ₄ yds. 582 lbs. TB 133, add \$1740 List	8942	10900	11371	12205	13039	13836	14670	15431	16265

OPTIONS (XXXX - REFERS TO BOOTH MODEL NUMBER)

MODEL	DESCRIPTION	LIST	OPTIONAL ACCESSORIES	PAGE REFERENCE
XXXX-MB07	Moisture Barrier, Seats Only (60" D Models)	290	Shelf	page 39
XXXX-MB08	Moisture Barrier, Seats Only (72" D Models)	340	Linking Table	page 40
XXXX-LED2	LED Light (two fixtures, full canopy only)	500	Cantilever Table	page 40
XXXX-SB2	Sandbags, Set of 6 (150 lbs. per seat)	700	Storage Cubby	page 41
			Meeting Tables	page 42

FOR PLACEMENT BELOW SEATS

XXXX-PB1-S	Power Band 1 (one power, two USB), Silver	413
XXXX-PB1-W	Power Band 1 (one power, two USB), White	413
XXXX-PB2-S	Power Band 2 (dual power), Silver	322
XXXX-PB2-W	Power Band 2 (dual power), White	322
XXXX-PB3-S	Power Band 3 (dual power, two USB), Silver	429
XXXX-PB3-W	Power Band 3 (dual power, two USB), White	429

CO-OP MEETING SPACES

designed by qdesign

NOTES:

- Seating models with accent tier. Refer to pages 3 and 5 for product details.
- Accent tier available in Maple, Walnut and White Oak veneer (-V), laminate (-L) and whiteboard material (-WB). Please specify code for interior and exterior material selections.
- Standard with black plinth base.
- When specifying electrical or over-head LED light fixture, cord exit grommet position must be specified as well as power source location, as applicable.

SPECIFY:

1. Model number
2. Accent tier finish, interior
3. Accent tier finish, exterior
4. Upholstery selection
5. Options, as applicable

ORDERING EXAMPLE:

#6533-V-WB-PB3-W
 60" Love Seat w/Open Canopy Veneer Accent Tier, Interior Whiteboard Accent Tier, Exterior Power Band 3 Unit, White Seat Placement

SIN #711-16

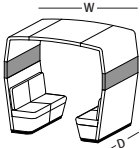
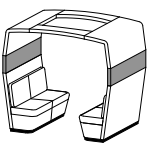
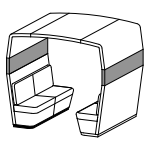
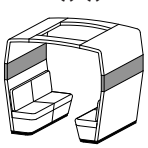
MODEL NUMBER	PRODUCT SPECIFICATIONS	FABRIC GRADES								
		COM	1	2	3	4	5	6	7	8
Specify Interior Material Code, Followed by Exterior Material Code V = Veneer L = Laminate WB = Whiteboard										
6532-(-)(-) 	60" D Booth with Full Canopy Non-Upholstered Accent Tier W 88 ¹ / ₂ D 60 H 80 ¹ / ₄ Seat Height 18 Inside Seat Width 60 Inside Seat Depth 19 30 yds. 506 lbs. TB 133, add \$1440 List	9034	10654	11044	11734	12424	13084	13774	14404	15094
6533-(-)(-) 	60" D Booth with Open Canopy Non-Upholstered Accent Tier W 88 ¹ / ₂ D 60 H 80 ¹ / ₄ Seat Height 18 Inside Seat Width 60 Inside Seat Depth 19 28 ¹ / ₄ yds. 480 lbs. TB 133, add \$1356 List	9090	10616	10983	11633	12283	12904	13554	14147	14797
6534-(-)(-) 	72" D Booth with Full Canopy Non-Upholstered Accent Tier W 88 ¹ / ₂ D 72 H 80 ¹ / ₄ Seat Height 18 Inside Seat Width 60 Inside Seat Depth 19 34 ¹ / ₂ yds. 604 lbs. TB 133, add \$1656 List	10581	12444	12893	13686	14480	15239	16032	16757	17550
6535-(-)(-) 	72" D Booth with Open Canopy Non-Upholstered Accent Tier W 88 ¹ / ₂ D 72 H 80 ¹ / ₄ Seat Height 18 Inside Seat Width 60 Inside Seat Depth 19 31 ³ / ₄ yds. 592 lbs. TB 133, add \$1524 List	10522	12237	12650	13380	14110	14809	15539	16206	16936

OPTIONS (XXXX - REFERS TO BOOTH MODEL NUMBER)

MODEL	DESCRIPTION	LIST	OPTIONAL ACCESSORIES	PAGE REFERENCE
XXXX-MB07	Moisture Barrier, Seats Only (60" D Models)	290	Shelf	page 39
XXXX-MB08	Moisture Barrier, Seats Only (72" D Models)	340	Linking Table	page 40
XXXX-LED2	LED Light (two fixtures, full canopy only)	500	Cantilever Table	page 40
XXXX-SB2	Sandbags, Set of 6 (150 lbs. per seat)	700	Storage Cubby	page 41
			Meeting Tables	page 42

FOR PLACEMENT BELOW SEATS

XXXX-PB1-S	Power Band 1 (one power, two USB), Silver	412
XXXX-PB1-W	Power Band 1 (one power, two USB), White	412
XXXX-PB2-S	Power Band 2 (dual power), Silver	322
XXXX-PB2-W	Power Band 2 (dual power), White	322
XXXX-PB3-S	Power Band 3 (dual power, two USB), Silver	429
XXXX-PB3-W	Power Band 3 (dual power, two USB), White	429

NOTES:

- Fully upholstered canopy units with black plinth base. Refer to page 4 for product details.
- Table available in Maple, Walnut and White Oak veneer as well as laminate.
- Base available in standard and premium metal finishes.
- When specifying electrical or over-head LED light fixture, cord exit grommet position must be specified as well as power source location, as applicable.

SPECIFY:

- Model number
- Upholstery selection
- Table wood species
- Table wood finish
- Base finish
- Options, as applicable

ORDERING EXAMPLE:

#6543-3029-PP1
 60" D Open Canopy with
 30" Wide x 29" H Table
 Portal Power 1 Unit

CO-OP
MEETING SPACES

designed by qdesign

SIN #711-16

MODEL NUMBER	PRODUCT SPECIFICATIONS	FABRIC GRADES									
		TABLE HEIGHT	COM	1	2	3	4	5	6	7	8
6542-24(TABLE HEIGHT) 	60" D Stand-Alone Full Canopy with 24" Wide Table W 88 ¹ / ₂ D 60 H 80 ¹ / ₄ 23 yds. 461 lbs. average weight TB 133, add \$1104 List	27"	7024	8266	8565	9094	9623	10129	10658	11141	11670
		29"	6994	8236	8535	9064	9593	10099	10628	11111	11640
		39"	7259	8501	8800	9329	9858	10364	10893	11376	11905
6542-30(TABLE HEIGHT) 	60" D Stand-Alone Full Canopy with 30" Wide Table W 88 ¹ / ₂ D 60 H 80 ¹ / ₄ 23 yds. 475 lbs. average weight TB 133, add \$1104 List	27"	7523	8765	9064	9593	10122	10628	11157	11640	12169
		29"	7494	8736	9035	9564	10093	10599	11128	11611	12140
		39"	7757	8999	9298	9827	10356	10862	11391	11874	12403
6543-24(TABLE HEIGHT) 	60" D Stand-Alone Open Canopy with 24" Wide Table W 88 ¹ / ₂ D 60 H 80 ¹ / ₄ 21 ¹ / ₄ yds. 435 lbs. average weight TB 133, add \$1020 List	27"	7080	8228	8504	8993	9482	9949	10438	10884	11373
		29"	7051	8199	8475	8964	9453	9920	10409	10855	11344
		39"	7315	8463	8739	9228	9717	10184	10673	11119	11608
6543-30(TABLE HEIGHT) 	60" D Stand-Alone Open Canopy with 30" Wide Table W 88 ¹ / ₂ D 60 H 80 ¹ / ₄ 21 ¹ / ₄ yds. 449 lbs. average weight TB 133, add \$1020 List	27"	7579	8727	9003	9492	9981	10448	10937	11383	11872
		29"	7550	8698	8974	9463	9952	10419	10908	11354	11843
		39"	7813	8961	9237	9726	10215	10682	11171	11617	12106

TABLE LENGTHS (ALL WIDTHS)

- 27" High = 78" L
- 29" High = 78¹/₂" L
- 39" High = 81¹/₂" L

OPTIONS (XXXX - REFERS TO BOOTH MODEL NUMBER)

MODEL	DESCRIPTION	LIST	OPTIONAL ACCESSORIES	PAGE REFERENCE
XXXX-LED2	LED Light (two fixtures, full canopy only)	500	Shelf	page 39
XXXX-PF03	Premium Finish, Table Base	110	Linking Table	page 40
			Cantilever Table	page 40
			Storage Cubby	page 41
FOR TABLE PLACEMENT ONLY				
XXXX-PB1-S or XXXX-PB1-W	Power Band 1 (one power, two USB), Silver (-S) or White (-W)	413		
XXXX-PB2-S or XXXX-PB2-W	Power Band 2 (dual power), Silver (-S) or White (-W)	322		
XXXX-PB3-S or XXXX-PB3-W	Power Band 3 (dual power, two USB), Silver (-S) or White (-W)	429		
XXXX-PP1	Portal Power 1 (one power, one data)	612		
XXXX-PP2	Portal Power 2 (dual power)	542		
XXXX-PP3	Portal Power 3 (one power, two USB)	643		

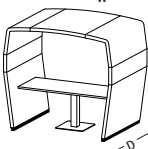
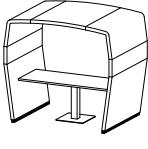
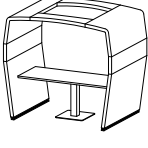
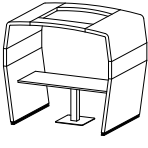
CO-OP MEETING SPACES

designed by qdesign

NOTES:

- Fully upholstered canopy units with table and black plinth base. Refer to page 4 for product details.
- Table available in Maple, Walnut and White Oak veneer as well as laminate.
- Base available in standard and premium metal finishes.
- When specifying electrical or overhead LED light fixture, cord exit grommet position must be specified as well as power source location, as applicable.

SPECIFY:

- Model number
- Upholstery selection
- Table wood species
- Table wood finish
- Base finish
- Options, as applicable

ORDERING EXAMPLE:

#6544-3029-PF03
72" D Open Canopy with 30" Wide x 29" H Table Premium Base Finish

SIN #711-16

MODEL NUMBER	PRODUCT SPECIFICATIONS	FABRIC GRADES										
		TABLE HEIGHT	COM	1	2	3	4	5	6	7	8	
6544-30(TABLE HEIGHT) 	72" D Stand-Alone Full Canopy with 30" Wide Table W 88 ¹ / ₂ D 72 H 80 ¹ / ₄ 27 yds. 547 lbs. average weight TB 133, add \$1296 List	27"	8309	9767	10118	10739	11360	11954	12575	13142	13763	
		29"	8280	9738	10089	10710	11331	11925	12546	13113	13734	
		39"	8543	10001	10352	10973	11594	12188	12809	13376	13997	
6544-36(TABLE HEIGHT) 	72" D Stand-Alone Full Canopy with 36" Wide Table W 88 ¹ / ₂ D 72 H 80 ¹ / ₄ 27 yds. 562 lbs. average weight TB 133, add \$1296 List	27"	8342	9800	10151	10772	11393	11987	12608	13175	13796	
		29"	8313	9771	10122	10743	11364	11958	12579	13146	13767	
		39"	8577	10035	10386	11007	11628	12222	12843	13410	14031	
6545-30(TABLE HEIGHT) 	72" D Stand-Alone Open Canopy with 30" Wide Table W 88 ¹ / ₂ D 72 H 80 ¹ / ₄ 24 ¹ / ₄ yds. 511 lbs. average weight TB 133, add \$1164 List	27"	8250	9560	9875	10433	10991	11524	12082	12591	13149	
		29"	8220	9530	9845	10403	10961	11494	12052	12561	13119	
		39"	8484	9794	10109	10667	11225	11758	12316	12825	13383	
6545-36(TABLE HEIGHT) 	72" D Stand-Alone Open Canopy with 36" Wide Table W 88 ¹ / ₂ D 72 H 80 ¹ / ₄ 24 ¹ / ₄ yds. 526 lbs. average weight TB 133, add \$1164 List	27"	8283	9593	9908	10466	11024	11557	12115	12624	13182	
		29"	8254	9564	9879	10437	10995	11528	12086	12595	13153	
		39"	8517	9827	10142	10700	11258	11791	12349	12858	13416	

TABLE LENGTHS (ALL WIDTHS)

27" High = 78" L
 29" High = 78¹/₂" L
 39" High = 81¹/₂" L

OPTIONS (XXXX - REFERS TO CANOPY MODEL NUMBER)

MODEL	DESCRIPTION	LIST	OPTIONAL ACCESSORIES	PAGE REFERENCE
XXXX-LED2	LED Light (two fixtures, full canopy only)	500	Shelf	page 39
XXXX-PF03	Premium Finish, Table Base	110	Linking Table	page 40
			Cantilever Table	page 40
			Storage Cubby	page 41
FOR TABLE PLACEMENT ONLY				
XXXX-PB1-S or XXXX-PB1-W	Power Band 1 (one power, two USB), Silver (-S) or White (-W)	413		
XXXX-PB2-S or XXXX-PB2-W	Power Band 2 (dual power), Silver (-S) or White (-W)	322		
XXXX-PB3-S or XXXX-PB3-W	Power Band 3 (dual power, two USB), Silver (-S) or White (-W)	429		
XXXX-PP1	Portal Power 1 (one power, one data)	612		
XXXX-PP2	Portal Power 2 (dual power)	542		
XXXX-PP3	Portal Power 3 (one power, two USB)	643		

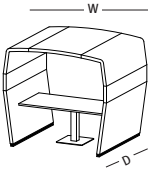
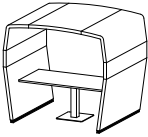
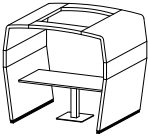
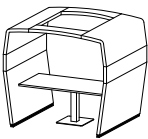
NOTES:

- Canopy units with table and accent tier black plinth base. Refer to pages 4-5 for product details.
- Standard with black plinth base.
- Accent tier available in Maple, Walnut and White Oak veneer (-V), laminate (-L) and whiteboard material (-WB). Please specify code for interior and exterior material selections.
- Table available in Maple, Walnut and White Oak veneer as well as laminate.
- Base available in standard and premium metal finishes.
- When specifying electrical or overhead LED light fixture, cord exit grommet position must be specified as well as power source location, as applicable.

SPECIFY:

1. Model number
2. Accent tier finish, interior
3. Accent tier finish, exterior
4. Upholstery selection
5. Table wood species
6. Table wood finish
7. Base finish
8. Options, as applicable

ORDERING EXAMPLE:

#6542-L-L-3039-LED2

60" D Full Canopy with
30" W x 39" H Table
Laminate Accent Tier, Interior
Laminate Accent Tier, Exterior
LED Lights

CO-OP
MEETING SPACES

designed by qdesign

SIN #711-16

MODEL NUMBER	PRODUCT SPECIFICATIONS	FABRIC GRADES										
		TABLE HEIGHT	COM	1	2	3	4	5	6	7	8	
Specify Interior Material Code, Followed by Exterior Material Code V = Veneer L = Laminate WB = Whiteboard												
6542-24-(-)(-)(TABLE HEIGHT) 	60" D Stand-Alone Full Canopy Non-Upholstered Accent Tier with 24" Wide Table W 88 ¹ / ₂ D 60 H 80 ¹ / ₄ 19 yds. 471 lbs. average weight TB 133, add \$912 List	27"	8572	9598	9845	10282	10719	11137	11574	11973	12410	
		29"	8543	9569	9816	10253	10690	11108	11545	11944	12381	
		39"	8807	9833	10080	10517	10954	11372	11809	12208	12645	
6542-30-(-)(-)(TABLE HEIGHT) 	60" D Stand-Alone Full Canopy Non-Upholstered Accent Tier with 30" Wide Table W 88 ¹ / ₂ D 60 H 80 ¹ / ₄ 19 yds. 485 lbs. average weight TB 133, add \$912 List	27"	9071	10097	10344	10781	11218	11636	12073	12472	12909	
		29"	9042	10068	10315	10752	11189	11607	12044	12443	12880	
		39"	9306	10332	10579	11016	11453	11871	12308	12707	13144	
6543-24-(-)(-)(TABLE HEIGHT) 	60" D Stand-Alone Open Canopy Non-Upholstered Accent Tier with 24" Wide Table W 88 ¹ / ₂ D 60 H 80 ¹ / ₄ 17 ¹ / ₄ yds. 445 lbs. average weight TB 133, add \$828 List	27"	8629	9561	9785	10182	10579	10958	11355	11717	12114	
		29"	8599	9531	9755	10152	10549	10928	11325	11687	12084	
		39"	8863	9795	10019	10416	10813	11192	11589	11951	12348	
6543-30-(-)(-)(TABLE HEIGHT) 	60" D Stand-Alone Open Canopy Non-Upholstered Accent Tier with 30" Wide Table W 88 ¹ / ₂ D 60 H 80 ¹ / ₄ 17 ¹ / ₄ yds. 459 lbs. average weight TB 133, add \$828 List	27"	9128	10060	10284	10681	11078	11457	11854	12216	12613	
		29"	9098	10030	10254	10651	11048	11427	11824	12186	12583	
		39"	9363	10295	10519	10916	11313	11692	12089	12451	12848	

TABLE LENGTHS (ALL WIDTHS)

- 27" High = 78" L
- 29" High = 78¹/₂" L
- 39" High = 81¹/₂" L

OPTIONS (XXXX-REFERS TO CANOPY MODEL NUMBER)

MODEL	DESCRIPTION	LIST	OPTIONAL ACCESSORIES	PAGE REFERENCE
XXXX-LED2	LED Light (two fixtures, full canopy only)	500	Shelf Linking Table Cantilever Table Storage Cubby	page 39 page 40 page 40 page 41
	Refer to page 26 for electrical options			

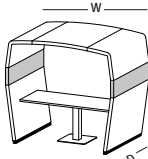
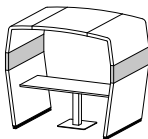
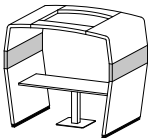
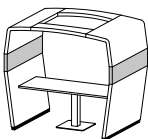
CO-OP MEETING SPACES

designed by qdesign

NOTES:

- Canopy units with table and accent tier black plinth base. Refer to pages 4-5 for product details.
- Standard with black plinth base.
- Accent tier available in Maple, Walnut and White Oak veneer (-V), laminate (-L) and whiteboard material (-WB). Please specify code for interior and exterior material selections.
- Table available in Maple, Walnut and White Oak veneer as well as laminate.
- Base available in standard and premium metal finishes.
- When specifying electrical or overhead LED light fixture, cord exit grommet position must be specified as well as power source location, as applicable.

SPECIFY:

1. Model number
2. Accent tier finish, interior
3. Accent tier finish, exterior
4. Upholstery selection
5. Table wood species
6. Table wood finish
7. Base finish
8. Options, as applicable

ORDERING EXAMPLE:

#6545-V-V-3039-LED2
 72" D Open Canopy with 30" W x 39" H Table
 Veneer Accent Tier, Interior
 Veneer Accent Tier, Exterior
 LED Lights

SIN #711-16

MODEL NUMBER PRODUCT SPECIFICATIONS FABRIC GRADES

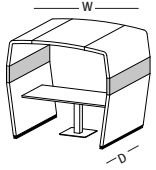
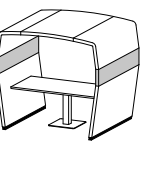
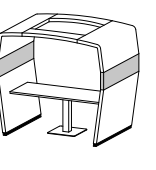
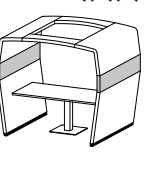
	TABLE HEIGHT	COM	FABRIC GRADES							
			1	2	3	4	5	6	7	8
Specify Interior Material Code, Followed by Exterior Material Code V = Veneer L = Laminate WB = Whiteboard										
6544-30-(-)(-)(TABLE HEIGHT) 										
	27"	9888	11103	11396	11913	12431	12926	13443	13916	14433
	29"	9859	11074	11367	11884	12402	12897	13414	13887	14404
	39"	10123	11338	11631	12148	12666	13161	13678	14151	14668
6544-36-(-)(-)(TABLE HEIGHT) 										
	27"	9921	11136	11429	11946	12464	12959	13476	13949	14466
	29"	9892	11107	11400	11917	12435	12930	13447	13920	14437
	39"	10156	11371	11664	12181	12699	13194	13711	14184	14701
6545-30-(-)(-)(TABLE HEIGHT) 										
	27"	9828	10895	11152	11606	12060	12495	12949	13364	13818
	29"	9799	10866	11123	11577	12031	12466	12920	13335	13789
	39"	10064	11131	11388	11842	12296	12731	13185	13600	14054
6545-36-(-)(-)(TABLE HEIGHT) 										
	27"	9862	10929	11186	11640	12094	12529	12983	13398	13852
	29"	9833	10900	11157	11611	12065	12500	12954	13369	13823
	39"	10097	11164	11421	11875	12329	12764	13218	13633	14087
TABLE LENGTHS (ALL WIDTHS) 27" High = 78" L 29" High = 78 1/2" L 39" High = 81 1/2" L										

OPTIONS (XXXX - REFERS TO CANOPY MODEL NUMBER)

MODEL	DESCRIPTION	LIST	OPTIONAL ACCESSORIES	PAGE REFERENCE
XXXX-LED2	LED Light (two fixtures, full canopy only)	500	Shelf Linking Table Cantilever Table Storage Cubby	page 39 page 40 page 40 page 41
	Refer to page 26 for electrical options			

NOTES:

- Fully upholstered wall-mount canopy units with, or without suspended table. Refer to page 5 for product details.
- Table available in Maple, Walnut and White Oak veneer as well as laminate.
- Standard with black plinth base.
- When specifying electrical or over-head LED light fixture, cord exit grommet position must be specified as well as power source location, as applicable.

SPECIFY:

- Model number
- Upholstery selection
- Table wood species
- Table wood finish
- Options, as applicable

ORDERING EXAMPLE:

#6552-2439

60" W Wall-Mount Full Canopy with 24" W x 39" H Table

CO-OP MEETING SPACES

designed by qdesign

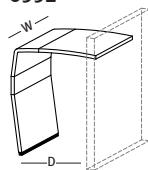
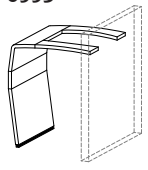
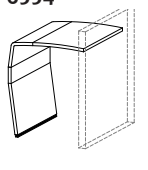
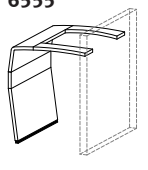

SIN #711-16

MODEL NUMBER	PRODUCT SPECIFICATIONS	FABRIC GRADES								
		COM	1	2	3	4	5	6	7	8
 <p>6552 60" W Wall-Mount Unit with Full Canopy, Panel Only W 60 D 66¹/₄ H 80¹/₄ 13¹/₄ yds. 196 lbs. TB 133, add \$636 List</p>	2916	3632	3804	4109	4414	4705	5010	5288	5593	
 <p>6553 60" W Wall-Mount Unit with Open Canopy, Panel Only W 60 D 66¹/₄ H 80¹/₄ 11¹/₂ yds. 170 lbs. TB 133, add \$552 List</p>	2978	3599	3749	4013	4278	4531	4795	5037	5301	
 <p>6554 72" W Wall-Mount Unit with Full Canopy, Panel Only W 72 D 66¹/₄ H 80¹/₄ 15³/₄ yds. 237 lbs. TB 133, add \$756 List</p>	3366	4217	4422	4784	5146	5493	5855	6186	6548	
 <p>6555 72" W Wall-Mount Unit with Open Canopy, Panel Only W 72 D 66¹/₄ H 80¹/₄ 13 yds. 201 lbs. TB 133, add \$624 List</p>	3313	4015	4184	4483	4782	5068	5367	5640	5939	

OPTIONS (XXXX - REFERS TO WALL-MOUNT UNIT MODEL NUMBER)

MODEL	DESCRIPTION	LIST	OPTIONAL ACCESSORIES	PAGE REFERENCE
XXXX-2427	24" W x 61" L x 27" H Suspended Table (for 60" W models only)	957		
XXXX-2429	24" W x 61 ¹ / ₂ " L x 29" H Suspended Table (for 60" W models only)	957	Shelf	page 39
XXXX-2439	24" W x 63" L x 39" H Suspended Table (for 60" W models only)	957	Linking Table	page 40
XXXX-3027	30" W x 61" L x 27" H Suspended Table (for 60" or 72" W models)	1551	Cantilever Table	page 40
XXXX-3029	30" W x 61 ¹ / ₂ " L x 29" H Suspended Table (for 60" or 72" W models)	1551	Storage Cubby	page 41
XXXX-3039	30" W x 63" L x 39" H Suspended Table (for 60" or 72" W models)	1551		
XXXX-3627	36" W x 61" L x 27" H Suspended Table (for 72" W models only)	1585		
XXXX-3629	36" W x 61 ¹ / ₂ " L x 29" H Suspended Table (for 72" W models only)	1585		
XXXX-3639	36" W x 63" L x 39" H Suspended Table (for 72" W models only)	1585		
XXXX-LED2	LED Light - only available with addition of suspended table (two fixtures, full canopy only)	500		
FOR TABLE PLACEMENT ONLY, CENTER PLACEMENT				
XXXX-PB1-S or XXXX-PB1-W	Power Band 1 (one power, two USB), Silver (-S) or White (-W)	413		
XXXX-PB2-S or XXXX-PB2-W	Power Band 2 (dual power), Silver (-S) or White (-W)	322		
XXXX-PB3-S or XXXX-PB3-W	Power Band 3 (dual power, two USB), Silver (-S) or White (-W)	429		
XXXX-PP1	Portal Power 1 (one power, one data)	612		
XXXX-PP2	Portal Power 2 (dual power)	542		
XXXX-PP3	Portal Power 3 (one power, two USB)	643		

CO-OP MEETING SPACES

designed by qdesign

NOTES:

- Wall-mount canopy units with accent tier and suspended table option. Refer to page 5 for product details.
- Accent tier available in Maple, Walnut and White Oak veneer (-V), laminate (-L) and whiteboard material (-WB). Please specify code for interior and exterior material selections.
- Table available in Maple, Walnut and White Oak veneer as well as laminate.
- Standard with black plinth base.
- When specifying electrical or over-head LED light fixture, cord exit grommet position must be specified as well as power source location, as applicable.

SPECIFY:

1. Model number
2. Accent tier finish, interior
3. Accent tier finish, exterior
4. Upholstery selection
5. Table wood species
6. Table wood finish
7. Options, as applicable

ORDERING EXAMPLE:

#6552-2439
60" W Wall-Mount Full Canopy with 24" W x 39" H Table

SIN #711-16

MODEL NUMBER PRODUCT SPECIFICATIONS FABRIC GRADES

Specify Interior Material Code, Followed by Exterior Material Code
V = Veneer L = Laminate WB = Whiteboard

6552-()-()

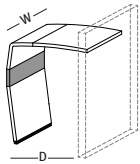

60" W Wall-Mount Unit with Full Canopy and Non-Upholstered Accent Tier, Panel Only
W 60 D 66¹/₄ H 80¹/₄
11¹/₄ yds. 201 lbs.
TB 133, add \$540 List

COM 1 2 3 4 5 6 7 8

3690 4298 4444 4703 4962 5209 5468 5704 5963

6553-()-()

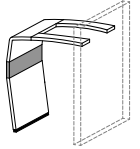

60" W Wall-Mount Unit with Open Canopy and Non-Upholstered Accent Tier, Panel Only
W 60 D 66¹/₄ H 80¹/₄
9¹/₂ yds. 175 lbs.
TB 133, add \$456 List

3752 4265 4389 4607 4826 5035 5253 5453 5671

6554-()-()

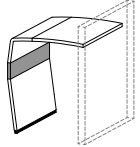

72" W Wall-Mount Unit with Full Canopy and Non-Upholstered Accent Tier, Panel Only
W 72 D 66¹/₄ H 80¹/₄
13¹/₂ yds. 242 lbs.
TB 133, add \$648 List

4155 4884 5060 5370 5681 5978 6288 6572 6882

6555-()-()

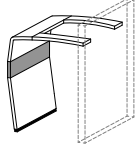

72" W Wall-Mount Unit with Open Canopy and Non-Upholstered Accent Tier, Panel Only
W 72 D 66¹/₄ H 80¹/₄
10³/₄ yds. 206 lbs.
TB 133, add \$516 List

4102 4683 4823 5070 5317 5554 5801 6027 6274

OPTIONS (XXXX - REFERS TO WALL-MOUNT UNIT MODEL NUMBER)

MODEL	DESCRIPTION	LIST	OPTIONAL ACCESSORIES	PAGE REFERENCE
XXXX-2427	24" W x 61" L x 27" H Suspended Table (for 60" W models only)	957	Shelf	page 39
XXXX-2429	24" W x 61 ¹ / ₂ " L x 29" H Suspended Table (for 60" W models only)	957	Linking Table	page 40
XXXX-2439	24" W x 63" L x 39" H Suspended Table (for 60" W models only)	957	Cantilever Table	page 40
XXXX-3027	30" W x 61" L x 27" H Suspended Table (for 60" or 72" W models)	1551	Storage Cubby	page 41
XXXX-3029	30" W x 61 ¹ / ₂ " L x 29" H Suspended Table (for 60" or 72" W models)	1551		
XXXX-3039	30" W x 63" L x 39" H Suspended Table (for 60" or 72" W models)	1551		
XXXX-3627	36" W x 61" L x 27" H Suspended Table (for 72" W models only)	1585		
XXXX-3629	36" W x 61 ¹ / ₂ " L x 29" H Suspended Table (for 72" W models only)	1585		
XXXX-3639	36" W x 63" L x 39" H Suspended Table (for 72" W models only)	1585		
XXXX-LED2	LED Light - only available with addition of suspended table (two fixtures, full canopy only)	500		

Refer to page 29 for electrical options

NOTES:

- Fully upholstered wall-mount unit with love seat. Refer to page 5 for product details.
- Standard with black plinth base.
- When specifying electrical or over-head LED light fixture, cord exit grommet position must be specified as well as power source location, as applicable.

SPECIFY:

1. Model number
2. Upholstery selection
3. Options, as applicable

ORDERING EXAMPLE:

#6562-LED2

60" W Wall-Mount Love Seat
with Full Canopy
Overhead Light Fixture

CO-OP
MEETING SPACES

designed by qdesign

SIN #711-16

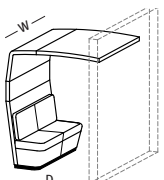
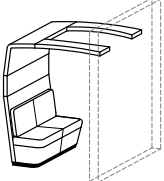
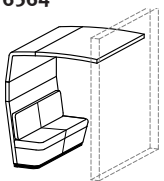
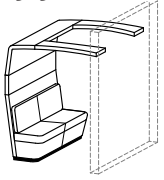
MODEL NUMBER	PRODUCT SPECIFICATIONS	FABRIC GRADES								
		COM	1	2	3	4	5	6	7	8
<p>6562</p> 	<p>60" W Wall-Mount Seating Unit with Full Canopy W 60 D 66¹/₄ H 80¹/₄ Seat Height 18 Inside Seat Width 60 Inside Seat Depth 19 18³/₄ yds. 273 lbs. TB 133, add \$900 List</p>	4157	5170	5414	5845	6276	6689	7120	7514	7945
<p>6563</p> 	<p>60" W Wall-Mount Seating Unit with Open Canopy W 60 D 66¹/₄ H 80¹/₄ Seat Height 18 Inside Seat Width 60 Inside Seat Depth 19 17 yds. 247 lbs. TB 133, add \$816 List</p>	4219	5137	5358	5749	6140	6514	6905	7262	7653
<p>6564</p> 	<p>72" W Wall-Mount Seating Unit with Full Canopy W 72 D 66¹/₄ H 80¹/₄ Seat Height 18 Inside Seat Width 60 Inside Seat Depth 19 21³/₄ yds. 332 lbs. TB 133, add \$1044 List</p>	4973	6148	6431	6931	7431	7910	8410	8867	9367
<p>6565</p> 	<p>72" W Wall-Mount Seating Unit with Open Canopy W 72 D 66¹/₄ H 80¹/₄ Seat Height 18 Inside Seat Width 60 Inside Seat Depth 19 19 yds. 296 lbs. TB 133, add \$912 List</p>	4920	5946	6193	6630	7067	7485	7922	8321	8758

OPTIONS (XXXX - REFERS TO SEATING UNIT MODEL NUMBER)

MODEL	DESCRIPTION	LIST	OPTIONAL ACCESSORIES	PAGE REFERENCE
XXXX-MB03	Moisture Barrier, Seats Only (60" D Models)	145	Shelf	page 39
XXXX-MB04	Moisture Barrier, Seats Only (72" D Models)	170	Linking Table	page 40
XXXX-LED2	LED Light (two fixtures, full canopy only)	500	Cantilever Table	page 40
XXXX-SB3	Sandbags, Set of 3 (150 lbs. per seat)	350	Storage Cubby	page 41

FOR PLACEMENT BELOW SEATS

XXXX-PB1-S	Power Band 1 (one power, two USB), Silver	413
XXXX-PB1-W	Power Band 1 (one power, two USB), White	413
XXXX-PB2-S	Power Band 2 (dual power), Silver	322
XXXX-PB2-W	Power Band 2 (dual power), White	322
XXXX-PB3-S	Power Band 3 (dual power, two USB), Silver	429
XXXX-PB3-W	Power Band 3 (dual power, two USB), White	429

CO-OP MEETING SPACES

designed by qdesign

NOTES:

- Wall-mount unit with loveseat and accent tier.
- Accent tier available in Maple, Walnut and White Oak veneer (-V), laminate (-L) and whiteboard material (-WB). Please specify code for interior and exterior material selections.
- Standard with black plinth base.
- When specifying electrical or over-head LED light fixture, cord exit grommet position must be specified as well as power source location, as applicable.

SPECIFY:

1. Model number
2. Accent tier finish, interior
3. Accent tier finish, exterior
4. Upholstery selection
5. Options, as applicable

ORDERING EXAMPLE:

#6563-V-WB
60" W Wall-Mount Love Seat with Open Canopy Veneer Accent Tier, Interior Whiteboard Accent Tier, Exterior

SIN #711-16

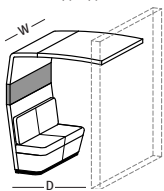
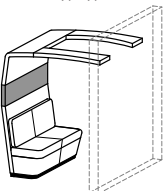
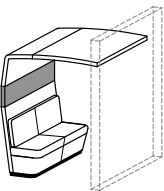
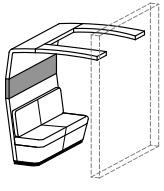
MODEL NUMBER	PRODUCT SPECIFICATIONS	FABRIC GRADES								
		COM	1	2	3	4	5	6	7	8
<p>Specify Interior Material Code, Followed by Exterior Material Code V = Veneer L = Laminate WB = Whiteboard</p>										
<p>6562-(-)(-)</p> 	<p>60" W Wall-Mount Seating Unit, Full Canopy Non-Upholstered Accent Tier W 60 D 66¹/₄ H 80¹/₄ Seat Height 18 Inside Seat Width 60 Inside Seat Depth 19 16³/₄ yds. 278 lbs. TB 133, add \$804 List</p>	4932	5837	6055	6440	6825	7194	7579	7931	8316
<p>6563-(-)(-)</p> 	<p>60" W Wall-Mount Seating Unit, Open Canopy Non-Upholstered Accent Tier W 60 D 66¹/₄ H 80¹/₄ Seat Height 18 Inside Seat Width 60 Inside Seat Depth 19 15 yds. 252 lbs. TB 133, add \$720 List</p>	4994	5804	5999	6344	6689	7019	7364	7679	8024
<p>6564-(-)(-)</p> 	<p>72" W Wall-Mount Seating Unit, Full Canopy Non-Upholstered Accent Tier W 72 D 66¹/₄ H 80¹/₄ Seat Height 18 Inside Seat Width 60 Inside Seat Depth 19 19¹/₂ yds. 338 lbs. TB 133, add \$936 List</p>	5763	6816	7070	7518	7967	8396	8844	9254	9702
<p>6565-(-)(-)</p> 	<p>72" W Wall-Mount Seating Unit, Open Canopy Non-Upholstered Accent Tier W 72 D 66¹/₄ H 80¹/₄ Seat Height 18 Inside Seat Width 60 Inside Seat Depth 19 16³/₄ yds. 302 lbs. TB 133, add \$804 List</p>	5710	6615	6833	7218	7603	7972	8357	8709	9094

OPTIONS (XXXX - REFERS TO SEATING UNIT MODEL NUMBER)

MODEL	DESCRIPTION	LIST	OPTIONAL ACCESSORIES PAGE REFERENCE
XXXX-MB03	Moisture Barrier, Seats Only (60" D Models)	145	Shelf page 39
XXXX-MB04	Moisture Barrier, Seats Only (72" D Models)	170	Linking Table page 40
XXXX-LED2	LED Light (two fixtures, full canopy only)	500	Cantilever Table page 40
XXX-SB3	Sandbags, Set of 3 (150 lbs. total)	350	Storage Cubby page 41

Refer to page 31 for electrical options

NOTES:

- Fully upholstered seating unit. Refer to page 6 for product details.
- Standard with black plinth base.
- Power units available on front and side of seating units. Positioning must be specified in addition to cord exit grommet placement and power source location, as applicable.

SPECIFY:

1. Model number
2. Upholstery selection
3. Options, as applicable

ORDERING EXAMPLE:

#6503-PB1-W





60" W Private Love Seat
Power Band 1 Unit, White

CO-OP
MEETING SPACES

designed by qdesign

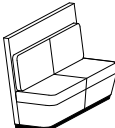

SIN #711-16

MODEL NUMBER	PRODUCT SPECIFICATIONS	FABRIC GRADES								
		COM	1	2	3	4	5	6	7	8
6502 	60" W Seating Unit W 60 D 27 ¹ / ₄ H 43 ¹ / ₂ Seat Height 18 Inside Seat Width 60 Inside Seat Depth 19 9 ³ / ₄ yds. 162 lbs. TB 133, add \$444 List	2171	2671	2791	3004	3217	3420	3633	3827	4040
6503 	60" W Private Seating Unit W 60 D 27 ¹ / ₄ H 56 ³ / ₄ Seat Height 18 Inside Seat Width 60 Inside Seat Depth 19 11 ¹ / ₄ yds. 183 lbs. TB 133, add \$540 List	2657	3265	3411	3670	3929	4176	4435	4671	4930
6504 	72" W Seating Unit W 72 D 27 ¹ / ₄ H 43 ¹ / ₂ Seat Height 18 Inside Seat Width 60 Inside Seat Depth 19 10 ¹ / ₂ yds. 192 lbs. TB 133, add \$504 List	2685	3252	3389	3630	3872	4103	4344	4565	4806
6505 	72" W Private Seating Unit W 72 D 27 ¹ / ₄ H 56 ³ / ₄ Seat Height 18 Inside Seat Width 60 Inside Seat Depth 19 12 ³ / ₄ yds. 219 lbs. TB 133, add \$612 List	3216	3905	4071	4364	4657	4938	5231	5499	5792

OPTIONS (XXXX - REFERS TO SEATING UNIT MODEL NUMBER)

MODEL	DESCRIPTION	LIST	OPTIONAL ACCESSORIES PAGE REFERENCE
XXXX-MB03	Moisture Barrier, Seats Only (60" D Models)	145	Storage Cubby page 41
XXXX-MB04	Moisture Barrier, Seats Only (72" D Models)	170	Meeting Tables page 42
XXXX-SB3	Sandbags, Set of 3 (150 lbs. per seat)	350	

FOR PLACEMENT BELOW SEATS

XXXX-PB1-S	Power Band 1 (one power, two USB), Silver	413
XXXX-PB1-W	Power Band 1 (one power, two USB), White	413
XXXX-PB2-S	Power Band 2 (dual power), Silver	322
XXXX-PB2-W	Power Band 2 (dual power), White	322
XXXX-PB3-S	Power Band 3 (dual power, two USB), Silver	429
XXXX-PB3-W	Power Band 3 (dual power, two USB), White	429

CO-OP MEETING SPACES

designed by qdesign

NOTES:

- Upholstered seating unit with accent tier.
- Accent tier available in Maple, Walnut and White Oak veneer (-V), laminate (-L) and whiteboard material (-WB). Please specify code for interior and exterior material selections.
- Standard with black plinth base.
- Power units available on front and side of seating units. Positioning must be specified in addition to cord exit grommet placement and power source location, as applicable.

SPECIFY:

1. Model number
2. Accent tier finish, interior
3. Accent tier finish, exterior
4. Upholstery selection
5. Options, as applicable

ORDERING EXAMPLE:

#6503-V-L

60" W Private Love Seat
Veneer Accent Tier, Interior
Laminate Accent Tier, Exterior

SIN #711-16

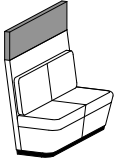
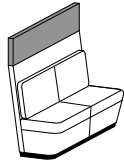
MODEL NUMBER	PRODUCT SPECIFICATIONS	FABRIC GRADES								
		COM	1	2	3	4	5	6	7	8
<p>Specify Interior Material Code, Followed by Exterior Material Code V = Veneer L = Laminate WB = Whiteboard</p>										
<p>6503-()-()</p> 	<p>60" W Private Seating Unit Non-Upholstered Tier W 60 D 27¹/₄ H 56³/₄ Seat Height 18 Inside Seat Width 60 Inside Seat Depth 19 9¹/₄ yds. 188 lbs. TB 133, add \$444 List</p>	3430	3930	4050	4263	4476	4679	4892	5086	5299
<p>6505-()-()</p> 	<p>72" W Private Seating Unit Non-Upholstered Tier W 72 D 27¹/₄ H 56³/₄ Seat Height 18 Inside Seat Width 60 Inside Seat Depth 19 10¹/₂ yds. 224 lbs. TB 133, add \$504 List</p>	4007	4574	4711	4952	5194	5425	5666	5887	6128

OPTIONS (XXXX - REFERS TO SEATING UNIT MODEL NUMBER)

MODEL	DESCRIPTION	LIST	OPTIONAL ACCESSORIES PAGE REFERENCE
XXXX-MB03	Moisture Barrier, Seats Only (60" D Models)	145	Storage Cubby page 41
XXXX-MB04	Moisture Barrier, Seats Only (72" D Models)	170	
XXXX-SB3	Sandbags, Set of 3 (150 lbs. per seat)	350	

FOR PLACEMENT BELOW SEATS

XXXX-PB1-S	Power Band 1 (one power, two USB), Silver	413
XXXX-PB1-W	Power Band 1 (one power, two USB), White	413
XXXX-PB2-S	Power Band 2 (dual power), Silver	322
XXXX-PB2-W	Power Band 2 (dual power), White	322
XXXX-PB3-S	Power Band 3 (dual power, two USB), Silver	429
XXXX-PB3-W	Power Band 3 (dual power, two USB), White	429

NOTES:

- Fully upholstered seating unit. Refer to page 6 for product details.
- Standard with black plinth base.
- Power units available on front and side of seating units. Positioning must be specified in addition to cord exit grommet placement and power source location, as applicable.

SPECIFY:

1. Model number
2. Upholstery selection
3. Options, as applicable

ORDERING EXAMPLE:

#6506-PB1-S

60" W Love Seat
Power Band 1 Unit, Silver
Below Seat Placement

CO-OP
MEETING SPACES

designed by qdesign

SIN #711-16

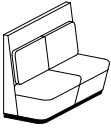
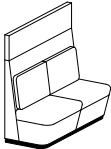
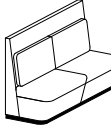
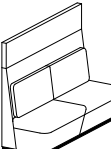
MODEL NUMBER	PRODUCT SPECIFICATIONS	FABRIC GRADES								
		COM	1	2	3	4	5	6	7	8
6506 	60" W Seating Unit, 90-Degree Back W 60 D 27 ¹ / ₄ H 43 ¹ / ₂ Seat Height 18 Inside Seat Width 60 Inside Seat Depth 19 9 ³ / ₄ yds. 172 lbs. TB 133, add \$468 List	2190	2717	2844	3068	3292	3507	3731	3936	4160
6507 	60" W Private Seating Unit, 90-Degree Back W 60 D 27 ¹ / ₄ H 56 ³ / ₄ Seat Height 18 Inside Seat Width 60 Inside Seat Depth 19 11 ³ / ₄ yds. 193 lbs. TB 133, add \$564 List	2675	3310	3463	3733	4003	4262	4532	4779	5049
6508 	72" W Seating Unit, 90-Degree Back W 72 D 27 ¹ / ₄ H 43 ¹ / ₂ Seat Height 18 Inside Seat Width 72 Inside Seat Depth 19 11 yds. 202 lbs. TB 133, add \$528 List	2706	3300	3443	3696	3949	4191	4444	4675	4928
6509 	72" W Private Seating Unit, 90-Degree Back W 60 D 27 ¹ / ₄ H 56 ³ / ₄ Seat Height 18 Inside Seat Width 72 Inside Seat Depth 19 13 ¹ / ₄ yds. 229 lbs. TB 133, add \$636 List	3238	3954	4126	4431	4736	5027	5332	5610	5915

OPTIONS (XXXX - REFERS TO SEATING UNIT MODEL NUMBER)

MODEL	DESCRIPTION	LIST
XXXX-MB03	Moisture Barrier, Seats Only (60" D Models)	145
XXXX-MB04	Moisture Barrier, Seats Only (72" D Models)	170

FOR PLACEMENT BELOW SEATS, AND/OR CENTER SIDE PANEL PLACEMENT

XXXX-PB1-S	Power Band 1 (one power, two USB), Silver	413
XXXX-PB1-W	Power Band 1 (one power, two USB), White	413
XXXX-PB2-S	Power Band 2 (dual power), Silver	322
XXXX-PB2-W	Power Band 2 (dual power), White	322
XXXX-PB3-S	Power Band 3 (dual power, two USB), Silver	429
XXXX-PB3-W	Power Band 3 (dual power, two USB), White	429

CO-OP MEETING SPACES

designed by qdesign

NOTES:

- Upholstered seating unit with accent tier.
- Accent tier available in Maple, Walnut and White Oak veneer (-V), laminate (-L) and whiteboard material (-WB). Please specify code for interior and exterior material selections.
- Standard with black plinth base.
- Power units available on front and side of seating units. Positioning must be specified in addition to cord exit grommet placement and power source location, as applicable.

SPECIFY:

1. Model number
2. Accent tier finish, interior
3. Accent tier finish, exterior
4. Upholstery selection
5. Options, as applicable

ORDERING EXAMPLE:

#6507-V-L
60" W Private Love Seat
Veneer Accent Tier, Interior
Laminate Accent Tier, Exterior

SIN #711-16

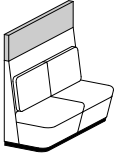
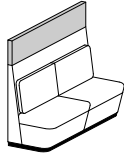
MODEL NUMBER	PRODUCT SPECIFICATIONS	FABRIC GRADES								
		COM	1	2	3	4	5	6	7	8
<p>Specify Interior Material Code, Followed by Exterior Material Code V = Veneer L = Laminate WB = Whiteboard</p>										
<p>6507-()-()</p> 	<p>60" W Private Seating Unit Non-Upholstered Tier, 90-Degree Back W 60 D 27¹/₄ H 56³/₄ Seat Height 18 Inside Seat Width 60 Inside Seat Depth 19 9³/₄ yds. 193 lbs. TB 133, add \$468 List</p>	3450	3977	4104	4328	4552	4767	4991	5196	5420
<p>6509-()-()</p> 	<p>72" W Private Seating Unit Non-Upholstered Tier 90-Degree Back W 60 D 27¹/₄ H 56³/₄ Seat Height 18 Inside Seat Width 72 Inside Seat Depth 19 11 yds. 229 lbs. TB 133, add \$528 List</p>	4027	4621	4764	5017	5270	5512	5765	5996	6249

OPTIONS (XXXX - REFERS TO SEATING UNIT MODEL NUMBER)

MODEL	DESCRIPTION	LIST
XXXX-MB03	Moisture Barrier, Seats Only (60" D Models)	145
XXXX-MB04	Moisture Barrier, Seats Only (72" D Models)	170
FOR PLACEMENT BELOW SEATS, AND/OR CENTER SIDE PANEL PLACEMENT		
XXXX-PB1-S	Power Band 1 (one power, two USB), Silver	413
XXXX-PB1-W	Power Band 1 (one power, two USB), White	413
XXXX-PB2-S	Power Band 2 (dual power), Silver	322
XXXX-PB2-W	Power Band 2 (dual power), White	322
XXXX-PB3-S	Power Band 3 (dual power, two USB), Silver	429
XXXX-PB3-W	Power Band 3 (dual power, two USB), White	429

NOTES:

- Fully upholstered seating unit. Refer to page 7 for product details.
- Standard with black plinth base.
- Power units available on front and side of seating units. Positioning must be specified in addition to cord exit grommet placement and power source location, as applicable.

SPECIFY:

1. Model number
2. Upholstery selection
3. Options, as applicable

ORDERING EXAMPLE:

#6566-PB1-S

60" W Love Seat
Power Band 1 Unit, Silver
Center Panel Placement

CO-OP
MEETING SPACES

designed by qdesign

SIN #711-16

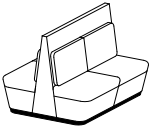
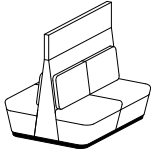
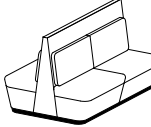
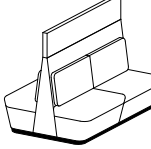
MODEL NUMBER	PRODUCT SPECIFICATIONS	FABRIC GRADES								
		COM	1	2	3	4	5	6	7	8
<p>6566</p> 	<p>60" W Public Back-to-Back Seating Unit, 90-Degree Back W 60 D 51¹/₂ H 43¹/₂ Seat Height 18 Inside Seat Width 60 Inside Seat Depth 19 15¹/₄ yds. 314 lbs. TB 133, add \$732 List</p>	4105	4929	5127	5478	5829	6164	6515	6835	7186
<p>6567</p> 	<p>60" W Private Back-to-Back Seating Unit, 90-Degree Back W 60 D 51¹/₂ H 56³/₄ Seat Height 18 Inside Seat Width 60 Inside Seat Depth 19 17¹/₄ yds. 356 lbs. TB 133, add \$828 List</p>	4591	5523	5747	6144	6541	6920	7317	7679	8076
<p>6568</p> 	<p>72" W Public Back-to-Back Seating Unit, 90-Degree Back W 72 D 51¹/₂ H 43¹/₂ Seat Height 18 Inside Seat Width 72 Inside Seat Depth 19 17¹/₄ yds. 374 lbs. TB 133, add \$828 List</p>	4960	5892	6116	6513	6910	7289	7686	8048	8445
<p>6569</p> 	<p>72" W Private Back-to-Back Seating Unit, 90-Degree Back W 72 D 51¹/₂ H 56³/₄ Seat Height 18 Inside Seat Width 72 Inside Seat Depth 19 19¹/₂ yds. 428 lbs. TB 133, add \$936 List</p>	5493	6546	6800	7248	7697	8126	8574	8984	9432

OPTIONS (XXXX - REFERS TO SEATING UNIT MODEL NUMBER)

MODEL	DESCRIPTION	LIST
XXXX-MB07	Moisture Barrier, Seats Only	290

FOR PLACEMENT BELOW SEATS, AND/OR CENTER SIDE PANEL PLACEMENT

XXXX-PB1-S	Power Band 1 (one power, two USB), Silver	413
XXXX-PB1-W	Power Band 1 (one power, two USB), White	413
XXXX-PB2-S	Power Band 2 (dual power), Silver	322
XXXX-PB2-W	Power Band 2 (dual power), White	322
XXXX-PB3-S	Power Band 3 (dual power, two USB), Silver	429
XXXX-PB3-W	Power Band 3 (dual power, two USB), White	429

CO-OP MEETING SPACES

designed by qdesign

NOTES:

- Upholstered seating unit with accent tier.
- Accent tier available in Maple, Walnut and White Oak veneer (-V), laminate (-L) and whiteboard material (-WB). Please specify code for interior and exterior material selections.
- Standard with black plinth base.
- Power units available on front and side of seating units. Positioning must be specified in addition to cord exit grommet placement and power source location, as applicable.

SPECIFY:

1. Model number
2. Accent tier finish, interior
3. Accent tier finish, exterior
4. Upholstery selection
5. Options, as applicable

ORDERING EXAMPLE:

#6569-V-L
72" W Private Back-to-Back Love Seat Veneer Accent Tier, Interior Laminate Accent Tier, Exterior

SIN #711-16

MODEL NUMBER PRODUCT SPECIFICATIONS FABRIC GRADES

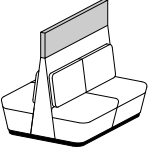
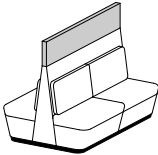
	COM	1	2	3	4	5	6	7	8
<p>Specify Interior Material Code, Followed by Exterior Material Code V = Veneer L = Laminate WB = Whiteboard</p>									
<p>6567-()-()</p> 									
<p>60" W Private Back-to-Back Seating Unit, 90-Degree Back, Non-Upholstered Tier W 60 D 51¹/₂ H 56³/₄ Seat Height 18 Inside Seat Width 60 Inside Seat Depth 19 15¹/₄ yds. 356 lbs. TB 133, add \$732 List</p>	5366	6190	6388	6739	7090	7425	7776	8096	8447
<p>6569-()-()</p> 									
<p>72" W Private Back-to-Back Seating Unit, Non-Upholstered Tier, 90-Degree Back W 72 D 51¹/₂ H 56³/₄ Seat Height 18 Inside Seat Width 72 Inside Seat Depth 19 17¹/₄ yds. 428 lbs. TB 133, add \$828 List</p>	6282	7214	7438	7835	8232	8611	9008	9370	9767

OPTIONS (XXXX - REFERS TO SEATING UNIT MODEL NUMBER)

MODEL	DESCRIPTION	LIST
XXXX-MB08	Moisture Barrier, Seats Only	340
FOR PLACEMENT BELOW SEATS		
XXXX-PB1-S	Power Band 1 (one power, two USB), Silver	413
XXXX-PB1-W	Power Band 1 (one power, two USB), White	413
XXXX-PB2-S	Power Band 2 (dual power), Silver	322
XXXX-PB2-W	Power Band 2 (dual power), White	322
XXXX-PB3-S	Power Band 3 (dual power, two USB), Silver	429
XXXX-PB3-W	Power Band 3 (dual power, two USB), White	429

NOTES:

- Shelf available on all 60" and 72" wide/deep models.
- Available in Maple, Walnut and White Oak veneer as well as laminate selections. Refer to page 7 for additional information.
- Shelf support posts available in standard and premium metal finishes. Refer to page 1 for premium colors and additional information on shelf edge details.

SPECIFY:

1. Model number
2. Wood species, as applicable
3. Wood finish, as applicable
4. Post finish, as applicable

ORDERING EXAMPLE:

#65S2-PF02
30" High Shelf
Shelf Post Premium Finish

CO-OP
MEETING SPACES

designed by qdesign

SIN #711-16

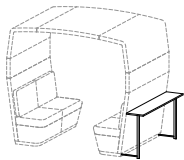
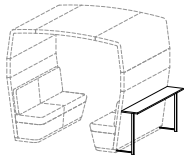
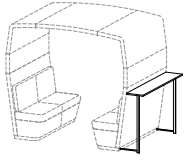
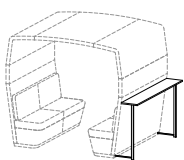
MODEL NUMBER	PRODUCT SPECIFICATIONS	VENEER OR LAMINATE
65S1-30 	30" H Shelf for 60" Width/Depth Units L 60 D 12 H 30 36 lbs.	802
65S2-30 	30" H Shelf for 72" Width/Depth Units L 72 D 12 H 30 42 lbs.	819
65S1-40 	40" H Shelf for 60" Width/Depth Units L 60 D 12 H 40 40 lbs.	906
65S2-40 	40" H Shelf for 72" Width/Depth Units L 72 D 12 H 40 46 lbs.	913

OPTIONS (XXXX - REFERS TO SHELF MODEL NUMBER)

MODEL	DESCRIPTION	LIST
XXXX-PF02	Premium Finish, Shelf Posts	80

CO-OP MEETING SPACES

designed by qdesign



SIN #711-16

NOTES:

- Linking and cantilever tables ordered separately.
- Linking table can be mounted between any 60" wide and 72" wide unit. Refer to page 6 for product information.
- Cantilever table can be affixed to any love seat and wall-mount unit. Refer to page 6 for product information.
- Tables available in Maple, Walnut and White Oak veneer as well as laminate.
- Power unit placement and cord exit location must be specified on applicable seating model.

SPECIFY:

1. Model number
2. Wood species
3. Wood finish
4. Base finish, as applicable
5. Options, as applicable

ORDERING EXAMPLE:

6580-307239

30 x 72 x 39 Linking Table

	MODEL NUMBER	VENEER OR LAMINATE	WEIGHT
LINKING TABLES			
29" Table Height			
	30" W x 60" L x 29" H	6580-306029	1577
	30" W x 72" L x 29" H	6580-307229	1809
	36" W x 60" L x 29" H	6580-366029	1798
	36" W x 72" L x 29" H	6580-367229	2048
39" Table Height			
	30" W x 60" L x 39" H	6580-306039	1577
	30" W x 72" L x 39" H	6580-307239	1809
	36" W x 60" L x 39" H	6580-366039	1798
	36" W x 72" L x 39" H	6580-367239	2048
CANTILEVER TABLES			
29" Table Height			
	30" W x 60" L x 29" H	6585-306029	2323
	30" W x 72" L x 29" H	6585-307229	2544
	36" W x 60" L x 29" H	6585-366029	2555
	36" W x 72" L x 29" H	6585-367229	2820
39" Table Height			
	30" W x 60" L x 39" H	6585-306039	2612
	30" W x 72" L x 39" H	6585-307239	2808
	36" W x 60" L x 39" H	6585-366039	2843
	36" W x 72" L x 39" H	6585-367239	3082

OPTIONS (XXXX - REFERS TO TABLE MODEL NUMBER)

MODEL	DESCRIPTION	LIST
XXXX-PF03	Premium Finish	110
FOR TABLE PLACEMENT ONLY		
XXXX-PB1-S or XXXX-PB1-W	Power Band 1 (one power, two USB), Silver (-S) or White (-W)	413
XXXX-PB2-S or XXXX-PB2-W	Power Band 2 (dual power), Silver (-S) or White (-W)	322
XXXX-PB3-S or XXXX-PB3-W	Power Band 3 (dual power, two USB), Silver (-S) or White (-W)	429
XXXX-PP1	Portal Power 1 (one power, one data)	612
XXXX-PP2	Portal Power 2 (dual power)	542
XXXX-PP3	Portal Power 3 (one power, two USB)	643

NOTES:

- Storage cubby fits between tapered spaces of back-to-back, or side-to-side, love seat models. Refer to page 6 for details.
- Available in Maple, Walnut and White Oak veneer as well as laminate selections.
- Inside clearance, per cubby: 6" wide at the top, 10" wide at the bottom and 14¹/₄" high.

SPECIFY:

1. Model number
2. Wood species, as applicable
3. Wood finish, as applicable

ORDERING EXAMPLE:

#6586-60
60" Length Storage Cubby

CO-OP
MEETING SPACES

designed by qdesign

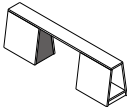
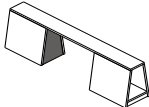

SIN #711-16

MODEL NUMBER	PRODUCT SPECIFICATIONS	VENEER OR LAMINATE
<p>6586-60</p> 	<p>60" Length Storage Cubby L 60 D 12 H 18 42 lbs.</p>	1289
<p>6586-72</p> 	<p>72" Length Storage Cubby L 72 D 12 H 18 44 lbs.</p>	1313

CO-OP MEETING SPACES

designed by qdesign



SIN #711-11

NOTES:

- Stand-alone tables available in Maple, Walnut and White Oak veneer as well as laminate.
- Metal base available in standard and premium finishes.
- Power units not available on free-standing tables.

SPECIFY:

1. Model number
2. Wood species
3. Wood finish
4. Base finish
5. Options, as applicable

ORDERING EXAMPLE:

#6590-306029-PF06

30 x 60 x 29 Arc Rectangle
Premium Base Finish

	MODEL NUMBER	VENEER OR LAMINATE	COLUMN DIMENSION	BASE DIMENSION	WEIGHT
<p>Arc Rectangle Top, 27" Height</p> <p>30" W x 60" L x 27" H 30" W x 72" L x 27" H 36" W x 60" L x 27" H 36" W x 72" L x 27" H 42" W x 84" L x 27" H</p>	6590-306027	3038	4 ³ / ₄ x 4 ³ / ₄	18x18	135
	6590-307227	3271	4 ³ / ₄ x 4 ³ / ₄	18x18	146
	6590-366027	3252	4 ³ / ₄ x 4 ³ / ₄	18x18	146
	6590-367227	3514	4 ³ / ₄ x 4 ³ / ₄	18x18	159
	6590-428427	3862	4 ³ / ₄ x 4 ³ / ₄	18x18	188
<p>Arc Rectangle Top, 29" Height</p> <p>30" W x 60" L x 29" H 30" W x 72" L x 29" H 36" W x 60" L x 29" H 36" W x 72" L x 29" H 42" W x 84" L x 29" H</p>	6590-306029	3089	4 ³ / ₄ x 4 ³ / ₄	18x18	147
	6590-307229	3279	4 ³ / ₄ x 4 ³ / ₄	18x18	158
	6590-366029	3276	4 ³ / ₄ x 4 ³ / ₄	18x18	158
	6590-367229	3520	4 ³ / ₄ x 4 ³ / ₄	18x18	171
	6590-428429	3869	4 ³ / ₄ x 4 ³ / ₄	18x18	200

OPTIONS (XXXX - REFERS TO TABLE MODEL NUMBER)

MODEL	DESCRIPTION	LIST
XXXX-PF06	Premium Finish, 2 Bases	220

MULTI-TONE UPHOLSTERY COMBINATIONS:

For upholstery fabric, panel fabric and/or vinyl combinations, refer to the pricing below:

- When combining **two** fabrics, add \$125 List per unit.
 - When combining **three** fabrics, add \$175 List per unit.
 - When combining **four or more** fabrics, add \$250 List per unit.
 - Excluding the back and seat cushions, fabric upholstery will always be railroaded.
 - **Canopy not available with polyurethane or vinyl upholstery.**
- For multiple seating models, please contact Customer Service for assistance with exact yardage requirements.
 - Note: Yardage amounts are based on fabric which is plain (i.e. non-directional), a full 54" wide and railroaded.

**CO-OP
MEETING SPACES**

designed by qdesign

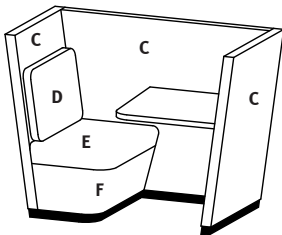

Public Single Work Module

Model	Location	COM Requirement
6514-65TA	C	Back Panel = 8 ¹ / ₂ yds.
6517-65TA	D	Back Cushion = 1 yd.
	E	Seat Cushion Top = 1 yd.
	F	Seat Cushion Bottom = 1 yd.

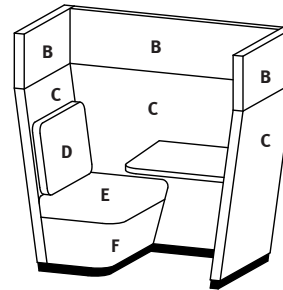

Private Single Work Module

Model	Location	COM Requirement
6515-65TA	B	Accent Tier = 4 yds.
6518-65TA	C	Back Panel = 8 ¹ / ₂ yds.
	D	Back Cushion = 1 yd.
	E	Seat Cushion Top = 1 yd.
	F	Seat Cushion Bottom = 1 yd.

Also applicable to models with veneer, laminate or whiteboard material as accent tier (B).

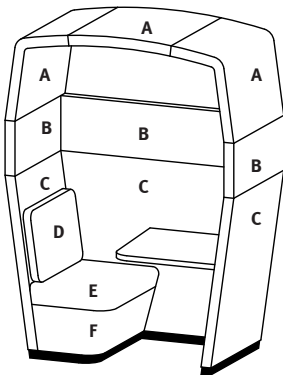

Private Single Work Module, Full Canopy

Model	Location	COM Requirement
6516-65TA	A	Canopy = 5 yds.
6519-65TA	B	Accent Tier = 4 yds.
	C	Back Panel = 8 ¹ / ₂ yds.
	D	Back Cushion = 1 yd.
	E	Seat Cushion Top = 1 yd.
	F	Seat Cushion Bottom = 1 yd.

Also applicable to models with veneer, laminate or whiteboard material as accent tier (B).

CO-OP MEETING SPACES

designed by qdesign

MULTI-TONE UPHOLSTERY COMBINATIONS:

For upholstery fabric, panel fabric and/or vinyl combinations, refer to the pricing below:

- When combining **two** fabrics, add \$125 List per unit.
 - When combining **three** fabrics, add \$175 List per unit.
 - When combining **four or more** fabrics, add \$250 List per unit.
 - Excluding the back and seat cushions, fabric upholstery will always be railroaded.
 - For multiple seating models, please contact Customer Service for assistance with exact yardage requirements.
- Note: Yardage amounts are based on fabric which is plain (i.e. non-directional), a full 54" wide and railroaded.

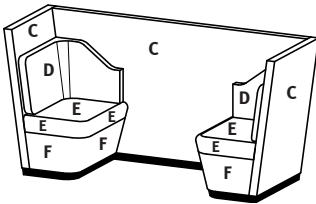

Public Lounge Unit

Model	Location	COM Requirement
6510	C	Back Panel = 9 ¹ / ₄ yds.
	D	Back Cushion = 2 yds.
	E	Seat Cushion Top = 2 yds.
	F	Seat Cushion Bottom = 2 yds.

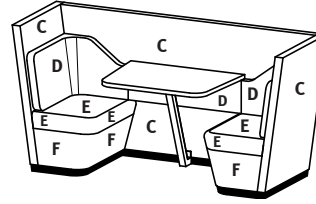

Public Lounge Unit with Integrated Table

Model	Location	COM Requirement
6510-65TS	C	Back Panel = 9 ¹ / ₄ yds.
	D	Back Cushion = 2 yds.
	E	Seat Cushion Top = 2 yds.
	F	Seat Cushion Bottom = 2 yds.

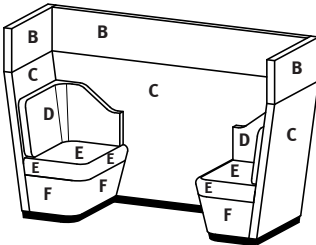

Private Lounge Unit

Model	Location	COM Requirement
6511	B	Upholstered Accent Tier = 4 ³ / ₄ yds.
	C	Back Panel = 9 ¹ / ₄ yds.
	D	Back Cushion = 2 yds.
	E	Seat Cushion Top = 2 yds.
	F	Seat Cushion Bottom = 2 yds.

Also applicable to models with veneer, laminate or whiteboard material as accent tier (B).

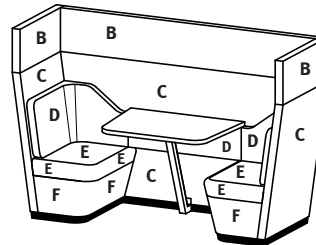

Private Lounge Unit with Integrated Table

Model	Location	COM Requirement
6511-65TS	B	Upholstered Accent Tier = 4 ³ / ₄ yds.
	C	Back Panel = 9 ¹ / ₄ yds.
	D	Back Cushion = 3 yds.
	E	Seat Cushion Top = 2 yds.
	F	Seat Cushion Bottom = 2 yds.

Also applicable to models with veneer, laminate or whiteboard material as accent tier (B).

MULTI-TONE UPHOLSTERY COMBINATIONS:

For upholstery fabric, panel fabric and/or vinyl combinations, refer to the pricing below:

- When combining **two** fabrics, add \$125 List per unit.
 - When combining **three** fabrics, add \$175 List per unit.
 - When combining **four or more** fabrics, add \$250 List per unit.
 - Excluding the back and seat cushions, fabric upholstery will always be railroaded.
 - **Canopy not available with polyurethane or vinyl upholstery.**
- For multiple seating models, please contact Customer Service for assistance with exact yardage requirements.
 - Note: Yardage amounts are based on fabric which is plain (i.e. non-directional), a full 54" wide and railroaded.

**CO-OP
MEETING SPACES**

designed by qdesign

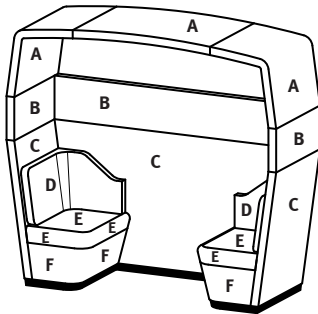

Private Lounge Unit with Full Canopy

Model	Location	COM Requirement
6512	A	Canopy = 5 ¹ / ₂ yds.
	B	Upholstered Accent Tier = 4 ³ / ₄ yds.
	C	Back Panel = 9 ¹ / ₄ yds.
	D	Back Cushion = 2 yds.
	E	Seat Cushion Top = 2 yds.
	F	Seat Cushion Bottom = 2 yds.

Also applicable to models with veneer, laminate or whiteboard material as accent tier (B).

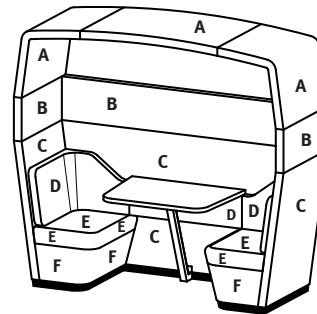

Private Lounge Unit with Full Canopy and Integrated Table

Model	Location	COM Requirement
6512-65TS	A	Canopy = 5 ¹ / ₂ yds.
	B	Upholstered Accent Tier = 4 ³ / ₄ yds.
	C	Back Panel = 9 ¹ / ₄ yds.
	D	Back Cushion = 3 yds.
	E	Seat Cushion Top = 2 yds.
	F	Seat Cushion Bottom = 2 yds.

Also applicable to models with veneer, laminate or whiteboard material as accent tier (B).

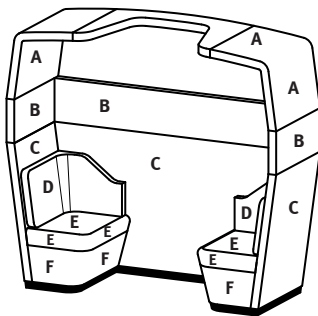

Private Lounge Unit with Partial Canopy

Model	Location	COM Requirement
6513	A	Canopy = 5 ¹ / ₂ yds.
	B	Upholstered Accent Tier = 4 ³ / ₄ yds.
	C	Back Panel = 9 ¹ / ₄ yds.
	D	Back Cushion = 2 yds.
	E	Seat Cushion Top = 2 yds.
	F	Seat Cushion Bottom = 2 yds.

Also applicable to models with veneer, laminate or whiteboard material as accent tier (B).

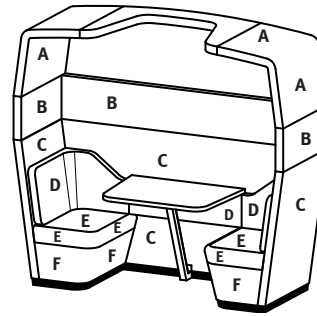

Private Lounge Unit with Partial Canopy and Integrated Table

Model	Location	COM Requirement
6513-65TS	A	Canopy = 5 ¹ / ₂ yds.
	B	Upholstered Accent Tier = 4 ³ / ₄ yds.
	C	Back Panel = 9 ¹ / ₄ yds.
	D	Back Cushion = 3 yds.
	E	Seat Cushion Top = 2 yds.
	F	Seat Cushion Bottom = 2 yds.

Also applicable to models with veneer, laminate or whiteboard material as accent tier (B).

CO-OP MEETING SPACES

designed by qdesign

MULTI-TONE UPHOLSTERY COMBINATIONS:

For upholstery fabric, panel fabric and/or vinyl combinations, refer to the pricing below:

- When combining **two** fabrics, add \$125 List per unit.
 - When combining **three** fabrics, add \$175 List per unit.
 - When combining **four or more** fabrics, add \$250 List per unit.
 - Excluding the back and seat cushions, fabric upholstery will always be railroaded.
 - For multiple seating models, please contact Customer Service for assistance with exact yardage requirements.
- Note: Yardage amounts are based on fabric which is plain (i.e. non-directional), a full 54" wide and railroaded.

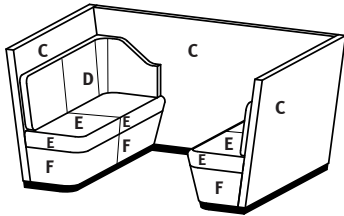

Public Love Seat Unit

Model	Location	COM Requirement
6520	C	Back Panel = 13 ¹ / ₄ yds.
	D	Back Cushion = 3 yds.
	E	Seat Cushion Top = 3 ¹ / ₂ yds.
	F	Seat Cushion Bottom = 3 ¹ / ₂ yds.

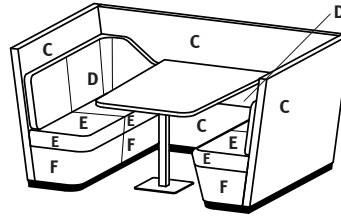

Public Love Seat Unit with Integrated Table

Model	Location	COM Requirement
6520-65TL	C	Back Panel = 13 ¹ / ₄ yds.
	D	Back Cushion = 3 yds.
	E	Seat Cushion Top = 3 ¹ / ₂ yds.
	F	Seat Cushion Bottom = 3 ¹ / ₂ yds.

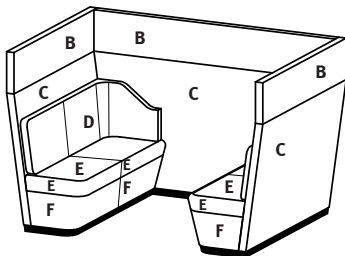

Private Love Seat Unit

Model	Location	COM Requirement
6521	B	Upholstered Accent Tier = 6 ³ / ₄ yds.
	C	Back Panel = 13 ¹ / ₄ yds.
	D	Back Cushion = 3 yds.
	E	Seat Cushion Top = 3 ¹ / ₂ yds.
	F	Seat Cushion Bottom = 3 ¹ / ₂ yds.

Also applicable to models with veneer, laminate or whiteboard material as accent tier (B).

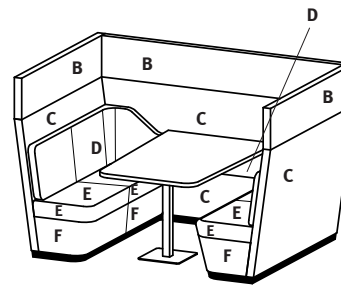

Private Love Seat Unit with Integrated Table

Model	Location	COM Requirement
6521-65TL	B	Upholstered Accent Tier = 6 ³ / ₄ yds.
	C	Back Panel = 13 ¹ / ₄ yds.
	D	Back Cushion = 3 yds.
	E	Seat Cushion Top = 3 ¹ / ₂ yds.
	F	Seat Cushion Bottom = 3 ¹ / ₂ yds.

Also applicable to models with veneer, laminate or whiteboard material as accent tier (B).

MULTI-TONE UPHOLSTERY COMBINATIONS:

For upholstery fabric, panel fabric and/or vinyl combinations, refer to the pricing below:

- When combining **two** fabrics, add \$125 List per unit.
 - When combining **three** fabrics, add \$175 List per unit.
 - When combining **four or more** fabrics, add \$250 List per unit.
 - Excluding the back and seat cushions, fabric upholstery will always be railroaded.
 - **Canopy not available with polyurethane or vinyl upholstery.**
- For multiple seating models, please contact Customer Service for assistance with exact yardage requirements.
 - Note: Yardage amounts are based on fabric which is plain (i.e. non-directional), a full 54" wide and railroaded.

**CO-OP
MEETING SPACES**

designed by qdesign

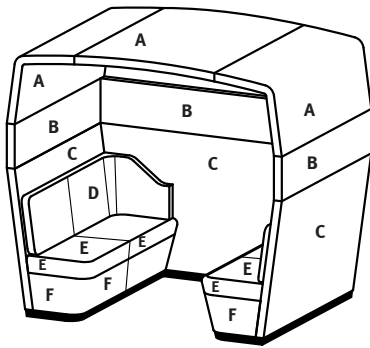

Private Love Seat Unit with Full Canopy

Model	Location	COM Requirement
6522	A	Canopy = 11 ¹ / ₂ yds.
	B	Upholstered Accent Tier = 6 ³ / ₄ yds.
	C	Back Panel = 13 ¹ / ₄ yds.
	D	Back Cushion = 3 yds.
	E	Seat Cushion Top = 3 ¹ / ₂ yds.
	F	Seat Cushion Bottom = 3 ¹ / ₂ yds.

Also applicable to models with veneer, laminate or whiteboard material as accent tier (B).

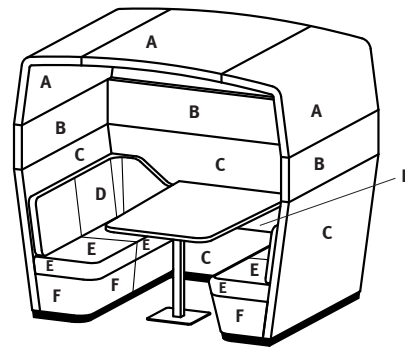

Private Love Seat Unit with Full Canopy and Integrated Table

Model	Location	COM Requirement
6522-65TL	A	Canopy = 11 ¹ / ₂ yds.
	B	Upholstered Accent Tier = 6 ³ / ₄ yds.
	C	Back Panel = 13 ¹ / ₄ yds.
	D	Back Cushion = 3 yds.
	E	Seat Cushion Top = 3 ¹ / ₂ yds.
	F	Seat Cushion Bottom = 3 ¹ / ₂ yds.

Also applicable to models with veneer, laminate or whiteboard material as accent tier (B).

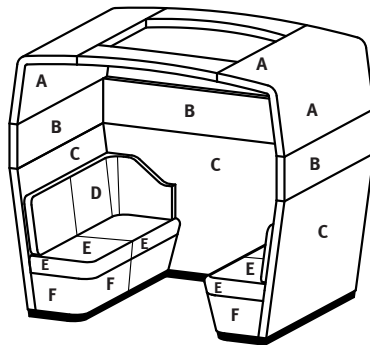

Private Love Seat Unit with Open Canopy

Model	Location	COM Requirement
6523	A	Canopy = 9 ³ / ₄ yds.
	B	Upholstered Accent Tier = 6 ³ / ₄ yds.
	C	Back Panel = 13 ¹ / ₄ yds.
	D	Back Cushion = 3 yds.
	E	Seat Cushion Top = 3 ¹ / ₂ yds.
	F	Seat Cushion Bottom = 3 ¹ / ₂ yds.

Also applicable to models with veneer, laminate or whiteboard material as accent tier (B).

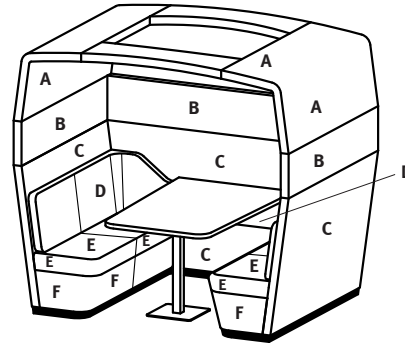

Private Love Seat Unit with Open Canopy and Integrated Table

Model	Location	COM Requirement
6523-65TL	A	Canopy = 9 ³ / ₄ yds.
	B	Upholstered Accent Tier = 6 ³ / ₄ yds.
	C	Back Panel = 13 ¹ / ₄ yds.
	D	Back Cushion = 3 yds.
	E	Seat Cushion Top = 3 ¹ / ₂ yds.
	F	Seat Cushion Bottom = 3 ¹ / ₂ yds.

Also applicable to models with veneer, laminate or whiteboard material as accent tier (B).

CO-OP MEETING SPACES

designed by qdesign

MULTI-TONE UPHOLSTERY COMBINATIONS:

For upholstery fabric, panel fabric and/or vinyl combinations, refer to the pricing below:

- When combining **two** fabrics, add \$125 List per unit.
 - When combining **three** fabrics, add \$175 List per unit.
 - When combining **four or more** fabrics, add \$250 List per unit.
 - Excluding the back and seat cushions, fabric upholstery will always be railroaded.
 - **Canopy not available with polyurethane or vinyl upholstery.**
- For multiple seating models, please contact Customer Service for assistance with exact yardage requirements.
 - Note: Yardage amounts are based on fabric which is plain (i.e. non-directional), a full 54" wide and railroaded.

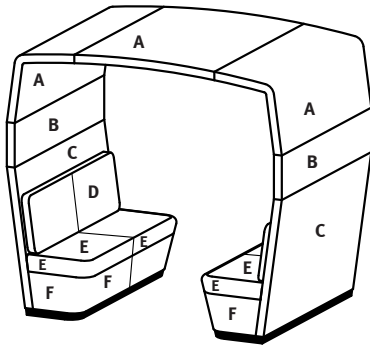

60" Depth Booth with Full Canopy

Model	Location	COM Requirement
6532	A	Canopy = 11 ¹ / ₂ yds.
	B	Upholstered Accent Tier = 4 yds.
	C	Back Panel = 8 yds.
	D	Back Cushion = 3 ¹ / ₂ yds.
	E	Seat Cushion Top = 3 ¹ / ₂ yds.
	F	Seat Cushion Bottom = 3 ¹ / ₂ yds.

Also applicable to models with veneer, laminate or whiteboard material as accent tier (B).

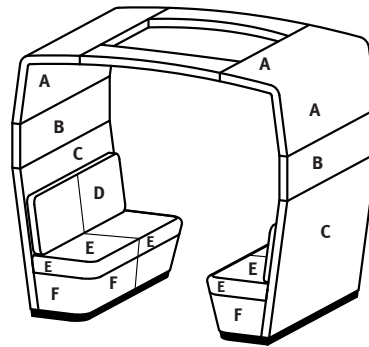

60" Depth Booth with Open Canopy

Model	Location	COM Requirement
6533	A	Canopy = 9 ³ / ₄ yds.
	B	Upholstered Accent Tier = 4 yds.
	C	Back Panel = 8 yds.
	D	Back Cushion = 3 ¹ / ₂ yds.
	E	Seat Cushion Top = 3 ¹ / ₂ yds.
	F	Seat Cushion Bottom = 3 ¹ / ₂ yds.

Also applicable to models with veneer, laminate or whiteboard material as accent tier (B).

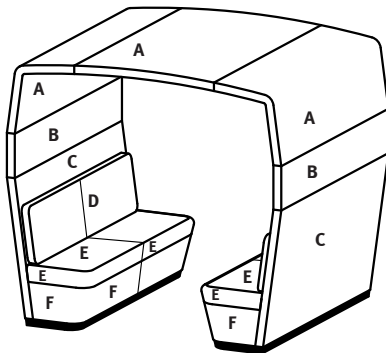

72" Depth Booth with Full Canopy

Model	Location	COM Requirement
6534	A	Canopy = 13 ¹ / ₂ yds.
	B	Upholstered Accent Tier = 4 ¹ / ₂ yds.
	C	Back Panel = 9 yds.
	D	Back Cushion = 4 yds.
	E	Seat Cushion Top = 4 yds.
	F	Seat Cushion Bottom = 4 yds.

Also applicable to models with veneer, laminate or whiteboard material as accent tier (B).

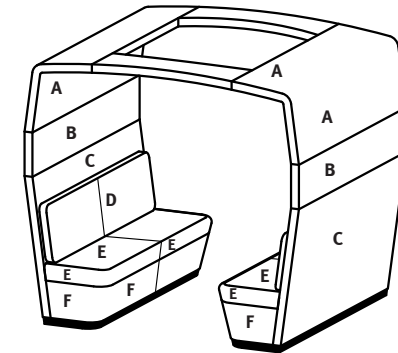

72" Depth Booth with Open Canopy

Model	Location	COM Requirement
6535	A	Canopy = 10 ³ / ₄ yds.
	B	Upholstered Accent Tier = 4 ¹ / ₂ yds.
	C	Back Panel = 9 yds.
	D	Back Cushion = 4 yds.
	E	Seat Cushion Top = 4 yds.
	F	Seat Cushion Bottom = 4 yds.

Also applicable to models with veneer, laminate or whiteboard material as accent tier (B).

MULTI-TONE UPHOLSTERY COMBINATIONS:

For upholstery fabric, panel fabric and/or vinyl combinations, refer to the pricing below:

- When combining **two** fabrics, add \$125 List per unit.
 - When combining **three** fabrics, add \$175 List per unit.
 - When combining **four or more** fabrics, add \$250 List per unit.
 - Excluding the back and seat cushions, fabric upholstery will always be railroaded.
 - **Canopy not available with polyurethane or vinyl upholstery.**
- For multiple seating models, please contact Customer Service for assistance with exact yardage requirements.
 - Note: Yardage amounts are based on fabric which is plain (i.e. non-directional), a full 54" wide and railroaded.

**CO-OP
MEETING SPACES**

designed by qdesign

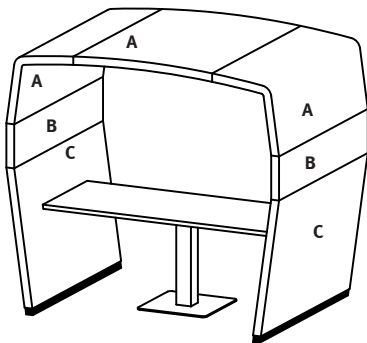

60" Depth Stand-Alone Full Canopy

Model	Location	COM Requirement
6542 with all table sizes	A B C	Canopy = 11 ¹ / ₂ yds. Upholstered Accent Tier = 4 yds. Back Panel = 7 ¹ / ₂ yds.

Also applicable to models with veneer, laminate or whiteboard material as accent tier (B).

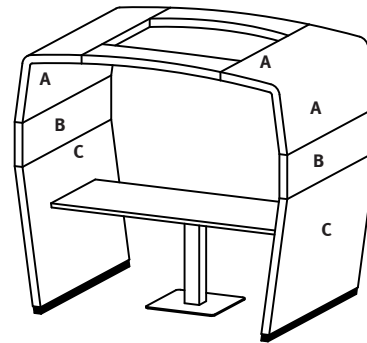

60" Depth Stand-Alone Open Canopy

Model	Location	COM Requirement
6543 with all table sizes	A B C	Canopy = 9 ³ / ₄ yds. Upholstered Accent Tier = 4 yds. Back Panel = 7 ¹ / ₂ yds.

Also applicable to models with veneer, laminate or whiteboard material as accent tier (B).

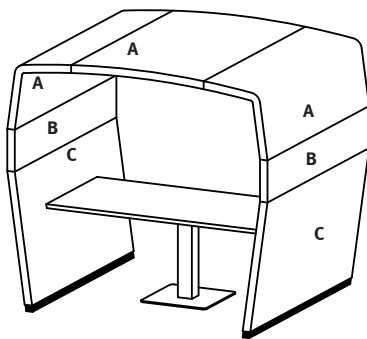

72" Depth Stand-Alone Full Canopy

Model	Location	COM Requirement
6544 with all table sizes	A B C	Canopy = 13 ¹ / ₂ yds. Upholstered Accent Tier = 4 ¹ / ₂ yds. Back Panel = 9 yds.

Also applicable to models with veneer, laminate or whiteboard material as accent tier (B).

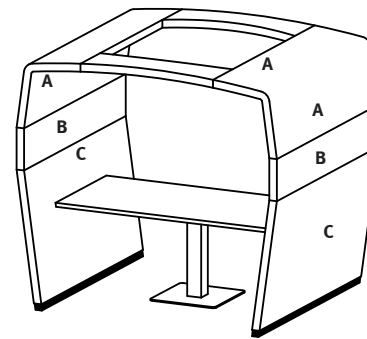

72" Depth Stand-Alone Open Canopy

Model	Location	COM Requirement
6545 with all table sizes	A B C	Canopy = 10 ³ / ₄ yds. Upholstered Accent Tier = 4 ¹ / ₂ yds. Back Panel = 9 yds.

Also applicable to models with veneer, laminate or whiteboard material as accent tier (B).

CO-OP MEETING SPACES

designed by qdesign

MULTI-TONE UPHOLSTERY COMBINATIONS:

For upholstery fabric, panel fabric and/or vinyl combinations, refer to the pricing below:

- When combining **two** fabrics, add \$125 List per unit.
- When combining **three** fabrics, add \$175 List per unit.
- When combining **four or more** fabrics, add \$250 List per unit.
- Excluding the back and seat cushions, fabric upholstery will always be railroaded.
- **Canopy not available with polyurethane or vinyl upholstery.**
- For multiple seating models, please contact Customer Service for assistance with exact yardage requirements.
- Note: Yardage amounts are based on fabric which is plain (i.e. non-directional), a full 54" wide and railroaded.

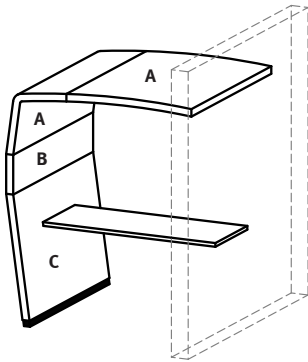

60" Wide Wall-Mount Unit with Full Canopy

Model	Location	COM Requirement
6552 and	A	Canopy = 7 ¹ / ₂ yds.
with all	B	Upholstered Accent Tier = 2 yds.
table sizes	C	Back Panel = 3 ³ / ₄ yds.

Also applicable to models with veneer, laminate or whiteboard material as accent tier (B).

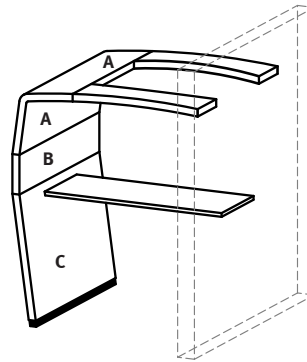

60" Wide Wall-Mount Unit with Open Canopy

Model	Location	COM Requirement
6553 and	A	Canopy = 5 ³ / ₄ yds.
with all	B	Upholstered Accent Tier = 2 yds.
table sizes	C	Back Panel = 3 ³ / ₄ yds.

Also applicable to models with veneer, laminate or whiteboard material as accent tier (B).

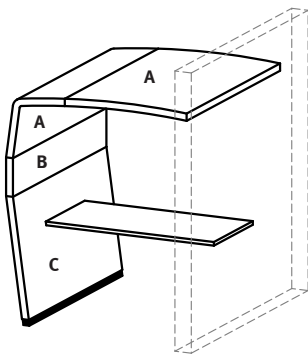

72" Wide Wall-Mount Unit with Full Canopy

Model	Location	COM Requirement
6554 and	A	Canopy = 9 yds.
with all	B	Upholstered Accent Tier = 2 ¹ / ₄ yds.
table sizes	C	Back Panel = 4 ¹ / ₂ yds.

Also applicable to models with veneer, laminate or whiteboard material as accent tier (B).

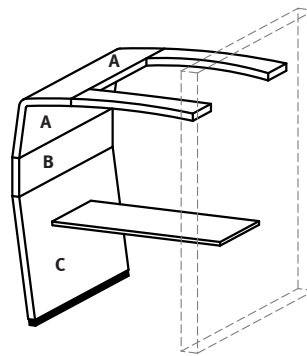

72" Wide Wall-Mount Unit with Open Canopy

Model	Location	COM Requirement
6555 and	A	Canopy = 6 ¹ / ₄ yds.
with all	B	Upholstered Accent Tier = 2 ¹ / ₄ yds.
table sizes	C	Back Panel = 4 ¹ / ₂ yds.

Also applicable to models with veneer, laminate or whiteboard material as accent tier (B).

MULTI-TONE UPHOLSTERY COMBINATIONS:

For upholstery fabric, panel fabric and/or vinyl combinations, refer to the pricing below:

- When combining **two** fabrics, add \$125 List per unit.
 - When combining **three** fabrics, add \$175 List per unit.
 - When combining **four or more** fabrics, add \$250 List per unit.
 - Excluding the back and seat cushions, fabric upholstery will always be railroaded.
 - **Canopy not available with polyurethane or vinyl upholstery.**
- For multiple seating models, please contact Customer Service for assistance with exact yardage requirements.
 - Note: Yardage amounts are based on fabric which is plain (i.e. non-directional), a full 54" wide and railroaded.

**CO-OP
MEETING SPACES**

designed by qdesign

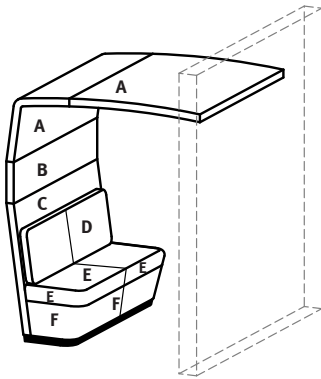

60" Wide Wall-Mount Seating Unit with Full Canopy

Model	Location	COM Requirement
6562	A	Canopy = 7 ¹ / ₂ yds.
	B	Upholstered Accent Tier = 2 yds.
	C	Back Panel = 4 yds.
	D	Back Cushion = 1 ³ / ₄ yds.
	E	Seat Cushion Top = 1 ³ / ₄ yds.
	F	Seat Cushion Bottom = 1 ³ / ₄ yds.

Also applicable to models with veneer, laminate or whiteboard material as accent tier (B).

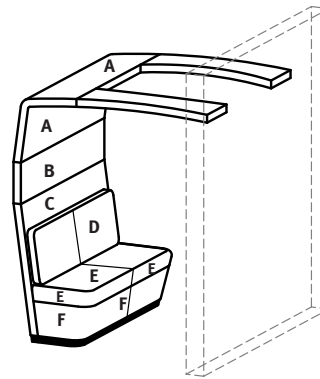

60" Wide Wall-Mount Seating Unit with Open Canopy

Model	Location	COM Requirement
6563	A	Canopy = 5 ³ / ₄ yds.
	B	Upholstered Accent Tier = 2 yds.
	C	Back Panel = 4 yds.
	D	Back Cushion = 1 ³ / ₄ yds.
	E	Seat Cushion Top = 1 ³ / ₄ yds.
	F	Seat Cushion Bottom = 1 ³ / ₄ yds.

Also applicable to models with veneer, laminate or whiteboard material as accent tier (B).

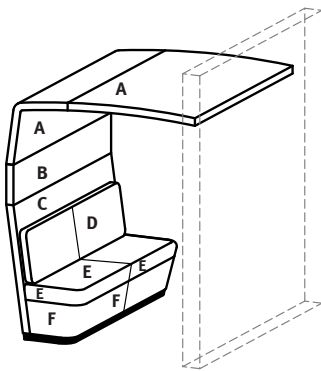

72" Wide Wall-Mount Seating Unit with Full Canopy

Model	Location	COM Requirement
6564	A	Canopy = 9 yds.
	B	Upholstered Accent Tier = 2 ¹ / ₄ yds.
	C	Back Panel = 4 ¹ / ₂ yds.
	D	Back Cushion = 2 yds.
	E	Seat Cushion Top = 2 yds.
	F	Seat Cushion Bottom = 2 yds.

Also applicable to models with veneer, laminate or whiteboard material as accent tier (B).

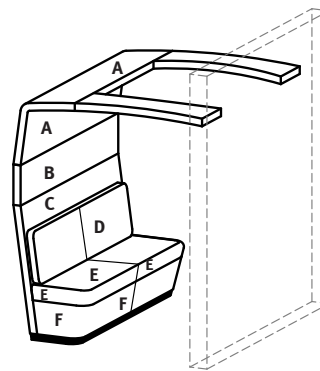

72" Wide Wall-Mount Seating Unit with Open Canopy

Model	Location	COM Requirement
6565	A	Canopy = 6 ¹ / ₄ yds.
	B	Upholstered Accent Tier = 2 ¹ / ₄ yds.
	C	Back Panel = 4 ¹ / ₂ yds.
	D	Back Cushion = 2 yds.
	E	Seat Cushion Top = 2 yds.
	F	Seat Cushion Bottom = 2 yds.

Also applicable to models with veneer, laminate or whiteboard material as accent tier (B).

CO-OP MEETING SPACES

designed by qdesign

MULTI-TONE UPHOLSTERY COMBINATIONS:

For upholstery fabric, panel fabric and/or vinyl combinations, refer to the pricing below:

- When combining **two** fabrics, add \$125 List per unit.
 - When combining **three** fabrics, add \$175 List per unit.
 - When combining **four or more** fabrics, add \$250 List per unit.
 - Excluding the back and seat cushions, fabric upholstery will always be railroaded.
 - For multiple seating models, please contact Customer Service for assistance with exact yardage requirements.
- Note: Yardage amounts are based on fabric which is plain (i.e. non-directional), a full 54" wide and railroaded.

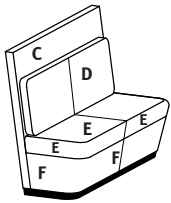

60" Wide Seating Unit

Model	Location	COM Requirement
6502	C	Back Panel = 4 yds.
	D	Back Cushion = 1 ³ / ₄ yds.
	E	Seat Cushion Top = 1 ³ / ₄ yds.
	F	Seat Cushion Bottom = 1 ³ / ₄ yds.

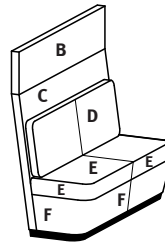

60" Wide Private Seating Unit

Model	Location	COM Requirement
6503	B	Upholstered Accent Tier = 2 yds.
	C	Back Panel = 4 yds.
	D	Back Cushion = 1 ³ / ₄ yds.
	E	Seat Cushion Top = 1 ³ / ₄ yds.
	F	Seat Cushion Bottom = 1 ³ / ₄ yds.

Also applicable to models with veneer, laminate or whiteboard material as accent tier (B).

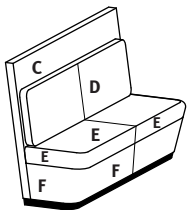

72" Wide Seating Unit

Model	Location	COM Requirement
6504	C	Back Panel = 4 ¹ / ₂ yds.
	D	Back Cushion = 2 yds.
	E	Seat Cushion Top = 2 yds.
	F	Seat Cushion Bottom = 2 yds.

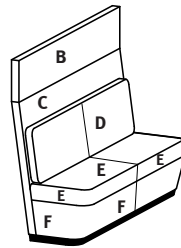

72" Wide Private Seating Unit

Model	Location	COM Requirement
6505	B	Upholstered Accent Tier = 2 ¹ / ₄ yds.
	C	Back Panel = 4 ¹ / ₂ yds.
	D	Back Cushion = 2 yds.
	E	Seat Cushion Top = 2 yds.
	F	Seat Cushion Bottom = 2 yds.

Also applicable to models with veneer, laminate or whiteboard material as accent tier (B).

MULTI-TONE UPHOLSTERY COMBINATIONS:

For upholstery fabric, panel fabric and/or vinyl combinations, refer to the pricing below:

- When combining **two** fabrics, add \$125 List per unit.
 - When combining **three** fabrics, add \$175 List per unit.
 - When combining **four or more** fabrics, add \$250 List per unit.
 - Excluding the back and seat cushions, fabric upholstery will always be railroaded.
 - **Canopy not available with polyurethane or vinyl upholstery.**
- For multiple seating models, please contact Customer Service for assistance with exact yardage requirements.
 - Note: Yardage amounts are based on fabric which is plain (i.e. non-directional), a full 54" wide and railroaded.

**CO-OP
MEETING SPACES**

designed by qdesign

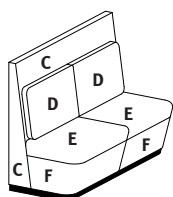

60" Wide Seating Unit, 90-Degree Back

Model	Location	COM Requirement
6506	C	Back Panel = 4 ¹ / ₂ yds.
	D	Back Cushion = 1 ³ / ₄ yds.
	E	Seat Cushion Top = 1 ³ / ₄ yds.
	F	Seat Cushion Bottom = 1 ³ / ₄ yds.

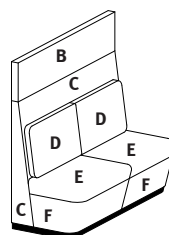

60" Wide Private Seating Unit, 90-Degree Back

Model	Location	COM Requirement
6507	B	Upholstered Accent Tier = 2 yds.
	C	Back Panel = 4 ¹ / ₂ yds.
	D	Back Cushion = 1 ³ / ₄ yds.
	E	Seat Cushion Top = 1 ³ / ₄ yds.
	F	Seat Cushion Bottom = 1 ³ / ₄ yds.

Also applicable to models with veneer, laminate or whiteboard material as accent tier (B).

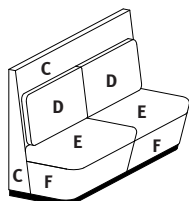

72" Wide Seating Unit, 90-Degree Back

Model	Location	COM Requirement
6508	C	Back Panel = 5 yds.
	D	Back Cushion = 2 yds.
	E	Seat Cushion Top = 2 yds.
	F	Seat Cushion Bottom = 2 yds.

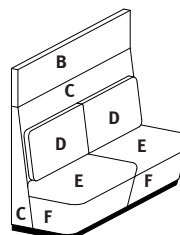

72" Wide Private Seating Unit, 90-Degree Back

Model	Location	COM Requirement
6509	B	Upholstered Accent Tier = 2 ¹ / ₄ yds.
	C	Back Panel = 5 yds.
	D	Back Cushion = 2 yds.
	E	Seat Cushion Top = 2 yds.
	F	Seat Cushion Bottom = 2 yds.

Also applicable to models with veneer, laminate or whiteboard material as accent tier (B).

CO-OP MEETING SPACES

designed by qdesign

MULTI-TONE UPHOLSTERY COMBINATIONS:

For upholstery fabric, panel fabric and/or vinyl combinations, refer to the pricing below:

- When combining **two** fabrics, add \$125 List per unit.
 - When combining **three** fabrics, add \$175 List per unit.
 - When combining **four or more** fabrics, add \$250 List per unit.
 - Excluding the back and seat cushions, fabric upholstery will always be railroaded.
 - For multiple seating models, please contact Customer Service for assistance with exact yardage requirements.
- Note: Yardage amounts are based on fabric which is plain (i.e. non-directional), a full 54" wide and railroaded.

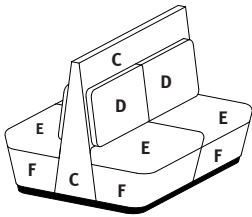

60" Wide Public Back-to-Back Seating Unit, 90-Degree Back

Model	Location	COM Requirement
6566	C	Back Panel = $4\frac{3}{4}$ yds.
	D	Back Cushion = $3\frac{1}{2}$ yds.
	E	Seat Cushion Top = $3\frac{1}{2}$ yds.
	F	Seat Cushion Bottom = $3\frac{1}{2}$ yds.

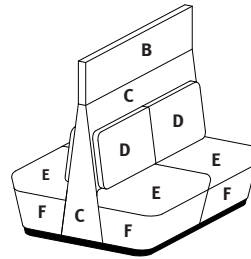

60" Wide Private Back-to-Back Seating Unit, 90-Degree Back

Model	Location	COM Requirement
6567	B	Upholstered Accent Tier = 2 yds.
	C	Back Panel = $4\frac{3}{4}$ yds.
	D	Back Cushion = $3\frac{1}{2}$ yds.
	E	Seat Cushion Top = $3\frac{1}{2}$ yds.
	F	Seat Cushion Bottom = $3\frac{1}{2}$ yds.

Also applicable to models with veneer, laminate or whiteboard material as accent tier (B).

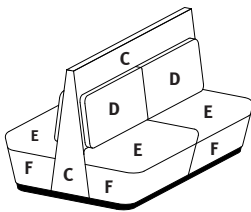

72" Wide Public Back-to-Back Seating Unit, 90-Degree Back

Model	Location	COM Requirement
6568	C	Back Panel = $5\frac{1}{2}$ yds.
	D	Back Cushion = 4 yds.
	E	Seat Cushion Top = 4 yds.
	F	Seat Cushion Bottom = 4 yds.

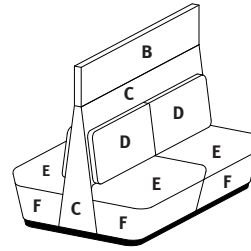

72" Wide Private Back-to-Back Seating Unit, 90-Degree Back

Model	Location	COM Requirement
6569	B	Upholstered Accent Tier = $2\frac{1}{4}$ yds.
	C	Back Panel = $5\frac{1}{2}$ yds.
	D	Back Cushion = 4 yds.
	E	Seat Cushion Top = 4 yds.
	F	Seat Cushion Bottom = 4 yds.

Also applicable to models with veneer, laminate or whiteboard material as accent tier (B).