

Installation Instructions for GlasBac®/GlasBacRE Tiles

Interface®

Important Notices

These Installation Instructions cover most installation procedures. If you run across a situation that isn't addressed in this document or requires more detailed assistance please contact the Interface Help Desk. U.S. (877) 733-7403 / Canada (888) 224-2972

All carpet tiles should be carefully inspected for damage or defects prior to installation. Interface will not be responsible for any cost associated with replacement or repair as a result of damaged or defective tiles being installed when said damage or defects were identifiable prior to installation.

If you encounter any conditions or defects during installation that could jeopardize the installation or affect the installation procedure, you should STOP the installation immediately and call the Interface Help Desk. U.S. (877) 733-7403 / Canada (888) 224-2972

The carpet tiles are warranted in accordance with Interface's Standard Product Warranty. If you do not have a copy of Interface's Standard Product Warranty and wish to obtain one, call the Interface Help Desk. U.S. (877) 733-7403 / Canada (888) 224-2972 or visit our website at www.interface.com/warranty.

EXCEPT AS EXPRESSLY PROVIDED IN THE STANDARD PRODUCT WARRANTY, INTERFACE MAKES NO REPRESENTATIONS OR WARRANTIES, EXPRESS OR IMPLIED, INCLUDING, WITHOUT LIMITATION, ANY WARRANTY OF MERCHANTABILITY OR FITNESS OF ITS PRODUCTS FOR ANY PARTICULAR PURPOSES, AND HEREBY DISCLAIMS THE SAME. Without limiting the foregoing, Interface will not be responsible for staining, soiling, contamination, tears, burns, cuts, pulls or other damage, deterioration or loss caused by abuse, misuse, improper installation, improper maintenance or failure to protect carpet tiles during building construction. Interface shall not be responsible for any damage or loss resulting from failure to strictly follow any part of these Installation Instructions, and such failure shall void any and all portions of the Standard Product Warranty that are affected by such failure.

WARNING: IN THE EVENT THAT ANY ASBESTOS-CONTAINING MATERIALS OR OTHER HAZARDOUS MATERIALS ARE ENCOUNTERED DURING INSTALLATION, YOU SHOULD STOP THE INSTALLATION IMMEDIATELY AND OBTAIN ASSISTANCE FROM A QUALIFIED REMEDIATION CONSULTANT OR CONTRACTOR PRIOR TO PROCEEDING.

Pre-installation visit

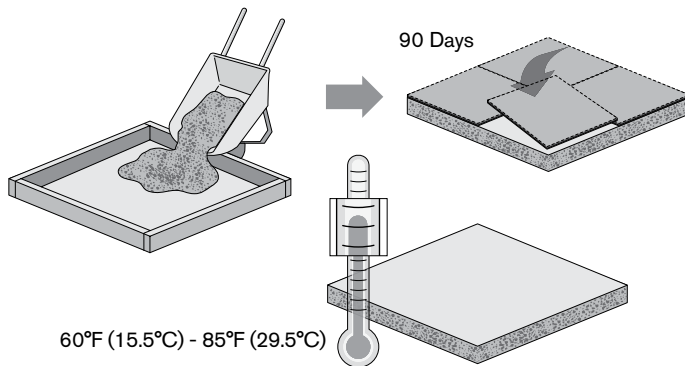

New concrete needs at least 90 days to dry under ideal conditions. Lightweight concrete and concrete poured above grade in metal pans take a considerably longer time to dry. Installation cannot begin until it is fully dried and in compliance with moisture and alkalinity requirements.

The temperature of your job site must stay within 60°F (15.5°C) and 85°F (29.5°C) with relative humidity between 40% - 60% for 48 - 72 hours prior to, during, and 48 - 72 hours after installation. So be sure the heating and air conditioning system is operating.

All carpet tiles must be removed from the cartons and allowed to adjust to the job site temperature for 48 hours prior to installation.

Concrete moisture and alkalinity testing

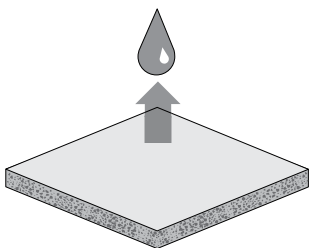

NOTE: The required pre-installation moisture and alkalinity tests should be performed to ASTM standards.

Per CRI guidelines it is recommended that these tests be performed by a qualified independent testing consultant.

Interface will not be responsible for failures, problems, or damage arising from high moisture, high alkalinity, or other subfloor conditions.

NOTE: New or bare concrete is defined as concrete free of adhesive residue, paint, sealers, primers and other applied materials.

Before installing, all concrete floors, regardless of age, must comply with the moisture and pH requirements stated below, and must otherwise be suitable for carpet tile installation. The moisture conditions of the concrete should be determined by use of the *In Situ* probe relative humidity (rH) test method (ASTM F 2170). Interface requires the use of a moisture testing device manufactured by Wagner or Vasela. The testing device must be properly maintained and calibrated in accordance with the manufacturer's specifications and frequency recommendations. Certificates of calibration should be maintained for test validation.

Interface allows for carpet tile installation under a variety of conditions depending on the type of slab and the moisture and pH test results at time of installation:

1. For installation over concrete with up to 97% rH and pH up to 11.0, you may install with Interface's TacTiles® connectors in conjunction with XL Brands' 9511 Moisture Vapor Reduction System. All XL Brands 9511 written requirements for product application, including but not limited to moisture and pH testing protocols, must be met for Interface warranty eligibility. More information concerning the proper use of XL Brands 9511 can be obtained through your local Interface representative or by visiting www.xlbrands.com.

Concrete moisture and alkalinity testing (continued)

2. For installation over concrete with up to 90% rH and pH up to 9.0, you may install with Interface's TacTiles® connectors provided the following conditions are met:

- a. The concrete slab must be a new, bare concrete less than one year old from date of pour.
- b. The slab must be on or above grade.
- c. On grade slabs must have a functional vapor barrier under the entire slab.
- d. An above grade slab must be a suspended slab or be poured in a vented pan.

3. For installation over concrete with up to 85% rH and pH up to 9.0, you may install over all other suitable concrete slab conditions when installed with Interface's TacTiles® connectors.

4. For glue-down installations, you may install over concrete with up to 80% rH and with a pH up to 9.0.

NOTE: Moisture and pH test results reflect only the conditions of the concrete at the time of testing. If the moisture and/or pH test results are outside of the stated allowable limits, **STOP** and **DO NOT PROCEED** with the installation. Seek further advice from Interface before proceeding.

Refer to Preparing the Subfloor for additional information concerning issues relating to surface conditions of the concrete slab prior to installation.

Product inspection

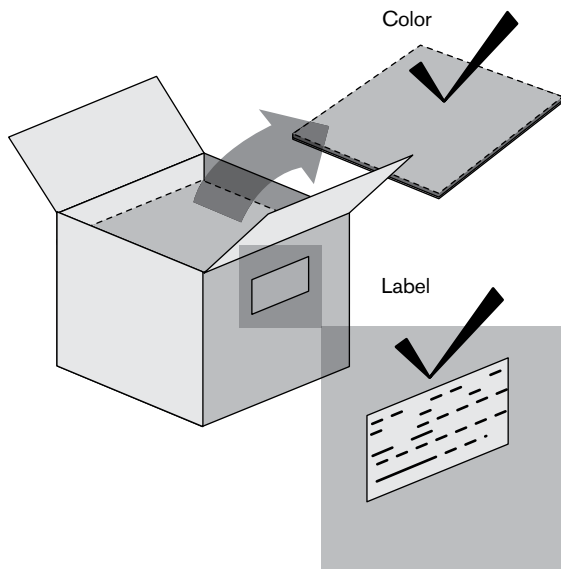

INSPECT INTERFACE GLASBAC/GLASBACRE CARPET TILES TO BE SURE THEY MEET THE ORDER SPECIFICATIONS. IF THE WRONG PRODUCT OR COLOR IS INSTALLED, INTERFACE WILL NOT BE RESPONSIBLE FOR CORRECTING THE PROBLEM.

The labels on each carton indicate product style, pattern, color, run number and dye lot. Be sure the style, pattern and color match the specifications for each area of your installation. On larger installations, you may find that some cartons have different run numbers and/or dye lots. To avoid subtle variations in the finished installation of non-i2® styles, do not mix run numbers or dye lots in the same area.

Dye lots may be mixed for Interface i2 styles.

Check to confirm that you have the right quantity and correct installation method. Be sure you also have enough tiles to establish an "attic stock" for future replacements.

Open all cartons to inspect for damaged or defective tiles. If you find any, call the Interface Help Desk. U.S. (877) 733-7403 / Canada (888) 224-2972

Lighting

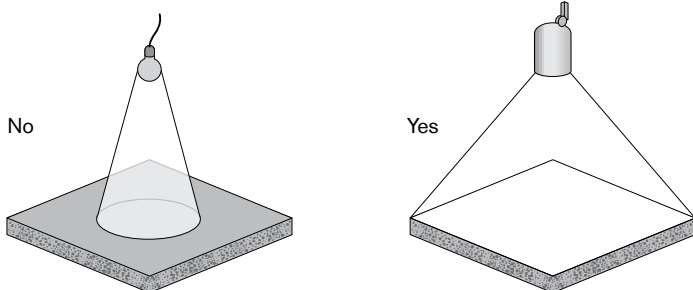

Ensure adequate overhead lighting is provided. Ideally, lighting should mimic or consist of the same conditions expected at time of occupancy.

INSTALLATION OF CARPET TILES SHOULD BE THE LAST ITEM ON THE CONSTRUCTION SCHEDULE. CAREFULLY CONSIDER THE RISKS IF YOU ARE ASKED TO INSTALL CARPET TILES TOO EARLY. IF CARPET TILES ARE INSTALLED BEFORE CONSTRUCTION IS COMPLETE, ANY STAINING, SOILING OR DAMAGE CAUSED BY OTHER TRADES MAY VOID THE PRODUCT WARRANTY.

SQUARE TILES

(for Plank Tile Instructions see page 11)

Monolithic Installation

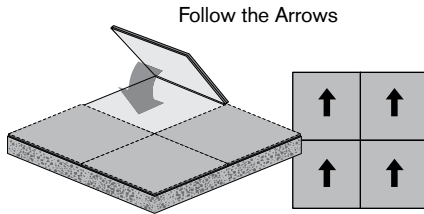

An arrow is printed on the back of each carpet tile to indicate pile direction. Make sure the arrows point in the same direction throughout your installation.

Quarter-Turn Installation

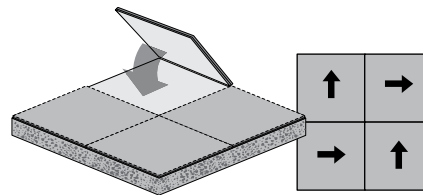

Some Interface GlasBac/GlasBacRE tiles are designed to be installed in a parquet pattern. In this case, the arrows should be turned 90 degrees every other tile.

Ashlar Installation

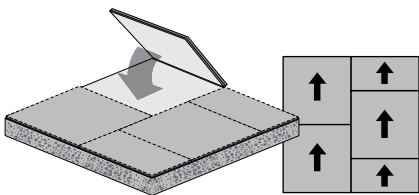

Some Interface GlasBac/GlasBacRE tiles are designed to be installed in an ashlar pattern by offsetting the front and back tile joints.

Non Directional Installation

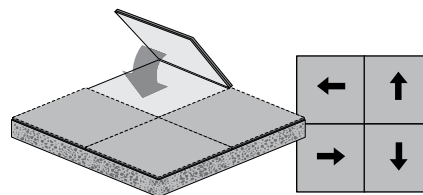

Some Interface GlasBac/GlasBacRE tiles are designed to be installed in a non directional pattern. This pattern allows installation of tiles without regard to arrow direction.

Brick Installation

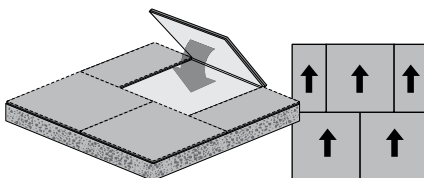

Some Interface GlasBac/GlasBacRE tiles are designed to be installed in a brick pattern by offsetting the side joints of the tiles.

Tools

Proper installation requires tools on the following checklist.

- | | |
|-------------------------------------|---|
| English/Metric steel measuring tape | Vacuum |
| Scraper | White chalk line |
| Carpet knife | TacTiles |
| Carpet knife replacement blades | OR |
| Steel straight edge | Recommended adhesive with 3/8" nap paint roller |
| Carpenter's square | |
| Broom | |
| Sander | |

NOTE: INTERFACE ASSUMES NO LIABILITY FOR ISSUES RELATED TO OR RESULTING FROM INSTALLING OUT OF SPECIFICATION, INCLUDING, BUT NOT LIMITED TO, RECOMMENDED INSTALLATION METHOD.

PREPARING THE SUBFLOOR

Installing over concrete

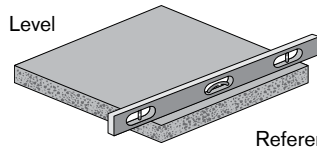

Reference 10' straight edge method. Level is defined as having up to 1/4" maximum gap within 90% of samples taken. No sample should exceed a maximum gap of 3/8".

All concrete floors must comply with moisture and alkalinity requirements prior to proceeding with installation. (See "Moisture and Alkalinity Test" above.)

Level the floor to the standards outlined in the American Concrete Institute specifications for Concrete Buildings in regards to troweled finish and finishing tolerances. Leveling compounds must be cementitious based.

Existing Concrete

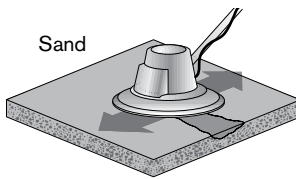
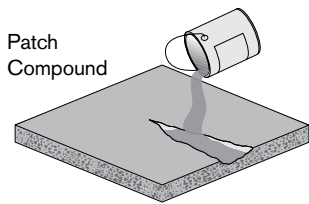

Patch cracks and holes with one of the following approved patching compounds: Ardex Feather Finish, Ardex K-15, Henry's 547, Armstrong S-184 or similar cement based compound. NOTE: Some patching compounds can be mixed with water while some must be mixed with latex. Follow the manufacturer's specifications and instructions for use.

NOTE: All adhesives, solvent based materials and other contaminants should be removed and encapsulated prior to application of adhesive and installation of carpet. Contact the Interface Help Desk. U.S. (877) 733-7403 / Canada (888) 224-2972

New Concrete

Interface recommends that dusty and / or porous conditions be primed using XL Brands Prelude or a similar product.

Installing over wood, plywood or particle board

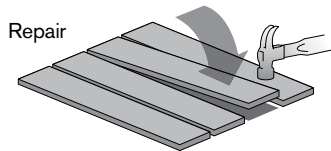

Repair loose or broken boards. Secure with 8-D cement-coated screw nails.

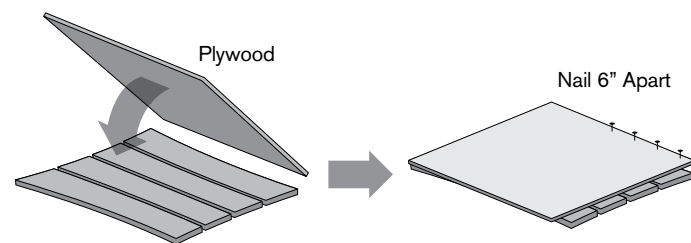

If the majority of the boards are worn or badly cupped, cover with 5/8 inch (1.6 cm) exterior grade AD plywood secured with 8-D cement-coated screw nails spaced 6 inches (15.2 cm) apart. Sand seams smooth.

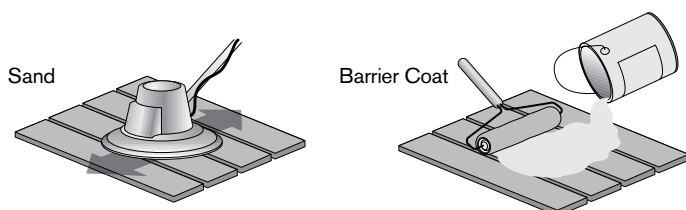

Sand the finish down to bare wood.

Remove dust by sweeping, then wiping with a tack cloth.

All wood surfaces should be primed prior to application of an adhesive. Interface recommends XL Brands TriSeal or similar product.

NOTE: All adhesives, solvent based materials and other contaminants should be removed and encapsulated prior to application of adhesive and installation of carpet. Contact the Interface Help Desk. U.S. (877) 733-7403 / Canada (888) 224-2972

Installing over vinyl tile, sheet vinyl or natural materials

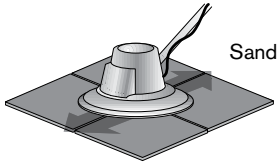

WARNING: EXISTING FLOOR COVERING MAY CONTAIN ASBESTOS OR OTHER HAZARDOUS MATERIALS. IN THE EVENT ASBESTOS-CONTAINING MATERIALS OR OTHER HAZARDOUS MATERIALS ARE ENCOUNTERED, YOU SHOULD STOP THE INSTALLATION IMMEDIATELY AND OBTAIN ASSISTANCE FROM A QUALIFIED REMEDIATION CONSULTANT OR CONTRACTOR PRIOR TO PROCEEDING.

Use an appropriate non solvent stripper or a sander to remove the wax top coat.

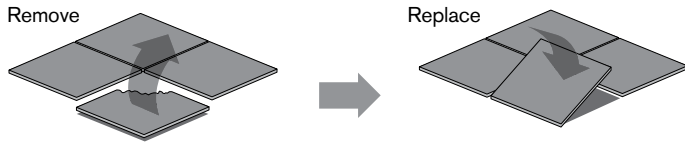

Remove any damaged or loose vinyl tiles and replace with comparable thickness tile or patching compound.

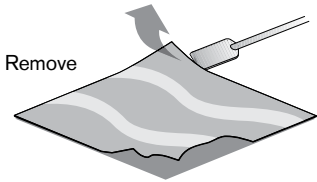

Remove sheet vinyl with a scraper. Do not install over sheet vinyl. Any existing adhesive remaining on subfloor should be removed by grinding/scraping and residue encapsulated.

NOTE: This is not necessary for TacTiles connectors. Sheet vinyl must be secure to subfloor.

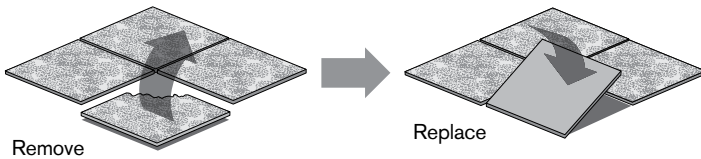

For natural materials such as granolithic, terrazzo, marble, ceramic tile, etc., breakout and remove all material or replace damaged areas with substitute material of the same thickness.

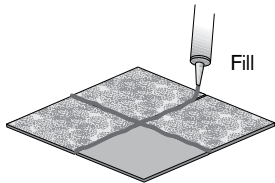

Patch and fill cracks and irregularities, including grout lines, with one of the following approved patching compounds: Ardex Feather Finish, Ardex K-15, Henry's 547 or similar cement based compound.

NOTE: Some patching compounds can be mixed with water while some must be mixed with latex. Follow the manufacturer's specification and instructions for use.

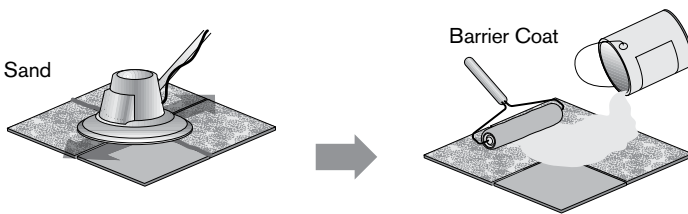

Sand top surface to remove glaze.

Remove dust by sweeping, then wiping with a tack cloth.

All porous surfaces should be primed prior to application of an adhesive. Interface recommends XL Brands TriSeal or similar product.

Installing over raised floors

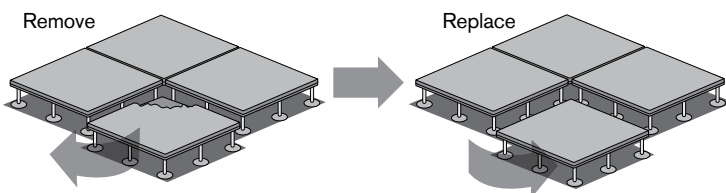

Patch or replace any damaged floor panel inserts.

Panels should be free of any dirt, grease, oil, paint, sealer, adhesive or other materials from floor.

NOTE: All adhesives, solvent based materials and other contaminants should be removed and encapsulated prior to application of adhesive and installation of carpet. Contact the Interface Help Desk. U.S. (877) 733-7403 / Canada (888) 224-2972

ESTABLISHING THE STARTING POINT

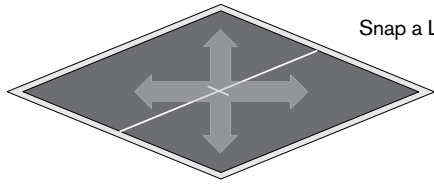

Snap a Line

1. Measure to determine the center point and mark. Snap a chalk line.

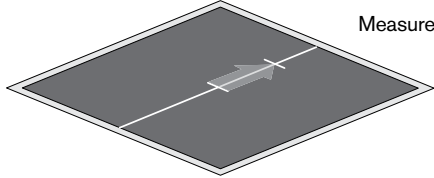

Measure

2. Measure 8 feet (243.5 cm) out from your center point along the chalk line. Make a mark.

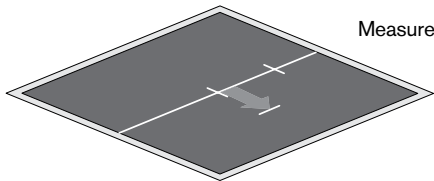

Measure

3. Measure 6 feet (182.9 cm) from your center point at a right angle to your chalk line and make a mark.

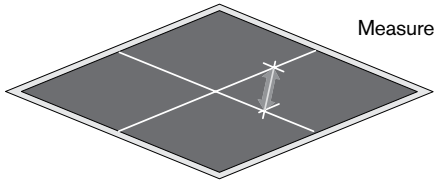

Measure

4. Measure the distance between your marks. It should be exactly 10 feet (304.8 cm). If it is, your quadrants will be square. Snap a chalk line here.

NOTE: If the room is too small for the above measurements, reduce them by half. Measure 4 feet (121.9 cm) vertically and 3 feet (91.4 cm) horizontally. In this case, the measurement between your two marks should be exactly 5 feet (152.4 cm).

Determine if center lines need to be offset

Dry fit (without adhesive) a row of tiles along the entire length of your vertical and horizontal center lines. Go all the way to the walls. If necessary, offset either or both center lines to ensure perimeter tiles will be cut no less than half size, or 9.84 inches (25 cm).

TacTiles Installation System

SQUARE TILES

(for Plank Tile Instructions see page 12)

Applying TacTiles connectors

NOTE: The average TacTiles connector application rate is four TacTiles per square yard of carpet when installed monolithic, quarter-turn or non directional and six TacTiles per square yard when installed ashlar or brick. In small spaces a higher per yard application rate may apply. Consult your local Account Executive or the Interface Help Desk. U.S. (877) 733-7403 / Canada (888) 224-2972

TacTiles connectors should not be used on stairs, ramps or inclines.

Lay anchor rows, placing a TacTiles connector at every joint. Install carpet using a step method placing a TacTiles connector at every corner.

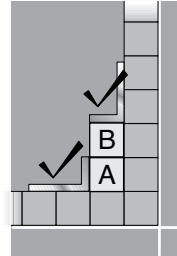

Check Square

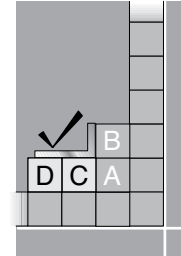

Check Square

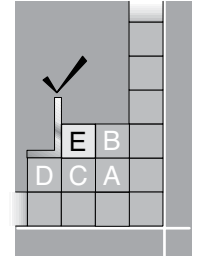

Check Square

TacTiles connector placement

Insert tiles based on approved installation method. TacTiles connectors should be applied based on the following diagrams.

Quarter-Turn / Monolithic / Non Directional Installations / Area Rugs

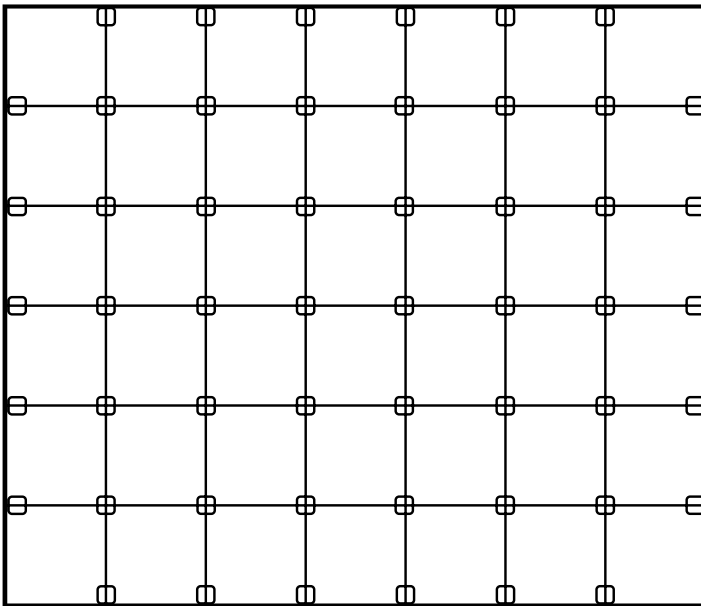

Brick / Ashlar Installations (Six TacTiles per yard - one at every corner.)

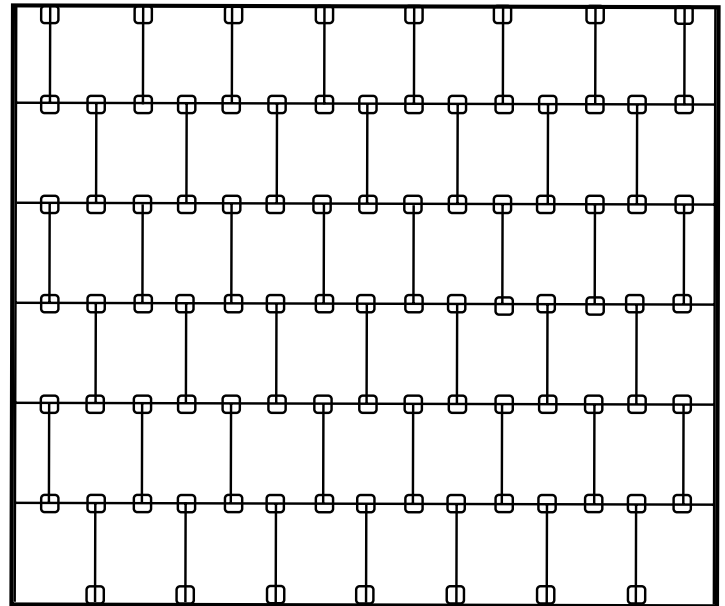

NOTE: When installing using Interface TacTiles connectors, perimeter tiles should be cut net to the wall. In the event a wall or other termination point does not extend to the subfloor, the perimeter tiles should be installed using an approved Interface adhesive.

Adhesive Installation

APPLYING ADHESIVE

If you choose spread adhesive, use only *XL Brands Adhesive 2000 Plus (U.S.)* or *Adhesive 2500 Plus (Canada)* on all areas other than stairs. On stairs, use only vinyl compatible permanent adhesive. For stair nosing, use manufacturer's recommended installation method.

Full spread adhesive application

Spread Rate:
39 - 44 Sq. Yds./Gallon

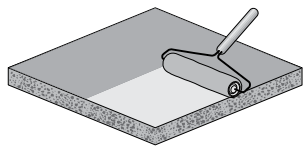

Raised Floor Systems

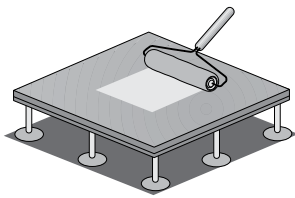

Apply adhesive with a 3/8" nap paint roller. Expect a spread rate of 39-44 square yards per gallon using a 3/8" nap paint roller.

For raised floor systems a full spread of adhesive is required.

Adhesive in special situations

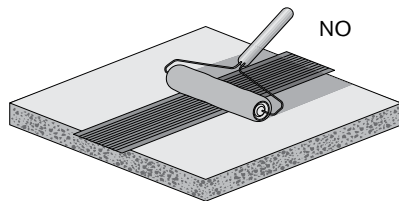

FLATWIRE

Never apply adhesive directly over flatwire. The flatwire may be damaged if the tiles need to be removed.

UNEVEN AREAS

Any surface that cannot be leveled may require adhesive or double-sided tape to hold a tile in place.

Tile Installation

LAYING TILES

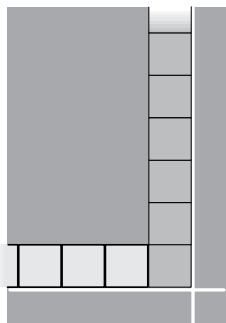

3mm or 1/8" Gain

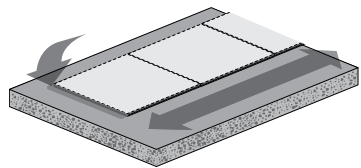

550cm or 216 17/32"

Follow the center lines closely. In smaller rooms, your anchor rows may consist of fewer than 11 tiles. Lay an anchor row of 10 additional tiles (11 including the one you've already placed) aligned with the center line.

Measure your anchor rows. Each should equal 550 cm (11 tiles x 50 cm each, or 216 17/32") with no more than a 3mm (1/8") gain. If the gain is more than 3 mm, the tiles aren't tight enough and should be laid again. After relaying, measure again. If tiles are less than 550 cm they are too tight and should be laid again.

Tip into place

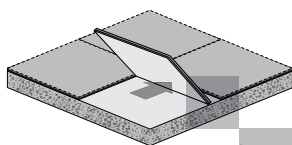

DON'T Slide

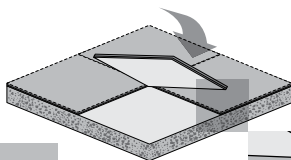

Tip In

Don't position tiles by sliding them across the adhesive. This will cause the corner to bend under. Instead, brush the pile back with one hand, then tip a corner of the tile into place. Position the rest of the tile once the corner is properly aligned. Do not catch the pile in the joints.

Lay tiles in step or pyramid pattern

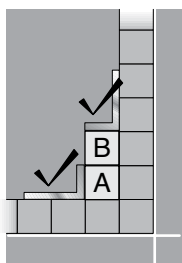

Check Square

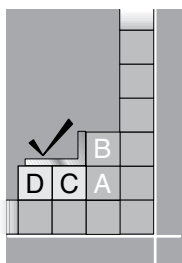

Check Square

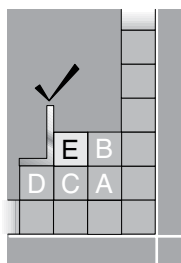

Check Square

1. Lay two tiles vertically, and check that they are square to the anchor rows.
2. Lay two tiles horizontally, and check that they are square to the anchor rows.
3. Lay one tile to complete the step.
4. Follow the ABCD pattern laid out here until you reach the end of your anchor rows. Repeat laying anchor rows and ABCD patterns in all quadrants until complete.

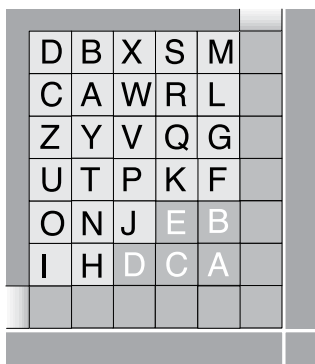

CUTTING TILES

Guidelines for cutting tiles

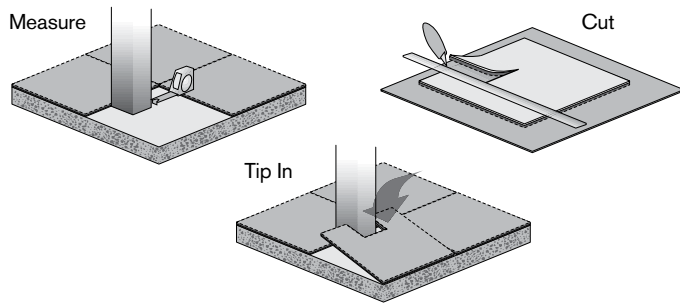

Tiles adjacent to fixtures, architectural elements and walls need to be cut. Follow these guidelines:

- If practical, remove the base molding before installing perimeter tiles. Replace molding when finished.
- Replace blades often. Sharp blades make cutting quicker, easier and more precise.
- Never use other tiles as a cutting surface. Place tiles on layers of cardboard before cutting.
- Always secure cut tiles with adhesive.

Floor outlets

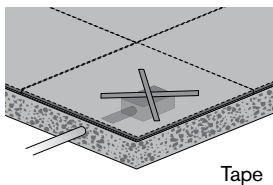

Floor outlets are usually wired after carpet tiles have been installed. Consequently, you should install tiles directly over floor outlets and mark the location with tape. This way, it will be easy to see which tiles need to be lifted for cutouts later.

Flatwire

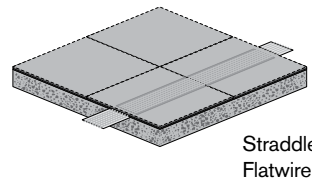

Tile layout should allow flatwire to be centered under a row of tile.

Trench headers

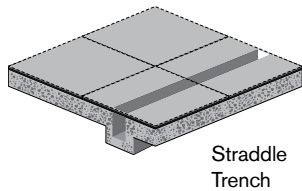

Tile layout should allow trench headers to be centered under a row of tile. Secure the tiles on either side of trench headers with adhesive. This will prevent the installation from shifting while servicing trench headers.

Raised floors

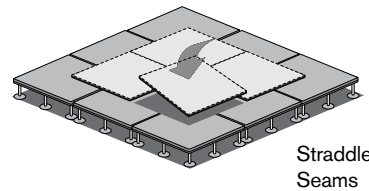

Raised floor panels are susceptible to subtle flexing. To ensure uniform appearance, avoid matching raised floor seams with tile joints.

PREPARING FOR OCCUPATION

Final inspection and vacuum

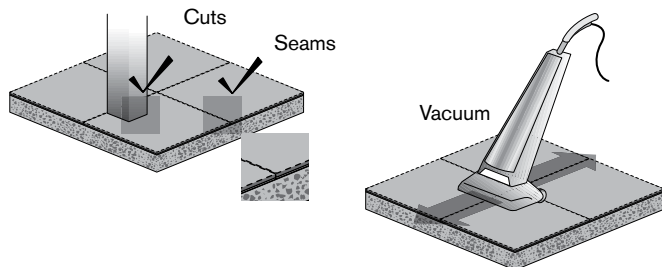

Inspect the entire installation, paying close attention to joints and any tiles that have been cut.

Vacuum the floor with a pile lifter. If you don't have a pile lifter, use an upright vacuum cleaner.

Follow CRI installation standards

In addition to the specific floor preparation and installation instructions detailed here, the Carpet and Rug Institute's Carpet Installation Standard must be followed. Please note that many of the Interface installation requirements may exceed or differ from those in the CRI Standard. In the event of conflict between the Interface Installation Instructions and the CRI Standard, you should follow the Interface Installation Instructions.

Special Product Guide

(for Square Tile Installation Instructions see page 3)

50CM X 1M PLANK TILES

Ashlar Installation

Follow the Arrows

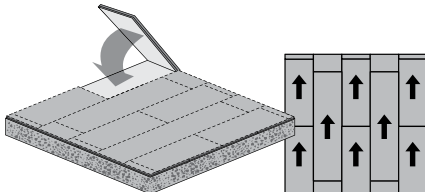

Ashlar is created by offsetting the front and back tile joints.

Herringbone Installation

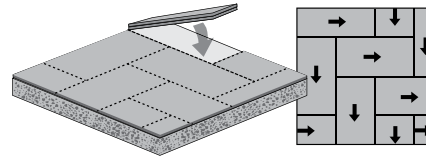

Herringbone is created by laying planks in an L pattern.

25CM X 1M PLANK TILES

Ashlar Installation

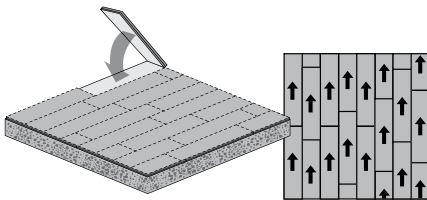

Ashlar is created by offsetting the front and back tile joints. We recommend a variable drop ashlar, as shown here, but our products can also be installed with a half drop ashlar.

Herringbone Installation

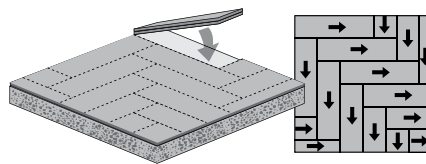

Herringbone is created by laying planks in an L pattern.

TacTiles Installation System

(for Square Tile Instructions see page 7)

PLANK TILES

Applying TacTiles connectors

NOTE: The average number of TacTiles connectors needed depends on the size of the plank and the installation method used.

50cm x 1m Plank Averages:

- Ashlar – 4/sq. yard
- Herringbone – 5/sq. yard

25cm x 1m Plank Averages:

- Ashlar – 7/sq. yard
- Herringbone – 8/sq. yard

Some applications may require an additional TacTiles connector in the center where tile edges meet. Consult your local Account Executive or the Interface Help Desk. U.S. (877) 733-7403 / Canada (888) 224-2972

TacTiles connectors should not be used on stairs, ramps or inclines

Lay anchor rows, placing a TacTiles connector at every joint. Install carpet using a step method placing a TacTiles connector at every corner. Interface recommends securing anchor rows with adhesive or two-sided tape.

Insert tiles based on approved installation method. TacTiles connectors should be applied based on the following diagrams.

50CM X 1M placement

Ashlar Installation

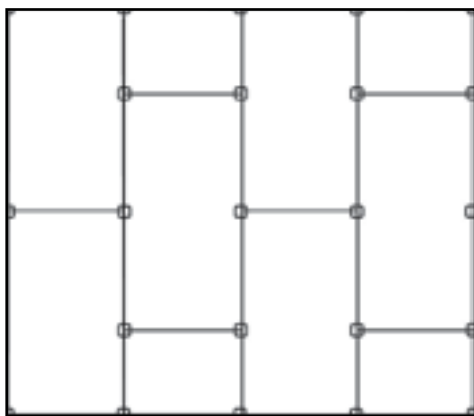

Herringbone Installation

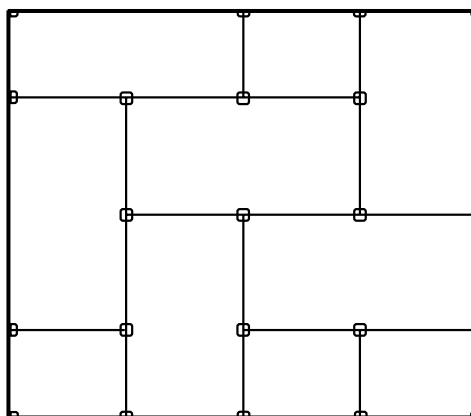

25CM X 1M placement

Ashlar Installation

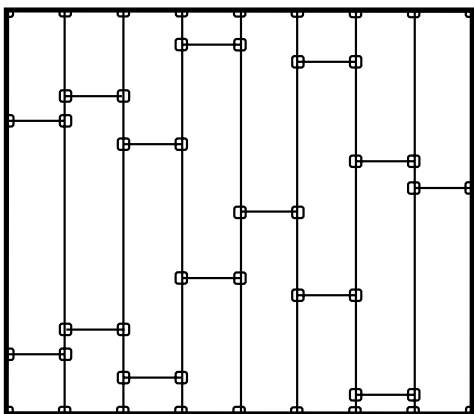

Herringbone Installation

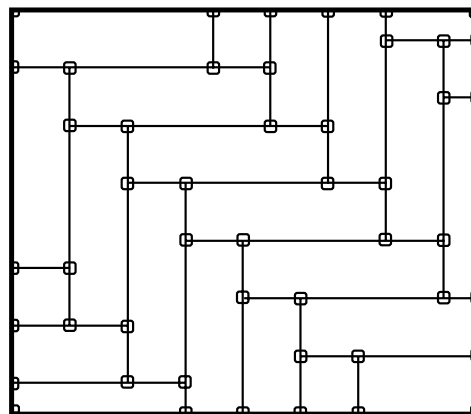

NOTE: When installing using Interface TacTiles connectors, perimeter tiles should be cut net to the wall. In the event a wall or other termination point does not extend to the subfloor, the perimeter tiles should be installed using an approved Interface adhesive.