



GSA prices effective April 3, 2017  
(based on February 1, 2016, commercial price list)  
Published April 2017

## Medical Equipment and Supplies Procedure/Supply Carts

### **Department of Veteran Affairs Marketing Division for Federal Supply Schedules Authorized Federal Supply Schedule Price List**

Online access to contract ordering information, terms and conditions, up-to-date pricing, and the option to create an electronic delivery order is available through GSA Advantage!, a menu-driven database system. The Internet address for GSA Advantage! is [www.gsaadvantage.gov](http://www.gsaadvantage.gov). For more information on ordering from Federal Supply Schedules, click on the FSS Schedules button at [www.fss.gsa.gov](http://www.fss.gsa.gov).

FSC Group 65, Part II, Section A, Medical Equipment and Supplies  
FSC Classes 6515 and 6530  
Contract Number: V797D-40147  
Contract Period: May 1, 2014, through April 30, 2019

Herman Miller, Inc.  
855 East Main Avenue  
Zeeland, Michigan 49464  
(616) 654 3000 Phone  
(616) 654 8278 Fax  
[www.HermanMiller.com/government](http://www.HermanMiller.com/government)

Business Size: Large



# Contract Information

## 1a. Special Item Numbers (SIN)

A-48: Carts, Emergency, Cardiopulmonary Resuscitation (Crash).  
A-83: Carts, Medical Supplies, Patient Application.

## 1b. Lowest Price Model:

A-48: CT773. \$66  
A-83: CT550.03 \$25

2. **Maximum Order.** \$50,000 net product value.

3. **Minimum Order.** None.

4. **Geographic Coverage.** 50 States, District of Columbia, and Puerto Rico.

5. **Production Points.** Zeeland, Michigan, County of Ottawa.

6a. **Pricing.** Prices shown are list. To calculate contract prices, deduct 16% up to \$30,000 list. Over \$30,000, deduct 18%.

6b. **10-Day or Less Program.** Same discounts as standard lead-time.

7. **Quantity Discounts.** See 6a. above.

8. **Payment Terms.** Net 30 Days.

9a. **Government Purchase Cards.** Government Purchase Cards are accepted below the micropurchase threshold.

9b. **Government Purchase Cards.** Government Purchase Cards are accepted above the micropurchase threshold.

10. **Foreign Items.** Not applicable.

11a. **Time of Delivery.** Within 45 days after receipt of order (ARO).

11b. **Expedited Delivery.** Items listed in the 10-day or less section of this price book are available for expedited delivery.

11c. **Overnight and 2-Day Delivery.** Select items may be available for overnight or 2-day delivery. Contact Herman Miller, Inc., or local authorized dealer for availability.

11d. **Urgent Requirements.** Select items may be available for urgent delivery. Contact Herman Miller, Inc., or local authorized dealer for availability.

12. **F.O.B.** Destination except Alaska, Hawaii, and Puerto Rico, which will be shipped F.O.B. inland carrier point of exportation.

## 13a. Order Address.

Herman Miller, Inc.  
Government Customer Care 0161  
855 East Main Avenue  
Zeeland, MI 49464

13b. **Order Procedures.** For supplies and services, the ordering procedures, information on Blanket Purchase Agreements (BPA's), and a sample BPA can be found at the GSA/FSS Schedule home page ([www.fss.gsa.gov/schedules](http://www.fss.gsa.gov/schedules)).

## 14. Payment Address.

Herman Miller, Inc.  
22764 Network Place  
Chicago, IL 60673-1227

15. **Warranty Provisions.** Herman Miller, Inc., commercial warranty applies.

16. **Export Packing Charges.** Prices supplied upon request.

17. **Terms and Conditions of Government Commercial Credit Card Acceptance.** Net 30 days (standard payment terms).

18. **Terms and Conditions of Rental, Maintenance, and Repair.** Not applicable.

19. **Terms and Conditions of Installation.** Installation services shall be negotiated between ordering agency and Herman Miller local authorized dealer.

20. **Terms and Conditions of Repair Parts.** Not applicable.

20a. **Terms and Conditions for Any Other Services.** Not applicable.

21. **List of Service and Distribution Points.** Access Herman Miller web site for current list of participating dealers: [www.HermanMiller.com](http://www.HermanMiller.com).

22. **List of Participating Dealers.** Access Herman Miller web site for current list of participating dealers: [www.HermanMiller.com](http://www.HermanMiller.com).

23. **Preventive Maintenance.** Not applicable.

24a. **Special Attributes.** Reconfigurable, renewable, recyclable.

24b. **Section 508 Compliance.** Not applicable.

25. **DUNS Number.** 0060112801

26. **Registered in Central Contractor Registration (CCR) Database.** Herman Miller, Inc., Federal ID Number: 38-0837640  
Commercial and Government Entity Code (CAGE): 40636



<b>Introduction</b>	<b>page 2</b>
<b>Procedure/Supply Carts</b>	<b>3</b>
Carts	5
Interior Components	14
Exterior Accessories	47
<b>Indices</b>	<b>89</b>
By Name	89
By Number	91
<b>Appendices</b>	
20-Day or Less/Assigned Lead-Time Order Information-Healthcare Packaging/Keyed-Alike Information-Procedure/Supply Carts	
<b>For the latest materials information, refer to the Materials pages on HermanMiller.com.</b>	

# Introduction

## A Note on the Organization of This Book

There are a few signals that will help you understand the organization of this book. Once you know them, you should be able to find your way around easily.

### Like a newspaper, this book is formatted with columns of text and illustrations that run vertically.

Information wraps from one column to the next and continues for as many pages as it needs to.

### Black bars are clues.

A black bar at the top of a page signals the start of information about a product.

This information is divided into two sections, each signaled by a black bar. Product Information includes a description, additional notes, and dimensional drawings. Specification Information, which always begins at the top of a column, includes a series of steps. Each step represents a decision you need to make in order to complete your product number. Steps must be followed sequentially. The number of pages needed to complete information on a product varies; some will be complete in one page; others may fill three or four pages. Just continue going through the steps until you run into the next product, signaled by the black bar at the top of the page.

Black tabs running along the outside edge of the page help you locate what section you are in or what section you want to go to. You can thumb forwards or backwards to find a section; tabs and text appear on both sides of the page.

The additional pages in the back of the book include the appendices and indices. They are signaled by a long black bar running along the outside edge of the page.

### The index is presented two ways.

The first index is in alphabetical order by product name. It can be helpful if you are new to the products and numbering scheme or if you are looking for a type of product, such as work chair or round table.

The second index is by product number. It lists, in alphanumeric order, the base product number, typically a five-digit number.

## General Information

This book is effective April 3, 2017, subject to change without notice. Products may be purchased from authorized Herman Miller dealers who will quote prices upon request. For more information about our products and services or to see a list of dealers, visit [www.HermanMiller.com](http://www.HermanMiller.com).

All prices are list prices. Additional services, such as planning services, design, storage, and installation, are not included and must be added to these prices when the additional services are requested.

Illustrations, specifications, and prices are based on the latest information at the time of publication. The right is reserved to make changes at any time without notice in prices, fabrics, finishes, materials, specifications, and models, and also to discontinue models and finishes.

Dimensions shown in the drawings are engineering drawing dimensions rounded up to the nearest  $\frac{1}{8}$ ". Product is shipped set up or knocked down. Products that include "Shipped knocked down" in the description require some assembly. If this statement does not appear in the description, the product is shipped assembled.

Service problems are normally handled by a Herman Miller authorized dealer. Where this cannot be accomplished on a local level, service problems should be referred to the Customer Care Representative for your region, Herman Miller, Inc., Zeeland, Michigan 49464.

### 20-Day or Less/Assigned Lead-Time Shipments

All products and options in this price book not designated by an Assigned Program icon  will ship in **20 business days or less** after being acknowledged by Herman Miller.

Products and options designated by an  are on the assigned lead-time program and may ship in 20 days, less than 20 days, or more than 20 days from order acknowledgement.

**Carts**

**Interior Components**

**Exterior Accessories**





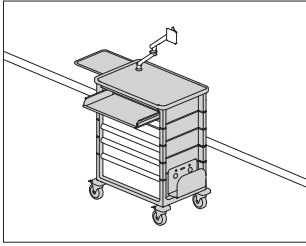

**Product Information**

**Description**

Storage and technology carts provide the ability to combine charting, inventory management, and storage in 1 cart. This cart has Flo® through-mount hardware installed on the left side of the cart top and is ready to accept a Flo monitor arm, sold separately. The cart has a raised-edge top and an optional shelf that slides out on the left or right side. It comes with a rail-attached power outlet strip or a bracket to mount a field-supplied power strip, and a cable management channel. There are 2 1"-diameter holes in the upper back of the cart body on the left and right sides for routing mouse and keyboard wires, and 10 interior slots at 3" intervals. When using the keyboard shelf, there are 9 available interior slots. The cart has 5" casters; 2 swivel/brake casters in front, 2 swivel casters in back.

Flo is an easy to move, slim profile monitor arm that can support a single flat panel monitor or laptop holder. It has a 13 3/4" height-adjustment range, a 20 5/8" extension range, and allows the monitor to tilt 40° upward and -40° downward. The arm includes a quick-disconnect feature that allows easy installation and removal of a monitor or laptop holder. It has integrated cable management along the underside of the arm, and a visual indicator that shows the arm's tension setting. The arm meets VESA 75mm and 100mm standards (Video Electronic Standards Association-Mounting Interface Standard). An allen wrench for adjusting arm tension is included. Cart ships with Flo through-mount hardware attached. The arm slides onto the mount; no additional hardware required.

**Notes**

Keyboard shelf has full-extension drawer slides and holds up to 25 pounds. Finish is black.

Cart is compatible only with Flo monitor arm.

Flo arm accommodates monitor and laptop weights ranging from 7 to 20 pounds.

Order the following products separately:

- Flo single screen monitor arm-arm only (Y92090.) (open market)
- Optional laptop mount (Y91177.) for Flo arm (open market)
- Cord wrap (CT779.)
- Drawers, drawer accessories, shelves, cassettes, and holders
- Rail-mounted electrical components, containers, and holders

Flo monitor arm will always mount on left side of cart and CPU holder on the right side to balance the weight.

Laptop mount (Y91177.) requires 100mm VESA plate (not included). It supports laptops of varying widths up to 11" deep and 1 1/2" thick. It supports docking stations up to 11" wide and 5" deep.

Flip-up shelf (CT750.) cannot be mounted on the same side of the cart as the CPU holder.

Side-mounted CPU holder finish is soft white (LU).

Side-mounted CPU holder width adjusts to hold computer cases ranging from 4"-6 1/2" wide. Maximum cube space for CPU cases is 6 1/2" wide x 13" deep x 25" high. Maximum weight capacity of CPU holder is 50 pounds.

**Dimensions**

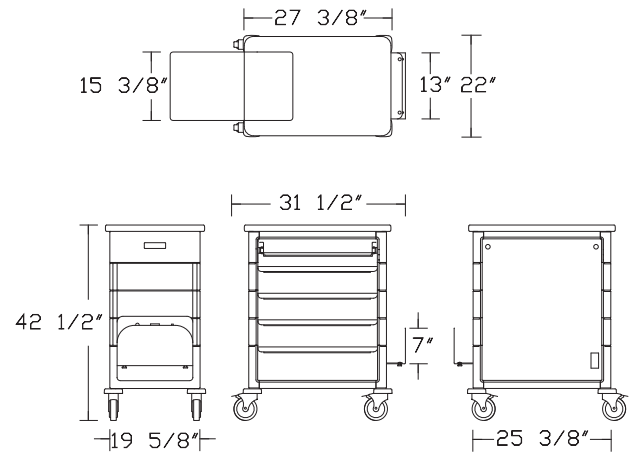

# Storage and Technology Cart

continued

Procedure/Supply Carts

## Specification Information

### Step 1.

**CTT.**

### Step 2. Cart Interior Width

**342** 20 series

**142** 24 series

### Step 3. Top

**60C** raised-edge top

**60SC** raised-edge top with slide-out shelf

### Step 4. Keyboard Shelf

**N** no keyboard shelf

**Y** keyboard shelf

### Prices for Steps 1-4.

		<b>N</b>	<b>Y</b>
<b>CTT.</b>	<b>342 60C</b>	\$850	992
	<b>60SC</b>	\$1001	1143
	<b>142 60C</b>	\$870	1012
	<b>60SC</b>	\$1031	1173

### Step 5. Surface Finish

**HF** inner tone light +\$0

**LT** light tone +\$0

**LU** soft white +\$0

**WN** warm grey neutral +\$0

### Step 6. CPU Side Mount Options

**NCR** for no CPU or for used with Compact CPU +\$0

**RMC** right side mounted CPU holder +\$85

### Step 7. Power Strip

**RMB** includes rail and mounting bracket only +\$0

**RPS** includes rail with power strip +\$130

# Locking Storage and Technology Cart

CTTL.

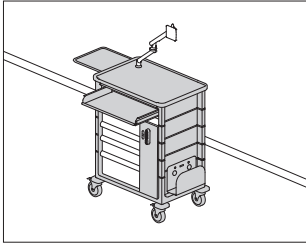

## Product Information

### Description

Storage and technology carts provide the ability to combine charting, inventory management, and storage in 1 cart. Flo® through-mount hardware comes installed on the left side of the cart top and is ready to accept a Flo monitor arm, sold separately. This 42"-high cart includes a divider between keyboard tray and storage to allow keyboard access while the storage can remain locked by the 36"-high lock bar. The cart has a raised-edge top and an optional shelf that slides out on the left or right side. It comes with a rail-attached power outlet strip or a bracket to mount a field-supplied power strip, and a cable management channel. There are 2 1"-diameter holes in the upper back of the cart body on the left and right sides for routing mouse and keyboard wires, and 8 interior slots at 3" intervals. The cart has 5" casters; 2 swivel/brake casters in front, 2 swivel casters in back.

The lockbar prevents unauthorized access to drawers or cassette bins. It offers multiple security and access options and re-locks automatically when closed. Keyless entry options have a sleep mode for tamper protection when several incorrect codes are entered, a 9-volt battery "jump" capability, and a keyed backup. Batteries included.

A wide range of capabilities can be utilized with the proximity reader option when used with the proximity lock bar software kit, sold separately. The proximity reader will read most low frequency HID Prox Cards (125 kHz). The use of a card other than one from Herman Miller, Inc., should be verified. Various combinations of "user" and "supervisor" codes can be set.

Flo is an easy to move, slim profile monitor arm that can support a single flat panel monitor or laptop holder. It has a 13 3/4" height-adjustment range, a 20 5/8" extension range, and allows the monitor to tilt 40° upward and -40° downward. The arm includes a quick-disconnect feature that allows easy installation and removal of a monitor or laptop holder. It has integrated cable management along the underside of the arm, and a visual indicator that shows the arm's tension setting. The arm meets VESA 75mm and 100mm standards (Video Electronic Standards Association-Mounting Interface Standard). An allen wrench for adjusting arm tension is included. Cart ships with Flo through-mount hardware attached. The arm slides onto the mount; no additional hardware required.

### Notes

Keyboard shelf has full-extension drawer slides and holds up to 25 pounds. Finish is black.

Cart is compatible only with Flo monitor arm.

Flo arm accommodates monitor and laptop weights ranging from 7 to 20 pounds.

Order the following products separately:

- Flo single screen monitor arm-arm only (Y92090.)
- Optional laptop mount (Y91177.) for Flo arm
- Cord wrap (CT779.)
- Drawers, drawer accessories, shelves, cassettes, and holders
- Rail-mounted electrical components, containers, and holders
- Lock bar software kit (CT631.)
- Proximity access (CT623., CT624.)

Flo monitor arm will always mount on left side of cart and CPU holder on the right side to balance the weight.

Laptop mount (Y91177.) requires 100mm VESA plate (not included). It supports laptops of varying widths up to 11" deep and 1 1/2" thick. It supports docking stations up to 11" wide and 5" deep.

Flip-up shelf (CT750.) cannot be mounted on the same side of the cart as the CPU holder.

Side-mounted CPU holder finish is soft white (LU).

Side-mounted CPU holder width adjusts to hold computer cases ranging from 4"-6 1/2" wide. Maximum cube space for CPU cases is 6 1/2" wide x 13" deep x 25" high. Maximum weight capacity of CPU holder is 50 pounds.

## Dimensions

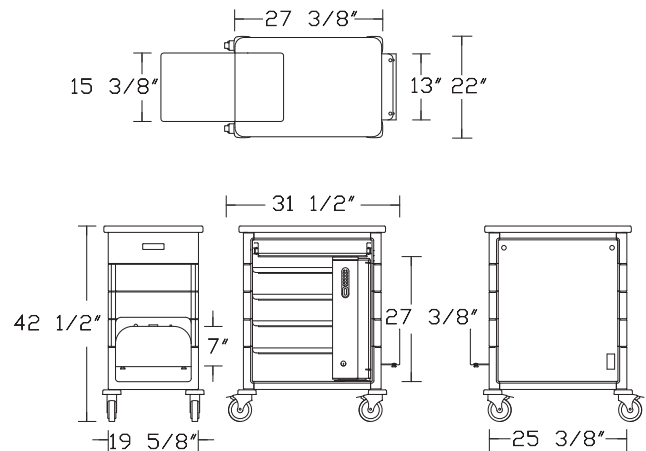

# Locking Storage and Technology

## Cart *continued*

Procedure/Supply Carts

### Specification Information

#### Step 1.

**CTTL.**

#### Step 2. Cart Interior Width

**342** 20 series  
**142** 24 series

#### Step 3. Top

**60C** raised-edge top  
**60SC** raised-edge top with slide-out shelf

#### Step 4. Lockbar

**B** basic lock bar  
**D** deluxe lock bar  
**P** proximity lock bar

#### Step 5. Lock

**K** keyed alike  
**L** keyed differently

#### Prices for Steps 1-5.

		BK	BL	DK	DL	PK	PL
<b>CTTL.</b>	<b>342 60C</b>	\$1471	1470	1675	1674	2257	2256
	<b>60SC</b>	\$1621	1621	1825	1825	2407	2407
	<b>142 60C</b>	\$1491	1490	1695	1694	2277	2276
	<b>60SC</b>	\$1651	1651	1855	1855	2437	2437

#### Step 6. Base/Lock Bar Finish

**HF** inner tone light +\$0  
**LT** light tone +\$0  
**LU** soft white +\$0  
**WN** warm grey neutral +\$0

#### Step 7. CPU Side Mount Options

**NCR** for no CPU or for used with Compact CPU +\$0  
**RMC** right side mounted CPU holder +\$85

#### Step 8. Power Strip

**RMB** includes rail and mounting bracket only +\$0  
**RPS** includes rail with power strip +\$130

#### Step 9. Key Number

*For keyed alike (K)*

**01** key number 01 +\$0  
**02** key number 02 +\$0  
**03** key number 03 +\$0

**04** key number 04 +\$0  
**05** key number 05 +\$0  
**06** key number 06 +\$0  
**07** key number 07 +\$0  
**08** key number 08 +\$0  
**09** key number 09 +\$0  
**10** key number 10 +\$0  
**11** key number 11 +\$0  
**12** key number 12 +\$0  
**13** key number 13 +\$0  
**14** key number 14 +\$0  
**15** key number 15 +\$0  
**16** key number 16 +\$0  
**17** key number 17 +\$0  
**18** key number 18 +\$0  
**19** key number 19 +\$0  
**20** key number 20 +\$0  
**21** key number 21 +\$0  
**22** key number 22 +\$0  
**23** key number 23 +\$0  
**24** key number 24 +\$0  
**25** key number 25 +\$0  
**26** key number 26 +\$0  
**27** key number 27 +\$0  
**29** key number 29 +\$0  
**30** key number 30 +\$0  
**31** key number 31 +\$0  
**32** key number 32 +\$0  
**33** key number 33 +\$0  
**34** key number 34 +\$0  
**35** key number 35 +\$0  
**36** key number 36 +\$0  
**37** key number 37 +\$0  
**38** key number 38 +\$0  
**39** key number 39 +\$0  
**40** key number 40 +\$0  
**41** key number 41 +\$0  
**42** key number 42 +\$0  
**43** key number 43 +\$0  
**44** key number 44 +\$0  
**45** key number 45 +\$0  
**46** key number 46 +\$0  
**47** key number 47 +\$0  
**48** key number 48 +\$0  
**49** key number 49 +\$0  
**50** key number 50 +\$0  
**51** key number 51 +\$0

# Locking Storage and Technology Cart *continued*

<b>52</b>	key number 52	+\$0	<b>99</b>	key number 99	+\$0
<b>53</b>	key number 53	+\$0			
<b>54</b>	key number 54	+\$0			
<b>55</b>	key number 55	+\$0			
<b>56</b>	key number 56	+\$0			
<b>57</b>	key number 57	+\$0			
<b>58</b>	key number 58	+\$0			
<b>59</b>	key number 59	+\$0			
<b>60</b>	key number 60	+\$0			
<b>61</b>	key number 61	+\$0			
<b>62</b>	key number 62	+\$0			
<b>63</b>	key number 63	+\$0			
<b>64</b>	key number 64	+\$0			
<b>65</b>	key number 65	+\$0			
<b>66</b>	key number 66	+\$0			
<b>67</b>	key number 67	+\$0			
<b>68</b>	key number 68	+\$0			
<b>69</b>	key number 69	+\$0			
<b>70</b>	key number 70	+\$0			
<b>71</b>	key number 71	+\$0			
<b>72</b>	key number 72	+\$0			
<b>73</b>	key number 73	+\$0			
<b>74</b>	key number 74	+\$0			
<b>75</b>	key number 75	+\$0			
<b>76</b>	key number 76	+\$0			
<b>77</b>	key number 77	+\$0			
<b>78</b>	key number 78	+\$0			
<b>79</b>	key number 79	+\$0			
<b>80</b>	key number 80	+\$0			
<b>81</b>	key number 81	+\$0			
<b>82</b>	key number 82	+\$0			
<b>83</b>	key number 83	+\$0			
<b>84</b>	key number 84	+\$0			
<b>85</b>	key number 85	+\$0			
<b>86</b>	key number 86	+\$0			
<b>87</b>	key number 87	+\$0			
<b>88</b>	key number 88	+\$0			
<b>89</b>	key number 89	+\$0			
<b>90</b>	key number 90	+\$0			
<b>91</b>	key number 91	+\$0			
<b>92</b>	key number 92	+\$0			
<b>93</b>	key number 93	+\$0			
<b>94</b>	key number 94	+\$0			
<b>95</b>	key number 95	+\$0			
<b>96</b>	key number 96	+\$0			
<b>97</b>	key number 97	+\$0			
<b>98</b>	key number 98	+\$0			

Procedure/Supply Carts

# Single-Wide Cart

- CT136.
- CT142.
- CT172.
- CT336.
- CT342.
- CT372.

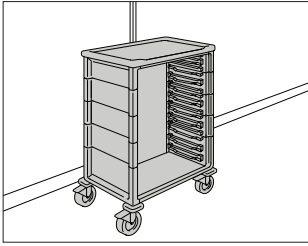

Procedure/Supply Carts

## Product Information

**Description**  
 This 20"-deep cart has 2 swivel/brake casters in front, 2 swivel casters in back, and bumpers on all 4 corners. It is available with a 20"- or 24"-wide interior. The 36"- and 42"-high carts have a raised-edge top, an optional shelf that slides out on the left or right side, and 5" casters; the 72"-high cart has a flat top and 6" casters. The 36"-high cart has 4 segments with 8 slots; the 42"-high cart has 5 segments with 10 slots; and the 72"-high cart has 10 segments with 20 slots.

**Notes**  
 Order the following products separately:

- Cart-mounted shelves, rails, trays, and holders
- Closure and lock components
- Drawers, drawer accessories, shelves, cassettes, and holders
- Rail-mounted electrical components, containers, and holders

## Dimensions

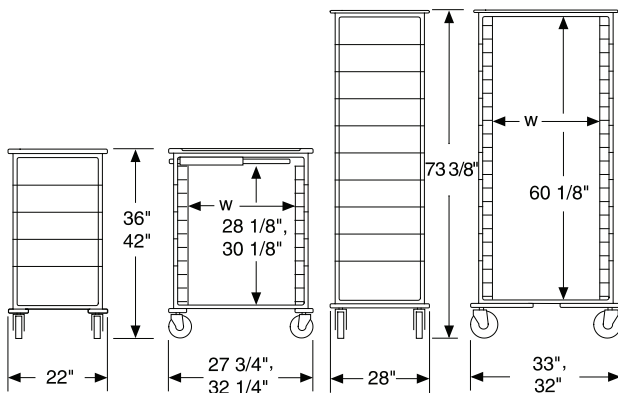
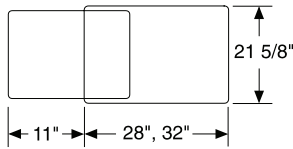

## Specification Information

**Step 1.**  
**CT**

**Step 2. Cart Interior Width**

<b>3</b>	20" wide
<b>1</b>	24" wide

**Step 3. Height**

<b>36.</b>	36" high
<b>42.</b>	42" high
<b>72.</b>	72" high

**Step 4. Top**

*For 36" high (36.) or 42" high (42.)*

<b>60N</b>	raised-edge top
<b>60S</b>	raised-edge top with slide-out shelf

*For 72" high (72.)*

<b>10N</b>	flat top
------------	----------

### Prices for Steps 1-4.

<b>CT336. 60N</b>	\$671
<b>60S</b>	\$836
<hr/>	
<b>CT342. 60N</b>	\$689
<b>60S</b>	\$854
<hr/>	
<b>CT372. 10N</b>	\$1114
<hr/>	
<b>CT136. 60N</b>	\$704
<b>60S</b>	\$870
<hr/>	
<b>CT142. 60N</b>	\$725
<b>60S</b>	\$890
<hr/>	
<b>CT172. 10N</b>	\$1163

**Step 5. Surface Finish**

<b>HF</b>	inner tone light	+\$0
<b>LT</b>	light tone	+\$0
<b>LU</b>	soft white	+\$0
<b>WN</b>	warm grey neutral	+\$0

# Single-Wide Cart, Dual Access

CT142.

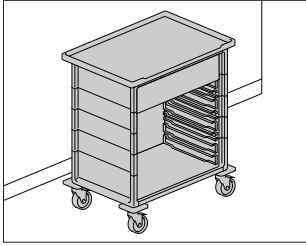

### Product Information

#### Description

This 42"-high cart provides access to the interior from the front and back, making it ideal for use as a response cart. It has a raised-edge top and an optional shelf that slides out on the left or right. A breakaway bar at front and back are also included. The cart has 5" casters; 2 swivel/brake casters in front, 2 swivel casters in back. It has a 24"-wide interior and slots at 3" intervals (7 slots in the front and 3 slots in the back) to hold interior components.

#### Notes

Order the following products separately:

- Cart-mounted shelves, rails, trays, and holders
- Drawers, drawer accessories, shelves, cassettes, and holders
- Rail-mounted electrical components, containers, and holders

#### Dimensions

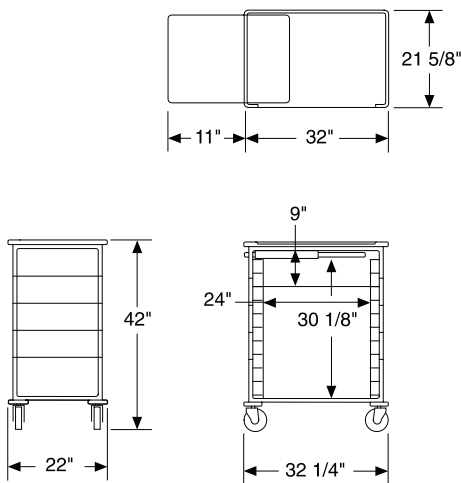

### Specification Information

#### Step 1.

**CT142.**

#### Step 2. Top

**61B** raised-edge top

**61S** raised-edge top with slide-out shelf

#### Prices for Steps 1-2.

<b>CT142. 61B</b>	\$853
<b>61S</b>	\$1018

#### Step 3. Surface Finish

<b>HF</b>	inner tone light	+\$0
<b>LT</b>	light tone	+\$0
<b>LU</b>	soft white	+\$0
<b>WN</b>	warm grey neutral	+\$0

# Double-Wide Cart

CT236.  
CT242.  
CT272.  
CT436.  
CT442.  
CT472.

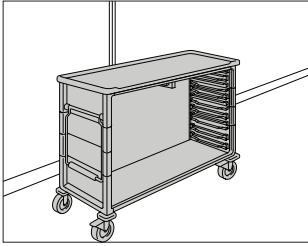

Procedure/Supply Carts

## Product Information

### Description

This 20"-deep cart has 1 swivel/brake caster and 1 swivel/direction-lock caster in front, 2 swivel casters in back, and bumpers on all 4 corners. A pull handle is installed on the left side of segment 4. 36"- and 42"-high carts have a flat top and 5" casters; the 72"-high cart has a flat top and 6" casters. The 36"- and 42"-high carts are available with a top or full spine; the 72"-high cart is available with or without a spine.

### Notes

Height, spine, and interior slot combinations are:

Height—Spine—Interior Slots

36"—top spine—2 single-wide slots and 7 double-wide slots

36"—full spine—16 single-wide slots

42"—top spine—2 single-wide slots and 9 double-wide slots

42"—full spine—20 single-wide slots

72"—no spine—20 double-wide slots

72"—partial spine—16 single-wide slots and 12 double-wide slots

72"—full spine—40 single-wide slots

Top spine extends 3" from the top of a 36"- or 42"-high cart. Partial spine extends 27 1/2" from the bottom of a 72"-high cart and includes a double-wide wire shelf.

Order the following products separately:

- Cart-mounted shelves, rails, trays, and holders
- Closure and lock components
- Drawers, drawer accessories, shelves, cassettes, and holders
- Rail-mounted electrical components, containers, and holders

## Dimensions

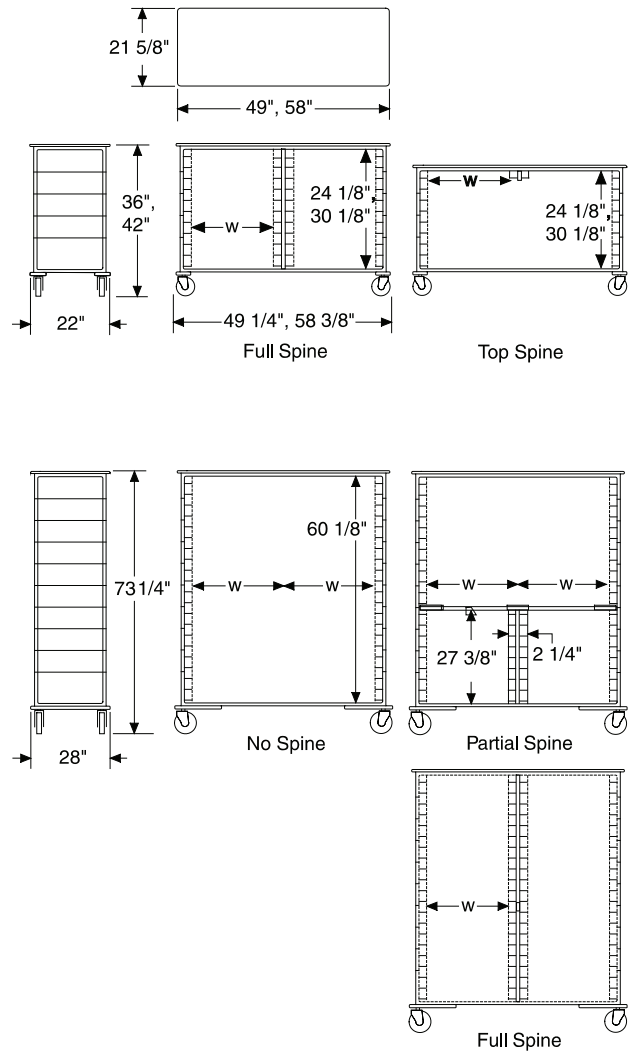



# Double-Wide Cart *continued*

## Specification Information

### Step 1.

**CT**

### Step 2. Cart Interior Width

- 4**     2 20"-wide sections
- 2**     2 24"-wide sections

### Step 3. Height

- 36.**   36" high
- 42.**   42" high
- 72.**   72" high

### Step 4. Top

*For 36" high (36.) or 42" high (42.)*

- 60**     flat top

*For 72" high (72.)*

- 10**     flat top

### Step 5. Spine

*For 36" high (36.) or 42" high (42.)*

- T**     top spine
- F**     full spine

*For 72" high (72.)*

- N**     no spine
- 4**     partial spine
- F**     full spine

### Prices for Steps 1-5.

	<b>N</b>	<b>T</b>	<b>4</b>	<b>F</b>
<b>CT436. 60</b>	—	\$940	—	1104
<b>CT442. 60</b>	—	\$1009	—	1132
<b>CT472. 10</b>	\$1587	—	1782	1666
<b>CT236. 60</b>	—	\$1088	—	1099
<b>CT242. 60</b>	—	\$1220	—	1235
<b>CT272. 10</b>	\$1612	—	1811	1846

### Step 6. Surface Finish

- HF**     inner tone light     +\$0
- LT**     light tone     +\$0
- LU**     soft white     +\$0
- WN**     warm grey neutral     +\$0

# Drawer

CT501.  
CT511.

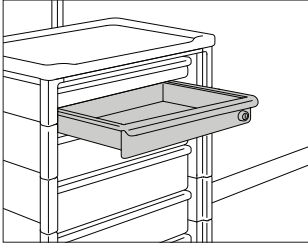

Procedure/Supply Carts – Interior Components

## Product Information

### Description

This drawer fits into a single- or double-wide cart and has stops to prevent accidental removal. It is available with no lock, a keyed lock, or keyless lock. Includes 1 label clip.

The 3"-high drawer fills 1 set of cart slots; the 6"-high drawer fills 2 sets of cart slots; the 9"-high drawer fills 3 sets of cart slots.

### Notes

Order optional accessories separately:

- 3"-high drawer organizer kit, 20"-wide cart interior (CT580., CT581., CT582., CT583., CT584., or CT585.)
- 3"-high drawer organizer kit, 24"-wide cart interior (CT560., CT561., CT562., CT563., or CT564.)
- 6"-high drawer organizer kit, 20"-wide cart interior (CT575. or CT576.)
- 6"-high drawer organizer kit, 24"-wide cart interior (CT570. or CT571.)
- Clear lid (CT508.)
- Drawer/shelf divider (CT550.)
- Full-extension drawer slides (CT504.) for 3"- or 6"-high drawer with no lock

Drawer with keyed or keyless lock cannot be used with full-extension drawer slides.

Drawer with keyless lock option (P) cannot be used with lockbar installed on left side of cart.

Keyed lock is located on right side; keyless lock is located on left side.

For general information on locks, see Keyed-Alike Information in Appendices.

## Dimensions

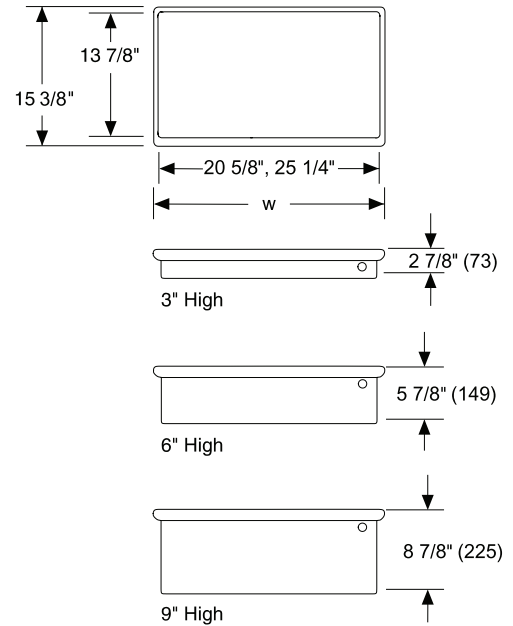

**Specification Information**

Step 1.  
**CT5**

Step 2. Cart Interior Width

- 01.** 20" wide
- 11.** 24" wide

Step 3. Height

*For 20" wide (01.)*

- 03** 3" high
- 06** 6" high
- 09** 9" high

*For 24" wide (11.)*

- 03** 3" high
- 06** 6" high

Step 4. Lock

*For no lock (\*), skip this step.*

- L** keyed differently
- K** keyed alike
- P** keyless lock

Prices for Steps 1-4.

	*	L	K	P
<b>CT501. 03</b>	\$50	102	102	327
<b>06</b>	\$64	116	116	340
<b>09</b>	\$82	134	134	359
<b>CT511. 03</b>	\$51	104	104	328
<b>06</b>	\$65	117	117	341

Step 5. Drawer Finish

<b>1B</b>	khaki	+\$0
<b>2B</b>	juniper	+\$0
<b>3B</b>	beachglass	+\$0
<b>4B</b>	plum	+\$0
<b>5B</b>	java	+\$0
<b>5E</b>	aquamarine	+\$0
<b>6F</b>	midnight	+\$0
<b>DA</b>	deep blue	+\$0
<b>HF</b>	inner tone light	+\$0
<b>LT</b>	light tone	+\$0
<b>LU</b>	soft white	+\$0
<b>VR</b>	vivid red	+\$0
<b>WN</b>	warm grey neutral	+\$0
<b>YT</b>	yellow	+\$0
<b>ZP</b>	terra cotta	+\$0

Step 6. Drawer Key Number

*For keyed alike (K)*

<b>01</b>	key number 01	+\$0
<b>02</b>	key number 02	+\$0
<b>03</b>	key number 03	+\$0
<b>04</b>	key number 04	+\$0
<b>05</b>	key number 05	+\$0
<b>06</b>	key number 06	+\$0
<b>07</b>	key number 07	+\$0
<b>08</b>	key number 08	+\$0
<b>09</b>	key number 09	+\$0
<b>10</b>	key number 10	+\$0
<b>11</b>	key number 11	+\$0
<b>12</b>	key number 12	+\$0
<b>13</b>	key number 13	+\$0
<b>14</b>	key number 14	+\$0
<b>15</b>	key number 15	+\$0
<b>16</b>	key number 16	+\$0
<b>17</b>	key number 17	+\$0
<b>18</b>	key number 18	+\$0
<b>19</b>	key number 19	+\$0
<b>20</b>	key number 20	+\$0
<b>21</b>	key number 21	+\$0
<b>22</b>	key number 22	+\$0
<b>23</b>	key number 23	+\$0
<b>24</b>	key number 24	+\$0
<b>25</b>	key number 25	+\$0
<b>26</b>	key number 26	+\$0
<b>27</b>	key number 27	+\$0
<b>28</b>	key number 28	+\$0

Drawer *continued*

**Procedure/Supply Carts – Interior Components**

<b>29</b>	key number 29	+\$0	<b>76</b>	key number 76	+\$0
<b>30</b>	key number 30	+\$0	<b>77</b>	key number 77	+\$0
<b>31</b>	key number 31	+\$0	<b>78</b>	key number 78	+\$0
<b>32</b>	key number 32	+\$0	<b>79</b>	key number 79	+\$0
<b>33</b>	key number 33	+\$0	<b>80</b>	key number 80	+\$0
<b>34</b>	key number 34	+\$0	<b>81</b>	key number 81	+\$0
<b>35</b>	key number 35	+\$0	<b>82</b>	key number 82	+\$0
<b>36</b>	key number 36	+\$0	<b>83</b>	key number 83	+\$0
<b>37</b>	key number 37	+\$0	<b>84</b>	key number 84	+\$0
<b>38</b>	key number 38	+\$0	<b>85</b>	key number 85	+\$0
<b>39</b>	key number 39	+\$0	<b>86</b>	key number 86	+\$0
<b>40</b>	key number 40	+\$0	<b>87</b>	key number 87	+\$0
<b>41</b>	key number 41	+\$0	<b>88</b>	key number 88	+\$0
<b>42</b>	key number 42	+\$0	<b>89</b>	key number 89	+\$0
<b>43</b>	key number 43	+\$0	<b>90</b>	key number 90	+\$0
<b>44</b>	key number 44	+\$0	<b>91</b>	key number 91	+\$0
<b>45</b>	key number 45	+\$0	<b>92</b>	key number 92	+\$0
<b>46</b>	key number 46	+\$0	<b>93</b>	key number 93	+\$0
<b>47</b>	key number 47	+\$0	<b>94</b>	key number 94	+\$0
<b>48</b>	key number 48	+\$0	<b>95</b>	key number 95	+\$0
<b>49</b>	key number 49	+\$0	<b>96</b>	key number 96	+\$0
<b>50</b>	key number 50	+\$0	<b>97</b>	key number 97	+\$0
<b>51</b>	key number 51	+\$0	<b>98</b>	key number 98	+\$0
<b>52</b>	key number 52	+\$0	<b>99</b>	key number 99	+\$0
<b>53</b>	key number 53	+\$0			
<b>54</b>	key number 54	+\$0			
<b>55</b>	key number 55	+\$0			
<b>56</b>	key number 56	+\$0			
<b>57</b>	key number 57	+\$0			
<b>58</b>	key number 58	+\$0			
<b>59</b>	key number 59	+\$0			
<b>60</b>	key number 60	+\$0			
<b>61</b>	key number 61	+\$0			
<b>62</b>	key number 62	+\$0			
<b>63</b>	key number 63	+\$0			
<b>64</b>	key number 64	+\$0			
<b>65</b>	key number 65	+\$0			
<b>66</b>	key number 66	+\$0			
<b>67</b>	key number 67	+\$0			
<b>68</b>	key number 68	+\$0			
<b>69</b>	key number 69	+\$0			
<b>70</b>	key number 70	+\$0			
<b>71</b>	key number 71	+\$0			
<b>72</b>	key number 72	+\$0			
<b>73</b>	key number 73	+\$0			
<b>74</b>	key number 74	+\$0			
<b>75</b>	key number 75	+\$0			

# Drawer with Lockable Lid

CT503.  
CT513.

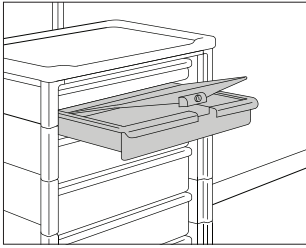

### Product Information

#### Description

This 15 1/4"-deep drawer fits into a single- or double-wide cart. It has a soft white, lockable lid that can open when the drawer is pulled out. The drawer has stops to prevent accidental removal and includes 1 label clip. The 3"-high drawer is 27/8" high and fills 1 cart slot; the 6"-high drawer is 57/8" high and fills 2 cart slots; the 9"-high drawer is 87/8" high and fills 3 cart slots.

#### Notes

To fully extend 3"- or 6"-high drawer in 36"- or 42"-high cart, order full-extension drawer slides (CT504.) separately.

For B-size drawer with lockable lid, order A-size subcontainer only. For C-size drawer with lockable lid, order A- or B-size subcontainers only.

For general information on locks, see Keyed-Alike Information in Appendices.

#### Dimensions

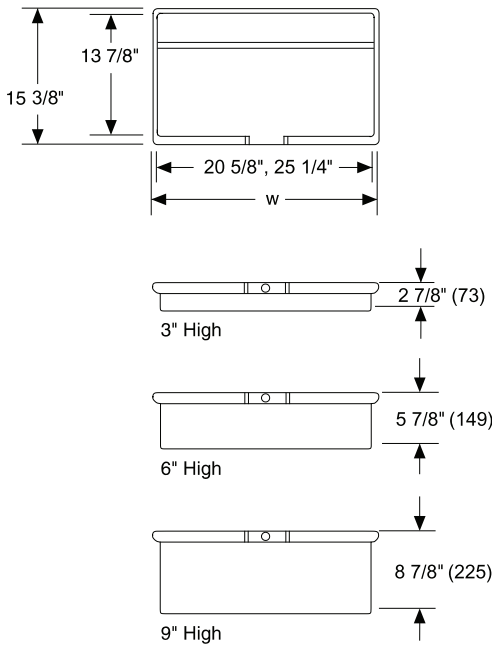

### Specification Information

#### Step 1.

#### CT5

#### Step 2. Cart Interior Width

- 03. 20" wide
- 13. 24" wide

#### Step 3. Height

#### For 20" wide (03.)

- 03 3" high
- 06 6" high
- 09 9" high

#### For 24" wide (13.)

- 06 6" high

#### Step 4. Lid Lock

- L keyed differently
- K keyed alike

#### Prices for Steps 1-4.

	L	K
CT503. 03	\$168	168
06	\$176	176
09	\$194	194
CT513. 06	\$182	182

#### Step 5. Drawer Finish

1B	khaki	+\$0
2B	juniper	+\$0
3B	beachglass	+\$0
4B	plum	+\$0
5B	java	+\$0
5E	aquamarine	+\$0
6F	midnight	+\$0
DA	deep blue	+\$0
HF	inner tone light	+\$0
LT	light tone	+\$0
LU	soft white	+\$0
VR	vivid red	+\$0
WN	warm grey neutral	+\$0
YT	yellow	+\$0
ZP	terra cotta	+\$0

Drawer with Lockable Lid *continued*

Procedure/Supply Carts – Interior Components

Step 6. Lid Key Number					
<i>For keyed alike (K)</i>					
01	key number 01	+\$0	46	key number 46	+\$0
02	key number 02	+\$0	47	key number 47	+\$0
03	key number 03	+\$0	48	key number 48	+\$0
04	key number 04	+\$0	49	key number 49	+\$0
05	key number 05	+\$0	50	key number 50	+\$0
06	key number 06	+\$0	51	key number 51	+\$0
07	key number 07	+\$0	52	key number 52	+\$0
08	key number 08	+\$0	53	key number 53	+\$0
09	key number 09	+\$0	54	key number 54	+\$0
10	key number 10	+\$0	55	key number 55	+\$0
11	key number 11	+\$0	56	key number 56	+\$0
12	key number 12	+\$0	57	key number 57	+\$0
13	key number 13	+\$0	58	key number 58	+\$0
14	key number 14	+\$0	59	key number 59	+\$0
15	key number 15	+\$0	60	key number 60	+\$0
16	key number 16	+\$0	61	key number 61	+\$0
17	key number 17	+\$0	62	key number 62	+\$0
18	key number 18	+\$0	63	key number 63	+\$0
19	key number 19	+\$0	64	key number 64	+\$0
20	key number 20	+\$0	65	key number 65	+\$0
21	key number 21	+\$0	66	key number 66	+\$0
22	key number 22	+\$0	67	key number 67	+\$0
23	key number 23	+\$0	68	key number 68	+\$0
24	key number 24	+\$0	69	key number 69	+\$0
25	key number 25	+\$0	70	key number 70	+\$0
26	key number 26	+\$0	71	key number 71	+\$0
27	key number 27	+\$0	72	key number 72	+\$0
28	key number 28	+\$0	73	key number 73	+\$0
29	key number 29	+\$0	74	key number 74	+\$0
30	key number 30	+\$0	75	key number 75	+\$0
31	key number 31	+\$0	76	key number 76	+\$0
32	key number 32	+\$0	77	key number 77	+\$0
33	key number 33	+\$0	78	key number 78	+\$0
34	key number 34	+\$0	79	key number 79	+\$0
35	key number 35	+\$0	80	key number 80	+\$0
36	key number 36	+\$0	81	key number 81	+\$0
37	key number 37	+\$0	82	key number 82	+\$0
38	key number 38	+\$0	83	key number 83	+\$0
39	key number 39	+\$0	84	key number 84	+\$0
40	key number 40	+\$0	85	key number 85	+\$0
41	key number 41	+\$0	86	key number 86	+\$0
42	key number 42	+\$0	87	key number 87	+\$0
43	key number 43	+\$0	88	key number 88	+\$0
44	key number 44	+\$0	89	key number 89	+\$0
45	key number 45	+\$0	90	key number 90	+\$0
			91	key number 91	+\$0
			92	key number 92	+\$0

## Drawer with Lockable Lid *continued*

<b>93</b>	key number 93	+\$0
<b>94</b>	key number 94	+\$0
<b>95</b>	key number 95	+\$0
<b>96</b>	key number 96	+\$0
<b>97</b>	key number 97	+\$0
<b>98</b>	key number 98	+\$0
<b>99</b>	key number 99	+\$0

# Locked Drawer with Lockable Lid

CT505.  
CT515.

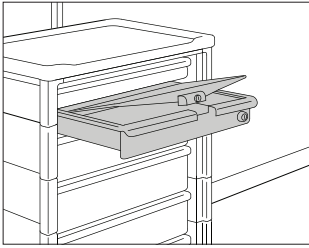

Procedure/Supply Carts – Interior Components

### Product Information

**Description**  
This drawer fits into a single- or double-wide cart and has stops to prevent accidental removal. It has a soft white, lockable lid that can open when the drawer is pulled out, and is available with a keyed lock or keyless lock. Includes 1 label clip.  
The 3"-high drawer fills 1 set of cart slots; the 6"-high drawer fills 2 sets of cart slots; the 9"-high drawer fills 3 sets of cart slots.

**Notes**  
Drawer with keyless lock option (P) cannot be used with lockbar installed on left side of cart.  
Keyed lock is located on right side; keyless lock is located on left side.  
For B-size drawer with lockable lid, order A-size subcontainer only. For C-size drawer with lockable lid, order A- or B-size subcontainers only.  
For general information on locks, see Keyed-Alike Information in Appendices.

### Dimensions

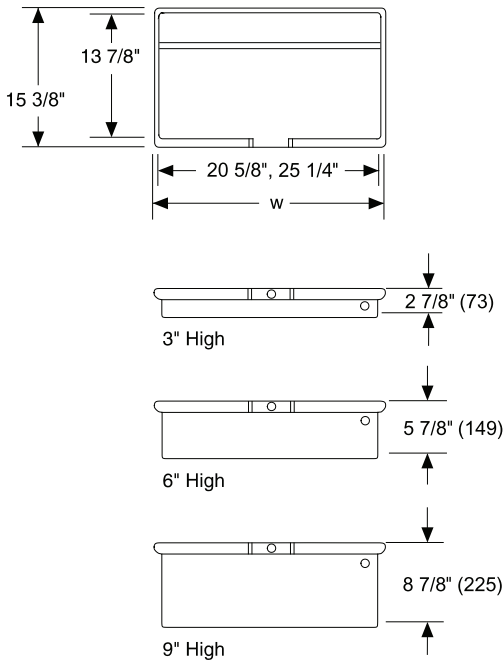

### Specification Information

**Step 1.**  
**CT5**

---

**Step 2. Cart Interior Width**

**05.** 20" wide  
**15.** 24" wide

---

**Step 3. Height**

*For 20" wide (05.)*

**03** 3" high  
**06** 6" high  
**09** 9" high

---

*For 24" wide (15.)*

**03** 3" high  
**06** 6" high

---

**Step 4. Drawer/Lid Lock**

**L** keyed differently  
**K** keyed alike  
**P** keyless lock

### Prices for Steps 1-4.

	L	K	P
<b>CT505. 03</b>	\$217	217	441
<b>06</b>	\$230	230	454
<b>09</b>	\$248	248	473
<b>CT515. 03</b>	\$218	218	442
<b>06</b>	\$231	231	455



# Locked Drawer with Lockable Lid

continued

<b>Step 5. Drawer Finish</b>					
<b>1B</b>	khaki	+\$0	<b>29</b>	key number 29	+\$0
<b>2B</b>	juniper	+\$0	<b>30</b>	key number 30	+\$0
<b>3B</b>	beachglass	+\$0	<b>31</b>	key number 31	+\$0
<b>4B</b>	plum	+\$0	<b>32</b>	key number 32	+\$0
<b>5B</b>	java	+\$0	<b>33</b>	key number 33	+\$0
<b>5E</b>	aquamarine	+\$0	<b>34</b>	key number 34	+\$0
<b>6F</b>	midnight	+\$0	<b>35</b>	key number 35	+\$0
<b>DA</b>	deep blue	+\$0	<b>36</b>	key number 36	+\$0
<b>HF</b>	inner tone light	+\$0	<b>37</b>	key number 37	+\$0
<b>LT</b>	light tone	+\$0	<b>38</b>	key number 38	+\$0
<b>LU</b>	soft white	+\$0	<b>39</b>	key number 39	+\$0
<b>VR</b>	vivid red	+\$0	<b>40</b>	key number 40	+\$0
<b>WN</b>	warm grey neutral	+\$0	<b>41</b>	key number 41	+\$0
<b>YT</b>	yellow	+\$0	<b>42</b>	key number 42	+\$0
<b>ZP</b>	terra cotta	+\$0	<b>43</b>	key number 43	+\$0
<b>Step 6. Drawer Key Number</b>			<b>44</b>	key number 44	+\$0
<i>For keyed alike (K)</i>			<b>45</b>	key number 45	+\$0
<b>01</b>	key number 01	+\$0	<b>46</b>	key number 46	+\$0
<b>02</b>	key number 02	+\$0	<b>47</b>	key number 47	+\$0
<b>03</b>	key number 03	+\$0	<b>48</b>	key number 48	+\$0
<b>04</b>	key number 04	+\$0	<b>49</b>	key number 49	+\$0
<b>05</b>	key number 05	+\$0	<b>50</b>	key number 50	+\$0
<b>06</b>	key number 06	+\$0	<b>51</b>	key number 51	+\$0
<b>07</b>	key number 07	+\$0	<b>52</b>	key number 52	+\$0
<b>08</b>	key number 08	+\$0	<b>53</b>	key number 53	+\$0
<b>09</b>	key number 09	+\$0	<b>54</b>	key number 54	+\$0
<b>10</b>	key number 10	+\$0	<b>55</b>	key number 55	+\$0
<b>11</b>	key number 11	+\$0	<b>56</b>	key number 56	+\$0
<b>12</b>	key number 12	+\$0	<b>57</b>	key number 57	+\$0
<b>13</b>	key number 13	+\$0	<b>58</b>	key number 58	+\$0
<b>14</b>	key number 14	+\$0	<b>59</b>	key number 59	+\$0
<b>15</b>	key number 15	+\$0	<b>60</b>	key number 60	+\$0
<b>16</b>	key number 16	+\$0	<b>61</b>	key number 61	+\$0
<b>17</b>	key number 17	+\$0	<b>62</b>	key number 62	+\$0
<b>18</b>	key number 18	+\$0	<b>63</b>	key number 63	+\$0
<b>19</b>	key number 19	+\$0	<b>64</b>	key number 64	+\$0
<b>20</b>	key number 20	+\$0	<b>65</b>	key number 65	+\$0
<b>21</b>	key number 21	+\$0	<b>66</b>	key number 66	+\$0
<b>22</b>	key number 22	+\$0	<b>67</b>	key number 67	+\$0
<b>23</b>	key number 23	+\$0	<b>68</b>	key number 68	+\$0
<b>24</b>	key number 24	+\$0	<b>69</b>	key number 69	+\$0
<b>25</b>	key number 25	+\$0	<b>70</b>	key number 70	+\$0
<b>26</b>	key number 26	+\$0	<b>71</b>	key number 71	+\$0
<b>27</b>	key number 27	+\$0	<b>72</b>	key number 72	+\$0
<b>28</b>	key number 28	+\$0	<b>73</b>	key number 73	+\$0
			<b>74</b>	key number 74	+\$0
			<b>75</b>	key number 75	+\$0

# Locked Drawer with Lockable Lid

continued

Procedure/Supply Carts – Interior Components

<b>76</b>	key number 76	+\$0	<b>21</b>	key number 21	+\$0
<b>77</b>	key number 77	+\$0	<b>22</b>	key number 22	+\$0
<b>78</b>	key number 78	+\$0	<b>23</b>	key number 23	+\$0
<b>79</b>	key number 79	+\$0	<b>24</b>	key number 24	+\$0
<b>80</b>	key number 80	+\$0	<b>25</b>	key number 25	+\$0
<b>81</b>	key number 81	+\$0	<b>26</b>	key number 26	+\$0
<b>82</b>	key number 82	+\$0	<b>27</b>	key number 27	+\$0
<b>83</b>	key number 83	+\$0	<b>28</b>	key number 28	+\$0
<b>84</b>	key number 84	+\$0	<b>29</b>	key number 29	+\$0
<b>85</b>	key number 85	+\$0	<b>30</b>	key number 30	+\$0
<b>86</b>	key number 86	+\$0	<b>31</b>	key number 31	+\$0
<b>87</b>	key number 87	+\$0	<b>32</b>	key number 32	+\$0
<b>88</b>	key number 88	+\$0	<b>33</b>	key number 33	+\$0
<b>89</b>	key number 89	+\$0	<b>34</b>	key number 34	+\$0
<b>90</b>	key number 90	+\$0	<b>35</b>	key number 35	+\$0
<b>91</b>	key number 91	+\$0	<b>36</b>	key number 36	+\$0
<b>92</b>	key number 92	+\$0	<b>37</b>	key number 37	+\$0
<b>93</b>	key number 93	+\$0	<b>38</b>	key number 38	+\$0
<b>94</b>	key number 94	+\$0	<b>39</b>	key number 39	+\$0
<b>95</b>	key number 95	+\$0	<b>40</b>	key number 40	+\$0
<b>96</b>	key number 96	+\$0	<b>41</b>	key number 41	+\$0
<b>97</b>	key number 97	+\$0	<b>42</b>	key number 42	+\$0
<b>98</b>	key number 98	+\$0	<b>43</b>	key number 43	+\$0
<b>99</b>	key number 99	+\$0	<b>44</b>	key number 44	+\$0
			<b>45</b>	key number 45	+\$0
			<b>46</b>	key number 46	+\$0
			<b>47</b>	key number 47	+\$0
			<b>48</b>	key number 48	+\$0
			<b>49</b>	key number 49	+\$0
			<b>50</b>	key number 50	+\$0
			<b>51</b>	key number 51	+\$0
			<b>52</b>	key number 52	+\$0
			<b>53</b>	key number 53	+\$0
			<b>54</b>	key number 54	+\$0
			<b>55</b>	key number 55	+\$0
			<b>56</b>	key number 56	+\$0
			<b>57</b>	key number 57	+\$0
			<b>58</b>	key number 58	+\$0
			<b>59</b>	key number 59	+\$0
			<b>60</b>	key number 60	+\$0
			<b>61</b>	key number 61	+\$0
			<b>62</b>	key number 62	+\$0
			<b>63</b>	key number 63	+\$0
			<b>64</b>	key number 64	+\$0
			<b>65</b>	key number 65	+\$0
			<b>66</b>	key number 66	+\$0
			<b>67</b>	key number 67	+\$0

## Step 7. Lid Key Number

For keyed alike (K) or keyless lock (P)

<b>01</b>	key number 01	+\$0	<b>48</b>	key number 48	+\$0
<b>02</b>	key number 02	+\$0	<b>49</b>	key number 49	+\$0
<b>03</b>	key number 03	+\$0	<b>50</b>	key number 50	+\$0
<b>04</b>	key number 04	+\$0	<b>51</b>	key number 51	+\$0
<b>05</b>	key number 05	+\$0	<b>52</b>	key number 52	+\$0
<b>06</b>	key number 06	+\$0	<b>53</b>	key number 53	+\$0
<b>07</b>	key number 07	+\$0	<b>54</b>	key number 54	+\$0
<b>08</b>	key number 08	+\$0	<b>55</b>	key number 55	+\$0
<b>09</b>	key number 09	+\$0	<b>56</b>	key number 56	+\$0
<b>10</b>	key number 10	+\$0	<b>57</b>	key number 57	+\$0
<b>11</b>	key number 11	+\$0	<b>58</b>	key number 58	+\$0
<b>12</b>	key number 12	+\$0	<b>59</b>	key number 59	+\$0
<b>13</b>	key number 13	+\$0	<b>60</b>	key number 60	+\$0
<b>14</b>	key number 14	+\$0	<b>61</b>	key number 61	+\$0
<b>15</b>	key number 15	+\$0	<b>62</b>	key number 62	+\$0
<b>16</b>	key number 16	+\$0	<b>63</b>	key number 63	+\$0
<b>17</b>	key number 17	+\$0	<b>64</b>	key number 64	+\$0
<b>18</b>	key number 18	+\$0	<b>65</b>	key number 65	+\$0
<b>19</b>	key number 19	+\$0	<b>66</b>	key number 66	+\$0
<b>20</b>	key number 20	+\$0	<b>67</b>	key number 67	+\$0

## Locked Drawer with Lockable Lid

*continued*

<b>68</b>	key number 68	+\$0
<b>69</b>	key number 69	+\$0
<b>70</b>	key number 70	+\$0
<b>71</b>	key number 71	+\$0
<b>72</b>	key number 72	+\$0
<b>73</b>	key number 73	+\$0
<b>74</b>	key number 74	+\$0
<b>75</b>	key number 75	+\$0
<b>76</b>	key number 76	+\$0
<b>77</b>	key number 77	+\$0
<b>78</b>	key number 78	+\$0
<b>79</b>	key number 79	+\$0
<b>80</b>	key number 80	+\$0
<b>81</b>	key number 81	+\$0
<b>82</b>	key number 82	+\$0
<b>83</b>	key number 83	+\$0
<b>84</b>	key number 84	+\$0
<b>85</b>	key number 85	+\$0
<b>86</b>	key number 86	+\$0
<b>87</b>	key number 87	+\$0
<b>88</b>	key number 88	+\$0
<b>89</b>	key number 89	+\$0
<b>90</b>	key number 90	+\$0
<b>91</b>	key number 91	+\$0
<b>92</b>	key number 92	+\$0
<b>93</b>	key number 93	+\$0
<b>94</b>	key number 94	+\$0
<b>95</b>	key number 95	+\$0
<b>96</b>	key number 96	+\$0
<b>97</b>	key number 97	+\$0
<b>98</b>	key number 98	+\$0
<b>99</b>	key number 99	+\$0

# Locked Drawer with Lid

CT502.  
CT512.

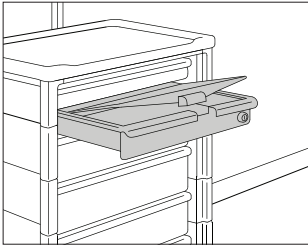

Procedure/Supply Carts – Interior Components

### Product Information

**Description**  
This drawer fits into a single- or double-wide cart and has stops to prevent accidental removal. It has a soft white lid that can open when the drawer is pulled out, and is available with a keyed lock or keyless lock. Includes 1 label clip.  
The 3"-high drawer fills 1 set of cart slots; the 6"-high drawer fills 2 sets of cart slots; the 9"-high drawer fills 3 sets of cart slots.

**Notes**  
Drawer with keyless lock option (P) cannot be used with lockbar installed on left side of cart.  
Keyed lock is located on right side; keyless lock is located on left side.  
For B-size drawer with lockable lid, order A-size subcontainer only. For C-size drawer with lockable lid, order A- or B-size subcontainers only.  
For general information on locks, see Keyed-Alike Information in Appendices.

### Dimensions

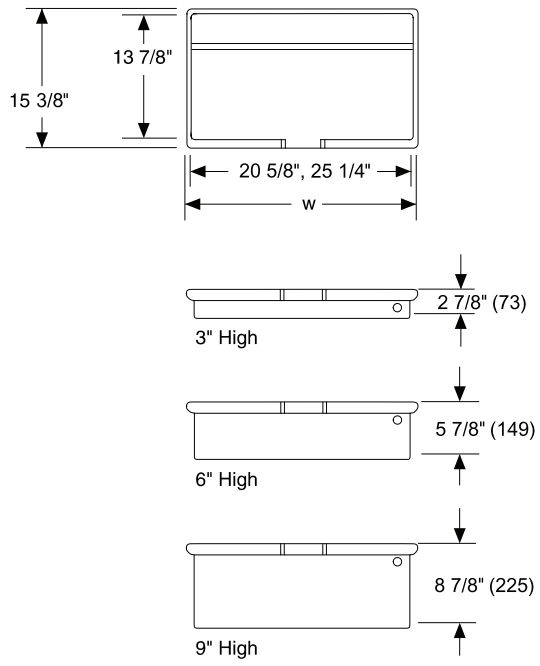

### Specification Information

Step 1.  
**CT5**

Step 2. Cart Interior Width  
**02.** 20" wide  
**12.** 24" wide

Step 3. Height  
*For 20" wide (02.)*  
**03** 3" high  
**06** 6" high  
**09** 9" high

*For 24" wide (12.)*  
**06** 6" high

Step 4. Drawer Lock  
**L** keyed differently  
**K** keyed alike  
**P** keyless lock

### Prices for Steps 1-4.

	L	K	P
<b>CT502. 03</b>	\$169	169	393
<b>06</b>	\$182	182	406
<b>09</b>	\$200	200	455
<b>CT512. 06</b>	\$183	183	407

### Step 5. Drawer Finish

<b>1B</b>	khaki	+\$0
<b>2B</b>	juniper	+\$0
<b>3B</b>	beachglass	+\$0
<b>4B</b>	plum	+\$0
<b>5B</b>	java	+\$0
<b>5E</b>	aquamarine	+\$0
<b>6F</b>	midnight	+\$0
<b>DA</b>	deep blue	+\$0
<b>HF</b>	inner tone light	+\$0
<b>LT</b>	light tone	+\$0
<b>LU</b>	soft white	+\$0
<b>VR</b>	vivid red	+\$0
<b>WN</b>	warm grey neutral	+\$0
<b>YT</b>	yellow	+\$0
<b>ZP</b>	terra cotta	+\$0

Locked Drawer with Lid *continued*

Step 6. Drawer Key Number					
<i>For keyed alike (K)</i>					
<b>01</b>	key number 01	+\$0	<b>46</b>	key number 46	+\$0
<b>02</b>	key number 02	+\$0	<b>47</b>	key number 47	+\$0
<b>03</b>	key number 03	+\$0	<b>48</b>	key number 48	+\$0
<b>04</b>	key number 04	+\$0	<b>49</b>	key number 49	+\$0
<b>05</b>	key number 05	+\$0	<b>50</b>	key number 50	+\$0
<b>06</b>	key number 06	+\$0	<b>51</b>	key number 51	+\$0
<b>07</b>	key number 07	+\$0	<b>52</b>	key number 52	+\$0
<b>08</b>	key number 08	+\$0	<b>53</b>	key number 53	+\$0
<b>09</b>	key number 09	+\$0	<b>54</b>	key number 54	+\$0
<b>10</b>	key number 10	+\$0	<b>55</b>	key number 55	+\$0
<b>11</b>	key number 11	+\$0	<b>56</b>	key number 56	+\$0
<b>12</b>	key number 12	+\$0	<b>57</b>	key number 57	+\$0
<b>13</b>	key number 13	+\$0	<b>58</b>	key number 58	+\$0
<b>14</b>	key number 14	+\$0	<b>59</b>	key number 59	+\$0
<b>15</b>	key number 15	+\$0	<b>60</b>	key number 60	+\$0
<b>16</b>	key number 16	+\$0	<b>61</b>	key number 61	+\$0
<b>17</b>	key number 17	+\$0	<b>62</b>	key number 62	+\$0
<b>18</b>	key number 18	+\$0	<b>63</b>	key number 63	+\$0
<b>19</b>	key number 19	+\$0	<b>64</b>	key number 64	+\$0
<b>20</b>	key number 20	+\$0	<b>65</b>	key number 65	+\$0
<b>21</b>	key number 21	+\$0	<b>66</b>	key number 66	+\$0
<b>22</b>	key number 22	+\$0	<b>67</b>	key number 67	+\$0
<b>23</b>	key number 23	+\$0	<b>68</b>	key number 68	+\$0
<b>24</b>	key number 24	+\$0	<b>69</b>	key number 69	+\$0
<b>25</b>	key number 25	+\$0	<b>70</b>	key number 70	+\$0
<b>26</b>	key number 26	+\$0	<b>71</b>	key number 71	+\$0
<b>27</b>	key number 27	+\$0	<b>72</b>	key number 72	+\$0
<b>28</b>	key number 28	+\$0	<b>73</b>	key number 73	+\$0
<b>29</b>	key number 29	+\$0	<b>74</b>	key number 74	+\$0
<b>30</b>	key number 30	+\$0	<b>75</b>	key number 75	+\$0
<b>31</b>	key number 31	+\$0	<b>76</b>	key number 76	+\$0
<b>32</b>	key number 32	+\$0	<b>77</b>	key number 77	+\$0
<b>33</b>	key number 33	+\$0	<b>78</b>	key number 78	+\$0
<b>34</b>	key number 34	+\$0	<b>79</b>	key number 79	+\$0
<b>35</b>	key number 35	+\$0	<b>80</b>	key number 80	+\$0
<b>36</b>	key number 36	+\$0	<b>81</b>	key number 81	+\$0
<b>37</b>	key number 37	+\$0	<b>82</b>	key number 82	+\$0
<b>38</b>	key number 38	+\$0	<b>83</b>	key number 83	+\$0
<b>39</b>	key number 39	+\$0	<b>84</b>	key number 84	+\$0
<b>40</b>	key number 40	+\$0	<b>85</b>	key number 85	+\$0
<b>41</b>	key number 41	+\$0	<b>86</b>	key number 86	+\$0
<b>42</b>	key number 42	+\$0	<b>87</b>	key number 87	+\$0
<b>43</b>	key number 43	+\$0	<b>88</b>	key number 88	+\$0
<b>44</b>	key number 44	+\$0	<b>89</b>	key number 89	+\$0
<b>45</b>	key number 45	+\$0	<b>90</b>	key number 90	+\$0
			<b>91</b>	key number 91	+\$0
			<b>92</b>	key number 92	+\$0

Locked Drawer with Lid *continued*

**Procedure/Supply Carts – Interior Components**

<b>93</b>	key number 93	+\$0
<b>94</b>	key number 94	+\$0
<b>95</b>	key number 95	+\$0
<b>96</b>	key number 96	+\$0
<b>97</b>	key number 97	+\$0
<b>98</b>	key number 98	+\$0
<b>99</b>	key number 99	+\$0

## Subcontainer

C0231  
C0232  
C0233  
C0234  
C0235  
C0236  
C0238  
C0240  
C0369

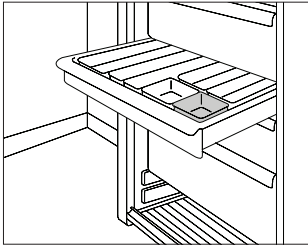

### Product Information

#### Description

This storage container fits into a drawer or onto a dispensing rail to organize and store small items. Package contains 12.

The A-size subcontainer is used with an A-size drawer (without lid) or A-size dispensing rail. It is  $2\frac{3}{16}$ " high; depth and width dimensions are:

Type—Depth—Width

A-1— $4\frac{9}{16}$ "— $4\frac{9}{16}$ "

A-2— $9\frac{3}{16}$ "— $4\frac{9}{16}$ "

A-3— $13\frac{13}{16}$ "— $4\frac{9}{16}$ "

A-4— $18\frac{7}{16}$ "— $4\frac{9}{16}$ "

A-5— $9\frac{3}{16}$ "— $9\frac{3}{16}$ "

A-8— $13\frac{13}{16}$ "— $2\frac{1}{4}$ "

The B-size subcontainer is used with a B-size drawer (without lid), B-size dispensing rail, or C-size drawer. It is  $5\frac{3}{16}$ " high; depth and width dimensions are:

Type—Depth—Width

B-1— $4\frac{9}{16}$ "— $4\frac{9}{16}$ "

B-3— $13\frac{13}{16}$ "— $4\frac{9}{16}$ "

B-5— $9\frac{3}{16}$ "— $9\frac{3}{16}$ "

#### Notes

Order following products separately:

- Drawer (C0207, C0208, or C0209)
- Dispensing rail (C0365, C0366, C0367, or C0368)

### Dimensions

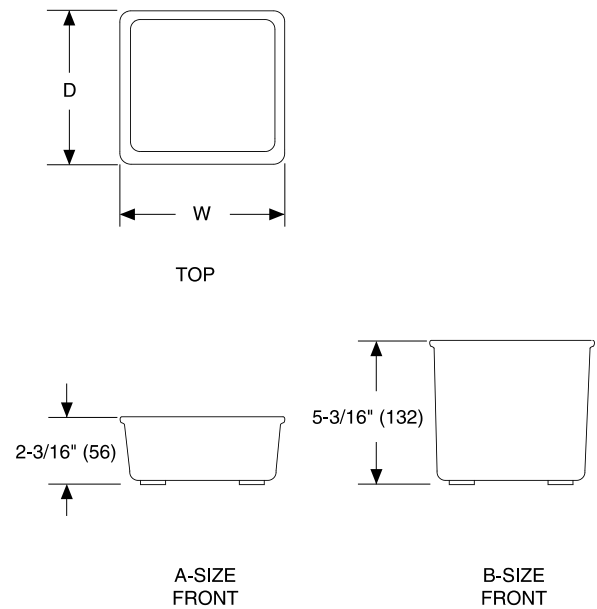

**Specification Information**

Step 1.

**CO**

Step 2. Size

- 231FF** a-1
- 232FF** a-2
- 233FF** a-3
- 234FF** a-4
- 235FF** a-5
- 369FF** a-8
- 236FF** b-1
- 238FF** b-3
- 240FF** b-5

Prices for Steps 1-2.

<b>CO231FF</b>	\$71
<b>CO232FF</b>	\$71
<b>CO233FF</b>	\$78
<b>CO234FF</b>	\$78
<b>CO235FF</b>	\$78
<b>CO369FF</b>	\$73
<b>CO236FF</b>	\$78
<b>CO238FF</b>	\$107
<b>CO240FF</b>	\$107

Step 3. Surface Finish

**LU** soft white + \$0



3"-High Drawer Organizer Kit,  
20"-Wide Cart Interior

CT580.  
CT581.  
CT582.  
CT583.  
CT584.  
CT585.

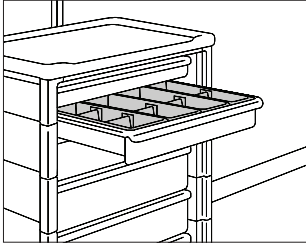

**Product Information**

**Description**

This kit fits inside a 3"-high drawer and has 6 combinations of subcontainers and subcontainer dividers. Finish is soft white.

The A-size subcontainer is 2<sup>3</sup>/<sub>16</sub>" high. Width and depth dimensions are:

Type—Width—Depth

A-1—4<sup>9</sup>/<sub>16</sub>"—4<sup>9</sup>/<sub>16</sub>"

A-2—4<sup>9</sup>/<sub>16</sub>"—9<sup>3</sup>/<sub>16</sub>"

A-3—4<sup>9</sup>/<sub>16</sub>"—13<sup>13</sup>/<sub>16</sub>"

A-4—4<sup>9</sup>/<sub>16</sub>"—18<sup>7</sup>/<sub>16</sub>"

A-5—9<sup>3</sup>/<sub>16</sub>"—9<sup>3</sup>/<sub>16</sub>"

A-8—2<sup>1</sup>/<sub>4</sub>"—13<sup>13</sup>/<sub>16</sub>"

**Notes**

Order 3"-high drawer (CT501.03) separately.

Full kit will interfere with drawer locking mechanism.

**Dimensions**

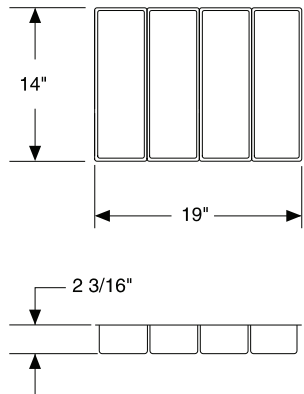

**Specification Information**

**Step 1.**

**CT58**

**Step 2. Components**

**0.03** 4 a-3 subcontainers, 6 a-3 dividers

**1.03** 1 a-3 subcontainer, 6 a-8 subcontainers, 2 a-3 dividers, 9 a-8 dividers

**2.03** 2 a-1 subcontainers, 2 a-2 subcontainers, 1 a-3 subcontainer, 2 a-8 subcontainers, 4 a-3 dividers, 3 a-8 dividers

**3.03** 3 a-3 subcontainers, 2 a-8 subcontainers, 4 a-3 dividers, 3 a-8 dividers

**4.03** 4 a-2 subcontainers, 1 a-4 subcontainer, 10 a-3 dividers

**5.03** 2 a-1 subcontainers, 2 a-3 subcontainers, 1 a-5 subcontainer, 4 a-3 dividers

**Prices for Steps 1-2.**

<b>CT580.03</b>	\$35
<b>CT581.03</b>	\$37
<b>CT582.03</b>	\$37
<b>CT583.03</b>	\$35
<b>CT584.03</b>	\$35
<b>CT585.03</b>	\$35

# Subcontainer Divider

C0378  
C0379  
C0380

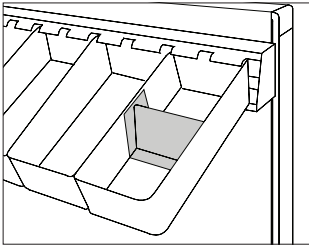

Procedure/Supply Carts – Interior Components

### Product Information

#### Description

This divider fits into subcontainers to separate and organize stored items. A divider can be adjusted by sliding it to the desired position. The divider is not available for A-5 and B-5 subcontainers. Package contains 12.

The divider for an A-8 subcontainer is 1<sup>5</sup>/<sub>8</sub>" high and 2<sup>1</sup>/<sub>8</sub>" wide; the divider for an A-1, A-2, A-3, or A-4 subcontainer is 1<sup>5</sup>/<sub>8</sub>" high and 4<sup>1</sup>/<sub>4</sub>" wide; and the divider for a B-1 or B-3 subcontainer is 4" high and 4<sup>1</sup>/<sub>4</sub>" wide.

#### Dimensions

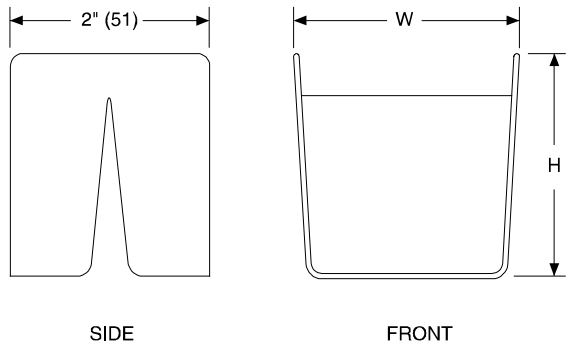

### Specification Information

#### Step 1.

**C03**

#### Step 2. Usage

- 78FF** for a-8 subcontainer
- 79FF** for a-1, a-2, a-3, or a-4 subcontainers
- 80FF** for b-1 or b-3 subcontainers

#### Prices for Steps 1-2.

<b>C0378FF</b>	\$66
<b>C0379FF</b>	\$66
<b>C0380FF</b>	\$68

#### Step 3. Surface Finish

**LU** soft white + \$0

6"-High Drawer Organizer Kit,  
20"-Wide Cart Interior

CT575.  
CT576.

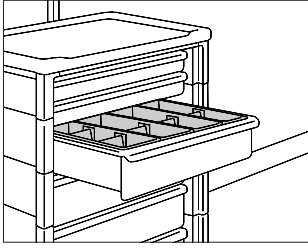

**Product Information**

**Description**

This kit fits inside a 6"- or 9"-high drawer and has 2 combinations of subcontainers and subcontainer dividers. Finish is soft white.

The B-size subcontainer is 5<sup>3</sup>/<sub>16</sub>" high. Width and depth dimensions are:

Type—Width—Depth

B-1—4<sup>9</sup>/<sub>16</sub>"—4<sup>9</sup>/<sub>16</sub>"

B-3—4<sup>9</sup>/<sub>16</sub>"—13<sup>13</sup>/<sub>16</sub>"

B-5—9<sup>3</sup>/<sub>16</sub>"—9<sup>3</sup>/<sub>16</sub>"

**Notes**

Order 6"- or 9"-high drawer (CT501.06 or CT501.09) separately.

Full kit will interfere with drawer locking mechanism.

**Dimensions**

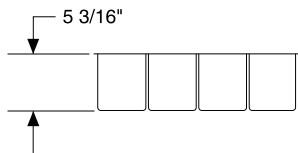
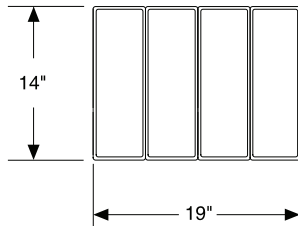

**Specification Information**

**Step 1.**

**CT57**

**Step 2. Components**

**5.06** 4 b-3 subcontainers, 4 b-3 dividers

**6.06** 2 b-1 subcontainers, 2 b-3 subcontainers, 1 b-5 subcontainer, 2 b-3 dividers

**Prices for Steps 1-2.**

**CT575.06** \$43

**CT576.06** \$43

3"-High Drawer Organizer Kit,  
24"-Wide Cart Interior

CT560.  
CT561.  
CT562.  
CT563.  
CT564.

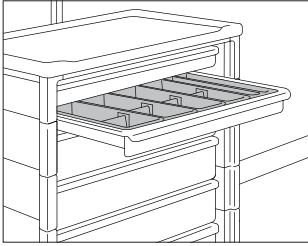

Procedure/Supply Carts — Interior Components

**Product Information**

**Description**

This kit fits inside a 3"-high drawer and has 5 combinations of subcontainers and subcontainer dividers. Finish is soft white.

The A-size subcontainer is 2<sup>3</sup>/<sub>16</sub>" high. Width and depth dimensions are:

Type—Width—Depth

A-1—4<sup>9</sup>/<sub>16</sub>"—4<sup>9</sup>/<sub>16</sub>"

A-2—4<sup>9</sup>/<sub>16</sub>"—9<sup>3</sup>/<sub>16</sub>"

A-3—4<sup>9</sup>/<sub>16</sub>"—13<sup>13</sup>/<sub>16</sub>"

A-4—4<sup>9</sup>/<sub>16</sub>"—18<sup>7</sup>/<sub>16</sub>"

A-5—9<sup>3</sup>/<sub>16</sub>"—9<sup>3</sup>/<sub>16</sub>"

A-8—2<sup>1</sup>/<sub>4</sub>"—13<sup>13</sup>/<sub>16</sub>"

**Notes**

Order 3"-high drawer (CT511.03) separately.

Full kit will interfere with drawer locking mechanism.

**Dimensions**

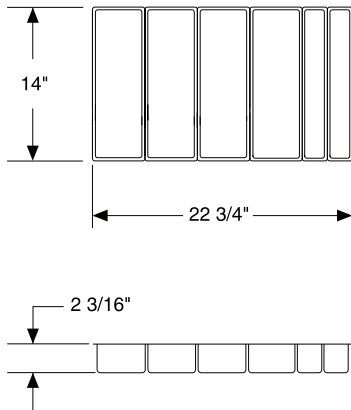

**Specification Information**

**Step 1.**

**CT56**

**Step 2. Components**

- 0.03** 4 a-3 subcontainers, 2 a-8 subcontainers, 6 a-3 dividers, 3 a-8 dividers
- 1.03** 2 a-1 subcontainers, 2 a-2 subcontainers, 1 a-3 subcontainer, 4 a-8 subcontainers, 4 a-3 dividers, 6 a-8 dividers
- 2.03** 4 a-2 subcontainers, 1 a-4 subcontainer, 2 a-8 subcontainers, 6 a-3 dividers, 3 a-8 dividers
- 3.03** 2 a-2 subcontainers, 1 a-3 subcontainer, 1 a-4 subcontainer, 1 a-5 subcontainer, 6 a-3 dividers
- 4.03** 1 a-3 subcontainer, 8 a-8 subcontainers, 2 a-3 dividers, 14 a-8 dividers

**Prices for Steps 1-2.**

<b>CT560.03</b>	\$39
<b>CT561.03</b>	\$47
<b>CT562.03</b>	\$39
<b>CT563.03</b>	\$36
<b>CT564.03</b>	\$51

6"-High Drawer Organizer Kit,  
24"-Wide Cart Interior

CT570.  
CT571.

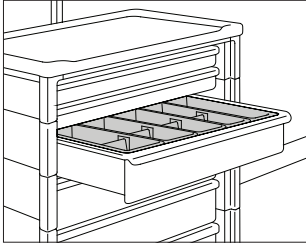

**Product Information**

**Description**

This kit fits inside a 6"-high drawer and has 2 combinations of subcontainers and subcontainer dividers. Finish is soft white.

The B-size subcontainer is 5<sup>3</sup>/<sub>16</sub>" high. Width and depth dimensions are:

Type—Width—Depth

B-1—4<sup>9</sup>/<sub>16</sub>"—4<sup>9</sup>/<sub>16</sub>"

B-3—4<sup>9</sup>/<sub>16</sub>"—13<sup>13</sup>/<sub>16</sub>"

B-5—9<sup>3</sup>/<sub>16</sub>"—9<sup>3</sup>/<sub>16</sub>"

**Notes**

Order 6"-high drawer (CT511.06) separately.

Full kit will interfere with drawer locking mechanism.

**Dimensions**

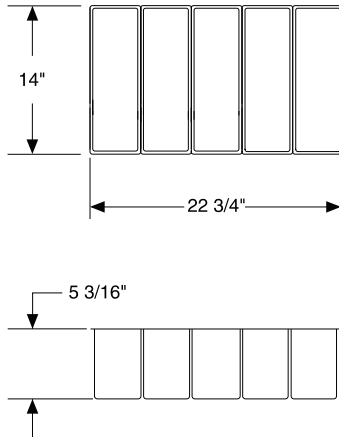

**Specification Information**

**Step 1.**

**CT57**

**Step 2. Components**

**0.06** 5 b-3 subcontainers, 4 b-3 dividers

**1.06** 2 b-1 subcontainers, 3 b-3 subcontainers, 1 b-5 subcontainer, 3 b-3 dividers

**Prices for Steps 1-2.**

<b>CT570.06</b>	\$50
<b>CT571.06</b>	\$50

Drawer/Shelf Divider

CT550.

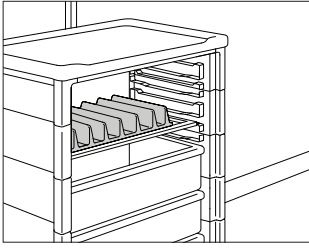

Procedure/Supply Carts – Interior Components

**Product Information**

**Description**  
This divider fits inside a drawer or on a solid, single-wide shelf. It organizes IV bags, tape rolls, and other small items. Finish is soft white.

**Notes**  
Order drawer (CT501.) or solid, single-wide shelf (CT523.) separately.

**Dimensions**

**Specification Information**

**Step 1.**  
**CT550.03** \$25

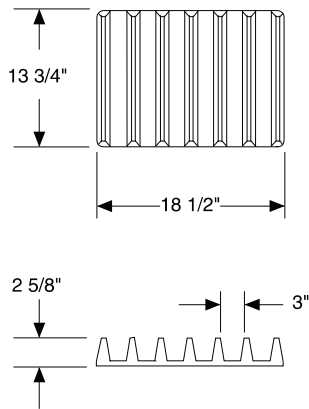

Clear Lid

CT508.

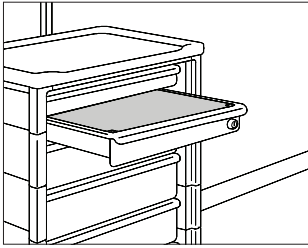

**Product Information**

**Description**  
 This clear lid fits on a 20"- or 24"-wide drawer and provides top closure.

**Notes**  
 Order drawer (CT501. or CT511.) separately.

**Dimensions**

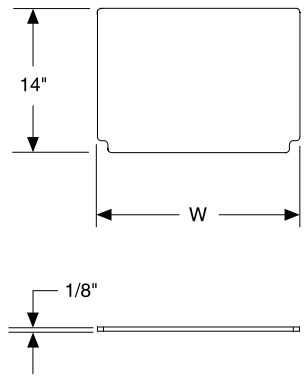

**Specification Information**

Step 1.

**CT508.**

Step 2. Width

**20** 20" wide

**24** 24" wide

Prices for Steps 1-2.

**CT508. 20** \$72

**24** \$76

# Drawer Color Strips

CT990.

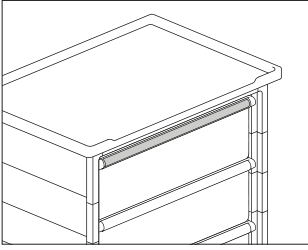

Procedure/Supply Carts – Interior Components

### Product Information

#### Description

These colored plastic strips can be inserted into drawer label holders or adhere directly to drawer handles to provide color-coded identification. Package of 8 includes 1 of each of the following colors: red, pink, green, orange, yellow, blue, purple, and white.

### Specification Information

Step 1.

**CT990.L8**

\$92



# Drawer Color Strips

CT991.

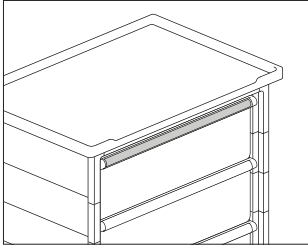

### Product Information

#### Description

These colored plastic strips can be inserted into drawer label holders or adhere directly to drawer handles to provide color-coded identification. Package contains 8 labels of the specified color.

### Specification Information

#### Step 1.

**CT991.**  A \$92

#### Step 2. Label Color

<b>RED</b>	red <input type="checkbox"/> A	+\$0
<b>PNK</b>	pink <input type="checkbox"/> A	+\$0
<b>GRN</b>	green <input type="checkbox"/> A	+\$0
<b>ORN</b>	orange <input type="checkbox"/> A	+\$0
<b>YLW</b>	yellow <input type="checkbox"/> A	+\$0
<b>BLU</b>	blue <input type="checkbox"/> A	+\$0
<b>PRP</b>	purple <input type="checkbox"/> A	+\$0
<b>WHT</b>	white <input type="checkbox"/> A	+\$0

Procedure/Supply Carts — Interior Components

# Full-Extension Drawer Slides, Single-Wide Cart

CT504.

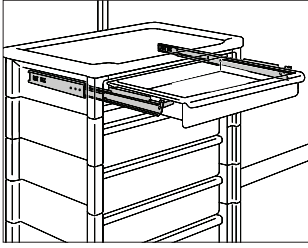

Procedure/Supply Carts – Interior Components

## Product Information

**Description**  
 These slides are factory installed in the drawer slots of a 36"- or 42"-high, single-wide cart. They hold 3"- or 6"-high non-locking drawers or drawers with lockable lids. The slides extend 15" for easy access to contents. They cannot be field installed.

## Dimensions

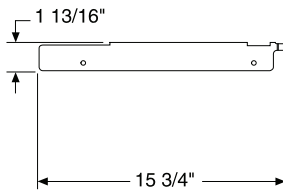
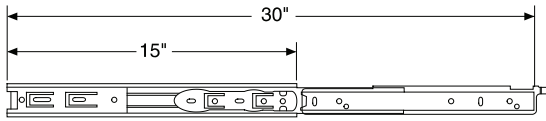

## Specification Information

**Step 1.**  
**CT504.**

### Step 2. Slot Location

- 01** top slot
- 02** 2nd slot from top
- 03** 3rd slot from top
- 04** 4th slot from top
- 05** 5th slot from top
- 06** 6th slot from top
- 07** 7th slot from top
- 08** 8th slot from top
- 09** 9th slot from top, 42"-high cart only
- 10** 10th slot from top, 42"-high cart only

### Prices for Steps 1-2.

<b>CT504. 01</b>	\$75
<b>02</b>	\$75
<b>03</b>	\$75
<b>04</b>	\$75
<b>05</b>	\$75
<b>06</b>	\$75
<b>07</b>	\$75
<b>08</b>	\$75
<b>09</b>	\$75
<b>10</b>	\$75

# Wire Shelf

CT521.  
CT522.  
CT525.  
CT526.

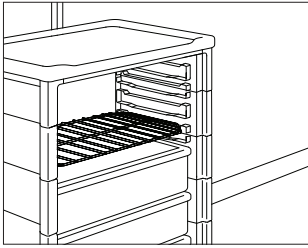

### Product Information

#### Description

This powder-coated wire shelf fills 1 slot of a single- or double-wide cart. Finish is soft white.

#### Dimensions

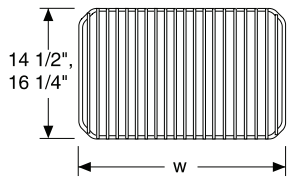

Single-Wide Cart

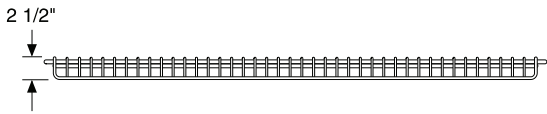
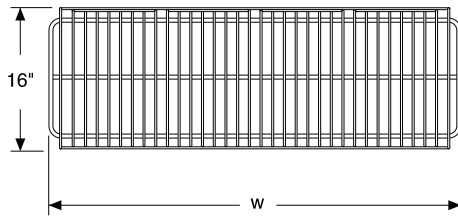

Double-Wide Cart

### Specification Information

#### Step 1.

**CT52**

#### Step 2. Cart Interior Width/Application

- 2. 20"-wide, single-wide cart
- 1. 24"-wide, single-wide cart
- 6. 20"-wide, double-wide cart
- 5. 24"-wide, double-wide cart

#### Prices for Steps 1-2.

<b>CT522.</b>	\$67
<b>CT521.</b>	\$68
<b>CT526.</b>	\$93
<b>CT525.</b>	\$113

# Wire Shelf Divider

CT527.

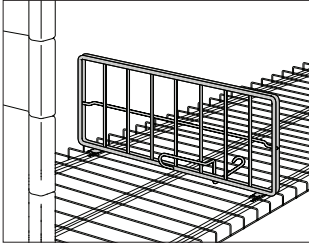

### Product Information

**Description**  
This 7"-high, 15"-deep divider attaches to a double-wide wire shelf. Finish is soft white. Package contains 3.

**Notes**  
Order double-wide wire shelf (CT525. or CT526.) separately.

### Dimensions

### Specification Information

**Step 1.**  
**CT527.** \$198

Procedure/Supply Carts — Interior Components

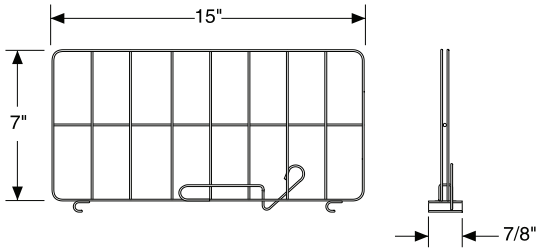

# Solid Shelf

CT523.

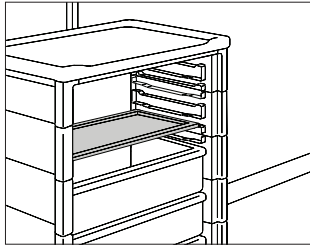

### Product Information

#### Description

This thermoplastic shelf fills 1 slot of a single-wide cart with an interior width of 20"-wide. Finish is soft white.

#### Dimensions

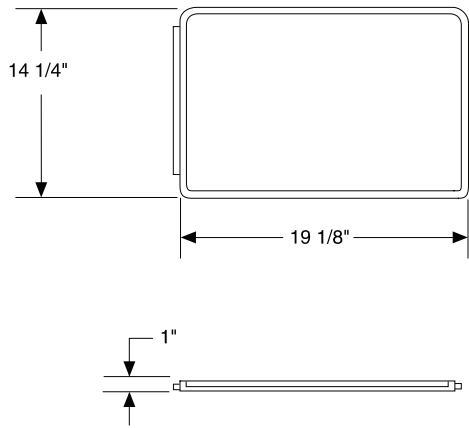

### Specification Information

#### Step 1.

CT523.

\$54

Pullout Catheter Rack

CT738.

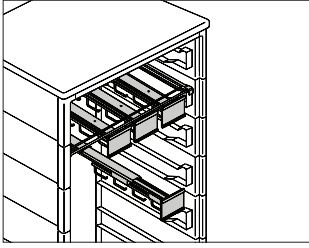

Procedure/Supply Carts — Interior Components

**Product Information**

**Description**

This rack fits into the slots of a single-wide, 72"-high cart or double-wide cart with full spine to organize catheters. Each pullout slide has 4 prongs, 4 side label clips, and 1 front label holder. Each prong holds up to 10 catheters. Finish is soft white.

The rack is 20" or 24" wide. The 20"-wide rack has 4 independent slides; the 24"-wide rack has 5 independent slides.

**Dimensions**

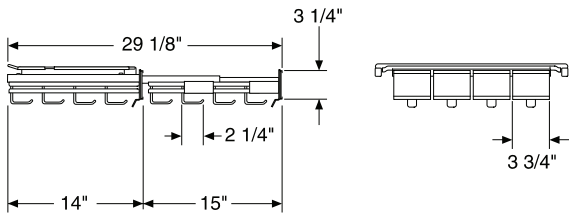
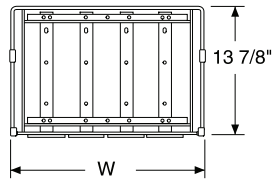

**Specification Information**

**Step 1.**

**CT738.**

**Step 2. Cart Interior Width**

**2004** 20" wide

**2405** 24" wide

**Prices for Steps 1-2.**

<b>CT738. 2004</b>	\$424
<b>2405</b>	\$494

# Keyboard Shelf

CT801.

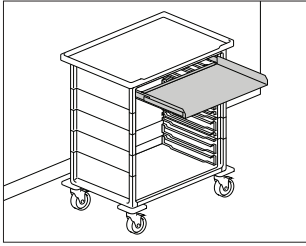

### Product Information

#### Description

This keyboard shelf attaches to a single-wide cart. It has full-extension drawer slides and holds up to 25 pounds. Finish is black.

#### Notes

Keyboard shelf cannot be field installed.

#### Dimensions

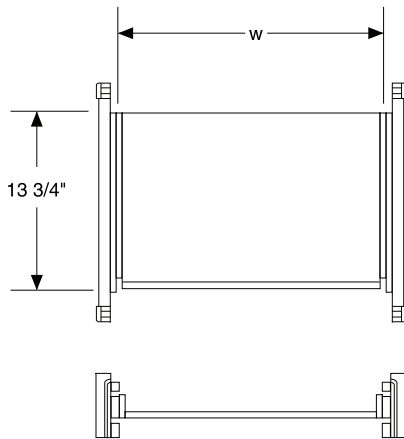

### Specification Information

#### Step 1.

**CT801.**

#### Step 2. Width

**20** 20" wide

**24** 24" wide

#### Prices for Steps 1-2.

<b>CT801. 20</b>	\$153
<b>24</b>	\$153

#### Step 3. Surface Finish

<b>BU</b> black umber	+ \$0
-----------------------	-------

# Cassette Bin

CT548.

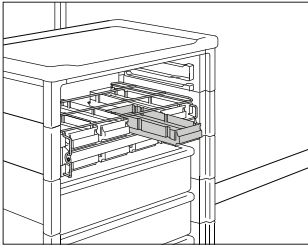

Procedure/Supply Carts – Interior Components

### Product Information

#### Description

This bin fits inside an 8- or 10-bin cassette. Package contains 10 bins, 20 dividers, and 10 label clips. Finish is soft white.

#### Notes

Order 8-bin (CT542.08) or 10-bin (CT543.10) cassette separately.

#### Dimensions

### Specification Information

#### Step 1.

**CT548.** \$88

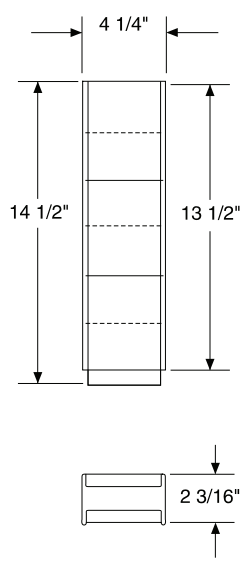



# Cassette

CT542.  
CT543.

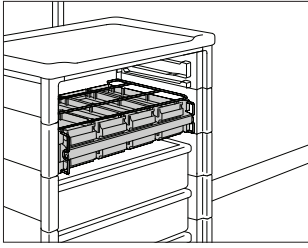

### Product Information

#### Description

This cassette fills 2 slots of a single-wide cart or double-wide cart with a spine. It has a cassette shell and 8 or 10 patient bins with dividers and label clips. The cassette does not include a cover. Finish is soft white.

#### Notes

Order additional or replacement cassette bins (CT548.) separately.  
Order optional cassette cover (CT542.C or CT543.C) separately.

#### Dimensions

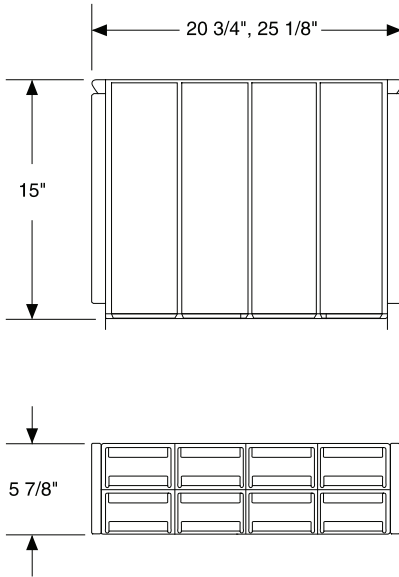

### Specification Information

#### Step 1.

**CT54**

#### Step 2. Cart Application

**2.08** 20"-wide cart interior  
**3.10** 24"-wide cart interior

#### Prices for Steps 1-2.

<b>CT542.08</b>	\$246
<b>CT543.10</b>	\$280

# Cassette Cover

CT542.  
CT543.

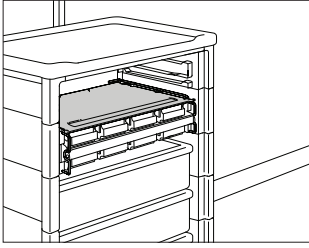

Procedure/Supply Carts – Interior Components

### Product Information

#### Description

This cover fits on an 8- or 10-bin cassette and provides top closure. Finish is soft white.

#### Notes

Order 8-bin cassette (CT542.08) or 10-bin cassette (CT543.10) separately.

#### Dimensions

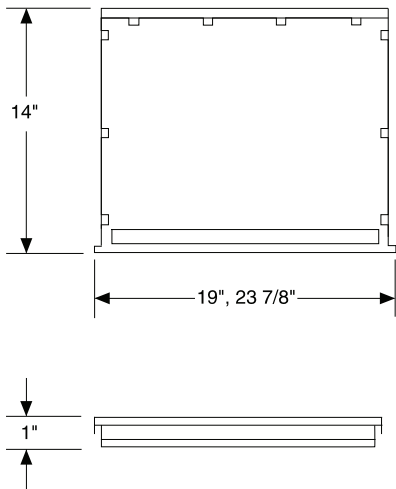

### Specification Information

#### Step 1.

#### CT54

#### Step 2. Cart Application

- 2.C 20"-wide cart interior
- 3.C 24"-wide cart interior

#### Prices for Steps 1-2.

CT542.C	\$56
CT543.C	\$57

Door

CT707.  
CT717.

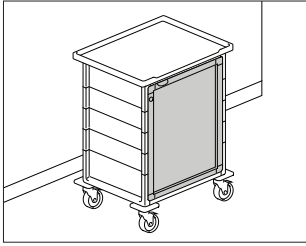

**Product Information**

**Description**

This door attaches to a single- or double-wide cart to conceal contents. The single-wide cart has 1 door; the double-wide cart has 2. The doors are available with or without locks. The clear door insert is clear plastic.

**Notes**

For general information on locks, see Keyed-Alike Information in Appendices.

**Dimensions**

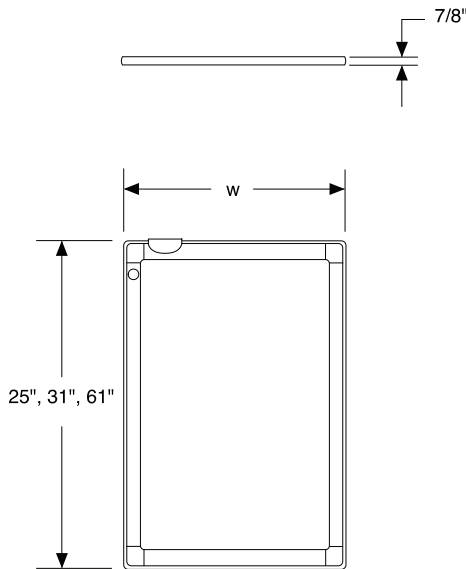

**Specification Information**

**Step 1.**

**CT7**

**Step 2. Cart Interior Width**

- 07.** 20" wide
- 17.** 24" wide

**Step 3. Cart Application**

- 1** single-wide cart
- 2** double-wide cart

**Step 4. Cart Height**

- 36** 36"-high cart
- 42** 42"-high cart
- 72** 72"-high cart

**Step 5. Lock**

- N** no lock
- L** keyed differently
- K** keyed alike
- P** keyless lock

**Prices for Steps 1-5.**

				<b>N</b>	<b>L</b>	<b>K</b>	<b>P</b>
<b>CT707.</b>	<b>1</b>	<b>36</b>		\$225	280	280	449
		<b>42</b>		\$240	295	295	465
		<b>72</b>		\$372	426	426	596
<b>2</b>	<b>36</b>		\$411	503	503	635	
	<b>42</b>		\$520	612	612	744	
	<b>72</b>		\$681	774	774	905	
<b>CT717.</b>	<b>1</b>	<b>36</b>		\$240	295	295	465
		<b>42</b>		\$255	310	310	480
		<b>72</b>		\$402	446	446	627
<b>2</b>	<b>36</b>		\$436	529	529	660	
	<b>42</b>		\$556	649	649	781	
	<b>72</b>		\$802	895	895	1027	

**Step 6. Door Frame Finish**

- HF** inner tone light +\$0
- LT** light tone +\$0
- LU** soft white +\$0
- WN** warm grey neutral +\$0

Door *continued*

Procedure/Supply Carts – Exterior Accessories

Step 7. Door Insert Finish		
<b>HF</b>	inner tone light	+\$0
<b>LT</b>	light tone	+\$0
<b>LU</b>	soft white	+\$0
<b>TR</b>	clear	+\$0
<b>WN</b>	warm grey neutral	+\$0

Step 8. Key Number		
<i>For keyed alike (K)</i>		
<b>01</b>	key number 01	+\$0
<b>02</b>	key number 02	+\$0
<b>03</b>	key number 03	+\$0
<b>04</b>	key number 04	+\$0
<b>05</b>	key number 05	+\$0
<b>06</b>	key number 06	+\$0
<b>07</b>	key number 07	+\$0
<b>08</b>	key number 08	+\$0
<b>09</b>	key number 09	+\$0
<b>10</b>	key number 10	+\$0
<b>11</b>	key number 11	+\$0
<b>12</b>	key number 12	+\$0
<b>13</b>	key number 13	+\$0
<b>14</b>	key number 14	+\$0
<b>15</b>	key number 15	+\$0
<b>16</b>	key number 16	+\$0
<b>17</b>	key number 17	+\$0
<b>18</b>	key number 18	+\$0
<b>19</b>	key number 19	+\$0
<b>20</b>	key number 20	+\$0
<b>21</b>	key number 21	+\$0
<b>22</b>	key number 22	+\$0
<b>23</b>	key number 23	+\$0
<b>24</b>	key number 24	+\$0
<b>25</b>	key number 25	+\$0
<b>26</b>	key number 26	+\$0
<b>27</b>	key number 27	+\$0
<b>28</b>	key number 28	+\$0
<b>29</b>	key number 29	+\$0
<b>30</b>	key number 30	+\$0
<b>31</b>	key number 31	+\$0
<b>32</b>	key number 32	+\$0
<b>33</b>	key number 33	+\$0
<b>34</b>	key number 34	+\$0
<b>35</b>	key number 35	+\$0
<b>36</b>	key number 36	+\$0
<b>37</b>	key number 37	+\$0
<b>38</b>	key number 38	+\$0

<b>39</b>	key number 39	+\$0
<b>40</b>	key number 40	+\$0
<b>41</b>	key number 41	+\$0
<b>42</b>	key number 42	+\$0
<b>43</b>	key number 43	+\$0
<b>44</b>	key number 44	+\$0
<b>45</b>	key number 45	+\$0
<b>46</b>	key number 46	+\$0
<b>47</b>	key number 47	+\$0
<b>48</b>	key number 48	+\$0
<b>49</b>	key number 49	+\$0
<b>50</b>	key number 50	+\$0
<b>51</b>	key number 51	+\$0
<b>52</b>	key number 52	+\$0
<b>53</b>	key number 53	+\$0
<b>54</b>	key number 54	+\$0
<b>55</b>	key number 55	+\$0
<b>56</b>	key number 56	+\$0
<b>57</b>	key number 57	+\$0
<b>58</b>	key number 58	+\$0
<b>59</b>	key number 59	+\$0
<b>60</b>	key number 60	+\$0
<b>61</b>	key number 61	+\$0
<b>62</b>	key number 62	+\$0
<b>63</b>	key number 63	+\$0
<b>64</b>	key number 64	+\$0
<b>65</b>	key number 65	+\$0
<b>66</b>	key number 66	+\$0
<b>67</b>	key number 67	+\$0
<b>68</b>	key number 68	+\$0
<b>69</b>	key number 69	+\$0
<b>70</b>	key number 70	+\$0
<b>71</b>	key number 71	+\$0
<b>72</b>	key number 72	+\$0
<b>73</b>	key number 73	+\$0
<b>74</b>	key number 74	+\$0
<b>75</b>	key number 75	+\$0
<b>76</b>	key number 76	+\$0
<b>77</b>	key number 77	+\$0
<b>78</b>	key number 78	+\$0
<b>79</b>	key number 79	+\$0
<b>80</b>	key number 80	+\$0
<b>81</b>	key number 81	+\$0
<b>82</b>	key number 82	+\$0
<b>83</b>	key number 83	+\$0
<b>84</b>	key number 84	+\$0
<b>85</b>	key number 85	+\$0

Door *continued*

<b>86</b>	key number 86	+\$0
<b>87</b>	key number 87	+\$0
<b>88</b>	key number 88	+\$0
<b>89</b>	key number 89	+\$0
<b>90</b>	key number 90	+\$0
<b>91</b>	key number 91	+\$0
<b>92</b>	key number 92	+\$0
<b>93</b>	key number 93	+\$0
<b>94</b>	key number 94	+\$0
<b>95</b>	key number 95	+\$0
<b>96</b>	key number 96	+\$0
<b>97</b>	key number 97	+\$0
<b>98</b>	key number 98	+\$0
<b>99</b>	key number 99	+\$0

Curtain

CT703.  
 CT705.  
 CT713.  
 CT715.

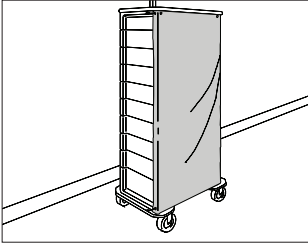

**Product Information**

**Description**  
 This removable nylon curtain hangs from the top of a 72"-high, single- or double-wide cart to conceal contents. Curtain color is charcoal.

**Specification Information**

Step 1.

**CT7**

Step 2. Cart Interior Width

- 1** 20" wide
- 0** 24" wide

Step 3. Cart Application

- 3.72** single-wide cart
- 5.72** double-wide cart

Prices for Steps 1-3.

<b>CT713.72</b>	\$77
<b>CT715.72</b>	\$99
<b>CT703.72</b>	\$82
<b>CT705.72</b>	\$102

# Lock Bar

CT621.  
CT710.

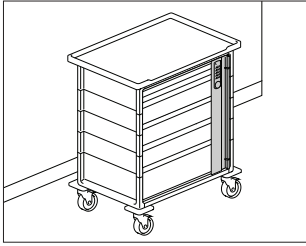

### Product Information

#### Description

This bar prevents unauthorized access to drawers or cassette bins within a 36"- or 42"-high cart. It offers multiple security and access options and re-locks automatically when closed. The basic keyless entry option allows access using a single programmable code that can be changed by a supervisor. Uses 2 AAA batteries (included).

#### Notes

Keyless entry options have a sleep mode to provide tamper protection when several incorrect codes are entered.

Keyless entry options have a 9-volt battery "jump" capability and a keyed back-up.

For general information on locks, see Keyed-Alike Information in Appendices.

#### Dimensions

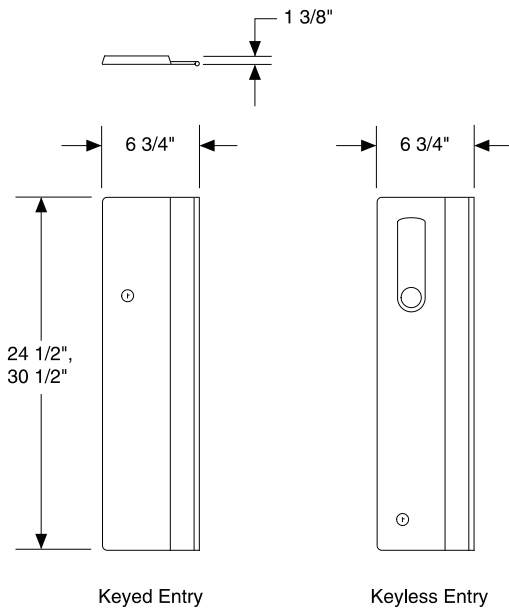

### Specification Information

#### Step 1.

**CT**

#### Step 2. Type

- 710.** keyed entry
- 621.** basic keyless entry™

#### Step 3. Cart Height

- 36** 36"-high cart
- 42** 42"-high cart

#### Step 4. Lock Position

- L** left side lock
- R** right side lock

#### Step 5. Lock

For keyed differently (\*), skip this step.

- K** keyed alike

#### Prices for Steps 1-5.

	*	K
<b>CT710. 36 L</b>	\$185	185
<b>R</b>	\$185	185
<b>42 L</b>	\$194	194
<b>R</b>	\$194	194
<b>CT621. 36 L</b>	\$345	345
<b>R</b>	\$345	345
<b>42 L</b>	\$381	381
<b>R</b>	\$381	381

#### Step 6. Surface Finish

<b>HF</b>	inner tone light	+\$0
<b>LT</b>	light tone	+\$0
<b>LU</b>	soft white	+\$0
<b>WN</b>	warm grey neutral	+\$0

#### Step 7. Key Number

For keyed alike (K)

<b>01</b>	key number 01	+\$0
<b>02</b>	key number 02	+\$0
<b>03</b>	key number 03	+\$0
<b>04</b>	key number 04	+\$0
<b>05</b>	key number 05	+\$0
<b>06</b>	key number 06	+\$0
<b>07</b>	key number 07	+\$0

Lock Bar *continued*

*Procedure/Supply Carts – Exterior Accessories*

<b>08</b>	key number 08	+\$0	<b>55</b>	key number 55	+\$0
<b>09</b>	key number 09	+\$0	<b>56</b>	key number 56	+\$0
<b>10</b>	key number 10	+\$0	<b>57</b>	key number 57	+\$0
<b>11</b>	key number 11	+\$0	<b>58</b>	key number 58	+\$0
<b>12</b>	key number 12	+\$0	<b>59</b>	key number 59	+\$0
<b>13</b>	key number 13	+\$0	<b>60</b>	key number 60	+\$0
<b>14</b>	key number 14	+\$0	<b>61</b>	key number 61	+\$0
<b>15</b>	key number 15	+\$0	<b>62</b>	key number 62	+\$0
<b>16</b>	key number 16	+\$0	<b>63</b>	key number 63	+\$0
<b>17</b>	key number 17	+\$0	<b>64</b>	key number 64	+\$0
<b>18</b>	key number 18	+\$0	<b>65</b>	key number 65	+\$0
<b>19</b>	key number 19	+\$0	<b>66</b>	key number 66	+\$0
<b>20</b>	key number 20	+\$0	<b>67</b>	key number 67	+\$0
<b>21</b>	key number 21	+\$0	<b>68</b>	key number 68	+\$0
<b>22</b>	key number 22	+\$0	<b>69</b>	key number 69	+\$0
<b>23</b>	key number 23	+\$0	<b>70</b>	key number 70	+\$0
<b>24</b>	key number 24	+\$0	<b>71</b>	key number 71	+\$0
<b>25</b>	key number 25	+\$0	<b>72</b>	key number 72	+\$0
<b>26</b>	key number 26	+\$0	<b>73</b>	key number 73	+\$0
<b>27</b>	key number 27	+\$0	<b>74</b>	key number 74	+\$0
<b>28</b>	key number 28	+\$0	<b>75</b>	key number 75	+\$0
<b>29</b>	key number 29	+\$0	<b>76</b>	key number 76	+\$0
<b>30</b>	key number 30	+\$0	<b>77</b>	key number 77	+\$0
<b>31</b>	key number 31	+\$0	<b>78</b>	key number 78	+\$0
<b>32</b>	key number 32	+\$0	<b>79</b>	key number 79	+\$0
<b>33</b>	key number 33	+\$0	<b>80</b>	key number 80	+\$0
<b>34</b>	key number 34	+\$0	<b>81</b>	key number 81	+\$0
<b>35</b>	key number 35	+\$0	<b>82</b>	key number 82	+\$0
<b>36</b>	key number 36	+\$0	<b>83</b>	key number 83	+\$0
<b>37</b>	key number 37	+\$0	<b>84</b>	key number 84	+\$0
<b>38</b>	key number 38	+\$0	<b>85</b>	key number 85	+\$0
<b>39</b>	key number 39	+\$0	<b>86</b>	key number 86	+\$0
<b>40</b>	key number 40	+\$0	<b>87</b>	key number 87	+\$0
<b>41</b>	key number 41	+\$0	<b>88</b>	key number 88	+\$0
<b>42</b>	key number 42	+\$0	<b>89</b>	key number 89	+\$0
<b>43</b>	key number 43	+\$0	<b>90</b>	key number 90	+\$0
<b>44</b>	key number 44	+\$0	<b>91</b>	key number 91	+\$0
<b>45</b>	key number 45	+\$0	<b>92</b>	key number 92	+\$0
<b>46</b>	key number 46	+\$0	<b>93</b>	key number 93	+\$0
<b>47</b>	key number 47	+\$0	<b>94</b>	key number 94	+\$0
<b>48</b>	key number 48	+\$0	<b>95</b>	key number 95	+\$0
<b>49</b>	key number 49	+\$0	<b>96</b>	key number 96	+\$0
<b>50</b>	key number 50	+\$0	<b>97</b>	key number 97	+\$0
<b>51</b>	key number 51	+\$0	<b>98</b>	key number 98	+\$0
<b>52</b>	key number 52	+\$0	<b>99</b>	key number 99	+\$0
<b>53</b>	key number 53	+\$0			
<b>54</b>	key number 54	+\$0			



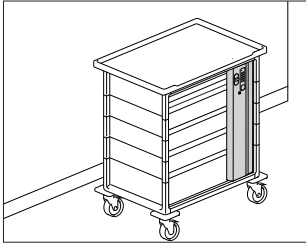

**Product Information**

**Description**

This bar prevents unauthorized access to drawers or cassette bins within a 36"- or 42"-high cart. It offers multiple security and access options and re-locks automatically when closed. It includes an alarm that is supervisor programmable and signifies when the cart is not secure. A sleep mode provides tamper protection when several incorrect codes are entered. Features to overcome low power include a 9-volt battery "jump" capability and a keyed back-up. Uses 6 "C" batteries (included), and has a low battery alert. The proximity version allows up to 250 codes in any combination of "user" and "supervisor." The deluxe version allows up to 89 "user" codes and 11 "supervisor" codes. The proximity version allows access by placing proximity access component near keypad.

**Notes**

A wide range of capabilities can be utilized with the proximity version when used with the proximity lock bar software kit (CT631), sold separately.

Proximity reader will read most low frequency HID Prox Cards (125 kHz). The use of a card other than Herman Miller's should be verified. For proximity reader, specify proximity access (CT623, or CT624.), sold separately.

For general information on locks, see Keyed-Alike Information in Appendices.

**Dimensions**

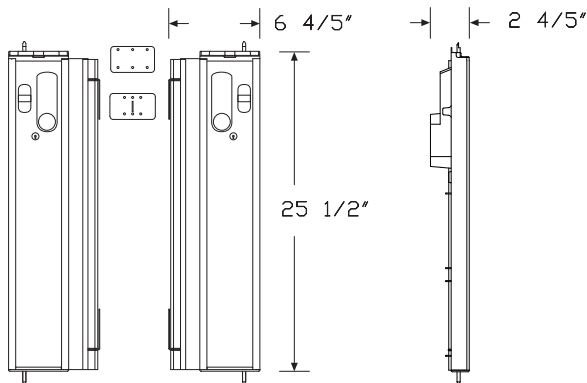

**Specification Information**

**Step 1.**

**CT630.**

**Step 2. Type**

- D** deluxe keyless entry™
- P** deluxe with proximity reader

**Step 3. Cart Height**

- 36** 36"-high cart
- 42** 42"-high cart

**Step 4. Lock Position**

- L** left side lock
- R** right side lock

**Step 5. Lock**

- K** keyed alike
- L** keyed differently

**Prices for Steps 1-5.**

	LK	LL	RK	RL
<b>CT630. D 36</b>	\$509	509	509	509
<b>42</b>	\$540	540	540	540
<b>P 36</b>	\$1209	1209	1209	1209
<b>42</b>	\$1261	1261	1261	1261

**Step 6. Surface Finish**

- HF** inner tone light +\$0
- LT** light tone +\$0
- LU** soft white +\$0
- WN** warm grey neutral +\$0

**Step 7. Key Number**

*For keyed alike (K)*

- 01** key number 01 +\$0
- 02** key number 02 +\$0
- 03** key number 03 +\$0
- 04** key number 04 +\$0
- 05** key number 05 +\$0
- 06** key number 06 +\$0
- 07** key number 07 +\$0
- 08** key number 08 +\$0
- 09** key number 09 +\$0
- 10** key number 10 +\$0
- 11** key number 11 +\$0
- 12** key number 12 +\$0

Lock Bar *continued*

*Procedure/Supply Carts – Exterior Accessories*

<b>13</b>	key number 13	+\$0	<b>60</b>	key number 60	+\$0
<b>14</b>	key number 14	+\$0	<b>61</b>	key number 61	+\$0
<b>15</b>	key number 15	+\$0	<b>62</b>	key number 62	+\$0
<b>16</b>	key number 16	+\$0	<b>63</b>	key number 63	+\$0
<b>17</b>	key number 17	+\$0	<b>64</b>	key number 64	+\$0
<b>18</b>	key number 18	+\$0	<b>65</b>	key number 65	+\$0
<b>19</b>	key number 19	+\$0	<b>66</b>	key number 66	+\$0
<b>20</b>	key number 20	+\$0	<b>67</b>	key number 67	+\$0
<b>21</b>	key number 21	+\$0	<b>68</b>	key number 68	+\$0
<b>22</b>	key number 22	+\$0	<b>69</b>	key number 69	+\$0
<b>23</b>	key number 23	+\$0	<b>70</b>	key number 70	+\$0
<b>24</b>	key number 24	+\$0	<b>71</b>	key number 71	+\$0
<b>25</b>	key number 25	+\$0	<b>72</b>	key number 72	+\$0
<b>26</b>	key number 26	+\$0	<b>73</b>	key number 73	+\$0
<b>27</b>	key number 27	+\$0	<b>74</b>	key number 74	+\$0
<b>28</b>	key number 28	+\$0	<b>75</b>	key number 75	+\$0
<b>29</b>	key number 29	+\$0	<b>76</b>	key number 76	+\$0
<b>30</b>	key number 30	+\$0	<b>77</b>	key number 77	+\$0
<b>31</b>	key number 31	+\$0	<b>78</b>	key number 78	+\$0
<b>32</b>	key number 32	+\$0	<b>79</b>	key number 79	+\$0
<b>33</b>	key number 33	+\$0	<b>80</b>	key number 80	+\$0
<b>34</b>	key number 34	+\$0	<b>81</b>	key number 81	+\$0
<b>35</b>	key number 35	+\$0	<b>82</b>	key number 82	+\$0
<b>36</b>	key number 36	+\$0	<b>83</b>	key number 83	+\$0
<b>37</b>	key number 37	+\$0	<b>84</b>	key number 84	+\$0
<b>38</b>	key number 38	+\$0	<b>85</b>	key number 85	+\$0
<b>39</b>	key number 39	+\$0	<b>86</b>	key number 86	+\$0
<b>40</b>	key number 40	+\$0	<b>87</b>	key number 87	+\$0
<b>41</b>	key number 41	+\$0	<b>88</b>	key number 88	+\$0
<b>42</b>	key number 42	+\$0	<b>89</b>	key number 89	+\$0
<b>43</b>	key number 43	+\$0	<b>90</b>	key number 90	+\$0
<b>44</b>	key number 44	+\$0	<b>91</b>	key number 91	+\$0
<b>45</b>	key number 45	+\$0	<b>92</b>	key number 92	+\$0
<b>46</b>	key number 46	+\$0	<b>93</b>	key number 93	+\$0
<b>47</b>	key number 47	+\$0	<b>94</b>	key number 94	+\$0
<b>48</b>	key number 48	+\$0	<b>95</b>	key number 95	+\$0
<b>49</b>	key number 49	+\$0	<b>96</b>	key number 96	+\$0
<b>50</b>	key number 50	+\$0	<b>97</b>	key number 97	+\$0
<b>51</b>	key number 51	+\$0	<b>98</b>	key number 98	+\$0
<b>52</b>	key number 52	+\$0	<b>99</b>	key number 99	+\$0
<b>53</b>	key number 53	+\$0			
<b>54</b>	key number 54	+\$0			
<b>55</b>	key number 55	+\$0			
<b>56</b>	key number 56	+\$0			
<b>57</b>	key number 57	+\$0			
<b>58</b>	key number 58	+\$0			
<b>59</b>	key number 59	+\$0			

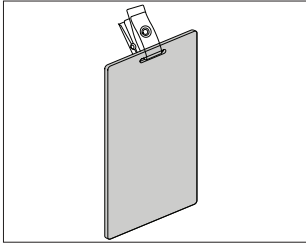

**Product Information**

**Description**

This proximity access provides access to a cart lockbar with proximity reader lock (CT630.P). It is available as a card, or as a sticker that can be attached to an I.D. badge. Package of 10.

**Notes**

Proximity access card has a slot for attaching a lanyard, clip, or other carrying device.

Proximity access sticker cannot be attached to a proximity I.D. badge with the same frequency (125 kHz).

Cards (or stickers) have identical codes. For individual codes, contact Options.

**Dimensions**

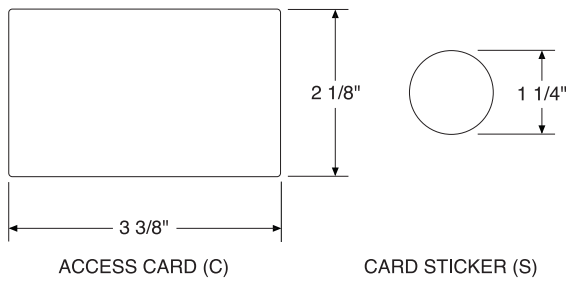

**Specification Information**

**Step 1.**

**CT623.**

**Step 2. Type**

- C**     access card
- S**     card sticker

**Prices for Steps 1-2.**

<b>CT623. C</b>	\$137
<b>S</b>	\$192

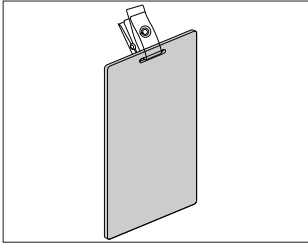

Procedure/Supply Carts – Exterior Accessories

**Product Information**

**Description**  
 This proximity access provides access to a cart lockbar with proximity reader lock (CT630.P). It is available as a card, or as a sticker that can be attached to an I.D. badge. Package of 10.

**Notes**  
 Proximity access card has a slot for attaching a lanyard, clip, or other carrying device.  
 Proximity access sticker cannot be attached to a proximity I.D. badge with the same frequency (125 kHz).  
 Cards (or stickers) have individual codes.

**Dimensions**

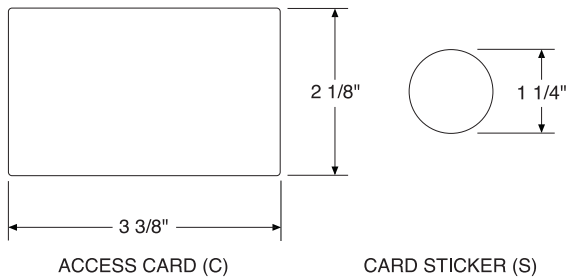

**Specification Information**

**Step 1.**  
**CT624.**

**Step 2. Type**  
**C** access card  
**S** card sticker

**Prices for Steps 1-2.**  
**CT624. C** \$137  
**S** \$192

**Step 3. Serial Number Set**

<b>A</b>	Serial Numbers 1-10	+\$0
<b>B</b>	Serial Numbers 11-20	+\$0
<b>C</b>	Serial Numbers 21-30	+\$0
<b>D</b>	Serial Numbers 31-40	+\$0
<b>E</b>	Serial Numbers 41-50	+\$0
<b>F</b>	Serial Numbers 51-60	+\$0
<b>G</b>	Serial Numbers 61-70	+\$0
<b>H</b>	Serial Numbers 71-80	+\$0
<b>I</b>	Serial Numbers 81-90	+\$0
<b>J</b>	Serial Numbers 91-100	+\$0
<b>K</b>	Serial Numbers 101-110	+\$0
<b>L</b>	Serial Numbers 111-120	+\$0
<b>M</b>	Serial Numbers 121-130	+\$0
<b>N</b>	Serial Numbers 131-140	+\$0
<b>O</b>	Serial Numbers 141-150	+\$0
<b>P</b>	Serial Numbers 151-160	+\$0
<b>Q</b>	Serial Numbers 161-170	+\$0
<b>R</b>	Serial Numbers 171-180	+\$0
<b>S</b>	Serial Numbers 181-190	+\$0
<b>T</b>	Serial Numbers 191-200	+\$0
<b>U</b>	Serial Numbers 201-210	+\$0
<b>V</b>	Serial Numbers 211-220	+\$0
<b>W</b>	Serial Numbers 221-230	+\$0
<b>X</b>	Serial Numbers 231-240	+\$0
<b>Y</b>	Serial Numbers 241-250	+\$0

**Product Information**

Description

This software kit is used with the lock bar, proximity reader (CT630.P). The software is used to create and manage a database and establish settings which are downloaded into the individual lock bars. Kit includes the Windows based software on a CD and a USB cable to connect a computer to the keypad of the lock bar.

Software allows administrators to add or delete PIN codes, name individual carts and set up unique settings for each one. An audit report can be printed that indicates which user attempted entry and the date and time of attempt. Administrators can set up users for access based on times or days.

Instructions for use and interfacing with the lock bars are included in a PDF file within the software.

**Specification Information**

Step 1.

**CT631.**

Step 2. Type

**P** for proximity lock bar

Prices for Steps 1-2.

**CT631. P** \$1064

# Breakaway Bar

CT701.

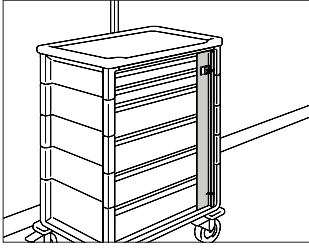

### Product Information

#### Description

This bar is used with a breakaway tab. It indicates that the drawer or cassette contents of a 36"- or 42"-high cart are unaltered.

#### Notes

Order breakaway tab (CT709.) separately.

#### Dimensions

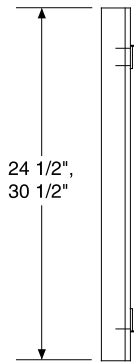

### Specification Information

#### Step 1.

#### CT701.

#### Step 2. Cart Height

- 36** 36"-high cart
- 42** 42"-high cart

#### Prices for Steps 1-2.

<b>CT701. 36</b>	\$93
<b>42</b>	\$99

#### Step 3. Surface Finish

<b>HF</b>	inner tone light	+\$0
<b>LT</b>	light tone	+\$0
<b>LU</b>	soft white	+\$0
<b>WN</b>	warm grey neutral	+\$0

# Breakaway Tab Holder

CT699.

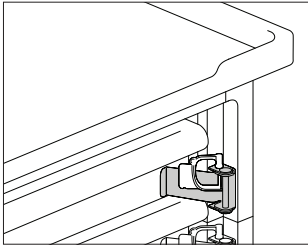

### Product Information

#### Description

This holder attaches to the front of any slot location on a 36"- or 42"-high cart. It holds a breakaway tab, indicating that the contents of an individual drawer are unaltered. Finish is red.

#### Notes

Specify breakaway tabs (CT709.) separately.

When specified with cart, breakaway tab holder is factory installed at the front of the cart on the right side.

Breakaway tab holder can be field installed with included hardware.

Drilling of cart body is required.

### Specification Information

#### Step 1.

**CT699.**

#### Step 2. Slot Location

- 01** top slot
- 02** 2nd slot from top
- 03** 3rd slot from top
- 04** 4th slot from top
- 05** 5th slot from top
- 06** 6th slot from top
- 07** 7th slot from top
- 08** 8th slot from top
- 09** 9th slot from top, 42"-high cart only
- 10** 10th slot from top, 42"-high cart only

#### Prices for Steps 1-2.

<b>CT699. 01</b>	\$43
<b>02</b>	\$43
<b>03</b>	\$43
<b>04</b>	\$43
<b>05</b>	\$43
<b>06</b>	\$43
<b>07</b>	\$43
<b>08</b>	\$43
<b>09</b>	\$43
<b>10</b>	\$43

# Breakaway Tab

CT709.

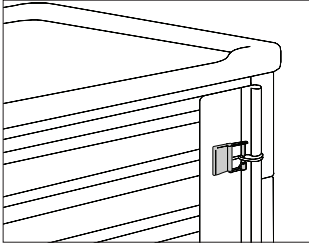

### Product Information

**Description**  
This tab indicates that a cart's drawer or cassette contents are unaltered. Package contains 100.

### Notes

Order breakaway bar (CT701.) or breakaway tab holder (CT699.) separately.

### Specification Information

**Step 1.**  
**CT709.** \$53

*Procedure/Supply Carts—Exterior Accessories*



# Wall Lock

CT708.

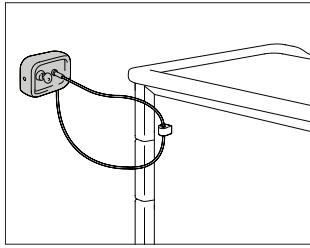

### Product Information

#### Description

This wall-mounted lock has a steel cable that loops through a cart-mounted ring to prevent cart removal. Package includes a 20"-long steel cable, lock box, and ring. Finish is soft white.

#### Dimensions

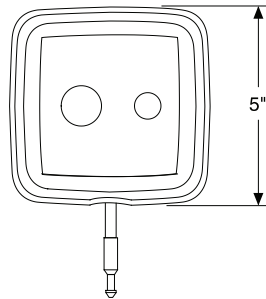
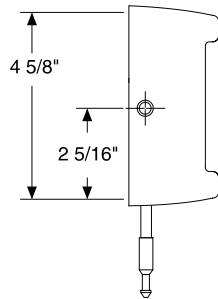
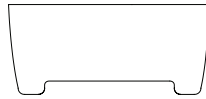

### Specification Information

#### Step 1.

**CT708.**

\$237

# Flip-Up Shelf

CT750.

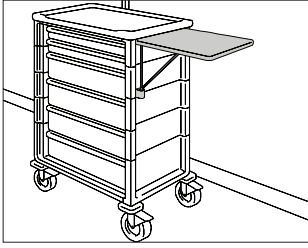

Procedure/Supply Carts – Exterior Accessories

## Product Information

### Description

This hinged shelf is factory installed on the top segment of a 36" or 42"-high cart. It is supported by a pivoting arm. The shelf provides a flat writing or utility surface; when lowered, the shelf is flush with the cart side. Accessories cannot attach to the cart segment where the shelf is installed or to the 2 segments below it. The shelf cannot be field installed.

For a single-wide cart, the shelf is installed on the left or right side. For a double-wide cart, the shelf is installed on the right side.

### Dimensions

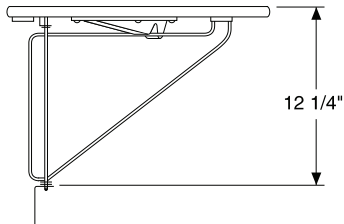
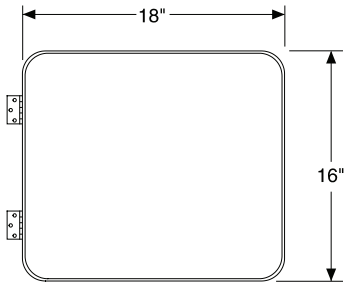

## Specification Information

### Step 1.

**CT750.**

### Step 2. Shelf Position

- L** left-single wide only
- R** right

### Prices for Steps 1-2.

<b>CT750. L</b>	\$172
<b>R</b>	\$172

### Step 3. Surface Finish

<b>HF</b> inner tone light	+ \$0
<b>LT</b> light tone	+ \$0
<b>LU</b> soft white	+ \$0
<b>WN</b> warm grey neutral	+ \$0

# Beltline Flip-Up Shelf

CT751.

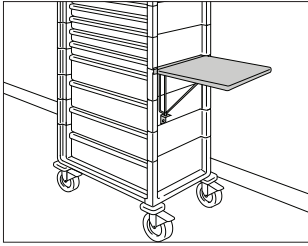

### Product Information

#### Description

This hinged shelf is factory installed on a cart and is supported by a pivoting arm. It provides a flat writing or utility surface; when lowered, the shelf is flush with the cart side. Accessories cannot attach to the cart segment where the shelf is installed or to the 2 segments below it. For a single-wide cart the shelf is installed on the left or right side. For a double-wide cart the shelf is installed on the right side.

#### Notes

Cart segments are numbered from the bottom up starting at 1. Cart segment 4 is available on the 42"- and 72"-high carts. Cart segment 5 is only available on the 72"-high cart.

#### Dimensions

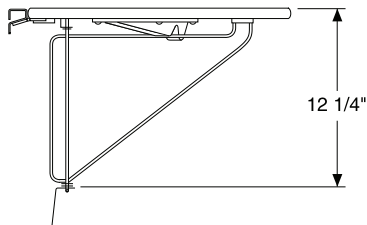
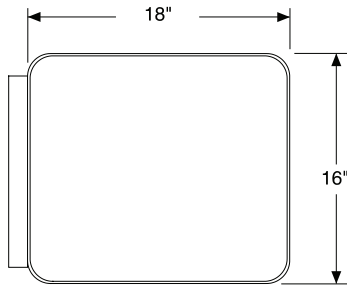

### Specification Information

#### Step 1.

**CT751.**

#### Step 2. Shelf Position

**L** left-single wide only  
**R** right

#### Step 3. Cart Segment

**3** cart segment 3  
**4** cart segment 4  
**5** cart segment 5

#### Prices for Steps 1-3.

	3	4	5
<b>CT751. L</b>	\$180	180	180
<b>R</b>	\$180	180	180

#### Step 4. Surface Finish

**HF** inner tone light +\$0  
**LT** light tone +\$0  
**LU** soft white +\$0  
**WN** warm grey neutral +\$0

Above-Cart Shelf, Single-Wide  
Cart

CT788.  
CT794.

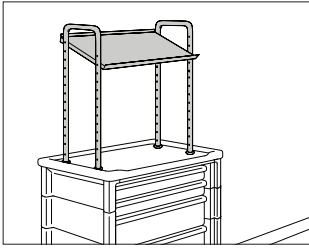

Procedure/Supply Carts – Exterior Accessories

**Product Information**

Description

This post and shelf assembly attaches to the top rear of a single-wide cart. It has a 20<sup>1</sup>/<sub>4</sub>"- or 24<sup>3</sup>/<sub>4</sub>"-wide shelf to support equipment above the cart. The shelf is height adjustable in 3" intervals and mounts horizontally or inclines at a 22° angle. It includes a 1<sup>1</sup>/<sub>2</sub>"-high lip on the front and back edge.

Dimensions

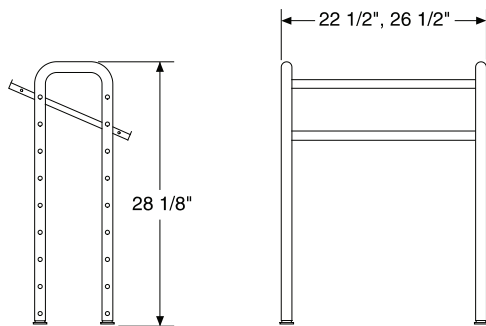
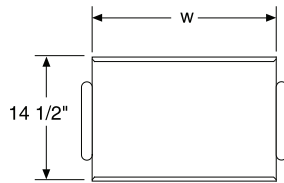

**Specification Information**

Step 1.

**CT7**

Step 2. Cart Interior Width

- 88.** 20" wide
- 94.** 24" wide

Prices for Steps 1-2.

<b>CT788.</b>	\$229
<b>CT794.</b>	\$234

Step 3. Surface Finish

<b>LU</b>	soft white	+\$0
<b>WN</b>	warm grey neutral	+\$0

Above-Cart Add-On Shelf, Single-Wide Cart

CT789.  
CT795.

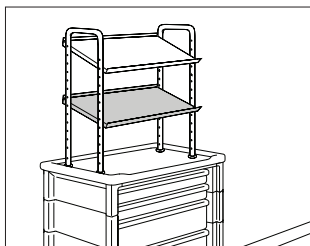

**Product Information**

**Description**

This shelf attaches to the threaded inserts on the posts of a 20"- or 24"-wide above-cart shelf to provide an additional shelf. It is height adjustable in 3" intervals and mounts horizontally or inclines at a 22° angle. It includes a 1½"-high lip on the front and back edge.

**Notes**

Order above-cart shelf (CT788. or CT794.) separately.

**Dimensions**

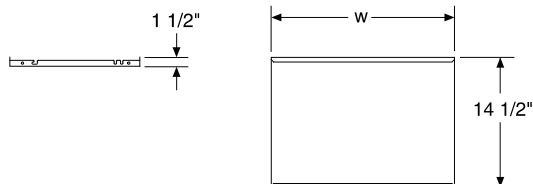

**Specification Information**

**Step 1.**

**CT7**

**Step 2. Cart Interior Width**

**89.** 20" wide

**95.** 24" wide

**Prices for Steps 1-2.**

**CT789.** \$84

**CT795.** \$88

**Step 3. Surface Finish**

**LU** soft white +\$0

**WN** warm grey neutral +\$0

Above-Cart Rail, Single-Wide Cart

CT790.  
CT796.

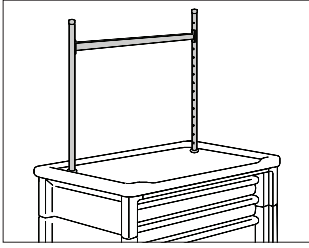

Procedure/Supply Carts – Exterior Accessories

**Product Information**

**Description**

This post and rail assembly attaches to the top rear of a single-wide cart. It has a 20"- or 24"-wide rail to hold rail-mounted components above the cart. The rail is height adjustable in 3" intervals.

**Notes**

Order rail-mounted components separately.

**Dimensions**

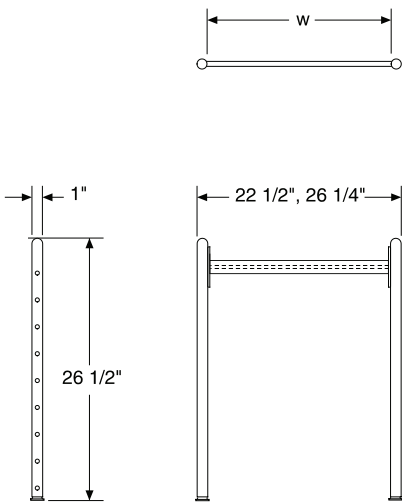

**Specification Information**

**Step 1.**

**CT79**

**Step 2. Cart Interior Width**

- 0.** 20" wide
- 6.** 24" wide

**Prices for Steps 1-2.**

<b>CT790.</b>	\$165
<b>CT796.</b>	\$175

**Step 3. Surface Finish**

<b>LU</b>	soft white	+\$0
<b>WN</b>	warm grey neutral	+\$0

# Above-Cart Add-On Rail, Single-Wide Cart

CT791.  
CT797.

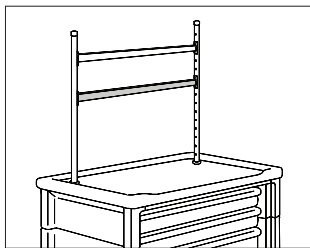

### Product Information

#### Description

This rail attaches to the threaded inserts on the posts of an above-cart shelf or above-cart rail. The mounting position of the rail is height adjustable in 3" intervals. It has a 20"- or 24"-wide rail to hold rail-mounted components above the cart.

#### Notes

Order above-cart rail (CT790. or CT796.) separately.  
Order rail-mounted components separately.

#### Dimensions

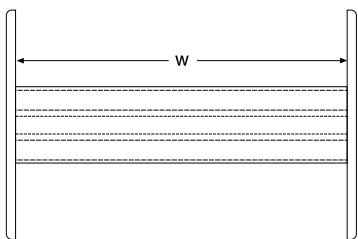
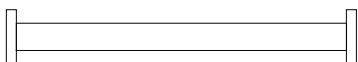
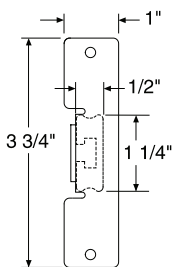

### Specification Information

#### Step 1.

**CT79**

#### Step 2. Cart Interior Width

- 1. 20" wide
- 7. 24" wide

#### Prices for Steps 1-2.

<b>CT791.</b>	\$72
<b>CT797.</b>	\$84

#### Step 3. Surface Finish

<b>LU</b>	soft white	+\$0
<b>WN</b>	warm grey neutral	+\$0

# Above-Cart Equipment Rail, Double-Wide Cart

CT792.

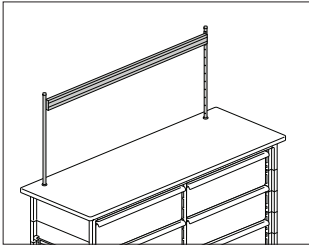

### Product Information

#### Description

This rail attaches to the top rear of a double-wide cart. It holds rail-mounted components and paper management tools. The rail includes two 26½"-high posts and a 41¾"-wide rail that adjusts in 3" increments.

#### Notes

Order rail-mounted and paper management tools separately.

#### Dimensions

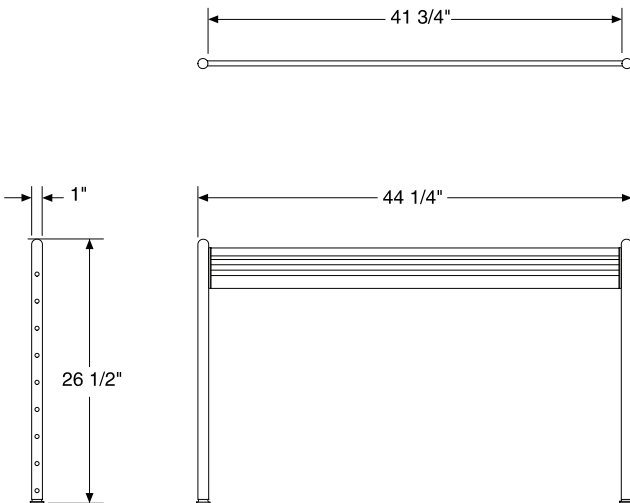

### Specification Information

#### Step 1.

**CT792.** \$210

#### Step 2. Surface Finish

**LU** soft white +\$0  
**WN** warm grey neutral +\$0



# Accessory Rail, Side

CT782.

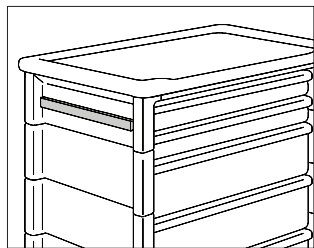

### Product Information

#### Description

This aluminum rail is permanently installed on the side of a cart or locker. It has a 15<sup>3</sup>/<sub>4</sub>"-wide track to hold rail-mounted components; the track allows positive placement, lateral movement, and quick removal of components.

For a single-wide cart, the rail is pre-installed on the left or right side.

For a double-wide cart, the rail is pre-installed in any segment on the right side or in segment 5, 6, or 7 on the left side.

For lockers, the rail can be field installed and includes mounting hardware. Specify any combination of rail position and cart segment when ordering rail for a locker.

#### Notes

Cart segments are numbered from the bottom up starting at 1.

Order rail-mounted components separately.

#### Dimensions

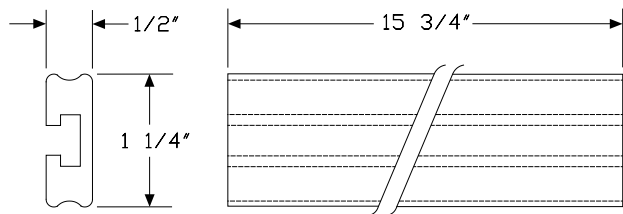

### Specification Information

#### Step 1.

**CT782.15**

#### Step 2. Rail Position

**L** left

**R** right

#### Step 3. Cart Segment

**1** cart segment 1

**2** cart segment 2

**3** cart segment 3

**4** cart segment 4

**5** cart segment 5

**6** cart segment 6

**7** cart segment 7

#### Prices for Steps 1-3.

		<b>1</b>	<b>2</b>	<b>3</b>	<b>4</b>	<b>5</b>	<b>6</b>	<b>7</b>
<b>CT782.15</b>	<b>L</b>	\$39	39	39	39	39	39	39
	<b>R</b>	\$39	39	39	39	39	39	39
								<b>7</b>
<b>CT782.15</b>	<b>L</b>							\$39
	<b>R</b>							\$39

# Accessory Rail, Back

CT782.

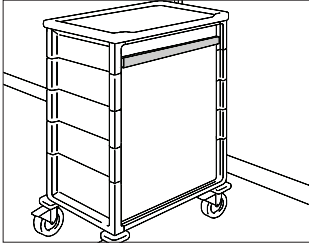

### Product Information

#### Description

This aluminum rail is permanently installed on the back of a single-wide cart. It has a  $21\frac{5}{8}$ "-wide track to hold rail-mounted components; the track allows positive placement, lateral movement, and quick removal of components.

#### Notes

Order rail-mounted components separately.

#### Dimensions

### Specification Information

#### Step 1.

**CT782.20**

\$64

Procedure/Supply Carts—Exterior Accessories

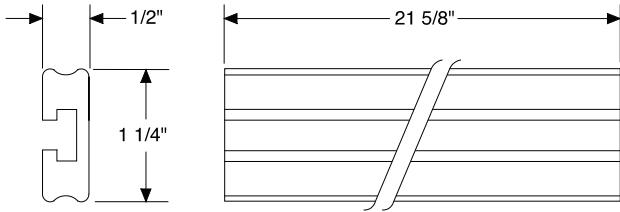

# Electrical Strip, 4 Outlet

CT778.

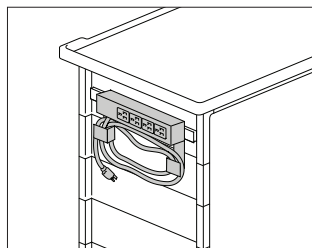

### Product Information

#### Description

This box hangs from an accessory rail. It has 4 hospital-grade 110-volt receptacles, a circuit breaker, and a 6' cord with cord wrap. Electrical strip finish is white; cord wrap finish is soft white.

#### Notes

Order accessory rail (CT782.15 or CT782.20) separately.

#### Dimensions

### Specification Information

#### Step 1.

**CT778.01**

\$214

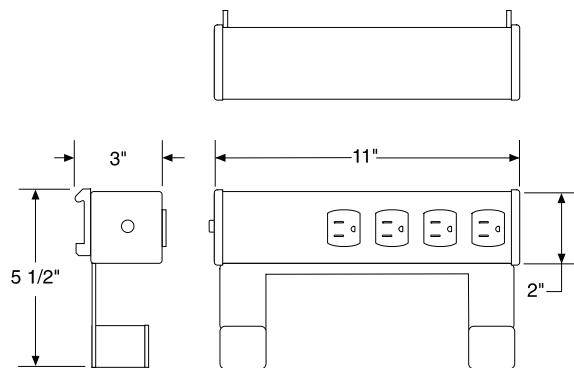

# Supply Basket

CT720.  
CT722.

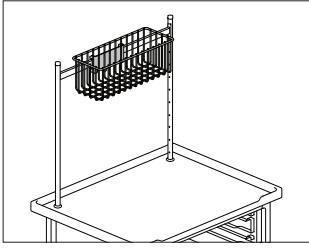

Procedure/Supply Carts – Exterior Accessories

### Product Information

**Description**  
This powder-coated wire basket is available in 2 sizes: the 11<sup>3</sup>/<sub>4</sub>"-wide basket hangs from an accessory rail or above-cart rail; the 18<sup>1</sup>/<sub>4</sub>"-wide basket mounts on an above-cart rail only and includes 2 adjustable dividers. Finish is soft white.

**Notes**  
Order accessory rail (CT782.) or above-cart rail (CT790. or CT796.) separately.

### Dimensions

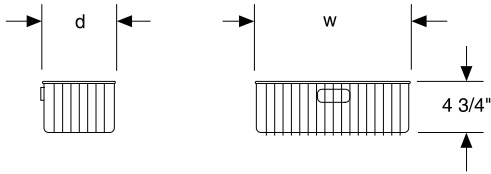
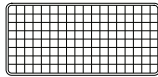

### Specification Information

**Step 1.**  
**CT72**

**Step 2. Size**  
**0.01** 4<sup>3</sup>/<sub>4</sub>" high x 4<sup>3</sup>/<sub>4</sub>" deep x 11<sup>3</sup>/<sub>4</sub>" wide  
**2.01** 4<sup>3</sup>/<sub>4</sub>" high x 9<sup>1</sup>/<sub>2</sub>" deep x 18<sup>1</sup>/<sub>4</sub>" wide

**Prices for Steps 1-2.**  
**CT720.01** \$77  
**CT722.01** \$163

# Suture Basket

CT723.

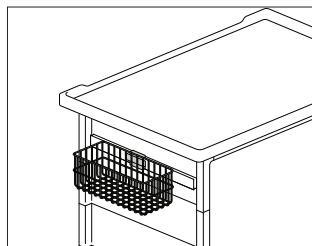

### Product Information

#### Description

This powder-coated basket attaches to an accessory rail. It holds 8 1-dozen count boxes or 4 3-dozen count boxes of sutures. Sutures can be accessed without removing the box from the basket. Finish is soft white.

#### Notes

Order accessory rail (CT782.15) or above-cart rail (CT790. or CT796.) separately.

#### Dimensions

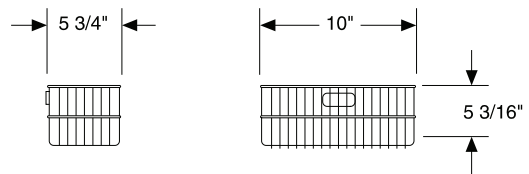
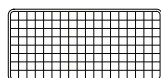

### Specification Information

#### Step 1.

CT723.

\$97

Wastebasket and Holder

CT728.

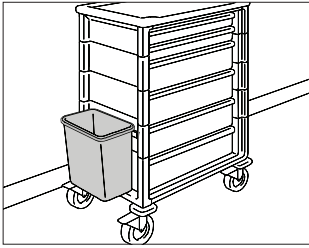

**Product Information**

**Description**  
This container hangs from an accessory rail. Finish is white.

**Notes**  
Order accessory rail (CT782.) separately.

**Dimensions**

**Specification Information**

**Step 1.**  
**CT728.** \$59

Procedure/Supply Carts—Exterior Accessories

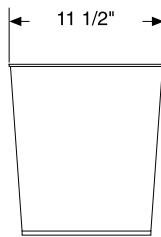
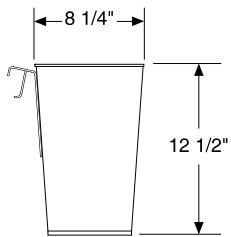
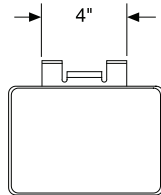

# Rail Clamp

CT729.

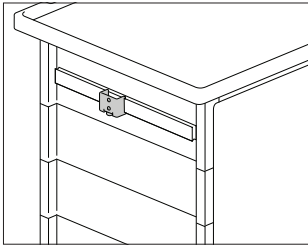

### Product Information

#### Description

This powder-coated clamp attaches to an equipment rail or cart-mounted accessory rail to hold customer-supplied accessories.

#### Notes

Order rail separately:

- Above-cart equipment rail (CT792.)
- Above-cart rail, single-wide cart (CT790. or CT796.)
- Accessory rail, back (CT782.20)
- Accessory rail, side (CT782.15)
- Equipment rail, systems mounted (C1172.)
- Equipment rail, wall mounted (C1170.)

#### Dimensions

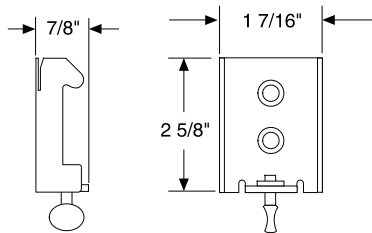

### Specification Information

#### Step 1.

CT729.01

\$26

Chart Holder

CT730.

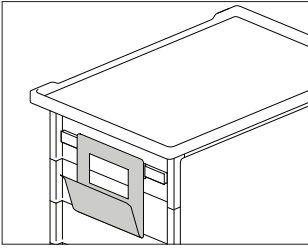

**Product Information**

**Description**  
This metal holder hangs from an accessory rail and organizes clipboards and charts. Finish is soft white.

**Notes**

Order accessory rail (CT782.) separately.

**Dimensions**

**Specification Information**

Step 1.  
**CT730.01** \$77

Procedure/Supply Carts—Exterior Accessories

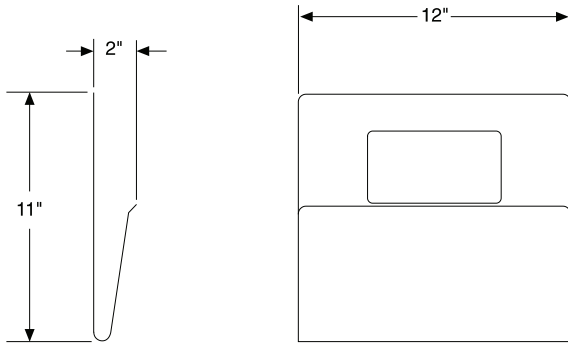



# Sharps Container Holder

CT734.

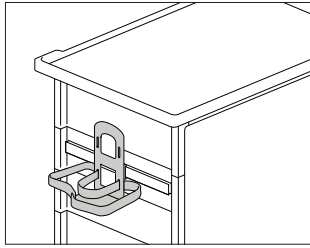

### Product Information

#### Description

This holder hangs from an accessory rail and has adjustable black Velcro straps to hold a variety of containers. A plastic locking sharps cabinet can also be mounted with screws to prevent theft. Finish is soft white.

#### Notes

Order accessory rail (CT782.) separately.

#### Dimensions

### Specification Information

#### Step 1.

CT734.01

\$54

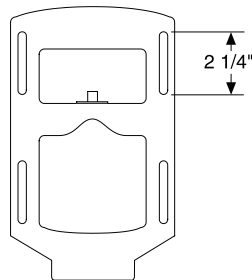
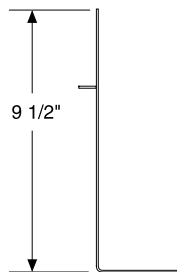
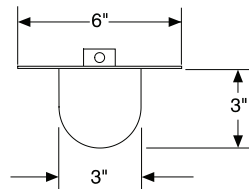

# Chest Tube Rack

CT737.

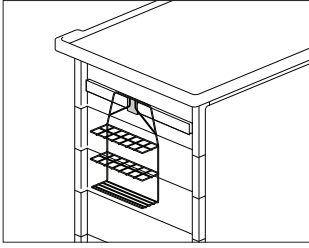

### Product Information

**Description**  
This powder-coated wire rack hangs from an accessory rail and holds up to 14 chest tubes. Finish is soft white.

**Notes**  
Order accessory rail (CT782.) separately.

### Dimensions

### Specification Information

**Step 1.**  
**CT737.** \$111

Procedure/Supply Carts — Exterior Accessories

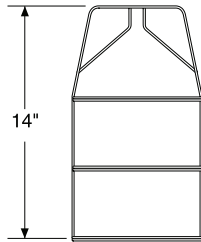
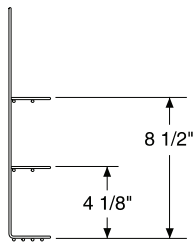
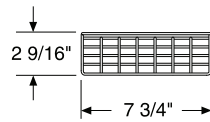

# Utility Hook

CT776.

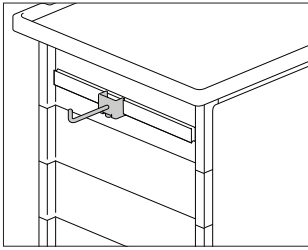

### Product Information

#### Description

This powder-coated hook hangs from an accessory rail to hold clipboards or other hanging items. Finish is soft white.

#### Notes

Order accessory rail (CT782.) separately.

#### Dimensions

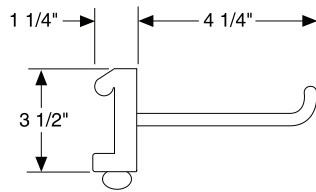

### Specification Information

#### Step 1.

**CT776.01**

\$43

# Cord Wrap

CT779.

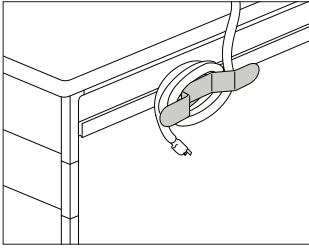

### Product Information

**Description**  
This powder-coated steel rack hangs from an accessory rail and holds excess electrical cord. Finish is soft white.

**Notes**  
Order side accessory rail (CT782.15) or back accessory rail (CT782.20) separately.

### Dimensions

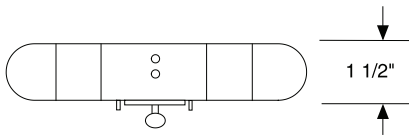
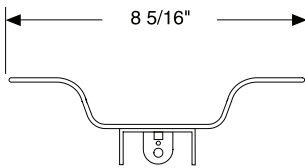

### Specification Information

**Step 1.**  
**CT779.01** \$33

Procedure/Supply Carts—Exterior Accessories

# Glove Box Holder

CT726.

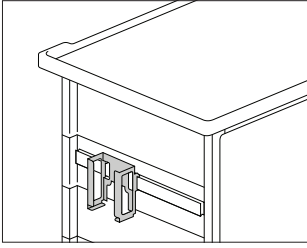

### Product Information

#### Description

This powder-coated steel holder hangs from an above-cart rail or side accessory rail. It holds glove boxes sized 10" x 5" x 3". Finish is soft white.

#### Notes

Order rail separately:

- Above-cart rail, single-wide cart (CT790. or CT796.)
- Above-cart rail, double-wide cart (CT792.)
- Side accessory rail (CT782.); cannot be located in top segment

#### Dimensions

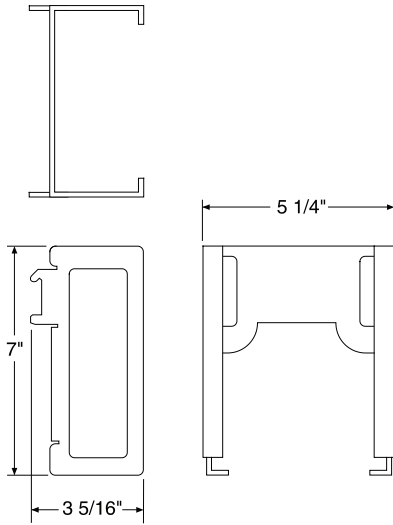

### Specification Information

#### Step 1.

CT726.

\$54

# Tilt-Out Storage Bin

CT9303  
CT9304  
CT9305  
CT9306

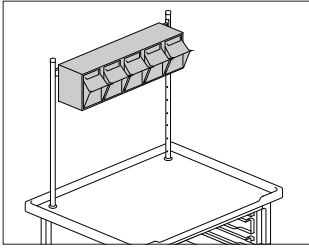

Procedure/Supply Carts — Exterior Accessories

## Product Information

**Description**  
This holder is white plastic and holds clear plastic bins. The bins tilt forward to provide access to contents and can be removed for easy refilling. Each bin has a label holder. It attaches to the above-cart rail only.

**Notes**  
Order above-cart rail, single-wide cart (CT790. or CT796.) or above-cart equipment rail, double-wide cart (CT792.) separately.

## Dimensions

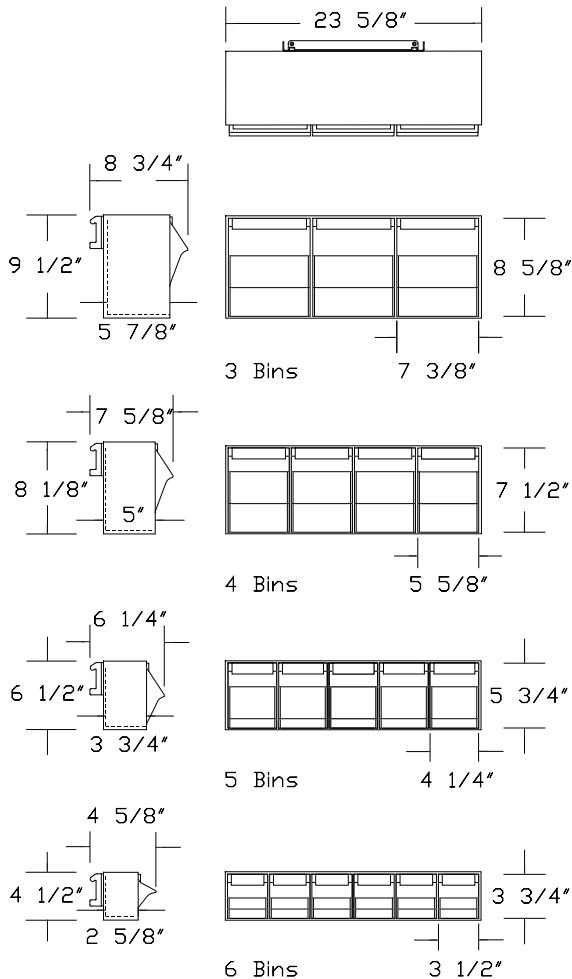

## Specification Information

Step 1.  
**CT930**

### Step 2. Number of Bins

- 3. 3 bins
- 4. 4 bins
- 5. 5 bins
- 6. 6 bins

### Prices for Steps 1-2.

<b>CT9303.</b>	\$106
<b>CT9304.</b>	\$100
<b>CT9305.</b>	\$85
<b>CT9306.</b>	\$70

# Vacuum Pump Shelf

CT756.

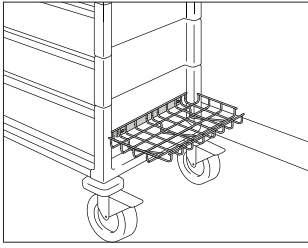

### Product Information

#### Description

This nylon-coated wire shelf attaches to the bottom right outside of a cart. Finish is soft white.

#### Dimensions

### Specification Information

#### Step 1.

**CT756.**

\$146

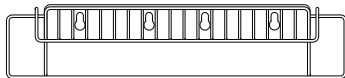
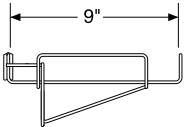
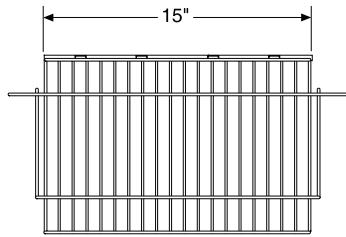

IV Pole

CT770.  
CT793.

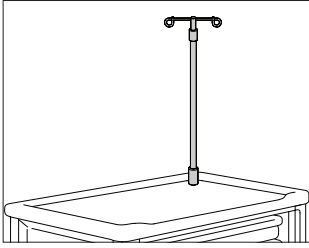

Procedure/Supply Carts – Exterior Accessories

**Product Information**

**Description**  
This pole holds IV bags and has a top-mount pole or post-mount pole. The top-mount pole attaches to the right rear corner of a cart top; it is height adjustable. The post-mount pole has a mounting bracket that attaches to the threaded inserts in the posts of an above-cart shelf or above-cart rail; the position of the bracket is height adjustable in 3" intervals. Finish is soft white.

**Dimensions**

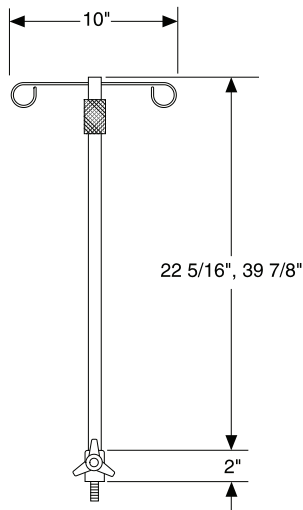

**Specification Information**

Step 1.

**CT7**

Step 2. Mount Position

**70.** top-mount position

**93.** post-mount position

Prices for Steps 1-2.

**CT770.** \$106

**CT793.** \$137



# Oxygen Tank Holder

CT772.

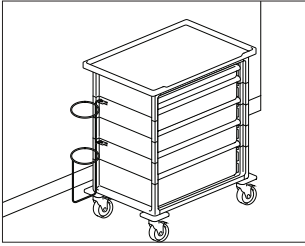

### Product Information

#### Description

This powder-coated wire assembly attaches to the left side of a cart and holds an E-size oxygen tank cylinder. Finish is soft white.

#### Notes

When holder is specified for 36"-high cart, accessory rail cannot be used on segments 1 or 3; for 42"-high cart, accessory rail cannot be used on segments 2 or 4.

#### Dimensions

### Specification Information

#### Step 1.

CT772.

\$85

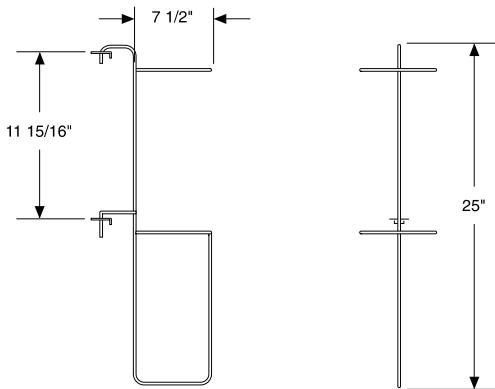
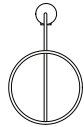

# Cardiac Board and Hangers

CT773.

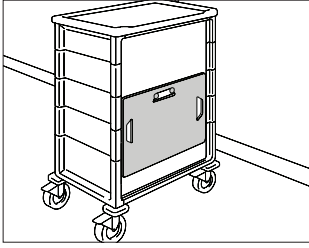

### Product Information

**Description**  
This product attaches to the back of a cart. It has a plastic surface and 3 hand-hold slots. Finish is soft white.

**Notes**  
When cardiac board is installed on 36"-high cart, back accessory rail cannot be installed.

### Dimensions

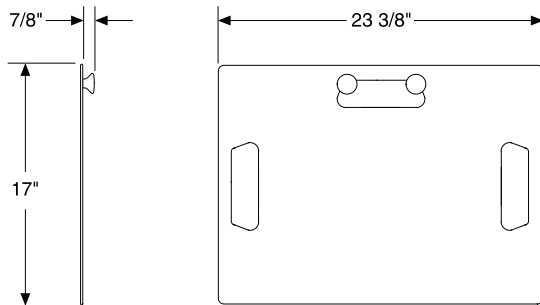
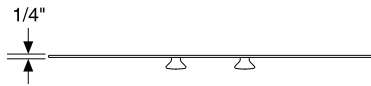

### Specification Information

**Step 1.**  
**CT773.** \$66

Procedure/Supply Carts – Exterior Accessories

Clear Overlay, Single-Wide Cart CT507.

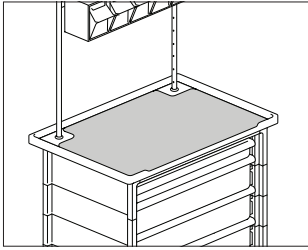

**Product Information**

**Description**

This clear, acrylic overlay sits on top of a single-wide cart with a molded, raised edge or a flat top. The overlay protects documents from spills and damage, and protects the cart top from scratches and wear.

**Notes**

Overlay cannot be used on cart with above-cart shelf (CT788., CT794.).

**Dimensions**

**Specification Information**

**Step 1.**

**CT507.**

**Step 2. Cart Interior Width**

**20** 20" wide

**24** 24" wide

**Prices for Steps 1-2.**

<b>CT507. 20</b>	<b>\$63</b>
<b>24</b>	<b>\$73</b>

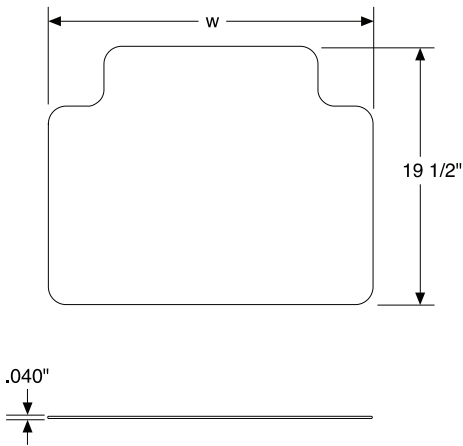

# Corner Shelf

CT761.

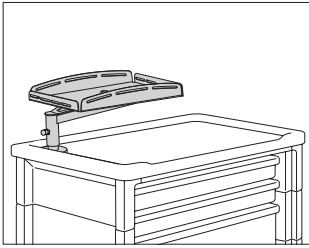

### Product Information

#### Description

This shelf attaches to the left rear corner of a cart top. The top pivots 360° on the mounting arm. The mounting arm can be released to swivel 90°. Straps can hold contents stored on the shelf. Finish is soft white.

#### Notes

Cannot be field installed on a cart with slide-out shelf.  
Above-cart rail and above-cart shelf cannot be installed on same cart with this shelf.

#### Dimensions

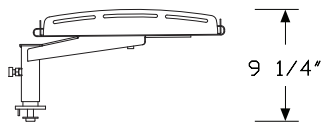
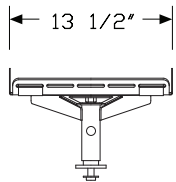
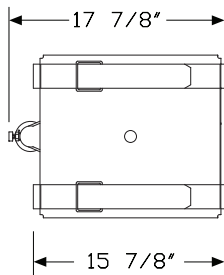

### Specification Information

#### Step 1.

CT761.

\$389

# Index by Product Name

<b>Procedure/Supply Carts</b>	
3"-High Drawer Organizer Kit, 20"-Wide Cart Interior	page(s) 29
3"-High Drawer Organizer Kit, 24"-Wide Cart Interior	32
6"-High Drawer Organizer Kit, 20"-Wide Cart Interior	31
6"-High Drawer Organizer Kit, 24"-Wide Cart Interior	33
Above-Cart Add-On Rail, Single-Wide Cart	67
Above-Cart Add-On Shelf, Single-Wide Cart	65
Above-Cart Equipment Rail, Double-Wide Cart	68
Above-Cart Rail, Single-Wide Cart	66
Above-Cart Shelf, Single-Wide Cart	64
Accessory Rail, Back	70
Accessory Rail, Side	69
Beltline Flip-Up Shelf	63
Breakaway Bar	58
Breakaway Tab	60
Breakaway Tab Holder	59
Cardiac Board and Hangers	86
Cassette	45
Cassette Bin	44
Cassette Cover	46
Chart Holder	76
Chest Tube Rack	78
Clear Lid	35
Clear Overlay, Single-Wide Cart	87
Cord Wrap	80
Corner Shelf	88
Curtain	50
Door	47
Double-Wide Cart	12
Drawer	14
Drawer Color Strips	36, 37
Drawer with Lockable Lid	17
Drawer/Shelf Divider	34
Electrical Strip, 4 Outlet	71
Flip-Up Shelf	62
Full-Extension Drawer Slides, Single-Wide Cart	38
Glove Box Holder	81
IV Pole	84
Keyboard Shelf	43
Lock Bar	51, 53
Lock Bar Software Kit	57
Locked Drawer with Lid	24
Locked Drawer with Lockable Lid	20
Locking Storage and Technology Cart	7
Oxygen Tank Holder	85
Proximity Access	55, 56

Pullout Catheter Rack	42
Rail Clamp	75
Sharps Container Holder	77
Single-Wide Cart	10
Single-Wide Cart, Dual Access	11
Solid Shelf	41
Storage and Technology Cart	5
Subcontainer	27
Subcontainer Divider	30
Supply Basket	72
Suture Basket	73
Tilt-Out Storage Bin	82
Utility Hook	79
Vacuum Pump Shelf	83
Wall Lock	61
Wastebasket and Holder	74
Wire Shelf	39
Wire Shelf Divider	40



# Index by Product Number

C0231	Subcontainer	page(s) 27	CT548.	Cassette Bin	44
C0232			CT550.	Drawer/Shelf Divider	34
C0233			CT560.	3"-High Drawer Organizer Kit, 24"-Wide Cart Interior	32
C0234			CT561.		
C0235			CT562.		
C0236			CT563.		
C0238			CT564.		
C0240			CT570.	6"-High Drawer Organizer Kit, 24"-Wide Cart Interior	33
C0369			CT571.		
C0378	Subcontainer Divider	30	CT575.	6"-High Drawer Organizer Kit, 20"-Wide Cart Interior	31
C0379			CT576.		
C0380			CT580.	3"-High Drawer Organizer Kit, 20"-Wide Cart Interior	29
CT136.	Single-Wide Cart	10	CT581.		
CT142.			CT582.		
CT142.	Single-Wide Cart, Dual Access	11	CT583.		
CT172.	Single-Wide Cart	10	CT584.		
CT236.	Double-Wide Cart	12	CT585.		
CT242.			CT621.	Lock Bar	51
CT272.			CT623.	Proximity Access	55
CT336.	Single-Wide Cart	10	CT624.	Proximity Access	56
CT342.			CT630.	Lock Bar	53
CT372.			CT631.	Lock Bar Software Kit	57
CT436.	Double-Wide Cart	12	CT699.	Breakaway Tab Holder	59
CT442.			CT701.	Breakaway Bar	58
CT472.			CT703.	Curtain	50
CT501.	Drawer	14	CT705.		
CT502.	Locked Drawer with Lid	24	CT707.	Door	47
CT503.	Drawer with Lockable Lid	17	CT708.	Wall Lock	61
CT504.	Full-Extension Drawer Slides, Single-Wide Cart	38	CT709.	Breakaway Tab	60
CT505.	Locked Drawer with Lockable Lid	20	CT710.	Lock Bar	51
CT507.	Clear Overlay, Single-Wide Cart	87	CT713.	Curtain	50
CT508.	Clear Lid	35	CT715.		
CT511.	Drawer	14	CT717.	Door	47
CT512.	Locked Drawer with Lid	24	CT720.	Supply Basket	72
CT513.	Drawer with Lockable Lid	17	CT722.		
CT515.	Locked Drawer with Lockable Lid	20	CT723.	Suture Basket	73
CT521.	Wire Shelf	39	CT726.	Glove Box Holder	81
CT522.			CT728.	Wastebasket and Holder	74
CT523.	Solid Shelf	41	CT729.	Rail Clamp	75
CT525.	Wire Shelf	39	CT730.	Chart Holder	76
CT526.			CT734.	Sharps Container Holder	77
CT527.	Wire Shelf Divider	40	CT737.	Chest Tube Rack	78
CT542.	Cassette	45	CT738.	Pullout Catheter Rack	42
CT542.	Cassette Cover	46	CT750.	Flip-Up Shelf	62
CT543.	Cassette	45	CT751.	Beltline Flip-Up Shelf	63
CT543.	Cassette Cover	46	CT756.	Vacuum Pump Shelf	83

## Index by Product Number *continued*

Index: Product Number

CT761. Corner Shelf	88
CT770. IV Pole	84
CT772. Oxygen Tank Holder	85
CT773. Cardiac Board and Hangers	86
CT776. Utility Hook	79
CT778. Electrical Strip, 4 Outlet	71
CT779. Cord Wrap	80
CT782. Accessory Rail, Back	70
CT782. Accessory Rail, Side	69
CT788. Above-Cart Shelf, Single-Wide Cart	64
CT789. Above-Cart Add-On Shelf, Single-Wide Cart	65
CT790. Above-Cart Rail, Single-Wide Cart	66
CT791. Above-Cart Add-On Rail, Single-Wide Cart	67
CT792. Above-Cart Equipment Rail, Double-Wide Cart	68
CT793. IV Pole	84
CT794. Above-Cart Shelf, Single-Wide Cart	64
CT795. Above-Cart Add-On Shelf, Single-Wide Cart	65
CT796. Above-Cart Rail, Single-Wide Cart	66
CT797. Above-Cart Add-On Rail, Single-Wide Cart	67
CT801. Keyboard Shelf	43
CT9303 Tilt-Out Storage Bin	82
CT9304	
CT9305	
CT9306	
CT990. Drawer Color Strips	36
CT991. Drawer Color Strips	37
CTT. Storage and Technology Cart	5
CTTL. Locking Storage and Technology Cart	7



## 20-Day or Less/Assigned Lead-Time Order Information – Healthcare

### 20-Day or Less/Assigned Lead-Time Programs

20-day or less and assigned lead-time products are designed for established Herman Miller dealers with pre-approved credit.

Products are distributed from multiple manufacturing facilities across the United States. All products and options not designated by an Assigned Lead-Time icon **A** will ship in 20 business days or less after being acknowledged by Herman Miller. Products and options designated by an **A** are on the assigned lead-time program and will ship in 20 days, less than 20 days, or more than 20 days from order acknowledgement.

### Ordering Procedure

Please place orders through Order Manager. If this is not available to you, place orders through mail or fax. Verbal purchase orders will not be accepted.

Order Entry fax number: (616) 654 3085.

For more information, contact your Customer Care representative at:  
(866) 854 3048 EXT 3400

### Shipments and Delivery

Per Herman Miller Terms and Conditions.

### Changes and Cancellation

Per Herman Miller Terms and Conditions.



# Packaging/Keyed-Alike Information – Procedure/Supply Carts

## **Packaging**

Packaging varies according to individual product. A surcharge may be added for special packaging requests. Contact Customer Care for specific information.

## **Keyed-Alike Locks**

All components with locks may be specified keyed alike. Products with keyed-alike locks will be shipped with lock plugs installed. Procedure/supply carts have Medeco locks.

To order keyed-alike locks:

1. Choose keyed-alike product number.
2. Specify a key number if desired (01 through 99). If no key number is specified, one will be selected for you.
3. Specify the quantity of each kind of component to be keyed-alike.

To remove lock plugs from existing components, loosen the hex nut inside the product and remove the plug.

Customers interested in ordering master keys for procedure/supply carts products should contact their local authorized dealer with a written request.

For more information about our products and services or to see a list of dealers, please visit us at [HermanMiller.com](http://HermanMiller.com) or call (800) 851 1196.

This book is recyclable. Printed in U.S.A. on recycled paper.

© 2017 Herman Miller, Inc., Zeeland, Michigan

® **HermanMiller**, , Action Office, Aeron, Aside, Avive, Canvas Office Landscape, Caper, Celle, Co/Struc, Eames, Embody, Equa 2, Ergon 3, Ethospace, Exclave, Fine-Tune, FlexFront, Formcoat, Ground Cloth, Herman Miller Healthcare, Layout Studio, Maharam, Meridian, Mirra, Passage, Pellicle, Perspectives, PostureFit, Resolve, Sayl, Setu, Thrive, Tu, Y-Tower, and Z-Axis are among the registered trademarks of Herman Miller, Inc., and its owned subsidiaries.

™ AireWeave, Bubbletack, Cellular Suspension, Compass, Connect, DOT, Durawrap, Everywhere, Flex-Edge, Hopsak 2, Iota, Keyless Entry, Latitude, Lyris 2, Motia, Multiscrim, Nelson, Renew, Stackable, Swoop, TriFlex, and Twist are among the trademarks of Herman Miller, Inc., and its owned subsidiaries.

®Chemsurf® is a registered trademark of Wilsonart International.

®Corian® is a registered trademark of E.I. du Pont de Nemours and Company Corporation.

FLEXNET™ is a trademark of Milliken & Company.

Floor Saver Glide® is a registered trademark of Carpin Manufacturing, Inc.

®Geiger® is a registered trademark of Geiger International.

®Microsoft® and Natural® Keyboard are registered trademarks of Microsoft Corporation.

®Place Textiles® is a registered trademark of Place Textiles.