



GSA prices effective April 3, 2017
(based on February 1, 2016, commercial price list)
Published April 2017

Multipurpose Seating

Ergon 3® Chairs

General Services Administration Federal Supply Service Authorized Federal Supply Schedule Price List

Online access to contract ordering information, terms and conditions, up-to-date pricing, and the option to create an electronic delivery order is available through GSA Advantage!, a menu-driven database system. The Internet address for GSA Advantage! is www.gsaadvantage.gov.

Office Furniture
FSC Group 71, Part 1
Contract Number: GS-03F-036DA
Contract Period: December 21, 2015—December 20, 2020

Contract Number: GS-28F-8049H
Contract Period: December 27, 2013—April 23, 2018 (Final Expiry Date)

Herman Miller, Inc.
855 East Main Avenue
Zeeland, Michigan 49464
(616) 654 3000 Phone
(616) 654 8278 Fax
www.HermanMiller.com/government

Business Size: Large

Contract Information

1a. Special Item Numbers (SIN)

SIN 71-1
Packaged Offices

SIN 711-1
Furniture Systems

SIN 711-2
Computer Furniture

SIN 711-3
Filing and Storage Cabinets

SIN 711-11
Tables and Accessories

SIN 711-16
Upholstered Seating

SIN 711-18
Multi-Purpose Seating

SIN 711-91
Project Management

Services under this SIN may be used only in conjunction with the purchase of new furniture. Please contact your local Herman Miller representative to discuss the available labor categories (listed below). The hourly rates listed are "Not To Exceed" or "NTE" values.

Furniture Project Manager: \$64.75 per hour
Furniture Project Coordinator: \$49.00 per hour
Build-Out Project Manager: \$80.00 per hour

SIN 711-93
Reconfiguration and Relocation Services

Reconfiguration and Relocation Services will be provided by Herman Miller, Inc., or its participating dealer based on a fee not to exceed \$55 per hour, which applies to services totaling \$150,000 (per SIN) and below only. Services above \$150,000 shall be negotiated on a case-by-case basis. This SIN may only be used with the purchase of new product under SIN 711-1.

See * Additional Notes for Installation & Reconfiguration and Relocation Services.

SIN 711-94
Design/Layout

Design service will be provided by Herman Miller, Inc., or its participating dealer based on a fee not to exceed \$65 per hour.

SIN 711-95
Installation Services

Installation Services will be provided by Herman Miller, Inc., or its participating dealer based on a fee not to exceed \$55 per hour (\$82.50 per hour for after-hours Installation), which applies to services totaling \$150,000 (per SIN) and below only. Services above \$150,000 shall be negotiated on a case-by-case basis.

See * Additional Notes for Installation & Reconfiguration and Relocation Services.

* Additional Notes for Installation & Reconfiguration and Relocation Services:

FOB Destination (Drop Ship): Price includes product delivery to the site, brought to the tailgate of the truck. The purchaser is responsible for unloading.

Prices effective up to the maximum order by SIN only. Above the MO, pricing shall be negotiated on a case-by-case basis between the client and local dealer.

Standard Services are Subject to the Following Conditions:

Installation will be performed during normal weekday working hours.

Adequate facilities for delivery, unloading, moving and staging/ storing the product during the installation process shall be provided.

Service work will not be hindered by other trades.

Electric, heat, and adequate elevator service will be furnished without charge.

The immediate installation area shall be complete and free of debris including the carpet/flooring before installation commences.

Any work requiring a licensed electrician is the responsibility of the buyer.

Additional Charges May Apply For:

Major Metro Markets and any non-ground floor installation.

Major Metro Markets include large population centers and urban environments.

Installation in a clinical/medical environment.

Special restrictions or limits established by local laws, ordinances or the directions of the buyer, including but not limited to restrictions on transportations of materials, street access to the job site and/or dock facilities.

Installations outside of a 50 mile radius of the servicing dealer.

Local Prevailing Wage and/or Union Labor Rates.

Any additional charges shall be quoted by the dealer and approved by the buyer prior to performance of the work.

SIN 711-96
Leasing

Contact Herman Miller participating government dealer for current leasing information.

SIN 711-99
New Product Introductions

Contract Information

continued

1b. Lowest Priced Model

SIN 711-1:	G9999.B	\$6
SIN 711-2:	6-5-D	\$33
SIN 711-3:	9M10018	\$13
SIN 711-11:	DT9A.	\$34
SIN 711-16:	OA401	\$40
SIN 711-18:	WC410NBK3MY7BK	\$229
SIN 711-99:	BVP3.S	\$11

1c. Not applicable

2. Maximum Order

SIN 711-1, SIN 711-2
\$500,000 net product value

SIN 711-3, SIN 711-11
\$300,000 net product value

SIN 711-16, SIN 711-18
\$200,000 net product value

SIN 711-93
\$150,000

SIN 711-94
\$150,000

SIN 711-95
\$150,000

SIN 711-96
\$500,000 net product value

SIN 711-99
\$50,000 net product value

3. Minimum Order

\$100 net

4. Geographic Coverage

Continental U.S.

Orders for Alaska, Hawaii, and Puerto Rico will be shipped F.O.B. inland carrier point of exportation.

5. Point of Production

Zeeland, Ottawa County, Michigan
Spring Lake, Ottawa County, Michigan

6. Pricing

Prices shown are list. Discounts include Industrial Funding Fee.

SIN 711-1

Product: Selected Action Office 1, Action Office 2, C-Style Overhead Storage, Ethospace System, Quadrant Pedestals, Supplemental Products, Tu Pedestals and Pedastools, and approved Herman Miller Options Products.

Standard Lead Time	Single Order Net Purchase	Discount From list
	\$100 - 250,000	73.8%
	\$250,001 - 500,000	76.8%

SIN 711-1

Product: Selected Renew™ Tables, Renew Link and approved Herman Miller Options Products

Standard Lead Time	Single Order Net Purchase	Discount From List
	\$100 - 500,000	72.8%

SIN 711-1

Product: Selected Motia™ Tables, and approved Herman Miller Options Products

Standard Lead Time	Single Order Net Purchase	Discount From List
	\$100 - 500,000	73.8%

SIN 711-1

Product: Tu Wood Pedestals and approved Herman Miller Options Products

Standard Lead Time	Single Order Net Purchase	Discount From List
	\$100 - 300,000	74.3%

SIN 711-1

Product: Selected Canvas Office Landscape and approved Herman Miller Options Products

Standard Lead Time	Single Order Net Purchase	Discount From List
	\$100 - 500,000	74.8%

SIN 711-1

Product: Selected Layout Studio® and approved Herman Miller Options Products

Standard Lead Time	Single Order Net Purchase	Discount From List
	\$100 - 500,000	60.7%

SIN 711-1

Product: Selected Meridian Pedestals, Meridian Pedastools, and approved Herman Miller Options Products

Standard Lead Time	Single Order Net Purchase	Discount From List
	\$100 - 500,000	64.2%

Contract Information

continued

SIN 711-1

Product: Selected Thrive Portfolio and approved Herman Miller Options Products

Standard Lead Time	Single Order Net Purchase	Discount From List
	\$100 - 250,000	62%
	\$250,001 - 500,000	66.4%

SIN 711-2

Product: Passage Desking System and approved Herman Miller Options Products

Standard Lead Time	Single Order Net Purchase	Discount From List
	\$100 - 500,000	56.7%

SIN 711-2

Product: 5000 Series Furniture and approved Herman Miller Options Products

Standard Lead Time	Single Order Net Purchase	Discount From List
	\$100 - 500,000	58.7%

SIN 711-3

Product: Meridian Laterals, Verticals, Towers, and Storage products and approved Herman Miller Options Products

Standard Lead Time	Single Order Net Purchase	Discount From List	Towers & Storage
	\$100 - 300,000	67.3%	62.7%
		66.3%	

SIN 711-3

Product: Tu Lateral Files, Tu Storage, Tu Towers, Tu Wood Cases, Tu Wood Cubbies, Tu Wood Credenzas, Tu Wood Towers, and approved Herman Miller Options Products

Standard Lead Time	Single Order Net Purchase	Discount From List
	\$100 - 300,000	74.3%

SIN 711-11

Product: Selected Tables and Accessories and approved Herman Miller Options Products

Standard Lead Time	Single Order Net Purchase	Discount From List
Avice® Tables	\$100 - 250,000	72.8%
	\$250,001 - 500,000	74.8%
Herman Miller Eames® Tables	\$100 - 250,000	73.6%
	\$250,001 - 300,000	77.6%
Everywhere™ Tables	\$100 - 300,000	72.8%

SIN 711-16

Product: Swoop upholstered seating products and approved Herman Miller Options Products

Standard Lead Time	Single Order Net Purchase	Discount From List
Swoop™	\$100 - 200,000	60.7%

SIN 711-18

Product: Selected Seating and approved Herman Miller Options Products

Standard Lead Time	Single Order Net Purchase	Discount From List
Aeron® (Classic and New)	\$100 - 200,000	64.5%
Aside®	\$100 - 200,000	64.2%
Caper®	\$100 - 200,000	61.5%
Celle®	\$100 - 200,000	59.7%
Embody®	\$100 - 200,000	59.7%
Equa 2®	\$100 - 200,000	65.8%
Ergon 3®	\$100 - 200,000	68.8%
Mirra® 2	\$100 - 200,000	59.7%
Setu®	\$100 - 200,000	59.7%
Sayl®	\$100 - 200,000	62.2%

SIN 711-99

Product: Selected Exclave™, Locale®, Public Office Landscape®, Resolve® System, and approved Herman Miller Options Products

Standard Lead Time	Single Order Net Purchase	Discount From List
Exclave	\$100 - 50,000	61.7%
Locale	\$100 - 50,000	63.7%
Public Office Landscape	\$100 - 50,000	61.7%
Resolve System	\$100 - 50,000	69.8%

7. Quantity Discounts

Reference item #6.

8. Payment Term

Net 30 days

9. Government Commercial Credit Card

- Government commercial credit cards are accepted below the micropurchase threshold.
- Government commercial credit cards are accepted above the micropurchase threshold.

10. Foreign Items

None

11. Time of Delivery

- 90 day ARO
- Expedited delivery: Items listed in the 10-Day section of the catalogs are available for expedited delivery.
- Overnight/2-day delivery: Select items may be available for overnight or 2-day delivery. Contact Herman Miller or a participating dealer for availability and rates.
- Urgent requirements: Agencies may contact contractor or participating dealer to request faster delivery.

Contract Information

continued

12. F.O.B.

F.O.B. destination except Alaska, Hawaii, and Puerto Rico, which will be shipped F.O.B. inland carrier point of exportation.

13. Ordering Address

- a. Herman Miller, Inc.,
Government Customer Care 0161
855 East Main Avenue
Zeeland MI 49464.
- b. For supplies and services, the ordering procedures information on Blanket Purchase Agreements (BPA 's) and a sample BPA can be found at the GSA/FSS Schedule homepage (www.fss.gsa.gov/schedules).

14. Payment Address.

Herman Miller, Inc.
22764 Network Place
Chicago, IL 60673-1227

15. Warranty

Herman Miller, Inc., commercial warranty applies.

16. Export Packing Charge

Prices supplied on request.

17. Terms and Conditions of Government Purchase Card Acceptance

(any thresholds above the micropurchase level)
None.

18. Rental Maintenance and Repair Terms

Not applicable

19. Terms and Conditions of Installation

Installation Services will be provided by Herman Miller, Inc., or its participating dealer based on a fee not to exceed \$55 per hour (\$82.50 per hour for after-hours Installation), which applies to services totaling \$150,000 (per SIN) and below only. Services above \$150,000 shall be negotiated on a case-by-case basis.

Additional Notes for Installation & Reconfiguration and Relocation Services:

FOB Destination (Drop Ship): Price includes product delivery to the site, brought to the tailgate of the truck. The purchaser is responsible for unloading.

Prices effective up to the maximum order by SIN only. Above the MO, pricing shall be negotiated on a case-by-case basis between the client and local dealer.

Standard Services are Subject to the Following Conditions:

Installation will be performed during normal weekday working hours.

Adequate facilities for delivery, unloading, moving and staging/storing the product during the installation process shall be provided.

Service work will not be hindered by other trades.

Electric, heat, and adequate elevator service will be furnished without charge.

The immediate installation area shall be complete and free of debris including the carpet/flooring before installation commences.

Any work requiring a licensed electrician is the responsibility of the buyer.

Additional Charges May Apply For:

Major Metro Markets and any non-ground floor installation.

Major Metro Markets include large population centers and urban environments.

Installation in a clinical/medical environment.

Special restrictions or limits established by local laws, ordinances or the directions of the buyer, including but not limited to restrictions on transportations of materials, street access to the job site and/or dock facilities.

Installations outside of a 50 mile radius of the servicing dealer.

Local Prevailing Wage and/or Union Labor Rates.

Any additional charges shall be quoted by the dealer and approved by the buyer prior to performance of the work.

20. Terms and Conditions of Repair Parts

Not applicable

21. Service and Distribution Points

For service and distribution points nearest you, call (800) 851 1196.

22. Participating Dealers

Access Herman Miller web site for current list of participating dealers: www.HermanMiller.com/government.

23. Preventive Maintenance

Not applicable

24a. Special Attributes.

2016

Herman Miller was recognized by the Michigan Minority Supplier Development Council (MMSDC), as a "Corporation of the Year" and was the only company in West Michigan to receive an "Ambassadors Championing Excellence" Award from the MMSDC this year.

Contract Information

continued

Herman Miller received a “2016 Excellence in Supplier Diversity Award” from the Great Lakes Women’s Business Council.

Herman Miller was named a 2020 Women on Boards Winning Company. Companies selected for this recognition are considered champions of board diversity as 20 percent or more of their board seats are occupied by women.

Herman Miller was selected for inclusion in the 2016 RobecoSAM Sustainability Yearbook for twelfth consecutive year.

2004-2015

Herman Miller was recognized for its commitment to best-in-class economic, environmental, and societal sustainability, earning a spot on the prestigious Dow Jones Sustainability Index (DJSI) for 12 consecutive years. We are one of 317 companies worldwide to be included in the DJSI World Index, and the only contract furniture company recognized globally for its corporate sustainability leadership.

2015

This is the fourth consecutive year that Herman Miller was named one of Michigan’s Best and Brightest Sustainable Companies.

Herman Miller has received the Forest Stewardship Council (FSC) Leadership Award for longstanding commitment to manufacturing with wood sourced from responsibly managed forests. Herman Miller was recognized for being dedicated to reducing environmental impacts by protecting against deforestation and forest degradation.

Herman Miller accepted its second Excellence in Reusable Packaging Award from the Reusable Packaging Association. We were acknowledged for eliminating more than 28,000 tons of corrugated waste from piling up in landfills.

Herman Miller received a Michigan Business Pollution Prevention (MBP₃) Certificate – a recognition given by the Michigan Department of Environmental Quality (MDEQ) to organizations committed to environmental stewardship, conservation, and sustainable operations.

Fast Company named Herman Miller as one of the World’s Top 10 Most Innovative Companies of 2015 in Design.

Renew Sit-to-Stand tables recognized on Record Products 2014 list by Architectural Record.

Herman Miller was again awarded a perfect score in the 2015 Corporate Equality Index.

2014

Herman Miller’s Locale wins International Design Excellence Awards (IDEA) Gold in the Office & Productivity category.

2013

Herman Miller Earns Perfect Score on the Corporate Equality Index. We are one of only 303 major U.S. businesses to receive a perfect score in 2013, an achievement we have now obtained seven years in a row.

Herman Miller is listed in Forbes Magazine inaugural “Platinum List” of America’s 400 best managed, large companies.

For the second consecutive year, Herman Miller is honored as one of West Michigan’s “101 Best and Brightest Sustainable Companies”.

2012

Architectural and design professionals participating in *Contract* magazine’s 2011 Brand Report Awareness Survey have once again named Herman Miller and its subsidiaries as their preferred source for key furnishings in the workplace and healthcare environments.

Herman Miller is named “Corporation of the Year” in the commercial products sector by the Michigan Minority Supplier Development Council.

Herman Miller was inducted into the Made in the USA Hall of Fame. Herman Miller was one of only 20 companies across the nation to receive this distinction. The Hall of Fame showcases exceptional U.S. manufacturers and demonstrates that many high-quality products are made in the United States.

Herman Miller is honored as one of West Michigan’s 101 Best and Brightest Sustainable Companies. The award celebrates organizations that are making their business more sustainable; the lives of their employees better; and the community, both locally and globally, more responsible as a whole.

The Sustainable Asset Management (SAM) group selected Herman Miller for inclusion in “The Sustainability Yearbook 2012” and has awarded Herman Miller both the “SAM Sector Leader” and “SAM Sector Mover” distinctions.

Herman Miller was named one of 16 Section Leaders on Climate Counts 2011-2012 Scorecard Report, making us the industry leader for Home and office Furnishings. The scorecard measures how well the largest companies across 16 industry sectors are preparing for a low-carbon future. Companies are scored based on 22 criteria including a company’s efforts to assess their climate footprint, reduce greenhouse gas emissions, and the ability to communicate their efforts to consumers.

2011

Herman Miller again tops the contract furniture industry in FORTUNE’s ‘Most Admired’ Companies survey. For the 23rd time in 25 years, Herman Miller was the highest ranking furniture manufacturer in a survey among the executives and board members of peer companies and independent industry analysts, as published in FORTUNE Magazine’s Annual ‘Most Admired’ Companies feature. Taking second overall in the expanded, 14 company category of ‘Home Equipment, Furnishings,’ Herman Miller received the number one ranking in five of the nine attributes surveyed.

Contract Information

continued

Trust Across America, a company dedicated to unraveling the complexities of trustworthy business behavior, listed Herman Miller as one of their "Top Ten Most Trustworthy Companies in America 2011."

The Michigan Minority Supplier Development Council (MMSDC) named Herman Miller as its "Corporation of the Year." The company was selected for the honor from among several finalists, including its largest direct competitors. This was the fifth time Herman Miller has received the prestigious award since 2005. When accepting the award, the Inclusiveness & Diversity Program Manager stated, "We are honored to be recognized for our commitment to creating an inclusive supply chain. Herman Miller strives to create a better world through all aspects of our business. Working with diverse suppliers, and the support of the MMSDC, brings us closer to that goal."

Herman Miller receives the Reader's Choice award from TreeHugger's Best of Green: Design and Architecture category for the SAYL chair.

Herman Miller wins prestigious Just Means Social Innovation Award for "Best Sustainability Performance." Herman Miller was nominated for making substantial gains in reducing its CO₂ footprint and significantly outperformed other nominees in the category of Operations.

Herman Miller Healthcare's Compass system was awarded a 2011 Medical Design Excellence Award (MDEA) for its research-based design and ability to be used in a variety of healing spaces, while simultaneously improving the overall delivery of healthcare.

The Sustainable Asset Management (SAM) Group selected Herman Miller for inclusion in the "Sustainability Yearbook 2011" and awarded us both the "SAM Sector Leader" and "SAM Sector Mover" distinctions.

2010

Herman Miller's SAYL chair named "Product Design of the Year" by the International Design Awards (IDA) jury. The award recognizes smart and sustainable multidisciplinary design.

The Flo monitor arm from Herman Miller, was chosen to receive a 2010 "Red Dot" award for product design. The Red Dot Program is considered by many to be the largest and most distinguished international design competition. There were almost 14,000 entries from 68 countries, with more than 4,400 products from 60 countries entered into the product design category.

The NASDAQ OMX CRD Global Sustainability Index (QCRD) has included Herman Miller among their top 100 companies in the world.

Herman Miller achieves LEED-CI Platinum certification from the U.S. Green Building Council for its recently completed Los Angeles Showroom.

2009

Herman Miller named Green Champion by *Business Review West Michigan*.

Herman Miller awarded the 2009 Recycling by Design award by the Institute of Scrap Recycling Industries, Inc.

Aeron receives MBDC Silver Cradle to Cradle certification.

Herman Miller's local fleet is recognized as a U.S. EPA SmartWay Transport Partnership Certified Carrier.

Herman Miller achieves LEED-CI Gold certification for its Main Site B West renovation.

2008

Herman Miller recognized by *Occupational Hazards* magazine as one of America's Safest Companies (ASC). It was one of 18 companies to achieve this distinction.

Herman Miller's Zeeland Main Site awarded status as a STAR participant in the Michigan Voluntary Protection Program (MVPP). The MVPP Star Award is the most prestigious safety and health award given in Michigan. Zeeland Main Site is the fourth Herman Miller facility to receive MVPP status, along with the Greenhouse (in 2005), Midwest Distribution Center (in 2007), and 171st Avenue facility (in 2006).

Teneo, Tu, and Meridian filing and storage product lines receive McDonough Braungart Design Chemistry (MBDC) Silver Cradle to Cradle certification.

2004-2009

Herman Miller achieves sixth consecutive placement on the Dow Jones Sustainability World Index, an international stock portfolio that evaluates the annual performance of the world's largest 2500 companies using economic, environmental, and social criteria, known as the "triple bottom line" of sustainability.

2007

Herman Miller earns the 2007 Waste Wise Gold Achievement Award for Smart Packaging. The U.S. Environmental Protection Agency (EPA) recognizes Herman Miller for its ongoing commitment to reduce transport packaging.

Herman Miller's IT North building in its Main Site facility earns LEED-CI Silver certification from the U.S. Green Building Council (USGBC).

My Studio Environments receive McDonough Braungart Design Chemistry (MBDC) Silver Cradle to Cradle certification.

Herman Miller, Inc., chosen for Sustainable Business 20 List. The company is featured for the fifth time as one of the "World's Top Sustainability Stocks," which includes companies with strong environmental initiatives and solid financial performance.

Herman Miller earns LEED-CI Gold Certification from the U.S. Green Building Council (USGBC) for its National Design Center in Atlanta, Georgia.

Contract Information

continued

2006

Business Ethics ranks Herman Miller, Inc. among the “100 Best Corporate Citizens” in America.

Herman Miller earns LEED-CI Gold Certification from the U.S. Green Building Council (USGBC) for its National Design Center in New York City, New York. This is the first LEED-CI Gold rating to be awarded in New York City.

Herman Miller honored by the U.S. Environmental Protection Agency (EPA) with its WasteWise Award for its commitment to build or renovate its facilities--leased or owned--to meet at least a LEED (Leadership in Energy and Environmental Design) Silver certification.

2005

The U.S. Environmental Protection Agency's Pacific Southwest office honors Herman Miller with its seventh annual Environmental Awards, recognizing the company's efforts to protect and preserve the environment during 2004.

The U.S. Environmental Protection Agency presents Herman Miller with its WasteWise 2005 Product Stewardship Gold Achievement Award in the Design category; Honorable Mention also received in the Large Business category for its recycling efforts.

Herman Miller earns LEED Gold Certification from the U.S. Green Building Council (USGBC) for the Design Yard Front Door in Holland, Michigan.

Michigan “Clean Corporate Citizen” Award given to Herman Miller's Greenhouse manufacturing facility for its environmental management system and record for active pollution prevention.

2004

American Institute of Architects (AIA) Committee on the Environment selects Herman Miller's Building C-1 renovation as one of the AIA/COTE Top 10 Green Projects in America.

The U.S. Green Building Council (USGBC) names Herman Miller among the recipients of its Green Building Leaders Recognition Award for 2004, in the Green Building Business category.

For the third year in a row, Herman Miller is included on SustainableBusiness.com's list of the top 20 sustainable stocks among public companies worldwide.

2003

The University of Colorado, Leeds School of Business, names Herman Miller among three finalists for the first annual “Summit Awards for Social Impact,” citing the company's environmental leadership.

Environmental Building News magazine's GreenSpec Product Directory names Herman Miller's Mirra chair among its Top 10 picks for best new “green” products.

2002

Program Champion recognition from the U.S. Environmental Protection Agency's WasteWise Program, for overall waste reduction achievements.

2000-2003

Business Ethics ranks Herman Miller, Inc. in the top 10 among the “100 Best Corporate Citizens” in America, and first among all ranked companies for “Service to the Environment.”

1999-2001

Environmental Protection Agency's (EPA) Large Industry Partners of the Year Award for overall waste reduction achievements.

2000

Waste Reduction Award Program (WRAP) from the State of California Environmental Protection Agency Integrated Waste Management Board for improving the environment by reducing waste.

24b. Section 508 Compliance

Not applicable

25. Data Universal Numbering System (DUNS): 00-601-2801

26. Registered in System for Award Management (www.SAM.gov) Database

27. Cancellation

Prior to production, no cancellation charge will apply. After production, only actual cost incurred that the contractor can demonstrate if items are sold after 3 months.

28. Restocking Charges

Agencies must notify the contractor for authorization prior to returning any items. The customer agency will be required to pay all packaging and return freight charges. A restocking fee of 50% for Systems Furniture and 35% for all other product lines will be charged for any returned items.

Herman Miller Miscellaneous Information:

Federal ID Number: 38-0837640

Commercial and Government Entity Code (CAGE): 40636

Data Universal Numbering System (DUNS) 00-601-2801

Commercial Entity Code (CEC): 00702290J

Introduction	page 2
Ergon 3® Chairs	3
Work Chair	5
Accessories	8
Appendices	
20-Day or Less/Assigned Lead-Time Order Information	
Casters and Glides	
Fire Retardancy-Seating	
Customer's Own Material/Customer's Own Leather Order Information-Seating	
Proprietary Textiles Application Chart-Seating	
Proprietary Textile Colors-Seating	
Maharam® Application Chart-Seating	
Maharam Colors-Seating	
For the latest materials information, refer to the Materials pages on HermanMiller.com.	

Introduction

A Note on the Organization of This Book

There are a few signals that will help you understand the organization of this book. Once you know them, you should be able to find your way around easily.

Like a newspaper, this book is formatted with columns of text and illustrations that run vertically.

Information wraps from one column to the next and continues for as many pages as it needs to.

Black bars are clues.

A black bar at the top of a page signals the start of information about a product.

This information is divided into two sections, each signaled by a black bar. Product Information includes a description, additional notes, and dimensional drawings. Specification Information, which always begins at the top of a column, includes a series of steps. Each step represents a decision you need to make in order to complete your product number. Steps must be followed sequentially. The number of pages needed to complete information on a product varies; some will be complete in one page; others may fill three or four pages. Just continue going through the steps until you run into the next product, signaled by the black bar at the top of the page.

Black tabs running along the outside edge of the page help you locate what section you are in or what section you want to go to. You can thumb forwards or backwards to find a section; tabs and text appear on both sides of the page.

The additional pages in the back of the book include the appendices and indices. They are signaled by a long black bar running along the outside edge of the page.

The index is presented two ways.

The first index is in alphabetical order by product name. It can be helpful if you are new to the products and numbering scheme or if you are looking for a type of product, such as work chair or round table.

The second index is by product number. It lists, in alphanumeric order, the base product number, typically a five-digit number.

General Information

This book is effective April 3, 2017, subject to change without notice. Products may be purchased from authorized Herman Miller dealers who will quote prices upon request. For more information about our products and services or to see a list of dealers, visit www.HermanMiller.com.

All prices are list prices. Additional services, such as planning services, design, storage, and installation, are not included and must be added to these prices when the additional services are requested.

Illustrations, specifications, and prices are based on the latest information at the time of publication. The right is reserved to make changes at any time without notice in prices, fabrics, finishes, materials, specifications, and models, and also to discontinue models and finishes.

Dimensions shown in the drawings are engineering drawing dimensions rounded up to the nearest $\frac{1}{8}$ ". Product is shipped set up or knocked down. Products that include "Shipped knocked down" in the description require some assembly. If this statement does not appear in the description, the product is shipped assembled.

Service problems are normally handled by a Herman Miller authorized dealer. Where this cannot be accomplished on a local level, service problems should be referred to the Customer Care Representative for your region, Herman Miller, Inc., Zeeland, Michigan 49464.

20-Day or Less/Assigned Lead-Time Shipments

All products and options in this price book not designated by an Assigned Program icon  will ship in **20 business days or less** after being acknowledged by Herman Miller.

Products and options designated by an  are on the assigned lead-time program and may ship in 20 days, less than 20 days, or more than 20 days from order acknowledgement.

Work Chair

Accessories

Work Chair

EE122
EE123

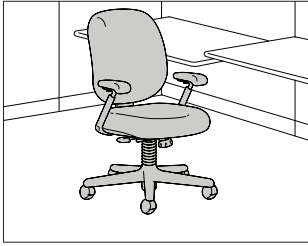

Product Information

Description

This chair is available in 2 sizes and has deeply contoured seat and back cushions with thick foam padding. It has a 5-star base, pneumatic seat-height adjustment, and back-height adjustment. All chair sizes have high backs; size B is also available in a mid-back.

Tilt options include a knee-tilt swivel that allows the user to lock the seat angle in a horizontal position, or a knee-tilt swivel with forward angle that allows the user to select a horizontal or 5° forward seat angle; the seat angle can be locked in either position.

Adjustable back angle has a 10° tilt range from an upright position.

Arm choices include no arms, fixed arms, or adjustable arms that adjust 4" vertically with armpads that adjust 3/4" horizontally and pivot outward and inward over a 25° range.

Fire-retardant chair meets CAL 133 requirements; this chair is manufactured with cushions covered with a fire-barrier material and is upholstered in approved fire-retardant fabrics.

Notes

Chairs are tested and warranted for use by persons 300 pounds and under.

Knee tilt option (2) is not available on C-size chairs.

For information on casters and glides, see Casters and Glides in Appendices.

Customer's Own Material (COM) requires 1 1/2 yards for size B chairs, and 1 2/3 yards for size C; add 3/4 yard to chair with fabric-back outer shells.

Customer's Own Leather (COL) requires 40 square feet for all sizes; add 8 square feet to chair with leather-back outer shells (FB option) and an additional 8 square feet when specifying upholstered armpads. See Order Information in Appendices.

Dimensions

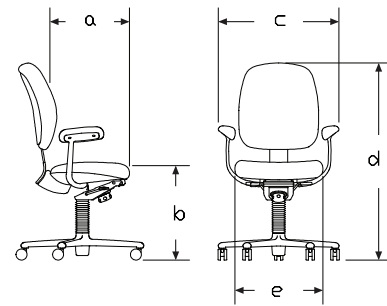

	Size B Mid-Back	Size B	Size C
a	16 3/4	16 3/4	18 1/2
b	16 - 20 3/4	16 - 20 3/4	16 - 21
c	26 1/2	26 1/2	27 3/4
d	40 max	44 3/4 max	45 1/4 max
e	20 1/4	20 1/4	21 1/2

All dimensions are in inches.

Specification Information

Step 1.

EE12

Step 2. Tilt

- 2** knee tilt
- 3** knee tilt with forward angle

Step 3. Arms

- N** no arms
- P** fixed arms, vinyl
- L** fixed arms, leather
- A** adjustable arms, vinyl
- R** adjustable arms, leather

Step 4. Size/Back Height

For knee tilt (2)

- K** b size and mid-back
- B** b size and high back

For knee tilt with forward angle (3)

- K** b size and mid-back
- B** b size and high back
- C** c size and high back

Step 5. Fire Retardancy

For not fire retardant (), skip this step.*

For no arms (N), fixed arms, vinyl (P), or adjustable arms, vinyl (A)

- FR** fire retardant

For fixed arms, leather (L) or adjustable arms, leather (R), skip this step.

Prices for Steps 1-5.

			*	FR
EE122	N	K	\$1044	1124
		B	\$1044	1124
	P	K	\$1205	1285
		B	\$1205	1285
	L	K	\$1205	—
		B	\$1205	—
	A	K	\$1331	1411
		B	\$1331	1411
	R	K	\$1331	—
		B	\$1331	—

EE123	N	K	\$1117	1198
		B	\$1117	1198
		C	\$1117	1198
	P	K	\$1279	1360
		B	\$1279	1360
		C	\$1279	1360
	L	K	\$1279	—
		B	\$1279	—
		C	\$1279	—
	A	K	\$1403	1513
		B	\$1403	1513
		C	\$1403	1513
	R	K	\$1403	—
		B	\$1403	—
		C	\$1403	—

Step 6. Back Angle

- AJ** adjustable +\$115

Step 7. Base Finish/Frame and Outer Shell Finish

- BU** black umber +\$0
- MT** medium tone +\$0

Step 8. Casters/Glides

- GF** 2½" glide, hard floors or carpet +\$0
- BB** 2½" hard caster, black yoke, carpet only +\$0
- C7** 2½" caster, black yoke, hard floors or carpet +\$40
- C9** 2½" braking caster, black yoke, hard floors or carpet +\$40

Step 9. Outer Shell Finish

- U6** nonupholstered +\$0
- FB** fabric back +\$160

Step 10. Armpad Finish

For fixed arms, vinyl (P) or adjustable arms, vinyl (A) with nonupholstered (U6), or fabric back (FB)

- BK** black +\$0
- MT** medium tone +\$0

For fixed arms, leather (L) or adjustable arms, leather (R)

- AT** upholstered armpad, leather +\$40

Step 11. Fabric

See application chart and textiles list for fabric usage and numbers.
 First 2 digits of number indicate fabric line; remaining digit(s) indicate fabric color.

For no arms (N), fixed arms, vinyl (P), adjustable arms, vinyl (A) AND not fire retardant (*)

Price Category 1	+\$0
Price Category 2	+\$31
Price Category 3	+\$61
Price Category 4	+\$97
Price Category 7	+\$180
Price Category E	+\$136
Price Category G	+\$228

For no arms (N), fixed arms, vinyl (P), adjustable arms, vinyl (A) AND fire retardant (FR)

Price Category 1	+\$0
Price Category 2	+\$31
Price Category 3	+\$61

For fixed arms, leather (L) or adjustable arms, leather (R) with not fire retardant

Price Category 7 A	+\$180
--	--------

Adjustable Arm Kit

EE900

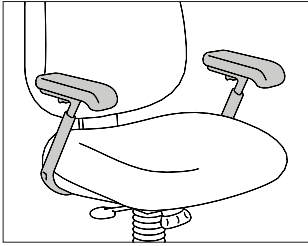

Ergon 3® Accessories

Product Information

Description
 These arms retrofit to an Ergon 3® chair. They adjust 4" vertically with armpads that adjust ¾" horizontally and pivot outward and inward over a 25° range. Attachment hardware is included.
 Fire-retardant arms meet CAL 133 requirements.

Notes
 Customer's Own Leather (COL) requires 8 square feet. See Order Information in Appendices.

Dimensions

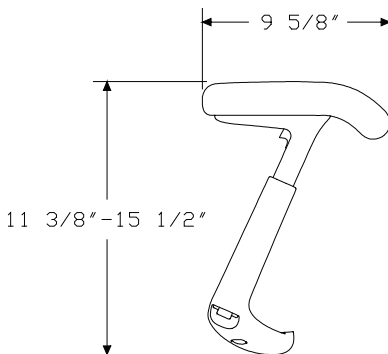

Specification Information

Step 1.

EE900A

Step 2. Armpad Upholstery

- N** nonupholstered armpads
- F** upholstered armpads, leather

Step 3. Fire Retardancy

For not fire retardant (), skip this step.*

For nonupholstered armpads (N)

- FR** fire retardant

For upholstered armpads, leather (F), skip this step.

Prices for Steps 1-3.

	*	FR
EE900A N	\$304	319
F	\$366	—

Step 4. Frame Finish

- BU** black umber +\$0
- MT** medium tone +\$0

Step 5. Armpad Finish

For nonupholstered armpads (N)

- BK** black +\$0
- MT** medium tone +\$0

Step 6. Armpad Leather

For upholstered armpads, leather (F) with not fire retardant
 See application chart and textiles list for fabric usage and numbers.
 First 2 digits of number indicate fabric line; remaining digit(s) indicate fabric color.

Price Category 7 **A** +\$0

20-Day or Less/Assigned Lead-Time Order Information

20-Day or Less and Assigned Lead-Time Programs

20-day or less and assigned lead-time products are designed for established Herman Miller dealers with pre-approved credit.

Products are distributed from multiple manufacturing facilities across the United States. All products and options not designated by an Assigned Lead-Time icon [A] will ship in 20 business days or less after being acknowledged by Herman Miller. Products and options designated by an [A] are on the assigned lead-time program and will ship in 20 days, less than 20 days, or more than 20 days from order acknowledgement.

Ordering Procedure

Please place orders through Order Manager. If this is not available to you, place orders through mail or fax. Verbal purchase orders will not be accepted.

Order Entry fax number for Passage®, 5000 Series, and Meridian® Filing and Storage: (616) 846 9236.

Order Entry fax number for all other products:
(616) 654 3085.

For more information, contact your Customer Care representative at:
(866) 854 3048 EXT 3400.

Shipments and Delivery

Per Herman Miller Terms and Conditions.

Changes and Cancellation

Per Herman Miller Terms and Conditions.



Casters and Glides

⚠	WARNING	⚠
Depending on the floor surface, chair may unexpectedly roll away from user when entering or exiting the chair, possibly leading to unexpected injury. Please refer to descriptions of floor types when selecting casters.		

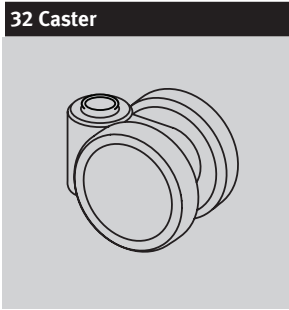

32 Caster
 17/8-inch-diameter hard double-wheel caster; black nylon wheels and yoke; for use on carpet only
 Applicable on:
 Sayl® Chairs

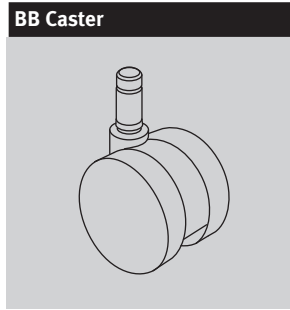

BB Caster
 2 1/2-inch-diameter hard double-wheel caster; black nylon wheels and yoke; for use on carpet only
 Applicable on:
 New Aeron® Chairs
 Classic Aeron Chairs
 Caper® Chairs
 Celle® Chairs
 Embody® Chairs
 Equa 2® Chairs
 Ergon 3® Chairs
 Mirra® 2 Chairs
 Sayl Chairs

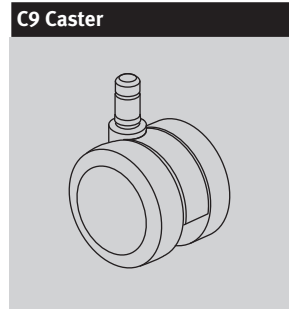

C9 Caster
 2 1/2-inch-diameter double-wheel caster; black nylon wheels and yoke; soft polyurethane tread; internal brake; for use on hard floors or carpet
 Applicable on:
 Classic Aeron Chairs
 Caper Chairs
 Celle Chairs
 Embody Chairs
 Equa 2 Chairs
 Ergon 3 Chairs
 Mirra 2 Chairs
 Sayl Chairs
 Setu® Stools Only

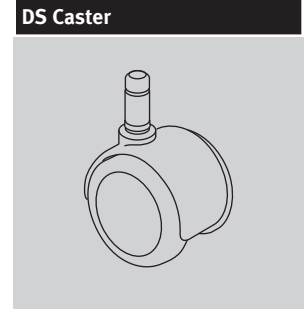

DS Caster
 2-inch-diameter soft double-wheel braking caster; black nylon wheels and hood; for use on hard floors only
 Applicable on:
 Aside® Chairs
 Caper Chairs

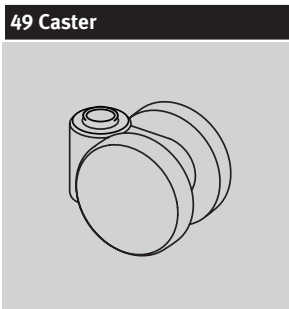

49 Caster
 17/8-inch-diameter soft double-wheel caster; black nylon wheels and yoke; for use on hard floors or carpet
 Applicable on:
 Sayl Chairs

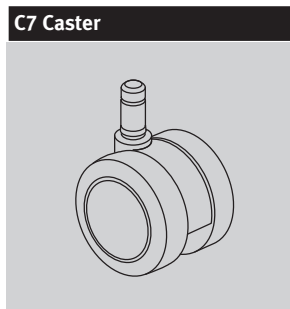

C7 Caster
 2 1/2-inch-diameter double-wheel caster; black nylon wheels and yoke; soft polyurethane tread; for use on hard floors or carpet
 Applicable on:
 New Aeron Chairs
 Classic Aeron Chairs
 Caper Chairs
 Celle Chairs
 Embody Chairs
 Equa 2 Chairs
 Ergon 3 Chairs
 Mirra 2 Chairs
 Sayl Chairs

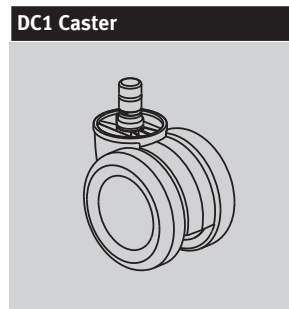

DC1 Caster
 2 1/2-inch-diameter double-wheel braking caster; black nylon wheels and yoke; for use on hard floors or carpet; quiet roll technology
 Applicable on:
 New Aeron Chairs

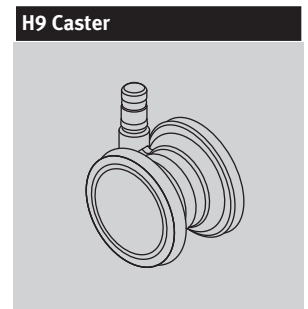

H9 Caster
 2 1/2-inch-diameter double-wheel caster; clear polycarbonate wheels; nylon yoke; soft polyurethane tread; for use on carpet only.
 Applicable on:
 Embody Chairs
 Setu Chairs

Casters and Glides

continued

HCC Caster

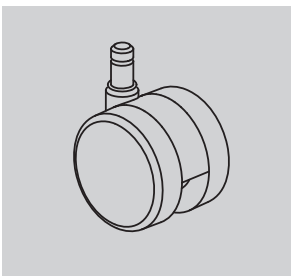

2 1/2-inch-diameter double-wheel medium roll resistance caster; black yoke; for use on hard floors or carpet.

Applicable on:
Setu Chairs

SC8 Caster

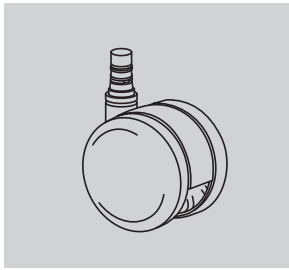

2 1/2-inch-diameter double-wheel caster; black nylon wheels and yoke; soft polyurethane tread; quiet roll technology; for use on hard floors or carpet

Applicable on:
Mirra 2 Chairs

U5 Caster

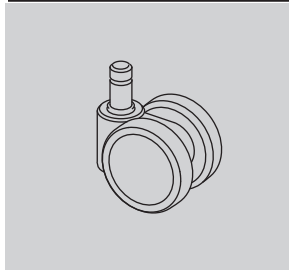

1 7/8-inch-diameter soft double-wheel caster; black nylon wheels and yoke; for use on hard floors or carpet

Applicable on:
Aside Chairs
Caper Chairs

69 Glide

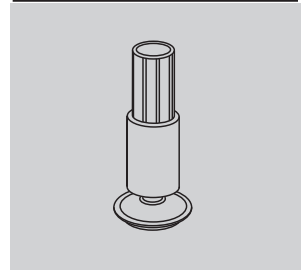

(Front glide shown)
2 1/8-inch-high glide; black glass-filled nylon stem; steel-plated swivel foot with Floor Saver Glide® insert; for use on hard floors only

Applicable on:
Sayl Chairs

OC Caster

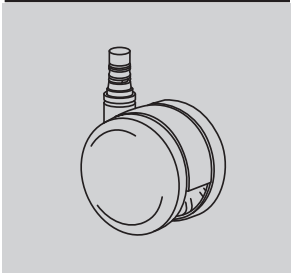

Setu-specific 2 1/2-inch-diameter double-wheel medium roll-resistant caster; black nylon wheels and yoke; soft polyurethane tread; for use on hard floors or carpet; quiet roll technology

Applicable on:
Setu Chairs

U4 Caster

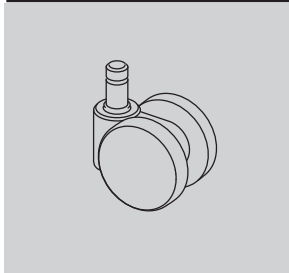

1 7/8-inch-diameter hard double-wheel caster; black nylon wheels and yoke; for use on carpet only

Applicable on:
Aside Chairs
Caper Chairs

16 Glide

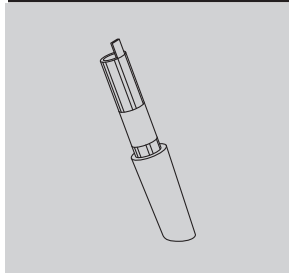

(Front glide shown)
2 1/8-inch-high glide; black or fog acetate; for use on carpet only

Applicable on:
Sayl Chairs

GF Glide

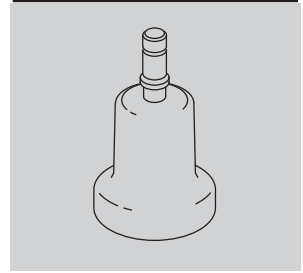

2 1/2-inch-high glide; black nylon; for use on hard floors or carpet

Applicable on:
New Aeron Chairs
Classic Aeron Chairs
Caper Chairs
Celle Chairs
Equa 2 Chairs
Ergon 3 Chairs
Mirra 2 Chairs
Sayl Chairs

Casters and Glides

continued

HG Glide



1/2-inch-high glide; black nylon glide with stainless-steel insert; for use on hard floors or carpet
Applicable on:
Aside Chairs

SG Glide (for Aside)



1/2-inch-high glide; black nylon; for use on carpet only
Applicable on:
Aside Chairs

Y7 Glide



1 7/8-inch-high glide; black acetal; for use on carpet only
Applicable on:
Caper Chairs

SB Glide



1/4-inch-high, 1-inch diameter glide; thermoplastic CAP material (G1 base has black glides; XT base has clear glides); for use on hard floors or carpet
Applicable on:
Classic Aeron Chairs
Equa 2 Chairs

XS Glide

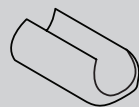

1/8-inch-high glide; polycarbonate in black, fog, clear, and studio white finishes; for use on hard floors or carpet
Applicable on:
Sayl Chairs

YX Glide

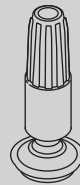

1 7/8-inch-high glide; black nylon stem; steel-plated swivel foot with Floor Saver Glide® insert; for use on hard floors only
Applicable on:
Caper Chairs



Fire Retardancy – Seating

Fire Retardancy

Fire-retardant chairs are manufactured with special cushions, cushions covered with fire-barrier material, and/or are upholstered in approved fire-retardant fabrics. These chairs meet California TB 133 requirements.

All foam, Proprietary Textiles, and Textile Alliance Program™ (TAP™) textiles on HermanMiller seating products comply with California TB 117-2013.

	State of California Bureau of Home Furnishings, Technical Bulletin 133	State of California Bureau of Home Furnishings, Technical Bulletin 117-2013
AireWeave™ 2	FR	●
Balance ¹	FR	●
Bento	FR	●
Coil	FR	●
ColorGuard	FR	●
Crepe	FR	●
Crossing	FR	●
Flexnet™	FR	●
Gem	FR	●
Latitude™	FR	●
Leather	FR	●
Lyris 2™ ³	FR	●
Mercer	FR	●
Moiré	FR	●
Pellicle® Classic ⁴	FR	●
Pellicle Tuxedo	FR	●
Pellicle Wave	FR	●
Plateau	FR	●
Quilty	FR	●
Railroad	FR	●
Rhythm ²	FR	●
Slideshow	FR	●
Spools	FR	●
Stitches	FR	●
Strata	FR	●
Twist	FR	●

- Fabric meets code requirements.

FR To meet California TB 133 code requirements, fabrics must be applied to approved chairs identified with FR product numbers.

To verify a fabric is approved for a specific chair, see the Fire-Retardant listing on the Seating Textiles Application Chart.

¹ Balance 3512 carbon and 3513 black only available on Embody® FR chairs.

² Rhythm 3014 black only available on Embody FR chairs.

³ Lyris 2 4W11 graphite only available on Setu® FR chairs.

⁴ Pellicle Classic 3Do1 carbon only available on Classic Aeron® FR chairs.



Customer's Own Material/Customer's Own Leather Order Information — Seating

Packaging

Packaging varies according to individual product. A surcharge may be added for special packaging requests. Contact Customer Care for specific information.

Customer's Own Material/Customer's Own Leather

Program Overview

The Customer's Own Material (COM) and Customer's Own Leather (COL) program gives you the option of using textiles other than those listed. Herman Miller will test textiles for application to Herman Miller products and will process orders for those with approved COM/COL textiles only. COM/COL are assigned lead-time textiles.

Omni lists an overview of fabrics and leathers that have been tested and indicates whether or not they were approved for application to Herman Miller products.

Specific information on the terms and conditions, testing, approval, and ordering process for COM/COL is listed below. Questions about the COM/COL program and requests for assistance may be directed to your COM representative at:

(616) 654 3400

(866) 854 3048 EXT 6543400

Customer's Own Material/Customer's Own Leather Warranty

Herman Miller does not warrant COM/COL textiles. COM/COL textiles are tested for application only; they are not tested for performance. The Herman Miller warranty does apply to the underlying products.

Suppliers of COM/COL textiles are responsible for color consistency within commercial tolerances, UV stability, and resistance to soiling and perspiration.

Customer's Own Material/Customer's Own Leather Pricing

COM is a Category 1 fabric. There are no application charges for COM fabrics. COL is a Category 7 textile; refer to prices on specific products to determine the application charge.

Ordering and payment for COM/COL textile yardage are the responsibility of the customer and the textile supplier.

If desired, Herman Miller will purchase COM textiles directly from True Textiles, C.F. Stinson, Luna Textiles, Maharam, and Momentum Textiles to simplify ordering and shipment. For this service, refer to the Supplier Connection program.

Customer's Own Material/Customer's Own Leather Order Information — Seating

continued

Textile Approval

1. Select a COM/COL textile and a Herman Miller product.
2. If your textile is not listed in Omni, obtain a test number from a COM representative at (616) 654 3400. You can also submit your request within Omni. Please have the following information ready before calling: textile name, number, pattern, roll width, and the product you will apply it to.

Additional yardage may be needed due to the unique characteristics of a textile. All package labels must include the words "COM test" or "COL test" and the assigned COM/COL test number.

3. Herman Miller will notify you of approval or disapproval within 4 days from receipt of the test yardage.

Ordering Products with COM/COL

1. Refer to the specific products to determine the yardage required for COM/COL textiles.
2. If your textile is not listed in Omni, call a COM representative at (616) 654 3400 or (866) 854 3048 EXT 6543400. The representative will assign an identification number for your textile (ID#) and will verify yardage requirements for your order. Additional yardage may be needed due to the unique characteristics of a textile.
3. Enter your order on Order Manager in Omni.
4. Upon receipt of your purchase order, Herman Miller will send you a PO acknowledgment.
5. Arrangements must be made for the textiles to be shipped from the supplier to Herman Miller for application to the seating products. Textiles must be tagged with the assigned identification number and the roll yardage quantity. See Omni for shipping procedures and current shipping addresses or contact a COM representative at (616) 654 3400 or (866) 854 3048 EXT 6543400.

Products will be scheduled for production when COM/COL textiles are received at Herman Miller. Standard lead times in effect at that time will apply.

Note: If textiles are to be purchased directly by Herman Miller through the Supplier Connection program, Herman Miller will handle the ordering and shipping process and will schedule your order for production upon receipt of your purchase order (dependent on textile availability). Refer to the Supplier Connection program for more information.

Supplier Connection

Program Overview

The Supplier Connection program is a service offered by Herman Miller to purchase approved COM textiles directly from True Textiles, C.F. Stinson, Luna Textiles, Maharam, and Momentum Textiles. When you select a textile through this program, Herman Miller will facilitate the ordering, scheduling, and shipment of the textile directly with the supplier.

Suppliers included in the Supplier Connection program keep an active inventory of textiles that are pre-approved for application to Herman Miller products. Pre-approval applies only to the suitability of a textile for manufacturing and application to a Herman Miller product. Omni provides an overview of fabrics that have been tested and indicates whether or not they were approved for application to Herman Miller products.

Specific information on the terms and conditions, testing, approval, and ordering process for the Supplier Connection program is listed below. Questions and requests for assistance may be directed to your COM representative at:

(616) 654 3400
(866) 854 3048 EXT 6543400

Supplier Connection Warranty

Textiles purchased by Herman Miller through the Supplier Connection program are COM and are not warranted by Herman Miller. COM textiles are tested for application only; they are not tested for performance. The Herman Miller warranty does apply to the underlying products.

Suppliers of COM textiles are responsible for color consistency within commercial tolerances, UV stability, and resistance to soiling and perspiration.

Customer's Own Material/Customer's Own Leather Order Information — Seating

continued

Supplier Connection Pricing

Textiles purchased by Herman Miller through the Supplier Connection program are COM. COM is a Category 1 fabric. There are no application charges for COM fabrics.

Payment for textiles purchased by Herman Miller through the Supplier Connection program is the responsibility of the customer or dealer. Herman Miller will invoice the order at the supplier's prices published at the time of the order.

Textile Approval

1. Refer to Omni to identify the approval status of the textile. If your textile is not listed, contact the COM Department to request testing for application to Herman Miller products.
2. Herman Miller will notify you of approval or disapproval in approximately 4 days from receipt of the test yardage. If the textile is approved, it will be assigned a COM identification number.

Ordering Products with Supplier Connection COM

1. Identify and include the following information on your purchase order:
 - Product number and option
 - Herman Miller's COM identification number
2. Enter your order on Order Manager in Omni.
3. Upon receipt of the purchase order, Herman Miller will process your order and send you a PO acknowledgment. Herman Miller will determine the yardage required to produce your product and will order and schedule for delivery the required textile. Standard lead times in effect at the time the textile is allocated at the supplier will apply to products ordered through this program.



Proprietary Textiles Application Chart – Seating

• Available

[A] Assigned lead-time textile.

See following page for exception notes.

[N] Non-woven textile.

	New Aeron® Chairs	Classic Aeron Work Chairs/Stools	Classic Aeron Armchairs/Arm Kit	Mirra® 2 Chairs/Stools	Celle® Chairs	Embody® Chairs	Sayl® Work Chairs/Stools	Sayl Side Chairs	Setu® Chairs/Stools	Ergon 3® Chairs	Ergon 3/Equa 2® Adjustable Arm Kit	Equa 2 Fully Upholstered Chairs/Stools	Equa 2 Split-Pad Upholstered Chairs/Stools	Aside® Chairs	Caper® Chairs/Stools	Locale® Bench Cushion	Public® Office Landscape Back	Public Office Landscape Seat	Swoop™ Lounge Seating - Fully Upholstered	Swoop Lounge Seating - Plywood	Cushion Tops	Workspaces
Price Category 1																						
COM Customer's Own Material [A]				14		1	1		1		1	1	1						1	1	1	1
231__ 8Z Pellicle®	•																					
1A7__ AireWeave 2			•																			
3P__ ColorGuard [N]				15		•	22		2			3	8			•			•	•	•	•
8T__ Crossing				•					•		•	•	•			•			•	•	•	•
6V__ Flexnet™															•							
95__ Gem				14				•	•		•					•			•	•	•	•
4W__ Lyris 2™									•													
3D__ Pellicle® Classic (3V__)		7																				
Price Category 2																						
92__ Crepe				•		•	•		•		•	•	•		•				•	•	•	•
1LM__ Loom				14		•	•									•		•		•	•	•
1HA__ Medley				14		•	•	22	•		•	•				•	•		•		•	•
3A__ Moiré				14		•	•	22	•	•	•	•	•								•	•
4M__ Pellicle Tuxedo (4Q__)		•																				
4E__ Pellicle Waves (4F__)		•																				
30__ Rhythm				•	23	•	•					•	•		•				•	•	•	•
8R__ Twist				•		•	•		•			•	•		•				•	•	•	•
Price Category 3																						
70__ Bento						•	•		2		•	•	8									•
8M__ Latitude™				23		•	•					3							•	•		
8U__ Stitches				•		•	•		•		•	•	•		•				•	•	•	•
Price Category 4																						
7Y__ Bingo [N]						•	•		2			3	8		•							•
213__ Mercer				14		•	•	22											•	•	•	•
1A9__ Network																•						
6J__ Plateau									•		•	•	•									•
6S__ Quilty				14		•	•								•				•		•	•
8Y__ Spools				14		21	•		•		•	•	•		•				•		•	•
22P__ Strata						21	22	•	•					•	•	•	•		•			
Price Category 5																						
No fabrics available at this time																						
Price Category 6																						
35__ Balance						•																
Price Category 7																						
COL Customer's Own Leather [A]			1	14						1	1	1	1	8								1
Price Category 8																						
No fabrics available at this time																						
Price Category 9																						
21__ Leather			•	14						•	•	•	8							•	•	

Proprietary Textiles Application Chart – Seating

continued

- Available
- [A] Assigned lead-time textile.
- See below for exception notes.
- [N] Non-woven textile.

Classic Aeron® Work Chairs/Stools																				
Mirra® 2 Chairs/Stools with Butterfly Back™																				
Celle® Chairs																				
Embody® Chairs																				
Sayl® Work Chairs/Stools																				
Sayl Side Chairs																				
Setu® Chairs/Stools																				
Ergon 3® Chairs																				
Equa 2® Fully Upholstered Chairs/Stools																				
Equa 2 Split-Pad Upholstered Chairs/Stools																				
Aside® Chairs																				
Caper® Chairs/Stools																				
Swoop™ Lounge Seating - Fully Upholstered																				

Fire-Retardant Chairs/Fabrics

Price Category 1

COM Customer's Own Material [A]																					
1A7__ AireWeave™ 2																					
3P__ ColorGuard [N]																					
8T__ Crossing																					
6V__ Flexnet™																					
95__ Gem																					
4W__ Lyris 2™																					
3D__ Pellicle® Classic																					

Price Category 2

92__ Crepe																					
3A__ Moiré																					
30__ Rhythm																					
8R__ Twist																					

Price Category 3

70__ Bento																					
8S__ Coil																					
8M__ Latitude™																					
8U__ Stitches																					

Price Category 4

6J__ Plateau																					
6S__ Quilty																					

Price Category 5

No fabrics available at this time																					
-----------------------------------	--	--	--	--	--	--	--	--	--	--	--	--	--	--	--	--	--	--	--	--	--

Price Category 6

35__ Balance																					
--------------	--	--	--	--	--	--	--	--	--	--	--	--	--	--	--	--	--	--	--	--	--

Price Category 9

21__ Leather																					
--------------	--	--	--	--	--	--	--	--	--	--	--	--	--	--	--	--	--	--	--	--	--

All foam and Proprietary Textiles on HermanMiller seating comply with California TB 117-2013.

Application Note: Herman Miller cannot guarantee material/pattern alignment in adjacent products. For example, a fabric's pattern may not align from one pedestal cushion top to the next, or from one chair to the next.

- | | |
|--|--|
| <ul style="list-style-type: none"> 1 Refer to price book appendices and Kiosk for COM/COL information. 2 Available on all Ergon 3 chairs except for fabric back (FB) option. 3 Available on A-and B-size Equa 2 split-pad upholstered chairs. 5 Available on all Ambi chairs except for fabric back (FB) option. 7 Only available in 3D01 Graphite. 8 Only available on non-upholstered outer back (PB) option. 14 Available on Celle UC (upholstered seat) chairs. 15 Available on Celle HC (upholstered seat with protective edge) Chairs. 16 Only available in 3014 Black. | <ul style="list-style-type: none"> 17 Only available in 3512 Carbon and 3513 Black. 18 Only available in 4W31 Graphite. 21 Not available on Sayl upholstered back work chairs. 22 Not available on Sayl side chairs with upholstered backs. 23 Available in select colors. Refer to "Proprietary Textile Colors - Seating" for color offering. 24 Not available on Sayl upholstered High-Back Work Chairs. |
|--|--|

Proprietary Textile Colors – Seating

Price Category 1

Customer's Own Material
See Order Information in
Appendices.
Assigned lead-time textile. A

8Z Pellicle®
For New Aeron® Chairs
56% elastomeric
44% polyester
23101 Mineral
23102 Carbon
23103 Graphite

AireWeave™ 2
For Mirra® 2 Chairs
67% elastomeric
33% antimony-free polyester
1A701 Alpine
1A702 Slate Grey
1A703 Graphite
1A704 Lime Green
1A705 Cappuccino
1A706 Urban Orange
1A707 Dark Turquoise
1A708 Twilight

ColorGuard
54" wide
100% vinyl
3P01 Grey
3P02 Navy
3P03 Spruce A
3P04 Jade A
3P05 Natural A
3P08 Blueberry A
3P09 Coal A
3P12 Black Plum A
3P14 Black
3P15 New Burgundy A
3P17 Burgundy A
3P19 Slate
3P31 Horizon Blue A
3P33 Pumice
3P54 Candy Apple A
3P58 Beige A
3P66 Deep Clay A
3P72 Allspice A
3P90 Green Tea A
3P93 Camelback A
3P96 Manzanita A
3P97 Fudge A
3PB2 Sea Grass A
3PB5 Vizcaya Palm A
3PB9 Neptune A
3PC7 Bucksuede A
3PD4 Otter A

A Assigned lead-time color.

Crossing
54" wide
86% antimony-free polyester
14% polyester
8T03 Wicker
8T04 Porcelain
8T05 Warm Grey
8T06 Sepia
8T07 Pumpkin
8T08 Copper
8T09 Cranberry
8T10 Tomato
8T11 Mulberry
8T12 Plum
8T13 Green Apple
8T14 Loden
8T15 Spruce
8T16 Periwinkle
8T17 Cerulean
8T18 Indigo
8T19 Shale
8T20 Brownstone
8T21 Bark
8T22 Tin
8T23 Graphite
8T24 Black

Flexnet™
For Caper® Chairs
69% elastomeric
31% polyester
6V01 Black
6V02 Silver Grey

Gem
54" wide
100% antimony-free polyester
9501 Sesame
9502 Tangerine
9503 Red
9504 Red Violet
9505 Mulberry
9506 Java
9507 Twilight
9508 Bayou
9509 Iris
9510 Berry Blue
9511 Aqua Green
9512 Green Apple
9513 Spruce
9514 Black
9515 Slate Grey
9516 Fog

Lyris 2™
For Setu® Chairs
74% elastomeric
26% polyester
4W21 Alpine
4W22 Mango
4W23 Chartreuse
4W25 Berry Blue
4W26 Slate Grey
4W28 Chino
4W29 Rattan
4W30 Java
4W31 Graphite

Proprietary Textile Colors – Seating

continued

Price Category 1

continued

Pellicle® Classic

For Classic Aeron® chairs with a graphite or polished aluminum base.

70% elastomeric

30% polyester

3D01 Carbon

3D02 Lead

Pellicle Classic

For Classic Aeron chairs with a titanium base.

70% elastomeric

30% polyester

3V01 Zinc

3V03 Quartz

Price Category 2

Crepe

54" wide

100% recycled polyester

9201 Licorice

9203 Smoke

9207 Cherry

9209 Claret

9212 Raisin

9218 Aquamarine

9223 Cadet

9241 Beachglass

9243 Midnight

9244 Artichoke

9248 Warm White

9249 Stone

9250 Earth

9251 Fog

9252 Slate Grey

9253 Yellow Dark

9254 Coral

9255 Blush Grey

9256 Wild Berry

9257 Clover

9258 Caribbean

9259 Cerulean

9260 Brownstone

9261 Shale

9262 Graphite

9263 Tomato

9264 Green Apple

Loom

54" wide

100% polyester

1LM01 Linen

1LM02 Brown Sugar and Spice

1LM03 Brick and Mortar

1LM04 Salt and Pepper

1LM05 Black

1LM06 Lemongrass

1LM07 Poppy

1LM08 Wild Berry

1LM09 Loden

1LM10 Jade

1LM11 Deep Sea

Medley

54" wide

100% polyester

1HA01 Stone

1HA02 Trail

1HA03 Charcoal

1HA04 Cinder

1HA05 Citrus

1HA06 Papaya

1HA07 Chutney

1HA08 Tundra

1HA09 Feather Grey

1HA10 Chartreuse

1HA11 Loden

1HA12 Peacock

1HA13 Bayou

1HA14 Blue Grotto

1HA15 Blueberry

1HA22 Khaki

1HA23 Pewter

1HA24 Yellow Oxide

1HA25 Vintage Rose

1HA26 Raspberry

1HA27 Acai Berry

Moiré

54" wide

100% recycled polyester

3A01 Concrete

3A02 Biscotti

3A03 Rattan

3A04 Chambray

3A05 Fern

3A08 Violet

3A09 Zin

3A10 Curry

3A11 Spice

3A12 Cork

Pellicle® Tuxedo

For Classic Aeron chairs with a graphite or polished aluminum base.

64% elastomeric

36% polyester

4M01 Grey Black

4M02 Blue Black

Pellicle Tuxedo

For Classic Aeron chairs with a titanium base.

64% elastomeric

36% polyester

4Q01 White Gold

Pellicle Waves

For Classic Aeron chairs with a graphite or polished aluminum base.

68% elastomeric

32% polyester

4E01 Carbon

4E03 Platinum

Pellicle Waves

For Classic Aeron chairs with a titanium base.

68% elastomeric

32% polyester

4F01 Zinc

4F03 Quartz

Proprietary Textile Colors – Seating

continued

Price Category 2

continued

Rhythm
54" wide
100% polyester
3001 Kiwi Green *
3002 Green Apple
3003 Peacock
3004 Bayou *
3005 Berry Blue
3006 Iris
3007 Twilight
3008 Pumpkin *
3009 Poppy *
3010 Molasses
3011 Mulberry
3012 Khaki *
3013 Mink
3014 Black
3015 Charcoal
* Colors not available on Embody Chair
Twist
54" wide
80% antimony-free polyester
13% recycled polyester
7% polyester
8R05 Wicker
8R10 Poppy
8R14 Tin
8R15 Shale
8R16 Graphite
8R17 Birch
8R18 Sepia
8R22 Blueberry
8R23 Green Apple
8R26 Gunmetal
8R27 Cinder
8R28 Citrus
8R29 Pekoe
8R30 Tangerine
8R31 Red Plum
8R32 Wisteria
8R33 Forest
8R34 Jade Dark
8R35 Waterfall
8R36 Midnight Blue
8R37 Carbon Dark

Price Category 3

Bento
54" wide
100% antimony-free polyester
7001 Frost
7002 Linen
7003 Khaki
7004 Truffle
7005 Grey Black
7006 Pumpkin
7007 Cranberry
7008 Everglade
7009 Cobalt
Latitude™
61" wide
100% polyester
8M01 Graphite
8M02 Shadow
8M03 Citron
8M05 Blue Fog
8M06 Cappuccino
8M10 Alpine
8M13 Midnight Blue
8M15 Champagne
8M16 Chestnut
8M17 Black
8M18 Brownstone

Stitches
54" wide
54% polyester
46% recycled polyester
8U02 Rye
8U03 Khaki
8U04 Honey
8U05 Cattail
8U06 Pumpkin
8U07 Brick
8U08 Cool Grey
8U09 Slate Blue
8U10 Juniper
8U11 Evening Blue
8U12 Charcoal
8U13 Kiwi Green
8U14 Olive
8U15 Pesto
8U16 Cocoa
8U17 Seed

Price Category 4

Bingo
54" wide
100% PVC-free polyurethane
Resilience® finish
7Y01 Oyster
7Y02 Natural
7Y03 Cashew
7Y04 Buff
7Y05 Rattan
7Y06 Root
7Y07 Woodland
7Y08 Camel
7Y09 Copper
7Y10 Allspice
7Y11 Canyon
7Y12 Henna
7Y13 Sedona
7Y14 Black Plum
7Y15 Currant
7Y16 Mahogany
7Y17 Seed
7Y18 Mushroom
7Y19 Blue Grey
7Y20 Navy
7Y21 Black
7Y22 Mint
7Y23 Seaport
7Y24 Evening Blue
7Y25 Hemlock
7Y26 Kiwi Green
7Y27 Celadon
7Y28 Moss
7Y29 Pesto

Proprietary Textile Colors – Seating

continued

Price Category 4

continued

Mercer

54" wide

50% solution dyed recycled nylon

50% solution dyed nylon

BLOCKaide

21301 Stone

21302 Rattan

21303 Cayenne

21304 Chutney

21305 Pesto

21306 Teal Blue

21307 Ultramarine

21308 Acai Berry

21309 Ash Brown

21310 Charcoal

Network

For Public Office Landscape®

sectional back/social chair.

knit to size

100% polyester

1A901 Warm White

1A902 Fog

1A903 Red

1A904 Wildberry

1A905 Green Apple

1A906 Twilight

1A907 Graphite

Plateau

knit to size

100% polyester

6J01 Feather Grey

6J02 Trail

6J03 Mustard Seed

6J04 Fennel

6J05 Red Pepper

6J06 Twig

6J07 Waterfall

6J08 Sagebrush

6J09 Winter Berry

6J10 Thunder

6J11 Blueberry

6J12 Rosemary

6J13 Wild Plum

6J14 Black

Quilty

56" wide

100% antimony-free polyester

GreenShield

6S03 Khaki

6S04 Straw

6S07 Brick

6S10 Mink

6S11 Green Apple

6S13 Indigo

6S14 Zinc

6S15 Slate

6S16 Beachwood

6S17 Paprika

6S18 Plum

6S19 Juniper

6S20 Grey Black

Spools

54" wide

51% recycled polyester

49% polyester

Crypton® Green

8Y01 Cashew

8Y02 Wick

8Y03 Trail

8Y04 Cappuccino

8Y05 Copper

8Y08 Bluegrass

8Y09 Lagoon

8Y10 Grape

8Y11 Beachglass

8Y12 Marsh

8Y13 Bud

Strata

54" wide

50% solution dyed recycled nylon

50% solution dyed nylon

BLOCKaide

22P01 Rattan

22P02 Yellow Jacket

22P03 Avocado

22P04 Pesto

22P05 Peacock

22P06 Blue Jay

22P07 Blueberry

22P08 Boysenberry

22P09 Mango

22P10 Paprika

22P12 Wheat

22P13 Brownstone

22P14 Bayou

22P15 Trail

No fabrics available at this time.

Proprietary Textile Colors – Seating

continued

Price Category 6

Balance

100% polyester

3512 Carbon

3513 Black

Price Category 7

Customer's Own Leather

See Order Information in Appendices. Assigned lead-time textile. [A](#)

Price Category 8

No fabrics available at this time.

Price Category 9

Leather

approx. 50 sq. ft. per hide

100% leather

2101 Ivory

2109 Black

2110 Smoke

2111 Graphite

2112 Khaki

2113 Rattan

2114 Truffle

2115 Alpine

2116 Haze

2117 Sable Grey

2118 Dark Mineral

2119 Dark Carbon

2120 Cranberry

2121 Deep Sea



Maharam Application Chart – Seating

- Available

Maharam textiles are on assigned lead times. A

[N] Non-woven textile.

	Classic Aeron® Work Chairs/Stools	Classic Aeron Armpads/Arm Kit	Mirra® Chairs	Celle® Chairs	Sayl® Work Chairs	Sayl Side Chairs	Setu® Chairs	Ergon 3® Chairs	Ergon 3 Adjustable Arm Kit	Equa 2® Fully Upholstered Chairs/Stools	Equa 2 Split-Pad Upholstered Chairs/Stools	Equa 2 Adjustable Arm Kit	Ambj® Work Chairs	Aside® Chairs	Caper® Chairs	Swoop™ Lounge Seating - Fully Upholstered	Swoop Lounge Seating - Plywood	Cushion Tops	Workspaces
Price Category A																			
No fabrics available at this time.																			
Price Category B																			
TI__ Messenger - Maharam *			14	•	•	•				•			•	•		•	•	•	•
Price Category C																			
No fabrics available at this time.																			
Price Category D																			
Z27__ Manner - Maharam			14	•	•		•			•	•			•		•	•	•	•
Price Category E																			
Z3__ Metric - Maharam			14	•	•		•			•	•			•		•	•	•	•
Z32__ Skein - Maharam			14	16	16	•								•			•	•	•
Price Category F																			
Z33__ Strum - Maharam [N]					16											•			
Price Category G																			
ZC2__ Compound - Maharam [N]				16	16		•			•				8			•		
TG__ Divina Melange - Maharam			14	•	•	•	•			•	•			•		•	•	•	•
V25__ Steelcut Trio - Maharam			14	•															•
Price Category H																			
ZT__ Circles - Maharam			14																•
ZK__ Dot Pattern - Maharam			14	•	•	•				•			•	•					•
ZL__ Small Dot Pattern - Maharam			14	•	•	•				•			•	•					•
Price Category I-V																			
No fabrics available at this time.																			

Appendix: Maharam Application Chart – Seating

* Available in select colors on 20-day lead-time.
Refer to “Maharam Colors - Seating” for 20-day colors.

- 8 Only available on nonupholstered outer back option (PB).
- 14 Available on Celle UC (upholstered seat) chairs.
- 16 Available on Sayl Chair seat.



Maharam Colors – Seating

Price Category A

No fabrics available at this time.

Price Category B

Messenger – Maharam

54" wide	
78% recycled polyester	
15% polyester	
7% nylon	
TI01/458640-001	Balsa
TI06/458640-006	Tobacco
TI07/458640-007	Shadow *
TI08/458640-008	Bayou *
TI10/458640-010	Zinc
TI24/458640-024	Poppy
TI25/458640-025	Mao
TI29/458640-029	Onyx
TI31/458640-031	Cloud *
TI38/458640-038	Depth *
TI40/458640-040	Nile
TI41/458640-041	Azure *
TI45/458640-045	Cactus *
TI46/458640-046	Ice *
TI48/458640-048	Neon *
TI50/458640-050	Hydrangea *
TI51/458640-051	Lilac
TI52/458640-052	Chestnut
TI53/458640-053	Tangelo
TI54/458640-054	Lumine *
TI58/458640-058	Snow
TI59/458640-059	Fennel

Messenger continued

TI60/458640-060	Peridot *
TI61/458640-061	Capri
TI62/458640-062	Ultramarine
TI63/458640-063	Squall
TI66/458640-066	Cassis
TI67/458640-067	Aster
TI68/458640-068	Spice
TI69/458640-069	Cherry
TI70/458640-070	Vibrant
TI71/458640-071	Satsuma *
TI72/458640-072	Maize
TI73/458640-073	Hay
TI74/458640-074	Cashew
TI77/458640-077	Ash
TI78/458640-078	Tusk
TI79/458640-079	Oyster
TI80/458640-080	Pensive
TI81/458640-081	Husk
TI82/458640-082	Fireside
TI83/458640-083	Chili
TI84/458640-084	Robust
TI85/458640-085	Beyond
TI86/458640-086	Voyage
TI87/458640-087	Everglade
TI88/458640-088	Electric

* Colors available on 20-day lead time.

Price Category C

No fabrics available at this time.

- Maharam textiles are on assigned lead times ^A unless otherwise noted.
- Fabric numbers are listed as Herman Miller fabric number/Maharam fabric number.

Maharam Colors – Seating

continued

Appendix: Maharam Colors – Seating

Price Category D

Manner - Maharam	
54" wide	
100% recycled polyester	
Z2701/466177-001	Magic
Z2702/466177-002	Carob
Z2703/466177-003	Porpoise
Z2704/466177-004	Flint
Z2705/466177-005	Hush
Z2706/466177-006	Nuance
Z2707/466177-007	Thicket
Z2708/466177-008	Cocoa
Z2709/466177-009	Pathway
Z2710/466177-010	Cola
Z2711/466177-011	Ember
Z2712/466177-012	Wagon
Z2713/466177-013	Ablaze
Z2714/466177-014	Peel
Z2715/466177-015	Penny
Z2716/466177-016	Butterscotch
Z2717/466177-017	Harvest
Z2718/466177-018	Lioness
Z2719/466177-019	Caper
Z2720/466177-020	Parakeet
Z2721/466177-021	Greenway
Z2722/466177-022	Aquatic
Z2723/466177-023	Cottage
Z2724/466177-024	Dahlia
Z2725/466177-025	Vivid
Z2726/466177-026	Basin
Z2727/466177-027	Schooner

Price Category E

Metric – Maharam	
54" wide	
51% recycled polyester	
49% polyester	
Z301/466014-001	Phantom
Z302/466014-002	Fog
Z303/466014-003	Fleece
Z304/466014-004	Sourdough
Z305/466014-005	Toffee
Z306/466014-006	Driftwood
Z307/466014-007	Mineral
Z308/466014-008	Bittersweet
Z309/466014-009	Arabica
Z310/466014-010	Cerise
Z311/466014-011	Brick
Z312/466014-012	Cardinal
Z313/466014-013	Lava
Z314/466014-014	Oriole
Z315/466014-015	Cedar
Z317/466014-017	Caramel
Z318/466014-018	Pollen
Z319/466014-019	Tupelo
Z320/466014-020	Alligator
Z321/466014-021	Envy
Z322/466014-022	Bonsai
Z323/466014-023	Tar
Z324/466014-024	Anchor
Z325/466014-025	Twilight
Z326/466014-026	Admiral
Z327/466014-027	Seaport
Z328/466014-028	Scuba

Price Category F

Strum - Maharam	
54" wide	
100% polyurethane	
with silver-based antimicrobial	
Z3301/466122-001	Overcast
Z3302/466122-002	Ridge
Z3303/466122-003	Twilight
Z3304/466122-004	Pigeon
Z3305/466122-005	Char
Z3306/466122-006	Cabin
Z3307/466122-007	Bur
Z3308/466122-008	Abalone
Z3309/466122-009	Prawn
Z3310/466122-010	Gourd
Z3311/466122-011	Wheat
Z3312/466122-012	Lemongrass

- Maharam textiles are on assigned lead times ^A unless otherwise noted.
- Fabric numbers are listed as Herman Miller fabric number/Maharam fabric number.

Maharam Colors – Seating

continued

Price Category G

Compound - Maharam	
54" wide	
100% polyurethane	
silane-based antimicrobial	
ZC201/466196-001	001
ZC202/466196-002	002
ZC203/466196-003	003
ZC204/466196-004	004
ZC205/466196-005	005
ZC206/466196-006	006
ZC207/466196-007	007
ZC208/466196-008	008
ZC209/466196-009	009
ZC210/466196-010	010
ZC211/466196-011	011
ZC212/466196-012	012
ZC213/466196-013	013
ZC214/466196-014	014
ZC215/466196-015	015
ZC216/466196-016	016
ZC217/466196-017	017
ZC218/466196-018	018
ZC219/466196-019	019

Divina Melange – Maharam	
59" wide	
100% wool	
TG01/460830-120	120
TG02/460830-170	170
TG03/460830-180	180
TG04/460830-220	220
TG05/460830-260	260
TG06/460830-280	280
TG07/460830-871	871
TG08/460830-821	821
TG09/460830-771	771
TG10/460830-721	721
TG11/460830-731	731
TG12/460830-681	681
TG13/460830-631	631
TG15/460830-671	671
TG16/460830-581	581
TG17/460830-531	531
TG18/460830-521	521
TG19/460830-571	571
TG20/460830-421	421
TG21/460830-471	471
TG22/460830-931	931
TG24/460830-971	971
TG25/460830-925	925
TG26/460830-620	620

Steelcut Trio - Maharam	
55" wide	
90% wool	
10% nylon	
V2501/465906-105	105
V2502/465906-113	113
V2503/465906-124	124
V2504/465906-133	133
V2505/465906-144	144
V2506/465906-153	153
V2507/465906-195	195
V2508/465906-205	205
V2509/465906-213	213
V2510/465906-225	225
V2511/465906-235	235
V2512/465906-245	245

Steelcut Trio continued	
V2513/465906-253	253
V2514/465906-283	283
V2515/465906-325	325
V2516/465906-333	333
V2517/465906-353	353
V2518/465906-383	383
V2519/465906-395	395
V2520/465906-413	413
V2521/465906-415	415
V2522/465906-425	425
V2523/465906-453	453
V2524/465906-465	465
V2525/465906-515	515
V2526/465906-533	533
V2527/465906-553	553
V2528/465906-565	565
V2529/465906-645	645
V2530/465906-653	653
V2531/465906-665	665
V2532/465906-675	675
V2533/465906-683	683
V2534/465906-713	713
V2535/465906-733	733
V2536/465906-745	745
V2537/465906-753	753
V2538/465906-815	815
V2539/465906-825	825
V2540/465906-845	845
V2541/465906-853	853
V2542/465906-865	865
V2543/465906-883	883
V2544/465906-915	915
V2545/465906-933	933
V2546/465906-945	945
V2547/465906-953	953
V2548/465906-965	965

Price Category H

Circles – Maharam	
55" wide	
70% cotton	
30% polyester	
ZT01/458310-001	Khaki
ZT02/458310-002	Fatigue
ZT03/458310-003	Document
ZT04/458310-004	Engine
ZT05/458310-005	Charcoal

Dot Pattern – Maharam	
55" wide	
71% cotton	
29% polyester	
ZK01/458300-001	Document
ZK02/458300-002	Taupe
ZK04/458300-004	Red
ZK05/458300-005	Navy

Small Dot Pattern – Maharam	
55" wide	
71% cotton	
29% polyester	
ZL01/458320-001	Document
ZL02/458320-002	Sand
ZL03/458320-003	Khaki
ZL04/458320-004	Taupe
ZL05/458320-005	Charcoal
ZL06/458320-006	Document Reverse
ZL07/458320-007	Red
ZL08/458320-008	Yellow
ZL09/458320-009	Green

Appendix: Maharam Colors – Seating

- Maharam textiles are on assigned lead times ^A unless otherwise noted.
- Fabric numbers are listed as Herman Miller fabric number/Maharam fabric number.

Maharam Colors – Seating

continued

Price Category I-V

No fabrics available at this time.

Appendix: Maharam Colors – Seating

For more information about our products and services or to see a list of dealers, please visit us at HermanMiller.com or call (800) 851 1196.

This book is recyclable. Printed in U.S.A. on recycled paper.

© 2017 Herman Miller, Inc., Zeeland, Michigan

® **HermanMiller**, , Action Office, Aeron, Aside, Avive, Canvas Office Landscape, Caper, Celle, Co/Struc, Eames, Embody, Equa 2, Ergon 3, Ethospace, Exclave, Fine-Tune, FlexFront, Formcoat, Ground Cloth, Herman Miller Healthcare, Layout Studio, Maharam, Meridian, Mirra, Passage, Pellicle, Perspectives, PostureFit, Resolve, Sayl, Setu, Thrive, Tu, Y-Tower, and Z-Axis are among the registered trademarks of Herman Miller, Inc., and its owned subsidiaries.

™ AireWeave, Bubbletack, Cellular Suspension, Compass, Connect, DOT, Durawrap, Everywhere, Flex-Edge, Hopsak 2, Iota, Keyless Entry, Latitude, Lyris 2, Motia, Multiscrim, Nelson, Renew, Stackable, Swoop, TriFlex, and Twist are among the trademarks of Herman Miller, Inc., and its owned subsidiaries.

®Chemsurf® is a registered trademark of Wilsonart International.

®Corian® is a registered trademark of E.I. du Pont de Nemours and Company Corporation.

FLEXNET™ is a trademark of Milliken & Company.

Floor Saver Glide® is a registered trademark of Carpin Manufacturing, Inc.

®Geiger® is a registered trademark of Geiger International.

®Microsoft® and Natural® Keyboard are registered trademarks of Microsoft Corporation.

®Place Textiles® is a registered trademark of Place Textiles.