



Prices effective February 6, 2017

Ergon 3® Chairs

Introduction	page 2
Ergon 3® Chairs	3
Work Chairs	5
Accessories	8
Appendices	
20-Day or Less/Assigned Lead-Time Order Information	
Casters and Glides	
Fire Retardancy-Seating	
Customer's Own Material/Customer's Own Leather Order Information-Seating	
Proprietary Textiles Application Chart-Seating	
Proprietary Textile Colors-Seating	
Maharam® Application Chart-Seating	
Maharam Colors-Seating	
For the latest materials information, refer to the Materials pages on HermanMiller.com.	

Introduction

A Note on the Organization of This Book

There are a few signals that will help you understand the organization of this book. Once you know them, you should be able to find your way around easily.

Like a newspaper, this book is formatted with columns of text and illustrations that run vertically.

Information wraps from one column to the next and continues for as many pages as it needs to.

Black bars are clues.

A black bar at the top of a page signals the start of information about a product.

This information is divided into two sections, each signaled by a black bar. Product Information includes a description, additional notes, and dimensional drawings. Specification Information, which always begins at the top of a column, includes a series of steps. Each step represents a decision you need to make in order to complete your product number. Steps must be followed sequentially. The number of pages needed to complete information on a product varies; some will be complete in one page; others may fill three or four pages. Just continue going through the steps until you run into the next product, signaled by the black bar at the top of the page.

Black tabs running along the outside edge of the page help you locate what section you are in or what section you want to go to. You can thumb forwards or backwards to find a section; tabs and text appear on both sides of the page.

The additional pages in the back of the book include the appendices and indices. They are signaled by a long black bar running along the outside edge of the page.

The index is presented two ways.

The first index is in alphabetical order by product name. It can be helpful if you are new to the products and numbering scheme or if you are looking for a type of product, such as work chair or round table.

The second index is by product number. It lists, in alphanumeric order, the base product number, typically a five-digit number.

General Information

This book is effective February 6, 2017, subject to change without notice. Products may be purchased from authorized Herman Miller dealers who will quote prices upon request. For more information about our products and services or to see a list of dealers, visit www.HermanMiller.com.

All prices are list prices. Additional services, such as planning services, design, storage, and installation, are not included and must be added to these prices when the additional services are requested.

Illustrations, specifications, and prices are based on the latest information at the time of publication. The right is reserved to make changes at any time without notice in prices, fabrics, finishes, materials, specifications, and models, and also to discontinue models and finishes.

Dimensions shown in the drawings are engineering drawing dimensions rounded up to the nearest $\frac{1}{8}$ ". Product is shipped set up or knocked down. Products that include "Shipped knocked down" in the description require some assembly. If this statement does not appear in the description, the product is shipped assembled.

Service problems are normally handled by a Herman Miller authorized dealer. Where this cannot be accomplished on a local level, service problems should be referred to the Customer Care Representative for your region, Herman Miller, Inc., Zeeland, Michigan 49464.

20-Day or Less/Assigned Lead-Time Shipments

All products and options in this price book not designated by an Assigned Program icon  will ship in **20 business days or less** after being acknowledged by Herman Miller.

Products and options designated by an  are on the assigned lead-time program and may ship in 20 days, less than 20 days, or more than 20 days from order acknowledgement.

Work Chairs

Accessories

Work Chair

EE122
EE123

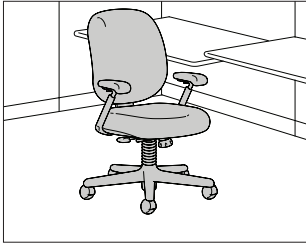

Product Information

Description

This chair is available in 2 sizes and has deeply contoured seat and back cushions with thick foam padding. It has a 5-star base, pneumatic seat-height adjustment, and back-height adjustment. All chair sizes have high backs; size B is also available in a mid-back.

Tilt options include a knee-tilt swivel that allows the user to lock the seat angle in a horizontal position, or a knee-tilt swivel with forward angle that allows the user to select a horizontal or 5° forward seat angle; the seat angle can be locked in either position.

Adjustable back angle has a 10° tilt range from an upright position.

Arm choices include no arms, fixed arms, or adjustable arms that adjust 4" vertically with armpads that adjust 3/4" horizontally and pivot outward and inward over a 25° range.

Fire-retardant chair meets CAL 133 requirements; this chair is manufactured with cushions covered with a fire-barrier material and is upholstered in approved fire-retardant fabrics.

Notes

Chairs are tested and warranted for use by persons 300 pounds and under.

Knee tilt option (2) is not available on C-size chairs.

For information on casters and glides, see Casters and Glides in Appendices.

Customer's Own Material (COM) requires 1 1/2 yards for size B chairs, and 1 2/3 yards for size C; add 3/4 yard to chair with fabric-back outer shells.

Customer's Own Leather (COL) requires 40 square feet for all sizes; add 8 square feet to chair with leather-back outer shells (FB option) and an additional 8 square feet when specifying upholstered armpads. See Order Information in Appendices.

Dimensions

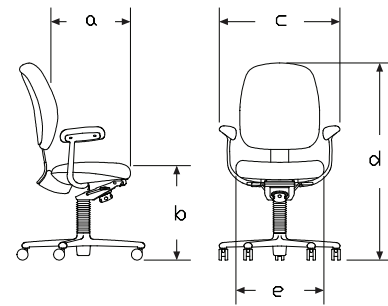

	Size B Mid-Back	Size B	Size C
a	16 3/4	16 3/4	18 1/2
b	16 - 20 3/4	16 - 20 3/4	16 - 21
c	26 1/2	26 1/2	27 3/4
d	40 max	44 3/4 max	45 1/4 max
e	20 1/4	20 1/4	21 1/2

All dimensions are in inches.

Specification Information

Step 1.

EE12

Step 2. Tilt

- 2** knee tilt
- 3** knee tilt with forward angle

Step 3. Arms

- N** no arms
- P** fixed arms, vinyl
- L** fixed arms, leather
- A** adjustable arms, vinyl
- R** adjustable arms, leather

Step 4. Size/Back Height

For knee tilt (2)

- K** b size and mid-back
- B** b size and high back

For knee tilt with forward angle (3)

- K** b size and mid-back
- B** b size and high back
- C** c size and high back

Step 5. Fire Retardancy

For not fire retardant (), skip this step.*

For no arms (N), fixed arms, vinyl (P), or adjustable arms, vinyl (A)

- FR** fire retardant

For fixed arms, leather (L) or adjustable arms, leather (R), skip this step.

Prices for Steps 1-5.

			*	FR
EE122	N	K	\$1081	1164
		B	\$1081	1164
	P	K	\$1248	1330
		B	\$1248	1330
	L	K	\$1248	—
		B	\$1248	—
	A	K	\$1378	1461
		B	\$1378	1461
	R	K	\$1378	—
		B	\$1378	—

EE123	N	K	\$1157	1240
		B	\$1157	1240
		C	\$1157	1240
	P	K	\$1324	1408
		B	\$1324	1408
		C	\$1324	1408
	L	K	\$1324	—
		B	\$1324	—
		C	\$1324	—
	A	K	\$1453	1566
		B	\$1453	1566
		C	\$1453	1566
	R	K	\$1453	—
		B	\$1453	—
		C	\$1453	—

Step 6. Back Angle

- AJ** adjustable +\$115

Step 7. Base Finish/Frame and Outer Shell Finish

- BU** black umber +\$0
- MT** medium tone +\$0

Step 8. Casters/Glides

- GF** 2½" glide, hard floors or carpet +\$0
- BB** 2½" hard caster, black yoke, carpet only +\$0
- C7** 2½" caster, black yoke, hard floors or carpet +\$40
- C9** 2½" braking caster, black yoke, hard floors or carpet +\$40

Step 9. Outer Shell Finish

- U6** nonupholstered +\$0
- FB** fabric back +\$160

Step 10. Armpad Finish

For fixed arms, vinyl (P) or adjustable arms, vinyl (A) with nonupholstered (U6), or fabric back (FB)

- BK** black +\$0
- MT** medium tone +\$0

For fixed arms, leather (L) or adjustable arms, leather (R)

- AT** upholstered armpad, leather +\$40

Step 11. Fabric

See application chart and textiles list for fabric usage and numbers.
 First 2 digits of number indicate fabric line; remaining digit(s) indicate fabric color.

For no arms (N), fixed arms, vinyl (P), or adjustable arms, vinyl (A) with not fire retardant with fabric back (FB)

Price Category 1	+\$0
Price Category 2	+\$31
Price Category 3	+\$61
Price Category 4	+\$97
Price Category 5	+\$146
Price Category 7	+\$180
Price Category B	+\$65
Price Category C	+\$89
Price Category D	+\$112
Price Category E	+\$136
Price Category F	+\$175
Price Category G	+\$228
Price Category H	+\$277

For no arms (N), fixed arms, vinyl (P), or adjustable arms, vinyl (A) with not fire retardant with nonupholstered (U6)

Price Category 1	+\$0
Price Category 2	+\$31
Price Category 3	+\$61
Price Category 4	+\$97
Price Category 5	+\$146
Price Category 7	+\$180
Price Category B	+\$65
Price Category E	+\$136
Price Category G	+\$228

For no arms (N), fixed arms, vinyl (P), adjustable arms, vinyl (A) AND fire retardant (FR)

Price Category 1	+\$0
Price Category 2	+\$31
Price Category 3	+\$61
Price Category 5	+\$146

For fixed arms, leather (L) or adjustable arms, leather (R) with not fire retardant

Price Category 7 A	+\$180
--	--------

Adjustable Arm Kit

EE900

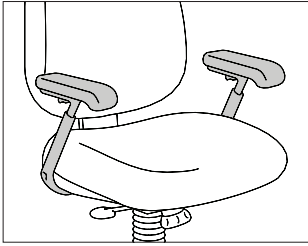

Ergon 3® Accessories

Product Information

Description
 These arms retrofit to an Ergon 3® chair. They adjust 4" vertically with armpads that adjust ¾" horizontally and pivot outward and inward over a 25° range. Attachment hardware is included.
 Fire-retardant arms meet CAL 133 requirements.

Notes
 Customer's Own Leather (COL) requires 8 square feet. See Order Information in Appendices.

Dimensions

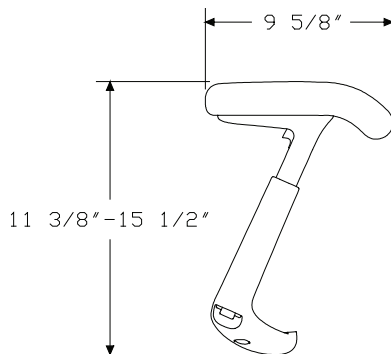

Specification Information

Step 1.

EE900A

Step 2. Armpad Upholstery

- N** nonupholstered armpads
- F** upholstered armpads, leather

Step 3. Fire Retardancy

For not fire retardant (), skip this step.*

For nonupholstered armpads (N)

- FR** fire retardant

For upholstered armpads, leather (F), skip this step.

Prices for Steps 1-3.

	*	FR
EE900A N	\$315	331
F	\$379	—

Step 4. Frame Finish

- BU** black umber +\$0
- MT** medium tone +\$0

Step 5. Armpad Finish

For nonupholstered armpads (N)

- BK** black +\$0
- MT** medium tone +\$0

Step 6. Armpad Leather

For upholstered armpads, leather (F) with not fire retardant
 See application chart and textiles list for fabric usage and numbers.
 First 2 digits of number indicate fabric line; remaining digit(s) indicate fabric color.

Price Category 7 A +\$0

20-Day or Less/Assigned Lead-Time Order Information

20-Day or Less and Assigned Lead-Time Programs

20-day or less and assigned lead-time products are designed for established Herman Miller dealers with pre-approved credit.

Products are distributed from multiple manufacturing facilities across the United States. All products and options not designated by an Assigned Lead-Time icon **A** will ship in 20 business days or less after being acknowledged by Herman Miller. Products and options designated by an **A** are on the assigned lead-time program and will ship in 20 days, less than 20 days, or more than 20 days from order acknowledgement.

Ordering Procedure

Please place orders through Order Manager. If this is not available to you, place orders through mail or fax. Verbal purchase orders will not be accepted.

Order Entry fax number for Passage®, 5000 Series, and Meridian® Filing and Storage: (616) 846 9236.

Order Entry fax number for all other products:
(616) 654 3085.

For more information, contact your Customer Care representative at:
(866) 854 3048 EXT 3400.

Shipments and Delivery

Per Herman Miller Terms and Conditions.

Changes and Cancellation

Per Herman Miller Terms and Conditions.



Casters and Glides

▲	WARNING	▲
Depending on the floor surface, chair may unexpectedly roll away from user when entering or exiting the chair, possibly leading to unexpected injury. Please refer to descriptions of floor types when selecting casters.		

32 Caster

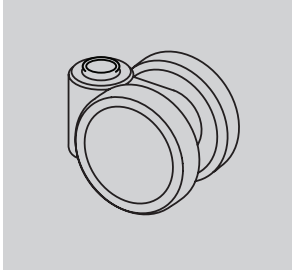

17/8-inch-diameter hard double-wheel caster; black nylon wheels and yoke; for use on carpet only

Applicable on:
Keyn Chairs
Sayl® Chairs

BB Caster

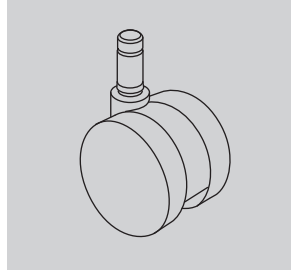

2 1/2-inch-diameter hard double-wheel caster; black nylon wheels and yoke; for use on carpet only

Applicable on:
New Aeron® Chairs
Classic Aeron Chairs
Caper® Chairs
Celle® Chairs
Embody® Chairs
Equa 2® Chairs
Ergon 3® Chairs
Mirra 2 Chairs
Sayl Chairs

C7 Caster

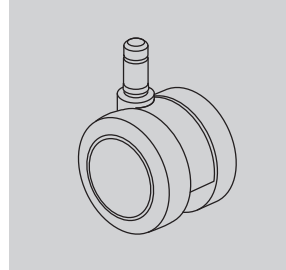

2 1/2-inch-diameter double-wheel caster; black nylon wheels and yoke; soft polyurethane tread; for use on hard floors or carpet

Applicable on:
New Aeron Chairs
Classic Aeron Chairs
Caper Chairs
Celle Chairs
Embody Chairs
Equa 2 Chairs
Ergon 3 Chairs
Mirra 2 Chairs
Sayl Chairs

CA Caster

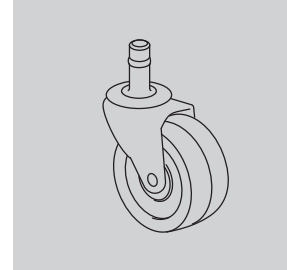

2-inch-diameter single-wheel caster; black rubber wheel with black yoke; for use on hard floors or carpet

Applicable on:
Co/Struc® System

49 Caster

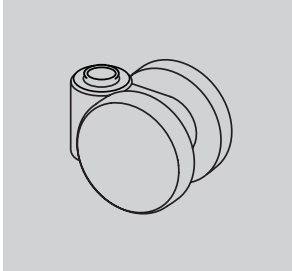

1 7/8-inch-diameter soft double-wheel caster; black nylon wheels and yoke; for use on hard floors or carpet

Applicable on:
Keyn Chairs
Sayl Chairs

BSC Caster

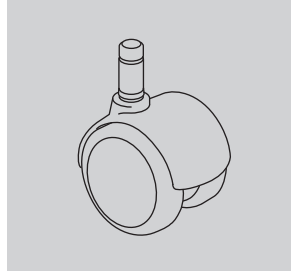

2-inch-diameter double-wheel caster; black nylon wheels and hood; soft polyurethane tread; for use on hard floors or carpet

Applicable on:
Eames® Aluminum Group
Eames Executive Chairs
Eames Soft Pad Group

C9 Caster

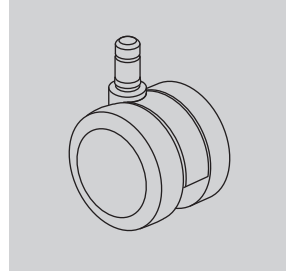

2 1/2-inch-diameter double-wheel caster; black nylon wheels and yoke; soft polyurethane tread; internal brake; for use on hard floors or carpet

Applicable on:
Classic Aeron Chairs
Caper Chairs
Celle Chairs
Embody Chairs
Equa 2 Chairs
Ergon 3 Chairs
Mirra 2 Chairs
Setu® Stools only

Sayl Chairs

DC1 Caster

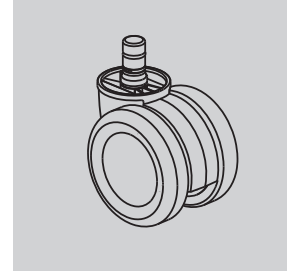

2 1/2-inch-diameter double-wheel braking caster; black nylon wheels and yoke; for use on hard floors or carpet; quiet roll technology

Applicable on:
New Aeron Chairs

Casters and Glides

continued

DS Caster

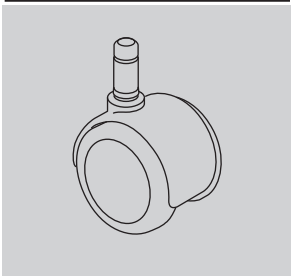

2-inch-diameter soft double-wheel braking caster; black nylon wheels and hood; for use on hard floors only

Applicable on:
Aside® Chairs
Caper Chairs

HCC Caster

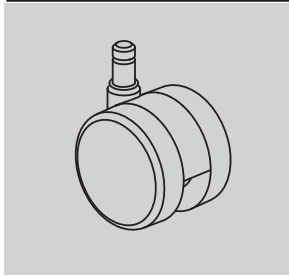

2 1/2-inch-diameter double-wheel medium roll resistance caster; black yoke; for use on hard floors or carpet.

Applicable on:
Setu Chairs

MD Caster

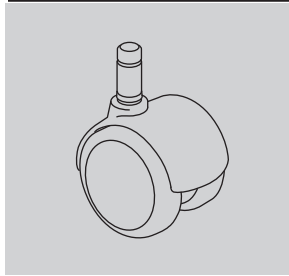

2-inch-diameter double-wheel caster; black nylon wheels with integral chrome hood; soft polyurethane tread; for use on hard floors or carpet

Applicable on:
Eames® Aluminum Group
Eames Executive Chairs
Eames Soft Pad Group

SC8 Caster

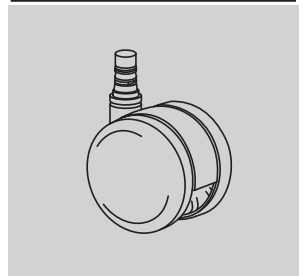

2 1/2-inch-diameter double-wheel caster; black nylon wheels and yoke; soft polyurethane tread; quiet roll technology; for use on hard floors or carpet

Applicable on:
Mirra 2 Chairs

H9 Caster

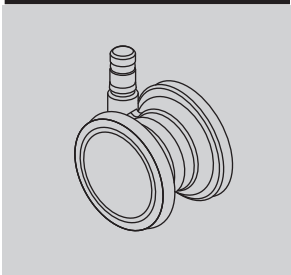

2 1/2-inch-diameter double-wheel caster; clear polycarbonate wheels; nylon yoke; soft polyurethane tread; for use on carpet only.

Applicable on:
Embody Chairs
Setu Chairs

HW Caster

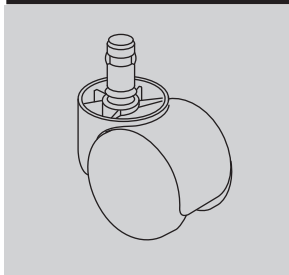

2-inch-diameter double-wheel caster; black nylon wheels and hood; for use on carpet only

Applicable on:
Limerick® Cart

OC Caster



Setu-specific 2 1/2-inch-diameter double-wheel medium roll-resistant caster; black nylon wheels and yoke; soft polyurethane tread; for use on hard floors or carpet; quiet roll technology

Applicable on:
Setu Chairs

SW Caster

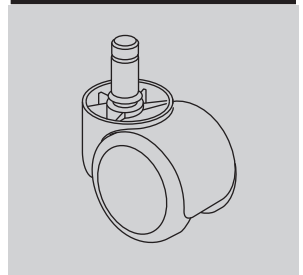

2-inch-diameter soft double-wheel caster; black nylon wheels and hood; for use on hard floors only

Applicable on:
Limerick Cart

Casters and Glides

continued

U4 Caster

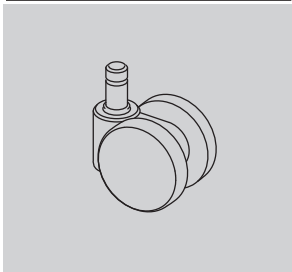

1 7/8-inch-diameter hard double-wheel caster; black nylon wheels and yoke; for use on carpet only

Applicable on:
Aside Chairs
Caper Chairs

UD Caster

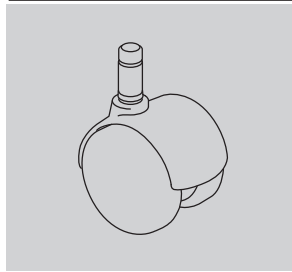

2-inch-diameter hard double-wheel caster; black nylon wheels with painted hood; for use on carpet only

Applicable on:
Eames® Aluminum Group
Eames Executive Chairs
Eames Soft Pad Group

16 Glide

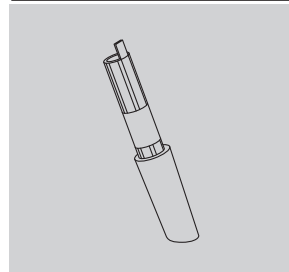

(Front glide shown)
2 1/8-inch-high glide; black or fog acetal; for use on carpet only

Applicable on:
Sayl Chairs

AGL Glide

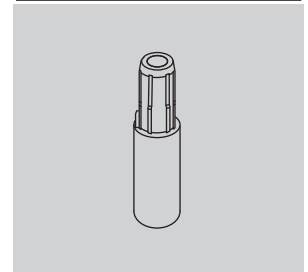

2 1/4-inch-high glide; black or white nylon stem; for use on carpet only

Applicable on:
Keyn Chairs

U5 Caster

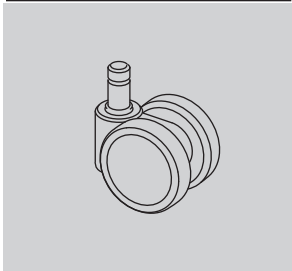

1 7/8-inch-diameter soft double-wheel caster; black nylon wheels and yoke; for use on hard floors or carpet

Applicable on:
Aside Chairs
Caper Chairs

VD Caster

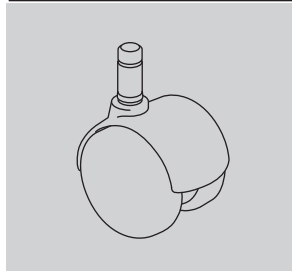

2-inch-diameter hard double-wheel caster; black nylon wheels with integral chrome hood; for use on carpet only

Applicable on:
Eames Aluminum Group
Eames Executive Chairs
Eames Soft Pad Group

69 Glide

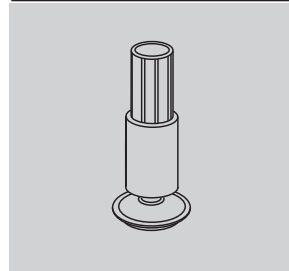

(Front glide shown)
2 1/8-inch-high glide; black glass-filled nylon stem; steel-plated swivel foot with Floor Saver Glide™ insert; for use on hard floors only

Applicable on:
Sayl Chairs

FSG Glide

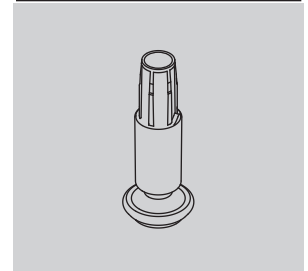

2 1/4-inch-high glide; black or white nylon stem; steel-plated swivel foot with Floor Saver Glide™ insert; for use on hard floors only

Applicable on:
Keyn Chairs

Casters and Glides

continued

Appendix: Casters and Glides



1½-inch-diameter glide; ½ inch in height; black nylon; for use on hard floors or carpet

Applicable on:
Eames Aluminum Group
Eames Executive Chairs
Eames Soft Pad Group



½-inch-high ganging glide; clear polycarbonate; for use on hard floors or carpet

Applicable on:
Limerick Chairs

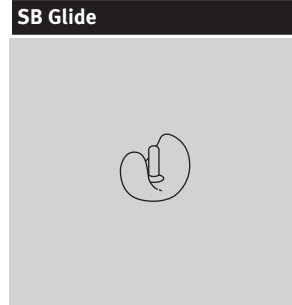

¼-inch-high, 1-inch diameter glide; thermoplastic CAP material (G1 base has black glides; XT base has clear glides); for use on hard floors or carpet

Applicable on:
Classic Aeron Chairs
Equa 2 Chairs

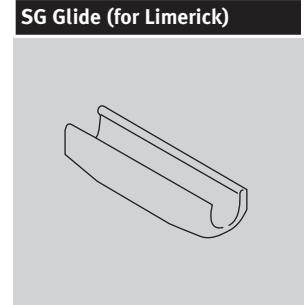

½-inch-high glide; clear polycarbonate; for use on hard floors or carpet

Applicable on:
Limerick Chairs



2½-inch-high glide; black nylon; for use on hard floors or carpet

Applicable on:
New Aeron Chairs
Classic Aeron Chairs
Celle Chairs
Equa 2 Chairs
Ergon 3 Chairs
Mirra 2 Chairs
Sayl Chairs



½-inch-high glide; black nylon glide with stainless-steel insert; for use on hard floors or carpet

Applicable on:
Aside Chairs



½-inch-high glide; black nylon; for use on carpet only

Applicable on:
Aside Chairs



⅛-inch-high glide; polycarbonate in black, fog, clear, and studio white finishes; for use on hard floors or carpet

Applicable on:
Sayl Chairs

Casters and Glides

continued

Y7 Glide

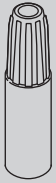

1 7/8-inch-high glide; black
acetal; for use on carpet only

Applicable on:
Caper Chairs

YX Glide

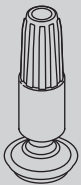

1 7/8-inch-high glide; black
nylon stem; steel-plated
swivel foot with Floor Saver
Glide™ insert; for use on
hard floors only

Applicable on:
Caper Chairs



Fire Retardancy – Seating

Fire Retardancy

Fire-retardant chairs are manufactured with special cushions, cushions covered with fire-barrier material, and/or are upholstered in approved fire-retardant fabrics. These chairs meet California TB 133 requirements.

All foam, Proprietary Textiles, and Textile Alliance Program™ (TAP™) textiles on HermanMiller seating products comply with California TB 117-2013.

State of California
Bureau of Home
Furnishings,
Technical Bulletin 133

State of California
Bureau of Home
Furnishings, Technical
Bulletin 117-2013

	State of California Bureau of Home Furnishings, Technical Bulletin 133	State of California Bureau of Home Furnishings, Technical Bulletin 117-2013
AireWeave™ 2	FR	•
Balance ¹	FR	•
Bento	FR	•
Bingo		•
Coil	FR	•
ColorGuard	FR	•
Crepe	FR	•
Crossing	FR	•
Cygnus™	FR	•
Flexnet™	FR	•
Gem	FR	•
Hopsak	FR	•
Latitude™	FR	•
Leather	FR	•
Lyris 2™ ³	FR	•
Mercer		•
Moiré	FR	•
Noble		•
Pellicle® Classic ⁴	FR	•
Pellicle Tuxedo		•
Pellicle Waves		•
Plateau	FR	•
Quilty	FR	•
Rhythm ²	FR	•
Spools	FR	•
Stitches	FR	•
Strata		•
Twist	FR	•

- Fabric meets code requirements.

FR To meet California TB 133 code requirements, fabrics must be applied to approved chairs identified with FR product numbers. To verify a fabric is approved for a specific chair, see the Fire-Retardant listing on the Seating Textiles Application Chart.

- 1 Balance 3512 carbon and 3513 black only available on Embody® FR chairs.
- 2 Rhythm 3014 black only available on Embody FR chairs.
- 3 Lyris 2 4W11 graphite only available on Setu® FR chairs.
- 4 Pellicle Classic 3Do1 graphite only available on Classic Aeron® FR chairs.



Customer's Own Material/Customer's Own Leather Order Information — Seating

Packaging

Packaging varies according to individual product. A surcharge may be added for special packaging requests. Contact Customer Care for specific information.

Customer's Own Material/Customer's Own Leather

Program Overview

The Customer's Own Material (COM) and Customer's Own Leather (COL) program gives you the option of using textiles other than those listed. Herman Miller will test textiles for application to Herman Miller products and will process orders for those with approved COM/COL textiles only. COM/COL are assigned lead-time textiles.

Omni lists an overview of fabrics and leathers that have been tested and indicates whether or not they were approved for application to Herman Miller products.

Specific information on the terms and conditions, testing, approval, and ordering process for COM/COL is listed below. Questions about the COM/COL program and requests for assistance may be directed to your COM representative at:

(616) 654 3400

(866) 854 3048 EXT 3400

Customer's Own Material/Customer's Own Leather Warranty

Herman Miller does not warrant COM/COL textiles. COM/COL textiles are tested for application only; they are not tested for performance. The Herman Miller warranty does apply to the underlying products.

Suppliers of COM/COL textiles are responsible for color consistency within commercial tolerances, UV stability, and resistance to soiling and perspiration.

Customer's Own Material/Customer's Own Leather Pricing

COM is a Category 1 fabric. There are no application charges for COM fabrics. COL is a Category 7 textile; refer to prices on specific products to determine the application charge.

Ordering and payment for COM/COL textile yardage are the responsibility of the customer and the textile supplier.

If desired, Herman Miller will purchase COM textiles directly from True Textiles, C.F. Stinson, Luna Textiles, Maharam, and Momentum Textiles to simplify ordering and shipment. For this service, refer to the Supplier Connection program.

Textile Approval

1. Select a COM/COL textile and a Herman Miller product.
2. If your textile is not listed in Omni, obtain a test number from a COM representative at (616) 654 3400. You can also submit your request within Omni. Please have the following information ready before calling: textile name, number, pattern, roll width, and the product you will apply it to.

Additional yardage may be needed due to the unique characteristics of a textile. All package labels must include the words "COM test" or "COL test" and the assigned COM/COL test number.

3. Herman Miller will notify you of approval or disapproval within 4 days from receipt of the test yardage.

Ordering Products with COM/COL

1. Refer to the specific products to determine the yardage required for COM/COL textiles.
2. If your textile is not listed in Omni, call a COM representative at (616) 654 3400 or (866) 854 3048 EXT 3400. The representative will assign an identification number for your textile (ID#) and will verify yardage requirements for your order. Additional yardage may be needed due to the unique characteristics of a textile.
3. Enter your order on Order Manager in Omni.
4. Upon receipt of your purchase order, Herman Miller will send you a PO acknowledgment.
5. Arrangements must be made for the textiles to be shipped from the supplier to Herman Miller for application to the seating products. Textiles must be tagged with the assigned identification number and the roll yardage quantity. See Omni for shipping procedures and current shipping addresses or contact a COM representative at (616) 654 3400 or (866) 854 3048 EXT 3400.

Products will be scheduled for production when COM/COL textiles are received at Herman Miller. Standard lead times in effect at that time will apply.

Note: If textiles are to be purchased directly by Herman Miller through the Supplier Connection program, Herman Miller will handle the ordering and shipping process and will schedule your order for production upon receipt of your purchase order (dependent on textile availability). Refer to the Supplier Connection program for more information.

Customer's Own Material/Customer's Own Leather Order Information — Seating

continued

Supplier Connection

Program Overview

The Supplier Connection program is a service offered by Herman Miller to purchase approved COM textiles directly from True Textiles, C.F. Stinson, Luna Textiles, Maharam, and Momentum Textiles. When you select a textile through this program, Herman Miller will facilitate the ordering, scheduling, and shipment of the textile directly with the supplier.

Suppliers included in the Supplier Connection program keep an active inventory of textiles that are pre-approved for application to Herman Miller products. Pre-approval applies only to the suitability of a textile for manufacturing and application to a Herman Miller product. Omni provides an overview of fabrics that have been tested and indicates whether or not they were approved for application to Herman Miller products.

Specific information on the terms and conditions, testing, approval, and ordering process for the Supplier Connection program is listed below. Questions and requests for assistance may be directed to your COM representative at:

(616) 654 3400

(866) 854 3048 EXT 3400

Supplier Connection Warranty

Textiles purchased by Herman Miller through the Supplier Connection program are COM and are not warranted by Herman Miller. COM textiles are tested for application only; they are not tested for performance. The Herman Miller warranty does apply to the underlying products.

Suppliers of COM textiles are responsible for color consistency within commercial tolerances, UV stability, and resistance to soiling and perspiration.

Supplier Connection Pricing

Textiles purchased by Herman Miller through the Supplier Connection program are COM. COM is a Category 1 fabric. There are no application charges for COM fabrics.

Payment for textiles purchased by Herman Miller through the Supplier Connection program is the responsibility of the customer or dealer. Herman Miller will invoice the order at the supplier's prices published at the time of the order.

Textile Approval

1. Refer to Omni to identify the approval status of the textile. If your textile is not listed, contact the COM Department to request testing for application to Herman Miller products.
2. Herman Miller will notify you of approval or disapproval in approximately 4 days from receipt of the test yardage. If the textile is approved, it will be assigned a COM identification number.

Ordering Products with Supplier Connection COM

1. Identify and include the following information on your purchase order:
 - Product number and option
 - Herman Miller's COM identification number
2. Enter your order on Order Manager in Omni.
3. Upon receipt of the purchase order, Herman Miller will process your order and send you a PO acknowledgment. Herman Miller will determine the yardage required to produce your product and will order and schedule for delivery the required textile. Standard lead times in effect at the time the textile is allocated at the supplier will apply to products ordered through this program.

Proprietary Textiles Application Chart – Seating

• Available

[A] Assigned lead-time textile.

See following page for exception notes.

[N] Non-woven textile.

	New Aeron® Chairs	Classic Aeron Work Chairs/Stools	Classic Aeron Arm pads/Arm Kit	Mirra® 2 Chairs/Stools	Celle® Chairs/Stools	Embody® Chairs	Sayl® Work Chairs/Stools	Sayl Side Chairs	Setu® Chairs/Stools	Ergon 3® Chairs	Ergon 3/Equa 2® Adjustable Arm Kit	Equa 2 Fully Upholstered Chairs/Stools	Equa 2 Split-Pad Upholstered Chairs/Stools	Aside® Chairs	Cape® Chairs/Stools	Celeste™ Seating	Keyn Chair Group	Locale® Bench Cushion	Public Office Landscape® Back	Public Office Landscape Seat	Plex™ Lounge Furniture	Swoop™ Lounge Seating - Fully Upholstered	Swoop Lounge Seating - Plywood	Eames Tandem Sling Seating	Cushion Tops	Workspaces	
Price Category 1																											
COM Customer's Own Material [A]					14		1	1		1		1	1	1		1	1	1				1	1	1	1	1	1
231__ 8Z Pellicle®	•																										
1A7__ AireWeave™ 2				•																							
3P__ ColorGuard [N]					15		•	22	•	2			3	8		•	•	•					•	•	6	•	•
8T__ Crossing					•				•	•		•	•	•					•				•	•		•	•
6V__ Flexnet™																•											
95__ Gem					14				•	•		•	•	•		•		•				•	•			•	•
4W__ Lyris 2™									•																		
3D__ Pellicle® Classic (3V__)			•																								
3DK__ Stretch Knit [A]								21																			
235__ Tailored [A]					•		•	•	•					•		•	•					•	•				•
Price Category 2																											
92__ Crepe					•		•	•	•	•		•	•	•		•	•	•				•	•			•	•
22Q__ Fish Net					•		•	•	•	•		•	•	•		•	•	•				•	•			•	•
1LM__ Loom					14		•	•									•	•	•			•	•			•	•
1MV__ Marvel					14		21	•					•	8		•	•	•				•	•			•	•
1HA__ Medley					14		•	22		•		•	•	•		•	•	•				•	•			•	•
3A__ Moiré					14		•	•	•	•		•	•	•		•	•	•				•	•			•	•
4M__ Pellicle Tuxedo (4Q__)			•																								
4E__ Pellicle Waves (4F__)			•																								
30__ Rhythm					•	23	•	•				•	•				•	•				•	•			•	•
1RV__ Rivet					14		21	22						•		•	•	•				•	•			•	•
8R__ Twist					•		•	•	•	•				•	•	•	•					•	•			•	•
22T__ Well Suited														•	8							•	•			•	•
Price Category 3																											
70__ Bento							•	•	•	2		•	•	8			•										•
8M__ Latitude™				23			•	•					3										•	•			
22R__ Pins and Needles					14		•	•	•			•	•			•	•					•	•			•	•
8U__ Stitches					•		•	•	•	•		•	•	•		•	•	•				•	•			•	•
22V__ String Plaid					14		•	•						•		•	•	•				•	•			•	•
Price Category 4																											
7Y__ Bingo [N]							•	•	•	2			3	8		•	•	•									•
213__ Mercer					14		•	•	22							•	•					•	•			•	•
1A9__ Network																			•								
6J__ Plateau										•		•	•	•													•
6S__ Quilty					14		•	•						•		•	•	•					•				•
8Y__ Spools					14		21	•	•	•		•	•	•		•	•	•					•			•	•
22P__ Strata							21	22	•	•				•		•	•	•				•	•			•	•
Price Category 5																											
14A__ Hopsak					14		•	22	•	•		•	•	•		•	•	•				•	•			•	•
22N__ Noble (22H__) [A]					14		•	23	•	•		•	3	8		•	•	•				•	•			•	•
Price Category 6																											
35__ Balance							•																				
Price Category 7																											
COL Customer's Own Leather [A]			1		14		•	•		1	1	1	1	8			1									1	
Price Category 8																											
No fabrics available at this time																											
Price Category 9																											
21__ Leather			•		14		•	•			•	•	•	8		4	•						•				•

continued on next page

Proprietary Textiles Application Chart – Seating

continued

- Available

[A] Assigned lead-time textile.

See below for exception notes.

[N] Non-woven textile.

Fire-Retardant Chairs/Fabrics

	Classic Aeron® Work Chairs/Stools	Mirra® 2 Chairs/Stools with Butterfly Back	Celle® Chairs/Stools	Embody® Chairs	Sayl® Work Chairs/Stools	Sayl Side Chairs	Setu® Chairs/Stools	Ergon 3® Chairs	Equa 2® Fully Upholstered Chairs/Stools	Equa 2 Split-Pad Upholstered Chairs/Stools	Aside® Chairs	Caper® Chairs/Stools	Celeste™ Seating	Plex™ Lounge Furniture	Swoop™ Lounge Seating - Fully Upholstered	Eames® Tandem Sling Seating
Price Category 1																
COM Customer's Own Material [A]								1	1	1	1		1			
1A7__ AireWeave™ 2		•														
3P__ ColorGuard [N]			15	24	22		2		3	8					•	6
8T__ Crossing			14				•	•	•	•			•		•	
6V__ Flexnet™												•				
95__ Gem			14				•	•	•	•			•	•	•	
4W__ Lyris 2™						18										
3D__ Pellicle® Classic	7															
235__ Tailored [A]			•				•						•	•		
Price Category 2																
92__ Crepe			14		•	•			•	•	•		•	•	•	
22Q__ Fish Net					•	•	•								•	
3A__ Moiré			14		•	•	•	•	•	•			•			
30__ Rhythm			14	16	24	•					8				•	
8R__ Twist			14		•	•	•	•		•	8		•	•	•	
Price Category 3																
70__ Bento					•	•	•	2	•		8				•	
8S__ Coil			14		•	•	•	•	•	•			•		•	
8M__ Latitude™					•	•	•									
22R__ Pins and Needles					•	•	•									
8U__ Stitches			14		•	•	•	•	•	•			•	•	•	
22V__ String Plaid					•								•			
Price Category 4																
6J__ Plateau											•					
6S__ Quilty			14		•	•									•	
Price Category 5																
14A__ Hopsak			14		•				•	•	•				•	•
Price Category 6																
35__ Balance				17												
Price Category 9																
21__ Leather			14	21							8					

All foam and Proprietary Textiles on HermanMiller seating comply with California TB 117-2013.

Application Note: Herman Miller cannot guarantee material/pattern alignment in adjacent products. For example, a fabric's pattern may not align from one pedestal cushion top to the next, or from one chair to another.

- | | |
|--|--|
| 1 Refer to price book appendices and Omni for COM/COL information. | 16 Only available in 3014 Black. |
| 2 Available on all Ergon 3 chairs except for fabric back (FB) option. | 17 Only available in 3512 Carbon and 3513 Black. |
| 3 Available on A-and B-size Equa 2 split-pad upholstered chairs. | 18 Only available in 4W26 Slate Grey, 4W30 Java, and 4W31 Graphite. |
| 4 See specific products for information on specifying leather in combination with fabric. | 21 Not available on Sayl upholstered back work chairs. |
| 6 Only available in 3P02 Navy, 3P03 Spruce, 3P14 Black, 3P17 Burgundy, 3P19 Slate, and 3PC7 Bucksuede. | 22 Not available on Sayl side chairs with upholstered backs. |
| 7 Only available in 3D01 Graphite. | 23 Available in select colors. Refer to "Proprietary Textile Colors-Seating" for color offering. |
| 8 Only available on nonupholstered outer back option (PB). | 24 Not available on Sayl upholstered High-Back Work Chairs. |
| 14 Available on Celle UC (upholstered seat) and HC (upholstered seat with protective edge) Chairs. | |
| 15 Available only on Celle HC (upholstered seat with protective edge) Chairs. | |

Proprietary Textile Colors – Seating

Price Category 1

Customer's Own Material
See Order Information in
Appendices.
Assigned lead-time textile. A

8Z Pellicle®
For New Aeron® Chairs
56% elastomeric
44% polyester
23101 Mineral
23102 Carbon
23103 Graphite

AireWeave™ 2
For Mirra® 2 Chairs
67% elastomeric
33% antimony-free polyester
1A701 Alpine
1A702 Slate Grey
1A703 Graphite
1A704 Lime Green
1A705 Cappuccino
1A706 Urban Orange
1A707 Dark Turquoise
1A708 Twilight

ColorGuard
54" wide
100% vinyl
3P01 Grey
3P02 Navy *
3P03 Spruce * A
3P04 Jade A
3P05 Natural A
3P08 Blueberry A
3P09 Coal A
3P12 Black Plum A
3P14 Black *
3P15 New Burgundy A
3P17 Burgundy * A
3P19 Slate *
3P31 Horizon Blue A
3P33 Pumice
3P54 Candy Apple A
3P58 Beige A
3P66 Deep Clay A
3P72 Allspice A
3P90 Green Tea A
3P93 Camelback A
3P96 Manzanita A
3P97 Fudge A
3PB2 Sea Grass A
3PB5 Vizcaya Palm A
3PB9 Neptune A
3PC7 Bucksuede * A
3PD4 Otter A

* Colors available on Eames®
Tandem Sling Seating.

A Assigned lead-time color.

Crossing
54" wide
86% antimony-free polyester
14% polyester
8T03 Wicker
8T04 Porcelain
8T05 Warm Grey
8T06 Sepia
8T07 Pumpkin
8T08 Copper
8T09 Cranberry
8T10 Tomato
8T11 Mulberry
8T12 Plum
8T13 Green Apple
8T14 Loden
8T15 Spruce
8T16 Periwinkle
8T17 Cerulean
8T18 Indigo
8T19 Shale
8T20 Brownstone
8T21 Bark
8T22 Tin
8T23 Graphite
8T24 Black

Flexnet™
For Caper® Chairs
69% elastomeric
31% polyester
6V01 Black
6V02 Silver Grey

Gem
54" wide
100% antimony-free polyester
9501 Sesame
9502 Tangerine
9503 Red
9504 Red Violet
9505 Mulberry
9506 Java
9507 Twilight
9508 Bayou
9509 Iris
9510 Berry Blue
9511 Aqua Green
9512 Green Apple
9513 Spruce
9514 Black
9515 Slate Grey
9516 Fog

Lyris 2™
For Setu® Chairs
74% elastomeric
26% polyester
4W21 Alpine
4W22 Mango
4W23 Chartreuse
4W25 Berry Blue
4W26 Slate Grey
4W28 Chino
4W29 Rattan
4W30 Java
4W31 Graphite

Category 1 continued on next
page

Proprietary Textile Colors – Seating

continued

Appendix: Proprietary Textile Colors – Seating

Price Category 1

continued

Pellicle® Classic	
For Classic Aeron® chairs with a graphite or polished aluminum base.	
70% elastomeric, 30% polyester	
3D01	Carbon
3D02	Lead

Pellicle Classic	
For Classic Aeron chairs with a titanium base.	
70% elastomeric	
30% polyester	
3V01	Zinc
3V03	Quartz

Stretch Knit	
Assigned lead-time textile. A	
Available only on Sayl®	
Suspension Back Work Chairs	
97% polyester, 3% spandex	
3DK01	Fog
3DK02	Slate Grey
3DK03	Java
3DK04	Black
3DK05	Red
3DK06	Green Apple
3DK07	Berry Blue

Tailored	
Assigned lead-time textile. A	
54" wide	
56% polyester	
44% recycled polyester	
23501	Studio White
23502	Sugar
23503	Tomato
23504	Orchid
23505	Boysenberry
23506	Chive
23507	Bluegrass
23508	Cobalt
23509	Cadet
23510	Fog
23511	Graphite
23512	Black
23513	Coffee

Price Category 2

Crepe	
54" wide	
100% recycled polyester	
9201	Licorice
9203	Smoke
9207	Cherry
9209	Claret
9212	Raisin
9218	Aquamarine
9223	Cadet
9241	Beachglass
9243	Midnight
9244	Artichoke
9248	Warm White
9249	Stone
9250	Earth
9251	Fog
9252	Slate Grey
9253	Yellow Dark
9254	Coral
9255	Blush Grey
9256	Wild Berry
9257	Clover
9258	Caribbean
9259	Cerulean
9260	Brownstone
9261	Shale
9262	Graphite
9263	Tomato
9264	Green Apple

Fish Net	
55" wide	
100% recycled polyester	
22Q01	Oyster
22Q02	Stone
22Q03	Citrus
22Q04	Curry
22Q05	Chipotle
22Q06	Cherry
22Q07	Fuschia
22Q08	Claret
22Q09	Purple
22Q10	Clover
22Q11	Pesto
22Q12	Peacock
22Q13	Lagoon
22Q14	Twilight
22Q15	Bluestone
22Q16	Storm
22Q17	Black
22Q18	Cocoa

Loom	
54" wide	
100% polyester	
1LM01	Linen
1LM02	Brown Sugar and Spice
1LM03	Brick and Mortar
1LM04	Salt and Pepper
1LM05	Black
1LM06	Lemongrass
1LM07	Poppy
1LM08	Wild Berry
1LM09	Loden
1LM10	Jade
1LM11	Deep Sea

Marvel	
54" wide	
100% pvc-free polyurethane	
1MV01	Summer White
1MV02	Sand Dollar
1MV03	Espresso
1MV04	Folkstone Grey
1MV05	Graphite
1MV06	Onyx
1MV07	Polar Blue
1MV08	Blush Grey
1MV09	Woodrose
1MV10	Citrus
1MV11	Adobe
1MV12	Red
1MV13	Kiwi Green
1MV14	Pine
1MV15	Teal Green
1MV16	Twilight

Medley	
54" wide	
100% polyester	
1HA01	Stone
1HA02	Trail
1HA03	Charcoal
1HA04	Cinder
1HA05	Citrus
1HA06	Papaya
1HA07	Chutney
1HA08	Tundra
1HA09	Feather Grey
1HA10	Chartreuse
1HA11	Loden
1HA12	Peacock
1HA13	Bayou
1HA14	Blue Grotto
1HA15	Blueberry
1HA22	Khaki
1HA23	Pewter
1HA24	Yellow Oxide
1HA25	Vintage Rose
1HA26	Raspberry
1HA27	Acai Berry

Category 2 continued on next page

Proprietary Textile Colors – Seating

continued

Price Category 2

continued

Moiré	
54" wide	
100% recycled polyester	
3A01	Concrete
3A02	Biscotti
3A03	Rattan
3A04	Chambray
3A05	Fern
3A08	Violet
3A09	Zin
3A10	Curry
3A11	Spice
3A12	Cork

Pellicle® Tuxedo	
For Classic Aeron® chairs with a graphite or polished aluminum base.	
64% elastomeric	
36% polyester	
4M01	Grey Black
4M02	Blue Black

Pellicle Tuxedo	
For Classic Aeron chairs with a titanium base.	
64% elastomeric	
36% polyester	
4Q01	White Gold

Pellicle Waves	
For Classic Aeron chairs with a graphite or polished aluminum base.	
68% elastomeric	
32% polyester	
4E01	Carbon
4E03	Platinum

Pellicle Waves	
For Classic Aeron chairs with a titanium base.	
68% elastomeric	
32% polyester	
4F01	Zinc
4F03	Quartz

Rhythm	
54" wide	
100% polyester	
3001	Kiwi Green *
3002	Green Apple
3003	Peacock
3004	Bayou *
3005	Berry Blue
3006	Iris
3007	Twilight
3008	Pumpkin *
3009	Poppy *
3010	Molasses
3011	Mulberry
3012	Khaki *
3013	Mink
3014	Black
3015	Charcoal

* Colors not available on Embody® Chair.

Rivet	
54" wide	
100% recycled polyester	
1RV01	Twig
1RV02	Deep Clay
1RV03	Woodrose
1RV04	Otter
1RV05	Hemlock
1RV06	Olive
1RV07	Lagoon
1RV08	Deep Sea
1RV09	Charcoal
1RV10	Grey Brindle

Twist	
54" wide	
80% antimony-free polyester	
13% recycled polyester	
7% polyester	
8R05	Wicker
8R10	Poppy
8R14	Tin
8R15	Shale
8R16	Graphite
8R17	Birch
8R18	Sepia
8R22	Blueberry
8R23	Green Apple
8R26	Gunmetal
8R27	Cinder
8R28	Citrus
8R29	Pekoe
8R30	Tangerine
8R31	Red Plum
8R32	Wisteria
8R33	Forest
8R34	Jade Dark
8R35	Waterfall
8R36	Midnight Blue
8R37	Carbon Dark

Well Suited	
55" wide	
79% polyester	
21% recycled polyester	
22T01	Oyster
22T02	Raffia
22T03	Peppermint
22T04	Wild Berry
22T05	Spring Green
22T06	Mint
22T07	Periwinkle
22T08	Cool Grey
22T09	Citrus
22T10	Pumpkin
22T11	Red
22T12	Fuschia
22T13	Orchid
22T14	Chartreuse
22T15	Green Apple
22T16	Jade
22T17	Peacock
22T18	Blueberry
22T19	Bluestone
22T20	Mink

Proprietary Textile Colors – Seating

continued

Price Category 3

Bento	
54" wide	
100% antimony-free polyester	
7001 Frost	
7002 Linen	
7003 Khaki	
7004 Truffle	
7005 Grey Black	
7006 Pumpkin	
7007 Cranberry	
7008 Everglade	
7009 Cobalt	

Latitude™	
61" wide	
100% polyester	
8M01 Graphite	
8M02 Shadow	
8M03 Citron	
8M05 Blue Fog	
8M06 Cappuccino	
8M10 Alpine	
8M15 Champagne	
8M16 Chestnut	
8M17 Black	
8M18 Brownstone	
8M21 Slate Grey	
8M22 Lime Green	
8M23 French Press	
8M24 Urban Orange	
8M25 Dark Turquoise	
8M26 Twilight	

Latitude	
Colors for Mirra 2 Chairs	
100% polyester	
8M10 Alpine	
8M17 Black	
8M21 Slate Grey	
8M22 Lime Green	
8M23 French Press	
8M24 Urban Orange	
8M25 Dark Turquoise	
8M26 Twilight	

Pins and Needles	
58" wide	
76% recycled polyester	
24% polyester	
22R01 Day and Night	
22R02 Night and Day	

Price Category 4

Bingo	
54" wide	
100% PVC-free polyurethane	
Resilience® finish	
7Y01 Oyster	
7Y02 Natural	
7Y03 Cashew	
7Y04 Buff	
7Y05 Rattan	
7Y06 Root	
7Y07 Woodland	
7Y08 Camel	
7Y09 Copper	
7Y10 Allspice	
7Y11 Canyon	
7Y12 Henna	
7Y13 Sedona	
7Y14 Black Plum	
7Y15 Currant	
7Y16 Mahogany	
7Y17 Seed	
7Y18 Mushroom	
7Y19 Blue Grey	
7Y20 Navy	
7Y21 Black	
7Y22 Mint	
7Y23 Seaport	
7Y24 Evening Blue	
7Y25 Hemlock	
7Y26 Kiwi Green	
7Y27 Celadon	
7Y28 Moss	
7Y29 Pesto	

Category 4 continued on next page

Proprietary Textile Colors – Seating

continued

Price Category 4

continued

Mercer	
54" wide	
50% solution dyed recycled nylon	
50% solution dyed nylon	
BLOCKaide	
21301	Stone
21302	Rattan
21303	Cayenne
21304	Chutney
21305	Pesto
21306	Teal Blue
21307	Ultramarine
21308	Acai Berry
21309	Ash Brown
21310	Charcoal

Network	
For Public Office Landscape®	
Sectional Back/Social Chair Back	
knit to size	
100% polyester	
1A901	Warm White
1A902	Fog
1A903	Red
1A904	Wildberry
1A905	Green Apple
1A906	Twilight
1A907	Graphite

Plateau Perspectives® Collection	
knit to size	
100% polyester	
6J01	Feather Grey
6J02	Trail
6J03	Mustard Seed
6J04	Fennel
6J05	Red Pepper
6J06	Twig
6J07	Waterfall
6J08	Sagebrush
6J09	Winter Berry
6J10	Thunder
6J11	Blueberry
6J12	Rosemary
6J13	Wild Plum
6J14	Black

Quilty	
56" wide	
100% antimony-free polyester	
GreenShield	
6S03	Khaki
6S04	Straw
6S07	Brick
6S10	Mink
6S11	Green Apple
6S13	Indigo
6S14	Zinc
6S15	Slate
6S16	Beachwood
6S17	Paprika
6S18	Plum
6S19	Juniper
6S20	Grey Black

Spools	
54" wide	
51% recycled polyester	
49% polyester	
Crypton® Green	
8Y01	Cashew
8Y02	Wicker
8Y03	Trail
8Y04	Cappuccino
8Y05	Copper
8Y08	Bluegrass
8Y09	Lagoon
8Y10	Grape
8Y11	Beachglass
8Y12	Marsh
8Y13	Bud

Strata	
54" wide	
50% solution dyed recycled nylon	
50% solution dyed nylon	
BLOCKaide	
22P01	Rattan
22P02	Yellow Jacket
22P03	Avocado
22P04	Pesto
22P05	Peacock
22P06	Blue Jay
22P07	Blueberry
22P08	Boysenberry
22P09	Mango
22P10	Paprika
22P11	Mulberry
22P12	Wheat
22P13	Brownstone
22P14	Bayou
22P15	Trail

Price Category 5

Hopsak	
56" wide	
100% recycled polyester	
14A20	Black
14A22	Raw Umber Dark
14A26	Grey Blue Dark
14A30	Sepia Dark
14A38	Emerald Dark
14A39	Yellow Dark
14A40	Orange
14A41	Sienna
14A42	Olive Green Dark
14A43	Crimson
14A44	Crimson Dark Dark
14A45	Violet Dark
14A46	Pink Dark Dark
14A47	Ultramarine Dark
14A48	Cobalt Blue
14A49	Terra Cotta
14A50	Ochre Dark

Noble	
Assigned lead-time textile. <input type="checkbox"/>	
54" wide	
100% wool	
22N02	Chipotle *
22N04	Cherry *
22N07	Cadet *
22N08	Berry Blue *
22N09	Peacock *
22N11	Pesto *
22N12	Blue Grey Mix *
22H15	Heathered Black
22H16	Heathered Grey
22H17	Heathered Twilight
22H18	Heathered Rye Grass
22N19	Lemongrass Mix *
22H20	Heathered Red
22H21	Heathered Wild Berry
22N22	Pesto Mix *
22N23	Lagoon Mix *

* Colors not available on Sayl® Side Chairs.

Proprietary Textile Colors – Seating

continued

Appendix: Proprietary Textile Colors | Seating

Price Category 6

Balance

For Embody® chairs

100% polyester

3512 Carbon

3513 Black

Price Category 7

Customer's Own Leather

See Order Information in
Appendices. Assigned lead-time
textile. [A](#)

Price Category 8

No fabrics available at this time.

Price Category 9

Leather

approx. 50 sq. ft. per hide

100% leather

2101 Ivory

2109 Black

2110 Smoke

2111 Graphite

2112 Khaki

2113 Rattan

2114 Truffle

2115 Alpine

2116 Haze

2117 Sable Grey

2118 Dark Mineral

2119 Dark Carbon

2120 Cranberry

2121 Deep Sea

Maharam® Application Chart – Seating

- Available

See below for exception notes.

Maharam textiles are on assigned lead times. A

[N] Non-woven textile.

	Classic Aeron® Work Chairs/Stools	Classic Aeron Arm pads/Arm Kit	Mirra® Chairs/Stools	Celle® Chairs	Sayl® Work Chairs/Stools	Sayl Side Chairs	Setu® Chairs/Stools	Ergon 3® Chairs	Ergon 3 Adjustable Arm Kit	Equa 2® Fully Upholstered Chairs/Stools	Equa 2 Split-Pad Upholstered Chairs/Stools	Equa 2 Adjustable Arm Kit	Aside® Chairs	Caper® Chairs/Stools	Celeste™ Seating	Keyn Chair Group	Locale® Bench Cushions	Public Office Landscape® Seat	Plex™ Lounge Furniture	Swoop™ Lounge Seating - Fully Upholstered	Swoop Lounge Seating - Plywood	Cushion Tops	Workspaces
Price Category A																							
No fabrics available at this time.																							
Price Category B																							
VM__ Medium - Maharam				14	•	•	•			•	3		•		•	•				•	•	•	•
TI__ Messenger - Maharam *				14	•	•	•				•		•		•	•				•	•	•	•
Price Category C																							
No fabrics available at this time.																							
Price Category D																							
Z27__ Manner - Maharam				14	•	•	•			•	•		•		•	•				•	•	•	•
Price Category E																							
ZFS__ Focus - Maharam				14	16	16							•			•							•
ZLR__ Lariat - Maharam [N]				14	16	16										•		•		•			•
VgG__ Ledger - Maharam [N]				14	16	16										•							•
Z3__ Metric - Maharam				14	•	•	•			•	•		•		•	•				•	•	•	•
ZMD__ Mode - Maharam				14	•	•					•		•			•	•				•	•	•
ZBQ__ Oblique - Maharam						16			•				•			•	•				•	•	•
ZP2__ Pick - Maharam						•	•	•					•			•	•				•	•	•
Z32__ Skein - Maharam				14	16	16	•						•			•	•						•
ZT3__ Technic - Maharam				14	18	16							•			•	•						
Price Category F																							
ZCH__ Chock - Maharam															•								
ZC8__ Coin - Maharam				14	18	16							•			•							•
ZCJ__ Coincide - Maharam					16	16							•			•							•
VS__ Crush - Maharam							•								•	•				•			•
ZD1__ Disc - Maharam				14	18	16							•			•	•						•
ZD3__ Divide - Maharam				14	18	16							•			•	•						•
ZEE__ Exchange - Maharam				14	16	16							•			•	•				•		•
Z29__ Plait - Maharam				14	16	16	•								•	•					•		•
V26__ Remix - Maharam					16	16									•	•					•		•
ZRV__ Rove - Maharam				14	16	16										•	•						
ZRA__ Runner Standard - Maharam				14	16	16										•	•						
ZSM__ Seam - Maharam				14	18	16							•			•	•						
Z31__ Sequence - Maharam				14	16	•				•			•		•	•					•		•
ZSS__ Shuttle Standard - Maharam				14	16	16										•	•						
Z33__ Strum - Maharam [N]						16									•	•					•		
ZWX__ Waxen - Maharam				14	16	16										•	•						

* Available in select colors on 20-day lead-time.
Refer to "Maharam Colors - Seating" for 20-day colors.

continued on next page

Maharam® Application Chart – Seating *continued*

- Available

See below for exception notes.

Maharam textiles are on assigned lead times. A

[N] Non-woven textile.

Appendix: Maharam Application Chart – Seating

	Classic Aeron® Work Chairs/Stools	Classic Aeron Arm pads/Arm Kit	Mirra® Chairs/Stools	Celle® Chairs	Sayl® Work Chairs/Stools	Sayl Side Chairs	Setu® Chairs/Stools	Ergon 3® Chairs	Ergon 3 Adjustable Arm Kit	Equa 2® Fully Upholstered Chairs/Stools	Equa 2 Split-Pad Upholstered Chairs/Stools	Equa 2 Adjustable Arm Kit	Aside® Chairs	Caper® Chairs/Stools	Celeste™ Seating	Keyn Chair Group	Locale® Bench Cushions	Public Office Landscape® Seat	Plex™ Lounge Furniture	Swoop™ Lounge Seating - Fully Upholstered	Swoop Lounge Seating - Plywood	Cushion Tops	Workspaces
Price Category G																							
ZC9__ Coin Crypton - Maharam					18	16																	
ZCF__ Coincide High Performance - Maharam				14	16	16								•		•							
ZCQ__ Colline - Maharam																				•			
ZC2__ Compound - Maharam [N]					16	16		•		•			8			•			•		•		
ZD2__ Disc Crypton - Maharam				14	18	16										•							
ZD4__ Divide Crypton - Maharam				14	18	16								•		•							
Z23__ Divina MD - Maharam				14	•	16		•		•					•	•				•		•	•
TF__ Divina - Maharam				14	•	•	•	•		•	•				•	•				•	•	•	•
TG__ Divina Melange - Maharam				14	•	•	•	•		•	•				•	•				•	•	•	•
ZEM__ Emboss - Maharam [N]				14	16	16																	
ZF1__ Fold - Maharam [N]				14	18	16														•			
ZH1__ Hero by Kvadrat - Maharam				14	18	16								•		•							
ZQM__ Omen - Maharam				14	16	16								•		•							
ZP1__ Pick Crypton - Maharam				14	18	16								•		•							
ZP3__ Pocket - Maharam				14		•								•		•					•		•
ZRG__ Ring - Maharam				14	16	16										•							
ZRF__ Runner - Maharam				14	16	16										•							•
ZSN__ Sheen - Maharam				14	18	16								•		•							
ZSE__ Steelcut - Maharam																•				•			
V25__ Steelcut Trio - Maharam				14		•									•	•				•			•
ZS1__ Stride - Maharam				14	18	16								•		•							
ZT4__ Ticker - Maharam				14	18	16								•		•						•	•
ZVT__ Vestige - Maharam				14	16	16								•		•							
Price Category H																							
ZT__ Circles - Maharam				14											•	•							•
ZS__ Crosspatch - Maharam				14											•	•							•
Z2D__ Ditto - Maharam				14											•	•					•		•
ZK__ Dot Pattern - Maharam				14	•	•	•			•				•	•	•					•		•
Z24__ Hallingdal - Maharam				14	•	•	•	•		•					•	•				•		•	•
ZQF__ Offset - Maharam				14	16	16								•		•							•
ZL__ Small Dot Pattern - Maharam				14	•	•	•			•				•	•	•							•
ZTN__ Tonus - Maharam																				•			
Price Category I																							
ZLC__ Latch - Maharam				14	18	16								•		•							
ZT2__ Teatro - Maharam					18	16																	
Price Category J																							
ZT1__ Tokyo - Maharam																				•			
Price Category K																							
ZC7__ Coda by Kvadrat - Maharam				14										•							•	•	•
Price Category L																							
ZMK__ Minicheck - Maharam				14	18	16								•		•							
ZPF__ Plait High Performance- Maharam				14	16	16										•							
Price Category M																							
ZF2__ Fruit - Maharam				14		16								•									
Price Category N-Z																							
No fabrics available at this time.																							

3 Available on A- and B-size Equa 2 split-pad upholstered chairs.

8 Only available on nonupholstered outer back option (PB).

14 Available on Celle UC (upholstered seat) and HC (upholstered seat with protective edge) chairs.

16 Available on Sayl Chair seat.

18 Available on Sayl Chair seat and upholstered mid-back.

Maharam® Colors – Seating

Price Category A

No fabrics available at this time.

Price Category B

Medium – Maharam

54" wide
100% polyester
VM01/463490-001 Raven
VM02/463490-002 Smoke
VM03/463490-003 Alloy
VM04/463490-004 Flax
VM06/463490-006 Bark
VM07/463490-007 Espresso
VM08/463490-008 Pecan
VM12/463490-012 Pumpkin
VM13/463490-013 Persimmon
VM14/463490-014 Laser
VM16/463490-016 Port
VM22/463490-022 Marina
VM29/463490-029 Pistachio
VM32/463490-032 Prospect
VM36/463490-036 Delight
VM39/463490-039 Nautical
VM40/463490-040 Pool
VM44/463490-044 Washed
VM45/463490-045 Sculpture
VM46/463490-046 Thatched
VM47/463490-047 Hike
VM48/463490-048 Tangle
VM49/463490-049 Pacific
VM50/463490-050 Cosmic
VM51/463490-051 Cascade
VM52/463490-052 Blackberry
VM53/463490-053 Nasturtium
VM54/463490-054 Wooded

Messenger – Maharam

54" wide
78% recycled polyester
15% polyester, 7% nylon
TI01/458640-001 Balsa
TI06/458640-006 Tobacco
TI07/458640-007 Shadow *
TI08/458640-008 Bayou *
TI10/458640-010 Zinc
TI24/458640-024 Poppy
TI25/458640-025 Mao
TI29/458640-029 Onyx
TI31/458640-031 Cloud *
TI38/458640-038 Depth *
TI40/458640-040 Nile
TI41/458640-041 Azure *
TI45/458640-045 Cactus *
TI46/458640-046 Ice *
TI48/458640-048 Neon *
TI50/458640-050 Hydrangea *
TI51/458640-051 Lilac
TI52/458640-052 Chestnut
TI53/458640-053 Tangelo
TI54/458640-054 Lumine *
TI58/458640-058 Snow
TI59/458640-059 Fennel
TI60/458640-060 Peridot *
TI61/458640-061 Capri
TI62/458640-062 Ultramarine
TI63/458640-063 Squall
TI66/458640-066 Cassis
TI67/458640-067 Aster
TI68/458640-068 Spice
TI69/458640-069 Cherry
TI70/458640-070 Vibrant
TI71/458640-071 Satsuma *
TI72/458640-072 Maize

* Colors available on 20-day lead time.

Messenger continued

TI76/458640-076 Fossil
TI77/458640-077 Ash
TI78/458640-078 Tusk
TI79/458640-079 Oyster
TI80/458640-080 Pensive
TI81/458640-081 Husk
TI82/458640-082 Fireside
TI83/458640-083 Chili
TI84/458640-084 Robust
TI85/458640-085 Beyond
TI86/458640-086 Voyage
TI87/458640-087 Everglade
TI88/458640-088 Electric

- Maharam textiles are on assigned lead times A unless otherwise noted.
- Fabric numbers are listed as Herman Miller fabric number/Maharam fabric number.

Maharam® Colors – Seating

continued

Price Category C

No fabrics available at this time.

Price Category D

Manner - Maharam

54" wide	
100% recycled polyester	
Z2701/466177-001	Magic
Z2702/466177-002	Carob
Z2703/466177-003	Porpoise
Z2704/466177-004	Flint
Z2705/466177-005	Hush
Z2706/466177-006	Nuance
Z2707/466177-007	Thicket
Z2708/466177-008	Cocoa
Z2709/466177-009	Pathway
Z2710/466177-010	Cola
Z2711/466177-011	Ember
Z2712/466177-012	Wagon
Z2713/466177-013	Ablaze
Z2714/466177-014	Peel
Z2715/466177-015	Penny
Z2716/466177-016	Butterscotch
Z2717/466177-017	Harvest
Z2718/466177-018	Lioness
Z2719/466177-019	Caper
Z2720/466177-020	Parakeet
Z2721/466177-021	Greenway
Z2722/466177-022	Aquatic
Z2723/466177-023	Cottage
Z2724/466177-024	Dahlia
Z2725/466177-025	Vivid
Z2726/466177-026	Basin
Z2727/466177-027	Schooner

Price Category E

Focus - Maharam

57" wide	
54% post-industrial recycled polyester	
33% polyester	
13% post-consumer recycled polyester	
ZFS01/465910-001	Ivory
ZFS02/465910-002	Allow
ZFS03/465910-003	Safari
ZFS04/465910-004	Lichen
ZFS06/465910-006	Sierra
ZFS07/465910-007	Merlot
ZFS08/465910-008	Clove
ZFS09/465910-009	Carbon
ZFS10/465910-010	Regatta
ZFS11/465910-011	Emerald

Lariat – Maharam

54" wide	
100% vinyl	
ZLR01/440401-001	001
ZLR02/440401-002	002
ZLR03/440401-003	003
ZLR04/440401-004	004
ZLR06/440401-006	006
ZLR07/440401-007	007
ZLR08/440401-008	008
ZLR10/440401-010	010
ZLR11/440401-011	011
ZLR12/440401-012	012
ZLR13/440401-013	013
ZLR14/440401-014	014
ZLR15/440401-015	015
ZLR16/440401-016	016
ZLR17/440401-017	017
ZLR18/440401-018	018
ZLR20/440401-020	020
ZLR21/440401-021	021
ZLR23/440401-023	023
ZLR24/440401-024	024
ZLR25/440401-025	025
ZLR26/440401-026	026
ZLR27/440401-027	027
ZLR28/440401-028	028
ZLR29/440401-029	029
ZLR30/440401-030	030
ZLR31/440401-031	031
ZLR32/440401-032	032
ZLR33/440401-033	033
ZLR34/440401-034	034
ZLR35/440401-035	035
ZLR36/440401-036	036
ZLR37/440401-037	037
ZLR38/440401-038	038

Price category E continued on next page

- Maharam textiles are on assigned lead times A unless otherwise noted.
- Fabric numbers are listed as Herman Miller fabric number/Maharam fabric number.

Maharam® Colors – Seating

continued

Price Category E

continued

Ledger – Maharam

54" wide	
100% polyurethane	
V9G1/463770-001	001
V9G2/463770-002	002
V9G3/463770-003	003
V9G4/463770-004	004
V9G6/463770-006	006
V9G7/463770-007	007
V9GG/463770-017	017
V9GH/463770-018	018
V9GJ/463770-019	019
V9GK/463770-020	020
V9GM/463770-022	022
V9GQ/463770-025	025
V9GS/463770-026	026
V9GT/463770-027	027
V9GU/463770-028	028
V9GV/463770-029	029
V9GW/463770-030	030
V9GX/463770-031	031
V9GY/463770-032	032
V9GZ/463770-033	033
V9G10/463770-034	034
V9G11/463770-035	035
V9G12/463770-036	036
V9G13/463770-037	037
V9G14/463770-038	038
V9G15/463770-039	039
V9G16/463770-040	040
V9G17/463770-041	041
V9G18/463770-042	042
V9G19/463770-043	043
V9G20/463770-044	044
V9G21/463770-045	045
V9G22/463770-046	046

Metric – Maharam

54" wide	
51% recycled polyester	
49% polyester	
Z301/466014-001	Phantom
Z302/466014-002	Fog
Z303/466014-003	Fleece
Z304/466014-004	Sourdough
Z305/466014-005	Toffee
Z306/466014-006	Driftwood
Z307/466014-007	Mineral
Z308/466014-008	Bittersweet
Z309/466014-009	Arabica
Z310/466014-010	Cerise
Z311/466014-011	Brick
Z312/466014-012	Cardinal
Z313/466014-013	Lava
Z314/466014-014	Oriole
Z315/466014-015	Cedar
Z317/466014-017	Caramel
Z318/466014-018	Pollen
Z319/466014-019	Tupelo
Z320/466014-020	Alligator
Z321/466014-021	Envy
Z322/466014-022	Bonsai
Z323/466014-023	Tar
Z324/466014-024	Anchor
Z325/466014-025	Twilight
Z326/466014-026	Admiral
Z327/466014-027	Seaport
Z328/466014-028	Scuba

Mode – Maharam

54" wide	
80% post-consumer recycled polyester	
20% polyester	
PFOA-Free stain resistant finish	
ZMD01/466337-001	Stroll
ZMD02/466337-002	Intaglio
ZMD03/466337-003	Ominous
ZMD04/466337-004	Machine
ZMD05/466337-005	Talus
ZMD06/466337-006	Marsh
ZMD07/466337-007	Hollow
ZMD08/466337-008	Sycamore
ZMD09/466337-009	Clavicle
ZMD10/466337-010	Billygoat
ZMD11/466337-011	Spindle
ZMD12/466337-012	Lemon
ZMD13/466337-013	Oxeye
ZMD14/466337-014	Henge
ZMD15/466337-015	Goldenrod
ZMD16/466337-016	Cottontail
ZMD17/466337-017	Lioness
ZMD18/466337-018	Oriole
ZMD19/466337-019	Rust
ZMD20/466337-020	Carotene
ZMD21/466337-021	Blush
ZMD22/466337-022	Vermillion
ZMD23/466337-023	Alder
ZMD24/466337-024	Kermes
ZMD25/466337-025	Barberry
ZMD26/466337-026	Petal
ZMD27/466337-027	Valley
ZMD28/466337-028	Odyssey
ZMD29/466337-029	Ballpoint
ZMD30/466337-030	Toile
ZMD31/466337-031	Paradise
ZMD32/466337-032	Angelfish
ZMD33/466337-033	Denim
ZMD34/466337-034	Crush
ZMD35/466337-035	Jetty
ZMD36/466337-036	Saltwater
ZMD37/466337-037	Mallard
ZMD38/466337-038	Celtic

Mode continued

ZMD39/466337-039	Eucalyptus
ZMD40/466337-040	Bonsai
ZMD41/466337-041	Sassafras
ZMD42/466337-042	Yucca
ZMD43/466337-043	Lichen

Oblique - Maharam

58" wide	
100% polyester	
with stain resistant finish	
ZBQ01/466222-001	001
ZBQ02/466222-002	002
ZBQ03/466222-003	003
ZBQ04/466222-004	004
ZBQ05/466222-005	005
ZBQ06/466222-006	006
ZBQ07/466222-007	007

Pick - Maharam

58" wide	
100% polyester	
with stain resistant finish	
ZP201/466224-001	001
ZP202/466224-002	002
ZP203/466224-003	003
ZP204/466224-004	004
ZP205/466224-005	005
ZP206/466224-006	006
ZP207/466224-007	007
ZP208/466224-008	008
ZP209/466224-009	009
ZP210/466224-010	010

Price category E continued on next page

Appendix: Maharam Colors – Seating

- Maharam textiles are on assigned lead times A unless otherwise noted.
- Fabric numbers are listed as Herman Miller fabric number/Maharam fabric number.

Maharam® Colors – Seating

continued

Appendix: Maharam Colors – Seating

Price Category E

continued

Skein - Maharam	
54" wide	
56% recycled polyester	
44% polyester	
Z3201/466170-001	Burrow
Z3202/466170-002	Thatch
Z3204/466170-004	Sumac
Z3205/466170-005	Pomegranate
Z3206/466170-006	Cavern
Z3207/466170-007	Bitter
Z3208/466170-008	Cinder
Z3209/466170-009	Dock
Z3210/466170-010	Cadet
Z3211/466170-011	Marsh

Technic - Maharam	
56" wide	
60% post-industrial recycled polyester	
40% post-consumer recycled polyester	
PFOA-Free stain resistant finish	
Acrylic backing	
ZT301/466226-001	Cumin
ZT302/466226-002	Evergreen
ZT303/466226-003	Cobalt
ZT304/466226-004	Bear
ZT305/466226-005	Squirrel

Price Category F

Chock - Maharam	
59" wide	
36% rayon	
35% cotton	
29% solution-dyed post-industrial recycled nylon	
PFOA-Free stain resistant finish	
Acrylic backing	
ZCH01/466219-001	Beige
ZCH02/466219-002	Stone
ZCH03/466219-003	Brown
ZCH04/466219-004	Red
ZCH05/466219-005	Copper
ZCH06/466219-006	Lime
ZCH07/466219-007	Smoke
ZCH08/466219-008	Ebony

Coin - Maharam	
57" wide	
43% polyester	
37% post-industrial recycled polyester	
20% post-consumer recycled polyester	
PFOA-Free stain resistant finish	
Acrylic backing	
ZC801/466233-001	Nickel
ZC802/466233-002	Diner
ZC803/466233-003	Copper
ZC804/466233-004	Maroon
ZC805/466233-005	Penny
ZC806/466233-006	Exchange
ZC807/466233-007	Lead

Coincide - Maharam	
54" wide	
100% polyester	
ZCJ01/465808-001	Mist
ZCJ02/465808-002	Drizzle
ZCJ03/465808-003	Cicada
ZCJ04/465808-004	Bungalow
ZCJ05/465808-005	Aurora
ZCJ06/465808-006	Currant
ZCJ07/465808-007	Raisin
ZCJ08/465808-008	Tranquil
ZCJ09/465808-009	Caribbean
ZCJ10/465808-010	Woodland
ZCJ11/465808-011	Acre

Crush - Maharam	
54" wide	
85% solution-dyed nylon	
13% polyester	
2% polyolefin	
VS01/464780-001	001
VS02/464780-002	002
VS05/464780-005	005
VS08/464780-008	008
VS13/464780-013	013
VS16/464780-016	016
VS17/464780-017	017
VS18/464780-018	018
VS19/464780-019	019
VS20/464780-020	020
VS22/464780-022	022
VS23/464780-023	023
VS24/464780-024	024
VS25/464780-025	025
VS26/464780-026	026
VS27/464780-027	027

Disc - Maharam	
57" wide	
100% polyester	
PFOA-Free stain resistant finish	
Acrylic backing	
ZD101/466221-001	Nude
ZD102/466221-002	Khaki
ZD103/466221-003	Festive
ZD104/466221-004	Vibrant
ZD105/466221-005	Somber
ZD106/466221-006	Warm
ZD107/466221-007	Steel

Divide - Maharam	
57" wide	
45% polyester	
36% post-industrial recycled polyester	
19% post-consumer recycled polyester	
PFOA-Free stain resistant finish	
Acrylic backing	
ZD301/466220-001	Ecru
ZD302/466220-002	Café
ZD303/466220-003	Concrete
ZD304/466220-004	Forest
ZD305/466220-005	Tropic
ZD306/466220-006	Lagoon
ZD307/466220-007	Mocha
ZD308/466220-008	Singe
ZD309/466220-009	Cayenne

Exchange - Maharam	
58" wide	
58% post-industrial recycled polyester	
42% post-consumer recycled polyester	
ZEE01/466027-001	Cinder
ZEE02/466027-002	Sable
ZEE04/466027-004	Gull
ZEE06/466027-006	Coastline
ZEE07/466027-007	Clay
ZEE08/466027-008	Buck
ZEE10/466027-010	Rhubarb
ZEE11/466027-011	Punch

Price category F continued on next page

- Maharam textiles are on assigned lead times **A** unless otherwise noted.
- Fabric numbers are listed as Herman Miller fabric number/Maharam fabric number.

Maharam® Colors – Seating

continued

Price Category F

continued

Plait - Maharam

58" wide	
68% recycled polyester	
32% polyester	
Z2901/466052-001	Cobblestone
Z2902/466052-002	Sachet
Z2903/466052-003	Mesa
Z2904/466052-004	Tavern
Z2905/466052-005	Sequoia
Z2906/466052-006	Rhubarb
Z2907/466052-007	Sangria
Z2908/466052-008	Reef
Z2909/466052-009	Stormy
Z2910/466052-010	Dapper

Remix - Maharam

54" wide	
90% wool	
10% nylon	
V2601/465956-113	113
V2602/465956-123	123
V2603/465956-133	133
V2604/465956-143	143
V2605/465956-152	152
V2606/465956-163	163
V2607/465956-173	173
V2608/465956-183	183
V2609/465956-223	223
V2610/465956-233	233
V2611/465956-242	242
V2612/465956-252	252
V2613/465956-362	362
V2614/465956-373	373
V2615/465956-383	383
V2616/465956-393	393
V2617/465956-412	412
V2618/465956-422	422
V2619/465956-433	433

Remix continued

V2620/465956-443	443
V2621/465956-452	452
V2622/465956-543	543
V2623/465956-612	612
V2624/465956-632	632
V2625/465956-643	643
V2626/465956-653	653
V2627/465956-662	662
V2628/465956-672	672
V2629/465956-682	682
V2630/465956-692	692
V2631/465956-722	722
V2632/465956-733	733
V2633/465956-743	743
V2634/465956-753	753
V2635/465956-762	762
V2636/465956-773	773
V2637/465956-783	783
V2638/465956-823	823
V2639/465956-842	842
V2640/465956-852	852
V2641/465956-873	873
V2642/465956-912	912
V2643/465956-923	923
V2644/465956-933	933
V2645/465956-942	942
V2646/465956-962	962
V2647/465956-973	973
V2648/465956-982	982
V2649/465956-954	954

Rove - Maharam

54" wide	
100% solution-dyed polyolefin with silver-based antimicrobial	
ZRV01/466096-001	Rice
ZRV02/466096-002	Soba
ZRV03/466096-003	Owl
ZRV04/466096-004	Till
ZRV05/466096-005	Dijon
ZRV06/466096-006	Mum
ZRV07/466096-007	Nasturtium
ZRV08/466096-008	Vixen
ZRV09/466096-009	Roast
ZRV10/466096-010	Llama
ZRV11/466096-011	Rind
ZRV12/466096-012	Grackle
ZRV13/466096-013	Indigo
ZRV14/466096-014	Drip
ZRV15/466096-015	Neptunia
ZRV16/466096-016	Pomelo
ZRV17/466096-017	Fairy

Runner Standard - Maharam

58" wide	
57% post-industrial recycled polyester	
43% post-consumer recycled polyester	
ZRA07/466167-007	Bluff
ZRA08/466167-008	Arid
ZRA09/466167-009	Grove
ZRA10/466167-010	Starboard
ZRA11/466167-011	Plot
ZRA12/466167-012	Carousel

Seam - Maharam

54" wide	
100% polyester	
PFOA-Free stain resistant finish	
Acrylic backing	
ZSM01/466289-001	Reed
ZSM02/466289-002	Console
ZSM03/466289-003	Play
ZSM04/466289-004	Jock
ZSM05/466289-005	Engine
ZSM06/466289-006	Haunted
ZSM07/466289-007	Transmit
ZSM08/466289-008	Spark
ZSM09/466289-009	Storm
ZSM10/466289-010	Tunnel

Sequence - Maharam

54" wide	
100% solution-dyed polyolefin with silver-based antimicrobial	
Z3101/466179-001	Driftwood
Z3102/466179-002	Boardwalk
Z3103/466179-003	Rattan
Z3104/466179-004	Alfresco
Z3105/466179-005	Plunge
Z3106/466179-006	Starboard
Z3107/466179-007	Veranda
Z3108/466179-008	Lodge
Z3109/466179-009	Flare

Shuttle Standard - Maharam

54" wide	
84% post-industrial recycled polyester	
16% post-consumer recycled polyester	
ZSS16/466168-016	Clam
ZSS17/466168-017	Plateau
ZSS18/466168-018	Shoal

Price category F continued on next page

Appendix: Maharam Colors – Seating

- Maharam textiles are on assigned lead times A unless otherwise noted.
- Fabric numbers are listed as Herman Miller fabric number/Maharam fabric number.

Maharam® Colors – Seating

continued

Price Category F

continued

Strum - Maharam	
54" wide	
100% polyurethane with silver-based antimicrobial	
Z3301/466122-001	Overcast
Z3302/466122-002	Ridge
Z3303/466122-003	Twilight
Z3304/466122-004	Pigeon
Z3305/466122-005	Char
Z3306/466122-006	Cabin
Z3307/466122-007	Bur
Z3308/466122-008	Abalone
Z3309/466122-009	Prawn
Z3310/466122-010	Gourd
Z3311/466122-011	Wheat
Z3312/466122-012	Lemongrass

Waxen - Maharam	
54" wide	
100% polyester	
ZWX01/466078-001	Appear
ZWX03/466078-003	Savanna
ZWX05/466078-005	Frozen
ZWX06/466078-006	Highland
ZWX07/466078-007	Patina
ZWX10/466078-010	Ruby
ZWX11/466078-011	Ember
ZWX12/466078-012	Harvest
ZWX13/466078-013	Yolk
ZWX14/466078-014	Fresh
ZWX15/466078-015	Polar
ZWX16/466078-016	Jay
ZWX17/466078-017	Gazer
ZWX19/466078-019	Bayou

Price Category G

Coin Crypton - Maharam	
54" wide	
43% polyester 37% post-industrial recycled polyester 20% post-consumer recycled polyester	
Crypton Green finish and backing	
ZC901/466236-001	Nickel
ZC902/466236-002	Diner
ZC903/466236-003	Copper
ZC904/466236-004	Maroon
ZC905/466236-005	Penny
ZC906/466236-006	Exchange
ZC907/466236-007	Lead

Coincide High Performance- Maharam	
54" wide	
100% polyester	
ZCF02/466132-002	Drizzle
ZCF03/466132-003	Cicada
ZCF04/466132-004	Bungalow
ZCF07/466132-007	Raisin
ZCF10/466132-010	Woodland
ZCF11/466132-011	Acre

Colline - Maharam	
55" wide	
75% wool 17% acrylic 8% nylon	
ZCQ01/466155-108	108
ZCQ02/466155-118	118
ZCQ03/466155-148	148
ZCQ04/466155-188	188
ZCQ05/466155-228	228
ZCQ06/466155-348	348
ZCQ07/466155-448	448
ZCQ08/466155-548	548
ZCQ09/466155-568	568
ZCQ10/466155-668	668
ZCQ11/466155-688	688
ZCQ12/466155-788	788

Compound - Maharam	
54" wide	
100% polyurethane silane-based antimicrobial	
ZC201/466196-001	001
ZC202/466196-002	002
ZC203/466196-003	003
ZC204/466196-004	004
ZC205/466196-005	005
ZC206/466196-006	006
ZC207/466196-007	007
ZC208/466196-008	008
ZC209/466196-009	009
ZC210/466196-010	010
ZC211/466196-011	011
ZC212/466196-012	012
ZC213/466196-013	013
ZC214/466196-014	014
ZC215/466196-015	015
ZC216/466196-016	016
ZC217/466196-017	017
ZC218/466196-018	018
ZC219/466196-019	019

Disc Crypton - Maharam	
57" wide	
100% polyester Crypton finish and backing	
ZD201/466237-001	Nude
ZD202/466237-002	Khaki
ZD203/466237-003	Festive
ZD204/466237-004	Vibrant
ZD205/466237-005	Somber
ZD206/466237-006	Warm
ZD207/466237-007	Steel

Divide Crypton - Maharam	
57" wide	
45% polyester 36% post-industrial recycled polyester 19% post-consumer recycled polyester	
Crypton Green finish and backing	
ZD401/466238-001	Ecru
ZD402/466238-002	Café
ZD403/466238-003	Concrete
ZD404/466238-004	Forest
ZD405/466238-005	Tropic
ZD406/466238-006	Lagoon
ZD407/466238-007	Mocha
ZD408/466238-008	Singe
ZD409/466238-009	Cayenne

Divina MD - Maharam	
59" wide	
100% wool	
Z2301/466150-193	193
Z2302/466150-203	203
Z2303/466150-213	213
Z2304/466150-293	293
Z2305/466150-343	343
Z2306/466150-353	353
Z2307/466150-363	363
Z2308/466150-413	413
Z2309/466150-433	433
Z2310/466150-453	453
Z2311/466150-613	613
Z2312/466150-633	633
Z2313/466150-653	653
Z2314/466150-673	673
Z2315/466150-683	683
Z2316/466150-713	713
Z2317/466150-733	733
Z2318/466150-743	743
Z2319/466150-753	753
Z2320/466150-773	773
Z2321/466150-783	783
Z2322/466150-813	813
Z2323/466150-843	843
Z2324/466150-873	873
Z2325/466150-913	913
Z2326/466150-943	943
Z2327/466150-973	973

- Maharam textiles are on assigned lead times A unless otherwise noted.
- Fabric numbers are listed as Herman Miller fabric number/Maharam fabric number.

Price category G continued on next page

Maharam® Colors – Seating

continued

Price Category G

continued

Divina - Maharam	
59" wide	
100% wool	
TF01/460730-154	154
TF03/460730-171	171
TF04/460730-173	173
TF05/460730-181	181
TF06/460730-191	191
TF08/460730-224	224
TF10/460730-334	334
TF13/460730-384	384
TF14/460730-393	393
TF16/460730-444	444
TF17/460730-462	462
TF18/460730-542	542
TF19/460730-552	552
TF20/460730-562	562
TF22/460730-584	584
TF23/460730-623	623
TF25/460730-652	652
TF26/460730-662	662
TF27/460730-671	671
TF29/460730-684	684
TF30/460730-691	691
TF31/460730-692	692
TF33/460730-712	712
TF37/460730-742	742
TF41/460730-782	782
TF42/460730-791	791
TF43/460730-793	793
TF47/460730-893	893
TF49/460730-922	922
TF51/460730-944	944
TF53/460730-984	984
TF55/460730-106	106
TF56/460730-236	236
TF57/460730-246	246
TF58/460730-346	346
TF59/460730-356	356
TF60/460730-376	376
TF61/460730-426	426
TF62/460730-526	526
TF63/460730-536	536
TF64/460730-626	626

Divina continued	
TF65/460730-636	636
TF66/460730-666	666
TF67/460730-676	676
TF68/460730-686	686
TF69/460730-696	696
TF70/460730-756	756
TF71/460730-826	826
TF72/460730-836	836
TF73/460730-846	846
TF74/460730-856	856
TF75/460730-876	876
TF76/460730-886	886
TF77/460730-936	936
TF78/460730-956	956
TF79/460730-966	966

Divina Melange – Maharam	
59" wide	
100% wool	
TG01/460830-120	120
TG02/460830-170	170
TG03/460830-180	180
TG04/460830-220	220
TG05/460830-260	260
TG06/460830-280	280
TG07/460830-871	871
TG08/460830-821	821
TG09/460830-771	771
TG10/460830-721	721
TG11/460830-731	731
TG12/460830-681	681
TG13/460830-631	631
TG15/460830-671	671
TG16/460830-581	581
TG17/460830-531	531
TG18/460830-521	521
TG19/460830-571	571
TG20/460830-421	421
TG21/460830-471	471
TG22/460830-931	931
TG24/460830-971	971
TG25/460830-925	925
TG26/460830-620	620

Emboss - Maharam	
54" wide	
100% polyurethane	
Polyester backing	
ZEM01/466281-001	Bronze
ZEM02/466281-002	Brass
ZEM03/466281-003	Gold
ZEM04/466281-004	Platinum
ZEM05/466281-005	Silver
ZEM06/466281-006	Aqua
ZEM07/466281-007	Aegean
ZEM08/466281-008	Cobalt
ZEM09/466281-009	Ultraviolet
ZEM10/466281-010	Copper
ZEM11/466281-011	Molten

Fold - Maharam	
54" wide	
100% polyurethane	
Polyester backing	
ZF101/466292-001	Jet
ZF102/466292-002	Chalk
ZF103/466292-003	Smoke
ZF104/466292-004	Putty
ZF105/466292-005	Fatigue
ZF106/466292-006	Splash
ZF107/466292-007	Apple
ZF108/466292-008	Moss
ZF109/466292-009	Graphite
ZF110/466292-010	Midnight

Hero by Kvadrat - Maharam	
55" wide	
96% wool	
4% nylon	
ZH101/466318-101	101
ZH102/466318-141	141
ZH103/466318-151	151
ZH104/466318-181	181
ZH105/466318-191	191
ZH106/466318-201	201
ZH107/466318-211	211
ZH108/466318-231	231
ZH109/466318-311	311
ZH110/466318-381	381
ZH111/466318-411	411
ZH112/466318-441	441
ZH113/466318-451	451
ZH114/466318-481	481
ZH115/466318-511	511
ZH116/466318-541	541
ZH117/466318-551	551
ZH118/466318-601	601
ZH119/466318-681	681
ZH120/466318-701	701
ZH121/466318-711	711
ZH122/466318-751	751
ZH123/466318-791	791
ZH124/466318-901	901
ZH125/466318-931	931
ZH126/466318-941	941
ZH127/466318-981	981
ZH128/466318-991	991

Price category G continued on next page

Appendix: Maharam Colors – Seating

- Maharam textiles are on assigned lead times **A** unless otherwise noted.
- Fabric numbers are listed as Herman Miller fabric number/Maharam fabric number.

Maharam® Colors – Seating

continued

Price Category G

continued

Appendix: Maharam Colors – Seating

Omen - Maharam	
54" wide	
75% polyester	
16% post-industrial recycled polyester	
9% post-consumer recycled polyester	
ZQM01/466172-001 Clam	
ZQM02/466172-002 Pewter	
ZQM03/466172-003 Hazel	
ZQM04/466172-004 Grain	
ZQM05/466172-005 Bundle	
ZQM07/466172-007 Glacier	
ZQM08/466172-008 Surf	
ZQM09/466172-009 Wade	
ZQM10/466172-010 Marble	
ZQM11/466172-011 Silt	
ZQM12/466172-012 Persimmon	
ZQM13/466172-013 Rocket	

Pick Crypton - Maharam	
54" wide	
100% polyester	
Crypton finish and backing	
ZP101/466235-001 Rattan	
ZP102/466235-002 Olive	
ZP103/466235-003 Slate	
ZP104/466235-004 Espresso	
ZP105/466235-005 Pepper	
ZP106/466235-006 Masala	
ZP107/466235-007 Fresh	
ZP108/466235-008 Cool	
ZP109/466235-009 Ink	
ZP110/466235-010 Jet	

Pocket - Maharam	
54" wide	
76% recycled polyester	
24% nylon	
ZP301/466243-001	001
ZP302/466243-002	002
ZP303/466243-003	003
ZP304/466243-004	004
ZP305/466243-005	005
ZP306/466243-006	006
ZP307/466243-007	007

Ring - Maharam	
54" wide	
48% polyester	
34% post-industrial recycled polyester	
18% post-consumer recycled polyester	
ZRG01/466182-001 Bone	
ZRG02/466182-002 Flax	
ZRG04/466182-004 Black	
ZRG05/466182-005 Scarlet	
ZRG06/466182-006 Rust	
ZRG07/466182-007 Green	
ZRG09/466182-009 Royal	

Runner - Maharam	
54" wide	
57% post-industrial recycled polyester	
43% post-consumer recycled polyester	
ZRF01/466108-001 Bluff	
ZRF02/466108-002 Arid	
ZRF03/466108-003 Grove	
ZRF04/466108-004 Starboard	
ZRF05/466108-005 Plot	
ZRF06/466108-006 Carousel	

Sheen - Maharam	
54" wide	
100% polyurethane with silane-based antimicrobial	
ZSN01/466246-001 Sail	
ZSN02/466246-002 Silver	
ZSN03/466246-003 Pewter	
ZSN04/466246-004 Hearth	
ZSN05/466246-005 Fern	
ZSN06/466246-006 Bog	
ZSN07/466246-007 Cricket	
ZSN08/466246-008 Clove	
ZSN09/466246-009 Mystic	
ZSN10/466246-010 Vat	
ZSN11/466246-011 Huckleberry	
ZSN12/466246-012 Mauve	
ZSN13/466246-013 Brick	
ZSN14/466246-014 Ruby	
ZSN15/466246-015 Dragon	
ZSN16/466246-016 Kumquat	
ZSN17/466246-017 Cinnamon	
ZSN18/466246-018 Alder	
ZSN19/466246-019 Fog	
ZSN20/466246-020 Olive	
ZSN21/466246-021 Bronze	
ZSN22/466246-022 Crystal	

Steelcut - Maharam	
55" wide	
90% wool	
10% nylon	
ZSE01/464470-110	110
ZSE02/464470-120	120
ZSE03/464470-135	135
ZSE04/464470-140	140
ZSE05/464470-155	155
ZSE06/464470-160	160
ZSE07/464470-180	180
ZSE08/464470-190	190
ZSE09/464470-220	220
ZSE10/464470-240	240
ZSE11/464470-255	255
ZSE12/464470-265	265
ZSE13/464470-365	365
ZSE14/464470-370	370
ZSE15/464470-380	380
ZSE16/464470-435	435
ZSE17/464470-445	445
ZSE18/464470-535	535
ZSE19/464470-545	545
ZSE20/464470-550	550
ZSE21/464470-605	605
ZSE22/464470-615	615
ZSE23/464470-625	625
ZSE24/464470-635	635
ZSE25/464470-655	655
ZSE26/464470-660	660
ZSE27/464470-685	685
ZSE28/464470-695	695
ZSE29/464470-760	760
ZSE30/464470-775	775
ZSE31/464470-780	780
ZSE32/464470-820	820
ZSE33/464470-835	835
ZSE34/464470-935	935
ZSE35/464470-950	950
ZSE36/464470-975	975
ZSE37/464470-985	985

Price category G continued on next page

- Maharam textiles are on assigned lead times **A** unless otherwise noted.
- Fabric numbers are listed as Herman Miller fabric number/Maharam fabric number.

Maharam® Colors – Seating

continued

Price Category G

continued

Steelcut Trio - Maharam	
55" wide	
90% wool	
10% nylon	
V2501/465906-105	105
V2502/465906-113	113
V2503/465906-124	124
V2504/465906-133	133
V2505/465906-144	144
V2506/465906-153	153
V2507/465906-195	195
V2508/465906-205	205
V2509/465906-213	213
V2510/465906-225	225
V2511/465906-235	235
V2512/465906-245	245
V2513/465906-253	253
V2514/465906-283	283
V2515/465906-325	325
V2516/465906-333	333
V2517/465906-353	353
V2518/465906-383	383
V2519/465906-395	395
V2520/465906-413	413
V2521/465906-415	415
V2522/465906-425	425
V2523/465906-453	453
V2524/465906-465	465
V2525/465906-515	515
V2526/465906-533	533
V2527/465906-553	553
V2528/465906-565	565
V2529/465906-645	645
V2530/465906-653	653
V2531/465906-665	665
V2532/465906-675	675

Steelcut Trio continued	
V2533/465906-683	683
V2534/465906-713	713
V2535/465906-733	733
V2536/465906-745	745
V2537/465906-753	753
V2538/465906-815	815
V2539/465906-825	825
V2540/465906-845	845
V2541/465906-853	853
V2542/465906-865	865
V2543/465906-883	883
V2544/465906-915	915
V2545/465906-933	933
V2546/465906-945	945
V2547/465906-953	953
V2548/465906-965	965

Stride - Maharam	
58" wide	
40% post-industrial recycled polyester	
39% polyester	
21% post-consumer recycled polyester	
PFOA-Free stain resistant finish	
Acrylic backing	
ZS101/466252-001	Sand
ZS102/466252-002	Cave
ZS103/466252-003	Midnight
ZS104/466252-004	Moss
ZS105/466252-005	Fauna
ZS106/466252-006	Ember

Ticker - Maharam	
54" wide	
47% polyester	
31% post-industrial recycled polyester	
22% post-consumer recycled polyester	
Crypton green finish and backing	
ZT401/466304-001	Calm
ZT402/466304-002	Millet
ZT403/466304-003	Sow
ZT404/466304-004	Beaver
ZT405/466304-005	Patch
ZT406/466304-006	Balloon
ZT407/466304-007	Squad
ZT408/466304-008	Bale
ZT409/466304-009	Fecund
ZT410/466304-010	Aquarium
ZT411/466304-011	Drink
ZT412/466304-012	Depth
ZT413/466304-013	Far

Vestige - Maharam	
54" wide	
71% polyester	
29% rayon	
ZVT01/466259-001	001
ZVT02/466259-002	002
ZVT03/466259-003	003
ZVT04/466259-004	004
ZVT05/466259-005	005
ZVT06/466259-006	006
ZVT07/466259-007	007
ZVT08/466259-008	008
ZVT09/466259-009	009
ZVT10/466259-010	010

Price Category H

Circles – Maharam	
55" wide	
70% cotton	
30% polyester	
ZT01/458310-001	Khaki
ZT02/458310-002	Fatigue
ZT03/458310-003	Document
ZT04/458310-004	Engine
ZT05/458310-005	Charcoal

Crosspatch – Maharam	
54" wide	
75% rayon	
25% polyester	
ZS01/458920-001	Song
ZS02/458920-002	Fresh
ZS03/458920-003	Spring
ZS04/458920-004	Document
ZS06/458920-006	Circus
ZS08/458920-008	Grounded

Ditto – Maharam	
54" wide	
77% recycled polyester	
23% solution dyed nylon	
Z2D1/465993-001	Nacre
Z2D2/465993-002	Shadow
Z2D3/465993-003	Saddle
Z2D6/465993-006	Aztec
Z2D9/465993-009	Fern
Z2DA/465993-010	Fountain
Z2DB/465993-011	Cobalt
Z2DC/465993-012	Iron
Z2DD/465993-013	Driftwood

Dot Pattern – Maharam	
55" wide	
71% cotton	
29% polyester	
ZK01/458300-001	Document
ZK02/458300-002	Taupe
ZK04/458300-004	Red
ZK05/458300-005	Navy

Price category H continued on next page

- Maharam textiles are on assigned lead times A unless otherwise noted.
- Fabric numbers are listed as Herman Miller fabric number/Maharam fabric number.

Maharam® Colors – Seating

continued

Price Category H

continued

Appendix: Maharam Colors – Seating

Hallingdal - Maharam	
51" wide	
70% wool	
30% rayon	
Z2401/460760-100	100
Z2402/460760-103	103
Z2403/460760-110	110
Z2404/460760-113	113
Z2405/460760-116	116
Z2406/460760-123	123
Z2407/460760-126	126
Z2408/460760-130	130
Z2409/460760-143	143
Z2410/460760-153	153
Z2411/460760-166	166
Z2412/460760-173	173
Z2413/460760-180	180
Z2414/460760-190	190
Z2415/460760-200	200
Z2416/460760-220	220
Z2417/460760-224	224
Z2418/460760-227	227
Z2419/460760-270	270
Z2420/460760-350	350
Z2421/460760-368	368
Z2422/460760-370	370
Z2423/460760-376	376
Z2424/460760-390	390
Z2425/460760-407	407
Z2426/460760-420	420
Z2427/460760-457	457
Z2428/460760-526	526
Z2429/460760-547	547
Z2430/460760-563	563
Z2431/460760-573	573
Z2432/460760-590	590
Z2433/460760-596	596
Z2434/460760-600	600
Z2435/460760-657	657
Z2436/460760-660	660
Z2437/460760-674	674
Z2438/460760-680	680
Z2439/460760-687	687

Hallingdal continued	
Z2440/460760-694	694
Z2441/460760-702	702
Z2442/460760-723	723
Z2443/460760-733	733
Z2444/460760-750	750
Z2445/460760-753	753
Z2446/460760-754	754
Z2447/460760-763	763
Z2448/460760-764	764
Z2449/460760-773	773
Z2450/460760-810	810
Z2451/460760-840	840
Z2452/460760-850	850
Z2453/460760-890	890
Z2454/460760-907	907
Z2455/460760-944	944
Z2456/460760-960	960
Z2457/460760-968	968
Z2458/460760-980	980

Offset – Maharam	
54" wide	
40% cotton	
36% nylon	
24% wool	
ZQF01/465951-001	Passage
ZQF02/465951-002	Fieldstone
ZQF03/465951-003	Coast
ZQF04/465951-004	Esplanade
ZQF05/465951-005	Oasis
ZQF06/465951-006	Spice
ZQF07/465951-007	Bloom

Small Dot Pattern – Maharam	
55" wide	
71% cotton	
29% polyester	
ZL01/458320-001	Document
ZL02/458320-002	Sand
ZL03/458320-003	Khaki
ZL04/458320-004	Taupe
ZL05/458320-005	Charcoal
ZL06/458320-006	Document Reverse
ZL07/458320-007	Red
ZL08/458320-008	Yellow
ZL09/458320-009	Green

Tonus - Maharam	
51" wide	
90% wool	
10% helanka	
ZTN01/460800-100	100
ZTN03/460800-109	109
ZTN05/460800-118	118
ZTN10/460800-125	125
ZTN13/460800-128	128
ZTN14/460800-129	129
ZTN15/460800-130	130
ZTN16/460800-131	131
ZTN17/460800-132	132
ZTN19/460800-135	135
ZTN21/460800-207	207
ZTN23/460800-210	210
ZTN26/460800-216	216
ZTN27/460800-240	240
ZTN29/460800-440	440
ZTN32/460800-508	508
ZTN34/460800-605	605
ZTN35/460800-608	608
ZTN36/460800-609	609
ZTN37/460800-610	610
ZTN38/460800-613	613
ZTN40/460800-615	615
ZTN41/460800-619	619
ZTN51/460800-631	631

Tonus continued	
ZTN54/460800-634	634
ZTN56/460800-636	636
ZTN59/460800-690	690
ZTN62/460800-840	840
ZTN63/460800-940	940
ZTN65/460800-224	224
ZTN66/460800-244	244
ZTN67/460800-364	364
ZTN68/460800-374	374
ZTN69/460800-394	394
ZTN70/460800-424	424
ZTN71/460800-454	454
ZTN72/460800-464	464
ZTN73/460800-474	474
ZTN74/460800-554	554
ZTN75/460800-654	654
ZTN76/460800-664	664
ZTN77/460800-684	684
ZTN78/460800-754	754
ZTN79/460800-764	764
ZTN80/460800-854	854
ZTN81/460800-914	914
ZTN82/460800-934	934
ZTN83/460800-954	954
ZTN84/460800-964	964
ZTN85/460800-974	974

- Maharam textiles are on assigned lead times **A** unless otherwise noted.
- Fabric numbers are listed as Herman Miller fabric number/Maharam fabric number.

Maharam® Colors – Seating

continued

Price Category I

Latch - Maharam	
55" wide	
61% cotton	
39% solution-dyed post-industrial recycled nylon	
16% rayon	
PFOA-Free stain resistant finish	
Acrylic backing	
ZLC01/466301-001	Rescue
ZLC02/466301-002	Guide
ZLC03/466301-003	Rotary
ZLC04/466301-004	Radar
ZLC05/466301-005	Sphere
ZLC06/466301-006	Solemn

Teatro - Maharam	
55" wide	
100% polyester	
Polyester/Cotton backing	
ZT201/466309-001	Crumb
ZT202/466309-002	Dorper
ZT203/466309-003	Herd
ZT204/466309-004	Deep
ZT205/466309-005	Robe
ZT206/466309-006	Heat
ZT207/466309-007	Caspian
ZT208/466309-008	Misty
ZT209/466309-009	Boulder
ZT210/466309-010	Elixir
ZT211/466309-011	Guard
ZT212/466309-012	Throne

Price Category J

Tokyo - Maharam		
59" wide		
67% wool		
24% polyester		
9% nylon		
ZT101/466247-112	112	
ZT102/466247-132	132	
ZT103/466247-182	182	
ZT104/466247-242	242	
ZT105/466247-252	252	
ZT106/466247-352	352	
ZT107/466247-432	432	
ZT108/466247-632	632	
ZT109/466247-652	652	
ZT110/466247-682	682	
ZT111/466247-692	692	
ZT112/466247-732	732	
ZT113/466247-782	782	
ZT114/466247-952	952	
ZT115/466247-982	982	

Price Category K

Coda by Kvadrat - Maharam		
55" wide		
90% wool		
10% nylon		
ZC701/464480-100	100	
ZC702/464480-103	103	
ZC703/464480-116	116	
ZC704/464480-182	182	
ZC705/464480-222	222	
ZC706/464480-232	232	
ZC707/464480-242	242	
ZC708/464480-362	362	
ZC709/464480-382	382	
ZC710/464480-410	410	
ZC711/464480-422	422	
ZC712/464480-442	442	
ZC713/464480-610	610	
ZC714/464480-632	632	
ZC715/464480-642	642	
ZC716/464480-722	722	
ZC717/464480-762	762	
ZC718/464480-962	962	

Price Category L

Minicheck - Maharam	
55" wide	
78% cotton	
22% polyester	
PFOA-Free stain resistant finish	
ZMK01/466268-001	Black/White

Plait High Performance - Maharam	
58" wide	
53% post-industrial polyester	
32% polyester	
15% post-consumer recycled polyester	
ZPF02/466138-002	Sachet
ZPF05/466138-005	Sequoia
ZPF08/466138-008	Reef

Appendix: Maharam Colors – Seating

Maharam® Colors – Seating

continued

Price Category M

Price Category N-Z

Appendix: Maharam Colors – Seating

Fruit - Maharam

54" wide
55% cotton
32% nylon
13% post-consumer recycled
polyester
PFOA-Free stain resistant finish
Acrylic backing
ZF201/466262-001 Opal
ZF202/466262-002 Lime
ZF203/466262-003 Olive
ZF204/466262-004 Sky
ZF205/466262-005 Kernal
ZF206/466262-006 Droplet
ZF207/466262-007 Russet

No fabrics available at this time.

- Maharam textiles are on assigned lead times A unless otherwise noted.
- Fabric numbers are listed as Herman Miller fabric number/Maharam fabric number.

For more information about our products and services or to see a list of dealers, please visit us at HermanMiller.com or call (800) 851 1196.

This book is recyclable. Printed in U.S.A. on recycled paper.

© 2017 Herman Miller, Inc., Zeeland, Michigan

® **HermanMiller**, ●, 3D Intelligent, AO, Action Office, Aeron, ArcSpan, Aside, Avall, Avive, Bubble Lamps, Canvas Office Landscape, Caper, Celle, Co/Struc, Daisyone, Distil, Eames, Eco-Dematerialized, Embody, Envelop, Equa 2, Ergon 3, Ethospace, Exclave, Fine-Tune, FlexFront, Flo, Formcoat, Formwork, Ground Cloth, Herman Miller for the Home, Herman Miller for Healthcare, Intersect, Kinemat, Lapjack, Layout Studio, Lifework, Limerick, Live Unframed, Living Office, Locale, Maharam, Meridian, Mirra, Passage, Pellicle, Perspectives, PostureFit, Public Office Landscape, Resolve, Rodney, Sayl, Setu, Thrive, Tu, Wishbone, and Y-Tower are among the registered trademarks of Herman Miller, Inc., and its owned subsidiaries.

™ 8Z Pellicle, About Face, AireWeave, Albert, Backfit, Bubbletack, Burdick Group, Butterfly Back, Celeste, Cellular Suspension, Clam, Compass, Connect, Cubert, DOT, Duracare, Durawrap, Eames Soft Pad, EnhancedAccess, Everywhere, Flex-Edge, Flute, Harmonic, Herman Miller Select, Hopsak 2, Iota, Jaw, Keyless Entry, Keyn Chair Group by Herman Miller, Latitude, Locale, Logic Mini, Logic Power Access Solutions, Loop, Lyris, Lyris 2, Made-to-Measure Storage, Metaform Portfolio, Motia, Multiscrim, Nelson, Pari, Pixelated Support, Plex, PostureFit SL, Q, Renew, Sense, Soft Pad, Stackable, Stackable Storage, Striad, Swoop, Tone, TriFlex, Twist, Ubi, and Wireframe are among the trademarks of Herman Miller, Inc., and its owned subsidiaries.

SM Herman Miller Options is among the service marks of Herman Miller, Inc.

Alexander Girard® is a registered trademark of The Alexander Girard Estate.

Chemsurf® is a registered trademark of Wilsonart International.

Corian® is a registered trademark of E. I. du Pont de Nemours and Company Corporation.

Crypton® is a registered trademark of Crypton, Inc.

DACRON® is a registered trademark of INVISTA S.a r.l.

Edelman® Leather is a registered trademark of Edelman Leather, Inc.

FLEXNET™ is a trademark of Milliken & Company.

Floor Saver Glide® is a registered trademark of Carpin Manufacturing, Inc.

Geiger® is a registered trademark, and Bumper™, Saiba™, and Ward Bennett™ are trademarks, of Geiger International.

Goetz™ is a trademark of Mark W. Goetz.

Hang-It-All® is a registered trademark of Lucia Eames Demetrios, d.b.a. Eames Office.

Holophane® is a registered trademark of Holophane.

Ingeo™ is a trademark of Cargill Dow LLC.

iPad® is a registered trademark of Apple, Inc.

LifeSize® is a registered trademark of LifeSize Communications, Inc.

Magis®, Bombo®, and Me Too® are registered trademarks of Magis SpA.

Microsoft® and Natural® Keyboard are registered trademarks of Microsoft Corporation.

Noguchi® and the Noguchi table configuration (trade dress) are registered trademarks, and Rudder Table™ is a trademark, of The Isamu Noguchi Foundation and Garden Museum.

Place Textiles® is a registered trademark of Place Textiles.

SuperSeat™ is a trademark of Dahti Seating, a division of ITW.