

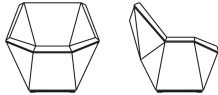























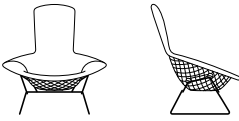

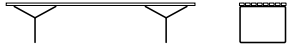

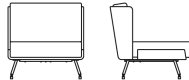
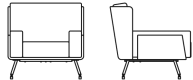
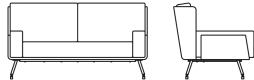
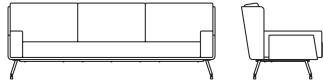
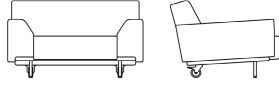
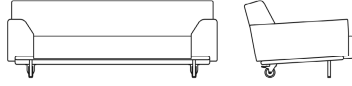



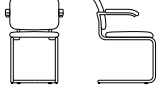
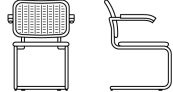
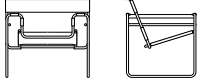







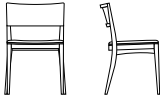
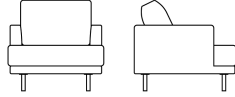
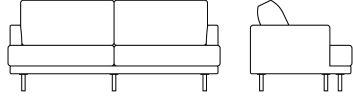
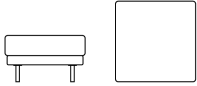
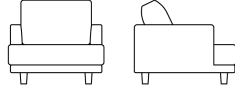
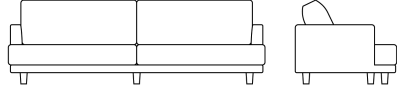
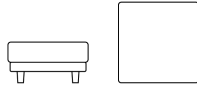
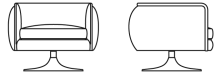
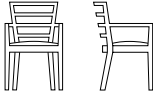
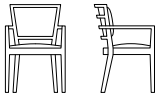
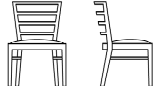

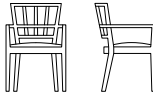
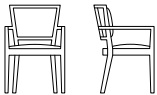
Introduction	Designer Index	3	
	Visual Index	5	
	Using the KnollStudio Price List	16	
	Spinneybeck Leather Grades	17	
	Upholstery Notes	18	
	📌 California Technical Bulletin 133	19	
	Knoll and Sustainable Design	22	
	GREENGUARD™ Certified KnollStudio Products	23	
	KnollStudio Finish Code Chart: Compatibility with Knoll Office Systems	25	
	Materials and Finishes	26	
	Product Maintenance	28	
	📄 KnollStudio 20-Day Program	30	
	📄 KnollStudio 20-Day Program Upholstery Scope	30	
	📄 Items Available on KnollStudio 20-Day Program	31	
	Placing Your KnollStudio Order	33	
	Side Chairs and Lounge Seating	David Adjaye : The Washington Collection for Knoll™	34
		Edward Barber & Jay Osgerby : Sofa Collection	38
Edward Barber & Jay Osgerby : Pilot by Knoll™ Lounge Collection		46	
Edward Barber & Jay Osgerby : Piton™ Stools		50	
Harry Bertoia : Side Chair		52	
Harry Bertoia : Two-Tone Side Chair		54	
Harry Bertoia : Barstools		56	
Harry Bertoia : Diamond Lounge Seating		60	
Harry Bertoia : Two-Tone Diamond Chair		62	
Harry Bertoia : Bird Lounge Chair and Ottoman		64	
Harry Bertoia : Asymmetric Chaise		66	
Harry Bertoia : Bench		68	
Harry Bertoia : Bertoia Molded Shell Side Chair and Barstool		70	
Pierre Beucler and Jean-Christophe Poggioli: Contract Lounge Seating		72	
Pierre Beucler and Jean-Christophe Poggioli: Residential Lounge Seating		78	
Cini Boeri : Lounge Collection		90	
Marcel Breuer : Cesca Chair		94	
Marcel Breuer : Wassily Chair		98	
Don Chadwick : Spark® Series		100	
Pepe Cortés : Jamaica Barstool		104	
Jonathan Crinion : Crinion Chair		106	
Joseph Paul D'Urso : Contract Lounge Seating		108	
Joseph Paul D'Urso : Residential Lounge Seating		112	
Joseph Paul D'Urso : Swivel Lounge Seating		116	
Raul de Armas : de Armas Chair		118	
Raul de Armas : Vertical de Armas Chair		124	
Frank Gehry : Side and Dining Chairs		128	
Frank Gehry : Lounge Seating		130	
Markus Jehs and Jürgen Laub : Jehs+Laub Lounge Collection, pedestal base		132	
Markus Jehs and Jürgen Laub : Jehs+Laub Lounge Collection, wire base		134	
Florence Knoll : Lounge Seating		136	
Florence Knoll : Relaxed Lounge Seating		138	
Knoll Design : k.™ lounge Collection		140	
KnollStudio : Throw Pillows		150	
Antti Kotilainen : CHIP Chair and Barstool		152	
Marc Krusin : Guest Seating Collection		154	
Maya Lin : Stones	160		
Piero Lissoni : Divina® Lounge Seating	164		
Ross Lovegrove : Sprite Armless Chair	170		
Ross Lovegrove : Sprite Arm Chair	172		
Vico Magistretti : Cirene Stacking Chair	174		
Marco Maran : Gigi® Arm Chair	176		

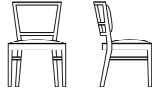
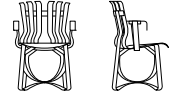
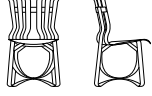
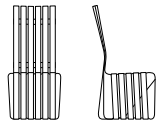
Side Chairs and Lounge Seating (cont'd.)	Marco Maran : Gigi® Armless Chair	180	
	Marco Maran : Gigi® Armless Chair with Sled Base	184	
	Marco Maran : Gigi® Barstool and Swivel Chair	188	
	Ludwig Mies van der Rohe : Tubular Brno Chair	190	
	Ludwig Mies van der Rohe : Flat Bar Brno Chair	192	
	Ludwig Mies van der Rohe : Four Seasons Stool	194	
	Ludwig Mies van der Rohe : MR Lounge Seating	196	
	Ludwig Mies van der Rohe : MR Chair	198	
	Ludwig Mies van der Rohe : Barcelona® Lounge Seating	200	
	Ludwig Mies van der Rohe : Krefeld™ Collection	202	
	George Nakashima : Straight Chair	208	
	Jonathan Olivares : Aluminum Stacking Chair	210	
	Jorge Pensi : Toledo Stacking Chair	212	
	Charles Pfister : Petite Lounge Seating	214	
	Charles Pfister : Lounge Seating	218	
	Charles Pfister : Sofa System	220	
	Warren Platner : Seating Collection	222	
	Warren Platner : Easy Chair and Ottoman	224	
	Charles Pollock : Executive Conference Arm and Armless Chairs	226	
	Charles Pollock : Arm Chair	228	
	Carlos Riart : Riart Rocker	230	
	Joe Ricchio : Joe™ Chair	232	
	Joe and Linda Ricchio : JR® and Ricchio Chair with Upholstered Seat	234	
	Joe and Linda Ricchio : Fully Upholstered Ricchio and JR® Chairs	238	
	Jens Risom : Side Chairs and Stool	242	
	Jens Risom : Child's Side Chairs and Stool	244	
	Jens Risom : Lounge Chairs	246	
	Eero Saarinen : Tulip Chairs	248	
	Eero Saarinen : Executive Arm Chairs	250	
	Eero Saarinen : Executive Armless Chairs	254	
	Eero Saarinen : Womb Chair, Ottoman and Settee	258	
	Richard Schultz : 1966 Collection® Dining Chairs	266	
	Richard Schultz : 1966 Collection® Barstools	268	
	Richard Schultz : 1966 Collection® Lounge Seating	270	
	Richard Schultz : 1966 Collection® Chaise Lounge Chairs	272	
	Richard Schultz : Swell® Seating Collection	274	
	Richard Schultz : Topiary® Seating Collection	276	
	Richard Schultz : Fresh Air Dining Chair	278	
	Shelton Mindel : Shelton Mindel Side Chair	280	
	Shelton Mindel : SM1 Lounge Collection	282	
	Shelton Mindel : SM2 Lounge Collection	284	
	Kazuhide Takahama : Suzanne Lounge Seating	288	
	Ufficio Tecnico : Spoleto Chair	290	
	Vignelli Associates : Handkerchief Armless Chair	292	
	Vignelli Associates : Handkerchief Arm Chair	294	
	Tables/Executive Office	David Adjaye : The Washington Collection for Knoll™	296
		Franco Albini : Albini Desk	300
Edward Barber & Jay Osgerby : Piton™ Side Table		302	
Marcel Breuer : Laccio Tables		304	
Joseph Paul D'Urso : Square Work and Low Tables		306	
Joseph Paul D'Urso : Round Work and Low Tables		308	
Joseph Paul D'Urso : Racetrack Work Tables		312	
Frank Gehry : Face Off Cafe Table		314	
Alexander Girard : Coffee Table		316	
Florence Knoll : Oval Table Desks		318	
Florence Knoll : Round Table Desk		320	
Florence Knoll : Dining Tables and Mini Desk		322	
Florence Knoll : Executive Desk		326	
Florence Knoll : Credenzas		328	
Florence Knoll : Coffee Tables		332	
Florence Knoll : End Tables		334	

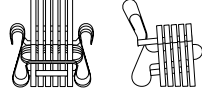
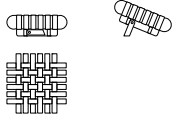

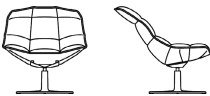











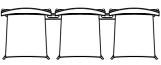
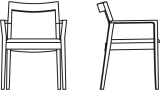
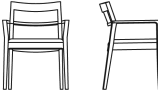
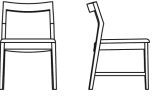
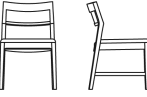
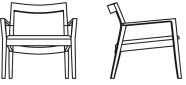
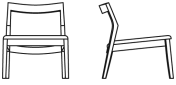
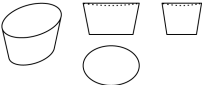

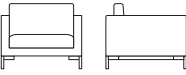
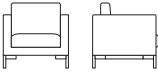
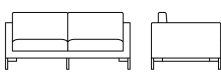
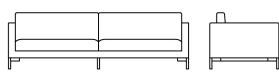
Tables/Executive Office (cont'd.)	Florence Knoll : Hairpin™ Stacking Table	336
	Rem Koolhaas : 04 Counter	338
	Marc Krusin : Occasional Tables	340
	Ludwig Mies van der Rohe : Barcelona® Table, MR Table	342
	Ludwig Mies van der Rohe : Krefeld™ Side and Coffee Table	344
	Pascal Mourgue : Square and Rectangular Conference Tables	346
	Pascal Mourgue : Round and Racetrack Conference Tables	348
	Pascal Mourgue : Bullet Conference Tables	350
	George Nakashima : Splay-Leg Table and Tray	352
	Isamu Noguchi : Cyclone™ Dining and Side Tables	354
	Jorge Pensi : Pensi Tables	356
	Piironen : Arena Cafe Tables	360
	Warren Platner : Dining and Side Tables	362
	Warren Platner : Coffee Tables	364
	Jens Risom : Dining and Side Tables	366
	Jens Risom : Child's Amoeba Table	368
	Eero Saarinen : Round Dining Tables	370
	Eero Saarinen : Oval Dining Tables	376
	Eero Saarinen : Round End and Coffee Tables	378
	Eero Saarinen : Oval End and Coffee Tables	382
	Eero Saarinen : Outdoor Tables	384
	Richard Schultz : Petal® Table Collection	386
	Richard Schultz : 1966 Collection® Dining Tables	388
	Richard Schultz : 1966 Collection® Counter Height Tables	390
	Richard Schultz : 1966 Collection® Bar Height Tables	392
	Richard Schultz : 1966 Collection® End and Coffee Tables	394
	Richard Schultz : 1966 Collection® Serving Cart	398
	Richard Schultz : Fresh Air Dining Tables	400
	Richard Schultz : Topiary® Dining Tables	402
	Shelton Mindel : SM Tables	404
	Daniel Stromborg : Round Tables	406
	Daniel Stromborg : Square Tables	408
	Daniel Stromborg : Rectangular Tables	410
	Vignelli Associates : PaperClip™ Cafe Tables	412
Alpha-Numeric Index		413
Selling Policy		418
General Ordering Information		420



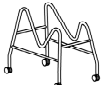

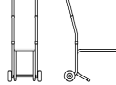





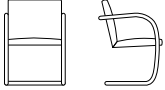
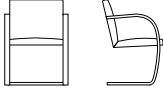
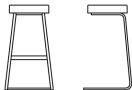
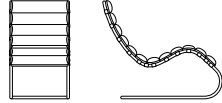
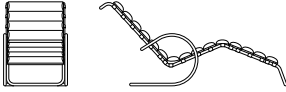

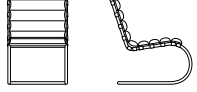
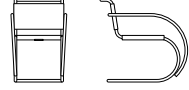
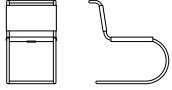
David Adjaye	34-37, 296-299
Franco Albini	300-301
Edward Barber & Jay Osgerby	38-45
Edward Barber & Jay Osgerby	46-51, 302-303
Harry Bertoina	52-71
Pierre Beucler & Jean-Christophe Poggioli	72-89
Cini Boeri	90-93
Marcel Breuer	94-99, 304-305
Don Chadwick	100-103
Pepe Cortés	104-105
Jonathan Crinion	106-107
Raul de Armas	118-127
Joseph Paul D'Urso	108-117, 306-313
Frank Gehry	128-131, 314-315
Alexander Girard	316-317
Markus Jehs and Jürgen Laub	132-135
Florence Knoll	136-139, 318
Knoll Design	140-147
Rem Koolhaas	338-339
Antti Kotilainen	152-153
Marc Krusin	148-149, 154-159, 340-341
Maya Lin	160-163
Piero Lissoni	164-169
Ross Lovegrove	170-173
Vico Magistretti	174-175
Marco Maran	176-189
Ludwig Mies van der Rohe	190-207, 342-345
Pascal Mourgue	346-351
George Nakashima	208-209, 352-353
Isamu Noguchi	354-355
Jonathan Olivares	210-211
Jorge Pensi	212-213, 356-359
Charles Pfister	214-221
Piiroinen	360-361
Warren Platner	222-225, 362-365
Charles Pollock	226-229
Carlos Riart	230-231
Joseph Ricchio	232-241
Linda Ricchio	234-241
Jens Risom	242-247, 366-369
Eero Saarinen	248-265, 370-385
Richard Schultz	266-279, 386-403
Peter Shelton & Lee Mindel	280-287, 404-405
Daniel Stromborg	406-411
Kazuhide Takahama	288-289
Ufficio Tecnico	290-291
Vignelli Associates	292
Vignelli Associates: David Law, Lella Vignelli & Massimo Vignelli	412-413



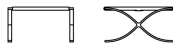
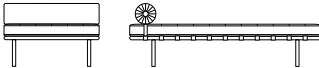
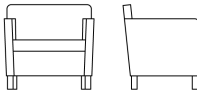
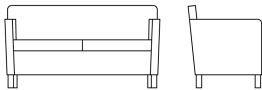
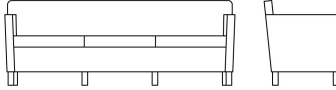

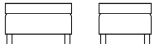





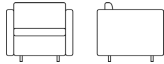
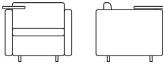
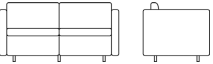
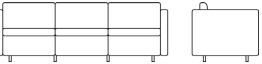

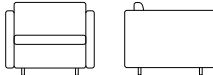
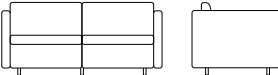
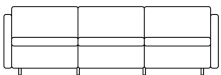

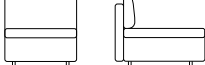

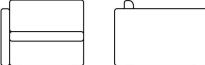



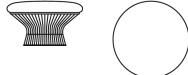

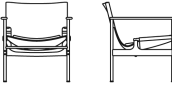
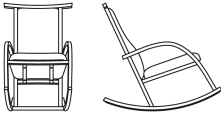

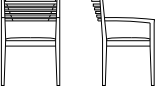

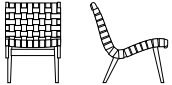

Page	SIDE CHAIRS AND LOUNGE SEATING				
34	ADJAYE	Prism™ Lounge chair 	Prism™ Ottoman 	Washington Skin™ 	Washington Skeleton™ 
38	BARBER & OSGERBY	Sofa 	Ottoman 	Arm chair 	Pillow 
		Piton™ stools 	Pilot High back 	Pilot Low back 	
52	BERTOIA	Side chair 	Barstools 	Diamond chair 	Child's Diamond chair 
		Large Diamond chair 	Bird high back chair 	Ottoman 	Bench 
		Asymmetric Lounge 			
72	BEUCLER & POGGIOLI	Small lounge chair 	Lounge chair 	Settee 	Sofa 
90	BOERI	Lounge chair 		Sofa 	
		Ottoman 	Large pillow 	Small pillow 	
94	BREUER	Cesca chair 	Cesca chair, cane 	Wassily chair 	
		Spark side chair 	Spark lounge chair 		

















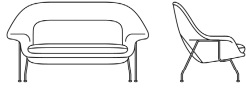

Page		SIDE CHAIR AND LOUNGE SEATING, continued			
104	CORTES	Jamaica Barstools	Jamaica low stool		
					
106 107	CRINION	Crinion arm chair	Crinion armless chair		
					
108 117	D'URSO	Contract Lounge chair	Small Sofa	Ottoman	
					
		Residential Lounge chair	Sofa	Ottoman	
					
		Swivel Lounge chair			
					
118 125	DE ARMAS	de Armas arm chairs	de Armas armless chairs		
					
		Vertical de Armas arm chairs	Vertical de Armas armless chairs		
					
128 131	GEHRY	Hat Trick arm chair	Hat Trick armless chair	High Sticking chair	Cross Check chair
					
		Power Play chair	Offside ottoman		
					
132 135	JEHS+LAUB	Lounge chair, pedestal base	Ottoman, pedestal base		
					
		Lounge chair, wire base	Ottoman, wire base		
					

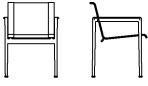

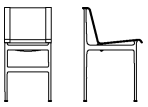
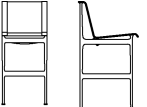
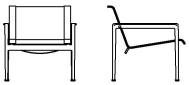
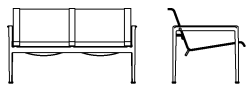
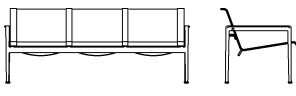
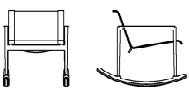
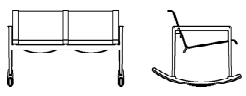
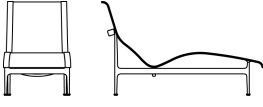
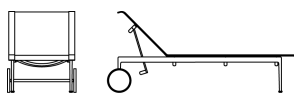
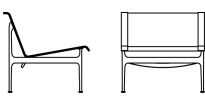
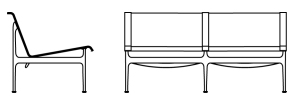
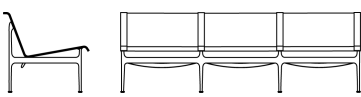

Page		SIDE CHAIR AND LOUNGE SEATING, continued			
136	KNOLL	Lounge chair	Settee	Sofa	
		Two seater bench	Three seater bench		
		Relaxed Lounge Chair	Relaxed Settee	Relaxed Sofa	
0	KNOLL DESIGN	Bench, two seat	Bench, three seat	Bench, 48" inside radius, 60°	Bench with back, single seat
		Bench with back, two seat	Bench with back, three seat	60° Curved bench with back, inside radius	60° Curved bench with back, outside radius
		Ottoman	Stool	Pouf	
		Corner Tables			
		Corner Tables Electrical			
150	KNOLLSTUDIO	Lumbar pillow	Throw pillow	Large throw pillow	



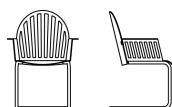

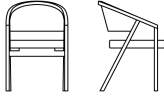
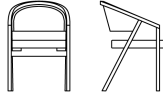
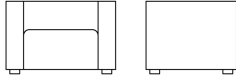
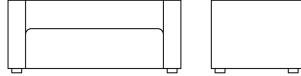
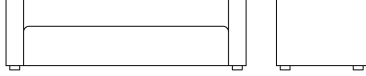
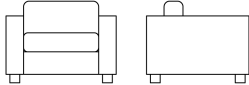
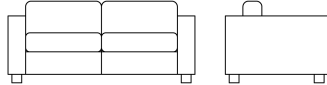
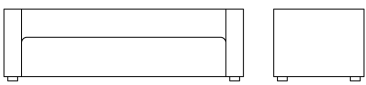
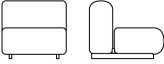

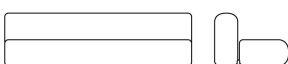
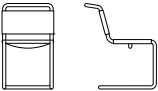





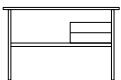





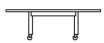



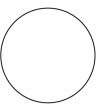



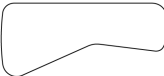
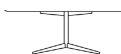

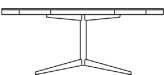

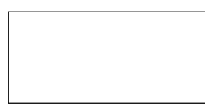
Page		SIDE CHAIR AND LOUNGE SEATING, continued			
152	KOTILAINEN	CHIP armless chair 	CHIP arm chair 	CHIP barstools 	Dolly 
		Ganging mechanism 			
154	KRUSIN	Arm chair 	Arm chair with inset 	Armless chair 	Armless chair with inset 
		Arm lounge 	Armless lounge 		
160	LIN	Adult stones 	Child stones 	Stones Coffee table 	
164	LISSONI	Divina Lounge chair 	Petite Lounge chair 	Settee 	Sofa 
		Ottoman 			
170	LOVEGROVE	Sprite armless chair 	Sprite arm chair 	Sprite Dolly 	
174	MAGISTRETTI	Cirene arm stacking chair 	Cirene armless stacking chair 	Cirene Dolly 	
60	MARAN	Gigi arm chair 	Gigi armless chair 	Gigi Barstools 	Gigi Swivel chair 



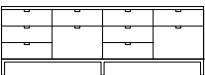







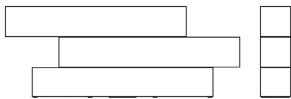

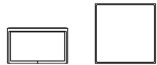
Page		SIDE CHAIRS AND LOUNGE SEATING, continued			
190	MIES VAN DER ROHE	Tubular Brno chair 	Flat Bar Brno chair 	Four Seasons stool 	
		MR Chaise lounge 	MR adjustable chaise lounge 	MR arm lounge chair 	MR armless lounge chair 
		MR arm chair 	MR armless chair 		
200	MIES VAN DER ROHE	Barcelona chair 	Child's Barcelona chair 	Barcelona stool 	Child's Barcelona stool 
		Barcelona stool with cowhide sling 	Barcelona couch 		
		Krefeld Lounge chair 	Krefeld Settee 	Krefeld Sofa 	
		Krefeld medium and large benches 	Ottoman 		
208	NAKASHIMA	Straight chair 			
210	OLIVARES	Olivares chair 			
212	PENSI	Toledo chair 	Toledo chair seat cushion 		

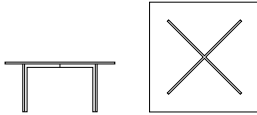
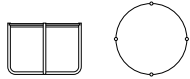
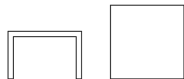

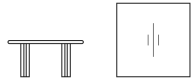
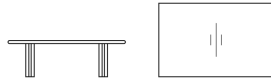

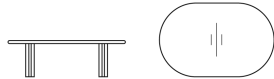

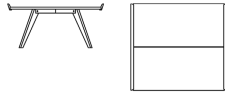
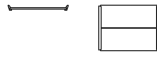

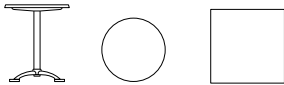
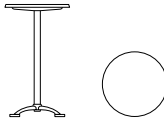
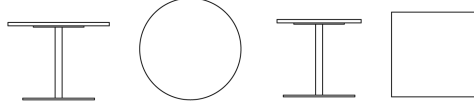
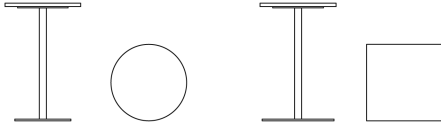

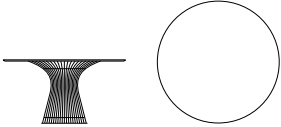

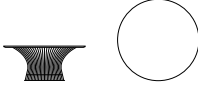
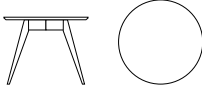

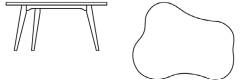
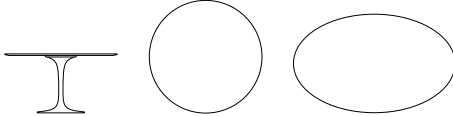
Page		SIDE CHAIRS AND LOUNGE SEATING, continued				
214	PFISTER	Petite Lounge chair 	Petite Lounge chair with tablet arm 	Petite Settee 	Petite Sofa 	
		Petite Ottoman 	Lounge chair 	Settee 	Sofa 	
		Ottoman 	Modular Sofa System Center module 	End modules 	Corner module 	
222	PLATNER	Lounge chair 	Arm chair 	Stool 	Easy chair 	Ottoman 
226	POLLOCK	Executive Conference arm chair 	Executive Conference armless chair 		Arm chair 	
230	RIART	Riart Rocker 				
232	RICCHIO	Joe arm chair 	JR chair 	Ricchio arm chair 	Ricchio armless chair 	
		Ricchio Fully upholstered chair 		JR Fully upholstered chair 		
242	RISOM	Lounge chairs 		Side chairs 		
		Sitting stool 	Child's Side chairs 		Child's Sitting stool 	
248	SAARINEN	Tulip arm chair 	Tulip armless chair 	Stool 		

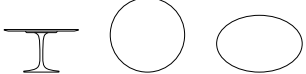
Page		SIDE CHAIRS AND LOUNGE SEATING, continued			
250	SAARINEN	Executive arm chair 	Executive armless chair 	Arm chair 	Armless chair 
258	SAARINEN	Womb chair 	Ottoman 	Womb Settee 	Medium Womb chair 
		Medium Ottoman 	Child's Womb chair 		
266	SCHULTZ	Dining chair with arm 	Dining chair, armless 	Counter height armless barstool 	Bar height armless barstool 
		Lounge chair with arms 	Two seat lounge chair with arms 	Three seat lounge chair with arms 	
		Single rocker 	Double rocker 		
		Contour chaise lounge 	Adjustable chaise lounge 		
		Single seat club chair 	Two seat sofa 	Three seat sofa 	
		Topiary dining chair 	Topiary lounge chair 	Topiary bench 	Topiary small ottoman/end table 
		Topiary stacking chair 	Fresh Air dining chair 		

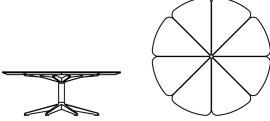
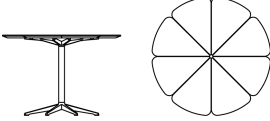
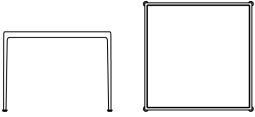
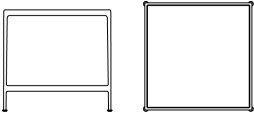
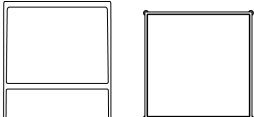
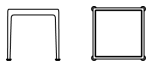
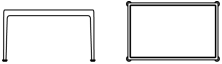
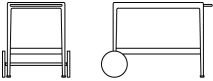
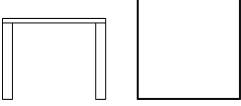
Page		SIDE CHAIRS AND LOUNGE SEATING, continued			
280	SHELTON & MINDEL	SM side chair	SM side chair, fully upholstered		
					
		SM1 Lounge chair	SM1 Settee	SM1 Sofa	
					
		SM2 Lounge chair	SM2 Settee	SM2 Sofa	
					
288	TAKAHAMA	Suzanne lounge chair	Double lounge chair	Settee	Sofa
					
290	TECHNICO	Spoleto chair			
					
292	VIGNELLI ASSOCIATES	Handkerchief arm chair	Handkerchief armless chair		
					

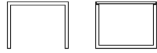
Page	TABLES / EXECUTIVE OFFICE			
296	ADJAYE	Washington Corana™	Prism™ side tables	
				
300	ALBINI	Pedestal desk		
				
302	BARBER & OSGERBY	PITON™ side tables		
				
304	BREUER	Laccio tables		
				
306	D'URSO	Work and low tables - Square	Work and low tables - Round	Work tables - Racetrack
				
				
314	GEHRY	Face Off café tables		
				
316	GIRARD	Coffee table		
				
318	KNOLL	Oval and Round table desks	Dining Table and Mini Desk	Executive desk
				
				
				
		Two Position Credenza	Four Position Credenza	Coffee and end tables
				
				
				
				
		Hairpin stacking table		
				

Page	TABLES / EXECUTIVE OFFICE				
338	KOOLHAAS	Counter			
					
340	KRUSIN	Square side tables	Square end tables	Square coffee tables	Square coffee tables
					
342	MIES VAN DER ROHE	Barcelona table	MR table	Krefeld side table	Krefeld coffee table
					
346	MOURGUE	Pascal square table	Pascal rectangular table	Pascal round table	Pascal racetrack table
					
		Pascal bullet table			
					
352	NAKASHIMA	Splay-leg table	Tray		
					
354	NOGUCHI	Cyclone dining table	Cyclone side table		
					
356	PENSI	Pensi tables	Pensi high table		
					
360	PIIROINEN	Arena tables	Arena high tables		
					

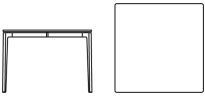
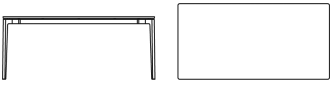
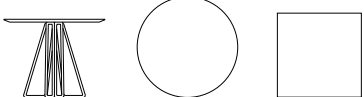
Page		TABLES / EXECUTIVE OFFICE, continued			
362	PLATNER	Dining table	Side table	Coffee tables	
					
366	RISOM	Dining table	Side tables	Amoeba coffee table	Child's Amoeba coffee table
					
370	SAARINEN	Dining tables		Side tables	Coffee tables
					
		Outdoor tables			
					
386	SCHULTZ	Petal end table	Petal coffee table	Petal dining table	
					
		1966 Dining table	1966 Counter Height table	1966 Bar Height table	1966 End table
					
		1966 Coffee table	1966 Serving Cart	Fresh Air Dining table	Topiary® Dining table
					
404	SHELTON & MINDEL	SM side table	SM small coffee table	SM large coffee table	SM square coffee table
					
406	STROMBORG	Round table	Square table	Rectangular table	
					
412	VIGNELLI ASSOCIATES	PaperClip tables			
					

A Price List Overview

Where do I send my order? How should I maintain my marble table? From textile options to wood polishes, the KnollStudio price list is designed to provide you with everything you need to know in order to understand, specify, and care for furniture in the KnollStudio Collection.

This book is divided into three easy-to-use sections.

- Side Chairs and Lounge Seating
- Tables and Executive Office
- Propeller Table Series

For a quick overview of the collection's scope, review the Visual Index on pages 5-15. If you're looking for pieces by a specific designer, try the Designer Index on page 4.

Need furniture in a hurry? KnollStudio 20-day on pages 30-31 highlights KnollStudio pieces available in only twenty days.

Leathers, Textiles, and Finishes

If you're confused about which leather to select, pages 17-18 explains the broad selection of Spinneybeck leathers available for KnollStudio furniture.

Additional upholstery notes and Customer's Own Material (COM) information are available on page 18.

For detailed explanations of the many materials used in constructing KnollStudio furniture, consult page 27. A cross-reference of KnollStudio veneer or lumber finishes with standard Knoll Office veneers is provided on page 25. Easy-care maintenance information is also provided on pages 28-29.

Placing Your KnollStudio Order

For information about where to send your order and key terms and conditions, see page 33. The complete Knoll Selling Policy is available on pages 418-419.

General Ordering Information and Knoll's Sustainability Statement is available on page 420

Product Information On Each Page

On each page, the following features will assist you:

Description provides both the pattern number and a basic description of the product.

Dimensions provide the overall space the product will require. Statistics are based on the maximum width, depth, and height of the product.

Weight is based on the product itself. It does not include packaging. Weights are rounded to the nearest pound.

Weights of upholstered items do not include weight of textile/leather. To calculate total weight, multiply covering requirements by textile/leather weight, and add to product weight.

Pattern Number provides both the product identification number and all additional selections required for ordering. Finish options are enclosed in parentheses. Finish suffix descriptions are found under Finishes on the bottom portion of the page.

Order Code/Ordering Information outlines exactly how to specify KnollStudio product and the full scope of finishes and other options. The Order Code provides an example of how one pattern number on the page is specified.

20-Day pieces available in 20 days ex-factory are noted with helicopters  next to the items. Additional information is provided under Ordering Information and in the 20-Day section of this book.

Construction provides specific materials and finishes employed, as well as specific construction details.

Textiles and Leather Grades list by price group all KnollTextiles and Spinneybeck Leathers approved for each seating piece. This list is derived through careful examination of the textile or leather's distinctive upholstery characteristics and the form and structure of each piece of furniture. KnollTextiles or

Spinneybeck leathers that are not listed have been rejected because Knoll cannot ensure their performance on that product. To view the full range of colorways available for each fabric or leather, consult any Knoll or Spinneybeck representative.

Cal 133 Technical Bulletin

Many KnollStudio products meet California Technical Bulletin 133. Information for specifying these items is on page 19. Items available are indicated with a flame . Applicable upcharge will be listed on the respective price list page.

Greenguard

Many KnollStudio products meet Greenguard environmental standards. Please see page 24 for a complete listing of products.

CPSIA Testing

Many knoll kids products meet the consumer Product Safety Improvement Act of 2008 for Children's Products, 16 C.F.R. 1303 CPSIA Title 1 Section 101 for Total Lead in Substrates and Surface Coatings. For a complete listing of approved products, please refer to individual price list pages.

Note to Knoll Dealer Sellers:

The products contained in this price list are also available through the Knoll Essentials program, with limited exceptions. For additional information, please contact your customer service representative or visit Knoll Exchange.

For More Information

For more information, contact your KnollStudio representative, a Knoll Space reailer or e-tailer, or telephone Customer Services at 800 343-KNOLL. To find the retailer or showroom nearest you, visit www.knoll.com.

For the ultimate in comfort, durability, and prestige, many KnollStudio products can be upholstered in Spinneybeck leathers.

Spinneybeck leathers are made from the top 2% of the world's finest hides, inspected numerous times during production to ensure evenness of grain, surface, color and the absence of scars.

After tanning, all Spinneybeck leathers are drum-dyed, a time-consuming procedure which ensures color penetration throughout the hide. Each hide is then finished in the manner which will best bring out its individual character.

Spinneybeck leathers are all full-grain aniline drum-dyed products imported from Italy.

The following Spinneybeck leathers are approved for application on KnollStudio products. Leathers are grouped into five price categories referred to as "grades." The selection of approved leathers varies by product. Please refer to the pricing page of each product line for more information.

Square footage requirements for Customer's Own Leather (COL) are listed on the left side of the pricing page. Please refer to Upholstery Notes on page 18 and The Knoll Selling Policy on pages 418-419 for further information regarding COL.

For further information call Spinneybeck at 1-800-482-7777.

Grades	Characteristics
U Vicenza Volo	Heavily finished cowhide, corrected grain, slightly raised grain texture Heavily finished cowhide, corrected grain, slightly raised grain texture
V Acqua Andes Embossed Tipped España Hand Tipped Maremma Velluto Pelle	Heavy water-repellent finished kip, corrected grain, slightly raised grain texture Slightly pronounced grain cowhide with a medium finish, and enhanced grain Lightly finished cowhide, full grain, embossed pronounced pebble grain Smooth, tight grain cowhide; breathable, protective medium finish, enhanced grain Two-toned leather, lightly finished cowhide, pronounced pebble grain texture Full grain textured suede with impregnated soil-resistant treatment Slightly pronounced grain cowhide with a medium finish, enhanced grain
W Alaska Amazon Antique Derby Forte Lucente Sabrina	Pearlized-iridescent protective finish cowhide, full grain with smooth texture Mid-weight, full grain cowhide; colors of the Amazonian jungle, raised grain texture Smooth tight grain cowhide, lightly antiqued to produce an elegant patina, enhanced grain Combination-tanned cowhide; full grain, medium finish and raised grain texture High performance, full grain leather with slightly pronounced grain texture Smooth, very tight grain cowhide; subtle sheen; light casein finish Smooth, tight and full grain kip with a breathable protective finish
X Ducale Ducale Velour	Embossed shrunken grain cowhide, medium protective finish, full grain Full grain-sueded cowhide, embossed shrunken grain, scotch-guarded
Y Capri Cervo Copenhagen Distressed Lucca Marissa Portofino Riva Saddle Torello	Chrome-free, light protective finish, full grain cowhide Full aniline, pronounced grain texture, soft luxurious hand Full aniline, 100% vegetable tanned leather, full grain Aniline-dyed, paraffin wax final ironing process with a smooth finish, and full grain Aniline-dyed, pebble grain sueded leather Grain-sueded cowhide, scotch-guarded smooth suede grain Full grain, lightly finished cowhide, with a pronounced raised texture Slightly pronounced grain texture, water-repellent, full grain Full aniline, smooth very tight grain surface takes on a rich patina over time Full grain, aniline dyed, natural shrunken bovine leather; light protective finish

Textile and Leather Notes

All seating in this price list includes the cost of applied fabric or leather. To simplify ordering, the seating is arranged into specific upholstery grades and priced accordingly. Samples and prices of cut textiles are available on request. For a full list of the Spinneybeck leathers available, see page 17.

Leather*The Natural Qualities of Leather*

Natural leather is unique. Because every animal is different, each hide has its own individual color, texture, and life-marks. In fact, our leathers are painstakingly treated to retain their natural appearance and hand. Range marks are not camouflaged. Colors and texture vary, and will do so more with age as the leather mellows and takes on a rich patina.

Spinneybeck Leathers

Spinneybeck offers full-grain Italian leathers.

Spinneybeck features three different tanning processes which preserve the leather. The first is mineral tannage, in which chromium salts are used; the second is vegetable tannage, in which bark tanning is used; and the third is a combination of the first two processes. Each leather is tanned in the manner which will best accentuate its unique characteristics.

Spinneybeck leathers are drum-dyed which tumbles the leather over and over for smooth, even coloring absorbed directly into the leather. This aniline-dyeing process enhances the natural qualities of leather grain. Many competitors use vat-dyeing. This does not dye the leather in an even manner.

If you have further questions on Spinneybeck leathers, contact your Knoll representative or telephone Spinneybeck Customer Service at 1-800 482-7777.

Below are additional details on the three major types of Spinneybeck leathers.

Naked Leather (Capri, Copenhagen, Distressed, Maremma, Saddle) Naked leather contains no foreign substances which would affect the superbly soft, mellow hand of this most luxurious of upholstery leathers. Natural markings are

accentuated. Since there are no barriers against spillage or staining, naked leathers should be carefully specified. However, scratches and marks will dissipate in time as the leather develops a beautiful patina.

Leathers with Protective Finishes:

(Acqua, Alaska, Amazon, Andes, Antique, Derby, Ducale, España, Forte, Hand Tipped, Lucente, Montalcino, Portofino, Riva, Sabrina, Velluto Pelle, Volo)

For high traffic areas, protective finishes allow leather to be not only practical, but easy to maintain.

Grain Sueded Leathers (Ducale Velour, Marissa)

Full grain leathers that have been lightly buffed to raise the nap of the surface are referred to as "grain sueded" leathers. This produces the soft hand of sueded leathers. For maximum soil resistance and durability, these leathers have received an impregnated soil resistance treatment during the drum-dye process which permeates the leather, making it repellent to liquid and dirt.

Textile*Classic Boucle*

Classic Boucle is with spun Boucle yarn that is a blend of wool and nylon that is piece dyed. Color can vary from lot-to-lot and it is important to use the same lot for multiple piece orders. Please notate sales order when items must match. Classic Boucle, Pearl contains natural, un-dyed wool and will have darker hairs woven within the textile.

Knoll Upholstery Restrictions

Every Knoll leather and fabric is exhaustively tested on each Knoll upholstered item. This is done in addition to the most extensive program of independent fabric testing in the industry. On furniture, testing ensures precise fit and appearance, without stretch, puddling, telegraphing or other common problems frequently experienced when careful factory pre-qualification is eliminated.

When Knoll suggests that a particular leather or fabric not be used on an object, this does not mean the material is defective in any way; it only implies less than perfect performance with the form and structure of a specific item on furniture.

Instructions for Ordering Nano-Tex

The minimum for Nano-Tex on KnollStudio orders is 1-lot of \$206 net for up to 65 yards. Nano-Tex orders of 65 yards or more is \$3.00 net/yard.

Dealer instructions for ordering Nano-Tex:

- 1) Visit knolltextiles.com/technical documents and open the Nano-Tex specifications to see if the fabric is approved with the finish.
- 2) If approved, check the seating matrix at knolltextiles.com to see if the fabric alone is approved on the chair. (If yes, proceed to #3).
- 3) Contact your account manager with the fabric name, treatment required, and name and pattern number of desired chair. They will see if Knoll has tested this fabric with finish/treatment on said chair. In most cases, application testing has not been done and they will contact the appropriate parties to initiate approval and determine leadtime for testing.
- 4) If approved, book order with a suffix of N (for Nano-Tex) after the fabric pattern number.
- 5) The fabric grade will remain the same. Add line item for finish/treatment required and multiply the finish cost by the number of yards required.

Customer's Own Material (COM)**Customer's Own Leather (COL)**

While Knoll is pleased to cooperate with COM/COL selections, an extra charge is required to help offset receiving and handling costs. Such charges are included under the COM/COL title of the price columns in this price list. Prior to order placement, a sample cutting of actual COM/COL must be submitted to Knoll in East Greenville or through your regional Knoll office for preliminary approval of intended item (8' x 8" minimum memo sample if solid; if COM has a repeat, the sample must be large enough to show the repeat).

Even after such preliminary approval, Knoll reserves the right to reject COM/COL, including, if necessary, the item intended for use with COM/COL, if Knoll considers the customer-supplied material inadequate for any reason. When COM/COL is accepted, KnollStudio assumes no responsibility for its appearance, durability, color fastness or any other quality after upholstered on a Knoll product.

Published yardage requirements are based upon Knoll 52" width material unless specified otherwise. Leather requirements are based on whole hides with a minimum of 50 square feet per hide. However, in some cases, the nature or pattern of COM/COL will require additional yardage/square feet and/or additional labor charges. When this is necessary, the customer will be notified at the same time that the preliminary sample is approved.

If your COM/COL is approved, you may send the required amount for the product to:

Knoll, Inc.
1235 Water St
East Greenville, PA 18041
Attn: Customer Resources

COM/COL must be marked with designated approval number and customer's name.

For additional information, see Customer's Own Material (COM) under Selling Policy on pages 418-419.

Test Objective

California Technical Bulletin 133 (Cal 133) is a full-scale seating test, not a component test. Testing must be performed on the designated seating unit and textile together. Component data alone cannot be used to certify compliance with the regulation. Under Cal 133 you cannot assume that seating or textiles that have passed individually will pass together.

Test Procedure

The seating unit is exposed to a square open flame gas burner for 80 seconds, positioned at the center of the seating unit, two inches from the back and one inch from the seat.

Scope

Cal 133 only applies to seating units. The bulletin is designed for high risk public areas:

- Nursing homes
- Health care facilities
- Public auditoriums
- Hotels (more than 10 seating units in one room)
- Motels (more than 10 seating units in one room)
- Jails and prisons

Tables and desks are not covered by the bulletin. Variations may occur in individual states with regards to specific application. In California only, compliance is at the discretion of the fire marshal in any building which is fully sprinklered.

KnollStudio Approvals

Tested seating units have been tested in a worst case scenario thus covering other fabrics of lighter weight and same construction. When specifying Cal 133, the seating unit may be constructed with a fire resistant foam and a fire blocker will be laminated to the textile.

How To Specify

It is easy to specify Cal 133 on KnollStudio seating. Simply add the suffix “C” to the end of the pattern number prior to the textile selection. Approved textile selections must have the suffix 133 added to the end of the pattern number.

Example: Bertoia side chair, chrome, seat pad in Common Ground/Basalt 420C-C-K-C-K448/12-133

Testing Additional Product

If you would like to test a specific product:

Specify chair and textile desired - adding appropriate C and 133 codes as explained.

Testing lead time will be the standard lead time of the chair plus 4 - 6 weeks for testing procedure.

Test cost will be the regular price of the chair plus \$500 for the testing procedures.

Cal 133 tested and approved fabrics and seating units are indicated with a flame . All prices below are list.

KnollStudio CAL 133 Approved Products					
Designer	Product	Pattern #	Unupholstered, no upcharge	Knoll Textiles, upcharge	Spinneybeck leather, upcharge
Bertoia	Side Chair, seat cushion	420K	approved	approved, no upcharge	approved, no upcharge
Bertoia	Barstools, Bar Height, seat cushion	427K	approved	approved, no upcharge	approved, no upcharge
Bertoia	Barstools, Counter Height, seat cushion	428K	approved	approved, no upcharge	approved, no upcharge
Bertoia	Diamond Lounge Chair	421K	approved	approved, no upcharge	approved, no upcharge
Bertoia	Diamond Lounge Chair	421F	approved	approved, no upcharge	approved, no upcharge
Bertoia	Child’s Diamond Lounge Chair	421LS-K		approved, no upcharge	approved, no upcharge
Bertoia	Child’s Diamond Lounge Chair	421LS-U		approved, no upcharge	
Bertoia	Large Diamond Chair	422F		approved, no upcharge	
Bertoia	Bird Lounge Chair and Ottoman	423LU, 424YU		approved, no upcharge	
Bertoia	Asymmetric Chaise	429LU, 429F		approved, no upcharge	
Boeri	Lounge Chair	CB1		\$623.00	\$826.00
Boeri	Sofa	CB2		\$852.00	\$1,176.00
Boeri	Ottoman	CB3		\$363.00	\$661.00
Breuer	Cesca Chair	50A, 50C		\$93.00	
Breuer	Wassily Chair	50L	approved		approved
Chadwick	Spark Series	4-C-SD-S, 4-C-LG-S		\$60.00	
Cortes	Jamaica Barstool	30C	approved		
Crinion	Crinion Chair	58A, 58C		\$60.00	
D’Urso	Lounge Chair	2160, 2160R		\$596.00	\$697.00
D’Urso	Lounge Chair, split upholstery	2160S, 2160RS		\$907.00	\$907.00
D’Urso	Swivel Lounge Chair	2165		\$540.00	
D’Urso	Small Sofa	2161		\$1064.00	\$1,165.00
D’Urso	Small Sofa, split upholstery	2161S		\$1,399.00	\$1,399.00
D’Urso	Residential Sofa	2162R		\$1,300.00	\$1,399.00
D’Urso	Residential Sofa, split upholstery	2162RS		\$1,633.00	\$1,633.00
D’Urso	Ottoman	2163, 2163R		\$321.00	\$427.00
D’Urso	Ottoman, split upholstery	2163S, 2163RS		\$544.00	\$544.00
de Armas	de Armas Chair Collection	38A, 38AW, 38C, 28CW, 41A, 41AW, 41C, 41CW		\$60.00	\$60.00
de Armas	de Armas Chair Collection	38AW-U, 38CW-U, 41AW-U, 41CW-U		\$105.00	\$105.00

KnollStudio CAL 133 Approved Products (continued)					
Designer	Product	Pattern #	Unupholstered, no upcharge	Knoll Textiles, upcharge	Spinneybeck leather, upcharge
Jehs+Laub	Lounge Chair	JL1-P, JL1-PLt, JL2-P, JL2-PLT, JL1-W, JL1-WLT, JL2-W, JL2-WLT		\$246.00	\$334.00
Jehs+Laub	Ottoman Chair	JL3-P, JL3-PLT, JL3-W, JL3-WLT		\$94.00	\$165.00
Knoll	Lounge Chair	1205S1		\$573.00	\$675.00
Knoll	Settee	1205S2		\$998.00	\$1,179.00
Knoll	Sofa	1205S3		\$1,336.00	\$1,576.00
Knoll	Small Bench	2530Y2C		\$133.00	\$358.00
Knoll	Large Bench	2530Y3C		\$206.00	\$506.00
Kotilainen	CHIP Chair	23C, 23A	approved		
Lin	Stones, seat pad	83Y-K, 84Y-K		\$60.00	
Lissoni	Divina Petite Lounge Chair	67S		\$387.00	\$726.00
Lissoni	Divina Standard Lounge Chair	67, 67R		\$620.00	\$905.00
Lissoni	Divina Settee	68, 68R		\$953.00	\$1,433.00
Lissoni	Divina Optional Side Cushion	68C		\$85.00	
Lissoni	Divina Sofa	69, 69R		\$1,430.00	\$1,845.00
Lissoni	Divina Ottoman	73, 73R		\$340.00	\$620.00
Lovegrove	Sprite Arm and Armless Chair	27C, 27A	approved	\$60.00	\$60.00
Mies van der Rohe	Tubular Brno Chair	245AT, 245AB		\$629.00	\$629.00
Mies van der Rohe	Flat Bar Brno Chair	255AS, 255CS		\$629.00	\$629.00
Mies van der Rohe	Four Seasons Stool	257C			\$164.00
Mies van der Rohe	Barcelona Lounge Chair	250LS, 250LC			\$514.00
Mies van der Rohe	Child's Barcelona Chair	250LC-S			\$452.00
Mies van der Rohe	Barcelona Ottoman	251YS, 251YC			\$260.00
Mies van der Rohe	Child's Barcelona Ottoman	251YC-S			\$224.00
Mies van der Rohe	Krefeld Lounge Chair	751		\$548.00	\$870.00
Mies van der Rohe	Krefeld Settee	752		\$678.00	\$1,211.00
Mies van der Rohe	Krefeld Sofa	753		\$932.00	\$1,564.00
Mies van der Rohe	Krefeld Ottoman	754		\$254.00	\$454.00
Mies van der Rohe	Krefeld Medium Bench	755		\$424.00	\$712.00
Mies van der Rohe	Krefeld Large Bench	756		\$465.00	\$961.00
Pensi	Toledo Stacking Chair	29C	approved		
Pfister	Standard Lounge Chair, Petite Lounge Chair	1051C, 1051C-S		\$633.00	\$955.00
Pfister	Standard Settee	1052C		\$1,083.00	\$1,653.00
Pfister	Standard Sofa	1053C		\$1,529.00	\$2,341.00
Pfister	Corner Module	1050C-3		\$591.00	\$970.00
Pfister	End Module, left panel and right panel	1050C-1, 1050C-2		\$530.00	\$828.00
Pfister	Center Module	1050C		\$434.00	\$684.00
Pfister	Standard Ottoman	1059C		\$333.00	\$458.00
Pollock	Executive/Conference Arm and Armless Chairs	12A, 12C		\$109.00	\$109.00
Ricchio	Joe Chair	48A		\$60.00	\$60.00
Ricchio	Ricchio Chair	37A, 37C		\$60.00	\$60.00
Ricchio	JR Chair	44A		\$60.00	\$60.00
Ricchio	Fully Upholstered Ricchio Chair	37A-U, 37C-U, 44A-U		\$166.00	\$166.00
Ricchio	Ricchio Barstool	37CH, 37CM		\$60.00	\$60.00
Risom	Risom Stool, Side and Lounge Chair	666C, 667Y, 666CS, 667YS, 654LA, 654LC		approved, no upcharge	approved, no upcharge
Saarinen	Executive Arm Chairs	71A		\$264.00	\$383.00
Saarinen	Executive Armless Chairs	72C		\$182.00	\$383.00
Saarinen	Womb Settee	73L		\$805.00	\$1,496.00
Saarinen	Womb Chair	70L		\$642.00	\$1,187.00
Saarinen	Medium Womb Chair	70LM		\$446.00	\$1,083.00
Saarinen	Womb Ottoman	74Y		\$194.00	\$354.00
Saarinen	Medium Womb Ottoman	74YM		\$151.00	\$310.00
Shelton Mindel	Side Chair	SM8A		\$60.00	\$60.00
Shelton Mindel	Side Chair Fully Upholstered	SM8A-U		\$166.00	\$164.00
Shelton Mindel	SM1 Lounge Chair	SM1-1		\$547.00	\$687.00

KnollStudio CAL 133 Approved Products (continued)					
Designer	Product	Pattern #	Unupholstered, no upcharge	Knoll Textiles, upcharge	Spinneybeck leather, upcharge
Shelton Mindel	SM1 Settee	SM1-2		\$762.00	\$980.00
Shelton Mindel	SM1 Sofa	SM1-3		\$955.00	\$1,299.00
Shelton Mindel	SM2 Lounge Chair	SM2-1		\$701.00	\$762.00
Shelton Mindel	SM2 Lounge Chair- combination	SM2S-1		\$1,235.00	\$1,235.00
Shelton Mindel	SM2 Settee	SM2-2		\$1,121.00	\$1,163.00
Shelton Mindel	SM2 Settee- combination	SM2S-2		\$1,830.00	\$1,830.00
Shelton Mindel	SM2 Sofa	SM2-3		\$1,647.00	\$1,793.00
Shelton Mindel	SM2 Sofa- combination	SM2S-3		\$2,597.00	\$2,597.00
Vignelli Associates	Handkerchief Arm and Armless Chair	4901K, 4902K	approved	\$60.00	

Each year Knoll sets key initiatives in our journey to sustainability. We are members of a global consortium on energy, have adopted a scientific, metrics-based approach to sustainable product design, and maintain a leadership position in establishing universal, verifiable, sustainability standards for our industry.

Knoll promotes independent third-party certification because it provides the most impartial and trustworthy foundation for industry-wide environmental compliance. Certification by established and respected third parties ensures that all manufacturers are held to the same high standards and that customers can trust a company's declaration about the environmental benefits of its products. Knoll third-party partners include: the International Standards Organization (ISO); Forest Stewardship Council (FSC®); Rainforest Alliance; GREENGUARD® Environmental Institute; and The Business and Institutional Furniture Manufacturer's Association (BIFMA) level® certification from Scientific Certification Systems (SCS).

In addition, Knoll is aligned with the U.S. Green Building Council and can help companies, healthcare organizations and educational institutions achieve Leadership in Energy and Environmental Design (LEED®) workplace certification.

Global Climate Change

- Knoll is a sponsor of the Clinton Global Initiative, which brings together a community of global leaders to devise and implement solutions to some of the world's most pressing challenges, including environmental change.
- Knoll has a comprehensive Energy Management Program to increase energy efficiency in products and processes.

Life Cycle Assessment (LCA) Tool

- Life Cycle Assessment is a science-based measurement of a product's environmental impacts throughout its life cycle, from raw materials sourcing through manufacture, shipping, use and re-use or end-of-life. LCA enables cradle-to-cradle implementation of sustainable practices.

Setting Industry Standards

- Knoll partners with MTS (The Institute for Market Transformation to Sustainability) to develop the SMaRT® Consensus Sustainable Products Standards, a set of consensus-based sustainable product standards based on the LEED® model, for all building products, fabric, apparel, flooring and carpet. MTS, the developer of SMaRT®, is an accredited American National Standards Institute (ANSI) standard developer.
- Knoll also partners with BIFMA (Business and Institutional Furniture Manufacturers Association) to promote level® sustainability standards for the contract furniture industry.
- Knoll has established FSC® (Forest Stewardship Council) certified wood as the standard for general office open plan office systems, casegoods and tables.
- Knoll has launched Full Circle, a resource recovery program developed with ANEW, to help customers extend the life cycle of surplus furniture, fixtures and equipment (FF&E) in an economically, socially and environmentally responsible manner.
- Our goal is to encourage all manufacturers in the contract furniture industry and related industries to adopt standards that will lead to sustainable products and practices.

For more information about Knoll and sustainable design, visit knoll.com/environment.

GREENGUARD™

- The most respected independent testing program for low-emitting products.
- GREENGUARD™ – certified products help reduce indoor air pollution and create healthier interior environments.
- Knoll GREENGUARD™ – certified products help achieve points for the U.S. Green Building Council’s LEED – CI (Commercial Interiors) Program.
- GREENGUARD™ – tested and certified office furniture is required for Credit 4.5 in the LEED – CI Indoor Environmental Quality section.

GREENGUARD™ provides the only guide to certified low-emitting interior products and building materials. Its goal is to help building owners and managers, architects, interior designers and product specifiers build and furnish healthier offices, hospitals, schools and homes by providing a register of tested and certified low-emitting products and materials. GREENGUARD™ certification is recognized by LEED. Air Quality Science, an Independent indoor air quality laboratory, tests products submitted for GREENGUARD™ certification using stringent environmental chamber testing protocols and current indoor air quality standards. Certification is administered by the GREENGUARD™ Environmental Institute.

Designer	Product
Side Chairs and Lounge Seating	
David Adjaye	Washington Skin and Skeleton Chairs
Paul Aferiat and Peter Stamberg	Salsa Lounge Seating
Edward Barber and Jay Osgerby	Piton Stools
Harry Bertoia	Side Chair, Barstools, Diamond Chairs, Bird Lounge Chair, Asymmetric Chaise
Cini Boeri	Lounge Collection
Marcel Breuer	Cesca Chair, Wassily Chair
Don Chadwick	Spark Series
Pepe Cortes	Jamica Barstool
Jonathan Crinion	Crinion Side Chair
Raul de Armas	de Armas Chair, Vertical de Armas Chair
Markus Jehs and Jürgen Laub	Jehs+Laub Lounge Collection
Antti Kotilainen	Chip Chair and Barstool
Florence Knoll	Lounge Seating
Knoll Design	k. lounge Collection and k. lounge Throw Pillows
Marc Krusin	Wood Guest Seating Collection
Piero Lissoni	Divina Lounge Collection
Ross Lovegrove	Sprite Chair in Maple, Exotic Alpi and Veneer finishes
Maya Lin	Seats and Coffee Table
Vico Magistretti	Cirene Chair
Marco Maran	Gigi Chair, Gigi Swivel, Gigi Barstool, X3 Chair, X3 Barstool
Ludwig Mies van der Rohe	Brno Chairs, Four Seasons Stool, MR Chair, MR Lounge Chair, Barcelona Lounge Seating, Krefeld Lounge Seating
George Nakashima	Straight Chair
Jonathan Olivares	Aluminum Chair
Jorge Pensi	Toledo Chair
Charles Pfister	Petite Lounge Seating, Lounge Seating, Sofa System
Warren Platner	Lounge Seating
Charles Pollock	Executive/ Conference Arm and Armless Chairs
Carlos Riart	Riart Rocker
Joe Ricchio	Joe Chair
Joe and Linda Ricchio	JR Chair, Ricchio Chair
Jens Risom	Side and Lounge Chairs
Eero Saarinen	Tulip Chairs, Executive Arm and Armless Chairs, Womb Chair and Ottoman
Richard Schultz	1966 Collection, Topiary, Swell and Fresh Air Seating
Peter Shelton and Lee Mindel	Shelton Mindel Wood Side Chair, SM1 Lounge Collection, SM2 Lounge Collection
Kazhide Takahama	Suzanne Lounge Seating
Ufficio Tecnico	Spoletto Chair
Massimo and Lella Vignelli	Handkerchief Arm and Armless Chairs

Designer	Product
Tables	
David Adjaye	Washington Corona Table
Edward Barberand Jay Osgerby	Piton Side Table
Marcel Breuer	Laccio Table
Joseph D'Urso	D'Urso Tables with Laminate Top and PVC Edge; Granite Tops; Veneer Tops
Alexander Girard	Coffee Table
Florence Knoll	Coffee and End Tables
Florence Knoll	Table Desks
Florence Knoll	Credenzas and Executive Desk
Ross Lovegrove	Rectangular, Round and Tri-Oval Tables
Ludwig Mies van der Rohe	Barcelona Table, MR Table
Pascal Mourgue	Tables with laminate Tops and PVC Edge
George Nakashima	Splay-Leg Table
Isamu Noguchi	Cyclone Table
Jorge Pensi	Pensi Tables
Piironen	Arena Café Tables
Warren Platner	Platner Tables with Glass, Natural Marble and Veneer Tops
Jens Risom	Dining Table, Side Tables, Amoeba Coffee Table
Eero Saarinen	Saarinen Tables with Laminate, Natural Marble, Veneer or Granite Tops
Richard Schultz	1966 Collection, Petal, Fresh Air and Topiary Tables
Peter Shelton and Lee Mindel	Shelton Mindel Side and Coffee Tables
Massimo and Lella Vignelli	PaperClip Café Tables

KnollStudio Finish Code Chart

Compatibility with Knoll Office Systems

Wood Compatibility Matrix

To match KnollStudio wood side chairs with Knoll Office or KnollStudio veneer finishes, please specify the appropriate Special code. Finishes are matched on either maple or beech basewood depending on depth of color.

Please note: this match is complimentary in color only. Perception can be affected by the variation in the grain of the basewood.

Example: **37A-BQV436-K784/74**

37A, Ricchio Side Chair

BQV436, V2 Natural Veneer - Medium Brown Cherry

K784/74, Knoll Velvet/Moss

To match Propeller, Pixel, and LSM with Knoll Office or KnollStudio finishes, please submit a request through CPD. Any of the finishes listed below may be used at no additional upcharge.

KNOLL OFFICE VENEER FINISHES			STUDIO WOOD SIDE CHAIR FINISHES	
	CUT	Standard Finish Code	Special Code - Maple	Special Code - Beech
V1 Engineered Techwoods				
Maple *	FC	Y316	•	•
Cherry *	FC	Y319	•	BQY319
Medium Walnut*	FC	Y323	•	B323
Dark Mahogany*	FC	Y326	•	BQY326
Light Oak*	RC	Y327	QY327	•
Medium Oak*	RC	Y329	•	BQY329
Wenge	QC	Y341	•	BQY341
Medium Teak	QC	Y342	•	BQY342
Dark Grey Oak	RC	Y343	•	BQY343
Espresso	QC	Y344	•	BQY344
Natural**	QC	Y811 (T)	QY811	•
Blond Maple (Maple)**	QC	Y821 (4)	KC	•
Light Cherry (Cherry)**	QC	Y831 (6)	•	BQY831
Medium Brown Mahogany	QC	C6F3 (7)	•	BQE7
Black Oak	RC	Y851	•	BQY851
Medium Red Mahogany	QC	C6F4 (8)	•	BQE8
* = previously Reff Techwoods, ** = previously, Morrison Techgrain. Names and codes in parenthesis () are names prior to 2009.				
V2 Natural Veneers				
Beech	FC	V311	•	B311
Bronzed Cherry	FC	V312	•	B312
Maple (Light Maple)	FC	V316	•	•
Mahogany on Beech	FC	V317	•	BQV317
Medium Cherry	FC	V319	•	BQV319
Medium Cherry on Beech	FC	V321	•	BQV321
Medium Walnut on Beech	FC	V322	•	BQV322
Light Walnut	FC	V411	•	BQV411
Peacock Green Walnut	FC	V415	•	BQV415
Old English Walnut	FC	V417	•	BQV417
Smoked Walnut	FC	V418	•	BQV418
Chalk Oak	RC	V421	QV421	•
Light Oak	RC	V423	QV423	•
Amber Oak	RC	V425	QV425	•
Brown Oak	RC	V427	•	BQV427
Light Fawn Cherry	FC	V433	•	BQV433
Medium Brown Cherry	FC	V436	•	BQV436
Straight Anigre	QC	V439	QV439	•
V3 Natural Exotic Veneers				
Figured Anigre	QC	V512	QV512	•
Graphite Oak	RC	V513	•	BQV513
Makore	QC	V514	•	BQV514
Figured Sycamore	QC	V515	•	•
Sapele	QC	V517	•	BQV517
Propeller Veneer Finishes				
American Cherry	FC	X	•	BQEX
Warm Brown Walnut	FC	J	•	BQEJ
Ebonized Walnut	FC	D	KE	BE

FC= Flat Cut Veneer, exhibits cathedral pattern

RC= Rift Cut Veneer, Straight Grain

QC = Quarter Cut Veneer, Straight Grain

• = Not possible

KnollStudio Natural Materials

Wood, marble, granite, and slate are natural materials that vary. Use material samples and printed sample materials as reference only.

KnollStudio printed and finish samples offer an example of what an “average” natural material may look like, within a range of acceptance carefully delineated by Knoll.

Because of the breadth of variations possible with any natural material, Knoll specialists select these materials with stringent criteria, accepting only the top 3 - 5% of what is available.

Wood*Knoll Natural Veneers*

All natural finishes are selected from the finest hardwoods available around the world. Veneers are flat cut and carefully matched so that cathedral or heart patterns are perfectly balanced. Natural veneers also are cut to allow a generous margin of quarter-grain figuring ensuring invisible splicing.

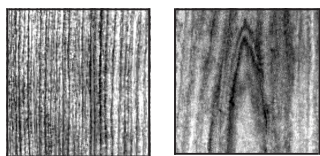

*Quarter
Pattern*

*Cathedral
Pattern*

Knoll Techgrain®

Knoll Techgrain is a veneer product that eliminates the inherent disparities in pattern, color and texture that characterize natural wood veneers. The consistency of Techgrain is important for uniformity. All KnollStudio Techgrains are non-figured and feature a regular, homogenous pattern.

The Techgrain process begins with wood veneers vat-dyed in natural vegetable mineral solines to create a perfectly clear, integrated color throughout. The veneer is finish coated with a clear water-white catalyzed varnish, a polymer finish which helps resist staining and marring. The result is a handsome surface with the appearance of a hand-rubbed oil finish.

Finishes

Most finishes are designed to coordinate with standard Morrison, Reff and Equity. For reference, consult the matrix on page 25.

Laminated Plywood (Cirene)

De Padova laminated plywood shells are made of the world's top 3-5% veneers available. The unique lamination process allows for an extremely thin yet sturdy shell with unmatched flexibility and dimensionality. Shells are natural veneer.

Marble, Granite and Slate

Knoll selects the highest quality, structurally sound marble, granite and slate available, through a host of quarries in Africa, South America, Greece, Turkey, Spain, Slovenia and Italy. Because each mountain range and quarry have their own signature, every marble piece - even within a single quarry - is unique. Hues, veins, crystals, fossils, clouds, and distinctive marks will vary from piece to piece. This is the extraordinary character of stone as a material. Below are the marbles, granites, travertines, and slates that KnollStudio offers:

Coated Marbles*Coated Marbles*

Coated marbles have transparent, high-polish, polyester coating to prevent use-associated stains. Even with this protection, coated marbles should not be used outdoors. Stains should be wiped immediately. Coating will yellow over time.

Satin Coated Marble

Satin coated marbles have transparent satin polyester coating to prevent use-associated stains. This satin finish gives the stone a natural, honed appearance while providing the same protective qualities as the Coated Marbles. Even with this protection, satin coated marbles should not be used outdoors. Stains should be wiped immediately. Coating will yellow over time.

Arabescato

Ivory white with dark grey veining. May contain random green veins.

Calacatta

Ivory white. Gold and beige random veins with additional veins varying from cream to green and grey.

Carrara

White background with grey veining.

Emperador Dark

Dark Brown with light brown and white veining. Natural finished stones will contain open fissures and pin-holes, which is considered a natural desirable trait.

Empire Beige

Yellowish-cream with yellow and rose colored veining and fissures.

Grey Marble

Grey with black and white veins. Hues vary in tone and intensity.

Nero Marquina

Rich black with random veins that can vary from white to gold.

Verde Alpi

Green. Black and white veins. Hues vary in tone and intensity.

Natural Marbles

Natural marbles have a protective sealer to protect the stone from aging and staining. Sealer has to be renewed periodically (see product maintenance on page 28). Natural marbles are not suitable for outdoor use.

Carrara

White background with grey veining.

Calacatta

Ivory white. Gold and beige random veins with additional veins varying from cream to green and grey.

Emperador Dark

Dark Brown with light brown and white veining. Natural finished stones will contain open fissures and pin-holes, which is considered a natural desirable trait.

Natural Granites

Natural granites have a sealer to protect the stone from aging and staining. Sealer has to be renewed periodically (see product maintenance on page 29). Because of its non-porous density, granite does not require protective polyester coatings.

Black Andes Granite

Black with reflective mica crystallines.

Slate

Natural cleft slate is available on Vignelli PaperClip Tables, SM Tables, and Saarinen Tables.

In combination with a weather-resistant base, PaperClip tables with slate tops are suitable for outdoor use. Please refer to respective product pages for recommended outdoor finish combinations.

Cane

A natural material, hand-woven for impeccable finish and smooth surface. Cane on Cesca chair has a light polyurethane coating for stain resistance.

Man-Made Materials & Finishes*Stainless Steel*

Completely rust-proof, highly durable, and resistant to bending stress.

Polished Chrome

Several-step plating process that includes a heavy layer of nickel for added rust protection and a bright mirror finish.

Satin Chrome

Chrome plating applied for a soft satinized chrome finish with a higher nickel content.

Nickel Finish

A warm, lustrous finish of nickel electroplate. Yellowish in color. Coated with clear lacquer to prevent oxidation.

Polished Aluminum

A shiny, polished finish.

Clear Anodized Aluminum

A light grey satin finish.

Fused Nylon Rilsan

A very durable and adhesive fused nylon-dipped finish. Scratch, chip, and chemical resistant. Appropriate for outdoor use.

Laminate/Color Core Laminate

An exceptionally durable plastic surface. Highly resistant to most chemicals and extensive wear.

Cotton Webbing

100% cotton unfinished webbing.

Cotton/Nylon Webbing

60% nylon, 40% cotton mixed yarns with silicone water-based protective coating.

Porcelain

An oven-baked finish on steel support with high durability.

Outdoor Powder Coat:

Durable outdoor powder finish that will provide excellent color and gloss retention with limited exposure to outdoor elements.

Painted, acid etched glass:

Clear glass with an acid etched top and painted underside. Polished and beveled edges surround.

Vetro Bianco:

Vetro Bianco is an engineered resin free quartz surface. The brilliant white surface is nonporous, stain proof, and extremely durable making it suitable for indoor and outdoor use.

With proper care, your KnollStudio furniture should last for years to come. To help ensure the longevity of your purchase, below are helpful hints on routine cleaning for your KnollStudio piece. Most basic maintenance can be performed with common household cleaning products.

Textiles

See KnollTextiles website for detailed cleaning and care instructions. Wipe all spills immediately. Brush and vacuum every three to four months. Use a foam upholstery cleaner as directed semi-annually, or more frequently if necessary. Try a hidden area to test for color fastness.

Spinneybeck Leathers

Leather is hardy and will adjust to its environment. It mellows gracefully with age. Leather is expected to change; even the oils from our hands help to develop the patina.

Full grain, aniline leather is undemanding. It breathes, has a life of its own, and requires little care. It should not be abused by harsh cleaners, or substances such as wax or mink oils which will clog the pores. A periodic wipe with a damp cloth is a sufficient means of cleaning under normal conditions.

Spinneybeck now offers a leather maintenance kit specifically designed for the 28 quantities offered. The kit includes a cleaner, conditioner and ink-remover and can be ordered by calling 1 800 482-7777. There are three types of kits:

- finished products
- full aniline products
- brush-sueded products

The following guidelines will help you to maintain the beauty of the leather without destroying any of its natural characteristics.

Naked Leather (Capri, Cervo, Copenhagen, Cordovan, Distressed, Prima, Saddle)

Naked leathers contain no foreign substances that act as a barrier against spillage or staining. They should be selected with this in mind.

The only recommended cleaning method for naked leather is to wipe the entire surface with a soft woolen cloth and water. Do not spot rub for it will darken only that area. The idea is to even out any abrasions or stains.

With use, naked leather develops a beautiful patina that removes many small scratches and abrasions as body oils moisturize and revitalize the leather. Substantial body oil marks will also dissipate over time, particularly if rubbed down with cool water.

Protective Finished Leathers (Acqua, Alaska, Amazon, Andes, Antique, Arizona, Derby, Ducale, España, Forte, Hand Tipped, Portofino, Riva, Sabrina, Salon, Torello, Velluto Pelle, Vicenza, Volo)

For high traffic use, breathable protective finish allows leather not only to be practical but also easy to maintain. It can be cleaned by wiping the entire surface with a soft cloth and a very mild solution of Ivory Flakes and cold water, followed by wiping the entire surface with water alone.

Grain Sueded Leather (Ducale Velour, Marissa)

For maximum soil resistance and durability these leathers have received an impregnated soil resistant treatment in the drum which permeates the leather making it repellent to liquid and dirt.

Grain sueded leather can be maintained with moderate care because spillage will bead and roll off. However, spillage should not be allowed to puddle, and should be blotted dry immediately. For normal care, leather should be brushed occasionally, with a sueded cleaning block to help remove general soilage.

If you have further questions about the care and maintenance of Spinneybeck leather, call Spinneybeck Customer Service at 800 482-7777.

Cowhide Slings, Belting Leather

For normal cleaning, use a soft cloth dampened with a solution of mild soap or detergent (Ivory Flakes) well dissolved in water. Rub very lightly, never pressing hard. Do not use solvents because dye may run. For scratches, use liquid shoe polish and buff when dry. Any liquids spilled on leather should be mopped up as soon as possible in order to avoid being absorbed by the leather.

Natural Caning

Use water and glycerin every three months to keep cane from drying out.

Vinyl

Clean frequently with a mild detergent and water. Use leather or plastic cleaners for unusually heavy use. Do not use solvents such as gasoline because plastic surface will gum and deteriorate.

Wood

Clean with a commercial brand of liquid furniture polish twice a month. For stubborn dirt or light scratches, rub lightly with very fine steel wool before using furniture polish. To rejuvenate luster, apply a furniture cream as a last step. Do not use water or household solvents: they will destroy the protective finish.

Lacquer Finishes on Wood (Florence Knoll credenza)

Frequent cleaning recommended: once per week with heavy use or once per month with light use. Clean with ordinary household soaps or detergents, well dissolved in water. Polish with lemon oil using a very soft cloth. For stubborn dirt or light scratches, uniformly apply Cleanbright Liquid Ebony or Guardsman liquid furniture polish with cheesecloth. Allow ten minutes to dry and wipe with a clean, dry cloth. For nicks, chips, and deep scratches, contact a professional refinisher. Never use abrasives.

Teak

Do not apply teak oil if you are using your furniture outdoors. For teak furniture used indoors, wipe surface with soft cloth to remove dust. Apply thin layer of teak oil using a paint brush and wipe excess using a soft cloth. Oil can be applied every 3 months to maintain rich color.

Wood Frame Chairs

Clean with dry and soft cloth. Rub smoothly with damp, lukewarm cloth. Treat stubborn stains with household soap solution or a solution with dishwashing liquid. Wipe off with clean, dry cloth. Do not use acid or abrasive detergents.

Marble with Polyester Coating

Wash with lukewarm water. Wash more thoroughly with Windex, Fantastik, Ivory Flakes in warm water, or other non-abrasive solutions. Rinse with warm water and dry with a soft cloth.

Natural Marbles/Marbles without Polyester Coating

Cleaning: Wipe off stains and liquid spills immediately with water and soft cloth. Never use steel wool or other abrasives on marble.

Maintenance: The mineral surface of marble is very porous and easily absorbs moisture and fluids causing staining and discoloring. If applied on a yearly basis, impregnators or penetrating sealers protect the interior of the stone, inhibit discoloration and allow the stone to breathe and release water vapor.

To restore a uniform luster, clean surface from any grit or debris, then remove all topical coatings with Stoneguard Stripper. Use Marblex to rinse surface, then let top dry for twelve hours before applying stone impregnator. Apply SCI Impregnator using a clean and dry applicator brush. After five minutes, wipe off the excess with soft, white terry cloth. If impregnator is absorbed within five minutes apply second coat at least twelve hours later.

Never use steel wool or other abrasives on marble.

Slate

Apply a generous amount of soap solution (1:5) to the table top with a hard brush. Wipe off the top with a clean, damp cloth. Repeat as often as required. Apply mineral oil or lemon oil as needed to protect surface and maintain color.

Granite

Clean with Windex, Fantastik, or other non-abrasive solutions on a regular basis. Apply a marble wax to improve luster and protect finish. Routine maintenance will prevent the stone from darkening with use from body oils, and will help maintain an evenness of color.

Vetro Bianco

Wash surface with lukewarm water. Clean more thoroughly with a non-abrasive solution such as Windex or Fantastik. Rinse with warm water and dry with a soft cloth. Wipe off stains immediately with water and a soft cloth. Never use steel wool or other abrasives on surface.

Glass/Acrylic Polycarbonate

Clean with Windex, Fantastik or other non-abrasive cleaning solutions. Wipe dry with a clean cloth.

Laminate/Melamine

Scrub with Windex, Fantastik, Mr. Clean, or other household soaps or detergents well dissolved in water, or with a very soft cloth dampened with alcohol or a synthetic thinner. For a dull finish, rub with jeweler's rouge as a polishing agent and finish with paste wax. Never use abrasives. Remove stubborn stains with Soft Scrub.

Stainless Steel

Use Windex, Fantastik, or other non-abrasive household cleaners. For small scratches, rub with Comet, Ajax, or other mild abrasives in the direction of the grain. Apply a coat of auto wax to maintain beauty.

Chrome/Satin Chrome

Clean with Windex or an automotive chrome cleaner such as Semi-Chrome twice a month. Apply a coat of hard paste wax to protect against moisture.

Nickel

Clean with Windex, Fantastik, or other non-abrasive cleaning solutions. If discoloration occurs, rub lightly with a fine steel wool to restore luster. Steel wool Grade #0000 is recommended. Touch-up with a clear lacquer to prevent oxidation.

Copper (uncoated)

Polish using a soft cloth and metal polish cream such as BlueMagic®. Do not use harsh abrasive or steel wool.

Polished Aluminum

Clean with Windex, Fantastik, or other non-abrasive cleaning solutions. Coat with a hard paste wax semi-annually to maintain luster and prevent discoloration.

Anodized Aluminum

Clean with mild soaps, detergents, or other non-abrasive cleaning agents. Apply paste wax or DuPont non-abrasive car polish #7 twice a year to prevent oxidation.

For stubborn stains or discolorations, apply navel jelly aluminum cleaner.

Urethane Edge

Clean with household soaps and detergents well dissolved in water. Do not use abrasive cleaning solutions.

Epoxy

Clean with Windex, Fantastik, or other ordinary non-abrasive household soaps, detergents, or ammonia at least once a month to prevent yellowing. For scratches and chips, rub with Comet, Ajax, or other mild abrasives. For deeper scratches, contact Knoll Customer Service for touch-up paint. Shine with a high grade auto polish. Never use harsh abrasives or steel wool.

Rilsan

Clean with Windex, Fantastik, or other ordinary non-abrasive household soaps or detergents. For ink stains on white surfaces, use Soft Scrub. For scratches and chips, rub with Comet, Ajax, or other mild abrasives. For deeper scratches, use a good grade automotive acrylic-lacquer touch-up paint. Shine with a high grade auto polish. Never use harsh abrasives or steel wool.

Porcelain

Clean with damp cloth using water or Windex. Do not use any abrasive detergent.

Powder Coat Paint

Clean with Windex or Endust using a soft cloth. Remove stubborn stains with Soft Scrub.

Polyester Shell

Clean with Windex or soap and water. Do not use any abrasive detergent.

Plastic Seat Shells

Clean with damp cloth with diluted soap. Wipe dry with clean cloth. Do not use any abrasive or acid detergents.

Cotton Webbing

Use damp cloth to clean. Do not use detergent or soap or any abrasive detergent.

Cotton/Nylon Webbing

Use damp cloth to wipe off stains.

Moving Parts

Lubricate moving parts every six months.

Swivel Mechanism

Apply a paste-type grease to swivel mechanism once a year.

Plastic/Polyethelene

Clean using a soft rag, either dry or wet. When needed, use mild pH-balanced soap diluted in water. Do not use abrasives sponges, acidic products or solvents containing ammonia.

To remove scuff marks, lightly rub scuff mark with a dry, non-scratch scour pad, like Scotch-Brite.

An assortment of our most popular products are available to ship in twenty working days:

Scope:

The KnollStudio 20-Day program offers a selection of products, finishes and upholstery materials for KnollStudio products only. 20-Day products and finishes are denoted by a helicopter () on the relevant page of the price list. See page 31 for a list of products and finishes, and maximum order quantities that are available within the 20-Day program.

Knoll will upholster 20-Day pieces in any approved KnollTextile or Spinneybeck leather that is in stock in sufficient quantity at time of order entry if not denoted otherwise. To check availability, call 1-800-523-0346 for KnollTextiles and 1-800-482-7777 for Spinneybeck leathers or contact your KnollStudio sales representative.

The upholstery scope listed below represents KnollTextiles and Spinneybeck leathers that are guaranteed to be in stock to support upholstered pieces on the 20-Day program unless noted otherwise in the upholstery column on page 31.

Availability:

20-Day orders can be fulfilled pending availability. Before specifying a 20-Day order, please check the lead time sheet on Knoll Exchange or contact your KnollStudio sales or customer resources representative to ensure availability.

Maximum order quantities are listed on page 31. Please check with your customer resources representative for availability of larger quantities.

For specific terms and conditions, consult the Knoll Selling Policy on pages 418-419.

Specification Guidelines:

20-Day orders should contain the following:

- Orders should be specified separately from standard lead time orders. Separate delivery charges may apply.
- A special prefix is required for 20-Day items. Please make sure all 20-Day items are marked with a “KS” prefix, as outlined on page 31.
- Full payment is required, including applicable tax and delivery fees.
- No changes or cancellations are allowed.
- 20-Day products are only available in the continental United States and Canada.

 KnollStudio 20-Day Program Upholstery Scope

Knoll will upholster 20-day pieces in any approved KnollTextile or Spinneybeck leather that is in stock at the time of order entry. To check availability, call 1-800-523-0346 for KnollTextiles or 1-800-482-7777 for Spinneybeck leathers, or contact your KnollStudio customer resources representative. The textile and leather selection listed below are reserved for the 20-day quickship program and are most likely to be instock at time of order entry.

KnollTextiles

Spinneybeck Leather

Grade A:	Grade B:	Grade C:	Grade G:	Grade U:
<p><i>Common Ground K448</i> 15 colorways, Teflon soil and stain repellent, 100% nylon content</p> <p><i>Mariner K642</i> 8 colorways, 100% nylon content</p>	<p><i>Vinyl K242</i> 10 colorways, outdoor approved, 100% vinyl face, backing 6% polyester, 91% vinyl, 3% cotton content</p>	<p><i>Classic Boucle K162</i> 13 colorways, 48% nylon, 52% wool content</p>	<p><i>Ultrasuede K1021</i> 21 colorways, high performance, stain resistant, 100% Polyester Ultra Microfiber content</p>	<p><i>Volo</i> Black (BLK) Toast(903)</p>

<i>Product</i>	<i>Code</i>	<i>Finish</i>	<i>Upholstery</i>	<i>Max. qty. per order</i>	<i>Page</i>
Side Chairs, Barstools and Lounge Seating					
Bertoia side chair	420C-C	Chrome	unupholstered	10	52
Bertoia side chair	420C-C-K	Chrome	In stock upholstery	10	52
Bertoia counter height stool	427C-C	Chrome	unupholstered	5	58
Bertoia counter height stool	427C-C-K	Chrome	In stock upholstery	5	58
Bertoia bar height stool	428C-C	Chrome	unupholstered	5	56
Bertoia bar height stool	428C-C-K	Chrome	In stock upholstery	5	56
Bertoia Diamond chair	421L-C-K	Chrome	In stock upholstery	5	60
Bertoia Seat cushions	420K, 427K, 428K		In stock upholstery	5	52
Wassily chair	50L-BLBLCK 50L-BL1905	Black or Red Spinneybeck Belting Leather		2	98
Spark side chair	4-C-SD-N	Red, Blue, Citron, Light Grey, Dark Grey, Recycled Black	unupholstered	25	100
Spark lounge chair	4-C-LG-N	Red, Blue, Citron, Light Grey, Dark Grey, Recycled Black	unupholstered	25	100
Jamaica bar height stool	30C-A	Aluminum top		10	104
Jamaica counter height stool	30C2-A	Aluminum top		10	104
Chip armless chair	23C	Chrome Base, White, Birch, Grey		10	152
Sprite armless chair	27C	Chrome base, Black, White, Maple, solid front and back only		10	170
Gigi armless chair	87C	White, Graphite, Black, Red, Navy		25	176
Gigi arm chair	87A	White, Graphite, Black, Red, Navy		10	176
Gigi barstool, counter height	87CM	White, Graphite, Black, Red, Navy		10	188
Gigi barstool, bar height	87CH	White, Graphite, Black, Red, Navy		10	188
Barcelona chair	250LC	Chrome	Volo Black (VO BLK)	2	200
Barcelona ottoman	251YC	Chrome	Volo Black (VO BLK)	2	200
Toledo chair	29C			10	212
Spoletto chair	50CS-BLBLCK	Black belting leather		2	290
Womb chair	70L-C	Chrome Base	Classic Boucle/Pearl Classic Boucle/Cayenne	2	258
Womb ottoman	74Y-C	Chrome Base	Classic Boucle/Pearl Classic Boucle/Cayenne	2	258
Tables					
Albini desk	80D-E	Ebonized		1	300
Laccio side table	50T1	Black, white		2	304
Laccio coffee table	50T2	Black, white		2	304
D'Urso square work table	6348	In stock laminate, black legs, glides		10	306
D'Urso round work table	6242	In stock laminate, black legs, glides		10	308
D'Urso racetrack work table	6472	In stock laminate, black legs, glides		10	312
Florence Knoll tables	2510T-C-G2 2511T-C-G2	Chrome base, glass top		2	332
Pensi café table	29TS-35-DE 29TR27-DE 29TR-39-DE	Disks		3	356
Arena round café table	23TR36-C-W	Chrome base, white top		3	360
Barcelona table	252C	Chrome base, clear glass top		1	342
MR table	259TS-G			2	342
Cyclone dining table	311-F2	White top		1	354
Platner side and coffee tables	3710T-N-G2	Nickel base, clear glass top		2	362
	3710T-BRM-G2	Bronze base, clear glass top		2	362
	3712T-BRM-G2				
	3714-BRM-G2				
	3710T-BRM-BRG	Bronze base, bronze glass top		2	362
	3712T-BRM-BRG				
	3714T-BRM-BRG				

<i>Product</i>	<i>Code</i>	<i>Finish</i>	<i>Upholstery</i>	<i>Max. qty. per order</i>	<i>Page</i>
Tables, continued					
Saarinen dining tables	173TR-F2-2 176TR-F2-2 164TR-F2-2	Laminate top, white base		2	370
Saarinen side and coffee tables	169TR-LO-2 169TR-F2-2 163TR-F2-2	Light oak top, white base White laminate top, white base White laminate top, white base		1	378

Please see pages 30 and 33 for more information on placing a KnollStudio 20-Day order.

Use the Following Address:

If you would like to send an order directly to our order entry departments, please use the following address:

Knoll, Inc.
P.O. Box 157
East Greenville, PA 18041
Attn: Order Entry

Fax: 215 679-1570
Tel: 800 343-KNOLL

When Placing Your Order, Include:

- All information requested on the order form.
- Local taxes for the “delivered to” address.
- For orders \$2,000 or under (including applicable taxes and delivery/installation fees, if any), full payment must be made when order is placed.
- For orders over \$2,000, a deposit equal to one-half of the complete order value is required at order placement. Balance must be settled before shipment.
- For 20-day orders, please adhere to the specification guidelines on page 30.

Key Points to Remember:

All accepted orders will be confirmed in writing on the Knoll standard acknowledgement form. A copy of the acknowledgement will be mailed to the customer prior to production.

Freight within the 48 contiguous United States and Canada, excluding the Yukon, Northwest Territories and Newfoundland, is prepaid and included in the price of all orders.

For residential orders, Knoll strongly recommends White Glove delivery service to most locations in the Continental United States and Canada. White Glove service includes inside delivery, unpacking, furniture installation and removing cartons and crates. The fee for this service will be quoted at the point of purchase.

KnollStudio’s limited warranty covers all furniture against manufacturing defects in this price list for a period of five years after delivery to the customer.



All pricing is in U.S. dollars.

For More Information:

For complete Knoll Selling Policy and warranty information, please refer to pages 418-419 in the back of this price list.

For additional information on KnollStudio, contact your KnollStudio representative, a Knoll Space retailer or e-tailer, or telephone Customer Services at 800 343-KNOLL. To find the retailer or showroom nearest you, visit www.knoll.com.

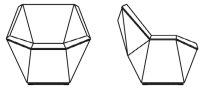
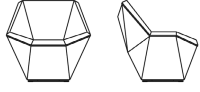
David Adjaye
The Washington Collection for Knoll™
Prism™ Lounge Chair and Ottoman

	description	w	d	h	height, seat	textile fabric yards
<p><i>Designer(s):</i> David Adjaye, 2014</p> <p><i>Award(s):</i> Editors Choice Award, Lounge Furniture Collection, NeoCon June 2015, USA; Metropolis Likes Award, Metropolis Magazine, June 2015, USA</p> 	<p>WL21F Lounge Chair, fixed base</p> 	33 1/4"	31 1/2"	31 1/2"	16 1/4"	2
	<p>WL21S Lounge Chair, swivel base</p> 	33 1/4"	31 1/2"	31 1/2"	16 1/4"	2
	<p>WL23 Ottoman</p> 	26 3/4"	17"	16 3/4"	15 1/2"	1







pattern no.	A	B	C	D	E	F	G	H	I
WL21F-(-)	\$14,518.	\$14,562.	\$14,612.	\$14,670.	\$14,752.	\$14,799.	\$14,882.	\$14,937.	\$15,102.
WL21S-(-)	14,958.	15,002.	15,051.	15,110.	15,191.	15,239.	15,322.	15,377.	15,542.
WL23-(-)	7,506.	7,527.	7,552.	7,582.	7,622.	7,646.	7,687.	7,715.	7,797.

Order Code	Ordering Information	Construction
<p><i>Example:</i> WL21S-111G-K1882/9</p> <p>WL21S Lounge, swivel</p> <p>111G Black base</p> <p>K1882/9 Melange/Onyx</p>	<p><i>Base finishes:</i> Black (suffix 111G) White (suffix 118G) Red (suffix 845G)</p> <p><i>Maintenance:</i> See pages 28-29.</p>	<p><i>Base:</i> Constructed of 3/4" Baltic Birch plywood panels covered in a plastic color core laminate which maintains color throughout so vibrancy is maintained from edge to edge. Panels are assembled together using poplar wood corner blocks.</p> <p><i>Upholstery:</i> Textile upholstered over individual panels of urethane molded foam. All upholstery will feature a black leather welt along the edges where the base and upholstery meet.</p> <p><i>Note:</i> Swivel base returns to center.</p>

- Specify:*
1. Pattern number
 2. Base finish selection
 3. Textile selection

Approved KnollTextiles Grades/Fabrics		
<p>A Hourglass Sonnet</p>	<p>C Circa Classic Boucle</p>	<p>G Haze Melange Ultrasuede</p>
<p>B Cameo Chroma Journey Keaton Knoll Felt Knoll Hopsack Ransom Ricochet Synth</p>	<p>F Atelier Calais Cotton Velvet Cornaro Rivington</p>	<p>H Arno Magritte Rosemond</p>
<p><i>Check with your KnollTextiles Representatives for changes or additions.</i></p>		

David Adjaye
The Washington Collection for Knoll™
Skin™ and Skeleton™ Chair

	description	seat h	w	d	h	weight
<i>Designer(s):</i> David Adjaye, 2013 <i>Award(s):</i> 2014 Design Guild Mark Best of NeoCon Gold Award 2014	WS2CN Washington Skin™ nylon chair 	17 1/2"	18"	20 1/4"	32 1/2"	13 lbs.
	WS1CA Washington Skeleton™ painted aluminum chair 	17 1/2"	18"	20 1/4"	32 1/2"	20 lbs.
	WS1CA Washington Skeleton™ nickel plated aluminum chair 	17 1/2"	18"	20 1/4"	32 1/2"	20 lbs.
	WS1CA Washington Skeleton™ copper plated aluminum chair, natural 	17 1/2"	18"	20 1/4"	32 1/2"	20 lbs.
	WS1CA Washington Skeleton™ copper plated aluminum chair with ceramic coating 	17 1/2"	18"	20 1/4"	32 1/2"	20 lbs.

pattern no.	
WS2CN-()	\$656.
WS1CA-()	1,070.
WS1CA-NO	2,163.
WS1CA-NCU	2,163.
WS1CA-CC	2,587.

Order Code	Ordering Information	Construction
<i>Example:</i> WS1CA-001 WS1CA Aluminum chair 001 Black paint finish	<i>Nylon finishes:</i> Black (suffix 011) White (suffix 012) Grey (suffix 013) Red (suffix 014) Orange (suffix 015) Yellow (suffix 016) Lime (suffix 017) <i>Aluminum paint finishes:</i> Black (suffix 001) Grey (suffix 003) Green (suffix 007) White (suffix WHT) Sterling (suffix 906T) <i>Aluminum, plated finish:</i> Copper, natural (suffix NCU) Copper, coated (suffix CC) Brushed Nickel (suffix NO) <i>Outdoor Use:</i> With proper maintenance painted aluminum chairs are appropriate for outdoor environments. <i>Maintenance:</i> See pages 28-29.	<i>Nylon Chair:</i> Injection molded, glass reinforced nylon cantilevered chair. The chair's shell and legs are cast in three parts and are connected using mortise and tenon joinery and stainless steel fasteners. The unique leg design is reinforced internally with a cast aluminum brace. Features four integral glides that elevate and protect the leg profile. <i>Aluminum Chair:</i> Constructed from die-cast aluminum, the chair's shell and legs are cast in three parts and connected using mortise and tenon joinery and stainless steel fasteners. Available in ultra-durable powder coat paint, a nickel plated finish, a natural copper plated finish that will patina with age and a copper plated finish with ceramic coating that will maintain the original copper finish and prevent patina. Features four nylon glides. <i>Outdoor Use:</i> With proper care, the Washington Skeleton Chair in powder coat paint finishes is appropriate for outdoor environments.
<i>Specify:</i> 1. Pattern number 2. Paint finish selection	<i>Note:</i> Copper plated chairs without the ceramic coating will patina with age. The Washington Skin and Washington Skeleton chairs are Greenguard certified.	







Edward Barber & Jay Osgerby

Sofa Collection

Lounge Seating

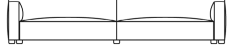
Designer(s):
Edward Barber and Jay Osgerby,
2013

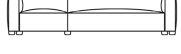

description	seat h	arm h	w	d	h	textile fabric yds.	req. leather sq. ft.
BO2 Two Seat Sofa 	15 3/4"	25"	73 3/4"	40 1/4"	28 3/4"	10.7	220
BO3 Three Seat Sofa 	15 3/4"	25"	85"	40 1/4"	28 3/4"	13	240
BO4 Four Seat Sofa 	15 3/4"	25"	132 1/4"	40 1/4"	28 3/4"	14.9	330
BO5L Asymmetric Sofa, left 	15 3/4"	25"	102 3/4"	40 1/4"	28 3/4"	12.3	270
BO5R Asymmetric Sofa, right 	15 3/4"	25"	102 3/4"	40 1/4"	28 3/4"	12.3	270
BO15L Asymmetric Sofa with Left Chaise 	15 3/4"	25"	102 3/4"	66"	28 3/4"	13.9	310
BO15R Asymmetric Sofa with Right Chaise 	15 3/4"	25"	102 3/4"	66"	28 3/4"	13.9	310

Order Code	Ordering Information	Construction
<i>Example:</i> BO3-C-H800/19	<i>Base/Leg Finish:</i> Chrome (suffix C) Jet Black (suffix 111) Medium Metallic Grey (suffix 612) Red Coral (suffix CRL)	<i>Frame:</i> Hardwood and plywood construction with elastomeric suspension sheet webbing and foam supported sit-through feature at the cushion breaks.
BO3 Barber & Osgerby Three Seat sofa		<i>Stitching:</i> Pinched topstitched seaming.
C Polished chrome		<i>Legs:</i> Die cast aluminum legs with height adjustable glides.
H800/19 Cato, Fire Red	<i>Upholstery/COM information:</i> Prices shown include fabric or leather upholstery. Contact your Knoll representative for colors. Only approved KnollTextiles and Spinneybeck leathers may be ordered.	<i>Note:</i> Four Seat and Asymmetric Sofas come in two sections and are joined by a pin and socket locking mechanism in the joining leg.
<i>Specify:</i> 1. Pattern number 2. Base finish selection 3. Textile/leather selection	Customer's Own Material is available pending approval. For approval requirements, processing instructions and ordering information please see page 18. <i>Maintenance:</i> See pages 28-29.	Asymmetric Sofa with Chaise: The fabric on the sofa will always run perpendicular to the fabric on the chaise as both pieces must railroaded. Therefore, only textiles with a solid color and a non-specific directional weave may be used. Approved fabrics are noted with an asterisk (*).

pattern no.	grades A	COM B	C	D	E	F	G	H	I	COL U	V	W	X	Y
BO2-(-)(-)	\$7,941.	\$8,184.	\$8,457.	\$8,781.	\$9,229.	\$9,490.	\$9,947.	\$10,251.	\$11,159.	\$14,890.	\$15,865.	\$17,849.	\$18,262.	\$18,743.
BO3-(-)(-)	9,135.	9,432.	9,762.	10,156.	10,701.	11,018.	11,572.	11,942.	13,045.	16,666.	17,730.	19,895.	20,346.	20,871.
BO4-(-)(-)	11,983.	12,322.	12,702.	13,152.	13,777.	14,141.	14,776.	15,200.	16,465.	22,395.	23,859.	26,835.	27,454.	28,176.
BO5L-(-)(-)	10,366.	10,646.	10,959.	11,331.	11,847.	12,148.	12,672.	13,021.	14,066.	18,990.	20,188.	22,623.	23,130.	23,720.
BO5R-(-)(-)	10,366.	10,646.	10,959.	11,331.	11,847.	12,148.	12,672.	13,021.	14,066.	18,990.	20,188.	22,623.	23,130.	23,720.
BO15L-(-)(-)	12,174.	12,491.	12,845.	13,265.	13,848.	14,187.	14,781.	15,175.	16,354.	20,582.	21,958.	24,753.	25,335.	26,013.
BO15R-(-)(-)	12,174.	12,491.	12,845.	13,265.	13,848.	14,187.	14,781.	15,175.	16,354.	20,582.	21,958.	24,753.	25,335.	26,013.





Approved KnollTextiles Grades/Fabrics	Spinneybeck Leather
A Crossroad Delite Hourglass * Mariner * Presto * Sonnet Uni-Form *	U Vicenza * Volo *
B Cameo Diva Helios Keaton Knoll Felt * Knoll Hopsack * Little Devil Melody Ricochet Spark Summit Tinge Westwood *	V Acqua * Andes * Embossed Tipped * Espana *
C Circa Classic Boucle * Lagos Palisade Pullman Spot On Star Struck Swing	W Antique * Alaska * Forte * Lucente * Sabrina *
D Compass CR Tara	X Riva *
E Aegean * Highland *	Y Velluto Pelle *
F Atelier Cornaro *	
G Alter Ego Feeling Plaid Haze Kingston * Melange * Modern Tweed Petite Floral Sablon Ultrasuede *	
H Arno * Magritte *	
I Cato	

*Approved for the Asymmetric Sofa with Chaise (BO15R, BO15L)
Check with your KnollTextiles or Spinneybeck Representative for changes or additions.

Edward Barber & Jay Osgerby

Sofa Collection

Lounge Seating

	description	seat h	arm h	w	d	h	textile fabric yds.	req. leather sq. ft.
<i>Designer(s):</i> Edward Barber and Jay Osgerby, 2013	BO6 Ottoman, small 			29 1/2"	29 1/2"	15 1/4"	2.1	45
	BO7 Ottoman, medium 			35 1/2"	35 1/2"	15 1/4"	2.5	60
								

pattern no.	grades A	COM B	C	D	E	F	G	H	I	COL U	V	W	X	Y
BO6-(-)(-)	\$2,694.	\$2,743.	\$2,795.	\$2,859.	\$2,947.	\$2,999.	\$3,088.	\$3,148.	\$3,326.	\$4,164.	\$4,363.	\$4,769.	\$4,853.	\$4,952.
BO7-(-)(-)	3,009.	3,066.	3,130.	3,205.	3,310.	3,371.	3,477.	3,548.	3,761.	4,981.	5,180.	5,586.	5,670.	5,769.

Order Code	Ordering Information	Construction
<i>Example:</i> BO3-C-H800/19	<i>Base/Leg Finish:</i> Chrome (suffix C) Jet Black (suffix 111) Medium Metallic Grey (suffix 612) Red Coral (suffix CRL)	<i>Frame:</i> Hardwood and plywood construction with elastomeric suspension sheet webbing and foam supported sit-through feature at the cushion breaks.
BO3 Barber & Osgerby Three Seat sofa		<i>Stitching:</i> Pinched topstitched seaming.
C Polished chrome		<i>Legs:</i> Die cast aluminum legs with height adjustable glides.
H800/19 Cato, Fire Red	<i>Upholstery/COM information:</i> Prices shown include fabric or leather upholstery. Contact your Knoll representative for colors. Only approved KnollTextiles and Spinneybeck leathers may be ordered.	<i>Upholstery:</i> High density foam construction throughout with gel infused high density memory foam on top seating surface. All textiles must be railroaded - including COMs.
<i>Specify:</i> 1. Pattern number 2. Base finish selection 3. Textile/leather selection	Customer's Own Material is available pending approval. For approval requirements, processing instructions and ordering information please see page 18. <i>Maintenance:</i> See pages 28-29.	<i>Note:</i> Four Seat and Asymmetric Sofas come in two sections and are joined by a pin and socket locking mechanism in the joining leg. All textiles must be railroaded - including COMs



Approved KnollTextiles Grades/Fabrics				Spinneybeck Leather	
A Crossroad Delite Hourglass * Mariner * Presto * Sonnet Uni-Form *	C Circa Classic Boucle * Lagos Palisade Pullman Spot On Star Struck Swing	D Compass CR Tara	E Aegean * Highland *	F Atelier Cornaro * Tivoli	G Alter Ego Feeling Plaid Haze Kingston * Melange * Modern Tweed Petite Floral Sablon Ultrasuede *
B Cameo Diva Helios Keaton Knoll Felt * Knoll Hopsack * Little Devil Melody Ricochet Spark Summit Tinge Westwood *			H Arno * Magritte *	I Cato	V Vicenza * Volo * V Acqua * Andes * Embossed Tipped * Espana * Velluto Pelle *
					W Antique * Alaska * Forte * Lucente * Sabrina *
					Y Riva *

* Approved for the Asymmetric Sofa with Chaise (BO15R, BO15L)
Check with your KnollTextiles or Spinneybeck Representative for changes or additions.

Edward Barber & Jay Osgerby

Sofa Collection

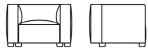
Compact Lounge Seating



	description	seat h	arm h	w	d	h	textile fabric yds.	req. leather sq. ft.	weight
<i>Designer(s):</i> Edward Barber and Jay Osgerby, 2013 	BOC1 Armchair	15 3/4"	25"	39 1/2"	33 3/4"	25"	5.9	125	
									
	BOC2 Two Seat sofa	15 3/4"	25"	64 1/2"	33 3/4"	25"	8.7	175	
									

pattern no.	grades A	COM B	C	D	E	F	G	H	I	COL U	V	W	X	Y
BOC1-(-)(-)	\$4,905.	\$5,040.	\$5,190.	\$5,368.	\$5,616.	\$5,760.	\$6,011.	\$6,179.	\$6,680.	\$8,991.	\$9,546.	\$10,673.	\$10,908.	\$11,181.
BOC2-(-)(-)	6,904.	7,103.	7,324.	7,588.	7,952.	8,165.	8,536.	8,782.	9,520.	12,726.	13,501.	15,079.	15,409.	15,791.

Order Code	Ordering Information	Construction
<i>Example:</i> BOC2-SGE-K1320/3		
BOC2 Barber & Osgerby Two Seat sofa	Base/Leg Finish: Chrome (suffix C) Jet Black (suffix 111) Medium Metallic Grey (suffix 612) Red Coral (suffix CRL)	Frame: Hardwood and plywood construction with elastomeric suspension sheet webbing and foam supported sit-through feature at the cushion breaks.
SGE Sage		Upholstery: High density foam construction throughout with gel infused high density memory foam on top seating surface.
K1320/3 Cornaro, Mist	Upholstery/COM information: Prices shown include fabric or leather upholstery. Contact your Knoll representative for colors. Only approved KnollTextiles and Spinneybeck leathers may be ordered.	Stitching: Pinched topstitched seaming.
Specify: 1. Pattern number 2. Base finish selection 3. Textile/leather selection	Customer's Own Material is available pending approval. For approval requirements, processing instructions and ordering information please see page 18.	Legs: Die cast aluminum legs with height adjustable glides.
	Maintenance: See pages 28-29.	

Approved KnollTextiles Grades/Fabrics				Spinneybeck Leather
A Crossroad Delite Hourglass Mariner Presto Sonnet Uni-Form	C Circa Classic Boucle Lagos Palisade Pullman Spot On Star Struck Swing	D Compass CR Tara	E Aegean Highland	F Atelier Cornaro Tivoli
B Cameo Diva Helios Keaton Knoll Felt Knoll Hopsack Little Devil Melody Ricochet Spark Summit Tinge Westwood			G Alter Ego Feeling Plaid Haze Kingston Melange Modern Tweed Petite Floral Sablon Ultrasuede	H Arno Magritte
			I Cato	
				U Vicenza * Volo *
				V Acqua * Andes * Embossed Tipped * Espana * Velluto Pelle *
				W Antique * Alaska * Forte * Lucente * Sabrina *
				Y Riva *
				Check with your KnollTextiles or Spinneybeck Representative for changes or additions.

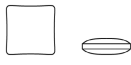
Edward Barber & Jay Osgerby
Sofa Collection
Pillows

	description	w	d	textile fabric yds.	req. leather sq. ft.
<i>Designer(s):</i> Edward Barber and Jay Osgerby, 2013 	BO8P Pillow, small	19"	19"	1.9	25
					
	BO9P Pillow, large	23 1/2"	23 1/2"	2.6	30
					

pattern no.	A	B	C	D	E	F	G	H	I	U	V	W	X	Y
BO8P-()	\$535.	\$578.	\$627.	\$684.	\$764.	\$811.	\$891.	\$946.	\$1,106.	\$1,246.	\$1,358.	\$1,583.	\$1,630.	\$1,685.
BO9P-()	715.	775.	840.	920.	1,028.	1,092.	1,203.	1,276.	1,497.	1,544.	1,676.	1,947.	2,003.	2,069.







Order Code	Ordering Information	Construction
<i>Example:</i> BO8P-K1054/9	<i>Upholstery/COM information:</i> Prices shown include fabric upholstery only. Contact your Knoll representative for colors. Only approved KnollTextiles may be ordered. Customer's Own Material is not approved.	<i>Fill:</i> Made from 90% feather and 10% down. <i>Ticking:</i> 100% cotton.
BO8P Small pillow		
K1054/9 Circa/Red		
<i>Specify:</i> 1. Pattern number 2. Textile selection		

Approved KnollTextiles Grades/Fabrics			
A Crossroad Delite Hourglass Mariner Presto Sonnet Uni-Form	C Circa Classic Boucle Lagos Pullman Spot On Star Struck Swing	D Compass CR Tara Woodland E Highland Kampala Meroe	G Alter Ego Feeling Plaid Haze Kingston Melange Modern Tweed Striae Stripe Ultrasuede
B Cameo Diva Helios Keaton Knoll Felt Knoll Hopsack Little Devil Melody Ricochet Spark Tinge Westwood Zipline	F Atelier Cornaro In Stitches Liberty	H Arno Magritte Stretch Appeal	I Cato Digi Velvet Ita

Edward Barber & Jay Osgerby

Pilot by Knoll™ Lounge Collection

High Back

	description	seat h	arm h	w	d	h	Base Finish	textile fabric yds.	req. leather sq. ft.	weight
<i>Designer(s):</i> Edward Barber and Jay Osgerby, 2014	BO30-AL Pilot by Knoll High Back Lounge Chair, Loop arm 	16"	20"	27 1/4"	30 3/8"	39 3/8"	Dark Grey, painted	6	61	59 lbs.
		16"	20"	27 1/4"	30 3/8"	39 3/8"	Polished aluminum	6	61	59 lbs.
	BO30-AU Pilot by Knoll High Back Lounge Chair, Upholstered arm 	16"	21 1/2"	27 1/4"	30 3/8"	39 3/8"	Dark Grey, painted	6	61	59 lbs.
		16"	21 1/2"	27 1/4"	30 3/8"	39 3/8"	Polished aluminum	6	61	59 lbs.
	BO30-C Pilot by Knoll High Back Lounge Chair, Armless 	16"		23 3/8"	30 3/8"	39 3/8"	Dark Grey, painted	6	61	57 lbs.
		16"		23 3/8"	30 3/8"	39 3/8"	Polished aluminum	6	61	57 lbs.
										

pattern no.	grades A	COM B	C	D	E	F	G	H	I	COL U	V	W	X	Y
BO30-AL-3- ()	\$4,769.	\$4,872.	\$5,019.	\$5,137.	\$5,308.	\$5,458.	\$5,627.	\$5,757.	\$6,342.	\$7,120.	\$7,466.	\$8,203.	\$8,452.	\$8,887.
BO30-AL-P- ()	5,046.	5,149.	5,296.	5,414.	5,585.	5,735.	5,904.	6,034.	6,619.	7,397.	7,743.	8,480.	8,729.	9,164.
BO30-AU-3- ()	5,180.	5,283.	5,430.	5,548.	5,719.	5,869.	6,038.	6,168.	6,753.	7,643.	7,988.	8,726.	8,974.	9,410.
BO30-AU-P- ()	5,335.	5,438.	5,585.	5,703.	5,874.	6,024.	6,193.	6,323.	6,908.	7,798.	8,143.	8,881.	9,129.	9,565.
BO30-C-3- ()	4,144.	4,247.	4,394.	4,512.	4,683.	4,833.	5,002.	5,132.	5,717.	6,424.	6,770.	7,507.	7,756.	8,191.
BO30-C-P- ()	4,299.	4,402.	4,549.	4,667.	4,838.	4,988.	5,157.	5,287.	5,872.	6,579.	6,925.	7,662.	7,911.	8,346.

Order Code	Ordering Information
<i>Example:</i> BO30-AL-3-K1523/25	<i>Base finishes:</i> Polished Aluminum (suffix P) Dark Grey paint (suffix 3)
BO30	Pilot by Knoll High Back Lounge Chair
AL	Loop arms
3	Dark Grey, painted (base and arms)
K1523/25	Hourglass/Iron
<i>Specify:</i>	<i>Loop Arm finishes:</i> Loop with chrome brackets Black painted loop with dark grey painted brackets
1. Pattern number	<i>Loop Arm specification:</i> The selected base finish will automatically designate coordinating arm finish: Polished Aluminum base / Chrome loop arms Dark Grey painted base / Black loop arms with Dark Grey brackets
2. Arm option	
3. Base finish selection (loop arm finish will match base finish)	
4. Split upholstery (optional)	<i>Two or three split upholstery option:</i> Seat, back and upholstered arms can be specified in different fabrics or leathers. <u>Fabric and leather cannot be mixed.</u> Indicate S followed by the textile or leather for seat, back and arms (if applicable). For any split upholstery, price equals the higher seat or back upholstery grade plus \$150 upcharge. <u>Specification example:</u> Pattern number: BO30-AU-P-S-K-1882/8-K2063/3-K1579/5 High Back Lounge Chair, upholstered arms, polished aluminum base, split upholstery Seat textile: Melange/Flannel (Grade G) Back textile: Tivoli/Dove (Grade F) Arms textile: Tudor/Glacier (grade I) Price = Grade G + \$150 upcharge
5. Textile selection	<i>Upholstery/COM information:</i> Prices shown include fabric or leather upholstery. Contact your Knoll representative for colors. Only approved KnollTextiles and Spinneybeck leathers may be ordered. Customer's Own Material is available pending approval. For approval requirements, processing instructions and ordering information please see page 18. <i>Maintenance:</i> See pages 28-29.
	<i>COM split fabric requirements:</i> Seat: 2.4 yards Back: 2.4 yards Arms: 1.2 yards
	<i>COL split leather requirements:</i> Seat: 19 square feet Back: 28 square feet Arms: 14 square feet

Construction	Approved KnollTextiles Grades/Fabrics	Spinneybeck Leather
<i>Base:</i> Four star, cantilevered, 360° swivel, die cast aluminum base, available polished or painted in a highly durable powder coat.	A Common Ground Delite Dristi Hourglass Mariner Presto Sonnet	U Vicenza Volo V Acqua Andes España Velluto Pelle
<i>Upholstery:</i> Highly resilient polyurethane molded foam, overlaid with knit backed polyester fiber. Top stitched, open parallel double side seaming.	B cont. Ransom Ricochet Summit Tinge Utmost Venue Vinyl Westwood	W Alaska Antique Forte Sabrina Y Copenhagen Marissa Riva Saddle
<i>Substructure:</i> Comprised of steel, die cast aluminum and elastic webbing embedded inside polyurethane molded foam.	C Atlas Biota Circa Classic Boucle Dune Lagos Noble Palisade Regard Sahara Sequin CR Spot On Star Struck Swing	H Arno I Tudor
<i>Arms:</i> <u>Loop Arms:</u> steel rod loop arms and die cast aluminum arm brackets. <u>Upholstered Arms:</u> steel weldment substructure embedded inside highly resilient polyurethane molded foam, overlaid with knit backed polyester fiber.	E Demure Highland Whip F Atelier Cornaro Rivington Tweed Frieze Tivoli	<i>Check with your KnollTextiles or Spinneybeck Representative for changes or additions.</i>

Edward Barber & Jay Osgerby

Pilot by Knoll™ Lounge Collection

Low Back

Designer(s):
Edward Barber and Jay Osgerby,
2014



description	seat h	arm h	w	d	h	Base Finish	textile fabric yds.	req. leather sq. ft.	weight
BO31-AL Pilot by Knoll Low Back Lounge Chair, Loop arm	16"	20"	27 1/4"	27 1/2"	31 7/8"	Dark Grey, painted	5.5	57	57 lbs.
	16"	20"	27 1/4"	27 1/2"	31 7/8"	Polished aluminum	5.5	57	57 lbs.



BO31-AU Pilot by Knoll Low Back Lounge Chair, Upholstered arm	16"	21 1/2"	27 1/4"	27 1/2"	31 7/8"	Dark Grey, painted	5.5	57	57 lbs.
	16"	21 1/2"	27 1/4"	27 1/2"	31 7/8"	Polished aluminum	5.5	57	57 lbs.



BO31-C Pilot by Knoll Low Back Lounge Chair, Armless	16"		23 3/8"	27 1/2"	31 7/8"	Dark Grey, painted	5.5	55	55lbs.
	16"		23 3/8"	27 1/2"	31 7/8"	Polished aluminum	5.5	55	55lbs.

Order Code

<i>Example:</i>	BO31-AL-3-K1523/25
BO31	Pilot by Knoll Low Back Lounge Chair
AL	Loop arms
3	Dark Grey, painted (base and arms)
K1523/25	Hourglass/Iron

Specify:

1. Pattern number
2. Arm option
3. Base finish selection (loop arm finish will match base finish)
4. Split upholstery (optional)
5. Textile selection

Ordering Information

Base finishes:
Polished Aluminum (suffix P)
Dark Grey paint (suffix 3)

Loop Arm finishes:
Loop with chrome brackets
Black painted loop with dark grey painted brackets

Loop Arm specification:
The selected base finish will automatically designate coordinating arm finish:
Polished Aluminum base / Chrome loop arms
Dark Grey painted base / Black loop arms with Dark Grey brackets

Two or three split upholstery option:
Seat, back and upholstered arms can be specified in different fabrics or leathers. Fabric and leather cannot be mixed. Indicate **S** followed by the textile or leather for seat, back and arms (if applicable).

For any split upholstery, price equals the higher seat or back upholstery grade plus \$150 upcharge.

Specification example:
Pattern number:
BO31-AU-P-S-K-1882/8-K2063/3-K1579/5
Low Back Lounge Chair, upholstered arms, polished aluminum base, split upholstery
Seat textile: Melange/Flannel (Grade G)
Back textile: Tivoli/Dove (Grade F)
Arms textile: Tudor/Glacier (grade I)
Price = Grade G+ \$150 upcharge

COM split fabric requirements:
Seat: 2.4 yards
Back: 1.9 yards
Arms: 1.2 yards

COL split leather requirements:
Seat: 19 square feet
Back: 22 square feet
Arms: 14 square feet

Upholstery/COM information:
Prices shown include fabric or leather upholstery. Contact your Knoll representative for colors. Only approved KnollTextiles and Spinneybeck leathers may be ordered.

Customer's Own Material is available pending approval. For approval requirements, processing instructions and ordering information please see page 18.

Maintenance:
See pages 28-29.

pattern no.	grades A	COM B	C	D	E	F	G	H	I	COL U	V	W	X	Y
BO31-AL-3(-)	\$4,466.	\$4,561.	\$4,696.	\$4,804.	\$4,961.	\$5,098.	\$5,253.	\$5,372.	\$5,909.	\$6,602.	\$6,914.	\$7,579.	\$7,803.	\$8,195.
BO31-AL-P(-)	4,743.	4,838.	4,973.	5,081.	5,238.	5,375.	5,530.	5,649.	6,186.	6,879.	7,191.	7,856.	8,080.	8,472.
BO31-AU-3(-)	4,912.	5,007.	5,142.	5,250.	5,407.	5,544.	5,699.	5,818.	6,355.	7,107.	7,419.	8,084.	8,308.	8,700.
BO31-AU-P(-)	5,067.	5,162.	5,297.	5,405.	5,562.	5,699.	5,854.	5,973.	6,510.	7,262.	7,574.	8,239.	8,463.	8,855.
BO31-C-3(-)	3,847.	3,942.	4,077.	4,185.	4,342.	4,479.	4,634.	4,753.	5,290.	5,906.	6,218.	6,883.	7,107.	7,499.
BO31-C-P(-)	4,002.	4,097.	4,232.	4,340.	4,497.	4,634.	4,789.	4,908.	5,445.	6,061.	6,373.	7,038.	7,262.	7,654.

Construction

Base:
Four star, cantilevered, 360° swivel, die cast aluminum base, available polished or painted in a highly durable powder coat.

Upholstery:
Highly resilient polyurethane molded foam, overlaid with knit backed polyester fiber. Top stitched, open parallel double side seaming.

Substructure:
Comprised of steel, die cast aluminum and elastic webbing embedded inside polyurethane molded foam.

Arms:
Loop Arms: steel rod loop arms and die cast aluminum arm brackets.
Upholstered Arms: steel weldment substructure embedded inside highly resilient polyurethane molded foam, overlaid with knit backed polyester fiber.

Approved KnollTextiles Grades/Fabrics

A Common Ground Delite Dristi Hourglass Mariner Presto Sonnet	B continued Ransom Ricochet Summit Tinge Utmost Venue Vinyl Westwood	C Atlas Biota Circa Classic Boucle Dune Lagos Noble Palisade Regard Sahara Sequin CR Spot On Star Struck Swing	D Woodland	E Demure Highland Whip	F Atelier Cornaro Rivington Tweed Frieze Tivoli	G Haze Kingston Melange Petite Floral Ultrasuede	H Arno	I Tudor
--	---	--	-------------------	-------------------------------------	--	---	---------------	----------------



Spinneybeck Leather

U Vicenza Volo	V Acqua Andes España Velluto Pelle	W Alaska Antique Forte Sabrina	X Copenhagen Marissa Riva Saddle
--------------------------	--	--	--

Check with your KnollTextiles or Spinneybeck Representative for changes or additions.

Designer(s):
 Edward Barber and Jay Osgerby,
 2014

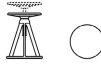

description	w	d	h	seat finish	weight
BO10C stool, indoor fixed height, swivel seat 	14 1/4"	14 1/4"	18"	Aluminum, polished	14 lbs.
	14 1/4"	14 1/4"	18"	Ash	12 lbs.
BO10CO stool, outdoor fixed height, swivel seat 	14 1/4"	14 1/4"	18"	Aluminum, painted (seat matches base)	14 lbs.
	14 1/4"	14 1/4"	18"	Teak	12 lbs.
BO11C stool, indoor adjustable height, swivel seat 	14 1/4"	14 1/4"	18" - 22"	Aluminum, painted (seat matches base)	15 lbs.
	14 1/4"	14 1/4"	18" - 22"	Aluminum, polished	15 lbs.
	14 1/4"	14 1/4"	18" - 22"	Ash	13 lbs.
	14 1/4"	14 1/4"	18" - 22"	Teak	13 lbs.

pattern no.	list
BO10C-AP-()	\$695.
BO10C-AE-()	979.
BO10CO-()-()	592.
BO10CO-K-()	1,241.
BO11C-()-()	639.
BO11C-AP-()	742.
BO11C-AE-()	1,025.
BO11C-K-()	1,288.

Order Code

<i>Example:</i> BO10C-AP-CRLT	
BO10C	Stool, indoor fixed height, swivel seat
AP	Aluminum, polished
CRLT	Red Coral

Specify:

1. Pattern number
2. Seat selection
3. Base selection

Ordering Information

Aluminum seat finishes:
 Polished Aluminum (suffix AP)
 Painted Aluminum Seat *:
 Jet Black (Suffix 111T)
 Med. Metallic Grey, (suffix 612T)
 Red Coral (suffix CRLT)
 Sterling (suffix 906T)
 White (suffix WHTT)
 (base must be specified in the same color)

Wood Seat Finishes:
 Ebonized Ash (suffix AE)
 Teak, natural (suffix K) *

*** Outdoor Use:**
The painted aluminum and teak seats are approved for outdoor use when used on the fixed height stool only





Construction

Base paint finishes:
 Jet Black (suffix 111T)
 Medium Metallic Grey (suffix 612T)
 Red Coral (suffix CRLT)
 Sterling (suffix 906T)
 White (suffix WHTT)

Aluminum Seats:
 Contoured die-cast aluminum seats are attached to the base with stainless steel fasteners. Available in a polished aluminum or painted with a highly durable powder coat paint.

Wood Seats:
 Contoured wood seats are available in ebonized ash or an oiled teak.

Harry Bertoia Side Chair

	description	seat h	w	d	h	textile fabric yds.	req. leather sq. ft.	weight
<i>Designer(s):</i> Harry Bertoia, 1952	420CU Side chair, full cover 	17 3/4"	21 3/4"	19 3/4"	28 3/4"	1.8	n/a	14 lbs.
		17 7/8"	21 3/4"	19 3/4"	28 3/4"	1.8	n/a	14 lbs.
<i>Award(s):</i> “Designer of the Year” 1955, USA; Certificate of Merit, American Institute of Architects	420F Full cover replacement 420C Side chair, back pad and seat cushion 					1.8	n/a	
		17 3/4"	21 3/4"	19 3/4"	28 3/4"	1.5	n/a	14 lbs.
	420P Back pad replacement 420KP Back pad and seat cushion replacement 420C Side chair, seat cushion or unupholstered 					0.7	n/a	
		17 3/4"	21 3/4"	19 3/4"	28 3/4"	0.8	14	14 lbs.
	420K Seat cushion replacement 					0.8	14	

Order Code

<i>Example:</i>	420C-C-K-K242/13
420C	Side chair
C	Polished Chrome
K	Seat cushion
K242/13	Vinyl, White

Specify:

1. Pattern number
2. Finish selection
3. Upholstery option
4. Cal 133 Fire Code option
5. Textile selection

For cushion replacement specify:

1. Pattern number
2. Textile selection

Ordering Information

Frame finishes:
Black (suffix BL)
Blue (suffix BU)
Green (suffix GE)
 Polished Chrome (suffix C)
Red (suffix RD)
Satin Chrome (suffix CO)
White (suffix W)
Yellow (suffix YL)

Upholstery options:
Full cover (suffix U)
 Seat cushion only (suffix K)
Back pad and seat cushion combination (suffix KP)

Upholstery/COM information:
Prices shown include fabric or leather upholstery. Contact your Knoll representative for colors. Only approved KnollTextiles and Spinneybeck leathers may be ordered.

Customer's Own Material is available pending approval. For approval requirements, processing instructions and ordering information please see page 18.

 *KnollStudio 20 Day Program:*
The Bertoia 420 Side Chair is available in polished chrome finish on the 20-day program unupholstered or with a seat cushion upholstered with in-stock KnollTextile. Replacement seat cushions are also available with in-stock KnollTextiles. For specific information, consult pages 30 - 33.



Outdoor use:
With proper care and limited exposure to the elements, the Bertoia Collection is appropriate for outdoor environments. Specify powder coat finish (red, yellow, green, blue, black, white). Consult a Knoll representative for appropriate upholstery options.

Cal 133 Fire Code :
The Bertoia Chairs with seat cushion attached comply with the California Technical Bulletin 133 standard in all upholstery. **All textiles marked with a flame are also Cal 133 approved for full cover or seat and back pad upholstery.** Specify suffix -C at end of pattern number and suffix -133 at end of textile selection.

Note:
The Knoll logo is stamped into the base of the chair.

The Bertoia Side Chair is Greenguard certified.

Maintenance:
See pages 28-29.











pattern no.	unuph. (remove suffix -K)	grades A	COM B	C	D	E	F	G	H	I	COL U	V	W	X	Y
420C-()-U		\$1,601.	\$1,685.	\$1,761.	\$1,857.	\$1,926.	\$1,982.	\$2,066.	\$2,240.	\$2,366.					
420C-CO-U		1,868.	1,954.	2,030.	2,124.	2,195.	2,252.	2,335.	2,508.	2,634.					
420F-()		712.	789.	859.	943.	1,012.	1,059.	1,137.	1,298.	1,411.					
420C-()-KP		1,718.	1,761.	1,804.	1,849.	1,887.	1,916.	1,960.	2,049.	2,188.					
420C-CO-KP		1,997.	2,040.	2,082.	2,128.	2,166.	2,194.	2,240.	2,328.	2,467.					
420P-()		475.	493.	511.	531.	546.	558.	578.	616.	645.					
420KP-()		756.	794.	832.	876.	909.	935.	977.	1,057.	1,117.					
420C-()-K 	902.	1,132.	1,167.	1,205.	1,246.	1,279.	1,308.	1,346.	1,424.	1,485.	1,707.	1,846.	2,127.	2,185.	2,254.
420C-CO-K	1,179.	1,411.	1,447.	1,483.	1,525.	1,558.	1,587.	1,624.	1,704.	1,762.	1,986.	2,124.	2,406.	2,464.	2,533.
420K-() 	271.	303.	337.	374.	402.	425.	460.	530.	581.	779.	900.	1,145.	1,195.	1,250.	

Construction

Base and basket:
Welded steel with rods in polished or satin chrome, or highly durable outdoor power coat (red, yellow, green, blue, white, black). The diameter of the base rods are 11mm. The diameter of the edge rods is 4.5 mm and the interlacements measure 4mm. The chair features stainless steel connections and plastic glides.

Upholstery:
Cushion and back pad secured to chair with domed metal lock snaps. Seat cushions and back pads have fabric edges. Full covers are stretched over wire seat basket and attach to seat basket with hooks. Back pad is not available with leather upholstery.

Approved KnollTextiles Grades/Fabrics

A Bocce Common Ground * Commuter Cloth * Crossroad * Delite * Hourglass Mariner * Presto * Soliloquy Sonnet * Stacks Trophy * Uni-Form *	B Abacus Belize Bistro Cameo Chronicle Diva * Ferry * Forza Grande Grandview Holbrook Journey * Keaton * Knoll Felt *   Knoll Hopsack *   Little Devil * Night Life Petal Pusher * Prairie Prim  Ransom * Ricochet	C Axiom Biota Classic Boucle *   Dahlia CR Durand Earthwork Entourage * Hula Hoop Lagos Milestone Moto CR Noble Pullman * Quark Roundtrip Sinclair Smart Spectator Spot On Swing * Tight Rope Tower Grid Vibe Wit	D continued Roam Rush Hour Soiree Summit * Sutton Synth * Tabloid Venue * Versa Vinyl Wide Angle Zipline	E Aegean * Highland * Ikat Stripe Ikat Square Kampala Katazome Kimono Marquee Nature Walk Sherman * Tryst	F Atelier * Calais Cotton Velvet Cornaro * Glider Icon Intrigue * In Stitches * Liberty Mod Plaid Totem Tweed Frieze	G Alter Ego * Arabella Feeling Plaid * Haze * Kamani Kinabalu * Kingston Melange * Metallic Gloss Modern Tweed * Petite Floral Sablon * Serendipity Straie Stripe Ultrasuede * Utrillo *  	H Arno *   Bavaria * Catwalk * Gezelle * Magritte * Rosemond	I Aswan Byron Cato * Cummings Dynamic Fiori * Ita * Knoll Velvet * North Island *   Rutledge Tudor Vermeer * Zimba *	U Vicenza Volo	V Acqua Andes Embossed Tipped Hand Tipped Velluto Pelle	W Alaska Amazon Antique Derby Forte Lucente Sabrina	X Ducale Ducale Velour	Y Capri Cervo Copenhagen Distressed Lucca Marissa Portofino Riva Torello
--	--	--	--	---	---	---	---	--	-----------------------------	---	---	-------------------------------------	--

Spinneybeck Leather

U Vicenza Volo	V Acqua Andes Embossed Tipped Hand Tipped Velluto Pelle	W Alaska Amazon Antique Derby Forte Lucente Sabrina	X Ducale Ducale Velour	Y Capri Cervo Copenhagen Distressed Lucca Marissa Portofino Riva Torello
-----------------------------	---	---	-------------------------------------	--

* Approved for fully upholstered versions.
 Approved for Cal 133 upholstery.

Check with your KnollTextiles or Spinneybeck Representative for changes or additions.

Harry Bertoia

Two-Tone Side Chair

	description	seat h	w	d	h	textile fabric yds	req. leather sq. ft	weight
<i>Designer(s):</i> Harry Bertoia, 1952	420CT-U Two-Tone Side chair, full cover	17 3/4"	21 3/4"	19 3/4"	28 3/4"	1.8	n/a	14 lbs.
<i>Award(s):</i> "Designer of the Year" 1955, USA; Certificate of Merit, American Institute of Architects	420CT-KP Two-Tone Side chair, back pad and seat cushion	17 3/4"	21 3/4"	19 3/4"	28 3/4"	1.5	n/a	14 lbs.
	420CT-K Two-Tone Side chair, seat cushion	17 3/4"	21 3/4"	19 3/4"	28 3/4"	0.8	14	14 lbs.
	420F Full cover replacement					1.8	n/a	
	420KP Back pad and seat cushion replacement					1.5	n/a	
	420P Back pad replacement					0.7	n/a	
	420K Seat cushion replacement					0.8	14	



Order Code	Ordering Information
<i>Example:</i> 420CT-U-BU-W-K242/13	<i>Frame finishes:</i> Polished Chrome (suffix C) Black (suffix BL) Blue (suffix BU) Red (suffix RD) White (suffix W)
420CT-U Two-Tone Side chair, fully upholstered	Customer's Own Material is available pending approval. For approval requirements, processing instructions and ordering information please see page 18.
BU Blue basket	<i>KnollStudio 20 Day Program:</i> Replacement seat cushions are available with in-stock KnollTextiles. For specific information, consult pages 30 - 33.
W White base	<i>Upholstery options:</i> Full cover (suffix U) Seat cushion only (suffix K) Back pad and seat cushion combination (suffix KP)
K242/13 Vinyl, White	<i>Upholstery/COM information:</i> Prices shown include fabric or leather upholstery. Contact your Knoll representative for colors. Only approved KnollTextiles and Spinneybeck leathers may be ordered.
<i>Specify:</i> 1. Pattern number 2. Basket finish selection 3. Base finish selection 4. Textile selection	<i>Cal 133 Fire Code ▲:</i> The Bertoia Chairs with seat cushion attached comply with the California Technical Bulletin 133 standard in all upholstery. All textiles marked with a flame are also Cal 133 approved for full cover or seat and back pad upholstery. Specify suffix -C at end of pattern number and suffix -133 at end of textile selection. <i>Note:</i> The Knoll logo is stamped into the base of the chair. The Bertoia Side Chair is Greenguard certified. <i>Maintenance:</i> See pages 28-29.
<i>For cushion replacement specify:</i> 1. Pattern number 2. Textile selection	

pattern no.	unuph.	A	COM B	C	D	E	F	G	H	I	COL U	V	W	X	Y
420CT-U(-)(-)(-)		\$1,601.	\$1,685.	\$1,761.	\$1,857.	\$1,926.	\$1,982.	\$2,066.	\$2,240.	\$2,366.					
420CT-K(-)(-)(-)		1,718.	1,761.	1,804.	1,849.	1,887.	1,916.	1,960.	2,049.	2,188.					
420CT-K(-)(-)(-)	902.	1,132.	1,167.	1,205.	1,246.	1,279.	1,308.	1,346.	1,424.	1,485.	1,707.	1,846.	2,127.	2,185.	2,254.
420F(-)		712.	789.	859.	943.	1,012.	1,059.	1,137.	1,298.	1,411.					
420KP(-)		756.	794.	832.	876.	909.	935.	977.	1,057.	1,117.					
420P(-)		475.	493.	511.	531.	546.	558.	578.	616.	645.					
420K(-)		271.	303.	337.	374.	402.	425.	460.	530.	581.	779.	900.	1,145.	1,195.	1,250.

Construction	Approved KnollTextiles Grades/Fabrics	Spinneybeck Leather
<i>Base and basket:</i> Welded steel with rods in polished chrome, or highly durable power coat (red, blue, white, black). The diameter of the base rods are 11mm. The diameter of the edge rods is 4.5 mm and the interlacements measure 4mm. The chair features stainless steel connections and plastic glides.	A Bocce Common Ground * Commuter Cloth * Crossroad * Delite * Hourglass Mariner * Presto * Soliloquy Sonnet * Stacks Trophy * Uni-Form *	U Vicenza Volo V Acqua Andes Embossed Tipped Hand Tipped Velluto Pelle W Alaska Amazon Antique Derby Forte Lucente Sabrina
<i>Upholstery:</i> Cushion and back pad secured to chair with domed metal lock snaps. Seat cushions and back pads have fabric edges. Full covers are stretched over wire seat basket and attach to seat basket with hooks. Back pad is not available with leather upholstery.	B Abacus Belize Bistro Cameo Chronicle Diva * Ferry * Forza Grande Grandview Holbrook Journey * Keaton * Knoll Felt *▲ Knoll Hopsack *▲ Little Devil * Night Life Petal Pusher * Prairie Prim ▲ Ransom * Ricochet	X Ducale Ducale Velour Y Capri Cervo Copenhagen Distressed Lucca Marissa Portofino Riva Torello
<i>Note:</i> Two-Tone Bertoia Chairs are not appropriate for outdoor use.	C Axiom Biota Classic Boucle *▲ Dahlia CR Durand Earthwork Entourage * Hula Hoop Lagos Milestone Moto CR Noble Pullman * Quark Roundtrip Sinclair Smart Spectator Spot On Swing * Tight Rope Tower Grid Vibe Wit	H Arno *▲ Bavaria * Catwalk * Gezelle * Magritte * Rosemond I Aswan Byron Cato * Cummings Dynamic Fiori * Ita * Knoll Velvet * North Island *▲ Rutledge Tudor Vermeer * Zimba
Screws that attach the base to the basket are not painted to match the basket finish.	D Hologram Masquerade Menagerie Theory Zoom E Aegean * Highland * Ikat Stripe Ikat Square Kampala Katazome Kimono Marquee Nature Walk Sherman * Tryst F Atelier * Calais Cotton Velvet Cornaro * Glider Icon Intrigue * In Stitches * Liberty Mod Plaid Totem Tweed Frieze	G Alter Ego * Arabella Feeling Plaid * Haze * Kamani Kinabalu * Kingston Melange * Metallic Gloss Modern Tweed * Petite Floral Sablon * Serendipity Straie Stripe Ultrasuede * Utrillo *▲ * Approved for fully upholstered versions. ▲ Approved for Cal 133 upholstery. <i>Check with your KnollTextiles or Spinneybeck Representative for changes or additions.</i>

Harry Bertoia



Barstools

Bar Height Stools

Designer(s):
Harry Bertoia, 1952

Award(s):
“Designer of the Year” 1955,
USA; Certificate of Merit,
American Institute of Architects





description	seat h	w	d	h	textile fabric yds.	req. leather sq. ft.	weight
428CU Barstool, full cover, bar height 	29 1/4"	21 3/4"	22"	41 1/4"	1.8	n/a	22 lbs.
	29 1/4"	21 3/4"	22"	41 1/4"	1.8	n/a	22 lbs.
428F Full cover replacement for 428C					1.8	n/a	
428C-KP Barstool, back pad and seat cushion, bar height 	29 1/4"	21 3/4"	22"	41 1/4"	1.5	n/a	22 lbs.
	29 1/4"	21 3/4"	22"	41 1/4"	1.5	n/a	22 lbs.
428P Back pad replacement					0.7	n/a	
428KP Back pad and seat cushion replacement					1.5	n/a	
428C Barstool, seat cushion or unupholstered, bar height 	29 1/4"	21 3/4"	22"	41 1/4"	0.8	14	21 lbs.
	29 1/4"	21 3/4"	22"	41 1/4"	0.8	14	21 lbs.
428K Seat cushion replacement for 428C					0.8	14	

Order Code

<i>Example:</i>	428C-C-KP-K1021/8
428C	Barstool, bar height
C	Polished Chrome
KP	Back and seat pad
K1021/8	Ultrasuede, Poppy

Ordering Information

Frame finishes:
Black (suffix BL)
 Polished Chrome (suffix C)
Satin Chrome (suffix CO)
White (suffix W)

Upholstery options:
Full cover (suffix U)
 Seat cushion only (suffix K)
Back pad and seat cushion combination (suffix KP)

Upholstery/COM information:
Prices shown include fabric or leather upholstery. Contact your Knoll representative for colors. Only approved KnollTextiles and Spinneybeck leather may be ordered.

Outdoor use:
With proper care and limited exposure to the elements, the 428 Bertoia Barstool is appropriate for outdoor environments. Specify outdoor powder coat. Consult a Knoll representative for appropriate upholstery options.

Customer's Own Material is available pending approval. For approval requirements, processing instructions and ordering information, please see page 18.

 *KnollStudio 20-Day Program:*
The Bertoia 428 barstool is available in a polished chrome finish on the 20-Day Program unupholstered or with seat cushion upholstered with any in-stock KnollTextile. Seat cushion only is available on the 20-day program with any in-stock KnollTextile. For specific information, consult pages 30-33.

Cal 133 Fire Code  :
The Bertoia Barstools with seat cushion attached comply with the California Technical Bulletin 133 standard in all upholstery. **All textiles marked with a flame are also Cal 133 approved for full cover or seat and back pad upholstery.** Specify suffix -C at end of pattern number and suffix -133 at end of textile selection.

Maintenance:
See pages 28-29.

Note:
The Knoll logo is stamped into the base of the barstool.

The Bertoia Bar Height stool is Greenguard certified.

pattern no.	unuph. (remove suffix -K)	grades A	COM B	C	D	E	F	G	H	I	COL U	V	W	X	Y
428C-()-U		\$2,171.	\$2,244.	\$2,313.	\$2,392.	\$2,454.	\$2,503.	\$2,578.	\$2,723.	\$2,834.					
428C-CO-U		2,630.	2,703.	2,773.	2,850.	2,915.	2,961.	3,036.	3,184.	3,291.					

428F-()	712.	789.	859.	943.	1,012.	1,059.	1,137.	1,298.	1,411.						
428C-()-KP	2,419.	2,464.	2,505.	2,550.	2,588.	2,616.	2,662.	2,749.	2,814.						
428C-CO-KP	2,898.	2,942.	2,983.	3,030.	3,067.	3,093.	3,140.	3,229.	3,291.						

428P-()	475.	493.	511.	531.	546.	558.	578.	616.	645.						
428KP-()	756.	794.	832.	876.	909.	935.	977.	1,057.	1,117.						

428C-()-K 	1,602.	1,797.	1,831.	1,863.	1,900.	1,929.	1,951.	1,983.	2,055.	2,105.	2,299.	2,416.	2,659.	2,709.	2,767.
428C-CO-K	2,080.	2,275.	2,309.	2,340.	2,378.	2,408.	2,429.	2,463.	2,534.	2,583.	2,777.	2,894.	3,137.	3,189.	3,246.

428K-() 	271.	303.	337.	374.	402.	425.	460.	530.	581.	779.	900.	1,145.	1,195.	1,250.	
---	------	------	------	------	------	------	------	------	------	------	------	--------	--------	--------	--

Construction

Base and basket:
Welded steel with rods in polished or satin chrome or highly durable bonded powder coat (white and black). Stainless steel connections. Holes pre-drilled for easy snap-in installation. 1 1/4" wide round articulated glides on barstool. Black plastic glide with metal cover. Barstool base wire diameter measures 14mm, basket edge measures 7mm and interlacements measure 5 mm.

Upholstery:
Cushion and back pad secured to chair with domed metal lock snaps. Seat cushions and back pads have fabric edges. Full covers are stretched over wire seat basket and attach to seat basket with hooks. Back pad is not available with leather upholstery.

Approved KnollTextiles Grades/Fabrics

A Bocce Common Ground * Commuter Cloth * Crossroad * Delite * Hourglass * Mariner * Presto * Soliloquy Sonnet * Stacks Trophy * Uni-Form *	B Abacus Belize Bistro Cameo Chronicle Diva * Ferry * Forza Grande Grandview Holbrook Journey * Keaton * Knoll Felt *  Knoll Hopsack *  Little Devil * Night Life Petal Pusher * Prairie Prim  Ransom * Ricochet Roam Rush Hour	C Axiom Biota Classic Boucle *  Dahlia CR Durand Earthwork Entourage * Hula Hoop Lagos Milestone Moto CR Noble Pullman * Quark Roundtrip Sinclair Smart Spectator Spot On Swing * Tight Rope Tower Grid Vibe Wit	D Hologram Masquerade Menagerie Theory Zoom	E Aegean * Highland * Ikat Stripe Ikat Square Kampala Katazome Kimono Marquee Nature Walk Sherman * Tryst	F Atelier * Calais CottonVelvet Cornaro * Glider Groove Line Icon Intrigue * In Stitches * Liberty Mod Plaid Totem Tweed Frieze	G Alter Ego * Arabella Feeling Plaid * Haze * Kamani Kinabalu * Kingston Melange * Metallic Gloss Modern Tweed * Petite Floral Sablon * Serendipity Straie Stripe Ultrasuede * Utrillo *  H Arno *  Bavaria * Catwalk * Gezelle * Magritte * Rosemond I Aswan Byron Cato * Cummings Dynamic Fiori * Ita * Knoll Velvet * North Island *  Rutledge Tudor Vermeer * Zimba	U Vicenza Volo V Acqua Andes Embossed Tipped Hand Tipped Velluto Pelle W Alaska Amazon Antique Derby Forte X Ducale Ducale Velour Y Capri Cervo Copenhagen Distressed Lucca Marissa Portofino Riva Torello	W continued Lucente Sabrina
--	---	--	---	---	--	--	--	--

Spinneybeck Leather

U Vicenza Volo	V Acqua Andes Embossed Tipped Hand Tipped Velluto Pelle	W Alaska Amazon Antique Derby Forte	X Ducale Ducale Velour	Y Capri Cervo Copenhagen Distressed Lucca Marissa Portofino Riva Torello
-----------------------------	---	---	-------------------------------------	--

* Approved for fully upholstered versions.
 Available for Cal 133 upholstery.

Check with your KnollTextiles or Spinneybeck Representative for changes or additions.

Harry Bertoia



Barstools

Counter Height Stools

Designer(s):
Harry Bertoia, 1952

Award(s):
“Designer of the Year” 1955,
USA; Certificate of Merit,
American Institute of Architects



description	seat h	w	d	h	textile fabric yds.	req. leather sq. ft.	weight
427CU Barstool, full cover, counter height	27 1/2"	21 3/4"	22"	39 1/2"	1.8	n/a	20 lbs.
	27 1/2"	21 3/4"	22"	39 1/2"	1.8	n/a	20 lbs.
427F Full cover replacement for 427C					1.8	n/a	
427C-KP Barstool, back pad and seat cushion, counter height	27 1/2"	21 3/4"	22"	39 1/2"	1.5	n/a	20 lbs.
	27 1/2"	21 3/4"	22"	39 1/2"	1.5	n/a	20 lbs.
427P Back pad replacement					0.7	n/a	
427KP Back pad and seat cushion replacement					1.5	n/a	
427C Barstool, seat cushion or unupholstered, counter height	27 1/2"	21 3/4"	22"	39 1/2"	0.8	14	20 lbs.
							
427K Seat cushion replacement for 427C					0.8	14	
412 Barstool, counter height	27 1/2"	21 3/4"	22"	39 1/2"			22 lbs.

Order Code

Example: **427C-C-U-K1207/2**

427C	Barstool, counter height
C	Polished Chrome
U	Fully upholstered
K1207/2	Knoll Felt, Tan

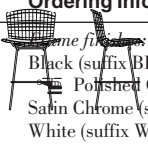

Upholstery options:
Full cover (suffix U)
Seat cushion only (suffix K)
Back pad and seat cushion combination (suffix KP)

Upholstery/COM information:
Prices shown include fabric or leather upholstery. Contact your Knoll representative for colors. Only approved KnollTextiles and Spinneybeck leathers may be ordered.

Outdoor use:
With proper care and limited exposure to the elements, the 427 Bertoia Barstool is appropriate for outdoor environments. Specify outdoor powder coat. Consult a Knoll representative for appropriate upholstery options.

Customer's Own Material is available pending approval for approval requirements, processing instructions and ordering information please see page 18.

KnollStudio 20-Day Program:
The Bertoia 427 barstool is available in a polished chrome finish unupholstered or with a seat pad on the 20-day program. Replacement seat cushion is also available. Seat cushion must be upholstered with an in-stock KnollTextile. For specific information, consult pages 30-33.

Cal 133 Fire Code :
The Bertoia Barstools with seat cushion attached comply with the California Technical Bulletin 133 standard in all upholstery. **All textiles marked with a flame are also Cal 133 approved for full cover or seat and back pad upholstery.** Specify suffix -C at end of pattern number and suffix -133 at end of textile selection.

Maintenance:
See pages 28-29.

Note:
The Knoll logo is stamped into the base of the barstool.

The Bertoia Counter Height stool is Greenguard certified

pattern no.	unuph. (remove suffix -K)	grades A	COM B	C	D	E	F	G	H	I	COL U	V	W	X	Y
427C-()-U		\$2,171.	\$2,244.	\$2,313.	\$2,392.	\$2,454.	\$2,503.	\$2,578.	\$2,723.	\$2,834.					
427C-CO-U		2,630.	2,703.	2,773.	2,850.	2,915.	2,961.	3,036.	3,184.	3,291.					

427F-()	712.	789.	859.	943.	1,012.	1,059.	1,137.	1,298.	1,411.						
427C-()-KP	2,419.	2,464.	2,505.	2,550.	2,588.	2,616.	2,662.	2,749.	2,814.						
427C-CO-KP	2,898.	2,942.	2,983.	3,030.	3,067.	3,093.	3,140.	3,229.	3,291.						

427P-()	475.	493.	511.	531.	546.	558.	578.	616.	645.						
427KP-()	756.	794.	832.	876.	909.	935.	977.	1,057.	1,117.						

427C-CO-K	2,080.	2,275.	2,309.	2,340.	2,378.	2,408.	2,429.	2,463.	2,534.	2,583.	2,777.	2,894.	3,137.	3,189.	3,246.
------------------	--------	--------	--------	--------	--------	--------	--------	--------	--------	--------	--------	--------	--------	--------	--------

427K-()	271.	303.	337.	374.	402.	425.	460.	530.	581.	779.	900.	1,145.	1,195.	1,250.
-----------------	------	------	------	------	------	------	------	------	------	------	------	--------	--------	--------

412-C-() Construction

Base and basket:
Welded steel with rods in polished or satin chrome or highly durable bonded powder coat (white and black). Stainless steel connections. Holes pre-drilled for easy snap-in installation. 1 1/4" wide round articulated glides on barstool. Black plastic glide with metal cover. Barstool base wire diameter measures 14mm, basket edge measures 7mm and interlacements measure 5 mm.

Upholstery:
Cushion and back pad secured to chair with domed metal lock snaps. Seat cushions and back pads have fabric edges. Full covers are stretched over wire seat basket and attach to seat basket with hooks. Back pad is not available with leather upholstery.

Approved KnollTextiles Grades/Fabrics	Spinneybeck Leather
A Bocce Common Ground * Commuter Cloth * Crossroad * Delite * Hourglass Mariner * Presto * Soliloquy Sonnet * Stacks Trophy * Uni-Form *	U Vicenza Volo V Acqua Andes Embossed Tipped Hand Tipped Velluto Pelle W Alaska Amazon Antique Derby Forte
B Abacus Belize Bistro Cameo Chronicle Diva * Ferry * Forza Grande Grandview Holbrook Journey * Keaton * Knoll Felt * Knoll Hopsack * Little Devil * Night Life Petal Pusher * Prairie Prim * Ransom * Ricochet Roam Rush Hour	W Ducale Ducale Velour X Capri Cervo Copenhagen Distressed Lucca Marissa Portofino Riva Torello
C Axiom Biota Classic Boucle * Dahlia CR Durand Earthwork Entourage * Hula Hoop Lagos Milestone Moto CR Noble Pullman * Quark Roundtrip Sinclair Smart Spectator Spot On Swing * Tight Rope * Tower Grid * Vibe Wit	I Aswan Byron Cato * Cummings Dynamic Fiori * Ita * Knoll Velvet * North Island * Rutledge Tudor Vermeer * Zimba
D Hologram Masquerade Menagerie Theory Zoom	E Aegean * Highland * Ikat Stripe Ikat Square Kampala Katazome Kimono Marquee Nature Walk Sherman * Tryst
E continued Soiree Summit * Sutton Synth * Tabloid Venue Versa Vinyl Wide Angle Zipline	G Alter Ego * Arabella Feeling Plaid * Haze * Kamani Kinabalu * Kingston Melange * Metallic Gloss Modern Tweed * Petite Floral Sablon * Serendipity Straie Stripe Ultrasuede * Utrillo * H Arno * Bavaria * Catwalk * Gezelle * Magritte * Rosemond
F Atelier * Calais Cotton Velvet Cornaro * Glider Icon Intrigue * In Stitches * Liberty Mod Plaid Totem Tweed Frieze	I * Approved for fully upholstered versions. * Available for Cal 133 upholstery.

Check with your KnollTextiles or Spinneybeck Representative for changes or additions.





Harry Bertoia

Diamond Lounge Seating

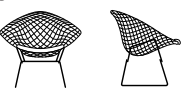

Designer(s):
Harry Bertoia, 1952

Award(s):
“Designer of the Year” 1955, USA; Certificate of Merit, American Institute of Architects



description	seat h	w	d	h	textile fabric yds.	req. leather sq. ft.	weight
421L Diamond chair, seat cushion with glides 	16 1/2"	33 1/2"	28 1/4"	30"	0.7	14	16 lbs.
	16 1/2"	33 1/2"	28 1/4"	30"	0.7	14	16 lbs.
	16 1/2"	33 1/2"	28 1/4"	30"	0.7	14	16 lbs.
421K Seat cushion replacement					0.7	14	
421LU Diamond chair, full cover with glides 	16 1/2"	33 1/2"	28 1/4"	30"	3.0	n/a	16 lbs.
	16 1/2"	33 1/2"	28 1/4"	30"	3.0	n/a	16 lbs.
421F Full cover replacement					3.0	n/a	
421LS Child's Diamond chair, seat cushion with glides 	11 1/4"	24 1/2"	22 3/4"	24"	0.7	11	9 lbs.
421KS Child's Diamond, seat cushion replacement					0.7	11	
421LS Child's Diamond chair, full cover with glides 	11 1/4"	24 1/2"	22 3/4"	24"	2.5	n/a	10 lbs.
421FS Child's Diamond, full cover replacement					2.5	n/a	
422LU Large diamond chair, full cover with glides 	15 1/4"	45"	31 1/2"	28 3/4"	3.8	n/a	24 lbs.
422F Full cover replacement					3.8	n/a	



Order Code	Ordering Information
<i>Example:</i> 421L-CO-U-K231/1	<i>Frame finishes (421L,LU,LS):</i> Black (suffix BL) Polished Chrome (suffix C) Satin Chrome (suffix CO) Fully upholstered (suffix U) Cuddle Cloth, Neutral (suffix K231/1)
421L	Diamond chair
CO	Satin Chrome
U	Fully upholstered
K231/1	Cuddle Cloth, Neutral
<i>Specify:</i> 1. Pattern number 2. Finish selection 3. Upholstery option 4. Cal 133 Fire Code Option 5. Textile selection	<i>Frame finishes (422LU):</i> Black (suffix 1) Polished Chrome (suffix C) White (suffix W) <i>Upholstery options:</i> Full cover (suffix U) Seat cushion only (suffix K) <i>Upholstery/COM information:</i> Prices shown include fabric or leather upholstery. Contact your Knoll representative for colors. Only approved KnollTextiles and Spinneybeck leathers may be ordered. Customer's Own Material is available pending approval. For approval requirements, processing instructions and ordering information please see page 18.
<i>For cushion replacement, specify:</i> 1. Pattern number 2. Textile selection	<i>KnollStudio 20-Day Program:</i> The Diamond chair in a polished chrome finish is available on the KnollStudio 20-Day program with seat cushion upholstered with any in-stock KnollTextile. For specific information, consult pages 31 -33. <i>Outdoor use:</i> With proper care and limited exposure to the elements, the 421 Bertoia Diamond Chair is appropriate for outdoor environments. Specify powder coat finish. Consult a Knoll representative for appropriate upholstery options. <i>Cal 133 Fire Code ▲ :</i> Bertoia 421 chair with seat pad attached complies with the California Technical Bulletin 133 standard in <i>all</i> upholstery. Cal 133 is approved for selected fabrics marked with a flame for fully upholstered versions. Specify suffix -C at end of pattern number. <i>Maintenance:</i> See pages 28-29. <i>Note:</i> The Knoll logo is stamped into the base of the chair. The Bertoia Diamond Lounge Seating is Greenguard certified. The Child's Diamond Chair is compliant to the Consumer Product Safety Improvement Act of 2008 for Children's Products, 16 C.F.R. 1303, CPSIA Title 1 Section 101 for Total Lead in Substrates and Surface Coatings.

pattern no.	grades	COM	C	D	E	F	G	H	I	COL	V	W	X	Y
421L(-)-K 	\$1,780.	\$1,819.	\$1,858.	\$1,894.	\$1,926.	\$1,950.	\$1,990.	\$2,065.	\$2,118.	\$2,509.	\$2,657.	\$2,963.	\$3,028.	\$3,102.
421L-GLD-K 	3,080.	3,095.	3,113.	3,133.	3,161.	3,179.	3,207.	3,226.	3,284.	4,571.	4,632.	4,754.	4,779.	4,809.
421LCO-K	2,163.	2,202.	2,241.	2,277.	2,310.	2,334.	2,375.	2,448.	2,501.	2,893.	3,043.	3,349.	3,411.	3,487.
421K(-)	450.	485.	517.	552.	581.	604.	636.	705.	755.	1,105.	1,243.	1,516.	1,572.	1,639.
421L(-)-U	2,810.	2,972.	3,116.	3,276.	3,407.	3,503.	3,664.	3,974.	4,200.					
421LCO-U	3,178.	3,339.	3,482.	3,643.	3,776.	3,870.	4,030.	4,341.	4,567.					
421F(-)	1,099.	1,240.	1,369.	1,514.	1,630.	1,714.	1,862.	2,133.	2,336.					
421LS-C-K	1,039.	1,055.	1,069.	1,086.	1,099.	1,107.	1,128.	1,159.	1,188.	1,282.	1,346.	1,474.	1,501.	1,532.
421KS(-)	267.	285.	305.	322.	340.	351.	372.	406.	435.	556.	629.	782.	814.	850.
421LS-C-U	1,350.	1,406.	1,460.	1,519.	1,568.	1,604.	1,664.	1,778.	1,860.					
421FS(-)	678.	743.	809.	879.	935.	977.	1,048.	1,180.	1,278.					
422L(-C,1,2)-U	3,753.	3,923.	4,075.	4,250.	4,387.	4,491.	4,665.	4,992.	5,233.					
422F(-)	1,139.	1,284.	1,420.	1,570.	1,691.	1,780.	1,929.	2,216.	2,426.					

Construction	Approved KnollTextiles Grades/Fabrics	Spinneybeck Leather
<i>Frame:</i> Welded steel with rods in polished or satin (421L only) chrome finish, powder coat (white and black), or plated in 18k gold. Stainless steel connections. Four plastic glides. On all Diamond chairs, the base wire diameter measures 11mm. The frame edge wire diameter measures 4.5mm, the interlacements measure 4mm in diameter.	A Common Ground ▲ Crossroad Delite Hourglass Mariner Presto Sonnet Stacks * Trophy Uni-Form	U Vicenza * Volo * V Acqua * Andes * Embossed Tipped * Hand Tipped * Velluto Pelle * W Alaska * Amazon * Antique * Derby * Forte *
<i>Upholstery:</i> Cushion secured to chair with lock-snaps. Full covers are stretched over wire frame and attach to seat basket with hooks. Cushions and covers fit all Bertoia Diamond Chairs manufactured since 1952 within a limited range of tolerance.	B continued Knoll Felt Knoll Hopsack Little Devil Night Life * Ransom * Ricochet * Synth Venue Vinyl * C Classic Boucle ▲ Entourage Hula Hoop * Moto CR * Pullman Quark * Swing Vibe *	D Hologram * Masquerade * Zoom * E Aegean Highland Marquee * Sherman F Atelier Calais Cotton Velvet * Cornaro Icon * Intrigue In Stitches Totem * Tweed Frieze * G Alter Ego Feeling Plaid Haze Kinabalu
422L is not available with seat pad option.		H continued Melange Modern Tweed Sablon Ultrasuede ▲ Utrillo * I Cato Dynamic Fiori Ita Knoll Velvet North Island Vermeer Zimba X Sabrina * Ducale * Ducale Velour * Y Capri * Cervo * Copenhagen * Distressed * Lucca * Marissa * Portofino * Riva * Saddle * Torello *
<i>Child's Diamond Chair:</i> The Child's Diamond Chair is 75% scale of the standard size and is only available with polished chrome frame.		* Available on 421K and 421KS seat cushion only. ▲ Available for Cal 133 upholstery. <i>Check with your KnollTextiles or Spinneybeck Representative for changes or additions.</i>

Harry Bertoia

Two-Tone Diamond Chair

	description	seat h	w	d	h	textile fabric yds.	req. leather sq. ft.	weight
<i>Designer(s):</i> Harry Bertoia, 1952	421LT-U Two-Tone Diamond chair, full cover with glides	16 1/2"	33 1/2"	28 3/4"	30"	3.0	n/a	16 lbs.
<i>Award(s):</i> "Designer of the Year" 1955, USA; Certificate of Merit, American Institute of Architects								
	421LT-K Two-Tone Diamond chair, seat cushion with glides	16 1/2"	33 1/2"	28 3/4"	30"	0.7	14	16 lbs.
								
	421F Full cover replacement					3.0	n/a	
	421K Seat cushion replacement					0.7	14	

pattern no.	grades A	COM B	C	D	E	F	G	H	I	COL U	V	W	X	Y
421LT-U-(-)(-)(-)	\$2,810.	\$2,972.	\$3,116.	\$3,276.	\$3,407.	\$3,503.	\$3,664.	\$3,974.	\$4,200.					

421LT-K-(-)(-)(-)	1,780.	1,819.	1,858.	1,894.	1,926.	1,950.	1,990.	2,065.	2,118.	2,509.	2,657.	2,963.	3,028.	3,102.
--------------------------	--------	--------	--------	--------	--------	--------	--------	--------	--------	--------	--------	--------	--------	--------



421F-(-)	1,099.	1,240.	1,369.	1,514.	1,630.	1,714.	1,862.	2,133.	2,336.					
421K-(-)	450.	485.	517.	552.	581.	604.	636.	705.	755.	1,105.	1,243.	1,516.	1,572.	1,639.

Order Code	Ordering Information
<i>Example:</i> 421LT-K-RD-BL-H800/19	<i>Frame finishes:</i> Polished Chrome (suffix C) Black (suffix BL) Blue (suffix BU) Red (suffix RD) White (suffix W)
421LT-K Two-Tone Diamond chair, seat pad	<i>Cal 133 Fire Code # :</i> Bertoia 421 chair with seat pad attached complies with the California Technical Bulletin 133 standard in <i>all</i> upholstery. Cal 133 is approved for selected fabrics marked with a flame for fully upholstered versions. Specify suffix -C at end of pattern number.
RD Red basket	<i>Maintenance:</i> See pages 28-29.
BL Black base	<i>Note:</i> The Knoll logo is stamped into the base of the chair.
H800/19 Cato, Fire Red	The Bertoia Diamond Lounge Seating is Greenguard certified.
	The Child's Diamond Chair is compliant to the Consumer Product Safety Improvement Act of 2008 for Children's Products, 16 C.F.R. 1303, CPSIA Title 1 Section 101 for Total Lead in Substrates and Surface Coatings.
<i>Upholstery options:</i> Full cover (suffix U) Seat cushion only (suffix K)	
<i>Upholstery/COM information:</i> Prices shown include fabric or leather upholstery. Contact your Knoll representative for colors. Only approved KnollTextiles and Spinneybeck leathers may be ordered.	
<i>For cushion replacement, specify:</i> 1. Pattern number 2. Textile selection	Customer's Own Material is available pending approval. For approval requirements, processing instructions and ordering information please see page 18.

Construction	Approved KnollTextiles Grades/Fabrics	Spinneybeck Leather
<i>Frame:</i> Welded steel with rods in polished chrome finish and powder coat. Stainless steel connections. Four plastic glides. On all Diamond chairs, the base wire diameter measures 11mm. The frame edge wire diameter measures 4.5mm, the interlacements measure 4mm in diameter.	A Common Ground # Crossroad Delite Hourglass Mariner Presto Sonnet Stacks * Trophy Uni-Form B Abacus * Digit * Ferry Forza * Grande * Journey Keaton Knoll Felt Knoll Hopsack Night Life *	U Vicenza * Volo * V Acqua * Andes * Embossed Tipped * Hand Tipped * Velluto Pelle * W Alaska * Amazon * Antique * Derby * Forte * Lucente * Santalina * Santalina available on 421K seat cushion only. # Available for Cal 133 upholstery.
<i>Upholstery:</i> Cushion secured to chair with lock-snaps. Full covers are stretched over wire frame and attach to seat basket with hooks. Cushions and covers fit all Bertoia Diamond Chairs manufactured since 1952 within a limited range of tolerance.	B continued Ransom * Ricochet * Synth Venue Vinyl * C Classic Boucle # Entourage Hula Hoop * Moto CR * Pullman Quark * Swing Vibe *	X Ducale * Ducale Velour * Y Capri * Cervo * Copenhagen * Distressed * Lucca * Marissa * Portofino * Riva * Saddle * Torello *
<i>Note:</i> Two-Tone Bertoia Diamond Chairs are not appropriate for outdoor use.	D Hologram * Masquerade * Zoom * E Aegean Highland Marquee * Sherman F Atelier Calais Cotton Velvet * Cornaro Icon * Intrigue In Stitches Totem * Tweed Frieze *	H Arno Bavaria Catwalk * Gezelle Magritte Stretch Appeal I Cato Dynamic Fiori Ita Knoll Velvet North Island Vermeer Zimba
Screws that attach the base to the basket are not painted to match the basket finish.		<i>Check with your KnollTextiles or Spinneybeck Representative for changes or additions.</i>

Harry Bertoia

Bird Lounge Chair and Ottoman

	description	seat h	w	d	h	textile fabric yds.	req. leather sq. ft.	weight
<i>Designer(s):</i> Harry Bertoia, 1952	423LU Bird high back chair, full cover with glides	14 1/2"	38 1/2"	33"	40 1/4"	3.8	n/a	21 lbs.
<i>Award(s):</i> "Designer of the Year," USA, 1955; Certificate of Merit, American Institute of Architects; Design Center Stuttgart Award, W. Germany, 1962								
	423F Full cover replacement					3.8	n/a	
	424YU Ottoman, full cover with glides	14 1/2"	23 1/2"	17 1/4"	14 1/2"	1.3	n/a	9 lbs.
								
	424F Full cover replacement					1.3	n/a	



pattern no.	grades A	COM B	C	D	E	F	G	H	I
423L-(C,1,2)-U	\$4,491.	\$4,669.	\$4,837.	\$5,023.	\$5,172.	\$5,281.	\$5,466.	\$5,822.	\$6,079.
423F-()	1,391.	1,552.	1,707.	1,875.	2,011.	2,112.	2,275.	2,604.	2,836.
424Y-(C,1,2)-U	1,464.	1,522.	1,575.	1,641.	1,692.	1,732.	1,789.	1,914.	2,001.
424F-()	586.	641.	690.	744.	794.	829.	883.	996.	1,076.

Order Code

<i>Example:</i>	423L-C-U-K1084/9
423L	Bird high back chair
C	Polished Chrome
U	Full cover
K1084/9	Harrison, Dunbar

Specify:

1. Pattern number
2. Finish selection
3. Upholstery option
4. Textile selection

For cushion replacement, specify:

1. Pattern number
2. Textile selection

Ordering Information

Frame finishes:

- Black (suffix 1)
- Polished Chrome (suffix C)
- White (suffix 2)

Upholstery/COM information:

Prices shown include fabric or leather upholstery. Contact your Knoll representative for colors. Only approved KnollTextiles and Spinneybeck leathers may be ordered.

Customer's Own Material is available pending approval. For approval requirements, processing instructions and ordering information please see page 18.

Cal 133 Fire Code #:

The Bird chair and ottoman complies with the California Technical Bulletin 133 standard if upholstered in Cal133 approved KnollTextiles. Specify suffix -C at end of pattern number and suffix -133 at end of textile selection.

Maintenance:

See pages 28-29.

Note:

The Knoll logo is stamped into the base of the chair and bench.

The Bertoia Bird Lounge Seating is Greenguard certified.

Construction

Frame:

Welded steel with rods in polished chrome or bonded rilsan, a very durable and adhesive fused nylon-dipped finish. Scratch, chip, and chemical resistant. Stainless steel connections. Four plastic glides. Frame wire diameter measures 4.5mm. Interlacement wire diameter measures 4mm.

Upholstery:

High back chairs only available with full cover. Full covers are stretched over wire frame and attach to seat basket with hooks. Full cover replacement for High Back Chairs fit all Bertoia High Back Chairs manufactured since 1952 within a limited range of tolerance.



Approved KnollTextiles Grades/Fabrics

A Common Ground Crossroad Delite Hourglass Mariner Presto Sonnet Trophy Uni-Form	C Classic Boucle # Entourage Pullman Swing	H Arno Bavaria Gezelle Magritte Stretch Appeal
B Diva Ferry Helios Journey Keaton Knoll Felt Knoll Hopsack Little Devil Synth	E Aegean Highland	I Cato Dynamic Fiori Ita Knoll Velvet North Island Vermeer Zimba
	F Atelier Cornaro Intrigue In Stitches	
	G Alter Ego Feeling Plaid Haze Melange Modern Tweed Sablon Ultrasuede	

Check with your KnollTextiles Representative for changes or additions.

Harry Bertoia

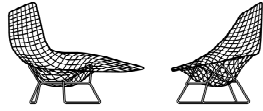
Asymmetric Chaise

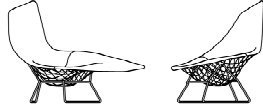
	description	seat h	w	d	h	textile fabric yds.	weight
<i>Designer(s):</i> Harry Bertoia, 1952	429L Asymmetric Chaise, unupholstered, with glides		52"	38 1/2"	40 1/4"		23 lbs.
<i>Award(s):</i> Honorable Mention, Annual Design Awards, ID Magazine 2006							
	429L Asymmetric Chaise, seat pad, with glides		52"	38 1/2"	40 1/4"	2.5	24 lbs.
							
	429K Seat cushion replacement					2.5	
	429L Asymmetric Chaise, fully upholstered, with glides		52"	38 1/2"	40 1/4"	4.5	22 lbs.
							
	429F Full cover replacement					4.5	

pattern no.	grades	COM	C	D	E	F	G	H	I
429L-()		\$10,340.							
429L-()-K		11,103.	11,179.	11,254.	11,336.	11,403.	11,455.	11,536.	11,696.
429K-()		812.	885.	957.	1,034.	1,098.	1,142.	1,223.	1,370.
429L-()-U		11,847.	11,987.	12,124.	12,272.	12,392.	12,483.	12,632.	12,915.
429F-()		1,934.	2,067.	2,194.	2,335.	2,450.	2,534.	2,674.	2,942.
									3,136.

Order Code

<i>Example:</i>	429L-C-U-K1152/8
429L	Asymmetric chaise
C	Polished Chrome
U	Fully upholstered
K1152/8	Stirling, Cobble

Specify:

1. Pattern number
2. Frame finish
3. Upholstery option
4. Textile selection

For seat cushion replacement specify:

1. Pattern number
2. Textile selection

Ordering Information

Frame finishes:

- Chrome (suffix C)
- White (suffix 2)

Upholstery options:

- Fully upholstered (suffix U)
- Seat cushion only (suffix K)

Upholstery/COM information:

Prices shown include fabric or leather upholstery. Contact your Knoll representative for colors. Only approved KnollTextiles and Spinneybeck leathers may be ordered.

Customer's Own Material is available pending approval. For approval requirements, processing instructions and ordering information please see page 18.

Outdoor Use:

With proper care and limited exposure to the elements, the 429 Bertoia Asymmetric chaise is appropriate for outdoor environments. Specify rilsan finish. Consult a Knoll representative for appropriate upholstery options.

Cal 133 Fire Code #:

The Asymmetric chaise complies with the California Technical Bulletin 133 standard if upholstered in Cal 133 approved KnollTextiles. Specify suffix -C at end of pattern number and suffix -133 at end of textile selection.

Maintenance:

See pages 28-29.

Note:

The Knoll logo is stamped into the base of the Chaise.

The Bertoia Asymmetric Chaise is Greenguard certified.

Construction

Frame:

Welded steel rods in polished chrome or bonded white rilsan, a very durable and adhesive fused nylon-dipped finish. Scratch, chip and chemical resistant. Chrome chair features chrome connections. White rilsan chair features stainless steel connections suitable for outdoor use. Holes are drilled for the glides, and are included with the Chaise.

Upholstery:

Seat cushion secured to chair with lock-snaps. Full covers are stretched over wire frame and attach with hooks. Seat cushions and full covers will ship already attached to the chaise. If ordering a full cover replacement, installation must be performed by Knoll Field Services.

Approved KnollTextiles Grades/Fabrics

A Common Ground **	C Classic Boucle # Entourage Pullman Swing * Theory *	F Atelier Cornaro Intrigue In Stitches *	H Arno ** Bavaria Gezelle Magritte Stretch Appeal
B Diva Ferry Journey Keaton Knoll Felt Knoll Hopsack Little Devil Ransom * Synth Venue * Vinyl *	E Aegean Highland	G Alter Ego Feeling Plaid * Haze * Kinabalu * Melange Modern Tweed Sablon Ultrasuede * Utrillo *	I Dynamic Fiori Ita Knoll Velvet * North Island Vermeer Zimba

* Available on seat cushion only.
** Available on full cover only.

Check with your KnollTextiles Representative for changes or additions.

Harry Bertoia Bench

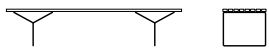
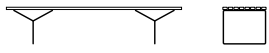
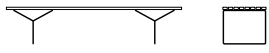
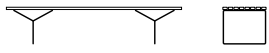
	description	seat h	w	d	h	textile fabric yds.	req.leather sq. ft.	weight	frame
<i>Designer(s):</i> Harry Bertoia, 1952	400Y Bench 	15 1/4"	72"	19"	15 1/4"			32 lbs.	Chrome
	400K Seat cushion (one of maximum three) 		19"	19"	3"	1.2	15	2 lbs.	
	410Y Outdoor Teak Bench 	15 1/4"	72"	19"	15 1/4"			32 lbs.	Paint
		15 1/4"	72"	19"	15 1/4"			32 lbs.	Stainless
	410K Outdoor Seat cushion (one of maximum three) 		19"	19"	3"	1.2	15	2 lbs.	

Order Code	Ordering Information
<i>Example:</i> 400Y-CBL	<i>Bench frame/slat finish combinations:</i>
400Y Bench	Chrome/black (suffix CBL)
C1 Chrome frame with black slats	Chrome/white (suffix CW)
	Black/teak (suffix BLK)
	White/teak (suffix WK)
	Stainless/teak (suffix SK)
<i>Example:</i> 400K-H800/19	
400K Seat cushion	
H800/19 Cato, Fire Red	
<i>Example:</i> 410K-K1557/8	
410K Outdoor Seat Cushion	
K1557/8 Baxter, Hazel	

- Specify:*
1. Pattern number
 2. Frame/Slat finish selection
 3. Seat cushion option
 4. Textile selection

- For seat cushion only, specify:*
1. Pattern number
 2. Textile selection

Customer's Own Material is available pending approval. For approval requirements, processing instructions and ordering information please see page 18.

Upholstery/COM information:
Prices shown include fabric or leather upholstery. Contact your Knoll representative for colors. Only approved KnollTextiles and Spinneybeck leathers may be ordered.

Maintenance:
See pages 28-29.

Note:
The Knoll logo is stamped into the base of the bench.

Construction

Bench platform:
Solid wood horizontal slats pre-treated to help prevent sagging or warping. Slats in black or white painted finish and teak. Base wire diameter measures 12mm.

Platform bench cushion available separately: firm foam cushions upholstered with welt detail. Three cushions maximum per bench.

Outdoor use:
With proper care and preventative maintenance, benches specified with painted or stainless steel base and teak slats are appropriate for outdoor use.

To specify outdoor bench cushions, use pattern number 410K and appropriate outdoor upholstery.

Outdoor paint:
Ultra-durable polyester powder coat paint.

pattern no.	grades	COM	C	D	E	F	G	H	I	COL	V	W	X	Y	
400Y-(CBL,CW)	\$3,555.														
400K-()		467.	515.	559.	610.	651.	682.	730.	826.	898.	987.	1,106.	1,347.	1,400.	1,455.
410Y-(BLK,WK)	2,625.														
410Y-SK	3,316.														
410K-()		0.	515.	559.	0.	0.	0.	0.	0.	0.	0.	0.	0.	0.	

Approved KnollTextiles Grades/Fabrics

- | | | | | | | | | |
|---|---|---|--|---|---|---|--|---|
| A
Alignment
Bocce
Cat's Cradle
Chance
Common Ground
Commuter Cloth
Crossroad
Delite
Dristi
Foil Rap
Heavy Metal
Hourglass
Mariner
Monarch
Prep
Presto
Soliloquy
Sonnet
Stacks
Trophy
Uni-Form | B continued
Little Devil
Ludlow
Lyric
Melody
Mini Stitch
Night Life
Paradigm
Petal Pusher
Pogo
Prairie *
Prim
Radiance
Ransom
Ricochet
Roam
Rush Hour
Soiree
Spark
Spree
Summit
Sutton
Synth
Tabloid
Tinge
Venue
Versa
Vinyl
Westwood
Wide Angle
Zipline | C continued
Enmesh
Entourage
Essence
Fable CR
Fibra
Greenwich
Hudson
Hula Hoop
Kaleidoscope CR
Kaya CR
Kora CR
Lagos
Legend CR
Lore CR
Metro
Milestone
Moto CR
Noble *
Palisade
Panache CR
Pullman
Quark
Regard CR
Roundtrip
Sahara
Sandpiper
Sashiko
Sequin CR
Sinclair *
Smart
Spectator
Spot On
Star Struck
Stepping Stones
Swing
Tilden
Tower Grid
Treble CR
Vibe
Wit
Zari CR
Zen Wave | D continued
Kabuki
Masquerade
Menagerie
Origins
Tara
Theory
Woodland
Zoom

E
Aegean
Demure
Highland
Ikat Stripe
Ikat Square
Kampala
Katazome
Kimono
Mamba
Marquee
Meroe
Midpoint
Nature Walk
Sherman
Shima
Tryst
Vatera | F
Alter Ego
Amore
Arabella
Arber
Brugge
Djenne
Feeling Plaid
Gibson
Hampshire
Haze
Kamani
Kinabalu
Kingston
Melange
Metallic Gloss
Modern Tweed
Petite Floral
Sablon
Serendipity
Spencer
Straie Stripe
Ultrasuede
Utrillo

H
Arno
Bavaria
Catwalk
Constance
Firefly | G
Atelier
Biscayne
Century
Coco
Cornaro
Glider
Icon
Intrigue
In Stitches
Jasmine
Liberty
Mod Plaid
Rivington
Tivoli
Topography
Totem
Tweed Frieze | H continued
Gezelle
Magritte
Rosemond
Stretch Appeal

I
Aswan
Byron
Canaan
Cato
Cummings
Diamond Days
Digi Velvet
Dynamic
Fiori
Ita
Jaipur
Knoll Velvet
Limani
North Island
Olema
Piper
Rutledge
Sandis
Tudor
Vermeer
Walker
Worth
Zimba | U
Vicenza
Volo

V
Acqua
Andes
Embossed Tipped
España
Hand Tipped
Maremma
Velluto Pelle

W
Alaska
Amazon
Antique
Derby
Forte
Lucente
Sabrina | X
Ducale
Ducale Velour





Y
Capri
Cervo
Copenhagen
Lucca
Marissa
Portofino
Riva
Saddle
Torello |
|---|---|---|--|---|---|---|--|---|

Spinneybeck Leather

- *Appropriate for outdoor use. Specify 410K.
- Check with your KnollTextiles or Spinneybeck Representative for changes or additions.*

Harry Bertoia

Bertoia Molded Shell Side Chair and Barstool

	description	seat h	w	d	h	weight	base finish
<i>Designer(s):</i> Harry Bertoia, 1952	410 Shell Side chair 	17 3/4"	21 3/4"	19 3/4"	28 3/4"	14 lbs.	Painted
		17 3/4"	21 3/4"	19 3/4"	28 3/4"	14 lbs.	Polished chrome
	412 Barstool, counter height 	27 1/2"	21 3/4"	22"	39 1/2"	22 lbs.	Painted
		27 1/2"	21 3/4"	22"	39 1/2"	22 lbs.	Polished Chrome
	411 Shell Barstool, bar height 	29 1/4"	21 3/4"	22"	41 1/4"	23 lbs.	Painted
		29 1/4"	21 3/4"	22"	41 1/4"	23 lbs.	Polished chrome

pattern no.	
410-(-)(-)	\$520.
410-C-(-)	540.
412-(-)(-)	860.
412-C-(-)	880.
411-(-)(-)	860.
411-C-(-)	880.

Order Code	Ordering Information	Construction
<i>Example:</i> 410-WH-C	<i>Shell finishes:</i> Black (suffix BL) White (suffix WH) Medium Grey (suffix MG) Blue (suffix BU) Orange Red (suffix OR) Yellow (suffix YE)	<i>Base:</i> Welded steel rods in polished chrome or highly durable bonded powder coat (white and black). Side Chairs: diameter of the base rods are 11mm featuring stainless steel connections and plastic glides. Bar and Counter Height Stools: the diameter of the base rods are 14mm featuring stainless steel connections and 1 1/4" wide round articulated glides with metal cover.
410 Shell side chair	<i>Base finishes:</i> Polished Chrome (suffix C) Black (suffix BL) White (suffix W)	<i>Basket:</i> Glass fiber reinforced nylon shell
WH White shell		<i>Note: Bertoia Molded Shell Chairs and Stools are not appropriate for outdoor use.</i>
C Polished chrome base		
<i>Specify:</i>		
1. Pattern number		
2. Shell finish		
3. Base finish		

Pierre Beucler and Jean-Christophe Poggioli Architecture & Associés Contract Lounge Seating

Designer(s):
Pierre Beucler and
Jean-Christophe Poggioli, 2012



description	seat h	arm h	w	d	h	type	textile	leather	weight
							fabric yds	sq ft	
AAC4 AA Small Lounge chair, low back, std. wing, same upholstery, frame and cushions	16 1/2"	—	27 1/8"	32 3/4"	30 1/8"		4.4	81	—
AAC4 AA Small Lounge chair, low back, std. wing, combination upholstery, frame and cushions	—	—	—	—	—	frame	2.4	41	—
						upchg, cushions	2.3	40	—
AAC1 AA Lounge chair, low back, std. wing, arm cushions, same upholstery, frame and cushions	16 1/2"	—	31 1/2"	32 3/4"	30 1/8"		6.3	113	—
AAC1 AA Lounge chair, low back, std. wing, arm cushions, combination upholstery, frame and cushions	—	—	—	—	—	frame	3.2	50	—
						upchg, cushions	3.5	63	—

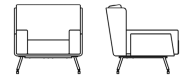
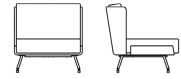

Order Code	Ordering Information	Construction
<i>Example:</i> AAC4-CU-K1479/6-K1406/7	<i>Leg finishes:</i> Chrome (suffix C) Copper (suffix CU)	<i>Frame:</i> Constructed in two formed plywood frames, back and seat, giving the pieces their architectural form. Frames are softened with highly resilient urethane foam wrapping.
AAC4 AA Small Lounge Chair	<i>Copper leg upcharge:</i> Copper leg finish is available at an upcharge of \$393 list. Use suffix CU to specify.	<i>Cushion fill:</i> "Contract" back and seat cushion are multi-density urethane foam.
CU Copper legs		<i>Legs:</i> Machined steel legs feature height adjustable feet for leveling.
K1479/6 Surround in Haiku, Storm		<i>Upholstery:</i> Interior loose cushions are available in either residential or contract versions. Contract cushions provide a tailored look for high use areas, while residential cushions convey a relaxed aesthetic. For units with combination upholstery, add list price of surround in appropriate grade with the list price of cushions to obtain total list price for item.
K1406/7 Cushions in Sonnet, Denim		
<i>Specify:</i> 1. Pattern number 2. Leg finish 3. Textile selection	<i>Upholstery/ COM information:</i> Prices shown includes fabric or leather upholstery. Contact your Knoll representative for colors. Only approved KnollTextiles and Spinneybeck leathers may be ordered.	
<i>Specify with split upholstery:</i> 1. Pattern number 2. Leg finish 3. Textile selection, Surround 4. Textile selection, Cushions	Customer's Own Material is available pending approval. For approval requirements, processing instructions and ordering information please see page 18.	
	<i>Maintenance:</i> See pages 28-29.	

pattern no.	grades	COM	C	D	E	F	G	H	I	COL	V	W	X	Y
	A	B								U				
AAC4-(-)(-)	\$3,994.	\$4,094.	\$4,191.	\$4,297.	\$4,383.	\$4,447.	\$4,552.	\$4,753.	\$4,904.	\$5,996.	\$6,365.	\$7,117.	\$7,275.	\$7,457.
AAC4S-(-)(-)	3,024.	3,079.	3,131.	3,189.	3,236.	3,270.	3,327.	3,437.	3,521.	3,981.	4,167.	4,550.	4,629.	4,722.
AAC4 cushions	1,182.	1,237.	1,286.	1,342.	1,387.	1,420.	1,476.	1,581.	1,659.	2,095.	2,277.	2,649.	2,726.	2,816.
AAC1-(-)(-)	4,387.	4,531.	4,669.	4,820.	4,945.	5,034.	5,186.	5,474.	5,688.	7,093.	7,608.	8,658.	8,877.	9,130.
AAC1S-(-)(-)	3,259.	3,334.	3,403.	3,480.	3,543.	3,589.	3,667.	3,813.	3,921.	4,397.	4,626.	5,090.	5,186.	5,298.
AAC1 cushions	1,347.	1,428.	1,505.	1,589.	1,658.	1,707.	1,791.	1,952.	2,071.	2,775.	3,063.	3,648.	3,771.	3,912.

Approved KnollTextiles Grades/Fabrics						Spinneybeck Leather		
A Chance Common Ground Commuter Cloth Crossroad Delite Dristi Hourglass Mariner Prep * Presto * Sonnet Stacks * Trophy Uni-Form *	B continued Pogo * Prairie * Ransom Ricochet * [†] Rush Hour Spark * Summit Sutton Synth * Tinge Venue * Westwood * Wide Angle Zipline	C continued Milestone * Palisade Panache * Quark * Sahara Sandpiper CR * Sequin CR * Spot On Stepping Stones * Swing Tilden *	D Eclat Weave * Menagerie	E Aegean Highland Kampala * Katazome Sherman Shima F Atelier Calais Cotton Velvet * Coco * Cornaro Icon Liberty Rivington * Soon Tivoli Topography *	G Alter Ego Brugge * Feeling Plaid * Hampshire * Haze Kamani * Kingston Melange Modern Tweed * Petite Floral Ultrasuede H Arno Gezelle Magritte Rosemond	I Cato Dynamic Knoll Velvet * [†] Piper * Rutledge Tudor Vermeer	U Vicenza Volo V Acqua Andes Embossed Tipped España Velluto Pelle W Alaska Amazon Antique Forte Sabrina * Not approved on frame [†] Indicates fabrics without topstitching Knoll Felt/Ivory K1207/1 not approved	X Ducale Velour Y Capri Cervo Copenhagen Distressed Marissa Riva Saddle

Check with your KnollTextiles or Spinneybeck Representative for additions or changes.

Pierre Beucler and Jean-Christophe Poggioli Architecture & Associés Contract Lounge Seating

Designer(s):
Pierre Beucler and
Jean-Christophe Poggioli, 2012



description	seat h	arm h	w	d	h	type	textile	leather	weight
							fabric yds	sq ft	
AAC2 AA Settee, low back, std. wing, arm cushions, same upholstery, frame and cushions	16 1/2"	—	58"	32 3/4"	30 1/8"		9.3	170	—
AAC2 AA Settee, low back, std. wing, arm cushions, combination upholstery, frame and cushions	—	—	—	—	—	frame uph.	4	70	—
						upchg, cushions	5.3	100	—
AAC3 AA Sofa, low back, std. wing, arm cushions, same upholstery, frame and cushions	16 1/2"	—	85 1/4"	32 3/4"	30 1/8"		11.5	225	—
AAC3 AA Sofa, low back, std. wing, arm cushions, combination upholstery, frame and cushions	—	—	—	—	—	frame uph.	4.7	90	—
						upchg, cushions	7.2	138	—

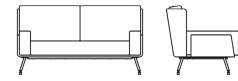

Order Code	Ordering Information	Construction
<i>Example:</i> AAC4-CU-K1479/6-K1406/7	<i>Leg finishes:</i> Chrome (suffix C) Copper (suffix CU)	<i>Frame:</i> Constructed in two formed plywood frames, back and seat, giving the pieces their architectural form. Frames are softened with highly resilient urethane foam wrapping.
AAC4 AA Small Lounge Chair	<i>Copper leg upcharge:</i> Copper leg finish is available at an upcharge of \$393 list. Use suffix CU to specify.	<i>Cushion fill:</i> "Contract" back and seat cushion are multi-density urethane foam.
CU Copper legs		<i>Legs:</i> Machined steel legs feature height adjustable feet for leveling.
K1479/6 Surround in Haiku, Storm		<i>Upholstery:</i> Interior loose cushions are available in either residential or contract versions. Contract cushions provide a tailored look for high use areas, while residential cushions convey a relaxed aesthetic. For units with combination upholstery, add list price of surround in appropriate grade with the list price of cushions to obtain total list price for item.
K1406/7 Cushions in Sonnet, Denim		
<i>Specify:</i> 1. Pattern number 2. Leg finish 3. Textile selection	<i>Upholstery/ COM information:</i> Prices shown includes fabric or leather upholstery. Contact your Knoll representative for colors. Only approved KnollTextiles and Spinneybeck leathers may be ordered.	
<i>Specify with split upholstery:</i> 1. Pattern number 2. Leg finish 3. Textile selection, Surround 4. Textile selection, Cushions	Customer's Own Material is available pending approval. For approval requirements, processing instructions and ordering information please see page 18.	
	<i>Maintenance:</i> See pages 28-29.	

pattern no.	grades	COM	C	D	E	F	G	H	I	COL	V	W	X	Y
	A	B								U				
AAC2-(-)(-)	\$6,192.	\$6,406.	\$6,608.	\$6,833.	\$7,015.	\$7,147.	\$7,371.	\$7,798.	\$8,113.	\$10,301.	\$11,077.	\$12,656.	\$12,984.	\$13,367.
AAC2S-(-)(-)	4,548.	4,639.	4,728.	4,822.	4,903.	4,958.	5,055.	5,239.	5,375.	6,161.	6,481.	7,132.	7,268.	7,424.
AAC2 cushions	1,963.	2,084.	2,199.	2,328.	2,432.	2,507.	2,634.	2,877.	3,057.	4,235.	4,693.	6,714.	5,814.	6,040.
AAC3-(-)(-)	7,913.	8,176.	8,427.	8,705.	8,931.	9,095.	9,371.	9,899.	10,288.	13,396.	14,424.	16,513.	16,949.	17,455.
AAC3S-(-)(-)	5,721.	5,829.	5,932.	6,044.	6,137.	6,203.	6,316.	6,531.	6,691.	7,816.	8,227.	9,062.	9,237.	9,439.
AAC3 cushions	2,630.	2,796.	2,954.	3,126.	3,268.	3,370.	3,543.	3,874.	4,117.	5,767.	6,398.	7,680.	7,946.	8,259.

Approved KnollTextiles Grades/Fabrics				Spinneybeck Leather									
A Chance Common Ground Commuter Cloth Crossroad Delite Dristi Hourglass Mariner Prep * Presto * Sonnet Stacks * Trophy Uni-Form *	B Argyle * Belize * Cameo Chroma Diva Ferry * Helios Journey Knoll Felt Knoll Hopsack Little Devil Ludlow Lyric Melody	C continued Pogo * Prairie * Ransom Ricochet * [†] Rush Hour Spark * Summit Sutton Synth * Tinge Venue * Westwood * Wide Angle Zipline	D Eclat Weave * Menagerie	E Aegean Highland Kampala * Katazome Sherman Shima	F Atelier Calais Cotton Velvet * Coco * Cornaro Icon Liberty Rivington * Soon Tivoli Topography *	G Alter Ego Brugge * Feeling Plaid * Hampshire * Haze Kamani * Kingston Melange Modern Tweed * Petite Floral Ultrasuede	H Arno Gezelle Magritte Rosemond	I Cato Dynamic Knoll Velvet * [†] Piper * Rutledge Tudor Vermeer	U Vicenza Volo	V Acqua Andes Embossed Tipped España Velluto Pelle	W Alaska Amazon Antique Forte Sabrina	X Ducale Velour	Y Capri Cervo Copenhagen Distressed Marissa Riva Saddle

* Not approved on frame
† Indicates fabrics without topstitching
Knoll Felt/Ivory K1207/1 not approved

Check with your KnollTextiles or Spinneybeck Representative for additions or changes.



Pierre Beucler and Jean-Christophe Poggioli

Architecture & Associés

Contract Lounge Seating

Designer(s):
Pierre Beucler and
Jean-Christophe Poggioli, 2012



description	seat h	arm h	w	d	h	type	textile fabric yds	leather sq ft	weight
AAC5 AA Small Ottoman, same upholstery, frame and cushions 	–	–	27 1/2"	24 1/2"	16"		2.2	40	–
AAC5 AA Small Ottoman, combination upholstery, frame and cushions	–	–	–	–	–	frame uph.	1.2	18	–
	–	–	–	–	–	upchg, cushions	1.3	22	–
AAC6 AA Medium Ottoman, same upholstery, frame and cushions 	–	–	31 1/8"	29 1/2"	16"		3.3	60	–
AAC6 AA Medium Ottoman, combination upholstery, frame and cushions	–	–	–	–	–	frame uph.	1.8	28	–
	–	–	–	–	–	upchg, cushions	2.3	32	–
AAC7 AA Large Ottoman, same upholstery, frame and cushions 	–	–	59"	29 1/2"	16 1/2"		4.5	70	–
AAC7 AA Large Ottoman, combination upholstery, frame and cushions	–	–	–	–	–	frame uph.	2.2	31	–
	–	–	–	–	–	upchg, cushions	2.7	43	–

Order Code	Ordering Information	Construction
<i>Example:</i> AAC7-C-K1617/3	<i>Leg finishes:</i> Chrome (suffix C) Copper (suffix CU)	<i>Frame:</i> Constructed in two formed plywood frames, back and seat, giving the pieces their architectural form. Frames are softened with highly resilient urethane foam wrapping.
AAC7 AA Large Ottoman		<i>Cushion fill:</i> "Contract" back and seat cushion are multi-density urethane foam.
C Chrome legs		<i>Legs:</i> Machined steel legs feature height adjustable feet for leveling.
K1617/3 Dynamic, Radiant	<i>Copper leg upcharge:</i> Copper leg finish is available at an upcharge of \$393 list. Use suffix CU to specify.	<i>Upholstery:</i> Interior loose cushions are available in either residential or contract versions. Contract cushions provide a tailored look for high use areas, while residential cushions convey a relaxed aesthetic. For units with combination upholstery, add list price of surround in appropriate grade with the list price of cushions to obtain total list price for item.
<i>Specify:</i> 1. Pattern number 2. Leg finish 3. Textile selection	<i>Upholstery/ COM information:</i> Prices shown includes fabric or leather upholstery. Contact your Knoll representative for colors. Only approved KnollTextiles and Spinneybeck leathers may be ordered.	
<i>Specify with split upholstery:</i> 1. Pattern number 2. Leg finish 3. Textile selection, Surround 4. Textile selection, Cushions	Customer's Own Material is available pending approval. For approval requirements, processing instructions and ordering information please see page 18.	
	<i>Maintenance:</i> See pages 28-29.	

pattern no.	grades A	COM B	C	D	E	F	G	H	I	COL U	V	W	X	Y
AAC5-(-)(-)	\$2,340.	\$2,393.	\$2,440.	\$2,492.	\$2,537.	\$2,567.	\$2,620.	\$2,721.	\$2,795.	\$3,357.	\$3,539.	\$3,911.	\$3,989.	\$4,078.
AAC5S-(-)(-)(-)	1,780.	1,808.	1,833.	1,863.	1,886.	1,903.	1,932.	1,988.	2,137.	2,193.	2,275.	2,443.	2,477.	2,518.
AAC5 cushions	706.	736.	765.	796.	822.	840.	871.	931.	975.	1,203.	1,304.	1,508.	1,551.	1,601.
AAC6-(-)(-)	2,466.	2,541.	2,613.	2,692.	2,757.	2,804.	2,884.	3,034.	3,147.	3,926.	4,200.	4,759.	4,874.	5,010.
AAC6S-(-)(-)(-)	1,853.	1,895.	1,934.	1,978.	2,013.	2,039.	2,082.	2,164.	2,226.	2,485.	2,615.	2,875.	2,928.	2,992.
AAC6 cushions	791.	844.	894.	950.	994.	1,027.	1,084.	1,190.	1,267.	1,481.	1,626.	1,923.	1,986.	2,057.
AAC7-(-)(-)	3,736.	3,839.	3,937.	4,045.	4,133.	4,197.	4,305.	4,512.	4,665.	5,479.	5,816.	6,504.	6,647.	6,814.
AAC7S-(-)(-)(-)	2,870.	2,920.	2,967.	3,021.	3,064.	3,096.	3,148.	3,250.	3,324.	3,552.	3,694.	3,983.	4,042.	4,112.
AAC7 cushions	1,018.	1,080.	1,138.	1,204.	1,258.	1,296.	1,360.	1,484.	1,576.	1,966.	2,162.	2,561.	2,645.	2,742.

Approved KnollTextiles Grades/Fabrics						Spinneybeck Leather							
A Chance Common Ground Commuter Cloth Crossroad Delite Dristi Hourglass Mariner Prep * Presto * Sonnet Stacks * Trophy	B continued Melody Pogo * Prairie * Ransom Ricochet *† Rush Hour Spark * Summit Sutton Synth Tinge Venue * Westwood * Wide Angle Zipline	C continued Milestone * Palisade Panache * Quark * Sahara Sandpiper CR * Sequin CR * Spot On Stepping Stones * Swing Tilden *	E Aegean Highland Kampala * Katazome Sherman Shima	F Atelier Calais Cotton Velvet * Coco * Cornaro Icon Liberty Rivington * Soon Tivoli Topography *	G Alter Ego Brugge * Feeling Plaid * Hampshire * Haze Kamani * Kingston Melange Petite Floral Ultrasuede	H Arno Gezelle Magritte Rosemond	I Cato Dynamic Knoll Velvet *† Piper * Rutledge Tudor Vermeer	U Vicenza Volo	X Ducale Velour	Y Capri Cervo Copenhagen Distressed Marissa Riva Saddle	V Acqua Andes Embossed Tipped España Velluto Pelle	W Alaska Amazon Antique Forte Sabrina	* Not approved on frame † Indicates fabrics without topstitching Knoll Felt/Ivory K1207/1 not approved

Check with your KnollTextiles or Spinneybeck Representative for additions or changes.

Pierre Beucler and Jean-Christophe Poggioli Architecture & Associés Residential Lounge Seating

Designer(s):
Pierre Beucler and
Jean-Christophe Poggioli, 2012



description	seat h	arm h	w	d	h	type	textile	leather	weight
							fabric yds	sq ft	
AAR4 AA Small Lounge chair, low back, std. wing, same upholstery, frame and cushions	16 1/2"	—	27 3/8"	32 3/4"	30 1/8"		4.5	82	—
AAR4 AA Small Lounge chair, low back, std. wing, combination upholstery, frame and cushions	—	—	—	—	—	from uph.	2.4	42	—
	—	—	—	—	—	upchg, cushions	2.5	40	—
AAR1 AA Lounge chair, low back, std. wing, arm cushions, same upholstery, frame and cushions	16 1/2"	—	31 1/2"	32 3/4"	30 1/8"		6.4	118	—
AAR1 AA Lounge chair, low back, std. wing, arm cushions, combination upholstery, frame and cushions	—	—	—	—	—	frame uph.	3.1	50	—
	—	—	—	—	—	upchg, cushions	4.7	68	—



Order Code	Ordering Information	Construction
<i>Example:</i> AAR1-CU-CV44-H800/2	<i>Leg finishes:</i> Chrome (suffix C) Copper (suffix CU)	<i>Frame:</i> Constructed in two formed plywood frames, back and seat, giving the pieces their architectural form. Frames are softened with highly resilient urethane foam wrapping.
AAR1 AA Lounge Chair		<i>Cushion fill:</i> "Residential" back cushion is 100% polyester fiber and the seat is a multi-density urethane foam.
CU Copper legs		<i>Legs:</i> Machined steel legs feature height adjustable feet for leveling.
CV44 Surround in Cervo, Lessinia	<i>Copper leg upcharge:</i> Copper leg finish is available at an upcharge of \$393 list. Use suffix CU to specify.	<i>Upholstery:</i> Interior loose cushions are available in either residential or contract versions. Contract cushions provide a tailored look for high use areas, while residential cushions convey a relaxed aesthetic. For units with combination upholstery, add list price of surround in appropriate grade with the list price of cushions to obtain total list price for item.
H800/2 Cushions in Cato, Sand	<i>Upholstery/ COM information:</i> Prices shown includes fabric or leather upholstery. Contact your Knoll representative for colors. Only approved KnollTextiles and Spinneybeck leathers may be ordered.	
	Customer's Own Material is available pending approval. For approval requirements, processing instructions and ordering information please see page 18.	
	<i>Maintenance:</i> See pages 28-29.	

Specify:

1. Pattern number
2. Leg finish
3. Textile selection

Specify with split upholstery:

1. Pattern number
2. Leg finish
3. Textile selection, Surround
4. Textile selection, Cushions

pattern no.	grades	COM	C	D	E	F	G	H	I	COL	V	W	X	Y
AAR4-(-)(-)	\$3,981.	\$4,083.	\$4,182.	\$4,290.	\$4,379.	\$4,443.	\$4,552.	\$4,759.	\$4,910.	\$6,002.	\$6,376.	\$7,138.	\$7,295.	\$7,481.
AAR4S-(-)(-)	3,011.	3,065.	3,118.	3,175.	3,222.	3,256.	3,315.	3,425.	3,505.	3,994.	4,185.	4,575.	4,658.	4,750.
AAR4 cushions	1,192.	1,247.	1,303.	1,363.	1,412.	1,448.	1,508.	1,623.	1,707.	2,088.	2,270.	2,643.	2,720.	2,809.
AAR1-(-)(-)	4,374.	4,521.	4,661.	4,814.	4,941.	5,031.	5,185.	5,479.	5,695.	7,203.	7,741.	8,837.	9,065.	9,331.
AAR1S-(-)(-)	3,240.	3,311.	3,379.	3,454.	3,513.	3,559.	3,633.	3,776.	3,881.	4,383.	4,611.	5,076.	5,173.	5,285.
AAR1 cushions	1,423.	1,532.	1,635.	1,747.	1,841.	1,907.	2,019.	2,234.	2,395.	2,899.	3,209.	3,841.	3,973.	4,126.

Approved KnollTextiles Grades/Fabrics

A Chance Common Ground Commuter Cloth Crossroad Delite Dristi Hourglass Mariner Prep * Presto * Sonnet Stacks * Trophy	B continued Melody Pogo * Prairie * Ransom Ricochet * [†] Rush Hour Spark * Summit Sutton Synth * Tinge Venue * Westwood * Wide Angle Zipline	C continued Milestone * Palisade Panache * Quark * Sahara Sandpiper CR * Sequin CR * Spot On Stepping Stones * Swing Tilden *	D Eclat Weave * Menagerie	E Aegean Highland Kampala * Katazome Sherman Shima	F Atelier Calais Cotton Velvet * Coco * Cornaro Icon Liberty Rivington * Soon Tivoli Topography *	G Alter Ego Brugge * Feeling Plaid * Hampshire * Haze Kamani * Kingston Melange Petite Floral Ultrasuede	H Arno Gezelle Magritte Rosemond	I Cato Dynamic Knoll Velvet * [†] Piper Rutledge Tudor Vermeer	U Vicenza Volo	V Acqua Andes Embossed Tipped España Velluto Pelle	W Alaska Amazon Antique Forte Sabrina * Not approved on frame [†] Indicates fabrics without topstitching Knoll Felt/Ivory K1207/1 not approved	X Ducale Velour	Y Capri Cervo Copenhagen Distressed Marissa Riva Saddle
--	--	---	--	---	---	---	---	---	-----------------------------	--	--	---------------------------	---

Spinneybeck Leather

Check with your KnollTextiles or Spinneybeck Representative for additions or changes.

Pierre Beucler and Jean-Christophe Poggioli

Architecture & Associés

Residential Lounge Seating

Designer(s):
Pierre Beucler and
Jean-Christophe Poggioli, 2012

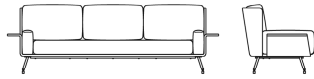

description	seat h	arm h	w	d	h	type	textile fabric yds	leather sq ft	weight
AAR2 AA Settee, low back, std. wing, arms, arm cushions, same upholstery, frame and cushions	16 1/2"	—	69 1/2"	32 3/4"	30 1/8"		9.5	177	—
						frame uph.	4.3	76	—
						upchg, cushions	6.7	101	—
AAR3 AA Sofa, low back, std. wing, arms, arm cushions, same upholstery, frame and cushions	16 1/2"	—	97"	32 3/4"	30 1/8"		12.5	231	—
						frame uph.	5.4	93	—
						upchg, cushions	8.5	138	—
AAR3 AA Sofa, low back, std. wing, arms, arm cushions, combination upholstery, frame and cushions	—	—	—	—	—				
						frame uph.	5.4	93	—
						upchg, cushions	8.5	138	—

Order Code	Ordering Information	Construction
<i>Example:</i> AAR1-CU-CV44-H800/2	<i>Leg finishes:</i> Chrome (suffix C) Copper (suffix CU)	<i>Frame:</i> Constructed in two formed plywood frames, back and seat, giving the pieces their architectural form. Frames are softened with highly resilient urethane foam wrapping.
AAR1 AA Lounge Chair		<i>Cushion fill:</i> “Residential” back cushion is 100% polyester fiber and the seat is a multi-density urethane foam.
CU Copper legs		<i>Legs:</i> Machined steel legs feature height adjustable feet for leveling.
CV44 Surround in Cervo, Lessinia	<i>Copper leg upcharge:</i> Copper leg finish is available at an upcharge of \$393 list. Use suffix CU to specify.	<i>Upholstery:</i> Interior loose cushions are available in either residential or contract versions. Contract cushions provide a tailored look for high use areas, while residential cushions convey a relaxed aesthetic. For units with combination upholstery, add list price of surround in appropriate grade with the list price of cushions to obtain total list price for item.
H800/2 Cushions in Cato, Sand	<i>Upholstery/ COM information:</i> Prices shown includes fabric or leather upholstery. Contact your Knoll representative for colors. Only approved KnollTextiles and Spinneybeck leathers may be ordered.	
<i>Specify:</i> 1. Pattern number 2. Leg finish 3. Textile selection	Customer’s Own Material is available pending approval. For approval requirements, processing instructions and ordering information please see page 18.	
<i>Specify with split upholstery:</i> 1. Pattern number 2. Leg finish 3. Textile selection, Surround 4. Textile selection, Cushions	<i>Maintenance:</i> See pages 28-29.	

pattern no.	grades A	COM B	C	D	E	F	G	H	I	COL U	V	W	X	Y
AAR2-(-)(-)	\$6,207.	\$6,424.	\$6,632.	\$6,860.	\$7,046.	\$7,182.	\$7,411.	\$7,847.	\$8,168.	\$10,483.	\$11,292.	\$12,936.	\$13,278.	\$13,676.
AAR2S-(-)(-)	4,568.	4,667.	4,762.	4,865.	4,949.	5,011.	5,113.	5,311.	5,456.	6,318.	6,664.	7,370.	7,518.	7,688.
AAR2 cushions	2,059.	2,213.	2,360.	2,519.	2,652.	2,747.	2,908.	3,216.	3,442.	4,262.	4,724.	5,661.	5,858.	6,084.
AAR3-(-)(-)	7,973.	8,262.	8,534.	8,835.	9,080.	9,258.	9,557.	10,132.	10,556.	13,545.	14,600.	16,746.	17,192.	17,712.
AAR3S-(-)(-)	5,763.	5,886.	6,005.	6,134.	6,240.	6,318.	6,447.	6,695.	6,879.	7,889.	8,312.	9,177.	9,358.	9,567.
AAR3 cushions	2,718.	2,912.	3,098.	3,302.	3,469.	3,592.	3,795.	4,185.	4,472.	5,765.	6,396.	7,678.	7,944.	8,254.

Approved KnollTextiles Grades/Fabrics				Spinneybeck Leather								
A Chance Common Ground Commuter Cloth Crossroad Delite Dristi Hourglass Mariner Prep * Presto * Sonnet Stacks * Trophy	B continued Melody Pogo * Prairie * Ransom Ricochet *† Rush Hour Spark * Summit Sutton Synth * Tinge Venue * Westwood * Wide Angle Zipline	C continued Milestone * Palisade Panache * Quark * Sahara Sandpiper CR * Sequin CR * Spot On Stepping Stones * Swing Tilden *	E Aegean Highland Kampala * Katazome Sherman Shima	F Atelier Calais Cotton Velvet * Coco * Cornaro Icon Liberty Rivington * Soon Tivoli Topography *	G Alter Ego Brugge * Feeling Plaid * Hampshire * Haze Kamani * Kingston Melange Petite Floral Ultrasuede	H Arno Gezelle Magritte Rosemond	I Cato Dynamic Knoll Velvet *† Piper Rutledge Tudor Vermeer	U Vicenza Volo	V Acqua Andes Embossed Tipped España Velluto Pelle	W Alaska Amazon Antique Forte Sabrina * Not approved on frame † Indicates fabrics without topstitching Knoll Felt/Ivory K1207/1 not approved	X Ducale Velour	Y Capri Cervo Copenhagen Distressed Marissa Riva Saddle

Check with your KnollTextiles or Spinneybeck Representative for additions or changes.

Pierre Beucler and Jean-Christophe Poggioli Architecture & Associés Residential Lounge Seating

Designer(s):
Pierre Beucler and
Jean-Christophe Poggioli, 2012



description	seat h	arm h	w	d	h	type	textile fabric yds	leather sq ft	weight
AAR8 AA Lounge chair, high back, std. wing, arm cushions, same upholstery, frame and cushions	16 1/2"	—	31 1/2"	36"	36 3/8"		7.3	132	—
AAR8 AA Lounge chair, high back, std. wing, arm cushions, combination upholstery, frame and cushions	—	—	—	—	—	frame uph.	3.6	60	—
	—	—	—	—	—	upchg, cushions	4.5	72	—
AAR9 AA Settee, high back, std. wing, arms, arm cushions, same upholstery, frame and cushions	16 1/2"	—	69 1/2"	36"	36 3/8"		11.2	203	—
AAR9 AA Settee, high back, std. wing, arms, arm cushions, combination upholstery, frame and cushions	—	—	—	—	—	frame uph.	5	89	—
	—	—	—	—	—	upchg, cushions	6.8	114	—



Order Code	Ordering Information	Construction
<i>Example:</i> AAR9-C-PR34-K128/3	<i>Leg finishes:</i> Chrome (suffix C) Copper (suffix CU)	<i>Frame:</i> Constructed in two formed plywood frames, back and seat, giving the pieces their architectural form. Frames are softened with highly resilient urethane foam wrapping.
AAR9	AA Settee, high back	<i>Cushion fill:</i> “Residential” back cushion is 100% polyester fiber and the seat is a multi-density urethane foam.
C	Chrome legs	<i>Legs:</i> Machined steel legs feature height adjustable feet for leveling.
PR34	Surround in Prima, Scarlatti	<i>Upholstery:</i> Interior loose cushions are available in either residential or contract versions. Contract cushions provide a tailored look for high use areas, while residential cushions convey a relaxed aesthetic. For units with combination upholstery, add list price of surround in appropriate grade with the list price of cushions to obtain total list price for item.
K128/3	Cushions in Arno, Obsidian	
<i>Specify:</i>	<i>Upholstery/ COM information:</i> Prices shown includes fabric or leather upholstery. Contact your Knoll representative for colors. Only approved KnollTextiles and Spinneybeck leathers may be ordered.	
<i>Specify with split upholstery:</i>	Customer’s Own Material is available pending approval. For approval requirements, processing instructions and ordering information please see page 18.	
	<i>Maintenance:</i> See pages 28-29.	

pattern no.	grades A	COM B	C	D	E	F	G	H	I	COL U	V	W	X	Y
AAR8-(-)(-)	\$4,456.	\$4,624.	\$4,782.	\$4,958.	\$5,102.	\$5,206.	\$5,382.	\$5,717.	\$5,965.	\$7,587.	\$8,191.	\$9,416.	\$9,673.	\$9,968.
AAR8S-(-)(-)	3,288.	3,370.	3,449.	3,535.	3,606.	3,657.	3,744.	3,909.	4,031.	4,658.	4,931.	5,489.	5,604.	5,740.
AAR8 cushions	1,416.	1,520.	1,618.	1,726.	1,815.	1,879.	1,987.	2,193.	2,345.	3,010.	3,338.	4,007.	4,147.	4,308.
AAR9-(-)(-)	6,496.	6,753.	6,998.	7,269.	7,488.	7,647.	7,916.	8,430.	8,810.	11,333.	12,262.	14,146.	14,539.	14,997.
AAR9S-(-)(-)	4,733.	4,847.	4,956.	5,077.	5,175.	5,246.	5,366.	5,596.	5,765.	6,773.	7,179.	8,005.	8,178.	8,378.
AAR9 cushions	2,123.	2,278.	2,428.	2,590.	2,724.	2,821.	2,984.	3,297.	3,528.	4,659.	5,178.	6,237.	6,458.	6,715.

Approved KnollTextiles Grades/Fabrics				Spinneybeck Leather								
A Chance Common Ground Commuter Cloth Crossroad Delite Dristi Hourglass Mariner Prep * Presto * Sonnet Stacks * Trophy	B continued Melody Pogo * Prairie * Ransom Ricochet *† Rush Hour Spark * Summit Sutton Synth * Tinge Venue * Westwood * Wide Angle Zipline	C continued Milestone * Palisade Panache * Quark * Sahara Sandpiper CR * Sequin CR * Spot On Stepping Stones * Swing Tilden *	E Aegean Highland Kampala * Katazome Sherman Shima	F Atelier Calais Cotton Velvet * Coco * Cornaro Icon Liberty Rivington * Soon Tivoli Topography *	G Alter Ego Brugge * Feeling Plaid * Hampshire * Haze Kamani * Kingston Melange Petite Floral Ultrasuede	H Arno Gezelle Magritte Rosemond	I Cato Dynamic Knoll Velvet *† Piper * Rutledge Tudor Vermeer	U Vicenza Volo	V Acqua Andes Embossed Tipped España Velluto Pelle	W Alaska Amazon Antique Forte Sabrina * Not approved on frame † Indicates fabrics without topstitching Knoll Felt/Ivory K1207/1 not approved	X Ducale Velour	Y Capri Cervo Copenhagen Distressed Marissa Riva Saddle

Check with your KnollTextiles or Spinneybeck Representative for additions or changes.

Pierre Beucler and Jean-Christophe Poggioli

Architecture & Associés

Residential Lounge Seating

Designer(s):
Pierre Beucler and
Jean-Christophe Poggioli, 2012



description	seat h	arm h	w	d	h	type	textile fabric yds	leather sq ft	weight
AAR10 AA Sofa, high back, std. wing, arms, arm cushions, same upholstery, frame and cushions	16 1/2"	—	97"	36"	36 3/8"		13.8	243	—
AAR10 AA Sofa, high back, std. wing, arms, arm cushions, combination upholstery, frame and cushions	—	—	—	—	—	frame uph.	6.1	110	—
	—	—	—	—	—	upchg, cushions	8.6	157	—
AAR11 AA Settee, high back, large wing, arms, same upholstery, frame and cushions	16 1/2"	—	69 1/2"	36"	36 3/8"		10.3	190	—
AAR11 AA Settee, high back, large wing, arms, combination upholstery, frame and cushions	—	—	—	—	—	frame uph.	5.5	97	—
	—	—	—	—	—	upchg, cushions	5	93	—

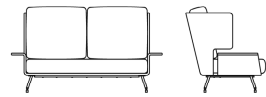

Order Code	Ordering Information	Construction
<i>Example:</i> AAR9-C-PR34-K128/3	<i>Leg finishes:</i> Chrome (suffix C) Copper (suffix CU)	<i>Frame:</i> Constructed in two formed plywood frames, back and seat, giving the pieces their architectural form. Frames are softened with highly resilient urethane foam wrapping.
AAR9 AA Settee, high back		<i>Cushion fill:</i> “Residential” back cushion is 100% polyester fiber and the seat is a multi-density urethane foam.
C Chrome legs		<i>Legs:</i> Machined steel legs feature height adjustable feet for leveling.
PR34 Surround in Prima, Scarlatti	<i>Copper leg upcharge:</i> Copper leg finish is available at an upcharge of \$393 list. Use suffix CU to specify.	<i>Upholstery:</i> Interior loose cushions are available in either residential or contract versions. Contract cushions provide a tailored look for high use areas, while residential cushions convey a relaxed aesthetic. For units with combination upholstery, add list price of surround in appropriate grade with the list price of cushions to obtain total list price for item.
K128/3 Cushions in Arno, Obsidian	<i>Upholstery/ COM information:</i> Prices shown includes fabric or leather upholstery. Contact your Knoll representative for colors. Only approved KnollTextiles and Spinneybeck leathers may be ordered.	
	Customer’s Own Material is available pending approval. For approval requirements, processing instructions and ordering information please see page 18.	
	<i>Maintenance:</i> See pages 28-29.	

Specify:

1. Pattern number
2. Leg finish
3. Textile selection

Specify with split upholstery:

1. Pattern number
2. Leg finish
3. Textile selection, Surround
4. Textile selection, Cushions

pattern no.	grades A	COM B	C	D	E	F	G	H	I	COL U	V	W	X	Y
AAR10-(-)(-)	\$8,298.	\$8,614.	\$8,916.	\$9,246.	\$9,518.	\$9,715.	\$10,047.	\$10,679.	\$11,147.	\$14,090.	\$15,201.	\$17,457.	\$17,927.	\$18,474.
AAR10S-(-)(-)(-)	5,968.	6,108.	6,240.	6,387.	6,508.	6,594.	6,741.	7,022.	7,226.	8,487.	8,990.	10,012.	10,225.	10,471.
AAR10 cushions	2,802.	2,998.	3,186.	3,393.	3,563.	3,684.	3,891.	4,286.	4,577.	6,338.	7,056.	8,513.	8,816.	9,170.
AAR11-(-)(-)	7,013.	7,249.	7,474.	7,722.	7,925.	8,071.	8,318.	8,791.	9,140.	11,574.	12,442.	14,207.	14,573.	15,002.
AAR11S-(-)(-)(-)	5,155.	5,281.	5,401.	5,533.	5,642.	5,720.	5,851.	6,105.	6,291.	7,369.	7,812.	8,713.	8,900.	9,119.
AAR11 cushions	2,190.	2,304.	2,413.	2,535.	2,632.	2,703.	2,824.	3,053.	3,222.	4,301.	4,727.	5,590.	5,769.	5,979.

Approved KnollTextiles Grades/Fabrics

A Chance Common Ground Commuter Cloth Crossroad Delite Dristi Hourglass Mariner Prep * Presto * Sonnet Stacks * Trophy	B continued Melody Pogo * Prairie * Ransom Ricochet * [†] Rush Hour Spark * Summit Sutton Synth * Tinge Venue * Westwood * Wide Angle Zipline	C continued Milestone * Palisade Panache * Quark * Sahara Sandpiper CR * Sequin CR * Spot On Stepping Stones * Swing Tilden *	D Eclat Weave * Menagerie	E Aegean Highland Kampala * Katazome Sherman Shima	F Atelier Calais Cotton Velvet * Coco * Cornaro Icon Liberty Rivington * Soon Tivoli Topography *	G Alter Ego Brugge * Feeling Plaid * Hampshire * Haze Kamani * Kingston Melange Petite Floral Ultrasuede	H Arno Gezelle Magritte Rosemond	I Cato Dynamic Knoll Velvet * [†] Piper * Rutledge Tudor Vermeer	U Vicenza Volo	V Acqua Andes Embossed Tipped España Velluto Pelle	W Alaska Amazon Antique Forte Sabrina * Not approved on frame [†] Indicates fabrics without topstitching Knoll Felt/Ivory K1207/1 not approved	X Ducale Velour	Y Capri Cervo Copenhagen Distressed Marissa Riva Saddle
--	--	---	--	---	---	---	---	---	-----------------------------	--	--	---------------------------	---

Spinneybeck Leather

Check with your KnollTextiles or Spinneybeck Representative for additions or changes.

Pierre Beucler and Jean-Christophe Poggioli

Architecture & Associés

Residential Lounge Seating

Designer(s):
Pierre Beucler and
Jean-Christophe Poggioli, 2012



description	seat h	arm h	w	d	h	type	leather sq ft	textile fabric yds	weight
AAR12L AA Chaise, high back, large wing, left arm, same upholstery, frame and cushions	16 1/2"	—	35 1/2"	69"	36 3/8"		150	8.3	—
AAR12L AA Chaise, high back, large wing, left arm, combination upholstery, frame and cushions	—	—	—	—	—	frame uph.	86	5.3	—
	—	—	—	—	—	upchg, cushions	64	4.4	—
AAR12R AA Chaise, high back, large wing, right arm, same upholstery, frame and cushions	16 1/2"	—	35 1/2"	69"	36 3/8"		150	8.3	—
AAR12R AA Chaise, high back, large wing, right arm, combination upholstery, frame and cushions	—	—	—	—	—	frame uph.	86	5.3	—
	—	—	—	—	—	upchg, cushions	64	4.4	—

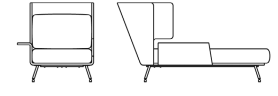
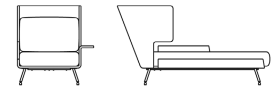

Order Code	Ordering Information	Construction
<i>Example:</i> AAR12L-CU-RA1805-K1021/5	<i>Leg finishes:</i> Chrome (suffix C) Copper (suffix CU)	<i>Frame:</i> Constructed in two formed plywood frames, back and seat, giving the pieces their architectural form. Frames are softened with highly resilient urethane foam wrapping.
AAR12L AA Chaise, left arm		<i>Cushion fill:</i> “Residential” back cushion is 100% polyester fiber and the seat is a multi-density urethane foam.
CU Copper legs	<i>Copper leg upcharge:</i> Copper leg finish is available at an upcharge of \$393 list. Use suffix CU to specify.	<i>Legs:</i> Machined steel legs feature height adjustable feet for leveling.
RA1805 Surround in Riva, Labbo		<i>Upholstery:</i> Interior loose cushions are available in either residential or contract versions. Contract cushions provide a tailored look for high use areas, while residential cushions convey a relaxed aesthetic. For units with combination upholstery, add list price of surround in appropriate grade with the list price of cushions to obtain total list price for item.
K1021/5 Cushions in Ultrasuede, Aztec	<i>Upholstery/ COM information:</i> Prices shown includes fabric or leather upholstery. Contact your Knoll representative for colors. Only approved KnollTextiles and Spinneybeck leathers may be ordered.	
	Customer’s Own Material is available pending approval. For approval requirements, processing instructions and ordering information please see page 18.	
	<i>Maintenance:</i> See pages 28-29.	

Specify:

1. Pattern number
2. Leg finish
3. Textile selection

Specify with split upholstery:

1. Pattern number
2. Leg finish
3. Textile selection, Surround
4. Textile selection, Cushions

pattern no.	grades	COM	C	D	E	F	G	H	I	COL	U	V	W	X	Y
AAR12L-(-)(-)	\$6,741.	\$6,932.	\$7,113.	\$7,313.	\$7,476.	\$7,593.	\$7,793.	\$8,174.	\$8,455.	\$10,397.	\$11,082.	\$12,476.	\$12,765.	\$13,104.	
AAR12LS-(-)(-)	5,129.	5,250.	5,366.	5,494.	5,598.	5,673.	5,801.	6,044.	6,223.	7,070.	7,463.	8,263.	8,427.	8,622.	
AAR12L cushions	2,026.	2,127.	2,224.	2,330.	2,415.	2,478.	2,584.	2,787.	2,936.	3,424.	3,715.	4,310.	4,434.	4,578.	
AAR12R-(-)(-)	6,741.	6,932.	7,113.	7,313.	7,476.	7,593.	7,793.	8,174.	8,455.	10,397.	11,082.	12,476.	12,765.	13,104.	
AAR12RS-(-)(-)	5,129.	5,250.	5,366.	5,494.	5,598.	5,673.	5,801.	6,044.	6,223.	7,070.	7,463.	8,263.	8,427.	8,622.	
AAR12R cushions	2,026.	2,127.	2,224.	2,330.	2,415.	2,478.	2,584.	2,787.	2,936.	3,424.	3,715.	4,310.	4,434.	4,578.	

Approved KnollTextiles Grades/Fabrics						Spinneybeck Leather							
A Chance Common Ground Commuter Cloth Crossroad Delite Dristi Hourglass Mariner Prep * Presto * Sonnet Stacks * Trophy	B continued Melody Pogo * Prairie * Ransom Ricochet * [†] Rush Hour Spark * Summit Sutton Synth * Tinge Venue * Westwood * Wide Angle Zipline	C continued Milestone * Palisade Panache * Quark * Sahara Sandpiper CR * Sequin CR * Spot On Stepping Stones * Swing Tilden *	E Aegean Highland Kampala * Katazome Sherman Shima	F Atelier Calais Cotton Velvet * Coco * Cornaro Icon Liberty Rivington * Soon Tivoli Topography *	G Alter Ego Brugge * Feeling Plaid * Hampshire * Haze Kamani * Kingston Melange Petite Floral Ultrasuede	H Arno Gezelle Magritte Rosemond	I Cato Dynamic Knoll Velvet * [†] Piper Rutledge Tudor Vermeer	U Vicenza Volo	X Ducale Velour	V Acqua Andes Embossed Tipped España Velluto Pelle	Y Capri Cervo Copenhagen Distressed Marissa Riva Saddle	W Alaska Amazon Antique Forte Sabrina	* Not approved on frame [†] Indicates fabrics without topstitching Knoll Felt/Ivory K1207/1 not approved

Check with your KnollTextiles or Spinneybeck Representative for additions or changes.



Pierre Beucler and Jean-Christophe Poggioli

Architecture & Associés

Residential Lounge Seating

Designer(s):
Pierre Beucler and
Jean-Christophe Poggioli, 2012



description	seat h	arm h	w	d	h	type	textile fabric yds	leather sq ft	weight
AAR5 AA Small Ottoman, same upholstery, frame and cushions 	–	–	27 1/2"	24 1/2"	16"		2.2	40	–
AAR5 AA Small Ottoman, combination upholstery, frame and cushions	–	–	–	–	–	frame uph.	1.2	18	–
	–	–	–	–	–	upchg, cushions	1.3	22	–
AAR6 AA Medium Ottoman, same upholstery, frame and cushions 	–	–	31 1/8"	29 1/2"	16"		3.3	60	–
AAR6 AA Medium Ottoman, combination upholstery, frame and cushions	–	–	–	–	–	frame uph.	1.8	28	–
	–	–	–	–	–	upchg, cushions	2.3	32	–
AAR7 AA Large Ottoman, same upholstery, frame and cushions 	–	–	59"	29 1/2"	16 1/2"		4.5	74	–
AAR7 AA Large Ottoman, combination upholstery, frame and cushions	–	–	–	–	–	frame uph.	2.2	31	–
	–	–	–	–	–	upchg, cushions	2.7	43	–

Order Code	Ordering Information	Construction
<i>Example:</i> AAR5-C-SL69	<i>Leg finishes:</i> Chrome (suffix C) Copper (suffix CU)	<i>Frame:</i> Constructed in two formed plywood frames, back and seat, giving the pieces their architectural form. Frames are softened with highly resilient urethane foam wrapping.
AAR5 AA Small Ottoman		<i>Cushion fill:</i> "Residential" back cushion is 100% polyester fiber and the seat is a multi-density urethane foam.
C Chrome legs	<i>Copper leg upcharge:</i> Copper leg finish is available at an upcharge of \$393 list. Use suffix CU to specify.	<i>Legs:</i> Machined steel legs feature height adjustable feet for leveling.
SL69 Saddle, Seal Bay	<i>Upholstery/ COM information:</i> Prices shown includes fabric or leather upholstery. Contact your Knoll representative for colors. Only approved KnollTextiles and Spinneybeck leathers may be ordered.	<i>Upholstery:</i> Interior loose cushions are available in either residential or contract versions. Contract cushions provide a tailored look for high use areas, while residential cushions convey a relaxed aesthetic. For units with combination upholstery, add list price of surround in appropriate grade with the list price of cushions to obtain total list price for item.
<i>Specify:</i> 1. Pattern number 2. Leg finish 3. Textile selection	Customer's Own Material is available pending approval. For approval requirements, processing instructions and ordering information please see page 18.	
<i>Specify with split upholstery:</i> 1. Pattern number 2. Leg finish 3. Textile selection, Surround 4. Textile selection, Cushions	<i>Maintenance:</i> See pages 28-29.	

pattern no.	grades A	COM B	C	D	E	F	G	H	I	COL U	V	W	X	Y
AAR5-(-)(-)	\$2,340.	\$2,393.	\$2,440.	\$2,492.	\$2,537.	\$2,567.	\$2,620.	\$2,721.	\$2,795.	\$3,357.	\$3,539.	\$3,911.	\$3,989.	\$4,078.
AAR5S-(-)(-)(-)	1,780.	1,808.	1,833.	1,863.	1,886.	1,903.	1,932.	1,988.	2,028.	2,193.	2,275.	2,443.	2,477.	2,518.
AAR5 cushions	706.	736.	765.	796.	822.	840.	871.	931.	975.	1,203.	1,304.	1,508.	1,551.	1,601.
AAR6-(-)(-)	2,466.	2,541.	2,613.	2,692.	2,757.	2,804.	2,884.	3,034.	3,147.	3,926.	4,200.	4,759.	4,874.	5,010.
AAR6S-(-)(-)(-)	1,853.	1,895.	1,934.	1,978.	2,013.	2,039.	2,082.	2,164.	2,226.	2,485.	2,615.	2,875.	2,928.	2,992.
AAR6 cushions	791.	844.	894.	950.	994.	1,027.	1,084.	1,190.	1,267.	1,481.	1,626.	1,923.	1,986.	2,057.
AAR7-(-)(-)	3,736.	3,839.	3,937.	4,045.	4,133.	4,197.	4,305.	4,512.	4,665.	5,479.	5,816.	6,504.	6,647.	6,814.
AAR7S-(-)(-)(-)	2,870.	2,920.	2,967.	3,021.	3,064.	3,096.	3,148.	3,250.	3,324.	3,552.	3,694.	3,983.	4,042.	4,112.
AAR7 cushions	1,018.	1,080.	1,138.	1,204.	1,258.	3,700.	1,360.	1,484.	1,576.	1,966.	2,162.	2,561.	2,645.	2,742.



Approved KnollTextiles Grades/Fabrics						Spinneybeck Leather			
A Chance Common Ground Commuter Cloth Crossroad Delite Dristi Hourglass Mariner Prep * Presto * Sonnet Stacks * Trophy	B continued Melody Pogo * Prairie * Ransom Ricochet * [†] Rush Hour Spark * Summit Sutton Synth * Tinge Venue * Westwood * Wide Angle Zipline	C continued Milestone * Palisade Panache * Quark * Sahara Sandpiper CR * Sequin CR * Spot On Stepping Stones * Swing Tilden *	E Aegean Highland Kampala * Katazome Sherman Shima	F Atelier Calais Cotton Velvet * Coco * Cornaro Icon Liberty Rivington * Soon Tivoli Topography *	G Alter Ego Brugge * Feeling Plaid * Hampshire * Haze Kamani * Kingston Melange Petite Floral Ultrasuede	H Arno Gezelle Magritte Rosemond	I Cato Dynamic Knoll Velvet * [†] Piper * Rutledge Tudor Vermeer	U Vicenza Volo V Acqua Andes Embossed Tipped España Velluto Pelle W Alaska Amazon Antique Forte Sabrina * Not approved on frame [†] Indicates fabrics without topstitching Knoll Felt/Ivory K1207/1 not approved	X Ducale Velour Y Capri Cervo Copenhagen Distressed Marissa Riva Saddle

Check with your KnollTextiles or Spinneybeck Representative for additions or changes.

Cini Boeri Lounge Collection

Designer(s):
Cini Boeri, 2008

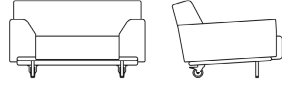
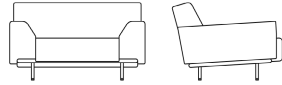
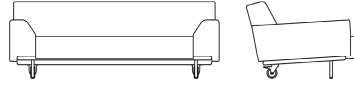
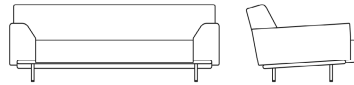

description	seat h	arm h	w	d	h	textile fabric yds.	req. leather sq. ft.	weight
CB1-C Lounge chair 	16 3/8"	22 7/16"	53 3/8"	43 3/8"	30 7/16"	6.2	145	113 lbs.
CB1-L Lounge chair with four standard legs 	16 3/8"	22 7/16"	53 3/8"	43 3/8"	30 7/16"	6.2	145	113 lbs.
CB2-C Sofa 	16 3/8"	22 7/16"	83"	43 3/8"	30 7/16"	7.8	200	142 lbs.
CB2-L Sofa with four standard legs 	16 3/8"	22 7/16"	83"	43 3/8"	30 7/16"	7.8	200	142 lbs.
CB3 Ottoman 			33"	33"	13 1/2"	3.6	50	50 lbs.

Order Code	Ordering Information	Construction
------------	----------------------	--------------

<i>Example:</i> CB2-L-K1152/1		
CB2	Cini Boeri sofa	
L	Four standard legs	
K1152/1	Stirling, Gable	

Upholstery/COM information:
Prices shown include fabric or leather upholstery. Contact your Knoll representative for colors. Only approved KnollTextiles and Spinneybeck leathers may be ordered.

Maintenance:
See pages 28-29.

Note:
The Cini Boeri Lounge Collection is Greenguard certified.

Frame:
Formed steel tubing with powder coat finish. Finish color is Dark Grey paint (113).

Legs:
Available with four legs or a combination of legs and casters. Fixed rear locking casters are standard on Lounge Chair and Sofa. Swivel casters on ottoman do not lock.

Seat Cushion:
Seat cushion is made of highly-resilient polyurethane open-cell Cal 117 foam. Cushion is not reversible.

Upholstery:
Textile application must be railroaded. Textile applications are standard with single needle top stitch. Leather applications are standard with double needle top stitch. Please note that ottoman stitch detail is applicable to top seams only; side seams for both textile and leather are single blind seams.

Customer's Own Material in textile applications is limited and no COL leather applications are approved. For approval requirements, processing instructions and ordering information, please see page 18.

Pillow:
Throw pillows for the Cini Boeri Lounge Collection are available in two sizes. Pillows are composed of recycled polyester. Since pillow is not fitted it is available in fabric only.

- Specify:
1. Pattern number
 2. Leg selection
 3. Textile selection

pattern no.	grades A	COM B	C	D	E	F	G	H	I	COL U	V	W	X	Y
CB1-C	\$7,697.	\$7,863.	\$8,043.	\$8,227.	\$8,383.	\$8,487.	\$8,674.	\$9,022.	\$9,283.	\$12,214.	\$13,139.	\$14,796.	\$15,166.	\$15,535.
CB1-L	7,697.	7,863.	8,043.	8,227.	8,383.	8,487.	8,674.	9,022.	9,283.	12,214.	13,139.	14,796.	15,166.	15,535.
CB2-C	9,918.	10,146.	10,395.	10,643.	10,858.	10,999.	11,259.	11,736.	12,092.	16,282.	17,555.	19,846.	20,355.	20,864.
CB2-L	9,918.	10,146.	10,395.	10,643.	10,858.	10,999.	11,259.	11,736.	12,092.	16,282.	17,555.	19,846.	20,355.	20,864.
CB3- ()	2,773.	2,869.	2,975.	3,080.	3,171.	3,231.	3,342.	3,541.	3,693.	3,791.	4,079.	4,594.	4,709.	4,822.

Approved KnollTextiles Grades/Fabrics	Spinneybeck Leather
---------------------------------------	---------------------

A Alignment * Beacon Bocce Cat's Cradle * Chance Common Ground Commuter Cloth Crossroad Delite Dristi Heavy Metal * Hourglass Mariner Monarch * Prep * Presto * Sonnet Stacks * Trophy Uni-Form	B Abacus * Argyle Belize * Bistro Cameo Chroma Chronicle * Close Knit * Diva Dovetail * Ferry Gala II * Grandview * Holbrook ** Journey Keaton Knoll Felt ▲ Knoll Hopsack ▲	C continued Little Devil Ludlow Lyric Melody Mini Stitch * Nightlife Nonchalant CR * Paradigm * Pogo * Prairie Prim ** Radiance Ransom Ricochet ▲ Roam * Rush Hour Soiree * Spark * Spree * Summit Sutton Synth Tabloid * * Tinge Utmost * * Venue * Versa * Westwood Zipline	C continued Dahlia CR Decade * Durand * * Earthwork ▲ Echo * Empire Stripe * Enmesh * Entourage Essence Fable CR * Fibra * Greenwich * Hudson * Kaleidoscope * Kora CR * Lagos Lore CR * Metro * Milestone * * Moto CR * Palisade Panache CR * Pullman Quark * Regard CR * Roundtrip * * Sahara Sandpiper * Spectator * * Spot On Star Struck * Stepping Stones Swing Tight Rope * * Tilden Tower Grid * *	C continued Treble CR * Vibe Zari CR * D Compass CR Coterie * Eclat Weave * Hologram * Island * * Kabuki * * Masquerade * Menagerie Origins * Tara Theory * Woodland * * Zoom *	E Aegean Highland Ikat Stripe * Ikat Square * Kampala Katazome Kimono * Mamba * Marquee * Meroe * * Sherman Shima Tryst * Whip	F Atelier Biscayne * Calais Cotton Velvet * Century * Coco * Cornaro Glider * Icon Intrigue * Liberty * * Mod Plaid * Rivington * Soon Tivoli Topography * Totem *	G Alter Ego Brugge * Djenne Feeling Plaid Gibson * Hampshire * Haze Kinabalu * Kingston Melange Modern Tweed Petite Floral Serendipity * Spencer * Ultrasuede ▲ Utrillo * *	H Arno Constance * Firefly * * Gezelle Magritte Rosemond I Byron * * Cato Diamond Days Digi Velvet * * Dynamic Fiori * Gates Jaipur * * Knoll Velvet Olema Piper Rutledge Sandis * Tudor Vermeer Walker * Worth * * Zimba	U Vicenza Volo V Acqua Andes España Embossed Tipped Hand Tipped Velluto Pelle W Alaska Amazon Antique Derby Forte Lucente Sabrina	X Ducale Ducale Velour Y Capri Cervo Copenhagen Distressed Marissa Riva Saddle
--	--	--	--	---	---	--	--	--	---	--

* Approved for CB3 ottoman, CBP1 and CBP2 throw pillows only.
** Approved for CBP1 and CBP2 throw pillows only.



Check with your KnollTextiles or Spinneybeck Representative for changes or additions.

Cini Boeri

Lounge Collection

Designer(s):
Cini Boeri, 2008



description	seat h	arm h	w	d	h	textile fabric yds.	req. leather sq. ft.	weight
CBP1 Large throw pillow 			31"		24"	2	n/a	
CBP2 Small throw pillow 			24"		18"	1.6	n/a	

pattern no.	grades A	COM B	C	D	E	F	G	H	I	COL U	V	W	X	Y
CBP1-()	\$484.	\$535.	\$586.	\$637.	\$682.	\$713.	\$768.	\$870.	\$945.					
CBP2-()	415.	461.	514.	569.	614.	643.	698.	797.	874.					

Order Code	Ordering Information	Construction
------------	----------------------	--------------

Example: **CB2-L-K1152/1**
CB2 Cini Boeri sofa
L Four standard legs
K1152/1 Stirling, Gable

Upholstery/COM information:
 Prices shown include fabric or leather upholstery. Contact your Knoll representative for colors. Only approved KnollTextiles and Spinneybeck leathers may be ordered.

Maintenance:
 See pages 28-29.
Note:
 The Cini Boeri Lounge Collection is Greenguard certified.

Frame:
 Formed steel tubing with powder coat finish. Finish color is Dark Grey paint (113).

Legs:
 Available with four legs or a combination of legs and casters. Fixed rear locking casters are standard on Lounge Chair and Sofa. Swivel casters on ottoman do not lock.

Seat Cushion:
 Seat cushion is made of highly-resilient polyurethane open-cell Cal 117 foam. Cushion is not reversible.

Upholstery:
Textile application must be railroaded. Textile applications are standard with single needle top stitch. Leather applications are standard with double needle top stitch. Please note that ottoman stitch detail is applicable to top seams only; side seams for both textile and leather are single blind seams.

Specify:

1. Pattern number
2. Leg selection
3. Textile selection

Customer's Own Material in textile applications is limited and no COL leather applications are approved. For approval requirements, processing instructions and ordering information, please see page 18.

Pillow:
 Throw pillows for the Cini Boeri Lounge Collection are available in two sizes. Pillows are composed of recycled polyester. Since pillow is not fitted it is available in fabric only.

Approved KnollTextiles Grades/Fabrics

- | | | | | | | | | |
|--|--|--|--|--|--|--|---|--|
| A
Alignment *
Beacon
Bocce
Cat's Cradle *
Chance
Common Ground
Commuter Cloth
Crossroad
Delite
Dristi
Heavy Metal *
Hourglass
Mariner
Monarch *
Prep *
Presto *
Sonnet
Stacks *
Trophy
Uni-Form | B
Abacus *
Argyle
Belize *
Bistro
Cameo
Chroma
Chronicle *
Close Knit *
Diva
Dovetail *
Ferry
Gala II *
Grandview *
Holbrook **
Journey
Keaton
Knoll Felt #
Knoll Hopsack # | C
continued
Little Devil
Ludlow
Lyric
Melody
Mini Stitch *
Nightlife
Nonchalant CR *
Paradigm *
Pogo *
Prairie
Prim **
Radiance
Ransom
Ricochet #
Roam *
Rush Hour
Soiree *
Spark *
Spree *
Summit
Sutton
Synth
Tabloid * *
Tinge
Utmost * *
Venue *
Versa *
Westwood
Zipline | C
continued
Dahlia CR
Decade *
Durand * *
Earthwork #
Echo *
Empire Stripe *
Enmesh *
Entourage
Essence
Fable CR *
Fibra *
Greenwich *
Hudson *
Kaleidoscope *
Kora CR *
Lagos
Lore CR *
Metro *
Milestone * *
Moto CR *
Palisade
Panache CR *
Pullman
Quark *
Regard CR *
Roundtrip * *
Sahara
Sandpiper *
Spectator * *
Spot On
Star Struck *
Stepping Stones
Swing
Tight Rope * *
Tilden
Tower Grid * * | C
continued
Treble CR *
Vibe
Zari CR *

D
Compass CR
Coterie *
Eclat Weave *
Hologram *
Island * *
Kabuki * *
Masquerade *
Menagerie
Origins *
Tara
Theory *
Woodland * *
Zoom *

E
Aegean
Highland
Ikat Stripe *
Ikat Square *
Kampala
Katazome
Kimono *
Mamba *
Marquee *
Meroe * *
Sherman
Shima
Tryst *
Whip | F
Atelier
Biscayne *
Calais Cotton
Velvet *
Century *
Coco *
Cornaro
Glider *
Icon
Intrigue *
Liberty * *
Mod Plaid *
Rivington *
Soon
Tivoli
Topography *
Totem *

G
Alter Ego
Brugge *
Djenne
Feeling Plaid
Gibson *
Hampshire *
Haze
Kinabalu *
Kingston
Melange
Modern Tweed
Petite Floral
Serendipity *
Spencer *
Ultrasuede #
Utrillo * * | H
Arno
Constance *
Firefly * *
Gezelle
Magritte
Rosemond

I
Byron * *
Cato
Diamond Days
Digi Velvet * *
Dynamic
Fiori *
Gates
Jaipur * *
Knoll Velvet
Olema
Piper
Rutledge
Sandis *
Tudor
Vermeer
Walker *
Worth * *
Zimba | U
Vicenza
Volo

V
Acqua
Andes
España
Embossed Tipped
Hand Tipped
Velluto Pelle

W
Alaska
Amazon
Antique
Derby
Forte
Lucente
Sabrina | X
Ducale
Ducale Velour

Y
Capri
Cervo
Copenhagen
Distressed
Marissa
Riva
Saddle |
|--|--|--|--|--|--|--|---|--|

Spinneybeck Leather

- * Approved for CB3 ottoman, CBP1 and CBP2 throw pillows only.
 ** Approved for CBP1 and CBP2 throw pillows only.

Check with your KnollTextiles or Spinneybeck Representative for changes or additions.

Marcel Breuer

Cesca Chair

Designer(s):
Marcel Breuer, 1928



description	seat h	arm h	w	d	h	textile fabric yds.	req. leather sq. ft.	weight
50A-7 Arm chair, fully upholstered seat and back	17 3/4"	27"	23 1/2"	23 1/2"	31 1/2"	1.1	20	17 lbs.
50AR-7 Replacement seat, back and arms for 50A-7						1.1	20	
50A-5 Arm chair, wood frame, handwoven cane inset seat and back	17 3/4"	27"	23 1/2"	23 1/2"	31 1/2"			16 lbs.
50AR-5 Replacement seat, back, arms for 50A-5								

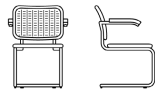
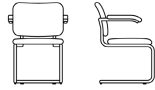

Order Code	Ordering Information	Construction
------------	----------------------	--------------

<i>Example:</i> 50A-5-BE		
50A-5	Cesca arm chair, cane seat	
BE	Ebonized frame	

Seat and back finishes:
Clear (suffix B)
Ebonized (suffix BE)

Upholstery/COM information:
Prices shown include fabric or leather upholstery. Contact your Knoll representative for colors. Only approved KnollTextiles and Spinneybeck leathers may be ordered.

Cal 133 Fire Code ♣ :
The Cesca chair complies with California Technical Bulltin 133 with select KnollTextiles. Upcharge applies, see page 18.

Note:
The KnollStudio logo and signature of Marcel Breuer are stamped into the base of the chair.

Fully upholstered chairs:
Urethane foam over molded plywood seat and back. Solid hardwood arms. Arms are upholstered.

Cane inset chairs:
Hardwood beech seat/back frames and arms with natural clear lacquer or matte ebonized finish. Handwoven cane insets.

Frame:
1" diameter round steel tube with chrome-plated and polished finish.

<i>Example:</i> 50C-2-K1106/8		
50C-2	Cesca armless chair, fully upholstered	
K1106/8	Spencer, Apricot	

Customer's Own Material is available pending approval. For approval requirements, processing instructions and ordering information please see page 18.

The Cesca Chair is Greenguard certified.

Maintenance:
See pages 28-29.

Glides:
Opaque plastic; snap-in place design. Glides shipped with each chair for optional in-field insertion.

Replacement seat baskets:
Cesca seat baskets can be replaced in the field by field services or a furniture repair specialist. Seat basket replacements do not ship with hardware and are not pre-drilled. They consist of seat and back for armless chairs; seat, back and arms for arm chair.

Note:
Cesca chairs are part of a collection. Please refer to the Wassily lounge chair and Laccio tables on pages 98 and 304.

- Specify:*
1. Pattern number
 2. Seat/back frame finish suffix

- For fully upholstered specify:*
1. Pattern number
 2. Seat/back frame finish suffix
 3. Textile selection

pattern no.	cane seat	grades A	COM B	C	D	E	F	G	H	I	COL U	V	W	X	Y
50A-7		\$1,453.	\$1,501.	\$1,546.	\$1,576.	\$1,607.	\$1,632.	\$1,661.	\$1,729.	\$1,864.	\$2,271.	\$2,429.	\$2,747.	\$2,830.	\$2,892.

50AR-7		850.	890.	933.	962.	991.	1,017.	1,041.	1,106.	1,234.	1,624.	1,777.	2,081.	2,157.	2,219.
50A-5-B		2,255.													
50A-5-BE		2,512.													

50AR-5-B		1,547.													
50AR-5-BE		1,801.													

Approved KnollTextiles Grades/Fabrics	Spinneybeck Leather
---------------------------------------	---------------------

A Alignment Beacon Bocce Chance Common Ground Commuter Cloth Crossroad Delite Dristi Hourlgass Mariner Prep Presto Soliloquy Sonnet Stacks Trophy Uni-Form	B continued Helios Journey Keaton Knoll Felt Knoll Hopsack Little Devil Lyric Melody Night Life Paradigm Petat Pusher Pogo Prairie Prim Radiance Ransom Ricochet Roam Rush Hour Soiree Spark Spree Summit Sutton Synth Tabloid Tinge Venue Versa Vinyl Westwood Wide Angle Yeni Zipline	C Atlas Axiom Baxter Biota Charm Circa Classic Boucle Dahlia CR Decade Durand Earthwork Echo Empire Stripe Enmesh Entourage Essence Fable CR Fibra Greenwich Hudson Hula Hoop Kora CR Lagos Magnolia Metro Moto CR Noble Palisade Panache CR Pullman Quark Roundtrip Sequin CR Sinclair Smart Spectator Spot On Star Struck Stepping Stones Swing	C continued Tight Rope Tilden Tower Grid Treble CR Vibe Wit Zari CR D Coterie Eclat Weave In Stitches Jasmine Liberty In The Loop Island Masquerade Menagerie Origins Tara Theory Woodand Zoom E Aegean Amore Arabella Brugge Djenne Feeling Plaid Kampala Katazome Mamba Marquee Midpoint Nature Walk Sherman Shima Vatera Whip	F Atelier Biscayne Calais Cotton Velvet Century Coco Cornaro Glider Icon Intrigue Jasmine Liberty Mod Plaid Rivington Tivoli Topography Totem Tweed Frieze	H Arno Bavaria Catwalk Constance Firefly Gezelle Magritte Rosemond Stretch Appeal I Aswan Byron Canaan Cato Diamond Days Digi Velvet Dynamic Fiori Ita Knoll Velvet Limani North Island Olema Piper Rutledge Tudor Vermeer Walker Worth Zimba	U Vicenza Volo V Acqua Andes Embossed Tipped España Velluto Pelle W Alaska Amazon Antique Derby Forte Lucente Sabrina	X Ducale Velour Y Capri Cervo Copenhagen Distressed Lucca Marissa Riva
---	--	--	--	---	---	--	---

♣ Approved for Cal 133 upholstery

Check with your KnollTextiles or Spinneybeck Representative for changes or additions.

Marcel Breuer

Cesca Chair

Designer(s):
Marcel Breuer, 1928



description	seat h	arm h	w	d	h	textile fabric yds.	leather sq. ft.	weight
50C-1 Armless chair, wood frame handwoven cane inset seat and back	17 3/4"		18 1/2"	23 1/2"	31 1/2"			11 lbs.
50CR-1 Replacement seat and back for 50C-1								
50C-2 Armless chair, fully upholstered seat and back	17 3/4"		18 1/2"	23 1/2"	31 1/2"	1.1	20	14 lbs.
50CR-2 Replacement seat, back and arms for 50C-2						1.1	20	

pattern no.	cane seat	grades A	COM B	C	D	E	F	G	H	I	COL U	V	W	X	Y
50C-1-BE	\$2,319.														
50C-1-B	2,067.														
50CR-1-B	1,353.														
50CR-1-BE	1,611.														
50C-2		1,164.	1,211.	1,254.	1,283.	1,315.	1,338.	1,369.	1,441.	1,570.	1,981.	2,135.	2,456.	2,537.	2,601.
50CR-2		572.	614.	653.	684.	712.	737.	764.	829.	957.	1,346.	1,496.	1,800.	1,877.	1,941.

Order Code	Ordering Information	Construction
<i>Example:</i> 50A-5-BE	<i>Seat and back finishes:</i> Clear (suffix B) Ebonized (suffix BE)	<i>Cal 133 Fire Code</i> † : The Cesca chair complies with California Technical Bulltin 133 with select KnollTextiles. Upcharge applies, see page 18.
50A-5 Cesca arm chair, cane seat		<i>Fully upholstered chairs:</i> Urethane foam over molded plywood seat and back. Solid hardwood arms. Arms are upholstered.
BE Ebonized frame		<i>Cane inset chairs:</i> Hardwood beech seat/back frames and arms with natural clear lacquer or matte ebonized finish. Handwoven cane insets.
<i>Example:</i> 50C-2-K1106/8	<i>Upholstery/COM information:</i> Prices shown include fabric or leather upholstery. Contact your Knoll representative for colors. Only approved KnollTextiles and Spinneybeck leathers may be ordered.	<i>Frame:</i> 1" diameter round steel tube with chrome-plated and polished finish.
50C-2 Cesca armless chair, fully upholstered		<i>Glides:</i> Opaque plastic; snap-in place design. Glides shipped with each chair for optional in-field insertion.
K1106/8 Spencer, Apricot	Customer's Own Material is available pending approval. For approval requirements, processing instructions and ordering information please see page 18.	<i>Replacement seat baskets:</i> Cesca seat baskets can be replaced in the field by field services or a furniture repair specialist. Seat basket replacements do not ship with hardware and are not pre-drilled. They consist of seat and back for armless chairs; seat, back and arms for arm chair.
Note: Cesca chairs are part of a collection. Please refer to the Wassily lounge chair and Laccio tables on pages 98 and 304.		
<i>Specify:</i>		
1. Pattern number		
2. Seat/back frame finish suffix		
<i>For fully upholstered specify:</i>		
1. Pattern number		
2. Seat/back frame finish suffix		
3. Textile selection		
		† The Cesca Chair is Greenguard certified.
		<i>Maintenance:</i> See pages 28-29.
		‡ Approved for Cal 133 upholstery
		<i>Check with your KnollTextiles or Spinneybeck Representative for changes or additions.</i>

Approved KnollTextiles Grades/Fabrics										Spinneybeck Leather					
A	B	C	C	F	H	U	X	Y	W	U	X	Y	W	U	X
Alignment	Helios	Atlas	Tight Rope	Atelier	Arno	Vicenza	Ducale Velour		Alaska				Alaska		
Beacon	Journey	Axiom	Tilden	Biscayne	Bavaria	Volo		Amazon					Amazon		
Bocce	Keaton	Baxter	Tower Grid	Calais Cotton	Catwalk			Antique					Antique		
Chance	Knoll Felt	Biota	Treble CR	Velvet	Constance			Derby					Derby		
Common Ground	Knoll Hopsack	Charm	Vibe	Century	Firefly			Forte					Forte		
Commuter Cloth	Little Devil	Circa	Wit	Coco	Gezelle			Lucente					Lucente		
Crossroad	Lyric	Classic Boucle	Zari CR	Cornaro	Magritte			Sabrina					Sabrina		
Delite	Melody	Dahlia CR		Glider	Rosemond										
Dristi	Night Life	Decade		Icon	Stretch Appeal										
Hourlgass	Paradigm	Durand	D	Intrigue											
Mariner	Petal Pusher	Earthwork	Coterie	In Stitches											
Prep	Pogo	Echo	Eclat Weave	Jasmine											
Presto	Prairie	Empire Stripe	Pogo	Liberty											
Soliloquy	Prim	Enmesh	In The Loop	Mod Plaid											
Sonnet	Radiance	Entourage	Island	Rivington											
Stacks	Ransom	Essense	Masquerade	Tivoli											
Trophy	Ricochet	Fable CR	Menagerie	Topography											
Uni-Form	Roam	Fibra	Origins	Totem											
	Rush Hour	Greenwich	Tara	Tweed Frieze											
	Soiree	Hudson	Theory												
	Spark	Hula Hoop	Woodland												
	Spree	Kora CR	Zoom	G											
	Summit	Lagos		Alter Ego											
	Sutton	Magnolia		Amore											
	Synth	Metro		Arabella											
	Tabloid	Moto CR		Brugge											
	Tinge	Noble		Djenne											
	Venue	Palisade		Feeling Plaid											
	Versa	Panache CR		Gibson											
	Vinyl	Pullman		Haze											
	Westwood	Quark		Kamani											
	Wide Angle	Roundtrip		Kinabalu											
	Yeni	Sequin CR		Kingston											
	Zipline	Sinclair		Melange											
		Smart		Metallic Gloss											
		Spectator		Modern Tweed											
		Spot On		Petite Floral											
		Star Struck		Sablon											
		Stepping Stones		Serendipity											
		Swing		Spencer ‡											
				Straie Stripe											
				Ultrasede											
				Utrillo											

Marcel Breuer Wassily Chair

description	seat h	arm h	w	d	h	weight
50L Wassily chair	16½"	23"	31"	27"	28¾"	25 lbs.

Designer(s):
Marcel Breuer, 1925

Award(s):
The Museum of Modern Art, New York, USA, 1968; Recognition as "Piece of Art," W. Germany, 1982

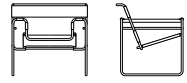

pattern no.	
50L-() 	\$3,783.

Order Code

<i>Example:</i>	50L-3COLHH
50L	Wassily chair
3COLHH	Haired Hide, Tri-Colored

Note:
The Wassily Chair is part of a collection. Please refer to Cesca side chairs and Laccio tables on pages 94 and 304.

Specify:
1. Pattern number
2. Sling material and color selection

Ordering Information

Spinneybeck Belting Leather:

-  Black (suffix BLBLCK)
- Brown (suffix BL1923)
- Burnt Orange (suffix BL1907)
- Chocolate (suffix BL1902)
- Cognac (suffix BL1904)
- Cream (suffix BL1919)
- Dark Mustard (suffix BL1903)
- Dark Salmon (suffix BL1906)
- Deep Green (suffix BL1911)
- Deep Purple (suffix BL1913)
- Eggplant (suffix BL1926)
- Fudge (suffix BL1901)
- Gun Metal (suffix BL1917)
- Key Lime (suffix BL1910)
- Khaki (suffix BL1922)
- Lemon Meringue (suffix BL1909)
- Light Grey (suffix BL1916)
- Medium Grey (suffix BL1918)
- Putty (suffix BL1920)
-  Simply Red (suffix BL1905)
- Smoke (suffix BL1915)
- Sunshine (suffix BL1908)
- Taupe (suffix BL1921)
- Umber (suffix BL1925)
- Warm Beige (suffix BL1924)
- White (suffix BL1914)

Cowhide leather colors:

- Black (suffix L80)
- Light Brown (suffix L82)
- White Beige (suffix L84)

Haired Hide:

- Black (suffix BLCKHH)
- Black and White (suffix BKWHHH)
- Chestnut (suffix OA12HH)
- Coffee (suffix OA18HH)
- Gold (suffix OCP5HH)
- Mahogany (suffix OA19HH)
- Tan (suffix OCP3HH)
- Tri-Color (suffix 3COLHH)

Upholstery note:

No Customer's Own Materials can be used.

Replacement slings:

Knoll does not recommend replacement slings. This procedure requires the chair to be disassembled and rebuilt, a complex and time consuming process.

KnollStudio 20-Day Program:

The Wassily Chair is available on the KnollStudio 20-Day program in Black and Simply Red. Spinneybeck belting leather. For specific information, consult pages 30-33.

Construction

Cal 133 Fire Code :

The Wassily chair complies with California Technical Bulltin 133, see page 18.

Maintenance:

See pages 28-29.

Note:

The KnollStudio logo and signature of Marcel Breuer is stamped into the base of the chair.

The Wassily Chair is Greenguard certified.

Please ask your Spinneybeck Representative for samples of the belting leather and haired hide.

Frame:

Tubular steel with a polished chrome finish

Upholstery:

Cowhide Slings:

Thick cowhide leather slings in three colors. Edges dyed to match for Black and Light Brown colors. White Beige will have edges matching Light Brown cowhide color.

Belting Leather:

Highly durable Spinneybeck belting leather in twenty seven colors. Belting leather edges will always match specified color.





Haired Hide:

Spinneybeck haired hide in eight colors. Haired Hide is a natural material, markings are one-of-a-kind and will vary from piece to piece.

Glides:

Four, molded clear plastic glides with twin-pin snap-in construction included with each chair.

Don Chadwick Spark® Series







	description	seat h	w	d	h	textile fabric yds.	weight	arm h
<i>Designer(s):</i> Don Chadwick, 2009	4-C-SD-N Spark stacking side chair	18"	20½"	22"	31"	0.75	10 lbs.	
<i>Award(s):</i> Editors' Choice Award, Best of NeoCon, June 2009, USA GOOD DESIGN Award, Chicago Athenaeum, 2009, USA								
	4-C-SD-S Spark stacking side chair, with seat pad	18"	20½"	22"	31"	0.75	10 lbs.	
								
	4SDSEAT Seat pad replacement for 4-C-SD-S							
	4DOLLY Spark stacking dolly		25"	43"	30¼"		19 lbs.	
								
	4GA Spark ganging mechanism for side chair							
								



Order Code	Ordering Information	Construction
------------	----------------------	--------------

<i>Example:</i> 4-C-SD-S-04-K1000/11		
4-C-SD	Spark stacking side chair	
S	Seat pad	
04	Light Grey	
K1000/11	Presto, Navy Blue	

- Specify:*
1. Pattern number
 2. Finish selection
 3. Cal 133 Fire Code option
 4. Textile selection

- Finishes:*
-  Blue (suffix 02)
 -  Citron (suffix 03)
 -  Dark Grey (suffix 05)
 -  Light Grey (suffix 04)
 -  Recycled Black (suffix 06)
 -  Red (suffix 01)

Note:
Spark colors Red, Blue and Citron coordinate with KnollStudio Maya Lin Stones in Warm Red, Blue and Chartreuse finishes.

Maintenance:
See pages 28-29.

Cal 133 Fire Code #:
The Spark stacking side and lounge chair complies with the Cal 133 fire code standard if upholstered in Cal 133 approved upholstery. Unupholstered chairs are not Cal 133 approved. Specify suffix -C at end of pattern number and suffix -133 at end of textile selection. Upcharge applies, see page 19.

 *KnollStudio 20-Day Program:*
Spark side and lounge chairs with no upholstery are available on the 20-day program in all finishes. For specific ordering information consult pages 30-30.

Outdoor use:
With proper care and preventative maintenance, the Spark Series is appropriate for outdoor environments.

Note:
The Spark Series is Greenguard certified. The Spark Series is Greenguard Children & Schools certified.

Upholstery/COM information:
Prices shown include fabric upholstery. Contact your Knoll representative for colors. Only approved KnollTextiles may be ordered.

Customer's Own Material is available pending approval. For approval requirements, processing instructions and ordering information please see page 18.

Recycled Content:
The Recycled Black color of both the non-upholstered side chair and the non-upholstered lounge chair contain 40% post-industrial recycled content. Recycled content percentages for the Recycled Black chairs with seat pads will vary depending on the fabric used. All other finishes do not contain recycled content.

Frame:
Integrally colored, textured, glass reinforced polypropylene; approved for indoor and out door use.

Seat Pad:
Molded highly-resilient polyurethane foam with textile cover and steel fasteners; approved for indoor use only.

Stacking:
Spark side and lounge chairs stack up to 6 units high on the floor and 10 units high on the Spark dolly, which can accommodate the side or lounge chair. The dolly stacked with 10 side chairs measures 54" high and with 10 lounge chairs measures 53" high.

Dolly:
Tubular metal frame with textured powder coat finish, four handles made of black thermoplastic elastomer (TPE) that act as bumpers to cushion the chairs, and four locking casters. **Not appropriate for outdoor storage.**

pattern no.	unuphol.	grades A	COM B	C	D	E	F	G	H	I
4-C-SD-N 	\$286.									
4-C-SD-S-()	0.	424.	443.	460.	475.	495.	509.	527.	565.	595.
4SDSEAT		183.	203.	220.	235.	255.	269.	286.	324.	356.
4DOLLY	410.									
4GA	7.									

Approved KnollTextiles Grades/Fabrics

Ganging Device:
Semi-translucent TPE. The Spark ganging device adjoins the Spark side chairs' back legs. Position the ganging device so the raised surface in the middle of the device faces toward the front of the chair. The angle of the device should mirror the angle of the chair's back legs.

A Alignment # Cat's Cradle # Chance Common Ground # Commuter Cloth # Crossroad Delite Dristi Hourglass Mariner Prep # Presto # Sonnet Stacks Uni-Form	B continued Ludlow Lyric Melody Mini Stitch # Night Life Paradigm Petal Pusher Prairie Prim Radiance Ransom Ricochet # Roam Rush Hour Soiree Spark # Spree Summit Sutton Tabloid Tinge Venue Versa Westwood Zipline	C continued Enmesh # Entourage # Essence Fable CR Fibra Greenwich Hudson # Hula Hoop Kaleidoscope CR Kaya CR Kora CR Lagos Legend CR Lore CR Metro Milestone Noble Palisade Panache CR Pullman Quark # Roundtrip # Sandpiper Sequin CR Sinclair Smart Spectator # Spot On Star Struck Stepping Stones Swing Tilden Tight Rope Tower Grid Trebble CR	D continued Vibe Wit Zari CR D Compass CR Coterie Eclat Weave Hologram Island Masquerede Menagerie Origins Tara Theory Woodland Zoom	E Aegean Demure Highland Ikat Stripe Ikat Square Kampala Katazome Kimono Mamba Marquee Meroe Midpoint Nature Walk Sherman Tryst Vatera Whip	F Atelier Biscayne Century Coco Cornaro Glider Icon Intrigue In Stitches Liberty Mod Plaid Rivington Soon Tivoli Topography G Alter Ego Amore Andissa Arabella Djenne Feeling Plaid Gibson Haze Kinabalu	G continued Melange Modern Tweed Sablon Serendipity Straie Stripe Ultrasuede # H Arno # Catwalk Constance Firefly Gezelle Magritte Rosemond Stretch Appeal I Aswan Diamond Days Digi Velvet Dynamic Fiori Ita Olema Piper Rutledge Vermeer Zimba
---	---	---	--	---	--	--

Approved for Cal 133 upholstery.

Check with your KnollTextiles or Spinneybeck Representative for changes or additions.

	description	seat h	w	d	h	textile fabric yds.	weight	arm h
<p><i>Designer(s):</i> Don Chadwick, 2009</p> <p><i>Award(s):</i> Editors' Choice Award, Best of NeoCon, June 2009, USA GOOD DESIGN Award, Chicago Athenaeum, 2009, USA</p> 	4-C-LG-N Spark stacking lounge chair	17"	25 1/2"	25 1/2"	30 1/2"	0.80	14 lbs.	
	4-C-LG-S Spark stacking lounge chair, with seat pad	17"	25 1/2"	25 1/2"	30 1/2"	0.80	14 lbs.	
	4LGSEAT Seat pad replacement for 4-C-LG-S							



Order Code	Ordering Information	Construction
------------	----------------------	--------------

<i>Example:</i> 4-C-SD-S-04-K1000/11	<i>Maintenance:</i> See pages 28-29.	<i>Note:</i> The Spark Series is Greenguard certified. The Spark Series is Greenguard Children & Schools certified.	
4-C-SD Spark stacking side chair	<p><i>Cal 133 Fire Code ♣:</i> The Spark stacking side and lounge chair complies with the Cal 133 fire code standard if upholstered in Cal 133 approved upholstery. Unupholstered chairs are not Cal 133 approved. Specify suffix -C at end of pattern number and suffix -133 at end of textile selection. Upcharge applies, see page 19.</p> <p>Customer's Own Material is available pending approval. For approval requirements, processing instructions and ordering information please see page 18.</p> <p><i>Recycled Content:</i> The Recycled Black color of both the non-upholstered side chair and the non-upholstered lounge chair contain 40% post-industrial recycled content. Recycled content percentages for the Recycled Black chairs with seat pads will vary depending on the fabric used. All other finishes do not contain recycled content.</p>	<i>Frame:</i> Integrally colored, textured, glass reinforced polypropylene; approved for indoor and out door use.	
S Seat pad		<i>Upholstery/COM information:</i> Prices shown include fabric upholstery. Contact your Knoll representative for colors. Only approved KnollTextiles may be ordered.	<i>Seat Pad:</i> Molded highly-resilient polyurethane foam with textile cover and steel fasteners; approved for indoor use only.
04 Light Grey		<i>Stacking:</i> Spark side and lounge chairs stack up to 6 units high on the floor and 10 units high on the Spark dolly, which can accommodate the side or lounge chair. The dolly stacked with 10 side chairs measures 54" high and with 10 lounge chairs measures 53" high.	<i>Dolly:</i> Tubular metal frame with textured powder coat finish, four handles made of black thermoplastic elastomer (TPE) that act as bumpers to cushion the chairs, and four locking casters. Not appropriate for outdoor storage.
K1000/11 Presto, Navy Blue			

Specify:

1. Pattern number
2. Finish selection
3. Cal 133 Fire Code option
4. Textile selection

Finishes:

- ☑ Blue (suffix 02)
- ☑ Citron (suffix 03)
- ☑ Dark Grey (suffix 05)
- ☑ Light Grey (suffix 04)
- ☑ Recycled Black (suffix 06)
- ☑ Red (suffix 01)

Note:

Spark colors Red, Blue and Citron coordinate with KnollStudio Maya Lin Stones in Warm Red, Blue and Chartreuse finishes.

KnollStudio 20-Day Program: Spark side and lounge chairs with no upholstery are available on the 20-day program in all finishes. For specific ordering information consult pages 30-30.

Outdoor use: With proper care and preventative maintenance, the Spark Series is appropriate for outdoor environments.

♣ Approved for Cal 133 upholstery.

Check with your KnollTextiles or Spinneybeck Representative for changes or additions.

pattern no.	unuphol.	grades A	COM B	C	D	E	F	G	H	I
4-C-LG-N ☑	\$445.									
4-C-LG-S-()		581.	599.	618.	632.	653.	666.	685.	723.	754.
4LGSEAT		196.	214.	232.	247.	267.	281.	299.	338.	367.





Approved KnollTextiles Grades/Fabrics



Ganging Device:

Semi-translucent TPE. The Spark ganging device adjoins the Spark side chairs' back legs. Position the ganging device so the raised surface in the middle of the device faces toward the front of the chair. The angle of the device should mirror the angle of the chair's back legs.

A Alignment ♣ Cat's Cradle ♣ Chance Common Ground ♣ Commuter Cloth ♣ Crossroad Delite Dristi Hourglass Mariner Prep ♣ Presto ♣ Sonnet Stacks Uni-Form	B continued Ludlow Lyric Melody Mini Stitch ♣ Night Life Paradigm Petal Pusher Prairie Prim Radiance Ransom Ricochet ♣ Roam Rush Hour Soiree Spark ♣ Spree Summit Sutton Tabloid Tinge Venue Versa Westwood Zipline	C continued Enmesh ♣ Entourage ♣ Essence Fable CR Fibra Greenwich Hudson ♣ Hula Hoop Kaleidoscope CR Kora CR Lagos Legend CR Lore CR Metro Milestone Noble Palisade Panache CR Pullman Quark ♣ Roundtrip ♣ Sandpiper Sequin CR Sinclair Smart Spectator ♣ Spot On Star Struck Stepping Stones Swing Tight Rope Tilden Tower Grid Trebble CR	C continued Vibe Wit Zari CR D Compass CR Coterie Eclat Weave Hologram Island Masquerede Menagerie Origins Tara Theory Woodland Zoom	E Aegean Demure Highland Ikat Stripe Ikat Square Kampala Katazome Kimono Mamba Marquee Meroe Midpoint Nature Walk Sherman Tryst Vàtera Whip	F Atelier Biscayne Century Coco Cornaro Glider Icon Intrigue In Stitches Liberty Mod Plaid Rivington Soon Tivoli Topography G Alter Ego Amore Andissa Arabella Djenne Feeling Plaid Gibson Haze Kinabalu	G continued Melange Modern Tweed Sablon Serendipity Straie Stripe Ultrasuede ♣ H Arno ♣ Catwalk Constance Firefly Gezelle Magritte Rosemond Stretch Appeal I Aswan Diamond Days Digi Velvet Dynamic Fiori Ita Olema Piper Rutledge Vermeer Zimba
---	---	--	--	---	--	--

Pepe Cortés
Jamaica Barstool

	description	seat h	w	d	h	type	weight
<i>Designer(s):</i> Pepe Cortés, 1993 	30C Jamaica Barstool, bar height 	30"	20"	20"	32"	aluminum seat	11 lbs.
	30C2 Jamaica Barstool, counter height 	26"	17 1/2"	17 1/2"	28 1/4"	aluminum seat	11 lbs.
	30C3 Jamaica Barstool, low, on casters 		19"	19"	17 3/4"		10 lbs.

pattern no.		
30C-A 		\$1,383.
30C2-A 		1,383.
30C3-A		1,346.

Order Code

<i>Example:</i> 30C-A
30C Jamaica barstool, bar height
A Aluminum

Specify:

1. Pattern number
2. Finish selection

Ordering Information

Finishes:
Aluminum (suffix A)

Note:
Available in the United States only.

 *KnollStudio 20-Day Program:*
The Jamaica bar and counter height stools in aluminum finish are available on the 20-day program. For specific information, consult pages 30-33.

Outdoor use:
The Jamaica Stool is approved for indoor use only.

Cal 133 Fire Code #:
The Jamaica Stool in aluminum finish comply with California Technical Bulletin 133. See page 18.

Maintenance:
See pages 28-29.

Note:
The Jamaica Barstool is Greenguard certified.

Construction



Seat and Frame
Contoured seat swivels 360°. Constructed of anodized aluminum. Base is chrome plated steel with plastic glides. The Jamaica aluminum stools on glides are 100% recyclable.

Jonathan Crinion Crinion Chair

Designer(s):
Jonathan Crinion, 1999

Award(s):
FX International Interior Design Award, 1999



description	seat h	arm h	w	d	h	textile fabric yds.	req. leather sq. ft.	weight	finish
58A Arm chair, upholstered seat 	17 1/2"	26 1/2"	23 1/4"	19 1/2"	30 3/4"	0.7	13	18 lbs.	beech stains
	17 1/2"	26 1/2"	23 1/4"	19 1/2"	30 3/4"	0.7	13	17 lbs.	maple
58C Armless chair, upholstered seat 	17 1/2"		20 1/2"	19 1/2"	30 3/4"	0.7	13	16 lbs.	beech stains
	17 1/2"		20 1/2"	19 1/2"	30 3/4"	0.7	13	15 lbs.	maple
58A-R Seat pad replacement, for arm chair with upholstered seat 58A						0.7	13		
58C-R Seat pad replacement, for armless chair with upholstered seat 58C						0.7	13		

pattern no.	grades A	COM B	C	D	E	F	G	H	I	COL U	V	W	X	Y
58A-()	\$1,641.	\$1,673.	\$1,702.	\$1,735.	\$1,760.	\$1,780.	\$1,816.	\$1,874.	\$1,924.	\$2,082.	\$2,197.	\$2,433.	\$2,479.	\$2,537.
58A-(KC)	2,011.	2,041.	2,070.	2,103.	2,129.	2,150.	2,185.	2,242.	2,294.	2,451.	2,567.	2,802.	2,849.	2,905.
58C-()	1,398.	1,430.	1,460.	1,489.	1,522.	1,537.	1,568.	1,635.	1,679.	1,839.	1,953.	2,187.	2,237.	2,291.
58C-(KC)	1,664.	1,695.	1,725.	1,755.	1,787.	1,801.	1,833.	1,898.	1,945.	2,103.	2,218.	2,451.	2,503.	2,553.
58A-R-()	274.	306.	330.	362.	388.	402.	436.	495.	539.	687.	797.	1,019.	1,066.	1,119.
58C-R-()	274.	306.	330.	362.	388.	402.	436.	495.	539.	687.	797.	1,019.	1,066.	1,119.

Order Code

<i>Example:</i> 58A-BB-K715/3
58A Crinion arm chair
B323 Medium Walnut
K715/3 Abacus, Gold Coin

Specify:

1. Pattern number
2. Finish selection
3. Textile selection

Ordering Information

Clear Maple finish:
Maple (suffix KC)

Beech frame stains:
Beech (suffix B311)
Bronzed Cherry (suffix B312A)
Burnt Walnut (suffix B313)
Deep Red Mahogany (suffix B328)
Ebonized (suffix BE)
Light Cherry (suffix B315)
Medium Cherry (suffix B319)
Medium Red Mahogany (suffix BR)
Medium Walnut (suffix B323)
Natural Beech (suffix BN)
Warm Brown Walnut (suffix J)

Upholstery/COM information:
Prices shown include fabric or leather upholstery. Contact your Knoll representative for colors. Only approved KnollTextiles and Spinneybeck leathers may be ordered.

Customer's Own Material is available pending approval. For approval requirements, processing instructions and ordering information please see page 18.

KnollStudio wood finishes:
KnollStudio wood finishes complement a large variety of KnollStudio veneer and Knoll Office veneer finishes. To select correct complementary finish, please refer to KnollStudio Wood Finish Matrix on page 25. Complementary finishes are available at no upcharge. If no complementary standard finish is available, please refer to custom finish policy below.

Custom finishes:
To complement non-Knoll wood veneer or lumber finishes, a one-time, non-negotiable net upcharge of \$637 applies. Re-orders are at no upcharge.

Please contact your KnollStudio representative, dealer or Customer Service associate for complete custom finish information and Order Code. Minimum order quantity for any custom finish order: 4 chairs.

Cal 133 Fire Code:
Crinion Chairs with upholstered seat comply with the California Technical Bulletin 133 standard if upholstered in Cal 133 approved upholstery. Specify suffix -C at end of pattern number and suffix -133 at end of textile selection. Upcharge applies, see page 18.

Maintenance:
See pages 28-29.

Note:
The Crinion Chair is Greenguard certified.

Construction

Frame:
Clear Maple Chair: Select clear maple hardwood frame with maple plywood back panel in clear finish. Dowel, mortise and tenon construction. Arm supported by metal cross dowel.

Beech Chair: Select beech hardwood frame with plywood back panel in clear or stained finishes. Arm supported by metal cross dowel.

Seat pad:
Upholstered, high-density polyurethane foam seat pad on a plywood seat basket with Dymetrol® suspension. Seat pad reaches to the seat frame edge, surrounds arm.

Seat pad replacement:
Seat pad can be replaced in the field.

Finish:
Catalyzed lacquer protective coating. Hand-applied final wax coating.

High Traffic Areas:
When specifying armless chair in high use or high traffic areas, we recommend the use of a stretcher for added strength. Contact CPD or your KnollStudio sales representative for more information.

Approved KnollTextiles Grades/Fabrics

A Alignment # Beacon Bocce Chance Common Ground # Commuter Cloth # Crossroad Delite Driсті Foil Rap Heavy Metal Hourglass Mariner Monarch # Prep # Presto # Soliloquy Sonnet Stacks Trophy Uni-Form	B continued Forza Gala II Grande Grandview Helios Holbrook Journey Keaton Knoll Felt Knoll Hopsack Little Devil Ludlow Lyric Melody Mini Stitch # Night Life Paradigm Petal Pusher Pogo # Prairie Prim # Radiance Ransom Ricochet # Roam Rush Hour Soiree Spark # Spree Summit Sutton Synth Tabloid Tinge Utmost Venue Versa Vinyl Westwood Wide Angle # Zipline	C Atlas Axiom Baxter Biota # Charm Circa Classic Boucle Dahlia CR Decade Durand Earthwork # Echo Empire Stripe Enmesh # Entourage Essence Fable CR Greenwich Hudson Hula Hoop Kaleidoscope CR Kora CR Lagos Legend CR Lore CR Magnolia Metro Milestone Moto CR Noble Palisade Panache CR Pullman Quark Regard CR Roundtrip Sandpiper Sequin CR Sinclair Smart Spot On Star Struck	C continued Stepping Stones Spectator Swing Tight Rope Tilden Tower Grid Treble CR Vibe Wit Zari CR	D Compass CR Coterie Hologram In The Loop Island Kabuki Masquerade Menagerie Origins Tara Theory Woodland Zoom	E Aegean Highland Ikat Stripe Ikat Square Kampala Katazome Mamba Marquee Midpoint Nature Walk Sherman Shima Tryst Vatera Whip #	F Atelier Biscayne Calais Cotton Velvet Century Coco Cornaro Glider Icon Intrigue In Stitches Liberty Mod Plaid Rivington Soon Tivoli Topography Totem Tweed Frieze	G Alter Ego Amore Arabella Arber Brugge Djenne Feeling Plaid Gibson Hampshire Haze Kamani Kinabalu Kingston Melange Metallic Gloss Modern Tweed Petite Floral Sablon Serendipity Straie Stripe Ultrasuede # Utrillo	H Arno Bavaria Constance Gezelle Magritte Rosemond Stretch Appeal Aswan Byron Canaan Cato Cummings Diamond Days Digi Velvet Dynamic Fiori Ita Jaipur Knoll Velvet Limani North Island Olema Piper Rutledge Tudor Vermeer Walker Worth Zimba	I Icon Intrigue In Stitches Liberty Mod Plaid Rivington Soon Tivoli Topography Totem Tweed Frieze	U Vicenza # Volo # Acqua # Andes # Embossed Tipped España # Hand Tipped Velluto Pelle # Alaska # Amazon # Antique # Forte # Lucente Sabrina # Ducale # Ducale Velour #	V Capri # Cervo Copenhagen # Gezelle Lucca Marissa # Portofino Riva # Torello	W Alaska # Amazon # Antique # Forte # Lucente Sabrina # Ducale # Ducale Velour #	X Ducale # Ducale Velour #	Y Capri # Cervo Copenhagen # Gezelle Lucca Marissa # Portofino Riva # Torello
---	--	--	--	--	---	---	--	---	---	---	---	---	---	---

Spinneybeck Leather

U Vicenza # Volo # Acqua # Andes # Embossed Tipped España # Hand Tipped Velluto Pelle # Alaska # Amazon # Antique # Forte # Lucente Sabrina # Ducale # Ducale Velour #	V Capri # Cervo Copenhagen # Gezelle Lucca Marissa # Portofino Riva # Torello	W Alaska # Amazon # Antique # Forte # Lucente Sabrina # Ducale # Ducale Velour #	X Ducale # Ducale Velour #	Y Capri # Cervo Copenhagen # Gezelle Lucca Marissa # Portofino Riva # Torello
---	---	---	---	---

Available for Cal 133 upholstery.

Check with your KnollTextiles or Spinneybeck Representative for changes or additions.

Joseph Paul D’Urso

Contract Lounge Seating

Designer(s):
Joseph Paul D’Urso, 2008

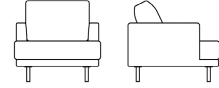

description	w	d	h	seat h	arm h	type	textile	leather	weight
							fabric yds.	sq ft	
2160 Contract Lounge chair, same upholstery, frame and cushions	34"	36 1/2"	30 1/2"	17 3/8"	22 3/8"		7.6	105	70 lbs.
2160 Contract Lounge chair, combination upholstery, frame and cushions	34"	36 1/2"	30 1/2"	17 3/8"	frame	4.6	60		
					upchg, cushions	3.2	50		

pattern no.	grades	COM								COL				
	A	B	C	D	E	F	G	H	I	U	V	W	X	Y
2160-C-()	\$4,202.	\$4,391.	\$4,567.	\$4,764.	\$4,922.	\$5,038.	\$5,234.	\$5,608.	\$5,884.	\$7,119.	\$7,635.	\$8,677.	\$8,896.	\$9,148.
2160S-C-()-()	3,206.	3,350.	3,486.	3,635.	3,755.	3,846.	3,994.	4,281.	4,489.	5,109.	5,495.	6,281.	6,444.	6,635.
upchg, cushions	1,374.	1,436.	1,494.	1,558.	1,610.	1,648.	1,711.	1,834.	1,924.	2,190.	2,356.	2,692.	2,761.	2,843.

Order Code	Ordering Information	Construction
<i>Example:</i> 2160-C-H800/40	<i>Leg finishes:</i> Polished Chrome (suffix C)	<i>Frame:</i> Constructed of plywood with sinuous spring seat suspension and matrix back suspension. Standard lounge chair and small sofa depth is 36"; residential sofa is 40" deep.
C H800/40	<i>Upholstery/COM information:</i> Prices shown includes fabric or leather upholstery. Contact your Knoll representative for colors. Only approved KnollTextles and Spinneybeck leathers may be ordered.	<i>Upholstery:</i> One seat and back cushion for the Lounge Chair, two seat and back cushions for the Small Sofa, one semi-attached cushion for Ottoman. For units with combination upholstery, add list price of surround in appropriate grade with the list price of cushions to obtain total list price for item.
<i>Example:</i> 2161-C-S-HT1502-K1206/6	Customer's Own Material is available pending approval. For approval requirements, processing instructions and ordering information please see page 18.	Railroad upholstery application is standard for all non-directional textiles. Please see 'Stitching' for seam details.
2161 C S HT1502 K1206/6	<i>Maintenance:</i> See pages 28-29.	<i>Cushions:</i> Seat cushions constructed of highly resilient polyurethane foam and polyester fiber, wrapped in polyester fiber batting. Back cushion constructed with a soft polyurethane foam core and polyester fiber fill. Side cushion constructed of 10/90 down with a down proof ticking. Leather cushions feature a perforated zipper breather panel.

Specify:

1. Pattern number
2. Leg finish
3. Textile selection

Specify with split upholstery:

1. Pattern number
2. Leg finish
3. Split upholstery option
4. Textile selection, Surround
5. Textile selection, Cushions

Approved KnollTextiles Grades/Fabrics						Spinneybeck Leather		
A Alignment ‡ Beacon Bocce Cat's Cradle Common Ground Commuter Cloth ‡ Crossroad Delite Dristi Hourglass Mariner Monarch ‡ Prep ‡ Presto ‡ Sonnet Stacks Trophy Uni-Form	B continued Melody Mini Stitch ‡ Night Life Paradigm Pogo Prairie Prim Radiance Ransom Ricochet ‡ Rush Hour Spark ‡ Spree Summit Sutton Synth Tabloid Tinge Venue Versa Vinyl Westwood Wide Angle ‡ Zipline	C continued Echo Empire Stripe Enmesh ‡ Entourage Essence Fable CR Fibra Hudson Hula Hoop Kaleidoscope CR Kora CR Lagos Legend CR Lore CR Metro Milestone Moto CR Palisade Panache CR Pullman Quark Regard CR Roundtrip Sahara Sandpiper Sequin CR Spectator * Spot On Star Struck Stepping Stones Swing Tilden Vibe Wit Zari CR	D Compass CR Coterie Eclat Weave Hologram Island Kabuki Masquerade Menagerie Tara Theory Woodland Zoom	E Aegean Demure Highland Ikat Stripe Ikat Square Kampala Katazome Kimono Mamba Marquee Meroe Sherman Shima Tryst Whip	F Atelier Calais Cotton Velvet Coco Cornaro Icon Intrigue In Stitches Liberty Mod Plaid Rivington Soon Tivoli Topography Tweed Frieze	H Arno ‡ Constance Firefly Gezelle Magritte Rosemond I Byron Cato Diamond Days Digi Velvet Dynamic Fiori Gramercy Knoll Velvet Piper Tudor Vermeer Walker Worth Zimba	U Vicenza ‡ Volo ‡ V Acqua ‡ Andes ‡ Embossed Tipped España ‡ Hand Tipped ‡ Velluto Pelle ‡ W Alaska ‡ Amazon ‡ Antique ‡ Derby ‡ Forte ‡ Lucente Sabrina ‡	X Ducale Ducale Velour ‡ Y Capri ‡ Cervo Copenhagen ‡ Distressed ‡ Marissa ‡ Riva ‡ Saddle ‡

* Approved for 2161P only.

Check with your KnollTextiles or Spinneybeck Representative for additions or changes.

Joseph Paul D’Urso

Contract Lounge Seating

Designer(s):
Joseph Paul D’Urso, 2008



description	width	depth	height	seat h, max	arm h, max	type	textile fabric yards	leather sq ft	weight
2161 Contract Small Sofa, same upholstery, frame and cushions	74"	36 1/2"	30 1/2"	17 3/8"	22 3/8"		13.5	215	135 lbs.
2161 Contract Small Sofa, combination upholstery, frame and cushions	74"	36 1/2"	30 1/2"	17 3/8"		frame uph.	6.5	95	
						upchg, cushions	7	120	
2163 Contract Ottoman, same upholstery, frame and cushions	28 1/2"	28 1/2"	16"	16"			3.5	45	29 lbs.
2163 Contract Ottoman, combination upholstery, frame and cushions	28 1/2"	28 1/2"	16"	16"		frame uph.	1.4	15	
						upchg, cushions	2.8	30	
2161P Optional side cushion for small sofa	17"	3"	11"				1	n/a	5 lbs.

Order Code	Ordering Information	Construction
<i>Example:</i> 2160-C-H800/40	<i>Leg finishes:</i> Polished Chrome (suffix C)	<i>Frame:</i> Constructed of plywood with sinuous spring seat suspension and matrix back suspension. Standard lounge chair and small sofa depth is 36"; residential sofa is 40" deep.
2160	D’Urso Contract Lounge Collection, lounge chair	
C	Polished Chrome legs	
H800/40	Cato, Orange	
<i>Example:</i> 2161-C-S-HT1502-K1206/6	<i>Upholstery/COM information:</i> Prices shown includes fabric or leather upholstery. Contact your Knoll representative for colors. Only approved KnollTextles and Spinneybeck leathers may be ordered.	<i>Stitching:</i> Non-directional textiles with railroad application, single needle topstitch for arms, double needle topstitch for seat and back cushions; directional textiles, single needle topstitch for arms, double needle topstitch for seat and back cushions, single blind stitch for vertical seams of seat cushion, a vertical single blind center seam joins inside and outside back panels of the sofa; leather, single needle topstitch for arms, double needle topstitch for seat and back cushions, single blind stitch for vertical seams of seat cushion, a vertical double needle topstitch seam joins inside and outside back panels of sofa. Ottoman; all applications, double needle topstitch for horizontal cushion seams, single blind seam for vertical seams of seat cushion.
2161	D’Urso Contract Lounge Collection, small sofa	
C	Polished Chrome legs	
S	Split upholstery	
HT1502	Surround in Hand Tipped, Mesa Verde	
K1206/6	Cushions in Knoll Hopsack, Gold	
	<i>Maintenance:</i> See pages 28-29.	<i>Upholstery:</i> One seat and back cushion for the Lounge Chair, two seat and back cushions for the Small Sofa, one semi-attached cushion for Ottoman. For units with combination upholstery, add list price of surround in appropriate grade with the list price of cushions to obtain total list price for item.
		<i>Legs:</i> 6" steel leg, 1 1/4" diameter, available in polished chrome with black nylon glides.
		<i>Cushions:</i> Seat cushions constructed of highly resilient polyurethane foam and polyester fiber, wrapped in polyester fiber batting. Back cushion constructed with a soft polyurethane foam core and polyester fiber fill. Side cushion constructed of 10/90 down with a down proof ticking. Leather cushions feature a perforated zipper breather panel.

Specify:

1. Pattern number
2. Leg finish
3. Textile selection

Specify with split upholstery:

1. Pattern number
2. Leg finish
3. Split upholstery option
4. Textile selection, Surround
5. Textile selection, Cushions

pattern no.	grade A	COM B	C	D	E	F	G	H	I	COL U	V	W	X	Y
2161-C(-)	\$6,633.	\$6,965.	\$7,281.	\$7,629.	\$7,913.	\$8,119.	\$8,466.	\$9,130.	\$9,620.	\$12,539.	\$13,591.	\$15,731.	\$16,176.	\$16,695.
2161S-C(-)(-)	5,061.	5,314.	5,556.	5,821.	6,039.	6,194.	6,459.	6,966.	7,339.	8,998.	9,752.	11,287.	11,607.	11,979.
upchg, cushions	2,169.	2,277.	2,380.	2,495.	2,587.	2,654.	2,768.	2,985.	3,146.	3,856.	4,180.	4,838.	4,976.	5,135.
2163-C(-)	2,531.	2,634.	2,732.	2,840.	2,928.	2,993.	3,100.	3,307.	3,461.	3,929.	4,149.	4,597.	4,691.	4,800.
2163S-C(-)(-)	1,930.	2,011.	2,084.	2,166.	2,234.	2,285.	2,366.	2,524.	2,640.	2,819.	2,978.	3,299.	3,364.	3,443.
upchg, cushions	827.	861.	893.	929.	958.	979.	1,015.	1,083.	1,131.	1,208.	1,276.	1,414.	1,443.	1,477.
2161P(-)	467.	492.	515.	541.	561.	577.	603.	652.	688.					

Approved KnollTextiles Grades/Fabrics

A Alignment † Beacon Bocce Cat’s Cradle Common Ground Commuter Cloth † Crossroad Delite Dristi Hourglass Mariner Monarch † Prep † Presto † Sonnet Stacks Trophy Uni-Form	B Abacus † Argyle Belize Cameo Chroma Chronicle Diva Ferry Gala II Grandview Helios Holbrook Journey Keaton Knoll Felt Knoll Hopsack Little Devil Ludlow Lyric	C continued Echo Empire Stripe Enmesh † Entourage Essence Fable CR Fibra Hudson Hula Hoop Kaleidoscope CR Kora CR Lagos Legend CR Lore CR Metro Milestone Moto CR Palisade Panache CR Pullman Quark Regard CR Roundtrip Sahara Sandpiper Sequin CR Spectator * Spot On Star Struck Stepping Stones Swing Tilden Vibe Wit Zari CR	D Compass CR Coterie Eclat Weave Hologram Island Kabuki Masquerade Menagerie Tara Theory Woodland Zoom	E Aegean Demure Highland Ikat Stripe Ikat Square Kampala Katazome Kimono Mamba Marquee Meroe Sherman Shima Tryst Whip	F Atelier Calais Cotton Velvet Coco Cornaro Icon Intrigue In Stitches Liberty Mod Plaid Rivington Soon Tivoli Topography Totem Tweed Frieze	G Alter Ego Brugge Djenne Feeling Plaid Gibson Hampshire Haze Kingston Melange Modern Tweed Petite Floral Spencer Ultrasuede †	H Arno † Constance Gezelle Firefly Magritte Rosemond I Byron Cato Diamond Days Digi Velvet Dynamic Gramercy Knoll Velvet Piper Tudor Vermeer Walker Worth Zimba	U Vicenza † Volo † V Acqua † Andes † Embossed Tipped España † Hand Tipped † Velluto Pelle † W Alaska † Amazon † Antique † Derby † Forte † Lucente Sabrina †	X Ducale Ducale Velour † Y Capri † Cervo Copenhagen † Distressed † Marissa † Riva † Saddle †
---	--	---	---	---	--	--	---	---	--

* Approved for 2161P only.

Check with your KnollTextiles or Spinneybeck Representative for additions or changes.

Joseph Paul D’Urso

Residential Lounge Seating

Designer(s):
Joseph Paul D’Urso, 2008



description	w	d	h	seat h	arm h	type	textile fabric yds.	leather sq ft.	weight
2160R Residential Lounge chair, same upholstery, frame and cushions	34"	36 1/2"	28 1/2"	15 3/8"	20 3/8"		7.6	105	67 lbs.
2160R Residential Lounge chair, combination upholstery, frame and cushions	34"	36 1/2"	28 1/2"	15 3/8"		frame uph.	4.6	60	
						upchg, cushions	3.2	50	

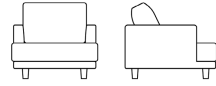

pattern no.	grades A	COM B	C	D	E	F	G	H	I	COL U	V	W	X	Y
2160R-(-)(-)	\$4,202.	\$4,391.	\$4,567.	\$4,764.	\$4,922.	\$5,038.	\$5,234.	\$5,608.	\$5,884.	\$7,119.	\$7,635.	\$8,677.	\$8,896.	\$9,148.
2160RS-(-)(-)(-)	3,206.	3,350.	3,486.	3,635.	3,755.	3,846.	3,994.	4,281.	4,489.	5,109.	5,495.	6,281.	6,444.	6,635.
upchg, cushions	1,374.	1,436.	1,494.	1,558.	1,610.	1,648.	1,711.	1,834.	1,924.	2,190.	2,356.	2,692.	2,761.	2,843.

Order Code	Ordering Information	Construction
<i>Example:</i> 2160R-OE-K162/25	<i>Leg finishes:</i> Burnt Walnut on Oak (suffix 0313) Clear Oak (suffix OC) Ebonized on Oak (suffix OE) Polished Chrome (suffix C)	<i>Frame:</i> Constructed of plywood with sinuous spring seat suspension and matrix back suspension. Standard lounge chair and sofa depth is 36"; residential sofa is 40" deep.
2160R	D’Urso Residential Lounge Collection, lounge chair	<i>Stitching:</i> Non-directional textiles with railroad application, single needle topstitch for arms, double needle topstitch for seat and back cushions; directional textiles, single needle topstitch for arms, double needle topstitch for seat and back cushions, single blind stitch for vertical seams of seat cushion, a vertical single blind center seam joins inside and outside back panels of the sofa; leather, single needle topstitch for arms, double needle topstitch for seat and back cushions, single blind stitch for vertical seams of seat cushion, a vertical double needle topstitch seam joins inside and outside back panels of sofa. Ottoman; all applications, double needle topstitch for horizontal cushion seams, single blind seam for vertical seams of seat cushion.
OE	Ebonized legs	<i>Upholstery:</i> One seat and back cushion for the Lounge Chair, two seat and back cushions for the Sofa, one semi-attached cushion for Ottoman. For units with combination upholstery, add list price of surround in appropriate grade with the list price of cushions to obtain total list price for item.
K162/25	Classic Boucle, Aegean	<i>Legs:</i> Seat cushions constructed of highly resilient polyurethane foam and polyester fiber, wrapped in polyester fiber batting. Back cushion constructed with a soft polyurethane foam core and polyester fiber fill. Side cushion constructed of 10/90 down with a down proof ticking.
<i>Example:</i> 21623R-0313-S-K1152/8-K1024/3	<i>Upholstery/COM information:</i> Prices shown includes fabric or leather upholstery. Contact your Knoll representative for colors. Only approved KnollTextiles and Spinneybeck leathers may be ordered.	Railroad upholstery application is standard for all non-directional textiles. Please see ‘Stitching’ for seam details.
2163R	D’Urso Residential Lounge Collection, ottoman	<i>Cushions:</i> Leather cushions feature a perforated zipper breather panel.
0313	Burnt Walnut legs	
S	Split upholstery	
K1152/8	Surround in Stirling, Cobble	
K1024/3	Cushions in Coco, Ciel	
<i>Specify:</i>	<i>Maintenance:</i> See pages 28-29.	
1. Pattern number		
2. Leg finish		
3. Textile selection		
<i>Specify with split upholstery:</i>		
1. Pattern number		
2. Leg finish		
3. Split upholstery option		
4. Textile selection, Surround		
5. Textile selection, Cushions		

Approved KnollTextiles Grades/Fabrics	Spinneybeck Leather
A Alignment ‡ Beacon Bocce Cat’s Cradle Common Ground Commuter Cloth ‡ Crossroad Delite Dristi Hourglass Mariner Monarch ‡ Prep ‡ Presto ‡ Sonnet Stacks Trophy Uni-Form	U Vicenza ‡ Volo ‡
B continued Melody Mini Stitch ‡ Paradigm Pogo Prairie Prim Radiance Ransom Ricochet ‡ Rush Hour Spark ‡ Spree Summit Sutton Synth Tabloid Tinge Venue Versa Vinyl Westwood Wide Angle ‡ Zipline	X Ducale Ducale Velour ‡
C continued Echo Empire Stripe Enmesh ‡ Entourage Essence Fable CR Fibra Hudson Hula Hoop Kaleidoscope CR Kora CR Lagos Legend CR Lore CR Metro Milestone Moto CR Palisade Panache CR Pullman Quark Regard CR Roundtrip Sahara Sandpiper Sequin CR Spectator * Spot On Star Struck Stepping Stones Swing Tilden Vibe Wit Zari CR	Y Capri ‡ Copenhagen ‡ Distressed ‡ Marissa ‡ Riva ‡ Saddle ‡
D Compass CR Coterie Eclat Weave Hologram Island Kabuki Masquerade Menagerie Tara Theory Woodland Zoom	V Acqua ‡ Andes ‡ Embossed Tipped España ‡ Hand Tipped ‡ Velluto Pelle ‡
E Aegean Demure Highland Ikat Stripe Ikata Square Kampala Katazome Kimono Mamba Marquee Meroe Sherman Shima Tryst Whip	W Alaska ‡ Amazon ‡ Antique ‡ Derby ‡ Forte ‡ Lucente Sabrina ‡
F Atelier Calais Cotton Velvet Coco Cornaro Icon Intrigue In Stitches Liberty Mod Plaid Rivington Soon Tivoli Topography Totem Tweed Frieze	I Byron Cato Diamond Days Digi Velvet Dynamic Gramercy Knoll Velvet Piper Tudor Vermeer Walker Worth Zimba
G Alter Ego Brugge Djenne Feeling Plaid Gibson Hampshire Haze Kingston Melange Modern Tweed Petite Floral Spencer Ultrasuede ‡	<i>* Approved for 2162P only.</i> <i>Check with your KnollTextiles or Spinneybeck Representative for additions or changes.</i>

Joseph Paul D’Urso

Residential Lounge Seating

Designer(s):
Joseph Paul D’Urso, 2008



description	width	depth	height	seat h, max	arm h, max	type	textile fabric yards	leather sq ft	weight
2162R Residential Sofa, same upholstery, frame and cushions	90"	40 1/2"	28 1/2"	15 3/8"	20 3/8"		14	250	151 lbs.
2162R Residential Sofa, combination upholstery, frame and cushions	90"	40 1/2"	28 1/2"	15 3/8"	frame uph.	upchg, cushions	6.7	110	
							7.7	145	
2163R Residential Ottoman, same upholstery, frame and cushions	28 1/2"	28 1/2"	14"	14"			3.5	45	26 lbs.
2163R Residential Ottoman, combination upholstery, frame and cushions	28 1/2"	28 1/2"	14"	14"	frame uph.	upchg, cushions	1.4	15	
							2.8	30	
2162P Optional side cushion for residential sofa	21"	5"	11"				1	n/a	6 lbs.

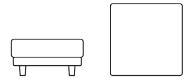
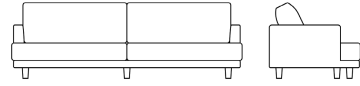

Order Code	Ordering Information	Construction
<i>Example:</i> 2160R-OE-K162/25	<i>Leg finishes:</i> Burnt Walnut on Oak (suffix 0313) Clear Oak (suffix OC) Ebonized on Oak (suffix OE) Polished Chrome (suffix C)	<i>Frame:</i> Constructed of plywood with sinuous spring seat suspension and matrix back suspension. Standard lounge chair and sofa depth is 36"; residential sofa is 40" deep.
2160R	D’Urso Residential Lounge Collection, lounge chair	<i>Stitching:</i> Non-directional textiles with railroad application, single needle topstitch for arms, double needle topstitch for seat and back cushions; directional textiles, single needle topstitch for arms, double needle topstitch for seat and back cushions, single blind stitch for vertical seams of seat cushion, a vertical single blind center seam joins inside and outside back panels of the sofa; leather, single needle topstitch for arms, double needle topstitch for seat and back cushions, single blind stitch for vertical seams of seat cushion, a vertical double needle topstitch seam joins inside and outside back panels of sofa. Ottoman; all applications, double needle topstitch for horizontal cushion seams, single blind seam for vertical seams of seat cushion.
OE	Ebonized legs	<i>Upholstery:</i> One seat and back cushion for the Lounge Chair, two seat and back cushions for the Sofa, one semi-attached cushion for Ottoman. For units with combination upholstery, add list price of surround in appropriate grade with the list price of cushions to obtain total list price for item.
K162/25	Classic Boucle, Aegean	Railroad upholstery application is standard for all non-directional textiles. Please see ‘Stitching’ for seam details.
<i>Example:</i> 21623R-0313-S-K1152/8-K1024/3	<i>Upholstery/COM information:</i> Prices shown includes fabric or leather upholstery. Contact your Knoll representative for colors. Only approved KnollTextiles and Spinneybeck leathers may be ordered.	<i>Cushions:</i> Seat cushions constructed of highly resilient polyurethane foam and polyester fiber, wrapped in polyester fiber batting. Back cushion constructed with a soft polyurethane foam core and polyester fiber fill. Side cushion constructed of 10/90 down with a down proof ticking.
2163R	D’Urso Residential Lounge Collection, ottoman	Leather cushions feature a perforated zipper breather panel.
0313	Burnt Walnut legs	
S	Split upholstery	
K1152/8	Surround in Stirling, Cobble	
K1024/3	Cushions in Coco, Ciel	
<i>Specify:</i>	<i>Maintenance:</i> See pages 28-29.	
1. Pattern number		
2. Leg finish		
3. Textile selection		
<i>Specify with split upholstery:</i>		
1. Pattern number		
2. Leg finish		
3. Split upholstery option		
4. Textile selection, Surround		
5. Textile selection, Cushions		

pattern no.	grade A	COM B	C	D	E	F	G	H	I	COL U	V	W	X	Y
2162R-(-)(-)	\$8,132.	\$8,487.	\$8,824.	\$9,195.	\$9,498.	\$9,717.	\$10,088.	\$10,795.	\$11,318.	\$15,018.	\$16,241.	\$18,728.	\$19,245.	\$19,849.
2162RS-(-)(-)(-)	6,204.	6,476.	6,732.	7,015.	7,247.	7,415.	7,697.	8,237.	8,636.	10,775.	11,653.	13,437.	13,808.	14,242.
upchg, cushions	2,659.	2,775.	2,886.	3,008.	3,105.	3,177.	3,299.	3,530.	3,702.	4,619.	4,993.	5,760.	5,917.	6,104.
2163R-(-)(-)	2,531.	2,634.	2,732.	2,840.	2,928.	2,993.	3,100.	3,307.	3,461.	3,929.	4,149.	4,597.	4,691.	4,800.
2163RS-(-)(-)(-)	1,930.	2,011.	2,084.	2,166.	2,234.	2,285.	2,366.	2,524.	2,640.	2,819.	2,978.	3,299.	3,364.	3,443.
upchg, cushions	827.	861.	893.	929.	958.	979.	1,015.	1,083.	1,131.	1,208.	1,276.	1,414.	1,443.	1,477.
2162P-(-)	467.	492.	515.	541.	561.	577.	603.	652.	688.					

Approved KnollTextiles Grades/Fabrics										Spinneybeck Leather			
A Alignment ‡ Beacon Bocce Cat’s Cradle Common Ground Commuter Cloth ‡ Crossroad Delite Dristi Hourglass Mariner Monarch ‡ Prep ‡ Presto ‡ Sonnet Stacks Trophy Uni-Form	B continued Melody Mini Stitch ‡ Night Life Paradigm Pogo Prairie Prim Radiance Ransom Ricochet ‡ Rush Hour Spark ‡ Spree Summit Sutton Synth Tabloid Tinge Venue Versa Vinyl Westwood Wide Angle ‡ Zipline	C continued Echo Empire Stripe Enmesh ‡ Entourage Essence Fable CR Fibra Hudson Hula Hoop Kaleidoscope CR Kora CR Lagos Legend CR Lore CR Metro Milestone Moto CR Palisade Panache CR Pullman Quark Regard CR Roundtrip Sahara Sandpiper Sequin CR Spectator * Spot On Star Struck Stepping Stones Swing Tilden Vibe Wit Zari CR	D Compass CR Coterie Eclat Weave Hologram Island Kabuki Masquerade Menagerie Tara Theory Woodland Zoom	E Aegean Demure Highland Ikat Stripe Ikat Square Kampala Katazome Kimono Mamba Marquee Meroe Sherman Shima Tryst Whip	F Atelier Calais Cotton Velvet Coco Cornaro Icon Intrigue In Stitches Liberty Mod Plaid Rivington Soon Tivoli Topography Totem Tweed Frieze	G Alter Ego Brugge Djenne Feeling Plaid Gibson Hampshire Haze Kingston Melange Modern Tweed Petite Floral Spencer Ultrasuede ‡	H Arno ‡ Constance Firefly Gezelle Magritte Rosemond I Byron Cato Diamond Days Digi Velvet Dynamic Gramercy Knoll Velvet Piper Tudor Vermeer Walker Worth Zimba	U Vicenza ‡ Volo ‡ V Acqua ‡ Andes ‡ Embossed Tipped España ‡ Hand Tipped ‡ Velluto Pelle ‡ W Alaska ‡ Amazon ‡ Antique ‡ Derby ‡ Forte ‡ Lucente Sabrina ‡	X Ducale Ducale Velour ‡ Y Capri ‡ Cervo Copenhagen ‡ Distressed ‡ Marissa ‡ Riva ‡ Saddle ‡				
										* Approved for 2162P only.			
Check with your KnollTextiles or Spinneybeck Representative for additions or changes.													

Joseph Paul D’Urso Swivel Lounge Seating

description	seat h, min	seat h, max	w	d	h, min	h, max	textile	req.	weight
							fabric yds.	leather sq. ft.	
2165 Swivel Lounge chair	17"	20"	32"	30"	25 3/4"	28 3/4"	4.25	100	52 lbs.

Designer(s):
Joseph Paul D’Urso, 2008

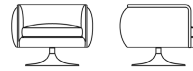

pattern no.	grades	COM	A	B	C	D	E	F	G	H	I	U	V	W	X	Y
2165-(-)(-)(-)	\$3,074.	\$3,178.	\$3,277.	n/a	n/a	\$3,541.	n/a	\$3,859.	\$4,013.	n/a	\$6,203.	\$7,024.	n/a	\$7,394.		

Order Code	Ordering Information	Construction
<p><i>Example:</i> 2165-RC-AP-K1320/4</p> <p>2165 Joseph Paul D’Urso Swivel lounge</p> <p>RC Return to center mechanism</p> <p>AP Polished Aluminum</p> <p>K1320/4 Comaro, Tabasco</p>	<p>Frame finish: Polished Aluminum (suffix AP) Textured Black (suffix TB) Warm White (suffix WW)</p> <p>Upholstery/COM information: Prices shown include fabric upholstery. Contact your Knoll representative for colors. Only approved KnollTextiles may be ordered.</p> <p>Customer’s Own Material in textile applications is limited. For approval requirements, processing instructions and ordering information please see page 13.</p>	<p>Maintenance: See pages 28-29.</p> <p>Note: The KnollStudio logo and signature of Joseph Paul D’Urso are located on the underside of chair.</p> <p>Frame: Inner frame of solid wood and bent laminate plywood.</p> <p>Base: Die cast aluminum base available in polished aluminum or powder coat paint finish.</p> <p>Upholstery: Textile application must be railroaded. Urethane foam with polyester top layer wraps interior frame and a fully upholstered panel surrounds chair.</p> <p>Leather upholstery features two vertical double-needle top stitched seams on the outside back of the chair.</p> <p>Cushion: Urethane foam with polyester fiber wrap. Case with a single needle-top stitch detail.</p>

Note:
The Joseph Paul D’Urso Swivel lounge chair is part of a collection. Please refer to the Joseph Paul D’Urso Lounge and Table Collections on pages 108, 112, 306, 308 and 312.

- Specify:*
1. Pattern number
 2. Return to center mechanism, option
 3. Frame finish
 4. Textile selection

Control:	Approved KnollTextiles Grades/Fabrics	Spinneybeck Leather
<p>360° Swivel mechanism with pneumatic seat height adjustment, cable operated with a low profile lever, flush mounted on the underside of the chair.</p> <p>Return to center mechanism: Optional return to center mechanism allows for 360° swivel movement and returns to a center position when not engaged. Available as fixed height only with an 19" seat height and a 27 3/4" overall height.</p> <p>To specify return to center mechanism, add suffix RC following parent pattern number.</p>	<p>A Mariner Sonnet</p> <p>B Knoll Felt # Knoll Hopsack Little Devil Melody Sutton</p> <p>C Classic Boucle</p> <p>F Coco Cornaro Rivington</p> <p>G Modern Tweed</p> <p>H Arno Bavaria Stretch Appeal</p> <p>I Aswan Cato North Island Vermeer</p>	<p>V Andes Espana</p> <p>W Sabrina</p> <p>Y Marissa Riva Torello</p>

Check with your KnollTextiles Representative for changes or additions.

Raul de Armas de Armas Chair

Designer(s):
Raul de Armas, 1991



description	seat h	arm h	w	d	h	textile	req.	weight	finish
						fabric yds/ welt	leather sq. ft.		
38A Arm chair, upholstered seat, no welt	17 1/2"	25 1/2"	21 1/4"	22 1/2"	33 1/2"	0.7/1.4	13	17 lbs.	other finishes
38AW Arm chair, upholstered seat, with welt	17 1/2"	25 1/2"	21 1/4"	22 1/2"	33 1/2"	0.7/1.4	13	16 lbs.	maple
38AW-U Arm chair, fully upholstered, with welt	17 1/2"	25 1/2"	21 1/4"	22 1/2"	33 1/2"	1.5	27	18 lbs.	other finishes
	17 1/2"	25 1/2"	21 1/4"	22 1/2"	33 1/2"	1.5	27	17 lbs.	maple

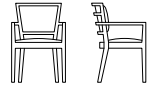
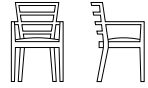

Order Code	Ordering Information	Construction
------------	----------------------	--------------

<i>Example:</i> 38A-B319-K787/174		
38A	de Armas arm chair, upholstered seat	
B319	Medium Cherry	
K787/174	Calais Cotton Velvet, Black Plum	

Specify:

1. Pattern number
2. Finish selection
3. Cal 133 Fire Code option
4. Textile selection

Ordering Information:

Maple:

Clear Maple (suffix KC)

Beech frame stains:

- Beech (suffix B311)
- Bronzed Cherry (suffix B312A)
- Burnt Walnut (suffix B313)
- Deep Red Mahogany (suffix B328)
- Ebonized (suffix BE)
- Light Cherry (suffix B315)
- Medium Cherry (suffix B319)
- Medium Red Mahogany (suffix BR)
- Medium Walnut (suffix B323)
- Natural Beech (suffix BN)
- Warm Brown Walnut (suffix J)

Upholstery/COM information:

Prices shown include fabric or leather upholstery. Contact your Knoll representative for colors. Only approved KnollTextiles and Spinneybeck leathers may be ordered.

Customer's Own Material is available pending approval. For approval requirements, processing instructions and ordering information please see page 18.

KnollStudio wood finishes:

KnollStudio wood finishes complement a large variety of KnollStudio veneer and Knoll Office veneer finishes. To select correct complementary finish, please refer to KnollStudio Wood Finish Matrix on page 25. Complimentary finishes are available at no upcharge. If no complementary standard finish is available, please refer to custom finish policy below.

Custom finishes:

To complement non-Knoll wood veneer or lumber finishes, a one-time, non-negotiable net upcharge of \$637 applies. Re-orders are at no upcharge.

Please contact your KnollStudio representative, dealer or Customer Service associate for complete custom finish information and Order Code. Minimum order quantity for any custom finish order: 4 chairs.

Cal 133 Fire Code : The de Armas Chairs comply with the California Technical Bulletin 133 standard if upholstered in Cal 133 approved upholstery. Specify suffix -C at end of pattern number and suffix -133 at end of textile selection. Upcharge applies, see page 18.

Certified Wood:

Chairs manufactured using FSC certified hardwoods are available through Custom Product Development. Extended leadtime and upcharge apply.

Maintenance:

See pages 28-29.

Note:

The de Armas Chair is Greenguard certified.

Frame:
Select clear maple hardwood in clear finish or select beech hardwood in stained finish.

Finish:
Catalyzed lacquer protective coating. Hand-applied final wax coating.

Seat:
Highly elastic woven membrane suspension with polyurethane foam insert.

Upholstery:
Inset seat available with optional welt detail. Fully upholstered features inset back with welt detail.

Glides:
Recessed plastic glides.

High Traffic Areas:
When specifying armless chair in high use or high traffic areas, we recommend the use of a stretcher for added strength. Contact CPD or your KnollStudio sales representative for more information.

pattern no.	grades	COM	C	D	E	F	G	H	I	COL	U	V	W	X	Y
38A-() or 38AW-()	\$1,383.	\$1,409.	\$1,437.	\$1,453.	\$1,471.	\$1,488.	\$1,505.	\$1,550.	\$1,623.	\$1,794.	\$1,897.	\$2,098.	\$2,142.	\$2,189.	
38A-KC or 38AW-KC	1,519.	1,544.	1,571.	1,589.	1,606.	1,623.	1,640.	1,683.	1,758.	1,929.	2,032.	2,232.	2,277.	2,325.	
38AW-U-()	2,072.	2,116.	2,157.	2,204.	2,240.	2,268.	2,313.	2,403.	2,467.	2,718.	2,873.	3,192.	3,259.	3,334.	
38AW-U-KC	2,271.	2,314.	2,357.	2,405.	2,440.	2,468.	2,513.	2,602.	2,666.	2,918.	3,072.	3,391.	3,460.	3,534.	

Approved KnollTextiles Grades/Fabrics

A Alignment *▲ Beacon * Bocce * Cat's Cradle * Chance * Common Ground * Commuter Cloth *▲ Crossroad Delite * Dristi * Foil Rap * Heavy Metal * Hourglass Mariner * Monarch *▲ Prep *▲ Presto *▲ Sonnet * Stacks * Trophy * Uni-Form *	B continued Gala II * Grandview * Grande * Helios * Holbrook * Journey * Keaton * Knoll Felt * Knoll Hopsack * Little Devil * Ludlow * Lyric * Melody * Mini Stitch *▲ Night Life * Paradigm * Petal Pusher * Prairie * Prim *▲ Radiance * Ransom * Ricochet *▲ Roam * Rush Hour * Soiree * Spark *▲ Sprée *	C Axiom * Atlas * Baxter * Biota * Cairo * Charm * Circa * Classic Boucle * Dahlia CR * Decade * Durand * Earthwork * Echo * Empire Stripe * Emesh *▲ Entourage * Essence * Fable CR * Fibra * Greenwich * Hudson * Hula Hoop * Kaleidoscope CR * Kora CR * Lagos * Legend CR * Lore CR * Magnolia * Metro * Milestone * Moto CR * Noble * Palisade * Panache CR * Pullman *	C continued Quark * Regard CR * Roundtrip * Sahara * Sandpiper * * Sequin CR * Sinclair * Smart * Spectator * Spot On * Star Struck * Stepping Stones * Swing * Tight Rope * Tilden * Tower Grid * Treble CR * Vibe * Wit * Zari CR *	D Compass CR * Coterie * Eclat Weave * Hologram * In The Loop * * Island * Masquerade * Menagerie * Origins * Tara * Theory * Woodland * Zoom *
--	--	--	--	---

Spinneybeck Leather

U Vicenza *▲ Volo *▲	V Acqua *▲ Andes *▲ Embossed Tipped * España *▲ Hand Tipped * * Velluto Pelle *▲	W Alaska *▲ Amazon *▲ Antique *▲ Derby * *▲ Forte *▲ Lucente Sabrina *▲	X Ducale * *▲ Ducale Velour * *▲	Y Capri *▲ Cervo * Copenhagen *▲ Distressed *▲ Lucca * Marissa * *▲ Portofino * * Riva *▲ Saddle * *▲ Torello *
-----------------------------------	---	---	---	--

* Approved for fully upholstered versions.
** Approved for seat pad with no welting only.
▲ Approved for Cal 133 upholstery.

Check with your KnollTextiles or Spinneybeck Representative for changes or additions.

Raul de Armas de Armas Chair

	description	seat h	arm h	w	d	h	textile fabric yds/ welt	req. leather sq. ft.	weight	finish
<i>Designer(s):</i> Raul de Armas, 1991	38C Armless chair, upholstered seat, no welt	17 1/2"		21 1/4"	22 1/2"	33 1/2"	0.7/1.4	13	15 lbs.	other finishes
	38CW Armless chair, upholstered seat, with welt	17 1/2"		21 1/4"	22 1/2"	33 1/2"	0.7/1.4	13	15 lbs.	maple

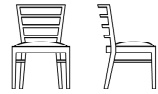

Order Code	Ordering Information	Construction
------------	----------------------	--------------

<i>Example:</i> 38A-B319-K787/174		
38A	de Armas arm chair, upholstered seat	
B319	Medium Cherry	
K787/174	Calais Cotton Velvet, Black Plum	

Specify:

1. Pattern number
2. Finish selection
3. Cal 133 Fire Code option
4. Textile selection

Ordering Information:

Maple:

Clear Maple (suffix KC)

Beech frame stains:

- Beech (suffix B311)
- Bronzed Cherry (suffix B312A)
- Burnt Walnut (suffix B313)
- Deep Red Mahogany (suffix B328)
- Ebonized (suffix BE)
- Light Cherry (suffix B315)
- Medium Cherry (suffix B319)
- Medium Red Mahogany (suffix BR)
- Medium Walnut (suffix B323)
- Natural Beech (suffix BN)
- Warm Brown Walnut (suffix J)

Upholstery/COM information:

Prices shown include fabric or leather upholstery. Contact your Knoll representative for colors. Only approved KnollTextiles and Spinneybeck leathers may be ordered.

Customer's Own Material is available pending approval. For approval requirements, processing instructions and ordering information please see page 18.

KnollStudio wood finishes:

KnollStudio wood finishes complement a large variety of KnollStudio veneer and Knoll Office veneer finishes. To select correct complementary finish, please refer to KnollStudio Wood Finish Matrix on page 25. Complimentary finishes are available at no upcharge. If no complementary standard finish is available, please refer to custom finish policy below.

Custom finishes:

To complement non-Knoll wood veneer or lumber finishes, a one-time, non-negotiable net upcharge of \$637 applies. Re-orders are at no upcharge.

Please contact your KnollStudio representative, dealer or Customer Service associate for complete custom finish information and Order Code. Minimum order quantity for any custom finish order: 4 chairs.

Cal 133 Fire Code : The de Armas Chairs comply with the California Technical Bulletin 133 standard if upholstered in Cal 133 approved upholstery. Specify suffix -C at end of pattern number and suffix -133 at end of textile selection. Upcharge applies, see page 18.

Certified Wood:

Chairs manufactured using FSC certified hardwoods are available through Custom Product Development. Extended leadtime and upcharge apply.

Maintenance:

See pages 28-29.

Note:

The de Armas Chair is Greenguard certified.

Frame: Select clear maple hardwood in clear finish or select beech hardwood in stained finish.

Finish: Catalyzed lacquer protective coating. Hand-applied final wax coating.

Seat: Highly elastic woven membrane suspension with polyurethane foam insert.

Upholstery: Inset seat available with optional welt detail. Fully upholstered features inset back with welt detail.

Glides: Recessed plastic glides.

High Traffic Areas: When specifying armless chair in high use or high traffic areas, we recommend the use of a stretcher for added strength. Contact CPD or your KnollStudio sales representative for more information.

pattern no.	grades	COM	C	D	E	F	G	H	I	COL	U	V	W	X	Y
38C-() or 38CW-()	\$1,308.	\$1,335.	\$1,364.	\$1,380.	\$1,398.	\$1,413.	\$1,434.	\$1,474.	\$1,552.	\$1,724.	\$1,825.	\$2,026.	\$2,066.	\$2,116.	
38C-KC or 38CW-KC	1,438.	1,465.	1,494.	1,510.	1,527.	1,544.	1,563.	1,604.	1,679.	1,854.	1,954.	2,155.	2,195.	2,246.	

Approved KnollTextiles Grades/Fabrics	Spinneybeck Leather
---------------------------------------	---------------------

- A** Alignment *▲
Beacon *
Bocce *
Cat's Cradle *
Chance *
Common Ground *
Commuter
Cloth *▲
Crossroad
Delite *
Dristi *
Foil Rap *
Heavy Metal *
Hourglass
Mariner *
Monarch *▲
Prep *▲
Presto *▲
Sonnet *
Stacks *
Trophy *
Uni-Form *
- B** Abacus *▲
Argyle *
Backdrop **
Belize
Bistro *▲
Boundary *▲
Cameo *
Chroma *▲
Chronicle *
Close Knit *
Digital Tape
Dovetail *▲
Fast Forward **
Ferry *
Forza *
- C** continued
Gala II *
Grandview *
Grande *
Helios *
Holbrook *
Journey *
Keaton *
Knoll Felt *
Knoll Hopsack *
Little Devil *
Ludlow *
Lyric *
Melody *
Mini Stitch *▲
Night Life *
Paradigm *
Petat Pusher *
Prairie *
Prim *▲
Radiance *
Ransom *
Ricochet *▲
Roam *
Rush Hour *
Soiree *
Spark *▲
Spree *
- C** continued
Axiom *
Atlas *
Baxter *
Biota *
Cairo *
Charm *
Circa *
Classic Boucle *
Dahlia CR *
Decade *
Durand *
Earthwork *
Echo *
Empire Stripe *
Emesh *▲
Entourage *
Essence *
Fable CR *
Fibra *
Greenwich *
Hudson *
Hula Hoop *
Kaleidoscope CR *
Kora CR *
Lagos *
Legend CR *
Lore CR *
Magnolia *
Metro *
Milestone *
Moto CR *
Noble *
Palisade *
Panache CR *
Pullman *
- D** continued
Quark *
Regard CR *
Roundtrip *
Sahara *
Sandpiper **
Sequin CR *
Sinclair *
Smart *
Spectator *
Spot On *
Star Struck *
Stepping Stones *
Swing *
Tight Rope *
Tilden *
Tower Grid *
Treble CR *
Vibe *
Wit *
Zari CR *
- D** continued
Compass CR *
Coterie *
Eclat Weave *
Hologram *
In The Loop **
Island *
Masquerade *
Menagerie *
Origins *
Tara *
Theory *
Woodland *
Zoom *

- E** Aegean *
Demure *
Highland *
Ikat Stripe *
Kampala *
Katazome *
Mamba *
Marquee *
Meroe *
Midpoint
Nature Walk
Sherman *
Shima *
Tryst *
Vatera *
Whip *
- F** Atelier *
Biscayne *
Calais Cotton
Velvet *
Century *
Coco **
Cornaro *
Glider *
Icon *
Intrigue *
In Stitches *
Liberty *
Mod Plaid *
Rivington *
Soon *
Tivoli *
Topography *
Totem *
Tweed Frieze *
- G** continued
Kinabalu *
Kingston *
Melange *
Metallic Gloss *
Modern Tweed *
Petite Floral *
Sablon *
Serendipity *
Spencer *
Straie Stripe *
Ultrasuede *▲
Utrillo *
- H** Arno *
Bavaria **
Catwalk *
Constance *
Firefly *
Gezelle *
Magritte *
Rosemond *
Stretch Appeal *
- I** Aswan *
Byron *
Canaan *
Cato **
Cummings *
Diamond Days *
Digi Velvet *
Dynamic *
Fiori *
Gramercy *
Ita *
Jaipur *
Knoll Velvet *▲
Limani *
Mepal *
North Island **
Olema *
Piper *
Rutledge *
Sandis *
Tudor *
Walker *
Worth **
Vermeer *
Zimba *
- U** Vicenza *▲
Volo *▲
- V** Acqua *▲
Andes *▲
Embossed Tipped *
España *▲
Hand Tipped **
Velluto Pelle *▲
- W** Alaska *▲
Amazon *▲
Antique *▲
Derby **▲
Forte *▲
Lucente
Sabrina *▲
- X** Ducale **▲
Ducale Velour **▲
- Y** Capri *▲
Cervo *
Copenhagen *▲
Distressed *▲
Lucca *
Marissa **▲
Portofino **
Riva *▲
Saddle **▲
Torello *

* Approved for fully upholstered versions.
** Approved for seat pad with no welting only.
▲ Approved for Cal 133 upholstery.

Check with your KnollTextiles or Spinneybeck Representative for changes or additions.

Raul de Armas de Armas Chair

Designer(s):
Raul de Armas, 1991



description	seat h	arm h	w	d	h	textile	req.	weight	finish
						fabric	leather		
yd/s/ welt	sq. ft.								
38CW-U Armless chair, fully upholstered, with welt	17 1/2"		21 1/4"	22 1/2"	33 1/2"	1.5	27	16 lbs.	other finishes
	17 1/2"		21 1/4"	22 1/2"	33 1/2"	1.5	27	16 lbs.	maple
38R Seat basket replacement						0.7/1.4	13		

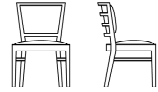

Order Code	Ordering Information	Construction
------------	----------------------	--------------

<i>Example:</i> 38A-B319-K787/174		
38A	de Armas arm chair, upholstered seat	
B319	Medium Cherry	
K787/174	Calais Cotton Velvet, Black Plum	

Specify:

1. Pattern number
2. Finish selection
3. Cal 133 Fire Code option
4. Textile selection

Ordering Information:

Maple:

Clear Maple (suffix KC)

Beech frame stains:

- Beech (suffix B311)
- Bronzed Cherry (suffix B312A)
- Burnt Walnut (suffix B313)
- Deep Red Mahogany (suffix B328)
- Ebonized (suffix BE)
- Light Cherry (suffix B315)
- Medium Cherry (suffix B319)
- Medium Red Mahogany (suffix BR)
- Medium Walnut (suffix B323)
- Natural Beech (suffix BN)
- Warm Brown Walnut (suffix J)

Upholstery/COM information:

Prices shown include fabric or leather upholstery. Contact your Knoll representative for colors. Only approved KnollTextiles and Spinneybeck leathers may be ordered.

Customer's Own Material is available pending approval. For approval requirements, processing instructions and ordering information please see page 18.

KnollStudio wood finishes:

KnollStudio wood finishes complement a large variety of KnollStudio veneer and Knoll Office veneer finishes. To select correct complementary finish, please refer to KnollStudio Wood Finish Matrix on page 25. Complimentary finishes are available at no upcharge. If no complementary standard finish is available, please refer to custom finish policy below.

Custom finishes:

To complement non-Knoll wood veneer or lumber finishes, a one-time, non-negotiable net upcharge of \$637 applies. Re-orders are at no upcharge.

Please contact your KnollStudio representative, dealer or Customer Service associate for complete custom finish information and Order Code. Minimum order quantity for any custom finish order: 4 chairs.

Cal 133 Fire Code : The de Armas Chairs comply with the California Technical Bulletin 133 standard if upholstered in Cal 133 approved upholstery. Specify suffix -C at end of pattern number and suffix -133 at end of textile selection. Upcharge applies, see page 18.

Certified Wood: Chairs manufactured using FSC certified hardwoods are available through Custom Product Development. Extended leadtime and upcharge apply.

Maintenance: See pages 28-29.

Note: The de Armas Chair is Greenguard certified.

Frame: Select clear maple hardwood in clear finish or select beech hardwood in stained finish.

Finish: Catalyzed lacquer protective coating. Hand-applied final wax coating.

Seat: Highly elastic woven membrane suspension with polyurethane foam insert.

Upholstery: Inset seat available with optional welt detail. Fully upholstered features inset back with welt detail.

Glides: Recessed plastic glides.

High Traffic Areas: When specifying armless chair in high use or high traffic areas, we recommend the use of a stretcher for added strength. Contact CPD or your KnollStudio sales representative for more information.

pattern no.	grades	COM	C	D	E	F	G	H	I	COL	V	W	X	Y
38CW-U-()	\$1,865.	\$1,907.	\$1,950.	\$1,995.	\$2,034.	\$2,061.	\$2,107.	\$2,192.	\$2,260.	\$2,517.	\$2,672.	\$2,976.	\$3,057.	\$3,133.
38CW-U-KC	2,044.	2,086.	2,128.	2,175.	2,213.	2,238.	2,287.	2,371.	2,438.	2,696.	2,851.	3,156.	3,238.	3,314.
38R-()	424.	448.	478.	493.	512.	527.	544.	588.	661.	837.	938.	1,137.	1,181.	1,228.

Approved KnollTextiles Grades/Fabrics	Spinneybeck Leather
---------------------------------------	---------------------

A Alignment *▲ Beacon * Bocce * Cat's Cradle * Chance * Common Ground * Commuter Cloth *▲ Crossroad Delite * Dristi * Foil Rap * Heavy Metal * Hourglass Mariner * Monarch *▲ Prep *▲ Presto *▲ Sonnet * Stacks * Trophy * Uni-Form *	B continued Gala II * Grandview * Grande * Helios * Holbrook * Journey * Keaton * Knoll Felt * Knoll Hopsack * Little Devil * Ludlow * Lyric * Melody * Mini Stitch *▲ Night Life * Paradigm * Petal Pusher * Prairie * Prim *▲ Radiance * Ransom * Ricochet *▲ Roam * Rush Hour * Soiree * Spark *▲ Spree * Summit * Sutton *▲ Synth * Tabloid * Utmost * Venue * Versa * Vinyl * Westwood * Wide Angle *▲ Yeni *	C Axiom * Atlas * Baxter * Biota * Cairo * Charm * Circa * Classic Boucle * Dahlia CR * Decade * Durand * Earthwork * Echo * Empire Stripe * Emesh *▲ Entourage * Essence * Fable CR * Fibra * Greenwich * Hudson * Hula Hoop * Kaleidoscope CR * Kora CR * Lagos * Legend CR * Lore CR * Magnolia * Metro * Milestone * Moto CR * Noble * Palisade * Panache CR * Pullman *	C continued Quark * Regard CR * Roundtrip * Sahara * Sandpiper ** Sequin CR * Sinclair * Smart * Spectator * Spot On * Star Struck * Stepping Stones * Swing * Tight Rope * Tilden * Tower Grid * Treble CR * Vibe * Wit * Zari CR *	D Compass CR * Coterie * Eclat Weave * Hologram * In The Loop ** Island * Masquerade * Menagerie * Origins * Tara * Theory * Woodland * Zoom *	E Aegean * Demure * Highland * Ikat Stripe * Kampala * Katazome * Mamba * Marquee * Meroe * Midpoint Nature Walk Sherman * Shima * Tryst * Vatera * Whip *	F Atelier * Biscayne * Calais Cotton Velvet * Century * Coco ** Cornaro * Glider * Icon * Intrigue * In Stitches * Liberty * Mod Plaid * Rivington * Soon * Tivoli * Topography * Totem * Tweed Frieze *	G continued Kinabalu * Kingston * Melange * Metallic Gloss * Modern Tweed * Petite Floral * Sablon * Serendipity * Spencer * Straie Stripe * Ultrasuede *▲ Utrillo * H Arno * Bavaria ** Catwalk * Constance * Firefly * Gezelle * Magritte * Rosemond * Stretch Appeal *	I Aswan * Byron * Canaan * Cato ** Cummings * Diamond Days * Digi Velvet * Dynamic * Fiori * Gramercy * Ita * Jaipur * Knoll Velvet *▲ Limani * Mepal * North Island ** Olema * Piper * Rutledge * Sandis * Tudor * Walker * Worth ** Vermeer * Zimba *	U Vicenza *▲ Volo *▲ V Acqua *▲ Andes *▲ Embossed Tipped * España *▲ Hand Tipped ** Velluto Pelle *▲ W Alaska *▲ Amazon *▲ Antique *▲ Derby **▲ Forte *▲ Lucente Sabrina *▲ X Ducale **▲ Ducale Velour **▲ Y Capri *▲ Cervo * Copenhagen *▲ Distressed *▲ Lucca * Marissa **▲ Portofino ** Riva *▲ Saddle **▲ Torello *
--	---	--	---	--	---	---	---	---	---

* Approved for fully upholstered versions.
** Approved for seat pad with no welting only.
▲ Approved for Cal 133 upholstery.

Check with your KnollTextiles or Spinneybeck Representative for changes or additions.

Raul de Armas

Vertical de Armas Chair

Designer(s):
Raul de Armas, 2000

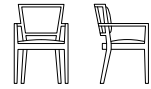
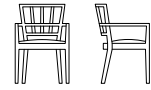

description	seat h	arm h	w	d	h	textile fabric yds/ welt	req. leather sq. ft.	weight	finish
41A Arm chair, upholstered seat, no welt	17 1/2"	25 1/2"	21 1/4"	22 1/2"	33 1/2"	0.7/1.4	13	17 lbs.	other finishes
41AW Arm chair, upholstered seat, with welt	17 1/2"	25 1/2"	21 1/4"	22 1/2"	33 1/2"	0.7/1.4	13	16 lbs.	maple
41AW-U Arm chair, fully upholstered, with welt	17 1/2"	25 1/2"	21 1/4"	22 1/2"	33 1/2"	1.5	27	18 lbs.	other finishes
	17 1/2"	25 1/2"	21 1/4"	22 1/2"	33 1/2"	1.5	27	17 lbs.	maple
41R Seat basket replacement						0.7/1.4	13		

Order Code	Ordering Information	Construction
------------	----------------------	--------------

<i>Example:</i> 41A-B319-K787/174	<i>Upholstery/COM information:</i>	Please contact your KnollStudio representative, dealer or Customer Service associate for complete custom finish information and Order Code. Minimum order quantity for any custom finish order: 4 chairs.
41A	de Armas arm chair	
B319	Medium Cherry	
K787/174	Calais Cotton Velvet, Black Plum	

Prices shown include fabric or leather upholstery. Contact your Knoll representative for colors. Only approved KnollTextiles and Spinneybeck leathers may be ordered.

Cal 133 Fire Code : The de Armas Chairs comply with the California Technical Bulletin 133 standard if upholstered in Cal 133 approved upholstery. Specify suffix -C at end of pattern number and suffix -133 at end of textile selection. Upcharge applies, see page 18.

Frame: Select clear maple hardwood in clear finish or select beech hardwood in stained finish.

Finish: Catalyzed lacquer protective coating. Hand-applied final wax coating.

Seat: Highly elastic woven membrane suspension with polyurethane foam insert.

Upholstery: Inset seat available with optional welt detail. Fully upholstered features inset back with welt detail.

Glides: Recessed plastic glides.

High Traffic Areas: When specifying armless chair in high use or high traffic areas, we recommend the use of a stretcher for added strength. Contact CPD or your KnollStudio sales representative for more information.

Certified Wood: Chairs manufactured using FSC certified hardwoods are available through Custom Product Development. Extended leadtime and upcharge apply.

Maintenance: See pages 28-29.

Note: The Vertical de Armas Chair is Greenguard certified.

Customer's Own Material is available pending approval. For approval requirements, processing instructions and ordering information please see page 18.

KnollStudio wood finishes: KnollStudio wood finishes complement a large variety of KnollStudio veneer and Knoll Office veneer finishes. To select correct complementary finish, please refer to KnollStudio Wood Finish Matrix on page 25. Complementary finishes are available at no upcharge. If no complementary standard finish is available, please refer to custom finish policy below.

Custom finishes: To complement non-Knoll wood veneer or lumber finishes, a one-time, non-negotiable net upcharge of \$637 applies. Re-orders are at no upcharge.

Specify:

1. Pattern number
2. Finish selection
3. Cal 133 Fire Code option
4. Textile selection

Ordering Information:

Maple: Clear Maple (suffix KC)

Beech frame stains:
Beech (suffix B311)
Bronzed Cherry (suffix B312A)
Burnt Walnut (suffix B313)
Deep Red Mahogany (suffix B328)
Ebonized (suffix BE)
Light Cherry (suffix B315)
Medium Cherry (suffix B319)
Medium Red Mahogany (suffix BR)
Medium Walnut (suffix B323)
Natural Beech (suffix BN)
Warm Brown Walnut (suffix J)

pattern no.	grades A	COM B	C	D	E	F	G	H	I	COL U	V	W	X	Y
41A-() or 41AW-()	\$1,383.	\$1,409.	\$1,437.	\$1,453.	\$1,471.	\$1,488.	\$1,505.	\$1,550.	\$1,623.	\$1,794.	\$1,897.	\$2,098.	\$2,142.	\$2,189.
41A-KC or 41AW-KC	1,519.	1,544.	1,571.	1,589.	1,606.	1,623.	1,640.	1,683.	1,758.	1,929.	2,032.	2,232.	2,277.	2,325.
41AW-U-()	2,072.	2,116.	2,157.	2,204.	2,240.	2,268.	2,313.	2,403.	2,467.	2,718.	2,873.	3,192.	3,259.	3,334.
41AW-U-KC	2,271.	2,314.	2,357.	2,405.	2,440.	2,468.	2,513.	2,602.	2,666.	2,918.	3,072.	3,391.	3,460.	3,534.
41R-()	424.	448.	478.	493.	512.	527.	544.	588.	661.	837.	938.	1,137.	1,181.	1,228.

Approved KnollTextiles Grades/Fabrics	Spinneybeck Leather
---------------------------------------	---------------------

A Alignment * Beacon * Bocce * Cat's Cradle * Chance * Common Ground * Commuter Cloth * Crossroad * Delite * Dristi * Foil Rap * Heavy Metal * Hourglass Mariner * Monarch * Prep * Presto * Sonnet * Stacks * Trophy * Uni-Form *	B continued Gala II * Grandview * Grande * Helios * Holbrook * Journey * Keaton * Knoll Felt * Knoll Hopsack * Little Devil * Ludlow * Lyric * Melody * Mini Stitch * Night Life * Paradigm * Petal Pusher * Prairie * Prim * Radiance * Ransom * Ricochet * Roam * Rush Hour * Soiree * Spark * Spree * Starry Night * Summit * Sutton * Synth * Tabloid * Tinge * Utmost * Venue * Versa * Vinyl * Westwood * Wide Angle * Yeni *	C Axiom * Atlas * Baxter * Biota * Cairo * Charm * Circa * Classic Boucle * Dahlia CR * Decade * Durand * Earthwork * Echo * Empire Stripe * Emesh * Entourage * Essence * Fable CR * Fibra * Greenwich * Hudson * Hula Hoop * Kaleidoscope CR * Kora CR * Lagos * Legend CR * Lore CR * Magnolia * Metro * Milestone * Moto CR * Noble * Palisade * Panache CR * Pullman *	C continued Quark * Regard CR * Roundtrip * Sahara * Sandpiper * Sequin CR * Sinclair * Smart * Spectator * Spot On * Star Struck * Stepping Stones * Swing * Tight Rope * Tilden * Tower Grid * Treble CR * Vibe * Wit * Zari CR *	D Compass CR * Coterie * Eclat Weave * Hologram * In The Loop * Island * Masquerade * Menagerie * Origins * Tara * Theory * Woodland * Zoom *	E Aegean * Demure * Highland * Ikat Stripe * Kampala * Katazome * Mamba * Marquee * Meroe * Midpoint Nature Walk Sherman * Shima * Tilden * Tryst * Vatera * Whip *	F Atelier * Biscayne * Calais Cotton Velvet * Century * Coco * Cornaro * Glider * Icon * Intrigue * In Stitches * Liberty * Mod Plaid * Rivington * Soon * Tivoli * Topography * Totem * Tweed Frieze *	G continued Kinabalu * Kingston * Melange * Metallic Gloss * Modern Tweed * Petite Floral * Sablon * Serendipity * Spencer * Straie Stripe * Ultrasuede * Utrillo * H Arno * Bavaria * Catwalk * Constance * Firefly * Gezelle * Magritte * Rosemond * Stretch Appeal *	I Aswan * Byron * Canaan * Cato * Cummings * Diamond Days * Digi Velvet * Dynamic * Fiori * Gramercy * Ita * Jaipur * Knoll Velvet * Limani * Mepal * North Island * Olema * Piper * Rutledge * Sandis * Tudor * Walker * Worth * Vermeer * Zimba *	U Vicenza * Volo * V Acqua * Andes * Embossed Tipped * España * Hand Tipped * Velluto Pelle * W Alaska * Amazon * Antique * Derby * Forte * Lucente Sabrina * X Ducale * Ducale Velour * Y Capri * Cervo * Copenhagen * Lucca * Marissa * Portofino * Riva * Saddle * Torello *
---	--	---	--	---	---	---	---	---	--

* Approved for fully upholstered versions.
** Approved for seat pad with no welting only.
 Approved for Cal 133 upholstery.

Check with your KnollTextiles or Spinneybeck Representative for changes or additions.

Raul de Armas

Vertical de Armas Chair

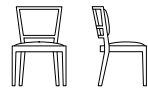
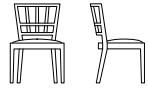

	description	seat h	arm h	w	d	h	textile fabric yds/ welt	leather sq. ft.	weight	finish
<i>Designer(s):</i> Raul de Armas, 2000	41C Armless chair, upholstered seat, no welt	17 1/2"		21 1/4"	22 1/2"	33 1/2"	0.7/1.4	13	15 lbs.	other finishes
	41CW Armless chair, upholstered seat, with welt	17 1/2"		21 1/4"	22 1/2"	33 1/2"	0.7/1.4	13	16 lbs.	maple
	41CW-U Armless chair, fully upholstered, with welt	17 1/2"		21 1/4"	22 1/2"	33 1/2"	1.5	27	16 lbs.	other finishes
		17 1/2"		21 1/4"	22 1/2"	33 1/2"	1.5	27	17 lbs.	maple
	41R Seat basket replacement						0.7/1.4	13		

Order Code	Ordering Information	Construction
<i>Example:</i> 41A-B319-K787/174	<i>Upholstery/COM information:</i>	
41A	de Armas arm chair	Please contact your KnollStudio representative, dealer or Customer Service associate for complete custom finish information and Order Code. Minimum order quantity for any custom finish order: 4 chairs.
B319	Medium Cherry	
K787/174	Calais Cotton Velvet, Black Plum	

Specify:

1. Pattern number
2. Finish selection
3. Cal 133 Fire Code option
4. Textile selection

Ordering Information:

Maple:
Clear Maple (suffix KC)

Beech frame stains:
Beech (suffix B311)
Bronzed Cherry (suffix B312A)
Burnt Walnut (suffix B313)
Deep Red Mahogany (suffix B328)
Ebonized (suffix BE)
Light Cherry (suffix B315)
Medium Cherry (suffix B319)
Medium Red Mahogany (suffix BR)
Medium Walnut (suffix B323)
Natural Beech (suffix BN)
Warm Brown Walnut (suffix J)

Customer's Own Material is available pending approval. For approval requirements, processing instructions and ordering information please see page 18.

KnollStudio wood finishes:
KnollStudio wood finishes complement a large variety of KnollStudio veneer and Knoll Office veneer finishes. To select correct complementary finish, please refer to KnollStudio Wood Finish Matrix on page 25. Complementary finishes are available at no upcharge. If no complementary standard finish is available, please refer to custom finish policy below.

Custom finishes:
To complement non-Knoll wood veneer or lumber finishes, a one-time, non-negotiable net upcharge of \$637 applies. Re-orders are at no upcharge.

Cal 133 Fire Code :
The de Armas Chairs comply with the California Technical Bulletin 133 standard if upholstered in Cal 133 approved upholstery. Specify suffix -C at end of pattern number and suffix -133 at end of textile selection. Upcharge applies, see page 18.

Certified Wood:
Chairs manufactured using FSC certified hardwoods are available through Custom Product Development. Extended leadtime and upcharge apply.

Maintenance:
See pages 28-29.

Note:
The Vertical de Armas Chair is Greenguard certified.

Frame:
Select clear maple hardwood in clear finish or select beech hardwood in stained finish.

Finish:
Catalyzed lacquer protective coating. Hand-applied final wax coating.

Seat:
Highly elastic woven membrane suspension with polyurethane foam insert.

Upholstery:
Inset seat available with optional welt detail. Fully upholstered features inset back with welt detail.





Glides:
Recessed plastic glides.

High Traffic Areas:
When specifying armless chair in high use or high traffic areas, we recommend the use of a stretcher for added strength. Contact CPD or your KnollStudio sales representative for more information.

pattern no	grades A	COM B	C	D	E	F	G	H	I	COL U	V	W	X	Y
41C-() or 41CW-()	\$1,308.	\$1,335.	\$1,364.	\$1,380.	\$1,398.	\$1,413.	\$1,434.	\$1,474.	\$1,552.	\$1,724.	\$1,825.	\$2,026.	\$2,066.	\$2,116.
41C-KC or 41CW-KC	1,438.	1,465.	1,494.	1,510.	1,527.	1,544.	1,563.	1,604.	1,679.	1,854.	1,954.	2,155.	2,195.	2,246.
41CW-U-()	1,865.	1,907.	1,950.	1,995.	2,034.	2,061.	2,107.	2,192.	2,260.	2,517.	2,672.	2,976.	3,057.	3,133.
41CW-U-KC	2,044.	2,086.	2,128.	2,175.	2,213.	2,238.	2,287.	2,371.	2,438.	2,696.	2,851.	3,156.	3,238.	3,314.
41R-()	424.	448.	478.	493.	512.	527.	544.	588.	661.	837.	938.	1,137.	1,181.	1,228.

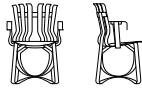
Approved KnollTextiles Grades/Fabrics	Spinneybeck Leather
A Alignment *▲ Beacon * Bocce * Cat's Cradle * Chance * Common Ground * Commuter Cloth *▲ Crossroad * Delite * Dristi * Foil Rap * Heavy Metal * Hourglass Mariner * Monarch *▲ Prep *▲ Presto *▲ Sonnet * Stacks * Trophy * Uni-Form *	B Abacus *▲ Argyle * Backdrop ** Belize Bistro *▲ Boundary *▲ Cameo * Chroma *▲ Chronicle * Close Knit * Digital Tape * Dovetail *▲ Fast Forward ** Ferry * Forza *
E Empire Stripe * Night Life * Paradigm * Petal Pusher * Prairie * Prim *▲ Radiance * Ransom * Ricochet *▲ Roam * Rush Hour * Soiree * Spark *▲ Spree * Starry Night *▲ Summit * Sutton *▲ Synth * Tabloid * Tinge * Utmost * Venue * Versa * Vinyl * Westwood * Wide Angle *▲ Yeni *	C Axiom * Atlas * Baxter * Biota * Cairo * Charm * Circa * Classic Boucle * Dahlia CR * Decade * Durand * Earthwork * Echo * Empire Stripe * Emesh *▲ Entourage * Essence * Fable CR * Fibra * Greenwich * Hudson * Hula Hoop * Kaleidoscope CR * Kora CR * Lagos * Legend CR * Lore CR * Magnolia * Metro * Milestone * Moto CR * Noble * Palisade * Panache CR * Pullman *
G Alter Ego * Amore * Abington * Arabella * Arber * Brugge * Djenne * Feeling Plaid * Garden City * Gibson * Hampshire ** Haze * Kamani *	D Compass CR * Coterie * Eclat Weave * Hologram * In The Loop ** Island * Masquerade * Menagerie * Origins * Tara * Theory * Woodland * Zoom * E Aegean * Demure * Highland * Ikat Stripe * Ikat Square * Kampala *
F Atelier * Biscayne * Calais Cotton Velvet * Century * Coco ** Cornaro * Glider * Icon * Intrigue * In Stitches * Liberty * Mod Plaid * Rivington * Soon * Tivoli * Topography * Totem * Tweed Frieze *	H Arno * Bavaria ** Catwalk * Constance * Firefly * Gezelle * Magritte * Rosemond * Stretch Appeal *
I Aswan * Byron * Canaan * Cato ** Cummings * Diamond Days * Digi Velvet * Dynamic * Fiori * Gramercy * Ita * Jaipur * Knoll Velvet *▲ Limani * Mepal * North Island ** Olema * Piper * Rutledge * Sandis * Tudor * Walker * Worth ** Vermeer * Zimba *	U Vicenza *▲ Volo *▲ V Acqua *▲ Andes *▲ Embossed Tipped * España *▲ Hand Tipped ** Velluto Pelle *▲ W Alaska *▲ Amazon *▲ Antique *▲ Derby *▲ Forte *▲ Lucente Sabrina *▲ * Approved for fully upholstered versions. ** Approved for seat pad with no welting only. ▲ Approved for Cal 133 upholstery. <i>Check with your KnollTextiles or Spinneybeck Representative for changes or additions.</i>
X Ducale **▲ Ducale Velour **▲ Y Capri *▲ Cervo * Copenhagen *▲ Lucca * Marissa **▲ Portofino ** Riva *▲ Saddle **▲ Torello *	

Frank Gehry Side and Dining Chairs

	description	seat h	arm h	w	d	h	textile fabric yds.	req. leather sq. ft.	weight
<i>Designer(s):</i> Frank Gehry, 1990	91A-GC Hat Trick arm chair 	18"	25 7/8"	23 7/8"	22 1/4"	33 1/2"			14 lbs.
		18"	25 7/8"	23 7/8"	22 1/4"	33 1/2"	0.8	15	14 lbs.
<i>Award(s):</i> ASID Award, 1992; ROSCOE Award, 1992; ID Magazine Gold Award, 1992; ICFE Award for Excellence, 1992; IBD Award (Silver), 1992; Premium Imperiale Award (Prince Takamatsu World Culture Award), 1992; Time Magazine, Best Design of 1992	91C-GC Hat Trick armless chair 	18"	20"	22 1/4"	33 1/2"				11 lbs.
		18"	20"	22 1/4"	33 1/2"	0.8	15		11 lbs.
	91K Seat cushion replacement for Hat Trick arm and armless chair						0.8	15	
	92C-GC High Sticking high back chair 	17 7/8"	20 1/8"	23 7/8"	43 7/8"				12 lbs.
		17 7/8"	20 1/8"	23 7/8"	43 7/8"	0.7	14		12 lbs.
	92K Seat cushion replacement						0.7	14	

Order Code

<i>Example:</i>	91A-GC-K-SA783
91A	Hat Trick arm chair
GC	Clear Maple
K	Seat cushion
SA783	Sabrina, Carmen
<i>Example:</i>	92K-K1320/4
92K	High sticking seat cushion replacement
K1320/4	Cornaro, Tabasco

Note:
The Gehry chairs are part of a collection. Please refer to Gehry tables on page 314.

Specify:

1. Pattern number
2. Finish selection
3. Textile selection

Seat cushion replacement, specify:

1. Pattern number
2. Textile selection

Ordering Information

Finishes:
Clear Maple (suffix GC)

Seat cushion option:
To specify seat cushion, add "K" to end of pattern number and then list textile/leather pattern number.

Upholstery/COM information:
Prices shown include fabric or leather upholstery. Contact your Knoll representative for colors. Only approved KnollTextiles and Spinneybeck leathers may be ordered.

Customer's Own Material is available pending approval. For approval requirements, processing instructions and ordering information please see page 18.

Construction

Hat Trick note:
Hat Trick arms are 9-ply and arm supports are a total of 26-ply for added strength. Arms may be retrofitted on armless Hat Trick chair, or removed from arm version. Easily added or removed with bolts. Contoured seat constructed of cross-ply maple for rigidity.

High Sticking note:
Built-in lumbar curve for enhanced back support. To maximize tension compression, limited assembly glue is used in woven seat: weaves flex in unison for spring-like comfort.

Note:
The underside of each piece is embossed with the Knoll logo and Frank Gehry's signature.

Maintenance:
See pages 28-29.

Frame:
Constructed of hard white maple veneers in 2" wide, 1/32" thick strips on Hat Trick and High Sticking chair, laminated to 7 to 9-ply thickness with high-bonding urea glue. All wood grains run in same direction for resilience. Thermo-set assembly glue provides structural rigidity without the need for metal connectors, while allowing for ergonomic movement and flexibility. Backs on all chairs flex for added comfort.

Cushions:
1/2" thick high resiliency foam on Hat Trick. 3/4" thick high resiliency foam on High Sticking. Hat Trick cushion "shower cap" design envelopes entire seat. Square High Sticking cushion snap-locks underneath chair.

Glides:
Clear plastic with matte frost finish.

pattern no.	unuphol.	grades A	COM B	C	D	E	F	G	H	I	COL U	V	W	X	Y
91A-GC	\$3,732.														
91A-GC-K		4,083.	4,104.	4,125.	4,147.	4,165.	4,179.	4,201.	4,243.	4,275.	4,387.	4,469.	4,632.	4,665.	4,705.
91C-GC	2,838.														
91C-GC-K		3,190.	3,212.	3,231.	3,254.	3,273.	3,285.	3,308.	3,352.	3,383.	3,497.	3,575.	3,739.	3,773.	3,812.
91K-()		422.	444.	462.	485.	505.	516.	540.	584.	614.	729.	809.	969.	1,004.	1,044.
92C-GC	4,878.														
92C-GC-K		5,230.	5,253.	5,272.	5,294.	5,313.	5,324.	5,348.	5,391.	5,422.	5,513.	5,588.	5,739.	5,770.	5,806.
92K-()		453.	475.	495.	517.	537.	547.	572.	615.	646.	736.	812.	962.	993.	1,029.

Approved KnollTextiles Grades/Fabrics

A Alignment Beacon Bocce Chance Common Ground Commuter Cloth Crossroad Delite Dristi Hourglass Mariner Prep Presto Soliloquy Sonnet Stacks Trophy Uni-Form	B continued Night Life Paradigm Pogo Prairie Prim # Radiance Ransom Ricochet Roam Rush Hour Soiree Spark Spree Summit Sutton Synth Tabloid Utmost Venue Versa Vinyl Westwood Wide Angle Zipline	C continued Earthwork Echo Empire Stripe Enmesh Entourage Essence Fibra Greenwich Hudson Hula Hoop Kora CR Lagos Legend CR Lore CR Magnolia Metro Milestone Moto CR Noble Palisade Panache CR Pullman Quark Regard CR Roundtrip Sequin CR Sinclair Smart Spot On Star Struck Stepping Stones Swing Tilden Tower Grid	C continued Treble CR Vibe Zari CR	D Compass CR Coterie Eclat Weave Hologram Island Masquerade Menagerie Origins Tara Theory Woodland Zoom	E Aegean Demure Highland Ikat Stripe Ikat Square Kampala Katazome Kimono Mamba Marquee Midpoint Nature Walk Sherman Shima Tryst Vatera
---	---	--	---	--	---

Spinneybeck Leather

F Atelier Biscayne Calais Cotton Velvet Century Coco Cornaro Glider Icon Intrigue In Stitches Liberty Mod Plaid Rivington Tivoli Topography Totem Tweed Frieze	H Arno Bavaria Catwalk Firefly Gezelle Magritte Rosemond Stretch Appeal	I Aswan Byron Canaan Diamond Days Dynamic Ita Jaipur Knoll Velvet Limani North Island Olema Piper Rutledge Sandis Tudor Vermeer Walker Worth Zimba	U Vicenza Volo	V Acqua Andes Embossed Tipped España Velluto Pelle	W Alaska Amazon Antique Forte Lucente Sabrina	X Ducale Ducale Velour	Y Capri Cervo Copenhagen Distressed Lucca Marissa Riva
---	--	--	-----------------------------	--	--	-------------------------------------	--

Check with your KnollTextiles or Spinneybeck Representative for changes or additions.

Frank Gehry Lounge Seating

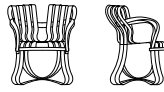
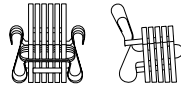
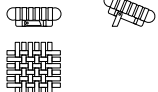
	description	seat h	arm h	w	d	h	textile fabric yds.	req. leather sq. ft.	weight
<i>Designer(s):</i> Frank Gehry, 1990	93A-GC Cross Check arm chair 	18 1/8"	28 3/4"	28 1/2"	24 7/8"	33 3/8"			12 lbs.
		18 1/8"	28 3/4"	28 1/2"	24 7/8"	33 3/8"	0.8	15	12 lbs.
<i>Award(s):</i> ASID Award, 1992; ROSCOE Award, 1992; ID Magazine Gold Award, 1992; ICFE Award for Excellence, 1992; IBD Award (Silver), 1992; Premium Imperiale Award (Prince Takamatsu World Culture Award), 1992; Time Magazine, Best Design of 1992	93K Seat cushion replacement						0.8	15	
	94L-GC Power Play club chair 	16"	23 1/2"	31 1/8"	30 1/8"	32 7/8"			26 lbs.
		16"	23 1/2"	31 1/8"	30 1/8"	32 7/8"	0.7	14	26 lbs.
	94K Seat cushion replacement						0.7	14	
	94LY-GC Off Side ottoman 			23 1/8"	23 3/8"	8 1/8"-13 3/8"			6 lbs.
				23 1/8"	23 3/8"	8 1/8"-13 3/8"	0.7	14	6 lbs.
	94YK Seat cushion replacement						0.7	14	



Order Code	Ordering Information	Construction
<i>Example:</i> 93A-GC-K-K124/14	<i>Finishes:</i> Clear Maple (suffix GC)	<i>Power Play note:</i> Power Play slats flex individually for added comfort. Recessed screws connect seat and arm.
93A Cross Check arm chair		<i>Frame:</i> Constructed of hard white maple veneers in 2" wide, 1/8" thick strips. Laminated to 6 to 9-ply thickness with high-bonding urea glue. All wood grains run in same direction for resilience. Thermoset assembly glue provides structural rigidity minimizing the need for metal connectors, while allowing for ergonomic movement and flexibility. Backs on all chairs flex for added comfort.
GC Clear Maple	<i>Seat cushion option:</i> To specify seat cushion, add "K" to end of pattern number and then list textile/leather pattern number.	<i>Note:</i> The underside of each piece is embossed with the Knoll logo and Frank Gehry's signature.
K Seat cushion		<i>Maintenance:</i> See pages 28-29.
K1106/8 Spencer, Apricot	<i>Upholstery/COM information:</i> Prices shown include fabric or leather upholstery. Contact your Knoll representative for colors. Only approved KnollTextiles and Spinneybeck leathers may be ordered.	<i>Cushions:</i> 1" thick high resiliency foam for fish-shaped Cross Check cushion. 3/4" thick high resiliency foam for square Power Play and Off Side cushions. Cushions snap-lock underneath chair.
<i>Example:</i> 93K-K1106/8	Customer's Own Material is available pending approval. For approval requirements, processing instructions and ordering information please see page 18.	<i>Glides:</i> Clear plastic with a matte frost finish.
93K Cross Check chair seat cushion replacement		
K1175/3 Obi, Geta		

Note:
The Gehry chairs are part of a collection. Please refer to Gehry tables on page 314.

- Specify:*
1. Pattern number
 2. Seat cushion option
 3. Textile selection

- Seat cushion replacement, specify:*
1. Pattern number
 2. Textile selection

pattern no.	unuphol.	grades	COM	A	B	C	D	E	F	G	H	I	COL	U	V	W	X	Y
93A-GC	\$6,034.																	
93A-GC-K		6,599.	6,652.	6,702.	6,759.	6,802.	6,834.	6,893.	6,994.	7,071.	7,447.	7,648.	8,046.	8,129.	8,227.			
93K-()		662.	716.	767.	823.	869.	897.	954.	1,058.	1,135.	1,510.	1,709.	2,108.	2,194.	2,291.			
94L-GC	12,451.																	
94L-GC-K		12,979.	13,028.	13,070.	13,121.	13,162.	13,190.	13,241.	13,337.	13,409.	13,806.	13,996.	14,377.	14,458.	14,556.			
94K-()		623.	666.	714.	765.	804.	834.	884.	982.	1,050.	1,451.	1,640.	2,023.	2,103.	2,197.			
94LY-GC	3,732.																	
94LY-GC-K		4,234.	4,281.	4,323.	4,372.	4,407.	4,435.	4,484.	4,575.	4,644.	5,024.	5,205.	5,570.	5,651.	5,735.			
94YK-()		595.	637.	682.	730.	767.	796.	846.	938.	1,005.	1,383.	1,564.	1,930.	2,009.	2,098.			

Approved KnollTextiles Grades/Fabrics	Spinneybeck Leather
A Alignment Beacon Bocce Chance Common Ground Commuter Cloth Crossover Delite Dristi Hourglass Mariner Prep Presto Soliloquy Sonnet Stacks Trophy Uni-Form	U Vicenza Volo V Acqua Andes Embossed Tipped España Velluto Pelle W Alaska Amazon Antique Forte Lucente Sabrina X Ducale Ducale Velour
B Abacus Argyle Belize Bistro Boundary Cameo Chroma Chronicle Close Knit Diva Dovetail Ferry Forza Gala II Grande Grandview Helios Holbrook Journey Keaton Knoll Felt Knoll Hopsack	Y Capri Cervo Copenhagen Distressed Lucca Marissa Riva
C continued Earthwork Echo Empire Stripe Enmesh Entourage Essence Fibra Greenwich Hudson Hula Hoop Kora CR Lagos Legend CR Lore CR Magnolia Metro Milestone Moto CR Noble Palisade Panache CR Pullman Quark Regard CR Roundtrip Sequin CR Sinclair Smart Spot On Star Struck Stepping Stones Swing Tower Grid	H Arno Bavaria Catwalk Firefly Gezelle Magritte Rosemond Stretch Appeal I Aswan Byron Canaan Diamond Days Dynamic Ita Jaipur Knoll Velvet Limani North Island Olema Piper Rutledge Sandis Tudor Vermeer Walker Worth Zimba
D continued Treble CR Vibe Zari CR D Compass CR Coterie Eclat Weave Hologram Island Masquerade Menagerie Origins Tara Tilden Theory Woodland Zoom	F Atelier Biscayne Calais Cotton Velvet Century Coco Cornaro Glider Icon Intrigue In Stitches Liberty Mod Plaid Rivington Tivoli Topography Totem Tweed Frieze
E Aegean Demure Highland Ikat Stripe Ikat Square Kampala Katazome Kimono Mamba Marquee Midpoint Nature Walk Sherman Shima Tryst Vatera	G Alter Ego Amore Arber Gibson Feeling Plaid Haze Kamani Kinabalu Kingston Melange Metallic Gloss Modern Tweed Petite Floral Sablou Serendipity Spencer Straie Stripe Ultrasuede Utrillo



Check with your KnollTextiles or Spinneybeck Representative for changes or additions.

Markus Jehs and Jürgen Laub

Jehs+Laub Lounge Collection, pedestal base

Designer(s):
Markus Jehs and Jürgen Laub,
2008

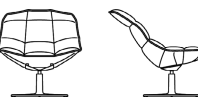

description	seat h	w	d	h	weight	type	textile fabric yds.	req. leather sq. ft.
JL1-P Jehs+Laub Lounge chair, fixed back, pedestal base	15"	33 1/4"	30 1/2"	38 1/2"	48 lbs.		3.1	50
								
JL1-PLT Jehs+Laub Lounge chair, fixed back, pedestal base, contrast leather welt option	15"	33 1/4"	30 1/2"	38 1/2"	48 lbs.	uphol.	3.1	50
						welt		4
JL2-P Jehs+Laub Lounge chair, articulating back, pedestal base	15"	33 1/4"	30 1/2"	38 1/2"	47 lbs.		3.1	50
								
JL2-PLT Jehs+Laub Lounge chair, articulating back, pedestal base, contrast leather welt option	15"	33 1/4"	30 1/2"	38 1/2"	47 lbs.	uphol.	3.1	50
						welt		4
JL3-P Jehs+Laub Ottoman, pedestal base		31"	22 1/2"	17 1/4"	27 lbs.		1.2	20
								
JL3-PLT Jehs+Laub Ottoman, pedestal base, contrast leather welt option		31"	22 1/2"	17 1/4"	27 lbs.	uphol.	1.2	20
						welt		3

Order Code	Ordering Information	Construction
------------	----------------------	--------------

<i>Example:</i> JL2-PLT-C-K1080/8-VO939	<i>Base finishes:</i> Polished Chrome (suffix C) Textured Black paint (suffix TB)	<i>Maintenance:</i> See pages 28-29.
JL2 Jehs+Laub Lounge chair, articulating back		
PLT Pedestal base with contrast leather trim	<i>Upholstery/COM information:</i> Prices shown include fabric or leather upholstery. Contact your Knoll representative for colors. Only approved KnollTextiles and Spinneybeck leathers may be ordered.	<i>Note:</i> The KnollStudio logo and signature of Markus Jehs and Jürgen Laub are located on the underside of the chair and ottoman.
AP Polished Chrome		<i>The Jehs+Laub Lounge Collection with pedestal base is Greenguard certified.</i>
K1080/8 Rivington, Parchment		
VO939 Volo, Talc		

Specify:

1. Pattern number
2. Return to center mechanism, option
3. Base finish selection
4. Textile selection
5. Contrast leather trim selection, upcharge applies

Customer's Own Material is available pending approval. For approval requirements, processing instructions and ordering information please see page 18.

Construction



















Shell:
Molded and reinforced urethane.

Base:
Pedestal base is available with polished aluminum finish and wire base is available with polished chrome finish, both bases are also available with textured black paint finish.

Upholstery:
Polyurethane foam with polyester-fiber backing. Hidden seam tufting eliminates the need for traditional pulls or buttons. A perimeter welt is standard on both chair and ottoman and is available as a self welt (same material) or as a contrasting leather welt. Please specify pattern number with LT suffix, for contrasting welt, and add appropriate leather upcharge for total list price of the piece. Leather welt option is available on textile and leather upholstery.

pattern no.	grades A	COM B	C	D	E	F	G	H	I	COL U	V	W	X	Y
JL1-P-(-)(-)(-)	\$4,548.	\$4,625.	\$4,696.	\$4,775.	\$4,841.	\$4,887.	\$4,968.	\$5,121.	\$5,233.	\$6,421.	\$6,665.	\$7,164.	\$7,265.	\$7,386.
JL1-PLT-(-)(-)(-)(-)	4,548.	4,625.	4,696.	4,775.	4,841.	4,887.	4,968.	5,121.	5,233.	6,421.	6,665.	7,164.	7,265.	7,386.
upchg, welt										778.	902.	1,148.	1,202.	1,262.
JL2-P-(-)(-)(-)	5,537.	5,614.	5,686.	5,765.	5,830.	5,877.	5,960.	6,111.	6,222.	7,661.	7,906.	8,404.	8,507.	8,627.
JL2-PLT-(-)(-)(-)(-)	5,537.	5,614.	5,686.	5,765.	5,830.	5,877.	5,960.	6,111.	6,222.	7,661.	7,906.	8,404.	8,507.	8,627.
upchg, welt										778.	902.	1,148.	1,202.	1,262.
JL3-P-(-)(-)	2,652.	2,682.	2,709.	2,739.	2,766.	2,784.	2,815.	2,874.	2,919.	3,149.	3,246.	3,444.	3,488.	3,535.
JL3-PLT-(-)(-)(-)(-)	2,652.	2,682.	2,709.	2,739.	2,766.	2,784.	2,815.	2,874.	2,919.	3,149.	3,246.	3,444.	3,488.	3,535.
upchg, welt										631.	755.	1,003.	1,056.	1,117.

Approved KnollTextiles Grades/Fabrics	Spinneybeck Leather
---------------------------------------	---------------------

<i>Return to center mechanism:</i> Optional return to center mechanism allows for 360° swivel movement and returns to a center position when not engaged.	A Common Ground Crossroad Delite Dristi Hourglass Mariner Presto Sonnet Uni-Form	B cont. Ransom Ricochet Spark Summit Synth Tinge Venue Vinyl Westwood	E Aegean Demure Highland Whip	F continued Tivoli Tweed Frieze	U Vicenza  Volo 	X Ducale Velour
To specify return to center mechanism, add suffix RC following the parent pattern number.	B Cameo Chroma Diva Ferry Helios Journey Keaton Knoll Felt Knoll Hopsack Little Devil Ludlow Prairie	C Atlas Biota Circa Classic Boucle Enmesh Palisade Pullman Regard Sahara Sequin CR Spot On Star Struck Swing Vibe	F Atelier Calais Cotton Velvet Coco Cornaro Rivington Soon	G Alter Ego Feeling Plaid Haze Kingston Melange Modern Tweed Petite Floral Ultrasuede	V Acqua  Andes  Embossed Tipped España  Maremma  Velluto Pelle 	Y Capri  Cervo  Copenhagen  Distressed  Marissa  Riva  Saddle  Torello
<i>Glides:</i> Nylon glides, natural.			H Arno  Catwalk Magritte Rosemond Stretch Appeal	I Knoll Velvet Tudor	W Alaska  Antique  Forte  Sabrina 	
<i>Control:</i> 360° swivel mechanism.						<i>Check with your KnollTextiles or Spinneybeck Representative for changes or additions.</i>

Markus Jehs and Jürgen Laub

Jehs+Laub Lounge Collection, wire base

Designer(s):
Markus Jehs and Jürgen Laub,
2008

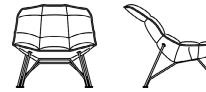
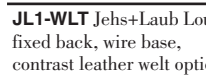
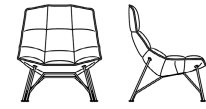

description	seat h	w	d	h	weight	type	textile fabric yds.	req. leather sq. ft.
JL1-W Jehs+Laub Lounge chair, fixed back, wire base	14 1/2"	33 1/4"	30 1/2"	38"	43 lbs.		3.1	50
JL1-WLT Jehs+Laub Lounge chair, fixed back, wire base, contrast leather welt option	14 1/2"	33 1/4"	30 1/2"	38"	43 lbs.	uphol. welt	3.1	50 4
JL2-W Jehs+Laub Lounge chair, articulating back, wire base	14 1/2"	33 1/4"	30 1/2"	38"	42 lbs.		3.1	50
JL2-WLT Jehs+Laub Lounge chair, articulating back, wire base, contrast leather welt option	14 1/2"	33 1/4"	30 1/2"	38"	42 lbs.	uphol. welt	3.1	50 4
JL3-W Jehs+Laub Ottoman, wire base		31"	22 1/2"	16 3/4"	22 lbs.		1.2	20
JL3-WLT Jehs+Laub Ottoman, wire base, contrast leather welt option		31"	22 1/2"	16 3/4"	22 lbs.	uphol. welt	1.2	20 3

pattern no.	grades A	COM B	C	D	E	F	G	H	I	COL U	V	W	X	Y
JL1-W-(-)-(-)	\$4,548.	\$4,625.	\$4,696.	\$4,775.	\$4,841.	\$4,887.	\$4,968.	\$5,121.	\$5,233.	\$6,421.	\$6,665.	\$7,164.	\$7,265.	\$7,386.

JL1-WLT-(-)-(-)-(-)	4,548.	4,625.	4,696.	4,775.	4,841.	4,887.	4,968.	5,121.	5,233.	6,421.	6,665.	7,164.	7,265.	7,386.
upchg, welt										778.	902.	1,148.	1,202.	1,262.

JL2-W-(-)-(-)	5,537.	5,614.	5,686.	5,765.	5,830.	5,877.	5,960.	6,111.	6,222.	7,661.	7,906.	8,404.	8,507.	8,627.
----------------------	--------	--------	--------	--------	--------	--------	--------	--------	--------	--------	--------	--------	--------	--------

JL2-WLT-(-)-(-)-(-)	5,537.	5,614.	5,686.	5,765.	5,830.	5,877.	5,960.	6,111.	6,222.	7,661.	7,906.	8,404.	8,507.	8,627.
upchg, welt										778.	902.	1,148.	1,202.	1,262.

JL3-W-(-)-(-)	2,652.	2,682.	2,709.	2,739.	2,766.	2,784.	2,815.	2,874.	2,919.	3,149.	3,246.	3,444.	3,488.	3,535.
----------------------	--------	--------	--------	--------	--------	--------	--------	--------	--------	--------	--------	--------	--------	--------

JL3-WLT-(-)-(-)-(-)	2,652.	2,682.	2,709.	2,739.	2,766.	2,784.	2,815.	2,874.	2,919.	3,149.	3,246.	3,444.	3,488.	3,535.
upchg, welt										631.	755.	1,003.	1,056.	1,117.

Order Code	Ordering Information	Construction
------------	----------------------	--------------

<i>Example:</i> JL2-PLT-C-K1080/8-VO939	<i>Base finishes:</i> Polished Chrome (suffix C) Textured Black paint (suffix TB)	<i>Maintenance:</i> See pages 28-29.
JL2	Jehs+Laub Lounge chair, articulating back	<i>Note:</i> The KnollStudio logo and signature of Markus Jehs and Jürgen Laub are located on the underside of the chair and ottoman.
PLT	Pedestal base with contrast leather trim	<i>Base:</i> Pedestal base is available with polished aluminum finish and wire base is available with polished chrome finish, both bases are also available with textured black paint finish.
C	Polished Chrome	<i>Upholstery:</i> Polyurethane foam with polyester-fiber backing. Hidden seam tufting eliminates the need for traditional pulls or buttons. A perimeter welt is standard on both chair and ottoman and is available as a self welt (same material) or as a contrasting leather welt. Please specify pattern number with LT suffix, for contrasting welt, and add appropriate leather upcharge for total list price of the piece. Leather welt option is available on textile and leather upholstery.
K1080/8	Rivington, Parchment	
VO939	Volo, Talc	

<i>Upholstery/COM information:</i> Prices shown include fabric or leather upholstery. Contact your Knoll representative for colors. Only approved KnollTextiles and Spinneybeck leathers may be ordered.
Customer's Own Material is available pending approval. For approval requirements, processing instructions and ordering information please see page 18.

<i>The Jehs+Laub Lounge Collection with pedestal base is Greenguard certified.</i>
--

- Specify:*
1. Pattern number
 2. Return to center mechanism, option
 3. Base finish selection
 4. Textile selection
 5. Contrast leather trim selection, upcharge applies

Approved KnollTextiles Grades/Fabrics

Return to center mechanism:
Optional return to center mechanism allows for 360° swivel movement and returns to a center position when not engaged.

To specify return to center mechanism, add suffix RC following the parent pattern number.

Glides:
Nylon glides, natural.

Control:
360° swivel mechanism.

A Common Ground Crossroad Delite Dristi Hourglass Mariner Presto Sonnet Uni-Form	B continued Ransom Ricochet Spark Summit Synth Tinge Venue Vinyl Westwood	E Aegean Demure Highland Whip	F continued Tivoli Tweed Frieze	G Alter Ego Feeling Plaid Haze Kingston Melange Modern Tweed Petite Floral Ultrasuede	H Arno Catwalk Magritte Rosemond Stretch Appeal	I Knoll Velvet Tudor
B Cameo Chroma Diva Ferry Helios Journey Keaton Knoll Felt Knoll Hopsack Little Devil Ludlow Prairie	C Atlas Biota Circa Classic Boucle Enmesh Palisade Pullman Regard Sahara Sequin CR Spot On Star Struck Swing Vibe	F Atelier Calais Cotton Velvet Coco Cornaro Rivington Soon	G Feeling Plaid Haze Kingston Melange Modern Tweed Petite Floral Ultrasuede	V Acqua Andes Embossed Tipped España Maremma Velluto Pelle	W Alaska Antique Forte Sabrina	

Spinneybeck Leather

U Vicenza Volo	X Ducale Velour
V Acqua Andes Embossed Tipped España Maremma Velluto Pelle	Y Capri Cervo Copenhagen Distressed Marissa Riva Saddle Torello
<i>Check with your KnollTextiles or Spinneybeck Representative for changes or additions.</i>	

Florence Knoll Lounge Seating

Designer(s):
Florence Knoll, 1954

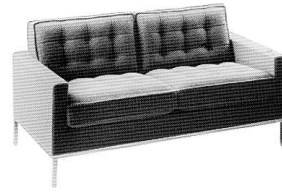

description	seat h	arm h	w	d	h	textile fabric yds.	req. leather sq. ft.	weight
1205S1 Lounge chair	17 1/2"	23 1/2"	32 1/4"	32 1/4"	31 1/4"	6.75	97	70 lbs.
	17 1/2"	23 1/2"	32 1/4"	32 1/4"	31 1/4"	6.75	97	70 lbs.

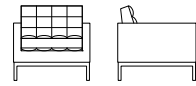

1205S2 Settee	17 1/2"	23 1/2"	62 1/2"	32 1/4"	31 1/4"	11.8	145	101 lbs.
	17 1/2"	23 1/2"	62 1/2"	32 1/4"	31 1/4"	11.8	145	101 lbs.

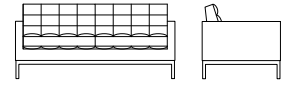

1205S3 Sofa	17 1/2"	23 1/2"	90 1/2"	32 1/4"	31 1/4"	15.7	193	166 lbs.
	17 1/2"	23 1/2"	90 1/2"	32 1/4"	31 1/4"	15.7	193	166 lbs.

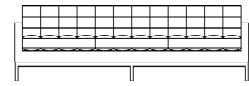

2530Y2C Two Seater Bench			36 1/4"	19 1/2"	16 1/4"	1.6	20	29 lbs.
---------------------------------	--	--	---------	---------	---------	-----	----	---------

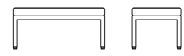

2530Y3C Three Seater Bench			60 1/4"	19 1/2"	16 1/4"	2.5	32	47 lbs.
-----------------------------------	--	--	---------	---------	---------	-----	----	---------



Order Code

<i>Example:</i>	1205-CO-S3-K349/4
1205	Florence Knoll Lounge
CO	Satin Chrome
S3	Sofa
K349/4	Alignment, Paprika

Note:
Florence Knoll lounge seating is part of a collection. Please refer to Florence Knoll executive collection, conference and low tables beginning on page 318.

Specify:

1. Pattern number
2. Base finish selection (chair, settee and sofa only)
3. Textile selection

Ordering Information

Base finish options:
Polished Chrome (suffix C)
Satin Chrome (suffix CO) Not available on bench

Upholstery/COM information:
Prices shown include fabric or leather upholstery. Contact your Knoll representative for colors. Only approved KnollTextiles and Spinneybeck leathers may be ordered.

Customer's Own Material is available pending approval. For approval requirements, processing instructions and ordering information please see page 18.

Note:
Designer signature and KnollStudio logo are stamped into the base of the frame.

Cal 133 Fire Code:
The Florence Knoll Lounge collection complies with the California Technical Bulletin 133 standard if upholstered in Cal 133 approved upholstery. Specify suffix -C at end of pattern number and suffix -133 at end of textile selection. Upcharge applies, see page 18.

Maintenance:
See pages 28-29.

Note:
The Florence Knoll Lounge Collection is Greenguard certified.

Construction

Chair, Settee and Sofa:
Inner frame solid wood. Exposed metal frame and legs heavy gauge tubular steel in polished or satin chrome finish.

Bench:
Upholstered seat attached to exposed metal frame. Heavy gauge steel in a polished chrome finish. Seat cushion is permanently attached to frame. Large bench consists of 2 separate 30" cushions. Frame only available in polished chrome.

Upholstery:
Seat suspension with No-Sag springs. Arm, seat and back cushions variable density foam. Seat and back covering is fully welted and tufted. Pieces upholstered in leather have matching buttons, pieces upholstered in fabric do not have buttons.

Glides:
Bench and lounge collection have chrome-plated adjustable glides used for levelling.

pattern no.	grades A	COM B	C	D	E	F	G	H	I	COL U	V	W	X	Y
1205-C-S1	\$7,322.	\$7,493.	\$7,654.	\$7,834.	\$7,978.	\$8,082.	\$8,263.	\$8,604.	\$8,855.	\$10,705.	\$11,364.	\$12,711.	\$12,991.	\$13,318.
1205-CO-S1	7,463.	7,636.	7,796.	7,976.	8,122.	8,225.	8,405.	8,745.	8,998.	10,847.	11,507.	12,852.	13,135.	13,460.

1205-C-S2	11,701.	11,966.	12,223.	12,499.	12,728.	12,894.	13,175.	13,705.	14,100.	16,660.	17,654.	19,667.	20,084.	20,573.
1205-CO-S2	11,916.	12,180.	12,438.	12,716.	12,944.	13,109.	13,389.	13,920.	14,315.	16,878.	17,869.	19,882.	20,298.	20,788.

1205-C-S3	16,187.	16,526.	16,849.	17,199.	17,491.	17,702.	18,057.	18,727.	19,231.	22,937.	24,255.	26,938.	27,492.	28,143.
1205-CO-S3	16,476.	16,817.	17,137.	17,491.	17,781.	17,990.	18,346.	19,018.	19,521.	23,228.	24,544.	27,228.	27,783.	28,433.

2530Y2C	3,594.	3,641.	3,683.	3,735.	3,776.	3,805.	3,856.	3,949.	4,019.	4,237.	4,406.	4,747.	4,821.	4,904.
----------------	--------	--------	--------	--------	--------	--------	--------	--------	--------	--------	--------	--------	--------	--------

2530Y3C	5,937.	6,022.	6,105.	6,194.	6,265.	6,317.	6,408.	6,579.	6,700.	6,950.	7,219.	7,769.	7,883.	8,021.
----------------	--------	--------	--------	--------	--------	--------	--------	--------	--------	--------	--------	--------	--------	--------

Approved KnollTextiles Grades/Fabrics

A Alignment † Beacon Bocce Chance Common Ground Commuter Cloth Crossroad Delite Dristi Hourglass Mariner Monarch † Presto † ** Sonnet Trophy Uni-Form	B continued Grande Helios Journey Keaton Knoll Felt † Knoll Hopsack † Little Devil Ludlow Lyric Melody Night Life Prairie Radiance Ransom Ricochet † Spark † Spree Summit Synth Tinge Venue Diva Westwood	C Atlas Biota † Circa Classic Boucle Entourage Greenwich Hula Hoop Lagos Lore CR Palisade Pullman Sahara Sequin CR	C continued Spot On Stepping Stones Swing ** Tilden	D Eclat Weave Hologram Masquerade Woodland Zoom	E Aegean Demure Highland Katazome Mamba Whip	F Atelier Calais Cotton Velvet Coco ** Cornaro ** Rivington Soon Tivoli Topography	G Alter Ego Feeling Plaid Haze Kingston Melange Modern Tweed Petite Floral Spencer Ultrasuede †	H Arno Gezelle Magritte Rosemond	I Cato Dynamic Knoll Velvet Tudor Vermeer	U Vicenza † Volo †	V Acqua † Andes † Embossed Tipped España † Velluto Pelle †	W Alaska † Amazon † Antique † Forte † Lucente Sabrina †	Y Capri † Cervo Copenhagen † Distressed † Marissa † Riva † Saddle †
--	---	--	--	---	---	--	---	---	---	---------------------------------	--	--	---

Spinneybeck Leather

† Available for Cal 133 upholstery.
* Will be produced with matching buttons rather than tufted
**Fabric will be railroaded

Check with your KnollTextiles or Spinneybeck Representative for changes or additions.

Florence Knoll

Relaxed Lounge Seating

Designer(s):
Florence Knoll, 1954

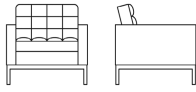
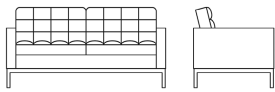
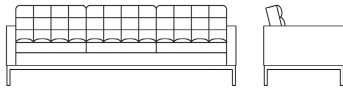

description	seat h	arm h	w	d	h	textile fabric yds.	req. leather sq. ft.	w
1206S1 Relaxed Lounge Chair	18 1/4"	23 1/2"	32 1/4"	32 1/4"	31 1/4"	6.9 yards	125 sq ft	70
								
1206S2 Relaxed Settee	18 1/4"	23 1/2"	63"	35"	31 1/4"	10.9 yards	182 sq ft	125
								
1206S3 Relaxed Sofa	18 1/4"	23 1/2"	91"	35"	31 1/4"	13.8 yards	240 sq ft	177
								

pattern no.	grade A	COM B	C	D	E	F	G	H	I	COL U	V	W	X	Y
1206-C-S1	\$6,043.	\$6,184.	\$6,316.	\$6,465.	\$6,584.	\$6,670.	\$6,819.	\$7,100.	\$7,307.	\$8,834.	\$9,378.	\$10,490.	\$10,721.	\$10,991.
1206-C-S2	9,656.	9,874.	10,087.	10,315.	10,503.	10,640.	10,872.	11,310.	11,636.	13,749.	14,569.	16,230.	16,574.	16,978.
1206-C-S3	13,359.	13,638.	13,904.	14,193.	14,435.	14,608.	14,901.	15,455.	15,870.	18,929.	20,017.	22,230.	22,687.	23,225.

Order Code

<i>Example:</i>	1206-C-S3-K349/4
1206	Florence Knoll Relaxed Lounge
C	Polished Chrome
S3	Sofa
K349/4	Alignment, Paprika

Note:
Florence Knoll lounge seating is part of a collection. Please refer to Florence Knoll executive collection, conference and low tables beginning on page 322.

Specify:

1. Pattern number
2. Base finish selection (chair, settee and sofa only)
3. Textile selection

Ordering Information

Base finish options:
Polished Chrome (suffix C)

Upholstery/COM information:
Prices shown include fabric or leather upholstery. Contact your Knoll representative for colors. Only approved KnollTextiles and Spinneybeck leathers may be ordered.

Customer's Own Material is available pending approval. For approval requirements, processing instructions and ordering information please see page 18.

Note:
Designer signature and KnollStudio logo are stamped into the base of the frame.

Maintenance:
See pages 28-29.

Construction

Chair, Settee and Sofa:
Inner frame solid wood. Exposed metal frame and legs heavy gauge tubular steel in polished chrome finish.

Sofa has four legs (versus six on the standard version). Relaxed back cushions are attached with a zipper as opposed to sewn.

Upholstery:
Seat suspension with springs. Arm, seat and back cushions multi-density foam. Seat and back covering is tufted and covered with polyester fiberfill to enhance comfort. Pieces upholstered in leather have matching buttons. Pieces upholstered in fabric do not have buttons.
*Due to differing textile thicknesses, dimensions may vary by +/- 1/2".

Glides:
Lounge collection has chrome-plated adjustable glides used for leveling.

Approved KnollTextiles Grades/Fabrics





A Alignment Beacon Bocce Chance Common Ground Commuter Cloth Crossroad Delite Dristi Hourglass Mariner Monarch Presto * * Sonnet Trophy Uni-Form	B continued Grande Helios Journey Keaton Knoll Felt Knoll Hopsack Little Devil Ludlow Lyric Melody Night Life Prairie Radianc Ransom Ricochet Spark Spree Summit Synth Tinge Venue Westwood	C Atlas Biota Circa Classic Boucle Entourage Greenwich Hula Hoop Lagos Lore CR Palisade Pullman Sahara Sequin CR	C continued Spot On Stepping Stones Swing * * Tilden	D Eclat Weave Hologram Masquerade Woodland Zoom	E Aegean Demure Highland Katazome Mamba Whip	F Atelier Calais Cotton Velvet Coco * * Cornaro * * Rivington Soon Tivoli Topography	G Alter Ego Feeling Plaid Haze Kingston Melange Modern Tweed Petite Floral Spencer Ultrasuede	H Arno Gezelle Magritte Rosemond	I Cato Dynamic Knoll Velvet Tudor Vermeer
---	--	--	---	---	---	--	---	---	---

Spinneybeck Leather

U Vicenza Volo	V Acqua Andes Embossed Tipped España Velluto Pelle
Y Capri Cervo Copenhagen Distressed Marissa Riva Saddle	W Alaska Amazon Antique Forte Lucente Sabrina

* Will be produced with matching buttons rather than tufted
**Fabric will be railroaded

Check with your KnollTextiles or Spinneybeck Representative for changes or additions.

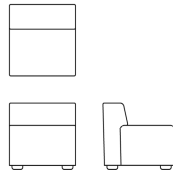
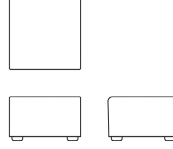
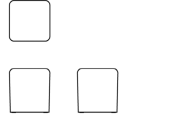
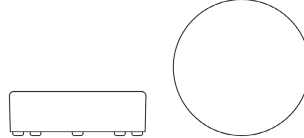
	description	seat h	w	d	h	textile fabric yds.
<p>Designer(s): Knoll Design, 2014</p>    	KL4 Bench with back, single seat	17 1/4"	26"	28 1/4"	26"	3.5
						
	KL9 Ottoman	17 1/4"	28 1/4"	28"	17 1/4"	2.75
						
KL10 Stool	17 1/4"	16"	16"	17 1/4"	1.75	
						
KL11 Pouf	17 1/4"	50"	50"	17 1/4"	4.75	
						

Order Code

Example:	KL4-KLF01
KL4	Bench, two seat
KLF01	k.™ lounge textile, Green Tea

Specify:

1. Pattern number
2. Textile selection

Ordering Information

Upholstery/COM information:
Prices shown include fabric upholstery. Contact your Knoll representative for colors.

Customer's Own Material is available pending approval. For approval requirements, processing instructions and ordering information please see page 18.

Split upholstery option:
The seat and back sections of the KL4 may be specified with split upholstery for **KnollTextiles ONLY**. Indicate B before selected back upholstery, followed by selected seat upholstery. Price equals the higher upholstery grade.

Note:
Split upholstery with base grade textiles or a combination of KnollTextiles and base grade textiles must be requested through Custom Product Development.

COM split fabric requirements:
KL4 seat: 2 yards
KL4 back: 1.75 yards

Cutout Options: (\$65 list per cutout)
KL4 bench may be specified with left, right, or left and right cutouts to accommodate a KE1 electrical module. Indicate cutout suffix code before textile selection. Electrical modules must be ordered separately.

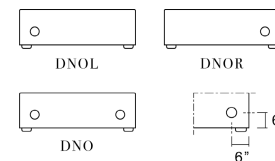

Construction

Frame:
Constructed from zero-emission plywood frames. Finger joints are glued and reinforced with corner blocks and fasteners.

Upholstery:
High resilience, multi-density urethane foam. Exceeds Cal 117 standards, and meets British Standards.

Glides:
Large footprint, non-marking nylon leveling glides, standard on all k.™ lounge except stool. Stool has flat, non-marking teflon glides at bottom edge of frame.

Ganging:
Four no-tool nylon ganging brackets standard on all k.™ lounge except stool and pouf.

pattern no.	k.™ lounge fabric	A	COM B	C	D	E	F	G	H	I
KL4-()	\$1,740.	\$2,082.	\$2,143.	\$2,212.	\$2,294.	\$2,406.	\$2,473.	\$2,587.	\$2,664.	\$2,893.
KL9-()	1,056.	1,249.	1,289.	1,333.	1,383.	1,454.	1,497.	1,569.	1,617.	1,761.
KL10-()	631.	781.	806.	834.	868.	914.	941.	988.	1,019.	1,111.
KL11-()	2,312.	2,725.	2,801.	2,885.	2,984.	3,123.	3,204.	3,344.	3,438.	3,718.

Approved k.™ lounge Fabric











Fabric, Base Grade:
Green Tea (suffix KLF01)
Heirloom Tomato (suffix KLF02)
Blue Moon (suffix KLF03)
Earl Grey (suffix KLF04)
Chocolate Stout (suffix KLF05)
Black Tea (suffix KLF06)

Approved KnollTextiles Grades/Fabrics

A	B continued	C	D	F
Crossroad	Keaton	Atlas	Island	Atelier
Delite	Knoll Felt	Classic Boucle	Tara *	In Stitches
Hourglass	Knoll Hopsack	Dahlia CR	Theory *	Rivington
Mariner	Little Devil	Dune		Tivoli
Presto	Melody	Durand		Topography
Sonnet	Paradigm	Lagos	E Aegean	Totem
Uni-Form	Prairie	Lore CR	Shima	Tweed Frieze
	Ricochet	Noble	Vatera	
	Rush Hour	Pullman *	Whip	
	Summit	Roundtrip *		G Feeling Plaid
	Sutton	Sinclair *		Haze
	Tinge	Spot On		Melange
	Tabloid *	Star Struck *		Modern Tweed
	Utmost	Swing		Petite Floral
	Venue	Wit *		Ultrasuede
	Westwood			H Catwalk
	Wide Angle *			Firefly
				Stretch Appeal
				I Cato

*Not approved on KL3, KL7, KL8 and KL11

Check with your KnollTextiles Representative for changes or additions.

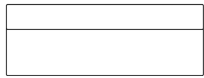
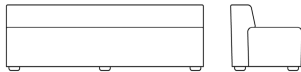
	description	seat h	w	d	h	textile fabric yds.
<p>Designer(s): Knoll Design, 2014</p>    	<p>KL1 Bench, two seat</p>  	17 1/4"	52"	21 1/2"	17 1/4"	4
	<p>KL2 Bench, three seat</p>  	17 1/4"	78"	21 1/2"	17 1/4"	7
	<p>KL5 Bench with back, two seat</p>  	17 1/4"	52"	28 1/4"	26"	6
	<p>KL6 Bench with back, three seat</p>  	17 1/4"	78"	28 1/4"	26"	8

Order Code

<i>Example:</i>	KL1-KLF01
KL1	Bench, two seat
KLF01	k.™ lounge textile, Green Tea

Specify:

1. Pattern number
2. Textile selection

Ordering Information

Upholstery/COM information:
KL1, KL2, KL5, and KL6 benches may be specified with left, right, or left and right cutouts to accommodate a KE1 electrical module. Indicate cutout suffix code before textile selection. Electrical modules must be ordered separately.

Customer's Own Material is available pending approval. For approval requirements, processing instructions and ordering information please see page 18.

Split upholstery option:
The seat and back sections of the KL5 and KL6 may be specified with split upholstery for **KnollTextiles ONLY**. Indicate B before selected back upholstery, followed by selected seat upholstery. Price equals the higher upholstery grade.

Note:
Split upholstery with base grade textiles or a combination of KnollTextiles and base grade textiles must be requested through Custom Product Development.

COM split fabric requirements:
KL5 seat: 4 yards
KL5 back: 2.75 yards
KL6 seat: 4.75 yards
KL6 back: 3.5 yards

Cutout Options: (\$65 list per cutout)
KL1, KL2, KL5, and KL6 benches may be specified with left, right, or left and right cutouts to accommodate a KE1 electrical module. Indicate cutout suffix code before textile selection. Electrical modules must be ordered separately.

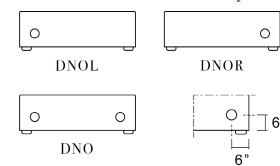

Example:
KL2-DNO-KLF01
Three seat bench, left and right cutout, Green Tea textile.

Construction

Frame:
Constructed from zero-emission plywood frames. Finger joints are glued and reinforced with corner blocks and fasteners.

Upholstery:
High resilience, multi-density urethane foam. Exceeds Cal 117 standards, and meets British Standards.

Glides:
Large footprint, non-marking nylon leveling glides, standard on all k.™ lounge except stool. Stool has flat, non-marking teflon glides at bottom edge of frame.

Ganging:
Four no-tool nylon ganging brackets standard on all k.™ lounge except stool and pouf.

pattern no.	k.™ lounge fabric	A	COM B	C	D	E	F	G	H	I
KL1-()	\$1,421.	\$1,701.	\$1,751.	\$1,807.	\$1,874.	\$1,965.	\$2,019.	\$2,114.	\$2,175.	\$2,362.
KL2-()	1,920.	2,238.	2,302.	2,373.	2,459.	2,576.	2,644.	2,763.	2,843.	3,081.
KL5-()	2,324.	2,880.	2,981.	3,093.	3,226.	3,410.	3,517.	3,706.	3,831.	4,204.
KL6-()	3,146.	3,848.	3,973.	4,113.	4,280.	4,510.	4,644.	4,879.	5,035.	5,502.



Approved k.™ lounge Fabric

Fabric, Base Grade:
Green Tea (suffix KLF01)
Heirloom Tomato (suffix KLF02)
Blue Moon (suffix KLF03)
Earl Grey (suffix KLF04)
Chocolate Stout (suffix KLF05)
Black Tea (suffix KLF06)

Approved KnollTextiles Grades/Fabrics

A	B continued	C	D	F
Crossroad Delite Hourglass Mariner Presto Sonnet Uni-Form	Keaton Knoll Felt Knoll Hopsack Little Devil Melody Paradigm Prairie Ricochet Rush Hour Summit Sutton Tinge Tabloid Utmost Venue Westwood Wide Angle	Atlas Classic Boucle Dahlia CR Dune Durand Lagos Lore CR Noble Pullman * Roundtrip Sinclair Spot On Star Struck Swing Wit	Island Tara Theory	Atelier In Stitches Rivington Tivoli Topography Totem Tweed Frieze
Cameo Chroma Chronicle Diva Gala II Helios Holbrook Journey			Aegean Shima Vatera Whip	Feeling Plaid Haze Melange Modern Tweed Petite Floral Ultrasuede
				Catwalk Firefly Stretch Appeal
				Cato

Check with your KnollTextiles Representative for changes or additions.

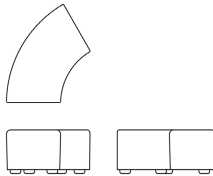
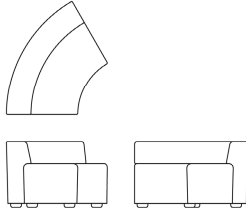
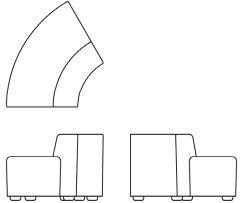
	description	seat h	w	d	h	textile fabric yds.
<p>Designer(s): Knoll Design, 2014</p>   	<p>KL3 Bench, 48" inside radius, 60°</p> 	17 1/4"	38 3/4"	38 3/4"	17 1/4"	3.25
	<p>KL7 60° Curved bench with back, inside radius</p> 	17 1/4"	44 1/2"	44 1/2"	26"	5.5
	<p>KL8 60° Curved bench with back, outside radius</p> 	17 1/4"	42"	42"	26"	4.5

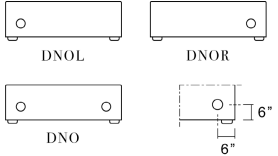
Order Code	Ordering Information	Construction
<p><i>Example:</i> KL7-KLF01</p> <p>KL7 curved bench with back, inside radius</p> <p>KLF01 k.™ lounge textile, Green Tea</p> <p><i>Specify:</i></p> <ol style="list-style-type: none"> Pattern number Textile selection 	<p>Upholstery/COM information: Prices shown include fabric upholstery. Contact your Knoll representative for colors.</p> <p>Customer's Own Material is available pending approval. For approval requirements, processing instructions and ordering information please see page 18.</p> <p>Split upholstery option: The seat and back sections of the KL7 and KL8 may be specified with split upholstery for KnollTextiles ONLY. Indicate B before selected back upholstery, followed by selected seat upholstery. Price equals the higher upholstery grade.</p> <p>Note: Split upholstery with base grade textiles or a combination of KnollTextiles and base grade textiles must be requested through Custom Product Development.</p> <p>COM split fabric requirements: KL7 seat: 3 yards KL7 back: 4 yards KL8 seat: 3.5 yards KL8 back: 2.5 yards</p>	<p>Cutout Options: (\$65 list per cutout) KL3, KL7, and KL8 benches may be specified with left, right, or left and right cutouts to accommodate a KE1 electrical module. Please note that KL3 benches can be specified with cutouts on the outside radius (suffix OR) or the inside radius (suffix IR). Indicate -OR or -IR after parent pattern number followed by cutout location code. Electrical modules must be ordered separately.</p>  <p><i>Example:</i> KL3-IR-DNO-KLF02 Curved bench with left and right cutout on the inside radius, Heirloom Tomato Textile.</p> <p>Frame: Constructed from zero-emission plywood frames. Finger joints are glued and reinforced with corner blocks and fasteners.</p> <p>Upholstery: High resilience, multi-density urethane foam. Exceeds Cal 117 standards, and meets British Standards.</p> <p>Glides: Large footprint, non-marking nylon leveling glides, standard on all k.™ lounge except stool. Stool has flat, non-marking teflon glides at bottom edge of frame.</p> <p>Ganging: Four no-tool nylon ganging brackets standard on all k.™ lounge except stool and pouf.</p>

pattern no.	k.™ lounge fabric	A	COM B	C	D	E	F	G	H	I
KL3-()	\$1,327.	\$1,611.	\$1,660.	\$1,717.	\$1,783.	\$1,875.	\$1,929.	\$2,023.	\$2,085.	\$2,271.
KL7-()	2,095.	2,528.	2,615.	2,712.	2,827.	2,986.	3,079.	3,241.	3,350.	3,672.
KL8-()	2,095.	2,528.	2,615.	2,712.	2,827.	2,986.	3,079.	3,241.	3,350.	3,672.

Approved k.™ lounge Fabric	Approved KnollTextiles Grades/Fabrics									
<p>Fabric, Base Grade: Green Tea (suffix KLF01) Heirloom Tomato (suffix KLF02) Blue Moon (suffix KLF03) Earl Grey (suffix KLF04) Chocolate Stout (suffix KLF05) Black Tea (suffix KLF06)</p>	<p>A Crossroad Delite Hourglass Mariner Presto Sonnet Uni-Form</p>	<p>B continued Keaton Knoll Felt Knoll Hopsack Little Devil Melody Paradigm Prairie Ricochet Rush Hour Summit Sutton Tinge Tabloid * Utmost Venue Westwood Wide Angle *</p>	<p>C Atlas Classic Boucle Dahlia CR Dune Durand Lagos Lore CR Noble Pullman * Roundtrip * Sinclair * Spot On Star Struck * Swing Wit *</p>	<p>D Island Tara * Theory *</p> <p>E Aegean Shima Vatera Whip</p>	<p>F Atelier In Stitches Rivington Tivoli Topography Totem Tweed Frieze</p> <p>G Feeling Plaid Haze Melange Modern Tweed Petite Floral Ultrasuede</p> <p>H Catwalk Firefly Stretch Appeal</p> <p>I Cato</p>					

*Not approved on KL7 or KL8

Check with your KnollTextiles Representative for changes or additions.



Knoll Design

k.™ lounge Collection

k.™ lounge Corner Tables

Designer(s):
Knoll Design, 2016

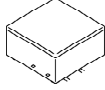

description	w	d	h	textile fabric yds.
KLCT1 Corner Table - adjacent to benches without backs 	21"	21"	15½"	0.0
KLCT2 Corner Table - adjacent to benches with backs 	27.5"	27.5"	15½"	0.0
KLCT3 Corner Table - adjacent to bench without back and bench with back on the right 	27.5"	21"	15½"	0.0
KLCT4 Corner Table - adjacent to bench without back and bench with back on the left 	21"	27.5"	15½"	0.0

Order Code	Ordering Information	Construction
<i>Example:</i> KLCT1-118-004-GNO-K1523/4	<i>Colored laminate finishes:</i> Bright White (suffix 118) Folkstone, matte (suffix 114) Black, matte (suffix 111)	<i>Upholstery/COM information:</i> Prices shown include fabric upholstery. Contact your Knoll representative for colors.
KLCT1 Corner Table, 21" x 21"	<i>Woodgrain laminate finishes:</i> Medium Cherry (suffix 124) Natural Maple (suffix 125) Walnut (suffix 127) Light Ash (suffix 139) Warm Ash (suffix 140) Whitened Ash (suffix 141) Grey Ash (suffix 142) Classic Oak (suffix 143) Graphite Pear (suffix 144) Zebra (suffix 145)	<i>Laminate tops:</i> Constructed of particle board substrates sandwiched between laminate top and phenolic backer sheet bottom. Edges can be specified with a molded urethane edge only.
118 Bright White laminate top	<i>Customer's Own Material is available pending approval. For approval requirements, processing instructions and ordering information please see page 18.</i>	<i>Frame:</i> Constructed from zero-emission plywood frames. Finger joints are glued and reinforced with corner blocks and fasteners.
004 Folkstone urethane edge	<i>Cutout Options: (\$30 list per cutout)</i> Tables may be specified with no cutout (code Y) or center-center cutout (code GNO) to accommodate a KE1 electrical module. Electrical modules must be ordered separately.	<i>Glides:</i> Large footprint, non-marking nylon leveling glides, standard on all k.™ lounge except stool.
GNO Center-center cutout	<i>Molded Edgeband finishes:</i> Black (suffix 300) Mink (suffix 324) Innertone (Suffix 386) Platinum (suffix 367) Folkstone (suffix 004)	<i>Ganging:</i> Four no-tool nylon ganging brackets standard on all k.™ lounge Corner Tables.
K1523/4 Hourglass/Cork		<i>Note:</i> Base and top of table will ship separately.

Specify:

1. Pattern number
2. Laminate top selection
3. Urethane edge selection
4. Cutout option
5. Textile selection

pattern no.	k.™ lounge fabric	A	COM B	C	D	E	F	G	H	I
KLCT1-(-)(-)(-)	\$1,348.	\$1,569.	\$1,598.	\$1,639.	\$1,672.	\$1,720.	\$1,762.	\$1,809.	\$1,845.	\$2,009.
KLCT2-(-)(-)(-)	1,782.	1,822.	1,855.	1,903.	1,942.	1,998.	2,047.	2,102.	2,144.	2,335.
KLCT3-(-)(-)(-)	1,536.	1,682.	1,711.	1,752.	1,785.	1,833.	1,875.	1,922.	1,958.	2,122.
KLCT4-(-)(-)(-)	1,536.	1,682.	1,711.	1,752.	1,785.	1,833.	1,875.	1,922.	1,958.	2,122.

Configuration

KLCT3 and KLCT4 configuration guide:

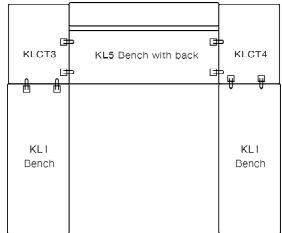

Configurations are limited to L and U shapes.

Please note location of ganging brackets when specifying KLCT3 and KLCT4 rectangular corner tables. KLCT3 should be specified if a k.lounge bench with back is to be ganged to the right of the table. KLCT4 should be specified if a k.lounge bench with back is to be ganged to the left of the table.

Underside detail of corner tables:

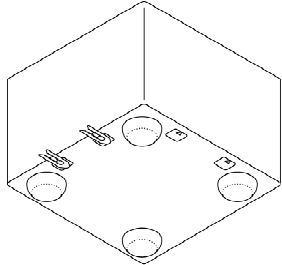

Approved k.™ lounge Fabric

Fabric, Base Grade:
Green Tea (suffix KLF01)
Heirloom Tomato (suffix KLF02)
Blue Moon (suffix KLF03)
Earl Grey (suffix KLF04)
Chocolate Stout (suffix KLF05)
Black Tea (suffix KLF06)

Approved KnollTextiles Grades/Fabrics

<p>A Crossroad Delite Hourglass Mariner Presto Sonnet</p> <p>B Cameo Chroma Chronicle Diva Gala II Helios Hollbrook Journey Keaton Knoll Felt Knoll Hopsack Melody Paradigm Prairie Ricochet Rush Hour Summit Sutton Tinge Tabloid Utmost Venue Westwood Wide Angle</p>	<p>C Atlas Classic Boucle Dahlia CR Dune Durand Lagos Lore CR Noble Roundtrip Sinclair Spot On Star Struck Swing Wit</p> <p>D Island Tara Theory</p> <p>E Aegean Shima Vatera Whip</p>	<p>F Atelier Rivington Tivoli</p> <p>G Haze Melange Petite Floral Ultrasuede</p> <p>I Cato</p> <p><i>Check with your KnollTextiles Representative for changes or additions.</i></p>
---	---	--

Knoll Design
k.™ lounge Collection
Electrical Modules

	description	type	power cord
<i>Designer(s):</i> Marc Krusin, 2015	KE1 Two receptacle module 	1 Power, 1 USB	120" Cordset
		2 Power	120" Cordset
		1 Power, 1 USB	48" Cordset
		2 Power	48" Cordset
		1 Power, 1 USB	72" Cordset
		2 Power	72" Cordset

pattern no.	
KE1101C120-()	\$337.
KE1200C120-()	236.
KE1101C48-()	337.
KE1200C48-()	236.
KE1101C72-()	337.
KE1200C72-()	236.

Order Code	Ordering Information	Construction	Electrical
<i>Example:</i> KE1200C72-BK	<i>Case and Receptacle Finishes:</i>	<i>Description:</i>	<i>USB:</i>
KE1 KE1 Electrical Module	Black case with Black receptacles (suffix BK)	KE1: Die-cast aluminum and plastic with powder coat matte paint finish.	The standard USB option that is included in the KE1 modules will have (2) USB jacks per position. For example a KE1101C72 module includes (1) Power and (1) USB but would actually have (1) Power and (2) USB jacks.
200 2 Power	White case with White receptables (suffix WH)		
C72 72" Cordset			
BK Black finish			



Specify:

1. Pattern number
2. Case Finish

Standard USB: 1Amp

Note:
 Additional data and power configurations can be requested through Custom Product Development.

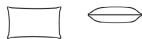

description	w	d	textile fabric yds.	type
KSP1 Lumbar pillow 	20"	10.5"	0.4	same upholstery
KSP1S Lumbar pillow	20"	10.5"	0.4	combination upholstery
KSP2 Throw pillow 	16"	16"	0.4	same upholstery
KSP2S Throw pillow	16"	16"	0.4	combination upholstery
KSP3 Large throw pillow 	20"	20"	0.7	same upholstery
KSP3S Large throw pillow	20"	20"	0.7	combination upholstery

pattern no.	A	B	C	D	E	F	G	H	I
KSP1-()	\$179.	\$187.	\$196.	\$205.	\$211.	\$217.	\$226.	\$244.	\$255.
KSP1S-()-()	197.	206.	214.	222.	231.	235.	245.	262.	275.
KSP2-()	225.	234.	243.	250.	258.	263.	274.	289.	303.
KSP2S-()-()	248.	256.	266.	275.	281.	285.	296.	313.	324.
KSP3-()	358.	375.	391.	408.	424.	434.	452.	485.	511.
KSP3S-()-()	396.	414.	428.	447.	461.	473.	489.	522.	549.

Order Code	Ordering Information	Construction
<i>Example:</i> KSP1-K1174/6	<i>Upholstery/COM information:</i>	<i>Fill:</i>
KSP1 Lumbar pillow, same upholstery	Prices shown include fabric upholstery only. Contact your Knoll representative for colors. Only approved KnollTextiles may be ordered.	Made from 100% recycled polyester.
K1174/6 Kimono, Sakura		<i>Ticking:</i>
<i>Example:</i> KSP3S-K1155/6-K1021/2	Customer's Own Material is not approved.	100% cotton.
KSP3S Large throw pillow, combination upholstery		
K1155/6 Jaipur, Ginger	<i>Note:</i>	
K1021/2 Ultrasuede, Sand	For pillows with combination upholstery, list price is the highest of the two grades.	

Specify:

1. Pattern number
2. Upholstery selection
3. Upholstery selection for split upholstery











Approved KnollTextiles Grades/Fabrics









A Alignment Beacon Bocce Cat's Cradle Chance Common Ground Commuter Cloth Crossroad Delite Dristi Heavy Metal Hourglass Mariner Monarch Prep Presto Soliloquy Sonnet Stacks Trophy Uni-Form	B continued Little Devil Ludlow Lyric Melody Mini Stitch Nonchalant CR Paradigm Pogo Prairie Prim Radiance Ransom Ricochet Roam Rush Hour Soiree Spark Spree Summit Sutton Synth Tabloid Tinge Utmost Venue Versa Westwood Wide Angle Yeni Zipline	C continued Empire Stripe Enmesh Entourage Essence Fable CR Fibra Greenwich Hudson Hula Hoop Kaleidoscope Kora CR Lagos Lore CR Magnolia Metro Milestone Moto CR Noble Panache CR Pullman Quark Regard CR Roundtrip Sahara Sandpiper Sequin CR Sinclair Spectator Spot On Star Struck Stepping Stones Swing Tight Rope Tilden Tower Grid Treble CR Vibe Wit Zari CR	D Coterie Eclat Weave Hologram Island Masquerade Menagerie Origins Tara Theory Woodland Zoom	E Aegean Demure Highland Ikat Square Ikat Stripe Kampala Katazome Kimono Mamba Marquee Merroe Midpoint Nature Walk Sherman Shima Tryst Vatera Whip	F Atelier Biscayne Calais Cotton Velvet Century Coco Cornaro Glider Intrigue In Stitches Jasmine Liberty Mod Plaid Rivington Soon Tivoli Topography Totem	G Abington Alter Ego Amore Arabella Arber Djenne Feeling Plaid Gibson Hampshire Haze Kamani Kinabalu Kingston Melange Metallic Gloss Modern Tweed Petite Floral Sablou Serendipity Spencer Straie Stripe Ultrasuede Utrillo	H Arno Bavaria Catwalk Constance Firefly Gezelle Magritte Rosemond Stretch Appeal	I Aswan Cato Diamond Days Digi Velvet Dynamic Fiori Gramercy Jaipur Knoll Velvet Olema Piper Rutledge Sandis Tudor Vermeer Walker Worth Zimba
---	---	---	--	---	--	---	---	--

Check with your KnollTextiles Representative for changes or additions.

Antti Kotilainen

CHIP Chair and Barstool

	description	seat h	arm h, max	w	d	h	weight
<i>Designer(s):</i> Antti Kotilainen, 2002	23C CHIP armless chair	17 3/4"		20"	19 3/4"	31"	7 lbs.
							
<i>Award(s):</i> Good Design Award, 2002	23CK CHIP armless chair, seat pad	17 3/4"		20"	19 3/4"	31"	8 lbs.
							
	23A CHIP arm chair	17 3/4"	26 1/4"	21 1/2"	19 3/4"	31"	10 lbs.
							
	23AK CHIP arm chair, seat pad	17 3/4"	26 3/4"	21 1/2"	19 3/4"	31"	10 lbs.
							
	23CH-C CHIP Barstool, bar height, chrome base	29 1/2"		19 1/2"	17 1/2"	33 3/4"	10 lbs.
							
	23DOLLY Dolly for 20 chairs			23 3/8"	32 3/4"	34 3/8"	24 lbs.
							
	23GA Ganging mechanism						
							

Order Code	Ordering Information	Construction
<i>Example:</i> 23CK-N-WV-C-D893	<i>Shell Finishes:</i>  Birch (suffix FMB)  Blue (suffix BU)  Black (suffix BL)  Oak (suffix FMO)  Red (suffix RD)  Grey (suffix SL)  White (suffix WV)	<i>Chair:</i> Constructed of melamine covered molded birch on a chrome plated base. <i>Note:</i> The backrest mounts will always be in the silver grey powder paint, even on a chair with chrome frame.
WV White shell		
C Chrome base		
D893 Divina 893 fabric		
<i>Example:</i> 23CH-BU-C	<i>Frame Finishes:</i>  Chrome (suffix C)	<i>Seat pad:</i> CHIP chair with seat pad does not stack. Seat pad is a dacron covered piece of plywood attached to the chair seat. Seat pad is permanently attached to seat by discrete screws not visible from top of chair. Upholstery available in Gabriel fabrics: Event, Fame, and Gaja . Please contact your KnollStudio sales representative for samples.
23CH Chip barstool		
BU Blue shell		
C Chrome base		

Specify:

1. Pattern number
2. Shell finish
3. Frame finish
4. Textile selection

pattern no.	unuphol.	seat pad
23C-()-C 	\$827.	
23CK-N-()-C-()		1,334.
23A-()-C	1,188.	
23AK-N-()-C-()		1,744.
23CH-()-C	874.	
23DOLLY	1,733.	
23GA	73.	

Approved Textiles
<i>Event (E):</i> 100% polyester crepe fabric. It is a synthetic fabric suitable for environments with special requirements regarding cleaning.
<i>Fame (F):</i> A unique woollen upholstery fabric with a wearability of 200,000 Martindale. Extra soft and stretchable with an elegant and vibrant color scale.
<i>Gaja (G):</i> Non directional crepe weave made from 100% pure New Wool from New Zealand with anti-slip properties.
<i>Please contact your KnollStudio representative for colorways, color codes and samples.</i>
<i>Barstool:</i> Constructed of melamine covered molded birch on a chrome plated base. Foot rest is 11 1/2" from the floor.
<i>Transportation Dolly:</i> Zinc coated dolly allows CHIP arm and armless chairs to stack 20 high. Height of dolly with 20 CHIP chairs, fully loaded is 63". Empty dollies can be stacked 5 high.
<i>Stackability:</i> <i>Chair</i> CHIP stacks 12 on the floor. Height of 12 CHIP chairs measures 46" high.
<i>Ganging Mechanism:</i> The easy to attach and detach mechanism links the back of the chair frames. The mechanism is composed of translucent polypropylene. Can be used for both arm and armless chairs.
<i>Barstool</i> CHIP Barstool stacks 6 high on the floor.

Marc Krusin

Guest Seating Collection

Side Chair with Arms

Designer(s):
Marc Krusin, 2011

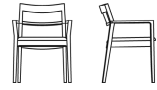

description	seat h	arm h	w	d	h	textile fabric yds.	required leather sq. ft.	weight	finish
MK01A Krusin arm chair	18 1/2"	24 1/2"	23 1/2"	21 3/4"	30 1/2"	0.8	14.5	14 lbs.	beech finish
	18 1/2"	24 1/2"	23 1/2"	21 3/4"	30 1/2"	0.8	14.5	14 lbs.	ash or oak finish
	18 1/2"	24 1/2"	23 1/2"	21 3/4"	30 1/2"	0.8	14.5	14 lbs.	walnut finish
MK01AU Krusin arm chair, uphol. inset back	18 1/2"	24 1/2"	23 1/2"	21 3/4"	30 1/2"	0.8	14.5	14 lbs.	beech finish
	18 1/2"	24 1/2"	23 1/2"	21 3/4"	30 1/2"	0.8	14.5	14 lbs.	ash or oak finish
	18 1/2"	24 1/2"	23 1/2"	21 3/4"	30 1/2"	0.8	14.5	14 lbs.	walnut finish
MK01R Seat basket replacement for side chair						0.8	14.5		
MK01RCN Woven rush seat basket replacement for side chair									light kraft

Order Code

<i>Example:</i>	MK01A-BE-K1207/17
MK01A	Krusin arm chair
BE	Ebonized
K1207/17	Knoll Felt, Pewter

Specify:

1. Pattern number
2. Woven rush seat, optional
3. Finish selection
4. Textile selection

Ordering Information:

Ash:
White Ash (suffix A101)

Beech frame stains:
Beech (suffix B311)
Bronzed Cherry (suffix B312A)
Burnt Walnut (suffix B313)
Deep Red Mahogany (suffix B328)
Ebonized (suffix BE)
Light Cherry (suffix B315)
Light Walnut (suffix B411)
Medium Cherry (suffix B319)
Medium Red Mahogany (suffix BR)
Medium Walnut (suffix B323)
Natural Beech (suffix BN)
Warm Brown Walnut (J)

Oak:
Ebonized Oak (suffix OE)
Fumed Oak (suffix OF)
Grey Oak, White Ceruse (suffix OGW)
Grey Oak, Black Ceruse (suffix OGB)
Natural Oak (suffix ON)

Walnut:
American Walnut (suffix AW)

Optional Woven Seat:
An optional woven paper rush seat is available at an upcharge, from grade A pricing, of \$284 for side chairs and \$318 for lounge chairs. Place suffix CN between parent pattern number and wood finish suffix.

Example:MK01A-CN-BE

Upholstery/COM information:
List prices shown include fabric or leather upholstery. Contact your Knoll representative for colors. Only approved KnollTextiles and Spinneybeck leathers may be ordered.

Customer's Own Material is available pending approval. For approval requirements, processing instructions and ordering information please see page 18.

KnollStudio natural wood finishes:
The Krusin Collection of guest seating features a low sheen, Greenguard approved, urethane finish. This finish, available on Ash, Oak, and Walnut delivers the tactility of natural wood while providing a durable matte finish.

Ash and Oak feature a unique staining process that replicate traditional cereused finishes.

KnollStudio Beech wood finishes:
KnollStudio Beech finishes complement a large variety of KnollStudio veneer and Knoll Office veneer finishes. To select correct complementary finish, please refer to KnollStudio Wood Finish Matrix on page 25. If no complementary finish is available, please refer to custom finish policy below.

Custom finishes:
Complementary finishes to any KnollStudio or Knoll Office wood finish are available at no upcharge. To complement non-Knoll wood veneer or lumber finishes, a one-time, non-negotiable net upcharge of \$637 applies. Re-orders are at no upcharge. Please contact your KnollStudio representative, dealer or Customer Service associate for complete custom finish information and Order Code. Minimum order quantity for any custom finish order: 4 chairs.

Certified Wood:
Chairs manufactured using FSC certified hardwoods are available through Custom Product Development. Extended leadtime and upcharge apply.

Maintenance:
See pages 28-29

Note:
The Krusin Collection chairs are Greenguard certified in all wood finishes.

Cal 133 Fire Code #:
The Krusin Side Chairs comply with the California Technical Bulletin 133 standard if upholstered in Cal 133 approved upholstery. Specify suffix -C at end of pattern number and suffix -133 at end of textile selection. Upcharge applies, see page 18.

Construction

Frame:
Select American and European hard wood frames. Dowel and mortise and tenon construction, steam bent top rail. A bent laminate upholstered inset back is available. The back of inset features horizontal grain direction.

Upholstered Seat:
High density, polyurethane foam used in all upholstered areas. Elastic seat belt suspension.

Woven Rush Seats:
A woven natural paper rush seat is available on side and lounge chairs. Not available on chairs with inset back upholstery. Paper rush is a natural, uncoated material.

KnollStudio will not warrant soiled or stained woven seats. A one year warranty will cover woven seats for manufacturer's defects.

Seat basket replacements:
Upholstered and woven seats sit on chair frame. Screws lock basket in place for easy installation or removal.

Finish:
Beech, Catalyzed lacquer protective coating. Hand applied final wax coating. Ash, Oak, and Walnut, urethane protective coating. Hand applied final wax coating.

Glides:
Chairs feature nylon glides.

pattern no.	grades A	COM B	C	D	E	F	G	H	I	COL U	V	W	X	Y
MK01A-()	\$1,131.	\$1,147.	\$1,167.	\$1,189.	\$1,203.	\$1,214.	\$1,235.	\$1,274.	\$1,302.	\$1,511.	\$1,565.	\$1,706.	\$1,735.	\$1,769.
MK01A-(A101, O_)	1,398.	1,415.	1,434.	1,454.	1,471.	1,482.	1,502.	1,541.	1,568.	1,779.	1,831.	1,972.	2,001.	2,036.
MK01A-(AW)	1,722.	1,739.	1,758.	1,779.	1,794.	1,807.	1,826.	1,865.	1,893.	2,102.	2,156.	2,297.	2,326.	2,360.
MK01AU-()	1,444.	1,460.	1,480.	1,500.	1,516.	1,527.	1,547.	1,587.	1,614.	1,824.	1,878.	2,018.	2,047.	2,081.
MK01AU-(A101, O_)	1,710.	1,727.	1,746.	1,767.	1,783.	1,794.	1,815.	1,853.	1,881.	2,091.	2,144.	2,286.	2,313.	2,347.
MK01AU-(AW)	2,035.	2,051.	2,071.	2,091.	2,107.	2,119.	2,138.	2,178.	2,205.	2,414.	2,469.	2,610.	2,638.	2,672.
MK01R	330.	347.	366.	387.	402.	414.	434.	473.	501.	699.	752.	893.	921.	956.
MK01RCN	426.	0.	0.	0.	0.	0.	0.	0.	0.	0.	0.	0.	0.	0.

Approved KnollTextiles Grades/Fabrics

A Alignment # Beacon Bocce # Cat's Cradle # Chance Common Ground # Commuter Cloth # Crossroad Delite Dristi Foil Rap Heavy Metal Hourglass Mariner Monarch Prep # Presto # Soliloquy Sonnet Stacks # Trophy # Uni-Form	B continued Ferry Forza Gala II Grande Grandview Hollbrook Journey Keaton Knoll Felt Knoll Hopsack Little Devil Ludlow Lyric Melody Mini Stitch # Night Life Paradigm Petal Pusher Prairie Prim # Radiance Ransom Ricochet # Roam Rush Hour Soiree # Spark # Spree # Summit Sutton Synth Tabloid Tinge Utmost Venue # Versa # Vinyl Westwood Wide Angle # Zipline #	C Atlas Axiom Baxter Biota # Cairo Charm Circa Classic Boucle Dahlia CR * Decade Durand Earthwork # Echo Empire Stripe Emmesh # Entourage # Essence Fable CR * Fibra Greenwich Hudson Hula Hoop Kaleidoscope CR Kaya CR Kora CR Lagos Legend CR Lore CR Magnolia Metro Milestone Moto CR Noble Palisade Panache CR Pullman Quark Regard CR Roundtrip # Sahara Sandpiper Sequin CR	C continued Sinclair Smart Spectator # Spot On Star Struck Stepping Stones Swing Tight Rope Tilden * Tower Grid Treble CR Vibe Wit Zari CR Zen Wave	E continued Mamba Marquee Midpoint Sherman Shima Tryst Vatera Whip	G continued Modern Tweed Sablon Serendipity Spencer Straie Stripe Stepping Stones Utrillo	H Arno Bavaria Catwalk Constance Firefly Gestelle Magritte Rosemond Stretch Appeal	I Aswan Byron Canaan Cato Cummings Diamond Days Digi Velvet Dynamic Ita Jaipur Knoll Velvet Limani Mepal North Island Olema Piper Rutledge Sandis Tudor Vermeer Walker Worth Zimba	U Vicenza # Volo #	V Acqua # Andes # Embossed Tip # España # Hand Tipped Maremma # Velluto Pelle #	W Alaska # Amazon # Antique # Derby Forte # Lucente Sabrina #	X Ducale * # Ducale Velour #	Y Capri * # Cervo * # Copenhagen # Distressed # Lucca * Marissa # Portofino Riva # Saddle Torello * #
---	--	--	---	---	---	--	--	---------------------------------	---	---	---	--

Spinneybeck Leather

U Vicenza # Volo #	V Acqua # Andes # Embossed Tip # España # Hand Tipped Maremma # Velluto Pelle #	W Alaska # Amazon # Antique # Derby Forte # Lucente Sabrina #	X Ducale * # Ducale Velour #	Y Capri * # Cervo * # Copenhagen # Distressed # Lucca * Marissa # Portofino Riva # Saddle Torello * #
G Alter Ego Arabella Arber Djenne Feeling Plaid Gibson Hampshire * Haze Kamani Kinabalu Kingston Melange Metallic Gloss	I Aswan Byron Canaan Cato Cummings Diamond Days Digi Velvet Dynamic Ita Jaipur Knoll Velvet Limani Mepal North Island Olema Piper Rutledge Sandis Tudor Vermeer Walker Worth Zimba	U Vicenza # Volo #	V Acqua # Andes # Embossed Tip # España # Hand Tipped Maremma # Velluto Pelle #	W Alaska # Amazon # Antique # Derby Forte # Lucente Sabrina #

Check with your KnollTextiles or Spinneybeck Representative for changes or additions.

Marc Krusin

Guest Seating Collection

Armless Side Chair

Designer(s):
Marc Krusin, 2011

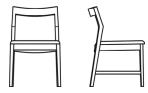

MK01C Krusin armless chair

MK01CU Krusin armless chair, uphol. inset back

MK01R Seat basket replacement for side chair

MK01RCN Woven rush seat basket replacement for side chair

MK01CU Krusin armless chair, uphol. inset back

description	seat h	w	d	h	textile fabric yds.	required leather sq. ft.	weight	finish
MK01C Krusin armless chair	18½"	20¼"	21¾"	30½"	0.8	14.5	12 lbs.	beech finish
	18½"	20¼"	21¾"	30½"	0.8	14.5	12 lbs.	ash or oak finish
	18½"	20¼"	21¾"	30½"	0.8	14.5	12 lbs.	walnut finish
MK01CU Krusin armless chair, uphol. inset back	18½"	20¼"	21¾"	30½"	0.8	14.5	12 lbs.	beech finish
	18½"	20¼"	21¾"	30½"	0.8	14.5	12 lbs.	ash or oak finish
MK01R Seat basket replacement for side chair					0.8	14.5		
MK01RCN Woven rush seat basket replacement for side chair								light kraft
MK01CU Krusin armless chair, uphol. inset back	18½"	20¼"	21¾"	30½"	0.8	14.5	12 lbs.	walnut finish

Order Code

<i>Example:</i>	MK01A-BE-K1207/17
MK01A	Krusin arm chair
BE	Ebonized
K1207/17	Knoll Felt, Pewter

Specify:

1. Pattern number
2. Woven rush seat, optional
3. Finish selection
4. Textile selection

Ordering Information:

Ash:
White Ash (suffix A101)

Beech frame stains:
Beech (suffix B311)
Bronzed Cherry (suffix B312A)
Burnt Walnut (suffix B313)
Deep Red Mahogany (suffix B328)
Ebonized (suffix BE)
Light Cherry (suffix B315)
Light Walnut (suffix B411)
Medium Cherry (suffix B319)
Medium Red Mahogany (suffix BR)
Medium Walnut (suffix B323)
Natural Beech (suffix BN)
Warm Brown Walnut (J)

Oak:
Ebonized Oak (suffix OE)
Fumed Oak (suffix OF)
Grey Oak, White Ceruse (suffix OGW)
Grey Oak, Black Ceruse (suffix OGB)
Natural Oak (suffix ON)

Walnut:
American Walnut (suffix AW)

Optional Woven Seat:
An optional woven paper rush seat is available at an upcharge, from grade A pricing, of \$284 for side chairs and \$318 for lounge chairs. Place suffix CN between parent pattern number and wood finish suffix.

*Example:***MK01A-CN-BE**

Upholstery/COM information:
List prices shown include fabric or leather upholstery. Contact your Knoll representative for colors. Only approved KnollTextiles and Spinneybeck leathers may be ordered.

Customer's Own Material is available pending approval. For approval requirements, processing instructions and ordering information please see page 18.

KnollStudio natural wood finishes:
The Krusin Collection of guest seating features a low sheen, Greenguard approved, urethane finish. This finish, available on Ash, Oak, and Walnut delivers the tactility of natural wood while providing a durable matte finish.

Ash and Oak feature a unique staining process that replicate traditional cereused finishes.

KnollStudio Beech wood finishes:
KnollStudio Beech finishes complement a large variety of KnollStudio veneer and Knoll Office veneer finishes. To select correct complementary finish, please refer to KnollStudio Wood Finish Matrix on page 25. If no complementary finish is available, please refer to custom finish policy below.

Custom finishes:
Complementary finishes to any KnollStudio or Knoll Office wood finish are available at no upcharge. To complement non-Knoll wood veneer or lumber finishes, a one-time, non-negotiable net upcharge of \$637 applies. Re-orders are at no upcharge. Please contact your KnollStudio representative, dealer or Customer Service associate for complete custom finish information and Order Code. Minimum order quantity for any custom finish order: 4 chairs.

Certified Wood:
Chairs manufactured using FSC certified hardwoods are available through Custom Product Development. Extended leadtime and upcharge apply.

Maintenance:
See pages 28-29

Cal 133 Fire Code #:
The Krusin Side Chairs comply with the California Technical Bulletin 133 standard if upholstered in Cal 133 approved upholstery. Specify suffix -C at end of pattern number and suffix -133 at end of textile selection. Upcharge applies, see page 18.

Construction

Frame:
Select American and European hard wood frames. Dowel and mortise and tenon construction, steam bent top rail. A bent laminate upholstered inset back is available. The back of inset features horizontal grain direction.

Upholstered Seat:
High density, polyurethane foam used in all upholstered areas. Elastic seat belt suspension.

Woven Rush Seats:
A woven natural paper rush seat is available on side and lounge chairs. Not available on chairs with inset back upholstery. Paper rush is a natural, uncoated material.

KnollStudio will not warrant soiled or stained woven seats. A one year warranty will cover woven seats for manufacturer's defects.

Seat basket replacements:
Upholstered and woven seats sit on chair frame. Screws lock basket in place for easy installation or removal.

Finish:
Beech, Catalyzed lacquer protective coating. Hand applied final wax coating. Ash, Oak, and Walnut, urethane protective coating. Hand applied final wax coating.

Glides:
Chairs feature nylon glides.

Note:
The Krusin Collection chairs are Greenguard certified in all wood finishes.

pattern no.	grades A	COM B	C	D	E	F	G	H	I	COL U	V	W	X	Y
MK01C-()	\$1,033.	\$1,052.	\$1,070.	\$1,091.	\$1,106.	\$1,119.	\$1,138.	\$1,176.	\$1,204.	\$1,398.	\$1,451.	\$1,592.	\$1,620.	\$1,654.
MK01C-(A101, O_)	1,302.	1,317.	1,338.	1,358.	1,374.	1,385.	1,406.	1,445.	1,472.	1,682.	1,736.	1,877.	1,904.	1,938.
MK01C-(AW)	1,625.	1,642.	1,661.	1,682.	1,698.	1,709.	1,729.	1,769.	1,795.	2,006.	2,059.	2,199.	2,228.	2,263.
MK01CU-()	1,346.	1,364.	1,383.	1,404.	1,419.	1,430.	1,451.	1,489.	1,517.	1,710.	1,763.	1,904.	1,933.	1,967.
MK01CU-(A101, O_)	1,614.	1,630.	1,650.	1,671.	1,686.	1,698.	1,718.	1,757.	1,784.	1,994.	2,048.	2,189.	2,218.	2,252.
MK01R	330.	347.	366.	387.	402.	414.	434.	473.	501.	699.	752.	893.	921.	956.
MK01RCN	426.	0.	0.	0.	0.	0.	0.	0.	0.	0.	0.	0.	0.	0.
MK01CU-(AW)	1,937.	1,955.	1,973.	1,994.	2,011.	2,022.	2,042.	2,081.	2,108.	2,320.	2,371.	2,512.	2,541.	2,576.

Approved KnollTextiles Grades/Fabrics

A Alignment # Beacon Boece # Cat's Cradle # Chance Common Ground # Commuter Cloth # Crossroad Delite Dristi Foil Rap Heavy Metal Hourglass Mariner Monarch Prep # Presto # Soliloquy Sonnet Stacks # Trophy # Uni-Form	B continued Ferry Forza Gala II Grande Grandview Holbrook Journey Keaton Knoll Felt Knoll Hopsack Little Devil Ludlow Lyric Melody Mini Stitch # Night Life Paradigm Petal Pusher Prairie Prim # Radiance Ransom Ricochet # Roam Rush Hour Soiree # Spark # Spree # Summit Sutton Synth Tabloid Tinge Utmost Venue # Versa # Vinyl Westwood Wide Angle # Zipline #	C Atlas Axiom Baxter Biota # Cairo Charm Circa Classic Boucle Dahlia CR * Decade Durand Earthwork # Echo Empire Stripe Enmesh # Entourage # Essence Fable CR * Fibra Greenwich Hudson Hula Hoop Kaleidoscope CR Kora CR Lagos Legend CR Lore CR Magnolia Metro Milestone Moto CR Noble Palisade Panache CR Quark Regard CR Roundtrip # Sahara Sandpiper Sequin CR Sinclair Smart	C continued Pullman Spectator # Spot On Star Struck Stepping Stones Swing Tight Rope Tilden * Tower Grid Treble CR Vibe Wit Zari CR	D Compass CR Coterie Eclat Weave Hologram In The Loop Island Masquerade Menagerie Origins Tara Theory Woodland Zoom	E continued Shima Tryst Vatera Whip F Atelier Biscayne Calais Cotton Velvet Century Coco Cornaro Glider Icon Intrigue In Stitches Liberty Mod Plaid Rivington Soon Tivoli Topography Totem Tweed Frieze	G continued Straie Stripe Ultrasuede Utrillo H Arno Bavaria Batwalk Constance Firefly Gezelle Magritte Rosemond Stretch Appeal I Aswan Byron Canaan Cato Cummings Diamond Days Digi Velvet Dynamic Ita Jaipur Knoll Velvet Limani Mepal North Island Olema Piper Rutledge Sandis Tudor Vermeer Walker Worth Zimba	U Vicenza # Volo # V Acqua # Andes # Embossed Tip # España # Hand Tipped Maremma # Velluto Pelle # W Alaska # Amazon # Antique # Derby Forte # Lucente Sabrina # *Not approved for inset back.	X Ducale * # Ducale Velour # Y Capri * # Cervo * # Copenhagen # Distressed # Lucca * Marissa # Portofino Riva # Saddle Torello * #
---	---	---	---	---	---	---	--	---

Spinneybeck Leather

Check with your KnollTextiles or Spinneybeck Representative for changes or additions.

Marc Krusin

Guest Seating Collection

Lounge Seating

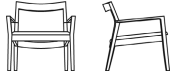
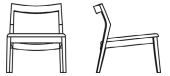
	description	seat h	arm h	w	d	h	textile fabric yds.	required leather sq. ft.	weight	finish
<i>Designer(s):</i> Marc Krusin, 2011	MK02A Krusin Lounge arm chair 	16"	21 1/2"	27"	25 3/4"	26"	0.9	16.5	14 lbs.	beech finish
		16"	21 1/2"	27"	25 3/4"	26"	0.9	16.5	14 lbs.	ash or oak finish
		16"	21 1/2"	27"	25 3/4"	26"	0.9	16.5	14 lbs.	walnut finish
	MK02C Krusin Lounge armless chair 	16"		23 1/2"	25 3/4"	26"	0.9	16.5	12 lbs.	beech finish
		16"		23 1/2"	25 3/4"	26"	0.9	16.5	12 lbs.	ash or oak finish
		16"		23 1/2"	25 3/4"	26"	0.9	16.5	12 lbs.	walnut finish
	MK02R Seat basket replacement for lounge chair						0.9	16.5		
	MK02RCN Woven rush seat basket replacement for lounge chair									light kraft

Order Code

<i>Example:</i>	MK02A-CN-A101
MK02A	Krusin lounge arm chair
CN	Woven rush seat
A101	White Ash

Specify:

1. Pattern number
2. Woven rush seat, optional
3. Finish selection
4. Textile selection

Ordering Information:

Ash:
White Ash (suffix A101)

Beech frame stains:
Beech (suffix B311)
Bronzed Cherry (suffix B312A)
Burnt Walnut (suffix B313)
Deep Red Mahogany (suffix B328)
Ebonized (suffix BE)
Light Cherry (suffix B315)
Light Walnut (suffix B411)
Medium Cherry (suffix B319)
Medium Red Mahogany (suffix BR)
Medium Walnut (suffix B323)
Natural Beech (suffix BN)
Warm Brown Walnut (J)

Oak:
Ebonized Oak (suffix OE)
Fumed Oak (suffix OF)
Grey Oak, White Ceruse (suffix OGW)
Grey Oak, Black Ceruse (suffix OGB)
Natural Oak (suffix ON)

Walnut:
American Walnut (suffix AW)

Optional Woven Seat:

An optional woven paper rush seat is available at an upcharge, from grade A pricing, of \$284 for side chairs and \$318 for lounge chairs. Place suffix CN between parent pattern number and wood finish suffix.

*Example:***MK02A-CN-A101**

Upholstery/COM information:

List prices shown include fabric or leather upholstery. Contact your Knoll representative for colors. Only approved KnollTextiles and Spinneybeck leathers may be ordered.

Customer's Own Material is available pending approval. For approval requirements, processing instructions and ordering information please see page 18.

KnollStudio natural wood finishes:

The Krusin Collection of guest seating features a low sheen, Greenguard approved, urethane finish. This finish, available on Ash, Oak, and Walnut delivers the tactility of natural wood while providing a durable matte finish.

Ash and Oak feature a unique staining process that replicate traditional cerused finishes.

KnollStudio Beech wood finishes:

KnollStudio Beech finishes complement a large variety of KnollStudio veneer and Knoll Office veneer finishes. To select correct complementary finish, please refer to KnollStudio Wood Finish Matrix on page 25. If no complementary finish is available, please refer to custom finish policy below.

Custom finishes:

Complementary finishes to any KnollStudio or Knoll Office wood finish are available at no upcharge. To complement non-Knoll wood veneer or lumber finishes, a one-time, non-negotiable net upcharge of \$637 applies. Re-orders are at no upcharge. Please contact your KnollStudio representative, dealer or Customer Service associate for complete custom finish information and Order Code. Minimum order quantity for any custom finish order: 4 chairs.

Certified Wood:

Chairs manufactured using FSC certified hardwoods are available through Custom Product Development. Extended leadtime and upcharge apply.

Maintenance:

See pages 28-29

Note:

The Krusin Collection chairs are Greenguard certified in all wood finishes.

Cal 133 Fire Code:

The Krusin Lounge Chairs comply with the California Technical Bulletin 133 standard if upholstered in Cal 133 approved upholstery. Specify suffix -C at end of pattern number and suffix -133 at end of textile selection. Upcharge applies, see page 18.

Construction

Frame:

Select American and European hard wood frames. Dowel and mortise and tenon construction, steam bent top rail.

Upholstered Seat:

High density, polyurethane foam used in all upholstered areas. Elastic seat belt suspension.

Woven Rush Seats:

A woven natural paper rush seat is available on side and lounge chairs. Not available on chairs with inset back upholstery. Paper rush is a natural, uncoated material.

KnollStudio will not warrant soiled or stained woven seats. A one year warranty will cover woven seats for manufacturer's defects.

Seat basket replacements:

Upholstered and woven seats sit on chair frame. Screws lock basket in place for easy installation or removal.

Finish:









































Beech, Catalyzed lacquer protective coating. Hand applied final wax coating. Ash, Oak, and Walnut, urethane protective coating. Hand applied final wax coating.

Glides:

Chairs feature nylon glides.

pattern no.	grades	COM	C	D	E	F	G	H	I	COL	U	V	W	X	Y
MK02A-()	\$1,659.	\$1,676.	\$1,698.	\$1,718.	\$1,737.	\$1,751.	\$1,773.	\$1,815.	\$1,847.	\$2,056.	\$2,119.	\$2,277.	\$2,310.	\$2,350.	
MK02A-(A101, O_)	1,727.	1,744.	1,765.	1,787.	1,806.	1,818.	1,842.	1,883.	1,915.	2,142.	2,204.	2,363.	2,397.	2,436.	
MK02A-(AW)	2,017.	2,035.	2,055.	2,076.	2,095.	2,108.	2,131.	2,172.	2,205.	2,433.	2,494.	2,652.	2,687.	2,725.	
MK02C-()	1,540.	1,557.	1,579.	1,599.	1,617.	1,630.	1,653.	1,696.	1,727.	1,937.	1,999.	2,158.	2,192.	2,231.	
MK02C-(A101, O_)	1,608.	1,625.	1,647.	1,668.	1,685.	1,700.	1,722.	1,763.	1,795.	2,023.	2,084.	2,243.	2,277.	2,318.	
MK02C-(AW)	1,898.	1,915.	1,936.	1,957.	1,976.	1,989.	2,012.	2,053.	2,085.	2,311.	2,374.	2,534.	2,567.	2,607.	
MK02R	409.	426.	446.	466.	482.	493.	514.	552.	579.	829.	883.	1,024.	1,053.	1,087.	
MK02RCN	460.	0.	0.	0.	0.	0.	0.	0.	0.	0.	0.	0.	0.	0.	

Approved KnollTextiles Grades/Fabrics

A Alignment  Beacon Bocce  Cat's Cradle  Chance Common Ground  Commuter Cloth  Crossroad Delite Dristi Foil Rap Heavy Metal Hourglass Mariner Monarch Prep  Presto  Soliloquy Sonnet Stacks  Trophy  Uni-Form	B continued Ferry Forza Gala II Grande Grandview Hollbrook Journey Keaton Knoll Felt Knoll Hopsack Little Devil Ludlow Lyric Melody Mini Stitch  Night Life Paradigm Petal Pusher Prairie Prim  Radiance Ransom Ricochet  Roam Rush Hour Soiree  Spark  Spree  Summit Boundary  Cameo Chroma  Chronicle Close Knit Digital Tape Diva Dovetail Fast Forward	C Atlas Axiom Baxter Biota  Cairo Charm Circa Classic Boucle Dahlia CR * Decade Durand Earthwork  Echo Empire Stripe Emmesh  Entourage  Essence Fable CR * Fibra Greenwich Hudson Hula Hoop Kaleidoscope CR Kora CR Lagos Legend CR Lore CR Magnolia Metro Milestone Moto CR Noble Palisade Panache CR Pullman Quark Regard CR Roundtrip  Sahara Sandpiper Sequin CR Sinclair Smart	C continued Spectator  Spot On Star Struck Stepping Stones Swing Tight Rope Tilden * Tower Grid Treble CR Vibe Wit Zari CR	D Compass CR Coterie Eclat Weave Hologram In The Loop Island Masquerade Menagerie Origins Tara Theory Woodland Zoom	E Aegean Highland Ikat Stripe Ikat Square Kampala Katazome Kimono Mamba Marquee Midpoint Sherman Shima Tryst Vatera Whip	F Atelier Biscayne Calais Cotton Velvet Century Coco Cornaro Glider Icon Intrigue In Stitches Liberty Mod Plaid Rivington Soon Tivoli Topography Totem Tweed Frieze	G Alter Ego Arabella Djenne Feeling Plaid Gibson Hampshire * Haze Kamani Kinabalu Kingston Melange Metallic Gloss Modern Tweed Sablon Serendipity Spencer Straite Stripe Ultrasuède Utrillo	H Arno Bavaria Catwalk Constance Firefly Gezelle Magritte Rosemond Stretch Appeal	I Aswan Byron Canaan Cato Cummings Diamond Days Digi Velvet Dynamic Ita Jaipur Knoll Velvet Limani Mepal North Island Olema Piper Rutledge Sandis Tudor Vermeer Walker Worth Zimba	U Vicenza  Volo  V Acqua  Andes  Embossed Tip  Hand Tipped Lucca Maremma  Velluto Pelle  W Alaska  Amazon  Antique  Derby Forte  Lucente Sabrina 	X Ducale  Ducale Velour  Y Capri  Cervo  Copenhagen  Distressed  Lucca Marissa  Portofino Riva  Saddle Torello 
---	---	--	--	---	--	---	---	---	--	--	---



Spinneybeck Leather

Check with your KnollTextiles or Spinneybeck Representative for changes or additions.

Maya Lin

Stones

Seats and Coffee Table

	description	w	d	h	material	textile fabric yds.	req. leather sq. ft.	weight	
<i>Designer(s):</i> Maya Lin, 1998	83Y Stones adult seat 	27"	19"	15"	molded polyethylene no weight			13 lbs.	
		27"	19"	15"	molded polyethylene with weight			22 lbs.	
<i>Award(s):</i> Best of Neocon Silver Award, 1998; Good Design Award, Chicago Athenaeum, 1998; Good Design Award, 2006		83Y-K Seat cushion for adult seat				1.3	30		
		84Y Stones child seat	16"	12"	10"	molded polyethylene no weight			6 lbs.
			16"	12"	10"	molded polyethylene with weight			17 lbs.
		84Y-K Seat cushion for child seat					1.0	25	

Order Code

<i>Example:</i>	84YM-W-KHRC-K642/5
84YM	Stones child seat
W	With weight
KHRC	Khaki
K642/5	Mariner, Steel

Specify:

1. Pattern number
2. Weight option
3. Finish option
4. Textile selection

Ordering Information:

Molded Polyethylene finish:
White (suffix WV)

Molded Polyethylene finishes with 100% recycled content:

- Blue (suffix BLRC)
- Chartreuse (CHRC)
- Khaki (suffix KHRC)
- Silver (suffix SPROC)
- Tarmac (suffix TARC)
- Warm Red (suffix WRRRC)

Seats and Table:

Stones are available in molded polyethylene in virgin or recycled material. Both versions are fully finished and are enclosed on top, bottom and sides. Seat tops are slightly concave and table top is slightly convex.

Note:

The original Maya Lin Coffee Table (85T42) is no longer available and has been replaced by a modified version (85T32). Please note the new dimensions and weight.

Outdoor application note:

With proper care and limited exposure to the elements, Stones tables and seats without seat pads are suitable for outdoor use. Polyethylene stones in all colors can be used outdoors. Remove water in the concave seats to avoid permanent stains. White patina may appear on surface. During cool or inclement weather, it is recommended to bring Stones inside.

Child seat application note:

Child seat is for child use only and not sized to be used by adults. Do not use as stepping stool.

Upholstery/COM information:

Prices shown include fabric or leather upholstery. Contact your Knoll representative for colors. Only approved KnollTextiles and Spinneybeck leathers may be ordered.

Customer's Own Material is available pending approval. For approval requirements, processing instructions and ordering information please see page 18.

Security Kit:

Security kit hooks onto latch on underside of polyethylene Stone directly into the ground for permanent applications. Due to variations in flooring, kit does not include hardware.

UV Testing:

Maya Lin Stones in polyethylene in all colors have passed UV testing standards including 100 hours under intense UV radiation to test for colorfastness.

Cal 133:

For polyethylene Maya Lin Stones in a Cal 133 finish please request through CPD. Please note, specifying the Maya Lin Stone seat pad in a Cal 133 textile does not make the polyethylene Stone Cal 133 approved.

Maintenance:

See pages 28-29.

Note:

The Maya Lin Seat and Coffee Table are Greenguard approved.

The Child's Maya Lin Stone is compliant to the Consumer Product Safety Improvement Act of 2008 for Children's Products, 16 C.F.R. 1303, CPSIA Title 1 Section 101 for Total Lead in Substrates and Surface Coatings.

Construction

Molded Polyethylene Stones:

Polyethylene stones have integral color with a light texture and a low gloss finish, available in one color.

Recycled Molded Polyethylene Stones:

Recycled polyethylene stones are composed of 100% recycled polyethylene in six colors. Black specs will appear randomly on the surface of the stone. Color will vary slightly from stone to stone. Warranty claims for color variations will not be honored.

Weighted Polyethylene Stones:

Adult and child stones in molded polyethylene can be specified with or without weight. For stones with weight, sand is added at the factory. Weight can be adjusted in the field through access on underside of the stones. There is no option for a sand kit if the Stones are ordered without weight. The coffee table can only be specified without weight.

Seat cushions (seats only):

Seat cushions are 2 1/4" thick, solid foam piece with tapered edge and fabric or leather zip-lock cover. Seat cushions are fully upholstered on top and bottom. Seat cushions are not attached to Stone.

pattern no.	unuphol.	grades	COM																	
		A	B	C	D	E	F	G	H	I	COL	U	V	W	X	Y				
83YM-()	\$625.																			
83YMW-()	739.																			
83Y-K-()		649.	682.	716.	751.	782.	803.	840.	908.	958.	1,331.	1,500.	1,850.	1,922.	2,009.					
84YM-()	430.																			
84YMW-()	496.																			
84Y-K-()		474.	509.	539.	572.	598.	616.	649.	716.	762.	1,177.	1,337.	1,656.	1,726.	1,801.					

Approved KnollTextiles Grades/Fabrics

A Alignment #
Beacon
Bocce
Cat's Cradle
Chance
Common Ground #
Commuter Cloth #
Crossover
Delite
Dristi
Hourglass
Mariner #
Monarch #
Prep #
Presto #
Soliloquy
Sonnet
Stacks
Trophy
Uni-Form

B Abacus #
Argyle
Backdrop
Belize
Bistro #
Boundary #
Cameo
Chroma #
Chronicle
Close Knit #
Diva
Dovetail #
Ferry
Forza
Gala II
Grande
Grandview
Helios
Holbrook
Journey
Keaton
Knoll Felt
Knoll Hopsack
Little Devil

C Atlas
Axiom
Baxter
Biota #
Cairo
Charm
Circa
Classic Boucle
Dahlia CR
Dune
Durand
Earthwork #
Echo

continued
Ludlow
Mini Stitch
Melody
Night Life
Paradigm
Petal Pusher
Pogo #
Prairie
Prim
Radianc
Ransom
Ricochet #
Roam
Rush Hour
Soiree
Spark #
Spree
Summit
Sutton
Synth
Tabloid
Tinge
Venue
Versa
Vinyl
Westwood
Wide Angle #
Yeni
Zipline

continued
Empire Stripe
Enmesh #
Entourage
Essence
Fable CR
Fibra
Greenwich
Hudson
Hula Hoop
Kaleidoscope CR
Kora CR
Lagos
Legend CR
Lore CR
Magnolia
Metro
Milestone
Moto CR
Noble
Palisade
Panache CR
Pullman
Quark
Regard CR
Roundtrip
Sahara
Sandpiper
Sequin CR
Sinclair
Smart
Spectator
Spot On
Star Struck
Stepping Stones
Swing
Tilden
Tower Grid
Treble CR
Wit
Zari CR

D Compass CR
Coterie
Eclat Weave
Hologram
Island
Masquerade
Menagerie
Origins
Tara
Theory
Woodland
Zoom

E Aegean
Demure
Highland
Ikat Stripe
Ikat Square
Kampala
Katazome
Kimono
Mamba
Marquee
Merroe
Midpoint
Nature Walk
Sherman
Shima
Tryst
Vaterca
Whip

F Atelier
Biscayne
Calais Cotton
Velvet
Century
Coco
Cornaro

continued
Glider
Icon
Intrigue
In Stitches
Jasmine
Liberty
Mod Plaid
Rivington
Soon
Tivoli
Topography
Totem
Tweed Frieze

G Alter Ego
Amore
Arabella
Arber
Brugge
Djenne
Feeling Plaid
Gibson
Hampshire
Haze
Kamani
Kinabalu
Kingston
Melange
Metallic Gloss
Modern Tweed
Petite Floral
Sablon
Serendipity
Spencer
Straie Stripe
Ultrasuede #
Utrillo

H Arno
Bavaria
Catwalk
Constance
Firefly
Gezelle
Magritte
Rosemond
Stretch Appeal

I Aswan
Byron
Canaan
Cato
Diamond Days
Digi Velvet
Dynamic
Fiorlta
Jaipur
Knoll Velvet
Limani
North Island
Olema
Piper
Rutledge
Tudor
Vermeer
Walker
Worth
Zimba

Spinneybeck Leather

U Vicenza
Volo

V Acqua
Andes
Embossed Tipped
España
Hand Tipped
Velluto Pelle

W Alaska
Amazon
Antique
Derby
Forte
Lucente
Sabrina

X Ducale
Ducale Velour

Y Capri
Cervo
Copenhagen
Distressed
Lucca
Marissa
Portofino
Riva
Torello



Approved for Cal 133 upholstery.

Check with your KnollTextiles or Spinneybeck Representative for changes or additions.

Maya Lin

Stones

Seats and Coffee Table

	description	w	d	h	material	textile fabric yds.	req. leather sq. ft.	weight
<p><i>Designer(s):</i> Maya Lin, 1998</p> <p><i>Award(s):</i> Best of Neocon Silver Award, 1998; Good Design Award, Chicago Athenaeum, 1998; Good Design Award, 2006</p> 	<p>85T32M Stones coffee table</p> 	32"	22½"	15"	molded polyethylene	no weight		26.5 lbs.
	<p>83ANCHOR Stone Security Kit</p>							

Order Code

<i>Example:</i>	84YM-W-KHRC-K642/5
84YM	Stones child seat
W	With weight
KHRC	Khaki
K642/5	Mariner, Steel

Specify:

- Pattern number
- Weight option
- Finish option
- Textile selection

Ordering Information:

Molded Polyethylene finish:
White (suffix WV)

Molded Polyethylene finishes with 100% recycled content:

- Blue (suffix BLRC)
- Chartreuse (CHRC)
- Khaki (suffix KHRC)
- Silver (suffix SPRC)
- Tarmac (suffix TARC)
- Warm Red (suffix WRRRC)

Upholstery/COM information:
Prices shown include fabric or leather upholstery. Contact your Knoll representative for colors. Only approved KnollTextiles and Spinneybeck leathers may be ordered.

Customer's Own Material is available pending approval. For approval requirements, processing instructions and ordering information please see page 18.

Seats and Table:

Stones are available in molded polyethylene in virgin or recycled material. Both versions are fully finished and are enclosed on top, bottom and sides. Seat tops are slightly concave and table top is slightly convex.

Note:

The original Maya Lin Coffee Table (85T42) is no longer available and has been replaced by a modified version (85T32). Please note the new dimensions and weight.

Outdoor application note:

With proper care and limited exposure to the elements, Stones tables and seats without seat pads are suitable for outdoor use. Polyethylene stones in all colors can be used outdoors. Remove water in the concave seats to avoid permanent stains. White patina may appear on surface. During cool or inclement weather, it is recommended to bring Stones inside.

Child seat application note:

Child seat is for child use only and not sized to be used by adults. Do not use as stepping stool.

Security Kit:

Security kit hooks onto latch on underside of polyethylene Stone directly into the ground for permanent applications. Due to variations in flooring, kit does not include hardware.

UV Testing:

Maya Lin Stones in polyethylene in all colors have passed UV testing standards including 100 hours under intense UV radiation to test for colorfastness.

Cal 133:

For polyethylene Maya Lin Stones in a Cal 133 finish please request through CPD. Please note, specifying the Maya Lin Stone seat pad in a Cal 133 textile does not make the polyethylene Stone Cal 133 approved.

Maintenance:

See pages 28-29.

Note:

The Maya Lin Seat and Coffee Table are Greenguard approved.

The Child's Maya Lin Stone is compliant to the Consumer Product Safety Improvement Act of 2008 for Children's Products, 16 C.F.R. 1303, CPSIA Title 1 Section 101 for Total Lead in Substrates and Surface Coatings.

Construction

Molded Polyethylene Stones:

Polyethylene stones have integral color with a light texture and a low gloss finish, available in one color.

Recycled Molded Polyethylene Stones:

Recycled polyethylene stones are composed of 100% recycled polyethylene in six colors. Black specs will appear randomly on the surface of the stone. Color will vary slightly from stone to stone. Warranty claims for color variations will not be honored.

Weighted Polyethylene Stones:

Adult and child stones in molded polyethylene can be specified with or without weight. For stones with weight, sand is added at the factory. Weight can be adjusted in the field through access on underside of the stones. There is no option for a sand kit if the Stones are ordered without weight. The coffee table can only be specified without weight.

Seat cushions (seats only):

Seat cushions are 2¼" thick, solid foam piece with tapered edge and fabric or leather zip-lock cover. Seat cushions are fully upholstered on top and bottom. Seat cushions are not attached to Stone.

pattern no.	unuphol.	grades A	COM B	C	D	E	F	G	H	I	COL U	V	W	X	Y
85T32M- ()	\$1,125.														
83ANCHOR	147.														

Approved KnollTextiles Grades/Fabrics

A

Alignment ‡
Beacon
Bocce
Cat's Cradle
Chance
Common Ground ‡
Commuter Cloth ‡
Crossroad
Delite
Dristi
Hourglass
Mariner ‡
Monarch ‡
Prep ‡
Presto ‡
Soliloquy
Sonnet
Stacks
Trophy
Uni-Form

B

Abacus ‡
Argyle
Backdrop
Belize
Bistro ‡
Boundary ‡
Cameo
Chroma ‡
Chronicle
Close Knit ‡
Diva
Dovetail ‡
Ferry
Forza
Gala II
Grande
Grandview
Helios
Holbrook
Journey
Keaton
Knoll Felt
Knoll Hopsack
Little Devil

C

Atlas
Axiom
Baxter
Biota ‡
Cairo
Charm
Circa
Classic Boucle
Dahlia CR
Dune
Durand
Earthwork ‡
Echo

D

Empire Stripe
Enmesh ‡
Entourage
Essence
Fable CR
Fibra
Greenwich
Hudson
Hula Hoop
Kaleidoscope CR
Kora CR
Lagos
Legend CR
Lore CR
Magnolia
Metro
Milestone
Moto CR
Sutton
Palisade
Panache CR
Pullman
Tinge
Venue
Versa
Vinyl
Westwood
Wide Angle ‡
Yeni
Zipline

E

Compass CR
Coterie
Eclat Weave
Hologram
Island
Masquerade
Menagerie
Origins
Tara
Theory
Woodland
Zoom

F

Aegean
Demure
Highland
Ikat Stripe
Ikat Square
Kampala
Katazome
Kimono
Mamba
Marquee
Meroe
Midpoint
Nature Walk
Sherman
Shima
Tryst
Vatera
Whip

G

Alter Ego
Amore
Arabella
Arber
Brugge
Djenne
Feeling Plaid
Gibson
Hampshire
Haze
Kamani
Kinabalu
Kingston
Melange
Metallic Gloss
Modern Tweed
Petite Floral
Sablon
Serendipity
Spencer
Straie Stripe
Ultrasuede ‡
Utrillo

H

Arno
Bavaria
Catwalk
Constance
Firefly
Gezelle
Magritte
Rosemond
Stretch Appeal

I

Aswan
Byron
Canaan
Cato
Diamond Days
Digi Velvet
Dynamic
Fiorlita
Jaipur
Knoll Velvet
Limani
North Island
Olema
Piper
Rutledge
Tudor
Vermeer
Walker
Worth
Zimba

J

Alaska
Amazon
Antique
Derby
Forte
Lucente
Sabrina

K

Vicenza
Volo

L

Acqua
Andes
Embossed Tipped
España
Hand Tipped
Velluto Pelle

M

Ducale
Ducale Velour

N

Capri
Cervo
Copenhagen
Distressed
Lucca
Marissa
Portofino
Riva
Torello

O

Approved for Cal 133 upholstery.

P

Check with your KnollTextiles or Spinneybeck Representative for changes or additions.

Q

R

S

T

U

V

W

X

Y

Piero Lissoni

Divina® Lounge Seating

Designer(s):
Piero Lissoni, 2001



description	seat h	arm h	w	d	h	foam type	textile	req.	weight
							fabric yds.	leather sq. ft.	
67S Petite lounge chair	16 1/4"	24 1/2"	30 1/2"	31 1/4"	32 1/2"	standard	4.5	72	42 lbs.
67 Standard lounge chair	16 1/4"	24 1/4"	37"	35 1/2"	31 1/4"	standard	7.5	108	59 lbs.
	16 1/4"	24 1/4"	37"	35 1/2"	31 1/4"	dual density	7.5	108	59 lbs.

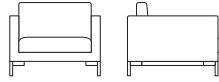
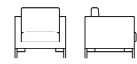

Order Code

<i>Example:</i>	69R-K1052/7
69R	Divina sofa, dual density
K1052/7	Topography, Canyon
<i>Example:</i>	68C-K1052/7
68C	Divina side cushion
K1052/7	Topography, Canyon

Specify:

1. Pattern number
2. R for dual density cushions
3. Textile selection

Side cushion, specify:

1. Pattern number
2. Textile selection

Ordering Information

Upholstery/COM information:
Prices shown include fabric or leather upholstery. Contact your Knoll representative for colors. Only approved KnollTextiles and Spinneybeck leathers may be ordered.

Customer's Own Material is available pending approval. For approval requirements, processing instructions and ordering information please see page 18.

Optional Side Cushion:
One or two cushions can be specified for the standard lounge chair, settee and sofa. Side cushion is composed of polyurethane with polyester wrap. Since cushion is not fitted, it is available in fabric only.

Cal 133 Fire Code #:
The Divina Lounge collection complies with the California Technical Bulletin 133 standard if upholstered in Cal 133 approved upholstery. Specify suffix -C at end of pattern number and suffix -133 at end of textile or leather selection. For Cal 133 approval, leather units must be double upholstered: in the F187 fabric barrier and then in leather. Upcharge applies, see page 18.

Maintenance:
See pages 28-29.

Note:
The Divina Lounge Collection is Greenguard certified.

Construction

Frame:
Inner frame solid wood. Exposed metal frame and legs in heavy gauge tubular steel in polished chrome finish.

Feet:
Chrome-plated feet with polyurethane glides measuring 5.75" high.

Standard Cushions:
Seat cushion in polyurethane with polyester fiber wrap. Back cushion in polyurethane. Cushions are not reversible.

Dual Density Cushions:
Back cushion is polyurethane. Seat cushion is dual density foam: a soft foam core with a memory topper. Cushions are not reversible.

Upholstery:
Double-needled stitching on leather upholstery. Double-needled stitching on thin solid textiles, single-needled stitching on heavily ribbed fabrics and multicolor prints.

pattern no.	grades	COM										COL				
	A	B	C	D	E	F	G	H	I	U	V	W	X	Y		
67S-()	\$5,051.	\$5,235.	\$5,416.	\$5,610.	\$5,770.	\$5,885.	\$6,083.	\$6,453.	\$6,732.	\$8,156.	\$8,825.	\$10,184.	\$10,466.	\$10,795.		
67-()	5,821.	6,070.	6,307.	6,568.	6,785.	6,937.	7,204.	7,700.	8,070.	9,862.	10,764.	12,590.	12,971.	13,413.		
67R-()	6,112.	6,371.	6,623.	6,898.	7,125.	7,284.	7,562.	8,087.	8,473.	10,354.	11,301.	13,218.	13,620.	14,084.		

Approved KnollTextiles Grades/Fabrics

A Alignment # Beacon Bocce Cat's Cradle Chance Common Ground Commuter Cloth # Crossroad Delite Hourglass Mariner Monarch # Prep # Presto # Sonnet Stacks Trophy Uni-Form	B continued Grandview Helios Holbrook Journey # Keaton Knoll Felt Knoll Hopsack Little Devil Ludlow Lyric Melody Paradigm Petat Pusher Pogo Prairie Prim Radianc Ransom Ricochet # Roam Rush Hour Soiree Spark # Spree Summit Sutton # Synth Tabloid Tinge Venue Versa Vinyl Westwood Wide Angle # Zipline	C Atlas Axiom Biota # Cairo Charm Circa Classic Boucle # Dahlia CR Durand Earthwork # Echo Empire Stripe Entourage Essence Fable CR Fibra Greenwich Hudson Hula Hoop Island Kaleidoscope CR Kora CR Lagos Lore CR Metro Milestone Moto CR Palisade Panache CR Pullman	C continued Quark Roundtrip Sahara Sandpiper Sequin CR Spot On Star Struck Stepping Stones Swing Tight Rope Tilden Tower Grid Wit Zari CR	E Aegean Demure Highland Ikat Stripe Ikat Square Kampala Katazome Mamba Marquee Meroe Nature Walk Shima Tryst Whip	G Alter Ego Brugge Djenne Feeling Plaid Hampshire Haze Kinabalu Kingston Melange Modern Tweed Petite Floral Serendipity Spencer Ultrasuede	H Arno # Constance Firefly Gezelle Magritte Rosemond Stretch Appeal	I Byron Cato Diamond Days Digi Velvet Dynamic Knoll Velvet Olema Piper Rutledge Sandis Tudor Vermeer Walker Worth Zimba	U Vicenza # Volo #	V Acqua # Andes # Embossed Tipped España # Hand Tipped Velluto Pelle #	W Alaska # Amazon # Antique # Derby # Forte # Lucente Sabrina #	X Ducale # Ducale Velour #	Y Capri # Cervo Copenhagen # Distressed # Marissa # Riva # Saddle #
---	--	--	--	---	---	---	---	---------------------------------	---	---	---	---

Approved for Cal 133 upholstery.

Check with your KnollTextiles or Spinneybeck Representative for changes or additions.

Piero Lissoni

Divina® Lounge Seating

Designer(s):
Piero Lissoni, 2001

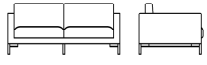
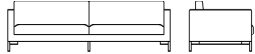

description	seat h	arm h	w	d	h	foam type	textile	req.	weight
							fabric yds.	leather sq. ft.	
68 Settee 	16 1/4"	24 1/4"	66"	35 1/2"	31 1/4"	standard	11.3	163	83 lbs.
	16 1/4"	24 1/4"	66"	35 1/2"	31 1/4"	dual density	11.3	163	83 lbs.
69 Sofa 	16 1/4"	24 1/4"	91"	35 1/2"	31 1/4"	dual density	13.3	192	130 lbs.
	16 1/4"	24 1/4"	91"	35 1/2"	31 1/4"	standard	13.3	192	130 lbs.

pattern no.	grades A	COM B	C	D	E	F	G	H	I	COL U	V	W	X	Y
68- ()	\$8,822.	\$9,204.	\$9,571.	\$9,975.	\$10,301.	\$10,539.	\$10,947.	\$11,712.	\$12,278.	\$15,053.	\$16,433.	\$19,245.	\$19,832.	\$20,512.
68R- ()	9,262.	9,664.	10,050.	10,473.	10,816.	11,068.	11,495.	12,298.	12,893.	15,804.	17,255.	20,209.	20,825.	21,538.
69R- ()	10,478.	11,000.	11,499.	12,046.	12,491.	12,813.	13,360.	14,398.	15,170.	20,066.	21,939.	25,747.	26,543.	27,465.
69- ()	9,979.	10,478.	10,951.	11,471.	11,897.	12,204.	12,724.	13,714.	14,450.	19,113.	20,898.	24,520.	25,280.	26,157.

Order Code

<i>Example:</i> 69R-K1052/7
69R Divina sofa, dual density
K1052/7 Topography, Canyon
<i>Example:</i> 68C-K1052/7
68C Divina side cushion
K1052/7 Topography, Canyon

Specify:

1. Pattern number
2. R for dual density cushions
3. Textile selection

Side cushion, specify:

1. Pattern number
2. Textile selection

Ordering Information

Upholstery/COM information: Prices shown include fabric or leather upholstery. Contact your Knoll representative for colors. Only approved KnollTextiles and Spinneybeck leathers may be ordered.

Customer's Own Material is available pending approval. For approval requirements, processing instructions and ordering information please see page 18.

Optional Side Cushion: One or two cushions can be specified for the standard lounge chair, settee and sofa. Side cushion is composed of polyurethane with polyester wrap. Since cushion is not fitted, it is available in fabric only.

Cal 133 Fire Code #: The Divina Lounge collection complies with the California Technical Bulletin 133 standard if upholstered in Cal 133 approved upholstery. Specify suffix -C at end of pattern number and suffix -133 at end of textile or leather selection. For Cal 133 approval, leather units must be double upholstered: in the F187 fabric barrier and then in leather. Upcharge applies, see page 18.

Maintenance: See pages 28-29.

Note: The Divina Lounge Collection is Greenguard certified.

Construction

Frame: Inner frame solid wood. Exposed metal frame and legs in heavy gauge tubular steel in polished chrome finish.

Feet: Chrome-plated feet with polyurethane glides measuring 5.75" high.

Standard Cushions: Seat cushion in polyurethane with polyester fiber wrap. Back cushion in polyurethane. Cushions are not reversible.

Dual Density Cushions: Back cushion is polyurethane. Seat cushion is dual density foam: a soft foam core with a memory topper. Cushions are not reversible.

Upholstery: Double-needled stitching on leather upholstery. Double-needled stitching on thin solid textiles, single-needled stitching on heavily ribbed fabrics and multicolor prints.

Approved KnollTextiles Grades/Fabrics

A Alignment # Beacon Bocce Cat's Cradle Chance Common Ground Commuter Cloth # Crossroad Delite Hourglass Mariner Monarch # Prep # Presto # Sonnet Stacks Trophy Uni-Form	B continued Grandview Helios Holbrook Journey # Keaton Knoll Felt Knoll Hopsack Little Devil Ludlow Lyric Melody Paradigm Petat Pusher Pogo Prairie Prim Radianc Ransom Ricochet # Roam Rush Hour Soiree Spark # Spree Summit Sutton # Synth Tabloid Tinge Venue Versa Vinyl Westwood Wide Angle # Zipline	C Atlas Axiom Biota # Cairo Charm Circa Classic Boucle # Dahlia CR Durand Earthwork # Echo Empire Stripe Entourage Essence Fable CR Fibra Greenwich Hudson Hula Hoop Island Kaleidoscope CR Kora CR Lagos Lore CR Metro Milestone Moto CR Palisade Panache CR Pullman	C continued Quark Roundtrip Sahara Sandpiper Sequin CR Spot On Star Struck Stepping Stones Swing Tight Rope Tilden Tower Grid Wit Zari CR	D Coterie Eclat Weave Hologram Island Kabuki Masquerade Menagerie Origins Tara Theory Woodland Zoom	E Aegean Demure Highland Ikat Stripe Ikat Square Kampala Katazome Mamba Marquee Meroe Nature Walk Shima Tryst Whip	F Atelier Biscayne Calais Cotton Velvet Century Coco Cornaro Icon Intrigue In Stitches Liberty Mod Plaid Rivington Soon Tivoli Topography Totem	G Alter Ego Brugge Djenne Feeling Plaid Hampshire Haze Kinabalu Kingston Melange Modern Tweed Petite Floral Serendipity Spencer Ultrasuede	H Arno # Constance Firefly Gezelle Magritte Rosemond Stretch Appeal	I Byron Cato Diamond Days Digi Velvet Dynamic Knoll Velvet Olema Piper Rutledge Sandis Tudor Vermeer Walker Worth Zimba	U Vicenza # Volo #	V Acqua # Andes # Embossed Tipped España # Hand Tipped Velluto Pelle #	W Alaska # Amazon # Antique # Derby # Forte # Lucente Sabrina #	X Ducale # Ducale Velour #	Y Capri # Cervo Copenhagen # Distressed # Marissa # Riva # Saddle #
---	--	--	--	--	---	---	---	---	---	---------------------------------	---	---	---	---

Approved for Cal 133 upholstery.



Check with your KnollTextiles or Spinneybeck Representative for changes or additions.

Piero Lissoni

Divina® Lounge Seating

Designer(s):
Piero Lissoni, 2001



description	seat h	arm h	w	d	h	foam type	textile fabric yds.	req. leather sq. ft.	weight
68C Optional side cushion for standard chair, settee and sofa 			21"	2 1/2"	13 1/4"	standard	1	n/a	5 lbs.
73 Ottoman 			29 1/2"	29 1/2"	16"	standard	4.1	43	27 lbs.
			29 1/2"	29 1/2"	16"	dual density	4.1	43	27 lbs.

pattern no.	grades A	COM B	C	D	E	F	G	H	I	COL U	V	W	X	Y
68C-()	\$606.	\$639.	\$673.	\$709.	\$739.	\$763.	\$798.	\$871.	\$920.					
73-()	3,013.	3,144.	3,266.	3,400.	3,510.	3,593.	3,729.	3,985.	4,030.	4,178.	4,299.	4,849.	4,963.	5,096.
73R-()	3,163.	3,300.	3,430.	3,571.	3,685.	3,774.	3,915.	4,185.	4,232.	4,386.	4,516.	5,092.	5,211.	5,351.

Order Code

Example:	69R-K1052/7
69R	Divina sofa, dual density
K1052/7	Topography, Canyon
Example:	68C-K1052/7
68C	Divina side cushion
K1052/7	Topography, Canyon

Specify:

1. Pattern number
2. R for dual density cushions
3. Textile selection

Side cushion, specify:

1. Pattern number
2. Textile selection

Ordering Information

Upholstery/COM information: Prices shown include fabric or leather upholstery. Contact your Knoll representative for colors. Only approved KnollTextiles and Spinneybeck leathers may be ordered.

Customer's Own Material is available pending approval. For approval requirements, processing instructions and ordering information please see page 18.

Optional Side Cushion: One or two cushions can be specified for the standard lounge chair, settee and sofa. Side cushion is composed of polyurethane with polyester wrap. Since cushion is not fitted, it is available in fabric only.

Cal 133 Fire Code #: The Divina Lounge collection complies with the California Technical Bulletin 133 standard if upholstered in Cal 133 approved upholstery. Specify suffix -C at end of pattern number and suffix -133 at end of textile or leather selection. For Cal 133 approval, leather units must be double upholstered: in the F187 fabric barrier and then in leather. Upcharge applies, see page 18.

Maintenance: See pages 28-29.

Note: The Divina Lounge Collection is Greenguard certified.

Construction

Frame: Inner frame solid wood. Exposed metal frame and legs in heavy gauge tubular steel in polished chrome finish.

Feet: Chrome-plated feet with polyurethane glides measuring 5.75" high.

Standard Cushions: Seat cushion in polyurethane with polyester fiber wrap. Back cushion in polyurethane. Cushions are not reversible.

Dual Density Cushions: Back cushion is polyurethane. Seat cushion is dual density foam: a soft foam core with a memory topper. Cushions are not reversible.

Upholstery: Double-needled stitching on leather upholstery. Double-needled stitching on thin solid textiles, single-needled stitching on heavily ribbed fabrics and multicolor prints.

Approved KnollTextiles Grades/Fabrics

A Alignment # Beacon Bocce Cat's Cradle Chance Common Ground Commuter Cloth # Crossroad Delite Hourglass Mariner Monarch # Prep # Presto # Sonnet Stacks Trophy Uni-Form	B continued Grandview Helios Holbrook Journey # Keaton Knoll Felt Knoll Hopsack Little Devil Ludlow Lyric Melody Paradigm Petat Pusher Pogo Prairie Prim Radiance Ransom Ricochet # Roam Rush Hour Soiree Spark # Spree Summit Sutton # Synth Tabloid Tinge Venue Versa Vinyl Westwood Wide Angle # Zipline	C Atlas Axiom Biota # Cairo Charm Circa Classic Boucle # Dahlia CR Durand Earthwork # Echo Empire Stripe Entourage Essence Fable CR Fibra Greenwich Hudson Hula Hoop Island Kaleidoscope CR Kora CR Lagos Lore CR Metro Milestone Moto CR Palisade Panache CR Pullman	C continued Quark Roundtrip Sahara Sandpiper Sequin CR Spot On Star Struck Stepping Stones Swing Tight Rope Tilden Tower Grid Wit Zari CR	D Coterie Eclat Weave Hologram Island Kabuki Masquerade Menagerie Origins Tara Theory Woodland Zoom	E Aegean Demure Highland Ikat Stripe Ikat Square Kampala Katazome Mamba Marquee Meroe Nature Walk Shima Tryst Whip	F Atelier Biscayne Calais Cotton Velvet Century Coco Cornaro Icon Intrigue In Stitches Liberty Mod Plaid Rivington Soon Tivoli Topography Totem	G Alter Ego Brugge Djenne Feeling Plaid Hampshire Haze Kinabalu Kingston Melange Modern Tweed Petite Floral Serendipity Spencer Ultrasuede	H Arno # Constance Firefly Gezelle Magritte Rosemond Stretch Appeal	I Byron Cato Diamond Days Digi Velvet Dynamic Knoll Velvet Olema Piper Rutledge Sandis Tudor Vermeer Walker Worth Zimba	U Vicenza # Volo #	V Acqua # Andes # Embossed Tipped España # Hand Tipped Velluto Pelle #	W Alaska # Amazon # Antique # Derby # Forte # Lucente Sabrina #	X Ducale # Ducale Velour #	Y Capri # Cervo Copenhagen # Distressed # Marissa # Riva # Saddle #
---	---	--	--	--	---	---	---	---	---	---------------------------------	---	---	---	---

Spinneybeck Leather



Approved for Cal 133 upholstery.

Check with your KnollTextiles or Spinneybeck Representative for changes or additions.

Ross Lovegrove Sprite Armless Chair

Designer(s):
Ross Lovegrove, 2004



description	face/back	seat h	w	d	h	textile fabric yds.	leather sq ft.	weight
27C Same finish, face and back 	maple/maple	17"	22"	22"	32"	0.5	10	10 lbs.
	paint A/paint A	17"	22"	22"	32"	0.5	10	10 lbs.
	veneer/veneer	17"	22"	22"	32"	0.5	10	10 lbs.
27C Combination face and back 	maple/paint or paint/maple	17"	22"	22"	32"	0.5	10	10 lbs.
	paint A/paint B or paint B/Paint A	17"	22"	22"	32"	0.5	10	10 lbs.
	veneer/paint or paint/veneer	17"	22"	22"	32"	0.5	10	10 lbs.
Sprite Dolly 			14.5"	31"	26.5"			10 lbs.
27CGA Sprite Ganging Mechanism, Armless								
TR Sprite Tablet Arm			9 1/4"	13"				

Order Code

<i>Example:</i>	27CTR-KC-BL-C-K(VP-BLK)
27C	Armless chair
TR	Tablet Arm (\$394 list upcharge)
KC	Rotary Maple face
BL	Black painted back
C	Chrome legs
K	Seat cushion
VP-BLK	Velluto Pelle, Black

Specify:

1. Pattern number
2. Optional tablet arm (\$394 list upcharge)
3. Finish selection, face
4. Finish selection, back
5. Leg finish (chrome only)
6. Seat cushion option
7. Textile selection

Ordering Information:

Maple finish:
☞ Rotary Maple (suffix KC)

Exotic Alpi and Veneer finishes:
Beech (suffix BN)
Cherry (suffix CY)
Walnut (suffix WA)
Zebra (suffix ZE)
Macasser Ebony (suffix ME)
Black and White Woodgrain (suffix WB)

Construction

Paint finishes:
☞ Black (suffix BL)
Grey (suffix SL)
Lime (suffix LI)
Navy (suffix NA)
Red (suffix RD)
☞ White (suffix WV)

Leg finish:
☞ Chrome (suffix C)

☞ *KnollStudio 20-Day Program:*
The Sprite armless chair with a chrome base and white, black or rotary maple shells are available on the 20-day program. For more specific information, please consult pages 30-33.

Maintenance:
See pages 28-29.

Cal 133 Fire Code ▲:
The Sprite chair complies with the Cal 133 standard if upholstered or if upholstered in Cal 133 approved upholstery. Specify suffix -C at end of pattern number and suffix -133 at end of textile selection. Upcharge applies, see page 19.

Note:
The Sprite Chair in Maple, Exotic Alpi and Veneer finishes are Greenguard certified.

Shell:
Molded plywood shell made of six layers of maple and three layers of adhesive.

Alpi Veneers:
Reconstituted veneers made of both plantation poplar and Obeche/Ayous, a bland African wood from well-managed sources with a long term forestry management plan.

Paint:
Smooth highly durable paint.

Edge finish:
On chairs painted one color, edge will be painted. For chairs in two-tone combination or with veneer option, edges are natural maple. For chairs in exotic Alpi veneer finish, edges are natural maple. For high use applications, maple or veneer options are recommended.

Base:
3/8" tubular steel with mirror chrome finish. Shell connected to the seat with four screws. Four rubber bumpers assure proper stacking.

Upholstery:
Seat pad, upholstered in fabric or leather with urethane foam. Water based glue used for upholstery. Seat pad is attached to chair by four screws.

Stacking:
Armless Sprite chairs without seatpad can stack 8-10 high, with seatpad, 4-6.

Transportation Dolly:
Chrome plated steel frame with rubber wheels, 10-12 Sprite armless chairs can stack on a dolly. Dolly with 10 armless chairs measures: 53" h x 40" w x 22" d

Ganging Mechanism:
Armless mechanism measures 7.4". Device is constructed of a low durometer thermoplastic elastomer with a neodymium magnet. When not in use, the mechanism is easily stored (magnetized) to the underside of the chair.

Tablet Arm:
Tablet is right-handed with a fixed, chrome-plated arm. Integral to the frame, the tablet is black laminate with a 1/2" beveled birch edge. Tablet is factory installed and cannot be retrofitted in the field. For left handed version, please contact CPD. Sprite tablet arm passes BIFMA standards. Sprite chairs with tablet arm stack 4 high.

pattern no.	unuphol. (remove suffix -k)	grades A	COM B	C	D	E	F	G	H	I	COL U	V	W	X	Y
27C-(KC)-(KC) -C-K ☞	\$618.	\$773.	\$790.	\$804.	\$822.	\$835.	\$848.	\$863.	\$897.	\$920.	\$1,024.	\$1,088.	\$1,218.	\$1,247.	\$1,279.
27C-(-)(-)-C-K ☞	742.	899.	914.	931.	946.	961.	971.	988.	1,022.	1,045.	1,148.	1,212.	1,344.	1,373.	1,405.
27C-(-)(-)-C-K	1,038.	1,193.	1,209.	1,224.	1,241.	1,252.	1,267.	1,281.	1,315.	1,338.	1,443.	1,506.	1,639.	1,668.	1,700.
27C-(-)(-)-C-K	773.	930.	945.	961.	977.	991.	1,002.	1,019.	1,053.	1,075.	1,179.	1,243.	1,375.	1,404.	1,736.
27C-(-)(-)-C-K	829.	986.	1,002.	1,018.	1,034.	1,049.	1,059.	1,076.	1,107.	1,132.	1,238.	1,301.	1,433.	1,460.	1,492.
27C-(-)(-)-C-K	1,086.	1,241.	1,255.	1,273.	1,288.	1,303.	1,313.	1,332.	1,364.	1,387.	1,490.	1,555.	1,686.	1,714.	1,746.
27DOLLY	681.														
27CGA	27.														
TR	480.														

Approved KnollTextiles Grades/Fabrics



A Alignment ▲ Bocce Cat's Cradle Common Ground Commuter Cloth ▲ CROSSROAD Delite Dristi Foil Rap Heavy Metal Hourglass Mariner Monarch ▲ Prep ▲ Presto ▲ Sonnet Stacks Uni-Form	B Abacus ▲ Argyle Backdrop Belize Bistro Boundary ▲ Cameo Chronicle Close Knit Digital Tape Diva Dovetail ▲ Ferry Forza Grande Grandview Helios Holbrook	C continued Journey Keaton Knoll Felt ▲ Knoll Hopsack ▲ Little Devil Ludlow Lyric Melody Mini Stitch ▲ Night Life Paradigm Petal Pusher Pogo Prairie Prim Radiance Ransom Ricochet ▲ Roam Rush Hour Soiree Spark ▲ Spree Summit Sutton ▲ Tabloid Tinge Versa Vinyl Westwood Wide Angle ▲ Yeni Zipline	C continued Cairo Charm Circa Classic Boucle Dahlia CR Decade Durand Earthwork ▲ Echo Empire Stripe Essence Fable CR Fibra Greenwich Hudson Hula Hoop Kaleidoscope CR Lagos Legend CR Lore CR Metro Milestone Moto CR Palisade Posh Pullman Quark Regard CR Roundtrip Sandpiper Sinclair Smart Spectator Spot On Star Struck Stepping Stones Tight Rope Tilden Tower Grid	C continued Treble CR Wit Zari CR D Compass CR Coterie Eclat Weave Hologram In The Loop Island Masquerade Menagerie Origins Tara Theory Woodland Zoom E Aegean Demure Highland Ikat Square Ikat Stripe Kampala Katazome Kimono Mamba Marquee Meroe Midpoint Nature Walk Sherman Shima Vatera Whip	F Atelier Biscayne Calais Cotton Velvet Century Coco Glider Icon Intrigue In Stitches Liberty Mod Plaid Rivington Soon Tivoli Topography Totem Tweed Frieze G Abington Alter Ego Amore Andissa Arabella Djenne Feeling Plaid Gibson Hampshire Haze Kamani Kinabalu Melange Modern Tweed Sablon Serendipity Spencer Straie Stripe Ultrasuede ▲	H Arno Bavaria Catwalk Constance Firefly Gezelle Magritte Rosemond Stretch Appeal I Aswan Byron Canaan Cato Diamond Days Digi Velvet Dynamic Ita Jaipur Knoll Velvet Limani North Island Olema Piper Rutledge Sandis Vermeer Walker Worth Zimba	U Vicenza ▲ Volo ▲ V Acqua Andes Embossed Tipped España Hand Tipped Maremma Velluto Pelle W Alaska Amazon Antique Derby Forte Lucente Sabrina X Ducale Ducale Velour ▲ Approved for Cal 133 upholstery. <i>Check with your KnollTextiles or Spinneybeck Representative for changes or additions.</i>	Y Capri Cervo Copenhagen Distressed Marissa Portofino Riva Saddle Torello
--	---	--	--	--	--	---	---	---

Spinneybeck Leather

Ross Lovegrove Sprite Arm Chair

Designer(s):
Ross Lovegrove, 2004



description	face/back/arm	arm h	seat h	w	d	h	textile fabric yds.	leather sq ft.	weight
27A Same finish, face and back 	maple/maple/urethane arms	25 1/2"	17"	29"	22"	32"	0.5	10	13 lbs.
	paint A/paint A/urethane arms	25 1/2"	17"	29"	22"	32"	0.5	10	13 lbs.
	veneer/veneer/urethane arms	25 1/2"	17"	29"	22"	32"	0.5	10	13 lbs.
27A Combination, face and back 	maple/paint or paint/maple urethane arms	25 1/2"	17"	29"	22"	32"	0.5	10	13 lbs.
	paint A/paint B or paint B/paint A urethane arms	25 1/2"	17"	29"	22"	32"	0.5	10	13 lbs.
	veneer/paint or paint/veneer urethane arms	25 1/2"	17"	29"	22"	32"	0.5	10	13 lbs.
Sprite Dolly 				14.5"	31"	26.5"			10 lbs.
27AGA Sprite Ganging Mechanism, Arm									

Order Code

Example: **27C-KC-BL-C-BP-K(VP-BLK)**

27C	Armless chair
KC	Rotary Maple face
BL	Black painted back
C	Chrome legs
BP	Urethane arms
K	Seat cushion
VP-BLK	Velluto Pelle, Black

Specify:

1. Pattern number
2. Finish selection, face
3. Finish selection, back
4. Leg finish (chrome only)
5. Arm finish
6. Seat cushion option
7. Textile selection

Ordering Information:

Maple finish:
Rotary Maple (suffix KC)

Exotic Alpi and Veneer finishes:

Beech (suffix BN)
Cherry (suffix CY)
Walnut (suffix WA)
Zebra (suffix ZE)
Macasser Ebony (suffix ME)
Black and White Woodgrain (suffix WB)

Construction

Shell:
Molded plywood shell made of six layers of maple and three layers of adhesive.

Paint:
Smooth highly durable paint.

Edge finish:
On chairs painted one color, edge will be painted. For chairs in two-tone combination or with veneer option, edge will be natural maple. For chairs in Exotic Alpi veneer finish, edges are natural maple. For high use applications, maple or veneer options are recommended.

Base:
3/8" tubular steel with mirror chrome finish. Shell connected to the seat with four screws. Four rubber bumpers assure proper stacking.

Note:

The Sprite Chair in Maple, Exotic Alpi and Veneer finishes are Greenguard certified.

Upholstery:
Seat pad, upholstered in fabric or leather with urethane foam. Water based glue used for upholstery. Seat pad is attached to chair by four screws.

Armpads:
Black self skinning polyurethane pads (available on painted or maple/veneer chairs).

Stacking:
Arm Sprite chairs with or without seatpad can stack 4-6 high.

Transportation Dolly:
Chrome-plated steel frame with rubber wheels. 4-6 Sprite arm chairs stack on a dolly. Dolly with 10 armless chairs measures: 53" h x 40" w x 29" d

Ganging Mechanism
Arm mechanism measures 10". Device is constructed of a low durometer thermoplastic elastomer with a neodymium magnet. When not in use, the mechanism is easily stored (magnetized) to the underside of the chair.

pattern no.	unuphol. (remove suffix -k)	grades A	COM B	C	D	E	F	G	H	I	COL U	V	W	X	Y
27A-(KC)-(KC)-C-(BP)-K	\$842.	\$1,000.	\$1,018.	\$1,032.	\$1,053.	\$1,067.	\$1,076.	\$1,097.	\$1,130.	\$1,156.	\$1,262.	\$1,331.	\$1,466.	\$1,496.	\$1,527.
27A-()-()-C-(BP)-K	908.	1,069.	1,087.	1,101.	1,122.	1,135.	1,144.	1,165.	1,198.	1,223.	1,332.	1,398.	1,533.	1,564.	1,585.
27A-()-()-C-(BP)-K	1,208.	1,369.	1,386.	1,401.	1,419.	1,436.	1,444.	1,465.	1,497.	1,522.	1,630.	1,698.	1,833.	1,864.	1,896.
27A-(KC)-()-C-(BP)-K	942.	1,103.	1,122.	1,135.	1,157.	1,169.	1,179.	1,199.	1,234.	1,255.	1,365.	1,433.	1,568.	1,600.	1,632.
27A-()-()-C-(BP)-K	996.	1,159.	1,174.	1,190.	1,209.	1,224.	1,234.	1,251.	1,284.	1,310.	1,418.	1,486.	1,622.	1,651.	1,684.
27A-()-()-C-(BP)-K	1,260.	1,420.	1,438.	1,452.	1,472.	1,487.	1,496.	1,517.	1,551.	1,573.	1,681.	1,749.	1,885.	1,916.	1,948.
27DOLLY	681.														
27AGA	27.														

Approved KnollTextiles Grades/Fabrics

A Alignment # Bocce Cat's Cradle Common Ground Commuter Cloth # Crossroad Delite Dristi Foil Rap Heavy Metal Hourglass Mariner Monarch # Prep # Presto # Sonnnet Stacks Uni-Form	B Abacus # Argyle Backdrop Belize Bistro Boundary # Cameo Chronicle Close Knit Digital Tape Diva Dovetail # Fast Forward Ferry Forza Grande Grandview Holbrook Journey	C continued Keaton Knoll Felt # Knoll Hopsack # Lyric Little Devil Melody Mini Stitch # Night Life Paradigm Petal Pusher Pogo Prairie Prim Radiance Ransom Ricochet # Roam Rush Hour Soiree Spark # Spree Summit Sutton # Tabloid Tinge Versa Vinyl Westwood Wide Angle # Yeni Zipline	C continued Cairo Charm Circa Classic Boucle Dahlia CR Decade Durand Earthwork # Echo Empire Stripe Essence Fable CR Fibra Greenwich Hudson Hula Hoop Kaleidoscope CR Lagos Legend CR Lore CR Metro Milestone Moto CR Palisade Posh Pullman Quark Regard CR Roundtrip Sandpiper Sinclair Smart Spectator Spot On Star Struck Stepping Stones Tight Rope Tilden Tower Grid	D continued Treble CR Wit Zari CR D Compass CR Coterie Eclat Weave Hologram In The Loop Island Masquerade Menagerie Origins Tara Theory Woodland Zoom	E Aegean Demure Highland Ikat Square Ikat Stripe Kampala Katazome Kimono Mamba Marquee Meroc Midpoint Nature Walk Sherman Shima Vatera Whip	F Atelier Biscayne Calais Cotton Velvet Century Coco Glider Icon Intrigue In Stitches Liberty Mod Plaid Rivington Soon Tivoli Topography Totem Tweed Frieze	G Abington Alter Ego Amore Andissa Arabella Djenne Feeling Plaid Gibson Hampshire Haze Kamani Kinabalu Melange Modern Tweed Sablou Serendipity Spencer Straie Stripe Ultrasuede #	H Arno Bavaria Catwalk Constance Firefly Gezelle Magritte Rosemond Stretch Appeal I Aswan Byron Canaan Cato Diamond Days Digi Velvet Dynamic Gramercy Ita Jaipur Knoll Velvet Limani North Island Olema Piper Rutledge Sandis Vermeer Walker Worth Zimba	I Vicenza # Volo # V Acqua Andes Embossed Tipped España Hand Tipped Maremma Velluto Pelle W Alaska Amazon Antique Derby Forte Lucente	W continued Sabrina X Ducale Ducale Velour Y Capri Cervo Copenhagen Distressed Lucca Marissa Portofino Riva Saddle Torello
---	--	---	--	---	---	--	---	---	---	---

Spinneybeck Leather

I Vicenza # Volo #	W continued Sabrina
V Acqua Andes Embossed Tipped España Hand Tipped Maremma Velluto Pelle	X Ducale Ducale Velour
W Alaska Amazon Antique Derby Forte Lucente	Y Capri Cervo Copenhagen Distressed Lucca Marissa Portofino Riva Saddle Torello





Approved for Cal 133 upholstery.

Check with your KnollTextiles or Spinneybeck Representative for changes or additions.

Vico Magistretti Cirene Stacking Chair

Designer(s):
Vico Magistretti, 1999

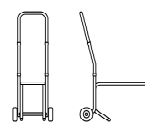

description	seat h	arm h	w	d	h	weight
46A Arm chair, unupholstered 	18"	24 7/8"	22 7/8"	20 1/2"	29 1/2"	14 lbs.
	18"	24 7/8"	22 7/8"	20 1/2"	29 1/2"	14 lbs.
46A-U Arm chair, upholstered 	18"	24 7/8"	22 7/8"	20 1/2"	29 1/2"	15 lbs.
46C Armless chair, unupholstered 	18"		21"	21 1/4"	29 1/2"	11 lbs.
	18"		21"	21 1/4"	29 1/2"	11 lbs.
46C-U Armless chair, upholstered 	18"		21"	21 1/4"	29 1/2"	13 lbs.
59Dolly Dolly for 8 Cirene chairs, unupholstered 			15 7/8"	27 1/2"	43 1/8"	7 lbs.
L Arm / Armless chair with ganging mechanism, installed, stored under seat						

pattern no.	unuphol.	fabric	leather
46A(CG,W)	\$1,296.		
46A-(KC,WE)	1,363.		
46A-U ()		1,755.	2,448.
46C-(CG,W)	1,075.		
46C-(KC,WE)	1,138.		
46C-U ()		1,632.	2,334.
59Dolly	1,271.		
L	136.		

Order Code	Ordering Information
<i>Example:</i> 46C-W-L	<i>Melamine Shell Finishes:</i>
46C Cirene armless stacking chair	White (suffix W)
W White shell	<i>Paint Shell Finishes:</i>
L With ganging mechanism	Charcoal (suffix CG)
<i>Example:</i> 46A-U-MA	<i>Veneer Shell Finishes:</i>
46A-U Cirene arm chair, upholstered	Maple (suffix KC)
MA Brown Leather	Wengè-stained oak (suffix WE)

Specify:

1. Pattern number
2. Shell color
3. Ganging option (suffix L)

For leather option, specify:



1. Pattern number
2. Textile selection

Construction	Approved Textiles
<i>Description:</i> Molded plywood shell in natural veneer finish (maple, wengè); smooth paint finish (charcoal); melamine finish with plywood edge (white). Frame is chrome-plated tubular steel. Arm chair features black polypropylene molded armpads. Armpads are not removable and cannot be retrofitted.	<i>Trevira textile colors:</i> Plain weave cross-dye fabrics: Blue (F941741) Orange (F941511) Red (F941521)
<i>Fabric & Leather cover:</i> Cirene can be ordered with full cover. Plywood-shell is covered with pad and fabric/leather is attached with velcro on the underside of the chair. Cover is not removable.	<i>Leather colors:</i> Tabacco (TA) Black (NE) <i>For samples of leathers and fabrics, please contact your KnollStudio sales representative.</i>

Marco Maran Gigi® Arm Chair

Designer(s):
Marco Maran, 2000



description	seat h	arm h	w	d	h	textile	
						fabric yds.	weight
87A Arm chair, stacking 	18"	26½"	19¾"	20"	34¼"		14 lbs.
87A-K-N Arm chair with seat pad, non-stacking 	18"	26½"	19¾"	20"	34¼"	0.7	15 lbs.

pattern no.	unuphol.	A	B	C	D	E	F	G	H	I
87A-() 	\$705.									
87A-K-N-()-()		983.	998.	1,016.	1,031.	1,048.	1,057.	1,075.	1,107.	1,133.

Order Code





<i>Example:</i> 87A-014	
87A	Gigi arm stacking chair
014	Black shell

Specify:

1. Pattern number
2. Shell finish
3. Textile selection

Ordering Information

Shell finishes:

-  Black (suffix 014)
-  Graphite (suffix 003)
- Mango (suffix 006)
-  Navy (suffix 012)
-  Red (suffix 007)
- Seafoam (suffix 010)
-  White (suffix 001)

 **KnollStudio 20-Day Program:**
Gigi arm chair is available on the 20-day program, unupholstered, in white, graphite, black, red and navy shell finishes. For specific ordering information consult pages 27-28.

Upholstery/Com information:
Prices shown include fabric or leather upholstery. Contact your Knoll representative for colors. Only approved KnollTextiles and Spinneybeck leathers may be ordered.

Customer's Own Material is available pending approval. For approval requirements, processing instructions and ordering information, please see page 18.

Maintenance:

See pages 28-29.

Stacking feature:

- Gigi armless unupholstered chairs stack 4 high on floor.
- Gigi armless chairs with seat pad and bumper stack 4 high on floor.
- Gigi armless chairs with seat pad and stacking bumper stack 8-10 high on a dolly.
- Gigi arm chair with seat pad and stacking bumper stack 4 high on floor and dolly.
- Gigi arm chair stacks 4 high on floor and dolly.
- Gigi chairs with seatpad without bumper (87CK-N, 87AK-N) do not stack.

Note:

The Gigi Chair is Greenguard certified.

Construction

Description:

Coloured polypropylene shell on a chrome-plated base. Arm chairs have black polypropylene molded arm pads. Chair back flexes for comfort. Gigi chairs are easily cleaned in food areas and work with a booster seat.

Seat Pad:

Seat pad is permanently attached to the seat with bolts in the factory. Seat pad is not retrofittable in the field. Constructed of ABS with high resilient foam.

Stacking bumper:

Black flexible urethane stacking pad secured between base and shell.

Transportation Dolly:

Chrome plated steel frame with rubber wheels. 10 Gigi armless chairs can be stacked on the dolly. Dollies can stack three high for compact storage. Dolly with 10 chairs will measure 56.3" h, 19.75" w, 41" d. Dolly does not lock.

Approved KnollTextiles Grades/Fabrics

Tablet Arm:

The tablet attaches to the chair frame underneath the seat. It is aligned with the front leg and has a flip up mechanism. Tablet is black melamine. Steel support with chrome finish. Tablet arm can be used with armless chair only. Gigi with tablet can be stacked 4 high on the floor and on the dolly.

Note:

Tablet arm option is not offered with stacking bumper.

Ganging Mechanism:

The easy-to-detach ganging mechanism links two adjoining frames at the front legs or rear legs. Ganging mechanism consists of black molded polypropylene. Chairs with ganging mechanism can be stacked. Tablet arm ships separate from the chair and can be retrofitted in the field. Arm chairs can not be ganged with armless chairs.

A Alignment Bocce Cat's Cradle Chance Common Ground Commuter Cloth Crossroad Delite Dristi Foil Rap Heavy Metal Hourglass Mariner Monarch Prep Presto Soliloquy Sonnet Stacks Uni-Form	B Abacus Argyle Belize Bistro Cameo Chroma Chronicle Close Knit Diva Dovetail Fast Forward Ferry Gala II Grande Grandview Baxter Holbrook	B continued Journey Keaton Knoll Felt Knoll Hopsack Little Devil Ludlow Lyric Melody Mini Stitch Night Life Paradigm Petal Pusher Pogo Prairie Prim Radiance Ransom Ricochet Roam Rush Hour Soiree Spark Spree Summit Sutton Tabloid Tinge Venue Versa Westwood Wide Angle Yeni Zipline	C continued Dahlia CR Decade Dune Durand Earthwork Echo Enmesh Entourage Essence Fable CR Fibra Greenwich Hudson Hula Hoop Kaleidoscope CR Kaya CR Kora CR Lagos Legend CR Lore CR Metro Milestone Moto CR Noble Palisade Panache CR Pullman Quark REGARD CR Roundtrip Sandpiper Sequin CR Smart Spectator Spot On Star Struck Stepping Stones Swing Tight Rope Tilden Tower Grid	C continued Dahlia CR Decade Dune Durand Earthwork Echo Enmesh Entourage Essence Fable CR Fibra Greenwich Hudson Hula Hoop Kaleidoscope CR Kaya CR Kora CR Lagos Legend CR Lore CR Metro Milestone Moto CR Noble Palisade Panache CR Pullman Quark REGARD CR Roundtrip Sandpiper Sequin CR Smart Spectator Spot On Star Struck Stepping Stones Swing Tight Rope Tilden Tower Grid	C continued Treble CR Vibe Wit Zari CR D Compass CR Coterie Eclat Weave Hologram Island In The Loop Masquerade Menagerie Origins Tara Theory Woodland Zoom	E Aegean Demure Highland Ikat Square Ikat Stripe Kampala Katazome Kimono Mamba Marquee Meroc Midpoint Nature Walk Sherman Tryst Vatera Whip	F Atelier Biscayne Calais Cotton Velvet Century Coco Cornaro Glider Icon Intrigue In Stitches Mod Plaid Liberty Rivington Soon Tivoli Topography Totem Tweed Frieze	G Abington Alter Ego Amore Andissa Arabella Djenne Feeling Plaid Gibson Hampshire Haze Kamani Kinabalu Melange Modern Tweed Sablon Serendipity Striae Stripe Ultrasuede	H Arno Bavaria Catwalk Constance Firefly Gezelle Magritte Rosemond Stretch Appeal I Aswan Byron Canaan Cato Cummings Diamond Days Digi Velvet Dynamic Fiori Gramercy Ita Jaipur Mepal Olema Piper Rutledge Sandis Vermeer Walker Worth Zimba
---	---	---	---	---	--	---	---	--	---

Check with your KnollTextiles representative for changes or additions.

Marco Maran Gigi® Arm Chair

Designer(s):
Marco Maran, 2000



description	seat h	arm h	w	d	h	textile fabric yds.	weight
87A-K-S Arm chair with seat pad, stacking	18"	26½"	19¾"	20"	34¼"	0.7	16 lbs.
87Dolly Dolly for 10 Gigi chairs			19.2"	31"	26½"		11 lbs.
87Tablet Folding tablet arm, right for armless chair				9¼"	12"		
87GA Gigi ganging mechanism							



Order Code

<i>Example:</i> 87A-014	
87A	Gigi arm stacking chair
014	Black shell

Specify:

1. Pattern number
2. Shell finish
3. Textile selection

Ordering Information

Shell finishes:

- ☑ Black (suffix 014)
- ☑ Graphite (suffix 003)
- Mango (suffix 006)
- ☑ Navy (suffix 012)
- ☑ Red (suffix 007)
- Seafoam (suffix 010)
- ☑ White (suffix 001)

☑ **KnollStudio 20-Day Program:**
Gigi arm chair is available on the 20-day program, unupholstered, in white, graphite, black, red and navy shell finishes. For specific ordering information consult pages 27-28.

Upholstery/Com information:
Prices shown include fabric or leather upholstery. Contact your Knoll representative for colors. Only approved KnollTextiles and Spinneybeck leathers may be ordered.

Customer's Own Material is available pending approval. For approval requirements, processing instructions and ordering information, please see page 18.

Maintenance:

See pages 28-29.

Stacking feature:

- Gigi armless unupholstered chairs stack 4 high on floor.
- Gigi armless chairs with seat pad and bumper stack 4 high on floor.
- Gigi armless chairs with seat pad and stacking bumper stack 8-10 high on a dolly.
- Gigi arm chair with seat pad and stacking bumper stack 4 high on floor and dolly.
- Gigi arm chair stacks 4 high on floor and dolly.
- Gigi chairs with seatpad without bumper (87CK-N, 87AK-N) do not stack.

Note:

The Gigi Chair is Greenguard certified.

Construction

Description:

Coloured polypropylene shell on a chrome-plated base. Arm chairs have black polypropylene molded arm pads. Chair back flexes for comfort. Gigi chairs are easily cleaned in food areas and work with a booster seat.

Seat Pad:

Seat pad is permanently attached to the seat with bolts in the factory. Seat pad is not retrofittable in the field. Constructed of ABS with high resilient foam.

Stacking bumper:

Black flexible urethane stacking pad secured between base and shell.

Transportation Dolly:

Chrome plated steel frame with rubber wheels. 10 Gigi armless chairs can be stacked on the dolly. Dollies can stack three high for compact storage. Dolly with 10 chairs will measure 56.3" h, 19.75" w, 41" d. Dolly does not lock.

pattern no.	unuphol.	A	COM B	C	D	E	F	G	H	I
87A-K-S(-)(-)		\$1,082.	\$1,099.	\$1,115.	\$1,133.	\$1,147.	\$1,159.	\$1,176.	\$1,211.	\$1,237.
87Dolly	744.									
87TABLET	305.									
87GA	37.									

Approved KnollTextiles Grades/Fabrics

Tablet Arm:

The tablet attaches to the chair frame underneath the seat. It is aligned with the front leg and has a flip up mechanism. Tablet is black melamine. Steel support with chrome finish. Tablet arm can be used with armless chair only. Gigi with tablet can be stacked 4 high on the floor and on the dolly.

Note:

Tablet arm option is not offered with stacking bumper.

Ganging Mechanism:

The easy-to-detach ganging mechanism links two adjoining frames at the front legs or rear legs. Ganging mechanism consists of black molded polypropylene. Chairs with ganging mechanism can be stacked. Tablet arm ships separate from the chair and can be retrofitted in the field. Arm chairs can not be ganged with armless chairs.



A Alignment Bocce Cat's Cradle Chance Common Ground Commuter Cloth Crossroad Delite Dristi Foil Rap Heavy Metal Hourglass Mariner Monarch Prep Presto Soliloquy Sonnet Stacks Uni-Form	B continued Journey Keaton Knoll Felt Knoll Hopsack Little Devil Ludlow Lyric Melody Mini Stitch Night Life Paradigm Petal Pusher Pogo Prairie Prim Radiance Ransom Ricochet Roam Rush Hour Soiree Spark Spree Summit Sutton Tabloid Tinge Venue Versa Westwood Wide Angle Yeni Zipline	C continued Dahlia CR Decade Dune Durand Earthwork Echo Enmesh Entourage Essence Fable CR Fibra Greenwich Hudson Hula Hoop Kaleidoscope CR Kaya CR Kora CR Lagos Legend CR Lore CR Metro Milestone Moto CR Noble Palisade Panache CR Pullman Quark Regard CR Roundtrip Sandpiper Sequin CR Smart Spectator Spot On Star Struck Stepping Stones Swing Tight Rope Tilden Tower Grid	C continued Treble CR Vibe Wit Zari CR D Compass CR Coterie Eclat Weave Hologram Island In The Loop Masquerade Menagerie Origins Tara Theory Woodland Zoom	E Aegean Demure Highland Ikat Square Ikat Stripe Kampala Katazome Kimono Mamba Marquee Meroc Midpoint Nature Walk Sherman Tryst Vatera Whip	F Atelier Biscayne Calais Cotton Velvet Century Coco Cornaro Glider Icon Intrigue In Stitches Mod Plaid Liberty Rivington Soon Tivoli Topography Totem Tweed Frieze	G Abington Alter Ego Amore Andissa Arabella Djenne Feeling Plaid Gibson Hampshire Haze Kamani Kinabalu Melange Modern Tweed Sablon Serendipity Straie Stripe Ultrasuede	H Arno Bavaria Catwalk Constance Firefly Gezelle Magritte Rosemond Stretch Appeal I Aswan Byron Canaan Cato Cummings Diamond Days Digi Velvet Dynamic Fiori Gramercy Ita Jaipur Mepal Olema Piper Rutledge Sandis Vermeer Walker Worth Zimba
---	---	---	--	---	---	--	---

Check with your KnollTextiles representative for changes or additions.

Marco Maran Gigi® Armless Chair

Designer(s):
Marco Maran, 2000



description	seat h	w	d	h	textile fabric	
					yds.	weight
87C Armless chair, stacking 	18"	19 3/4"	20"	34 1/4"		11 lbs.
87C-K-N Armless chair with seat pad, non-stacking 	18"	19 3/4"	20"	34 1/4"	0.7	12 lbs.

pattern no.	unuphol.	A	COM B	C	D	E	F	G	H	I
87C-() 	\$447.									
87C-K-N-()-()		727.	743.	759.	777.	792.	803.	822.	855.	882.







Order Code

<i>Example:</i>	87C-K-S-010-K1207/1
87C-K-S	Gigi armless stacking chair with seat pad
010	Seafoam shell
K1207/1	Knoll Felt, Ivory

Specify:

1. Pattern number
2. Shell finish
3. Textile finish

Ordering Information

Shell finishes:
 Black (suffix 014)
 Graphite (suffix 003)
 Mango (suffix 006)
 Navy (suffix 012)
 Red (suffix 007)
 Seafoam (suffix 010)
 White (suffix 001)
 **KnollStudio 20-Day Program:**
 Gigi armless chair is available on the 20-day program, unupholstered, in white, graphite, black, red and navy shell finishes. For specific ordering information consult pages 27-28.

Upholstery/Com information:
 Prices shown include fabric or leather upholstery. Contact your Knoll representative for colors. Only approved KnollTextiles and Spinneybeck leathers may be ordered.

Customer's Own Material is available pending approval. For approval requirements, processing instructions and ordering information, please see page 18.

Maintenance:
 See pages 28-29.
Stacking feature:
 Gigi armless unupholstered chairs stack 4 high on floor.
 Gigi armless chairs with seat pad and bumper stack 4 high on floor.
 Gigi armless chairs with seat pad and stacking bumper stack 8-10 high on a dolly.
 Gigi arm chair with seat pad and stacking bumper stack 4 high on floor and dolly.
 Gigi arm chair stacks 4 high on floor and dolly.
 Gigi chairs with seatpad without bumper (87CK-N, 87AK-N) do not stack.

Note:
 The Gigi Chair is Greenguard certified.

Construction

Description:
 Coloured polypropylene shell on a chrome-plated base. Arm chairs have black polypropylene molded arm pads. Chair back flexes for comfort. Gigi chairs are easily cleaned in food areas and work with a booster seat.
Seat Pad:
 Seat pad is permanently attached to the seat with bolts in the factory. Seat pad is not retrofittable in the field. Constructed of ABS with high resilient foam.

Stacking bumper:
 Black flexible urethane stacking pad secured between base and shell.

Transportation Dolly:
 Chrome plated steel frame with rubber wheels. 10 Gigi chairs can be stacked on the dolly. Dollies can stack three high for compact storage. Dolly with 10 chairs will measure 56.3" h, 19.75" w, 41" d. Dolly does not lock.

Approved KnollTextiles Grades/Fabrics

Tablet Arm:
 The tablet attaches to the chair frame underneath the seat. It is aligned with the front leg and has a flip up mechanism. Tablet is black melamine. Steel support with chrome finish. Tablet arm can be used with armless chair only. Gigi with tablet can be stacked 4 high on the floor and on the dolly.
Note:
 Tablet arm option is not offered with stacking bumper.
Ganging Mechanism:
 The easy-to-detach ganging mechanism links two adjoining frames at the front legs or rear legs. Ganging mechanism consists of black molded polypropylene. Chairs with ganging mechanism can be stacked. Tablet arm ships separate from the chair and can be retrofitted in the field. Arm chairs can not be ganged with armless chairs.



A Alignment Bocce Cat's Cradle Chance Common Ground Commuter Cloth Crossroad Delite Dristi Foil Rap Heavy Metal Hourglass Mariner Monarch Prep Presto Soliloquy Sonnet Stacks Uni-Form	B continued Journey Keaton Knoll Felt Knoll Hopsack Little Devil Ludlow Lyric Melody Mini Stitch Night Life Paradigm Petal Pusher Pogo Prairie Prim Radiance Ransom Ricochet Roam Rush Hour Soiree Spark Spree Summit Sutton Tabloid Tinge Venue Versa Westwood Wide Angle Yeni Zipline	C continued Dahlia CR Decade Dune Durand Earthwork Echo Enmesh Entourage Essence Fable CR Fibra Greenwich Hudson Hula Hoop Kaleidoscope CR Kora CR Lagos Legend CR Lore CR Metro Milestone Moto CR Noble Palisade Panache CR Pullman Quark Regard CR Roundtrip Sandpiper Sequin CR Smart Spectator Spot On Star Struck Stepping Stones Swing Tight Rope Tilden Tower Grid	C continued Treble CR Vibe Wit Zari CR D Compass CR Coterie Eclat Weave Hologram Island In The Loop Masquerade Menagerie Origins Tara Theory Woodland Zoom E Aegean Demure Highland Ikat Square Ikat Stripe Kampala Katazome Kimono Mamba Marquee Meroe Midpoint Nature Walk Sherman Tryst Vatera Whip	F Atelier Biscayne Calais Cotton Velvet Century Coco Cornaro Glider Icon Intrigue In Stitches Mod Plaid Liberty Rivington Soon Tivoli Topography Totem Tweed Frieze G Abington Alter Ego Amore Andissa Arabella Djenne Feeling Plaid Gibson Hampshire Haze Kamani Kinabalu Melange Modern Tweed Sablon Serendipity Straie Stripe Ultrasuede	H Arno Bavaria Catwalk Constance Firefly Gezelle Magritte Rosemond Stretch Appeal I Aswan Byron Canaan Cato Cummings Diamond Days Digi Velvet Dynamic Fiori Gramercy Ita Jaipur Mepal Olema Piper Rutledge Sandis Vermeer Walker Worth Zimba
---	---	--	---	---	---

Check with your KnollTextiles representative for changes or additions.

Marco Maran Gigi® Armless Chair

Designer(s):
Marco Maran, 2000



description	seat h	w	d	h	textile fabric yds.	weight
87C-K-S Armless chair with seat pad, stacking 	18"	19 3/4"	20"	34 1/4"	0.7	13 lbs.
87Dolly Dolly for 10 Gigi chairs 		19.2"	31"	26 1/2"		11 lbs.
87Tablet Folding tablet arm, right for armless chair			9 1/4"	12"		
87GA Gigi ganging mechanism						

pattern no.	unuphol.	A	COM B	C	D	E	F	G	H	I
87C-K-S(-)(-)		\$826.	\$845.	\$860.	\$879.	\$893.	\$904.	\$922.	\$957.	\$983.
87Dolly	744.									
87TABLET	305.									
87GA	37.									

Order Code







<i>Example:</i>	87C-K-S-010-K1207/1
87C-K-S	Gigi armless stacking chair with seat pad
010	Seafoam shell
K1207/1	Knoll Felt, Ivory

Specify:

1. Pattern number
2. Shell finish
3. Textile finish

Ordering Information

Shell finishes:

-  Black (suffix 014)
-  Graphite (suffix 003)
-  Mango (suffix 006)
-  Navy (suffix 012)
-  Red (suffix 007)
-  Seafoam (suffix 010)
-  White (suffix 001)

 **KnollStudio 20-Day Program:** Gigi armless chair is available on the 20-day program, unupholstered, in white, graphite, black, red and navy shell finishes. For specific ordering information consult pages 27-28.

Upholstery/Com information: Prices shown include fabric or leather upholstery. Contact your Knoll representative for colors. Only approved KnollTextiles and Spinneybeck leathers may be ordered.

Customer's Own Material is available pending approval. For approval requirements, processing instructions and ordering information, please see page 18.

Maintenance:

See pages 28-29.

Stacking feature:

- Gigi armless unupholstered chairs stack 4 high on floor.
- Gigi armless chairs with seat pad and bumper stack 4 high on floor.
- Gigi armless chairs with seat pad and stacking bumper stack 8-10 high on a dolly.
- Gigi arm chair with seat pad and stacking bumper stack 4 high on floor and dolly.
- Gigi arm chair stacks 4 high on floor and dolly.
- Gigi chairs with seatpad without bumper (87CK-N, 87AK-N) do not stack.

Note:

The Gigi Chair is Greenguard certified.

Construction

Description:

Coloured polypropylene shell on a chrome-plated base. Arm chairs have black polypropylene molded arm pads. Chair back flexes for comfort. Gigi chairs are easily cleaned in food areas and work with a booster seat.

Seat Pad:

Seat pad is permanently attached to the seat with bolts in the factory. Seat pad is not retrofittable in the field. Constructed of ABS with high resilient foam.

Stacking bumper:

Black flexible urethane stacking pad secured between base and shell.

Transportation Dolly:

Chrome plated steel frame with rubber wheels. 10 Gigi chairs can be stacked on the dolly. Dollies can stack three high for compact storage. Dolly with 10 chairs will measure 56.3" h, 19.75" w, 41" d. Dolly does not lock.

Approved KnollTextiles Grades/Fabrics

Tablet Arm:

The tablet attaches to the chair frame underneath the seat. It is aligned with the front leg and has a flip up mechanism. Tablet is black melamine. Steel support with chrome finish. Tablet arm can be used with armless chair only. Gigi with tablet can be stacked 4 high on the floor and on the dolly.

Note:

Tablet arm option is not offered with stacking bumper.

Ganging Mechanism:

The easy-to-detach ganging mechanism links two adjoining frames at the front legs or rear legs. Ganging mechanism consists of black molded polypropylene. Chairs with ganging mechanism can be stacked. Tablet arm ships separate from the chair and can be retrofitted in the field. Arm chairs can not be ganged with armless chairs.

A Alignment Bocce Cat's Cradle Chance Common Ground Commuter Cloth Crossroad Delite Dristi Foil Rap Heavy Metal Hourglass Mariner Monarch Prep Presto Soliloquy Sonnet Stacks Uni-Form	B continued Journey Keaton Knoll Felt Knoll Hopsack Little Devil Ludlow Lyric Melody Mini Stitch Night Life Paradigm Petal Pusher Pogo Prairie Prim Radiance Ransom Ricochet Roam Rush Hour Soiree Spark Spree Summit Sutton Tabloid Tinge Venue Versa Westwood Wide Angle Yeni Zipline	C continued Dahlia CR Decade Dune Durand Earthwork Echo Enmesh Entourage Essence Fable CR Fibra Greenwich Hudson Hula Hoop Kaleidoscope CR Kora CR Lagos Legend CR Lore CR Metro Milestone Moto CR Noble Palisade Panache CR Pullman Quark Regard CR Roundtrip Sandpiper Sequin CR Smart Spectator Spot On Star Struck Stepping Stones Swing Tight Rope Tilden Tower Grid	C continued Treble CR Vibe Wit Zari CR	D Compass CR Coterie Eclat Weave Hologram Island In The Loop Masquerade Menagerie Origins Tara Theory Woodland Zoom	E Aegean Demure Highland Ikat Square Ikat Stripe Kampala Katazome Kimono Mamba Marquee Meroe Midpoint Nature Walk Sherman Tryst Vatera Whip	F Atelier Biscayne Calais Cotton Velvet Century Coco Cornaro Glider Icon Intrigue In Stitches Mod Plaid Liberty Rivington Soon Tivoli Topography Totem Tweed Frieze	G Abington Alter Ego Amore Andissa Arabella Djenne Feeling Plaid Gibson Hampshire Haze Kamani Kinabalu Melange Modern Tweed Sablon Serendipity Straie Stripe Ultrasuede	H Arno Bavaria Catwalk Constance Firefly Gezelle Magritte Rosemond Stretch Appeal	I Aswan Byron Canaan Cato Cummings Diamond Days Digi Velvet Dynamic Fiori Gramercy Ita Jaipur Mepal Olema Piper Rutledge Sandis Vermeer Walker Worth Zimba
---	---	--	---	---	---	---	--	---	--

Check with your KnollTextiles representative for changes or additions.

Marco Maran

Gigi® Armless Chair with Sled Base

Designer(s):
Marco Maran, 2000



description	seat h	w	d	h	textile fabric	
					yds.	weight
87CSB Armless chair with sled base, stacking	18"	21 3/8"	21"	34 1/4"	0.7	14 lbs.
87CSB-K-N Armless chair with sled base, seat pad upholstery, non-stacking	18"	21 3/8"	21"	34 1/4"	0.7	14 lbs.



Order Code

<i>Example:</i>	87CSB-K-N-010-K1621/21
87CSB-K-N	Gigi armless chair with sled base, non-stacking with seat pad
010	Seafoam shell
K1621/21	Classic Boucle, Smoke

Specify:

1. Pattern number
2. Shell finish
3. Textile selection

Ordering Information

Shell finishes:

- ☑ Black (suffix 014)
- ☑ Graphite (suffix 003)
- Mango (suffix 006)
- ☑ Navy (suffix 012)
- ☑ Red (suffix 007)
- Seafoam (suffix 010)
- ☑ White (suffix 001)

Upholstery/COM information:

Prices shown include fabric or leather upholstery. Contact your Knoll representative for colors. Only approved KnollTextiles and Spinneybeck leathers may be ordered.

Customer's Own Material is available pending approval. For approval requirements, processing instructions and ordering information, please see page 18.

Maintenance:

See pages 28-28.

Stacking feature:

Gigi with sled base, armless, unupholstered stack 4 high on floor.
Gigi with sled base, armless, unupholstered stack 8-10 high on dolly.
Gigi with sled base, armless, seat pad upholstery with stacking bumper stack 4 high on floor.
Gigi with sled base, armless, seat pad upholstery with stacking bumper stack 8-10 high on dolly.

Construction

Description:

Coloured polypropylene shell on a chrome-plated base. Arm chairs have black polypropylene molded arm pads. Chair back flexes for comfort. Gigi chairs are easily cleaned in food areas and work with a booster seat.

Seat Pad:

Seat pad is permanently attached to the seat with bolts in the factory. Seat pad is not retrofittable in the field. Constructed of ABS with high resilient foam.

Stacking bumper:

Black flexible urethane stacking pad secured between base and shell.

Transportation Dolly:

Chrome plated steel frame with rubber wheels. 10 Gigi chairs can be stacked on the dolly. Dollies can stack three high for compact storage. Dolly with 10 chairs will measure 56.3" h, 19.75" w, 41" d. Dolly does not lock.

pattern no.	unuphol.	A	COM B	C	D	E	F	G	H	I
87CSB-()	\$616.									
87CSB-K-N-()-()		894.	912.	929.	946.	961.	971.	990.	1,024.	1,051.



Approved KnollTextiles Grades/Fabrics

A Alignment Bocce Cat's Cradle Chance Common Ground Commuter Cloth Crossroad Delite Dristi Foil Rap Heavy Metal Hourglass Mariner Monarch Prep Presto Soliloquy Sonnet Stacks Uni-Form	B Abacus Argyle Belize Bistro Cameo Chroma Chronicle Close Knit Diva Dovetail Fast Forward Ferry Gala II Grande Grandview Helios Holbrook	B continued Journey Keaton Knoll Felt Knoll Hopsack Little Devil Ludlow Lyric Melody Mini Stitch Night Life Paradigm Petal Pusher Pogo Prairie Prim Radiance Soliloquy Sonnet Roam Rush Hour Soiree Spark Spree Summit Sutton Tabloid Tinge Venue Versa Westwood Wide Angle Yeni Zipline	C continued Dahlia CR Decade Dune Durand Earthwork Echo Enmesh Entourage Essence Fable CR Fibra Greenwich Hudson Hula Hoop Kaleidoscope CR Kora CR Lagos Legend CR Lore CR Metro Milestone Moto CR Noble Palisade Panache CR Pullman Quark Regard CR Roundtrip Sandpiper Sequin CR Smart Spectator Spot On Star Struck Stepping Stones Swing Tight Rope Tilden Tower Grid	C continued Dahlia CR Decade Dune Durand Earthwork Echo Enmesh Entourage Essence Fable CR Fibra Greenwich Hudson Hula Hoop Kaleidoscope CR Kora CR Lagos Legend CR Lore CR Metro Milestone Moto CR Noble Palisade Panache CR Pullman Quark Regard CR Roundtrip Sandpiper Sequin CR Smart Spectator Spot On Star Struck Stepping Stones Swing Tight Rope Tilden Tower Grid	C continued Treble CR Vibe Wit Zari CR D Compass CR Coterie Eclat Weave Hologram Island In The Loop Masquerade Menagerie Origins Tara Theory Woodland Zoom	E Aegean Demure Highland Ikat Square Ikat Stripe Kampala Katazome Kimono Mamba Marquee Meroe Midpoint Nature Walk Sherman Tryst Vatera Whip	F Atelier Biscayne Calais Cotton Velvet Century Coco Cornaro Glider Icon Intrigue In Stitches Mod Plaid Liberty Rivington Soon Tivoli Topography Totem Tweed Frieze	G Abington Alter Ego Amore Andissa Arabella Djenne Feeling Plaid Gibson Hampshire Haze Kamani Kinabalu Melange Modern Tweed Sablon Serendipity Straie Stripe Ultrasuede	H Arno Bavaria Catwalk Constance Firefly Gezelle Magritte Rosemond Stretch Appeal	I Aswan Byron Canaan Cato Cummings Diamond Days Digi Velvet Dynamic Fiori Gramercy Ita Jaipur Mepal Olema Piper Rutledge Sandis Vermeer Walker Worth Zimba
---	---	--	--	--	--	---	---	--	---	--

Check with your KnollTextiles representative for changes or additions.

Marco Maran

Gigi® Armless Chair with Sled Base

	description	height, seat	width	depth	height	textile fabric yds.	weight
<i>Designer(s):</i> Marco Maran, 2000	87CSB-K-S Armless chair with sled base, seat pad upholstery, stacking	18"	21 3/8"	21"	34 1/4"	0.7	14 lbs.
							
	87Dolly Dolly for 10 Gigi chairs		19.2"	31"	26 1/2"		11 lbs.
							

pattern no.	unuphol.	A	COM B	C	D	E	F	G	H	I
87CSB-K-S-()-()		\$995.	\$1,014.	\$1,028.	\$1,048.	\$1,061.	\$1,071.	\$1,091.	\$1,126.	\$1,151.
87Dolly	744.									

Order Code





<i>Example:</i>	87CSB-K-N-010-K1621/21
87CSB-K-N	Gigi armless chair with sled base, non-stacking with seat pad
010	Seafoam shell
K1621/21	Classic Boucle, Smoke

Specify:

1. Pattern number
2. Shell finish
3. Textile selection

Ordering Information

Shell finishes:

-  Black (suffix 014)
-  Graphite (suffix 003)
- Mango (suffix 006)
-  Navy (suffix 012)
-  Red (suffix 007)
- Seafoam (suffix 010)
-  White (suffix 001)

Upholstery/COM information:

Prices shown include fabric or leather upholstery. Contact your Knoll representative for colors. Only approved KnollTextiles and Spinneybeck leathers may be ordered.

Customer's Own Material is available pending approval. For approval requirements, processing instructions and ordering information, please see page 18.

Maintenance:

See pages 28-28.

Stacking feature:

Gigi with sled base, armless, unupholstered stack 4 high on floor.
Gigi with sled base, armless, unupholstered stack 8-10 high on dolly.
Gigi with sled base, armless, seat pad upholstery with stacking bumper stack 4 high on floor.
Gigi with sled base, armless, seat pad upholstery with stacking bumper stack 8-10 high on dolly.

Construction

Description:

Coloured polypropylene shell on a chrome-plated base. Arm chairs have black polypropylene molded arm pads. Chair back flexes for comfort. Gigi chairs are easily cleaned in food areas and work with a booster seat.

Seat Pad:

Seat pad is permanently attached to the seat with bolts in the factory. Seat pad is not retrofittable in the field. Constructed of ABS with high resilient foam.

Stacking bumper:

Black flexible urethane stacking pad secured between base and shell.

Transportation Dolly:





Chrome plated steel frame with rubber wheels. 10 Gigi chairs can be stacked on the dolly. Dollies can stack three high for compact storage. Dolly with 10 chairs will measure 56.3" h, 19.75" w, 41" d. Dolly does not lock.

Approved KnollTextiles Grades/Fabrics

A Alignment Bocce Cat's Cradle Chance Common Ground Commuter Cloth Crossroad Delite Dristi Foil Rap Heavy Metal Hourglass Mariner Monarch Prep Presto Soliloquy Sonnet Stacks Uni-Form	B continued Journey Keaton Knoll Felt Knoll Hopsack Little Devil Ludlow Lyric Melody Mini Stitch Night Life Paradigm Petal Pusher Pogo Prairie Prim Radiance Soliloquy Sonnet Stacks Uni-Form Soiree Spark Spree Summit Sutton Tabloid Tinge Venue Versa Westwood Wide Angle Yeni Zipline	C continued Dahlia CR Decade Dune Durand Earthwork Echo Enmesh Entourage Essence Fable CR Fibra Greenwich Hudson Hula Hoop Kaleidoscope CR Kora CR Lagos Legend CR Lore CR Metro Milestone Moto CR Noble Palisade Panache CR Pullman Quark Regard CR Roundtrip Sandpiper Sequin CR Smart Spectator Spot On Star Struck Stepping Stones Swing Tight Rope Tilden Tower Grid	C continued Treble CR Vibe Wit Zari CR D Compass CR Coterie Eclat Weave Hologram Island In The Loop Masquerade Menagerie Origins Tara Theory Woodland Zoom	E Aegean Demure Highland Ikat Square Ikat Stripe Kampala Katazome Kimono Mamba Marquee Meroe Midpoint Nature Walk Sherman Tryst Vatera Whip	F Atelier Biscayne Calais Cotton Velvet Century Coco Cornaro Glider Icon Intrigue In Stitches Mod Plaid Liberty Rivington Soon Tivoli Topography Totem Tweed Frieze	G Abington Alter Ego Amore Andissa Arabella Djenne Feeling Plaid Gibson Hampshire Haze Kamani Kinabalu Melange Modern Tweed Sablon Serendipity Straie Stripe Ultrasuede	H Arno Bavaria Catwalk Constance Firefly Gezelle Magritte Rosemond Stretch Appeal	I Aswan Byron Canaan Cato Cummings Diamond Days Digi Velvet Dynamic Fiori Gramercy Ita Jaipur Mepal Olema Piper Rutledge Sandis Vermeer Walker Worth Zimba
---	---	--	--	---	---	--	---	--

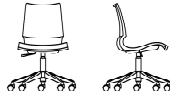
Check with your KnollTextiles representative for changes or additions.

Marco Maran
Gigi® Barstool and Swivel Chair

	description	seat h, min	seat h, max	arm h, min	arm h, max	w	d	h, min	h, max	weight
<p><i>Designer(s):</i> Marco Maran, 2002</p> 	87CS Gigi armless swivel chair 	17 1/4"	22 1/2"			22 9/10"	25"	33 1/2"	38 1/4"	17 lbs.
	87AS Gigi arm swivel chair 	17 1/4"	22 1/2"	24 1/4"	29 1/4"	22 9/10"	25"	33 1/2"	38 1/4"	21 lbs.
	87CM Gigi barstool, counter-height 		24"			19 3/4"	20"		40 1/2"	14 lbs.
	87CH Gigi barstool, bar-height 		29 1/2"			19 3/4"	20"		46"	15 lbs.

pattern no.	
87CS-()	\$1,212.
87AS-()	1,406.
87CM-()	858.
87CH-()	858.

Order Code





Example:	87AS-006
87AS	Gigi arm swivel chair
006	Mango shell

Specify:

1. Pattern number
2. Shell finish

Ordering Information

Shell Finishes:

-  Black (suffix 014)
-  Graphite (suffix 003)
- Mango (suffix 006)
-  Navy (suffix 012)
-  Red (suffix 007)
- Seafoam (suffix 010)
-  White (suffix 001)

 *KnollStudio 20-Day Program:*

Gigi arm and armless swivel chair and counter and bar-height barstools are available on the 20-day program, unupholstered, in white, graphite, black, red and navy shell finishes. For specific ordering information consult pages 27-28.

Maintenance:

See pages 28-29.

Note:

The Gigi Stool and Swivel Chair are Greenguard certified.

Construction

Description:

Coloured polypropylene and 15% fiberglass shell on a chrome-plated base. Arm chairs have black polypropylene molded arm pads. Chair back flexes for comfort. Gigi chairs are easily cleaned in food service areas.

Swivel:

Swivel mechanism with pneumatic seat height adjustment T-section polished aluminum base, with hard black casters. Colored polypropylene shell on a chrome-plated base. Armchairs have black polypropylene molded arm pads.

Ludwig Mies van der Rohe

Tubular Brno Chair

description	frame	seat	arm	w	d	h	textile	req.	weight
		h	h				fabric	leather	
245A Brno Tugendhat arm chair - tubular frame, with thin seat and back	polished chrome	17 1/4"	25 1/4"	22 3/4"	22 1/2"	31 1/2"	1.7	28	23 lbs.
	stainless steel	17 1/4"	25 1/4"	22 3/4"	22 1/2"	31 1/2"	1.7	28	24 lbs.
245AT Brno Classic arm chair - tubular frame, with thick seat and back	polished chrome	17 1/4"	25 1/4"	22 3/4"	22 1/2"	31 1/2"	1.7	28	23 lbs.
	stainless steel	17 1/4"	25 1/4"	22 3/4"	22 1/2"	31 1/2"	1.7	28	24 lbs.

Designer(s):
Ludwig Mies van der Rohe, 1930
Design from the Mies van der Rohe Archive of The Museum of Modern Art

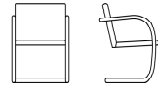

Award(s):
The Museum of Modern Art, New York, USA, 1977

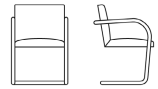

G Glides (add -G to end of pattern number)

P Perforated leather option (add P to end of pattern number and suffix -PERF to leather selection)

30

Order Code	Ordering Information	Construction
------------	----------------------	--------------

<i>Example:</i> 245A-S-P-VO906-PERF		
245A	Tubular arm chair, thin seat	
S	Stainless Steel	
P	Perforated leather	
VO906-PERF	Volo, Navy, perforated	

Finishes:
Polished Chrome (suffix C)
Stainless Steel (suffix S)

Upholstery/COM information:
Prices shown include fabric or leather upholstery. Contact your Knoll representative for colors. Only approved KnollTextiles and Spinneybeck leathers may be ordered.

Customer's Own Material is available pending approval. For approval requirements, processing instructions and ordering information please see page 18.

Woven leather option:
The Tubular Brno Chairs can be upholstered in woven leather as a COL. 30 sq. ft. of woven leather required. Specify suffix -W after pattern number.

Perforated leather option:
The Tubular Brno Chairs are available in perforated leather upholstery. Specify suffix -P at end of pattern number and suffix -PERF at end of leather selection. 30 sq. ft. of leather required.

Cal 133 Fire Code ♣ :
The Tubular Brno Chairs comply with the California Technical Bulletin 133 standard if upholstered in Cal 133 approved upholstery. Specify suffix -C at end of pattern number and suffix -133 at end of textile selection. Upcharge applies, see page 19.

Maintenance:
See pages 28-29.

Note:
The KnollStudio logo and signature of Ludwig Mies van der Rohe are stamped into the frame of the chair under the arm.

The Tubular Bar Brno Chair is Greenguard certified.

Frame:
Stainless steel:
Tubular pre-stressed, pre-buffed 14 gauge stainless steel. Clean, seamless joints and hidden drilled or countersunk holes (as opposed to punched) render the chair free of deformation.

Polished chrome:
11 gauge steel. The mirror chrome-plating process includes lengthy nickel and silicone coatings for rust protection and increased durability. All chairs are polished to a mirror finish. Clean, seamless joints and hidden drilled or countersunk holes (as opposed to punched) render the chair free of deformation.

Upholstery:
Inner hardwood frame cushioned with variable density foam. Dymetrol seat suspension enhances comfort level. Replacement seat and backs are not available on Brno chairs. Tubular Brno with thin seat (245A, 245AS) has no welt detail. Tubular Brno with thick seat (245AT, 245AB) has welt detail on underside of seat.

Optional glides:
Six clear plastic glides in specially drilled holes.

pattern no.	grades	COM	C	D	E	F	G	H	I	COL	V	W	X	Y
245A-C	\$2,225.	\$2,294.	\$2,360.	\$2,409.	\$2,453.	\$2,495.	\$2,539.	\$2,651.	\$2,850.	\$3,080.	\$3,304.	\$3,749.	\$3,858.	\$3,955.
245A-S	2,878.	2,947.	3,013.	3,062.	3,106.	3,147.	3,192.	3,304.	3,502.	3,733.	3,956.	4,403.	4,512.	4,606.

245AT-C	2,547.	2,614.	2,682.	2,733.	2,774.	2,816.	2,860.	2,972.	3,171.	3,400.	3,623.	4,072.	4,181.	4,275.
245AT-S	3,188.	3,254.	3,321.	3,372.	3,415.	3,457.	3,500.	3,611.	3,812.	4,041.	4,263.	4,712.	4,821.	4,916.

G	29.
P	902.

Approved KnollTextiles Grades/Fabrics	Spinneybeck Leather
---------------------------------------	---------------------

A Alignment ♣ Beacon Bocce Cat's Cradle Chance Common Ground ♣ Commuter Cloth ♣ Crossroad Delite Dristi Foil Rap Heavy Metal Hourglass Mariner Monarch ♣ Prep ♣ Presto ♣ Soliloquy Sonnet Stacks Trophy Uni-Form	B continued Gala II Grande Grandview Helios Holbrook Journey Keaton Knoll Felt Knoll Hopsack Little Devil Ludlow Lyric Melody Mini Stitch ♣ Night Life Prep ♣ Petal Pusher Pogo ♣ Prairie Prim ♣ Radiance Ransom Ricochet ♣ Roam Rush Hour Soiree Spark ♣ Spree Summit Sutton Synth Tabloid Tinge Venue Versa Vinyl Westwood Wide Angle ♣ Yeni Zipline	C Atlas Axiom Baxter Biota ♣ Cairo Charm Circa Classic Boucle Dahlia CR Decade Dune Durand Earthwork ♣ Echo Empire Stripe Enmesh Entourage Essence Fable CR Fibra Greenwich Hudson Hula Hoop Kaleidoscope CR Kora CR Lagos Legend CR Lore CR Magnolia Metro Milestone Moto CR Noble Palisade Panache CR Pullman Quark Regard CR Roundtrip Sahara Sandpiper Sequin CR Sinclair Smart Spectator Spot On	C continued Star Struck Stepping Stones Swing Tight Rope Tilden Tower Grid Treble CR Vibe Wit Zari CR	D Compass CR Coterie Eclat Weave Hologram In The Loop Island Masquerade Menagerie Origins Tara Theory Woodland Zoom	E Aegean Demure Highland Ikat Square Ikat Stripe Kampala Katzome Kimono Mamba Marquee Meroe Midpoint Nature Walk Sherman Shima Tryst Vatera Whip	F Atelier Biscayne Calais Cotton Velvet Century Coco Cornaro Glider Icon Intrigue In Stitches Jasmine Liberty Mod Plaid Rivington Soon Tivoli Topography Totem Tweed Frieze	G continued Spencer Straie Stripe Ultrasuede Utrillo	H Arno Bavaria Catwalk Constance Firefly Gezelle Magritte Rosemond Stretch Appeal	I Aswan Byron Canaan Cato Cummings Diamond Days Digi Velvet Dynamic Fiori Gramercy Ita Jaipur Knoll Velvet Limani Mepal North Island Olema Piper Rutledge Sandis Tudor Vermeer Walker Worth Zimba	U Vicenza ♣ Volo ♣	V Acqua ♣ Andes ♣ Embossed Tipped España ♣ Hand Tipped Maremma Velluto Pelle ♣	W Alaska ♣ Amazon ♣ Antique ♣ Derby ♣ Forte ♣ Lucente Sabrina ♣	X Ducale ♣ Ducale Velour ♣	Y Capri ♣ Cervo Copenhagen ♣ Distressed Lucca Marissa ♣ Portofino Riva ♣ Saddle ♣ Torello
---	---	--	--	---	---	--	---	---	---	---------------------------------	--	---	---	--

♣ Approved for Cal 133 upholstery.

Check with your KnollTextiles or Spinneybeck Representative for changes or additions.

Ludwig Mies van der Rohe

Flat Bar Brno Chair

	description	frame	seat h	arm h	w	d	h	textile fabric yds.	req. leather sq. ft.	weight
<i>Designer(s):</i> Ludwig Mies van der Rohe, 1930	255A Brno arm chair, flat bar frame, with arm pads	polished chrome	17 1/2"	25 1/4"	22 1/4"	22 1/2"	31 1/2"	1.7	28	37 lbs.
		stainless steel	17 1/2"	25 1/4"	22 1/4"	22 1/2"	31 1/2"	1.7	28	38 lbs.
<i>Award(s):</i> The Museum of Modern Art, New York, USA, 1977	255C Brno arm chair, flat bar frame, without arm pads	polished chrome	17 1/2"	25 1/4"	22 1/4"	22 1/2"	31 1/2"	1.7	28	37 lbs.
		stainless steel	17 1/2"	25 1/4"	22 1/4"	22 1/2"	31 1/2"	1.7	28	38 lbs.
	P Perforated leather option (add P to end of pattern number and suffix -PERF to leather selection)								30	
	G Glides (add -G to end of pattern number)									

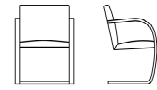
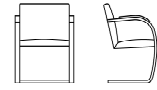

Order Code	Ordering Information	Construction
------------	----------------------	--------------

<i>Example:</i> 245A-S-P-VO906-PERF		
245A	Tubular arm chair, thin seat	
S	Stainless Steel	
P	Perforated leather	
VO906-PERF	Volo, Navy, perforated	

Finishes:
Polished Chrome (suffix C)
Stainless Steel (suffix S)

Upholstery/COM information:
Prices shown include fabric or leather upholstery. Contact your Knoll representative for colors. Only approved KnollTextiles and Spinneybeck leathers may be ordered.

Customer's Own Material is available pending approval. For approval requirements, processing instructions and ordering information please see page 18.

Woven leather option:
The Tubular Brno Chairs can be upholstered in woven leather as a COL. 30 sq. ft. of woven leather required. Specify suffix -W after pattern number.

Perforated leather option:
The Tubular Brno Chairs are available in perforated leather upholstery. Specify suffix -P at end of pattern number and suffix -PERF at end of leather selection. 30 sq. ft. of leather required.

Cal 133 Fire Code :
The Tubular Brno Chairs comply with the California Technical Bulletin 133 standard if upholstered in Cal 133 approved upholstery. Specify suffix -C at end of pattern number and suffix -133 at end of textile selection. Upcharge applies, see page 19.

Maintenance:
See pages 28-29.

Note:
The KnollStudio logo and signature of Ludwig Mies van der Rohe are stamped into the frame of the chair under the arm.

The Tubular Brno Chair is Greenguard certified.

Frame:
Stainless steel:
Tubular pre-stressed, pre-buffed 14 gauge stainless steel. Clean, seamless joints and hidden drilled or countersunk holes (as opposed to punched) render the chair free of deformation.

Polished chrome:
11 gauge steel. The mirror chrome-plating process includes lengthy nickel and silicone coatings for rust protection and increased durability. All chairs are polished to a mirror finish. Clean, seamless joints and hidden drilled or countersunk holes (as opposed to punched) render the chair free of deformation.

Upholstery:
Inner hardwood frame cushioned with variable density foam. Dymetrol seat suspension enhances comfort level. Replacement seat and backs are not available on Brno chairs. Tubular Brno with thin seat (245A, 245AS) has no welt detail. Tubular Brno with thick seat (245AT, 245AB) has welt detail on underside of seat.

Optional glides:
Six clear plastic glides in specially drilled holes.

pattern no.	grades A	COM B	C	D	E	F	G	H	I	COL U	V	W	X	Y
255A-C	\$3,171.	\$3,245.	\$3,314.	\$3,363.	\$3,408.	\$3,449.	\$3,496.	\$3,608.	\$3,814.	\$4,046.	\$4,270.	\$4,730.	\$4,840.	\$4,940.
255A-S	4,747.	4,820.	4,888.	4,941.	4,984.	5,026.	5,070.	5,183.	5,390.	5,623.	5,848.	6,307.	6,416.	6,514.
255C-C	2,860.	2,928.	2,994.	3,047.	3,093.	3,132.	3,174.	3,285.	3,490.	3,718.	3,939.	4,387.	4,496.	4,591.
255C-S	4,413.	4,483.	4,548.	4,600.	4,647.	4,687.	4,728.	4,838.	5,042.	5,272.	5,492.	5,941.	6,050.	6,143.
P	902.													
G	29.													

Approved KnollTextiles Grades/Fabrics	Spinneybeck Leather
---------------------------------------	---------------------

A Alignment # Beacon Bocce Cat's Cradle Chance Common Ground # Commuter Cloth # Crossroad Delite Dristi Foil Rap Heavy Metal Hourglass Mariner Monarch # Presto # Soliloquy Sonnet Stacks Trophy	B continued Gala II Grand Grandview Helios Holbrook Journey Keaton Knoll Felt Knoll Hopsack Little Devil Ludlow Lyric Melody Mini Stitch # Night Life Prep # Petal Pusher Pogo # Prairie Prim # Radiance Ransom Ricochet # Roam Rush Hour Soiree Spark # Spree Summit Sutton Synth Tabloid Tinge Venue Versa Vinyl Westwood Wide Angle # Yeni Zipline	C Atlas Axiom Baxter Biota # Cairo Charm Circa Classic Boucle Dahlia CR Decade Dune Durand Earthwork # Echo Empire Stripe Enmesh Entourage Essence Fable CR Fibra Greenwich Hudson Hula Hoop Kaleidoscope CR Kora CR Lagos Legend CR Lore CR Magnolia Metro Milestone Moto CR Noble Palisade Panache CR Quark Regard CR Roundtrip Sahara Sandpiper Sequin CR Sinclair Smart Spectator Spot On Star Struck	C continued Stepping Stones Swing Tight Rope Tilden Tower Grid Treble CR Vibe Wit Zari CR D Compass CR Coterie Eclat Weave Hologram In The Loop Island Masquerade Menagerie Origins Tara Theory Woodland Zoom E Aegean Demure Highland Ikat Square Ikat Stripe Kampala Katazome Kimono Mamba Marquee Meroe Midpoint Nature Walk Sherman Shima Tryst Vatera Whip	F Atelier Biscayne Calais Cotton Velvet Century Coco Cornaro Glider Icon Intrigue Jasmine Liberty Mod Plaid Rivington Soon Tivoli Topography Totem Tweed Frieze G Abington Alter Ego Amore Andissa Arabella Arber Brugge Djenne Feeling Plaid Garden City Gibson Hampshire Haze Kamani Kinabalu Kingston Melange Metallic Gloss Petite Floral Sablou Serenipity	G continued Spencer Straie Stripe Ultrasuede Utrillo H Arno Bavaria Constance Firefly Gezelle Magritte Rosemond I Aswan Byron Canaan Cato Cummings Diamond Days Digi Velvet Dynamic Fiori Gramercy Ita Jaipur Knoll Velvet Limani Mepal North Island Olema Piper Rutledge Sandis Tudor Vermeer Walker Worth Zimba	U Vicenza # Volo # V Acqua # Andes # Embossed Tipped España # Hand Tipped Maremma Velluto Pelle # W Alaska # Amazon # Antique # Derby # Forte # Lucente Sabrina #	X Ducale # Ducale Velour # Y Capri # Cervo Copenhagen # Distressed Lucca Marissa # Portofino Riva # Saddle # Torello
---	--	--	--	--	--	--	---

Approved for Cal 133 upholstery.

Check with your KnollTextiles or Spinneybeck Representative for changes or additions.

Ludwig Mies van der Rohe

Four Seasons Stool

description	w	d	seat h	textile fabric yds.	req. leather sq. ft.	weight
257C Four Seasons Stool	17"	17"	30"	0.8	15	24 lbs.

Designer(s):
Ludwig Mies van der Rohe, 1958

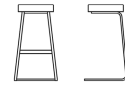

Order Code

<i>Example:</i>	257C-DV116
257C	Four Seasons Stool
DV116	Ducale Velour, Lava

Specify:

1. Pattern number
2. Textile selection

Ordering Information

Upholstery/COM information:

Prices shown include fabric or leather upholstery. Contact your Knoll representative for colors. Only approved KnollTextiles and Spinneybeck leathers may be ordered.

Customer's Own Material is available pending approval. For approval requirements, processing instructions and ordering information please see page 18.

Maintenance:

See pages 28-29.

Note:

The KnollStudio logo and signature of Ludwig Mies van der Rohe are stamped into the base of the stool.

Cal 133 Fire Code:

The Four Seasons Stools comply with the California Technical Bulletin 133 standard if upholstered in Cal 133 approved upholstery. Specify suffix -C at end of pattern number and suffix -133 at end of textile selection. Upcharge applies, see page 19.

The Four Season Stool is Greenguard certified.

Construction

Frame:

Bent steel frame with chrome plating.

Upholstery:

Seat upholstered in leather or fabric over foam cushion reinforced with a plywood form.

Stitching:

Stitching detail is found on the rear left hand corner of the stool.

pattern no.	grades	COM								COL					
	A	B	C	D	E	F	G	H	I	U	V	W	X	Y	
257C-()	\$3,385.	\$3,407.	\$3,429.	\$3,452.	\$3,470.	\$3,484.	\$3,507.	\$3,556.	\$3,586.	\$3,709.	\$3,793.	\$3,964.	\$4,002.	\$4,043.	

Approved KnollTextiles Grades/Fabrics

A Alignment # Beacon Bocce Cat's Cradle Chance Common Ground # Commuter Cloth # Crossroad Delite Dristi Foil Rap Heavy Metal Hourglass Mariner Monarch # Prep # Presto # Soliloquy Sonnet Stacks Trophy Uni-Form	B continued Dovetail # Fast Forward Ferry Forza Gala II Grande Grandview Helios Holbrook Journey Keaton Knoll Felt Knoll Hopsack Little Devil Ludlow Lyric Melody Mini Stitch # Night Life Paradigm Petal Pusher Pogo # Prairie Prim # Radiance Ransom Ricochet # Roam Rush Hour Soiree Spark # Spree Summit Sutton Synth Tabloid Tinge Venue Versa Vinyl Westwood Wide Angle # Yeni Zipline	C Atlas Axiom Baxter Biota # Cairo Charm Circa Classic Boucle Dahlia CR Decade Dune Durand Earthwork # Echo Empire Stripe Enmesh Entourage Essence Fable CR Fibra Greenwich Hudson Hula Hoop Kaleidoscope CR Kora CR Lagos Legend CR Lore CR Magnolia Metro Milestone Moto CR Noble Palisade Panache CR Pullman Quark Regard CR Roundtrip Sahara Sandpiper Sequin CR Sinclair Smart Spectator Spot On Star Struck	C continued Stepping Stones Swing Tight Rope Tilden Tower Grid Treble CR Vibe Wit Zari CR	D Compass CR Coterie Eclat Weave Hologram In The Loop Island Masquerade Menagerie Origins Tara Theory Woodland Zoom	E Aegean Demure Highland Ikat Square Ikat Stripe Kampala Katazome Kimono Mamba Marquee Meroe Midpoint Nature Walk Sherman Shima Tryst Vatera Whip	F Atelier Biscayne Calais Cotton Velvet Century Coco Cornaro Glider Icon Intrigue In Stitches Jasmine Liberty Mod Plaid Rivington Soon Tivoli Topography Totem Tweed Frieze	G Abington Alter Ego Amore Andissa Arabella Arber Brugge Djenne Feeling Plaid Garden City Gibson Hampshire Haze Kamani Kinabalu Kingston Melange Metallic Gloss Modern Tweed Petite Floral Sablon Serendipity Spencer Straie Stripe Ultrasuede Utrillo	H Arno Bavaria Catwalk Constance Firefly Gezelle Magritte Rosemond Stretch Appeal	I Aswan Byron Canaan Cato Cummings Diamond Days Digi Velvet Dynamic Fiori Gramercy Ita Jaipur Knoll Velvet Limani Mepal North Island Olema Piper Rutledge Sandis Tudor Vermeer Walker Worth Zimba	U Vicenza # Volo #	V Acqua # Andes # Embossed Tipped # España # Hand Tipped # Velluto Pelle #	W Alaska # Amazon # Antique # Derby # Forte # Lucente Sabrina #	X Ducale Ducale Velour	Y Capri # Cervo Copenhagen Distressed Lucca Marissa # Portofino Riva # Saddle #
---	---	---	---	---	--	--	---	---	---	---------------------------------	---	---	-------------------------------------	---





Spinneybeck Leather

U Vicenza # Volo #	V Acqua # Andes # Embossed Tipped # España # Hand Tipped # Velluto Pelle #	W Alaska # Amazon # Antique # Derby # Forte # Lucente Sabrina #	X Ducale Ducale Velour	Y Capri # Cervo Copenhagen Distressed Lucca Marissa # Portofino Riva # Saddle #
---------------------------------	---	---	-------------------------------------	---

Check with your KnollTextiles or Spinneybeck Representative for changes or additions.

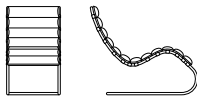
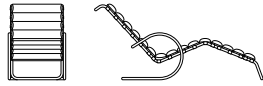
Ludwig Mies van der Rohe

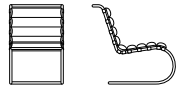
MR Lounge Seating

	description	frame	seat h	arm h	w	d	h	req. leather sq. ft.	weight
<i>Designer(s):</i> Mies van der Rohe, 1929 Design from the Mies van der Rohe Archive of The Museum of Modern Art	241LS MR chaise lounge 	Cowhide straps			23 1/2"	47 1/4"	37 1/2"	72	39 lbs.
		Sandwiched straps			23 1/2"	47 1/4"	37 1/2"	106	39 lbs.
<i>Award(s):</i> The Museum of Modern Art, New York, USA; Design Center Stuttgart Award, W. Germany, 1978	242LS MR adjustable chaise lounge 	Cowhide straps	19 1/2"	25 1/2"	70 1/4"	31 3/4"	91	43 lbs.	
		Sandwiched straps	19 1/2"	25 1/2"	70 1/4"	31 3/4"	133	43 lbs.	
	247LS MR armless lounge chair 	Cowhide straps	15 3/4"		23 1/2"	34 1/4"	33"	50	24 lbs.
		Sandwiched straps	15 3/4"		23 1/2"	34 1/4"	33"	75	24 lbs.
	248LS MR lounge chair with arms 	Cowhide straps	15 3/4"	23"	25 1/2"	36 1/4"	33"	50	32 lbs.
		Sandwiched straps	15 3/4"	23"	25 1/2"	36 1/4"	33"	75	32 lbs.

pattern no.	U	V	W	X	Y
241LS-(H01)	\$13,573.	\$14,143.	\$15,304.	\$15,546.	\$15,828.
241LS-(-)	14,744.	15,582.	17,288.	17,644.	18,060.
242LS-(H01)	16,615.	17,336.	18,805.	19,108.	19,461.
242LS-(-)	18,061.	19,112.	21,254.	21,700.	22,219.
247LS-(H01)	8,986.	9,384.	10,190.	10,354.	10,551.
247LS-(-)	9,846.	10,439.	11,647.	11,901.	12,192.
248LS-(H01)	10,486.	10,883.	11,684.	11,852.	12,049.
248LS-(-)	11,344.	11,937.	13,145.	13,399.	13,691.

Order Code	Ordering Information	Construction
<i>Example:</i> 241LS-H01-VP03	<i>Strap selection:</i> Cowhide belting frame supports to match the following colors: Black (suffix H01) For colors other than black, leather selected is sandwiched to belting thickness on cowhide backing. Select any approved Spinneybeck leather and color. <i>Upholstery note:</i> Prices shown include leather upholstery and strap selection. No Customer's Own Material can be used. <i>Note:</i> The MR Lounge Seating is Greenguard certified.	<i>Frame:</i> Seamless tubular stainless steel with a polished finish. Glides not included. <i>Upholstery straps:</i> Black cowhide belting straps with front, back, and sides all stained. For all other colors, upholstery is sandwiched to belting thickness on both front and back, with sides left natural. Cowhide backing. 241LS contains 12 belting support straps; 242LS contains 15 straps; 247LS and 248LS contain 9 straps each. <i>Upholstery:</i> Leather is crafted in a series of quilted and seamed cushion sections.
241LS Chaise lounge		
H01 Black cowhide straps		
VP03 Velluto Pelle, Espresso		
<i>Example:</i> 242LS-DE221-DE221		
242LS Chaise lounge		
DE221 Sandwiched Derby straps, Brick		
DE221 Derby, Brick		
<i>Note:</i> The Mies lounge chairs are part of a collection. Please refer to Mies side chairs and lounge seating beginning on page 190, and tables, beginning on page 342. <i>Specify:</i> 1. Pattern number 2. Strap selection 3. Textile selection		

Spinneybeck Leather	
U Vicenza Volo	X Ducale Ducale Velours
V Acqua Andes Embossed Tipped España Hand Tipped Velluto Pelle	Y Capri Cervo Copenhagen Distressed Lucca Marissa Portofino Riva Saddle Torello
W Alaska Amazon Antique Derby Forte Lucente Sabrina	

Check with your Spinneybeck Representative for changes or additions.

Ludwig Mies van der Rohe

MR Chair

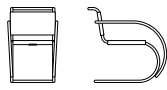
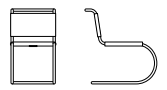





	description	seat h	arm h	w	d	h	weight
<i>Designer(s):</i> Ludwig Mies van der Rohe, 1927	256AS MR side chair with arms	18"	27"	21"	32 1/2"	31"	24 lbs.
<i>Award(s):</i> The Museum of Modern Art, New York, USA, 1977; Design Center Stuttgart Award, W.Germany, 1978							
	256CS MR side chair, armless	18"		19 1/4"	27 1/4"	31"	17 lbs.
							
	256AKIT Replacement sling kit with laces for arm chair						
	256CKIT Replacement sling kit with laces for armless chair						
	256LACE Replacement leather laces for arm/armless chair						





pattern no.	
256AS-L()	\$3,709.
256CS-L()	2,365.
256AKIT-L()	1,135.
256CKIT-L()	1,135.
256LACE-L()	87.

Order Code	Ordering Information	Construction
<i>Example:</i> 256AS-L82	<i>Cowhide Selection:</i> Black(suffix L80) Light Brown (suffix L82) White Beige (suffix L84)	<i>MR CHAIR</i> <i>Frame:</i> Tubular stainless steel in polished finish.
256AS MR side chair with arms	<i>Upholstery/COM information:</i> Prices shown include leather upholstery. No Customer's Own Material is available.	<i>Upholstery:</i> Thick cowhide sling with leather laces.
L82 Light Brown cowhide	<i>Note:</i> The KnollStudio logo and signature of Ludwig Mies van der Rohe is stamped into the base of the MR chair. Every piece of furniture has an individual production number of identification and authenticity.	<i>Glides:</i> Four molded clear plastic glides with twin-pin snap-in construction included with all MR chairs.
<i>Note:</i> The MR chairs are part of a collection. Please refer to Mies side chairs and lounge seating beginning on page 190 and tables, beginning on page 342.	<i>Maintenance:</i> See pages 28-29.	<i>Replacement Slings:</i> Slings can be replaced in the field by field services or a furniture repair specialist. Kit includes back and seat replacement slings with laces. Slings should be fitted by field services or by a professional reupholsterer.
<i>Specify:</i> 1. Pattern number 2. Cowhide selection		

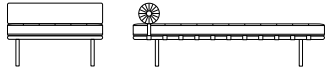
Ludwig Mies van der Rohe Barcelona® Lounge Seating

description	frame	straps	seat h	bolster			req. leather sq. ft.	weight	
				h	w	d			
<i>Designer(s):</i> Mies van der Rohe, 1929 <i>Award(s):</i> The Museum of Modern Art, New York, USA, 1977 	250L Barcelona chair	chrome	17"	29 1/2"	30"	30 1/4"	50	47 lbs.	
		stainless	17"	29 1/2"	30"	30 1/4"	50	53 lbs.	
251Y Barcelona stool	chrome		14 1/4"	25"	23 1/4"	14 3/4"	25	28 lbs.	
		stainless	14 1/4"	25"	23 1/4"	14 3/4"	25	31 lbs.	
251YC-L80 Barcelona stool with cowhide sling	chrome		12 1/4"	21 1/2"	23"	12 1/4"	n/a	26 lbs.	
									
250LC-S Child's Barcelona chair	chrome		14"	24"	24"	25"	32	41 lbs.	
									
251YC-S Child's Barcelona stool	chrome		12"	19"	18"	12"	15	25 lbs.	
									
258L Barcelona couch	stainless	black	15.35"	25"	39"	78"	25"	110	84 lbs.
		stainless	colors	15.35"	25"	39"	78"	25"	110

pattern no.	cowhide	U	V	W	X	Y
250LC 		\$8,471.	\$10,429.	\$11,098.	\$11,233.	\$11,395.
250LS		12,936.	13,381.	14,181.	14,321.	14,539.
<hr/>						
251YC 		4,005.	4,921.	5,256.	5,324.	5,404.
251YS		7,486.	7,683.	8,082.	8,179.	8,265.
<hr/>						
251YC-L80	2,745.					
<hr/>						
250LC-S		7,189.	8,855.	9,421.	9,538.	9,677.
<hr/>						
251YC-S		3,399.	4,179.	4,461.	4,522.	4,590.
<hr/>						
258LS-(HO1)		14,801.	15,371.	16,528.	16,768.	17,049.
258LS-(-)		15,946.	16,774.	18,460.	18,808.	19,215.

Order Code

<i>Example:</i>	250LS-DV116
250LS	Barcelona chair
DV116	Ducale Velour, Lava

Note:
Barcelona lounge seating and couch are part of a collection. Please refer to Mies side chairs and lounge seating beginning on page 190 and tables, beginning on page 342.

Specify:

1. Pattern number
2. Cal 133 Fire Code option (chair and stool only)
3. Leather selection

Ordering Information

Upholstery note:
Prices shown include leather upholstery and strap selection. **No Customer's Own Material can be used.**

 KnollStudio 20-day Program: The Barcelona chair and stool are available on the KnollStudio 20-day program with black volo leather and a chrome base. For specific information, consult pages 30-33.

Cal 133 Fire Code  :
The Barcelona Lounge Chair and Stool comply with the California Technical Bulletin 133 standard if upholstered in Cal 133 approved upholstery. Specify suffix -C after pattern number. Upcharge applies, see page 19.

Maintenance:
See pages 28-29.

Note:
The KnollStudio logo and signature of Ludwig Mies van der Rohe is stamped on each piece.

The Barcelona Lounge Seating Collection is Greenguard certified.

The Child's Barcelona chair and stool are compliant to the Consumer Product Safety Improvement Act of 2008 for Children's Products, 16 C.F.R. 1303, CPSIA Title 1 Section 101 for Total Lead in Substrates and Surface Coatings.

Construction

BARCELONA CHAIR AND STOOL
Stainless Steel Frame:
Premium grade 304 bar stock stainless steel. Single piece construction ensures long-term durability. Frame is shaped, welded and hand-buffed to mirror finish. Upholstery straps attached with solid stainless steel screws.

Chrome Frame:
Hand-ground and hand-buffed to a mirror finish. Upholstery attaches with aluminum rivets.

Upholstery straps:
Cowhide belting straps. Side and all sides are dyed to match specified upholstery color. Chair contains 17 belting support straps; stool 7. Child's Chair contains 13 belting support straps; stool 7.

Upholstery:
Chair has 40 individual panels for the chair and 16 for the stool; Child's Chair has 40 individual panels for the chair and 16 for the stool. Individual panels are cut, hand-weltd, and hand-tufted with leather and buttons produced from a single cowhide. Cushions are premium quality, highly resilient urethane foam with down-like dacron polyester fiberfill.

Child's Barcelona Chair and Stool:
The Child's Barcelona Chair and Stool is 80% scale of standard size.

BARCELONA STOOL WITH COWHIDE SLING:
Thick cowhide sling in black with nylon laces on a chrome frame.

BARCELONA COUCH
Platform:
Hardwood frame is Sapele Mahogany from Africa. Wood has oak-like strength and is characterized by a dark or reddish-brown color. Frame is finished with a protective clear lacquer finish. 11 thick cowhide leather straps over rubber webbing.















Legs:
Tubular steel in polished stainless steel finish.

Bolster:
Bolster in matching leather is secured to cushion platform with straps complete with lock snaps.

Upholstery straps:
Cowhide belting straps with front, back, and side edges all stained to match specified upholstery color. For black straps, specify option (HO1). For matching straps in all other colors, specify leather upholstery selection and straps will be produced to match. Couch contains 11 belting support straps over rubber webbing.

Upholstery:
72 individual panels are cut, hand-weltd and hand-tufted with leather and buttons produced from a single cowhide. Cushions are premium quality, fire retardant, high resilient urethane foam with down-like dacron polyester fiberfill.

Spinneybeck Leather



U Vicenza  Volo 	X Ducale  Ducale Velours 
V Acqua  Andes  España  Hand Tipped  * Maremma  Velluto Pelle 	Y Capri  Cervo  * Copenhagen  Distressed  Lucca  Marissa  Portofino  * Riva  Saddle 
W Alaska  Amazon  Antique  Derby  Forte  Lucente  * Sabrina 	

 Approved for Cal 133 upholstery.
* Not approved for Cal133 upholstery on 258LS.

Check with your KnollTextiles or Spinneybeck Representative for changes or additions.

Ludwig Mies van der Rohe

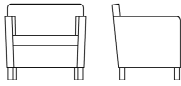
Krefeld™ Collection

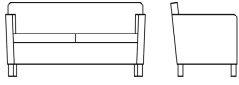
	description	seat h	arm h	w	d	h	type	textile fabric yds.	req. leather sq. ft.	weight
<i>Designer(s):</i> Ludwig Mies van der Rohe, 1930 Design from the Mies van der Rohe Archive of The Museum of Modern Art	751 Lounge chair	17 1/4"	25"	32"	27"	30"		6.5	80	59 lbs.
										
	Lounge chair in textile with leather welt option						uphol.	6.5		
							welt		21	
	752 Settee	17 1/4"	25"	57"	27"	30"		8	120	93 lbs.
										
	Settee in textile with leather welt option						uphol.	8		
							welt		25	

Order Code

<i>Example:</i>	751-AWE-DV112
751	Krefeld lounge chair
AWE	Wenge legs
DV112	Ducale Velour, Brandy
<i>Example:</i>	752-AWA-K1026/3-VO904
752	Krefeld settee
AWA	Light Walnut legs
K1026/3	Cross Stitch, Windsor
VO904	Volo, Stallion welt

Krefeld lounge seating is part of a collection. Please refer to Mies side chairs and lounge seating beginning on page 190 and tables, beginning on page 342.

Specify:

1. Pattern number
2. Leg finish
3. Textile selection

Leather Welt selection, specify:

1. Pattern number
2. Leg finish
3. Textile selection
4. Leather Welt Selection (upcharge applies)

Ordering Information

Leg finishes:
Clear Oak (suffix AOC)
Deep Red Mahogany (suffix AF)
Light Walnut (suffix AWA)
Medium Cherry (suffix AM)
Wenge (suffix AWE)

Leather Welt Option:
The Krefeld collection may be specified with an optional leather welt option. Welt contours all edges, including cushions. Please specify pattern number with LT suffix and add appropriate leather upcharge for total list price of the piece. Leather welt option is available on textile upholstery only.

Cal 133 Fire Code:
The Krefeld Lounge Collection complies with the California Technical Bulletin 133 standard if upholstered in Cal 133 approved upholstery. Specify suffix -C after pattern number. Upcharge applies, see page 19.

Maintenance:
See pages 28-29.

Note:
The Krefeld Collection is Greenguard certified.

Construction

Frame:
Inner frame in engineered hardwood and plywood. Legs are removable, and are attached to metal plate attached to frame. Coil spring suspension for enhanced comfort. Dynamic suspension in the back for added flexibility and support. Legs are ash hardwood stained (in wenge, medium cherry, deep red mahogany, walnut and clear oak).

Upholstery:
High-density foam cushions with dacron top layer. Benches and ottoman feature dual density foam for added softness and support. Side panel upholstery is tailored to fit, seat and back cushions are more loose.

Inside dimensions:
751 Lounge Chair:
d: 21"
w: 26" *

752 Settee:
d: 21"
w: 51" *

753 Sofa:
d: 21"
w: 76" *

**Width measured at the inside of the front of the arms. The chair tapers back, resulting in less width at the back of the chair than the front.*

pattern no.	grades	COM								COL					
	A	B	C	D	E	F	G	H	I	U	V	W	X	Y	
751-(-)(-)	\$3,568.	\$3,856.	\$4,126.	\$4,427.	\$4,670.	\$4,850.	\$5,148.	\$5,723.	\$6,307.	\$7,095.	\$7,616.	\$8,691.	\$8,911.	\$9,171.	
751LT-(-)(-)(-)	3,568.	3,856.	4,126.	4,427.	4,670.	4,850.	5,148.	5,723.	6,307.						
upchg, welt										1,002.	1,128.	1,382.	1,436.	1,497.	
752-(-)(-)	5,618.	5,913.	6,200.	6,513.	6,767.	6,956.	7,270.	7,869.	8,309.	11,118.	11,810.	13,215.	13,507.	13,847.	
752LT-(-)(-)(-)	5,618.	5,913.	6,200.	6,513.	6,767.	6,956.	7,270.	7,869.	8,309.						
upchg, welt										1,186.	1,334.	1,638.	1,702.	1,773.	

Approved KnollTextiles Grades/Fabrics

A
Alignment ‡
Beacon
Bocce
Cat's Cradle
Chance
Common Ground ‡
Commuter Cloth ‡
Crossroad
Delite
Hourglass
Mariner
Monarch ‡
Prep ‡
Sonnet
Stacks
Trophy
Uni-Form

B
Abacus ‡
Argyle
Belize
Bistro ‡
Cameo
Chroma ‡
Chronicle
Diva
Ferry
Gala II
Grande

B continued
Grandview
Helios
Holbrook
Journey
Keaton
Knoll Felt ‡
Knoll Hopsack ‡
Little Devil
Ludlow
Lyric ‡
Melody
Night Life
Paradigm
Petal Pusher
Prairie
Prim ‡
Pogo
Radiance
Ransom
Ricochet ‡
Roam
Rush Hour
Soiree
Spark ‡
Spree
Summit
Sutton ‡
Synth
Tabloid
Tinge
Venue
Versa
Vinyl
Wide Angle ‡
Zipline

C
Atlas
Axiom
Biota ‡
Cairo
Charm
Circa
Classic Boucle
Dahlia CR
Decade
Durand
Earthwork ‡
Echo
Empire Stripe
Entourage
Essence
Fable CR
Fibra
Greenwich
Hudson
Hula Hoop
Kora CR
Lagos
Lore CR
Metro
Milestone
Moto CR
Palisade
Panache CR
Pullman
Quark
Roundtrip

C continued
Sahara
Sequin CR
Spot On
Star Struck
Stepping Stones
Swing
Tight Rope
Tilden
Tower Grid
Vibe
Wit
Zari CR

D
Coterie
Eclat Weave
Hologram
Island
Kabuki
Masquerade
Menagerie
Origins
Theory
Woodland
Zoom

E
Aegean
Demure
Highland
Ikat Square
Ikat Stripe
Kampala
Katazome
Kimono
Mamba
Marquee
Meroe
Nature Walk
Paradigm
Shima
Tryst
Whip

F
Atelier
Biscayne
Calais Cotton
Velvet
Century
Coco
Cornaro
Clider
Icon
Intrigue
In Stitches
Liberty
Mod Plaid
Rivington
Soon
Tivoli
Topography
Totem

G
Alter Ego
Brugge
Djenne
Feeling Plaid
Garden City
Hampshire
Haze
Kinabalu
Kingston
Melange
Modern Tweed
Petite Floral
Sherman
Ultrasuede ‡

H
Arno
Constance
Firefly
Gezelle
Magritte
Rosemond
Stretch Appeal

I
Aswan
Byron
Cato
Diamond Days
Dynamic
Fiori
Gramercy
Knoll Velvet
Olema
Piper
Rutledge
Sandis
Tudor
Vermeer
Walker
Worth
Zimba

Spinneybeck Leather

U
Vicenza ‡
Volo ‡

V
Acqua ‡
Andes ‡
Embossed Tipped
España ‡
Hand Tipped ‡
Velluto Pelle ‡

W
Alaska ‡
Amazon ‡
Antique ‡
Forte ‡
Lucente
Sabrina ‡

‡ Approved for Cal 133 upholstery.

Check with your KnollTextiles or Spinneybeck Representative for changes or additions.

Ludwig Mies van der Rohe

Krefeld™ Collection

Designer(s):
Ludwig Mies van der Rohe, 1930
Design from the Mies van der Rohe Archive of The Museum of Modern Art



description	seat h	arm h	w	d	h	type	textile fabric yds.	req. leather sq. ft.	weight	
753 Sofa	17 1/4"	25"	82"	27"	30"		11	160	122 lbs.	
Sofa in textile with leather welt option							uphol.	11		
							welt		34	
754 Ottoman	17 1/4"		26"	20 1/2"	17 1/4"		3	50	17 lbs.	
Ottoman in textile with leather welt option							uphol.	3		
							welt		15	

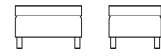
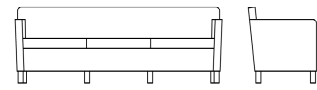

Order Code	Ordering Information	Construction
<i>Example:</i> 751-AWE-DV112	<i>Leg finishes:</i> Clear Oak (suffix AOC) Deep Red Mahogany (suffix AF) Light Walnut (suffix AWA) Medium Cherry (suffix AM) Wenge (suffix AWE)	<i>Frame:</i> Inner frame in engineered hardwood and plywood. Legs are removable, and are attached to metal plate attached to frame. Coil spring suspension for enhanced comfort. Dynamic suspension in the back for added flexibility and support. Legs are ash hardwood stained (in wenge, medium cherry, deep red mahogany, walnut and clear oak).
751 Krefeld lounge chair		<i>Inside dimensions:</i> 751 Lounge Chair: d: 21" w: 26" *
AWE Wenge legs		752 Settee: d: 21" w: 51" *
DV112 Ducale Velour, Brandy		753 Sofa: d: 21" w: 76" *
<i>Example:</i> 752-AWA-K1026/3-VO904	<i>Leather Welt Option:</i> The Krefeld collection may be specified with an optional leather welt option. Welt contours all edges, including cushions. Please specify pattern number with LT suffix and add appropriate leather upcharge for total list price of the piece. Leather welt option is available on textile upholstery only.	<i>Upholstery:</i> High-density foam cushions with dacron top layer. Benches and ottoman feature dual density foam for added softness and support. Side panel upholstery is tailored to fit, seat and back cushions are more loose.
752 Krefeld settee		<i>*Width measured at the inside of the front of the arms. The chair tapers back, resulting in less width at the back of the chair than the front.</i>
AWA Light Walnut legs		
K1026/3 Cross Stitch, Windsor	<i>Cal 133 Fire Code:</i> The Krefeld Lounge Collection complies with the California Technical Bulletin 133 standard if upholstered in Cal 133 approved upholstery. Specify suffix -C after pattern number. Upcharge applies, see page 19.	
VO904 Volo, Stallion welt	<i>Maintenance:</i> See pages 28-29.	
	<i>Note:</i> The Krefeld Collection is Greenguard certified.	

Krefeld lounge seating is part of a collection. Please refer to Mies side chairs and lounge seating beginning on page 190 and tables, beginning on page 342.

Specify:

1. Pattern number
2. Leg finish
3. Textile selection

Leather Welt selection, specify:

1. Pattern number
2. Leg finish
3. Textile selection
4. Leather Welt Selection (upcharge applies)

pattern no.	grades	COM								COL				
	A	B	C	D	E	F	G	H	I	U	V	W	X	Y
753-(-)(-)	\$7,317.	\$7,659.	\$7,985.	\$8,346.	\$8,643.	\$8,855.	\$9,215.	\$9,902.	\$10,408.	\$14,146.	\$14,984.	\$16,698.	\$17,054.	\$17,469.

753LT-(-)(-)(-)	7,317.	7,659.	7,985.	8,346.	8,643.	8,855.	9,215.	9,902.	10,408.					
upchg, welt										1,611.	1,815.	2,226.	2,311.	2,411.
754-(-)(-)	2,092.	2,179.	2,263.	2,355.	2,431.	2,484.	2,577.	2,752.	2,881.	3,853.	4,050.	4,455.	4,540.	4,637.

754LT-(-)(-)(-)	2,092.	2,179.	2,263.	2,355.	2,431.	2,484.	2,577.	2,752.	2,881.					
upchg, welt										711.	801.	983.	1,021.	1,064.

Approved KnollTextiles Grades/Fabrics

A Alignment ‡ Beacon Bocce Cat's Cradle Chance Common Ground ‡ Commuter Cloth ‡ Crossroad Delite Hourglass Mariner Monarch ‡ Prep ‡ Sonnet Stacks Trophy Uni-Form	B Abacus ‡ Argyle Belize Bistro ‡ Cameo Chroma ‡ Chronicle Diva Ferry Gala II Grande	C Atlas Axiom Biota ‡ Cairo Charm Circa Classic Boucle Dahlia CR Decade Durand Earthwork ‡ Echo Empire Stripe Entourage Essence Fable CR Fibra Greenwich Hudson Hula Hoop Kora CR Lagos Lore CR Metro Milestone Moto CR Palisade Synth Pullman Quark Roundtrip	C continued Sahara Sequin CR Spot On Star Struck Stepping Stones Swing Tight Rope Tilden Tower Grid Vibe Wit Zari CR	D Coterie Eclat Weave Hologram Island Kabuki Masquerade Menagerie Origins Theory Woodland Zoom	E Aegean Demure Highland Ikat Square Ikat Stripe Kampala Katazome Kimono Mamba Marquee Meroe Nature Walk Paradigm Shima Tryst Whip	F Atelier Biscayne Calais Cotton Velvet Century Coco Cornaro Clider Icon Intrigue In Stitches Liberty Mod Plaid Rivington Soon Tivoli Topography Totem	G Alter Ego Brugge Djenne Feeling Plaid Garden City Hampshire Haze Kinabalu Kingston Melange Modern Tweed Petite Floral Sherman Ultrasuede ‡	H Arno Constance Firefly Gezelle Magritte Rosemond Stretch Appeal	I Aswan Byron Cato Diamond Days Dynamic Fiori Gramercy Knoll Velvet Olema Piper Rutledge Sandis Tudor Vermeer Walker Worth Zimba	U Vicenza ‡ Volo ‡	V Acqua ‡ Andes ‡ Embossed Tipped España ‡ Hand Tipped ‡ Velluto Pelle ‡	W Alaska ‡ Amazon ‡ Antique ‡ Forte ‡ Lucente Sabrina ‡	Y Capri ‡ Cervo Copenhagen ‡ Distressed ‡ Marissa ‡ Riva ‡ Saddle ‡
---	--	--	---	--	---	---	---	---	--	---------------------------------	---	--	---

Spinneybeck Leather

‡ Approved for Cal 133 upholstery.

Check with your KnollTextiles or Spinneybeck Representative for changes or additions.

Ludwig Mies van der Rohe

Krefeld™ Collection

Designer(s):
Ludwig Mies van der Rohe, 1930
Design from the Mies van der Rohe Archive of The Museum of Modern Art



description	seat h	arm h	w	d	h	type	textile fabric yds.	req. leather sq. ft.	weight
755 Medium Bench	17 1/4"		51"	20 1/2"	17 1/4"		5	64	21 lbs.
Medium Bench in textile with leather welt option						uphol.	5		
						welt		20	
756 Large Bench	17 1/4"		76"	20 1/2"	17 1/4"		5.5	80	45 lbs.
Large Bench in textile with leather welt option						uphol.	5.5		
						welt		20	

Order Code	Ordering Information	Construction
<i>Example:</i> 751-AWE-DV112	<i>Leg finishes:</i> Clear Oak (suffix AOC) Deep Red Mahogany (suffix AF) Light Walnut (suffix AWA) Medium Cherry (suffix AM) Wenge (suffix AWE)	<i>Frame:</i> Inner frame in engineered hardwood and plywood. Legs are removable, and are attached to metal plate attached to frame. Coil spring suspension for enhanced comfort. Dynamic suspension in the back for added flexibility and support. Legs are ash hardwood stained (in wenge, medium cherry, deep red mahogany, walnut and clear oak).
751 Krefeld lounge chair		<i>Inside dimensions:</i> 751 Lounge Chair: d: 21" w: 26" *
AWE Wenge legs		752 Settee: d: 21" w: 51" *
DV112 Ducale Velour, Brandy		753 Sofa: d: 21" w: 76" *
<i>Example:</i> 752-AWA-K1026/3-VO904	<i>Leather Welt Option:</i> The Krefeld collection may be specified with an optional leather welt option. Welt contours all edges, including cushions. Please specify pattern number with LT suffix and add appropriate leather upcharge for total list price of the piece. Leather welt option is available on textile upholstery only.	<i>Upholstery:</i> High-density foam cushions with dacron top layer. Benches and ottoman feature dual density foam for added softness and support. Side panel upholstery is tailored to fit, seat and back cushions are more loose.
752 Krefeld settee	<i>Cal 133 Fire Code:</i> The Krefeld Lounge Collection complies with the California Technical Bulletin 133 standard if upholstered in Cal 133 approved upholstery. Specify suffix -C after pattern number. Upcharge applies, see page 19.	<i>*Width measured at the inside of the front of the arms. The chair tapers back, resulting in less width at the back of the chair than the front.</i>
AWA Light Walnut legs		
K1026/3 Cross Stitch, Windsor		
VO904 Volo, Stallion welt	<i>Maintenance:</i> See pages 28-29.	
	<i>Note:</i> The Krefeld Collection is Greenguard certified.	

Krefeld lounge seating is part of a collection. Please refer to Mies side chairs and lounge seating beginning on page 190 and tables, beginning on page 342.

Specify:

1. Pattern number
2. Leg finish
3. Textile selection

Leather Welt selection, specify:

1. Pattern number
2. Leg finish
3. Textile selection
4. Leather Welt Selection (upcharge applies)

pattern no.	grades	COM	C	D	E	F	G	H	I	COL	V	W	X	Y
755-(-)(-)	\$2,902.	\$3,053.	\$3,202.	\$3,365.	\$3,497.	\$3,594.	\$3,754.	\$4,065.	\$4,292.	\$4,605.	\$4,994.	\$5,789.	\$5,953.	\$6,144.
755LT-(-)(-)(-)	2,902.	3,053.	3,202.	3,365.	3,497.	3,594.	3,754.	4,065.	4,292.					
upchg, welt										950.	1,071.	1,323.	1,376.	1,437.
756-(-)(-)	3,367.	3,572.	3,772.	3,986.	4,165.	4,292.	4,507.	4,921.	5,226.	6,002.	6,551.	7,663.	7,893.	8,164.
756LT-(-)(-)(-)	3,367.	3,572.	3,772.	3,986.	4,165.	4,292.	4,507.	4,921.	5,226.					
upchg, welt										980.	1,101.	1,352.	1,406.	1,467.

Approved KnollTextiles Grades/Fabrics						Spinneybeck Leather						
A Alignment ‡ Beacon Bocce Cat's Cradle Chance Common Ground ‡ Commuter Cloth ‡ Crossroad Delite Hourglass Mariner Monarch ‡ Prep ‡ Sonnet Stacks Trophy Uni-Form	B Abacus ‡ Argyle Belize Bistro ‡ Cameo Chroma ‡ Chronicle Diva Ferry Gala II Grande	C Atlas Axiom Biota ‡ Journey Keaton Knoll Felt ‡ Knoll Hopsack ‡ Little Devil Ludlow Lyric ‡ Melody Night Life Paradigm Petal Pusher Prairie Prim ‡ Pogo Radiance Ransom Ricochet ‡ Roam Rush Hour Soiree Spark ‡ Spree Summit Sutton ‡ Synth Tabloid Tinge Venue Versa Vinyl Wide Angle ‡ Zipline	C continued Sahara Sequin CR Spot On Star Struck Stepping Stones Swing Tight Rope Tilden Tower Grid Vibe Wit Zari CR	D Coterie Eclat Weave Hologram Island Kabuki Masquerade Menagerie Origins Theory Woodland Zoom	E Aegean Demure Highland Ikat Square Ikat Stripe Kampala Katazome Kimono Mamba Marquee Meroe Nature Walk Paradigm Shima Tryst Whip	G Alter Ego Brugge Djenne Feeling Plaid Garden City Hampshire Haze Kinabalu Kingston Melange Modern Tweed Petite Floral Sherman Shima Ultrasuede ‡	H Arno Constance Firefly Gezelle Magritte Rosemond Stretch Appeal	I Aswan Byron Cato Diamond Days Dynamic Fiori Gramercy Knoll Velvet Olema Piper Rutledge Sandis Tudor Vermeer Walker Worth Zimba	U Vicenza ‡ Volo ‡	V Acqua ‡ Andes ‡ Embossed Tipped España ‡ Hand Tipped ‡ Velluto Pelle ‡	W Alaska ‡ Amazon ‡ Antique ‡ Forte ‡ Lucente Sabrina ‡	Y Capri ‡ Cervo Copenhagen ‡ Distressed ‡ Marissa ‡ Riva ‡ Saddle ‡

‡ Approved for Cal 133 upholstery.

Check with your KnollTextiles or Spinneybeck Representative for changes or additions.

George Nakashima
Straight Chair

	description	seat h	w	d	h	weight
<i>Designer(s):</i> George Nakashima, 1946	N19 Straight Chair	17 1/4"	22 1/2"	17 1/2"	30"	11 lbs.



pattern no.	
N19-AW	\$1,188.

Order Code	Ordering Information	Construction
<i>Example:</i> N19-AW	<i>Finishes:</i> American Walnut (suffix AW)	<i>Frame:</i> Constructed from solid American Walnut, turned American Walnut legs and stretchers, and contrasting Hickory spindles, clear low-sheen finish and nylon glides.
N19 Straight Chair	<i>Maintenance:</i> See pages 28-29.	<i>Note:</i> American Walnut exhibits a high degree of natural color characteristics, ranging from chocolate, grey and purplish-browns to deep honey. Color variation will soften and become more uniform over time.
AW American Walnut	<i>Note:</i> The Straight Chair is Greenguard certified.	
<i>Note:</i> The Straight chair is part of a collection. Please refer to the Splay-Leg table on page 352.	Each chair features George Nakashima's signature under the seat.	
<i>Specify:</i> 1. Pattern number 2. Finish		

Jonathan Olivares
Aluminum Stacking Chair

	description	seat h	w	d	h	weight
<i>Designer(s):</i> Jonathan Olivares, 2012	OAC1 Olivares Chair	17 1/2"	22 1/3"	21 7/8"	31 1/2"	15 lbs.



pattern no.	list
OAC1-()	\$923.

Order Code	Ordering Information	Construction
<i>Example:</i> OAC1-WHT	<i>Paint finishes:</i>	<i>Shell:</i>
OAC1 Olivares chair	White (suffix WHT)	Constructed from die-cast aluminum with integrated leg tenons. A long low-profile nylon stacking bumper distributes the chair's weight over a wide area providing a more stable stacking condition. The designer's signature and KnollStudio logo are located under the seat.
WHT White paint finish	Grey (suffix GRY)	
	Yellow (suffix YEL)	
	Lime Green (suffix LGR)	
	Orange (suffix ORG)	
	Plum (suffix PLM)	
	Sky Blue (suffix SBL)	
	Blue (suffix BLU)	
	Dark Charcoal (CHR)	
<i>Specify:</i>	<i>Maintenance:</i>	<i>Legs:</i>
1. Pattern number	See pages 28-29.	Aluminum extruded legs are secured to the chair's shell using epoxy and stainless steel fasteners.
2. Paint finish selection		
		<i>Paint:</i>
		Ultra-durable polyester powder coat paint.
		<i>Glides:</i>
		1/4" flat nylon glides.
		<i>Stacking:</i>
		Chairs stack six on the floor.
		<i>Outdoor use:</i>
		With proper preventative maintenance, the Olivares chair is appropriate for outdoor environments.

Jorge Pensi
Toledo Stacking Chair

	description	seat h	arm h	w	d	h	textile fabric yds.	req. leather sq. ft.	weight
<i>Designer(s):</i> Jorge Pensi, 1988	29C Toledo Chair	17 1/4"	27 1/4"	21 1/8"	21 1/4"	29 7/8"			15 lbs.
<i>Award(s):</i> First Place, Sidi Selection, Valencia, Spain, 1988; "Delta Plate" of ADI FAD, 1988; Design Center Stuttgart Award, W. Germany, 1990	29K Toledo Chair, seat cushion replacement						0.6	7	

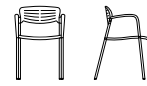

pattern no.	grades	COM	C	D	E	F	G	H	I	COL	V	W	X	Y
29C														
	\$1,935.													
29K	274.	299.	318.	344.	363.	377.	402.	450.	486.	480.	536.	643.	665.	692.

Order Code	Ordering Information	Construction
<i>Example:</i> 410-WH-C	<i>Shell finishes:</i>	<i>Base:</i>
410 Shell side chair	Black (suffix BL)	Welded steel with rods in polished chrome or highly durable bonded powder coat (white and black)
WH White shell	White (suffix WH)	
C Polished chrome base	Medium Grey (suffix MG)	<i>Basket:</i>
	Blue (suffix BU)	Glass fiber reinforced nylon shell
	Orange Red (suffix OR)	
	Yellow (suffix YE)	
	<i>Base finishes:</i>	
	Polished Chrome (suffix C)	
	Black (suffix BL)	
	White (suffix W)	

Charles Pfister

Petite Lounge Seating

Designer(s):
Charles Pfister, 1971



description	seat h	arm h	w	d	h	textile fabric yds.	req. leather sq. ft.	weight
1051C-S Petite lounge chair	16"	24"	29 1/2"	29 1/2"	26"	6.5	117	39 lbs.
1051C-ST-() Petite Pfister lounge chair with optional tablet arm	16"	24"	29 1/2"	29 1/2"	26"	6.5	117	41 lbs.

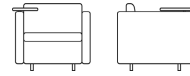
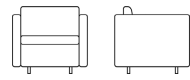

Order Code

<i>Example:</i>	1051C-ST-R-H-K109/15
1051C	Petite Pfister lounge chair
ST	Tablet arm option
R	Right handed tablet arm
H	Caster option
K109/15	Haze, Persimmon

Specify:

1. Pattern number
2. Cal 133 Fire Code option
3. Tablet option (lounge chair only), right or left
4. Caster option (lounge chair only)
5. Textile selection

Ordering Information

Tablet arm option (suffix ST), lounge chair only:
Left handed (suffix L)
Right handed (suffix R)

Caster option (suffix H), lounge chair only:
To specify four casters add -H to end of pattern number before upholstery selection.

Upholstery/COM information:
Prices shown include fabric or leather upholstery. Contact your Knoll representative for colors. Only approved KnollTextiles and Spinneybeck leathers may be ordered.

Customer's Own Material is available pending approval. Non-railroad COM fabrics will require additional yardage. For approval requirements, processing instructions and ordering information please see page 18.

Cal 133 Fire Code:
Petite Pfister lounge seating complies with the California Technical Bulletin 133 standard if upholstered in Cal 133 approved upholstery. Specify suffix -C at end of pattern number and suffix -133 at end of textile selection. Upcharge applies, see page 19.

Note:
The Petite Pfister Lounge Seating Collection is Greenguard certified.

Construction

Frame:
Constructed in sections with a combination plywood/hardwood seat and back.

Upholstery:
Petite Pfister lounge seat and back cushion are fully upholstered. Double-needled top stitching on leather upholstery and on thin solid textiles. Single-needled top stitching on heavily ribbed fabrics and multicolor prints. No sag spring deck covered in black cotton textile.

Swivel tablet:
Machined aluminum, post and socket mechanism with black phenolic rectangular tablet; swivels 360°. Tablet dimensions are 10" x 14".

Seat height:
Seat height is measured from the floor to the crown of the seat cushion. Height could vary up to 1/2" depending on leather or textile specified.

Glides:
Nylon, adjustable.

Cushion fill:
Polyester wrap; foam core with polyester fiber wrap for tight, tailored aesthetic.

pattern no.	upcharge	grades A	COM B	C	D	E	F	G	H	I	COL U	V	W	X	Y
1051C-S		\$2,745.	\$3,003.	\$3,250.	\$3,520.	\$3,741.	\$3,898.	\$4,166.	\$4,683.	\$5,210.	\$6,556.	\$7,480.	\$9,441.	\$9,747.	\$10,199.
1051C-ST-()		3,467.	3,723.	3,973.	4,239.	4,461.	4,621.	4,887.	5,405.	5,933.	7,279.	8,201.	10,163.	10,467.	10,922.

Approved KnollTextiles Grades/Fabrics

A Alignment † Beacon Bocce Cat's Cradle Chance Common Ground † Commuter Cloth † Crossroad Delite Dristi Hourglass Mariner Monarch Prep Soliloquy Sonnet Stacks Trophy Uni-Form	B Abacus † Argyle Belize Bistro † Boundary † Cameo Chroma † Chronicle Diva Dovetail Ferry Gala II Grande	C Atlas Axiom Baxter Biota † Cairo Charm Circa Classic Boucle Dahlia CR Decade Dune Durand Earthwork † Echo Empire Stripe Entourage Esseence Fable CR Fibra Greenwich Hudson Hula Hoop Kaleidoscope CR Kora CR Lagos Legend CR Lore CR Magnolia Metro Milestone Moto CR Noble Palisade Panache CR Pullman Quark Regard CR Roundtrip Sahara Sandpiper Sequin CR Sinclair Smart Spectator	C continued Grandview Helios Holbrook Journey Keaton Knoll Felt † Knoll Hopsack † Little Devil Ludlow Lyric Melody Mini Stitch Night Life Paradigm Petal Pusher Pogo † Prairie Prim † Radiance Ransom Ricochet † Roam Rush Hour Soiree Spark † Spree Summit Sutton Synth Tabloid Tinge Venue Versa Vinyl Westwood Wide Angle † Yeni Zipline	C continued Spot On Star Struck Stepping Stones Swing Tight Rope Tilden Tower Grid Trebble CR Wit Zari CR	D Compass CR Coterie Eclat Weave Hologram Island Masquerade Menagerie Origins Tara Theory Woodland Zoom	E Aegean Demure Highland Ikat Square Ikat Stripe Kampala Katazome Kimono Mamba Marquee Meroe Midpoint Nature Walk Sherman Shima Tryst Vatera Whip
--	--	--	--	--	--	--

Spinneybeck Leather

U Vicenza † Volo †	V Acqua † Andes † Embossed Tipped España † Hand Tipped Maremma Velluto Pelle †	W Alaska † Amazon † Antique † Derby † Forte † Lucente † Sabrina †	X Ducale † Ducale Velour †	Y Capri † Cervo Copenhagen † Distressed † Lucca Marissa † Portofino Riva † Saddle † Torello
---------------------------------	--	---	---	--



† Approved for Cal 133 upholstery.

Check with your KnollTextiles or Spinneybeck Representative for changes or additions.

Charles Pfister Petite Lounge Seating

Designer(s):
Charles Pfister, 1971

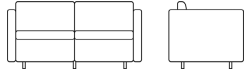

description	height, seat	height, arm	width	depth	height	textile fabric yards	leather sq ft	weight
1052C-S Petite settee 	16"	24"	53"	29 1/2"	26"	10.8	194	64 lbs.
1053C-S Petite sofa 	16"	24"	76 1/2"	29 1/2"	26"	15.0	270	88 lbs.
1059C-S Petite ottoman 			22"	22"	16"	3.8	69	18 lbs.
H Optional casters for Petite lounge chair								

Order Code

<i>Example:</i>	1051C-ST-R-H-K109/15
1051C	Petite Pfister lounge chair
ST	Tablet arm option
R	Right handed tablet arm
H	Caster option
K109/15	Haze, Persimmon

Specify:

1. Pattern number
2. Cal 133 Fire Code option
3. Tablet option (lounge chair only), right or left
4. Caster option (lounge chair only)
5. Textile selection

Ordering Information

Tablet arm option (suffix ST), lounge chair only:
Left handed (suffix L)
Right handed (suffix R)

Caster option (suffix H), lounge chair only:
To specify four casters add -H to end of pattern number before upholstery selection.

Upholstery/COM information:
Prices shown include fabric or leather upholstery. Contact your Knoll representative for colors. Only approved KnollTextiles and Spinneybeck leathers may be ordered.

Customer's Own Material is available pending approval. Non-railroad COM fabrics will require additional yardage. For approval requirements, processing instructions and ordering information please see page 18.

Cal 133 Fire Code:
Petite Pfister lounge seating complies with the California Technical Bulletin 133 standard if upholstered in Cal 133 approved upholstery. Specify suffix -C at end of pattern number and suffix -133 at end of textile selection. Upcharge applies, see page 19.

Note:
The Petite Pfister Lounge Seating Collection is Greenguard certified.

Construction

Frame:
Constructed in sections with a combination plywood/hardwood seat and back.

Upholstery:
Petite Pfister lounge seat and back cushion are fully upholstered. Double-needled top stitching on leather upholstery and on thin solid textiles. Single-needled top stitching on heavily ribbed fabrics and multicolor prints. No sag spring deck covered in black cotton textile.

Swivel tablet:
Machined aluminum, post and socket mechanism with black phenolic rectangular tablet; swivels 360°. Tablet dimensions are 10" x 14".

Seat height:
Seat height is measured from the floor to the crown of the seat cushion. Height could vary up to 1/2" depending on leather or textile specified.

Glides:
Nylon, adjustable.

Cushion fill:
Polyester wrap: foam core with polyester fiber wrap for tight, tailored aesthetic.

pattern no.	upcharge	grade A	COM B	C	D	E	F	G	H	I	COL U	V	W	X	Y
1052C-S		\$4,821.	\$5,245.	\$5,654.	\$6,095.	\$6,461.	\$6,725.	\$7,172.	\$8,022.	\$8,892.	\$11,168.	\$12,698.	\$15,951.	\$16,457.	\$17,209.
1053C-S		6,738.	7,332.	7,896.	8,519.	9,028.	9,397.	10,019.	11,204.	12,421.	15,624.	17,749.	22,275.	22,979.	24,027.
1059C-S		2,027.	2,170.	2,302.	2,448.	2,566.	2,652.	2,800.	3,074.	3,358.	4,282.	4,794.	5,881.	6,052.	6,305.
H	n/c														

Approved KnollTextiles Grades/Fabrics

A Alignment † Beacon Bocce Cat's Cradle Chance Common Ground † Commuter Cloth † Crossroad Delite Dristi Hourglass Mariner Monarch Prep Soliloquy Sonnet Stacks † Trophy Uni-Form	B Abacus † Argyle Belize Bistro † Boundary † Cameo Chroma † Chronicle Diva Dovetail Ferry Gala II	C Atlas Axiom Baxter Biota † Cairo Charm Circa Classic Boucle Dahlia CR Decade Dune Durand Earthwork † Echo Empire Stripe Entourage Island Fable CR Fibra Greenwich Hudson Hula Hoop Kaleidoscope CR Kora CR Lagos Legend CR Lore CR Magnolia Metro Milestone Moto CR Noble Palisade Panache CR Pullman Quark Regard CR Roundtrip Sahara Sandpiper Sequin CR Sinclair Smart Spectator	C continued Spot On Star Struck Stepping Stones Swing Tight Rope Tilden Tower Grid Treble CR Wit Zari CR	D Compass CR Coterie Eclat Weave Hologram Island Masquerade Menagerie Origins Tara Theory Woodland Zoom	E Aegean Demure Highland Ikat Square Ikat Stripe Kampala Katazome Kimono Mamba Marquee Meroe Midpoint Nature Walk Sherman Shima Tryst Vatera Whip
--	--	--	---	--	--

Spinneybeck Leather

F Atelier Biscayne Calais Cotton Velvet Century Coco Cornaro Glider Icon Intrigue In Stitches Jasmine Liberty Mod Plaid Rivington Soon Tivoli Topography Totem	G Abington Alter Ego Amore Andissa Arabella Arber Brugge Djenne Feeling Plaid Garden City Gibson Hampshire Haze Kamani Kinabalu Kingston Melange Metallic Gloss Modern Tweed Petite Floral Sablon Serendipity Spencer † Straie Stripe Ultrasuede Utrillo	H Arno Bavaria Catwalk Constance Firefly Gezelle Magritte Rosemond Stretch Appeal	I Aswan Byron Canaan Cato Cummings Diamond Days Digi Velvet Dynamic Fiori Gramercy Ita Jaipur Knoll Velvet † Mepal North Island Olema Piper Rutledge Sandis Tudor Vermeer Walker Worth Zimba	U Vicenza † Volo †	V Acqua † Andes † Embossed Tipped España † Hand Tipped Maremma Velluto Pelle †	W Alaska † Amazon † Antique † Derby † Forte † Lucente † Sabrina †	X Ducale † Ducale Velour †	Y Capri † Cervo Copenhagen † Distressed † Lucca Marissa † Portofino Riva † Saddle † Torello
--	---	---	---	---------------------------------	--	---	---	--



† Approved for Cal 133 upholstery.

Check with your KnollTextiles or Spinneybeck Representative for changes or additions.

Charles Pfister Lounge Seating

Designer(s):
Charles Pfister, 1971

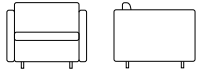
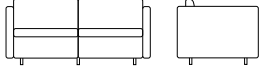

description	seat h	arm h	w	d	h	textile fabric yds.	req. leather sq. ft.	weight
1051C Standard lounge chair	16"	24"	33 1/2"	33"	26"	7.2	130	44 lbs.
								
1052C Standard settee	16"	24"	60 1/2"	33"	26"	12.4	224	73 lbs.
								
1053C Standard sofa	16"	24"	87"	33"	26"	17.6	318	101 lbs.
								
1059C Standard ottoman			27 1/4"	27 1/4"	16"	3.8	69	20 lbs.
								

Order Code

<i>Example:</i>	1053C-MABLK
1053C	Pfister sofa
MABLK	Marissa, Black

Specify:

1. Pattern number
2. Cal 133 Fire Code option
3. Textile selection

Ordering Information

Upholstery/COM information:
Prices shown include fabric or leather upholstery. Contact your Knoll representative for colors. Only approved KnollTextiles and Spinneybeck leathers may be ordered.

Customer's Own Material is available pending approval. Non-railroad COM fabrics will require additional yardage. For approval requirements, processing instructions and ordering information please see page 18.

Cal 133 Fire Code:
Pfister lounge seating complies with the California Technical Bulletin 133 standard if upholstered in Cal 133 approved upholstery. Specify suffix -C at end of pattern number and suffix -133 at end of textile selection. Upcharge applies, see page 19.

Maintenance:
To fluff standard Pfister cushions, turn cushion upside down occasionally. See also pages 28-29.

Note:
The Pfister Lounge Seating Collection is Greenguard certified.

Construction

Frame:
Constructed in sections with a combination plywood/hardwood seat and back.

Upholstery:
Pfister lounge seat and back cushion are fully upholstered. Double-needled top stitching on leather upholstery and on thin solid textiles. Single-needled top stitching on heavily ribbed fabrics and multicolor prints. No sag spring deck covered in black cotton textile.

Seat height:
Seat height is measured from the floor to the crown of the seat cushion. Height could vary up to 1/2" depending on leather or textile specified.

Glides:
Nylon, adjustable.

Cushion fill:
Polyester wrap: foam core with polyester fiber wrap for tight, tailored aesthetic.

pattern no.	grades A	COM B	C	D	E	F	G	H	I	COL U	V	W	X	Y
1051C	\$3,440.	\$3,715.	\$3,980.	\$4,267.	\$4,502.	\$4,675.	\$4,962.	\$5,515.	\$6,083.	\$7,602.	\$8,598.	\$10,705.	\$11,034.	\$11,525.
1052C	6,083.	6,559.	7,010.	7,507.	7,918.	8,208.	8,710.	9,658.	10,631.	13,267.	14,978.	18,614.	19,179.	20,020.
1053C	8,523.	9,199.	9,840.	10,548.	11,127.	11,542.	12,252.	13,600.	14,981.	18,772.	21,197.	26,360.	27,159.	28,359.
1059C	2,560.	2,709.	2,848.	2,999.	3,123.	3,213.	3,368.	3,657.	3,954.	4,943.	5,467.	6,585.	6,762.	7,020.

Approved KnollTextiles Grades/Fabrics

A Alignment # Beacon Bocce Cat's Cradle Chance Common Ground # Commuter Cloth # Crossroad Delite Dristi Hourglass Mariner Monarch Prep Soliloquy Sonnet Stacks Trophy Uni-Form	B Abacus # Argyle Belize Bistro # Boundary # Cameo Chroma # Chronicle Diva Dovetail Ferry Gala II	C Atlas Axiom Baxter Biota # Cairo Charm Circa Classic Boucle Dahlia CR Decade Dune Durand Earthwork # Echo Empire Stripe Entourage Essence Fable CR Fibra Greenwich Hudson Hula Hoop Kaleidoscope CR Kora CR Lagos Legend CR Lore CR Magnolia Metro Milestone Moto CR Noble Palisade Panache CR Pullman Quark Regard CR Roundtrip Sahara Sandpiper Sequin CR Sinclair Smart Spectator	C continued Spot On Star Struck Stepping Stones Swing Tight Rope Tilden Tower Grid Treble CR Wit Zari CR	D Compass CR Coterie Eclat Weave Hologram Island Masquerade Menagerie Origins Tara Theory Woodland Zoom	E Aegean Demure Highland Ikat Square Ikat Stripe Kampala Katazome Kimono Mamba Marquee Meroe Midpoint Nature Walk Sherman Shima Tryst Vatera Whip
--	--	---	---	--	--

Spinneybeck Leather

U Vicenza # Volo #	V Acqua # Andes # Embossed Tipped España # Hand Tipped Maremma Velluto Pelle #	W Alaska # Amazon # Antique # Derby # Forte # Lucente # Sabrina #	X Ducale # Ducale Velour #	Y Capri # Cervo Copenhagen # Distressed # Lucca Marissa # Portofino Riva # Saddle # Torello
---------------------------------	--	---	---	--



Approved for Cal 133 upholstery.

Check with your KnollTextiles or Spinneybeck Representative for changes or additions.

Charles Pfister Sofa System

Designer(s):
Charles Pfister, 1971

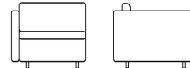

description	seat h	arm h	w	d	h	textile fabric yds.	req. leather sq. ft.	weight
1050C Center module	16"		27 1/4"	33"	26"	5.2	94	28 lbs.
								
1050C-1 End module, arm panel on right side of user	16"	24"	30 1/8"	33"	26"	6.2	112	36 lbs.
								
1050C-2 End module, arm panel on left side of user	16"	24"	30 1/8"	33"	26"	6.2	112	36 lbs.
								
1050C-3 Corner module	16"	24"	33"	33"	26"	7.0	126	41 lbs.
								

Order Code	Ordering Information	Construction
<i>Example:</i> 1050C-3-K349/1	<i>Upholstery/COM information:</i>	<i>Cal 133 Fire Code</i> ▲ :
1050C-3 Pfister corner module	Prices shown include fabric or leather upholstery. Contact your Knoll representative for colors. Only approved KnollTextiles and Spinneybeck leathers may be ordered. <u>Note:</u> Non-railroad COM fabrics will require additional yardage.	The Pfister Collection complies with the California Technical Bulletin 133 standard if upholstered in Cal 133 approved upholstery. Specify polyester fiber wrap and suffix -C at end of pattern number and suffix -133 at end of textile selection. Upcharge applies, see page 18.
K349/1 Alignment, Sand	Customer's Own Material is available pending approval. For approval requirements, processing instructions and ordering information please see page 18.	<i>Frame:</i> Constructed in sections with a combination plywood/hardwood seat and back.
<i>Specify:</i>		<i>Upholstery:</i> Pfister sofa system cushions are fully upholstered. Coverings are upholstered on both sides in fabric or leather. Double-needled top stitching on leather upholstery and thin solid textiles. Single-needled top stitching on heavily ribbed fabrics and multicolor prints. No sag spring deck covered in black cotton textile.
1. Pattern number		<i>Cushion fill:</i> Polyester wrap: foam core with polyester fiber wrap for tight, tailored aesthetic.
2. Cal 133 Fire Code option		<i>Glides:</i> Nylon, adjustable.
3. Textile selection		
	<i>Note:</i> Modules shipped with unupholstered sides unless specified. For upholstered sides, contact your Knoll representative for pricing. All modules shipped knocked-down (KD), assembly required.	
	<i>Note:</i> The Pfister Sofa System is Greenguard certified.	

pattern no.	grades A	COM B	C	D	E	F	G	H	I	COL U	V	W	X	Y
1050C	\$2,623.	\$2,824.	\$3,010.	\$3,221.	\$3,392.	\$3,516.	\$3,724.	\$4,126.	\$4,532.	\$5,765.	\$6,482.	\$7,938.	\$8,245.	\$8,601.
1050C-1	3,255.	3,495.	3,721.	3,974.	4,174.	4,323.	4,569.	5,048.	5,532.	7,048.	7,904.	9,641.	10,002.	10,425.
1050C-2	3,255.	3,495.	3,721.	3,974.	4,174.	4,323.	4,569.	5,048.	5,532.	7,048.	7,904.	9,641.	10,002.	10,425.
1050C-3	4,018.	4,288.	4,541.	4,825.	5,056.	5,221.	5,502.	6,039.	6,587.	8,376.	9,334.	11,289.	11,699.	12,172.

Approved KnollTextiles Grades/Fabrics						Spinneybeck Leather							
A Alignment ▲ Beacon Bocce Cat's Cradle Chance Common Ground ▲ Commuter Cloth ▲ Crossroad Delite Dristi Hourglass Mariner Monarch Prep Soliloquy Sonnet Stacks Trophy Uni-Form	B continued Journey Keaton Knoll Felt ▲ Knoll Hopsack ▲ Little Devil Ludlow Lyric Melody Mini Stitch Night Life Paradigm Petal Pusher Pogo ▲ Prairie Prim ▲ Radiance Ransom Ricochet ▲ Roam Rush Hour Soiree Spark ▲ Spree Summit Sutton Synth Tabloid Tinge Venue Versa Vinyl Westwood Wide Angle ▲ Yeni Zipline	C Atlas Axiom Baxter Biota ▲ Cairo Charm Circa Classic Boucle Dahlia CR Decade Dune Durand Earthwork ▲ Echo Empire Stripe Entourage Essence Fable CR Fibra Greenwich Hudson Hula Hoop Kaleidoscope CR Kora CR Lagos Legend CR Lore CR Magnolia Metro Milestone Moto CR Noble Palisade Panache CR Pullman Regard CR Roundtrip Sahara Sandpiper Sequin CR Sinclair Smart	C continued Spectator Spot On Star Struck Stepping Stones Swing Tight Rope Tilden Tower Grid Treble CR Wit Zari CR	D Compass CR Coterie Eclat Weave Hologram Island Masquerade Menagerie Origins Tara Theory Woodland Zoom	E continued Vatera Whip	F Atelier Biscayne Calais Cotton Velvet Century Coco Cornaro Glider Icon Intrigue In Stitches Jasmine Liberty Mod Plaid Rivington Soon Tivoli Topography Totem	G continued Sablon Serendipity Spencer ▲ Straie Stripe Utrasuede Utrillo	H Arno Bavaria Catwalk Constance Firefly Gezelle Magritte Rosemond Stretch Appeal	I Aswan Byron Canaan Cato Cummings Diamond Days Digi Velvet Dynamic Fiori Gramercy Ita Jaipur Knoll Velvet ▲ Mepal North Island Olema Piper Rutledge Sandis Tudor Vermeer Walker Worth Zimba	U Vicenza ▲ Volo ▲	V Acqua ▲ Andes ▲ Embossed Tipped España ▲ Hand Tipped Maremma Velluto Pelle ▲	W Alaska ▲ Amazon ▲ Antique ▲ Derby ▲ Forte ▲ Lucente ▲ Sabrina ▲	Y Ducale ▲ Ducale Velour ▲ Capri ▲ Cervo Copenhagen ▲ Distressed ▲ Lucca Marissa ▲ Portofino Riva ▲ Saddle ▲ Torello

▲ Approved for Cal 133 upholstery.



Check with your KnollTextiles or Spinneybeck Representative for changes or additions.

Warren Platner Seating Collection

Designer(s):
Warren Platner, 1962

Award(s):
1966 American Institute of
Architects International Award

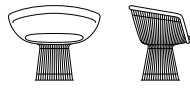
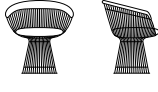



description	seat h	w	d	h	frame	textile fabric yds.	req. leather sq ft	weight
1715L Lounge chair 	18 1/2"	36 1/2"	25 1/2"	30 1/4"	gold	4.0	n/a	37 lbs.
	18 1/2"	36 1/2"	25 1/2"	30 1/4"	nickel	4.0	n/a	37 lbs.
	18 1/2"	36 1/2"	25 1/2"	30 1/4"	bronze	4.0	n/a	37 lbs.
1725A Arm chair 	19"	26 1/2"	22"	28 3/4"	nickel	1.8	35	21 lbs.
	19"	26 1/2"	22"	28 3/4"	bronze	1.8	35	21 lbs.
	19"	26 1/2"	22"	28 3/4"	gold	1.8	35	21 lbs.
1719Y Stool 	22 3/4"	15 1/4"		22 3/4"	nickel	1.1	20	12 lbs.
	22 3/4"	15 1/4"		22 3/4"	bronze	1.1	20	12 lbs.
	22 3/4"	15 1/4"		22 3/4"	gold	1.1	20	12 lbs.

pattern no.	grades A	COM B	C	D	E	F	G	H	I	COL U	V	W	X	Y
1715L-GLD-()	\$11,030.	\$11,119.	\$11,218.	\$11,335.	\$11,498.	\$11,593.	\$11,758.	\$11,869.	\$12,198.					
1715L-N-()	8,271.	8,392.	8,512.	8,639.	8,744.	8,819.	8,950.	9,195.	9,375.					
1715L-BRM-()	8,739.	8,861.	8,980.	9,107.	9,213.	9,289.	9,416.	9,663.	9,842.					
1725A-N-()	4,747.	4,803.	4,855.	4,913.	4,962.	4,996.	5,054.	5,165.	5,246.	5,574.	5,788.	6,221.	6,311.	6,417.
1725A-BRM-()	5,125.	5,180.	5,234.	5,292.	5,341.	5,376.	5,431.	5,543.	5,625.	5,955.	6,166.	6,601.	6,693.	6,796.
1725A-GLD-()	6,922.	6,962.	7,006.	7,060.	7,133.	7,175.	7,249.	7,300.	7,448.	10,654.	10,805.	11,111.	11,174.	11,249.
1719Y-N-()	2,680.	2,712.	2,744.	2,779.	2,808.	2,830.	2,865.	2,933.	2,983.	3,147.	3,268.	3,517.	3,569.	3,630.
1719Y-BRM-()	2,797.	2,831.	2,862.	2,898.	2,927.	2,948.	2,985.	3,051.	3,102.	3,266.	3,387.	3,636.	3,687.	3,748.
1719Y-GLD-()	4,015.	4,040.	4,066.	4,099.	4,144.	4,170.	4,216.	4,246.	4,336.	6,136.	6,221.	6,396.	6,433.	6,476.

Order Code	Ordering Information	Construction
<i>Example:</i> 410-WH-C	<i>Shell finishes:</i>	<i>Base:</i>
410 Shell side chair	Black (suffix BL)	Welded steel with rods in polished chrome or highly durable bonded powder coat (white and black)
WH White shell	White (suffix WH)	<i>Basket:</i>
C Polished chrome base	Medium Grey (suffix MG)	Glass fiber reinforced nylon shell
	Blue (suffix BU)	
	Orange Red (suffix OR)	
	Yellow (suffix YE)	
<i>Specify:</i>	<i>Base finishes:</i>	
1. Pattern number	Polished Chrome (suffix C)	
2. Shell finish	Black (suffix BL)	
3. Base finish	White (suffix W)	

Warren Platner Easy Chair and Ottoman

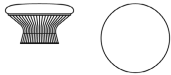
	description	seat h	w	d	h	frame	textile fabric yds.	weight
<i>Designer(s):</i> Warren Platner, 1962 	1705L Easy Chair	18 3/4"	39 7/8"	37"	33 3/4"	nickel	7.0	n/a
								
	1709Y Ottoman	—	26 3/4"	26 3/4"	16 7/8"	nickel	2.75	n/a
								

pattern no.	grades A	COM B	C	D	E	F	G	H	I
1705L-N	\$12,942.	\$13,109.	\$13,267.	\$13,443.	\$13,586.	\$13,690.	\$13,865.	\$14,200.	\$14,445.
1709Y-N	3,547.	3,613.	3,676.	3,746.	3,801.	3,842.	3,911.	4,042.	4,140.

Order Code	Ordering Information	Construction
<i>Example:</i> 1705L-N-H800/2	<i>Frame:</i> Polished Nickel (suffix N)	<i>Construction:</i> Hand bent vertical steel wire rods welded to circular horizontal and edge-framing rods. Finish in bright nickel with a clear lacquer protection. Clear plastic extrusion ring for a smooth bottom surface. Molded fiberglass shell with highly resilient molded urethane foam cushions. Seat and ottoman cushion utilize the same highly resilient molded urethane foam cushion.
1705L Platner Easy chair		
N Nickel frame	<i>Upholstery/COM information:</i> Prices shown include fabric upholstery. Contact your Knoll representative for colors. Only approved KnollTextiles may be ordered. All textiles will be cut railroad.	<i>Maintenance:</i> See pages 28-29.
H800/2 Cato, Sand	<i>Note:</i> The Platner Easy Chair and Ottoman are Greenguard certified.	
<i>Note:</i> Platner Easy Chair and Ottoman is part of a collection. Please refer to Platner Seating Collection on page 222 and Platner tables on page 362.	Customer's Own Material is available pending approval. For approval requirements, processing instructions and ordering information please see page 18.	
<i>Specify:</i> 1. Pattern number 2. Frame finish 3. Textile selection	<i>Cal 133 Fire Code</i>  : The Easy Chair and Ottoman comply with the California Technical Bulletin 133 standard if upholstered in Cal 133 approved upholstery. Specify suffix -C at end of pattern number and suffix -133 at end of textile selection. Upcharge applies, see page 19.	

Approved KnollTextiles Grades/Fabrics					
A Bocce Cat's Cradle Common Ground  Commuter Cloth Delite Hourglass Monarch Sonnet Stacks Trophy Uni-Form	B Abacus Argyle Belize Boundary Cameo Chronicle Diva Dovetail Ferry Grande Grandview Hollbrook Journey Keaton Knoll Felt  Knoll Hopsack  Little Devil Ludlow Lyric	C continued Melody Mini Stitch Night Life  Paradigm Petal Pusher Pogo Prim Radiance Ransom Roam Soiree Spark Spree Summit Yeni Zipline	D continued Hudson Hula Hoop Metro Milestone Pullman Quark Regard CR Roundtrip Smart Star Struck Swing Tight Rope Tower Grid Treble CR Wit	E continued Highland Ikat Square Ikat Stripe Kampala Katazome Kimono Mamba Marquee Meroe Shima Whip	F Atelier Biscayne Coco Glider Icon Intrigue In Stitches Liberty Mod Plaid Rivington Topography
G Abington Alter Ego Arabella Brugge Feeling Plaid Garden City Gibson Hampshire Haze Kamani Kinabalu Kingston Melange Metallic Gloss Modern Tweed Petite Floral Sablon Serendipity Spencer Straie Stripe Ultrasuede Utrillo	H Arno Bavaria Catwalk Constance Firefly Gezelle Magritte Rosemond	I Canaan Cato Diamond Days Dynamic Jaipur Knoll Velvet Limani North Island  Olema Piper Rutledge Vermeer Walker Worth Zimba			

 Approved for Cal 133 upholstery

Charles Pollock

Executive Conference Arm and Armless Chairs

	description	seat h	arm h	w	d	h	textile fabric yds.	req. leather sq. ft.	weight
<i>Designer(s):</i> Charles Pollock, 1963	12A-(1, 2, 3 or 4)-D5G-H Arm chair, swivel/tilt, pneumatic height, seat height adjustment	18"-23"	24"-29"	26 1/4"	28 1/4"	31"-36"	1.1	20	44 lbs.
									44 lbs.
	12C-(1, 2, 3 or 4)-D5G-H Armless chair, swivel/tilt, pneumatic height, seat height adjustment	18"-23"		23 1/2"	28 1/4"	31"-36"	1.1	20	41 lbs.
									41 lbs.
	R Optional casters for hard floors (substitute -R for -H in pattern number)								
	1250COVER Replacement cover						1.1	20	
	1250BUTTON Replacement buttons (specify upholstery)								



Order Code	Ordering Information	Construction
<i>Example:</i> 12A-1-D5G-H-AM3030	<i>Frame/base top cap finishes:</i> Polished aluminum/stainless steel (suffix 1) Satin anodized aluminum/brushed stainless steel (suffix 2) Black anodized aluminum/black epoxy (suffix 3) Black anodized aluminum/stainless steel (suffix 4)	<i>Outer shell:</i> Integrally colored, black textured polypropylene. <i>Frame:</i> Extruded aluminum with polished, satin or black anodized finish. Steel support plate spans the width of the seat cushion. <i>Upholstery:</i> Multi-density urethane foam (4 1/2" maximum thickness); button tufting on fabric and leather detail.
12A Pollock arm chair		<i>Standard casters:</i> Hard wheel casters standard. <i>Controls:</i> 360° swivel; tilt with tilt tension and pneumatic seat height adjustment. <i>Replacement buttons:</i> Set of 6 buttons for one chair.
1 Polished aluminum frame/stainless steel base top caps		<i>Replacement cover:</i> Must be installed by an upholsterer.
D5G Swivel/tilt control with pneumatic seat height adjustment	<i>Upholstery/COM information:</i> Prices shown include fabric or leather upholstery. Contact your Knoll representative for colors. Only approved Knoll/Textiles and Spinneybeck leathers may be ordered.	<i>Arms:</i> Seamless, black phenolic plastic. <i>Column cover:</i> Polypropylene on pneumatic seat height models; steel with epoxy finish on mechanical seat height models. <i>Base:</i> Steel armature with epoxy finish; polished stainless or black epoxy finished top caps. Standard five-star design.
H Hard-wheel casters	Customer's Own Material is available pending approval. For approval requirements, processing instructions and ordering information please see page 18.	
AM3030 Amazon, Bossa Nova	<i>Maintenance:</i> See pages 28-29. <i>Cal 133 Fire Code:</i> The Pollock Chair complies with the California Technical Bulletin 133 standard if upholstered in Cal 133 approved upholstery. Specify suffix -C at end of pattern number and suffix -133 at end of textile selection. Upcharge applies, see page 19.	
	<i>Note:</i> The Pollock Executive Conference Arm and Armless Chair is Greenguard certified.	

Specify:

1. Pattern number
2. Frame/base top cap finish
3. Cal 133 Fire Code option
4. Textile selection

pattern no.	grades	COM									COL				
	A	B	C	D	E	F	G	H	I	U	V	W	X	Y	
12A-(1 or 2)-D5G-H	\$2,942.	\$2,990.	\$3,034.	\$3,070.	\$3,099.	\$3,126.	\$3,156.	\$3,229.	\$3,363.	\$3,488.	\$3,646.	\$4,008.	\$4,071.	\$4,109.	
12A-(3 or 4)-D5G-H	2,691.	2,739.	2,785.	2,820.	2,850.	2,877.	2,905.	2,979.	3,115.	3,238.	3,398.	3,756.	3,822.	3,860.	
12C-(1 or 2)-D5G-H	2,702.	2,747.	2,792.	2,822.	2,852.	2,878.	2,905.	2,978.	3,106.	3,229.	3,380.	3,727.	3,790.	3,824.	
12C-(3 or 4)-D5G-H	2,465.	2,509.	2,552.	2,584.	2,614.	2,640.	2,667.	2,739.	2,869.	2,991.	3,140.	3,490.	3,555.	3,585.	
R	n/c														
1250COVER	460.	504.	545.	575.	604.	626.	653.	722.	845.	954.	1,100.	1,429.	1,488.	1,521.	
1250BUTTON- ()	57.	57.	57.	57.	57.	57.	57.	57.	57.	83.	83.	83.	83.	83.	

Approved KnollTextiles Grades/Fabrics							Spinneybeck Leather						
A Beacon Bocce Cat's Cradle Chance Common Ground Commuter Cloth Crossroad Delite Dristi Hourglass Mariner Monarch Prep Presto Soliloquy Sonnet Stacks Trophy Uni-Form	B continued Paradigm Petal Pusher Pogo Prairie Prim Radiance Ransom Ricochet Roam Rush Hour Soiree Spark Spree Summit Sutton Synth Tabloid Tinge Venue Versa Vinyl Westwood Wide Angle Zipline	C continued Fibra Greenwich Hudson Hula Hoop Kora CR Lagos Legend CR Lore CR Magnolia Metro Milestone Moto CR Noble Palisade Panache CR Pullman Quark Regard CR Roundtrip Sequin CR Sinclair Smart Spectator Spot On Star Struck Stepping Stones Swing Tight Rope Tower Grid Tilden Treble CR Vibe Wit Zari CR	D Compass CR Coterie Eclat Weave Hologram In The Loop Island Masquerade Menagerie In Stitches Tara Theory Woodland Zoom	E Aegean Demure Highland Ikat Square Ikat Stripe Kampala Katazome Kimono Mamba Marquee Meroe Midpoint Nature Walk Sherman Shima Tryst Vatera Whip	F Atelier Biscayne Century Coco Cornaro Glider Icon Intrigue Origins Liberty Mod Plaid Rivington Tivoli Topography Totem Tweed Frieze	G Abington Alter Ego Amore Arabella Arber Brugge Djenne Feeling Plaid Garden City Gibson Hampshire Haze Kamani Kinabalu Kingston Melange Metallic Gloss Modern Tweed Petite Floral Sablon Serendipity Spencer Straie Stripe Ultrasuede Utrillo	H Arno Bavaria Catwalk Constance Firefly Gezelle Magritte Rosemond Stretch Appeal Aswan Byron Canaan Cato Diamond Days Digi Velvet Dynamic Fiori Gramercy Ita Jaipur Knoll Velvet Limani North Island Olema Piper Rutledge Tudor Vermeer Walker Worth Zimba	I Acqua Andes Embossed Tipped España Hand Tipped Velluto Pelle Alaska Amazon Antique Derby Forte Lucente Sabrina	U Vicenza Volo Acqua Andes Embossed Tipped España Hand Tipped Velluto Pelle Alaska Amazon Antique Derby Forte Lucente Sabrina	V Capri Cervo Copenhagen Distressed Lucca Marissa Portofino Riva Torello	X Ducale Ducale Velour Capri Cervo Copenhagen Distressed Lucca Marissa Portofino Riva Torello	Y Capri Cervo Copenhagen Distressed Lucca Marissa Portofino Riva Torello	

▲ Approved for Cal 133 upholstery.

Check with your KnollTextiles or Spinneybeck Representative for changes or additions.

Charles Pollock
Arm Chair

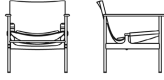
	description	seat h	arm h	w	d	h	weight
<i>Designer(s):</i> Charles Pollock, 1960	657 Arm Chair	16 1/4"	22 3/4"	25"	26"	27 3/4"	32 lbs.
							

pattern no.	
657-(BL_) - (PT_, HT_)	\$3,713.

Order Code	Ordering Information
<i>Example:</i> 657-BL-PT	<i>Frame finishes:</i> Chrome/black
657 arm chair	<i>Upholstery note:</i> No Customer's Own Materials can be used.
BL belting leather	<i>Replacement slings:</i> Knoll does not recommend replacement slings. This procedure requires the chair to be disassembled and rebuilt, a complex and time consuming process.
PT Portofino	<i>Maintenance:</i> See pages 28-29.
<i>Specify:</i>	<i>Seat pad:</i> Spinneybeck Portofino (suffix PT__) Spinneybeck Hand Tipped (suffix HT__)
1. Pattern number	Please ask your Spinneybeck Representative for samples of the belting leather.
2. Belting leather selection	
3. Cushion upholstery selection	

Construction
<i>Frame:</i> Tubular steel legs, polished chrome finish. Cast aluminum arms and stretchers, black painted finish. Stamped steel glides.
<i>Upholstery:</i> Belting leather sling. Cushion is urethane foam upholstered in Portofino or Hand Tipped leather.

Carlos Riart Riart Rocker

Designer(s):
Carlos Riart, 1982

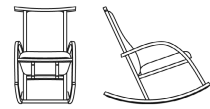

description	seat h	arm h	w	d	h	textile fabric yds.	req. leather sq. ft.	weight
790 Riart Rocker	21"	24 1/2"	24 1/4"	42 1/2"	38 1/4"	2	38	25 lbs.

pattern no.	grades A	COM B	C	D	E	F	G	H	I	COL U	V	W	X	Y
790-(-)(-)	\$5,289.	\$5,338.	\$5,385.	\$5,435.	\$5,478.	\$5,508.	\$5,561.	\$5,658.	\$5,731.	\$6,288.	\$6,475.	\$6,853.	\$6,931.	\$7,023.

Order Code	Ordering Information	Construction
<i>Example:</i> 790-LWT-K1320/6	<i>Walnut with light lacquer finish:</i> Light Walnut (suffix LWT)	<i>Frame:</i> Solid lumber frame construction with laminated runners and arms.
790 Riart Rocker		
LWT Light Walnut	<i>Medium Figured English Sycamore:</i> Sycamore (suffix S515)	<i>Upholstery/COM information:</i> Prices shown include fabric or leather upholstery. Contact your Knoll representative for colors. Only approved KnollTextiles and Spinneybeck leathers may be ordered.
K1320/6 Cornaro, Meadow		<i>Upholstery:</i> High density, polyurethane foam used in all upholstered areas. Elastic seat belt suspension.
		<i>Inlays:</i> Mother of Pearl inlays for product specified in Light Walnut. Ebony inlays for product in Sycamore.
		Customer's Own Material is available pending approval. For approval requirements, processing instructions and ordering information please see page 18.
		<i>Maintenance:</i> See pages 28-28.
		<i>Note:</i> Carlos Riart's signature is engraved in each chair.
		The Riart Rocker is Greenguard approved.

Specify:

1. Pattern number
2. Finish selection
3. Textile selection

Approved KnollTextiles Grades/Fabrics				Spinneybeck Leather
A Cat's Cradle Chance Common Ground Hourglass Mariner Presto Sonnet	B continued Melody Petal Pusher Pogo Prairie Ricochet Tinge Venue Vinyl Westwood	C continued Kaleidoscope CR Kaya CR Lore CR Palisade Panache CR Quark Regard CR Roundtrip Sahara Sandpiper Sequin CR Smart Spot On Swing Tilden Treble CR Vibe Zari CR	D Compass CR Eclat Weave Hologram Masquerade Theory Zoom	E Highland Katazome Shima Tryst
B Abacus Belize Chronicle Dovetail Ferry Gala II Grande Grandview Knoll Felt	C Atlas Biota Circa Classic Boucle Dahlia CR Earthwork Enmesh Fable CR Fibra Hula Hoop	F Atelier Calais Cotton Velvet Coco Cornaro Icon Intrigue Rivington Tweed Frieze	G Arabella Gibson Haze Kamani Kingston Melange Sablon Serendipity Ultrasuede	H Arno
			I Cato Knoll Velvet Rutledge Tudor	U Vicenza Volo
				V Acqua Andes España Velluto Pelle
				W Alaska Antique Forte Lucente Sabrina
				Y Copenhagen Marissa Riva

Check with your KnollTextiles or Spinneybeck Representatives for changes or additions.

Joe Ricchio Joe™ Chair



description	seat h	arm h	w	d	h	textile	req.	weight	finish
						fabric yds.	leather sq. ft.		
48A Joe arm chair	19"	26"	24"	22"	32"	0.8	14.5	16 lbs.	other stains
	19"	26"	24"	22"	32"	0.8	14.5	16 lbs.	maple, ebonized
48R Seat basket replacement for 48A						0.8	13		

Designer(s):
Joe Ricchio

Order Code	Ordering Information	Construction
<i>Example:</i> 48A-BN-K224/1	<i>Maple:</i> Clear Maple (suffix KC)	<i>Custom finishes:</i> Complementary finishes to any KnollStudio or Knoll Office wood finish are available at no upcharge. To complement non-Knoll wood veneer or lumber finishes, a one-time, non-negotiable net upcharge of \$637 applies. Re-orders are at no upcharge. Please contact your KnollStudio representative, dealer or Customer Service associate for complete custom finish information and Order Code. Minimum order quantity for any custom finish order: 4 chairs.
48A Joe arm chair	<i>Beech frame stains:</i> Beech (suffix B311) Bronzed Cherry (suffix B312A) Burnt Walnut (suffix B313) Deep Red Mahogany (suffix B328) Ebonized (suffix BE) Light Cherry (suffix B315) Medium Cherry (suffix B319) Medium Red Mahogany (suffix BR) Medium Walnut (suffix B323) Natural Beech (suffix BN) Warm Brown Walnut (suffix J)	<i>Frame:</i> Select maple hardwood in clear or beech hardwood in stained finish. <i>Upholstered seat:</i> Elastic seat belt suspension, high resilient foam. Seat basket is 1.25" thick.
BN Natural Beech	<i>Upholstery/COM information:</i> Prices shown include fabric or leather upholstery. Contact your Knoll representative for colors. Only approved KnollTextiles and Spinneybeck leathers may be ordered.	<i>Cal 133 Fire Code:</i> The Joe Chair complies with the California Technical Bulletin 133 standard if upholstered in Cal 133 approved upholstery. Specify suffix -C at end of pattern number and suffix -133 at end of textile selection. Upcharge applies, see page 19.
K224/1 Wide Angle, Castor	Customer's Own Material is available pending approval. For approval requirements, processing instructions and ordering information please see page 18.	<i>Certified Wood:</i> Chairs manufactured using FSC certified hardwoods are available through Custom Product Development. Extended leadtime and upcharge apply.
	<i>Maintenance:</i> See pages 28-29.	<i>Note:</i> The Joe Chair is Greenguard certified.
	<i>KnollStudio wood finishes:</i> KnollStudio wood finishes complement a large variety of KnollStudio veneer and Knoll Office veneer finishes. To select correct complementary finish, please refer to KnollStudio Wood Finish Matrix on page 25. If no complementary standard finish is available, please refer to custom finish policy below.	

pattern no.	grades	COM	C	D	E	F	G	H	I	COL	V	W	X	Y
	A	B								U				
48A-()	\$1,141.	\$1,168.	\$1,194.	\$1,222.	\$1,244.	\$1,259.	\$1,284.	\$1,340.	\$1,379.	\$1,509.	\$1,604.	\$1,799.	\$1,839.	\$1,885.
48A-(KC, BE)	1,315.	1,341.	1,367.	1,394.	1,417.	1,431.	1,458.	1,515.	1,553.	1,681.	1,778.	1,973.	2,013.	2,059.
48R-()	232.	260.	284.	314.	337.	352.	385.	433.	478.	615.	713.	918.	960.	1,008.

Approved KnollTextiles Grades/Fabrics						Spinneybeck Leather					
A Alignment # Beacon Bocce Cat's Cradle Chance Commuter Cloth # Crossroad Delite Dristi Foil Rap Heavy Metal Hourglass Mariner Monarch # Prep # Presto # Soliloquy Sonnet Stacks Trophy Uni-Form	B continued Forza Gala II Grande Grandview Helios Hollbrook Journey Keaton Knoll Felt Knoll Hopsack Little Devil Ludlow Lyric # Melody Mini Stitch # Night Life Paradigm Petal Pusher Prairie Prim # Radiance Ransom Ricochet # Roam Rush Hour Soiree Spark # Spree Summit Sutton Synth Tabloid Tinge Utmost Venue Versa Vinyl Wide Angle # Yeni Zipline	C Atlas Axiom Baxter Biota # Cairo Charm # Circa Classic Boucle Dahlia CR Decade Dune Durand Earthwork # Echo Empire Stripe Enmesh # Entourage Essence Fable CR Fibra Greenwich Hudson Hula Hoop # Kaleidoscope CR Kaya CR Kora CR Lagos Legend CR Lore CR Magnolia Metro Milestone Moto CR # Noble Palisade Panache CR Pullman Quark Regard CR	C continued Roundtrip Sahara Sandpiper Sashiko Sequin CR Sinclair Smart Star Struck # Stepping Stones Spectator Spot On Swing Tight Rope Tilden Tower Grid Trebble CR Vibe Wit Zari CR Zen Wave	D Compass CR Coterie Eclat Weave Hologram # In The Loop Island Kabuki Masquerade Menagerie Origins Tara Theory Woodland Zoom	E Aegean Demure Highland Ikat Square Ikat Stripe Kampala Katazome Kimono Mamba Marquee Meroe Midpoint Nature Walk Sherman Shima Tryst Vatera Whip	F Atelier Biscayne Calais Cotton Velvet Century Coco Cornaro Clider Icon # Intrigue In Stitches Liberty Mod Plaid Rivington Soon Tivoli Topography Totem Tweed Frieze	G continued Gibson Hampshire Haze Kamani Kinabalu Kingston Melange Metallic Gloss Modern Tweed Petite Floral Sablon Serendipity Spencer Straie Stripe Ultrasuede # Utrillo	H Arno Bavaria Catwalk Constance Firefly Gezelle Magritte Rosemond Stretch Appeal	I Aswan Byron Canaan Cato Cummings Diamond Days Dynamic Fiori Jaipur Knoll Velvet Mepal North Island Olema Piper Rutledge Sandis Tudor Vermeer Walker Worth Zimba	U Vicenza # Volo # V Acqua # Andes # Embossed Tipped España # Hand Tipped # Maremma # Velluto Pelle # W Alaska # Amazon # Antique # Derby # Forte # Lucente # Sabrina #	X Ducale # Ducale Velour # Y Capri # Cervo Copenhagen # Distressed # Lucca Marissa # Portofino # Riva # Saddle # Torello
						# Approved for Cal 133 upholstery.					
						<i>Check with your KnollTextiles or Spinneybeck Representative for changes or additions.</i>					

Joe and Linda Ricchio JR® and Ricchio Chair with Upholstered Seat

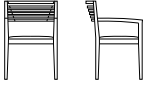
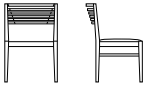
	description	seat h	arm h	w	d	h	textile fabric yds.	req. leather sq. ft.	weight	finish
<i>Designer(s):</i> Joseph and Linda Ricchio, 1990	37A Arm chair 	18"	25 1/4"	21 1/4"	23 1/2"	32 1/4"	0.7	13	17 lbs.	maple, ebonized
		18"	25 1/4"	21 1/4"	23 1/2"	32 1/4"	0.7	13	17 lbs.	other finishes
<i>Award(s):</i> Roscoe, 1991	37C Armless chair 	18"		21 1/4"	23 1/2"	32 1/4"	0.7	13	15 lbs.	maple, ebonized
		18"		21 1/4"	23 1/2"	32 1/4"	0.7	13	15 lbs.	other finishes
	T Thick seat option (add -T to end of pattern number)									
	37R-T Thick seat basket replacement for 37A and 37C						0.7	13		
	37R Seat basket replacement for 37A and 37C						0.7	13		



Order Code	Ordering Information	Construction
<i>Example:</i> 37A-T-BN-K1320/4	<i>Upholstery/COM information:</i>	<i>Cal 133 Fire Code #:</i>
37A Arm chair	Prices shown include fabric or leather upholstery. Contact your Knoll representative for colors. Only approved KnollTextiles and Spinneybeck leathers may be ordered.	The JR and Ricchio Chairs comply with the California Technical Bulletin 133 standard if upholstered in Cal 133 approved upholstery. Specify suffix -C at end of pattern number and suffix -133 at end of textile selection. Upcharge applies, see page 19.
T Thick seat	Customer's Own Material is available pending approval. For approval requirements, processing instructions and ordering information please see page 18.	<i>Upholstered seat:</i> Injection-molded copolymer plastic seat pan screws into corner blocks of chair frame. Standard seat basket is 1" thick. Thick seat basket option is 2" (Ricchio chair only). Note upcharge above.
BN Natural Beech	<i>KnollStudio wood finishes:</i> KnollStudio wood finishes complement a large variety of KnollStudio veneer and Knoll Office veneer finishes. To select correct complementary finish, please refer to KnollStudio Wood Finish Matrix on page 25. If no complementary standard finish is available, please refer to custom finish policy below.	<i>Certified Wood:</i> Chairs manufactured using FSC certified hardwoods are available through Custom Product Development. Extended leadtime and upcharge apply.
K1320/4 Cornaro, Tabasco	<i>Custom finishes:</i> Complementary finishes to any KnollStudio or Knoll Office wood finish are available at no upcharge. To complement non-Knoll wood veneer or lumber finishes, a one-time, non-negotiable net upcharge of \$637 applies. Re-orders are at no upcharge. Please contact your KnollStudio representative, dealer or Customer Service associate for complete custom finish information and Order Code. Minimum order quantity for any custom finish order: 4 chairs.	<i>Maintenance:</i> See pages 28-29.
		<i>Seat Basket Replacement:</i> Upholstered seat sits on chair frame. Screws lock basket in place for easy installation or removal. For seat basket replacements for JR chairs ordered prior to February 2007, specify pattern numbers 37R-S. Pricing for 44R will apply.
		<i>Finish:</i> Catalyzed lacquer protective coating. Hand-applied final wax coating.
		<i>Glides:</i> Recessed plastic glides.
		<i>Note:</i> The JR and Ricchio Chair are Greenguard certified.
		JR Chair (44A) does not stack.

- Specify:*
1. Pattern number
 2. Thick seat option (Ricchio chair only)
 3. Finish selection
 4. Cal 133 Fire Code option
 5. Textile selection

- Maple:*
Clear Maple (suffix KC)
- Beech frame stains:*
Beech (suffix B311)
Bronzed Cherry (suffix B312A)
Burnt Walnut (suffix B313)
Deep Red Mahogany (suffix B328)
Ebonized (suffix BE)
Light Cherry (suffix B315)
Medium Cherry (suffix B319)
Medium Red Mahogany (suffix BR)
Medium Walnut (suffix B323)
Natural Beech (suffix BN)
Warm Brown Walnut (suffix J)



pattern no.	upcharge	grades A	COM B	C	D	E	F	G	H	I	COL U	V	W	X	Y
37A-(KC, BE)		\$1,303.	\$1,331.	\$1,351.	\$1,380.	\$1,406.	\$1,419.	\$1,448.	\$1,501.	\$1,540.	\$1,707.	\$1,809.	\$2,006.	\$2,046.	\$2,095.
37A-()		1,239.	1,266.	1,284.	1,315.	1,340.	1,355.	1,382.	1,438.	1,476.	1,642.	1,744.	1,942.	1,982.	2,029.
37C-(KC, BE)		1,223.	1,250.	1,274.	1,302.	1,327.	1,339.	1,369.	1,422.	1,461.	1,629.	1,728.	1,925.	1,967.	2,015.
37C-()		1,163.	1,193.	1,213.	1,242.	1,267.	1,279.	1,309.	1,364.	1,402.	1,568.	1,670.	1,866.	1,907.	1,955.
T	28.														
37R-T-()		275.	304.	327.	350.	375.	392.	420.	474.	512.	680.	780.	979.	1,020.	1,067.
37R-()		247.	276.	299.	322.	347.	365.	392.	447.	485.	652.	752.	951.	992.	1,039.

Approved KnollTextiles Grades/Fabrics					Spinneybeck Leather				
A Alignment # Analogy Beacon Bocce Cat's Cradle Chance Common Ground # Commuter Cloth # Crossroad Dristi Foil Rap Heavy Metal Hourglass Mariner Monarch # Prep # Presto # Soliloquy Sonnet Stacks Trophy Uni-Form	B continued Forza Gala II Grande Grandview Holbrook Journey Knoll Felt Knoll Hopsack Little Devil Ludlow Lyric # Keaton Mini Stitch # Night Life Nonchalant CR Odeon Paradigm Petal Pusher Radiance Ransom Ricochet # Roam Rush Hour Prairie Prim # Soiree Spark # Spree Summit Sutton Synth Utmost Venue Versa Vinyl Westwood Wide Angle # Zephyr Zipline	C Atlas Axiom Baxter Biota # Cairo Charm # Circa Classic Boucle Dahlia CR Decade Dune Durand Earthwork # Echo Empire Stripe Enmesh # Entourage Fable CR Fibra Greenwich Hudson Kaleidoscope CR Kaya CR Kora CR Lagos Legend CR Lore CR Metro Milestone Moto CR # Noble Palisade Panache CR Posh Pullman Quark Regard CR Roundtrip Sequin CR Sahara Sandpiper Sashiko Sinclair Smart	C continued Star Struck # Stepping Stones Spectator Swing Tight Rope Tilden Tower Grid Trebble CR Vibe Zari CR Zen Wave D Compass CR Coterie Eclat Weave Hologram # In The Loop Island Kabuki Masquerade Menagerie Origins Tara Theory Woodland Zoom E Ikat Square Ikat Stripe Kampala Katazome Kimono Mamba Marquee Meroe Midpoint Nature Walk Sherman Shima Tryst Whip	F Atelier Biscayne Calais Cotton Velvet Century Coco Cornaro Glider Icon # Intrigue In Stitches Liberty Mod Plaid Rivington Soon Topography Totem Tweed Frieze G Alter Ego Arabella Arber Djenne Feeling Plaid Gibson Hampshire Haze Kamani Kinabalu Kingston Melange Metallic Gloss Modern Tweed Sablon Serendipity Spencer Straie Stripe Ultrasuede # Utrillo	H Arno Bavaria Catwalk Constance Firefly Gezelle # Magritte Rosemond Stretch Appeal I Aswan Byron Canaan Cato Cummings Diamond Days Digi Velvet Dynamic Gates Ita Jaipur Knoll Velvet Mepal North Island Olema Piper Rutledge Sandis Tudor Vermeer Walker Worth Zimba	U Vicenza # Volo # V Acqua # Andes # Embossed Tipped España # Hand Tipped # Maremma # Velluto Pelle # W Alaska # Amazon # Antique # Derby # Forte # Lucente # Sabrina #	X Ducale # Ducale Velour # Y Capri # Cervo Copenhagen # Distressed # Lucca Marissa # Portofino # Riva # Saddle # Torello		

Approved for Cal 133 upholstery.

Check with your KnollTextiles or Spinneybeck Representative for changes or additions.

Joe and Linda Ricchio JR® and Ricchio Chair with Upholstered Seat

	description	seat h	arm h	w	d	h	textile fabric, yds.	weight	finish	req. leather sq. ft
<i>Designer(s):</i> Joseph and Linda Ricchio, 1990	44A JR Arm chair, non-stacking 	19"	25 3/4"	23 1/2"	21 3/8"	32 1/8"	0.7	14 lbs.	maple, ebonized	13
		19"	25 3/4"	23 1/2"	21 3/8"	32 1/8"	0.7	14 lbs.	other finishes	13
<i>Award(s):</i> Roscoe, 1991	44R Seat basket replacement for 44A and 44A-U 						0.8			14.5



Order Code	Ordering Information	Construction
<i>Example:</i> 37A-T-BN-K1320/4	<i>Upholstery/COM information:</i>	<i>Cal 133 Fire Code #:</i>
37A Arm chair	Prices shown include fabric or leather upholstery. Contact your Knoll representative for colors. Only approved KnollTextiles and Spinneybeck leathers may be ordered.	The JR and Ricchio Chairs comply with the California Technical Bulletin 133 standard if upholstered in Cal 133 approved upholstery. Specify suffix -C at end of pattern number and suffix -133 at end of textile selection. Upcharge applies, see page 19.
T Thick seat	Customer's Own Material is available pending approval. For approval requirements, processing instructions and ordering information please see page 18.	<i>Certified Wood:</i>
BN Natural Beech		Chairs manufactured using FSC certified hardwoods are available through Custom Product Development. Extended leadtime and upcharge apply.
K1320/4 Cornaro, Tabasco	<i>KnollStudio wood finishes:</i>	<i>Maintenance:</i>
	KnollStudio wood finishes complement a large variety of KnollStudio veneer and Knoll Office veneer finishes. To select correct complementary finish, please refer to KnollStudio Wood Finish Matrix on page 25. If no complementary standard finish is available, please refer to custom finish policy below.	See pages 28-29.
	<i>Custom finishes:</i>	<i>Note:</i>
	Complementary finishes to any KnollStudio or Knoll Office wood finish are available at no upcharge. To complement non-Knoll wood veneer or lumber finishes, a one-time, non-negotiable net upcharge of \$637 applies. Re-orders are at no upcharge. Please contact your KnollStudio representative, dealer or Customer Service associate for complete custom finish information and Order Code. Minimum order quantity for any custom finish order: 4 chairs.	The JR and Ricchio Chair are Greenguard certified.
		JR Chair (44A) does not stack.
		<i>Seat Basket Replacement:</i>
		Upholstered seat sits on chair frame. Screws lock basket in place for easy installation or removal. For seat basket replacements for JR chairs ordered prior to February 2007, specify pattern numbers 37R-S. Pricing for 44R will apply.
		<i>Finish:</i>
		Catalyzed lacquer protective coating. Hand-applied final wax coating.
		<i>Glides:</i>
		Recessed plastic glides.

pattern no.	grades A	COM B	C	D	E	F	G	H	I	COL U	V	W	X	Y
44A-(KC, BE)	\$1,288.	\$1,318.	\$1,340.	\$1,369.	\$1,395.	\$1,409.	\$1,441.	\$1,495.	\$1,532.	\$1,675.	\$1,771.	\$1,976.	\$2,016.	\$2,065.
44A-()	1,223.	1,251.	1,275.	1,303.	1,331.	1,341.	1,374.	1,429.	1,467.	1,610.	1,705.	1,909.	1,951.	1,999.
44R-()	232.	260.	284.	314.	337.	352.	385.	433.	478.	615.	713.	918.	960.	1,008.

Approved KnollTextiles Grades/Fabrics					Spinneybeck Leather				
A	B	C	C	F	H	U	X	V	Y
Alignment #	Forza	Atlas	Star Struck #	Atelier	Arno	Vicenza #	Ducale #	Acqua #	Capri #
Analogy	Gala II	Axiom	Stepping Stones	Biscayne	Bavaria	Volo #	Ducale Velour #	Andes #	Cervo
Beacon	Grande	Baxter	Spectator	Calais Cotton	Catwalk			Embossed Tipped	Copenhagen #
Bocce	Grandview	Biota #	Swing	Velvet	Constance			España #	Distressed #
Cat's Cradle	Holbrook	Cairo	Tight Rope	Century	Firefly			Hand Tipped #	Lucca
Chance	Journey	Charm #	Tilden	Coco	Gezelle #			Maremma #	Marissa #
Common Ground #	Knoll Felt	Circa	Tower Grid	Cornaro	Magritte			Velluto Pelle #	Portofino #
Commuter Cloth #	Knoll Hopsack	Classic Boucle	Treble CR	Glider	Rosemond				Riva #
Crossroad	Little Devil	Dahlia CR	Vibe	Icon #	Stretch Appeal				Saddle #
Dristi	Ludlow	Decade	Zari CR	Intrigue					Torello
Foil Rap	Lyric #	Dune	Zen Wave	In Stitches					
Heavy Metal	Keaton	Durand		Liberty					
Hourglass	Mini Stitch #	Earthwork #		Mod Plaid					
Mariner	Night Life	Echo		Rivington					
Monarch #	Nonchalant CR	Empire Stripe		Soon					
Prep #	Odeon	Enmesh #		Topography					
Presto #	Paradigm	Entourage		Totem					
Soliloquy	Petal Pusher	Fable CR		Tweed Frieze					
Sonnet	Radiance	Fibra							
Stacks	Ransom	Greenwich							
Trophy	Ricochet #	Hudson							
Uni-Form	Roam	Hula Hoop #							
	Rush Hour	Kaleidoscope CR							
	Prairie	Kaya CR							
	Prim #	Kora CR							
	Soiree	Lagos							
	Spark #	Legend CR							
	Spree	Lore CR							
	Summit	Metro							
	Bistro #	Sutton							
	Synth	Milestone							
	Utmost	Moto CR #							
	Venue	Noble							
	Versa	Palisade							
	Vinyl	Panache CR							
	Westwood	Posh							
	Wide Angle #	Pullman							
	Zephyr	Quark							
	Zipline	Regard CR							
		Roundtrip							
		Sequin CR							
		Sahara							
		Sandpiper							
		Sashiko							
		Sinclair							
		Smart							

Joe and Linda Ricchio

Fully Upholstered Ricchio and JR® Chairs

Designer(s):
Joseph and Linda Ricchio, 1994

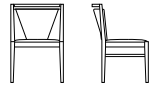
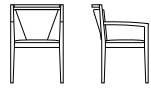

description	seat h	arm h	w	d	h	textile fabric yds.	req. leather sq. ft.	weight	finish
37A-U Ricchio arm chair, uphol. seat and back	18 1/2"	26"	21 3/8"	23 3/4"	32 1/4"	1	19	21 lbs.	maple, ebonized
	18 1/2"	26"	21 3/8"	23 3/4"	32 1/4"	1	19	21 lbs.	other finishes
37C-U Ricchio armless chair, uphol. seat and back	18 1/2"		21 3/8"	23 3/4"	32 1/4"	1	19	19 lbs.	maple, ebonized
	18 1/2"		21 3/8"	23 3/4"	32 1/4"	1	19	19 lbs.	other finishes

Order Code

<i>Example:</i>	37A-U-B319-K1084/2
37A	Ricchio arm chair, upholstered seat and back
U	Upholstered seat and back
B319	Medium Cherry
K1084/2	Harrison, Campbell

Specify:

1. Pattern number
2. Finish selection
3. Cal 133 Fire Code option
4. Textile selection

Maple:

Clear Maple (suffix KC)

Beech frame stains:

- Beech (suffix B311)
- Bronzed Cherry (suffix B312A)
- Burnt Walnut (suffix B313)
- Deep Red Mahogany (suffix B328)
- Ebonized (suffix BE)
- Light Cherry (suffix B315)
- Medium Cherry (suffix B319)
- Medium Red Mahogany (suffix BR)
- Medium Walnut (suffix B323)
- Natural Beech (suffix BN)
- Warm Brown Walnut (suffix J)

Ordering Information

Upholstery/COM information:

Prices shown include fabric or leather upholstery. Contact your Knoll representative for colors. Only approved KnollTextiles and Spinneybeck leathers may be ordered.

Customer's Own Material is available pending approval. For approval requirements, processing instructions and ordering information please see page 18.

KnollStudio wood finishes:

KnollStudio wood finishes complement a large variety of KnollStudio veneer and Knoll Office veneer finishes. To select correct complementary finish, please refer to KnollStudio Wood Finish Matrix on page 25. If no complementary standard finish is available, please refer to custom finish policy below.

Custom finishes:

Complementary finishes to any KnollStudio or Knoll Office wood finish are available at no upcharge. To complement non-Knoll wood veneer or lumber finishes, a one-time, non-negotiable net upcharge of \$637 applies. Re-orders are at no upcharge. Please contact your KnollStudio representative, dealer or Customer Service associate for complete custom finish information and Order Code. Minimum order quantity for any custom finish order: 4 chairs.

Construction

Frame:

Select clear maple hardwood in clear or beech hardwood in stained finish.

Fully upholstered chairs:

Plywood core back panel bolted to frame for added strength. Optional arm panels have plywood core bolted to frame. Injection-molded plastic seat pan. High density, polyurethane foam used in all upholstered areas. JR fully upholstered chair does not stack.

Finish:

Catalyzed lacquer protective coating. Hand-applied final wax coating.

Glides:

Recessed plastic glides.

pattern no.	grades A	COM B	C	D	E	F	G	H	I	COL U	V	W	X	Y
37A-U-(KC, BE)	\$1,740.	\$1,778.	\$1,815.	\$1,852.	\$1,886.	\$1,910.	\$1,951.	\$2,023.	\$2,080.	\$2,447.	\$2,595.	\$2,881.	\$2,944.	\$3,013.
37A-U-()	1,651.	1,691.	1,727.	1,764.	1,799.	1,823.	1,864.	1,936.	1,994.	2,363.	2,508.	2,795.	2,857.	2,926.
37C-U-(KC, BE)	1,661.	1,700.	1,731.	1,772.	1,807.	1,829.	1,869.	1,945.	1,999.	2,369.	2,512.	2,802.	2,863.	2,931.
37C-U-()	1,578.	1,615.	1,648.	1,689.	1,724.	1,746.	1,788.	1,863.	1,916.	2,287.	2,431.	2,719.	2,780.	2,850.

Approved KnollTextiles Grades/Fabrics

A	Alignment ‡ Beacon Bocce Cat's Cradle Chance Common Ground ‡ Commuter Cloth ‡ Crossroad Delite Dristi Foil Rap Heavy Metal Hourglass Mariner Prep ‡ Presto ‡ Soliloquy Sonnet Stacks Trophy Uni-Form	B	continued Gala II Grande Grandview Helios Holbrook Journey Keaton Knoll Felt Knoll Hopsack Little Devil Lyric ‡ Mini Stitch ‡ Melody Night Life Paradigm Petal Pusher Prairie Prim ‡ Radiance Ransom Ricochet ‡ Roam Rush Hour Soiree Spark ‡ Spree Summit Sutton Synth Tabloid Tinge Utmost Venue Versa Vinyl Westwood Wide Angle ‡ Zipline	C	Atlas Axiom Baxter Biota ‡ Cairo Charm Circa Classic Boucle Decade Durand Earthwork ‡ Echo Empire Stripe Emesh ‡ Entourage Fibra Greenwich Hudson Hula Hoop Kaleidoscope CR Kora CR Lagos Legend CR Lore CR Magnolia Metro Milestone Moto CR ‡ Noble Palisade Panache CR Pullman Quark Regard CR	C continued	Roundtrip Sandpiper Sequin CR Sinclair Smart Spot On Star Struck Stepping Stones Spectator Swing Tight Rope Tilden Tower Grid Trebble CR Vibe Wit Zari CR	D	Compass CR Coterie Eclat Weave Hologram ‡ In The Loop Island Masquerade Menagerie Origins Tara Theory Woodland Zoom	E	Aegean Highland Ikat Square Ikat Stripe Kampala Katazome Mamba Marquee Meroe Midpoint Nature Walk Sherman Shima Tryst Whip	F	Atelier Biscayne Calais Cotton Velvet Coco Cornaro Glider Icon Intrigue In Stitches Liberty Mod Plaid Rivington Soon Tivoli Topography Totem Tweed Frieze	G	Abington Alter Ego Amore Arabella Arber Brugge Djenne Feeling Plaid Garden City Gibson Haze Kamani Kinabalu	G continued	Kingston Melange Metallic Gloss Modern Tweed Petite Floral Sablon Serendipity Spencer Straie Stripe Ultrasuede ‡ Utrillo	H	Arno Bavaria Catwalk Constance Firefly Gezelle Magritte Rosemond Stretch Appeal	I	Aswan Byron Canaan Cato Cummings Diamond Days Digi Velvet Dynamic Fiori Ita Jaipur Knoll Velvet Limani North Island Olema Piper Rutledge Tudor Vermeer Walker Worth Zimba	U	Vicenza ‡ Volo ‡	V	Acqua ‡ Andes ‡ Embossed Tipped España ‡ Velluto Pelle ‡	W	Alaska ‡ Amazon ‡ Antique ‡	W continued	Forte ‡ Lucente Sabrina ‡	X	Ducale Velour ‡	Y	Capri ‡ Cervo Copenhagen ‡ Distressed ‡ Marissa ‡ Riva ‡ Torello
----------	--	----------	--	----------	---	--------------------	---	----------	---	----------	--	----------	--	----------	---	--------------------	--	----------	---	----------	--	----------	---------------------	----------	--	----------	-----------------------------------	--------------------	---------------------------------	----------	-----------------	----------	--

Spinneybeck Leather

‡ Approved for Cal 133 upholstery.

Check with KnollTextiles or Spinneybeck Representative for changes or additions.

Joe and Linda Ricchio

Fully Upholstered Ricchio and JR® Chairs

Designer(s):
Joseph and Linda Ricchio, 1994

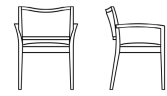

description	height, seat	height,		d	h	textile fabric yds.	reg. leather sq. ft.	weight	finish
		arm	w						
44A-U JR Arm chair, uphol. seat and back	19"	26"	24"	22"	32"	1	18	15 lbs.	maple, ebonized
	19"	26"	24"	22"	32"	1	18	15 lbs.	other finishes

Order Code

<i>Example:</i>	37A-U-B319-K1084/2
37A	Ricchio arm chair, upholstered seat and back
U	Upholstered seat and back
B319	Medium Cherry
K1084/2	Harrison, Campbell

Specify:

1. Pattern number
2. Finish selection
3. Cal 133 Fire Code option
4. Textile selection

Maple:

Clear Maple (suffix KC)

Beech frame stains:

- Beech (suffix B311)
- Bronzed Cherry (suffix B312A)
- Burnt Walnut (suffix B313)
- Deep Red Mahogany (suffix B328)
- Ebonized (suffix BE)
- Light Cherry (suffix B315)
- Medium Cherry (suffix B319)
- Medium Red Mahogany (suffix BR)
- Medium Walnut (suffix B323)
- Natural Beech (suffix BN)
- Warm Brown Walnut (suffix J)

Ordering Information

Upholstery/COM information:

Prices shown include fabric or leather upholstery. Contact your Knoll representative for colors. Only approved KnollTextiles and Spinneybeck leathers may be ordered.

Customer's Own Material is available pending approval. For approval requirements, processing instructions and ordering information please see page 18.

KnollStudio wood finishes:

KnollStudio wood finishes complement a large variety of KnollStudio veneer and Knoll Office veneer finishes. To select correct complementary finish, please refer to KnollStudio Wood Finish Matrix on page 25. If no complementary standard finish is available, please refer to custom finish policy below.

Custom finishes:

Complementary finishes to any KnollStudio or Knoll Office wood finish are available at no upcharge. To complement non-Knoll wood veneer or lumber finishes, a one-time, non-negotiable net upcharge of \$637 applies. Re-orders are at no upcharge. Please contact your KnollStudio representative, dealer or Customer Service associate for complete custom finish information and Order Code. Minimum order quantity for any custom finish order: 4 chairs.

Cal 133 Fire Code #:

The Fully Upholstered Ricchio Chairs comply with the California Technical Bulletin 133 standard if upholstered in Cal 133 approved upholstery. Specify suffix -C at end of pattern number and suffix -133 at end of textile selection. Upcharge applies, see page 19.

Certified Wood:

Chairs manufactured using FSC certified hardwoods are available through Custom Product Development. Extended leadtime and upcharge apply.

Maintenance:

See pages 28-29

Note:

The Fully Upholstered Ricchio and JR Chairs are Greenguard certified.

Construction

Frame:

Select clear maple hardwood in clear or beech hardwood in stained finish.

Fully upholstered chairs:

Plywood core back panel bolted to frame for added strength. Optional arm panels have plywood core bolted to frame. Injection-molded plastic seat pan. High density, polyurethane foam used in all upholstered areas. JR fully upholstered chair does not stack.

Finish:

Catalyzed lacquer protective coating. Hand-applied final wax coating.

Glides:

Recessed plastic glides.

pattern no.	grade											COL			
	A	B	C	D	E	F	G	H	I	U	V	W	X	Y	
44AU-(KC, BE)	\$1,689.	\$1,718.	\$1,746.	\$1,779.	\$1,804.	\$1,822.	\$1,854.	\$1,914.	\$1,956.	\$2,096.	\$2,202.	\$2,419.	\$2,464.	\$2,518.	
44AU-()	1,523.	1,553.	1,581.	1,612.	1,638.	1,654.	1,686.	1,746.	1,790.	1,928.	2,037.	2,254.	2,296.	2,350.	

Approved KnollTextiles Grades/Fabrics

A Alignment # Beacon Bocce Cat's Cradle Chance Common Ground # Commuter Cloth # Crossroad Delite Dristi Foil Rap Heavy Metal Hourglass Mariner Prep # Presto # Soliloquy Sonnet Stacks Trophy Uni-Form	B continued Gala II Grande Grandview Helios Holbrook Journey Keaton Knoll Felt Knoll Hopsack Little Devil Lyric # Mini Stitch # Melody Night Life Paradigm Petat Pusher Prairie Prim # Radiance Ransom Ricochet # Roam Rush Hour Soiree Spark # Backdrop Belize Summit Sutton Synth Tabloid Tinge Utmost Venue Versa Vinyl Westwood Wide Angle # Zipline	C Atlas Axiom Baxter Biota # Cairo Charm Circa Classic Boucle Decade Durand Earthwork # Echo Empire Stripe Emesh # Entourage Fibra Greenwich Hudson Hula Hoop Kaleidoscope CR Kora CR Lagos Legend CR Lore CR Magnolia Metro Milestone Moto CR # Noble Palisade Panache CR Pullman Quark Regard CR	C continued Roundtrip Sandpiper Sequin CR Sinclair Smart Spot On Star Struck Stepping Stones Spectator Swing Tight Rope Tilden Tower Grid Trebble CR Vibe Wit Zari CR	D Compass CR Coterie Eclat Weave Hologram # In The Loop Island Masquerade Menagerie Origins Tara Theory Woodland Zoom	E Aegean Highland Ikat Square Ikat Stripe Kampala Katazome Mamba Marquee Meroe Midpoint Nature Walk Sherman Shima Tryst Whip	F Atelier Biscayne Calais Cotton Velvet Coco Cornaro Glider Icon Intrigue In Stitches Liberty Mod Plaid Rivington Soon Tivoli Topography Totem Tweed Frieze	G continued Kingston Melange Metallic Gloss Modern Tweed Petite Floral Sablon Serendipity Spencer Straie Stripe Ultrasuede # Utrillo	H Arno Bavaria Catwalk Constance Firefly Gezelle Magritte Rosemond Stretch Appeal	I Aswan Byron Canaan Cato Cummings Diamond Days Digi Velvet Dynamic Fiori Ita Jaipur Knoll Velvet Limani North Island Olema Piper Rutledge Tudor Vermeer Walker Worth Zimba	U Vicenza # Volo #	V Acqua # Andes # Embossed Tipped España # Velluto Pelle #	W Alaska # Amazon # Antique #	U continued Forte # Lucente Sabrina #	X Ducale Velour #	Y Capri # Cervo Copenhagen # Distressed # Marissa # Riva # Torello
--	--	---	---	---	--	--	--	---	--	---------------------------------	--	---	---	-----------------------------	--

Spinneybeck Leather

Approved for Cal 133 upholstery.



Check with KnollTextiles or Spinneybeck Representative for changes or additions.

Jens Risom

Side Chairs and Stool

Designer(s):
Jens Risom, 1943

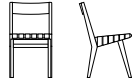

description	seat h	w	d	h	reuphol. kit ydg.	weight
666C-WB Side chair with webbed seat and back 	17 3/4"	17 1/4"	18"	30 3/8"		see below
666C-WB-KIT Re-upholstery kit for side chair with webbed back					14.0	
666C Side chair with webbed seat 	17 3/4"	17 1/4"	18"	30 3/8"		see below
666C-KIT Re-upholstery kit for side chair with wood back					9.0	
667Y Sitting stool 	17 1/8"	16 1/2"	15 1/8"	17 1/8"		see below
667Y-KIT Re-upholstery kit for stool					7.0	

pattern no.	maple, ebonized	walnut	webbing kit
666C-WB-()-()	\$1,091.	\$1,361.	
666C-WB-KIT-()			121.
666C-()-()	1,005.	1,305.	
666C-KIT-()			97.
667Y-()-()	649.	680.	
667Y-KIT-()			83.

Order Code

<i>Example:</i>	666C-WB-LWT-MZ
666C-WB	Risom side chair with webbed seat and back
LWT	Light Walnut
MZ	Maize cotton webbing

Note:
The Risom side chairs are part of a collection. Please refer to the Risom lounge chairs on page 246 and tables on page 366.

- Specify:
1. Pattern number
 2. Frame finish
 3. Webbing color selection

Ordering Information

Frame finishes:
Clear Maple (suffix KC)
Ebonized Maple (suffix KE)
Light Walnut (suffix LWT)

Cotton webbing colors:
Aubergine (suffix AU)
Black (suffix BL)
Dark Grey (suffix DG)
Flax (suffix FL)
Forest Green (suffix FG)
Khaki (suffix KH)
Maize (suffix MZ)
Navy (suffix NA)
Red (suffix RD)
Steel Blue (suffix SB)

Cotton/nylon webbing colors:
Blueberry (suffix BU)
Eucalyptus (suffix EU)
Licorice (suffix LC)
Nutmeg (suffix NM)
Squash (suffix SH)
Tomato (suffix TO)

Re-upholstery kit:
Webbing straps in one length to re-upholster existing chairs. Must be reupholstered by a professional upholsterer.

Note:
The Risom side chairs are Greenguard certified.

Maintenance:
See pages 28-29.

Construction

Frame:
Select maple or walnut hardwood with clear finish. Ebonized finish is stained maple hardwood. Mortise and tenon construction.

Finish:
Catalyzed lacquer protective coating.

Upholstery:
Cotton webbing is 100% natural cotton. Nylon webbing straps are 60% nylon, 40% cotton with water repellent finish. Cotton and Nylon webbing are CAL133 approved.



Weight:
Side chair with webbed seat and back in Maple and/or Ebonized finishes weigh 11 lbs., Walnut finish weigh 10 lbs., Side chair with webbed seat in Maple and/or Ebonized finishes weigh 10 lbs., Walnut finish weigh 9lbs. Sitting stool in Maple and/or Ebonized finishes weigh 7 lbs., Walnut finish weigh 6 lbs.

Jens Risom

Child's Side Chairs and Stool

Designer(s):
Jens Risom, 1943



description	seat h	w	d	h	reuphol. kit ydg.	weight
666CS Child's Risom chair, webbed seat only 	13 1/4"	13 1/8"	15 3/8"	23"		6 lbs.
666CS-KIT Re-upholstery kit for Child's side chair with webbed seat					7.0	
666CS-WB Child's Risom chair with webbed seat and back 	13 1/4"	13 1/8"	15 3/8"	23"		6 lbs.
666CS-WB-KIT Re-upholstery kit for Child's side chair with webbed seat and back					9.0	
667YS Child's sitting stool 	13 1/2"	12 3/8"	11 1/2"	13 1/2"		6 lbs.
667YS-KIT Re-upholstery kit for Child's Sitting stool					5.5	



pattern no.	honey beech	webbing kit
666CS-HB-()	\$368.	
666CS-KIT-()		70.
666CS-WB-HB-()	410.	
666CS-WB-KIT-()		102.
667YS-HB-()	267.	
667YS-KIT-()		62.

Order Code	Ordering Information	Construction
<i>Example:</i> 666CS-WB-HB-OR	<i>Frame finishes:</i> Honey Beech (suffix HB)	<i>Frame:</i> Select European Beech hardwood with a toned natural finish. Mortise and tenon construction.
666CS-WB Child's Risom side chair with webbed seat and back	<i>Child's nylon webbing colors:</i> Blue (suffix BC) Green (suffix GC) Orange (suffix OC) Red (suffix RC)	<i>Finish:</i> Toned catalyzed lacquer finish
HB Honey Beech		<i>Child's Risom Chairs:</i> Child's Risom Chairs are 75% scale of standard risom chair. Child's size chairs are only available in Honey Beech (HB) finish and approved nylon webbing.
OR Orange nylon webbing	<i>Re-upholstery kit:</i> Webbing straps in one length to re-upholster existing chairs. Must be reupholstered by a professional upholsterer.	<i>Upholstery:</i> Nylon webbing straps are 60% nylon, 40% cotton with water repellent finish. Cotton and Nylon webbing are CAL133 approved.
Note: The Child's Risom side chairs are part of a collection. Please refer to the Child's Risom Amoeba table on page 368.	<i>Maintenance:</i> See pages 28-29.	<i>Note:</i> The Child's Risom chair and stool are compliant to the Consumer Product Safety Improvement Act of 2008 for Children's Products, 16 C.F.R. 1303, CPSIA Title 1 Section 101 for Total Lead in Substrates and Surface Coatings.
<i>Specify:</i> 1. Pattern number 2. Frame finish 3. Webbing color selection		

Jens Risom Lounge Chairs

Designer(s):
Jens Risom, 1943



description	seat h	arm h	w	d	h	reuphol. kit ydg.	weight
654LA Arm lounge chair 	16"	22"	23 3/4"	27 1/4"	30 1/4"		see below
654LC Armless lounge chair 	16"		20"	27 1/2"	30 1/4"		see below
654L-KIT Re-upholstery kit for arm and armless lounge chair						25	

pattern no.	maple, ebonized	walnut	webbing kit
654LA-(-)-(-)	\$1,981.	\$2,080.	
654LC-(-)-(-)	1,508.	1,583.	
654L-KIT-(-)			163.

Order Code

<i>Example:</i>	654LC-KC-RD
654LC	Risom lounge chair, armless
KC	Clear Maple
RD	Red cotton webbing

Note:
The Risom lounge chairs are part of a collection. Please refer to the Risom side chairs on page 242 and tables on page 366.

- Specify:*
1. Pattern number
 2. Frame finish
 3. Webbing color selection

Ordering Information

Frame finishes:
Clear maple (suffix KC)
Ebonized maple (suffix KE)
Light walnut (suffix LWT)

Cotton webbing colors:
Aubergine (suffix AU)
Black (suffix BL)
Dark grey (suffix DG)
Flax (suffix FL)
Forest green (suffix FG)
Khaki (suffix KH)
Maize (suffix MZ)
Navy (suffix NA)
Red (suffix RD)
Steel blue (suffix SB)

Cotton/nylon webbing colors:
Blueberry (suffix BU)
Eucalyptus (suffix EU)
Licorice (suffix LC)
Nutmeg (suffix NM)
Squash (suffix SH)
Tomato (suffix TO)

Re-upholstery kit:
Webbing straps in one length to re-upholster existing chairs. Must be reupholstered by a professional upholsterer.

Note:
The Risom Lounge chairs are Greenguard certified.

Maintenance:
See pages 28-29.

Construction

Frame:
Select maple or walnut hardwood with clear finish. Ebonized finish is stained maple hardwood. Mortise and tenon construction. Seat basket of arm lounge chair attaches to arm frame with invisible screws.

Finish:
Lacquer finish.

Upholstery:
Cotton webbing is 100% natural cotton. Nylon webbing straps are 60% nylon, 40% cotton with water repellent finish. Cotton and Nylon webbing are CAL133 approved.



Weight:
Arm lounge chair in Maple and/or Ebonized finishes weigh 20 lbs. Walnut finish weigh 17 lbs. Armless lounge chair in Maple and/or Ebonized finishes weigh 14 lbs., Walnut finish weigh 12 lbs.

Eero Saarinen Tulip Chairs

Designer(s):
Eero Saarinen, 1957

Award(s):
The Museum of Modern Art, New York, USA, 1969; Federal Award for Industrial Design, W. Germany, 1969; Design Center Stuttgart Award, W. Germany, 1962



description	upholstery	seat h	arm h	w	d	h	textile	req.	weight
							fabric yds.	leather sq. ft.	
150A Tulip arm chair 	inner shell	18"	25 1/8"	26"	23 1/4"	32"	2.3	n/a	24 lbs.
	seat cushion	18"	25 1/8"	26"	23 1/4"	32"	0.8	14	18 lbs.
150K Upholstered cushion replacement, arm chair	inner shell	18"	25 1/8"	26"	23 1/4"	32"	2.3	n/a	23 lbs.
	seat cushion	18"	25 1/8"	26"	23 1/4"	32"	0.8	14	18 lbs.
151C Tulip armless chair 	inner shell	18 1/2"	20"	21 1/4"	32"	1.7	n/a	20 lbs.	
	seat cushion	18 1/2"	20"	21 1/4"	32"	0.8	14	17 lbs.	
	inner shell	18 1/2"	20"	21 1/4"	32"	1.7	n/a	19 lbs.	
	seat cushion	18 1/2"	20"	21 1/4"	32"	0.8	14	16 lbs.	
151K Upholstered cushion replacement, armless chair	seat cushion						0.8	14	
153Y Stool 		16 1/2"	15 1/2"		18"		0.8	14	10 lbs.

Order Code

<i>Example:</i>	150AX-2-U-K2074/6
150AX	Tulip arm chair, fixed position
2	White
U	Upholstered inner shell and seat cushion
K2074/6	Aegean, Sunshine

Ordering Information

Swivel or fixed position:
Swivel action (suffix S)
Fixed position (suffix X)

Base and shell finishes:
Black (suffix 1)
Platinum (suffix PL) (not on fully upholstered chairs)
White (suffix 2)

Upholstery options:
Upholstered seat cushion only (suffix K)
Upholstered inner shell and seat cushion (suffix U)

Upholstery/COM information:
Prices shown include fabric or leather upholstery. Contact your Knoll representative for colors. Only approved KnollTextiles and Spinneybeck leathers may be ordered.

Customer's Own Material is available pending approval. For approval requirements, processing instructions and ordering information please see page 18.

Maintenance:
See pages 28-29.

Note:
The signature of Eero Saarinen and the KnollStudio logo are located on the underside of the base.

The Tulip Chair is Greenguard certified.

Construction

Base:
Cast aluminum. Rilsan coated finish for black and white chairs, platinum chairs consist of a high-resilient polyurethane enamel wet coat with a clear satin finish.

Shell:
Molded fiberglass reinforced plastic bonded finish.

Upholstery:
Upholstered or unupholstered inner shell, with removable foam cushion (zippered cover and Velcro fastening).

Cal 133 Fire Code:
The 513Y Saarinen Stool complies with the California Technical Bulletin 133 standard if upholstered in Cal 133 approved upholstery. Specify suffix -C at end of pattern number and suffix -133 at end of textile selection. Upcharge applies, see page 19.

Note:
The Saarinen chairs are part of a collection. Please refer to Saarinen lounge seating, executive chairs and tables on pages 250 and 370.

- Specify:*
1. Pattern number
 2. Swivel or fixed position
 3. Finish selection
 4. Upholstery option (except stool)
 5. Textile selection

pattern no.	grades	COM	C	D	E	F	G	H	I	COL	V	W	X	Y
	A	B								U				
150AS-(1,2)U	\$4,635.	\$4,712.	\$4,783.	\$4,867.	\$4,930.	\$4,980.	\$5,060.	\$5,212.	\$5,324.					
150AS-(1,2,PL)K	2,763.	2,787.	2,807.	2,831.	2,851.	2,863.	2,889.	2,933.	2,965.	3,062.	3,143.	3,303.	3,336.	3,373.
150AX-(1,2)U	4,329.	4,407.	4,479.	4,561.	4,627.	4,674.	4,754.	4,909.	5,023.					
150AX-(1,2,PL)K	2,606.	2,625.	2,649.	2,674.	2,691.	2,704.	2,730.	2,774.	2,807.	2,904.	2,983.	3,144.	3,175.	3,216.
150K	546.	570.	589.	613.	629.	643.	665.	708.	739.	902.	976.	1,128.	1,159.	1,195.
151CS-(1,2)U	3,909.	3,967.	4,019.	4,079.	4,128.	4,164.	4,222.	4,336.	4,419.					
151CS-(1,2,PL)K	2,381.	2,406.	2,428.	2,450.	2,470.	2,484.	2,508.	2,552.	2,585.	2,723.	2,804.	2,963.	2,996.	3,036.
151CX-(1,2)U	3,774.	3,830.	3,886.	3,945.	3,993.	4,027.	4,088.	4,202.	4,287.					
151CX-(1,2,PL)K	2,154.	2,178.	2,197.	2,222.	2,241.	2,255.	2,278.	2,324.	2,357.	2,597.	2,678.	2,837.	2,872.	2,909.
151K	546.	570.	589.	613.	629.	643.	665.	708.	739.	902.	976.	1,128.	1,159.	1,195.
153YS-(1, 2, PL)	1,408.	1,429.	1,449.	1,472.	1,489.	1,501.	1,525.	1,568.	1,600.	1,691.	1,763.	1,916.	1,948.	1,984.

Approved KnollTextiles Grades/Fabrics

- A** Alignment *
Beacon
Bocce *
Cat's Cradle *
Common Ground *
Commuter
Cloth *▲
Crossroad *
Delite *
Dristi *
Hourglass *
Mariner *
Metaphor
Monarch
Prep
Presto (n/a on stool)
Soliloquy *
Sonnet *
Stacks *
Trophy *
Uni-Form
- B** Abacus *
Belize *
Bistro *▲
Boundary *▲
Cameo *
Chroma
Chronicle *
Close Knit *
Digit
Diva *
Dovetail *
Feeling Plaid *
Ferry *
Gala II
Grande *
Grandview *
Helios
Holbrook *
Journey *▲
- C** continued
Keaton *
Knoll Felt *
Knoll Hopsack *
Ludlow *
Lyric *
Melody
Mini Stitch *
Night Life *
Paradigm *
Petrol Pusher *
Pop *
Prairie *
Prim *▲
Radiance *
Ransom *
Ricochet *
Roam *
Rush Hour *
Soiree *
Spark *
Spinoff Nuance *
Spree *
Starry Night *
Summit
Sutton *▲
Synth *
Tabloid *
Tinge *
Venue *
Versa *
Vinyl
Westwood *
Wide Angle *
Yeni *
Zipline *
- C** continued
Atlas *
Autobahn
Axiom *
Baxter *
Biota *
Cairo *
Charm *
Circa *
Classic Boucle *
Dahlia *
Dune *
Durand *
Earthwork *
Echo *
Empire Stripe
Enmesh *
Entourage *
Essence *
Fable CR *
Fibra *
Greenwich *
Hudson
Hula Hoop *
Kora CR
Lagos *
Legend CR
Lore CR
Magnolia
Metro
Milestone *
Moto CR *
Noble *
Panache CR *
Pullman *
Regard CR *
Roundtrip *
Sahara *
Sandpiper
Sequin CR *
- D** continued
Sinclair *
Smart *
Spectator *
Spot On *
Star Struck *
Stepping Stones
Swing *
Tight Rope *
Tilden *
Tower Grid *
Transition *
Treble CR *
Vibe *
Wit *
Zari CR *
- D** Compass CR
Coterie *
Eclat Weave *
Hologram
Island *
Kabuki
Masquerade
Menagerie *
Origins *
Satellite
Satin Chisel
Tara *
Theory *
Woodland *
Zoom
- E** Aegean *
Demure *
Highland *
Ikat Square *
Ikat Stripe *
Kampala *
- F** continued
Sinclair *
Smart *
Spectator *
Spot On *
Star Struck *
Stepping Stones
Swing *
Tight Rope *
Tilden *
Tower Grid *
Transition *
Treble CR *
Vibe *
Wit *
Zari CR *
- F** Atelier *
Biscayne *
Calais Cotton
Velvet
Century *
Coco *
Cornaro *
Eclipse *
Glider *
Icon *
Intrigue *
In Stitches *
Liberty *
Mod Plaid *
Rivington *
Soon
Tivoli *
Topography *
Totem *
Tweed Frieze *
- G** continued
Kingston *
Little Devil *
Melange *
Metallic Gloss *
Modern Tweed
Petite Floral *
Sablon *
Serendipity *
Spencer *
Ultrasuede *
Utrillo *
- G** Abington *
Alter Ego
Amore
Arabella *
Arber *
Brugge *
Djenne
Garden City *
Gibson *
Hampshire *
Haze *
Kamani
Kinabalu *
- H** Arno *
Bavaria *
Catwalk
Constance *
Firefly *
Gezelle *
Magritte *
Rosemond *
Stretch Appeal *
- H** Arno *
Bavaria *
Catwalk
Constance *
Firefly *
Gezelle *
Magritte *
Rosemond *
Stretch Appeal *
- I** Aswan *
Bryon *
Canaan *
Cato *
Diamond Days *
Digi Velvet
Dynamic *
Fiori *
Gramercy *
Ita *
Jaipur *
Knoll Velvet *
Limani *
North Island *
Olema
Piper *
Ravello *
Rutledge *
Sandis *
Tudor *
Vermeer *
Walker *
Worth *
Zimba *

Spinneybeck Leather

- U** Vicenza
Volo
- V** Acqua
Andes
Embossed Tipped
España
Hand Tipped
Velluto Pelle
- W** Alaska
Amazon
Antique
Derby
Forte
Lucente
Sabrina
- X** Ducale
Ducale Velour
- Y** Capri
Cervo
Copenhagen
Distressed
Lucca
Marissa
Portofino
Riva
Torello

* Approved for fully upholstered versions.



▲ Approved for Cal133 upholstery.

Check with your KnollTextiles or Spinneybeck Representative for changes or additions.

Eero Saarinen Executive Arm Chairs

Designer(s):
Eero Saarinen, 1950



description	seat h,		w	d	h, min		h, max	textile fabric yds.	req. leather sq. ft.	weight	type
	min	max									
71A-T5G-H Executive arm chair with pneumatic seat height adjustment	16 1/2"	21 3/4"	26"	24 3/4"	31"	36 1/4"	2.9	47	34 lbs.		
											
Executive arm chair with pneumatic seat height adjustment, contrast leather welt option	16 1/2"	21 3/4"	26"	24 3/4"	31"	36 1/4"	2.9	47	34 lbs.	uphol.	
								6.25		welt	
71A Executive arm chair with tubular legs and glides	18"		26"	24 3/4"	31 1/2"		2.9	47	19 lbs.		
											
Executive arm chair with tubular legs and glides, contrast leather welt option	18"		26"	24 3/4"	31 1/2"		2.9	47	19 lbs.	uphol.	
								6.25		welt	
R Optional soft wheel casters (change -H to -R)											
3 Optional black top caps (add -3 after 71A, not available for 71A-PC)											

pattern no.	upcharge	grades A	COM B	C	D	E	F	G	H	I	COL U	V	W	X	Y
71A-T5G-(-)()		\$3,065.	\$3,146.	\$3,224.	\$3,311.	\$3,381.	\$3,432.	\$3,520.	\$3,682.	\$3,805.	\$4,784.	\$5,052.	\$5,590.	\$5,703.	\$5,832.

71A-T5G-(-)LT-(-)()	3,065.	3,146.	3,224.	3,311.	3,381.	3,432.	3,520.	3,682.	3,805.	4,784.	5,052.	5,590.	5,703.	5,832.
upchg, welt										234.	266.	331.	344.	361.

71A-(BL,C)-(-)()	2,262.	2,342.	2,424.	2,508.	2,579.	2,629.	2,717.	2,879.	3,001.	3,979.	4,243.	4,781.	4,893.	5,025.
--------------------------	--------	--------	--------	--------	--------	--------	--------	--------	--------	--------	--------	--------	--------	--------

71A-(BL,C)-LT-(-)()	2,262.	2,342.	2,424.	2,508.	2,579.	2,629.	2,717.	2,879.	3,001.	3,979.	4,243.	4,781.	4,893.	5,025.
upchg, welt										234.	266.	331.	344.	361.

R n/c

3 93.

Order Code	Ordering Information	Construction
<i>Example:</i> 71A-3-T5G-R-ES8080	<i>Wood Leg Finishes:</i> Ebony Walnut (suffix D) Light Oak (suffix L.O) Light Walnut (suffix LWA) Pearwood (suffix P) Polished Chrome (suffix C) Reff Dark Cherry (suffix V314)	<i>Upholstery/COM information:</i> Prices shown include fabric or leather upholstery. Contact your Knoll representative for colors. Only approved KnollTextiles and Spinneybeck leathers may be ordered. Customer's Own Material is available pending approval. For approval requirements, processing instructions and ordering information please see page 18. <i>Cal 133 Fire Code #:</i> The Saarinen Executive Chairs comply with the California Technical Bulletin 133 standard if upholstered in Cal 133 approved upholstery. Specify suffix -C at end of pattern number and suffix -133 at end of textile selection. Upcharge applies, see page 19. <i>Maintenance:</i> See pages 28-29. <i>Note:</i> The Saarinen Executive Arm Chair is Greenguard certified.
71A Open back arm chair	<i>Tubular Leg Finishes:</i> Black (BL) Polished Chrome (suffix C)	<i>Frame:</i> Molded reinforced polyurethane shell. Contoured plywood seat form. <i>Upholstery:</i> Urethane foam cushion. Welt detail along arm, back and top of seat is available as a self welt (same material) or as a contrasting leather welt. Please specify pattern number with LT suffix, for contrasting welt, and add appropriate leather upcharge for total list price of the piece. Leather welt option is available on both textile and leather upholstery. <i>Swivel base:</i> Five-star steel base in protective black epoxy finish. Stainless steel or optional black epoxy top caps. <i>Steel leg base:</i> Four legs in seamless tubular steel with polished chrome or matte black powder coat .
3 Black top caps	<i>Caster option:</i> Hard wheel casters standard. For soft wheel casters, change -H in pattern number to -R. No glide option on swivel models.	
T5G Advanced height adjustment, swivel/tilt	<i>Split upholstery option:</i> The seat and back of the Saarinen Executive Chair can be specified in split upholstery. Indicate S before selected seat upholstery, followed by selected back upholstery. The price equals the price of the higher upholstery grade.	
R Soft wheel casters	<i>COM split fabric requirements:</i> Back upholstery: 2.25 yards Seat upholstery: 1.25 yards	
ES8080 Espana, Serpentina	<i>COL split leather requirements:</i> Back upholstery: 40 square feet Seat upholstery: 23 square feet	

Note:
The Saarinen executive chairs are part of a collection. Please refer to Saarinen side chairs, lounge chairs and tables on beginning on pages 248 and 370.

- Specify:
1. Pattern number
 2. Black top cap option (swivel base only)
 3. Caster type (swivel base only)
 4. Cal 133 fire code option
 5. Split upholstery option (add S)
 6. Textile selection

Approved KnollTextiles Grades/Fabrics

Wood leg base:

Solid steam bent oak with a clear or stained finish. Finish is complementary match to Saarinen, Florence Knoll and Platner low tables.

Casters:

2" twin wheel hard casters for use on carpeted floors. Wheel and housing components in black textured plastic. Optional soft casters for use on wood and other resilient flooring (black with grey housing).

Glides:

Molded nylon disk in stamped steel shroud.

Approved KnollTextiles Grades/Fabrics				Spinneybeck Leather	
A Beacon Common Ground # Commuter Cloth # Crossroad Delite Dristi Hourglass Mariner Presto Sonnet Stacks Trophy	E continued Sutton Synth Tinge Venue Vinyl Westwood Wide Angle	D Hologram Tara Theory Woodland Zoom	G continued Garden City Hampshire Haze Kinabalu Melange Metallic Gloss Modern Tweed Petite Floral Sablon Serendipity Ultrasuede Utrillo	U Vicenza # Volo #	X Ducale # Ducale Velour #
B Abacus Boundary Cameo Diva Ferry Grande Journey Keaton Knoll Felt # Knoll Hopsack # Little Devil Lyric Melody Night Life Petal Pusher Prairie Ricochet Rush Hour	C Axiom Classic Boucle Durand Echo Entourage Essence Hula Hoop Lagos Metro Palisade Pullman Quark Sequin CR Sinclair Smart Stepping Stones Swing Tilden	F Atelier Biscayne Coco Cornaro Intrigue In Stitches Liberty Rivington Tivoli Tweed Frieze	H Arno Bavaria Catwalk Gezelle Magritte Rosemond	V Acqua # Andes # Embossed Tipped # España # Velluto Pelle #	Y Capri # Cervo # Copenhagen # Distressed # Marissa # Riva #
		G Abington Alter Ego Amore Arber Brugge Feeling Plaid	I Aswan Cato Diamond Days Dynamic Fiori Ita Knoll Velvet Limani North Island Rutledge Tudor Vermeer Walker Zimba	W Alaska # Amazon # Antique # Derby # Forte # Lucente # Sabrina #	# Approved for Cal 133 upholstery.

Check with your KnollTextiles or Spinneybeck Representative for changes or additions.

Eero Saarinen

Executive Arm Chairs

Designer(s):
Eero Saarinen, 1950



description	seat h,		w	d	h, min		textile fabric yds.	req. leather sq. ft.	weight	type
	min	max			h, min	h, max				
71A-W Executive arm chair with wood legs and glides	18"	26"	24 3/4"	31 1/2"	2.9	47	18 lbs.			
Executive arm chair with wood legs and glides, contrast leather welt option	18"	26"	24 3/4"	31 1/2"	2.9	47	18 lbs.	uphol.		
						6.25		welt		

pattern no.	upcharge	grades A	COM B	C	D	E	F	G	H	I	COL					U	V	W	X	Y
71A-W-()-()		\$2,648.	\$2,732.	\$2,812.	\$2,902.	\$2,975.	\$3,027.	\$3,117.	\$3,285.	\$3,410.	\$4,387.	\$4,664.	\$5,221.	\$5,335.	\$5,471.					
71A-W-()-LT-()-()		2,648.	2,732.	2,812.	2,902.	2,975.	3,027.	3,117.	3,285.	3,410.	4,387.	4,664.	5,221.	5,335.	5,471.					
upchg, welt											234.	266.	331.	344.	361.					

Order Code	Ordering Information	Construction
<i>Example:</i> 71A-3-T5G-R-ES8080	<i>Wood Leg Finishes:</i> Ebonized Walnut (suffix D) Light Oak (suffix L.O) Light Walnut (suffix LWA) Pearwood (suffix P) Polished Chrome (suffix C) Reff Dark Cherry (suffix V314)	<i>Upholstery/COM information:</i> Prices shown include fabric or leather upholstery. Contact your Knoll representative for colors. Only approved KnollTextiles and Spinneybeck leathers may be ordered.
71A	Open back arm chair	<i>Frame:</i> Molded reinforced polyurethane shell. Contoured plywood seat form.
3	Black top caps	<i>Upholstery:</i> Urethane foam cushion. Welt detail along arm, back and top of seat is available as a self welt (same material) or as a contrasting leather welt. Please specify pattern number with LT suffix, for contrasting welt, and add appropriate leather upcharge for total list price of the piece. Leather welt option is available on both textile and leather upholstery.
T5G	Advanced height adjustment, swivel/tilt	<i>Swivel base:</i> Five-star steel base in protective black epoxy finish. Stainless steel or optional black epoxy top caps.
R	Soft wheel casters	<i>Steel leg base:</i> Four legs in seamless tubular steel with polished chrome or matte black powder coat.
ES8080	Espana, Serpentina	<i>Maintenance:</i> See pages 28-29.
	<i>Tubular Leg Finishes:</i> Black (BL) Polished Chrome (suffix C)	<i>Note:</i> The Saarinen Executive Arm Chair is Greenguard certified.
	<i>Caster option:</i> Hard wheel casters standard. For soft wheel casters, change -H in pattern number to -R. No glide option on swivel models.	
	<i>Split upholstery option:</i> The seat and back of the Saarinen Executive Chair can be specified in split upholstery. Indicate S before selected seat upholstery, followed by selected back upholstery. The price equals the price of the higher upholstery grade.	
	<i>COM split fabric requirements:</i> Back upholstery: 2.25 yards Seat upholstery: 1.25 yards	
	<i>COL split leather requirements:</i> Back upholstery: 40 square feet Seat upholstery: 23 square feet	

Note:
The Saarinen executive chairs are part of a collection. Please refer to Saarinen side chairs, lounge chairs and tables on beginning on pages 248 and 370.

- Specify:
1. Pattern number
 2. Black top cap option (swivel base only)
 3. Caster type (swivel base only)
 4. Cal 133 fire code option
 5. Split upholstery option (add S)
 6. Textile selection

Approved KnollTextiles Grades/Fabrics	Spinneybeck Leather
<i>Wood leg base:</i> Solid steam bent oak with a clear or stained finish. Finish is complementary match to Saarinen, Florence Knoll and Platner low tables.	A Beacon Common Ground ‡ Commuter Cloth ‡ Crossroad Delite Dristi Hourglass Mariner Presto Sonnet Stacks Trophy
<i>Casters:</i> 2" twin wheel hard casters for use on carpeted floors. Wheel and housing components in black textured plastic. Optional soft casters for use on wood and other resilient flooring (black with grey housing).	E continued Sutton Synth Tinge Venue Vinyl Westwood Wide Angle
<i>Glides:</i> Molded nylon disk in stamped steel shroud.	C Axiom Classic Boucle Durand Echo Entourage Essence Hula Hoop Lagos Metro Palisade Pullman Quark Sequin CR Sinclair Smart Stepping Stones Swing Tilden
	D Hologram Tara Theory Woodland Zoom
	G continued Garden City Hampshire Haze Kinabalu Melange Metallic Gloss Modern Tweed Petite Floral Sablon Serendipity Ultrasuede Utrillo
	F Atelier Biscayne Coco Cornaro Intrigue In Stitches Liberty Rivington Tivoli Tweed Frieze
	H Arno Bavaria Catwalk Gezelle Magritte Rosemond
	I Aswan Cato Diamond Days Dynamic Fiori Ita Knoll Velvet Limani North Island Rutledge Tudor Vermeer Walker Zimba
	U Vicenza ‡ Volo ‡
	V Acqua ‡ Andes ‡ Embossed Tipped ‡ España ‡ Velluto Pelle ‡
	W Alaska ‡ Amazon ‡ Antique ‡ Derby ‡ Forte ‡ Lucente ‡ Sabrina ‡
	X Ducale ‡ Ducale Velour ‡
	Y Capri ‡ Cervo ‡ Copenhagen ‡ Distressed ‡ Marissa ‡ Riva ‡
	‡ Approved for Cal 133 upholstery.
	<i>Check with your KnollTextiles or Spinneybeck Representative for changes or additions.</i>

Eero Saarinen

Executive Armless Chairs

Designer(s):
Eero Saarinen, 1946



description	seat h,		w	d	h,		textile fabric yds.	req. leather sq. ft.	weight
	min	max			h, min	h, max			
72C-T5G-H Executive armless chair with pneumatic seat height adjustment	14 1/2"	19 3/4"	22 1/2"	24"	31"	36 1/4"	2.0	35	29 lbs.
72C Executive armless chair with tubular legs and glides	18 3/4"		22 1/2"	20 1/2"	31 1/2"		2.0	35	14 lbs.



3 Optional black top caps (add -3 after 72C, not available for 72C-PC)

R Optional soft wheel casters (change -H to -R)

Order Code

Example: **72C-C-S-CD70-AL5008**

72C	Open back chair, armless
C	Polished chrome leg
S	Split upholstery option
CD70	seat: Cordovan, Rembrandt Brown
AL5008	back: Alaska, Caribou

Note:
The Saarinen executive chairs are part of a collection. Please refer to Saarinen side chairs, lounge chairs and tables on beginning on pages 248 and 370.

Specify:

1. Pattern number
2. Leg base option
3. Cal 133 fire code option
4. Split upholstery option (add S)
5. Textile selection, seat
6. Textile selection, back

Wood Leg Finishes:
Ebonized Walnut (suffix D)
Light Oak (suffix LO)
Light Walnut (suffix LWA)
Pearwood (suffix P)
Polished Chrome (suffix C)
Reff Dark Cherry (suffix V314)

Tubular Leg Finishes:
Black (suffix BL)
Polished Chrome (C)

Plastic Back Finishes:
Black (suffix 1)
White (suffix 2)

Ordering Information

Caster option:
Hard wheel casters standard. For soft wheel casters, change -H to -R. No glide option on swivel models.

Split upholstery option:
The seat and back of the Saarinen Executive Chair can be specified in split upholstery. Indicate S before selected seat upholstery, followed by selected back upholstery. The price equals the price of the higher upholstery grade.

COM split fabric requirements:
Back upholstery: 1.5 yards
Seat upholstery: .75 yards

COL split leather requirements:
Back upholstery: 27 square feet
Seat upholstery: 13.5 square feet

Upholstery/COM information:
Prices shown include fabric or leather upholstery. Contact your Knoll representative for colors. Only approved KnollTextiles and Spinneybeck leathers may be ordered. Customer's Own Material is available pending approval. For approval requirements, processing instructions and ordering information please see page 18.

Cal 133 Fire Code #:
The Saarinen Executive Chairs comply with the California Technical Bulletin 133 standard if upholstered in Cal 133 approved upholstery. Specify suffix -C at end of pattern number and suffix -133 at end of textile selection. Upcharge applies, see page 19.

Maintenance:
See pages 28-29.

Note:
The Saarinen Executive Armless Chair is Greenguard certified

Construction:

Frame:
Molded reinforced polyurethane shell. Contoured plywood seat form.

Plastic Back:
Polycarbonate with a wet coat paint in black or white. Note that the seat of the plastic back version is slightly wider than the fully upholstered version.

Glides:
Molded nylon disk in stamped steel shroud.

Upholstery:
Urethane foam cushion.

Swivel base:
Five-star steel base in protective black epoxy finish. Stainless steel or optional black epoxy top caps.

Steel Leg base:
Four legs in seamless tubular steel with polished chrome or matte black powder coat.

Wood leg base:
Solid steam bent oak with a clear or stained finish. Finish is complementary match to Saarinen, Florence Knoll and Platner low tables

Casters:
2" twin wheel hard casters for use on carpeted floors. Wheel and housing components in black textured plastic. Optional soft casters for use on wood and other resilient flooring (black with grey housing).

pattern no.	upcharge	grades	COM	C	D	E	F	G	H	I	COL	V	W	X	Y
72C-T5G-H-()		\$2,195.	\$2,253.	\$2,306.	\$2,366.	\$2,412.	\$2,448.	\$2,508.	\$2,621.	\$2,704.	\$3,231.	\$3,429.	\$3,829.	\$3,913.	\$4,010.
72C-(BL,C)-()		1,516.	1,572.	1,626.	1,685.	1,733.	1,770.	1,828.	1,942.	2,026.	2,520.	2,718.	3,118.	3,201.	3,299.
3		93.													
R		n/c													

Approved KnollTextiles Grades/Fabrics

A Beacon Bocce Cat's Cradle Chance Common Ground # Commuter Cloth # Crossroad Delite Dristi Hourglass Mariner Prep # Presto # Soliloquy Sonnet Stacks Trophy	B continued Mini Stitch # Night Life Paradigm Petal Pusher Prairie Prim # Ransom Radiance Ricochet Roam Rush Hour Soiree Spark # Spree Summit Sutton Synth Tabloid Tinge Venue Versa Vinyl Westwood Wide Angle # Zipline	C continued Empire Stripe Enmesh # Entourage Essence Fable CR Fibra Greenwich Hudson Hula Hoop Kaleidoscope CR Kora CR Lagos Lore CR Magnolia Metro Milestone Noble Palisade Panache CR Pullman Quark Regard CR Rountrip Sandpiper Sequin CR Sinclair Smart Spectator Spot On Star Struck # Stepping Stones Swing Tilden Tower Grid Treble CR Vibe Zari CR	D Compass CR Coterie Eclat Weave Hologram Island Masquerade Menagerie Origins Tara Theory Woodland Zoom	E Aegean Demure Highland Ikata Square Kampala Katazome Mamba Marquee Nature Walk Sherman Shima Tryst Vatera Whip	F Atelier Biscayne Coco Cornaro Glider Icon Intrigue In Stitches Liberty Mod Plaid Rivington Soon Tivoli Topography Totem Tweed Frieze	G Abington Alter Ego Amore Arabella Arber Brugge Djenne Feeling Plaid Garden City Gibson Hampshire Haze Kamani Kinabalu Kingston Melange Metallic Gloss Modern Tweed Petite Floral Sablou Serendipity Spencer Straie Stripe Ultrasuede # Utrillo #	H Arno Bavaria Catwalk Constance Gezelle Magritte Rosemond	I Aswan Canaan Cato Diamond Days Dynamic Fiori Gramercy Ita Jaipur Knoll Velvet Limani North Island Olema Piper Rutledge Tudor Vermeer Walker Worth Zimba	U Vicenza # Volo #	V Acqua # Andes # Embossed Tipped # España # Velluto Pelle #	W Alaska # Amazon # Antique # Forte # Lucente # Sabrina #	X Ducale # Ducale Velour #	Y Capri # Cervo # Copenhagen # Distressed # Lucca # Marissa # Portofino # Riva #
--	--	--	--	---	---	--	--	--	---------------------------------	--	--	---	---



Spinneybeck Leather

Approved for Cal 133 upholstery; approval does not apply to chairs with plastic backs.

Check with your KnollTextiles or Spinneybeck Representative for changes or additions.

Eero Saarinen

Executive Armless Chairs

	description	seat h, min	seat h, max	width	d	h, min	h, max	textile fabric yds.	req. leather sq. ft.	weight
<i>Designer(s):</i> Eero Saarinen, 1946	72C-W Executive armless chair with wood legs and glides	18 3/4"		22 1/2"	20 1/2"	31 1/2"		2.0	35	13 lbs.
										
	72C Executive armless chair with plastic back, tubular legs and glides	18 3/4"		22"	20.5"	31 1/2"		1.3	12	16 lbs.
										



Order Code

<i>Example:</i>	72C-C-S-CD70-AL5008
72C	Open back chair, armless
C	Polished chrome leg
S	Split upholstery option
CD70	seat: Cordovan, Rembrandt Brown
AL5008	back: Alaska, Caribou

Note:
The Saarinen executive chairs are part of a collection. Please refer to Saarinen side chairs, lounge chairs and tables on beginning on pages 248 and 370.

Specify:

1. Pattern number
2. Leg base option
3. Cal 133 fire code option
4. Split upholstery option (add S)
5. Textile selection, seat
6. Textile selection, back

Wood Leg Finishes:
Ebonized Walnut (suffix D)
Light Oak (suffix LO)
Light Walnut (suffix LWA)
Pearwood (suffix P)
Polished Chrome (suffix C)
Reff Dark Cherry (suffix V314)

Tubular Leg Finishes:
Black (suffix BL)
Polished Chrome (C)

Plastic Back Finishes:
Black (suffix 1)
White (suffix 2)

Ordering Information

Caster option:
Hard wheel casters standard. For soft wheel casters, change -H to -R. No glide option on swivel models.

Split upholstery option:
The seat and back of the Saarinen Executive Chair can be specified in split upholstery. Indicate S before selected seat upholstery, followed by selected back upholstery. The price equals the price of the higher upholstery grade.

COM split fabric requirements:
Back upholstery: 1.5 yards
Seat upholstery: .75 yards

COL split leather requirements:
Back upholstery: 27 square feet
Seat upholstery: 13.5 square feet

Upholstery/COM information:
Prices shown include fabric or leather upholstery. Contact your Knoll representative for colors. Only approved KnollTextiles and Spinneybeck leathers may be ordered. Customer's Own Material is available pending approval. For approval requirements, processing instructions and ordering information please see page 18.

Cal 133 Fire Code #:
The Saarinen Executive Chairs comply with the California Technical Bulletin 133 standard if upholstered in Cal 133 approved upholstery. Specify suffix -C at end of pattern number and suffix -133 at end of textile selection. Upcharge applies, see page 19.

Maintenance:
See pages 28-29.

Note:
The Saarinen Executive Armless Chair is Greenguard certified

Construction:

Frame:
Molded reinforced polyurethane shell. Contoured plywood seat form.

Plastic Back:
Polycarbonate with a wet coat paint in black or white. Note that the seat of the plastic back version is slightly wider than the fully upholstered version.

Glides:
Molded nylon disk in stamped steel shroud.

Upholstery:
Urethane foam cushion.

Swivel base:
Five-star steel base in protective black epoxy finish. Stainless steel or optional black epoxy top caps.

Steel Leg base:
Four legs in seamless tubular steel with polished chrome or matte black powder coat.

Wood leg base:
Solid steam bent oak with a clear or stained finish. Finish is complementary match to Saarinen, Florence Knoll and Platner low tables

Casters:
2" twin wheel hard casters for use on carpeted floors. Wheel and housing components in black textured plastic. Optional soft casters for use on wood and other resilient flooring (black with grey housing).

pattern no.	upcharge	grades A	COM B	C	D	E	F	G	H	I	COL U	V	W	X	Y
72C-W-()-()		\$1,934.	\$1,991.	\$2,047.	\$2,109.	\$2,158.	\$2,195.	\$2,257.	\$2,374.	\$2,462.	\$2,962.	\$3,166.	\$3,580.	\$3,667.	\$3,768.
72C-(BL,C)-(1,2)-()		1,055.	1,092.	1,127.	1,165.	1,196.	1,217.	1,259.	1,332.	1,387.	1,306.	1,374.	1,511.	1,540.	1,573.

Approved KnollTextiles Grades/Fabrics

A Beacon Bocce Cat's Cradle Chance Common Ground # Commuter Cloth # Crossroad Delite Dristi Hourglass Mariner Prep # Presto # Soliloquy Sonnet Stacks Trophy	B continued Mini Stitch # Night Life Paradigm Petal Pusher Prairie Prim # Ransom Radiance Ricochet Roam Rush Hour Soiree Spark # Spree Summit Sutton Synth Tabloid Tinge Venue Versa Vinyl Westwood Wide Angle # Zipline	C continued Empire Stripe Enmesh # Entourage Essence Fable CR Fibra Greenwich Hudson Hula Hoop Kaleidoscope CR Kora CR Lagos Lore CR Magnolia Metro Milestone Noble Palisade Panache CR Pullman Quark Regard CR Rountrip Sandpiper Sequin CR Sinclair Smart Spectator Spot On Star Struck # Stepping Stones Swing Tilden Tower Grid Treble CR Vibe Zari CR	D Compass CR Coterie Eclat Weave Hologram Island Masquerade Menagerie Origins Tara Theory Woodland Zoom	E Aegean Demure Highland Ikat Square Kampala Katazome Mamba Marquee Nature Walk Sherman Shima Tryst Vatera Whip	F Atelier Biscayne Coco Cornaro Glider Icon Intrigue In Stitches Liberty Mod Plaid Rivington Soon Tivoli Topography Totem Tweed Frieze	G Abington Alter Ego Amore Arabella Arber Brugge Djenne Feeling Plaid Garden City Gibson Hampshire Haze Kamani Kinabalu Kingston Melange Metallic Gloss Modern Tweed Petite Floral Sablou Serendipity Spencer Straie Stripe Ultrasuede # Utrillo #	H Arno Bavaria Catwalk Constance Gezelle Magritte Rosemond	I Aswan Canaan Cato Diamond Days Dynamic Fiori Gramercy Ita Jaipur Knoll Velvet Limani North Island Olema Piper Rutledge Tudor Vermeer Walker Worth Zimba	U Vicenza # Volo #	V Acqua # Andes # Embossed Tipped # España # Velluto Pelle #	W Alaska # Amazon # Antique # Forte # Lucente # Sabrina #	X Ducale # Ducale Velour #	Y Capri # Cervo # Copenhagen # Distressed # Lucca # Marissa # Portofino # Riva #
--	--	--	--	--	---	--	--	--	---------------------------------	--	--	---	---



Spinneybeck Leather

Approved for Cal 133 upholstery; approval does not apply to chairs with plastic backs.

Check with your KnollTextiles or Spinneybeck Representative for changes or additions.

Eero Saarinen

Womb Chair, Ottoman and Settee

	description	seat h	arm h	w	d	h	textile fabric yds.	req. leather sq. ft.	weight
<p><i>Designer(s):</i> Eero Saarinen, 1948</p> 	<p>70L Womb chair</p> 	16"	20½"	40"	34"	35½"	7.2	165	36 lbs.
	<p>74Y Ottoman</p> 				25½"	20"	16"	2.1	55

Order Code

<i>Example:</i>	70LM-BL-K530/4
70LM	Medium womb chair
BL	Black base
K530/4	Lyonese Velvet, Cognac

Note:
The Womb chair and ottoman and Womb Settee are part of a collection. Please refer to Saarinen side and executive chairs and tables on pages 248 and 370.

Specify:

1. Pattern number/size
2. Base finish selection
3. Cal 133 option
4. Split upholstery option (add S)
5. Textile selection

Ordering Information

Base finishes:
Black (suffix BL)
Polished Chrome (suffix C)

Upholstery/COM information:
Prices shown include fabric or leather upholstery. Contact your Knoll representative for colors. Only approved KnollTextiles and Spinneybeck leathers may be ordered.

Customer's Own Material is available pending approval. For approval requirements, processing instructions and ordering information please see page 18.

KnollStudio 20-day Program:
The standard Womb chair and ottoman are available in a chrome finish on the 20-day program upholstered with in-stock KnollTextile. For more information, please consult pages 30-33.

Split upholstery option:
The surround and cushions of the Womb chair and ottoman and Womb settee may be specified with split upholstery. Indicate S before selected surround upholstery, followed by selected cushion upholstery. Price equals the higher upholstery grade.

COM split fabric requirements:
75% Womb chair body: 3.5 yards
75% Womb chair seat/back: 1.25 yards
85% Womb chair body: 3.75 yards
85% Womb chair seat/back: 1.25 yards
85% Ottoman body: 1 yard
85% Ottoman cushion: .75 yards
100% Womb chair body: 5.50 yards
100% Womb chair seat/back: 2 yards
100% Ottoman body: 1 yard
100% Ottoman cushion: 1.25 yards
100% Womb settee body: 9 yards
100% Womb settee seat/back: 2.6 yards

COL split leather requirements:
75% Womb chair body: 90 square ft
75% Womb chair seat/back: 23 square ft
85% Womb chair body: 96 square ft
85% Womb chair seat/back: 25 square ft
85% Ottoman cushion: 25 square ft
100% Womb chair body: 110 square ft
100% Womb chair seat/back: 40 square ft
100% Ottoman body: 27.5 square ft
100% Ottoman cushion: 27.5 square ft
100% Womb settee body: 275 square ft
100% Womb settee seat/back: 110 square ft

Maintenance:
See pages 28-29.

Cal 133 Fire Code:
The Womb Chair, Ottoman, and Settee comply with the California Technical Bulletin 133 standard if upholstered in Cal 133 approved upholstery. Specify suffix -C at end of pattern number and suffix -133 at end of textile selection. Upcharge applies, see page 19.

Note:
The Saarinen Womb chair and ottoman and Womb settee are Greenguard certified.

pattern no.	grades	COM	C	D	E	F	G	H	I	COL	V	W	X	Y
70L-(BL,C)-()	\$5,486.	\$5,761.	\$6,040.	\$6,348.	\$6,421.	\$6,583.	\$6,760.	\$7,206.	\$8,024.	\$9,147.	\$10,074.	\$12,451.	\$12,864.	\$13,117.
74Y-(BL,C)-()	1,617.	1,686.	1,760.	1,813.	1,860.	1,903.	1,950.	2,063.	2,271.	2,471.	2,741.	3,327.	3,435.	3,500.

Construction

Base:
Steel wire with a polished chrome finish or matte black powder-coat.

Frame and upholstery:
Foam over molded, reinforced fiberglass shell on chair. Foam cushion over molded plywood platform on ottoman. Separate seat, back, and ottoman cushions constructed of polyester fiber with foam core.

Glides:
Stainless steel and nylon articulating glides.

Medium and Child's Womb Chairs:
Medium Womb chair and ottoman are 85% scale of standard Womb chair. Child's Womb chair is 75% scale of standard chair. Child's chair does not have accompanying ottoman.

Approved KnollTextiles Grades/Fabrics

- A** Alignment #
Bocce
Cat's Cradle
Common Ground #
Commuter Cloth #
Crossroad
Delite
Hourglass
Mariner
Prep
Soliloquy *
Sonnet
Stacks
Uni-Form
- B** Abacus #
Argyle
Belize
Bistro #
Cameo
Chronicle
Diva
Dovetail #
Ferry
Grande
Grandview
Helios
Holbrook
Journey #
Keaton
Knoll Felt
Knoll Hopsack
Little Devil
Ludlow
Lyric
Melody
Mini Stitch #
Night Life
Paradigm
Pogo
Prairie
Prim #
Radiance
Ransom
Roam
Rush Hour
Soiree
Spark
Spree
Summit
- B** continued
Sutton #
Tabloid
Tinge
Versa
Westwood
Zipline
- C**
Atlas
Biota
Cairo
Charm
Circa
Classic Boucle
Dahlia CR
Durand
Earthwork
Echo
Empire Stripe *
Entourage *
Essence
Fibra
Greenwich
Hudson
Hula Hoop
Kaleidoscope CR
Kora CR *
Lagos
Legend CR
Lore CR
Metro
Milestone
Palisade
Posh
Pullman
Quark
Regard CR
Roundtrip
Sandpiper
Sequin CR *
Smart
Spectator *
Spot On *
Star Struck
Swing
Tilden
Tower Grid
Treble CR
Vibe *
Wit
Zari CR *
- D**
Compass CR
Coterie
Eclat Weave
Island
Masquerade
Menagerie
Origins
Tara
Theory
Woodland
- E**
Aegean
Highland
Ikat Square
Ikat Stripe
Kampala
Katazome
Kimono
Mamba
Marquee
Meroe
Midpoint
Nature Walk
Shima
Vatera
Whip
- F**
Atelier
Biscayne
Coco
Cornaro *
Glider
Icon
Intrigue
In Stitches
Liberty
Mod Plaid
Rivington
Soon
Tivoli
Topography
- G**
Abington
Amore

Spinneybeck Leather

- U** Vicenza #
Volo #
- V** Acqua #
Andes #
Embossed Tipped #
España #+
Velluto Pelle #
- W** Alaska #
Amazon #
Antique #
Derby #
Forte #
Lucente #
Sabrina #
- X** Ducale #+
Ducale Velour #
- Y** Capri #
Cervo #
Copenhagen #
Distressed #+
Lucca #
Marissa #
Portofino #+
Riva #
Torello #

Note: All KnollTextiles and COM fabrics are railroaded on the Womb chair.

* Approved for chair and ottoman cushion upholstery only.
+ Not approved for small and medium Womb chairs and ottomans.
Approved for Cal 133 upholstery.

Check with your KnollTextile or Spinneybeck Representative for any changes or additions.

Eero Saarinen

Womb Chair, Ottoman and Settee

description	seat h	arm h	w	d	h	textile fabric yds.	req. leather sq. ft.	weight
73L Womb Settee	16"	20½"	62¼"	34"	35½"	11.4	385	–

Designer(s):
Eero Saarinen, 1948

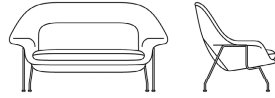

Order Code

<i>Example:</i>	70LM-BL-K530/4
70LM	Medium womb chair
BL	Black base
K530/4	Lyonese Velvet, Cognac

Note:
The Womb chair and ottoman and Womb Settee are part of a collection. Please refer to Saarinen side and executive chairs and tables on pages 248 and 370.

Specify:

1. Pattern number/size
2. Base finish selection
3. Cal 133 option
4. Split upholstery option (add S)
5. Textile selection

Ordering Information

Base finishes:
Black (suffix BL)
Polished Chrome (suffix C)

Upholstery/COM information:
Prices shown include fabric or leather representative for colors. Only approved KnollTextiles and Spinneybeck leathers may be ordered.

Customer's Own Material is available pending approval. For approval requirements, processing instructions and ordering information please see page 18.

KnollStudio 20-day Program:
The standard Womb chair and ottoman are available in a chrome finish on the 20-day program upholstered with in-stock KnollTextile. For more information, please consult pages 30-33.

Split upholstery option:
The surround and cushions of the Womb chair and ottoman and Womb settee may be specified with split upholstery. Indicate S before selected surround upholstery, followed by selected cushion upholstery. Price equals the higher upholstery grade.

COM split fabric requirements:
75% Womb chair body: 3.5 yards
75% Womb chair seat/back: 1.25 yards
85% Womb chair body: 3.75 yards
85% Womb chair seat/back: 1.25 yards
85% Ottoman body: 1 yard
85% Ottoman cushion: .75 yards
100% Womb chair body: 5.50 yards
100% Womb chair seat/back: 2 yards
100% Ottoman body: 1 yard
100% Ottoman cushion: 1.25 yards
100% Womb settee body: 9 yards
100% Womb settee seat/back: 2.6 yards

COL split leather requirements:
75% Womb chair body: 90 square ft
75% Womb chair seat/back: 23 square ft
85% Womb chair body: 96 square ft
85% Womb chair seat/back: 25 square ft
85% Ottoman cushion: 25 square ft
100% Womb chair body: 110 square ft
100% Womb chair seat/back: 40 square ft
100% Ottoman body: 27.5 square ft
100% Ottoman cushion: 27.5 square ft
100% Womb settee body: 275 square ft
100% Womb settee seat/back: 110 square ft

Maintenance:
See pages 28-29.

Cal 133 Fire Code:
The Womb Chair, Ottoman, and Settee comply with the California Technical Bulletin 133 standard if upholstered in Cal 133 approved upholstery. Specify suffix -C at end of pattern number and suffix -133 at end of textile selection. Upcharge applies, see page 19.

Note:
The Saarinen Womb chair and ottoman and Womb settee are Greenguard certified.

pattern no.	grades	COM	C	D	E	F	G	H	I	COL	V	W	X	Y
73L-(BL,C)-()	\$8,522.	\$8,949.	\$9,382.	\$9,701.	\$9,973.	\$10,226.	\$10,501.	\$11,193.	\$12,464.	\$14,209.	\$15,650.	\$19,341.	\$19,982.	\$20,375.

Construction

Base:
Steel wire with a polished chrome finish or matte black powder-coat.

Frame and upholstery:
Foam over molded, reinforced fiberglass shell on chair. Foam cushion over molded plywood platform on ottoman. Separate seat, back, and ottoman cushions constructed of polyester fiber with foam core.

Glides:
Stainless steel and nylon articulating glides.

Medium and Child's Womb Chairs:
Medium Womb chair and ottoman are 85% scale of standard Womb chair. Child's Womb chair is 75% scale of standard chair. Child's chair does not have accompanying ottoman.

Approved KnollTextiles Grades/Fabrics

A Alignment # Bocce Cat's Cradle Common Ground # Commuter Cloth # Crossroad Delite Hourglass Mariner Prep Soliloquy * Sonnet Stacks Uni-Form	B continued Sutton # Tabloid Tinge Versa Westwood Zipline	C Atlas Biota Cairo Charm Circa Classic Boucle Dahlia CR Durand Earthwork Echo Empire Stripe * Entourage * Essence Fibra Greenwich Hudson Hula Hoop Kaleidoscope CR Kora CR * Lagos Legend CR Lore CR Metro Milestone Palisade Posh Pullman Quark Regard CR Roundtrip Sandpiper Sequin CR * Smart Spectator * Spot On * Star Struck Swing Tilden Tower Grid Treble CR Vibe * Wit Zari CR *	D Compass CR Coterie Eclat Weave Island Masquerade Menagerie Origins Tara Theory Woodland	E Aegean Highland Ikat Square Ikat Stripe Kampala Katazome Kimono Mamba Marquee Meroe Midpoint Nature Walk Shima Vatera Whip	F Atelier Biscayne Coco Cornaro * Glider Icon Intrigue In Stitches Liberty Mod Plaid Rivington Soon Tivoli Topography	G Abington Amore
---	--	--	--	--	--	-------------------------------

Spinneybeck Leather

U Vicenza # Volo #	V Acqua # Andes # Embossed Tipped # España #+ Velluto Pelle #	W Alaska # Amazon # Antique # Derby # Forte # Lucente # Sabrina #	X Ducale #+ Ducale Velour #	Y Capri # Cervo # Copenhagen # Distressed #+ Lucca # Marissa # Portofino #+ Riva # Torello #
---------------------------------	---	---	--	--



Note: All KnollTextiles and COM fabrics are railroaded on the Womb chair.

* Approved for chair and ottoman cushion upholstery only.
+ Not approved for small and medium Womb chairs and ottomans.
Approved for Cal 133 upholstery.

Check with your KnollTextile or Spinneybeck Representative for any changes or additions.

Eero Saarinen

Womb Chair, Ottoman and Settee

	description	seat h	arm h	w	d	h	textile fabric yds.	req. leather sq. ft.	weight
<i>Designer(s):</i> Eero Saarinen, 1948	70LM Medium Womb chair	15"	18"	35"	31"	31 1/4"	5	96	31 lbs.
									
									
	74YM Medium ottoman			21"	17 1/2"	14 1/4"	1.7	48	11 lbs.
									

Order Code

<i>Example:</i>	70LM-BL-K530/4
70LM	Medium womb chair
BL	Black base
K530/4	Lyonese Velvet, Cognac

Note:
The Womb chair and ottoman and Womb Settee are part of a collection. Please refer to Saarinen side and executive chairs and tables on pages 248 and 370.

Specify:

1. Pattern number/size
2. Base finish selection
3. Cal 133 option
4. Split upholstery option (add S)
5. Textile selection

Ordering Information

Base finishes:
Black (suffix BL)
 Polished Chrome (suffix C)

Upholstery/COM information:
Prices shown include fabric or leather upholstery. Contact your Knoll representative for colors. Only approved KnollTextiles and Spinneybeck leathers may be ordered.

Customer's Own Material is available pending approval. For approval requirements, processing instructions and ordering information please see page 18.

 *KnollStudio 20-day Program:*
The standard Womb chair and ottoman are available in a chrome finish on the 20-day program upholstered with in-stock KnollTextile. For more information, please consult pages 30-33.

Split upholstery option:
The surround and cushions of the Womb chair and ottoman and Womb settee may be specified with split upholstery. Indicate S before selected surround upholstery, followed by selected cushion upholstery. Price equals the higher upholstery grade.

COM split fabric requirements:
75% Womb chair body: 3.5 yards
75% Womb chair seat/back: 1.25 yards
85% Womb chair body: 3.75 yards
85% Womb chair seat/back: 1.25 yards
85% Ottoman body: 1 yard
85% Ottoman cushion: .75 yards
100% Womb chair body: 5.50 yards
100% Womb chair seat/back: 2 yards
100% Ottoman body: 1 yard
100% Ottoman cushion: 1.25 yards
100% Womb settee body: 9 yards
100% Womb settee seat/back: 2.6 yards

COL split leather requirements:
75% Womb chair body: 90 square ft
75% Womb chair seat/back: 23 square ft
85% Womb chair body: 96 square ft
85% Womb chair seat/back: 25 square ft
85% Ottoman cushion: 25 square ft
100% Womb chair body: 110 square ft
100% Womb chair seat/back: 40 square ft
100% Ottoman body: 27.5 square ft
100% Ottoman cushion: 27.5 square ft
100% Womb settee body: 275 square ft
100% Womb settee seat/back: 110 square ft

Maintenance:
See pages 28-29.

Cal 133 Fire Code:
The Womb Chair, Ottoman, and Settee comply with the California Technical Bulletin 133 standard if upholstered in Cal 133 approved upholstery. Specify suffix -C at end of pattern number and suffix -133 at end of textile selection. Upcharge applies, see page 19.

Note:
The Saarinen Womb chair and ottoman and Womb settee are Greenguard certified.

pattern no.	grades	COM	C	D	E	F	G	H	I	COL	V	W	X	Y
70LM-(BL,C)-()	\$5,175.	\$5,434.	\$5,697.	\$5,892.	\$6,055.	\$6,210.	\$6,377.	\$6,795.	\$7,569.	\$8,629.	\$9,505.	\$11,747.	\$12,134.	\$12,375.
74YM-(BL,C)-()	1,526.	1,591.	1,663.	1,709.	1,755.	1,794.	1,839.	1,945.	2,143.	2,332.	2,556.	3,138.	3,240.	3,301.

Construction

Base:
Steel wire with a polished chrome finish or matte black powder-coat.

Frame and upholstery:
Foam over molded, reinforced fiberglass shell on chair. Foam cushion over molded plywood platform on ottoman. Separate seat, back, and ottoman cushions constructed of polyester fiber with foam core.

Glides:
Stainless steel and nylon articulating glides.























Medium and Child's Womb Chairs:
Medium Womb chair and ottoman are 85% scale of standard Womb chair. Child's Womb chair is 75% scale of standard chair. Child's chair does not have accompanying ottoman.

Approved KnollTextiles Grades/Fabrics

- A** Alignment  Bocce Cat's Cradle Common Ground  Commuter Cloth  Crossroad Delite Hourglass Mariner Prep Soliloquy * Sonnet Stacks Uni-Form
- B** continued Sutton  Tabloid Tinge Versa Westwood Zipline
- C** Atlas Biota Cairo Charm Circa Classic Boucle Dahlia CR Durand Earthwork Echo Empire Stripe * Entourage * Essence Fibra Greenwich Hudson Hula Hoop Kaleidoscope CR Kora CR * Lagos Legend CR Lore CR Metro Milestone Palisade Posh Pullman Quark Regard CR Roundtrip Sandpiper Sequin CR * Smart Spectator * Spot On * Star Struck Swing Tilden Tower Grid Treble CR Vibe * Wit Zari CR *
- D** continued
- E** Aegean Highland Ikat Square Ikat Stripe Kampala Katazome Kimono Mamba Marquee Meroe Midpoint Nature Walk Shima Vatera Whip
- F** Atelier Biscayne Coco Cornaro * Glider Icon Intrigue In Stitches Liberty Mod Plaid Rivington Soon Tivoli Topography
- G** Abington Amore

- D** Compass CR Coterie Eclat Weave Island Masquerade Menagerie Origins Tara Theory Woodland
- E** continued
- G** continued Alter Ego Andissa Arabella Brugge Djenne Feeling Plaid Garden City Gibson Hampshire * Haze Kamani Melange Modern Tweed Sablon Serendipity Spencer Straie Stripe Ultrasuede  Utrillo
- H** Arno Bavaria Catwalk Constance Firefly Gezelle Magritte Rosemond Stretch Appeal
- I** Aswan Byron * Canaan Cato Cummings * Diamond Days Dynamic Gramercy Ita Jaipur Knoll Velvet Limani Olema Piper Rutledge Sandis Vermeer Walker Worth Zimba

Spinneybeck Leather

- U** Vicenza  Volo 
- V** Acqua  Andes  Embossed Tipped  España  + Velluto Pelle 
- W** Alaska  Amazon  Antique  Derby  Forte  Lucente  Sabrina 
- X** Ducale  + Ducale Velour 
- Y** Capri  Cervo  Copenhagen  Distressed  + Lucca  Marissa  Portofino  + Riva  Torello 

Note: All KnollTextiles and COM fabrics are railroaded on the Womb chair.

* Approved for chair and ottoman cushion upholstery only.
+ Not approved for small and medium Womb chairs and ottomans.
 Approved for Cal 133 upholstery.

Check with your KnollTextile or Spinneybeck Representative for any changes or additions.

Eero Saarinen

Womb Chair, Ottoman and Settee

description	seat h	arm h	w	d	h	textile fabric yds.	req. leather sq. ft.	weight
70LS Child's Womb chair	14 1/2"	17"	31"	28"	27 1/4"	5	90	27 lbs.

Designer(s):
Eero Saarinen, 1948



Order Code

<i>Example:</i>	70LM-BL-K530/4
70LM	Medium womb chair
BL	Black base
K530/4	Lyonese Velvet, Cognac

Note:
The Womb chair and ottoman and Womb Settee are part of a collection. Please refer to Saarinen side and executive chairs and tables on pages 248 and 370.

Specify:

1. Pattern number/size
2. Base finish selection
3. Cal 133 option
4. Split upholstery option (add S)
5. Textile selection

Ordering Information

Base finishes:
Black (suffix BL)
Polished Chrome (suffix C)

Upholstery/COM information:
Prices shown include fabric or leather representative for colors. Only approved KnollTextiles and Spinneybeck leathers may be ordered.

Customer's Own Material is available pending approval. For approval requirements, processing instructions and ordering information please see page 18.

KnollStudio 20-day Program:
The standard Womb chair and ottoman are available in a chrome finish on the 20-day program upholstered with in-stock KnollTextile. For more information, please consult pages 30-33.

Split upholstery option:
The surround and cushions of the Womb chair and ottoman and Womb settee may be specified with split upholstery. Indicate S before selected surround upholstery, followed by selected cushion upholstery. Price equals the higher upholstery grade.

COM split fabric requirements:
75% Womb chair body: 3.5 yards
75% Womb chair seat/back: 1.25 yards
85% Womb chair body: 3.75 yards
85% Womb chair seat/back: 1.25 yards
85% Ottoman body: 1 yard
85% Ottoman cushion: .75 yards
100% Womb chair body: 5.50 yards
100% Womb chair seat/back: 2 yards
100% Ottoman body: 1 yard
100% Ottoman cushion: 1.25 yards
100% Womb settee body: 9 yards
100% Womb settee seat/back: 2.6 yards

COL split leather requirements:
75% Womb chair body: 90 square ft
75% Womb chair seat/back: 23 square ft
85% Womb chair body: 96 square ft
85% Womb chair seat/back: 25 square ft
85% Ottoman cushion: 25 square ft
100% Womb chair body: 110 square ft
100% Womb chair seat/back: 40 square ft
100% Ottoman body: 27.5 square ft
100% Ottoman cushion: 27.5 square ft
100% Womb settee body: 275 square ft
100% Womb settee seat/back: 110 square ft

Maintenance:
See pages 28-29.

Cal 133 Fire Code:
The Womb Chair, Ottoman, and Settee comply with the California Technical Bulletin 133 standard if upholstered in Cal 133 approved upholstery. Specify suffix -C at end of pattern number and suffix -133 at end of textile selection. Upcharge applies, see page 19.

Note:
The Saarinen Womb chair and ottoman and Womb settee are Greenguard certified.

pattern no.	grades	COM	C	D	E	F	G	H	I	COL	V	W	X	Y
70LS-(BL,C)-()	\$4,658.	\$4,890.	\$5,126.	\$5,302.	\$5,452.	\$5,589.	\$5,740.	\$6,116.	\$6,813.	\$7,766.	\$8,554.	\$10,572.	\$10,922.	\$11,137.

Construction

Base:
Steel wire with a polished chrome finish or matte black powder-coat.

Frame and upholstery:
Foam over molded, reinforced fiberglass shell on chair. Foam cushion over molded plywood platform on ottoman. Separate seat, back, and ottoman cushions constructed of polyester fiber with foam core.

Glides:
Stainless steel and nylon articulating glides.

Medium and Child's Womb Chairs:
Medium Womb chair and ottoman are 85% scale of standard Womb chair. Child's Womb chair is 75% scale of standard chair. Child's chair does not have accompanying ottoman.

Approved KnollTextiles Grades/Fabrics

A	Alignment # Bocce Cat's Cradle Common Ground # Commuter Cloth # Crossroad Delite Hourglass Mariner Prep Soliloquy * Sonnet Stacks Uni-Form	B	continued Sutton # Tabloid Tinge Versa Westwood Zipline	C	Atlas Biota Cairo Charm Circa Classic Boucle Dahlia CR Durand Earthwork Echo Empire Stripe * Entourage * Essence Fibra Greenwich Hudson Hula Hoop Kaleidoscope CR Kora CR * Lagos Legend CR Lore CR Metro Milestone Palisade Posh Pullman Quark Regard CR Roundtrip Sandpiper Sequin CR * Smart Spectator * Spot On * Star Struck Swing Tilden Tower Grid Treble CR Vibe * Wit Zari CR *	D	Compass CR Coterie Eclat Weave Island Masquerade Menagerie Origins Tara Theory Woodland	E	Aegean Highland Ikat Square Ikat Stripe Kampala Katazome Kimono Mamba Marquee Meroe Midpoint Nature Walk Shima Vatera Whip	F	Atelier Biscayne Coco Cornaro * Glider Icon Intrigue In Stitches Liberty Mod Plaid Rivington Soon Tivoli Topography	G	Abington Amore
----------	---	----------	---	----------	--	----------	--	----------	--	----------	--	----------	-------------------

Spinneybeck Leather



U	Vicenza # Volo #	X	Ducale #+ Ducale Velour #
V	Acqua # Andes # Embossed Tipped # España #+ Velluto Pelle #	Y	Capri # Cervo # Copenhagen # Distressed #+ Lucca # Marissa # Portofino #+ Riva # Torello #
W	Alaska # Amazon # Antique # Derby # Forte # Lucente # Sabrina #		

Note: All KnollTextiles and COM fabrics are railroaded on the Womb chair.

* Approved for chair and ottoman cushion upholstery only.
+ Not approved for small and medium Womb chairs and ottomans.
Approved for Cal 133 upholstery.

Check with your KnollTextile or Spinneybeck Representative for any changes or additions.

Richard Schultz
1966 Collection® Dining Chairs

	description	seat h	arm h	w	d	h	textile fabric yds.	weight
<p><i>Designer(s):</i> Richard Schultz, 1966</p>  	1966-45H Dining chair with arms	18"	25"	23"	24 1/4"	31"		22 lbs.
	1966-45HCOV Dining chair with arms cover	—	—	—	—	—		—
	1966-46H Dining chair, armless	18"		19"	24 1/4"	31"		20 lbs.
	1966-46HCOV Dining chair, armless, cover							
	1966-45P Chair pad for 1966-45H, 46H, 46C, 46B						1.25	

pattern no.		COM	
1966-45H-()-()			
1966-45HCOV			322.
1966-46H-()-()			1,917.
1966-46HCOV			322.
1966-45P		550.	577.



Order Code	Ordering Information
<i>Example:</i> 1966-45H-B-W-W	<i>Strap finishes:</i>
1966-45H Dining chair with arms	White (suffix W)
B Brown straps	Brown (suffix B)
W White mesh	Grey (suffix G)
W White frame	Onyx (suffix O)
	Sand (suffix S)
	Bronze (suffix Z)
	<i>Mesh finishes:</i>
	White (suffix W)
	Grey Tone (suffix T)
	Onyx (suffix O)
	Aluminum (suffix A)
	Bronze (suffix Z)
	Chestnut (suffix N)
	<i>Frame finishes:</i>
	Blue (suffix BLU)
	Chestnut (suffix N)
	Dark Bronze (suffix 14)
	Green (suffix 007)
	Light Bronze (suffix 13)
	Lime Green (suffix LGR)
	Onyx (suffix O)
	Orange (suffix ORG)
	Plum (suffix PLM)
	Sky Blue (suffix 3)
	Warm Bronze (suffix 16)
	Warm Wood (suffix 12)
	Weatherable Silver (suffix S)
	White (suffix W)
	Yellow (suffix YEL)
	<i>Maintenance:</i>
	See pages 28-29.
	<i>Upholstery/COM information:</i>
	Prices shown include fabric upholstery only. Contact your Knoll representative for colors.
	Customer's Own Material is available pending approval. For approval requirements, processing instructions and ordering information, please see page 18

- Specify:*
1. Pattern number
 2. Strap color
 3. Mesh color
 4. Frame color

Construction	Approved KnollTextiles Grades/Fabrics
<i>Frame:</i> Frame is aluminum castings and extrusions welded and glued together using a two-part epoxy. Finished in highly durable weather resistant polyester powder coat paint.	B Belize Prairie Vinyl
<i>Seat:</i> Woven vinyl coated polyester mesh is sewn to pure vinyl straps using Teflon thread to form the seat and back. Stainless steel supports provides shape and is attached to the frame with stainless steel connectors.	C Baxter Noble Sinclair
<i>Glides:</i> Clear butyrate plastic.	<i>Check with your KnollTextiles Representative for changes or additions.</i>

Designer(s):
Richard Schultz, 1966

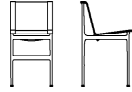

description	seat h	w	d	h	textile fabric yds.	weight
1966-46C Counter height armless barstool	26"	19"	24 1/4"	39 1/4"		24 lbs.
						
1966-46CCOV Counter height armless barstool cover						
1966-46B Bar height armless barstool	31"	19"	24 1/4"	44 1/4"		24 lbs.
						
1966-46BCOV Bar height armless barstool cover						
1966-45P Chair pad for 1966-45H, 46H, 46C, 46B					1.25	

pattern no.	COM	
1966-46C- ()-()		\$2,159.
1966-46CCOV		412.
1966-46B- ()-()		2,403.
1966-46BCOV		450.
1966-45P	550.	577.

Order Code

Example:	1966-46B-O-O-O
1966-46B	Bar height barstool
O	Onyx strap
O	Onyx mesh
O	Onyx frame

Specify:

1. Pattern number
2. Strap color
3. Mesh color
4. Frame color

Ordering Information

Strap finishes:
White (suffix W)
Brown (suffix B)
Grey (suffix G)
Onyx (suffix O)
Sand (suffix S)
Bronze (suffix Z)

Mesh finishes:
White (suffix W)
Grey Tone (suffix T)
Onyx (suffix O)
Aluminum (suffix A)
Bronze (suffix Z)
Chestnut (suffix N)

Frame finishes:
Blue (suffix BLU)
Chestnut (suffix N)
Dark Bronze (suffix 14)
Green (suffix 007)
Light Bronze (suffix 13)
Lime Green (suffix LGR)
Onyx (suffix O)
Orange (suffix ORG)
Plum (suffix PLM)
Sky Blue (suffix 3)
Warm Bronze (suffix 16)
Warm Wood (suffix 12)
Weatherable Silver (suffix S)
White (suffix W)
Yellow (suffix YEL)

Maintenance:
See pages 28-29.

Upholstery/COM information:
Prices shown include fabric upholstery only. Contact your Knoll representative for colors.

Customer's Own Material is available pending approval. For approval requirements, processing instructions and ordering information, please see page 18

Construction

Frame:
Frame is aluminum castings and extrusions welded and glued together using a two-part epoxy. Finished in highly durable weather resistant polyester powder coat paint.

Seat:
Woven vinyl coated polyester mesh is sewn to pure vinyl straps using Teflon thread to form the seat and back. Stainless steel supports provides shape and is attached to the frame with stainless steel connectors.

Glides:
Clear butyrate plastic.

Approved KnollTextiles Grades/Fabrics



- B** Belize
Prairie
Vinyl
- C** Baxter
Noble
Sinclair

Check with your KnollTextiles Representative for changes or additions.

Richard Schultz
1966 Collection® Lounge Seating

Designer(s):
Richard Schultz, 1966

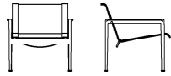
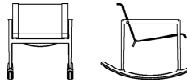
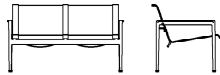
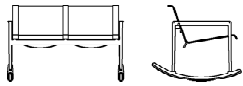
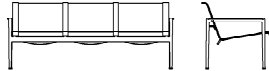

description	seat h	arm h	w	d	h	textile fabric yds.	weight
1966-25 Lounge chair with arms 	14"	20 1/2"	26"	28 1/4"	26"		24 lbs.
1966-25COV Lounge chair with arms, cover							
1966-25R Single Rocker 	14"	20 1/2"	26"	35"	29"		30 lbs.
1966-25RCOV Single Rocker, cover							
1966-255 Two seat lounge chair with arms 	14"	20 1/2"	46"	28 1/4"	26"		28 lbs.
1966-255COV Two seat lounge chair with arms, cover							
1966-255R Double Rocker 	14"	20 1/4"	46"	35"	29"		34 lbs.
1966-255RCOV Double Rocker, cover							
1966-355 Three seat lounge chair with arms 	14"	20 1/2"	66"	28 1/4"	26"		32 lbs.
1966-355COV Three seat lounge chair with arms, cover							
1966-250 ottoman 			23"	27"	14"		12 lbs.
1966-250COV ottoman cover							
1966-25P Chair pad for 1966-25, 25R, 255, 255R, 355						1.5	
1966-250P Ottoman pad for 1966-250						1.25	

Order Code

Example:	1966-25-G-T-S
1966-25	Lounge chair with arms
G	Grey strap
T	Grey Tone mesh
S	Weatherable Silver frame

Specify:

1. Pattern number
2. Strap color
3. Mesh color
4. Frame color

Ordering Information

Strap finishes:
White (suffix W)
Brown (suffix B)
Grey (suffix G)
Onyx (suffix O)
Sand (suffix S)
Bronze (suffix Z)

Mesh finishes:
White (suffix W)
Grey Tone (suffix T)
Onyx (suffix O)
Aluminum (suffix A)
Bronze (suffix Z)
Chestnut (suffix N)

Frame finishes:
Blue (suffix BLU)
Chestnut (suffix N)
Dark Bronze (suffix 14)
Green (suffix 007)
Light Bronze (suffix 13)
Lime Green (suffix LGR)
Onyx (suffix O)
Orange (suffix ORG)
Plum (suffix PLM)
Sky Blue (suffix 3)
Warm Bronze (suffix 16)
Warm Wood (suffix 12)
Weatherable Silver (suffix S)
White (suffix W)
Yellow (suffix YEL)

Maintenance:
See pages 28-29.

Upholstery/COM information:
Prices shown include fabric upholstery only. Contact your Knoll representative for colors.

Customer's Own Material is available pending approval. For approval requirements, processing instructions and ordering information, please see page 18

COM

pattern no.		
1966-25-(-)(-)(-)	\$2,098.	
1966-25COV	380.	
1966-25R-(-)(-)(-)	2,736.	
1966-25RCOV	448.	
1966-255-(-)(-)(-)	2,869.	
1966-255COV	673.	
1966-255R-(-)(-)(-)	3,557.	
1966-255RCOV	799.	
1966-355-(-)(-)(-)	3,786.	
1966-355COV	926.	
1966-250-(-)(-)(-)	1,855.	
1966-250COV	492.	
1966-25P	474.	507.
1966-250P	440.	468.

Construction

Frame:
Frame is aluminum castings and extrusions welded and glued together using a two-part epoxy. Finished in highly durable weather resistant polyester powder coat paint.

Seat:
Woven vinyl coated polyester mesh is sewn to pure vinyl straps using Teflon thread to form the seat and back. Stainless steel supports provides shape and is attached to the frame with stainless steel connectors.



Glides:
Clear butyrate plastic.

Approved KnollTextiles Grades/Fabrics

- B** Belize
Prairie
Vinyl
- C** Baxter
Noble
Sinclair

Check with your KnollTextiles Representative for changes or additions.

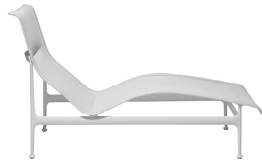
Richard Schultz
1966 Collection® Chaise Lounge Chairs

	description	seat h	w	d	h	textile fabric yds.	weight
<i>Designer(s):</i> Richard Schultz, 1966  	1966-41 Contour chaise lounge	13"	24½"	58"	33¾"		32 lbs.
	1966-41COV Contour chaise lounge cover						
	1966-42 Adjustable chaise lounge	14¾"	25½"	76"	36"		37 lbs.
	1966-42COV Adjustable chaise lounge cover						
	1966-41P 1966 Contour chaise pad					2.5	
	1966-42P 1966 Adjustable chaise pad					2.5	

pattern no.	COM	
1966-41-()-()		\$3,278.
1966-41COV		948.
1966-42-()-()		4,360.
1966-42COV		820.
1966-41P	878.	932.
1966-42P	687.	742.

Order Code	Ordering Information
<i>Example:</i> 1966-41-W-W-W	
1966-41 Contour chaise lounge	<i>Strap finishes:</i> White (suffix W) Brown (suffix B) Grey (suffix G) Onyx (suffix O) Sand (suffix S) Bronze (suffix Z)
W White strap	<i>Frame finishes:</i> Blue (suffix BLU) Chestnut (suffix N) Dark Bronze (suffix 14) Green (suffix 007) Light Bronze (suffix 13) Lime Green (suffix LGR) Onyx (suffix O) Orange (suffix ORG) Plum (suffix PLM) Sky Blue (suffix 3) Warm Bronze (suffix 16) Warm Wood (suffix 12) Weatherable Silver (suffix S) White (suffix W) Yellow (suffix YEL)
W White mesh	<i>Maintenance:</i> See pages 28-29.
W White frame	<i>Upholstery/COM information:</i> Prices shown include fabric upholstery only. Contact your Knoll representative for colors.
	<i>Customer's Own Material is available pending approval. For approval requirements, processing instructions and ordering information, please see page 18</i>
<i>Specify:</i> 1. Pattern number 2. Strap color 3. Mesh color 4. Frame color	<i>Mesh finishes:</i> White (suffix W) Grey Tone (suffix T) Onyx (suffix O) Aluminum (suffix A) Bronze (suffix Z) Chestnut (suffix N)

Construction	Approved KnollTextiles Grades/Fabrics
<i>Frame:</i> Frame is aluminum castings and extrusions welded and glued together using a two-part epoxy. Finished in highly durable weather resistant polyester powder coat paint.	B Belize Prairie Vinyl
<i>Seat:</i> Woven vinyl coated polyester mesh is sewn to pure vinyl straps using Teflon thread to form the seat and back. Stainless steel supports provides shape and is attached to the frame with stainless steel connectors.	C Baxter Noble Sinclair
<i>Glides:</i> Clear butyrate plastic.	<i>Check with your KnollTextiles Representative for changes or additions.</i>

	description	seat h	w	d	h	textile fabric yds.	weight
<p><i>Designer(s):</i> Richard Schultz, 2007</p> 	SWELL-31 single seat club chair	16 1/2"	30"	31 1/2"	28"		22 lbs.
	SWELL-31COV single seat club chair cover						
	SWELL-32 two seat sofa	16 1/2"	58 1/2"	31 1/2"	28"		42 lbs.
	SWELL-32COV two seat sofa cover						
	SWELL-33 three seat sofa	16 1/2"	87"	31 1/2"	28"		63 lbs.
	SWELL-33COV three seat sofa cover						
	SWELL-20P 20" square pillow for SWELL-31, 32, 33					0.75	
	SWELL-31P Seat pad for SWELL-31, 32, 33					2.75	

pattern no.		COM	
SWELL-31-()-()	\$3,028.		
SWELL-31COV	464.		
SWELL-32-()-()	4,774.		
SWELL-32COV	775.		
SWELL-33-()-()	6,081.		
SWELL-33COV	975.		
SWELL-20P	242.		258.
SWELL-31P	943.		1,003.





Order Code	Ordering Information
<i>Example:</i> SWELL-33-B-W-W	<i>Strap finishes:</i>
SWELL-33 Three seat sofa	White (suffix W)
B Brown strap	Brown (suffix B)
W White mesh	Grey (suffix G)
W White frame	Onyx (suffix O)
	Sand (suffix S)
	Bronze (suffix Z)
	<i>Mesh finishes:</i>
	White (suffix W)
	Grey Tone (suffix T)
	Onyx (suffix O)
	Aluminum (suffix A)
	Bronze (suffix Z)
	Chestnut (suffix N)
	<i>Frame finishes:</i>
	Blue (suffix BLU)
	Chestnut (suffix N)
	Dark Bronze (suffix 14)
	Green (suffix 007)
	Light Bronze (suffix 13)
	Lime Green (suffix LGR)
	Onyx (suffix O)
	Orange (suffix ORG)
	Plum (suffix PLM)
	Sky Blue (suffix 3)
	Warm Bronze (suffix 16)
	Warm Wood (suffix 12)
	Weatherable Silver (suffix S)
	White (suffix W)
	Yellow (suffix YEL)
	<i>Maintenance:</i>
	See pages 28-29.
	<i>Upholstery/COM information:</i>
	Prices shown include fabric upholstery only. Contact your Knoll representative for colors.
	Customer's Own Material is available pending approval. For approval requirements, processing instructions and ordering information, please see page 18

Construction	Approved KnollTextiles Grades/Fabrics
<i>Frame:</i>	B
Frame is aluminum castings and extrusions welded and glued together using a two-part epoxy. Finished in highly durable weather resistant polyester powder coat paint.	Belize
	Prairie
	Vinyl
	C
	Baxter
	Noble
	Sinclair
<i>Seat:</i>	
Woven vinyl coated polyester mesh is sewn to pure vinyl straps using Teflon thread to form the seat and back. Stainless steel supports provides shape and is attached to the frame with stainless steel connectors.	<i>Check with your KnollTextiles Representative for changes or additions.</i>
<i>Glides:</i>	
Clear butyrate plastic.	

Richard Schultz
Topiary® Seating Collection

Designer(s):
Richard Schultz, 1996



description	seat h	arm h	w	d	h	textile fabric yds.	weight
TOP-45 Topiary dining chair	18"	25"	26 1/2"	24"	34"		38 lbs.
							
TDCP Chair pad for Topiary dining chair TOP-45						1.0	
TOP-45COV Topiary dining chair cover							
TOP-25 Topiary lounge chair	16"	21 1/2"	32"	32"	30 1/2"		45 lbs.
							
TLCP Chair pad for Topiary lounge chair TOP-25						1.0	
TOP-25COV Topiary lounge chair cover							
TOP-455 Topiary bench	18"	25"	55"	26"	34 1/2"		84 lbs.
							
TBP Chair pad for Topiary bench TOP-455						2.0	
TOP-455COV Topiary bench cover							
TOP-250 Topiary small ottoman/end table			20 3/4"	22"	15"		23 lbs.
							
TSOP Seat pad for Topiary ottoman TOP-250						1.0	
TOP-250COV Topiary small ottoman/end table cover							
TOP-15 Topiary stacking chair	18 1/4"		22"	21"	30 1/4"		23 lbs.
							
TSC Chair pad for Topiary stacking chair TOP-15						1.0	
TSCOV Topiary stacking chair cover							
TSCOV4 Topiary stacking chair cover for stack of four							

Order Code

Example:	TOP-455-1
TOP-455	Bench
1	Forest Green finish

Specify:
1. Pattern number
2. Finish color

Ordering Information

Finishes:	Sky Blue (suffix 3)
Blue (suffix BLU)	Terra Cotta (suffix 5)
Chestnut (suffix N)	Warm Bronze (suffix 16)
Choice White (suffix 6)	Warm Wood (suffix 12)
Daffodil Yellow (suffix 2)	Weatherable Silver (suffix S)
Dark Bronze (suffix 14)	White (suffix W)
Forest Green (suffix 1)	Yellow (suffix YEL)
Green (suffix 007)	
Light Bronze (suffix 13)	
Lime Green (suffix LGR)	
Onyx (suffix 0)	
Orange (suffix ORG)	
Plum (suffix PLM)	

Maintenance:
See pages 28-29.

Upholstery/COM information:
Prices shown include fabric upholstery only. Contact your Knoll representative for colors.

Customer's Own Material is available pending approval. For approval requirements, processing instructions and ordering information, please see page 18

pattern no.		COM	
TOP-45- ()	\$1,887.		
TDCP		334.	356.
TOP-45COV	415.		
TOP-25- ()	2,438.		
TLCP		356.	459.
TOP-25COV	445.		
TOP-455- ()	3,614.		
TBP		695.	742.
TOP-455COV	804.		
TOP-250- ()	1,606.		
TSOP		440.	462.
TOP-250COV	366.		
TOP-15- ()	1,333.		
TSC		445.	467.
TSCOV	643.		
TSCOV4	767.		

Construction

Topiary frame:
3/16" aluminum sheet stamped and formed. Stainless steel connectors and finished in highly durable weather resistant polyester powder coat paint. Clear butyrate plastic glides.

Stacking Chair:
Seat and back is 3/16" aluminum sheet stamped and formed. Stainless steel connectors and finished in highly durable weather resistant polyester powder coat paint. Legs are 1" diameter stainless steel tubes attached to the seat using stainless steel connectors. Grey vinyl bumpers protect seats when stacked. Glides are natural color injection molded nylon.

Stacking:
Topiary stacking chair stacks 15 high.

Approved KnollTextiles Grades/Fabrics

- B** Belize
Prairie
Vinyl
- C** Baxter
Noble
Sinclair

Check with your KnollTextiles Representative for changes or additions.

Richard Schultz

Fresh Air Dining Chair



Designer(s):
Richard Schultz, 2011

description	seat h	arm h	w	d	h	textile	
						fabric yds.	weight
FA-45TB Fresh Air dining chair	17 1/2"	25 1/2"	26 1/2"	24"	35"		18 lbs.
FA-45COV Fresh Air dining chair cover							
FA-45P Chair pad for Fresh Air FA-45TB						1.0	

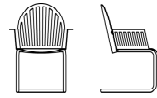

pattern no.		COM	
FA-45TB-()	\$1,141.		
FA-45COV	384.		
FA-45P		422.	444.

Order Code

<i>Example:</i> FA-45TB-14
FA-45TB Dining chair
14 Dark Bronze finish

Specify:

1. Pattern number
2. Finish color

Ordering Information

Finishes:
 Blue (suffix BLU)
 Chestnut (suffix N)
 Choice White (suffix 6)
 Daffodil Yellow (suffix 2)
 Dark Bronze (suffix 14)
 Forest Green (suffix 1)
 Green (suffix 007)
 Light Bronze (suffix 13)
 Lime Green (suffix LGR)
 Onyx (suffix 0)
 Orange (suffix ORG)
 Plum (suffix PLM)
 Sky Blue (suffix 3)
 Terra Cotta (suffix 5)
 Warm Bronze (suffix 16)
 Warm Wood (suffix 12)
 Weatherable Silver (suffix S)
 White (suffix W)
 Yellow (suffix YEL)

Construction

Maintenance:
 See pages 28-29.

Upholstery/COM information:
 Prices shown include fabric upholstery only. Contact your Knoll representative for colors.

Customer's Own Material is available pending approval. For approval requirements, processing instructions and ordering information, please see page 18

Seat:
 3/16" aluminum sheet laser cut and formed. Two piece construction. Stainless steel connectors and finished in highly durable weather resistant polyester powder coat paint.

Base:
 1" diameter electropolished 304 stainless steel tube. Attached to seat using stainless steel screws and connectors.

Glides:
 Nylon glides.

Approved KnollTextiles Grades/Fabrics

- B**
 Belize
 Prairie
 Vinyl
- C**
 Baxter
 Noble
 Sinclair

Check with your KnollTextiles Representative for changes or additions.

Shelton Mindel

Shelton Mindel Side Chair

Designer(s):
Peter Shelton and Lee Mindel,
2006

Award(s):
Good Design Award, 2006

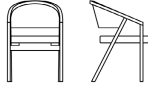
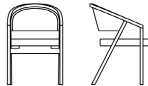

description	seat h	arm h	w	d	h	textile fabric yds.	leather sq. ft.	weight	finish
SM8A Arm chair 	18"	23 1/2"	22"	23 1/2"	32"	1	18	19 lbs.	Other finishes
	18"	23 1/2"	22"	23 1/2"	32"	1	18	24 lbs.	Golden Oak, Maple
	18"	23 1/2"	22"	23 1/2"	32"	1	18	22 lbs.	Light Walnut
SM8A-U Arm chair, fully uph. 	18"	23 1/2"	22"	23 1/2"	32"	1.5	27	20 lbs.	Other finishes
	18"	23 1/2"	22"	23 1/2"	32"	1.5	27	25 lbs.	Golden Oak, Maple
	18"	23 1/2"	22"	23 1/2"	32"	1.5	27	23 lbs.	Light Walnut
SM8R seat basket replacement for SM8A and SM8A-U						1	18		

Order Code	Ordering Information	Construction
------------	----------------------	--------------

Example: **SM8A-B312-K162/20**
SM8A Shelton Mindel side chair, seat upholstery only
B312 Bronzed Cherry
K162/20 Classic Boucle, Neutral

Oak with light lacquer finish:
Golden Oak (suffix GO)

Walnut with light lacquer finish:
Light Walnut (suffix LWT)

Maple:
Clear Maple (suffix KC)

Beech frame stains:
Bronzed Cherry (suffix B312A)
Burnt Walnut (suffix B313)
Ebonized (suffix BE)
Light Cherry (suffix B315)
Light Walnut (suffix B411)
Medium Cherry (suffix B319)
Medium Red Mahogany (suffix BR)
Medium Walnut (suffix B323)
Natural Beech (suffix BN)
Peacock Green Walnut (suffix B415)
Smoked Walnut (suffix B418)

KnollStudio wood finishes:
KnollStudio wood finishes complement a large variety of KnollStudio veneer and Knoll Office veneer finishes. To select correct complementary finish, please refer to KnollStudio Wood Finish Matrix on page 25. If no complementary standard finish is available, please refer to custom finish policy below.

Custom finishes:
Complementary finishes to any KnollStudio or Knoll Office wood finish are available at no upcharge. To complement non-Knoll wood veneer or lumber finishes, a one-time, non-negotiable net upcharge of \$618 applies. Re-orders are at no upcharge. Please contact your KnollStudio representative, dealer or Customer Service associate for complete custom finish information and Order Code. Minimum order quantity for any custom finish order: 4 chairs.

Frame:
Available in Beech, Walnut and Oak hardwood with mortise and tenon construction.

Upholstered Seat:
1 1/4" thick seat filled with high density polyurethane foam, with elastic webbing suspension in a cross weave. Seat frame is constructed of 1" plywood.

Fully Upholstered:
Inside back upholstery is inset in frame. * indicates approved textiles and leathers.

Finish:
Satin catalyzed lacquer finish. Oak and Walnut versions have lower sheen.

Glides:
Chairs feature plastic glides.

Certified Wood:
Chairs manufactured using FSC certified hardwoods are available through Custom Product Development. Extended leadtime and upcharge apply.

Cal 133 Fire Code:
The Shelton Mindel Side Chairs comply with the California Technical Bulletin 133 standard if upholstered in Cal 133 approved upholstery. Specify suffix -C at end of pattern number and suffix -133 at end of textile selection. Upcharge applies, see page 19.

Maintenance:
See pages 28-29.

Note:
The Shelton Mindel Side Chair is Greenguard certified.

The Shelton Mindel side chair is part of a collection. Please refer to the SM lounge collections starting on page 282 and the SM table collection on page 404.

Specify:
1. Pattern number
2. Finish selection
3. Textile selection

Upholstery/COM information:
Prices shown include fabric or leather upholstery. Contact your Knoll representative for colors. Only approved KnollTextiles and Spinneybeck leathers may be ordered.

Customer's Own Material is available pending approval. For approval requirements, processing instructions and ordering information please see page 18.

pattern no.	grades A	COM B	C	D	E	F	G	H	I	COM U	V	W	X	Y
SM8A-()	\$1,664.	\$1,692.	\$1,721.	\$1,752.	\$1,777.	\$1,793.	\$1,825.	\$1,833.	\$1,925.	\$2,064.	\$2,169.	\$2,380.	\$2,426.	\$2,478.
SM8A-(GO,KC)	1,997.	2,027.	2,055.	2,085.	2,110.	2,128.	2,158.	2,218.	2,261.	2,398.	2,504.	2,717.	2,760.	2,812.
SM8A-(LWT)	2,275.	2,305.	2,334.	2,365.	2,391.	2,407.	2,437.	2,497.	2,539.	2,678.	2,781.	2,994.	3,037.	3,091.
SM8A-U-()	2,004.	2,046.	2,089.	2,135.	2,171.	2,198.	2,246.	2,334.	2,397.	2,606.	2,760.	3,080.	3,147.	3,224.
SM8A-U-(GO,KC)	2,275.	2,320.	2,360.	2,407.	2,443.	2,471.	2,518.	2,607.	2,668.	2,877.	3,032.	3,353.	3,420.	3,497.
SM8A-U-(LWT)	2,578.	2,620.	2,660.	2,708.	2,745.	2,773.	2,819.	2,908.	2,972.	3,177.	3,333.	3,653.	3,720.	3,797.
SM8R-()	450.	475.	500.	524.	547.	563.	590.	642.	679.	1,023.	1,117.	1,302.	1,339.	1,386.

Approved KnollTextiles Grades/Fabrics	Spinneybeck Leather
---------------------------------------	---------------------

A Alignment ▲ Beacon * Bocce * Cat's Cradle * Chance * Common Ground Commuter Cloth *▲ Crossroad Delite * Dristi Hourglass * Mariner * Monarch ▲ Prep *▲ Presto *▲ Soliloquy * Sonnet * Stacks Trophy * Uni-Form *	B continued Night Life Petal Pusher * Prairie * Prim * Radianc * Ransom * Ricochet ▲ Roam * Rush Hour * Soiree * Spark ▲ Spree * Summit * Sutton * Synth * Tabloid * Tinge * Utmost * Venue * Versa * Vinyl Westwood * Wide Angle *▲ Zipline *	C continued Hudson * Hula Hoop Kaleidoscope CR Lagos * Legend CR * Lore CR * Magnolia * Metro Milestone * Noble * Palisade * Panache CR Pullman * Quark * Regard CR Roundtrip * Sahara Sandpiper * Sequin CR Sinclair * Smart * Spectator * Spot On * Star Struck Stepping Stones Swing * Tight Rope * Tilden Tower Grid * Treble CR Vibe * Wit *	D continued Masquerade Menagerie * Origins * Tara * Theory Woodland * Zoom E Aegean * Demure Highland * Ikat Square * Ikat Stripe * Kampala * Katazome * Kimono Mamba Marquee * Meroe Midpoint * Nature Walk * Sherman * Shima * Tryst * Vatera * Whip *	F continued Soon * Tivoli * Topography Totem * Tweed Frieze G Abington Alter Ego Amore * Arabella * Arber * Brugge * Djenne * Feeling Plaid Garden City * Hampshire Haze Kamani * Kinabalu * Kingston * Melange * Metallic Gloss * Modern Tweed * Petite Floral * Sablon * Serendipity * Spencer Straie Stripe * Ultrasuede *▲ Utrillo ▲ H Arno * Bavaria * Catwalk * Constance * Firefly * Gezelle * Magritte * Rosemond Stretch Appeal *	I Aswan * Byron * Canaan * Cato * Cummings * Diamond Days Digi Velvet Dynamic * Fiori * Gramercy * Ita * Jaipur Knoll Velvet * Limani North Island * Olema * Piper * Rutledge * Sandis Tudor * Vermeer * Walker * Worth Zimba *	U Vicenza *▲ Volo *▲ V Acqua *▲ Andes *▲ Embossed Tipped * España *▲ Maremma▲ Velluto Pelle *▲ W Alaska *▲ Amazon *▲ Antique *▲ Forte *▲ Lucente Sabrina *▲ *Approved for fully upholstered versions. ▲ Approved for Cal 133 upholstery. <i>Check with your KnollTextiles or Spinneybeck Representative for changes or additions.</i>	X Ducale *▲ Ducale Velour *▲ Y Capri *▲ Cervo * Copenhagen *▲ Distressed *▲ Lucca Marissa *▲ Riva *▲ Torello
--	---	--	--	---	--	---	---

Shelton Mindel

SM1 Lounge Collection

Designer(s):
Peter Shelton and Lee Mindel,
2006



description	seat h	arm h	w	d	h	textile fabric yds.	leather sq. ft.	weight
SM1-1 SM1 Lounge chair	15 1/2"	25 1/2"	39"	32 1/4"	25 1/2"	6.5	80	83 lbs.
SM1-2 SM1 Settee	15 1/2"	25 1/2"	61 1/2"	32 1/4"	25 1/2"	9.0	120	96 lbs.
SM1-3 SM1 Sofa	15 1/2"	25 1/2"	85 1/2"	32 1/4"	25 1/2"	11.3	148	116 lbs.

Order Code	Ordering Information	Construction
------------	----------------------	--------------

<i>Example:</i> SM1-1-AOC-K349/1		
SM1-1	SM1 Lounge Chair	
AOC	Clear Oak legs	
K349/1	Alignment, Sand	

Leg finishes:
Clear Oak (suffix AOC)
Ebonized (suffix AE)
Polished Stainless Steel (suffix S)

Upholstery/COM information:
Prices shown include fabric or leather upholstery. Contact your Knoll representative for colors. Only approved KnollTextiles and Spinneybeck leathers may be ordered.

Customer's Own Material is available pending approval. For approval requirements, processing instructions and ordering information please see page 18.

Cal 133 Fire Code:
The SM1 Lounge Collection complies with the California Technical Bulletin 133 standard if upholstered in Cal 133 approved upholstery. Specify suffix -C at end of pattern number and suffix -133 at end of textile selection. Upcharge applies, see page 19.

Maintenance:
See pages 28-29.

Frame:
Constructed in multi ply plywood with sinuous spring seat suspension and elastic webbing back suspension.

Upholstery:
Seat and back cushions are continuous on all models.

Cushion fill:
Arm, seat and back cushions in variable density foam with Dacron wrap.

Stitching:
Double-needled topstitching on leather upholstery. Double-needled topstitching on thin solid textiles, single-blind stitching on heavily ribbed fabrics and multicolor prints.

Legs:
Round legs in Ash hardwood stained in Clear Oak, Ebonized or Polished Stainless Steel finish.

pattern no.	grades A	COM B	C	D	E	F	G	H	I	COL U	V	W	X	Y
SM1-1-(-)(-)	\$4,279.	\$4,468.	\$4,648.	\$4,847.	\$5,011.	\$5,129.	\$5,328.	\$5,708.	\$5,987.	\$6,859.	\$7,440.	\$8,625.	\$8,872.	\$9,159.
SM1-2-(-)(-)	6,389.	6,652.	6,903.	7,179.	7,404.	7,567.	7,842.	8,371.	8,757.	10,178.	11,053.	12,831.	13,198.	13,628.
SM1-3-(-)(-)	7,546.	7,876.	8,192.	8,538.	8,820.	9,026.	9,372.	10,032.	10,519.	12,177.	13,256.	15,445.	15,900.	16,432.

Approved KnollTextiles Grades/Fabrics

A Alignment # Beacon Bocce Cat's Cradle Chance Common Ground Commuter Cloth # Crossroad Delite Dristi Heavy Metal Hourglass Mariner Monarch # Prep # Presto # Sonnet Stacks Trophy Uni-Form	B continued Prim Radiance Ransom Ricochet # Roam Rush Hour Soiree Spark # Spree Summit Sutton Synth Tabloid Tinge Venue Versa Vinyl Westwood Zipline	C continued Roundtrip Sahara Sandpiper Sequin CR Spot On Star Struck Swing Tight Rope Tilden Tower Grid Vibe Wit	D Coterie Eclat Weave * Island Kabuki Menagerie Origins Tara Theory Woodland	E continued Marquee Meroe Nature Walk Tryst Whip	F Atelier Biscayne Calais Cotton Velvet * Coco Cornaro Glider Intrigue In Stitches Liberty Mod Plaid Rivington Soon Tivoli Topography Totem Tweed Frieze *	G Brugge Djenne Feeling Plaid Garden City Hampshire Haze * Kinabalu Kingston Melange Modern Tweed Petite Floral Serendipity Spencer Ultrasuede #
--	--	---	--	--	--	---

Spinneybeck Leather

U Vicenza # Volo #	X Ducale # Ducale Velour #
V Acqua # Andes # Embossed Tipped España # Velluto Pelle #	Y Capri # Cervo Copenhagen # Distressed # Marissa # Riva # Saddle #
W Alaska # Amazon # Antique # Derby # Forte # Lucente Sabrina #	# Approved for Cal 133 upholstery. * Indicates fabrics without topstitching.

Check with your KnollTextiles or Spinneybeck Representative for additions or changes.

Shelton Mindel

SM2 Lounge Collection

Designer(s):
Peter Shelton and Lee Mindel,
2006



description	seat h	arm h	w	d	h	type	textile	leather	weight
							fabric yds.	sq ft	
SM2-1 SM2 Lounge chair, same upholstery, frame and cushions	17 3/4"	23 3/4"	39 1/4"	36 1/2"	29"		8.3	124	56 lbs.
SM2-1 SM2 Lounge chair, combination upholstery, frame and cushions	17 3/4"		39 1/4"	36 1/2"	29"	frame uph.	5	76	
						upchg, cushions	4.25	56	

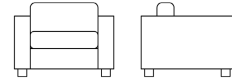

Order Code	Ordering Information	Construction
<i>Example:</i> SM2-2-S-K349/1	<i>Leg finishes:</i> Clear Oak (suffix AOC) Ebonized (suffix AE) Polished Stainless Steel (suffix S)	<i>Frame:</i> Constructed in 3/8" multi ply plywood with sinuous spring seat suspension and matrix back suspension.
SM2-2 SM2 Lounge Collection, settee		<i>Cushion fill:</i> Arm, seat and back cushions in variable density foams with Dacron wrap. The seat and back cushions are filled with memory foam.
S Stainless Steel legs		<i>Stitching:</i> Double needle top stitching on arms and back. Single needle top stitching on seat and back cushions in textile, double needle stitching for leather.
K349/1 Alignment, Sand	<i>Upholstery/ COM information:</i> Prices shown includes fabric or leather upholstery. Contact your Knoll representative for colors. Only approved KnollTextiles and Spinneybeck leathers may be ordered.	<i>Legs:</i> Round legs in Ash substrate with a Clear Oak, Ebonized or Polished Stainless Steel finish.
<i>Example:</i> SM2S-2-AE-VOBLK-K349/1	<i>Customer's Own Material</i> is available pending approval. For approval requirements, processing instructions and ordering information please see page 18.	
SM2-2 SM2 Lounge Collection, settee		
AE Ebonized legs		
VOBLK Surround in Volo, Black		
K349/1 Cushions in Alignment, Sand		
The SM2 lounge collection is part of a collection. Please refer to the Shelton Mindel side chair on page 280, SM1 lounge collection on page 282 and SM table collection on page 404.	<i>Cal 133 Fire Code:</i> The SM2 Lounge Collection complies with the California Technical Bulletin 133 standard if upholstered in Cal 133 approved upholstery. Specify suffix -C at end of pattern number and suffix -133 at end of textile selection. Upcharge applies, see page 19.	
<i>Specify:</i> 1. Pattern number 2. Leg finish 3. Textile selection	<i>Maintenance:</i> See pages 28-29.	
<i>Specify with split upholstery:</i> 1. Pattern number 2. Leg finish 3. Textile selection, Surround 4. Textile selection, Cushions		

pattern no.	grades	COM	C	D	E	F	G	H	I	COL	V	W	X	Y
SM2-1-(-)-(-)	\$5,514.	\$5,759.	\$5,987.	\$6,244.	\$6,450.	\$6,601.	\$6,857.	\$7,342.	\$7,698.	\$9,397.	\$10,297.	\$12,151.	\$12,518.	\$12,959.
SM2S-1-(-)-(-)	4,414.	4,591.	4,756.	4,942.	5,090.	5,200.	5,383.	5,734.	5,996.	6,485.	7,039.	8,165.	8,401.	8,672.
upchg, cushions	1,624.	1,748.	1,866.	1,997.	2,102.	2,182.	2,310.	2,560.	2,743.	3,161.	3,568.	4,399.	4,570.	4,771.

Approved KnollTextiles Grades/Fabrics						Spinneybeck Leather	
A Alignment ‡ Beacon Bocce Cat's Cradle Chance Common Ground Commuter Cloth ‡ Crossroad Delite Dristi Heavy Metal Hourglass Mariner Monarch ‡ Prep ‡ Presto ‡ Sonnet Stacks Trophy Uni-Form	B continued Knoll Hopsack Little Devil Ludlow Melody Night Life Paradigm Petal Pusher Pogo Prairie Prim Radiance Ransom Ricochet ‡ Roam Rush Hour Soiree Spark ‡ Spree Summit Sutton Synth Tabloid Tinge Venue Versa Vinyl Westwood Zipline	C continued Enmesh ‡ Entourage Essence Fibra Greenwich Hudson Hula Hoop Kaleidoscope CR Kora CR Lagos Metro Milestone Moto CR Palisade Panache CR * Pullman Roundtrip Sahara Sandpiper Sequin CR Spot On Star Struck Stepping Stones Swing Tight Rope Tilden Tower Grid Vibe Wit Zari CR	D continued Menagerie Origins Tara Theory Woodland E Aegean Demure Highland Ikat Square Ikat Stripe Kampala Katazome Mamba Marquee Meroe Nature Walk Shima Meroe Tryst Whip	F continued Soon Tivoli Topography Totem Tweed Frieze * G Brugge Feeling Plaid Garden City Hampshire Haze * Kinabalu Kingston Melange Modern Tweed Petite Floral Serendipity Spencer Ultrasuede ‡	H Arno Constance Firefly Gezelle Magritte Rosemond I Cato * Diamond Days Digi Velvet Dynamic Fiori Gramercy Knoll Velvet * Olema Piper Rutledge Sandis Tudor Vermeer Walker Worth Zimba	U Vicenza ‡ Volo ‡ V Acqua ‡ Andes ‡ Embossed Tipped España ‡ Velluto Pelle ‡ W Alaska ‡ Amazon ‡ Antique ‡ Derby ‡ Forte ‡ Lucente Sabrina ‡	X Ducale ‡ Ducale Velour ‡ Y Capri ‡ Cervo Copenhagen ‡ Distressed ‡ Marissa ‡ Riva ‡ Saddle ‡
						‡ Approved for Cal 133 upholstery. * Indicates fabrics without topstitching.	
						Check with your KnollTextiles or Spinneybeck Representative for additions or changes.	

Shelton Mindel

SM2 Lounge Collection

Designer(s):
Peter Shelton and Lee Mindel,
2006



description	seat h	arm h	w	d	height	type	textile fabric yds.	leather sq ft	weight
SM2-2 SM2 Settee, same upholstery, frame and cushions	17 3/4"	23 3/4"	66 1/2"	36 1/2"	29"		13.25	168	77 lbs.
SM2-2 SM2 Settee, combination upholstery, frame and cushions	17 3/4"		66 1/2"	36 1/2"	29"	frame uph.	7.5	104	
						upchg, cushions	7.5	80	
SM2-3 SM2 Sofa, same upholstery, frame and cushions	17 3/4"	23 3/4"	93 1/2"	36 1/2"	29"		19.5	208	108 lbs.
SM2-3 SM2 Sofa, combination upholstery, frame and cushions	17 3/4"		93 1/2"	36 1/2"	29"	frame uph.	9.5	128	
						upchg, cushions	11.25	104	

Order Code	Ordering Information	Construction
<i>Example:</i> SM2-2-S-K349/1	<i>Leg finishes:</i> Clear Oak (suffix AOC) Ebonized (suffix AE) Polished Stainless Steel (suffix S)	<i>Frame:</i> Constructed in 3/8" multi ply plywood with sinuous spring seat suspension and matrix back suspension.
SM2-2 SM2 Lounge Collection, settee		<i>Cushion fill:</i> Arm, seat and back cushions in variable density foams with Dacron wrap. The seat and back cushions are filled with memory foam.
S Stainless Steel legs		
K349/1 Alignment, Sand	<i>Upholstery/ COM information:</i> Prices shown includes fabric or leather upholstery. Contact your Knoll representative for colors. Only approved KnollTextiles and Spinneybeck leathers may be ordered.	<i>Upholstery:</i> One seat and back cushion for the Lounge chair, two seat and back cushions for the Settee and three seat and back cushions for the Sofa. For units with combination upholstery, add list price of surround in appropriate grade with the list price of cushions to obtain total list price for item.
<i>Example:</i> SM2S-2-AE-VOBLK-K349/1		<i>Stitching:</i> Double needle top stitching on arms and back. Single needle top stitching on seat and back cushions in textile, double needle stitching for leather.
SM2-2 SM2 Lounge Collection, settee		<i>Legs:</i> Round legs in Ash substrate with a Clear Oak, Ebonized or Polished Stainless Steel finish.
AE Ebonized legs	Customer's Own Material is available pending approval. For approval requirements, processing instructions and ordering information please see page 18.	
VOBLK Surround in Volo, Black		
K349/1 Cushions in Alignment, Sand	<i>Cal 133 Fire Code:</i> The SM2 Lounge Collection complies with the California Technical Bulletin 133 standard if upholstered in Cal 133 approved upholstery. Specify suffix -C at end of pattern number and suffix -133 at end of textile selection. Upcharge applies, see page 19.	
	<i>Maintenance:</i> See pages 28-29.	

The SM2 lounge collection is part of a collection. Please refer to the Shelton Mindel side chair on page 280, SM1 lounge collection on page 282 and SM table collection on page 404.

Specify:

1. Pattern number
2. Leg finish
3. Textile selection

Specify with split upholstery:

1. Pattern number
2. Leg finish
3. Textile selection, Surround
4. Textile selection, Cushions

pattern no.	grade	COM	C	D	E	F	G	H	I	COL	V	W	X	Y
SM2-2-(-)(-)	\$8,259.	\$8,645.	\$9,014.	\$9,420.	\$9,752.	\$9,991.	\$10,400.	\$11,172.	\$11,744.	\$13,358.	\$14,580.	\$17,068.	\$17,585.	\$18,186.
SM2S-2-(-)(-)(-)	6,478.	6,711.	6,934.	7,180.	7,380.	7,525.	7,769.	8,238.	8,584.	9,326.	10,083.	11,623.	11,941.	12,317.
upchg, cushionsS	2,425.	2,643.	2,851.	3,081.	3,269.	3,404.	3,636.	4,074.	4,399.	4,541.	5,122.	6,307.	6,554.	6,841.
SM2-3-(-)(-)	10,686.	11,257.	11,800.	12,398.	12,886.	13,239.	13,839.	14,979.	15,820.	16,872.	18,387.	21,465.	22,107.	22,851.
SM2S-3-(-)(-)(-)	8,359.	8,696.	9,016.	9,368.	9,657.	9,865.	10,219.	10,890.	11,388.	11,775.	12,708.	14,602.	14,996.	15,454.
upchg, cushionsSO	3,185.	3,512.	3,826.	4,174.	4,454.	4,658.	5,001.	5,659.	6,146.	5,856.	6,613.	8,152.	8,473.	8,846.

Approved KnollTextiles Grades/Fabrics						Spinneybeck Leather	
A Alignment ‡ Beacon Bocce Cat's Cradle Chance Common Ground Commuter Cloth ‡ Crossroad Delite Dristi Heavy Metal Hourglass Mariner Monarch ‡ Prep ‡ Presto ‡ Sonnet Stacks Trophy Uni-Form	B continued Knoll Hopsack Little Devil Ludlow Melody Night Life Paradigm Petal Pusher Pogo Prairie Prim Radiance Ransom Ricochet ‡ Roam Rush Hour Soiree Spark ‡ Spree Summit Sutton Synth Tabloid Tinge Venue Versa Vinyl Westwood Zipline	C continued Enmesh ‡ Entourage Essence Fibra Greenwich Hudson Hula Hoop Kaleidoscope CR Kora CR Lagos Metro Milestone Moto CR Palisade Panache CR * Pullman Roundtrip Sahara Sandpiper Sequin CR Spot On Star Struck Stepping Stones Swing Tight Rope Tilden Tower Grid Vibe Wit Zari CR	D continued Menagerie Origins Tara Theory Woodland E Aegean Demure Highland Ikat Square Ikat Stripe Kampala Katazome Mamba Marquee Meroe Nature Walk Shima Meroe Tryst Whip	F continued Soon Tivoli Topography Totem Tweed Frieze * G Brugge Garden City Feeling Plaid Hampshire Haze * Kinabalu Kingston Melange Modern Tweed Petite Floral Serendipity Spencer Ultrasuede ‡	H Arno Constance Firefly Gezelle Magritte Rosemond I Cato * Diamond Days Digi Velvet Dynamic Fiori Gramercy Knoll Velvet * Olema Piper Rutledge Sandis Tudor Vermeer Walker Worth Zimba	U Vicenza ‡ Volo ‡ V Acqua ‡ Andes ‡ Embossed Tipped España ‡ Velluto Pelle ‡ W Alaska ‡ Amazon ‡ Antique ‡ Derby ‡ Forte ‡ Lucente Sabrina ‡	X Ducale ‡ Ducale Velour ‡ Y Capri ‡ Cervo Copenhagen ‡ Distressed ‡ Marissa ‡ Riva ‡ Saddle ‡

‡ Approved for Cal 133 upholstery.
* Indicates fabrics without topstitching.





Check with your KnollTextiles or Spinneybeck Representative for additions or changes.

Kazuhide Takahama

Suzanne Lounge Seating

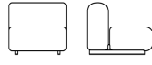
Designer(s):
Kazuhide Takahama, 1965

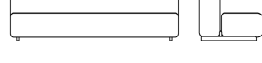
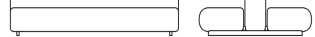

description	seat h	w	d	h	textile fabric yds.	weight
53S1 Lounge chair 	14 1/2"	30 1/2"	35"	27"	3.4	53 lbs.
53D1 Double lounge chair 	14 1/2"	30 1/2"	59"	27"	4.6	79 lbs.
53S2 Settee 	14 1/2"	60"	35"	27"	6.8	98 lbs.
53D2 Double Settee 	14 1/2"	60"	59"	27"	8.7	150 lbs.
53S3 Sofa 	14 1/2"	83"	35"	27"	10.2	146 lbs.
53D3 Double Sofa 	14 1/2"	83"	59"	27"	12.4	225 lbs.

pattern no.	Base Grade	grades A	COM B	C	D	E	F	G	H	I
53S1	\$1,910.	\$2,336.	\$2,413.	\$2,501.	\$2,604.	\$2,746.	\$2,828.	\$2,974.	\$3,070.	\$3,359.
53D1	3,130.	3,597.	3,708.	3,833.	3,981.	4,186.	4,306.	4,516.	4,655.	5,070.
53S2	3,321.	3,912.	4,053.	4,211.	4,398.	4,658.	4,809.	5,074.	5,249.	5,775.
53D2	5,283.	6,055.	6,254.	6,476.	6,739.	7,103.	7,316.	7,687.	7,933.	8,672.
53S3	5,214.	6,081.	6,286.	6,515.	6,788.	7,165.	7,384.	7,768.	8,024.	8,787.
53D3	8,169.	9,344.	9,627.	9,944.	10,319.	10,838.	11,140.	11,670.	12,022.	13,075.

Order Code

<i>Example:</i>	53S1-K134/21
53S1	Suzanne lounge chair
K134/21	Bank Shot, Thyme

Specify:

1. Pattern number
2. Textile selection

Ordering Information

Upholstery/COM information:
Prices shown include fabric or leather upholstery. Contact your KnollStudio representative for colors .

Customer's Own Material is available pending approval. For approval requirements, processing instructions and ordering information please see page 18.

Maintenance:
See pages 28-29.

Notes:
The Suzanne Lounge Seating is Greenguard certified.

Split upholstery back and seat:
The Suzanne Lounge Collection may be specified with split upholstery for **KnollTextiles ONLY**, where the horizontal seat module and the vertical back module are upholstered in different textiles. Indicate B before selected back upholstery, followed by the selected seat upholstery. Price equals the higher upholstery grade.

Note:
Split upholstery with base grade textiles or a combination of KnollTextiles and base grade textiles must be requested through Custom Product Development.

COM split fabric requirements:
53S1 seat: 1.6 yards
53S1 back: 1.8 yards
53D1 seat: 3.2 yards
53D1 back: 1.8 yards
53S2 seat: 2.7 yards
53S2 back: 2.8 yards
53D2 seat: 4.4 yards
53D2 back: 2.8 yards
53S3 seat: 3.7 yards
53S3 back: 4 yards
53D3 seat: 7.4 yards
53D3 back: 4 yards

Split upholstery side panel and main body:
The Suzanne Lounge Collection may be specified with split upholstery, where the side panels and the main body are upholstered in different textiles. Indicate P before selected side panel upholstery, followed by the selected main body upholstery. Price equals the higher upholstery grade.

COM split fabric requirements:
53S1 side: 0.9 yards
53S1 main: 2.7 yards
53D1 side: 1.2 yards
53D1 main: 3.6 yards
53S2 side: 0.9 yards
53S2 main: 4.6 yards
53D2 side: 1.2 yards
53D2 main: 6.2 yards
53S3 side: 0.9 yards
53S3 main: 6.7 yards
53D3 side: 1.2 yards
53D3 main: 8.9 yards

Construction

Frame:
Aluminum extrusion, polished aluminum end caps and top edge. Brushed aluminum sides. Comes with plastic glides

Upholstery:
Separate high-resilient Cal 117 foam cushions with MDF seat and back supports structure.

Base Grade Textile

Fabric, Base Grade:
Green Tea (suffix KLF01)
Heirloom Tomato (suffix KLF02)
Blue Moon (suffix KLF03)
Earl Grey (suffix KLF04)
Chocolate Stout (suffix KLF05)
Black Tea (suffix KLF06)

Approved KnollTextiles Grades/Fabrics

A Common Ground Delite Dristi Hourglass Mariner Presto * Sonnet Uni-Form	C Classic Boucle Dune Entourage Noble Palisade Pullman Smart Spot On Swing * Tilden	G Feeling Plaid Kingston Melange Metallic Gloss Modern Tweed Ultrasuede
B Diva Ferry Journey Knoll Felt Knoll Hopsack Little Devil Prairie Ricochet Summit Synth Venue Westwood	E Aegean Highland Marquee Vatera Whip	H Bavaria Firefly Gezelle Magritte Stretch Appeal
F Atelier Calais Cotton Velvet Cornaro Intrigue In Stitches Tweed Frieze		I Dynamic Fiori Knoll Velvet Tudor

* Fabric will be railroaded
Check with your KnollTextiles representative for changes or additions.

Ufficio Tecnico Spoleto Chair

Designer(s):
Ufficio Tecnico, 1971

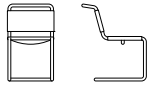

description	seat h	w	d	h	weight
50CS Spoleto armless chair	18"	18½"	23½"	32"	17 lbs.
					
50KIT Replacement sling kit with nylon laces, cowhide					
50KIT Replacement sling kit with nylon laces, belting leather					
50LACE Replacement nylon laces for cowhide, belting leather and hair hide slings					

pattern no.	
50CS-() 	\$2,019.
50KIT-L ()	909.
50KIT-(BL, HH) ()	909.
50LACE-(L, BL, HH)-()	87.

Order Code

<i>Example:</i> 50CS-BL1901
50CS Spoleto armless chair
BL1901 Belting leather, Fudge

Specify:

1. Pattern number
2. Sling material and color selection

Ordering Information

Spinneybeck Belting Leather:

 Black (suffix BLBLCK)
 Chocolate (suffix BL1902)
 Cognac (suffix BL1904)
 Dark Mustard (suffix BL1903)
 Dark Salmon (suffix BL1906)
 Deep Blue (suffix BL1912)
 Deep Green (suffix BL1911)
 Deep Purple (suffix BL1913)
 Fudge (suffix BL1901)
 Key Lime (suffix BL1910)
 Lemon Meringue (suffix BL1909)
 Simply Red (suffix BL1905)
 Sunshine (suffix BL1908)
 Sweet Potato (suffix BL1907)
 White (suffix BL1914)

Cowhide selection:

Black (suffix L80)
 Light Brown (suffix L82)
 White Beige (suffix L84)

Haired Hide:

Black (BLCKHH)
 Black and White (BKWHHH)
 Chestnut (suffix OA12HH)
 Coffee (suffix O18HH)
 Gold (suffix OCP5HH)
 Mahogany (suffix OA19HH)
 Tan (suffix OCP3HH)
 Tri-Color (3COLHH)

Upholstery/COM information:

Prices shown include leather upholstery.
Customer's Own Material is not available.

 **KnollStudio 20-day Program:**
 The Spoleto chair is available on the 20-day program in black belting leather. For more information, consult pages 30-33.

Maintenance:
 See pages 28-29.

Note:
 Please ask your Spinneybeck Representative for samples of the belting leather and haired hide.

Construction

Frame:

Seamless tubular steel in polished chrome finish.

Upholstery:

Cowhide Slings:

Thick cowhide leather slings in three colors. Edges dyed to match for Black and Light Brown colors. White Beige will have edges matching Light Brown cowhide color.

Belting Leather:

Highly durable Spinneybeck belting leather in fifteen colors. Belting leather edges will always match specified color.

Haired Hide:

Spinneybeck haired hide in eight colors. Haired Hide is a natural material, markings are one-of-a-kind and will vary from piece to piece.

Laces:

Nylon laces are dyed to match specified leather. Haired hide and belting leather option will have nylon laces.

Glides:

Four molded clear plastic glides with twin-pin snap-in construction included with all Spoleto chairs.

Replacement Slings:



Slings can be replaced in the field by field services or a furniture repair specialist. Kit includes back and seat replacement slings with nylon laces. Slings should be fitted by field services or by a professional upholsterer.

Vignelli Associates

Handkerchief Armless Chair

Designer(s):
Vignelli Designs, 1983

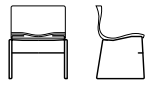

description	seat h	w	d	h	textile fabric yds.	weight
4901 Armless chair, unupholstered shell	18"	23"	22 1/2"	29"		21 lbs.
						
4901K-N Armless chair, seat pad, non-stacking	18"	23"	22 1/2"	29"	0.7	23 lbs.
						
4901K-S Armless chair, seat pad, stacking	18"	23"	22 1/2"	29"	0.7	23 lbs.
						
49100D Stacking dolly		24 3/8"	26"	12"		10 lbs.
G Optional glides						

Order Code	Ordering Information	Construction
<i>Example:</i> 4901-W-C	<i>Shell colors:</i> Black (suffix B) Grey (suffix G) Midnight (MD) Red (suffix R) White (suffix W)	Customer's Own Material is available pending approval. For approval requirements, processing instructions and ordering information please see page 18.
4901	Handkerchief unupholstered armless chair	<i>Shell:</i> Compression-molded. Highly durable fiberglass reinforced polyester; with urethane paint finish.
W	White shell	<i>Seat pad:</i> High-resilience polyurethane cushion bonded to a semi-rigid thermoformed support.
C	Polished chrome frame	<i>Base:</i> 7/16" steel wire finished in brightly polished chrome.
	<i>Base finishes:</i> Polished Chrome (suffix C)	<i>Optional glides:</i> Nylon. (Add -G to end of pattern number)
	<i>Upholstery/COM information:</i> Prices shown include fabric upholstery. Contact your Knoll representative for colors. Only approved KnollTextiles and Spinneybeck leathers may be ordered.	<i>Stacking bumper:</i> Black flexible urethane stacking pad secured between base and shell.
	<i>Maintenance:</i> See pages 28-29.	
	<i>Note:</i> The Handkerchief Armless Chair is Greenguard certified.	

Note:
The Vignelli Handkerchief side chairs are part of a collection. Please refer to Vignelli PaperClip Tables on page 412.

- Specify:
1. Pattern number
 2. Shell color selection
 3. Base finish selection
 4. Glide option
 5. Cal 133 Fire Code option for seat pad
 6. Textile selection for seat pad

pattern no.	grades	COM	C	D	E	F	G	H	I
4901-(-)C									
4901K-N-(-)C-(-)	1,147.	1,169.	1,195.	1,218.	1,241.	1,259.	1,282.	1,333.	1,369.
4901K-S-(-)C-(-)	1,190.	1,213.	1,238.	1,262.	1,282.	1,299.	1,325.	1,373.	1,410.
49100D	1,687.								
G	30.								

Approved KnollTextiles Grades/Fabrics
<i>Stacking features:</i> 4901 and 4901K-S chairs stack 15-20 high. Chairs without stacking bumper (4901K-N) do not stack.
<i>Stacking dolly:</i> 16 gauge steel with side bumper strips and four 5" casters (two which swivel). Total height of 24 chairs stacked on the dolly is 85".
A Alignment Beacon Bocce Cats Cradle Chance Common Ground # Commuter Cloth Crossroad Delite Hourglass Monarch Prep Soliloquy Sonnet Trophy Venue Versa Westwood Wide Angle
B Argyle Belize Bistro Cameo Chroma # Chronicle Close Knit Diva Dovetail Ferry Gala II Grandview Helios Holbrook Journey Knoll Felt Knoll Hopsack Little Devil Ludlow Lyric Melody Mini Stitch Paradigm Petal Pusher Pogo #
B continued Prairie Prim # Radiance Ransom Ricochet Roam Rush Hour Soiree Spark Spree Summit Sutton Synth Tabloid Tinge Venue Versa Westwood Wide Angle
C Atlas Axiom Baxter Biota Cairo Circa Classic Boucle Dahlia CR Decade Dune Durand Enmesh Entourage Essence Fable CR Fibra Greenwich Hudson Hula Hoop
C continued Kaleidoscope CR Kaya CR Lagos Legend CR Lore CR Magnolia Milestone Noble Palisade Pullman Regard CR Roundtrip Sinclair Smart Spectator Spot On Stepping Stones Tight Rope Tilden Tower Grid Treble CR Wit
D Compass CR Coterie Eclat Weave In The Loop Island Kabuki Masquerade Menagerie Origins Tara Theory Woodland
E Aegean Demure Highland Ikat Square Ikat Stripe Kampala Katazome Kimono Marquee Meroe Midpoint Nature Walk Sherman Tryst Vatera Whip
F Atelier Biscayne Cornaro Glider Intrigue In Stitches Liberty Mod Plaid Rivington Soon Topography Tweed Frieze
G Abington Alter Ego Andissa Arabella Arber Djenne Feeling Plaid Garden City Gibson Hampshire Kamani Kinabalu Kingston Melange Metallic Gloss Modern Tweed Sablon Serendipity Straie Stripe Ultrasede Utrillo
H Arno Bavaria Catwalk Constance Firefly Gezelle Magritte Rosemond Stretch Appeal
I Aswan Byron Canaan Cato Cummings Diamond Days Digi Velvet Dynamic Fiori Ita Jaipur Mepal Olema Piper Ravello Sandis Tudor Vermeer Walker Worth Zimba

Approved for Cal 133 upholstery.

Check with your KnollTextiles representative for changes or additions.

Vignelli Associates

Handkerchief Arm Chair

Designer(s):
Vignelli Designs, 1983



description	seat h	arm h	w	d	h	textile fabric yds.	weight
4902 Arm chair, unupholstered shell	18"	26"	26"	22 1/2"	29"		24 lbs.
4902K-N Arm chair, seat pad, non-stacking	18"	26"	26"	22 1/2"	29"	0.7	26 lbs.
4902K-S Arm chair, seat pad, stacking	18"	26"	26"	22 1/2"	29"	0.7	26 lbs.
49100D Stacking dolly			24 3/8"	26"	12"		10 lbs.
G Glides (add -G to end of pattern number)							

Order Code	Ordering Information	Construction
<i>Example:</i> 4902-MD-C	<i>Shell colors:</i> Black (suffix B) Grey (suffix G) Midnight (MD) Red (suffix R) White (suffix W)	<i>Shell:</i> Compression-molded. Highly durable fiberglass reinforced polyester; with urethane paint finish.
4902 Handkerchief unupholstered arm chair	<i>Base finishes:</i> Polished Chrome (suffix C)	<i>Seat pad:</i> High-resilience polyurethane cushion bonded to a semi-rigid thermoformed support.
MD Midnight shell	<i>Upholstery/COM information:</i> Prices shown include fabric upholstery. Contact your Knoll representative for colors. Only approved KnollTextiles and Spinneybeck leathers may be ordered.	<i>Base:</i> 7/16" steel wire finished in brightly polished chrome.
C Chrome frame	<i>Maintenance:</i> See pages 28-29.	<i>Optional glides:</i> Nylon. (Add -G to end of pattern number)
	<i>Note:</i> The Handkerchief Arm Chair is Greenguard certified.	<i>Stacking bumper:</i> Black flexible urethane stacking pad secured between base and shell.

Note:
The Vignelli Handkerchief side chairs are part of a collection. Please refer to Vignelli PaperClip Tables on page 412.

- Specify:
1. Pattern number
 2. Shell color selection
 3. Base finish selection
 4. Glide option
 5. Cal 133 Fire Code option for seat pad
 6. Textile selection for seat pad

pattern no.	grades	COM	C	D	E	F	G	H	I
4902-(-)C									
4902K-N-(-)C-(-)	1,296.	1,318.	1,341.	1,368.	1,389.	1,406.	1,414.	1,480.	1,516.
4902K-S-(-)C-(-)	1,335.	1,359.	1,382.	1,409.	1,430.	1,445.	1,471.	1,519.	1,556.
49100D	1,687.								
G [4902]	30.								

Approved KnollTextiles Grades/Fabrics					
<i>Stacking features:</i> 4902 and 4902K-S chairs stack 15-20 high. Chairs without stacking bumper (4902K-N) do not stack.	A Alignment Beacon Bocce Cats Cradle Chance Common Ground # Commuter Cloth Crossroad Delite Hourglass Monarch Prep Soliloquy Sonnet Trophy Venue Uni-Form	B continued Prairie Prim # Radiance Ransom Ricochet Roam Rush Hour Soiree Spark Spree Summit Sutton Synth Tabloid Tinge Venue Versa Westwood Wide Angle	C continued Kaleidoscope CR Lagos Legend CR Lore CR Magnolia Milestone Noble Palisade Pullman Regard CR Roundtrip Sinclair Smart Spectator Spot On Stepping Stones Tight Rope Tilden Tower Grid Treble CR Wit	D Compass CR Coterie Eclat Weave In The Loop Island Masquerade Menagerie Origins Tara Theory Woodland	E Aegean Demure Highland Ikat Square Ikat Stripe Kampala Katazome Kimono Marquee Meroe Midpoint Nature Walk Sherman Tryst Vatera Whip
	B Argyle Belize Bistro Cameo Chroma # Chronicle Close Knit Diva Dovetail Ferry Gala II Grandview Helios Holbrook Journey Knoll Felt Knoll Hopsack Little Devil Ludlow Lyric Melody Mini Stitch Paradigm Petal Pusher Pogo #	C Atlas Axiom Baxter Biota Cairo Circa Classic Boucle Dahlia CR Decade Dune Durand Enmesh Entourage Essence Fable CR Fibra Greenwich Hudson Hula Hoop	D In Stitches Liberty Mod Plaid Rivington Soon Topography Tweed Frieze	E Atelier Biscayne Cornaro Glider Intrigue In Stitches Liberty Mod Plaid Rivington Soon Topography Tweed Frieze	F Atelier Biscayne Cornaro Glider Intrigue In Stitches Liberty Mod Plaid Rivington Soon Topography Tweed Frieze
					G Abington Alter Ego Andissa Arabella Arber Djenne Feeling Plaid Garden City Gibson Hampshire Kamani Kinabalu Kingston Melange Metallic Gloss Modern Tweed Sablon Serendipity Straie Stripe Ultrasede Utrillo
					H Arno Bavaria Catwalk Constance Firefly Gezelle Magritte Rosemond Stretch Appeal
					I Aswan Byron Canaan Cato Cummings Diamond Days Digi Velvet Dynamic Fiori Ita Jaipur Mepal Olema Piper Ravello Sandis Tudor Vermeer Walker Worth Zimba

Approved for Cal 133 upholstery.

Check with your KnollTextiles representative for changes or additions.

David Adjaye
The Washington Collection for Knoll™
 Corona™ Coffee Table

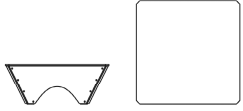
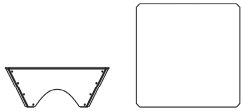
	description	w	d	h	base	weight
Designer(s): David Adjaye, 2013 	WC1T Washington Corona™ bronze coffee table	40 3/4"	40 3/4"	15 3/4"	Bronze	450 lbs.
						
	WC2T Washington Corona™ aluminum coffee table, black painted	40 3/4"	40 3/4"	15 3/4"	Aluminum	170 lbs.
						

pattern no	clear glass
WC1T	\$106,090.
WC2T	9,283.

Order Code	Ordering Infomation	Construction
Example: WC2T WC2T Aluminum coffee table, black painted	Glass finish: Clear glass Maintenance: See pages 28-29.	Clear glass top: Top is 1/2" thick optically clear glass with a jewel-polished, chamfered edge. Bronze base: Constructed from four sand-cast bronze panels, connected by machined bronze plates and brass hardware. The interior of the panels are CNC-machined and hand-polished to a mirror finish, contrasting the rough hewn exterior. Aluminum base: Constructed from four die-cast aluminum panels, connected by aluminum connector plates and stainless steel hardware. The interior of the panels are finished in a smooth gloss black powder coat paint, contrasting the matte textured black powder coat paint exterior.
Specify: 1. Pattern number		Note: To mark our 75th anniversary, the Washington Corona coffee table in bronze is limited to an edition of 75. Each piece is numbered and comes with a commemorative signature plate. The Washington Corona coffee table is Greenguard certified.

David Adjaye
The Washington Collection for Knoll™
Prism™ Side Table

	description	w	d	h
<i>Designer(s):</i> David Adjaye, 2014	WL25T Side table	17"	14½"	18"

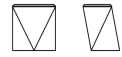

Award(s):
 Editors Choice Award, Lounge Furniture Collection, NeoCon June 2015, USA; MetropolisLikes Award, Metropolis Magazine, June 2015, USA



pattern no	MA, MAS, GG, GGS, MN, MNS	MC, MCS	MV, MVS
WL25T-()-()	\$7,522.	\$7,803.	\$7,932.

Order Code

<i>Example:</i> WL25T-118G-MCS
WL25T Side table
118G White base
MCS Satin Calacatta

- Specify:*
1. Pattern number
 2. Base finish selection
 3. Marble selection

Ordering Information

Base finishes:
 Black (suffix 111G)
 White (suffix 118G)
 Red (suffix 845G)

Polished Coated marble top finishes:
 Arabescato: white-grey (suffix MA)
 Calacatta: white-grey/beige (suffix MC)
 Grey Marble: light grey (suffix GG)
 Nero Marquina: black (suffix MN)
 Verdi Alpi: green (suffix MV)

Satin Coated marble top finishes:
 Arabescato: white-grey (suffix MAS)
 Calacatta: white-grey/beige (suffix MCS)
 Grey Marble: light grey (suffix GGS)
 Nero Marquina: black (suffix MNS)
 Verdi Alpi: green (suffix MVS)

Maintenance:
 See pages 28-29.

Construction

Base:
 Constructed of ¾" Baltic Birch plywood panels covered in a plastic color core laminate which maintains color throughout so vibrancy is maintained from edge to edge.
 Panels are assembled together using poplar wood corner blocks.

Franco Albini
Albini Desk

description	w	d	h	weight
80D Pedestal desk	48"	26"	27 1/2"	95 lbs.

Designer(s):
Franco Albini, 1938



pattern no.	
80D-(E, L2) 	\$6.119.

Order Code

<i>Example:</i> 80D-E
80D Albini desk
E Ebonized Oak pedestal

Specify:

1. Pattern number
2. Pedestal finish

Ordering Information

Albini pedestal finishes:
 Ebonized Oak (suffix E)
 White Lacquer (suffix L2)

 *20-Day:*
 The Albini desk in ebonized oak finish is available on the KnollStudio 20-Day program. For specific information consult pages 30-33.

Maintenance:
 See pages 28-29.

Construction

Base:
 Frame and legs in square steel tube with chrome finish.

Top:
 1/2" clear tempered glass.

Pedestal:
 2 drawer "floating" wood pedestal. Rear open shelf for magazines or small books.

Pedestal dimensions:
 16 1/2" w x 26" d x 8 1/4" h

Drawer dimensions:
 14 1/8" w x 14 1/8" d x 2 1/2" h

Rear shelf dimensions:
 15 1/2" w x 8 1/2" d x 7" h

Drawer mounts only on the right side.

Edward Barber & Jay Osgerby
Piton™ Side Table

description	w	d	h	top finish	weight
BO21T side table	16 1/4"	16 1/4"	21 1/4"	Ash	16 lbs.
	16 1/4"	16 1/4"	21 1/4"	Teak	16 lbs.

Designer(s):
 Edward Barber and Jay Osgerby,
 2014

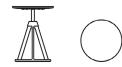

pattern no.	list
BO21T-AE-()	\$1,025.
BO21T-K-()	1,288.

Order Code

<i>Example:</i>	BO21T-K-WHTT
BO21T	Side Table
K	Teak
WHTT	White

Specify:

1. Pattern number
2. Top selection
3. Base selection

Ordering Information

Wood Top Finishes:
 Ebonized Ash (suffix AE)
 Teak, natural (suffix K)

Base Paint Finishes:
 Jet Black (suffix 111T)
 Medium Metallic Grey (suffix 612T)
 Red Coral (suffix CRLT)
 Sterling (suffix 906T)
 White (suffix WHTT)

Maintenance:
 See pages 28-29.

Construction

Base:
 Base is constructed of die-cast aluminum with stainless steel fasteners and finished with a highly durable powder coat in a variety of colors.

Wood Tops:
 Knife edge wood tops are available in ebonized ash or an oiled teak.

Marcel Breuer
Laccio Tables

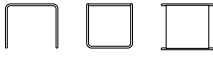
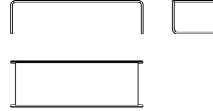
	description	w	d	h	weight
<p><i>Designer(s):</i> Marcel Breuer, 1924</p> 	<p>50T1 Laccio side table</p> 	21 3/4"	19"	17 3/4"	13 lbs.
	<p>50T2 Laccio coffee table</p> 	53 1/2"	19"	13 1/2"	29 lbs.

pattern no.	
50T1-	\$896.
50T2-	1,268.

Order Code





<i>Example:</i> 50T1-F1
50T1 Laccio side table
F1 Black Laminate

Note:
Laccio tables are part of a collection. Please refer to the Cesca and Wassily chairs on pages 94 and 98.

Specify:

1. Pattern number
2. Top finish selection

Ordering Information

Top finishes:
 Black (suffix F1)
 Red (suffix F3)
 White (suffix F2)
 *KnollStudio 20-Day Program:*
Laccio tables in black and white laminates are available on the 20-day program. For specific information, consult pages 30-33.

Maintenance:
See pages 28-29.

Note:
The KnollStudio logo and signature of Marcel Breuer is stamped into the base of the table.



Construction

Top:
Satin finish, smooth plastic laminate.

Base:
Frame and legs seamless tubular steel in polished chrome finish.

Joseph Paul D’Urso







Square Work and Low Tables

description	width between legs		h, work tables	h, low tables	weight	top
	w	d				
6348 Square table, medium 	22 1/2"	48"	27 1/2"	15 1/4"	130 lbs.	laminate
	22 1/2"	48"	27 1/2"	15 1/4"	128 lbs.	figured techgrain®
	22 1/2"	48"	27 1/2"	15 1/4"	128 lbs.	natural veneer
	22 1/2"	48"	27 1/2"	15 1/4"	197 lbs.	natural marble
	22 1/2"	48"	27 1/2"	15 1/4"	197 lbs.	coated marble
6354 Square table, medium 	25 1/8"	54"	27 1/2"	15 1/4"	281 lbs.	granite
	25 1/8"	54"	27 1/2"	15 1/4"	145 lbs.	laminate
	25 1/8"	54"	27 1/2"	15 1/4"	141 lbs.	figured techgrain®
	25 1/8"	54"	27 1/2"	15 1/4"	141 lbs.	natural veneer
	25 3/8"	54"	27 1/2"	15 1/4"	241 lbs.	natural marble
	25 1/2"	54"	27 1/2"	15 1/4"	241 lbs.	coated marble
6360 Square table, large 	25 1/8"	60"	27 1/2"	15 1/4"	288 lbs.	coated marble
	25 1/8"	60"	27 1/2"	15 1/4"	338 lbs.	granite
	25 1/8"	60"	27 1/2"	15 1/4"	183 lbs.	laminate
	25 1/8"	60"	27 1/2"	15 1/4"	179 lbs.	figured techgrain®
	25 1/8"	60"	27 1/2"	15 1/4"	179 lbs.	natural veneer
	25 1/8"	60"	27 1/2"	15 1/4"	288 lbs.	natural marble
GL Glides						
C Casters						
CX Locking casters						



Designer(s):
Joseph Paul D’Urso, 1980

Award(s):
Design Center Stuttgart Award, W. Germany, 1983; Federal Award for Industrial Design, W. Germany, 1983



Order Code	Ordering Information
<i>Example:</i> 6354L-C-111-C	
6354 54" square table	<i>Laminate top finishes:</i>  Bright White (suffix 118)  Fog (suffix 128)  Jet Black (suffix 111)  Light Grey (suffix L)  Pumice (suffix 119)
L Low height	<i>Coated marble top finishes:</i> Carrara: white-grey (suffix GC) Empire Beige: beige (suffix GB)
C Casters	<i>Granite top finishes:</i> Black Andes: black (suffix GA)
111 Jet Black laminate	<i>Low Tables:</i> D’Urso tables are available in two heights: standard and low. For low tables, add an L after the parent pattern number. Example: 6348L for low height option.
C Polished Chrome	<i>Maintenance:</i> See pages 28-29.
	<i>Note:</i> D’urso Tables with Laminate, Veneer or Granite tops and PVC edge are Greenguard certified.
<i>Specify:</i>	<i>Leg finishes:</i>  Jet Black (suffix 111) Medium Metallic Grey (suffix 612) Polished Chrome (suffix C) Red (suffix RD)
1. Pattern number	<i>Glides/ casters:</i> Casters (suffix C)  Glides, standard option (suffix GL) Locking casters (suffix CX)
2. Specify L for low height tables	
3. Glides/casters selection	
4. Top finish selection	
5. Leg finish selection	

pattern no.	upcharge	base painted	base chrome
6348-(-)(-)(-) 		\$2,659.	\$3,106.
6348-(-)(-)(-)		3,822.	4,267.
6348-(-)(-)(-)		4,481.	4,925.
6348-(-)(NGC)-(-)		6,239.	6,686.
6348-(-)(GC, GB)-(-)		7,241.	7,687.
6354-(-)GA-(-)		9,826.	10,269.
6354-(-)(-)(-)		2,760.	3,205.
6354-(-)(-)(-)		3,924.	4,371.
6354-(-)(-)(-)		4,633.	5,080.
6354-(-)(NGC)-(-)		7,322.	7,766.
6354-(-)(GC, GB)-(-)		8,585.	9,030.
6360-(-)(GC, GB)-(-)		10,021.	10,466.
6360-(-)GA-(-)		11,045.	11,491.
6360-(-)(-)(-)		3,007.	3,451.
6360-(-)(-)(-)		4,431.	4,875.
6360-(-)(-)(-)		5,348.	5,793.
6360-(-)(NGC)-(-)		8,473.	8,919.
GL	n/c		
C	642.		
CX	732.		

Construction
<p><i>Top:</i> Laminate, Techgrain® and veneer or stone surface. Laminate, Techgrain® and veneer tops are 3-ply construction with medium density fiberboard core and plastic laminate backer (laminate tops) or paper backer (wood veneer tops). Laminate, Techgrain® and veneer tops have a black vinyl bullnose edge. Wood tops are longitudinal veneered. 3/4" thick stone tops have an integral, hand-crafted bullnose edge.</p> <p><i>Edge detail:</i> Laminate/Techgrain/wood tops:  Stone tops: </p> <p><i>Base:</i> Racetrack-shaped steel legs with painted or polished chrome finish.</p> <p><i>Glides:</i> Black nylon.</p> <p><i>Casters:</i> 3" single, black hard-rubber wheel. Polished chrome wheel housings with black or medium metallic grey legs. Black housings with polished chrome and red leg. Locking caster housings always polished chrome. Tables with casters are at the same height as tables with glides.</p> <p>Wood tables with casters are weighted with steel plates to ensure stability. Plates are painted and secured under table top.</p> <p>Please note: Casters cannot be retrofitted to tables with glides.</p>



Joseph Paul D’Urso

Round Work and Low Tables

Designer(s):
Joseph Paul D’Urso, 1980

Award(s):
Design Center Stuttgart Award, W. Germany, 1983; Federal Award for Industrial Design, W. Germany, 1983







description	width		h, work tables	h, low tables	weight	top
	between legs	w				
6242 Round table, small 	20 7/8"	42"	27 1/2"	15 1/4"	110 lbs.	laminata
	20 7/8"	42"	27 1/2"	15 1/4"	109 lbs.	figured techgrain®
	20 7/8"	42"	27 1/2"	15 1/4"	109 lbs.	natural veneer
	20 7/8"	42"	27 1/2"	15 1/4"	132 lbs.	natural marble
	20 7/8"	42"	27 1/2"	15 1/4"	132 lbs.	coated marble
6248 Round table, medium 	22 1/2"	48"	27 1/2"	15 1/4"	120 lbs.	laminata
	22 1/2"	48"	27 1/2"	15 1/4"	118 lbs.	figured techgrain®
	22 1/2"	48"	27 1/2"	15 1/4"	118 lbs.	natural veneer
	22 1/2"	48"	27 1/2"	15 1/4"	162 lbs.	natural marble
	22 1/2"	48"	27 1/2"	15 1/4"	162 lbs.	coated marble
6254 Round table, medium 	25 7/8"	54"	27 1/2"	15 1/4"	229 lbs.	granite
	25 7/8"	54"	27 1/2"	15 1/4"	156 lbs.	laminata
	25 7/8"	54"	27 1/2"	15 1/4"	153 lbs.	figured techgrain®
	25 7/8"	54"	27 1/2"	15 1/4"	153 lbs.	natural veneer
	25 7/8"	54"	27 1/2"	15 1/4"	197 lbs.	natural marble
	25 7/8"	54"	27 1/2"	15 1/4"	197 lbs.	coated marble
C Casters						
GL Glides						
CX Locking casters						

pattern no.	upcharge	base painted	base chrome
6242-(-)(-)(-) 		\$2,515.	\$2,958.
6242-(-)(-)(-)		3,718.	4,161.
6242-(-)(-)(-)		4,379.	4,821.
6242-(-)(NGC)-(-)		4,541.	4,985.
6242-(-)(GC, GB)-(-)		5,146.	5,589.
6248-(-)(-)(-)		2,659.	3,106.
6248-(-)(-)(-)		3,822.	4,267.
6248-(-)(-)(-)		4,481.	4,925.
6248-(-)(NGC)-(-)		5,348.	5,791.
6248-(-)(GC, GB)-(-)		6,139.	6,582.
6254-(-)GA-(-)		10,038.	10,483.
6254-(-)(-)(-)		2,760.	3,205.
6254-(-)(-)(-)		3,924.	4,371.
6254-(-)(-)(-)		4,633.	5,080.
6254-(-)(NGC)-(-)		6,268.	6,713.
6254-(-)(GC, GB)-(-)		7,269.	7,713.
C	642.		
GL	n/c		
CX	732.		

Order Code

<i>Example:</i> 6248-C-NGC-C	
6248	48" diameter round table
C	Casters
NGC	Carrara Marble
C	Polished Chrome

Ordering Information

Laminate top finishes:
 Bright White (suffix 118)
 Fog (suffix 123)
 Jet Black (suffix 111)
 Light Grey (suffix L)
 Pumice (suffix 119)

Natural veneer top finishes:
 American Cherry (suffix X)
 Maple (suffix K)

Natural marble top finishes:
 Carrara: white-grey (suffix NGC)

Coated marble top finishes:
 Carrara: white-grey (suffix GC)
 Empire Beige: beige (suffix GB)

Granite top finishes
 Black Andes: black (suffix GA)

Leg finishes:
 Jet Black (suffix 111)
 Medium Metallic Grey (suffix 612)
 Polished Chrome (suffix C)
 Red (suffix RD)

Glides/casters:
 Casters (suffix C)
 Glides, standard option (suffix GL)
 Locking casters (suffix CX)

Low Tables:
 D’Urso tables are available in two heights: standard and low. For low tables, add an L after the parent pattern number. Example: 6348L for low height option.

Specify:

1. Pattern number
2. Specify L for low height tables
3. Glides/casters selection
4. Top finish selection
5. Leg finish selection

Construction

 *KnollStudio 20-Day Program:*
 The 6242 D’Urso Work Table with black legs and glides is available on the KnollStudio 20-Day program. All laminates in stock can be specified for the top finish. For specific information, consult pages 30-33.

Maintenance:
 See pages 28-29.

Note:
 The D’Urso Tables with Laminate, Veneer or Granite tops and PVC edge are Greenguard certified.

Weight information above is based on work height tables. For weight information on low height tables, please contact your KnollStudio representative.

Top:
 Laminate, Techgrain® and veneer or stone surface. Laminate, Techgrain® and veneer tops are 3-ply construction with medium density fiberboard core and plastic laminate backer (laminata tops) or paper backer (wood veneer tops). Laminate, Techgrain® and veneer tops have a black vinyl bullnose edge. 3/4" thick stone tops have an integral, hand-crafted bullnose edge.

Edge detail:
 Laminate/Techgrain/wood tops

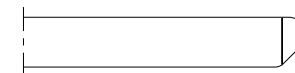

Stone tops:



Base:
 Racetrack-shaped steel legs with painted or polished chrome finish.

Glides:
 Black nylon.

Casters:
 3" single, black hard-rubber wheel. Polished chrome wheel housings with black or medium metallic grey legs. Black housings with polished chrome and red leg. Locking caster housings always polished chrome.

Wood tables with casters are weighted with steel plates to ensure stability. Plates are painted and secured under table top.

Please note: Casters cannot be retrofitted to tables with glides.





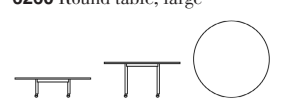
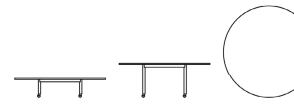

Joseph Paul D’Urso

Round Work and Low Tables

description	width		h, work tables	h, low tables	weight	top
	between legs	w				
6260 Round table, large 	25 1/8"	60"	27 1/2"	15 1/4"	164 lbs.	figured techgrain®
	25 1/8"	60"	27 1/2"	15 1/4"	164 lbs.	natural veneer
	25 1/8"	60"	27 1/2"	15 1/4"	167 lbs.	laminated
	25 1/8"	60"	27 1/2"	15 1/4"	235 lbs.	coated marble
	25 1/8"	60"	27 1/2"	15 1/4"	235 lbs.	natural marble
	25 1/8"	60"	27 1/2"	15 1/4"	274 lbs.	granite
6272 Round table, large 	31"	72"	27 1/2"	15 1/4"	255 lbs.	Natural veneer
C Casters						
GL Glides						
CX Locking casters						



pattern no.	upcharge	base, painted	base, chrome
6260-()-()-()		\$4,431.	\$4,875.
6260-()-()-()		5,348.	5,793.
6260-()-()-()		3,007.	3,451.
6260-()-(GC, GB)-()		8,363.	8,809.
6260-()-(NGC)-()		7,147.	7,592.
6260-()-GA-()		10,995.	11,441.
6272-()-()-()		6,364.	6,874.
C	642.		
GL	n/c		
CX	732.		

Order Code	Order Information
<i>Example:</i> 6248-C-NGC-C	
6248 48" diameter round table	Laminate top finishes:  Bright White (suffix 118)  Fog (suffix 123)  Jet Black (suffix 111)  Light Grey (suffix L)  Pumice (suffix 119)
C Casters	Natural veneer top finishes: American Cherry (suffix X) Maple (suffix K)
NGC Carrara Marble	Natural marble top finishes: Carrara: white-grey (suffix NGC)
C Polished Chrome	Coated marble top finishes: Carrara: white-grey (suffix GC) Empire Beige: beige (suffix GB)
	Figured Techgrain top finishes: American Cherry (suffix P) Cherry (suffix R) Maple (suffix M) Medium Red Mahogany (suffix C)
	Granite top finishes: Black Andes: black (suffix GA)
	Leg finishes:  Jet Black (suffix 111) Medium Metallic Grey (suffix 612) Polished Chrome (suffix C) Red (suffix RD)
	Glides/casters: Casters (suffix C)  Glides, standard option (suffix GL) Locking casters (suffix CX)
	Low Tables: D’Urso tables are available in two heights: standard and low. For low tables, add an L after the parent pattern number. Example: 6348L for low height option.

- Specify:*
1. Pattern number
 2. Specify L for low height tables
 3. Glides/casters selection
 4. Top finish selection
 5. Leg finish selection

Construction

 **KnollStudio 20-Day Program:**
The 6242 D’Urso Work Table with black legs and glides is available on the KnollStudio 20-Day program. All laminates in stock can be specified for the top finish. For specific information, consult pages 30-33.

Maintenance:
See pages 28-29.

Note:
The D’Urso Tables with Laminate, Veneer or Granite tops and PVC edge are Greenguard certified.

Weight information above is based on work height tables. For weight information on low height tables, please contact your KnollStudio representative.

Top:
Laminate, Techgrain® and veneer or stone surface. Laminate, Techgrain® and veneer tops are 3-ply construction with medium density fiberboard core and plastic laminate backer (laminate tops) or paper backer (wood veneer tops). Laminate, Techgrain® and veneer tops have a black vinyl bullnose edge. 1/4" thick stone tops have an integral, hand-crafted bullnose edge.

Edge detail:
Laminate/Techgrain/wood tops

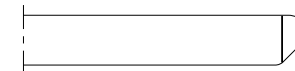

Stone tops:



Base:
Racetrack-shaped steel legs with painted or polished chrome finish.

Glides:
Black nylon.

Casters:
3" single, black hard-rubber wheel. Polished chrome wheel housings with black or medium metallic grey legs. Black housings with polished chrome and red leg. Locking caster housings always polished chrome.

Wood tables with casters are weighted with steel plates to ensure stability. Plates are painted and secured under table top.

Please note: Casters cannot be retrofitted to tables with glides.

Joseph Paul D'Urso

Racetrack Work Tables

Designer(s):
Joseph Paul D'Urso, 1980

Award(s):
Design Center Stuttgart Award, W. Germany, 1983; Federal Award for Industrial Design, W. Germany, 1983



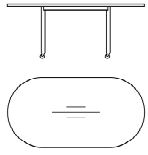
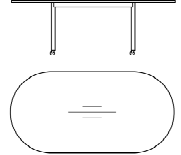
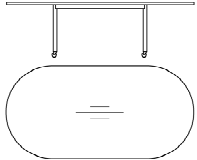



description	w between legs		d between legs		h	weight	top
	w	d	w	d			
6472 Racetrack table, small 	32 3/4"	20 3/8"	72"	36"	27 1/2"	232 lbs.	granite
	32 3/4"	20 3/8"	72"	36"	27 1/2"	144 lbs.	laminate
	32 3/4"	20 3/8"	72"	36"	27 1/2"	141 lbs.	figured techgrain®
	32 3/4"	20 3/8"	72"	36"	27 1/2"	141 lbs.	natural veneer
	32 3/4"	20 3/8"	72"	36"	27 1/2"	200 lbs.	natural marble
	32 3/4"	20 3/8"	72"	36"	27 1/2"	200 lbs.	coated marble
6484 Racetrack table, medium 	38 3/4"	20 3/8"	84"	42"	27 1/2"	294 lbs.	coated marble
	38 3/4"	20 3/8"	84"	42"	27 1/2"	338 lbs.	granite
	38 3/4"	20 3/8"	84"	42"	27 1/2"	162 lbs.	laminate
	38 3/4"	20 3/8"	84"	42"	27 1/2"	159 lbs.	figured techgrain®
	38 3/4"	20 3/8"	84"	42"	27 1/2"	159 lbs.	natural veneer
	38 3/4"	20 3/8"	84"	42"	27 1/2"	294 lbs.	natural marble
6496 Racetrack table, large 	44 3/4"	22 1/2"	96"	48"	27 1/2"	377 lbs.	natural marble
	44 3/4"	22 1/2"	96"	48"	27 1/2"	377 lbs.	coated marble
	44 3/4"	22 1/2"	96"	48"	27 1/2"	434 lbs.	granite
	44 3/4"	22 1/2"	96"	48"	27 1/2"	177 lbs.	laminate
	44 3/4"	22 1/2"	96"	48"	27 1/2"	173 lbs.	figured techgrain®
	44 3/4"	22 1/2"	96"	48"	27 1/2"	173 lbs.	natural veneer
	44 3/4"	22 1/2"	96"	48"	27 1/2"	173 lbs.	natural veneer
GL Glides							
C Casters							
CX Locking casters							

Order Code



Example:	6472-GL-GA-C
6472	72" x 36" racetrack table
GL	Glides
GA	Granite
C	Polished Chrome

Ordering Information

Laminate top finishes:
 Bright White (suffix 118)
 Fog (suffix 128)
 Jet Black (suffix 111)
 Light Grey (suffix L)
 Pumice (suffix 119)

Natural marble top finishes:
Carrara: white-grey (suffix NGC)

Coated marble top finishes:
Carrara: white-grey (suffix GC)
Empire Beige: beige (suffix GB)

Glides/casters:
Casters (suffix C)
 Glides, standard option (suffix GL)
 Locking casters (suffix CX)

Granite top finish:
Black Andes: black (suffix GA)

Leg finishes:
 Jet Black (suffix 111)
 Medium Metallic Grey (suffix 612)
 Polished Chrome (suffix C)
 Red (suffix RD)

 **KnollStudio 20-Day Program:**
The 6472 D'Urso Table with black legs and glides is available on the KnollStudio 20-Day program. All laminates in stock can be specified for top finish. For specific information, consult pages 30-33.

Specify:

1. Pattern number
2. Specify L for low height tables
3. Glides/casters selection
4. Top finish selection
5. Leg finish selection

Figured Techgrain top finishes:
American Cherry (suffix P)
Cherry (suffix R)
Maple (suffix M)
Medium Red Mahogany (suffix C)

Natural veneer top finishes:
American Cherry (suffix X)
Maple (suffix K)

pattern no.	upcharge	base painted	base chrome
6472-()-GA-()		\$11,043.	\$11,486.
6472-()-()-() 		3,400.	3,845.
6472-()-()-()		4,770.	5,212.
6472-()-()-()		5,465.	5,908.
6472-()-(NGC)-()		6,813.	7,255.
6472-()-(GC, GB)-()		7,929.	8,374.
6484-()-(GC, GB)-()		10,666.	11,111.
6484-()-GA-()		12,761.	13,206.
6484-()-()-()		3,648.	4,092.
6484-()-()-()		5,057.	5,502.
6484-()-()-()		6,106.	6,550.
6484-()-(NGC)-()		9,179.	9,623.
6496-()-(NGC)-()		11,513.	11,955.
6496-()-(GC, GB)-()		13,530.	13,972.
6496-()-GA-()		15,343.	15,786.
6496-()-()-()		3,748.	4,189.
6496-()-()-()		5,348.	5,791.
6496-()-()-()		6,685.	7,129.
GL	n/c		
C	642.		
CX	732.		

Maintenance:
See pages 28-29.

Note:
The D'Urso Tables with Laminate, Veneer or Granite tops and PVC edge are Greenguard certified.

Weight information above is based on work height tables. For weight information on low height tables, please contact your KnollStudio representative.

Construction

Top:
Laminate, Techgrain® and veneer or stone surface. Laminate, Techgrain® and veneer tops are 3-ply construction with medium density fiberboard core and plastic laminate backer (laminate tops) or paper backer (wood veneer tops). Laminate, Techgrain® and veneer tops have a black vinyl bullnose edge. Wood tops are longitudinal veneered. 3/4" thick stone tops have an integral, hand-crafted bullnose edge.

Edge detail:
Laminate/Techgrain/wood tops:



Stone tops:

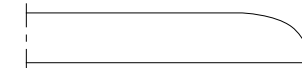

Base:
Racetrack-shaped steel legs with painted or polished chrome finish.

Glides:
Black nylon.

Casters:
3" single, black hard-rubber wheel. Polished chrome wheel housings with black or medium metallic grey legs. Black housings with polished chrome and red leg. Locking caster housings always polished chrome. Not available on stone racetrack tables.

Wood tables with casters are weighted with steel plates to ensure stability. Plates are painted and secured under table top.

Please note: Casters cannot be retrofitted to tables with glides.

Frank Gehry Face Off Cafe Table

Designer(s):
Frank Gehry, 1990

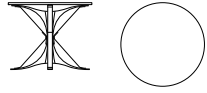
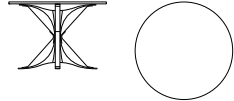

description	w	d	h	weight	top	base
95T-36 Face Off 36" café table 	36"		28 3/4"	10 lbs.	glass	clear maple
	36"		28 3/4"	10 lbs.	white laminate	clear maple
95T-40 Face Off 40" café table 	40"		28 3/4"	10 lbs.	glass	clear maple
	40"		28 3/4"	10 lbs.	white laminate	clear maple

pattern no.	
95T-36-G2-GC	\$4,604.
95T-36-W-GC	5,458.
95T-40-G2-GC	5,540.
95T-40-W-GC	6,389.

Order Code

Example:	95T-36-G2-GC
95T-36	36" Face Off table
G2	Clear Glass
GC	Clear Maple

Note:
The Gehry tables are part of a collection. Please refer to Gehry side chairs and lounge seating starting on page 128.

Specify:

1. Pattern number
2. Top finish selection

Ordering Information

Glass top finish:
Clear Glass (suffix G2)

Laminate top finish :
White (suffix W)

Maple Base finish:
Clear (suffix GC)

Shipping note:
Tops ship separately.

Signature:
The underside of each piece in the Gehry Collection is embossed with Frank Gehry's signature and the Knoll logo.

Maintenance:
See pages 28-29.

Construction

Face Off Cafe Table tops:
1/2" thick tempered clear glass with polished edge; 3/8" thick textured laminate top with clear solid edgeband. Four bolts attach table top to base.

Face Off Cafe Table base:
Constructed of hard white maple veneers in 2" wide, 1/8" thick strips. Laminated to 7-ply thickness with high-bonding urea glue. All wood grains run in the same direction for resilience. State-of-the-art thermoset assembly glue provides structural rigidity without the need for metal connectors. Solid maple center column prevents cracking. Arched base design allows ample leg room.

Glides:
Clear plastic with a matte frost finish.

Alexander Girard
Coffee Table

	description	w	d	h	weight
<i>Designer(s):</i> Alexander Girard, 1948 	108 Coffee Table	59"	26"	16"	23 lbs.
		59"	26"	16"	23 lbs.

pattern no.	
108-(LWA, D, V319)-111	\$1,546.
108-KC-111	1,977.

Order Code	Ordering Information	Construction
<i>Example:</i> 108-LWA-111	<i>Top Finishes:</i>	<i>Top:</i>
108 Coffee Table	Ebonized Walnut (suffix D)	Top is 3/4" baltic birch core with either
LWA Light Walnut	Light Walnut (suffix LWA)	plain slice bookmatch maple, cherry or
111 Jet Black	Maple (suffix K)	ebonized veneer. Top has a 45° beveled
	Medium Cherry (suffix V319)	edge.
<i>Specify:</i>	<i>Leg Finish:</i>	<i>Legs:</i>
1. Pattern number	Jet Black (suffix 111)	Cold-roll steel tubes with metal
2. Top finish delection		weldment in black powder coat.
3. Leg finish selection		



Maintenance:
See pages 28-29.

Florence Knoll

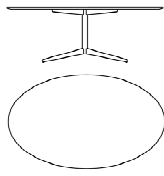
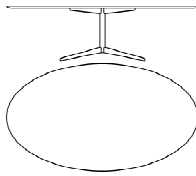
Oval Table Desks

	description	w	d	h	weight	top	
<p><i>Designer(s):</i> Florence Knoll, 1961</p> <p><i>Award(s):</i> Design Center Stuttgart Award, 1969-70</p> 	<p>2480D Oval table desk</p> 	78"	47 3/4"	27 1/2"	313 lbs.	coated marble	
		78"	47 3/4"	28"	174 lbs.	natural oak	
		78"	47 3/4"	27 1/2"	313 lbs.	coated marble	
		78"	47 3/4"	28"	174 lbs.	mahogany	
		78"	47 3/4"	28"	174 lbs.	ebonized oak	
		78"	47 3/4"	27 1/2"	313 lbs.	coated marble	
		78"	47 3/4"	27 1/2"	313 lbs.	coated marble	
		78"	47 3/4"	28"	174 lbs.	pearwood	
		78"	47 3/4"	27 1/2"	313 lbs.	coated marble	
		78"	47 3/4"	27 1/2"	313 lbs.	coated marble	
		78"	47 3/4"	27 1/2"	313 lbs.	natural marble	
		78"	47 3/4"	28"	185 lbs.	white laminate	
		<p>2481D Oval table desk</p> 	96"	54"	27 1/2"	402 lbs.	natural marble
			96"	54"	27 1/2"	402 lbs.	coated marble
96"	54"		28"	223 lbs.	white laminate		
96"	54"		27 1/2"	402 lbs.	coated marble		
96"	54"		28"	207 lbs.	natural oak		
96"	54"		28"	207 lbs.	mahogany		
96"	54"		28"	207 lbs.	ebonized oak		
96"	54"		27 1/2"	402 lbs.	coated marble		
96"	54"		28"	207 lbs.	pearwood		
96"	54"		27 1/2"	402 lbs.	coated marble		
96"	54"		27 1/2"	402 lbs.	coated marble		
96"	54"		27 1/2"	402 lbs.	coated marble		
96"	54"		27 1/2"	402 lbs.	coated marble		

pattern no.	polished chrome base (C)	satn chrome base (CO)
2480D-()-(MG, MGS)	\$10,087.	\$10,485.
2480D-()-O	10,602.	11,013.
2480D-()-(GC, GCS, GB, GBS)	10,746.	11,159.
2480D-()-(M7, M9)	11,075.	11,483.
2480D-()-E	11,539.	11,951.
2480D-()-(MN, MNS, MA, MAS, GG, GGS)	12,444.	12,853.
2480-()-(ME, MES)	12,554.	12,952.
2480D-()-P	12,697.	13,109.
2480D-()-(MC, MCS)	13,190.	13,602.
2480D-()-(MV, MVS)	16,186.	16,595.
2480D-()-(NGC)	9,360.	9,770.
2480D-()-F2	9,556.	9,970.
2481D-()-(NGC)	11,343.	11,751.
2481D-()-(MG, MGS)	12,829.	13,225.
2481D-()-F2	13,190.	13,600.
2481D-()-(GC, GCS, GB, GBS)	13,274.	13,685.
2481D-()-O	14,452.	14,860.
2481D-()-(M7,M9)	14,919.	15,326.
2481D-()-E	15,388.	15,798.
2481D-()-(ME, MES)	16,597.	16,993.
2481D-()-P	16,931.	17,338.
2481D-()-(MN, MNS, MA, MAS, GG, GGS)	17,139.	17,549.
2481D-()-(MC, MCS)	18,168.	18,575.
2481D-()-(MV, MVS)	22,224.	22,634.

Order Code	Ordering Information
<i>Example:</i> 2510T-C-G2	<i>Base finishes:</i>
2510T Florence Knoll square coffee table	 Polished Chrome (suffix C) Satin Chrome (suffix CO)
C Polished Chrome	<i>Glass top finishes:</i>
G2 Clear glass	Black Glass (suffix C1)  Clear Glass (suffix G2) White Glass (suffix C2)
<i>Note:</i> Florence Knoll coffee tables are part of a collection. Please refer to Florence Knoll lounge seating on page 136 and desks and credenzas beginning on page 318.	<i>Veneer finishes:</i> Ebony Walnut (suffix D) Light Oak (suffix LO) Light Walnut (suffix LWA) Reff Dark Cherry (suffix V314)
<i>Specify:</i> 1. Pattern number 2. Base finish option 3. Top selection	<i>Pearwood finish:</i> Pearwood (suffix P)
	<i>Polished Coated marble top finishes:</i> Arabescato: white-grey (suffix MA) Calacatta: white-grey/beige (suffix MC) Carrara: white-grey (suffix GC) Empire Beige: beige (suffix GB) Espresso: dark brown (suffix ME) Grey Marble: light grey (suffix GG) Grigio Marquina: warm grey (suffix MG) Nero Marquina: black (suffix MN) Verdi Alpi: green (suffix MV)
	<i>Satin Coated marble top finishes:</i> Arabescato: white-grey (suffix MAS) Calacatta: white-grey/beige (suffix MCS) Carrara: white-grey (suffix GCS) Empire Beige: beige (suffix GBS) Espresso: dark brown (suffix MES) Grey Marble: light grey (suffix GGS) Grigio Marquina: warm grey (suffix MGS) Nero Marquina: black (suffix MNS) Verde Alpi: green (suffix MVS)
	<i>Natural marble top finishes:</i> Calacatta: white-grey/beige (suffix NC) Carrara: white-grey (suffix NGC)
	<i>Granite top finish:</i> Black Andes: black (suffix GA)  KnollStudio 20-Day Program: The Florence Knoll 2510T and 2511T tables in polished chrome finish and clear glass top are available on the KnollStudio 20-Day program. For specific information, consult pages 30-33.
	<i>Note:</i> Wood finishes on Florence Knoll low tables differ from those on the table desk and credenzas.
	<i>Base:</i> Polished chrome-plated or satin chrome-plated steel.
	<i>Maintenance:</i> See pages 28-29.
	<i>Note:</i> KnollStudio logo and signature of Florence Knoll are stamped into the base.

Construction
<i>Top:</i> 5/8" thick polished plate glass or coated marble with transparent polyester to help eliminate use-associated stains. 3/4" thick natural marble and granite top with protective sealer.
<i>Note:</i> Marbles with a coating will yellow over time.
<i>Wood Top:</i> Tops are constructed of veneered medium density fiberboard with a cathedral grain pattern in various toned or stained finishes for light oak, light walnut, reff dark cherry and pearwood. Ebonized walnut features a black stain on walnut substrate. Tops are 3/4" thick. Base and Top ship separately. Top is attached to base with wood screws that are enclosed in hardware packet.

The Florence Knoll Coffee and End Tables in all finishes are Greenguard certified.

Florence Knoll Round Table Desk

	description	w	d	h	weight	top
<p><i>Designer(s):</i> Florence Knoll, 1961</p> <p><i>Award(s):</i> Design Center Stuttgart Award, 1969-70</p> 	2482T Round table desk	54"		27 1/2"	241 lbs.	coated marble
		54"		28"	134 lbs.	natural oak
	54"		28"	134 lbs.	mahogany	
	54"		28"	134 lbs.	ebonized oak	
	54"		27 1/2"	241 lbs.	coated marble	
	54"		28"	134 lbs.	pearwood	
	54"		27 1/2"	241 lbs.	coated marble	
	54"		27 1/2"	241 lbs.	coated marble	
	54"		28"	142 lbs.	white laminate	
	54"		27 1/2"	241 lbs.	natural marble	
	54"		27 1/2"	241 lbs.	coated marble	
	54"		27 1/2"	241 lbs.	coated marble	



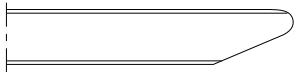
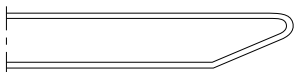

pattern no.	polished chrome base (C)	satin chrome base (CO)
2482-()-(ME, MES)	\$10,196.	\$10,650.
2482T-()-O	10,406.	10,876.
2482T-()-(M7,M9)	10,849.	11,318.
2482T-()-E	11,294.	11,765.
2482T-()-(MN, MNS, MA, MAS, GG, GGS)	12,368.	12,837.
2482T-()-P	12,424.	12,895.
2482T-()-(MC, MCS)	12,987.	13,455.
2482T-()-(MV, MVS)	16,099.	16,567.
2482T-()-F2	7,615.	8,086.
2482T-()-(NGC)	8,294.	8,762.
2482T-()-(MG, MGS)	8,726.	9,180.
2482T-()-(GC, GCS, GB, GBS)	9,285.	9,753.

Order Code	Ordering Information
<i>Example:</i> 2482T-C-NGC	<i>Base finishes:</i> Polished Chrome (suffix C) Satin Chrome (suffix CO)
2482T Florence Knoll round table desk	
C Polished Chrome	<i>Laminate top finish:</i> White Laminate (suffix F2)
NGC Carrara Marble	<i>Veneer top finishes:</i> Ebonized Oak (suffix E) Natural Oak (suffix O) Medium Brown Mahogany (suffix M7) Medium Red Mahogany (suffix M9) Pearwood (suffix P)
<i>Note:</i> Florence Knoll table desks are part of a collection. Please refer to Florence Knoll lounge seating on page 136 and credenzas, conference and low tables on the following pages.	<i>Polished Coated marble top finishes:</i> Arabescato: white-grey (suffix MA) Calacatta: white-grey/beige (suffix MC) Carrara: white-grey (suffix GC) Empire Beige: beige (suffix GB) Espresso: dark brown (suffix ME) Grey Marble: light grey (suffix GG) Grigio Marquina: warm grey (suffix MG) Nero Marquina: black (suffix MN) Verde Alpi: green (suffix MV)
<i>Specify:</i> 1. Pattern number 2. Base finish option 3. Top finish selection	<i>Maintenance:</i> See pages 28-29. <i>Note:</i> The KnollStudio logo and signature of Florence Knoll are stamped into the base of the table. The Florence Knoll Round Table Desk is Greenguard certified.
	<i>Satin Coated marble top finishes:</i> Arabescato: white-grey (suffix MAS) Calacatta: white-grey/beige (suffix MCS) Carrara: white-grey (suffix GCS) Empire Beige: beige (suffix GBS) Espresso: dark brown (suffix MES) Grey Marble: light grey (suffix GGS) Grigio Marquina: warm grey (suffix MGS) Nero Marquina: black (suffix MNS) Verde Alpi: green (suffix MVS)
	<i>Natural marble top finishes:</i> Carrara: white-grey (suffix NGC)

Construction
<p><i>Base:</i> Frame and legs heavy gauge welded steel. Post and four-star legs in polished chrome finish. Optional satin chrome finish.</p> <p><i>Base footprint dimensions:</i> Base dimensions for the 2480D and 2481D are 42 7/8" w x 27 7/8" d. Base dimensions for the 2482T are 28 7/8" w x 28 7/8" d.</p> <p><i>Laminate edge detail:</i></p>  <p><i>Top:</i> Satin finish smooth laminate, wood veneer, or marble with bevel-edge. Laminate tops are 1 1/4" thick and veneer tops are 1 3/16" thick. Marble is 3/4" thick. Marble coated with transparent polyester to help eliminate use-associated stains.</p> <p><i>Note:</i> Marbles with a coating will yellow over time.</p> <p><i>Marble edge detail:</i></p>  <p><i>Glides:</i> Adjustable steel glides with a chrome finish.</p>

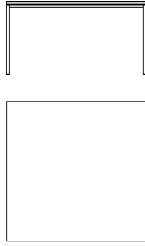
Florence Knoll

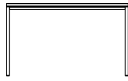
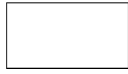
Dining Tables and Mini Desk

	description	w	d	h	weight	top
Designer(s): Florence Knoll, 1954 Award(s): American Institute of Interior Designers First Award, USA, 1954	2520T Square Table 	55 1/8"	55 1/8"	28 3/8"	- lbs.	Coated marble
		55 1/8"	55 1/8"	28 3/8"	- lbs.	Coated marble
		55 1/8"	55 1/8"	28 3/8"	- lbs.	Coated marble
		55 1/8"	55 1/8"	28 3/8"	- lbs.	Coated marble
	2521T Mini Desk  	48"	26"	28 3/8"	- lbs.	Clear glass
		48"	26"	28 3/8"	- lbs.	Coated marble
		48"	26"	28 3/8"	- lbs.	Coated marble
		48"	26"	28 3/8"	- lbs.	Coated marble
		48"	26"	28 3/8"	- lbs.	Coated marble
2522T Rectangular Table  	60"	36"	28 3/8"	- lbs.	Coated marble	
	60"	36"	28 3/8"	- lbs.	Coated marble	
	60"	36"	28 3/8"	- lbs.	Coated marble	
	60"	36"	28 3/8"	- lbs.	Coated marble	
	60"	36"	28 3/8"	- lbs.	Coated marble	

pattern no.	polished chrome (suffix C)
2520T-C-(MG, MGS)	\$10,277.
2520T-C-(GC, GCS)	11,032.
2520T-C-(MA, MAS)	11,978.
2520T-C-(MC, MCS)	15,751.
<hr/>	
2521T-C-G2	2,833.
2521T-C-(MG, MGS)	5,455.
2521T-C-(GC, GCS)	5,767.
2521T-C-(MA, MAS)	6,147.
2521T-C-(MC, MCS)	7,705.
<hr/>	
2522T-C-(MG, MGS)	10,682.
2522T-C-(GC, GCS)	11,237.
2522T-C-(MA, MAS)	11,888.
2522T-C-(MC, MCS)	14,554.

Order Code

<i>Example:</i> 2523T-C-MGS	Florence Knoll Rectangular Dining Table
C	Polished Chrome
MGS	Grigio Marquina, Satin

- Specify:*
1. Pattern number
 2. Base finish option
 3. Top finish selection

Ordering Information

Base finishes:
 Polished Chrome (suffix C)

Glass top finishes:
 Clear Glass (suffix G2) *

Polished Coated marble top finishes:
 Arabescato: white-grey (suffix MA)
 Calacatta: white-grey/beige (suffix MC)
 Carrara: white-grey (suffix GC)
 Grigio Marquina: warm grey (suffix MG)

Satin Coated marble top finishes:
 Arabescato: white-grey (suffix MAS)
 Calacatta: white-grey/beige (suffix MCS)
 Carrara: white-grey (suffix GCS)
 Grigio Marquina: warm grey (suffix MGS)

*available on 2521T only

Maintenance:
 See pages 28-29.

Note:
 The KnollStudio logo and signature of Florence Knoll are stamped into the base of the table.

Construction

Top:
 Thick polished plate glass or coated marble with transparent polyester coating in polished or satin finish to help eliminate use-associated stains. Marble tops arrive with a 1/8" thick black high density particle board spacer glued underneath the perimeter and rests on the table frame with double sided adhesive.

Note:
 Marbles with a coating will yellow over time giving the marble a warmer tone.

Base:
 Legs are made of solid steel bars and connected to horizontal steel tube rails using steel connectors.

Substructure:
 Larger tables, 2523T and 2524T, include an added cross bar between the rails and feature a tension rod substructure to help support the weight of the marble top. Four steel rods connected to the top corners of the table base converge into a chrome box attached to the cross bar. This hidden structure prevents any deflection of the marble.

Tension rod substructure for 2523T and 2524T:

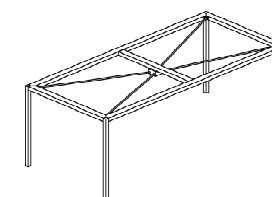

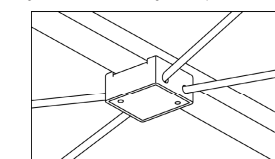

Tension rod and chrome box detail (view from underside of table):

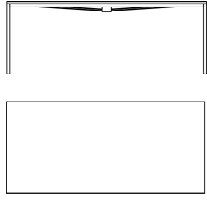

Florence Knoll

Dining Tables and Mini Desk

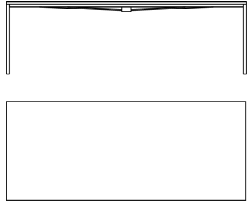
	description	w	d	h	weight	top
Designer(s): Florence Knoll, 1954 Award(s): American Institute of Interior Designers First Award, USA, 1954	2523T Rectangular Table 	78 7/8"	35 1/2"	28 3/8"	- lbs.	Coated marble
		78 7/8"	35 1/2"	28 3/8"	- lbs.	Coated marble
		78 7/8"	35 1/2"	28 3/8"	- lbs.	Coated marble
		78 7/8"	35 1/2"	28 3/8"	- lbs.	Coated marble
	2524T Rectangular Table 	94 1/2"	39 3/8"	28 3/8"	- lbs.	Coated marble
		94 1/2"	39 3/8"	28 3/8"	- lbs.	Coated marble
		94 1/2"	39 3/8"	28 3/8"	- lbs.	Coated marble
		94 1/2"	39 3/8"	28 3/8"	- lbs.	Coated marble

pattern no.	polished chrome (suffix C)
2523T-C-(MG, MGS)	\$12,798.
2523T-C-(GC, GCS)	13,494.
2523T-C-(MA, MAS)	14,342.
2523T-C-(MC, MCS)	17,809.
<hr/>	
2524T-C-(MG, MGS)	15,134.
2524T-C-(GC, GCS)	16,066.
2524T-C-(MA, MAS)	17,197.
2524T-C-(MC, MCS)	21,840.

Order Code

<i>Example:</i>	2523T-C-MGS
2523T	Florence Knoll Rectangular Dining Table
C	Polished Chrome
MGS	Grigio Marquina, Satin

Specify:

1. Pattern number
2. Base finish option
3. Top finish selection

Ordering Information

Base finishes:
Polished Chrome (suffix C)

Glass top finishes:
Clear Glass (suffix G2) *

Polished Coated marble top finishes:
Arabescato: white-grey (suffix MA)
Calacatta: white-grey/beige (suffix MC)
Carrara: white-grey (suffix GC)
Grigio Marquina: warm grey (suffix MG)

Satin Coated marble top finishes:
Arabescato: white-grey (suffix MAS)
Calacatta: white-grey/beige (suffix MCS)
Carrara: white-grey (suffix GCS)
Grigio Marquina: warm grey (suffix MGS)

*available on 2521T only

Maintenance:
See pages 28-29.

Note:
The KnollStudio logo and signature of Florence Knoll are stamped into the base of the table.

Construction

Top:
Thick polished plate glass or coated marble with transparent polyester coating in polished or satin finish to help eliminate use-associated stains. Marble tops arrive with a 1/8" thick black high density particle board spacer glued underneath the perimeter and rests on the table frame with double sided adhesive.

Note:
Marbles with a coating will yellow over time giving the marble a warmer tone.

Base:
Legs are made of solid steel bars and connected to horizontal steel tube rails using steel connectors.

Substructure:
Larger tables, 2523T and 2524T, include an added cross bar between the rails and feature a tension rod substructure to help support the weight of the marble top. Four steel rods connected to the top corners of the table base converge into a chrome box attached to the cross bar. This hidden structure prevents any deflection of the marble.

Tension rod substructure for 2523T and 2524T:

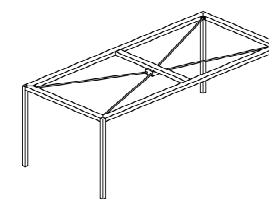

Tension rod and chrome box detail (view from underside of table):

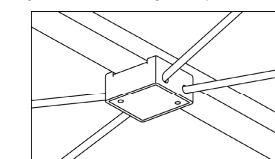

Florence Knoll *Executive Desk*

Designer(s):
Florence Knoll, 1954



description	w	d	h	weight	top
2485D Rectangular desk with two pencil drawers	72"	37 1/4"	29 1/4"	–	Mahogany/Oak/ Walnut
	72"	37 1/4"	29 1/4"	–	Teak
	72"	37 1/4"	29 1/4"	–	Rosewood

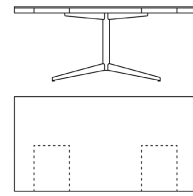

pattern no.	polished chrome base (C)	satin chrome base (CO)
2485D-(C, CO)-()	\$10,954.	\$11,579.
2485D-(C, CO)-(TK)	13,988.	14,614.
2485D-(C, CO)-(RO)	15,781.	16,407.

Order Code

<i>Example:</i>	2485D-C-LWA
2523T	Florence Knoll rectangular desk
C	Polished Chrome
LWA	Light Walnut

Specify:

1. Pattern number
2. Base finish option
3. Top finish selection

Ordering Information

Base finishes:
Polished Chrome (suffix C)
Satin Chrome (suffix CO)

Veneer top finishes:
Medium Brown Mahogany (suffix M7)
Ebonized Oak (suffix E)
Natural Oak (suffix O)
Light Walnut (suffix LWA)
Rosewood (suffix RO)
Teak (suffix TK)

Maintenance:
See pages 28-29.

Note:
The KnollStudio logo and signature of Florence Knoll are stamped into the base of the table.

Construction

Base:
Frame and legs heavy gauge welded steel. Post and four-star legs in polished chrome finish.

Top:
Top and side are constructed of solid MDF core with veneer faces.

Drawers:
Two pencil drawers are constructed of solid maple lumber. Fronts are solid lumber with veneer face and edge. Pencil tray is solid lumber. Drawers on ball bearing metal slides.

Base footprint dimensions:
Base dimensions for the 2485D is 42 1/8" w x 27 1/8" d.

Glides:
Adjustable steel glides with a chrome finish.





Florence Knoll

Credenzas

Two Position Credenzas

Designer(s):
Florence Knoll, 1961



description	w	d	h	body
2541M Six box drawers (each with one removable partition) 	37 1/2"	18"	25 1/2"	natural oak
	37 1/2"	18"	25 1/2"	mahogany
	37 1/2"	18"	25 1/2"	ebonized oak
	37 1/2"	18"	25 1/2"	pearwood
2542M Four box drawers (each with one removable partition), one full extension file drawer with two metal bars for hanging files 	37 1/2"	18"	25 1/2"	natural oak
	37 1/2"	18"	25 1/2"	mahogany
	37 1/2"	18"	25 1/2"	ebonized oak
	37 1/2"	18"	25 1/2"	pearwood
2545M Two storage cabinets with two adjustable shelves for use in one or both cabinets 	37 1/2"	18"	25 1/2"	white lacquer
	37 1/2"	18"	25 1/2"	natural oak
	37 1/2"	18"	25 1/2"	mahogany
	37 1/2"	18"	25 1/2"	ebonized oak
	37 1/2"	18"	25 1/2"	pearwood
2546M Two box drawers (each with one removable partition), two full extension file drawers with two metal bars for hanging files 	37 1/2"	18"	25 1/2"	mahogany
	37 1/2"	18"	25 1/2"	ebonized oak
	37 1/2"	18"	25 1/2"	pearwood
	37 1/2"	18"	25 1/2"	natural oak

Order Code	Ordering Information
<i>Example:</i> 2545M-C-M9-M9	<i>Specify:</i>
2545M Florence Knoll credenza, two position	1. Pattern number
C Polished Chrome	2. Base finish option
M9 Medium Red Mahogany body	3. Body veneer selection
M9 Medium Red Mahogany top	4. Top marble or wood selection
2545x Optional central locking system	5. Optional central locking system (upcharge \$377)
	<i>Base finishes:</i> Polished Chrome (suffix C) Satin Chrome (suffix CO)

Florence Knoll credenzas are part of a collection. Please refer to Florence Knoll lounge seating on page 136 and table desks, conference and low tables on beginning on page 318.

Body and top veneers/lacquer:
Ebonyed Oak (suffix E)
Medium Brown Mahogany (suffix M7)
Medium Red Mahogany (suffix M9)
Natural Oak (suffix O)
Pearwood (suffix P)
White Lacquer (on 2545M only: suffix 2)

Polished Coated marble top finishes:
Arabescato: white-grey (suffix MA)
Calacatta: white-grey/beige (suffix MC)
Carrara: white-grey (suffix GC)
Empire Beige: beige (suffix GB)
Grey Marble: light grey (suffix GG)
Nero Marquina: black (suffix MN)
Verde Alpi: green (suffix MV)

Satin Coated marble top finishes:
Arabescato: white-grey (suffix MAS)
Calacatta: white-grey/beige (suffix MCS)
Carrara: white-grey (suffix GCS)
Empire Beige: beige (suffix GBS)
Grey Marble: light grey (suffix GGS)
Nero Marquina: black (suffix MNS)
Verde Alpi: green (suffix MVS)

Natural marble top finishes:
Carrara: white-grey (suffix NGC)

Central locking:
Optional central locking secures drawers and doors instantly with one single key lock located in credenza top (left front side). Add proper lock suffix to item number at an additional cost of \$377. See chart for ordering information.

Credenza pattern no.	Locking system pattern no.
2541M	2541X
2542M	2542X
2545M	2545X
2546M	2546X

Note:
KnollStudio logo and Florence Knoll's signature are stamped on each piece.

For weight information, please contact your KnollStudio representative.

Maintenance:
See pages 28-29.

pattern no.	wood top/ polished base	(MN, MNS, MA, MAS, MC, MCS MV, MVS, GG, GGS) marble top/ polished base	(GC, GCS, GB, GBS) marble top/ polished base	(NGC) marble top/ polished base	wood top/ satin base	(MN, MNS, MA, MAS, MC, MCS MV, MVS, GG, GGS) marble top/ satin base	(GC, GCS, GB, GBS) marble top/ satin base	(NGC) marble top/ satin base
2541M-()-O-()-()	\$10,383.	\$11,291.	\$11,291.	\$11,053.	\$10,533.	\$11,441.	\$11,441.	\$11,202.
2541M-()-(M7, M9)-()-()	11,014.	11,951.	11,951.	11,700.	11,162.	12,099.	12,099.	11,848.
2541M-()-E-()-()	11,686.	12,479.	12,479.	12,222.	11,836.	12,628.	12,628.	12,369.
2541M-()-P-()-()	13,727.	13,727.	13,727.	13,464.	13,874.	13,875.	13,875.	13,612.
2542M-()-O-()-()	10,018.	10,896.	10,896.	10,655.	10,163.	11,043.	11,043.	10,802.
2542M-()-(M7, M9)-()-()	10,500.	11,422.	11,422.	11,170.	10,646.	11,567.	11,567.	11,317.
2542M-()-E-()-()	11,052.	11,951.	11,951.	11,693.	11,197.	12,096.	12,096.	11,838.
2542M-()-P-()-()	13,146.	13,146.	13,146.	12,891.	13,291.	13,292.	13,292.	13,037.
2545M-()-2-()-()	n/a	8,926.	8,926.	8,624.	n/a	9,075.	9,075.	8,773.
2545M-()-O-()-()	6,586.	7,348.	7,348.	7,143.	6,734.	7,496.	7,496.	7,292.
2545M-()-(M7, M9)-()-()	7,074.	7,878.	7,878.	7,661.	7,223.	8,028.	8,028.	7,809.
2545M-()-E-()-()	7,598.	8,401.	8,401.	8,172.	7,748.	8,549.	8,549.	8,319.
2545M-()-P-()-()	9,240.	9,240.	9,240.	9,031.	9,387.	9,387.	9,387.	9,180.
2546M-()-(M7, M9)-()-()	10,252.	11,161.	11,161.	10,903.	10,396.	11,402.	11,402.	11,146.
2546M-()-E-()-()	10,738.	11,686.	11,686.	11,424.	10,883.	11,929.	11,929.	11,666.
2546M-()-P-()-()	12,859.	12,859.	12,859.	12,599.	13,003.	13,100.	13,100.	12,842.
2546M-()-O-()-()	9,833.	10,701.	10,701.	10,453.	9,979.	10,941.	10,941.	10,694.

Construction		
<i>Base:</i> Welded square steel tube in polished chrome finish. Optional satin chrome finish. Adjustable glides.	<i>Top :</i> 3/4" thick marble coated with transparent polyester to help eliminate use-associated stains. Squared edge detail. 3/4" wood top matching body available. Wood tops finished with transparent polyurethane coat.	<i>Front:</i> Drawer and door fronts in same wood veneers or lacquer finish as body. All have polished aluminum pulls, top flush mounted storage doors with magnetic closures. Location A storage hinges open from left. Location B storage hinges open from right. Other hinging available as special. Pull out drawers with smooth-glide extension slides. Drawer and storage have matching veneer inside.
<i>Body:</i> Wood veneer sides and matching back panel in oak, pearwood, or mahogany. Oak, mahogany and pearwood finished with transparent polyurethane coat. Only 2545M storage cabinet available in white lacquer.	<i>Note:</i> Marbles with a coating will yellow over time.	

Florence Knoll

Credenzas

Four Position Credenzas

Designer(s):
Florence Knoll, 1961



description	w	d	h	body
2543M Eight box drawers (each with one removable partition), two full-extension file drawers with two metal bars each for hanging files	74 3/4"	18"	25 1/2"	natural oak
	74 3/4"	18"	25 1/2"	mahogany
	74 3/4"	18"	25 1/2"	ebonized oak
	74 3/4"	18"	25 1/2"	pearwood
2544M Four storage cabinets with four adjustable shelves for use in two or more of the cabinets	74 3/4"	18"	25 1/2"	natural oak
	74 3/4"	18"	25 1/2"	mahogany
	74 3/4"	18"	25 1/2"	ebonized oak
	74 3/4"	18"	25 1/2"	pearwood
	74 3/4"	18"	25 1/2"	white lacquer
2547M Four box drawers (each with one removable partition), one full-extension file drawer with two metal bars for hanging files. Two storage cabinets with two adjustable shelves for use in one or both cabinets	74 3/4"	18"	25 1/2"	natural oak
	74 3/4"	18"	25 1/2"	mahogany
	74 3/4"	18"	25 1/2"	ebonized oak
	74 3/4"	18"	25 1/2"	pearwood
2548M Four box drawers (each with one removable partition), one full-extension file drawer with two metal bars, two storage cabinets with two adjustable shelves for use in one or both cabinets	74 3/4"	18"	25 1/2"	natural oak
	74 3/4"	18"	25 1/2"	mahogany
	74 3/4"	18"	25 1/2"	ebonized oak
	74 3/4"	18"	25 1/2"	pearwood
2549M Four box drawers (each with one removable partition), four full-extension file drawers with two metal bars each for hanging files	74 3/4"	18"	25 1/2"	natural oak
	74 3/4"	18"	25 1/2"	mahogany
	74 3/4"	18"	25 1/2"	ebonized oak
	74 3/4"	18"	25 1/2"	pearwood

Order Code

<i>Example:</i>	2543M-CO-P-MN
2543M	Florence Knoll credenza, four position
CO	Satin Chrome
P	Pearwood body
MN	Nero Marquina top
2543x	Optional locking system

Florence Knoll credenzas are part of a collection. Please refer to Florence Knoll lounge seating on page 136 and table desks, conference and low tables beginning on page 318.

Ordering Information

<i>Specify:</i>	Grey Marble: light grey (suffix GG) Nero Marquina: black (suffix MN) Verde Alpi: green (suffix MV)	<i>Central locking:</i> Optional central locking secures drawers and doors instantly with one single key lock located in credenza top (left front side). Add proper lock suffix to item number at an additional cost of \$755. See chart below for ordering information.
<i>Base finishes:</i> Polished Chrome (suffix C) Satin Chrome (suffix CO)	<i>Satin Coated marble top finishes:</i> Arabescato: white-grey (suffix MAS) Calacatta: white-grey/beige (suffix MCS) Carrara: white-grey (suffix GCS) Empire Beige: beige (suffix GBS) Grey Marble: light grey (suffix GGS) Nero Marquina: black (suffix MNS) Verde Alpi: green (suffix MVS)	Credenza pattern no. 2453M 2544M 2547M 2548M 2549M
<i>Body and top veneers/lacquer:</i> Ebonized Oak (suffix E) Medium Brown Mahogany (suffix M7) Medium Red Mahogany (suffix M9) Natural Oak (suffix O) Pearwood (suffix P) White Lacquer (on 2544M only: suffix 2)	<i>Natural marble top finishes:</i> Carrara: white-grey (suffix NGC)	Central locking system pattern no. 2543X 2544X 2547X 2548X 2549X
<i>Polished Coated marble top finishes:</i> Arabescato: white-grey (suffix MA) Calacatta: white-grey/beige (suffix MC) Carrara: white-grey (suffix GC) Empire Beige: beige (suffix GB)		<i>Note:</i> KnollStudio logo and Florence Knoll's signature are stamped on each piece.
		For weight information, please contact your KnollStudio representative.
		<i>Maintenance:</i> See pages 28-29.



pattern no.	wood top/ polished base	(MN, MNS, MA, MAS, MC, MCS MV, MVS, GG, GGS) marble top/ polished base	(GC, GCS, GB, GBS) marble top/ polished base	(NGC) marble top/ polished base	wood top/ satin base	(MN, MNS, MA, MAS, MC, MCS MV, MVS, GG, GGS) marble top/ satin base	(GC, GCS, GB, GBS) marble top/ satin base	(NGC) marble top/ satin base
2543M-()-O-()-()	\$19,969.	\$21,808.	\$21,808.	\$21,311.	\$20,212.	\$22,050.	\$22,050.	\$21,555.
2543M-()-(M7,M9)-()-()	21,218.	22,991.	22,991.	22,470.	21,459.	23,236.	23,236.	22,714.
2543M-()-E-()-()	22,320.	24,176.	24,176.	23,635.	22,561.	24,417.	24,417.	23,878.
2543M-()-P-()-()	26,594.	26,594.	26,594.	26,062.	26,837.	26,838.	26,838.	26,305.
2544M-()-O-()-()	13,025.	14,580.	14,580.	14,155.	13,269.	14,825.	14,825.	14,399.
2544M-()-(M7,M9)-()-()	13,868.	15,369.	15,369.	14,925.	14,113.	15,614.	15,614.	15,169.
2544M-()-E-()-()	14,591.	16,159.	16,159.	15,702.	14,834.	16,402.	16,402.	15,947.
2544M-()-P-()-()	17,777.	17,736.	17,736.	17,323.	18,021.	17,980.	17,980.	17,566.
2544M-()-2-()-()	n/a	17,777.	17,777.	17,137.	n/a	18,021.	18,021.	17,383.
2547M-()-O-()-()	16,499.	18,208.	18,208.	17,744.	16,740.	18,450.	18,450.	17,986.
2547M-()-(M7,M9)-()-()	17,479.	19,129.	19,129.	18,647.	17,723.	19,373.	19,373.	18,890.
2547M-()-E-()-()	18,337.	20,045.	20,045.	19,545.	18,578.	20,287.	20,287.	19,786.
2547M-()-P-()-()	22,056.	22,056.	22,056.	21,586.	22,301.	22,300.	22,300.	21,827.
2548M-()-O-()-()	16,499.	18,208.	18,208.	17,744.	16,740.	18,450.	18,450.	17,986.
2548M-()-(M7,M9)-()-()	17,479.	19,129.	19,129.	18,647.	17,723.	19,373.	19,373.	18,890.
2548M-()-E-()-()	18,337.	20,045.	20,045.	19,545.	18,578.	20,287.	20,287.	19,786.
2548M-()-P-()-()	22,056.	22,056.	22,056.	21,586.	22,301.	22,300.	22,300.	21,827.
2549M-()-O-()-()	19,231.	21,016.	21,016.	20,512.	19,475.	21,260.	21,260.	20,758.
2549M-()-(M7,M9)-()-()	20,483.	22,198.	22,198.	21,675.	20,727.	22,443.	22,443.	21,920.
2549M-()-E-()-()	21,583.	23,382.	23,382.	22,819.	21,826.	23,628.	23,628.	23,064.
2549M-()-P-()-()	25,857.	25,857.	25,857.	25,323.	26,101.	26,102.	26,102.	25,568.

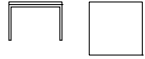
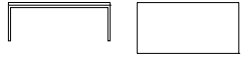

Construction

<i>Base:</i> Welded square steel tube in polished chrome finish. Optional satin chrome finish. Adjustable glides.	<i>Top:</i> 3/4" thick marble coated with transparent polyester to help eliminate use-associated stains. Squared edge detail. 3/8" wood top matching body available. Wood tops finished with transparent polyurethane coat.	<i>Front:</i> Drawer and door fronts in same wood veneers or lacquer finish as body. All have polished aluminum pulls, top flush mounted storage doors with magnetic closures. Location A storage hinges open from left. Location B storage hinges open from right. Other hinges open from right. Other hinging available as special. Pull out drawers with smooth-glide extension slides. Drawer and storage have matching veneer inside.
<i>Body:</i> Wood veneer sides and matching back panel in oak, pearwood, or mahogany. Oak, mahogany and pearwood finished with transparent polyurethane coat. Only 2544M storage cabinet available in white lacquer.	<i>Note:</i> Marbles with a coating will yellow over time.	

Florence Knoll Coffee Tables

	description	w	d	h	weight	top	
<p><i>Designer(s):</i> Florence Knoll, 1954</p> <p><i>Award(s):</i> American Institute of Interior Designers First Award, USA, 1954</p> 	<p>2510T Square coffee table</p> 	23 1/2"	23 1/2"	17"	50 lbs.	clear glass	
		23 1/2"	23 1/2"	17"	50 lbs.	white or black glass	
		23 1/2"	23 1/2"	17"	65 lbs.	natural marble	
		23 1/2"	23 1/2"	17"	65 lbs.	coated marble	
		23 1/2"	23 1/2"	17"	33 lbs.	veneer	
		23 1/2"	23 1/2"	17"	65 lbs.	coated marble	
		23 1/2"	23 1/2"	17"	65 lbs.	coated marble	
		23 1/2"	23 1/2"	17"	33 lbs.	pearwood	
		23 1/2"	23 1/2"	17"	65 lbs.	coated marble	
		23 1/2"	23 1/2"	17"	65 lbs.	coated marble	
		23 1/2"	23 1/2"	17"	67 lbs.	granite	
		23 1/2"	23 1/2"	17"	65 lbs.	natural marble	
		<p>2511T Rectangular coffee table</p> 	45"	22 1/2"	17"	76 lbs.	clear glass
			45"	22 1/2"	17"	104 lbs.	coated marble
			45"	22 1/2"	17"	104 lbs.	natural marble
45"	22 1/2"		17"	104 lbs.	coated marble		
45"	22 1/2"		17"	45 lbs.	veneer		
45"	22 1/2"		17"	104 lbs.	coated marble		
45"	22 1/2"		17"	45 lbs.	pearwood		
45"	22 1/2"		17"	104 lbs.	coated marble		
45"	22 1/2"		17"	104 lbs.	coated marble		
45"	22 1/2"		17"	104 lbs.	coated marble		
45"	22 1/2"		17"	106 lbs.	granite		
45"	22 1/2"		17"	104 lbs.	natural marble		

pattern no.	polished chrome (suffix C)	satin chrome (suffix CO)
2510T(-)G2 	\$1,107.	\$1,194.
2510T(-)C1, C2	1,525.	1,610.
2510T(-)(-)(NGC)	1,934.	2,017.
2510T(-)(-)(MN, MNS, MA, MAS, GG, GGS)	2,035.	2,119.
2510T(-)(-)(LO, LWA, D, V314)	2,114.	2,197.
2510T(-)(-)(GC, GCS, GB, GBS)	2,132.	2,217.
2510(-)(-)(MG, MGS)	2,194.	2,277.
2510T(-)(-)(P)	2,294.	2,377.
2510T(-)(-)(MC, MCS)	2,322.	2,406.
2510(-)(-)(ME, MES)	2,378.	2,461.
2510T(-)(-)(MV, MVS)	2,694.	2,778.
2510T(-)(-)(GA)	3,468.	3,552.
2510T(-)(-)(NC)	3,762.	3,846.
2511T(-)G2 	1,533.	1,654.
2511T(-)(-)(MG, MGS)	2,278.	2,395.
2511T(-)(-)(NGC)	2,579.	2,700.
2511T(-)(-)(MN, MNS, MA, MAS, GG, GGS)	2,785.	2,905.
2511T(-)(-)(LO, LWA, D, V314)	2,806.	2,927.
2511T(-)(-)(GC, GCS, GB, GBS)	2,919.	3,040.
2511T(-)(-)(P)	3,055.	3,175.
2511T(-)(-)(MC, MCS)	3,178.	3,300.
2511T(-)(-)(MV, MVS)	3,754.	3,875.
2511(-)(-)(ME, MES)	4,060.	4,177.
2511T(-)(-)(GA)	4,644.	4,767.
2511T(-)(-)(NC)	5,346.	5,467.

Order Code	Ordering Information
<i>Example:</i> 2510T-C-G2	<i>Base finishes:</i>
2510T Florence Knoll square coffee table	 Polished Chrome (suffix C) Satin Chrome (suffix CO)
C Polished Chrome	<i>Glass top finishes:</i>
G2 Clear glass	Black Glass (suffix C1)  Clear Glass (suffix G2) White Glass (suffix C2)
<i>Note:</i> Florence Knoll coffee tables are part of a collection. Please refer to Florence Knoll lounge seating on page 136 and desks and credenzas beginning on page 318.	<i>Veneer finishes:</i> Ebony Walnut (suffix D) Light Oak (suffix LO) Light Walnut (suffix LWA) Reff Dark Cherry (suffix V314)
<i>Specify:</i> 1. Pattern number 2. Base finish option 3. Top selection	<i>Pearwood finish:</i> Pearwood (suffix P)
	<i>Polished Coated marble top finishes:</i> Arabescato: white-grey (suffix MA) Calacatta: white-grey/beige (suffix MC) Carrara: white-grey (suffix GC) Empire Beige: beige (suffix GB) Espresso: dark brown (suffix ME) Grey Marble: light grey (suffix GG) Grigio Marquina: warm grey (suffix MG) Nero Marquina: black (suffix MN) Verdi Alpi: green (suffix MV)
	<i>Granite top finish:</i> Black Andes: black (suffix GA)
	 <i>KnollStudio 20-Day Program:</i> The Florence Knoll 2510T and 2511T tables in polished chrome finish and clear glass top are available on the KnollStudio 20-Day program. For specific information, consult pages 30-33.
	<i>Note:</i> Wood finishes on Florence Knoll low tables differ from those on the table desk and credenzas.
	<i>Base:</i> Polished chrome-plated or satin chrome-plated steel.
	<i>Maintenance:</i> See pages 28-29.
	<i>Natural marble top finishes:</i> Arabescato: white-grey (suffix MAS) Calacatta: white-grey/beige (suffix MCS) Carrara: white-grey (suffix GCS) Empire Beige: beige (suffix GBS) Espresso: dark brown (suffix MES) Grey Marble: light grey (suffix GGS) Grigio Marquina: warm grey (suffix MGS) Nero Marquina: black (suffix MNS) Verde Alpi: green (suffix MVS)
	<i>Note:</i> Wood finishes on Florence Knoll low tables differ from those on the table desk and credenzas.
	<i>Note:</i> KnollStudio logo and signature of Florence Knoll are stamped into the base.

Construction
<i>Top:</i> 5/8" thick polished plate glass or coated marble with transparent polyester to help eliminate use-associated stains. 3/4" thick natural marble and granite top with protective sealer.
<i>Note:</i> Marbles with a coating will yellow over time.
<i>Wood Top:</i> Tops are constructed of veneered medium density fiberboard with a cathedral grain pattern in various toned or stained finishes for light oak, light walnut, reff dark cherry and pearwood. Ebony walnut features a black stain on walnut substrate. Tops are 3/4" thick. Base and Top ship separately. Top is attached to base with wood screws that are enclosed in hardware packet.

The Florence Knoll Coffee and End Tables in all finishes are Greenguard certified.

Florence Knoll End Tables

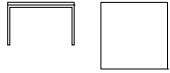
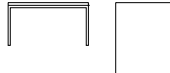
	description	w	d	h	weight	top	
<p><i>Designer(s):</i> Florence Knoll, 1954</p> <p><i>Award(s):</i> American Institute of Interior Designers First Award, USA, 1954</p> 	<p>2515T Square end table</p> 	29 1/2"	29 1/2"	19"	71 lbs.	clear glass	
		29 1/2"	29 1/2"	19"	95 lbs.	natural marble	
		29 1/2"	29 1/2"	19"	95 lbs.	coated marble	
		29 1/2"	29 1/2"	19"	95 lbs.	coated marble	
		29 1/2"	29 1/2"	19"	44 lbs.	veneer	
		29 1/2"	29 1/2"	19"	95 lbs.	coated marble	
		29 1/2"	29 1/2"	19"	44 lbs.	pearwood	
		29 1/2"	29 1/2"	19"	95 lbs.	coated marble	
		29 1/2"	29 1/2"	19"	95 lbs.	coated marble	
		29 1/2"	29 1/2"	19"	95 lbs.	coated marble	
		29 1/2"	29 1/2"	19"	96 lbs.	granite	
		29 1/2"	29 1/2"	19"	95 lbs.	natural marble	
		<p>2517T Square end table</p> 	35 1/2"	35 1/2"	19"	93 lbs.	clear glass
			35 1/2"	35 1/2"	19"	128 lbs.	natural marble
			35 1/2"	35 1/2"	19"	53 lbs.	veneer
35 1/2"	35 1/2"		19"	128 lbs.	coated marble		
35 1/2"	35 1/2"		19"	53 lbs.	pearwood		
35 1/2"	35 1/2"		19"	128 lbs.	coated marble		
35 1/2"	35 1/2"		19"	128 lbs.	coated marble		
35 1/2"	35 1/2"		19"	128 lbs.	coated marble		
35 1/2"	35 1/2"		19"	128 lbs.	coated marble		
35 1/2"	35 1/2"		19"	128 lbs.	coated marble		
35 1/2"	35 1/2"		19"	131 lbs.	granite		
35 1/2"	35 1/2"		19"	128 lbs.	natural marble		

pattern no.	polished chrome (suffix C)	satin chrome (suffix CO)
2515T (-)G2	\$1,480.	\$1,566.
2515T (-)(NGC)	2,277.	2,366.
2515T (-)(MN, MNS, MA, MAS, GG, GGS)	2,436.	2,524.
2515T (-)(GC, GCS, GB, GBS)	2,552.	2,642.
2515T (-)(LO, LWA, D, V314)	2,898.	2,986.
2515T (-)(MG, MGS)	2,977.	3,063.
2515T (-)(P)	3,147.	3,234.
2515T (-)(MC, MCS)	3,339.	3,427.
2515T (-)(MV, MVS)	3,387.	3,473.
2515 (-)(ME, MES)	3,559.	3,645.
2515T (-)(GA)	4,443.	4,530.
2515T (-)(NC)	4,958.	5,037.
2517T (-)G2	1,721.	1,841.
2517T (-)(NGC)	2,962.	3,084.
2517T (-)(LO, LWA, D, V314)	3,019.	3,140.
2517T (-)(MN, MNS, MA, MAS, GG, GGS)	3,246.	3,365.
2517T (-)(P)	3,269.	3,390.
2517T (-)(GC, GCS, GB, GBS)	3,400.	3,522.
2517T (-)(MG, MGS)	3,908.	4,024.
2517T (-)(MV, MVS)	4,239.	4,360.
2517T (-)(MC, MCS)	4,445.	4,567.
2517T (-)(ME, MES)	4,643.	4,759.
2517T (-)(GA)	5,294.	5,416.
2517T (-)(NC)	6,037.	6,157.

Order Code	Ordering Information
<p><i>Example:</i> 2517T-CO-GS</p> <p>2517T Florence Knoll square end table</p> <p>CO Satin Chrome</p> <p>GS Cedar Stone</p>	<p><i>Base finishes:</i> Polished Chrome (suffix C) Satin Chrome (suffix CO)</p> <p><i>Glass top finishes:</i> Clear Glass (suffix G2)</p> <p><i>Veneer finishes:</i> Ebonized Walnut (suffix D) Light Oak (suffix LO) Light Walnut (suffix LWA) Reff Dark Cherry (suffix V314)</p> <p><i>Pearwood finish:</i> Pearwood (suffix P)</p>
<p><i>Note:</i> Florence Knoll end tables are part of a collection. Please refer to Florence Knoll lounge seating on page 136 and desks and credenzas beginning on page 318.</p> <p><i>Specify:</i> 1. Pattern number 2. Base finish option 3. Top selection</p>	<p><i>Polished Coated marble top finishes:</i> Arabescato: white-grey (suffix MA) Calacatta: white-grey/beige (suffix MC) Carrara: white-grey (suffix GC) Empire Beige: beige (suffix GB) Espresso: dark brown (suffix ME) Grey Marble: light grey (suffix GG) Grigio Marquina: warm grey (suffix MG) Nero Marquina: black (suffix MN) Verdi Alpi: green (suffix MV)</p> <p><i>Satin Coated marble top finishes:</i> Arabescato: white-grey (suffix MAS) Calacatta: white-grey/beige (suffix MCS) Carrara: white-grey (suffix GCS) Empire Beige: beige (suffix GBS) Espresso: dark brown (suffix MES) Grey Marble: light grey (suffix GGS) Grigio Marquina: warm grey (suffix MGS) Nero Marquina: black (suffix MNS) Verde Alpi: green (suffix MVS)</p> <p><i>Natural marble top finishes:</i> Calacatta: white-grey/beige (suffix NC) Carrara: white-grey (suffix NGC)</p> <p><i>Granite top finish:</i> Black Andes: black (suffix GA)</p>
	<p><i>Note:</i> Wood finishes on Florence Knoll low tables differ from those on the table desk and credenzas.</p> <p><i>Base:</i> Polished chrome-plated or satin chrome-plated steel.</p> <p><i>Maintenance:</i> See pages 28-29.</p> <p><i>Note:</i> KnollStudio logo and signature of Florence Knoll are stamped into the base.</p> <p>The Florence Knoll Coffee and End Tables in all finishes are Greenguard certified.</p>

Construction
<p><i>Top:</i> 3/8" thick polished plate glass or coated marble with transparent polyester to help eliminate use-associated stains. 1/4" thick natural marble and granite top with protective sealer.</p> <p><i>Note:</i> Marbles with a coating will yellow over time.</p> <p><i>Wood Top:</i> Tops are constructed of veneered medium density fiberboard with a cathedral grain pattern in various toned or stained finishes for light oak, light walnut, reff dark cherry and pearwood. Ebonized walnut features a black stain on walnut substrate. Tops are 3/4" thick. Tops contain threaded inserts and attach to base with screws.</p>

Florence Knoll

Hairpin™ Stacking Table

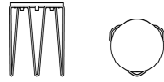
	description	w	d	h	base	weight
<i>Designer(s):</i> Florence Knoll, 1947	75 Hairpin stacking table 	13"	13"	18½"	Paint	7 lbs
		13"	13"	18½"	Chrome	7 lbs

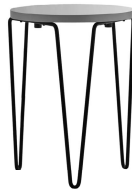

pattern no.	colored laminate	woodgrain laminate
75-(-)()	\$293.	\$323.
75-(-)(C)	323.	353.

Order Code	Ordering Information	Construction
<i>Example:</i> 75-F1-W	<i>Colored Laminate Finishes:</i>	<i>Base:</i>
75 Hairpin stacking table	Black (suffix F1)	Base is constructed of bent cold rolled steel rods and powder coated paint finish or chrome plated. Stainless steel screws attach base to the table top.
F1 Black laminate	White (suffix F2)	
W White base	<i>Woodgrain Laminate Finishes:</i>	<i>Laminate Top:</i>
	Grey Ash (suffix 142)	MDF top is sandwiched between laminate layer with ABS edge. Woodgrain laminate tops will feature a matching woodgrain ABS edge.
	Light Ash (suffix 139)	Three nylon bumpers underneath the top prevent scratches when tables are stacked.
	Zebra (suffix 145)	
<i>Specify:</i>	<i>Base Finishes:</i>	<i>Note:</i>
1. Pattern number	Chrome (suffix C)	Tables stack up to 5 high.
2. Top selection	Black (suffix BL)	
3. Base selection	White (suffix W)	
	Blue (suffix BU)	
	Red (suffix RD)	
	Yellow (suffix YL)	
	Green (suffix GE)	
	<i>Maintenance:</i>	The Florence Knoll Hairpin Stacking Table is Greenguard certified.
	See pages 28-29.	

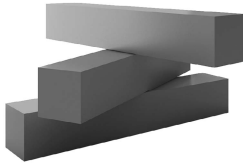
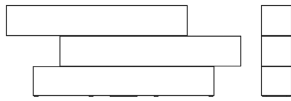
	description	w	d	h	weight
<p><i>Designer(s):</i> Rem Koolhaas, 2013</p> 	<p>04CTR Counter</p> 	94 1/2"	15 3/4"	47"	925 lbs.

pattern no.	list
04CTR-()	\$125,000.

Order Code

Example: **04CTR-845CC**

04CTR 04 Counter

845CC Red

Specify:

1. Pattern number
2. Solid core laminate selection

Ordering Information

Solid core laminate finishes:

Black (suffix 111CC)

Fog (suffix 128CC)

Folkstone (suffix 114CC)

Red (suffix 845CC)

Maintenance:

See pages 28-29.

Prior to Ordering:

Installation Requirements Package:

Please contact your KnollStudio sales representative to obtain a complete installation requirement package *before* submitting an order.

Spatial Considerations:

Please consider these specific spatial dimensions before ordering the 04 Counter:

- Individual beam dimensions: 94 1/2 inches length, 15 3/4 inches square width/height
- Height of the overall counter: 47 inches
- Clear circular footprint required: 13.6 foot diameter
- Total assembled weight: 925 lbs











Note:

Once installed, the 04 Counter is a permanent structure in your space, akin to building a wall. It cannot be easily removed to install flooring, lay a rug, etc. Please think through the alignment and underlayment prior to installation.

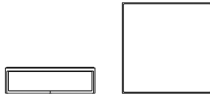
Site Flooring Requirements

These site flooring requirements are solely the customer's responsibility and must be completed prior to installation:

- A minimum of 4" solid concrete floor foundation must be present at the installation site.
- The floor under the mounting plate should be level to within .05 inches
- The floor under the first box should be level to within .25 inches
- No electrical, plumbing, HVAC or reinforcements can be imbedded in the flooring
- Raised floors are not acceptable
- If there is floor covering, there can be no gap between the floor covering and the concrete

	description	w	d	h	base	
<i>Designer(s):</i> Marc Krusin, 2012		MK11 Square side table	18"	18"	18"	Ash, Beech & Oak
			18"	18"	18"	Walnut
		MK12 Square side table	18"	18"	22"	Ash, Beech & Oak
			18"	18"	22"	Walnut
		MK13 Square end table	24"	24"	14"	Ash, Beech & Oak
			24"	24"	14"	Walnut
		MK14 Square coffee table	36"	36"	10"	Ash, Beech & Oak
			36"	36"	10"	Walnut
		MK15 Square coffee table	36"	36"	14"	Ash, Beech & Oak
			36"	36"	14"	Walnut
		MK16 Rectangular coffee table	40"	24"	14"	Ash, Beech & Oak
			40"	24"	14"	Walnut

pattern no	glass& lamine tops	veneer top	leather	GE, GES	MA, MAS, ME, MES, MG, MGS	MC, MCS	engineered stone (VB)
MK11-(-)(-)	\$1,131.	\$1,700.	\$1,915.	\$2,080.	\$2,183.	\$2,404.	\$2,012.
MK11-(-)-AW	1,268.	1,926.	2,085.	2,251.	2,354.	2,569.	2,188.
MK12-(-)(-)	1,141.	1,710.	1,926.	2,091.	2,193.	2,414.	2,035.
MK12-(-)-AW	1,283.	1,950.	2,097.	2,272.	2,375.	2,596.	2,217.
MK13-(-)(-)	1,392.	1,824.	2,183.	2,562.	2,693.	3,068.	2,745.
MK13-(-)-AW	1,619.	2,120.	2,467.	2,846.	2,978.	3,353.	3,029.
MK14-(-)(-)	1,893.	2,120.	3,335.	3,755.	4,256.	4,881.	4,886.
MK14-(-)-AW	2,080.	2,409.	3,574.	3,995.	4,494.	5,125.	5,131.
MK15-(-)(-)	1,893.	2,120.	3,335.	3,755.	4,256.	4,881.	4,886.
MK15-(-)-AW	2,080.	2,409.	3,574.	3,995.	4,494.	5,125.	5,131.
MK16-(-)(-)	2,022.	2,617.	3,563.	4,087.	4,907.	5,775.	3,748.
MK16-(-)-AW	2,103.	2,704.	3,649.	4,191.	5,011.	5,878.	3,847.

Order Code	Ordering Information
<i>Example:</i> MK13-G2-A101	Base Finishes:
MK13 Square End Table	<i>Ash:</i> White Ash, suffix A101
G2 Clear Glass	<i>Oak:</i> Natural Oak (suffix ON) Ebonized Oak (suffix OE) Fumed Oak (suffix OF)
A101 White ash base	<i>Walnut:</i> American Walnut (suffix AW)
	<i>Beech:</i> Beech (suffix B311) Bronzed Cherry (suffix B12A) Burnt Walnut (suffix B313) Deep Red Mahogany (suffix B328) Ebonized (suffix BE) Light Cherry (suffix B315) Light Walnut (suffix B411) Medium Cherry (suffix B319) Medium Red Mahogany (suffix BR) Medium Walnut (suffix B323) Natural Beech (suffix BN)
	<i>Top Finishes:</i> <i>Laminate:</i> Bright White (suffix 118)
	<i>Glass:</i> Clear Glass (suffix G2)
	<i>Ash:</i> White Ash (suffix A101)
	<i>Oak:</i> Natural Oak (suffix ON) Ebonized Oak (suffix OE) Fumed Oak (suffix OF)
	<i>Walnut:</i> American Walnut (suffix AW)
	<i>Veneer:</i> <i>Beech:</i> Beech (suffix B311) Bronzed Cherry (suffix B312A) Burnt Walnut (suffix B313) Deep Red Mahogany (suffix B328) Ebonized (suffix BE) Light Cherry (suffix B315) Medium Cherry (suffix B319) Medium Red Mahogany (suffix BR) Medium Walnut (suffix B323) Natural Beech (suffix BN)



Note:
When specifying veneer tops, the base finish matches top. Contrasting top and base finish is not a standard option



- Specify:*
1. Pattern number
 2. Top Finish
 3. Base Finish

Construction
<i>Leather:</i> <i>Spinneybeck Riva:</i> Anata Beccorosso (suffix RA1808) Aquila de Mare (suffix RA1813) Beccaccia de Mare (suffix RA1815) Black (suffix RABLK) Cavaliere d'Italia (suffix RA1804) Paggiarolo (suffix RA1809) Spatola (suffix RA1806) *CFA waived for this product line
<i>Frame:</i> Select American and European hard wood frames. Dowel and mortise and tenon construction.
<i>Marble and Glass Tops:</i> Inset 1/4" thick coated marbles in polished or satin polyester coating and clear tempered glass with radius corners. Tops rest within the frame.
<i>Veneer and Laminate Tops:</i> Constructed with MDF core with solid lumber edges. Laminate has painted filled edge. Face and back are veneer or laminate. Inset tops have threaded inserts to attach to frame.
<i>Leather Tops:</i> Constructed with MDF core wrapped in select Riva leather in various colors.
<i>Finish:</i> Beech, Catalyzed lacquer protective coating. Hand applied final wax coating. Ash, Oak, and Walnut with low sheen urethane protective coating. Hand applied final wax coating. Conversion varnish top coat.
<i>Glides:</i> Felt glides included with all bases for use on hard floor surfaces.
<i>Engineered Stone:</i> Vetro Bianco (VB)

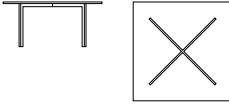
Ludwig Mies van der Rohe

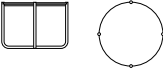
Barcelona® Table, MR Table

	description	w	d	h	weight	top	base
<p><i>Designer(s):</i> Ludwig Mies van der Rohe, 1930</p>  	<p>252 Barcelona table</p>	40"	40"	17"	134 lbs.	Clear glass	Stainless steel
		40"	40"	18.5"	140 lbs.	Clear glass	Polished chrome
		40"	40"	17"	134 lbs.	Starphire glass	Stainless steel
		40"	40"	18.5"	140 lbs.	Starphire glass	Polished chrome
 	<p>259TS MR table</p>	28.5"		20.8"	37 lbs.	Clear glass	Stainless steel

pattern no.	
252	\$4,457.
252C 	2,684.
252-SFG	4,980.
252C-SFG	3,356.
259TS-G 	2,118.

Order Code

<i>Example:</i>	252C-SFG
252	Barcelona table
C	Polished Chrome
SFG	Starphire Glass

Note:
The Mies Barcelona and MR tables are part of a collection. Please refer to Mies side chairs and lounge seating beginning on page 190.

Specify:

1. Pattern number
2. Base finish option
3. Top selection

Ordering Information

Shipping:
Top and base of MR Tables ship in separate packages.

 *KnollStudio 20-Day Program:*
The Barcelona table in chrome with clear glass top and the MR table are available on the KnollStudio 20-day program. For specific information, consult pages 30-33.

Maintenance:
See pages 28-29.

Note:
The KnollStudio logo and signature of Ludwig Mies van der Rohe is stamped into the base of the MR and Barcelona tables.

The Barcelona Table and MR Table are Greenguard certified.

Construction

BARCELONA TABLE
Clear Glass Top:
3/4" thick top with a 1/8" wide beveled edge. Top and edges have a slight green tint.

Starphire™ Glass Top:
Starphire glass is more clear and luminous than regular glass. The low iron content gives glass a crystal quality. 1/8" bevel edge has an exceptionally clear character.

Stainless Steel Base:
Premium grade 202 bar stock stainless steel. Single piece construction ensures long-term durability. Frame hand-ground and hand-buffed to mirror finish.

Polished Chrome Base:
Hand-ground and hand-buffed to a mirror finish. Single piece construction.



Bumpers:
Polished Chrome table has black bumpers. Stainless steel table has white bumpers.

MR TABLE
Top:
1/2" thick clear polished plate glass.

Base:
Frame and legs are tubular and rectangular stainless steel welded together. Seamless construction buffed to a mirror finish.

Ludwig Mies van der Rohe

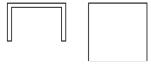
Krefeld™ Side and Coffee Table

	description	w	d	h	weight
Designer(s): Ludwig Mies van der Rohe, 1930 Design from the Mies van der Rohe Archive of The Museum of Modern Art	759 Square Table 	27 1/2"	27 1/2"	17 3/4"	35 lbs.
	760 Rectangular Coffee Table 	54"	27 1/2"	17 3/4"	63 lbs.



pattern number	clear oak	stained finishes
759-()	\$2,475.	\$2,548.
760-()	5,296.	5,453.

Order Code

<i>Example:</i>	759-OWE
759	Krefeld square coffee table
OWE	Wenge

Note:
 The Mies Krefeld tables are part of a collection. Please refer to Mies side chairs and lounge seating beginning on page 190.

Specify:
 1. Pattern number
 2. Finish selection

Ordering Information

Table finishes:
 Wenge (OWE)
 Medium Cherry (OM)
 Deep Red Mahogany (OF)
 Light Walnut (OWA)
 Clear Oak (OC)

Maintenance:
 See pages 27-28.





Construction

Base and Top:
 Oak with stained or clear oak finish.
 Open pore finish. Black plastic glides.
 Seamless connection between top and base.

Pascal Mourgue

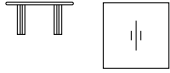
Square and Rectangular Conference Tables

PVC-T edge

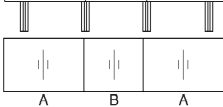
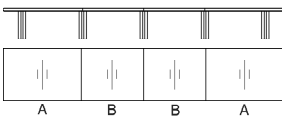

	description	seating capacity *	section	legs	w	d	h	weight	top
Designer(s): Pascal Mourgue, 1985 Award(s): The Roscoe Commendation, USA 1985; IBD Product Design Award, 1985; Corporate Design and Reality Product Design Award, 1986	47TS15 square table 	8	1	4	60 1/4"	60 1/4"	28 3/4"	309 lbs.	Coated marble
		8	1	4	60 1/4"	60 1/4"	28 3/4"	309 lbs.	Natural marble
		8	1	4	60 1/4"	60 1/4"	28 3/4"	178 lbs.	Laminate
		8	1	4	60 1/4"	60 1/4"	28 3/4"	166 lbs.	Veneer
	47TS20 rectangular table 	8	1	4	80"	48 1/2"	28 3/4"	328 lbs.	Coated marble
		8	1	4	80"	48 1/2"	28 3/4"	328 lbs.	Natural marble
		8	1	4	80"	48 1/2"	28 3/4"	187 lbs.	Laminate
		8	1	4	80"	48 1/2"	28 3/4"	175 lbs.	Veneer
	47TS31 rectangular table 	10	2	6	120"	48 1/2"	28 3/4"	279 lbs.	Laminate
		10	2	6	120"	48 1/2"	28 3/4"	262 lbs.	Veneer
47TS48 rectangular table 		16	3	8	204"	48 1/2"	28 3/4"	450 lbs.	Laminate
		16	3	8	204"	48 1/2"	28 3/4"	425 lbs.	Veneer
47TS64 rectangular table 		22	4	10	268"	48 1/2"	28 3/4"	586 lbs.	Laminate
		22	4	10	268"	48 1/2"	28 3/4"	554 lbs.	Veneer

* Based on 26" wide arm chairs

Order Code	Ordering Information
Example: 47TS31-1-V315	Leg finishes:
47TS31 Pascal rectangular table	Matte Black Epoxy (suffix 1)
1 Black Epoxy	Polished Aluminum (suffix AP)
V315 Light Cherry Veneer	Laminate finishes:
Example: 47TSV15-AP-119-V315	Bright White (suffix 118)
47TSV15 Pascal square table, with veneer edge	Folkstone Grey (suffix 114)
AP Polished Aluminum	Fog (suffix 128)
119 Pumice	Jet Black (suffix 111)
V315 Light Cherry Veneer	Light Grey (suffix L)
	Pumice (suffix 119)
	Slate (suffix SL)
	Soft Grey (suffix 117)
	Veneer/bullnose finishes:
	American Cherry (suffix X)
	Ebonized Walnut (suffix D)
	Light Cherry (suffix V315)
	Maple (suffix K)
	Medium Red Mahogany (suffix Z)
	Natural Beech (suffix B)
	Warm Brown Walnut (suffix J)
	Polished Coated marble finishes:
	Carrara: white-grey (suffix GC)
	Empire Beige: beige (suffix GB)
	Natural marble finishes:
	Carrara: white-grey (suffix NGC)
	Veneer edge:
	For veneer edge, add 'V' after 4th digit. For example, for a 48 1/2" square table with veneer edge, specify 47TSV12.
	Certified Wood:
	Tables manufactured using FSC certified hardwoods and veneers and/or LEED compliant recyclable components are available through Custom Product Development. Extended leadtime and upcharge apply.
	Maintenance:
	See pages 28-29.
	Note:
	Polyester marble coating will yellow over time.
	Standard size tables:
	For additional standard size tables please consult your KnollStudio representative, dealer or Customer Service associate.
	Special width tables:
	For standard depth tables (42 1/4", 48 1/2", and 60 1/4"), you may determine list pricing on any special width between two standard sizes simply by identifying the next higher standard width tables, and add 5% to the standard list price.

- Specify:**
1. Pattern number
 2. Leg finish selection
 3. Top finish selection
 4. Wood bullnose finish selection (for laminate tops only)

pattern no.	pvc edge	veneer edge (add V after 4th digit)	marble top
47TS15-(1, AP)-(GC, GB)			\$13,291.
47TS15-(1, AP)-(NGC)			11,160.
47TS15-(1, AP)-(-)(-)	4,556.	5,314.	
47TS15-(1, AP)-(-)	5,122.	6,259.	
47TS20-(1, AP)-(GC, GB)			13,431.
47TS20-(1, AP)-(NGC)			11,300.
47TS20-(1, AP)-(-)(-)	4,556.	5,122.	
47TS20-(1, AP)-(-)	5,314.	6,259.	
47TS31-(1, AP)-(-)(-)	7,018.	8,729.	
47TS31-(1, AP)-(-)	8,539.	10,434.	
47TS48-(1, AP)-(-)(-)	12,464.	14,797.	
47TS48-(1, AP)-(-)	16,315.	18,405.	
47TS64-(1, AP)-(-)(-)	14,336.	18,041.	
47TS64-(1, AP)-(-)	20,300.	22,767.	

Construction		
<p>Combining tables: If individual tables are purchased with the intent of placing them contiguously, they should be quoted for flitch or book match. When desired specifically for combination, note that information on the order so that bullnose edges and legs at each table junction are removable. Leveling strip slides into slots at edges. Legs connect into inserts that span tops. Bullnose edges store for future retrieval and separation.</p> <p>Special sizes and finishes: For all other sizes and for special finishes, consult your KnollStudio representative, dealer, or Customer Services for information.</p> <p>Legs: Extruded aluminum leg in black epoxy or polished aluminum finish. Multiple sectioned tables have two legs bridging each section, plus two legs at each end.</p> <p>Marble top: 13/16" thick marble coated with transparent polyester to help eliminate use-associated stains.</p>	<p>Laminate and wood tops: Tops are 1 1/8" thick. Wood tops are cross-veneered. Tops available with black semi-gloss extruded PVC-T mold bullnose edge or stained solid wood bullnose edge. For PVC-T bullnose, short ends of rectangular table have a wood bullnose with a black semi-gloss paint to match the PVC-T edges.</p> <p>Glides: Adjustable nylon, black epoxy finish.</p> <p>Shipping: Top and base shipped in separate pieces; assembly required.</p>	<p>To assemble: Legs connect into predrilled inserts using mounting hardware (included).</p>  <p>Bullnose edge detail:</p> 

Pascal Mourgue

Round and Racetrack Conference Tables

PVC-T edge

Designer(s):
Pascal Mourgue, 1985

Award(s):
The Roscoe Commendation, USA
1985; IBD Product Design Award,
1985; Corporate Design and
Reality Product Design Award,
1986



description	seating capacity *	section	legs	w	d	h	weight	top	pattern no.		pvc edge	veneer edge (add V after 4th digit)	marble top
									(-)	(-)			
47TR15 round table 	7	1	4	60 1/4"		28 3/4"	250 lbs.	Coated marble	47TR15-(1, AP)-(GC, GB)				\$10,671.
	7	1	4	60 1/4"		28 3/4"	250 lbs.	Natural marble	47TR15-(1, AP)-(NGC)				9,051.
	7	1	4	60 1/4"		28 3/4"	147 lbs.	Laminate	47TR15-(1, AP)-(-)(-)	4,744.	6,259.		
	7	1	4	60 1/4"		28 3/4"	138 lbs.	Veneer	47TR15-(1, AP)-(-)	5,314.	7,398.		
47TR24 racetrack table 	8	1	4	97"	48 1/2"	28 3/4"	605 lbs.	Coated marble	47TR24-(1, AP)-(GC, GB)				15,911.
	8	1	4	97"	48 1/2"	28 3/4"	605 lbs.	Natural marble	47TR24-(1, AP)-(NGC)				13,274.
	8	1	4	97"	48 1/2"	28 3/4"	315 lbs.	Laminate	47TR24-(1, AP)-(-)(-)	5,503.	7,398.		
	8	1	4	97"	48 1/2"	28 3/4"	313 lbs.	Veneer	47TR24-(1, AP)-(-)	6,449.	8,729.		
47TR26 racetrack table 	8	2	6	108"	48 1/2"	28 3/4"	380 lbs.	Laminate	47TR26-(1, AP)-(-)(-)				8,934.
	8	2	6	108"	48 1/2"	28 3/4"	377 lbs.	Veneer	47TR26-(1, AP)-(-)	7,894.	10,390.		
47TR30 racetrack table 	10	2	6	120"	48 1/2"	28 3/4"	262 lbs.	Veneer	47TR30-(1, AP)-(-)				12,882.
	10	2	6	120"	48 1/2"	28 3/4"	280 lbs.	Laminate	47TR30-(1, AP)-(-)(-)	7,894.	10,803.		
47TR50 racetrack table 	16	3	8	192"	60 1/4"	28 3/4"	510 lbs.	Laminate	47TR50-(1, AP)-(-)(-)				17,267.
	16	3	8	192"	60 1/4"	28 3/4"	485 lbs.	Veneer	47TR50-(1, AP)-(-)	19,738.	24,516.		
47TR72 racetrack table 	6	1	4	84"	42 1/4"	28 3/4"	177 lbs.	Laminate	47TR72-(1, AP)-(-)(-)				6,449.
	6	1	4	84"	42 1/4"	28 3/4"	165 lbs.	Veneer	47TR72-(1, AP)-(-)	5,692.	7,968.		

* Based on 26" wide arm chairs

Order Code	Ordering Information		
<i>Example:</i> 47TR26-1-K	<i>Specify:</i>	<i>Veneer/bullnose finishes:</i>	<i>Certified Wood:</i>
47TR26 Pascal racetrack table	1. Pattern number	American Cherry (suffix X)	Tables manufactured using FSC certified
1 Black Epoxy	2. Leg finish selection	Ebonized Walnut (suffix D)	hardwoods and veneers and/or LEED
K Maple Veneer	3. Top finish selection	Light Cherry (suffix V315)	compliant recyclable components are
<i>Example:</i> 47TRV15-AP-J	4. Wood bullnose finish selection (for laminate tops only)	Maple (suffix K)	available through Custom Product
47TRV15 Pascal round table, with veneer edge	<i>Leg finishes:</i>	Medium Red Mahogany (suffix Z)	Development. Extended leadtime and
AP Polished Aluminum	Matte Black Epoxy (suffix 1)	Natural Beech (suffix B)	upcharge apply.
J Warm Brown Walnut Veneer	Polished Aluminum (suffix AP)	Warm Brown Walnut (suffix J)	<i>Maintenance:</i>
	<i>Laminate finishes:</i>	<i>Polished Coated marble finishes:</i>	See pages 28-29.
	Bright White (suffix 118)	Carrara: white-grey (suffix GC)	<i>Note:</i>
	Fog (suffix 128)	Empire Beige: beige (suffix GB)	Polyester marble coating will yellow over
	Folkstone Grey (suffix 114)	<i>Natural marble finishes:</i>	time.
	Jet Black (suffix 111)	Carrara: white-grey (suffix NGC)	<i>Veneer edge:</i>
	Light Grey (suffix L)		For veneer edge, add 'V' after 4th digit.
	Pumice (suffix 119)		For example, for a 48 1/2" round table,
	Soft Grey (suffix 117)		specify 47TRV12.
	Slate (suffix SL)		

pattern no.	pvc edge	veneer edge (add V after 4th digit)	marble top
47TR15-(1, AP)-(GC, GB)			\$10,671.
47TR15-(1, AP)-(NGC)			9,051.
47TR15-(1, AP)-(-)(-)	4,744.	6,259.	
47TR15-(1, AP)-(-)	5,314.	7,398.	
47TR24-(1, AP)-(GC, GB)			15,911.
47TR24-(1, AP)-(NGC)			13,274.
47TR24-(1, AP)-(-)(-)	5,503.	7,398.	
47TR24-(1, AP)-(-)	6,449.	8,729.	
47TR26-(1, AP)-(-)(-)	6,647.	8,934.	
47TR26-(1, AP)-(-)	7,894.	10,390.	
47TR30-(1, AP)-(-)	10,390.	12,882.	
47TR30-(1, AP)-(-)(-)	7,894.	10,803.	
47TR50-(1, AP)-(-)(-)	12,142.	17,267.	
47TR50-(1, AP)-(-)	19,738.	24,516.	
47TR72-(1, AP)-(-)(-)	4,934.	6,449.	
47TR72-(1, AP)-(-)	5,692.	7,968.	

Construction

Standard size tables:
For additional standard size tables please consult your KnollStudio representative, dealer or Customer Service associate.

Special width tables:
For standard depth tables (42 1/4", 48 1/2", and 60 1/4"), you may determine list pricing on any special width between two standard sizes simply by identifying the next higher standard width tables, and add 5% to the standard list price.

For example, if requesting an 80" w x 42 1/4" d table, you would identify the next wider table (84" w x 42 1/4" d) and add 5% to the list price of that standard size. Consult a KnollStudio representative for special Order Code.

Special sizes and finishes:
For all other sizes and for special finishes, consult your KnollStudio representative, dealer, or Customer Services for information.

Legs:
Extruded aluminum leg in black epoxy or polished aluminum finish. Multiple sectioned tables have two legs bridging each section, plus two legs at each end.

Laminate and wood tops:
Tops are 1 1/8" thick. Wood tops are cross-veneered. Tops available with black semi-gloss extruded PVC-T mold bullnose edge or stained solid wood bullnose edge. Bullnose edges on ends of racetrack tables are single, continuous arcs of wood.

Marble top:
13/16" thick marble coated with transparent polyester to help eliminate use-associated stains.

Glides:
Adjustable nylon, black epoxy finish.

Shipping:
Top and base shipped in separate pieces; assembly required.



To assemble:
Legs connect into predrilled inserts using mounting hardware (included).

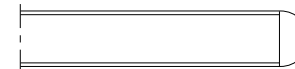

Bullnose edge detail:



Pascal Mourgue
Bullet Conference Tables
PVC-T edge

description	seating capacity *	section	legs	w	d	h	weight	top	
47TR22 bullet table 	8	1	4	87 3/4"	48 1/2"	28 3/4"	356 lbs.	Coated marble	
	8	1	4	87 3/4"	48 1/2"	28 3/4"	356 lbs.	Natural marble	
	8	1	4	87 3/4"	48 1/2"	28 3/4"	201 lbs.	Laminate	
	8	1	4	87 3/4"	48 1/2"	28 3/4"	188 lbs.	Veneer	
47TR19 bullet table 	7	1	4	76"	60 1/4"	28 3/4"	353 lbs.	Coated marble	
	7	1	4	76"	60 1/4"	28 3/4"	353 lbs.	Natural marble	
	7	1	4	76"	60 1/4"	28 3/4"	200 lbs.	Laminate	
	7	1	4	76"	60 1/4"	28 3/4"	187 lbs.	Veneer	

Designer(s):
 Pascal Mourgue, 1985

Award(s):
 The Roscoe Commendation, USA
 1985; IBD Product Design Award,
 1985; Corporate Design and
 Reality Product Design Award,
 1986



pattern no.	pvc edge	veneer edge (add V after 4th digit)	marble top
47TR22-(1, AP)-(GC, GB)			\$13,911.
47TR22-(1, AP)-(NGC)			11,680.
47TR22-(1, AP)-(-)(-)	5,195.	7,018.	
47TR22-(1, AP)-(-)	5,692.	7,968.	
47TR19-(1, AP)-(GC, GB)			14,756.
47TR19-(1, AP)-(NGC)			12,354.
47TR19-(1, AP)-(-)(-)	5,195.	7,018.	
47TR19-(1, AP)-(-)	5,692.	7,968.	

* Based on 26" wide arm chairs



Order Code	Ordering Information
<i>Example:</i> 47TR19-AP-111	<i>Specify:</i>
47TR19 Pascal bullet table	1. Pattern number
AP Polished Aluminum	2. Leg finish selection
111 Jet Black Laminate	3. Top finish selection
	4. Wood bullnose finish selection (for laminate tops only)
<i>Example:</i> 47TRV22-1-111-B	<i>Leg finishes:</i>
47TRV22 Pascal bullet table, with veneer edge	Matte Black Epoxy (suffix I)
1 Black Epoxy	Polished Aluminum (suffix AP)
111 Jet Black Laminate	
B Natural Beech Veneer	
	<i>Laminate finishes:</i>
	Bright White (suffix 118)
	Fog (suffix 128)
	Jet Black (suffix 111)
	Light Grey (suffix L)
	Pumice (suffix 119)
	Slate (suffix SL)
	<i>Laminate finishes, continued:</i>
	Folkstone Grey (suffix 114)
	Soft Grey (suffix 117)
	<i>Veneer/bullnose finishes:</i>
	American Cherry (suffix X)
	Ebonized Walnut (suffix D)
	Light Cherry (suffix V315)
	Maple (suffix K)
	Medium Red Mahogany (suffix Z)
	Natural Beech (suffix B)
	Warm Brown Walnut (suffix J)
	<i>Polished Coated marble finishes:</i>
	Carrara: white-grey (suffic GC)
	Empire Beige: beige (suffix GB)
	<i>Natural marble finishes:</i>
	Carrara: white-grey (suffix NGC)
	<i>Veneer edge:</i>
	For veneer edge, add "V" after 4th digit.
	For example, for a 204" x 60 1/4" rectangular table with veneer edge, specify 47TSV52.

Construction

<i>Certified Wood:</i> Tables manufactured using FSC certified hardwoods and veneers and/or LEED compliant recyclable components are available through Custom Product Development. Extended leadtime and upcharge apply.	<i>Standard size tables:</i> For additional standard size tables please consult your KnollStudio representative, dealer or Customer Service associate.	<i>Special sizes and finishes:</i> For all other sizes and for special finishes, consult your KnollStudio representative, dealer, or Customer Services for information.	<i>Marble top:</i> 1 1/16" thick marble coated with transparent polyester to help eliminate use-associated stains.
<i>Maintenance:</i> See pages 28-29.	<i>Special width tables:</i> For standard depth tables (42 3/4", 48 1/2", and 60 1/4"), you may determine list pricing on any special width between two standard sizes simply by identifying the next higher standard width tables, and add 5% to the standard list price.	<i>Legs:</i> Extruded aluminum leg in black epoxy or polished aluminum finish. Multiple sectioned tables have two legs bridging each section, plus two legs at each end.	<i>Glides:</i> Adjustable nylon, black epoxy finish.
<i>Note:</i> Polyester marble coating will yellow over time.	<i>Note:</i> For example, if requesting an 80" w x 42 3/4" d table, you would identify the next wider table (84" w x 42 3/4" d) and add 5% to the list price of that standard size. Consult a KnollStudio representative for special Order Code.	<i>Laminate and wood tops:</i> Tops are 1 1/8" thick. Wood tops are cross-veneered. Tops available with black semi-gloss extruded PVC-T mold bullnose edge or stained solid wood bullnose edge. Bullnose edges on ends of racetrack tables are single, continuous arcs of wood.	<i>Shipping:</i> Top and base shipped in separate pieces; assembly required.
The Pascal Table with Laminate top and PVC edge is Greenguard certified.			<i>To assemble:</i> Legs connect into predrilled inserts using mounting hardware (included).

George Nakashima

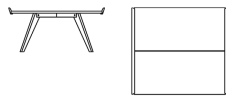
Splay-Leg Table and Tray

	description	w	d	h	weight
	N10 Splay-Leg Table 	37 1/4"	34 1/4"	17 1/2"	33 lbs.
	N20 Tray 	21 3/8"	16"	1 3/4"	5 lbs.

pattern no.	
N10-()-AW	\$2,801.
N20-DF-()	609.

Order Code	Ordering Information	Construction
<i>Specify:</i> N10-HK-AW N10 Splay-Leg Table HK Hickory AW American Walnut	<i>Finishes, table only:</i> American Walnut (suffix AW) Hickory (suffix HK)	<i>TABLE:</i> <i>Top:</i> Tops are veneered with reverse slip-matched cathedral pattern, matching solid wood edge in clear low-sheen finish.
<i>Specify:</i> N20-DF-BS N20 Tray DF Douglas Fir BS Brazilian Santos	<i>Finishes, tray only:</i> Brazilian Santos (suffix BS) Douglas Fir (suffix DF) Wenge (suffix WG)	<i>TRAY:</i> <i>Top:</i> Tops are constructed of solid Douglas Fir lumber that is quarter-cut and finished in a clear low-sheen finish. <i>Edge detail:</i> Available in two finishes: solid Brazilian Santos; solid Wenge. Edge details are joined to top with mortise and tenon joints.
<i>Maintenance:</i> See pages 28-28.	<i>Note:</i> Each table and tray features George Nakashima's signature under the table top. The Splay-Leg Table is Greenguard certified.	<i>Legs, apron and edge detail:</i> Solid American Walnut. Mortise and tenon joints with solid brass hardware. Nylon glides. Edge detail finish is available in American Walnut only.

Note:
The Splay-Leg Table and Tray are part of a collection. Please refer to the Straight chair on page 208.

For Splay-Leg Table, specify:

1. Pattern number
2. Primary finish
3. Edge detail finish



For Splay-Leg Tray, specify:

1. Pattern number
2. Tray finish
3. Edge detail finish

Isamu Noguchi Cyclone™ Dining and Side Tables

Designer(s):
Isamu Noguchi, 1954

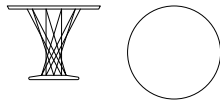
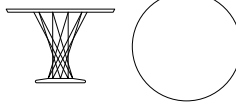

description	w	d	h	weight	top	base
311 Cyclone Dining table 	36"		28"	89 lbs.	Black laminate	Cast iron black
	36"		28"	89 lbs.	White laminate	Cast iron black
312 Cyclone Dining table 	42"		28"	97 lbs.	Black laminate	Cast iron black
	42"		28"	97 lbs.	White laminate	Cast iron black
87 Side table 	24"		20"	31 lbs.	Black laminate	Cast iron black
	24"		20"	31 lbs.	White laminate	Cast iron black

pattern no.	
311-F1	\$3,172.
311-F2 	3,172.
312-F1	3,484.
312-F2	3,484.
87-F1	2,092.
87-F2	2,092.

Order Code

Example:	312-F2
312	Cyclone dining table
F2	White Laminate top

Specify:

1. Pattern number
2. Top finish selection

Ordering Information

Laminate top finish:
Black (F1)
 White (F2)

 **KnollStudio 20-Day Program:**
The Noguchi table is available on the KnollStudio 20-day program in round 36" with a white laminate top. For more specific information, please consult pages 30-33.

Note:
Each table features a signature plate under the table top with the KnollStudio logo and Isamu Noguchi's signature.

Maintenance:
See pages 28-29.

Note:
The Cyclone Table is Greenguard certified.





Construction

Noguchi table top:
Top is black or white laminate with a natural birch edge. Top is 0.8" thick.

Noguchi table base:
Cast iron, black textured powder-coat.

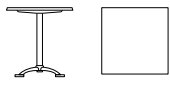
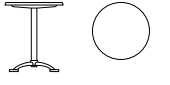
Noguchi table column:
Steel wire column, chrome plated finish.

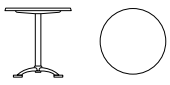
Jorge Pensi
Pensi Tables
Small Cafe and Bar Height Tables

	description	top	w	d	h	weight
<i>Designer(s):</i> Jorge Pensi, 1988	29TS-27 Square café table 	Disks, wrapped edge	27 1/2"	27 1/2"	28 1/4"	35 lbs.
		Metallic Trespa, natural black edge	27 1/2"	27 1/2"	28 1/4"	32 lbs.
<i>Award(s):</i> First Place, Sidi Selection, Valencia, Spain, 1988; "Delta Plate" of ADI FAD, 1988; Design Center Stuttgart Award, W. Germany, 1990	29TR-23 Round café table 	Disks, wrapped edgeband	23 3/8"		28 1/4"	25 lbs.
		Metallic Trespa, natural black edge	23 3/8"		28 1/4"	23 lbs.
	29TR-27 Round café table 	Disks, wrapped edge	27 1/2"		28 1/4"	31 lbs.
		Metallic Trespa, natural black edge	27 1/2"		28 1/4"	27 lbs.
	29TR-H-23 Bar-height café table 	Disks, wrapped edge	23 3/8"		43 1/8"	26 lbs.
		Metallic Trespa, natural black edge	23 3/8"		43 1/8"	24 lbs.

pattern no.	
29TS-27-DE	\$1,643.
29TS-27-LM	2,708.
29TR-23-DE	1,492.
29TR-23-LM	2,081.
29TR-27-DE	1,643.
29TR-27-LM	2,708.
29TR-H-23-DE	1,833.
29TR-H23-LM	2,474.

Order Code	Ordering Information	Construction
<i>Example:</i> 29TS-27-DE	<i>Table top finishes:</i>  Disks, wrapped edge * (suffix DE) Metallic Trespa (suffix LM) *Disks pattern does not appear on edge.	<i>KnollStudio 20-Day Program:</i> Pensi tables are available on the KnollStudio 20-day program in a round 23" bar height size with concentric circle finish and in the round 27" size with disks finish. For specific information, please consult pages 30-33.
29TS Pensi table, square top	<i>Note:</i> The Pensi Tables are available in the United States only.	<i>Top:</i> Two stainless steel finishes: acid-etched pattern of concentric circles; sanded pattern of scalloped, compact disk-like, 1 1/4" wide circles; both with wrapped edge. One metallic Trespa option with a natural black phenolic edge. The Trespa metallic (LM) top finish is UV resistant, does not reflect heat, easy to clean and made of recyclable materials. The Trespa metallic (LM) top finish is ideal for outdoor use.
27 27" wide and deep		
DE Disks, wrapped edge		
<i>Note:</i> Pensi Tables are part of a collection. Please refer to Toledo chairs on page 212.		
<i>Specify:</i> 1. Pattern number 2. Table size 3. Top finish selection		

Base:
Anodized and polished cast aluminum with 4 1/8" pad-like feet. Four-star base on cafe tables. Five-star base on bistro and dining tables. The central column is a polished and anodized aluminum round tube. Internal weight for additional stability. Black silicone non-scuffing glides.

Outdoor use:
With proper preventative maintenance, the Toledo Table is appropriate for outdoor environments.

Square tables, Disks, wrapped edge (DE)

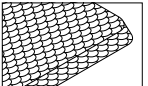

Round tables, Disks, wrapped edge (DE)

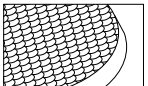





Round tables, Metallic Trespa top, phenolic black edge (LM)

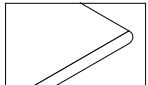

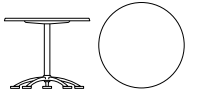
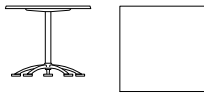

Square tables, Metallic Trespa top, phenolic black edge (LM)

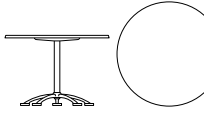

Jorge Pensi
Pensi Tables
Large Bistro Tables

	description	top	w	d	h	weight
<i>Designer(s):</i> Jorge Pensi, 1988	29TR-35 Round bistro table 	Disks, wrapped edge	35 7/8"		29 1/2"	50 lbs.
		Metallic Trespa, natural black edge	35 7/8"		29 1/2"	46 lbs.
<i>Award(s):</i> First Place, Sidi Selection, Valencia, Spain, 1988; "Delta Plate" of ADI FAD, 1988; Design Center Stuttgart Award, W. Germany, 1990	29TS-35 Square bistro table 	Disks, wrapped edge	35 7/8"	35 7/8"	29 1/2"	58 lbs.
		Metallic Trespa, natural black edge	35 7/8"	35 7/8"	29 1/2"	54 lbs.
	29TR-43 Round dining table 	Disks, wrapped edge	43 1/4"		29 1/2"	65 lbs.
		Metallic Trespa, natural black edge	43 1/4"		29 1/2"	57 lbs.
						

pattern no.	
29TR-35-DE	\$3,823.
29TR-35-LM	4,563.
29TS-35-DE 	3,823.
29TS-35-LM	4,563.
29TR-43-DE	4,674.
29TR-43-LM	7,950.

Order Code	Ordering Information	Construction
<i>Example:</i> 29TS-35-DE	<i>Table top finishes:</i>  Disks, wrapped edge * (suffix DE) Metallic Trespa (suffix LM)	 <i>KnollStudio 20-Day Program:</i> The Pensi bistro table is available on the KnollStudio 20-Day program in square 35" size with disks finish and 39" size with disks finish. For specific information, please consult pages 30-33.
29TS Pensi table		<i>Top:</i> Two stainless steel finishes: acid-etched pattern of concentric circles; sanded pattern of scalloped, compact disk-like, 1 1/4" wide circles; both with wrapped edge. One metallic Trespa option with a natural black phenolic edge. The Trespa metallic (LM) top finish is UV resistant, does not reflect heat, easy to clean and made of recyclable materials. The Trespa metallic (LM) top finish is ideal for outdoor use.
35 35" wide and deep	*Disks pattern does not appear on edge.	<i>Maintenance:</i> See pages 28-29.
DE Disks, wrapped edge	<i>Note:</i> The Pensi Tables are available in the United States only.	<i>Note:</i> The Pensi Table is Greenguard certified.
<i>Note:</i> Pensi Tables are part of a collection. Please refer to Toledo chairs on page 212.		
<i>Specify:</i> 1. Pattern number 2. Table size 3. Top finish selection		

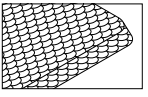
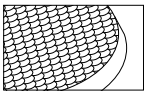
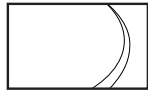
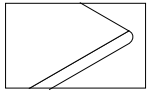
<i>Base:</i> Anodized and polished cast aluminum with 4 7/8" pad-like feet. Four-star base on cafe tables. Five-star base on bistro and dining tables. The central column is a polished and anodized aluminum round tube. Internal weight for additional stability. Black silicone non-scuffing glides.	<i>Square tables, Disks, wrapped edge (DE)</i> 	<i>Round tables, Disks, wrapped edge (DE)</i> 	<i>Round tables, Metallic Trespa top, phenolic black edge (LM)</i> 
<i>Outdoor use:</i> With proper preventative maintenance, the Toledo Table is appropriate for outdoor environments.	<i>Square tables, Metallic Trespa top, phenolic black edge (LM)</i> 		

Piironen
Arena Cafe Tables

Designer(s):
Piironen, 2003

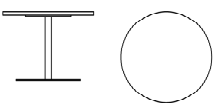
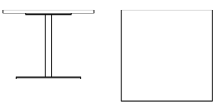
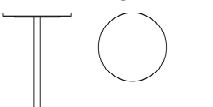
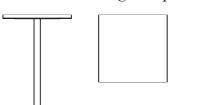

description	w	d	h	weight
23TR Round Cafe Table 	24"	24"	28 1/4"	44 lbs.
	27"	27"	28 1/4"	47 lbs.
	36"	36"	28 1/4"	73 lbs.
	42"	42"	28 1/4"	81 lbs.
23TS Square Cafe Table 	24"	24"	28 1/4"	63 lbs.
	30"	30"	28 1/4"	70 lbs.
23TRH Bar-height Round Cafe Table 	24"	24"	41 1/2"	46 lbs.
	27"	27"	41 1/2"	49 lbs.
23TSH Bar-height Square Cafe Table 	24"	24"	41 1/2"	65 lbs.
	27"	27"	41 1/2"	69 lbs.

pattern no.	silver grey base	chrome base
23TR24- (-)(-)	\$2,265.	\$2,354.
23TR27- (-)(-)	2,464.	2,545.
23TR36- (-)(-)	2,924.	3,008.
23TR42- (-)(-)	3,195.	3,281.
<hr/>		
23TS24- (-)(-)	2,265.	2,354.
23TS30- (-)(-)	2,391.	2,470.
<hr/>		
23TRH24- (-)(-)	2,265.	2,354.
23TRH27- (-)(-)	2,464.	2,545.
<hr/>		
23TSH24- (-)(-)	2,265.	2,354.
23TSH27- (-)(-)	2,464.	2,545.



Order Code

Example: **23TR24-C-W**
23TR24 Arena cafe table, 24"
C Chrome
W White

Specify:

1. Pattern number
2. Column finish selection
3. Top finish

Ordering Information

Column Finish:
 Chrome (C)
 Silver grey paint (S)
Top finish:
 White (W)

 **KnollStudio 20-Day Program:**
The Arena table is available on the 20-day program in round 36" dining height with chrome base and white finish. Please consult pages 30-33.

Note:
The Arena Cafe Table is Greenguard certified.

Construction

Top:
Top is laminate with a natural birch edge. Top is .8" thick. Top is connected to base via mounting plate.

Base:
Base and mounting plates are solid steel. Laser cut and always finished in a silver grey powder coat finish. The column is bolted to both the base plate and mounting plate. The 24" and 27" round tables comprise a 19.7" round base plate. All other size tables, round and square comprise a 25.5" round baseplate. Column is 2.36" in diameter.

Warren Platner

Dining and Side Tables

Designer(s):
Warren Platner, 1962



description	base w	w	h	weight	top	
3716T Dining table 	20 3/4"	53 3/4"	27"	254 lbs.	Coated marble	
	20 3/4"	53 3/4"	27"	267 lbs.	Granite	
	20 3/4"	53 3/4"	27"	227 lbs.	Veneer	
	20 3/4"	53 3/4"	27"	227 lbs.	Pearwood	
	20 3/4"	53 3/4"	27"	254 lbs.	Coated marble	
	20 3/4"	53 3/4"	27"	254 lbs.	Natural marble	
	20 3/4"	53 3/4"	27"	152 lbs.	Clear glass	
	20 3/4"	53 3/4"	27"	152 lbs.	Bronze glass	
	20 3/4"	53 3/4"	27"	254 lbs.	Natural marble	
	20 3/4"	53 3/4"	27"	254 lbs.	Coated marble	
	20 3/4"	53 3/4"	27"	254 lbs.	Coated marble	
	3710T Side table 	13"	15 3/4"	18"	14 lbs.	Clear glass
		13"	15 3/4"	18"	14 lbs.	Bronze glass
13"		15 3/4"	18"	22 lbs.	Natural marble	
13"		15 3/4"	18"	22 lbs.	Coated marble	
13"		15 3/4"	18"	22 lbs.	Coated marble	
13"		15 3/4"	18"	22 lbs.	Coated marble	
13"		15 3/4"	18"	22 lbs.	Coated marble	
13"		15 3/4"	18"	22 lbs.	Coated marble	
13"		15 3/4"	18"	15 lbs.	Veneer	
13"		15 3/4"	18"	15 lbs.	Pearwood	
13"		15 3/4"	18"	25 lbs.	Granite	
13"		15 3/4"	18"	22 lbs.	Natural marble	

pattern no.	polished nickel	metallic bronze	gold plated
3716T-()-(MC, MCS)	\$10,323.	\$10,944.	\$16,035.
3716T-()-(GA)	11,036.	12,333.	17,144.
3716T-()-(LO, LWA, D, V314)	11,782.	12,489.	18,303.
3716T-()-(P)	12,752.	13,516.	19,809.
3716T-()-(MV, MVS)	13,292.	14,087.	20,647.
3716T-()-(NC)	14,344.	15,205.	22,281.
3716T-()-G2	5,573.	5,907.	8,657.
3716T-()-BRG	5,851.	6,202.	9,091.
3716T-()-(NGC)	8,178.	9,472.	12,704.
3716T-()-(GC, GCS, GB, GBS)	9,169.	10,465.	14,244.
3716T-()-(MN, MNS, MA, MAS, GG, GGS)	9,911.	10,505.	15,395.
3710T-()-G2	1,297.	1,733.	2,266.
3710T-()-BRG	1,360.	1,820.	2,377.
3710T-()-(NGC)	1,759.	2,225.	2,733.
3710T-()-(GC, GCS, GB, GBS)	1,899.	2,366.	2,950.
3710T-()-(MN, MNS, MA, MAS, GG, GGS)	2,127.	2,256.	3,304.
3710T-()-(MV, MVS)	2,155.	2,285.	3,348.
3710T-()-(MC, MCS)	2,233.	2,369.	3,469.
3710T-()-(LO, LWA, D, V314)	2,960.	3,136.	4,598.
3710T-()-(P)	3,182.	3,371.	4,942.
3710T-()-(GA)	3,604.	4,071.	5,598.
3710T-()-(NC)	4,031.	4,496.	6,262.

Order Code	Ordering Information
<i>Example:</i> 3710T-N-BRG	<i>Frame:</i>
3710T Platner side table	Polished Nickel (suffix N)
N Nickel	Metallic Bronze (suffix BRM)
BRG Bronze Glass	18k Gold Plated (suffix GLD)
	<i>Glass top finishes:</i>
	Clear Glass (suffix G2)
	Bronze Glass (suffix BRG)
	<i>Veneer finishes:</i>
	Ebonized Walnut (suffix D)
	Light Oak (suffix LO)
	Light Walnut (suffix LWA)
	Reff Dark Cherry (suffix V314)
	<i>Pearwood finish:</i>
	Pearwood (suffix P)
	<i>Polished Coated marble top finishes:</i>
	Arabescatto: white-grey (suffix MA)
	Carrara: white-grey (suffix GC)
	Calacatta: white-grey/beige (suffix MC)
	Empire Beige: beige (suffix GB)
	Grey Marble: light grey (suffix GG)
	Nero Marquina: black (suffix MN)
	Verde Alpi: green (suffix MV)
	<i>Satin Coated marble top finishes:</i>
	Arabescato: white-grey (suffix MAS)
	Calacatta: white-grey/beige (suffix MCS)
	Carrara: white-grey (suffix GCS)
	Empire Beige: beige (suffix GBS)
	Grey Marble: light grey (suffix GGS)
	Nero Marquina: black (suffix MNS)
	Verde Alpi: green (suffix MVS)
	<i>Natural marble top finishes:</i>
	Calacatta: white-grey/beige (suffix NC)
	Carrara: white-grey (suffix NGC)
	<i>Granite top finish:</i>
	Black Andes: black (suffix GA)



Note:
Platner dining and side tables are part of a collection. Please refer to Platner lounge seating on page 222 and Platner coffee tables on page 364.





- Specify:*
1. Pattern number
 2. Base finish option
 3. Top option

Construction
<i>Maintenance:</i> See pages 28-29.
<i>KnollStudio 20-Day Program:</i> The Platner side table 3710 in selected finishes are available on the KnollStudio 20-Day program. For specific information, consult pages 30-33.
<i>Note:</i> Marbles with a coating will yellow over time.
The Platner Tables with glass, veneer and natural marble tops are Greenguard certified.
<i>Frame:</i> Vertical steel wire rods welded to circular horizontal and edge-framing rods. Finish in bright nickel with a clear lacquer protection, a painted metallic bronze, or plated in 18k gold.
<i>Base:</i> Clear plastic extrusion ring for smooth bottom surface.
<i>Glass top:</i> 3/8" thick tempered glass for coffee and dining tables. 1/4" thick tempered glass for side tables.
<i>Edge detail for glass:</i>
<i>Marble Top:</i> All marble tops feature a bevel edge. 3/4" thick coated marble tops have transparent polyester coating to help eliminate use-associated stains. 3/4" thick natural marble tops and granite tops have protective sealer. Larger tops have subtop that fits into base opening to ensure stability.
<i>Marble edge detail:</i>
<i>Wood Top:</i> Tops are constructed of veneered medium density fiberboard with a cathedral grain pattern in various toned or stained finishes for light oak, light walnut, reff dark cherry and pearwood. Ebonized walnut features a black stain on walnut substrate. All tops are 1 1/16" thick. Edges are 3/4" solid wood to match face veneer. Wood tops are weighted with plates to ensure stability.

Warren Platner Coffee Tables

	description	base w	w	h	weight	top	
Designer(s): Warren Platner, 1962 	3712T Coffee table	18 1/2"	36"	15 1/4"	58 lbs.	Clear glass	
		18 1/2"	36"	15 1/4"	58 lbs.	Bronze glass	
		18 1/2"	36"	15 1/4"	107 lbs.	Natural marble	
		18 1/2"	36"	15 1/4"	107 lbs.	Coated marble	
		18 1/2"	36"	15 1/4"	107 lbs.	Coated marble	
		18 1/2"	36"	15 1/4"	107 lbs.	Coated marble	
		18 1/2"	36"	15 1/4"	107 lbs.	Granite	
		18 1/2"	36"	15 1/4"	107 lbs.	Coated marble	
		18 1/2"	36"	15 1/4"	107 lbs.	Natural marble	
		18 1/2"	36"	15 1/4"	96 lbs.	Natural veneer	
		18 1/2"	36"	15 1/4"	96 lbs.	Pearwood	
		3714T Coffee table	18 1/2"	42 1/4"	15 1/4"	108 lbs.	Pearwood
			18 1/2"	42 1/4"	15 1/4"	71 lbs.	Clear glass
			18 1/2"	42 1/4"	15 1/4"	71 lbs.	Bronze glass
			18 1/2"	42 1/4"	15 1/4"	139 lbs.	Natural marble
			18 1/2"	42 1/4"	15 1/4"	139 lbs.	Coated marble
			18 1/2"	42 1/4"	15 1/4"	139 lbs.	Coated marble
			18 1/2"	42 1/4"	15 1/4"	139 lbs.	Coated marble
18 1/2"	42 1/4"		15 1/4"	139 lbs.	Granite		
18 1/2"	42 1/4"		15 1/4"	139 lbs.	Coated marble		
18 1/2"	42 1/4"		15 1/4"	139 lbs.	Natural marble		
18 1/2"	42 1/4"		15 1/4"	108 lbs.	Veneer		

pattern no.	polished nickel	metallic bronze	gold plated
3712T-()-G2	\$2,374.	\$2,517.	\$3,688.
3712T-()-BRG 	2,492.	2,642.	3,871.
3712T-()-(NGC)	3,926.	4,533.	6,100.
3712T-()-(GC, GCS, GB, GBS)	4,421.	5,029.	6,867.
3712T-()-(MN, MNS, MA, MAS, GG, GGS)	4,613.	4,889.	7,167.
3712T-()-(MC, MCS)	4,843.	5,136.	7,523.
3712T-()-(GA)	5,709.	6,317.	8,869.
3712T-()-(MV, MVS)	6,175.	6,546.	9,591.
3712T-()-(NC)	6,796.	7,405.	10,558.
3712T-()-(LO, LWA, D, V314)	7,173.	7,603.	11,143.
3712T-()-(P)	7,709.	8,169.	11,975.
3714T-()-(P)	10,051.	10,652.	15,613.
3714T-()-G2	3,112.	3,299.	4,834.
3714T-()-BRG 	3,267.	3,465.	5,076.
3714T-()-(NGC)	4,778.	5,387.	7,422.
3714T-()-(GC, GCS, GB, GBS)	5,416.	6,021.	8,413.
3714T-()-(MN, MNS, MA, MAS, GG, GGS)	5,606.	5,941.	8,708.
3714T-()-(MC, MCS)	6,447.	6,835.	10,015.
3714T-()-(GA)	7,012.	7,554.	10,893.
3714T-()-(MV, MVS)	7,949.	8,424.	12,347.
3714T-()-(NC)	8,446.	9,054.	13,120.
3714T-()-(LO, LWA, D, V314)	9,385.	9,948.	14,580.

Order Code	Ordering Information
<i>Example:</i> 3712T-BRM-MA	<i>Frame:</i>
3712T Platner coffee table	 Polished Nickel (suffix N)
BRM Metallic Bronze	 Metallic Bronze (suffix BRM)
MA Arabescato Marble	18k Gold Plated (suffix GLD)
	<i>Glass top finishes:</i>
	 Clear Glass (suffix G2)
	 Bronze Glass (suffix BRG)
	<i>Veneer finishes:</i>
	Ebonized Walnut (suffix D)
	Light Oak (suffix LO)
	Light Walnut (suffix LWA)
	Reff Dark Cherry (suffix V314)
	<i>Pearwood finish:</i>
	Pearwood (suffix P)
	<i>Polished Coated marble top finishes:</i>
	Arabescato: white-grey (suffix MA)
	Carrara: white-grey (suffix GC)
	Calacatta: white-grey/beige (suffix MC)
	Empire Beige: beige (suffix GB)
	Grey Marble: light grey (suffix GG)
	Nero Marquina: black (suffix MN)
	Verde Alpi: green (suffix MV)
	<i>Satin Coated marble top finishes:</i>
	Arabescato: white-grey (suffix MAS)
	Calacatta: white-grey/beige (suffix MCS)
	Carrara: white-grey (suffix GCS)
	Empire Beige: beige (suffix GBS)
	Grey Marble: light grey (suffix GGS)
	Nero Marquina: black (suffix MNS)
	Verde Alpi: green (suffix MVS)
	<i>Natural marble top finishes:</i>
	Calacatta: white-grey/beige (suffix NC)
	Carrara: white-grey (suffix NGC)
	<i>Granite top finish:</i>
	Black Andes: black (suffix GA)

Note:
Platner coffee table are part of a collection. Please refer to Platner lounge seating on page 222 and Platner dining and side tables on page 362.

Specify:



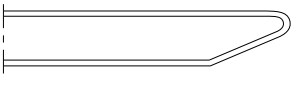
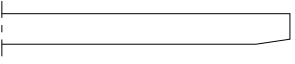

1. Pattern number
2. Base finish option
3. Top option

Maintenance:	Construction
See pages 28-29.	<i>Frame:</i> Vertical steel wire rods welded to circular horizontal and edge-framing rods. Finish in bright nickel with a clear lacquer protection, a painted metallic bronze, or plated in 18k gold.
 <i>KnollStudio 20-Day Program:</i> The Platner coffee table 3712 and 3714 in selected finishes are available on the KnollStudio 20-Day program. For specific information, consult pages 30-33.	<i>Marble Top:</i> All marble tops feature a bevel edge. 3/4" thick coated marble tops have transparent polyester coating to help eliminate use-associated stains. 3/4" thick natural marble tops and granite tops have protective sealer. Larger tops have subtop that fits into base opening to ensure stability.
<i>Note:</i> Marbles with a coating will yellow over time.	<i>Marble edge detail:</i> 
The Platner Tables with glass, veneer and natural marble tops are Greenguard certified.	<i>Edge detail for glass:</i> 

Jens Risom
Dining and Side Tables

Designer(s):
Jens Risom, 1943



description	w	d	h	weight	base	top
642TR Round dining table 	42"	42"	23"	40 lbs.	Clear Maple	Clear Maple
	42"	42"	23"	40 lbs.	Ebonized Maple	Ebonized Walnut
	42"	42"	23"	40 lbs.	Light Walnut	Light Walnut
614TS Square side table 	14"	14"	18"	7 lbs.	Clear Maple	Clear Maple
	14"	14"	18"	7 lbs.	Ebonized Maple	Ebonized Walnut
	14"	14"	18"	7 lbs.	Light Walnut	Light Walnut
618TR Round side table 	18"	18"	20"	9 lbs.	Clear Maple	Clear Maple
	18"	18"	20"	9 lbs.	Ebonized Maple	Ebonized Walnut
	18"	18"	20"	9 lbs.	Light Walnut	Light Walnut
643TA Amoeba shaped coffee table 	42"	32"	16"	22 lbs.	Clear Maple	Clear Maple
	42"	32"	16"	22 lbs.	Ebonized Maple	Ebonized Walnut
	42"	32"	16"	22 lbs.	Light Walnut	Light Walnut

pattern no.	
642TR-KC-KC	\$1,938.
642TR-KE-D	2,015.
642TR-LWT-LWT	2,116.
614TS-KC-KC	902.
614TS-KE-D	936.
614TS-LWT-LWT	984.
618TR-KC-KC	964.
618TR-KE-D	1,002.
618TR-LWT-LWT	1,054.
643TA-KC-KC	1,655.
643TA-KE-D	1,723.
643TA-LWT-LWT	1,809.

Order Code	Ordering Information
<i>Example:</i> 642TR-KE-BL	<i>Base finishes:</i>
642TR Round dining table	Clear Maple (suffix KC)
KE Ebonized Maple	Ebonized Maple (suffix KE)
D Ebonized Walnut	Light Walnut (suffix LWT)

Note:
The Risom Tables are part of a Collection. Please refer to Risom chairs on page 242 and lounge chairs on page 246.

Specify:

1. Pattern number
2. Base finish selection
3. Top finish selection

Ordering Information
<i>Top finishes:</i>
Clear Maple (suffix KC)
Ebonized Walnut (suffix D)
Light Walnut (suffix LWT)

Shipping information:
Dining table and Amoeba table shipped knocked down with top and legs in one box. Simple field assembly required. Side tables and coffee tables shipped fully assembled.

Maintenance:
See pages 28-29.



Note:
The Risom dining, side and amoeba tables are Greenguard certified.

Construction
Legs and aprons:
Solid maple or walnut hardwood. Mortise and tenon joints.

Top:
Tops are veneer with cathedral pattern with poplar cross bands and backing. Core and edge is solid hardwood lumber in clear finish.

Finish:
Clear lacquer or ebonized finish.

Jens Risom
Child's Amoeba Table

	description	w	d	h	weight	base	top
<p><i>Designer(s):</i> Jens Risom, 1943</p> 	<p>643TAS Child's Amoeba shaped coffee table</p> 	42"	32"	20"	32 lbs.	Honey Beech	Honey laminate

pattern no.	
643TAS-HB-HL	\$757.

Order Code	Ordering Information
<i>Example:</i> 643TAS-HB-HL	<i>Base finish:</i> Honey Beech (suffix HB)
643TAS	Child's Risom Amoeba table
HB	Honey Beech
HL	Honey laminate

Top finish:
Honey laminate (suffix HL)

Construction

Shipping information:
Child's Risom Amoeba table is shipped knocked down with top and legs in one box. Simple field assembly required.

Maintenance:
See pages 28-29.

Note:
The Child's Risom Amoeba table is compliant to the Consumer Product Safety Improvement Act of 2008 for Children's Products, 16 C.F.R. 1303, CPSIA Title 1 Section 101 for Total Lead in Substrates and Surface Coatings.

Legs and aprons:
Select European Beech hardwood with a toned natural finish. Mortise and tenon construction.

Top:
3/4" thick wood grain laminate top is 3-ply construction with medium density fiberboard core and plastic laminate backer. Honey laminate features a Beech grain pattern.

Finish:
Toned catalyzed lacquer finish.



Note:
The Child's Risom Amoeba table is part of a Collection. Please refer to the Child's Risom side chairs on page 244.

- Specify:*
1. Pattern number
 2. Base finish selection
 3. Top finish selection

Eero Saarinen Round Dining Tables

Designer(s):
Eero Saarinen, 1957



description	w	d	h	weight	top
172TR Small round table, dining height 	35 1/4"		28 1/4"	47 lbs.	Laminate
	35 1/4"		28 1/4"	95 lbs.	Natural marble
	35 1/4"		28 1/4"	95 lbs.	Coated marble
	35 1/4"		28 1/4"	95 lbs.	Coated marble
	35 1/4"		28 1/4"	95 lbs.	Vetro Bianco
	35 1/4"		28 1/4"	95 lbs.	Coated marble
	35 1/4"		28 1/4"	95 lbs.	Coated marble
	35 1/4"		28 1/4"	95 lbs.	Coated marble
	35 1/4"		28 1/4"	51 lbs.	Veneer
	35 1/4"		28 1/4"	51 lbs.	Veneer
	35 1/4"		28 1/4"	51 lbs.	Pearwood
	35 1/4"		28 1/4"	103 lbs.	Granite
	35 1/4"		28 1/4"	95 lbs.	Natural marble
	35 1/4"		28 1/4"	95 lbs.	Coated marble
	35 1/4"		28 1/4"	95 lbs.	Slate, natural
173TR Medium round table, dining height 	42 1/4"		28 1/4"	58 lbs.	Laminate
	42 1/4"		28 1/4"	125 lbs.	Natural marble
	42 1/4"		28 1/4"	125 lbs.	Coated marble
	42 1/4"		28 1/4"	125 lbs.	Vetro Bianco
	42 1/4"		28 1/4"	125 lbs.	Coated marble
	42 1/4"		28 1/4"	125 lbs.	Coated marble
	42 1/4"		28 1/4"	125 lbs.	Coated marble
	42 1/4"		28 1/4"	63 lbs.	Veneer
	42 1/4"		28 1/4"	125 lbs.	Coated marble
	42 1/4"		28 1/4"	63 lbs.	Veneer
	42 1/4"		28 1/4"	125 lbs.	Coated marble
	42 1/4"		28 1/4"	63 lbs.	Pearwood
	42 1/4"		28 1/4"	136 lbs.	Granite
	42 1/4"		28 1/4"	125 lbs.	Coated marble
	42 1/4"		28 1/4"	125 lbs.	Slate, natural
42 1/4"		28 1/4"	125 lbs.	Natural marble	

pattern no.	
172TR-(F2)-(1, 2, PL)	\$3,019.
172TR-(NGC)-(1, 2, PL)	3,791.
172TR-(MG, MGS)-(1, 2, PL)	4,105.
172TR-(GC, GCS, GB, GBS)-(1, 2, PL)	4,289.
172TR-(VB)-(1, 2, PL)	4,391.
172TR-(MN, MNS, MA, MAS, GG, GGS)-(1, 2, PL)	4,609.
172TR-(ME, MES)-(1, 2, PL)	4,901.
172TR-(MC, MCS)-(1, 2, PL)	5,049.
172TR-(LO, LWA, D, V314)-(1, 2, PL)	5,107.
172TR-(RO, TK)-(1, 2, PL)	5,197.
172TR-(P)-(1, 2, PL)	5,529.
172TR-(GA)-(1, 2, PL)	5,662.
172TR-(NC)-(1, 2, PL)	6,752.
172TR-(MV, MVS)-(1, 2, PL)	6,759.
172TR-(SN)-(1, 2, PL)	7,059.
173TR-(F2)-(1, 2, PL)	3,221.
173TR-(NGC)-(1, 2, PL)	4,644.
173TR-(MG, MGS)-(1, 2, PL)	5,185.
173TR-(VB)-(1, 2, PL)	5,212.
173TR-(GC, GCS, GB, GBS)-(1, 2, PL)	5,281.
173TR-(MN, MNS, MA, MAS, GG, GGS)-(1, 2, PL)	5,377.
173TR-(RO, TK)-(1, 2, PL)	5,691.
173TR-(MC, MCS)-(1, 2, PL)	5,892.
173TR-(LO, LWA, D, V314)-(1, 2, PL)	6,142.
173TR-(ME, MES)-(1, 2, PL)	6,226.
173TR-(P)-(1, 2, PL)	6,685.
173TR-(GA)-(1, 2, PL)	6,900.
173TR-(MV, MVS)-(1, 2, PL)	7,243.
173TR-(SN)-(1, 2, PL)	7,548.
173TR-(NC)-(1, 2, PL)	8,401.

Order Code

<i>Example:</i>	176TR-MN-1
176TR	Saarinen dining table
MN	Nero Marquina Marble
1	Black

Note:
Saarinen tables are part of a collection. Please refer to Saarinen side chairs, lounge seating, and executive chairs on beginning on page 248.

Specify:

1. Pattern number
2. Top selection
3. Base finish selection

Ordering Information

Base finishes:

Black (suffix 1)
Platinum (suffix PL)
☑ White (suffix 2)

Laminate top finish:

☑ White (suffix F2)

Veneer finishes:

Ebonized Walnut (suffix D)
Light Oak (suffix LO)
Light Walnut (suffix LWA)
Pearwood (suffix P)
Reff Dark Cherry (suffix V314)
Rosewood (suffix RO)
Teak (suffix TK)

Polished Coated marble top finishes:

Arabescato: white-grey (suffix MA)
Calacatta: white-grey/beige (suffix MC)
Carrara: white-grey (suffix GC)
Empire Beige: beige (suffix GB)
Espresso: dark brown (suffix ME)
Grey Marble: light grey (suffix GG)
Grigio Marquina: warm grey (suffix MG)
Nero Marquina: black (suffix MN)
Verde Alpi: green (suffix MV) *

Satin Coated marble top finishes:

Arabescato: white-grey (suffix MAS)
Calacatta: white-grey/beige (suffix MCS)
Carrara: white-grey (suffix GCS)
Empire Beige: beige (suffix GBS)
Espresso: dark brown (suffix MES)
Grey Marble: light grey (suffix GGS)
Grigio Marquina: warm grey (suffix MGS)
Nero Marquina: black (suffix MNS)
Verde Alpi: green (suffix MVS) *

Natural marble top finishes:

Calacatta: white-grey/beige (suffix NC)
Carrara: white-grey (suffix NGC)

Granite top finish:

Black Andes: black (suffix GA)

Engineered Stone:

Vetro Bianco: white (suffix VB)

Slate top finish:

Slate, natural (suffix SN)

* Note:

Verdi Alpi may not be specified for 165TR.

Construction

☑ KnollStudio 20-Day Program:

Saarinen dining table 164TR, 173TR, 176TR is available on the KnollStudio 20-Day program with a white base and white laminate top. For specific information, consult pages 30-33.

Maintenance:

See pages 28-29.

Note:

Top and base shipped in separate packages. The Knoll logo is stamped into the base of the Saarinen tables. Tops have nameplate with designer's signature. **Not suitable for outdoor use.**

Marbles with a coating will yellow over time.

Saarinen Dining Tables with Laminate, Natural Marble, Veneer or Granite tops are Greenguard certified.

Base:

Heavy molded cast aluminum, strap-polished. Black and white bases are coated in a tough, abrasion-resistant Rilsan finish. Platinum bases consist of a highly resilient polyurethane enamel wet coat with a clear satin finish.

Base Measurements:

172TR, 173TR, 176TR: 20" diameter
164TR, 165TR: 25.984" diameter

Marble and Laminate Tops:

Bevel-edged satin smooth laminate or marble. 1/4" thick coated marble tops have transparent polyester coating to help eliminate use-associated stains. 3/4" thick natural marble tops and granite tops have protective sealer. Laminate tops are 1.06" thick.

Laminate edge detail:

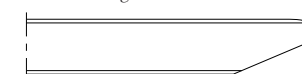

Marble edge detail:

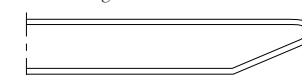

Wood Top:

Tops are constructed of veneered medium density fiberboard with a cathedral grain pattern in various clear or toned stains. All tops are 1 1/16" thick with the exception of 164TR and 165TR which are 1 1/4" thick. Edges are 1/4" solid wood to match face veneer.

Engineered Stone:

Polished, bright white surface is nonporous and more compact than most granites. Comprised of 93% fused quartz. It does not yellow or stain and is scratch resistant. Suitable for outdoors.

Slate:

Beveled edge, 3/4" thick natural cleft slate.

Note:



Vetro Bianco (VBO) top for outdoor use is only available on 162TR, 164TR, 169TR, 172TR, 173TR, 174TO tables. 162TR, 164TR, 172TR, 173TR, and 174TO use a phenolic subtop with exposed black edges and white laminate faces. Stainless steel hardware will be used for all connections.

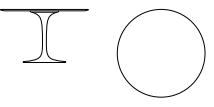
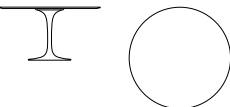

Eero Saarinen Round Dining Tables

Designer(s):
Eero Saarinen, 1957



description	w	d	h	weight	top	
176TR Medium round table, dining height 	47 1/4"		28 1/4"	76 lbs.	Laminate	
	47 1/4"		28 1/4"	153 lbs.	Natural marble	
	47 1/4"		28 1/4"	153 lbs.	Coated marble	
	47 1/4"		28 1/4"	153 lbs.	Coated marble	
	47 1/4"		28 1/4"	153 lbs.	Vetro Bianco	
	47 1/4"		28 1/4"	153 lbs.	Coated marble	
	47 1/4"		28 1/4"	74 lbs.	Veneer	
	47 1/4"		28 1/4"	153 lbs.	Coated marble	
	47 1/4"		28 1/4"	74 lbs.	Veneer	
	47 1/4"		28 1/4"	153 lbs.	Coated marble	
	47 1/4"		28 1/4"	166 lbs.	Granite	
	47 1/4"		28 1/4"	153 lbs.	Natural marble	
	164TR Large round table, dining height 	54"		28 1/4"	203 lbs.	Coated marble
		54"		28 1/4"	203 lbs.	Natural marble
		54"		28 1/4"	102 lbs.	Laminate
		54"		28 1/4"	203 lbs.	Natural marble
		54"		28 1/4"	203 lbs.	Vetro Bianco
54"			28 1/4"	203 lbs.	Coated marble	
54"			28 1/4"	203 lbs.	Coated marble	
54"			28 1/4"	203 lbs.	Coated marble	
54"			28 1/4"	103 lbs.	Veneer	
54"			28 1/4"	203 lbs.	Coated marble	
54"			28 1/4"	103 lbs.	Veneer	
54"			28 1/4"	203 lbs.	Coated marble	
54"			28 1/4"	103 lbs.	Pearwood	
54"			28 1/4"	218 lbs.	Granite	



pattern no.	
176TR-(F2)-(1, 2, PL) 	\$3,458.
176TR-(NGC)-(1, 2, PL)	4,938.
176TR-(GC, GCS, GB, GBS)-(1, 2, PL)	5,672.
176TR-(MN, MNS, MA, MAS, GG, GGS)-(1, 2, PL)	5,774.
176TR-(VB)-(1, 2, PL)	5,951.
176TR-(MG, MGS)-(1, 2, PL)	5,997.
176TR-(RO, TK)-(1, 2, PL)	6,035.
176TR-(MC, MCS)-(1, 2, PL)	6,328.
176TR-(LO, LWA, D, V314)-(1,2, PL)	6,874.
176TR-(ME, MES)-(1, 2, PL)	7,314.
176TR-(P)-(1, 2, PL)	7,507.
176TR-(MV, MVS)-(1, 2, PL)	7,724.
176TR-(SN)-(1, 2, PL)	7,794.
176TR-(GA)-(1,2, PL)	7,890.
176TR-(NC)-(1, 2, PL)	9,880.
164TR-(MV, MVS)-(1, 2, PL)	10,433.
164TR-(NC)-(1, 2, PL)	12,801.
164TR-F2-(1,2, PL) 	4,603.
164TR-(NGC)-(1, 2, PL)	6,608.
164TR-VB-(1, 2, PL)	7,504.
164TR-(GC, GCS, GB, GBS)-(1, 2, PL)	7,602.
164TR-(MN, MNS, MA, MAS, GG, GGS)-(1, 2, PL)	7,763.
164TR-(MG, MGS)-(1, 2, PL)	7,891.
164TR-(RO, TK)-(1, 2, PL)	8,424.
164TR-(MC, MCS)-(1, 2, PL)	8,509.
164TR-(LO, LWA, D, V314)-(1, 2, PL)	8,610.
164TR-(ME, MES)-(1, 2, PL)	9,362.
164TR-(P)-(1, 2, PL)	9,369.
164TR-(GA)-(1, 2, PL)	9,557.

Order Code	Ordering Information
<i>Example:</i> 176TR-MN-1	<i>Base finishes:</i>
176TR Saarinen dining table	Black (suffix 1)
MN Nero Marquina Marble	Platinum (suffix PL)
1 Black	 White (suffix 2)
	<i>Laminate top finish:</i>
	 White (suffix F2)
	<i>Veneer finishes:</i>
	Ebonized Walnut (suffix D)
	Light Oak (suffix LO)
	Light Walnut (suffix LWA)
	Pearwood (suffix P)
	Reff Dark Cherry (suffix V314)
	Rosewood (suffix RO)
	Teak (suffix TK)
	<i>Polished Coated marble top finishes:</i>
	Arabescato: white-grey (suffix MA)
	Calacatta: white-grey/beige (suffix MC)
	Carrara: white-grey (suffix GC)
	Empire Beige: beige (suffix GB)
	Espresso: dark brown (suffix ME)
	Grey Marble: light grey (suffix GG)
	Grigio Marquina: warm grey (suffix MG)
	Nero Marquina: black (suffix MN)
	Verde Alpi: green (suffix MV) *
	<i>Satin Coated marble top finishes:</i>
	Arabescato: white-grey (suffix MAS)
	Calacatta: white-grey/beige (suffix MCS)
	Carrara: white-grey (suffix GCS)
	Empire Beige: beige (suffix GBS)
	Espresso: dark brown (suffix MES)
	Grey Marble: light grey (suffix GGS)
	Grigio Marquina: warm grey (suffix MGS)
	Nero Marquina: black (suffix MNS)
	Verde Alpi: green (suffix MVS) *
	<i>Natural marble top finishes:</i>
	Calacatta: white-grey/beige (suffix NC)
	Carrara: white-grey (suffix NGC)
	<i>Granite top finish:</i>
	Black Andes: black (suffix GA)
	<i>Engineered Stone:</i>
	Vetro Bianco: white (suffix VB)
	<i>Slate top finish:</i>
	Slate, natural (suffix SN)
	<i>* Note:</i>
	Verdi Alpi may not be specified for 165TR.

Note:
Saarinen tables are part of a collection. Please refer to Saarinen side chairs, lounge seating, and executive chairs on beginning on page 248.

Specify:

1. Pattern number
2. Top selection
3. Base finish selection

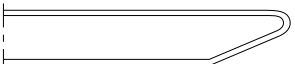
Construction
 <i>KnollStudio 20-Day Program:</i> Saarinen dining table 164TR, 173TR, 176TR is available on the KnollStudio 20-Day program with a white base and white laminate top. For specific information, consult pages 30-33.
<i>Maintenance:</i> See pages 28-29.
<i>Note:</i> Top and base shipped in separate packages. The Knoll logo is stamped into the base of the Saarinen tables. Tops have nameplate with designer's signature. Not suitable for outdoor use.
Marbles with a coating will yellow over time.
Saarinen Dining Tables with Laminate, Natural Marble, Veneer or Granite tops are Greenguard certified.
<i>Base:</i> Heavy molded cast aluminum, strap-polished. Black and white bases are coated in a tough, abrasion-resistant Rilsan finish. Platinum bases consist of a highly resilient polyurethane enamel wet coat with a clear satin finish.
<i>Base Measurements:</i> 172TR, 173TR, 176TR: 20" diameter 164TR, 165TR: 25.984" diameter
<i>Marble and Laminate Tops:</i> Bevel-edged satin smooth laminate or marble. 3/4" thick coated marble tops have transparent polyester coating to help eliminate use-associated stains. 3/4" thick natural marble tops and granite tops have protective sealer. Laminate tops are 1.06" thick.
<i>Wood Top:</i> Tops are constructed of veneered medium density fiberboard with a cathedral grain pattern in various clear or toned stains. All tops are 1 1/16" thick with the exception of 164TR and 165TR which are 1 1/4" thick. Edges are 1/4" solid wood to match face veneer.
<i>Engineered Stone:</i> Polished, bright white surface is nonporous and more compact than most granites. Comprised of 93% fused quartz. It does not yellow or stain and is scratch resistant. Suitable for outdoors.
<i>Slate:</i> Beveled edge, 3/4" thick natural cleft slate.
<i>Note:</i> Vetro Bianco (VBO) top for outdoor use is only available on 162TR, 164TR, 169TR, 172TR, 173TR, 174TO tables. 162TR, 164TR, 172TR, 173TR, and 174TO use a phenolic subtop with exposed black edges and white laminate faces. Stainless steel hardware will be used for all connections.
<i>Laminate edge detail:</i> 
<i>Marble edge detail:</i> 

Eero Saarinen Round Dining Tables

Designer(s):
Eero Saarinen, 1957

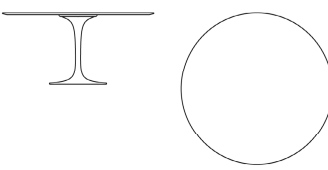

description	w	d	h	weight	top
165TR Large round table, dining height 	60"		28 1/4"	121 lbs.	Pearwood
	60"		28 1/4"	244 lbs.	Coated marble
	60"		28 1/4"	263 lbs.	Granite
	60"		28 1/4"	244 lbs.	Coated marble
	60"		28 1/4"	244 lbs.	Coated marble
	60"		28 1/4"	244 lbs.	Natural marble
	60"		28 1/4"	115 lbs.	Laminate
	60"		28 1/4"	244 lbs.	Natural marble
	60"		28 1/4"	244 lbs.	Coated marble
	60"		28 1/4"	121 lbs.	Veneer
	60"		28 1/4"	121 lbs.	Veneer
	60"		28 1/4"	244 lbs.	Coated marble
	60"		28 1/4"	244 lbs.	Vetro Bianco

pattern no.	
165TR-(P)-(1, 2, PL)	\$10,165.
165TR-(ME, MES)-(1, 2, PL)	11,429.
165TR-(GA)-(1, 2, PL)	11,474.
165TR-(MN, MNS, MA, MAS, GG, GGS)-(1, 2, PL)	11,944.
165TR-(MC, MCS)-(1, 2, PL)	13,079.
165TR-(NC)-(1, 2, PL)	15,365.
165TR-F2-(1, 2, PL)	7,187.
165TR-(NGC)-(1, 2, PL)	7,575.
165TR-(GC, GCS, GB, GBS)-(1, 2, PL)	8,800.
165TR-(RO, TK)-(1, 2, PL)	8,969.
165TR-(LO, LWA, D, V314)-(1, 2, PL)	9,361.
165TR-(MG, MGS)-(1, 2, PL)	9,453.
165TR-VB-(1, 2, PL)	9,753.

Order Code

<i>Example:</i>	176TR-MN-1
176TR	Saarinen dining table
MN	Nero Marquina Marble
1	Black

Note:
Saarinen tables are part of a collection. Please refer to Saarinen side chairs, lounge seating, and executive chairs on beginning on page 248.

Specify:

1. Pattern number
2. Top selection
3. Base finish selection

Ordering Information

Base finishes:

Black (suffix 1)
Platinum (suffix PL)
☑ White (suffix 2)

Laminate top finish:

☑ White (suffix F2)

Veneer finishes:

Ebonized Walnut (suffix D)
Light Oak (suffix LO)
Light Walnut (suffix LWA)
Pearwood (suffix P)
Reff Dark Cherry (suffix V314)
Rosewood (suffix RO)
Teak (suffix TK)

Polished Coated marble top finishes:

Arabescato: white-grey (suffix MA)
Calacatta: white-grey/beige (suffix MC)
Carrara: white-grey (suffix GC)
Empire Beige: beige (suffix GB)
Espresso: dark brown (suffix ME)
Grey Marble: light grey (suffix GG)
Grigio Marquina: warm grey (suffix MG)
Nero Marquina: black (suffix MN)
Verde Alpi: green (suffix MV) *

Satin Coated marble top finishes:

Arabescato: white-grey (suffix MAS)
Calacatta: white-grey/beige (suffix MCS)
Carrara: white-grey (suffix GCS)
Empire Beige: beige (suffix GBS)
Espresso: dark brown (suffix MES)
Grey Marble: light grey (suffix GGS)
Grigio Marquina: warm grey (suffix MGS)
Nero Marquina: black (suffix MNS)
Verde Alpi: green (suffix MVS) *

Natural marble top finishes:

Calacatta: white-grey/beige (suffix NC)
Carrara: white-grey (suffix NGC)

Granite top finish:

Black Andes: black (suffix GA)

Engineered Stone:

Vetro Bianco: white (suffix VB)

Slate top finish:

Slate, natural (suffix SN)

* Note:

Verdi Alpi may not be specified for 165TR.

Construction

☑ KnollStudio 20-Day Program:

Saarinen dining table 164TR, 173TR, 176TR is available on the KnollStudio 20-Day program with a white base and white laminate top. For specific information, consult pages 30-33.

Maintenance:

See pages 28-29.

Note:

Top and base shipped in separate packages. The Knoll logo is stamped into the base of the Saarinen tables. Tops have nameplate with designer's signature. **Not suitable for outdoor use.**

Marbles with a coating will yellow over time.

Saarinen Dining Tables with Laminate, Natural Marble, Veneer or Granite tops are Greenguard certified.

Base:

Heavy molded cast aluminum, strap-polished. Black and white bases are coated in a tough, abrasion-resistant Rilsan finish. Platinum bases consist of a highly resilient polyurethane enamel wet coat with a clear satin finish.

Base Measurements:

172TR, 173TR, 176TR: 20" diameter
164TR, 165TR: 25.984" diameter

Marble and Laminate Tops:

Bevel-edged satin smooth laminate or marble. 1/4" thick coated marble tops have transparent polyester coating to help eliminate use-associated stains. 3/4" thick natural marble tops and granite tops have protective sealer. Laminate tops are 1.06" thick.

Laminate edge detail:

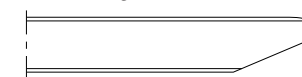

Marble edge detail:

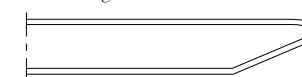

Wood Top:

Tops are constructed of veneered medium density fiberboard with a cathedral grain pattern in various clear or toned stains. All tops are 1 1/16" thick with the exception of 164TR and 165TR which are 1 1/4" thick. Edges are 1/4" solid wood to match face veneer.

Engineered Stone:

Polished, bright white surface is nonporous and more compact than most granites. Comprised of 93% fused quartz. It does not yellow or stain and is scratch resistant. Suitable for outdoors.

Slate:

Beveled edge, 3/4" thick natural cleft slate.

Note:

Vetro Bianco (VBO) top for outdoor use is only available on 162TR, 164TR, 169TR, 172TR, 173TR, 174TO tables. 162TR, 164TR, 172TR, 173TR, and 174TO use a phenolic subtop with exposed black edges and white laminate faces. Stainless steel hardware will be used for all connections.

Eero Saarinen

Oval Dining Tables

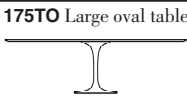
	description	w	d	h	weight	top		
<p><i>Designer(s):</i> Eero Saarinen, 1957</p> 	174TO Medium oval table, dining height	78"	47 1/4"	28 1/4"	131 lbs.	Veneer		
		78"	47 1/4"	28 1/4"	259 lbs.	Vetro Bianco		
		78"	47 1/4"	28 1/4"	131 lbs.	Veneer		
		78"	47 1/4"	28 1/4"	259 lbs.	Coated marble		
		78"	47 1/4"	28 1/4"	259 lbs.	Coated marble		
		78"	47 1/4"	28 1/4"	229 lbs.	Granite		
		78"	47 1/4"	28 1/4"	259 lbs.	Slate, natural		
		78"	47 1/4"	28 1/4"	131 lbs.	Pearwood		
		78"	47 1/4"	28 1/4"	259 lbs.	Coated marble		
		78"	47 1/4"	28 1/4"	259 lbs.	Natural marble		
		78"	47 1/4"	28 1/4"	259 lbs.	Coated marble		
		78"	47 1/4"	28 1/4"	131 lbs.	Laminate		
		78"	47 1/4"	28 1/4"	259 lbs.	Natural marble		
		78"	47 1/4"	28 1/4"	259 lbs.	Coated marble		
		78"	47 1/4"	28 1/4"	259 lbs.	Coated marble		
			175TO Large oval table, dining height	96"	54"	28 1/4"	348 lbs.	Natural marble
				96"	54"	28 1/4"	168 lbs.	Veneer
				96"	54"	28 1/4"	348 lbs.	Coated marble
				96"	54"	28 1/4"	348 lbs.	Coated marble
				96"	54"	28 1/4"	168 lbs.	Veneer
96"	54"			28 1/4"	348 lbs.	Vetro Bianco		
96"	54"			28 1/4"	348 lbs.	Coated marble		
96"	54"			28 1/4"	168 lbs.	Pearwood		
96"	54"			28 1/4"	374 lbs.	Granite		
96"	54"			28 1/4"	348 lbs.	Coated marble		
96"	54"			28 1/4"	348 lbs.	Coated marble		
96"	54"			28 1/4"	348 lbs.	Natural marble		
96"	54"			28 1/4"	348 lbs.	Coated marble		
96"	54"			28 1/4"	348 lbs.	Coated marble		
96"	54"			28 1/4"	169 lbs.	Laminate		

pattern no.	
174TO-(RO, TK)-(1, 2, PL)	\$10,088.
174TO-(VB)-(1, 2, PL)	10,607.
174TO-(LO, LWA, D, V314)-(1, 2, PL)	11,772.
174TO-(ME, MES)-(1, 2, PL)	12,177.
174TO-(MN, MNS, MA, MAS, GG, GGS)-(1, 2, PL)	12,258.
174TO-(GA)-(1, 2, PL)	12,278.
174TO-(SN)-(1, 2, PL)	12,547.
174TO-(P)-(1, 2, PL)	12,811.
174TO-(MC, MCS)-(1, 2, PL)	13,421.
174TO-(NC)-(1, 2, PL)	15,834.
174TO-(MV, MVS)-(1, 2, PL)	18,003.
174TO-(F2)-(1, 2, PL)	7,927.
174TO-(NGC)-(1, 2, PL)	8,095.
174TO-(GC, GCS, GB, GBS)-(1, 2, PL)	9,483.
174TO-(MG, MGS)-(1, 2, PL)	9,711.
175TO-(NGC)-(1, 2, PL)	10,178.
175TO-(RO, TK)-(1, 2, PL)	11,150.
175TO-(GC, GCS, GB, GBS)-(1, 2, PL)	12,108.
175TO-(MG, MGS)-(1, 2, PL)	12,452.
175TO-(LO, LWA, D, V314)-(1, 2, PL)	13,107.
175TO-(VB)-(1, 2, PL)	13,657.
175TO-(MN, MNS, MA, MAS, GG, GGS)-(1, 2, PL)	14,079.
175TO-(P)-(1, 2, PL)	14,308.
175TO-(GA)-(1, 2, PL)	14,832.
175TO-(MC, MCS)-(1, 2, PL)	15,414.
175TO-(ME, MES)-(1, 2, PL)	16,221.
175TO-(NC)-(1, 2, PL)	20,344.
175TO-(MV, MVS)-(1, 2, PL)	20,688.
175TO-F2-(1, 2, PL)	8,972.

Order Code	Ordering Information
<i>Example:</i> 174TO-MA-PL	<i>Base finishes:</i>
174TO Saarinen dining table	Black (suffix 1)
MA Arabescato Marble	Platinum (suffix PL)
PL Platinum	White (suffix 2)
	<i>Laminate top finish:</i>
	White (suffix F2)
	<i>Veneer finishes:</i>
	Ebonized Walnut (suffix D)
	Light Oak (suffix LO)
	Light Walnut (suffix LWA)
	Pearwood (suffix P)
	Reff Dark Cherry (suffix V314)
	Rosewood (suffix RO)
	Teak (suffix TK)
	<i>Polished Coated marble top finishes:</i>
	Arabescato: white-grey (suffix MA)
	Calacatta: white-grey/beige (suffix MC)
	Carrara: white-grey (suffix GC)
	Empire Beige: beige (suffix GB)
	Espresso: dark brown (suffix ME)
	Grey Marble: light grey (suffix GG)
	Grigio Marquina: warm grey (suffix MG)
	Nero Marquina: black (suffix MN)
	Verde Alpi: green (suffix MV)
	<i>Satin Coated marble top finishes:</i>
	Arabescato: white-grey (suffix MAS)
	Calacatta: white-grey/beige (suffix MCS)
	Carrara: white-grey (suffix GCS)
	Empire Beige: beige (suffix GBS)
	Espresso: dark brown (suffix MES)
	Grey Marble: light grey (suffix GCS)
	Grigio Marquina: warm grey (suffix MGS)
	Nero Marquina: black (suffix MNS)
	Verde Alpi: green (suffix MVS)
	<i>Natural marble top finishes:</i>
	Calacatta: white-grey/beige (suffix NC)
	Carrara: white-grey (suffix NGC)
	<i>Granite top finish:</i>
	Black Andes: black (suffix GA)
	<i>Engineered Stone:</i>
	Vetro Bianco: white (suffix VB)
	<i>Slate top finish:</i>
	Slate, natural (suffix SN)

Note:
Saarinen tables are part of a collection. Please refer to Saarinen side chairs, lounge seating, and executive chairs on beginning on page 248.

- Specify:*
1. Pattern number
 2. Top selection
 3. Base finish selection

Construction

Maintenance:
See pages 28-29.

Note:
Top and base shipped in separate packages. The Knoll logo is stamped into the base of the Saarinen tables. Tops have nameplate with designer's signature.
Not suitable for outdoor use.

Marbles with a coating will yellow over time.

Saarinen Dining Tables with Laminate, Natural Marble, Veneer or Granite tops are Greenguard certified.

Base:
Heavy molded cast aluminum, strap-polished. Black and white bases are coated in a tough, abrasion-resistant Rilsan finish. Platinum bases consist of a highly resilient polyurethane enamel wet coat with a clear satin finish.

Base Measurements:
174TO, 175TO: width is 31.3" and depth is 23"

Marble and Laminate Tops:
Bevel-edged satin smooth laminate or marble. 3/4" thick coated marble tops have transparent polyester coating to help eliminate use-associated stains. 3/4" thick natural marble tops and granite tops have protective sealer. Laminate tops are 1.06" thick.

Laminate edge detail:

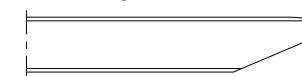

Marble edge detail:

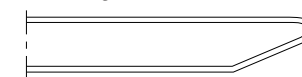





Engineered Stone:
Polished, bright white surface is nonporous and more compact than most granites. Comprised of 93% fused quartz. It does not yellow or stain and is scratch resistant.

Slate:
Beveled edge, 3/4" thick natural cleft slate.

Note:
Vetro Bianco (VBO) top for outdoor use is only available on 162TR, 164TR, 169TR, 172TR, 173TR, 174TO tables. 162TR, 164TR, 172TR, 173TR, and 174TO use a phenolic subtop with exposed black edged and white laminate faces. Stainless steel hardware will be used for all connections.



Veneer Tops:
Tops are constructed of veneered medium density fiberboard with a cathedral grain pattern in various clear or toned stains. Oval dining tops are 1 1/4" thick. Edges are 1/4" solid wood to match face veneer.

Eero Saarinen Round End and Coffee Tables



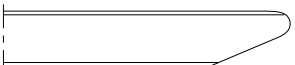

	description	w	d	h	weight	top
<p><i>Designer(s):</i> Eero Saarinen, 1957</p> 	<p>160TR Small round side table, intermediate height</p> 	16 1/4"		20"	21 lbs.	Natural marble
		16 1/4"		20"	21 lbs.	Coated marble
		16 1/4"		20"	21 lbs.	Coated marble
		16 1/4"		20"	21 lbs.	Coated marble
		16 1/4"		20"	21 lbs.	Coated marble
		16 1/4"		20"	21 lbs.	Coated marble
		16 1/4"		20"	21 lbs.	Vetro Bianco
		16 1/4"		20"	25 lbs.	Granite
		16 1/4"		20"	21 lbs.	Natural marble
		16 1/4"		20"	14 lbs.	Veneer
		16 1/4"		20"	14 lbs.	Pearwood
		16 1/4"		20"	21 lbs.	Slate, natural
		16 1/4"		20"	14 lbs.	Veneer
		16 1/4"		20"	12 lbs.	Laminate
			<p>162TR Medium round coffee table, low level</p> 	35 1/4"		15 1/4"
35 1/4"				15 1/4"	88 lbs.	Natural marble
35 1/4"				15 1/4"	88 lbs.	Coated marble
35 1/4"				15 1/4"	88 lbs.	Coated marble
35 1/4"				15 1/4"	43 lbs.	Veneer
35 1/4"				15 1/4"	88 lbs.	Vetro Bianco
35 1/4"				15 1/4"	43 lbs.	Veneer
35 1/4"				15 1/4"	88 lbs.	Coated marble
35 1/4"				15 1/4"	43 lbs.	Pearwood
35 1/4"				15 1/4"	88 lbs.	Coated marble
35 1/4"				15 1/4"	88 lbs.	Coated marble
35 1/4"				15 1/4"	96 lbs.	Granite
35 1/4"				15 1/4"	88 lbs.	Coated marble
35 1/4"				15 1/4"	88 lbs.	Natural marble
35 1/4"				15 1/4"	88 lbs.	Slate, natural
<p><i>Designer(s):</i> Eero Saarinen, 1957</p>	<p>163TR Small round side table, intermediate height</p> 	20"		20"	16 lbs.	Laminate
		20"		20"	30 lbs.	Natural marble
		20"		20"	30 lbs.	Coated marble
		20"		20"	30 lbs.	Coated marble

pattern no.	
160TR-(NGC)-(1, 2, PL)	\$1,121.
160TR-(GC, GCS, GB, GBS)-(1, 2, PL)	1,228.
160TR-(MN, MNS, MA, MAS, GG, GGS)-(1, 2, PL)	1,289.
160TR-(MC, MCS)-(1, 2, PL)	1,352.
160TR-(MG, MGS)-(1, 2, PL)	1,517.
160TR-(ME, MES)-(1, 2, PL)	1,563.
160TR-(MV, MVS)-(1, 2, PL)	1,611.
160TR-(VB)-(1, 2, PL)	1,633.
160TR-(GA)-(1, 2, PL)	2,132.
160TR-(NC)-(1, 2, PL)	2,168.
160TR-(LO, LWA, D, V314)-(1, 2, PL)	2,194.
160TR-(P)-(1, 2, PL)	2,501.
160TR-(SN)-(1, 2, PL)	2,960.
160TR-(RO, TK)-(1, 2, PL)	2,981.
160TR-(F2)-(1, 2, PL)	931.
162TR-(F2)-(1, 2, PL)	2,528.
162TR-(NGC)-(1, 2, PL)	2,870.
162TR-(GC, GCS, GB, GBS)-(1, 2, PL)	3,365.
162TR-(MG, MGS)-(1, 2, PL)	3,717.
162TR-(LO, LWA, D, V314)-(1, 2, PL)	3,722.
162TR-(VB)-(1, 2, PL)	3,957.
162TR-(RO, TK)-(1, 2, PL)	4,216.
162TR-(MN, MNS, MA, MAS, GG, GGS)-(1, 2, PL)	4,245.
162TR-(P)-(1, 2, PL)	4,253.
162TR-(MC, MCS)-(1, 2, PL)	4,457.
162TR-(ME, MES)-(1, 2, PL)	4,514.
162TR-(GA)-(1, 2, PL)	4,971.
162TR-(MV, MVS)-(1, 2, PL)	5,777.
162TR-(NC)-(1, 2, PL)	6,057.
162TR-(SN)-(1, 2)	6,660.
163TR-(F2)-(1, 2, PL)	1,096.
163TR-(NGC)-(1, 2, PL)	1,223.
163TR-(GC, GCS, GB, GBS)-(1, 2, PL)	1,376.
163TR-(MN, MNS, MA, MAS, GG, GGS)-(1, 2, PL)	1,485.

Order Code	Ordering Information
<i>Example:</i> 160TR-MV-2	
161TO Saarinen side table	<i>Base finishes:</i> Black (suffix 1) Platinum (suffix PL) ☑ White (suffix 2)
MV Verdi Alpi Marble	<i>Laminate top finish:</i> ☑ White (suffix F2)
2 White	<i>Veneer Finishes:</i> Ebonyed Walnut (suffix D) ☑ Light Oak (suffix LO) Light Walnut (suffix LWA) Reff Dark Cherry (suffix V314) Pearwood (suffix P) Rosewood (suffix RO) Teak (suffix TK)
<i>Note:</i> Saarinen tables are part of a collection. Please refer to Saarinen side chairs, lounge seating and executive chairs on pages 248.	<i>Polished Coated marble top finishes:</i> Arabescato: white-grey (suffix MA) Calacatta: white-grey/beige (suffix MC) Carrara: white-grey (suffix GC) Empire Beige: beige (suffix GB) Espresso: dark brown (suffix ME) Grey Marble: light grey (suffix GG) Grigio Marquina: warm grey (suffix MG) Nero Marquina: black (suffix MN) Verde Alpi: green (suffix MV)
<i>Specify:</i> 1. Pattern number 2. Top selection 3. Base finish selection	<i>Natural marble top finishes:</i> Calacatta: white-grey/beige (suffix NC) Carrara: white-grey (suffix NGC) <i>Granite top finish:</i> Black Andes: black (suffix GA) <i>Engineered Stone:</i> Vetro Bianco: white (suffix VB) <i>Slate top finishes:</i> Slate, natural (suffix SN) ☑ KnollStudio 20-Day Program: Saarinen 169TR and 163TR side tables are available on the KnollStudio 20-day program in select finishes. For specific information, consult pages 30-33.
	<i>Satin Coated marble top finishes:</i> Arabescato: white-grey (suffix MAS) Calacatta: white-grey/beige (suffix MCS) Carrara: hite-grey (suffix GCS) Empire Beige: beige (suffix GBS) Espresso: dark brown (suffix MES) Grey Marble: light grey (suffix GGS) Grigio Marquina: warm grey (suffix MGS) Nero Marquina: black (suffix MNS) Verde Alpi: green (suffix MVS)

Maintenance:	Construction
See pages 28-29.	<i>Base:</i> Heavy molded cast aluminum, strap-polished. Black and white bases are coated in a tough, abrasion-resistant Rilsan finish. Platinum bases consist of a highly resilient polyurethane enamel wet coat with a clear satin finish.
<i>Note:</i> Top and base shipped in separate packages. The Knoll logo is stamped into the base of the Saarinen tables. Tops have a nameplate with the designers signature.	<i>Laminate and Marble Tops:</i> Bevel-edged satin smooth laminate or marble. 3/4" thick coated marble tops have transparent polyester coating to help eliminate use-associated stains. 3/4" thick natural marble tops and granite tops have protective sealer. Laminate tops are 1.06" thick.
Not suitable for outdoor use.	<i>Veneer Tops:</i> Tops are constructed of veneered medium density fiberboard with a cathedral grain pattern in various clear or toned or stains. All tops are 1 1/16" thick.
Marbles with a coating will yellow over time.	<i>Engineered Stone:</i> Polished, bright white surface is nonporous and more compact than most granites. Comprised of 93% fused quartz. It does not yellow or stain and is scratch resistant. Suitable for outdoors.
Saarinen Round End and Coffee Tables with Laminate, Natural Marble, Veneer or Granite tops are Greenguard certified.	<i>Slate:</i> Beveled edge, 3/4" thick natural cleft slate.
	<i>Note:</i> Vetro Bianco (VBO) top for outdoor use is only available on 162TR, 164TR, 169TR, 172TR, 173TR, 174TO tables. 162TR, 164TR, 172TR, 173TR, and 174TO use a phenolic subtop with exposed black edges and white laminate faces. Stainless steel hardware will be used for all connections.
	<i>Base Diameters:</i> 160TR, 163TR: 10.7" 162TR: 17" 169TR: 13.5"
	<i>Laminate edge detail:</i> 
	<i>Marble edge detail:</i> 

Eero Saarinen Round End and Coffee Tables



	description	w	d	h	weight	top		
<p><i>Designer(s):</i> Eero Saarinen, 1957</p> 	<p>163TR Small round side table, intermediate height</p> 	20"		20"	30 lbs.	Coated marble		
		20"		20"	30 lbs.	Coated marble		
		20"		20"	30 lbs.	Vetro Bianco		
		20"		20"	30 lbs.	Coated marble		
		20"		20"	30 lbs.	Coated marble		
		20"		20"	17 lbs.	Veneer		
		20"		20"	33 lbs.	Granite		
		20"		20"	30 lbs.	Natural marble		
		20"		20"	17 lbs.	Pearwood		
		20"		20"	17 lbs.	Veneer		
		20"		20"	30 lbs.	Slate, natural		
			<p>169TR Small round side table, low height</p> 	20"		13 3/4"	14 lbs.	Laminate
				20"		13 3/4"	29 lbs.	Natural marble
				20"		13 3/4"	29 lbs.	Coated marble
20"				13 3/4"	29 lbs.	Coated marble		
20"				13 3/4"	29 lbs.	Coated marble		
20"				13 3/4"	29 lbs.	Coated marble		
20"				13 3/4"	29 lbs.	Coated marble		
20"				13 3/4"	29 lbs.	Coated marble		
20"				13 3/4"	16 lbs.	Veneer		
20"				13 3/4"	32 lbs.	Granite		
20"				13 3/4"	29 lbs.	Natural marble		
20"				13 3/4"	16 lbs.	Pearwood		
20"				13 3/4"	16 lbs.	Veneer		
20"				13 3/4"	29 lbs.	Slate, natural		

pattern no.	
163TR-(MC, MCS)-(1, 2, PL)	\$1,558.
163TR-(MG, MGS)-(1, 2, PL)	1,808.
163TR-(VB)-(1, 2, PL)	1,841.
163TR-(ME, MES)-(1, 2, PL)	2,007.
163TR-(MV, MVS)-(1, 2, PL)	2,113.
163TR-(LO, LWA, D, V314)-(1, 2, PL)	2,334.
163TR-(GA)-(1, 2, PL)	2,525.
163TR-(NC)-(1, 2, PL)	2,562.
163TR-(P)-(1, 2, PL)	2,667.
163TR-(TK, RO)-(1, 2, PL)	3,086.
163TR-(SN)-(1, 2, PL)	3,166.
169TR-(F2)-(1, 2, PL)	1,005.
169TR-(NGC)-(1, 2, PL)	1,193.
169TR-(GC, GCS, GB, GBS)-(1, 2, PL)	1,336.
169TR-(MN, MNS, MA, MAS, GG, GGS)-(1, 2, PL)	1,443.
169TR-(MC, MCS)-(1, 2, PL)	1,516.
169TR-(MV, MVS)-(1, 2, PL)	1,916.
169TR-(MG, MGS)-(1, 2, PL)	1,922.
169TR-(ME, MES)-(1, 2, PL)	2,121.
169TR-(LO, LWA, D, V314)-(1, 2, PL)	2,441.
169TR-(GA)-(1, 2, PL)	2,475.
169TR-(NC)-(1, 2, PL)	2,511.
169TR-(P)-(1, 2, PL)	2,778.
169TR-(RO, TK)-(1, 2, PL)	3,159.
169TR-(SN)-(1, 2, PL)	3,263.

Order Code	Ordering Information
<i>Example:</i> 160TR-MV-2	
161TO Saarinen side table	<i>Base finishes:</i> Black (suffix 1) Platinum (suffix PL) ☑ White (suffix 2)
MV Verdi Alpi Marble	<i>Laminate top finish:</i> ☑ White (suffix F2)
2 White	<i>Veneer Finishes:</i> Ebonized Walnut (suffix D) ☑ Light Oak (suffix LO) Light Walnut (suffix LWA) Reff Dark Cherry (suffix V314) Pearwood (suffix P) Rosewood (suffix RO) Teak (suffix TK)
	<i>Polished Coated marble top finishes:</i> Arabescato: white-grey (suffix MA) Calacatta: white-grey/beige (suffix MC) Carrara: white-grey (suffix GC) Empire Beige: beige (suffix GB) Espresso: dark brown (suffix ME) Grey Marble: light grey (suffix GG) Grigio Marquina: warm grey (suffix MG) Nero Marquina: black (suffix MN) Verde Alpi: green (suffix MV)
	<i>Natural marble top finishes:</i> Calacatta: white-grey/beige (suffix NC) Carrara: white-grey (suffix NGC)
	<i>Granite top finish:</i> Black Andes: black (suffix GA)
	<i>Engineered Stone:</i> Vetro Bianco: white (suffix VB)
	<i>Slate top finish:</i> Slate, natural (suffix SN)
	<i>Satin Coated marble top finishes:</i> Arabescato: white-grey (suffix MAS) Calacatta: white-grey/beige (suffix MCS) Carrara: hite-grey (suffix GCS) Empire Beige: beige (suffix GBS) Espresso: dark brown (suffix MES) Grey Marble: light grey (suffix GGS) Grigio Marquina: warm grey (suffix MGS) Nero Marquina: black (suffix MNS) Verde Alpi: green (suffix MVS)
	☑ KnollStudio 20-Day Program: Saarinen 169TR and 163TR side tables are available on the KnollStudio 20-day program in select finishes. For specific information, consult pages 30-33.

Note:
Saarinen tables are part of a collection. Please refer to Saarinen side chairs, lounge seating and executive chairs on pages 248.

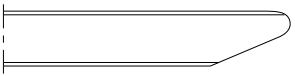
- Specify:*
1. Pattern number
 2. Top selection
 3. Base finish selection

Maintenance:	Construction
See pages 28-29.	<i>Base:</i> Heavy molded cast aluminum, strap-polished. Black and white bases are coated in a tough, abrasion-resistant Rilsan finish. Platinum bases consist of a highly resilient polyurethane enamel wet coat with a clear satin finish.
<i>Note:</i> Top and base shipped in separate packages. The Knoll logo is stamped into the base of the Saarinen tables. Tops have a nameplate with the designers signature.	<i>Laminate and Marble Tops:</i> Bevel-edged satin smooth laminate or marble. 3/4" thick coated marble tops have transparent polyester coating to help eliminate use-associated stains. 3/4" thick natural marble tops and granite tops have protective sealer. Laminate tops are 1.06" thick.
Not suitable for outdoor use.	<i>Veneer Tops:</i> Tops are constructed of veneered medium density fiberboard with a cathedral grain pattern in various clear or toned or stains. All tops are 1 1/16" thick.
Marbles with a coating will yellow over time.	<i>Engineered Stone:</i> Polished, bright white surface is nonporous and more compact than most granites. Comprised of 93% fused quartz. It does not yellow or stain and is scratch resistant. Suitable for outdoors.
Saarinen Round End and Coffee Tables with Laminate, Natural Marble, Veneer or Granite tops are Greenguard certified.	<i>Slate:</i> Beveled edge, 3/4" thick natural cleft slate.
	<i>Note:</i> Vetro Bianco (VBO) top for outdoor use is only available on 162TR, 164TR, 169TR, 172TR, 173TR, 174TO tables. 162TR, 164TR, 172TR, 173TR, and 174TO use a phenolic subtop with exposed black edges and white laminate faces. Stainless steel hardware will be used for all connections.
	<i>Laminate edge detail:</i> 
	<i>Marble edge detail:</i> 

Eero Saarinen

Oval End and Coffee Tables

Designer(s):
Eero Saarinen, 1957

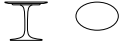
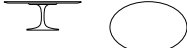

description	w	d	h	weight	top
161TO Oval side table, intermediate height 	22 1/2"	15"	20"	15 lbs.	Laminate
	22 1/2"	15"	20"	28 lbs.	Natural marble
	22 1/2"	15"	20"	28 lbs.	Coated marble
	22 1/2"	15"	20"	28 lbs.	Coated marble
	22 1/2"	15"	20"	28 lbs.	Coated marble
	22 1/2"	15"	20"	28 lbs.	Coated marble
	22 1/2"	15"	20"	28 lbs.	Coated marble
	16 1/4"		20"	28 lbs.	Vetro Bianco
	22 1/2"	15"	20"	28 lbs.	Coated marble
	22 1/2"	15"	20"	16 lbs.	Veneer
	22 1/2"	15"	20"	29 lbs.	Granite
	22 1/2"	15"	20"	28 lbs.	Natural marble
	22 1/2"	15"	20"	16 lbs.	Pearwood
	22 1/2"	15"	20"	16 lbs.	Veneer
	16 1/4"		20"	28 lbs.	Slate, natural
162TO Oval coffee table, low level 	42 1/4"	27 1/2"	15 1/4"	37 lbs.	Laminate
	42 1/4"	27 1/2"	15 1/4"	80 lbs.	Natural marble
	42 1/4"	27 1/2"	15 1/4"	80 lbs.	Coated marble
	42 1/4"	27 1/2"	15 1/4"	80 lbs.	Coated marble
	42 1/4"	27 1/2"	15 1/4"	40 lbs.	Veneer
	42 1/4"	27 1/2"	15 1/4"	80 lbs.	Vetro Bianco
	42 1/4"	27 1/2"	15 1/4"	80 lbs.	Coated marble
	42 1/4"	27 1/2"	15 1/4"	80 lbs.	Coated marble
	42 1/4"	27 1/2"	15 1/4"	40 lbs.	Veneer
	42 1/4"	27 1/2"	15 1/4"	40 lbs.	Pearwood
	42 1/4"	27 1/2"	15 1/4"	80 lbs.	Coated marble
	42 1/4"	27 1/2"	15 1/4"	86 lbs.	Granite
	42 1/4"	27 1/2"	15 1/4"	80 lbs.	Coated marble
	42 1/4"	27 1/2"	15 1/4"	80 lbs.	Slate, natural
	42 1/4"	27 1/2"	15 1/4"	80 lbs.	Natural marble



pattern no.	
161TO-(F2)-(1, 2, PL)	\$1,124.
161TO-(NGC)-(1, 2, PL)	1,128.
161TO-(GC, GCS, GB, GBS)-(1, 2, PL)	1,237.
161TO-(MN, MNS, MA, MAS, GG, GGS)-(1, 2, PL)	1,272.
161TO-(MC, MCS)-(1, 2, PL)	1,335.
161TO-(MV, MVS)-(1, 2, PL)	1,511.
161TO-(MG, MGS)-(1, 2, PL)	1,662.
161TO-(VB)-(1, 2, PL)	1,713.
161TO-(ME, MES)-(1, 2, PL)	1,823.
161TO-(LO, LWA, D, V314)-(1, 2, PL)	2,438.
161TO-(GA)-(1, 2, PL)	2,460.
161TO-(NC)-(1, 2, PL)	2,515.
161TO-(P)-(1, 2, PL)	2,788.
161TO-(RO, TK)-(1, 2, PL)	3,030.
161TO-(SN)-(1, 2, PL)	3,442.
162TO-(F2)-(1, 2, PL)	2,539.
162TO-(NGC)-(1, 2, PL)	3,208.
162TO-(GC, GCS, GB, GBS)-(1, 2, PL)	3,643.
162TO-(MG, MGS)-(1, 2, PL)	3,710.
162TO-(LO, LWA, D, V314)-(1, 2, PL)	3,722.
162TO-(VB)-(1, 2, PL)	3,771.
162TO-(MN, MNS, MA, MAS, GG, GGS)-(1, 2, PL)	3,829.
162TO-(MC, MCS)-(1, 2, PL)	4,021.
162TO-(RO, TK)-(1, 2, PL)	4,115.
162TO-(P)-(1, 2, PL)	4,254.
162TO-(ME, MES)-(1, 2, PL)	4,422.
162TO-(GA)-(1, 2, PL)	5,066.
162TO-(MV, MVS)-(1, 2, PL)	5,234.
162TO-(SN)-(1, 2, PL)	5,375.
162TO-(NC)-(1, 2, PL)	6,310.

Order Code	Ordering Information
<i>Example:</i> 161TO-NGC-2	<i>Base finishes:</i>
161TO Saarinen side table	Black (suffix 1)
NGC Carrara Marble	Platinum (suffix PL)
2 White	White (suffix 2)
	<i>Laminate top finish:</i>
	White (suffix F2)
	<i>Veneer Finishes:</i>
	Ebonized Walnut (suffix D)
	Light Oak (suffix LO)
	Light Walnut (suffix LWA)
	Pearwood (suffix P)
	Reff Dark Cherry (suffix V314)
	Rosewood (suffix RO)
	Teak (suffix TK)
	<i>Polished Coated marble top finishes:</i>
	Arabescato: white-grey (suffix MA)
	Calacatta: white-grey/beige (suffix MC)
	Carrara: white-grey (suffix GC)
	Empire Beige: beige (suffix GB)
	Espresso: dark brown (suffix ME)
	Grey Marble: light grey (suffix GG)
	Grigio Marquina: warm grey (suffix MG)
	Nero Marquina: black (suffix MN)
	Verde Alpi: green (suffix MV)
	<i>Satin Coated marble top finishes:</i>
	Arabescato: white-grey (suffix MAS)
	Calacatta: white-grey/beige (suffix MCS)
	Carrara: white-grey (suffix GCS)
	Empire Beige: beige (suffix GBS)
	Espresso: dark brown (suffix MES)
	Grey Marble: light grey (suffix GGS)
	Grigio Marquina: warm grey (suffix MGS)
	Nero Marquina: black (suffix MNS)
	Verde Alpi: green (suffix MVS)
	<i>Natural marble top finishes:</i>
	Calacatta: white-grey/beige (suffix NC)
	Carrara: white-grey (suffix NGC)
	<i>Granite top finish:</i>
	Black Andes: black (suffix GA)
	<i>Engineered Stone:</i>
	Vetro Bianco: white (suffix VB)
	<i>Slate top finish:</i>
	Slate, natural (suffix SN)

Note:
Saarinen tables are part of a collection. Please refer to Saarinen side chairs, lounge seating and executive chairs on pages 248.

Specify:

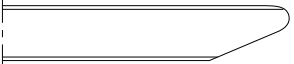



1. Pattern number
2. Top selection
3. Base finish selection

Construction
<i>Maintenance:</i> See pages 28-29.
<i>Note:</i> Top and base shipped in separate packages. The Knoll logo is stamped into the base of the Saarinen tables. Tops have a nameplate with the designers signature. Not suitable for outdoor use.
Marbles with a coating will yellow over time.
Saarinen Oval End and Coffee Tables with Laminate, Natural Marble, Veneer or Granite tops are Greenguard certified.
<i>Base:</i> Heavy molded cast aluminum, strap-polished. Black and white bases are coated in a tough, abrasion-resistant Rilsan finish. Platinum bases consist of a highly resilient polyurethane enamel wet coat with a clear satin finish.
<i>Base Diameters:</i> 161TO: 10.7" 162TO: 17"
<i>Laminate and Marble Tops:</i> Bevel-edged satin smooth laminate or marble. 3/4" thick coated marble tops have transparent polyester coating to help eliminate use-associated stains. 3/4" thick natural marble tops and granite tops have protective sealer. Laminate tops are 1.06" thick.
<i>Veneer Tops:</i> Tops are constructed of veneered medium density fiberboard with a cathedral grain pattern in various clear or toned or stains. All tops are 1 1/16" thick.
<i>Slate:</i> Beveled edge, 3/4" thick natural cleft slate.
<i>Note:</i> Vetro Bianco (VBO) top for outdoor use is only available on 162TR, 164TR, 169TR, 172TR, 173TR, 174TO tables. 162TR, 164TR, 172TR, 173TR, and 174TO use a phenolic subtop with exposed black edges and white laminate faces. Stainless steel hardware will be used for all connections.
<i>Laminate edge detail:</i> 
<i>Marble edge detail:</i> 

Eero Saarinen Outdoor Tables

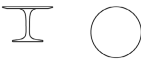
Designer(s):
Eero Saarinen, 1957

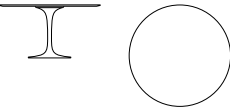
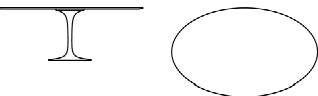

description	w	d	h	weight	top
169TR Small round side table, low height 	20"		13 3/4"	29 lbs.	Vetro Bianco
	20"		13 3/4"	29 lbs.	Slate, natural
162TR Medium round coffee table, low level 	35 1/4"		15 1/4"	88 lbs.	Vetro Bianco
	35 1/4"		15 1/4"	88 lbs.	Slate, natural
172TR Small round table, dining height 	35 1/4"		28 1/4"	95 lbs.	Vetro Bianco
	35 1/4"		28 1/4"	95 lbs.	Slate, natural
173TR Medium round table, dining height 	42 1/4"		28 1/4"	125 lbs.	Vetro Bianco
	42 1/4"		28 1/4"	125 lbs.	Slate, natural
164TR Large round table, dining height 	54"		28 1/4"	203 lbs.	Vetro Bianco
174TO Medium oval table, dining height 	78"	47 1/4"	28 1/4"	259 lbs.	Vetro Bianco
	78"	47 1/4"	28 1/4"	259 lbs.	Slate, natural

pattern no.	list
169TR-(VBO)-(1, 2)	\$2,004.
169TR-(SNO)-(1, 2)	3,308.
162TR-(VBO)-(1, 2)	4,163.
162TR-(SNO)-(1, 2)	6,830.
172TR-(VBO)-(1, 2)	4,546.
172TR-(SNO)-(1, 2)	7,243.
173TR-(VBO)-(1, 2)	5,473.
173TR-(SNO)-(1, 2)	7,738.
164TR-VBO-(1, 2)	7,709.
174TO-(VBO)-(1, 2)	11,408.
174TO-(SNO)-(1, 2)	13,262.

Order Code



Example:	173TR-VBO-2
173TR	Saarinen dining table
VBO	Vetro Bianco
2	White

Note:
Saarinen tables are part of a collection. Please refer to Saarinen side chairs, lounge seating, and executive chairs on beginning on page 248.

Specify:

1. Pattern number
2. Top selection
3. Base finish selection

Ordering Information

Base finishes:
 White (suffix 2)
 Black (suffix 1)
 Engineered Stone:
 Vetro Bianco (suffix VBO)

Slate top finish:
 Slate, natural (suffix SNO)

Maintenance:
 See pages 28-29.

Note:
 Top and base shipped in separate packages. The Knoll logo is stamped into the base of the Saarinen tables. Tops have nameplate with designer's signature.

Construction

Base:
 Heavy molded cast aluminum, strap-polished. White bases are coated in a tough, abrasion-resistant Rilsan finish.

Base Measurements:
 162TR: 17" diameter
 164TR: 25.984" diameter
 174TO: 31.3"W x 23"D
 173TR and 172TR: 20" diameter
 169TR: 13.5" diameter

Tops:
 3/4" thick bevel-edged Vetro Bianco or Slate top.

Edge detail:

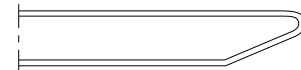

Engineered Stone:
 Polished, bright white surface is nonporous and more compact than most granites. Comprised of 93% fused quartz. It does not yellow or stain and is scratch resistant. Exposed black phenolic sub-top edge with white laminate faces. Suitable for outdoors.

Slate:
 Beveled edge, 3/4" thick natural cleft slate. Black phenolic sub-top with black laminate faces. Suitable for outdoor use.

Designer(s):
 Richard Schultz, 1960

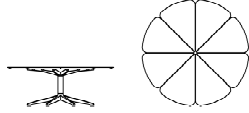
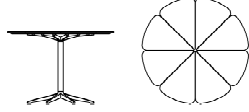

description	w	d	h	weight	top
P320 Petal end table	16"		19"	5 lbs.	Teak
	16"		19"	5 lbs.	White HPDE
P320COV Petal end table cover	–		–	–	–
P321 Petal coffee table	42"		15"	60 lbs.	Teak
	42"		15"	60 lbs.	White HPDE
P321COV Petal coffee table cover	–		–	–	–
P322 Petal dining table	42"		28"	62 lbs.	Teak
	42"		28"	62 lbs.	White HPDE
P322COV Petal dining table cover	–		–	–	–

pattern no.	
P320-K-()	\$1,516.
P320-W-()	1,383.
P320COV	398.
P321-K-()	3,429.
P321-W-()	3,309.
P321COV	598.
P322-K-()	3,548.
P322-W-()	3,429.
P322COV	628.

Order Code

<i>Example:</i> P320-K-W	
P320	Petal side table
K	Teak top
W	White

Specify:

1. Pattern number
2. Top selection
3. Base finish selection

Ordering Information

Base finishes:
 Blue (suffix BLU)
 Chestnut (suffix N)
 Dark Bronze (suffix 14)
 Green (suffix 007)
 Light Bronze (suffix 13)
 Lime Green (suffix LGR)
 Onyx (suffix O)
 Orange (suffix ORG)
 Plum (suffix PLM)
 Sky Blue (suffix 3)
 Warm Bronze (suffix 16)
 Warm Wood (suffix 12)
 Weatherable Silver (suffix S)
 White (suffix W)
 Yellow (suffix YEL)

Construction

Wood top finishes:
 Teak (suffix K)

High Density Polyurethane top finishes:
 White HPDE (suffix W)

Maintenance:
 See pages 28-29.

Base:
 Top spider and base are powder coated cast aluminum. Stem is powder coated stainless steel.

Wood top:
 Vertical grain teak with natural finish.

HPDE top:
 Machined high density polyurethane.

Note:
 Teak tops will patina over time if left outdoors and will turn a silvery grey color.



Glides:
 Molded nylon glides are included on P321 and P322 models only.

Richard Schultz

1966 Collection® Dining Tables

Designer(s):
Richard Schultz, 1966

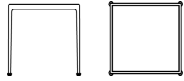
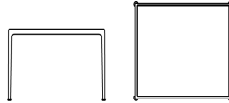
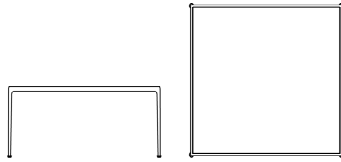
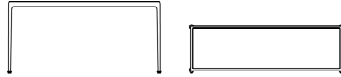
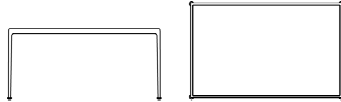

description	w	d	h	weight	top
1966-24H 1966 Dining Table 	28"	28"	28"	39 lbs.	Glass
	28"	28"	28"	36 lbs.	Porcelain
	28"	28"	28"	38 lbs.	Teak
	28"	28"	28"	37 lbs.	Fiberglass
1966-24HCOV 1966 Dining Table cover	-	-	-	-	-
1966-26H 1966 Dining Table 	38"	38"	28"	63 lbs.	Glass
	38"	38"	28"	50 lbs.	Porcelain
	38"	38"	28"	50 lbs.	Teak
	38"	38"	28"	49 lbs.	Fiberglass
1966-26HCOV 1966 Dining Table cover	-	-	-	-	-
1966-60H 1966 Dining Table 	60"	60"	28"	143 lbs.	Glass
	60"	60"	28"	131 lbs.	Porcelain
	60"	60"	28"	120 lbs.	Teak
	60"	60"	28"	106 lbs.	Fiberglass
1966-60HCOV 1966 Dining Table cover	-	-	-	-	-
1966-20H 1966 Dining Table 	60"	18"	28"	50 lbs.	Glass
	60"	18"	28"	61 lbs.	Porcelain
	60"	18"	28"	53 lbs.	Teak
	60"	18"	28"	47 lbs.	Fiberglass
1966-20HCOV 1966 Dining Table cover	-	-	-	-	-
1966-28H 1966 Dining Table 	60"	38"	28"	91 lbs.	Glass
	60"	38"	28"	93 lbs.	Porcelain
	60"	38"	28"	77 lbs.	Teak
	60"	38"	28"	71 lbs.	Fiberglass
1966-28HCOV 1966 Dining Table cover	-	-	-	-	-
1966-90H 1966 Dining Table 	90"	38"	28"	137 lbs.	Glass
	90"	38"	28"	TBD lbs.	Porcelain
	90"	38"	28"	115 lbs.	Teak
	90"	38"	28"	110 lbs.	Fiberglass
1966-90HCOV 1966 Dining Table cover	-	-	-	-	-

pattern no.	
1966-24H-G-(-)(-)	\$2,152.
1966-24H-P-(-)(-)	2,782.
1966-24H-K-(-)	2,897.
1966-24H-F-(-)(-)	3,012.
1966-24HCOV	607.
1966-26H-G-(-)(-)	2,840.
1966-26H-P-(-)(-)	3,386.
1966-26H-K-(-)	3,873.
1966-26H-F-(-)(-)	4,159.
1966-26HCOV	721.
1966-60H-G-(-)(-)	4,991.
1966-60H-P-(-)(-)	5,851.
1966-60H-K-(-)	6,512.
1966-60H-F-(-)(-)	6,942.
1966-60HCOV	903.
1966-20H-G-(-)(-)	2,421.
1966-20H-P-(-)(-)	3,052.
1966-20H-K-(-)	3,167.
1966-20H-F-(-)(-)	3,282.
1966-20HCOV	703.
1966-28H-G-(-)(-)	3,270.
1966-28H-P-(-)(-)	4,016.
1966-28H-K-(-)	4,763.
1966-28H-F-(-)(-)	4,991.
1966-28HCOV	820.
1966-90H-G-(-)(-)	4,647.
1966-90H-P-(-)(-)	5,683.
1966-90H-K-(-)	6,167.
1966-90H-F-(-)(-)	6,598.
1966-90HCOV	1,064.

Order Code	Ordering Information
<i>Example:</i> 1966-24H-P-W-W	<i>Base finishes:</i>
1966-24H 28" x 28" dining table	Blue (suffix BLU)
P Porcelain top	Chestnut (suffix N)
W White top	Dark Bronze (suffix 14)
W White frame	Green (suffix 007)
	Light Bronze (suffix 13)
	Lime Green (suffix LGR)
	Onyx (suffix O)
	Orange (suffix ORG)
	Plum (suffix PLM)
	Sky Blue (suffix 3)
	Warm Bronze (suffix 16)
	Warm Wood (suffix 12)
	Weatherable Silver (suffix S)
	White (suffix W)
	Yellow (suffix YEL)
	<i>Porcelain top finishes:</i>
	White (suffix W)
	Brown (suffix B)
	Marine Blue (suffix M)
	Warm Wood (suffix 12)
	Light Bronze (suffix 13)
	Dark Bronze (suffix 14)
	Warm Bronze (suffix 16)
	<i>Fiberglass top finishes:</i>
	White (suffix W)
	<i>Glass top finishes:</i>
	Clear glass (suffix C)
	Etched glass (suffix E)
<i>Specify:</i>	
1. Pattern number	
2. Top material	
3. Top finish selection	
4. Base finish selection	

Construction
<i>Wood top finishes:</i> Teak (suffix K)
<i>Maintenance:</i> See pages 28-29.
<i>Frame:</i> Frame is aluminum castings and extrusions welded together. Finished in highly durable weather resistant polyester powder coat paint. Y-shaped stainless steel connectors attach tops on corners.
<i>Porcelain Top:</i> .08" thick steel plate with a porcelain enamel layer comprised of glass particles, baked to melt into a .002" smooth surface. Honey comb subtop comprised of metal or particle wood board provides additional support.
<i>Teak:</i> 1" natural teak.
<i>Fiberglass Top:</i> 1" thick fiberglass available in white finish.
<i>Note:</i> Teak tops will patina over time if left outdoors and will turn a silvery grey color.
<i>Glides:</i> Clear butyrate plastic.
<i>Glass Top:</i> 3/8" beveled glass top available in clear or acid etched.

Richard Schultz
1966 Collection® Counter Height Tables

Designer(s):
Richard Schultz, 1966

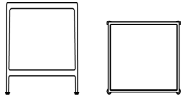
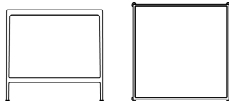
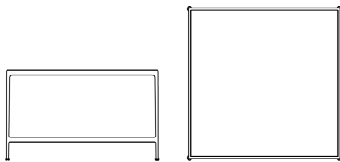
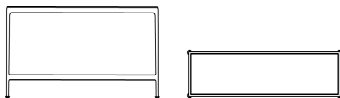
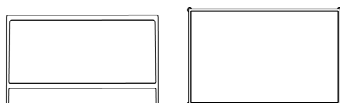

description	w	d	h	weight	top
1966-24C 1966 Counter Height Table 	28"	28"	36"	47 lbs.	Glass
	28"	28"	36"	41 lbs.	Porcelain
	28"	28"	36"	44 lbs.	Teak
	28"	28"	36"	36 lbs.	Fiberglass
1966-24CCOV 1966 Counter Height Table cover	-	-	-	-	-
1966-26C 1966 Counter Height Table 	38"	38"	36"	71 lbs.	Glass
	38"	38"	36"	55 lbs.	Porcelain
	38"	38"	36"	56 lbs.	Teak
	38"	38"	36"	47 lbs.	Fiberglass
1966-26CCOV 1966 Counter Height Table cover	-	-	-	-	-
1966-60C 1966 Counter Height Table 	60"	60"	36"	151 lbs.	Glass
	60"	60"	36"	141 lbs.	Porcelain
	60"	60"	36"	129 lbs.	Teak
	60"	60"	36"	106 lbs.	Fiberglass
1966-60CCOV 1966 Counter Height Table cover	-	-	-	-	-
1966-20C 1966 Counter Height Table 	60"	18"	36"	58 lbs.	Glass
	60"	18"	36"	69 lbs.	Porcelain
	60"	18"	36"	61 lbs.	Teak
	60"	18"	36"	45 lbs.	Fiberglass
1966-20CCOV 1966 Counter Height Table cover	-	-	-	-	-
1966-28C 1966 Counter Height Table 	60"	38"	36"	100 lbs.	Glass
	60"	38"	36"	102 lbs.	Porcelain
	60"	38"	36"	86 lbs.	Teak
	60"	38"	36"	66 lbs.	Fiberglass
1966-28CCOV 1966 Counter Height Table cover	-	-	-	-	-

pattern no.	
1966-24C-G-(-)(-)	\$2,639.
1966-24C-P-(-)(-)	3,270.
1966-24C-K-(-)	3,386.
1966-24C-F-(-)(-)	3,500.
1966-24CCOV	703.
1966-26C-G-(-)(-)	3,327.
1966-26C-P-(-)(-)	3,873.
1966-26C-K-(-)	4,360.
1966-26C-F-(-)(-)	4,647.
1966-26CCOV	818.
1966-60C-G-(-)(-)	5,851.
1966-60C-P-(-)(-)	6,713.
1966-60C-K-(-)	7,371.
1966-60C-F-(-)(-)	7,802.
1966-60CCOV	1,029.
1966-20C-G-(-)(-)	2,909.
1966-20C-P-(-)(-)	3,539.
1966-20C-K-(-)	3,653.
1966-20C-F-(-)(-)	3,769.
1966-20CCOV	799.
1966-28C-G-(-)(-)	3,901.
1966-28C-P-(-)(-)	4,647.
1966-28C-K-(-)	5,392.
1966-28C-F-(-)(-)	5,622.
1966-28CCOV	915.

Order Code

<i>Example:</i> 1966-26C-K-O
1966-26C 38" x 38" counter height table
K Teak top
O Onyx frame

Specify:

1. Pattern number
2. Top material
3. Top finish selection
4. Base finish selection

Ordering Information

<i>Base finishes:</i> Blue (suffix BLU) Chestnut (suffix N) Dark Bronze (suffix 14) Green (suffix 007) Light Bronze (suffix 13) Lime Green (suffix LGR) Onyx (suffix O) Orange (suffix ORG) Plum (suffix PLM) Sky Blue (suffix 3) Warm Bronze (suffix 16) Warm Wood (suffix 12) Weatherable Silver (suffix S) White (suffix W) Yellow (suffix YEL)	<i>Porcelain top finishes:</i> White (suffix W) Brown (suffix B) Marine Blue (suffix M) Warm Wood (suffix 12) Light Bronze (suffix 13) Dark Bronze (suffix 14) Warm Bronze (suffix 16)	<i>Fiberglass top finishes:</i> White (suffix W) <i>Glass top finishes:</i> Clear glass (suffix C) Etched glass (suffix E)
---	---	--

Construction

<i>Wood top finishes:</i> Teak (suffix K) <i>Maintenance:</i> See pages 28-29.	<i>Frame:</i> Frame is aluminum castings and extrusions welded together. Finished in highly durable weather resistant polyester powder coat paint. Y-shaped stainless steel connectors attach tops on corners. <i>Glass Top:</i> 3/8" beveled glass top available in clear or acid etched. <i>Porcelain Top:</i> .08" thick steel plate with a porcelain enamel layer comprised of glass particles, baked to melt into a .002" smooth surface. Honey comb subtop comprised of metal or particle wood board provides additional support.	<i>Teak:</i> 1" natural teak. <i>Fiberglass Top:</i> 1" thick fiberglass available in white finish. <i>Note:</i> Teak tops will patina over time if left outdoors and will turn a silvery grey color. <i>Glides:</i> Clear butyrate plastic.
---	--	---

Richard Schultz
1966 Collection® Bar Height Tables

Designer(s):
Richard Schultz, 1966

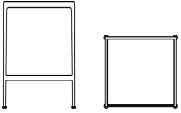
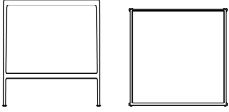
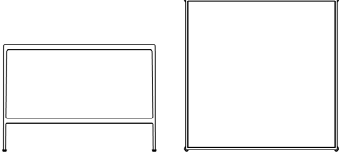
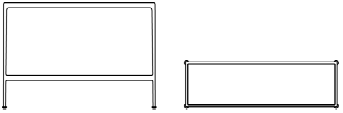
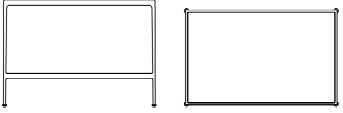

description	w	d	h	weight	top
1966-24B 1966 Bar Height Table 	28"	28"	42"	49 lbs.	Glass
	28"	28"	42"	44 lbs.	Porcelain
	28"	28"	42"	47 lbs.	Teak
	28"	28"	42"	39 lbs.	Fiberglass
1966-24BCOV 1966 Bar Height Table cover	–	–	–	–	–
1966-26B 1966 Bar Height Table 	38"	38"	42"	73 lbs.	Glass
	38"	38"	42"	58 lbs.	Porcelain
	38"	38"	42"	59 lbs.	Teak
	38"	38"	42"	50 lbs.	Fiberglass
1966-26BCOV 1966 Bar Height Table cover	–	–	–	–	–
1966-60B 1966 Bar Height Table 	60"	60"	42"	153 lbs.	Glass
	60"	60"	42"	145 lbs.	Porcelain
	60"	60"	42"	133 lbs.	Teak
	60"	60"	42"	110 lbs.	Fiberglass
1966-60BCOV 1966 Bar Height Table cover	–	–	–	–	–
1966-20B 1966 Bar Height Table 	60"	18"	42"	60 lbs.	Glass
	60"	18"	42"	71 lbs.	Porcelain
	60"	18"	42"	63 lbs.	Teak
	60"	18"	42"	48 lbs.	Fiberglass
1966-20BCOV 1966 Bar Height Table cover	–	–	–	–	–
1966-28B 1966 Bar Height Table 	60"	38"	42"	103 lbs.	Glass
	60"	38"	42"	105 lbs.	Porcelain
	60"	38"	42"	89 lbs.	Teak
	60"	38"	42"	70 lbs.	Fiberglass
1966-28BCOV 1966 Bar Height Table cover	–	–	–	–	–

pattern no.	
1966-24B-G-(-)(-)	\$2,754.
1966-24B-P-(-)(-)	3,386.
1966-24B-K-(-)	3,500.
1966-24B-F-(-)(-)	3,614.
1966-24BCOV	774.
1966-26B-G-(-)(-)	3,442.
1966-26B-P-(-)(-)	3,987.
1966-26B-K-(-)	4,475.
1966-26B-F-(-)(-)	4,763.
1966-26BCOV	908.
1966-60B-G-(-)(-)	5,967.
1966-60B-P-(-)(-)	6,827.
1966-60B-K-(-)	7,487.
1966-60B-F-(-)(-)	7,917.
1966-60BCOV	1,137.
1966-20B-G-(-)(-)	3,024.
1966-20B-P-(-)(-)	3,653.
1966-20B-K-(-)	3,769.
1966-20B-F-(-)(-)	3,884.
1966-20BCOV	895.
1966-28B-G-(-)(-)	4,016.
1966-28B-P-(-)(-)	4,763.
1966-28B-K-(-)	5,507.
1966-28B-F-(-)(-)	5,737.
1966-28BCOV	1,017.

Order Code

<i>Example:</i>	1966-20B-F-W-6
1966-20B	60" x 18" bar height table
F	Fiberglass top
W	White top
6	Choice White frame

Specify:

1. Pattern number
2. Top material
3. Top finish selection
4. Base finish selection

Ordering Information

Base finishes:

Blue (suffix BLU)
Chestnut (suffix N)
Dark Bronze (suffix 14)
Green (suffix 007)
Light Bronze (suffix 13)
Lime Green (suffix LGR)
Onyx (suffix O)
Orange (suffix ORG)
Plum (suffix PLM)
Sky Blue (suffix 3)
Warm Bronze (suffix 16)
Warm Wood (suffix 12)
Weatherable Silver (suffix S)
White (suffix W)
Yellow (suffix YEL)

Porcelain top finishes:

White (suffix W)
Brown (suffix B)
Marine Blue (suffix M)
Warm Wood (suffix 12)
Light Bronze (suffix 13)
Dark Bronze (suffix 14)
Warm Bronze (suffix 16)

Fiberglass top finishes:

White (suffix W)

Glass top finishes:
Clear glass (suffix C)
Etched glass (suffix E)

Construction

Wood top finishes:

Teak (suffix K)

Maintenance:

See pages 28-29.

Frame:

Frame is aluminum castings and extrusions welded together. Finished in highly durable weather resistant polyester powder coat paint. Y-shaped stainless steel connectors attach tops on corners.

Glass Top:

3/8" beveled glass top available in clear or acid etched.

Porcelain Top:

.08" thick steel plate with a porcelain enamel layer comprised of glass particles, baked to melt into a .002" smooth surface. Honey comb subtop comprised of metal or particle wood board provides additional support.

Teak:

1" natural teak.

Fiberglass Top:

1" thick fiberglass available in white finish.

Note:



Teak tops will patina over time if left outdoors and will turn a silvery grey color.

Glides:

Clear butyrate plastic.

Designer(s):
Richard Schultz, 1966

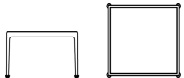
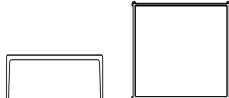
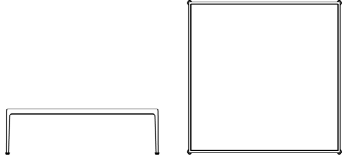
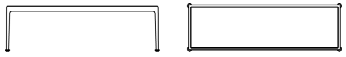

description	w	d	h	weight	top
1966-18L 1966 End Table 	18"	18"	15"	17 lbs.	Glass
	18"	18"	15"	16 lbs.	Porcelain
	18"	18"	15"	24 lbs.	Teak
	18"	18"	15"	17 lbs.	Fiberglass
1966-18LCOV 1966 End Table cover	—	—	—	—	—
1966-19L 1966 Coffee Table 	32"	20"	15"	28 lbs.	Glass
	32"	20"	15"	23 lbs.	Porcelain
	32"	20"	15"	27 lbs.	Teak
	32"	20"	15"	24 lbs.	Fiberglass
1966-19LCOV 1966 Coffee Table cover	—	—	—	—	—
1966-24L 1966 Coffee Table 	28"	28"	15"	34 lbs.	Glass
	28"	28"	15"	30 lbs.	Porcelain
	28"	28"	15"	28 lbs.	Teak
	28"	28"	15"	31 lbs.	Fiberglass
1966-24LCOV 1966 Coffee Table cover	—	—	—	—	—
1966-26L 1966 Coffee Table 	38"	38"	15"	57 lbs.	Glass
	38"	38"	15"	44 lbs.	Porcelain
	38"	38"	15"	44 lbs.	Teak
	38"	38"	15"	43 lbs.	Fiberglass
1966-26LCOV 1966 Coffee Table cover	—	—	—	—	—
1966-60L 1966 Coffee Table 	60"	60"	15"	138 lbs.	Glass
	60"	60"	15"	127 lbs.	Porcelain
	60"	60"	15"	108 lbs.	Teak
	60"	60"	15"	100 lbs.	Fiberglass
1966-60LCOV 1966 Coffee Table cover	—	—	—	—	—
1966-20L 1966 Coffee Table 	60"	18"	15"	44 lbs.	Glass
	60"	18"	15"	55 lbs.	Porcelain
	60"	18"	15"	47 lbs.	Teak
	60"	18"	15"	40 lbs.	Fiberglass
1966-20LCOV 1966 Coffee Table cover	—	—	—	—	—

Order Code

Example:	1966-18L-G-E-S
1966-18L	18" x 18" end table
G	Glass top
E	Etched glass top
S	Weatherable Silver frame

Specify:

1. Pattern number
2. Top material
3. Top finish selection
4. Base finish selection

Ordering Information

Base finishes:

- Blue (suffix BLU)
- Chestnut (suffix N)
- Dark Bronze (suffix 14)
- Green (suffix 007)
- Light Bronze (suffix 13)
- Lime Green (suffix LGR)
- Onyx (suffix O)
- Orange (suffix ORG)
- Plum (suffix PLM)
- Sky Blue (suffix 3)
- Warm Bronze (suffix 16)
- Warm Wood (suffix 12)
- Weatherable Silver (suffix S)
- White (suffix W)
- Yellow (suffix YEL)

Porcelain top finishes:

- White (suffix W)
- Brown (suffix B)
- Marine Blue (suffix M)
- Warm Wood (suffix 12)
- Light Bronze (suffix 13)
- Dark Bronze (suffix 14)
- Warm Bronze (suffix 16)

Fiberglass top finishes:

- White (suffix W)
- Glass top finishes:
- Clear glass (suffix C)
- Etched glass (suffix E)

pattern no.

1966-18L-G-(-)(-)	\$1,692.
1966-18L-P-(-)(-)	1,928.
1966-18L-K-(-)	1,991.
1966-18L-F-(-)(-)	2,048.
1966-18LCOV	272.
1966-19L-G-(-)(-)	1,979.
1966-19L-P-(-)(-)	2,237.
1966-19L-K-(-)	2,364.
1966-19L-F-(-)(-)	2,478.
1966-19LCOV	443.
1966-24L-G-(-)(-)	1,951.
1966-24L-P-(-)(-)	2,582.
1966-24L-K-(-)	2,697.
1966-24L-F-(-)(-)	2,812.
1966-24LCOV	607.
1966-26L-G-(-)(-)	2,582.
1966-26L-P-(-)(-)	3,126.
1966-26L-K-(-)	3,614.
1966-26L-F-(-)(-)	3,901.
1966-26LCOV	616.
1966-60L-G-(-)(-)	4,647.
1966-60L-P-(-)(-)	5,507.
1966-60L-K-(-)	6,167.
1966-60L-F-(-)(-)	6,598.
1966-60LCOV	832.
1966-20L-G-(-)(-)	2,277.
1966-20L-P-(-)(-)	2,909.
1966-20L-K-(-)	3,024.
1966-20L-F-(-)(-)	3,138.
1966-20LCOV	632.

Construction

Wood top finishes:

- Teak (suffix K)

Maintenance:

See pages 28-29.

Frame:

Frame is aluminum castings and extrusions welded together. Finished in highly durable weather resistant polyester powder coat paint. Y-shaped stainless steel connectors attach tops on corners.

Glass Top:

3/8" beveled glass top available in clear or acid etched.

Porcelain Top:

.08" thick steel plate with a porcelain enamel layer comprised of glass particles, baked to melt into a .002" smooth surface. Honey comb subtop comprised of metal or particle wood board provides additional support.

Teak:

1" natural teak.

Fiberglass Top:

1" thick fiberglass available in white finish.





Note:

Teak tops will patina over time if left outdoors and will turn a silvery grey color.

Glides:

Clear butyrate plastic.

Richard Schultz
1966 Collection® End and Coffee Tables

	description	w	d	h	weight	top
<i>Designer(s):</i> Richard Schultz, 1966  	1966-28L 1966 Coffee Table  	60"	38"	15"	85 lbs.	Glass
		60"	38"	15"	87 lbs.	Porcelain
		60"	38"	15"	71 lbs.	Teak
		60"	38"	15"	65 lbs.	Fiberglass
	1966-28LCOV 1966 Coffee Table cover	–	–	–	–	–
	1966-90L 1966 Coffee Table	90"	38"	15"	132 lbs.	Glass
90"		38"	15"	TBD lbs.	Porcelain	
90"		38"	15"	105 lbs.	Teak	
90"		38"	15"	100 lbs.	Fiberglass	
	1966-90LCOV 1966 Coffee Table cover	–	–	–	–	–

pattern no.	
1966-28L-G-(-)(-)	\$2,926.
1966-28L-P-(-)(-)	3,672.
1966-28L-K-(-)	4,418.
1966-28L-F-(-)(-)	4,647.
1966-28LCOV	796.
1966-90L-G-(-)(-)	4,360.
1966-90L-P-(-)(-)	5,245.
1966-90L-K-(-)	5,879.
1966-90L-F-(-)(-)	6,310.
1966-90LCOV	1,010.

Order Code

<i>Example:</i>	1966-18L-G-E-S
1966-18L	18" x 18" end table
G	Glass top
E	Etched glass top
S	Weatherable Silver frame

Specify:

1. Pattern number
2. Top material
3. Top finish selection
4. Base finish selection

Ordering Information

Base finishes:

Blue (suffix BLU)
Chestnut (suffix N)
Dark Bronze (suffix 14)
Green (suffix 007)
Light Bronze (suffix 13)
Lime Green (suffix LGR)
Onyx (suffix O)
Orange (suffix ORG)
Plum (suffix PLM)
Sky Blue (suffix 3)
Warm Bronze (suffix 16)
Warm Wood (suffix 12)
Weatherable Silver (suffix S)
White (suffix W)
Yellow (suffix YEL)

Porcelain top finishes:

White (suffix W)
Brown (suffix B)
Marine Blue (suffix M)
Warm Wood (suffix 12)
Light Bronze (suffix 13)
Dark Bronze (suffix 14)
Warm Bronze (suffix 16)

Fiberglass top finishes:

White (suffix W)

Glass top finishes:
Clear glass (suffix C)
Etched glass (suffix E)

Construction

Wood top finishes:

Teak (suffix K)

Maintenance:

See pages 28-29.

Frame:

Frame is aluminum castings and extrusions welded together. Finished in highly durable weather resistant polyester powder coat paint. Y-shaped stainless steel connectors attach tops on corners.

Glass Top:

3/8" beveled glass top available in clear or acid etched.

Porcelain Top:

.08" thick steel plate with a porcelain enamel layer comprised of glass particles, baked to melt into a .002" smooth surface. Honey comb subtop comprised of metal or particle wood board provides additional support.

Teak:

1" natural teak.

Fiberglass Top:

1" thick fiberglass available in white finish.

Note:

Teak tops will patina over time if left outdoors and will turn a silvery grey color.

Glides:

Clear butyrate plastic.

Richard Schultz
1966 Collection® Serving Cart

Designer(s):
Richard Schultz, 1966

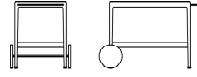

description	w	d	h	weight	top
1966-55 Serving cart 	23 1/2"	39"	26 1/4"	55 lbs.	Porcelain
	23 1/2"	39"	26 1/4"	61 lbs.	Teak
	23 1/2"	39"	26 1/4"	61 lbs.	Fiberglass
1966-55COV Serving cart cover					

pattern no.	
1966-55-P-(-)(-)	\$4,318.
1966-55-K-(-)	5,200.
1966-55-F-(-)(-)	5,413.
1966-55COV	721.

Order Code

<i>Example:</i> 1966-55-P-M-W	
1966-55	Serving Cart
P	Porcelain top
M	Marine Blue top
W	White frame

Specify:

1. Pattern number
2. Top material
3. Top finish selection
4. Base finish selection

Ordering Information

<i>Base finishes:</i>	<i>Porcelain top finishes:</i>	<i>Fiberglass top finishes:</i>
Blue (suffix BLU)	White (suffix W)	White (suffix W)
Chestnut (suffix N)	Brown (suffix B)	
Dark Bronze (suffix 14)	Marine Blue (suffix M)	
Green (suffix 007)	Warm Wood (suffix 12)	
Light Bronze (suffix 13)	Light Bronze (suffix 13)	
Lime Green (suffix LGR)	Dark Bronze (suffix 14)	
Onyx (suffix O)	Warm Bronze (suffix 16)	
Orange (suffix ORG)		
Plum (suffix PLM)		
Sky Blue (suffix 3)		
Warm Bronze (suffix 16)		
Warm Wood (suffix 12)		
Weatherable Silver (suffix S)		
White (suffix W)		
Yellow (suffix YEL)		

Construction

Wood top finishes:
Teak (suffix K)

Maintenance:
See pages 28-29.

Frame:
Frame is aluminum castings and extrusions welded together. Finished in highly durable weather resistant polyester powder coat paint. Y-shaped stainless steel connectors attach tops on corners. Wheels are cast aluminum with rubber tires and a differential axle.

Porcelain Top:
.08" thick steel plate with a porcelain enamel layer comprised of glass particles, baked to melt into a .002" smooth surface. Honey comb subtop comprised of metal or particle wood board provides additional support.

Teak:
1" natural teak.

Fiberglass Top:
1" thick fiberglass available in white finish.

Note:
Teak tops will patina over time if left outdoors and will turn a silvery grey color.



Glides:
Clear butyrate plastic.

Richard Schultz

Fresh Air Dining Tables

Designer(s):
Richard Schultz, 2011

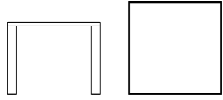
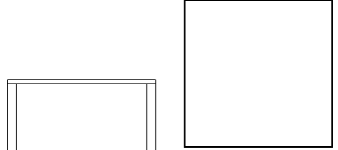
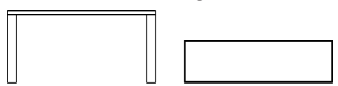

description	w	d	h	weight	top
FA-26H Fresh Air dining table 	36 3/4"	36 3/4"	28 3/8"	90 lbs.	Glass
	36 3/4"	36 3/4"	28 3/8"	88 lbs.	Porcelain
	36 3/4"	36 3/4"	28 3/8"	90 lbs.	Teak
FA-26HCOV Fresh Air dining table cover					
FA-60H Fresh Air dining table 	58 3/4"	58 3/4"	28 3/8"	168 lbs.	Glass
	58 3/4"	58 3/4"	28 3/8"	177 lbs.	Porcelain
	58 3/4"	58 3/4"	28 3/8"	158 lbs.	Teak
FA-60HCOV Fresh Air dining table cover					
FA-20H Fresh Air dining table 	58 3/4"	16 3/4"	28 3/8"	78 lbs.	Glass
	58 3/4"	16 3/4"	28 3/8"	88 lbs.	Porcelain
	58 3/4"	16 3/4"	28 3/8"	81 lbs.	Teak
FA-20HCOV Fresh Air dining table cover					
FA-28H Fresh Air dining table 	58 3/4"	36 3/4"	28 3/8"	120 lbs.	Glass
	58 3/4"	36 3/4"	28 3/8"	120 lbs.	Porcelain
	58 3/4"	36 3/4"	28 3/8"	104 lbs.	Teak
FA-28HCOV Fresh Air dining table cover					
FA-90H Fresh Air dining table 	88 3/4"	36 3/4"	28 3/8"	162 lbs.	Glass
	88 3/4"	36 3/4"	28 3/8"	TBD lbs.	Porcelain
	88 3/4"	36 3/4"	28 3/8"	156 lbs.	Teak
FA-90HCOV Fresh Air dining table cover					

pattern no.	
FA-26H-G-(-)(-)	\$2,409.
FA-26H-P-(-)(-)	3,041.
FA-26H-K-(-)	3,156.
FA-26HCOV	722.
FA-60H-G-(-)(-)	4,130.
FA-60H-P-(-)(-)	4,877.
FA-60H-K-(-)	5,622.
FA-60HCOV	908.
FA-20H-G-(-)(-)	2,208.
FA-20H-P-(-)(-)	2,840.
FA-20H-K-(-)	2,955.
FA-20HCOV	703.
FA-28H-G-(-)(-)	2,869.
FA-28H-P-(-)(-)	3,500.
FA-28H-K-(-)	3,614.
FA-28HCOV	825.
FA-90H-G-(-)(-)	4,016.
FA-90H-P-(-)(-)	4,963.
FA-90H-K-(-)	5,507.
FA-90HCOV	1,061.

Order Code	Ordering Information
<i>Example:</i> FA-20H-G-C-14	<i>Base finishes:</i>
FA-20H 58 3/4" x 16 3/4" dining table	Blue (suffix BLU)
G Glass top	Chestnut (suffix N)
C Clear glass top	Choice White (suffix 6)
14 Dark Bronze frame	Daffodil Yellow (suffix 2)
	Dark Bronze (suffix 14)
	Forest Green (suffix 1)
	Green (suffix 007)
	Light Bronze (suffix 13)
	Lime Green (suffix LGR)
	Onyx (suffix O)
	Orange (suffix ORG)
	Plum (suffix PLM)
	Sky Blue (suffix 3)
	Terra Cotta (suffix 5)
	Warm Bronze (suffix 16)
	Warm Wood (suffix 12)
	Weatherable Silver (suffix S)
	White (suffix W)
	Yellow (suffix YEL)
	<i>Porcelain top finishes:</i>
	White (suffix W)
	Brown (suffix B)
	Marine Blue (suffix M)
	Warm Wood (suffix 12)
	Light Bronze (suffix 13)
	Dark Bronze (suffix 14)
	Warm Bronze (suffix 16)
	<i>Glass top finishes:</i>
	Clear glass (suffix C)
	Etched glass (suffix E)





- Specify:
1. Pattern number
 2. Top material
 3. Top finish selection
 4. Base finish selection

Construction
<i>Wood top finishes:</i> Teak (suffix K)
<i>Maintenance:</i> See pages 28-29.
<i>Frame:</i> Frame is aluminum extrusions with mitered corners and interior stainless steel connectors. Extruded aluminum legs screw into frame with stainless steel screws. Tops fit flush within the frame.
<i>Glass Top:</i> 3/8" beveled glass top available in clear or acid etched.
<i>Porcelain Top:</i> .08" thick steel plate with a porcelain enamel layer comprised of glass particles, baked to melt into a .002" smooth surface. Honey comb subtop comprised of metal or particle wood board provides additional support.
<i>Teak:</i> 1" natural teak.
<i>Note:</i> Teak tops will patina over time if left outdoors and will turn a silvery grey color.
<i>Glides:</i> Nylon adjustable glides.

Richard Schultz
Topiary® Dining Tables

Designer(s):
 Richard Schultz, 1996



description	w	d	h	weight	top
TOP-28 Topiary dining table base only	24"	24"	28"	45 lbs.	–
					
TH Umbrella support, powder coated, accepts 1 1/4" diameter umbrella shaft					
TI Umbrella weight				13 lbs.	
TG-30 Glass top	30"	30"		30 lbs.	tempered glass
					
TG-42 Glass top	42"	42"		66 lbs.	tempered glass
					
TG-56 Glass top	56"	56"		105 lbs.	tempered glass
					

pattern no.	
TOP-28-()	\$2,858.
TH-()	717.
TI	304.
TG-30	746.
TG-42	1,147.
TG-56	1,946.

Order Code	Ordering Information	Construction
<i>Example:</i> TOP-28-1	<i>Finishes:</i>	<i>Topiary frame:</i>
TOP-28 Dining table base	Blue (suffix BLU)	3/16" aluminum sheet stamped and formed. Stainless steel connectors and finished in highly durable weather resistant polyester powder coat paint.
1 Forest Green base	Chestnut (suffix N)	
	Choice White (suffix 6)	
	Daffodil Yellow (suffix 2)	
	Dark Bronze (suffix 14)	
	Forest Green (suffix 1)	
	Green (suffix 007)	
	Light Bronze (suffix 13)	
	Lime Green (suffix LGR)	
	Onyx (suffix 0)	
	Orange (suffix ORG)	
	Plum (suffix PLM)	
	Sky Blue (suffix 3)	
	Terra Cotta (suffix 5)	
	Warm Bronze (suffix 16)	
	Warm Wood (suffix 12)	
	Weatherable Silver (suffix S)	
	White (suffix W)	
	Yellow (suffix YEL)	
		<i>Glass Top:</i>
		3/8" beveled clear glass top.





Specify:
 1. Pattern number
 2. Base finish selection

Shelton Mindel

SM Tables

Designer(s):
Peter Shelton and Lee Mindel,
2006



description	w	d	h
SM9 Shelton Mindel side table 	24"	24"	18"
SM91 Shelton Mindel small coffee table 	42"	24"	14"
SM92 Shelton Mindel large coffee table 	48"	30"	14"
SM93 Shelton Mindel square coffee table 	40"	40"	14"

pattern no.	white/ clear glass	white/ painted glass	white/ slate	stainless/ clear glass	stainless/ painted glass	stainless/ slate
SM9-(-)(-)	\$3,649.	\$3,961.	\$6,507.	\$4,023.	\$4,334.	\$6,877.
SM91-(-)(-)	3,671.	4,217.	7,564.	4,176.	4,724.	8,069.
SM92-(-)(-)	4,080.	4,759.	8,554.	4,434.	5,113.	8,908.
SM93-(-)(-)	6,664.	7,476.	9,594.	7,314.	8,206.	10,245.

Order Code

<i>Example:</i> SM93-2-S2	
SM93	Shelton Mindel square coffee table
2	White
S2	Painted White Starphire

Note:
The SM tables are part of a collection. Please refer to SM side chair on page 280 and SM1 and SM2 lounge collection on pages 282 and 284.

Ordering Information

Specify:

1. Pattern number
2. Base option
3. Top option

Shipping:

Top and base of SM tables will ship in separate packages.

Glass top finishes:

Clear glass (suffix G2)
Painted White Starphire (suffix S2)

Slate top finish:

Natural black (suffix SN)

Base finishes:

White (suffix 2)
Stainless Steel (suffix S)

Maintenance:

See pages 27-28.

Note:

The SM Table Collection is Greenguard certified.

For weight information, please contact your KnollStudio representative.

Construction

Frame:





Constructed of seamless stainless steel, frame has continuous appearance. White bases are coated in a tough, abrasion-resistant Rilsan finish. Polished bases are stainless steel, hand buffed to a mirror finish. Tops rest on four transparent silicon spacers.

Top:

Three top options: 3/8" thick clear glass with a 1/8" wide bevel, top and edges have a slight green tint; 3/4" thick Starphire™ glass with a bevel edge, underside of glass is painted white; 3/8" thick natural cleft slate with beveled edge.

Glides:

Glides are included with the table base.

	description	w	d	h
<p><i>Designer(s):</i> Daniel Stromborg, 2012</p> <p><i>Award(s):</i> Best of NeoCon Silver Award 2012</p> 	<p>DS02 Round table</p> 	32"	32"	29"
	<p>DS04 Round table</p> 	36"	36"	29"
	<p>DS06 Round table</p> 	42"	42"	29"

pattern no.	laminate	glass (G2)	GCO	engineered stone (VB)
DS02-(-)-(-)-(-)	\$1,536.	\$1,906.	\$2,926.	\$3,111.
DS04-(-)-(-)-(-)	1,696.	2,207.	3,272.	3,490.
DS06-(-)-(-)-(-)	1,966.	2,717.	4,252.	4,477.

Order Code	Ordering Information	Construction
<p><i>Example:</i> DS02-118-WHT-YEL</p> <p>DS02 32" Round table</p> <p>118 Bright White laminate top</p> <p>WHT White leg finish</p> <p>YEL Yellow rail finish</p>	<p><i>Leg paint finishes:</i> White (suffix WHT) Dark Charcoal (suffix CHR)</p> <p><i>Rail paint finishes:</i> White (suffix WHT) Grey (suffix GRY) Dark Charcoal (suffix CHR) Yellow (suffix YEL) Lime Green (suffix LGR) Orange (suffix ORG) Plum (suffix PLM) Sky Blue (suffix SBL) Blue (suffix BLU)</p>	<p><i>Top Finishes:</i> White (suffix WHT) Bright White (suffix O118)</p> <p><i>Laminate, outdoor:</i> Bright White (suffix O118)</p> <p><i>Glass:</i> Clear Glass (suffix G2)</p> <p><i>Natural Marble:</i> Cararra, honed (suffix GCO)</p> <p><i>Engineered Stone:</i> Vetro Bianco (suffix VB)</p> <p><i>Note:</i> All finishes and surfaces are suitable for outdoor use.</p> <p><i>Maintenance:</i> See pages 28-29.</p>
<p><i>Specify:</i> 1. Pattern number 2. Top finish 3. Leg finish 4. Rail finish</p>		<p><i>Frame:</i> Frames are constructed from extruded aluminum rails, which are connected using die-cast aluminum 'X' and 'Y' shaped castings. Structural steel legs join the table's extruded aluminum rails through a blind assembly, seamlessly tying the leg to the cope detailed rail. Stainless steel hardware and fasteners are used throughout the table's construction.</p> <p>All painted parts are finished in ultra-durable outdoor polyester powder coat finish. Steel legs are pre-treated with a zinc-rich epoxy primer that provides a robust base of protection from the elements.</p> <p>Tops are elevated off the table's base using cast aluminum (glass) or nylon spacers (laminate, marble, or engineered stone). All tops are secured to the base using threaded metal inserts and fasteners. For glass tops, the plated brushed aluminum spacer acts as a glass bolt and is attached to the glass using an ultra-strong adhesive.</p>

<p><i>Outdoor Laminate:</i> White laminate faces with black phenolic core. Core is constructed of FSC certified craft paper and phenolic resin.</p> <p><i>Glass:</i> 1/2" thick clear tempered glass.</p> <p><i>Marble:</i> Honed natural Cararra marble.</p> <p><i>Note:</i> Marble is treated to resist stains with a topical sealer, which requires maintenance. Natural marbles will develop a rich patina when used outdoors. Natural finished marbles will contain open fissures and pin-holes, which is considered a natural desirable trait.</p> <p><i>Engineered Stone:</i> Polished, bright white surface is nonporous and more compact than most granites. Comprised of 93% fused quartz. It does not yellow or stain and is scratch resistant. Suitable for outdoors.</p> <p><i>Glides:</i> Non-marking indoor/outdoor grey nylon glide protects the table and the floor. An adjustable height indoor glide kit is also included.</p>

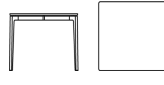
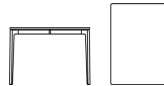
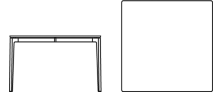
	description	w	d	h	
<p><i>Designer(s):</i> Daniel Stromborg, 2012</p> <p><i>Award(s):</i> Best of NeoCon Silver Award 2012</p> 	DS08 Square table	36"	36"	29"	
		DS10 Square table	42"	42"	29"
		DS12 Square table	48"	48"	29"
					

pattern no.	laminate	G2	GCO	engineered stone (VB)
DS08-(-)-(-)	\$1,736.	\$2,157.	\$3,325.	\$3,496.
DS10-(-)-(-)	2,016.	2,519.	3,724.	3,984.
DS12-(-)-(-)	2,332.	3,091.	4,173.	4,451.

Order Code	Ordering Information	Construction
<i>Example:</i> DS08-NGC-CHR-PLM	<i>Leg paint finishes:</i> White (suffix WHT) Dark Charcoal (suffix CHR)	<i>Top Finishes:</i> <i>Laminate, outdoor:</i> Bright White (suffix O118)
DS08 36" square table	<i>Rail paint finishes:</i> White (suffix WHT) Grey (suffix GRY) Dark Charcoal (suffix CHR) Yellow (suffix YEL) Lime Green (suffix LGR) Orange (suffix ORG) Plum (suffix PLM) Sky Blue (suffix SBL) Blue (suffix BLU)	<i>Glass:</i> Clear Glass (suffix G2)
NGC Cararra marble top		<i>Natural Marble:</i> Cararra, honed (suffix GCO)
CHR Dark Charcoal leg finish		<i>Engineered Stone:</i> Vetro Bianco (suffix VB)
PLM Plum rail finish		<i>Note:</i> All finishes and surfaces are suitable for outdoor use.
		<i>Maintenance:</i> See pages 28-29.
<i>Specify:</i> 1. Pattern number 2. Top finish 3. Leg finish 4. Rail finish		<i>Frame:</i> Frames are constructed from extruded aluminum rails, which are connected using die-cast aluminum 'X' and 'Y' shaped castings. Structural steel legs join the table's extruded aluminum rails through a blind assembly, seamlessly tying the leg to the cope detailed rail. Stainless steel hardware and fasteners are used throughout the table's construction. All painted parts are finished in ultra-durable outdoor polyester powder coat finish. Steel legs are pre-treated with a zinc-rich epoxy primer that provides a robust base of protection from the elements. Tops are elevated off the table's base using cast aluminum (glass) or nylon spacers (laminate, marble, or engineered stone). All tops are secured to the base using threaded metal inserts and fasteners. For glass tops, the plated brushed aluminum spacer acts as a glass bolt and is attached to the glass using an ultra-strong adhesive.

Outdoor Laminate:
White laminate faces with black phenolic core. Core is constructed of FSC certified craft paper and phenolic resin.

Glass:
1/2" thick clear tempered glass.

Marble:
Honed natural Cararra marble.

Note:
Marble is treated to resist stains with a topical sealer, which requires maintenance. Natural marbles will develop a rich patina when used outdoors. Natural finished marbles will contain open fissures and pin-holes, which is considered a natural desirable trait.

Engineered Stone:
Polished, bright white surface is nonporous and more compact than most granites. Comprised of 93% fused quartz. It does not yellow or stain and is scratch resistant. Suitable for outdoors.

Glides:
Non-marking indoor/outdoor grey nylon glide protects the table and the floor. An adjustable height indoor glide kit is also included.

Daniel Stromborg

Rectangular Tables

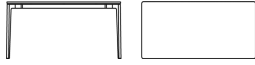
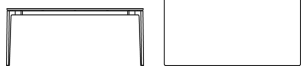
	description	w	d	h
<p><i>Designer(s):</i> Daniel Stromborg, 2012</p> <p><i>Award(s):</i> Best of NeoCon Silver Award 2012</p> 	<p>DS14 Rectangular table</p> 	60"	30"	29"
	<p>DS16 Rectangular table</p> 	72"	36"	29"

pattern no.	laminate	G2	GCO	engineered stone (VB)
DS14-(-)-(-)-(-)	\$2,093.	\$2,753.	\$3,846.	\$4,082.
DS16-(-)-(-)-(-)	2,551.	3,481.	4,591.	4,836.

Order Code	Ordering Information	Construction
<p><i>Example:</i> DS14-G2-WHT-BLU</p> <p>DS14 60" x 30" rectangular table</p> <p>G2 Clear glass top</p> <p>WHT White leg finish</p> <p>BLU Blue rail finish</p> <p><i>Specify:</i></p> <ol style="list-style-type: none"> 1. Pattern number 2. Top finish 3. Leg finish 4. Rail finish 	<p><i>Leg paint finishes:</i></p> <p>White (suffix WHT)</p> <p>Dark Charcoal (suffix CHR)</p> <p><i>Rail paint finishes:</i></p> <p>White (suffix WHT)</p> <p>Grey (suffix GRY)</p> <p>Dark Charcoal (suffix CHR)</p> <p>Yellow (suffix YEL)</p> <p>Lime Green (suffix LGR)</p> <p>Orange (suffix ORG)</p> <p>Plum (suffix PLM)</p> <p>Sky Blue (suffix SBL)</p> <p>Blue (suffix BLU)</p>	<p>Top Finishes:</p> <p><i>Laminate, outdoor:</i></p> <p>Bright White (suffix O118)</p> <p><i>Glass:</i></p> <p>Clear Glass (suffix G2)</p> <p><i>Natural Marble:</i></p> <p>Cararra, honed (suffix GCO)</p> <p><i>Engineered Stone:</i></p> <p>Vetro Bianco (suffix VB)</p> <p><i>Note:</i></p> <p>All finishes and surfaces are suitable for outdoor use.</p> <p><i>Maintenance:</i></p> <p>See pages 28-29.</p> <p><i>Frame:</i></p> <p>Frames are constructed from extruded aluminum rails, which are connected using die-cast aluminum 'X' and 'Y' shaped castings. Structural steel legs join the table's extruded aluminum rails through a blind assembly, seamlessly tying the leg to the cope detailed rail. Stainless steel hardware and fasteners are used throughout the table's construction.</p> <p>All painted parts are finished in ultra-durable outdoor polyester powder coat finish. Steel legs are pre-treated with a zinc-rich epoxy primer that provides a robust base of protection from the elements.</p> <p>Tops are elevated off the table's base using cast aluminum (glass) or nylon spacers (laminate, marble, or engineered stone). All tops are secured to the base using threaded metal inserts and fasteners. For glass tops, the plated brushed aluminum spacer acts as a glass bolt and is attached to the glass using an ultra-strong adhesive.</p>

Outdoor Laminate:

White laminate faces with black phenolic core. Core is constructed of FSC certified craft paper and phenolic resin.

Glass:

1/2" thick clear tempered glass.

Marble:

Honed natural Cararra marble.

Note:



Marble is treated to resist stains with a topical sealer, which requires maintenance. Natural marbles will develop a rich patina when used outdoors. Natural finished marbles will contain open fissures and pin-holes, which is considered a natural desirable trait.

Engineered Stone:

Polished, bright white surface is nonporous and more compact than most granites. Comprised of 93% fused quartz. It does not yellow or stain and is scratch resistant. Suitable for outdoors.

Glides:

Non-marking indoor/outdoor grey nylon glide protects the table and the floor. An adjustable height indoor glide kit is also included.

	description	w	d	h	weight	top
<p><i>Designer(s):</i> Vignelli Design, 1994</p>  	49TS-30 Square table, small	30"	30"	28 1/8"	37 lbs.	Laminate
		30"	30"	28 1/8"	51 lbs.	Clear glass
		30"	30"	28 1/8"	51 lbs.	White glass
		30"	30"	28 1/8"	72 lbs.	Slate
	49TS-36 Square table, medium	36"	36"	28 1/8"	105 lbs.	Slate
		36"	36"	28 1/8"	55 lbs.	Laminate
		36"	36"	28 1/8"	75 lbs.	Clear glass
		36"	36"	28 1/8"	75 lbs.	White glass
	49TS-42 Square table, large	42"	42"	28 1/8"	103 lbs.	Clear glass
		42"	42"	28 1/8"	103 lbs.	White glass
		42"	42"	28 1/8"	144 lbs.	Slate
		42"	42"	28 1/8"	75 lbs.	Laminate
49TR-36 Round table, small	36"		28 1/8"	41 lbs.	Laminate	
	36"		28 1/8"	57 lbs.	Clear glass	
	36"		28 1/8"	57 lbs.	White glass	
	36"		28 1/8"	80 lbs.	Slate	
49TR-42 Round table, medium	42"		28 1/8"	112 lbs.	Slate	
	42"		28 1/8"	58 lbs.	Laminate	
	42"		28 1/8"	80 lbs.	Clear glass	
	42"		28 1/8"	80 lbs.	White glass	
49TR-48 Round table, large	48"		28 1/8"	106 lbs.	Clear glass	
	48"		28 1/8"	106 lbs.	White glass	
	48"		28 1/8"	147 lbs.	Slate	
	48"		28 1/8"	76 lbs.	Laminate	

pattern no.	Painted/ black base	Pol. chrome base
49TS-30-(-)-(-)	\$2,044.	\$2,271.
49TS-30-G2-(-)	2,271.	2,500.
49TS-30-G3-(-)	2,499.	2,726.
49TS-30-SN-(-)	5,229.	5,456.
49TS-36-SN-(-)	6,209.	6,548.
49TS-36-(-)-(-)	2,271.	2,612.
49TS-36-G2-(-)	2,730.	3,069.
49TS-36-G3-(-)	3,021.	3,361.
49TS-42-G2-(-)	3,184.	3,641.
49TS-42-G3-(-)	3,526.	3,983.
49TS-42-SN-(-)	7,652.	8,112.
49TS-42-(-)-(-)	2,499.	2,957.
49TR-36-(-)-(-)	2,044.	2,271.
49TR-36-G2-(-)	2,957.	3,185.
49TR-36-G3-(-)	3,184.	3,410.
49TR-36-SN-(-)	6,382.	6,608.
49TR-42-SN-(-)	7,996.	8,336.
49TR-42-(-)-(-)	2,271.	2,612.
49TR-42-G2-(-)	3,299.	3,639.
49TR-42-G3-(-)	3,596.	3,934.
49TR-48-G2-(-)	3,753.	4,212.
49TR-48-G3-(-)	4,210.	4,667.
49TR-48-SN-(-)	9,154.	9,611.
49TR-48-(-)-(-)	2,499.	2,957.

Order Code

<i>Example:</i>	49TS-30-SN-1
49TS-30	PaperClip table, square, 30"
SN	Natural Black slate
1	Black

Ordering Information

Laminate top finishes:
Bright White (suffix 118)
Light Grey (suffix L)
Fog (suffix 128)
Jet Black (suffix 111)

Urethane edge finishes:
Light Grey (suffix LG)
Medium Grey (suffix MG)
Black (suffix BL)

Glass top finishes:
Clear (suffix G2)
White (suffix G3)

Slate top finish:
Natural Black (suffix SN)

Outdoor Powder Coat Finish:
Black (suffix 1)

Chrome base finish:
Polished Chrome (suffix C)

Maintenance:
See pages 28-29.

Note:
The PaperClip Table is Greenguard certified.

The Vignelli PaperClip Tables are part of a collection. Please refer to Vignelli Handkerchief Chairs on page 292.

Specify:

1. Pattern number
2. Top finish selection
3. Urethane edge detail (laminate tops only)
4. Leg finish selection

Construction

Top:
Three top options: 1" thick laminate top with molded urethane beveled edge; 1/2" thick clear tempered glass with polished pencil edge; and 3/4" thick natural cleft slate with beveled edge.

Base:
7/16" diameter cold rolled steel rod with fused polyester, outdoor powder coat and chrome-plated finishes.

Glides:
Plastic.

Outdoor use:
With proper preventative maintenance and limited exposure to the elements, the PaperClip cafe table is appropriate for outdoor environments. Specify outdoor powder coat black (suffix 1) base finish and clear glass (suffix G2) or slate (suffix SN) tops.

Shipping:
All tables shipped knocked-down. Base and top assembly required.

Laminate/slate edge detail:

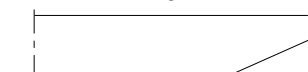

Glass edge detail:

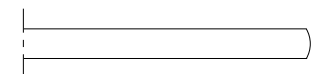

<i>pattern no.</i>	<i>page</i>	<i>pattern no.</i>	<i>page</i>	<i>pattern no.</i>	<i>page</i>	<i>pattern no.</i>	<i>page</i>
04CTR	338	173TR	370, 384	1966-255R	270	1966-46H	266
1050C	220	174TO	376, 384	1966-255RCOV	270	1966-46HCOV	266
1050C-1	220	175TO	376	1966-25COV	270	1966-55COV	398
1050C-2	220	175TO-F2	376	1966-25P	270	1966-55-F	398
1050C-3	220	176TR	372	1966-25R	270	1966-55-K	398
1051C	218	1966-18LCOV	394	1966-25RCOV	270	1966-55-P	398
1051C-S	214	1966-18L-F	394	1966-26BCOV	392	1966-60BCOV	392
1051C-ST	214	1966-18L-G	394	1966-26B-F	392	1966-60B-F	392
1052C	218	1966-18L-K	394	1966-26B-G	392	1966-60B-G	392
1052C-S	216	1966-18L-P	394	1966-26B-K	392	1966-60B-K	392
1053C	218	1966-19LCOV	394	1966-26B-P	392	1966-60B-P	392
1053C-S	216	1966-19L-F	394	1966-26CCOV	390	1966-60CCOV	390
1059C	218	1966-19L-G	394	1966-26C-F	390	1966-60C-F	390
1059C-S	216	1966-19L-K	394	1966-26C-G	390	1966-60C-G	390
108	316	1966-19L-P	394	1966-26C-K	390	1966-60C-K	390
108-KC-111	316	1966-20BCOV	392	1966-26C-P	390	1966-60C-P	390
1205-CO-S1	136	1966-20B-F	392	1966-26HCOV	388	1966-60HCOV	388
1205-CO-S2	136	1966-20B-G	392	1966-26H-F	388	1966-60H-F	388
1205-CO-S3	136	1966-20B-K	392	1966-26H-G	388	1966-60H-G	388
1205-C-S1	136	1966-20B-P	392	1966-26H-K	388	1966-60H-K	388
1205-C-S2	136	1966-20CCOV	390	1966-26H-P	388	1966-60H-P	388
1205-C-S3	136	1966-20C-F	390	1966-26LCOV	394	1966-60LCOV	394
1206-C-S1	138	1966-20C-G	390	1966-26L-F	394	1966-60L-F	394
1206-C-S2	138	1966-20C-K	390	1966-26L-G	394	1966-60L-G	394
1206-C-S3	138	1966-20C-P	390	1966-26L-K	394	1966-60L-K	394
1250BUTTON	226	1966-20HCOV	388	1966-26L-P	394	1966-60L-P	394
1250COVER	226	1966-20H-F	388	1966-28BCOV	392	1966-90HCOV	388
12A	226	1966-20H-G	388	1966-28B-F	392	1966-90H-F	388
12C	226	1966-20H-K	388	1966-28B-G	392	1966-90H-G	388
150AS	248	1966-20H-P	388	1966-28B-K	392	1966-90H-K	388
150AX	248	1966-20LCOV	394	1966-28B-P	392	1966-90H-P	388
150K	248	1966-20L-F	394	1966-28CCOV	390	1966-90LCOV	396
151CS	248	1966-20L-G	394	1966-28C-F	390	1966-90L-F	396
151CX	248	1966-20L-K	394	1966-28C-G	390	1966-90L-G	396
151K	248	1966-20L-P	394	1966-28C-K	390	1966-90L-K	396
153YS	248	1966-24BCOV	392	1966-28C-P	390	1966-90L-P	396
160TR	378	1966-24B-F	392	1966-28HCOV	388	2160-C	108
161TO	382	1966-24B-G	392	1966-28H-F	388	2160R	112
162TO	382	1966-24B-K	392	1966-28H-G	388	2160RS	112
162TR	378, 384	1966-24B-P	392	1966-28H-K	388	2160S-C	108
163TR	378, 380	1966-24CCOV	390	1966-28H-P	388	2161-C	110
164TR	372	1966-24C-F	390	1966-28LCOV	396	2161P	110
164TR-F2	372	1966-24C-G	390	1966-28L-F	396	2161S-C	110
164TR-VB	372	1966-24C-K	390	1966-28L-G	396	2162P	114
164TR-VBO	384	1966-24C-P	390	1966-28L-K	396	2162R	114
165TR	374	1966-24HCOV	388	1966-28L-P	396	2162RS	114
165TR-F2	374	1966-24H-F	388	1966-355	270	2163-C	110
165TR-VB	374	1966-24H-G	388	1966-355COV	270	2163R	114
169TR	380, 384	1966-24H-K	388	1966-41	272	2163RS	114
1705L-N	224	1966-24H-P	388	1966-41COV	272	2163S-C	110
1709Y-N	224	1966-24LCOV	394	1966-41P	272	2165	116
1715L-BRM	222	1966-24L-F	394	1966-42	272	23A	152
1715L-GLD	222	1966-24L-G	394	1966-42COV	272	23AK-N	152
1715L-N	222	1966-24L-K	394	1966-42P	272	23C	152
1719Y-BRM	222	1966-24L-P	394	1966-45H	266	23CH	152
1719Y-GLD	222	1966-25	270	1966-45HCOV	266	23CK-N	152
1719Y-N	222	1966-250	270	1966-45P	266, 268	23DOLLY	152
1725A-BRM	222	1966-250COV	270	1966-46B	268	23GA	152
1725A-GLD	222	1966-250P	270	1966-46BCOV	268	23TR24	360
1725A-N	222	1966-255	270	1966-46C	268	23TR27	360
172TR	370, 384	1966-255COV	270	1966-46CCOV	268	23TR36	360

<i>pattern no.</i>	<i>page</i>	<i>pattern no.</i>	<i>page</i>	<i>pattern no.</i>	<i>page</i>	<i>pattern no.</i>	<i>page</i>
23TR42	360	256AS-L	198	412	70	46C	174
23TRH24	360	256CKIT-L	198	412-C	58, 70	46C-U	174
23TRH27	360	256CS-L	198	41A	124	47TR15	348
23TS24	360	256LACE-L	198	41A-KC or 41AW-KC	124	47TR19	350
23TS30	360	257C	194	41AW-U	124	47TR22	350
23TSH24	360	258LS	200	41AW-U-KC	124	47TR24	348
23TSH27	360	259TS-G	342	41C	126	47TR26	348
241LS	196	27A	172	41C-KC or 41CW-KC	126	47TR30	348
242LS	196	27AGA	172	41CW-U	126	47TR50	348
245A-C	190	27C	170	41CW-U-KC	126	47TR72	348
245A-S	190	27CGA	170	41R	124, 126	47TS15	346
245AT-C	190	27DOLLY	170, 172	420C	52	47TS20	346
245AT-S	190	29C	212	420C-CO-K	52	47TS31	346
247LS	196	29K	212	420C-CO-KP	52	47TS48	346
2480	318	29TR-23-DE	356	420C-CO-U	52	47TS64	346
2480D	318	29TR-23-LM	356	420CT-K	54	48A	232
2481D	318	29TR-27-DE	356	420CT-KP	54	48R	232
2482	320	29TR-27-LM	356	420CT-U	54	4901	292
2482T	320	29TR-35-DE	358	420F	52, 54	4901K-N	292
2485D	326	29TR-35-LM	358	420K	52, 54	4901K-S	292
248LS	196	29TR-43-DE	358	420KP	52, 54	4902	294
250LC	200	29TR-43-LM	358	420P	52, 54	4902K-N	294
250LC-S	200	29TR-H-23-DE	356	421F	60, 62	4902K-S	294
250LS	200	29TR-H23-LM	356	421FS	60	49100D	292, 294
2510T	332	29TS-27-DE	356	421K	60, 62	49TR-36	412
2510()	332	29TS-27-LM	356	421KS	60	49TR-36-G2	412
2510T()	332	29TS-35-DE	358	421L	60	49TR-36-G3	412
2511T	332	29TS-35-LM	358	421LCO-K	60	49TR-36-SN	412
2511()	332	3	250, 254	421LCO-U	60	49TR-42	412
2511T()	332	30C2-A	104	421L-GLD-K	60	49TR-42-G2	412
2515T	334	30C3-A	104	421LS-C-K	60	49TR-42-G3	412
2515()	334	30C-A	104	421LS-C-U	60	49TR-42-SN	412
2515T()	334	311-F1	354	421LT-K	62	49TR-48	412
2517T	334	311-F2	354	421LT-U	62	49TR-48-G2	412
2517T()	334	312-F1	354	422F	60	49TR-48-G3	412
251YC	200	312-F2	354	422L	60	49TR-48-SN	412
251YC-L80	200	3710T	362	423F	64	49TS-30	412
251YC-S	200	3712T	364	423L	64	49TS-30-G2	412
251YS	200	3714T	364	424F	64	49TS-30-G3	412
252	342	3716T	362	424Y	64	49TS-30-SN	412
2520T-C	322	37A	234	427C	58	49TS-36	412
2521T-C	322	37A-U	238	427C-CO-K	58	49TS-36-G2	412
2521T-C-G2	322	37C	234	427C-CO-KP	58	49TS-36-G3	412
2522T-C	322	37C-U	238	427C-CO-U	58	49TS-36-SN	412
2523T-C	324	37R	234	427F	58	49TS-42	412
2524T-C	324	37R-T	234	427K	58	49TS-42-G2	412
252C	342	38A	118	427KP	58	49TS-42-G3	412
252C-SFG	342	38A-KC or 38AW-KC	118	427P	58	49TS-42-SN	412
252-SFG	342	38AW-U	118	428C	56	4-C-LG-N	102
2530Y2C	136	38AW-U-KC	118	428C-CO-K	56	4-C-LG-S	102
2530Y3C	136	38C	120	428C-CO-KP	56	4-C-SD-N	100
2541M	328	38C-KC or 38CW-KC	120	428C-CO-U	56	4-C-SD-S	100
2542M	328	38CW-U	122	428F	56	4DOLLY	100
2543M	330	38CW-U-KC	122	428K	56	4GA	100
2544M	330	38R	122	428KP	56	4LGSEAT	102
2545M	328	400K	68	428P	56	4SDSEAT	100
2546M	328	400Y	68	429F	66	50A-5-B	94
2547M	330	410	70	429K	66	50A-5-BE	94
2548M	330	410-C	70	429L	66	50A-7	94
2549M	330	410K	68	44A	236	50AR-5-B	94
255A-C	192	410Y	68	44AU	240	50AR-5-BE	94
255A-S	192	410Y-SK	68	44R	236	50AR-7	94
255C-C	192	411	70	46A	174	50C-1-B	96
255C-S	192	411-C	70	46A-U	174	50C-1-BE	96
256AKIT-L	198					50C-2	96

<i>pattern no.</i>	<i>page</i>	<i>pattern no.</i>	<i>page</i>	<i>pattern no.</i>	<i>page</i>	<i>pattern no.</i>	<i>page</i>
50CR-1-B	96	68C	168	91K	128	AAR6	88
50CR-1-BE	96	68R	166	92C-GC	128	AAR6 cushions	88
50CR-2	96	69	166	92C-GC-K	128	AAR6S	88
50CS	290	69R	166	92K	128	AAR7	88
50KIT	290	70L	258	93A-GC	130	AAR7 cushions	88
50KIT-L	290	70LM	262	93A-GC-K	130	AAR7S	88
50L	98	70LS	264	93K	130	AAR8	82
50LACE	290	71A	250	94K	130	AAR8 cushions	82
50T1	304	71A-T5G	250	94L-GC	130	AAR8S	82
50T2	304	71A-W	252	94L-GC-K	130	AAR9	82
53D1	288	72C	254, 256	94LY-GC	130	AAR9 cushions	82
53D2	288	72C-T5G-H	254	94LY-GC-K	130	AAR9S	82
53D3	288	72C-W	256	94YK	130	BO10C-AE	50
53S1	288	73	168	95T-36-G2-GC	314	BO10C-AP	50
53S2	288	73L	260	95T-36-W-GC	314	BO10CO	50
53S3	288	73R	168	95T-40-G2-GC	314	BO10CO-K	50
58A	106	74Y	258	95T-40-W-GC	314	BO11C	50
58A-R	106	74YM	262	AAC1	72	BO11C-AE	50
58C	106	75	336	AAC1 cushions	72	BO11C-AP	50
58C-R	106	751	202	AAC1S	72	BO11C-K	50
59Dolly	174	751LT	202	AAC2	74	BO15L	38
614TS-KC-KC	366	752	202	AAC2 cushions	74	BO15R	38
614TS-KE-D	366	752LT	202	AAC2S	74	BO2	38
614TS-LWT-LWT	366	753	204	AAC3	74	BO21T-AE	302
618TR-KC-KC	366	753LT	204	AAC3 cushions	74	BO21T-K	302
618TR-KE-D	366	754	204	AAC3S	74	BO3	38
618TR-LWT-LWT	366	754LT	204	AAC4	72	BO30-AL-3	46
6242	308	755	206	AAC4 cushions	72	BO30-AL-P	46
6248	308	755LT	206	AAC4S	72	BO30-AU-3	46
6254	308	756	206	AAC5	76	BO30-AU-P	46
6260	310	756LT	206	AAC5 cushions	76	BO30-C-3	46
6272	310	759	344	AAC5S	76	BO30-C-P	46
6348	306	760	344	AAC6	76	BO31-AL-3	48
6354	306	790	230	AAC6 cushions	76	BO31-AL-P	48
6360	306	80D	300	AAC6S	76	BO31-AU-3	48
642TR-KC-KC	366	83ANCHOR	162	AAC7	76	BO31-AU-P	48
642TR-KE-D	366	83Y-K	160	AAC7 cushions	76	BO31-C-3	48
642TR-LWT-LWT	366	83YM	160	AAC7S	76	BO31-C-P	48
643TA-KC-KC	366	83YMW	160	AAR1	78	BO4	38
643TA-KE-D	366	84Y-K	160	AAR1 cushions	78	BO5L	38
643TA-LWT-LWT	366	84YM	160	AAR10	84	BO5R	38
643TAS-HB-HL	368	84YMW	160	AAR10 cushions	84	BO6	40
6472	312	85T32M	162	AAR10S	84	BO7	40
6484	312	87A	176	AAR11	84	BO8P	44
6496	312	87A-K-N	176	AAR11 cushions	84	BO9P	44
654LA	246	87A-K-S	178	AAR11S	84	BOC1	42
654LC	246	87AS	188	AAR12L	86	BOC2	42
654L-KIT	246	87C	180	AAR12L cushions	86	C	306, 308, 310, 312
657	228	87CH	188	AAR12LS	86	CB1-C	90
666C	242	87C-K-N	180	AAR12R	86	CB1-L	90
666C-KIT	242	87C-K-S	182	AAR12R cushions	86	CB2-C	90
666CS-HB	244	87CM	188	AAR12RS	86	CB2-L	90
666CS-KIT	244	87CS	188	AAR1S	78	CB3	90
666CS-WB-HB	244	87CSB	184	AAR2	80	CBP1	92
666CS-WB-KIT	244	87CSB-K-N	184	AAR2 cushions	80	CBP2	92
666C-WB	242	87CSB-K-S	186	AAR2S	80	CX	306, 308, 310, 312
666C-WB-KIT	242	87Dolly	178, 182, 186	AAR3	80	DS02	406
667Y	242	87-F1	354	AAR3 cushions	80	DS04	406
667Y-KIT	242	87-F2	354	AAR3S	80	DS06	406
667YS-HB	244	87GA	178, 182	AAR4	78	DS08	408
667YS-KIT	244	87TABLET	178, 182	AAR4 cushions	78	DS10	408
67	164	91A-GC	128	AAR4S	78	DS12	408
67R	164	91A-GC-K	128	AAR5	88	DS14	410
67S	164	91C-GC	128	AAR5 cushions	88	DS16	410
68	166	91C-GC-K	128	AAR5S	88	FA-20HCOV	400

<i>pattern no.</i>	<i>page</i>	<i>pattern no.</i>	<i>page</i>	<i>pattern no.</i>	<i>page</i>
FA-20H-G	400	L	174	TOP-15	276
FA-20H-K	400	MK01A	154	TOP-25	276
FA-20H-P	400	MK01AU	154	TOP-250	276
FA-26HCOV	400	MK01C	156	TOP-250COV	276
FA-26H-G	400	MK01CU	156	TOP-25COV	276
FA-26H-K	400	MK01R	154, 156	TOP-28	402
FA-26H-P	400	MK01RCN	154, 156	TOP-45	276
FA-28HCOV	400	MK02A	158	TOP-455	276
FA-28H-G	400	MK02C	158	TOP-455COV	276
FA-28H-K	400	MK02R	158	TOP-45COV	276
FA-28H-P	400	MK02RCN	158	TR	170
FA-45COV	278	MK11	340	TSC	276
FA-45P	278	MK12	340	TSCOV	276
FA-45TB	278	MK13	340	TSCOV4	276
FA-60HCOV	400	MK14	340	TSOP	276
FA-60H-G	400	MK15	340	upchg, welt 132, 134, 202, 204, 206, 250, 252	
FA-60H-K	400	MK16	340	upchg,	
FA-60H-P	400	N10	352	cushions	108, 110, 112, 114, 284
FA-90HCOV	400	N19-AW	208	upchg,	
FA-90H-G	400	N20-DF	352	cushionsS	286
FA-90H-K	400	OAC1	210	upchg,	
FA-90H-P	400	P	190, 192	cushionsSO	286
G	190, 192, 292	P320COV	386	WC1T	296
G [4902]	294	P320-K	386	WC2T	296
GL	306, 308, 310, 312	P320-W	386	WL21F	34
H	216	P321COV	386	WL21S	34
JL1-P	132	P321-K	386	WL23	34
JL1-PLT	132	P321-W	386	WL25T	298
JL1-W	134	P322COV	386	WS1CA	36
JL1-WLT	134	P322-K	386	WS1CA-CC	36
JL2-P	132	P322-W	386	WS1CA-NCU	36
JL2-PLT	132	R	226, 250, 254	WS1CA-NO	36
JL2-W	134	SM1-1	282	WS2CN	36
JL2-WLT	134	SM1-2	282		
JL3-P	132	SM1-3	282		
JL3-PLT	132	SM2-1	284		
JL3-W	134	SM2-2	286		
JL3-WLT	134	SM2-3	286		
KE1101C120	148	SM2S-1	284		
KE1101C48	148	SM2S-2	286		
KE1101C72	148	SM2S-3	286		
KE1200C120	148	SM8A	280		
KE1200C48	148	SM8A-U	280		
KE1200C72	148	SM8R	280		
KL1	142	SM9	404		
KL10	140	SM91	404		
KL11	140	SM92	404		
KL2	142	SM93	404		
KL3	144	SWELL-20P	274		
KL4	140	SWELL-31	274		
KL5	142	SWELL-31COV	274		
KL6	142	SWELL-31P	274		
KL7	144	SWELL-32	274		
KL8	144	SWELL-32COV	274		
KL9	140	SWELL-33	274		
KLCT1	146	SWELL-33COV	274		
KLCT2	146	T	234		
KLCT3	146	TBP	276		
KLCT4	146	TDCP	276		
KSP1	150	TC-30	402		
KSP1S	150	TC-42	402		
KSP2	150	TC-56	402		
KSP2S	150	TH	402		
KSP3	150	TI	402		
KSP3S	150	TLCP	276		

Selling Policy

	<p>This Selling Policy supercedes all previous selling policies. Prices, discounts and product offerings are subject to change without notice.</p>
Terms & Conditions of Sales	<p>Sales by Knoll, Inc. or Knoll North America Corp. ("Seller") of Knoll Product Lines (hereinafter "Products") within the United States and Canada are made only on the terms which are contained in this Selling Policy. Seller hereby gives notice of its objection to any different or additional terms and conditions. This sale is expressly conditional upon Purchaser's assent to the terms and conditions set forth below. Additional terms and conditions may apply to KnollStudio and KnollTextiles orders. These terms and conditions may be modified or supplemented only by a written document signed by an authorized representative of Seller. These terms and conditions supercede any prior and/or contemporaneous agreements or correspondence between Purchaser and Seller. Written quotations expire thirty (30) days from the date of issuance and can be withdrawn by written notice anytime during that period. Where Purchaser and Seller have entered into the Knoll Electronic Terms and Conditions, all orders, acknowledgements, invoices and other business communications placed or transmitted in accordance with the Knoll Electronic Terms and Conditions shall be deemed to be in writing and signed and shall be valid for all purposes as if they were originated and maintained in documentary form.</p>
Ordering Information	<p>All orders must be in writing. The product pattern number(s) contained on Seller's order acknowledgement shall be the final expression of the order.</p>
Order Confirmation	<p>A purchase order is not binding on Seller until Purchaser has received Seller's order confirmation or acknowledgment.</p>
Pricing Policies	<p>List prices are subject to change without notice.</p> <p>List prices shall be those prices in effect on the date of receipt of a complete purchase order unless shipment is requested more than ninety (90) days after order entry in which case prices in effect on the date of shipment apply. List prices include specified freight costs. Unless specified in writing by Seller, no other charges are included in Seller's list prices.</p>
Taxes	<p>All sales, use, excise and other taxes applicable to the sale of the Products shall be paid by Purchaser. If Purchaser claims an exemption from any tax, Purchaser shall submit to Seller the appropriate exemption certificates.</p>
Terms of Payment	<p>Payment for one hundred percent (100%) of the net order amount is due within thirty (30) days of the date of invoice, which is generally issued upon shipment. In case of any discrepancies, such as shortages, and Seller is notified in writing within ten (10) days of receipt of Product, only that portion may be deducted and the balance paid. For orders greater than \$100,000 net, a fifty percent (50%) deposit is due at the time of order placement, with the remainder due within thirty (30) days of the date of invoice.</p> <p>KnollStudio orders less than \$2,000 require payment for one hundred percent (100%) of the net order amount (including any applicable sales tax and charges for inside delivery, special packaging, etc.), due at time of order placement. For KnollStudio orders greater than \$2,000, a one-half (50%) deposit is due at time of order placement with the remainder (including any applicable sales tax and charges for inside delivery, special packaging, etc.) due prior to shipment.</p> <p>If, in the judgment of Seller, Purchaser's financial condition does not justify the terms of the payment, Seller may require full or partial payment in advance.</p> <p>Past due accounts shall be charged one and one-half percent (1.5%) per month, or the highest rate permitted by law, whichever is less, and will be added to the outstanding balance. In the event Purchaser defaults on payment, Purchaser shall be liable for all collection costs, including reasonable attorney's fees and costs.</p>
Changes and Cancellation	<p>Purchase orders may not be changed or cancelled, in whole or in part, without prior written consent of Seller. Changes may effect delivery dates. Expenses incurred because of changes shall be charged to Purchaser. In the event of cancellations, Purchaser will be liable for reasonable cancellation charges established by Seller. Orders for special Product, orders including "COM" (hereinafter defined) material and orders pursuant to expedited delivery programs, may not be canceled.</p>
Freight Prepaid	<p>Freight is prepaid and included in the price of all Products, except KnollTextiles, within the 48 contiguous United States for orders placed with Knoll, Inc. and within Canada, excluding the Yukon, Northwest Territories, Nunavut and Newfoundland for orders placed with Knoll North America Corp. Packing is tested for rigorous motion and transportation but is not guaranteed to protect furniture from all conditions. If special packaging is required for any reason, please consult with your sales representative or dealer. Seller shall select the method of shipment and routing. Freight for all KnollTextiles orders is prepaid and added to the invoice.</p>
Delivery/Freight Charges	<p>Shipments outside the contiguous 48 United States and Canada shall be shipped F.O.B. Origin.</p> <p>For shipments outside the contiguous United States and Canada, Purchaser is responsible for the cost of freight from point of embarkation, including any handling and transportation charges incidental to loading at the point of departure and unloading at the final destination.</p> <p>Conditions beyond the control of Seller, including weather, available facilities and traffic conditions, may affect exact time of delivery. Seller shall not be responsible for specific carrier delivery date or time unless it has made a specific delivery commitment, in writing.</p> <p>Nonstandard methods of shipment and/or additional services are available upon request. Purchaser will be billed for the differential cost of any special services in excess of standard surface carrier freight costs. Premium charges, at Purchaser's request, will be added for airfreight, exclusive use of vehicle and extra, export or special packaging. Accessorial charges will be added for inside delivery, extra labor, reconsignment and redelivery.</p> <p>Partial shipments may be made and invoiced by Seller.</p>
Claims	<p>All shipments for Knoll Products within the contiguous United States and Canada are F.O.B. Origin. All risk of loss passes to Purchaser at time of delivery to carrier. Purchaser shall inspect all Products upon receipt and notify Seller within ten (10) working days after receipt of any damage or defects which are, or should be, apparent from an inspection of the Product and its packaging. Failure of Purchaser to notify Seller during the ten (10) working day period shall constitute acceptance of the Products and waiver of any apparent defects, errors or shortages. For all claims relating to Product damaged in transit or for any other claims relating to or arising out of the transportation of the Product, Purchaser must seek recovery from the carrier and Seller has no liability to Purchaser for such claims. Seller may, upon request, assist Purchaser with filing of such claims with the carrier, but Seller will not be liable for any of these transportation related claims.</p>
Seller's Security Interest	<p>Until Seller receives the full payment for the Product, Seller shall have a security interest in the Product. Purchaser agrees to perform all acts, including but not limited to the execution and filing of documentation, which may be necessary to perfect and assure the security interest of Seller.</p>
Returns	<p>The return of Products without a written authorization by Seller shall not be accepted. To receive authorization for Product return, please call Customer Service. All Products that are returned pursuant to a valid authorization shall be subject to a twenty-five percent (25%) of list restocking charge. Products not currently offered for sale by Seller (including COM) shall not be authorized for return. All returned Products must be unused, in original condition and in the original Seller packing cartons. No refund or credit shall be given for damaged Products.</p>
Held Orders/Storage	<p>If Purchaser requests that an order be held or delayed, prices and terms and conditions in effect at the time of shipment shall apply. If Purchaser requests a delay after the time when Seller can defer production, Purchaser will be invoiced for the Product, payable in accordance with standard terms, when the order is ready for shipment. Seller may transfer the Product to storage, in which case all expenses incurred in connection with storage, including demurrage, preparation for storage, storage charges and handling shall be payable by Purchaser upon submission of invoices by Seller. Risk of loss to the Product shall pass to the Purchaser upon delivery of the Product into storage.</p>

Selling Policy

Customer's Own Material	A Purchaser who requests a fabric or other surface material not standard to Seller's line of Products ("COM") must submit samples of the requested material to Seller prior to entry of a purchaser order. Seller shall determine if the material is suitable to its manufacturing processes and meets any requirements of Underwriters Laboratories. If the COM is acceptable, Seller will then establish a price for using the COM or the Product in question. For a description of the procedures for submitting samples and testing, contact customer resources or your sales representative. Seller shall have no responsibility for the appearance, condition, performance, durability, colorfastness or any other physical attribute of the COM. Purchaser shall indemnify and hold Seller harmless for any damages, injuries or losses arising out of or related to use of the COM on the Product.
Warranty	<p>Seller warrants to the original Purchaser only that the Products Seller manufactures and sells to Purchaser are free of defects in workmanship and materials, during the applicable warranty period set forth below.</p> <p>Warranty period set forth below is for 24-hour, 7 days a week, multi shift use (includes parts and labor to repair).</p> <p>Should any failure to conform with this limited warranty appear to a Product listed below during the applicable warranty period from the date of shipment, Seller shall, upon prompt written notice, repair or replace, at its option and costs, the affected part or parts.</p> <p><i>Product and Period of Warranty</i></p> <p><i>Lifetime: Antenna Workspaces, AutoStrada, Calibre, Crinion Open Table, Currents, Dividends Horizon, Morrison, Reff Profiles laminate, Rockwell Unscripted, Series 2 Storage, Template and other non-wood components (except cascade edge worksurfaces, operational parts, controls, electrical, Lighting, Series 2 Veneer Front Storage, upholstery, textiles and leathers, special or custom products, see below)</i></p> <p><i>12 Years: Chadwick, Essentials Work Chairs, Generation by Knoll, k. task, Life, Moment, MultiGeneration by Knoll, ReGeneration by Knoll, Remix, and Toboggan seating (except seating upholstery, textiles, leathers and finishes, see below).</i></p> <p><i>10 Years: Anchor Storage except digital keypad lock, Antenna Workspaces, AutoStrada, Crinion Open Table, Dividends Horizon, Dividends Horizon Satellite Surfaces, Reff Profiles, Rockwell Unscripted, Template wood components, Series 2 Veneer Front Storage, cascade edge worksurfaces, Wood Casegoods (The Graham Collection) (except wood casegoods upholstered surfaces, see below), Reuter overheads, Reuter vertical storage, KnollExtra Sapper Monitor Arm Collection, Sapper XYZ Monitor Arm, Adjustable keyboard mechanisms and platforms, Communication Boards (except fabric board textiles, cork and FilzFelt, see below), Smokador collection (except leathers, see below), and Orchestra Universal Systems Accessories, k. lounge structural components, Tone Height-Adjustable Tables.</i></p> <p><i>5 Years: Operational parts, controls, electrical, Lighting (except light ballasts, bulbs and power supply, see below), special or custom product, wood veneer products and plywood, Currents handcrank, Interaction Counterforce, KnollStudio, Rockwell Unscripted wire bases, Spark Series seating structural elements, structural elements of all KnollStudio outdoor products including all Richard Schultz designed products, KnollExtra CPU storage and all universal storage drawers and Power Collection, k. stand (except changes in finish, see below).</i></p> <p><i>3 Years: Rockwell Unscripted upholstery (except textiles and leather), Office Seating upholstery, textiles, leathers and finishes. Fabric boards textiles and Smokador Collection leathers, KnollExtra Pop Up Screens.</i></p> <p><i>2 Years: Anchor Storage digital keypad lock, all other KnollExtra product</i></p> <p><i>1 Year: Light ballasts, bulbs and power supply, seating upholstered armpads and soft armpads, wood casegoods upholstered surfaces. KnollStudio, outdoor product finishes, k. lounge upholstery and k. lounge fabric. Rockwell Unscripted fabric and accessories.</i></p> <p>This warranty does not apply to:</p> <ul style="list-style-type: none">• Damage caused by a carrier other than the Seller.• Normal wear and tear or acts or omissions of parties other than Seller (including user modification, improper use or installation of Products).• COM or other third party materials applied to Products.• Products not installed by or under the auspices of a Knoll Dealer.• Dramatic temperature variations or exposure to unusual conditions.• Changes in surface finishes, including colorfastness due to aging or exposure to light.• Except as specifically noted above, textiles and upholstery supplied by KnollTextiles and Spinneybeck FilzFelt (consult current price lists for applicable warranties). <p>Natural variations occurring in wood, marble, and leather shall not be considered defects, and the Seller does not guarantee the colorfastness or matching of the colors, grains or textures, or surface hardness of such materials. The Seller also does not guarantee the colorfastness of fiberglass panel surfaces.</p> <p>THE EXPRESS WARRANTIES CONTAINED HEREIN ARE IN LIEU OF ALL OTHER WARRANTIES, EXPRESS OR IMPLIED, INCLUDING ANY WARRANTIES OF MERCHANTABILITY AND FITNESS FOR PARTICULAR PURPOSE AND ALL OTHER WARRANTIES ARISING FROM COURSE OF DEALING OR USAGE OF TRADE.</p> <p>The remedies provided above are the Purchaser's sole remedies for any failure of Seller to comply with its obligations regarding the workmanship of its Products. Correction of any nonconformity in the manner and for the period of time provided shall constitute complete fulfillment of all liabilities of Seller, with respect to or arising out of the Product furnished hereunder.</p>
Delay/Force Majeure	Seller shall not be liable for failure to perform or for delay in performance due to fire, flood, strike or other labor difficulty, act of God, act of any governmental authority or of the Purchaser, riot, embargo, fuel or energy shortage, wrecks or delay in transportation, inability to obtain necessary labor, materials or manufacturing facilities from usual sources or failure of suppliers to meet their contractual obligations, or due to any cause beyond its reasonable control. If any such event occurs, Seller may extend delivery dates by a period of time necessary to overcome the effect of such delay, allocate available Product or cancel any purchase order.
Compliance with Law	PURCHASER IS SOLELY RESPONSIBLE FOR COMPLIANCE WITH ALL APPLICABLE FEDERAL, STATE AND LOCAL LAWS, ORDINANCES, REGULATIONS, RULES AND STANDARDS RELATING TO THE INSTALLATION, MAINTENANCE, USE AND OPERATION OF THE PRODUCTS.
Patents	<p>Subject to the following provisions, Seller shall, at its own expense, defend or, at its option, settle any claim, suit or proceeding brought against the Purchaser, and/or its vendees, mediate and immediate, so far as based on an allegation that any Product or any part thereof furnished hereunder constitutes a direct or a contributory infringement of any claim of any patent of the United States or Canada. This obligation shall be effective only if Purchaser shall have made all payments then due hereunder and if Seller is notified promptly in writing and given authority, information and assistance for the defense of said claim, suit or proceeding. Seller shall pay all damages and costs awarded in such suit or proceedings so defended.</p> <p>The foregoing indemnity does not apply to the following:</p> <ul style="list-style-type: none">• Products supplied according to a design other than that of Seller, and which is required by the Purchaser.• Combination of the Product with another product not furnished hereunder unless Seller is a contributory infringer.• Any settlements of a suit or proceeding made without Seller's written consent.
Limitations of Liability	<p>SELLER, ITS CONTRACTORS, AUTHORIZED DEALERS AND SUBCONTRACTORS OR SUPPLIERS OF ANY TIER SHALL NOT BE LIABLE TO PURCHASER FOR ANY SPECIAL, INDIRECT, INCIDENTAL OR CONSEQUENTIAL DAMAGES ARISING FROM A BREACH OF THIS AGREEMENT.</p> <p>Purchaser's remedies set forth herein are exclusive and the liability of Seller with respect to the breach of this agreement or any contract entered into between the parties pursuant hereto shall not exceed the price of the Product or part on which such liability is based.</p>

General Ordering Information

The Products

This guide encompasses all standard products for this product group.

Sizes

Dimensions listed in this guide are indicated as:

H = height

W = width

D = depth

Dia. = diameter

Rad. = radius

Pricing

All prices shown are list.

How to Order

Select pattern numbers and quantities required for your complete installation. Product questions can be addressed in the specific sections of this guide or by contacting your sales representative or customer resource representative at 1-800-343-5665.

Next, select options (if required), along with colors and finishes appropriate to each product. Reference the Finishes and Fabrics pages for color designations.

On large installations, an item's "designated area" can be specified to assist in product organization and handling.

To expedite complete / correct entry of your order, be certain all pattern numbers, quantities, colors and area identifications are completely specified. Also, include complete purchase order numbers, bill-to and ship-to addresses, a contact name and specific factory shipping dates required.

Mail all orders to:

Knoll, Inc.

1235 Water Street

P.O. Box 157

East Greenville, PA 18041

Attention: Order Entry

Once your order is entered at Knoll, an acknowledgment will be mailed to you. You will be advised of your scheduled shipping date within five days of the original acknowledgment. If it is necessary to revise your order, please contact your customer resource representative.

Sustainability Statement

Sustainable design is a key component of Knoll's environmental focus. Our commitment to social responsibility and a healthy environment has prompted us to further articulate our longstanding environmental programs and, with encouragement and support from our colleagues in the industry, we have re-energized our focus on such "green" initiatives as life cycle analysis and LEED™ certification. Knoll is proud to have contributed to projects that have received LEED certification from the U.S. Green Building Council.

For the latest information on Knoll products that help our customers achieve LEED certification, log on to knoll.com, click on "About Knoll" and then "Environmental Focus."