

Private Offices



Design for the modern office.

Rooted in the pioneering work of Florence Knoll, whose table desk became a design icon, we have endeavored to design and produce furnishings for the private office appropriate to contemporary architecture and suited to the changing needs of today's workplace.

Whether it's a *distinguished* office, the refined expression of place; a *classic* office, designed to withstand the test of time; an *efficient* office, streamlined to the essence of what matters functionally; or a *progressive* office, which supports new work styles and a new spirit of work, this heritage provides the foundation as the modern office evolves from a symbol of prestige to a flexible meeting space.

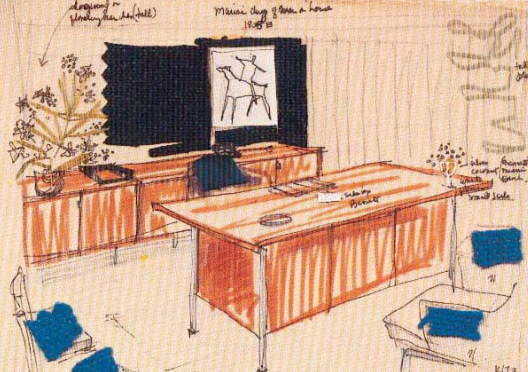
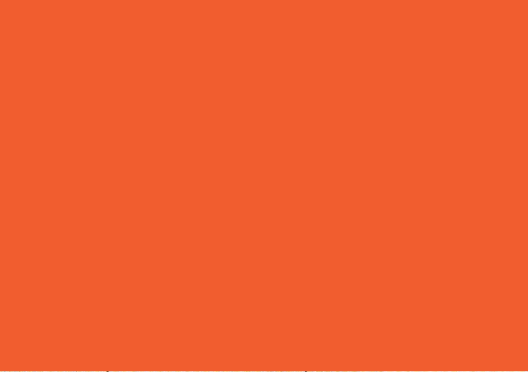



The Distinguished Office

Knoll balances functional and aesthetic needs with innovative, elemental forms that define the office. The result: modern, distinguished spaces that achieve a definitive expression of place and provide inspirational day-to-day settings for focused and collective work.



Definitive Form: Table Desks and Credenzas

Ross Lovegrove rectangular table, top, in Red Panelite™, with tri-oval table in Painted Blue acid-etched glass and credenza in White with Starphire™ glass top; Life® chair in Beige.

Florence Knoll table desk, left, in Arabescato Marble with Graham Collection™ double-tier open overhead, credenza with lateral files and hinged modesty in Teak Techwood; tackboard in Palladium, Talc; Sapper™ chair in Spinneybeck® Volo, Black.

AutoStrada™ table, worksurfaces and storage, opposite, in Smoked Walnut; Saarinen Executive chair in Spinneybeck Sabrina 0785, White; Tubular Brno chair in Spinneybeck Velluto Pelle 0559, Gull; and Barcelona® chair in Spinneybeck Arizona 1028, Secret Mountain.





The Classic Office

Knoll creates offices characterized by clean lines that withstand the test of time, melding unassailable structure with rich materials. Typically including a freestanding desk and complementary storage, the classic office conveys integrity of form and function.



Classic Design: Enclosed Desks and Storage

Reff® desk, opposite, in Teak Techwood with 1¾"-thick worksurfaces, and storage with J-pulls form a wrap-around work space with open and enclosed double-height overheads with cubby. Tackable panel in Knoll Hopsack, Silver; Sapper™ Executive chair in Spinneybeck® Volo, Black; Saarinen Executive side chair in Cato, Ivory with Ebonized Walnut legs.

Graham Collection™ rectangular top, double pedestal desk in Bronze Cherry, top, with stepped modesty panel and Spinneybeck leather blotter; Freestanding credenza with double-tier, hinged door overhead and hinged door desktop tower, with Satin Bronze metal pull tabs. Tackboard in English Accent, Earl Grey; Life® chair in Platinum; de Armas side chairs in Cherry finish with Icon, Elizabeth seat.

Magnusson® double pedestal desk and kneespace credenza and 5-high bookcases, right, in Peacock Green Walnut. Life chair in Grain; Crinion side chair in Walnut with Pogo, Hopscotch seat.





The Efficient Office

Knoll excels at connecting the vitality of streamlined architectural and design qualities with furniture that's logical and affordable. Marked by the judicious interplay of table desk, worksurfaces, storage and display shelves, the efficient office gets to the essence of what matters.



Efficient Expression: Workwall and Desk Integration

Reff® worksurfaces in Chalk Oak veneer, top, with Calibre™ pedestals and AutoStrada™ diamond legs in Bright White, AutoStrada double-tier overhangs with sliding doors in White laminate with frosted glass sliding doors. Tackboard in Knoll Felt, Apple; Chadwick™ chair in Platinum; Saarinen armless chair in Cato, Ivory with Light Oak legs.

AutoStrada L-leg desk with partial modesty and credenza, left, with wide metal pedestals, in Peacock Green Walnut with Medium Grey painted finish legs and pulls. AutoStrada applied wall 84"H x 120"W with marker surface and veneer covers, open shelves and open overhead storage cabinets in Peacock Green Walnut. Life® chair in Avocado; Sprite™ chairs in White and Lime.

Dividends Horizon™ Natural Techwood worksurface, opposite, with AutoStrada Clear Anodized Aluminum L-legs; New Knoll storage system in Medium Grey; Life chair in Rouge with Knoll Hopsack, Melon seat; X3 stacking chair in Tangerine.





The Progressive Office

Knoll sets the standard for perfectly planned offices that combine forward-thinking vision with a collaborative eye. Cohesive individual and shared office compositions with adeptly blended materials, the progressive office conveys an adventurous spirit of work.



Progressive Planning: Informal and Shared Spaces

Graham Collection™ wall-mounted shelves and mobile pedestal in Light Oak veneer, opposite, with Saarinen table and plastic back armless chair with Icon, Marilyn seat; Chadwick™ chair in Silver, Cini Boeri sofa in Knoll Felt, Grey, and ottomans in Knoll Felt, Canary and Tangerine.

AutoStrada™ table, credenza, wall-mounted overhead storage and freestanding storage cabinet, top, in Bronze Cherry veneer; Life® chairs in Beige with Decade, Hip Hop seat.

Propeller® C-leg tables and table returns with screen and shelves, right; Propeller rolling cart; AutoStrada applied wall 84"H plus 22½" add on frames in Burnt Walnut veneer, marker surface and tackable Forbo linoleum covers; Clear Anodized Aluminum display shelves and marker trays. Chadwick chairs in Black.



Planning the Changing Office

In today's increasingly open work environments, private offices are more connected to open plan and activity areas than ever before. Often separated from adjacent open areas only by glass, they are better integrated into the overall architectural space and work styles of the workplace.

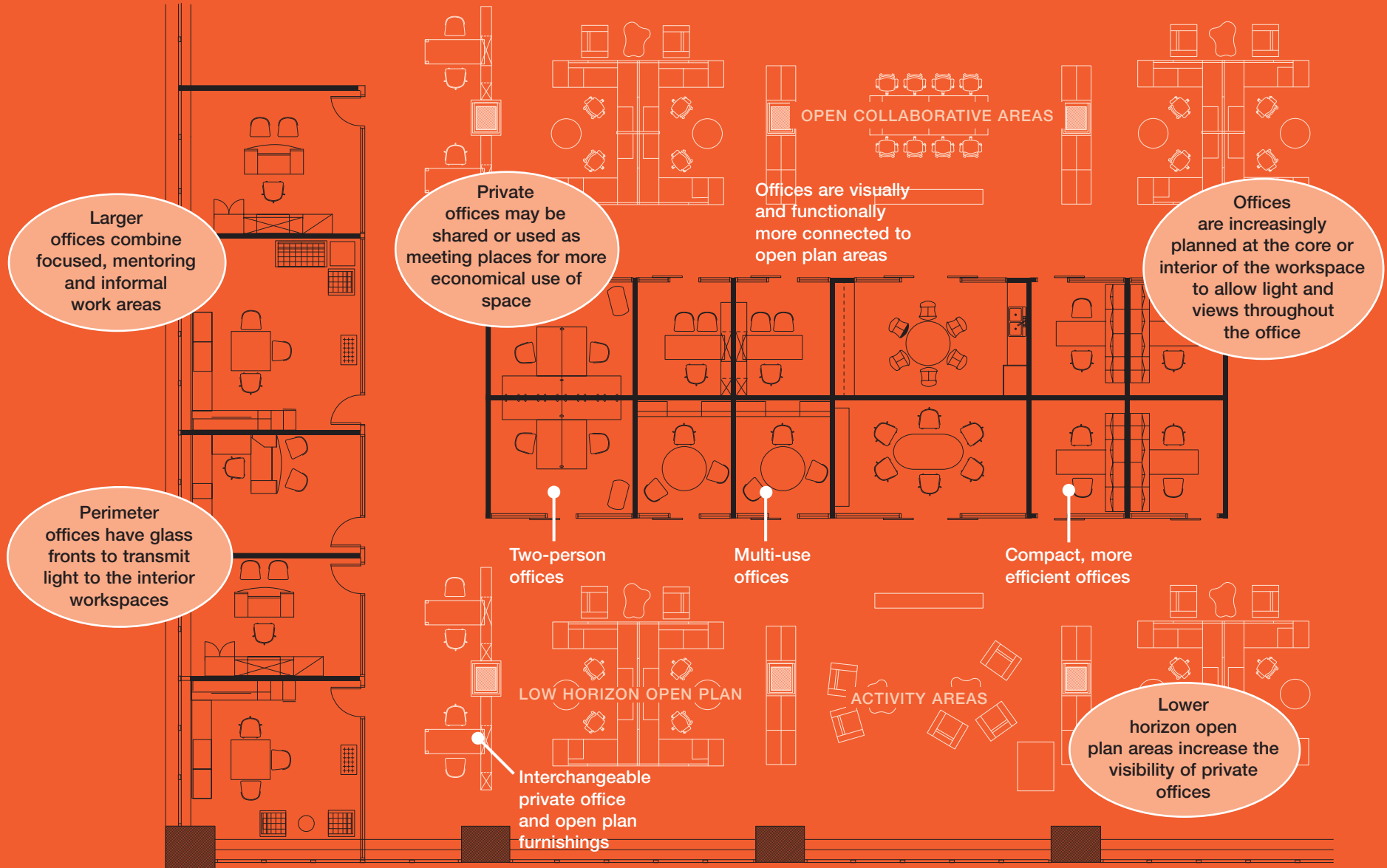

Planning Compact 10' x 12' Offices

Distinguished by quality

A tall storage cabinet and an open peninsula desk makes this compact office feel prestigious.

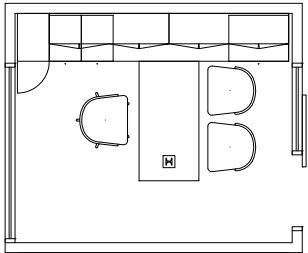

12'

- Reff® 120" x 24" and 60" x 30" worksurfaces
- Graham Collection™ wide-flange leg
- Reff 16"W cabinet and 30"W wood pedestals
- Reff 60"W double-high overheads
- Pollock™ chair
- Saarinen Executive side chairs

Classic form

The classic office often includes wall-mounted overheads and a wrap-around worksurface layout.

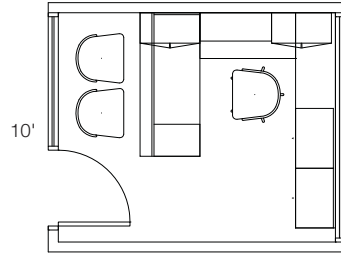

12'

- Reff 72" x 30" desk, 48" x 24" bridge and 108" x 20" credenza
- Reff 36"W double-high open and 30"W enclosed overheads
- Life® chair
- Ricchio armless chairs

Efficient and transparent

The efficient office typically includes a storage wall and a table-like desk return to optimize space.

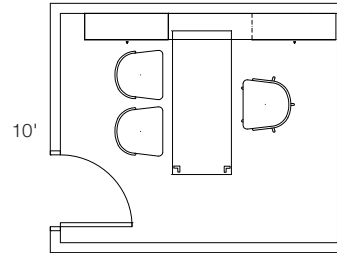

12'

- Storage system 125"W x 15"D
- Dividends Horizon™ 72" x 30" worksurface
- AutoStrada™ L-legs
- Life chair
- X3 side chair

Progressive flexibility

The progressive office may also serve as a meeting room when the primary user is away from the office.

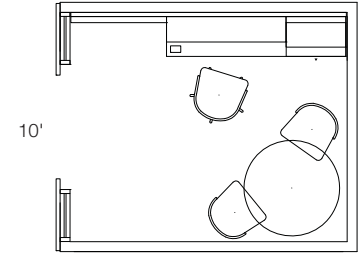

12'

- AutoStrada 84"H x 114"W Applied Wall system with marker, tackable, veneer and slatwall surfaces
- AutoStrada 90" x 42" worksurface with 30"W metal AutoStrada pedestal
- AutoStrada mobile 48" round table with casters
- Chadwick™ chairs

Planning Standard 12' x 15' Offices

Distinguished refinement

This medium size office is generous enough for a formal credenza and table desk with two or more visitor chairs.

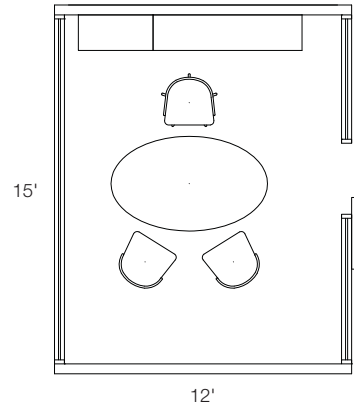

- Florence Knoll 78" table desk
- Florence Knoll 37½" and 75" credenzas
- Pollock chair
- Brno side chairs

Classic surround

The classic office typically features an enclosed desk, open bridge and credenza, for a complete worksurface surround.

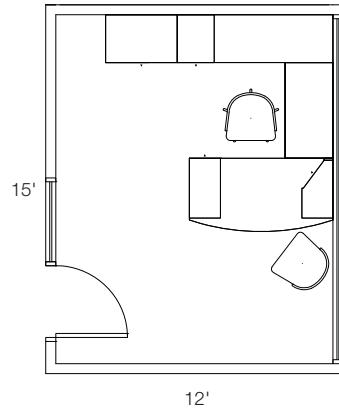

- Graham Collection™ 72" x 37" flush modesty single pedestal desk with corner shelf, 48" bridge and 108" credenza for U configuration
- Life® chair
- JR® side chair

Efficient combination

Efficient offices may combine elements of systems furniture and metal storage for aesthetics as well as economy.

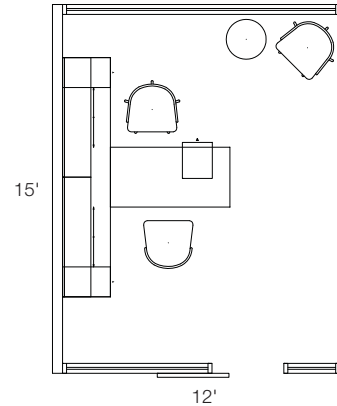

- Reff® 120" x 24" and 60" x 30" worksurfaces
- Calibre™ 15"W floorstanding and mobile pedestals
- AutoStrada™ 60"W double-high overhead cabinets with sliding doors
- Life chair
- Saarinen Executive side chairs

Progressive shape

Progressive offices may feature more mobile elements, like these freestanding storage units and tables.

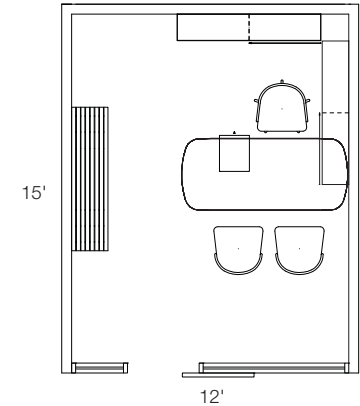

- Dividends Horizon™ 84" x 30" Y-leg table
- Dividends Horizon 72" credenzas and 72" sliding door overdesk
- Series 2 mobile pedestal
- Chadwick™ chair
- Sprite™ chairs

Planning Larger 15' x 15' and 15' x 20' Offices

Distinguished restraint

Larger offices open up space for additional lounge furniture as well as visitor chairs.

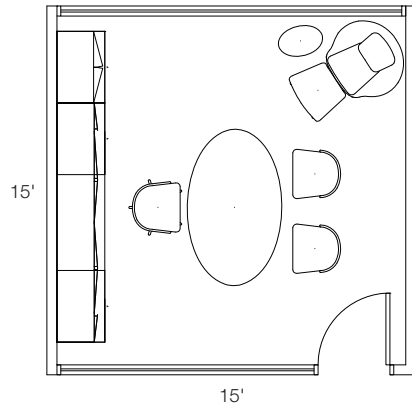

- Florence Knoll 78" table desk
- Graham Collection™ 120" x 24" credenza and 120" double-high overhead
- Graham Collection 85"H freestanding cabinet
- Life® chair
- Saarinen Executive side chairs

Classic status

A substantial storage wall frames the focused work area, while the desk supports small meetings.

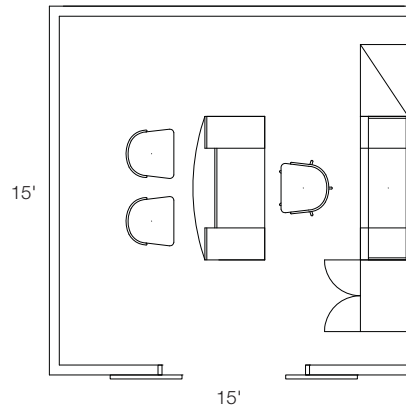

- Reff® 72" x 36" bow front desk
- Reff 72" credenza and wall-hung overhead
- Reff 72"H x 36"W freestanding cabinets
- Life chair
- Shelton Mindel side chairs

Distinguished collaboration

The largest offices present the opportunity for multiple work areas: focused, collective and casual.

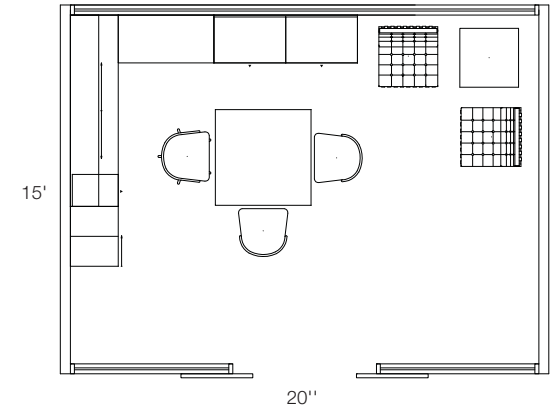

- AutoStrada™ 48" x 48" diamond-leg table
- Autostrada 96" and 120" worksurfaces and AutoStrada wood pedestals
- AutoStrada 96" wall attached, double-high overhead and 84"H x 30"W freestanding cabinet
- Life chair
- Shelton Mindel side chairs

Planning Elements for Total Design

Knoll offers a complete range of worksurface, wall mounted overhead, workwall and other complementary storage components designed with standards of simplicity and visual proportion to solve the practical needs of the modern office.

Cubby Storage

Easily accessible cubby storage offers architectural interest and detail while supporting work in progress.



Wall Surface Options

The range of Knoll tackable surfaces, slatwall and marker board options offer a refined and functional backdrop for work.



Technology Support

The convenient positioning of outlets and displays facilitates workspace efficiency, with options ranging from desk grommets to monitor arms.



Power and Data

Hinged modesty panels enable discreet, yet unobstructed, access to power and communications.

Task and Guest Seating

The complete range of Knoll work and guest chairs offers thoughtful design, comfort and choice for any office where focused or collective work occurs.

Architectural Presence

Graham Collection™ double-wide hinged-door desktop tower, double-tier hinged-door and open overhead, credenza with pedestal, lateral files and open shelf/file drawer storage, right, in Bronze Cherry; tackboard in Palladium, Abalone; Life® chair in Beige; JR® chair with Cherry finish, fully upholstered in Rivington, Spruce.





Vertical Storage

Knoll storage products maximize storage capabilities without compromising available workspace. Lateral files, pedestals and vertical cabinets organize and personalize offices with style.



Overhead Storage

Versatile wall mounted overhead storage options include open shelves and closed cabinets, with hinged or sliding doors, in veneer or glass.

Desk Height Storage

The range of Knoll desk height storage offers design flexibility that helps keep workspaces clear and offices organized.

Lower Storage

Effective use of pedestals, lateral files and open shelves also creates more usable desk space.



Worksurface Support

Signature table legs, end panels and modesty panels create a range of aesthetics to define the desk.





Material and Finishes for Sustainable Design

Throughout our history, Knoll has been a leader in defining the private office as a place to celebrate tactile, enduring materials and finishes that reflect the Knoll standard of design. Our legendary attention to detail and the quality of our work have resulted in landmark offices for companies, government agencies, healthcare organizations and educational institutions of all sizes.

Knoll knows that the careful coordination of fabric, finishes, furniture and accessories to the scale and nature of the architectural space creates a harmonized aesthetic for the private office. Over the years, this tradition has evolved with a complementary emphasis on sustainable design practices and clean manufacturing technologies, making Knoll a leader in policies and practices designed to protect the biosphere, conserve natural resources and reduce waste.

Today, our ambitious environmental program includes a comprehensive wood policy to ensure that illegally harvested wood is not used in Knoll products, as well as partnerships with the GREENGUARD® Environmental Institute; the Forest Stewardship Council; the U.S. Green Building Council's Leadership in Energy and Environmental Design (LEED®) program and the Institute for Market Transformation to Sustainability, which administers the SMaRT® product certification program. These partnerships assure that our customers can trust environmental claims about our products.



Attention to Detail

Knoll has built a reputation for forward-thinking products, made from both traditional and innovative materials. The Knoll palette of natural and Techwood veneers, glass and marble along with complementary KnollTextiles fabrics and Spinneybeck® leathers ensures that the spirit of total design applied to Knoll furniture defines a personality for the office. Graham Collection credenza and desk return, top, in Teak with Spinneybeck Riva leather; Saarinen table with an Arabescato marble top, center. Ross Lovegrove Rectangular Table, bottom, is available in a number of innovative finishes and materials, including Panelite™ cast polymer tops, which are produced without the use of fuel-based energy and consist of inner cores made from up to 80% post-consumer recycled plastic.

Reff private office, opposite, in Smoked Walnut veneer with wall-hung double-height overheads, wood pedestals with J pull, 1¼" rectilinear worksurfaces with Graham Collection wide flange leg, tall cabinet with shelf and coat bar. Tackboard in Interknit, Grotto. Life® chair in Platinum with Kimono, Kuchiba seat. Flat Bar Brno chair in Spinneybeck Velluto Pelle 0004, Talc.



Private Offices

With more than seven decades of experience in office design and an outstanding range of appropriate products for the private office, including KnollStudio furnishings, intelligent systems, casegoods, storage, innovative seating and accessories, Knoll supports four distinctive office archetypes:

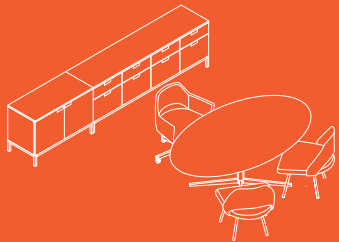

Distinguished
The definitive expression
of place

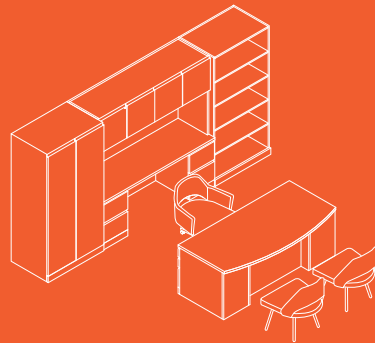

Classic
Designed to withstand
the test of time

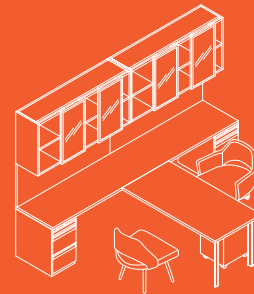

Efficient
Streamlined to the essence
of what matters

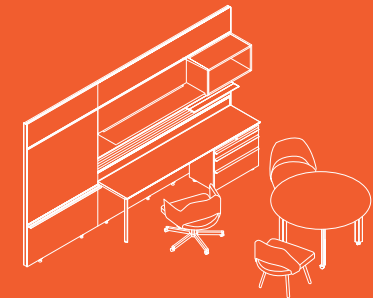

Progressive
Articulating the adventurous
spirit of work

On the cover, Graham Collection™ wall-hung shelf and hinged/flip door combination credenza with open shelf center in Chalk Oak veneer; tackboard in English Accent, Porcelain; Florence Knoll table desk with Brown Emperador marble top; Pollock chair in Spinneybeck® Volo, Black leather; wallcovering in Giza, Oyster.