

Assembly Instructions  
**MODEL NO.:NTT2436/2448/2460/2472**  
 RECTANGLE SHAPED

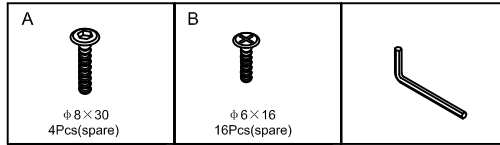

STEP1

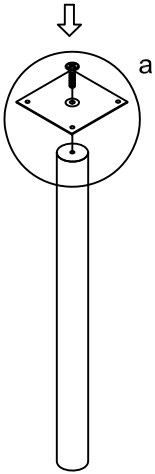

STEP2

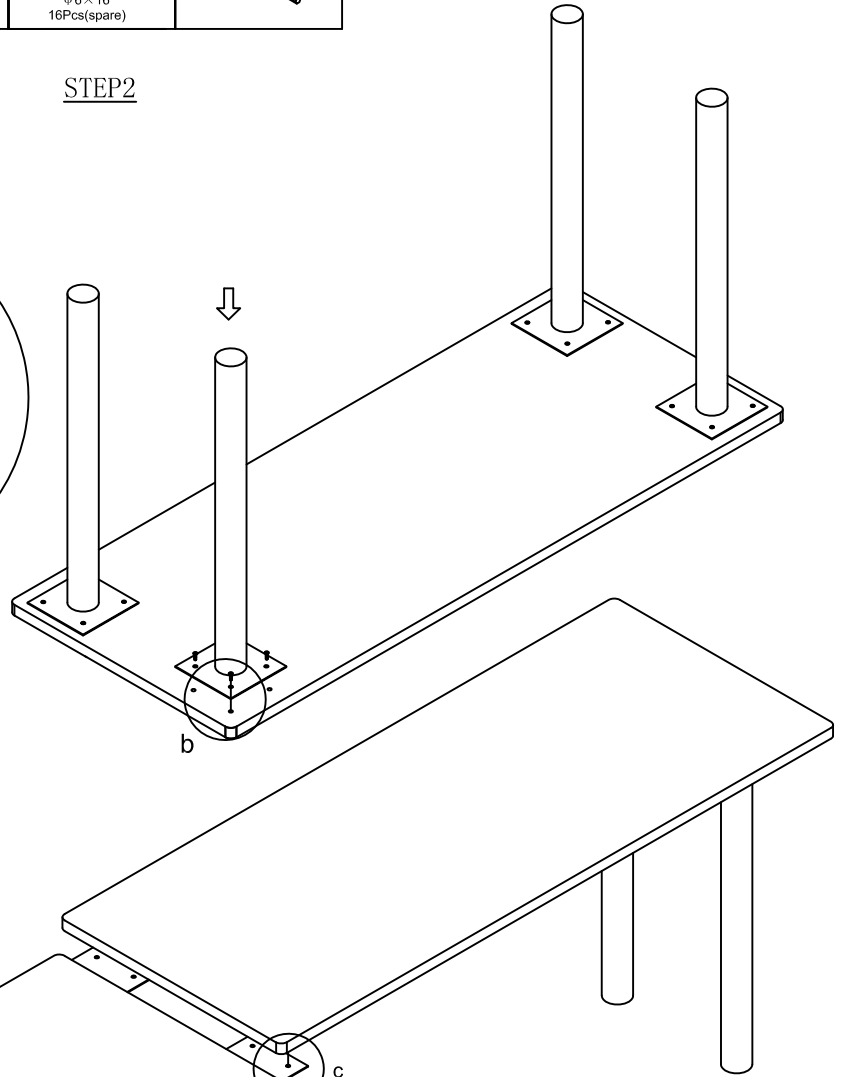
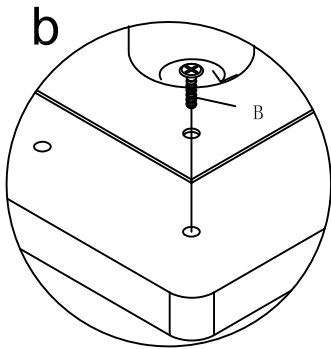
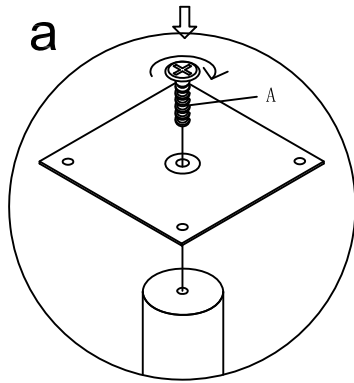

STEP3

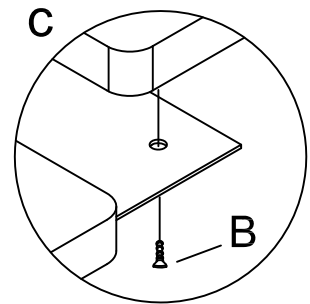
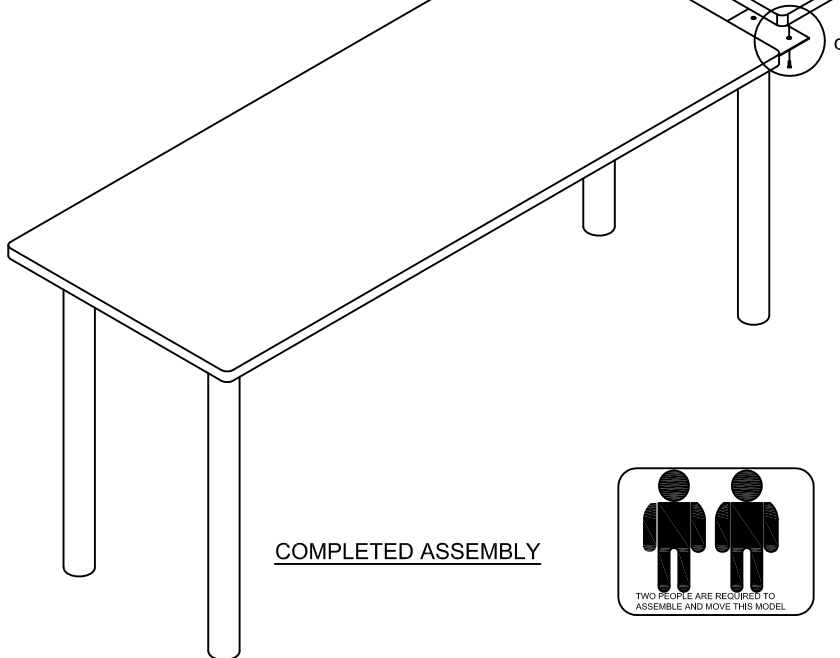

COMPLETED ASSEMBLY

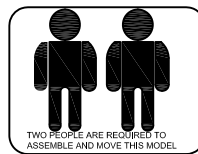

**IMPORTANT NOTE**

- Place all wooden parts on clean and smooth surface such as a rug or carpet to avoid the parts from being scratched.
- Check to be sure that you have all parts and hardware.
- Remove all wrapping materials, including staples & packing straps before you start to assemble.
- Do not tighten all screws/bolts until all completely assembled.
- Keep all hardware parts out of reach of children.