

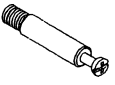





Assembly Instructions MODEL NO.:N147

Bullet Desk

TUN010CL	TUN011KC	TUN026	TUN021AG	TUN013LB	TUN018SC	
A  Cam Lock 9Pcs+2Pcs(spare)	B  Klix Cam 9Pcs+2Pcs(spare)	C  Dowel 5Pcs+1Pc(spare)	D  Adjustable Glide 4Pcs	E  6 Hole L-Bracket 2Pcs	F  Screw #4*5/8" 12Pcs+3Pcs(spare)	G  Screw #5*1/2" 4Pcs+1Pc(spare)

STEP1

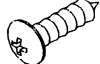
IMPORTANT:

FUNCTION OF KLIX CAM



1/4 RIGHT
TURN FOR
LOCKING

MAKE SURE THE ARROW IS
POINTING UPWARDS
BEFORE INSERTING INTO
THE PANEL'S HOLE.

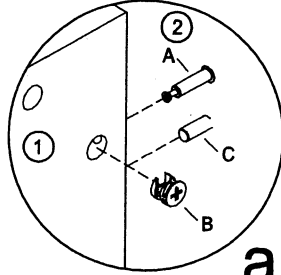
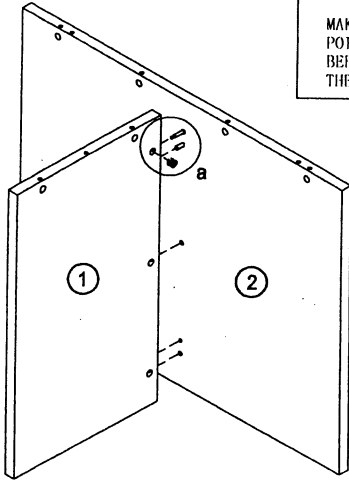

a

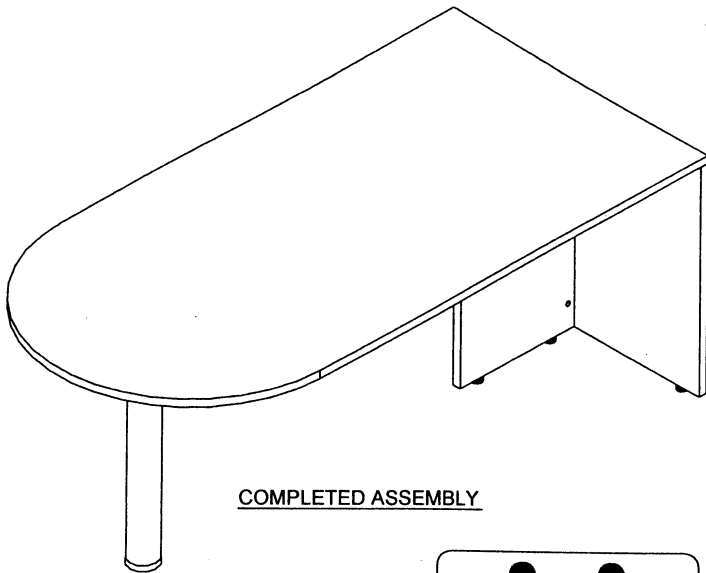

COMPLETED ASSEMBLY

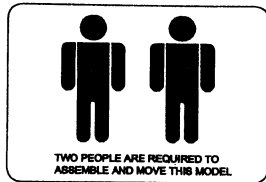

TWO PEOPLE ARE REQUIRED TO
ASSEMBLE AND MOVE THIS MODEL

IMPORTANT NOTE:

- Place all laminated parts on a clean and smooth surface such as a rug or carpet to avoid the parts from being scratched.
- Check to be sure that you have all parts and hardware.
- Remove all wrapping materials, including staples & packing straps before you start to assemble.
- Don't tighten all screws/bolts until all completely assembled.
- Keep all hardware parts out of reach of children.
- It is recommended to require 2 persons to complete the assembly.

STEP2

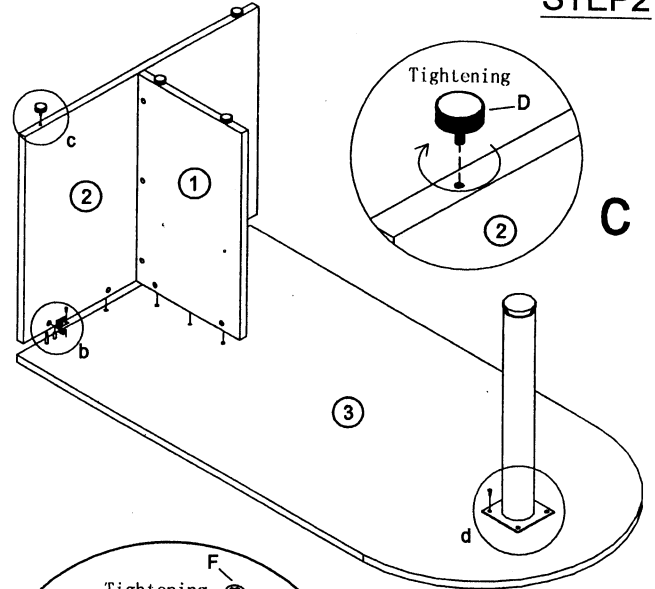

c

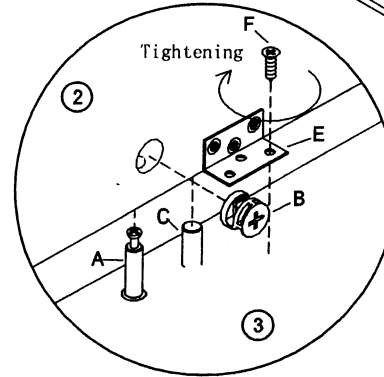

b

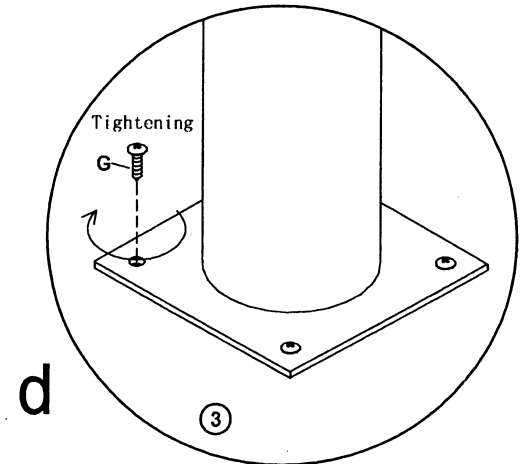

d