

# Disassembly Instructions

## Learn2 Mobile Classroom Seating

Material Type: A. Steel B. Aluminum C. Plastic D. Bronze E. Wood

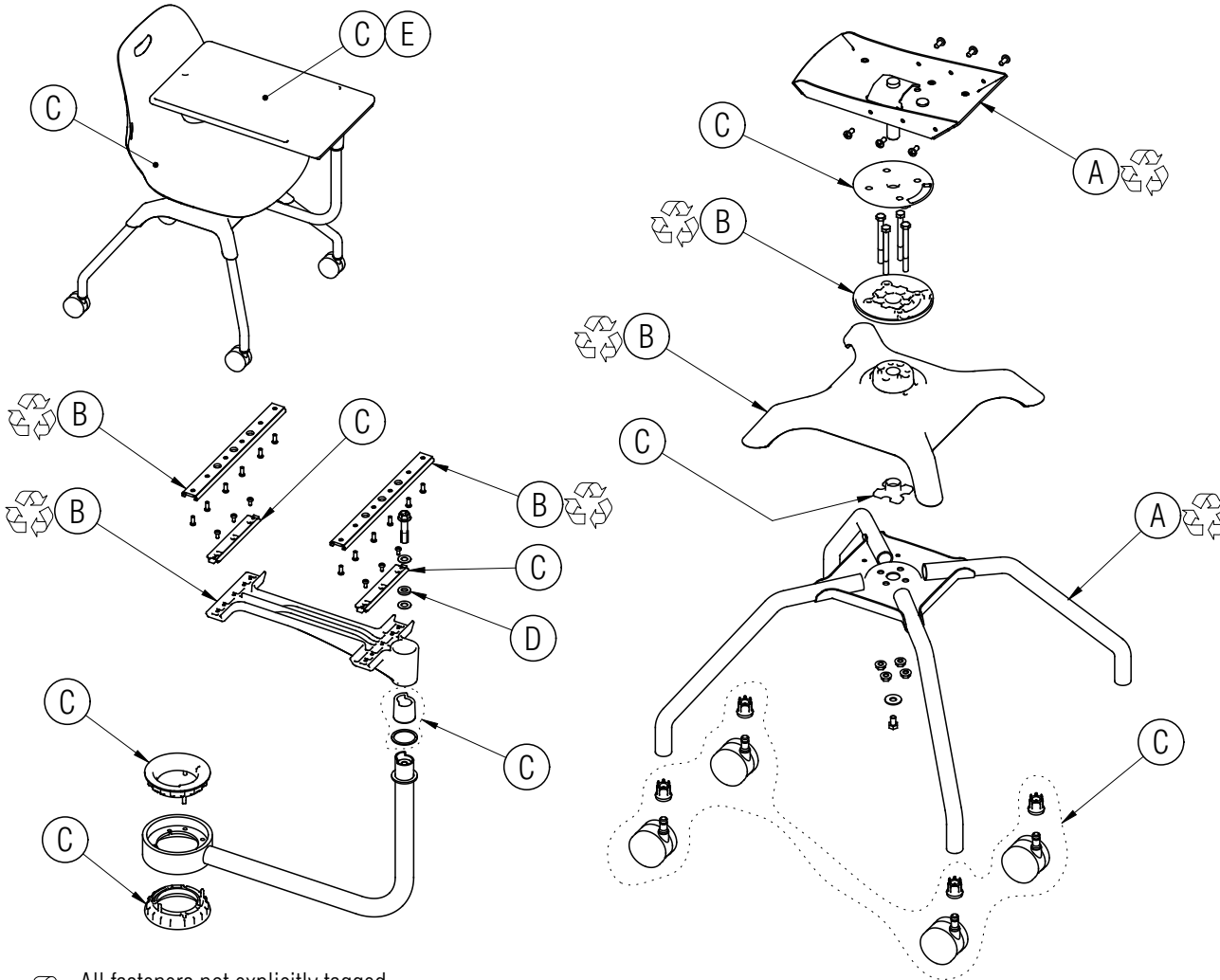

All fasteners not explicitly tagged are Material Type A: Steel

### Procedure:

1. Remove the screws holding the seat to the chair frame and remove the seat.
2. Remove the screws holding the tablet to the rails and remove the tablet. Slide off the rails from the rail supports.
3. Remove the screw underneath the chair frame holding the seat support and remove the seat support and swivel bushing.
4. Remove the nuts under the chair frame holding the tablet assembly pivot bearing together and remove the upper bearing mount, the tablet arm assembly and the lower bearing mount.
5. Pry out the upper and lower rotation bushings from the tablet assembly. Remove the screw and washers holding the upper tablet support to the lower support and remove the upper support and the support bushings.
6. Pry the out the casters and bushings from the ends of the leg tubes.

### General Notes:

1. Disassembly time: 15-20 minutes
2. This procedure assumes basic familiarity with hand tools and furniture terminology: no specialized training is required
3. All materials removed and disassembled shall be sorted and segregated with like materials and disposed of or recycled according to recycling availability or waste acceptance
4. For items to be recycled, refer to KI's End of Life Recycling Matrix and KI's End of Life Recovery Options Matrix, available at [www.ki.com](http://www.ki.com)

### Required Tools



Gloves



Safety Glasses

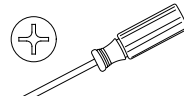

Phillips Screwdriver

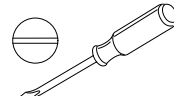

Flat Screwdriver

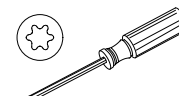

Torx Screwdriver

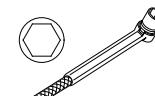

Hex Socket Wrench

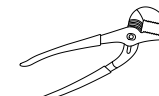

Channel Lock Pliers

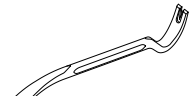

Pry Bar