

# 100 LINE

PERFORMANCE SCENCE



GARDCO  
LIGHTING



In five electrifying colors, the LED Circa sconce is a brilliant new way to unify the nighttime environment. Together with Circa area and post top luminaires, the colorful LED rings reinforce corporate and retail brands, and dramatically delineate a site as no other family of luminaires can.

# SCOPE

With the 100 Line, Gardco has changed the shape of the market along with its character. In this remarkable series, specifiers will find compact sconces that provide wide flexibility in high performance illumination and new opportunities to make an architectural statement. Sconce styles include various optic choices as well as soft glowing forms.

Noteworthy additions to the 100 Line include the distinctive Gullwing and Circa sconces. These luminaires are minimal in scale and, like all 100 Line sconces, offer exceptional glare-free, sharp cutoff optical performance. There is no need to compromise aesthetics for performance because Gullwing and Circa, like the Glowtop, can be paired with matching pole-mounted luminaires that elegantly unify the site lighting plan.

Gardco sconces. Once again, beautifully advancing the art and science of illumination.



111 — 101 — 141

With its tapered rectilinear form, this family immediately impresses with styling that integrates comfortably with a range of architectural elements. These luminaires provide sharp cutoff illumination free from the high angle brightness associated with refractor type products. There is also flexibility — three proportions mini to large. The 111, truly petite, is the obvious choice when lighting should be anything but obvious. The 141 Super Sconce is a powerful 400 watts strong.

	111	101	141
Height	5 <sup>3</sup> / <sub>8</sub> "	7"	9 <sup>5</sup> / <sub>8</sub> "
Width	12 <sup>1</sup> / <sub>8</sub> "	16 <sup>1</sup> / <sub>4</sub> "	24 <sup>1</sup> / <sub>8</sub> "
Depth	7"	9"	13 <sup>5</sup> / <sub>8</sub> "

102

The distinctive contoured wedge of the 102 establishes styling cues that prevail throughout the series — crisp, simple design and efficient scale. Overall dimensions for the series, including the distinctive offset created by the heat-dissipating mounting plate, measure just 9" deep by 16.25" wide by a 8.25" high.

Height	8 <sup>1</sup> / <sub>4</sub> "
Width	16 <sup>1</sup> / <sub>4</sub> "
Depth	9"

103

Uplight of both trees and architecture serves to open and define the overhead environment. The 103 provides the opportunity to use four different up/down optical combinations to provide decorative uplighting on building surfaces combined with horizontal illumination for pedestrians or small parking areas.

Height	7"
Width	18"
Depth	9"

104

This half-round shape integrates naturally with architecture that features soft, rounded corners and forms. The 104 is the perfect companion for Gardco's Round Form 10 Series site lighting products.

Height	7"
Width	18"
Depth	9"

105

The soft glowing form of the 105 combines performance downlight illumination with soft uplight that offers identification of the luminaire in the nighttime environment. The 105 is available with 2 optic choices. The 105 can be used with the Gardco Glowtops to dramatically enhance site entrances.

Height	9 <sup>1</sup> / <sub>8</sub> "
Width	18"
Depth	9"

four

106

The classic shape of the 106 can add subtle styling to a variety of architectures. The 106 can also be used in tandem with the domed styles of the Gardco Round Form 10 family.

Height	9 <sup>1</sup> / <sub>8</sub> "
Width	18"
Depth	9"

107

Performance takes on a new shape in the Gullwing sconce — the streamlined companion to the striking Gardco Gullwing series of area lighting luminaires. This sleek form, just 7.5" high, is a natural complement to any architectural vocabulary. The scale of the 107 allows it to match perfectly with the larger G18 or the smaller G13 Gullwing.

Height	7 <sup>1</sup> / <sub>2</sub> "
Width	21 <sup>1</sup> / <sub>4</sub> "
Depth	11 <sup>1</sup> / <sub>2</sub> "

108 & 108 LED

Circa is the most revolutionary of the Gardco sconces. It introduces radical new design themes and color options, even colorful LED rings once available only on custom fixtures. Circa features a slim appearance accentuated by the standard halo ring. The accent ring can be painted to match or complement the luminaire, or finished in stainless steel. Like Gullwing, the Circa sconce is part of an integrated series that includes pole and post top mounted luminaires.

Height	7 <sup>1</sup> / <sub>8</sub> "
Width	25 <sup>7</sup> / <sub>16</sub> " (includes ring)
Depth	12 <sup>1</sup> / <sub>16</sub> " (includes ring)

five



The luminaire installs easily. Mounting plate is affixed to wall, splices are made and luminaire is secured to plate.



The diecast ribbed back plate dissipates heat from the electrical components.



Electrical components are mounted to the diecast back plate.



The diecast door frame is secured with two captive stainless steel fasteners and hinges for easy relamping.



The diecast housing is completely sealed at all points of material transition to thoroughly exclude moisture and insects.

While the architectural appeal of Gardco sconces is self-evident, equal attention has been devoted to the construction and long term performance of the luminaires. It is a quality that never goes out of style.

All Gardco sconce housings, door frames and back plates are all precision diecast aluminum. The crafted housing forms are finished with a fade and abrasion resistant, electrostatically-applied, thermally cured, textured polyester powder coat finish. The textured semi-gloss Gardco finish preserves the appearance of the luminaire through years of service. Standard color choices are bronze, beige, natural, black and white. Special colors are available.

The single-piece diecast door frame fits flush to the housing. Gaskets seal the tempered lens to the door frame and the door frame to the housing, assuring weather tightness. Two captive stainless fasteners provide easy access for relamping and service.

Every Gardco sconce must pass a comprehensive battery of electrical tests before shipment. The luminaire's heat-dissipating fins are a noteworthy feature – integrated into the mounting plate – they cool electrical components within the compact sconce housing.

## Outdoor Emergency Lighting

Emergency lighting has recently been the subject of increasing attention, which includes particularly more stringent code requirements. Most local ordinances require compliance with the NEC code and the Life Safety Code of the National Fire Protection Association. The 2000 NFPA Code specifies that "emergency lighting needs to be provided outside the building should be to either a public way or a distance from the building that is considered safe."

In addition to code mandates there are also numerous security, safety and liability issues that, in the event of a power interruption, need to be addressed via emergency lighting.

Most Gardco sconces can be specified to provide emergency lighting, and this series is designated with an EM or EMR suffix. These sconces are available with battery/emergency ballasted compact fluorescent lamps.

The important point of distinction between EM and EMR series is ballast location. The 100EM luminaires utilize an integral emergency pack consisting of a high-temperature nickel-cadmium battery with charging and electronic circuitry on a protected circuit board. 100EMR sconces utilize remote emergency battery packs and electronic circuitry (which must be ordered separately with the luminaire or by others).

The 100EMR series should be utilized in applications with extreme ambient temperatures conditions – especially freezing weather. When AC power fails, the sconces automatically convert to battery operation. A minimum of 90 minutes of lamp output is provided.

## Sconce Emergency Highlights

- Electronic fluorescent ballasts are high power factor. Sockets are high temperature PBT with brass contacts.
- Operates lamps at minimum of 90 minutes at reduced light levels.
- Battery has 7-10 year life expectancy and requires no maintenance.
- Test switch accessible via easy-hinge door frame. Tamper-resistant hardware available.
- Configure for switched or unswitched normal mode circuits.
- Battery rated to 0°C ambient. For extreme temperatures, specify remote ballast models with EMR designation.

(See Pg. 35 for ordering information)



The indicator light and test switch are clearly visible through the lens. The door frame hinges for easy access to the test switch.

# APPLICATIONS

Clean lines. Purity of form. Timeless styling.

Clarity of purpose. Exceptional lighting

performance. These were the inspiration,

and remain the guiding principles in the

design of a compelling series of sconces

that are equal parts engineering, design

and performance. With tapered forms and

subtle twin edge reveals, these refreshingly

compact sconces integrate seamlessly into

virtually every application and budget.



*Tucking a sconce into discrete locations adds a dramatic effect, improving security and making the building come alive at night.*



*In addition to primary illumination, Gardco sconces are also an attractive solution for emergency lighting requirements.*



*Sharp cutoff combined with high performance means fewer luminaires and complete elimination of light trespass... a welcome relief for neighbors and neighborhoods.*



*The distinctive contoured wedge of the 111 is crisp and clean and a comfortable addition to almost any architectural design.*



*With its tapered shape, the Super Sconce delivers superior performance from a low profile luminaire.*



*Combining standard downlight sconces with inverted sconces allows for the right amount of light in all the right places around the building.*

# PERFORMANCE

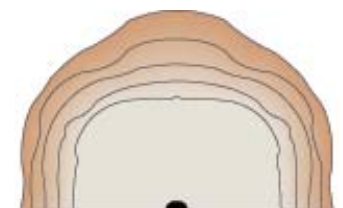
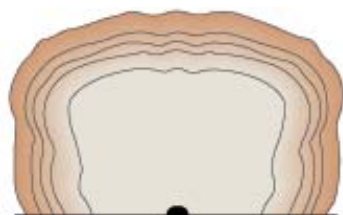

Optical systems feature highly specular faceted reflectors designed to direct light into desired patterns. A choice of three highly efficient downlight distributions are available.

**Versatility** – Gardco Sconces are available in a forward throw distribution for small parking areas, a wide distribution for pedestrian areas and an extremely low brightness medium distribution. The forward throw units are available with a 5° up tilt option (except 111 Mini Sconce) which extends the effective illumination pattern out and away from buildings. Medium throw units offer performance similar to interior downlights, allowing for illumination of interior spaces. All are suitable for damp location uplighting in lobbies, atriums and beneath canopies. An inverted Wet Location option is available with 101, 102 and 111 models.

**High Light Levels** – Optical systems feature highly specular faceted reflectors designed to efficiently direct light into very wide or forward projecting light patterns. In combination with the high lumen packages produced by HID lamps, Gardco 100 Line sconces provide remarkably high illumination levels. Fluorescent sources add instant-on capability.

**Uniform Distribution** – Reflector facets are precisely positioned to generate uniform distribution patterns without streaks or striations. Superior area lighting is achieved when sites are illuminated to footcandle levels of 10-to-1 to 15-to-1 maximum to minimum uniformity.

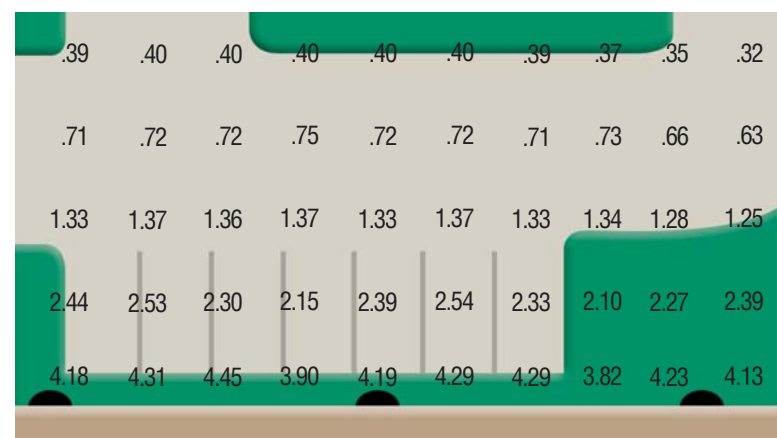

A typical site plan with footcandles superimposed illustrates not only high levels, but overall uniformity and sharp cutoff at the perimeter of the distribution.

**Spacings** – Sconce spacings can be driven by aesthetics or economy, or a combination of both, a benefit unique to the Gardco 100 Line. For aesthetic purposes, the luminaire style and placement are selected first, followed by lamp and optical system selection. The sconce may satisfy primary or supplemental lighting requirements. When economy rules and wide spacings are required, the Gardco 100 Line offers 5:1 spacing to mounting height ratios with WT optics. At a 12' mounting height, sconces may be spaced as far as 60' apart. If critical light levels are required at the property line, FT optics with the optional 5° up tilt, project light in a more forward direction. See the application guidelines section starting on page 14 for approximate spacing capabilities.

**Control of Glare & Light Trespass** – The factor most destructive to lighting performance is glare. The traditional refractor wall pack generates light at excessively high angles – creating glare within a driver's or pedestrian's field of view. In addition, light above 90° may result in distracting brightness into neighboring spaces. Gardco performance sconces utilize precision optical systems which meet IES cutoff criteria. This assures that light above 80° is minimized and light above 90° (except for controlled uplight) is eliminated – resulting in exceptional control of luminaire brightness and undesired illumination beyond the property line.



When economy rules and wide spacings are required, the Gardco 100 Line offers 5:1 spacing to mounting height ratios with WT optics. At a 12' mounting height, sconces may be spaced as far as 60' apart.



Gardco sconces provide sharp cutoff illumination with virtual elimination of source brightness.



Enhancement of the building facade as well as glare free illumination are all part of the sconce standard offering.

# ILLUMINATION

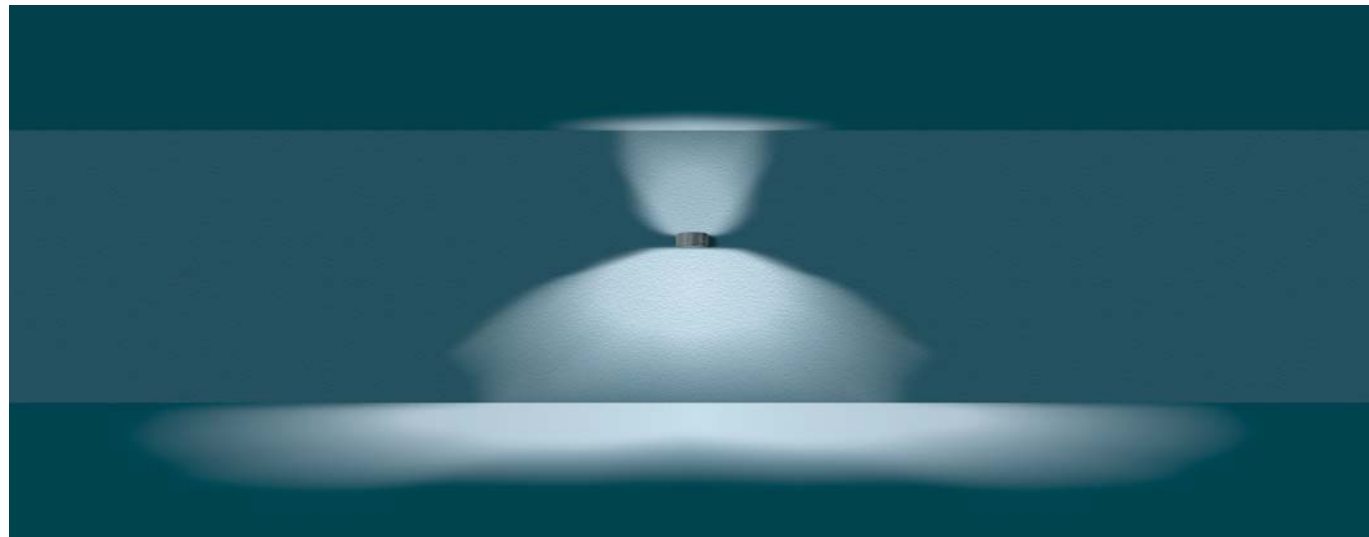

The wide choice in housing styles, optics and lamp combinations offers numerous options in balancing the illumination and aesthetic requirements of a project. The three-dimensional interpretation of typical performance presented here demonstrates the numerous up and downlighting choices, as well as the asymmetric distributions available with wide, medium, and forward throw optics. Note the especially sharp cutoff of these optical systems at the edge of the distribution.

The pages which follow provide photometric information for the most popular optics and light sources. Three mounting heights and three luminaire spacing distances are included in each chart. Referencing the desired sconce and optics/lamp combination that will provide the distance of projection (DP) from the luminaire which yields .5, 1, 2 and 3 minimum maintained footcandles.

Further photometric information is available through your Gardco representative or our Applications Engineering Department.

### **Wide Throw with Uplight WT-U**

*Excellent uniformity, sharp cutoff and exceptionally wide downlight distribution with uplighting of the overhead environment. Uplight is 10% and downlight 90% of available lumens.*



### **Wide Throw Downlight WT**

*With 100% of lamp output directed for downlight, the WT optics provide the widest, sharp cutoff distribution.*



### **103 Medium Up/Downlight MT-U**

*With 10% uplight and 90% downlight, the MT-U provides high light levels in the down direction and subtle illumination overhead.*

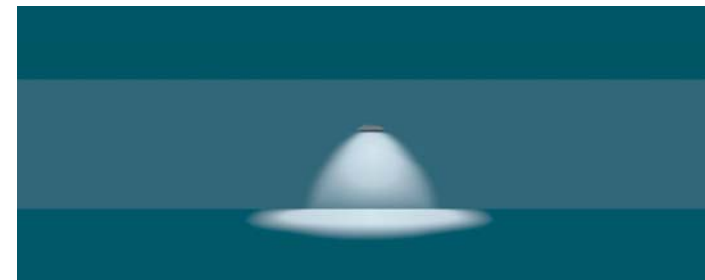

### **Medium Throw Downlight MT**

*Exceptionally uniform, this is the preferred optical choice when higher light levels and closer luminaire spacings are desired.*

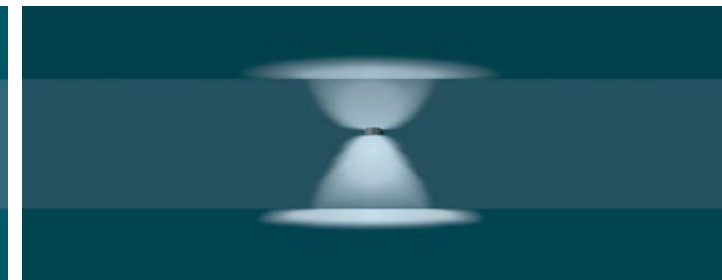

### **103 Medium 50/50 Up/Downlight UD**

*Available lumens are uniformly directed above and below the luminaire.*

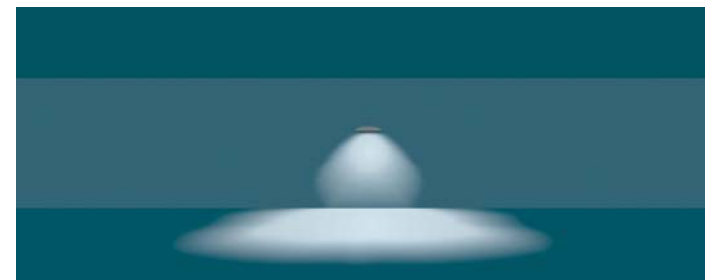

### **Forward Throw Downlight FT**

*High performance asymmetric distribution with sharp cutoff is ideal for directing illumination out and away from the building.*

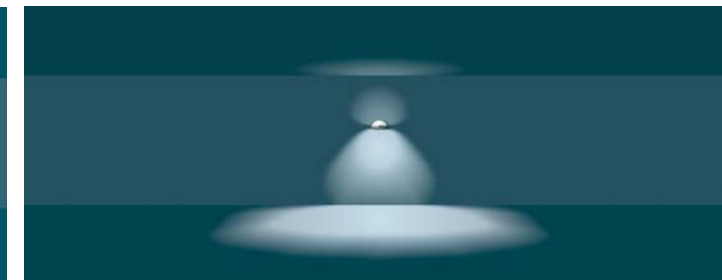

### **105 Forward Throw FT-U**

*A high performance asymmetric distribution has excellent forward illumination along with uniform uplight illumination.*

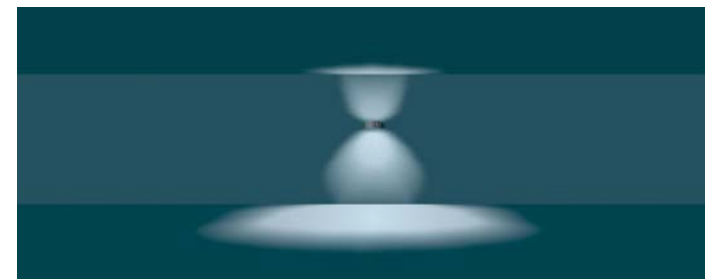

### **103 Forward Throw with Uplight FT-U**

*Asymmetric forward throw with 10% uplighting. Note illumination remains excellent even with addition of the uplight component.*

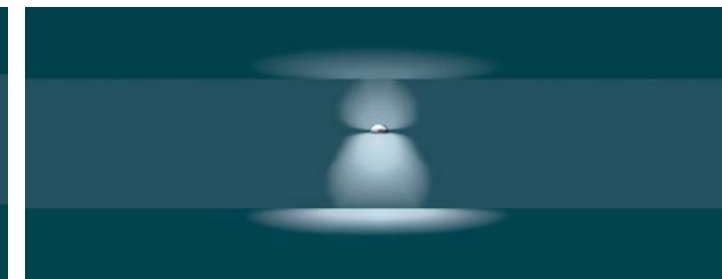

### **105 Up/Downlight UD**

*Exceptionally uniform, standard optical choice for a range of up and downlight applications. Note the exceptional uniformity throughout both distributions.*

# 111 PERFORMANCE

Horizontal Isofootcandle Chart. (10' Mounting Height, Initial Lumens)

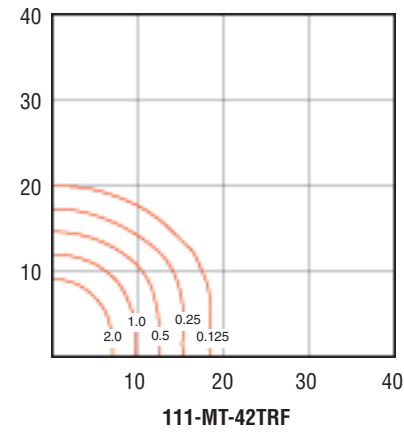
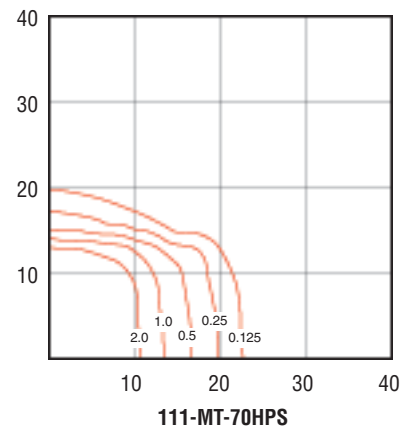
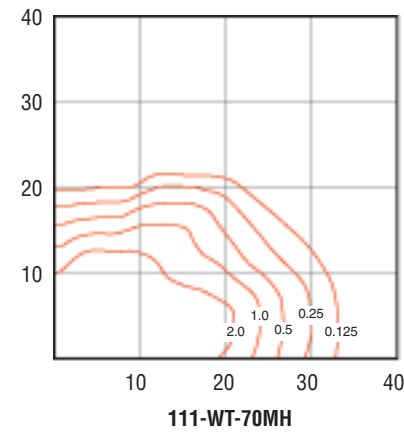
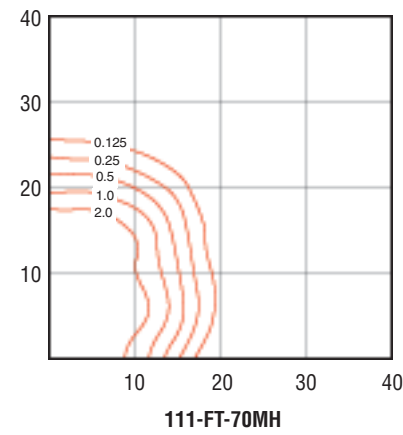

The table below gives conversion factors for various wattages:

From	To	Factor
111-Ft-70MH	111-Ft-39MH	0.515
111-Mt-70MH	111-Mt-50MH	0.685
111-Wt-70MH	111-Wt-39MH	0.515
111-Mt-70HPS	111-Mt-50HPS	0.635
111-Mt-70HPS	111-Mt-35HPS	0.357
111-Mt-42TRF	111-Mt-32TRF	0.750
111-Mt-42TRF	111-Mt-26TRF	0.563

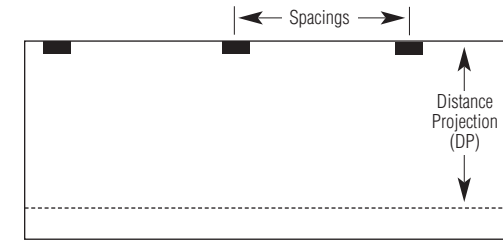

PLAN VIEW

## Illumination Levels

- Initial lamp lumens for 175W MH = 15,000  
Initial lamp lumens for 150W HPS = 16,000
- Maintained Footcandles (maintenance factors:  
Metal Halide - 0.72, High Pressure Sodium - 0.80)
- Light levels assume 40% wall reflectance and contribution from adjacent luminaires

### 175MH – 12' Mounting Height

Spacing	Distance Projection	Average	Minimum	Maximum
24'	26'	6.86	<b>0.48</b>	15.2
	23'	7.38	<b>0.98</b>	15.2
	19'	8.85	<b>1.96</b>	15.2
	15'	10.4	<b>3.27</b>	15.2
30'	25'	5.53	<b>0.51</b>	13.3
	20'	6.83	<b>1.15</b>	13.3
	16'	8.02	<b>2.11</b>	13.3
36'	14'	8.70	<b>2.92</b>	13.3
	23'	5.00	<b>0.50</b>	11.9
	18'	6.24	<b>1.11</b>	11.9
36'	14'	7.32	<b>2.18</b>	11.9
	12'	7.91	<b>3.06</b>	11.9

### 175MH – 15' Mounting Height

Spacing	Distance Projection	Average	Minimum	Maximum
30'	30'	4.75	<b>0.47</b>	9.79
	26'	5.33	<b>0.97</b>	9.79
	19'	6.66	<b>1.98</b>	9.79
	16'	7.34	<b>2.95</b>	9.79
37.5'	28'	3.95	<b>0.49</b>	8.49
	22'	4.73	<b>1.03</b>	8.49
	17'	5.59	<b>1.98</b>	8.49
45'	14'	6.13	<b>2.90</b>	8.49
	25'	3.55	<b>0.51</b>	7.32
	20'	4.24	<b>0.99</b>	7.32
45'	15'	5.02	<b>1.97</b>	7.32
	12'	5.45	<b>2.99</b>	7.32

### 175MH – 18' Mounting Height

Spacing	Distance Projection	Average	Minimum	Maximum
36'	33'	3.51	<b>0.54</b>	6.93
	26'	4.29	<b>1.03</b>	6.93
	19'	5.21	<b>2.10</b>	6.93
	16'	5.61	<b>2.90</b>	6.93
45'	30'	3.04	<b>0.50</b>	6.06
	23'	3.60	<b>1.04</b>	6.06
	17'	4.31	<b>1.97</b>	6.06
54'	13'	4.69	<b>2.93</b>	6.06
	27'	2.64	<b>0.48</b>	5.24
	21'	3.12	<b>0.96</b>	5.24
54'	15'	3.69	<b>1.94</b>	5.24

### 150HPS – 12' Mounting Height

Spacing	Distance Projection	Average	Minimum	Maximum
24'	27'	7.19	<b>0.49</b>	17.1
	24'	8.26	<b>0.95</b>	17.1
	20'	9.51	<b>2.24</b>	17.1
	17'	10.7	<b>3.17</b>	17.1
30'	27'	5.81	<b>0.48</b>	15.4
	23'	6.68	<b>0.98</b>	15.4
	18'	8.32	<b>2.05</b>	15.4
36'	15'	9.35	<b>3.06</b>	15.4
	25'	5.25	<b>0.50</b>	14.2
	21'	6.06	<b>1.00</b>	14.2
36'	16'	7.58	<b>2.15</b>	14.2
	14'	8.20	<b>2.96</b>	14.2

### 150HPS – 15' Mounting Height

Spacing	Distance Projection	Average	Minimum	Maximum
30'	31'	5.03	<b>0.49</b>	11.3
	27'	5.65	<b>1.04</b>	11.3
	21'	6.78	<b>2.03</b>	11.3
	17'	7.91	<b>3.04</b>	11.3
37.5'	30'	4.21	<b>0.51</b>	10.2
	25'	4.73	<b>0.99</b>	10.2
	18'	6.04	<b>2.12</b>	10.2
45'	15'	6.65	<b>3.01</b>	10.2
	28'	3.76	<b>0.50</b>	9.30
	23'	4.24	<b>0.96</b>	9.30
45'	17'	5.27	<b>2.03</b>	9.30
	12'	6.14	<b>3.18</b>	9.30

### 150HPS – 18' Mounting Height

Spacing	Distance Projection	Average	Minimum	Maximum
36'	35'	3.75	<b>0.47</b>	8.08
	29'	4.35	<b>1.04</b>	8.08
	21'	5.38	<b>1.99</b>	8.08
	16'	6.27	<b>3.16</b>	8.08
45'	33'	3.10	<b>0.50</b>	7.29
	26'	3.78	<b>0.98</b>	7.29
	19'	4.58	<b>1.93</b>	7.29
54'	13'	5.32	<b>3.16</b>	7.29
	30'	2.80	<b>0.51</b>	6.68
	23'	3.29	<b>1.05</b>	6.68
54'	15'	4.15	<b>2.04</b>	6.68







**Illumination Levels**

- Initial lamp lumens for 175W MH = 15,000  
Initial lamp lumens for 150W HPS = 16,000
- Maintained Footcandles (maintenance factors: Metal Halide - 0.72, High Pressure Sodium - 0.80)
- Light levels assume 40% wall reflectance and contribution from adjacent luminaires

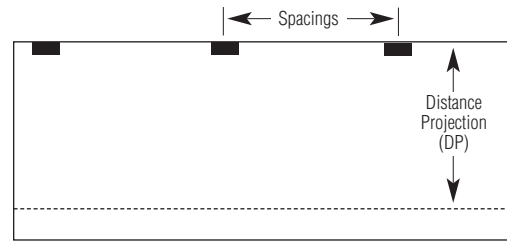

PLAN VIEW

175MH – 12' Mounting Height				
Spacing	Distance Projection	Average	Minimum	Maximum
12'	28'	10.2	<b>0.49</b>	22.0
	25'	11.3	<b>0.96</b>	22.0
	22'	12.5	<b>2.06</b>	22.0
	20'	13.4	<b>3.69</b>	22.0
18'	26'	7.26	<b>0.51</b>	18.4
	23'	8.13	<b>1.02</b>	18.4
	20'	8.99	<b>2.32</b>	18.4
24'	19'	9.46	<b>3.08</b>	18.4
	24'	6.03	<b>0.58</b>	16.9
24'	22'	6.48	<b>1.04</b>	16.9
	20'	6.97	<b>1.88</b>	16.9
	20'	6.97	<b>1.88</b>	16.9
175MH – 15' Mounting Height				
Spacing	Distance Projection	Average	Minimum	Maximum
15'	32'	7.07	<b>0.52</b>	14.4
	29'	7.76	<b>0.95</b>	14.4
	26'	8.40	<b>1.84</b>	14.4
	24'	8.90	<b>2.95</b>	14.4
22.5'	30'	4.92	<b>0.51</b>	12.0
	26'	5.52	<b>1.16</b>	12.0
22.5'	24'	5.85	<b>1.82</b>	12.0
	22'	6.17	<b>2.90</b>	12.0
30'	28'	3.88	<b>0.57</b>	11.2
	25'	4.29	<b>1.15</b>	11.2
175MH – 18' Mounting Height				
Spacing	Distance Projection	Average	Minimum	Maximum
18'	36'	5.22	<b>0.53</b>	10.0
	32'	5.76	<b>1.09</b>	10.0
	29'	6.26	<b>1.97</b>	10.0
	27'	6.56	<b>2.90</b>	10.0
27'	34'	3.68	<b>0.49</b>	8.39
	30'	4.06	<b>1.01</b>	8.39
	26'	4.44	<b>2.16</b>	8.39
36'	32'	2.88	<b>0.53</b>	7.83
	28'	3.17	<b>1.17</b>	7.83

150HPS – 12' Mounting Height				
Spacing	Distance Projection	Average	Minimum	Maximum
12'	29'	12.9	<b>0.48</b>	26.8
	26'	14.3	<b>0.95</b>	26.8
	23'	15.9	<b>2.46</b>	26.8
	22'	16.4	<b>3.49</b>	26.8
	22'	16.4	<b>3.49</b>	26.8
18'	27'	9.25	<b>0.49</b>	21.9
	24'	10.2	<b>1.13</b>	21.9
	22'	11.0	<b>2.23</b>	21.9
24'	21'	11.5	<b>3.11</b>	21.9
	26'	7.39	<b>0.46</b>	20.7
	23'	8.26	<b>1.21</b>	20.7
24'	21'	8.89	<b>2.45</b>	20.7
	20'	9.12	<b>3.35</b>	20.7
150HPS – 15' Mounting Height				
Spacing	Distance Projection	Average	Minimum	Maximum
15'	33'	9.07	<b>0.54</b>	17.1
	30'	9.84	<b>1.10</b>	17.1
	28'	10.4	<b>1.90</b>	17.1
	26'	11.0	<b>3.31</b>	17.1
	26'	11.0	<b>3.31</b>	17.1
22.5'	31'	6.31	<b>0.56</b>	14.1
	29'	6.69	<b>0.94</b>	14.1
	26'	7.25	<b>2.09</b>	14.1
30'	24'	7.63	<b>3.40</b>	14.1
	30'	4.81	<b>0.52</b>	13.3
	28'	5.10	<b>0.92</b>	13.3
30'	25'	5.59	<b>2.10</b>	13.3
	25'	5.59	<b>2.10</b>	13.3
150HPS – 18' Mounting Height				
Spacing	Distance Projection	Average	Minimum	Maximum
18'	38'	6.55	<b>0.49</b>	11.9
	35'	7.06	<b>0.93</b>	11.9
	32'	7.55	<b>1.91</b>	11.9
	30'	7.90	<b>2.95</b>	11.9
	30'	7.90	<b>2.95</b>	11.9
27'	36'	4.61	<b>0.49</b>	9.74
	33'	4.98	<b>0.95</b>	9.74
	29'	5.47	<b>2.26</b>	9.74
36'	27'	5.68	<b>3.21</b>	9.74
	34'	3.60	<b>0.58</b>	9.18
	31'	3.89	<b>1.17</b>	9.18



**Illumination Levels**

- Initial lamp lumens for (2) 26W Fluorescent = 3,600  
Initial lamp lumens for 42W Fluorescent = 3,200
- Maintained Footcandles (maintenance factors: Fluorescent - 0.90)
- Light levels assume 40% wall reflectance and contribution from adjacent luminaires

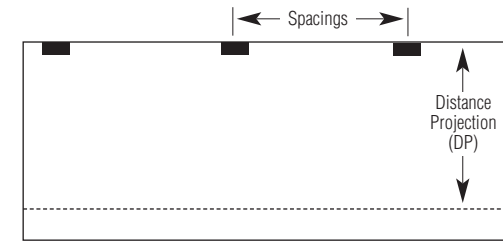

PLAN VIEW

(2) 26W Fluorescent – 10' Mounting Height				
Spacing	Distance Projection	Average	Minimum	Maximum
10'	13'	4.91	<b>0.53</b>	8.30
	12'	5.24	<b>0.97</b>	8.30
	10'	5.96	<b>2.41</b>	8.30
	9'	3.25	<b>3.25</b>	8.30
	12'	3.54	<b>0.57</b>	6.82
15'	11'	3.78	<b>0.96</b>	6.82
	9'	4.26	<b>1.91</b>	6.82
	6'	4.92	<b>3.16</b>	6.82
20'	10'	2.98	<b>0.62</b>	6.67
	8'	3.32	<b>1.11</b>	6.67
(2) 26W Fluorescent – 12' Mounting Height				
Spacing	Distance Projection	Average	Minimum	Maximum
12'	15'	3.53	<b>0.49</b>	5.77
	13'	3.94	<b>1.19</b>	5.77
	11'	4.36	<b>2.15</b>	5.77
	9'	4.74	<b>3.01</b>	5.77
18'	14'	2.51	<b>0.48</b>	4.70
	12'	2.80	<b>1.00</b>	4.70
24'	8'	3.32	<b>1.97</b>	4.70
	11'	2.24	<b>0.57</b>	4.63
24'	8'	2.53	<b>0.98</b>	4.63
	8'	2.53	<b>0.98</b>	4.63
(2) 26W Fluorescent – 15' Mounting Height				
Spacing	Distance Projection	Average	Minimum	Maximum
15'	17'	2.44	<b>0.58</b>	3.75
	15'	2.66	<b>1.04</b>	3.75
	11'	3.06	<b>1.95</b>	3.75
	7'	3.43	<b>2.87</b>	3.75
22.5'	16'	1.70	<b>0.48</b>	3.02
	12'	1.97	<b>1.02</b>	3.02
30'	11'	1.53	<b>0.55</b>	2.97
	11'	1.53	<b>0.55</b>	2.97

42W Fluorescent – 10' Mounting Height				
Spacing	Distance Projection	Average	Minimum	Maximum
10'	15'	6.77	<b>0.45</b>	12.3
	13'	7.65	<b>1.20</b>	12.3
	11'	8.66	<b>2.67</b>	12.3
	10'	9.20	<b>3.68</b>	12.3
	14'	4.78	<b>0.48</b>	10.7
15'	12'	5.41	<b>1.19</b>	10.7
	10'	6.12	<b>2.28</b>	10.7
	9'	6.47	<b>2.96</b>	10.7
20'	12'	4.07	<b>0.60</b>	10.5
	10'	4.60	<b>1.10</b>	10.5
42W Fluorescent – 12' Mounting Height				
Spacing	Distance Projection	Average	Minimum	Maximum
12'	17'	4.95	<b>0.47</b>	8.56
	15'	5.50	<b>1.02</b>	8.56
	13'	6.10	<b>1.94</b>	8.56
	11'	6.73	<b>3.19</b>	8.56
	16'	3.52	<b>0.45</b>	7.45
18'	14'	3.91	<b>0.93</b>	7.45
	11'	4.55	<b>1.94</b>	7.45
	9'	4.96	<b>2.85</b>	7.45
24'	14'	2.98	<b>0.46</b>	7.34
	11'	3.46	<b>0.97</b>	7.34
42W Fluorescent – 15' Mounting Height				
Spacing	Distance Projection	Average	Minimum	Maximum
15'	19'	3.48	<b>0.58</b>	5.57
	17'	3.78	<b>1.03</b>	5.57
	14'	4.27	<b>1.93</b>	5.57
	11'	4.73	<b>3.23</b>	5.57
	18'	2.41	<b>0.51</b>	4.79
22.5'	15'	2.73	<b>1.00</b>	4.79
	10'	3.23	<b>2.11</b>	4.79
30'	15'	2.05	<b>0.47</b>	4.71
	15'	2.05	<b>0.47</b>	4.71



**Illumination Levels**

- Initial lamp lumens for (2) 26W Fluorescent = 3,600  
Initial lamp lumens for 42W Fluorescent = 3,200
- Maintained Footcandles (maintenance factors: Fluorescent - 0.90)
- Light levels assume 40% wall reflectance and contribution from adjacent luminaires

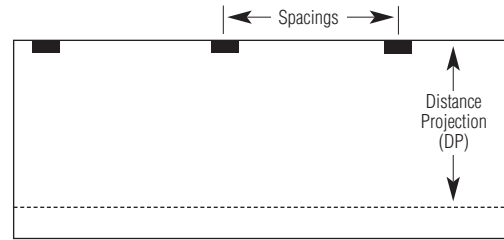

PLAN VIEW

(2) 26W Fluorescent – 10' Mounting Height				
Spacing	Distance Projection	Average	Minimum	Maximum
10'	12'	3.88	<b>0.58</b>	6.30
	11'	4.15	<b>1.06</b>	6.30
	9'	4.69	<b>2.48</b>	6.30
	8'	4.93	<b>3.02</b>	6.30
15'	11'	2.81	<b>0.63</b>	4.94
	10'	3.00	<b>1.03</b>	4.94
	7'	3.49	<b>2.13</b>	4.94
20'	10'	2.22	<b>0.47</b>	4.75
	7'	2.58	<b>1.11</b>	4.75
(2) 26W Fluorescent – 12' Mounting Height				
Spacing	Distance Projection	Average	Minimum	Maximum
12'	14'	2.79	<b>0.49</b>	4.38
	12'	3.12	<b>1.23</b>	4.38
	10'	3.42	<b>2.00</b>	4.38
	7'	3.83	<b>2.90</b>	4.38
18'	13'	1.96	<b>0.47</b>	3.38
	10'	2.27	<b>1.16</b>	3.38
	6'	2.63	<b>2.01</b>	3.38
24'	11'	1.68	<b>0.46</b>	3.31
	6'	2.02	<b>1.04</b>	3.31
(2) 26W Fluorescent – 15' Mounting Height				
Spacing	Distance Projection	Average	Minimum	Maximum
15'	16'	1.92	<b>0.54</b>	2.86
	14'	2.08	<b>0.98</b>	2.86
	8'	2.51	<b>1.98</b>	2.86
22.5'	14'	1.39	<b>0.58</b>	2.19
	10'	1.58	<b>1.01</b>	2.19
30'	10'	1.18	<b>0.49</b>	2.13

42W Fluorescent – 10' Mounting Height				
Spacing	Distance Projection	Average	Minimum	Maximum
10'	12'	3.40	<b>0.56</b>	5.31
	10'	3.89	<b>1.25</b>	5.31
	8'	4.40	<b>2.51</b>	5.31
	7'	4.62	<b>3.30</b>	5.31
	11'	2.43	<b>0.57</b>	4.33
15'	9'	2.77	<b>1.21</b>	4.33
	7'	3.08	<b>2.13</b>	4.33
	10'	1.95	<b>0.45</b>	4.20
20'	7'	2.31	<b>1.03</b>	4.20
	42W Fluorescent – 12' Mounting Height			
Spacing	Distance Projection	Average	Minimum	Maximum
12'	14'	2.43	<b>0.45</b>	3.69
	11'	2.87	<b>1.17</b>	3.69
	9'	3.16	<b>2.01</b>	3.69
	7'	3.37	<b>2.94</b>	3.69
18'	13'	1.72	<b>0.42</b>	2.98
	10'	2.02	<b>1.01</b>	2.98
	24'	1.54	<b>0.59</b>	2.92
42W Fluorescent – 15' Mounting Height				
Spacing	Distance Projection	Average	Minimum	Maximum
15'	15'	1.75	<b>0.54</b>	2.40
	12'	1.98	<b>1.09</b>	2.40
	8'	2.19	<b>2.01</b>	2.40
22.5'	14'	1.21	<b>0.47</b>	1.92
	10'	1.40	<b>1.02</b>	1.92
30'	11'	1.02	<b>0.44</b>	1.88



**Illumination Levels**

- Initial lamp lumens for 175W MH = 15,000  
Initial lamp lumens for 150W HPS = 16,000
- Maintained Footcandles (maintenance factors: Metal Halide - 0.72, High Pressure Sodium - 0.80)
- Light levels assume 40% wall reflectance and contribution from adjacent luminaires

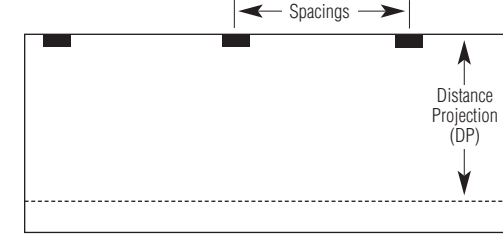

PLAN VIEW

175MH – 12' Mounting Height				
Spacing	Distance Projection	Average	Minimum	Maximum
12'	22'	6.38	<b>0.51</b>	18.7
	15'	8.70	<b>1.13</b>	18.7
	11'	11.1	<b>2.20</b>	18.7
	10'	11.9	<b>3.95</b>	18.7
	18'	18'	5.26	<b>0.53</b>
18'	14'	6.40	<b>1.00</b>	12.8
	11'	7.70	<b>1.61</b>	12.8
	10'	8.24	<b>2.79</b>	12.8
24'	15'	4.44	<b>0.54</b>	12.5
	11'	5.66	<b>0.89</b>	12.5
	10'	6.07	<b>1.49</b>	12.5
	9'	6.47	<b>2.51</b>	12.5
175MH – 15' Mounting Height				
Spacing	Distance Projection	Average	Minimum	Maximum
15'	20'	5.35	<b>0.51</b>	13.5
	16'	6.91	<b>1.00</b>	13.5
	13'	8.12	<b>2.13</b>	13.5
	12'	8.58	<b>3.33</b>	13.5
	19'	3.90	<b>0.50</b>	8.85
22.5'	13'	5.28	<b>1.33</b>	8.85
	12'	5.58	<b>2.14</b>	8.85
	11'	5.86	<b>3.03</b>	8.85
30'	17'	3.38	<b>0.50</b>	8.59
	13'	4.17	<b>0.97</b>	8.59
	11'	4.63	<b>1.99</b>	8.59
175MH – 18' Mounting Height				
Spacing	Distance Projection	Average	Minimum	Maximum
18'	21'	4.08	<b>0.55</b>	8.99
	16'	5.30	<b>1.12</b>	8.99
	14'	5.82	<b>2.45</b>	8.99
	13'	6.05	<b>3.20</b>	8.99
27'	16'	3.35	<b>0.60</b>	6.36
	14'	3.68	<b>1.43</b>	6.36
	13'	3.83	<b>2.00</b>	6.36
36'	10'	4.19	<b>2.90</b>	6.36
	17'	2.88	<b>0.54</b>	6.31
	14'	3.31	<b>1.20</b>	6.31
	11'	3.67	<b>2.09</b>	6.31

150HPS – 12' Mounting Height				
Spacing	Distance Projection	Average	Minimum	Maximum
12'	28'	7.59	<b>0.52</b>	28.8
	18'	10.8	<b>1.00</b>	28.8
	12'	15.1	<b>2.02</b>	28.8
	11'	16.2	<b>3.25</b>	28.8
	18'	18'	6.98	<b>0.55</b>
18'	12'	9.81	<b>1.11</b>	19.6
	11'	10.5	<b>1.99</b>	19.6
	10'	11.3	<b>3.72</b>	19.6
24'	18'	5.57	<b>0.52</b>	19.4
	12'	7.78	<b>1.03</b>	19.4
	10'	8.94	<b>2.30</b>	19.4
	9'	9.52	<b>3.54</b>	19.4
150HPS – 15' Mounting Height				
Spacing	Distance Projection	Average	Minimum	Maximum
15'	26'	6.38	<b>0.50</b>	18.6
	19'	8.23	<b>0.99</b>	18.6
	14'	10.6	<b>1.93</b>	18.6
	13'	11.2	<b>3.04</b>	18.6
	20'	5.21	<b>0.59</b>	12.9
22.5'	14'	6.92	<b>1.26</b>	12.9
	13'	7.32	<b>1.99</b>	12.9
	12'	7.72	<b>3.01</b>	12.9
30'	18'	4.43	<b>0.50</b>	12.7
	13'	5.77	<b>1.26</b>	12.7
	11'	6.39	<b>2.44</b>	12.7
	10'	6.67	<b>3.03</b>	12.7
150HPS – 18' Mounting Height				
Spacing	Distance Projection	Average	Minimum	Maximum
18'	24'	5.27	<b>0.52</b>	13.0
	17'	7.00	<b>1.06</b>	13.0
	15'	7.71	<b>2.46</b>	13.0
	14'	8.05	<b>3.45</b>	13.0
	17'	4.45	<b>0.59</b>	9.14
27'	15'	4.91	<b>1.46</b>	9.14
	14'	5.13	<b>2.09</b>	9.14
	12'	5.53	<b>3.05</b>	9.14
36'	17'	3.94	<b>0.68</b>	9.06
	15'	4.32	<b>1.16</b>	9.06
	12'	4.87	<b>2.28</b>	9.06

# 104/106/108 WIDE THROW DISTRIBUTION

# 104/106/108 MEDIUM THROW DISTRIBUTION



## Illumination Levels

- Initial lamp lumens for 175W MH = 15,000  
Initial lamp lumens for 150W HPS = 16,000
- Maintained Footcandles (maintenance factors: Metal Halide - 0.72, High Pressure Sodium - 0.80)
- Light levels assume 40% wall reflectance and contribution from adjacent luminaires

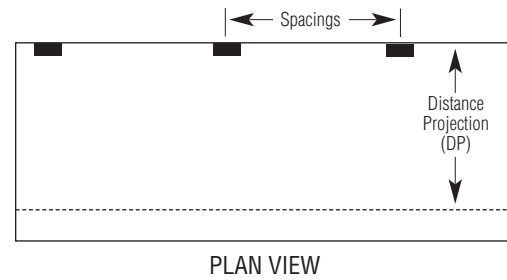

175MH – 12' Mounting Height				
Spacing	Distance Projection	Average	Minimum	Maximum
24'	24'	6.50	<b>0.53</b>	14.3
	21'	7.05	<b>1.04</b>	14.3
	17'	8.55	<b>1.97</b>	14.3
	14'	9.66	<b>3.26</b>	14.3
30'	22'	5.63	<b>0.51</b>	12.6
	18'	6.62	<b>1.01</b>	12.6
	14'	7.80	<b>2.26</b>	12.6
36'	12'	8.45	<b>3.27</b>	12.6
	21'	4.78	<b>0.50</b>	11.5
	17'	5.80	<b>0.99</b>	11.5
36'	13'	6.84	<b>2.15</b>	11.5
	11'	7.39	<b>3.21</b>	11.5

175MH – 15' Mounting Height				
Spacing	Distance Projection	Average	Minimum	Maximum
30'	28'	4.46	<b>0.50</b>	9.12
	23'	5.10	<b>0.97</b>	9.12
	17'	6.38	<b>2.18</b>	9.12
	14'	7.02	<b>3.18</b>	9.12
37.5'	24'	3.94	<b>0.51</b>	7.90
	20'	4.48	<b>0.96</b>	7.90
	15'	5.34	<b>2.08</b>	7.90
45'	12'	5.81	<b>3.21</b>	7.90
	23'	3.38	<b>0.49</b>	6.93
	18'	4.10	<b>1.06</b>	6.93
45'	14'	4.66	<b>2.00</b>	6.93
	11'	5.04	<b>2.96</b>	6.93

175MH – 18' Mounting Height				
Spacing	Distance Projection	Average	Minimum	Maximum
36'	30'	3.45	<b>0.52</b>	6.73
	24'	4.05	<b>1.00</b>	6.73
	18'	4.81	<b>1.93</b>	6.73
	14'	5.30	<b>3.05</b>	6.73
45'	26'	3.01	<b>0.50</b>	5.80
	21'	3.42	<b>0.99</b>	5.80
	15'	4.07	<b>2.14</b>	5.80
54'	11'	4.38	<b>3.10</b>	5.80
	24'	2.60	<b>0.53</b>	5.06
	19'	3.01	<b>1.01</b>	5.06
54'	13'	3.47	<b>2.04</b>	5.06

150HPS – 12' Mounting Height				
Spacing	Distance Projection	Average	Minimum	Maximum
24'	25'	7.41	<b>0.48</b>	18.1
	22'	8.58	<b>0.99</b>	18.1
	18'	10.1	<b>2.25</b>	18.1
	16'	11.0	<b>3.20</b>	18.1
30'	23'	6.44	<b>0.47</b>	15.1
	19'	7.83	<b>1.09</b>	15.1
	16'	8.86	<b>2.04</b>	15.1
36'	14'	9.62	<b>3.00</b>	15.1
	21'	5.86	<b>0.58</b>	13.4
	18'	6.87	<b>1.12</b>	13.4
36'	15'	7.78	<b>2.03</b>	13.4
	13'	8.44	<b>2.94</b>	13.4

150HPS – 15' Mounting Height				
Spacing	Distance Projection	Average	Minimum	Maximum
30'	28'	5.47	<b>0.55</b>	11.6
	24'	6.20	<b>1.10</b>	11.6
	20'	7.06	<b>2.00</b>	11.6
	16'	8.12	<b>3.19</b>	11.6
	16'	8.12	<b>3.19</b>	11.6
37.5'	25'	4.60	<b>0.56</b>	10.0
	21'	5.26	<b>1.10</b>	10.0
	17'	6.19	<b>2.06</b>	10.0
45'	14'	6.83	<b>3.23</b>	10.0
	24'	4.11	<b>0.54</b>	8.85
	20'	4.69	<b>1.08</b>	8.85
45'	16'	5.39	<b>1.95</b>	8.85
	12'	6.10	<b>3.03</b>	8.85

150HPS – 18' Mounting Height				
Spacing	Distance Projection	Average	Minimum	Maximum
36'	32'	4.02	<b>0.48</b>	8.58
	26'	4.72	<b>1.09</b>	8.58
	20'	5.57	<b>2.07</b>	8.58
	16'	6.25	<b>3.01</b>	8.58
	16'	6.25	<b>3.01</b>	8.58
45'	28'	3.51	<b>0.52</b>	7.17
	23'	3.97	<b>1.03</b>	7.17
	18'	4.66	<b>1.92</b>	7.17
54'	12'	5.39	<b>3.19</b>	7.17
	27'	2.89	<b>0.48</b>	6.39
	21'	3.43	<b>1.08</b>	6.39
54'	15'	4.11	<b>1.96</b>	6.39

PLAN VIEW

PLAN VIEW

## Illumination Levels

- Initial lamp lumens for (2) 26W Fluorescent = 3,600  
Initial lamp lumens for 42W Fluorescent = 3,200
- Maintained Footcandles (maintenance factors: Fluorescent - 0.90)
- Light levels assume 40% wall reflectance and contribution from adjacent luminaires

(2) 26W Fluorescent – 10' Mounting Height				
Spacing	Distance Projection	Average	Minimum	Maximum
10'	12'	4.82	<b>0.65</b>	7.86
	11'	5.17	<b>1.21</b>	7.86
	10'	5.53	<b>2.03</b>	7.86
	9'	5.87	<b>2.93</b>	7.86
	12'	3.27	<b>0.40</b>	6.31
15'	10'	3.74	<b>1.15</b>	6.31
	8'	4.19	<b>2.09</b>	6.31
	6'	4.60	<b>2.92</b>	6.31
20'	10'	2.76	<b>0.51</b>	6.12
	8'	3.10	<b>0.99</b>	6.12

(2) 26W Fluorescent – 12' Mounting Height				
Spacing	Distance Projection	Average	Minimum	Maximum
12'	14'	3.45	<b>0.55</b>	5.51
	13'	3.66	<b>0.90</b>	5.51
	11'	4.07	<b>1.93</b>	5.51
	9'	4.45	<b>2.86</b>	5.51
18'	13'	2.46	<b>0.52</b>	4.38
	11'	2.74	<b>1.06</b>	4.38
	7'	3.23	<b>2.07</b>	4.38
24'	11'	2.09	<b>0.49</b>	4.31
	7'	2.46	<b>1.01</b>	4.31

(2) 26W Fluorescent – 15' Mounting Height				
Spacing	Distance Projection	Average	Minimum	Maximum
15'	17'	2.26	<b>0.42</b>	3.58
	14'	2.58	<b>1.14</b>	3.58
	10'	2.96	<b>2.04</b>	3.58
	6'	3.29	<b>2.92</b>	3.58
22.5'	15'	1.65	<b>0.50</b>	2.83
	11'	1.91	<b>1.04</b>	2.83
30'	11'	1.43	<b>0.49</b>	2.77

42W Fluorescent – 10' Mounting Height				
Spacing	Distance Projection	Average	Minimum	Maximum
10'	14'	5.97	<b>0.47</b>	10.3
	12'	6.79	<b>1.19</b>	10.3
	10'	7.73	<b>2.65</b>	10.3
	9'	8.22	<b>3.65</b>	10.3
15'	13'	4.30	<b>0.48</b>	8.82
	11'	4.90	<b>1.19</b>	8.82
	9'	5.55	<b>2.27</b>	8.82
20'	8'	5.87	<b>2.97</b>	8.82
	11'	3.63	<b>0.57</b>	8.60
	9'	4.12	<b>1.16</b>	8.60

42W Fluorescent – 12' Mounting Height				
Spacing	Distance Projection	Average	Minimum	Maximum
12'	16'	4.35	<b>0.44</b>	7.15
	14'	4.85	<b>0.95</b>	7.15
	12'	5.40	<b>1.83</b>	7.15
	10'	5.97	<b>3.04</b>	7.15
	16'	3.07	<b>0.42</b>	6.09
18'	15'	3.07	<b>0.42</b>	6.09
	12'	3.62	<b>1.16</b>	6.09
	9'	4.19	<b>2.31</b>	6.09
24'	13'	2.62	<b>0.43</b>	5.97
	10'	3.05	<b>1.00</b>	5.97

42W Fluorescent – 15' Mounting Height				
Spacing	Distance Projection	Average	Minimum	Maximum
15'	18'	3.04	<b>0.51</b>	4.63
	15'	3.47	<b>1.14</b>	4.63
	12'	3.91	<b>2.09</b>	4.63
	10'	4.17	<b>2.94</b>	4.63
22.5'	17'	2.11	<b>0.46</b>	3.91
	13'	2.50	<b>1.09</b>	3.91
30'	13'	1.88	<b>0.55</b>	3.83

# 1.05 GLOW/FORWARD THROW DISTRIBUTION



## Illumination Levels

- Initial lamp lumens for 150W MH = 13,000  
Initial lamp lumens for 150W HPS = 16,000
- Maintained Footcandles (maintenance factors:  
Metal Halide - 0.72, High Pressure Sodium - 0.80)
- Light levels assume 40% wall reflectance and  
contribution from adjacent luminaires

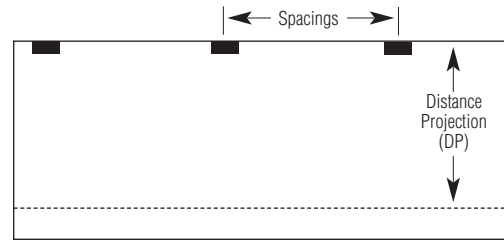

PLAN VIEW

150MH – 12' Mounting Height				
Spacing	Distance Projection	Average	Minimum	Maximum
12'	27'	9.31	<b>0.52</b>	18.2
	24'	10.3	<b>1.09</b>	18.2
	22'	11.1	<b>1.81</b>	18.2
	20'	11.9	<b>2.95</b>	18.2
18'	25'	6.66	<b>0.54</b>	14.6
	22'	7.39	<b>1.14</b>	14.6
	20'	7.95	<b>1.83</b>	14.6
	18'	8.54	<b>2.95</b>	14.6
24'	24'	5.32	<b>0.54</b>	13.6
	21'	5.98	<b>1.16</b>	13.6
	19'	6.46	<b>1.90</b>	13.6
150MH – 15' Mounting Height				
Spacing	Distance Projection	Average	Minimum	Maximum
15'	31'	6.48	<b>0.56</b>	11.6
	28'	7.04	<b>1.03</b>	11.6
	24'	7.92	<b>2.27</b>	11.6
	22'	8.38	<b>3.43</b>	11.6
22.5'	29'	4.60	<b>0.53</b>	9.33
	26'	5.00	<b>0.95</b>	9.33
	22'	5.61	<b>2.04</b>	9.33
30'	20'	5.91	<b>3.07</b>	9.33
	28'	3.46	<b>0.50</b>	8.69
30'	24'	3.89	<b>1.12</b>	8.69
	150MH – 18' Mounting Height			
Spacing	Distance Projection	Average	Minimum	Maximum
18'	36'	4.63	<b>0.47</b>	8.10
	31'	5.27	<b>1.07</b>	8.10
	27'	5.83	<b>2.10</b>	8.10
	25'	6.11	<b>3.00</b>	8.10
27'	33'	3.35	<b>0.49</b>	6.49
	28'	3.77	<b>1.09</b>	6.49
	24'	4.13	<b>2.14</b>	6.49
36'	31'	2.64	<b>0.53</b>	6.03
	27'	2.92	<b>1.04</b>	6.03

150HPS – 12' Mounting Height				
Spacing	Distance Projection	Average	Minimum	Maximum
12'	29'	12.9	<b>0.56</b>	24.8
	26'	14.3	<b>1.20</b>	24.8
	24'	15.3	<b>2.31</b>	24.8
	23'	15.9	<b>3.26</b>	24.8
	27'	9.22	<b>0.58</b>	19.6
18'	25'	9.88	<b>1.05</b>	19.6
	23'	10.6	<b>2.05</b>	19.6
	22'	10.9	<b>2.86</b>	19.6
24'	26'	7.31	<b>0.57</b>	18.3
	24'	7.82	<b>1.13</b>	18.3
	22'	8.37	<b>2.25</b>	18.3
	21'	8.70	<b>3.10</b>	18.3
150HPS – 15' Mounting Height				
Spacing	Distance Projection	Average	Minimum	Maximum
15'	34'	8.85	<b>0.53</b>	15.9
	31'	9.61	<b>1.11</b>	15.9
	29'	10.2	<b>1.92</b>	15.9
	27'	10.7	<b>3.23</b>	15.9
	32'	6.24	<b>0.54</b>	12.6
22.5'	29'	6.80	<b>1.21</b>	12.6
	27'	7.19	<b>2.02</b>	12.6
	25'	7.57	<b>3.28</b>	12.6
30'	31'	4.89	<b>0.55</b>	11.8
	28'	5.31	<b>1.23</b>	11.8
	26'	5.60	<b>2.08</b>	11.8
	24'	5.86	<b>3.07</b>	11.8
150HPS – 18' Mounting Height				
Spacing	Distance Projection	Average	Minimum	Maximum
18'	39'	6.32	<b>0.50</b>	11.0
	36'	6.86	<b>1.00</b>	11.0
	33'	7.25	<b>1.94</b>	11.0
	31'	7.60	<b>2.94</b>	11.0
	37'	4.43	<b>0.51</b>	8.75
27'	34'	4.75	<b>1.00</b>	8.75
	30'	5.16	<b>2.26</b>	8.75
	28'	5.39	<b>3.12</b>	8.75
	36'	3.46	<b>0.50</b>	8.18
36'	33'	3.71	<b>0.97</b>	8.18
	29'	4.08	<b>2.09</b>	8.18

# 1.05 GLOW/DOWNLIGHT DISTRIBUTION



## Illumination Levels

- Initial lamp lumens for 150W MH = 13,000  
Initial lamp lumens for 150W HPS = 16,000
- Maintained Footcandles (maintenance factors:  
Metal Halide - 0.72, High Pressure Sodium - 0.80)
- Light levels assume 40% wall reflectance and  
contribution from adjacent luminaires

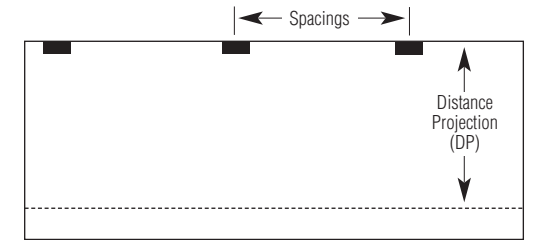

PLAN VIEW

150MH – 12' Mounting Height				
Spacing	Distance Projection	Average	Minimum	Maximum
12'	22'	3.65	<b>0.52</b>	10.3
	15'	4.58	<b>1.04</b>	10.3
	11'	5.69	<b>2.05</b>	10.3
	9'	6.41	<b>3.09</b>	10.3
	17'	2.74	<b>0.51</b>	8.19
18'	12'	3.75	<b>1.06</b>	8.19
	8'	4.69	<b>2.20</b>	8.19
	6'	5.24	<b>3.09</b>	8.19
24'	15'	2.39	<b>0.49</b>	7.87
	10'	3.31	<b>0.97</b>	7.87
	5'	4.40	<b>1.90</b>	7.87
150MH – 15' Mounting Height				
Spacing	Distance Projection	Average	Minimum	Maximum
15'	21'	2.72	<b>0.51</b>	6.73
	15'	3.50	<b>1.07</b>	6.73
	11'	4.23	<b>2.00</b>	6.73
	8'	5.02	<b>3.17</b>	6.73
22.5'	17'	2.15	<b>0.54</b>	5.36
	12'	2.81	<b>1.09</b>	5.36
	7'	3.55	<b>2.14</b>	5.36
30'	13'	1.94	<b>0.50</b>	5.14
	7'	2.55	<b>0.99</b>	5.14
150MH – 18' Mounting Height				
Spacing	Distance Projection	Average	Minimum	Maximum
18'	21'	2.16	<b>0.50</b>	4.60
	15'	2.82	<b>1.08</b>	4.60
	10'	3.44	<b>2.08</b>	4.60
	7'	3.83	<b>2.91</b>	4.60
27'	17'	1.75	<b>0.50</b>	3.80
	11'	2.23	<b>1.04</b>	3.80
36'	12'	1.63	<b>0.53</b>	3.65

150HPS – 12' Mounting Height				
Spacing	Distance Projection	Average	Minimum	Maximum
12'	25'	3.97	<b>0.51</b>	14.0
	17'	5.79	<b>0.96</b>	14.0
	12'	7.52	<b>2.04</b>	14.0
	10'	8.47	<b>3.12</b>	14.0
	18'	3.63	<b>0.54</b>	11.2
18'	13'	4.68	<b>1.04</b>	11.2
	9'	5.94	<b>2.34</b>	11.2
	7'	6.71	<b>3.44</b>	11.2
24'	17'	3.01	<b>0.48</b>	10.7
	11'	4.16	<b>1.02</b>	10.7
	7'	5.29	<b>1.97</b>	10.7
150HPS – 15' Mounting Height				
Spacing	Distance Projection	Average	Minimum	Maximum
15'	23'	3.31	<b>0.52</b>	9.21
	16'	4.62	<b>1.07</b>	9.21
	12'	5.60	<b>2.14</b>	9.21
	10'	6.18	<b>3.03</b>	9.21
	19'	2.72	<b>0.49</b>	7.33
22.5'	14'	3.40	<b>0.99</b>	7.33
	9'	4.35	<b>2.20</b>	7.33
	6'	4.97	<b>3.12</b>	7.33
30'	14'	2.45	<b>0.54</b>	6.99
	9'	3.13	<b>1.06</b>	6.99
150HPS – 18' Mounting Height				
Spacing	Distance Projection	Average	Minimum	Maximum
18'	22'	2.87	<b>0.51</b>	6.28
	17'	3.45	<b>0.98</b>	6.28
	12'	4.25	<b>2.09</b>	6.28
	9'	4.79	<b>3.08</b>	6.28
27'	18'	2.23	<b>0.52</b>	5.19
	13'	2.74	<b>1.04</b>	5.19
	7'	3.46	<b>2.01</b>	5.19
36'	15'	1.92	<b>0.49</b>	4.96
	8'	2.54	<b>1.01</b>	4.96



**Illumination Levels**

- Initial lamp lumens for 42W Fluorescent = 3,200
- Maintained Footcandles (maintenance factors: Fluorescent - 0.90)
- Light levels assume 40% wall reflectance and contribution from adjacent luminaires

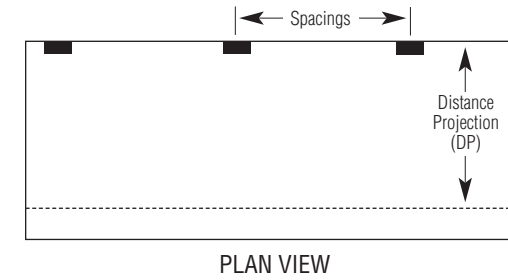
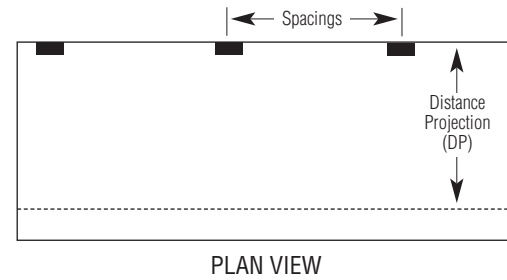

**Illumination Levels**

- Initial lamp lumens for 250W MH = 23,000  
Initial lamp lumens for 250W HPS = 29,000
- Maintained Footcandles (maintenance factors: Metal Halide - 0.72, High Pressure Sodium - 0.80)
- Light levels assume 40% wall reflectance and contribution from adjacent luminaires

42W Fluorescent – 10' Mounting Height				
Spacing	Distance Projection	Average	Minimum	Maximum
10'	13'	3.85	<b>0.61</b>	6.14
	11'	4.36	<b>1.22</b>	6.14
	9'	4.93	<b>2.41</b>	6.14
	8'	5.20	<b>3.29</b>	6.14
15'	12'	2.76	<b>0.59</b>	4.34
	10'	3.13	<b>1.17</b>	4.34
	8'	3.50	<b>2.09</b>	4.34
20'	11'	2.19	<b>0.47</b>	3.97
	8'	2.61	<b>1.23</b>	3.97
42W Fluorescent – 12' Mounting Height				
Spacing	Distance Projection	Average	Minimum	Maximum
12'	15'	2.78	<b>0.50</b>	4.28
	12'	3.25	<b>1.19</b>	4.28
	10'	3.58	<b>2.06</b>	4.28
	8'	3.85	<b>3.17</b>	4.28
18'	14'	1.95	<b>0.45</b>	2.99
	11'	2.28	<b>1.04</b>	2.99
	8'	2.57	<b>1.99</b>	2.99
24'	12'	1.66	<b>0.46</b>	2.79
	9'	1.91	<b>0.97</b>	2.79
42W Fluorescent – 15' Mounting Height				
Spacing	Distance Projection	Average	Minimum	Maximum
15'	17'	1.92	<b>0.47</b>	2.77
	14'	2.18	<b>0.94</b>	2.77
	10'	2.48	<b>2.01</b>	2.77
22.5'	15'	1.40	<b>0.51</b>	1.94
	11'	1.62	<b>1.09</b>	1.94
30'	12'	1.17	<b>0.52</b>	1.80

250HPS – 25' Mounting Height				
Spacing	Distance Projection	Average	Minimum	Maximum
75'	46'	2.95	<b>0.50</b>	7.60
	36'	3.60	<b>1.00</b>	7.60
	25'	4.43	<b>2.09</b>	7.60
	19'	5.06	<b>2.92</b>	7.60
	19'	5.06	<b>2.92</b>	7.60
87.5'	43'	2.77	<b>0.51</b>	7.16
	32'	3.46	<b>1.03</b>	7.16
	22'	4.24	<b>2.07</b>	7.16
100'	40'	2.34	<b>0.49</b>	6.90
	29'	2.97	<b>1.00</b>	6.90
	20'	3.57	<b>1.96</b>	6.90
250HPS – 20' Mounting Height				
Spacing	Distance Projection	Average	Minimum	Maximum
60'	41'	3.88	<b>0.51</b>	10.9
	34'	4.74	<b>1.00</b>	10.9
	25'	5.74	<b>2.07</b>	10.9
	20'	6.57	<b>3.05</b>	10.9
70'	39'	3.99	<b>0.51</b>	10.4
	32'	4.75	<b>0.96</b>	10.4
	22'	6.02	<b>2.08</b>	10.4
80'	18'	6.69	<b>3.03</b>	10.4
	38'	3.44	<b>0.49</b>	9.93
	30'	4.11	<b>1.00</b>	9.93
	21'	4.99	<b>2.00</b>	9.93
17'	5.68	<b>2.96</b>	9.93	
250HPS – 15' Mounting Height				
Spacing	Distance Projection	Average	Minimum	Maximum
45'	38'	6.38	<b>0.52</b>	18.7
	31'	7.34	<b>1.05</b>	18.7
	25'	8.72	<b>2.06</b>	18.7
	24'	9.85	<b>3.07</b>	18.7
52.5'	37'	5.53	<b>0.56</b>	18.0
	30'	6.82	<b>0.99</b>	18.0
	23'	8.09	<b>2.02</b>	18.0
60'	19'	9.16	<b>2.95</b>	18.0
	33'	4.94	<b>0.50</b>	16.6
	27'	5.78	<b>0.99</b>	16.6
	21'	6.95	<b>2.00</b>	16.6
	17'	7.93	<b>2.90</b>	16.6

250MH – 25' Mounting Height				
Spacing	Distance Projection	Average	Minimum	Maximum
75'	35'	2.88	<b>0.51</b>	7.33
	27'	3.46	<b>1.05</b>	7.33
	19'	4.26	<b>2.03</b>	7.33
	19'	4.26	<b>2.03</b>	7.33
87.5'	34'	2.69	<b>0.51</b>	7.21
	26'	3.22	<b>0.99</b>	7.21
100'	19'	3.80	<b>1.92</b>	7.21
	31'	2.33	<b>0.52</b>	6.87
	24'	2.79	<b>1.04</b>	6.87
250MH – 20' Mounting Height				
Spacing	Distance Projection	Average	Minimum	Maximum
60'	39'	3.17	<b>0.49</b>	7.48
	30'	3.94	<b>0.99</b>	7.48
	21'	4.79	<b>2.10</b>	7.48
	16'	5.44	<b>3.13</b>	7.48
70'	36'	3.30	<b>0.49</b>	7.42
	27'	3.97	<b>1.04</b>	7.42
	19'	4.87	<b>1.98</b>	7.42
80'	15'	5.29	<b>3.15</b>	7.42
	34'	2.86	<b>0.53</b>	7.26
	26'	3.43	<b>1.03</b>	7.26
19'	4.06	<b>1.94</b>	7.26	
250MH – 15' Mounting Height				
Spacing	Distance Projection	Average	Minimum	Maximum
45'	36'	5.10	<b>0.51</b>	13.3
	29'	5.92	<b>0.96</b>	13.3
	22'	7.41	<b>1.94</b>	13.3
	18'	8.35	<b>3.11</b>	13.3
52.5'	35'	4.44	<b>0.48</b>	12.3
	26'	5.78	<b>1.08</b>	12.3
	20'	6.87	<b>2.05</b>	12.3
60'	16'	7.80	<b>3.06</b>	12.3
	31'	4.00	<b>0.53</b>	11.7
	25'	4.74	<b>0.98</b>	11.7
	19'	5.85	<b>1.94</b>	11.7
	15'	6.62	<b>3.08</b>	11.7



**Illumination Levels**

- Initial lamp lumens for 250W MH = 23,000  
Initial lamp lumens for 250W HPS = 29,000
- Maintained Footcandles (maintenance factors: Metal Halide - 0.72, High Pressure Sodium - 0.80)
- Light levels assume 40% wall reflectance and contribution from adjacent luminaires

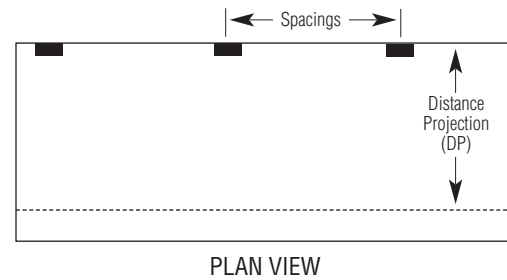

250HPS – 25' Mounting Height				
Spacing	Distance Projection	Average	Minimum	Maximum
25'	77'	6.84	<b>0.52</b>	13.9
	68'	7.73	<b>0.98</b>	13.9
	60'	8.54	<b>2.06</b>	13.9
	56'	8.97	<b>3.05</b>	13.9
37.5'	72'	4.85	<b>0.50</b>	9.39
	63'	5.39	<b>1.06</b>	9.39
	56'	5.94	<b>2.09</b>	9.39
	51'	6.27	<b>3.15</b>	9.39
50'	69'	3.98	<b>0.49</b>	8.69
	61'	4.40	<b>0.98</b>	8.69
	53'	4.87	<b>2.03</b>	8.69
	47'	5.18	<b>3.10</b>	8.69
250HPS – 20' Mounting Height				
Spacing	Distance Projection	Average	Minimum	Maximum
20'	71'	9.14	<b>0.50</b>	21.3
	59'	10.8	<b>1.03</b>	21.3
	52'	12.3	<b>2.09</b>	21.3
	48'	13.1	<b>3.28</b>	21.3
30'	64'	6.86	<b>0.50</b>	15.1
	55'	7.85	<b>1.05</b>	15.1
	49'	8.62	<b>1.98</b>	15.1
	45'	9.15	<b>3.20</b>	15.1
40'	60'	5.49	<b>0.50</b>	13.1
	53'	6.10	<b>0.98</b>	13.1
	46'	6.82	<b>2.18</b>	13.1
	43'	7.13	<b>3.00</b>	13.1
250HPS – 15' Mounting Height				
Spacing	Distance Projection	Average	Minimum	Maximum
15'	66'	13.0	<b>0.49</b>	37.9
	52'	16.5	<b>1.01</b>	37.9
	43'	19.5	<b>2.16</b>	37.9
	40'	20.8	<b>3.27</b>	37.9
22.5'	60'	9.71	<b>0.50</b>	25.8
	47'	12.2	<b>1.03</b>	25.8
	41'	13.8	<b>1.98</b>	25.8
	38'	14.7	<b>3.03</b>	25.8
30'	55'	8.06	<b>0.51</b>	23.6
	44'	9.77	<b>1.04</b>	23.6
	39'	11.0	<b>2.02</b>	23.6
	36'	11.7	<b>3.10</b>	23.6

250MH – 25' Mounting Height				
Spacing	Distance Projection	Average	Minimum	Maximum
25'	70'	5.28	<b>0.50</b>	12.2
	57'	6.35	<b>1.02</b>	12.2
	48'	7.27	<b>2.01</b>	12.2
	43'	7.86	<b>3.08</b>	12.2
37.5'	63'	3.87	<b>0.50</b>	8.20
	52'	4.55	<b>1.01</b>	8.20
	43'	5.20	<b>2.05</b>	8.20
	38'	5.61	<b>3.07</b>	8.20
50'	58'	3.25	<b>0.51</b>	6.98
	48'	3.75	<b>1.04</b>	6.98
	40'	4.22	<b>2.06</b>	6.98
	35'	4.70	<b>2.89</b>	6.98
250MH – 20' Mounting Height				
Spacing	Distance Projection	Average	Minimum	Maximum
20'	65'	7.12	<b>0.51</b>	18.8
	53'	8.51	<b>1.00</b>	18.8
	43'	10.2	<b>2.08</b>	18.8
	39'	11.1	<b>3.00</b>	18.8
30'	57'	5.39	<b>0.52</b>	12.7
	47'	6.38	<b>1.03</b>	12.7
	39'	7.44	<b>2.07</b>	12.7
	35'	8.00	<b>3.06</b>	12.7
40'	53'	4.39	<b>0.53</b>	10.8
	43'	5.21	<b>1.03</b>	10.8
	36'	5.94	<b>2.08</b>	10.8
	32'	6.51	<b>3.15</b>	10.8
250MH – 15' Mounting Height				
Spacing	Distance Projection	Average	Minimum	Maximum
15'	60'	10.3	<b>0.50</b>	33.2
	47'	12.8	<b>1.00</b>	33.2
	38'	15.5	<b>2.04</b>	33.2
	34'	17.0	<b>3.05</b>	33.2
22.5'	54'	7.71	<b>0.50</b>	22.5
	42'	9.59	<b>1.05</b>	22.5
	34'	11.6	<b>2.19</b>	22.5
	35'	11.4	<b>1.93</b>	22.5
30'	31'	12.5	<b>3.07</b>	22.5
	49'	6.34	<b>0.51</b>	19.3
	39'	7.81	<b>1.02</b>	19.3
	32'	9.09	<b>1.91</b>	19.3
30'	28'	9.99	<b>3.28</b>	19.3



**Illumination Levels**

- Initial lamp lumens for 350W PSMH = 34,200
- Maintained Footcandles (maintenance factors: Metal Halide - 0.72)
- Light levels assume 40% wall reflectance and contribution from adjacent luminaires

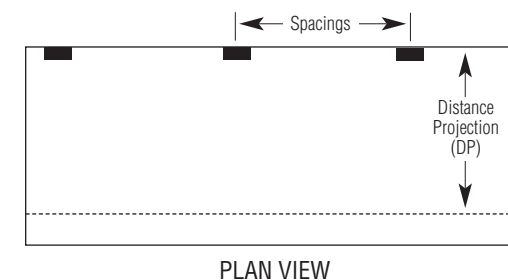

FORWARD THROW				
350MH – 30' Mounting Height				
Spacing	Distance Projection	Average	Minimum	Maximum
30'	90'	5.45	<b>0.49</b>	10.8
	77'	6.25	<b>1.03</b>	10.8
	67'	6.96	<b>2.10</b>	10.8
	61'	7.39	<b>3.10</b>	10.8
45'	83'	4.01	<b>0.48</b>	7.72
	72'	4.51	<b>1.05</b>	7.72
	62'	5.05	<b>2.06</b>	7.72
	55'	5.40	<b>3.02</b>	7.72
60'	79'	3.02	<b>0.49</b>	6.55
	68'	3.39	<b>1.02</b>	6.55
	57'	3.84	<b>2.01</b>	6.55
	350MH – 25' Mounting Height	82'	7.29	<b>0.51</b>
70'		8.42	<b>1.01</b>	15.7
61'		9.48	<b>1.97</b>	15.7
56'		10.1	<b>3.09</b>	15.7
75'		5.25	<b>0.51</b>	11.1
37.5'	65'	5.96	<b>1.03</b>	11.1
	56'	6.65	<b>2.15</b>	11.1
	51'	7.10	<b>3.14</b>	11.1
	72'	4.29	<b>0.50</b>	9.43
50'	62'	4.84	<b>1.03</b>	9.43
	53'	5.46	<b>2.05</b>	9.43
	47'	5.84	<b>3.08</b>	9.43
	350MH – 20' Mounting Height	77'	9.71	<b>0.50</b>
62'		11.8	<b>1.05</b>	24.0
53'		13.6	<b>2.15</b>	24.0
49'		14.5	<b>3.13</b>	24.0
68'		7.33	<b>0.51</b>	17.1
30'	57'	8.54	<b>1.00</b>	17.1
	50'	9.59	<b>1.97</b>	17.1
	46'	10.2	<b>3.00</b>	17.1
	64'	5.81	<b>0.50</b>	14.2
40'	54'	6.75	<b>1.05</b>	14.2
	47'	7.55	<b>2.06</b>	14.2
	43'	8.01	<b>3.06</b>	14.2

WIDE THROW				
350MH – 30' Mounting Height				
Spacing	Distance Projection	Average	Minimum	Maximum
90'	54'	2.57	<b>0.51</b>	6.04
	42'	3.05	<b>0.98</b>	6.04
	27'	3.80	<b>2.06</b>	6.04
105'	50'	2.16	<b>0.52</b>	5.71
120'	36'	2.73	<b>1.05</b>	5.71
	49'	2.01	<b>0.49</b>	5.35
35'	2.49	<b>1.01</b>	5.35	
350MH – 25' Mounting Height				
Spacing	Distance Projection	Average	Minimum	Maximum
75'	51'	3.19	<b>0.50</b>	7.83
	40'	3.72	<b>1.04</b>	7.83
	29'	4.58	<b>1.98</b>	7.83
	22'	5.22	<b>2.96</b>	7.83
87.5'	48'	2.99	<b>0.50</b>	7.55
	37'	3.55	<b>1.03</b>	7.55
	25'	4.40	<b>2.11</b>	7.55
100'	46'	2.49	<b>0.51</b>	7.24
	35'	3.01	<b>1.00</b>	7.24
	21'	3.81	<b>1.84</b>	7.24
350MH – 20' Mounting Height				
Spacing	Distance Projection	Average	Minimum	Maximum
60'	46'	4.24	<b>0.53</b>	11.2
	38'	5.03	<b>0.99</b>	11.2
	29'	5.97	<b>2.01</b>	11.2
	23'	11.1	<b>3.05</b>	11.2
	45'	4.20	<b>0.48</b>	10.6
70'	35'	5.00	<b>1.00</b>	10.6
	26'	6.15	<b>2.01</b>	10.6
	20'	6.99	<b>3.04</b>	10.6
80'	43'	3.59	<b>0.49</b>	10.8
	34'	4.38	<b>0.99</b>	10.8
	25'	5.23	<b>2.02</b>	10.8
	19'	5.89	<b>3.07</b>	10.8



**Illumination Levels**

- Initial lamp lumens for 400W MH = 39,000  
Initial lamp lumens for 400W HPS = 50,000
- Maintained Footcandles (maintenance factors: Metal Halide - 0.72, High Pressure Sodium - 0.80)
- Light levels assume 40% wall reflectance and contribution from adjacent luminaires

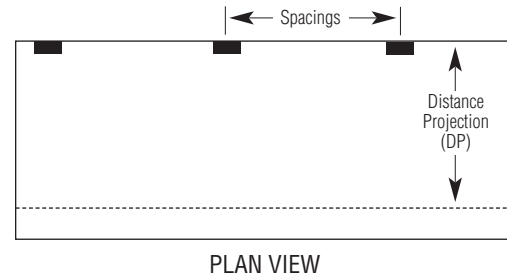

400HPS – 30' Mounting Height				
Spacing	Distance Projection	Average	Minimum	Maximum
30'	97'	7.60	<b>0.49</b>	16.1
	85'	8.61	<b>1.01</b>	16.1
	76'	9.42	<b>2.04</b>	16.1
	70'	10.0	<b>3.13</b>	16.1
45'	90'	5.65	<b>0.52</b>	11.4
	80'	6.23	<b>1.06</b>	11.4
	71'	6.81	<b>2.02</b>	11.4
60'	65'	7.26	<b>3.07</b>	11.4
	86'	4.20	<b>0.50</b>	10.1
	76'	4.65	<b>1.07</b>	10.1
60'	67'	5.10	<b>2.04</b>	10.1
	60'	5.44	<b>3.04</b>	10.1

400HPS – 25' Mounting Height				
Spacing	Distance Projection	Average	Minimum	Maximum
25'	89'	10.0	<b>0.49</b>	22.9
	76'	11.9	<b>1.02</b>	22.9
	68'	13.0	<b>1.95</b>	22.9
	63'	13.7	<b>3.05</b>	22.9
37.5'	81'	7.34	<b>0.53</b>	15.9
	71'	8.24	<b>1.04</b>	15.9
	63'	9.06	<b>2.10</b>	15.9
50'	59'	9.53	<b>3.02</b>	15.9
	78'	5.94	<b>0.51</b>	14.6
	68'	6.74	<b>1.07</b>	14.6
50'	61'	7.33	<b>1.92</b>	14.6
	56'	7.77	<b>3.02</b>	14.6

400HPS – 20' Mounting Height				
Spacing	Distance Projection	Average	Minimum	Maximum
20'	83'	13.3	<b>0.52</b>	35.7
	67'	16.3	<b>1.06</b>	35.7
	59'	18.3	<b>1.98</b>	35.7
	55'	19.4	<b>2.97</b>	35.7
30'	75'	9.85	<b>0.50</b>	25.6
	63'	11.6	<b>0.99</b>	25.6
	55'	13.2	<b>2.07</b>	25.6
40'	51'	14.1	<b>3.13</b>	25.6
	71'	7.92	<b>0.49</b>	22.1
	59'	9.38	<b>1.06</b>	22.1
40'	52'	10.6	<b>2.19</b>	22.1
	49'	11.1	<b>2.97</b>	22.1

400MH – 30' Mounting Height				
Spacing	Distance Projection	Average	Minimum	Maximum
30'	92'	5.15	<b>0.50</b>	10.5
	78'	6.06	<b>1.15</b>	10.5
	68'	6.73	<b>1.99</b>	10.5
	61'	7.22	<b>3.02</b>	10.5
45'	86'	3.78	<b>0.51</b>	7.21
	73'	4.33	<b>1.03</b>	7.21
	62'	4.83	<b>1.99</b>	7.21
60'	54'	5.20	<b>3.03</b>	7.21
	81'	2.85	<b>0.50</b>	6.24
	68'	3.27	<b>1.03</b>	6.24
60'	56'	3.68	<b>1.99</b>	6.24

400MH – 25' Mounting Height				
Spacing	Distance Projection	Average	Minimum	Maximum
25'	85'	6.91	<b>0.49</b>	14.7
	73'	7.90	<b>0.99</b>	14.7
	62'	9.00	<b>2.07</b>	14.7
	56'	9.76	<b>3.16</b>	14.7
	78'	4.93	<b>0.52</b>	10.1
37.5'	66'	5.68	<b>1.06</b>	10.1
	57'	6.34	<b>1.98</b>	10.1
	51'	6.82	<b>3.03</b>	10.1
50'	75'	3.96	<b>0.49</b>	9.00
	63'	4.58	<b>1.01</b>	9.00
	53'	5.22	<b>2.00</b>	9.00
50'	47'	5.58	<b>2.95</b>	9.00

  

400MH – 20' Mounting Height				
Spacing	Distance Projection	Average	Minimum	Maximum
20'	76'	9.57	<b>0.50</b>	22.5
	64'	11.1	<b>1.06</b>	22.5
	56'	12.5	<b>1.97</b>	22.5
	50'	13.7	<b>3.18</b>	22.5
	71'	6.75	<b>0.50</b>	16.2
30'	60'	7.91	<b>0.99</b>	16.2
	51'	9.06	<b>1.98</b>	16.2
	46'	9.78	<b>3.07</b>	16.2
40'	67'	5.42	<b>0.49</b>	13.6
	56'	6.40	<b>1.04</b>	13.6
	48'	7.22	<b>1.96</b>	13.6
40'	43'	7.79	<b>2.99</b>	13.6



**Illumination Levels**

- Initial lamp lumens for 400W MH = 39,000  
Initial lamp lumens for 400W HPS = 50,000
- Maintained Footcandles (maintenance factors: Metal Halide - 0.72, High Pressure Sodium - 0.80)
- Light levels assume 40% wall reflectance and contribution from adjacent luminaires

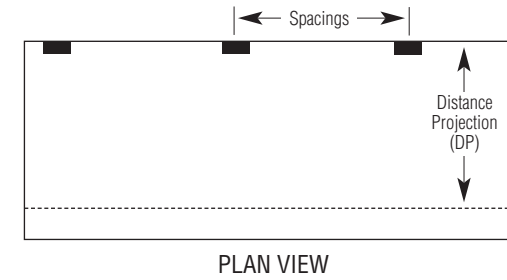

400HPS – 30' Mounting Height				
Spacing	Distance Projection	Average	Minimum	Maximum
90'	57'	3.62	<b>0.50</b>	9.70
	46'	4.20	<b>1.01</b>	9.70
	34'	5.11	<b>2.03</b>	9.70
105'	26'	5.94	<b>3.04</b>	9.70
	53'	3.02	<b>0.51</b>	9.26
	42'	3.70	<b>1.01</b>	9.26
120'	30'	4.53	<b>2.02</b>	9.26
	51'	2.93	<b>0.51</b>	8.88
	40'	3.44	<b>1.04</b>	8.88
120'	27'	4.32	<b>2.02</b>	8.88

400HPS – 25' Mounting Height				
Spacing	Distance Projection	Average	Minimum	Maximum
75'	52'	4.50	<b>0.53</b>	12.9
	43'	5.26	<b>1.04</b>	12.9
	34'	6.34	<b>1.99</b>	12.9
	27'	7.18	<b>3.12</b>	12.9
87.5'	50'	4.05	<b>0.54</b>	12.2
	40'	4.86	<b>1.07</b>	12.2
	31'	5.89	<b>1.99</b>	12.2
100'	25'	6.66	<b>3.04</b>	12.2
	47'	3.48	<b>0.49</b>	11.8
	38'	4.27	<b>1.01</b>	11.8
100'	28'	5.19	<b>2.00</b>	11.8
	21'	5.91	<b>3.08</b>	11.8

400HPS – 20' Mounting Height				
Spacing	Distance Projection	Average	Minimum	Maximum
60'	48'	6.05	<b>0.51</b>	18.7
	39'	7.02	<b>1.03</b>	18.7
	32'	8.39	<b>1.96</b>	18.7
	27'	9.25	<b>3.05</b>	18.7
	47'	5.60	<b>0.48</b>	17.5
70'	37'	7.03	<b>1.05</b>	17.5
	29'	8.43	<b>2.03</b>	17.5
	24'	9.68	<b>3.11</b>	17.5
80'	44'	4.90	<b>0.50</b>	17.1
	36'	6.09	<b>0.98</b>	17.1
	28'	7.30	<b>2.11</b>	17.1
80'	23'	8.10	<b>3.05</b>	17.1

400MH – 30' Mounting Height				
Spacing	Distance Projection	Average	Minimum	Maximum
90'	55'	2.51	<b>0.52</b>	6.12
	43'	2.99	<b>0.96</b>	6.12
	28'	3.80	<b>2.03</b>	6.12
105'	51'	2.13	<b>0.49</b>	5.53
	37'	2.59	<b>1.03</b>	5.53
	28'	2.98	<b>1.62</b>	5.53
120'	48'	1.98	<b>0.50</b>	5.61
	34'	2.44	<b>1.04</b>	5.61

400MH – 25' Mounting Height				
Spacing	Distance Projection	Average	Minimum	Maximum
75'	52'	3.12	<b>0.51</b>	8.28
	40'	3.80	<b>1.07</b>	8.28
	29'	4.63	<b>2.04</b>	8.28
	22'	5.28	<b>3.11</b>	8.28
87.5'	49'	2.91	<b>0.50</b>	7.89
	37'	3.57	<b>1.02</b>	7.89
	26'	4.40	<b>1.96</b>	7.89
100'	46'	2.50	<b>0.51</b>	7.58
	34'	3.05	<b>1.03</b>	7.58
	25'	3.57	<b>1.90</b>	7.58









  

400MH – 20' Mounting Height				
Spacing	Distance Projection	Average	Minimum	Maximum
60'	48'	4.20	<b>0.50</b>	11.8
	38'	5.06	<b>1.04</b>	11.8
	29'	6.01	<b>2.02</b>	11.8
	23'	6.86	<b>3.14</b>	11.8
	45'	4.26	<b>0.50</b>	11.5
70'	36'	5.05	<b>0.97</b>	11.5
	27'	6.01	<b>2.03</b>	11.5
	21'	6.87	<b>2.96</b>	11.5
80'	43'	3.56	<b>0.51</b>	10.9
	33'	4.35	<b>1.04</b>	10.9
	24'	5.38	<b>2.09</b>	10.9
	20'	5.77	<b>2.92</b>	10.9

# ORDERING INFORMATION

example:



	LUMINAIRE	DISTRIBUTION	WATTAGE	VOLTAGE	FINISH	108 RING	OPTIONS
	<b>101</b> height: 7" width: 16 1/4" depth: 9"	FT = Forward Throw Downlight (Not available with fluorescent) WT = Wide Throw Downlight (Not available with fluorescent) MT = Medium Throw	35 HPS (120V only) 50 HPS 70 HPS 100 HPS 150 HPS (S55) 50 MH 50 CMHE** 70 MH 70 CMHE** 100 MH 100 CMHE**	120V 277V 347V ( (2) 42 TRF not available) (Not available with CMHE lamps)	BRP Bronze Paint BLP Black Paint WP White Paint NP Natural Paint BGP Beige Paint OC Optional Color (see Color Selection Guide) SC Special Color (Color Chip Required)	AR = Ring Painted to Match Housing SR = Stainless Steel Ring (Brushed) OR = Optional Color Ring LR = Less Ring LER = Red LED LEO = Orange LED LEA = Amber LED LEG = Green LED LEB = Blue LED	F = Fusing (120V, 277V) PCB = Button Type Photocontrol (Not available on 480V, N/A 105) QS = Quartz Standby (Not available with 105 using 35 watt HPS, FT or MT distributions on 103-106 and 108 or electronic ballasts) Q924 = Quartz Emergency (HID only, 150 watt max. HID, 100 watt max. Quartz, WT Optics only) SL = Solite® Diffusing Lens (For daytime obscuring of optical system and lamp. Can reduce spacing capability of sconces) UT = 5° Uptilt for FT Optics WLU = Wet Location Door for Inverted (101/102 only) WS = Wall Mount, Surface Conduit (see photo on page 33) WS/UT = Wall Mount, Surface Conduit with 5P uptilt for FT optics WG = Wire Guard (N/A 103, 104, 105, 106, 108) * Contact factory for fluorescent dimming availability ** CMHE = Ceramic Metal Halide with electronic ballast (120/277 volt only)
	<b>102</b> height: 8 1/4" width: 16 1/4" depth: 9"		FT-U = 90% Downlight/10% Uplight (Not available with fluorescent) WT-U = 90% Downlight/10% Uplight (Not available with fluorescent) MT-U = 90% Downlight/10% Uplight MT-UD = 50% Downlight/50% Uplight (Coated MH lamps recommended)	150 MH (M102) 175 MH 26 QF (Quad Tube Fluorescent) (2) 26 QF (Quad Tube Fluorescent) (2) 26 QF-DIM* (120V only) 42 TRF (Triple Tube Fluorescent) 42 TRF-DIM* (120V only) (2) 42 TRF (101, 103, 104, 107, 108 only)	Contact factory for other voltages		
	<b>103</b> height: 7" width: 18" depth: 9"						
	<b>104</b> height: 7" width: 18" depth: 9"	FT = Forward Throw Downlight (Not available with fluorescent) WT = Wide Throw Downlight (Not available with fluorescent) MT = Medium Throw Downlight					
	<b>106</b> height: 9 1/8" width: 18" depth: 9"						
	<b>105</b> height: 9 1/8" width: 18" depth: 9"	FT-U = 70% Downlight/30% Uplight (Not available with fluorescent) UD = Uplight Glow/Downlight	35 - 150 HPS 50 - 70 MH 100 - 150 MH (1) 42 TRF (1) 42 TRF-DIM*	120V only 120V, 277V, 277V only 120V, 277V, 347V 120V			
	<b>107</b> height: 7 1/2" width: 21 1/4" depth: 11 1/2"	FT = Forward Throw Downlight (Not available with fluorescent) WT = Wide Throw Downlight (Not available with fluorescent) MT = Medium Throw Downlight	All Wattages	120V 277V 347V			
	<b>108</b> height: 7 1/8" width: 25 1/4" depth: 11 1/2"						

Prior to ordering, consult submittal data on [www.sitelighting.com](http://www.sitelighting.com) for the most current information.



# 111 ORDERING INFORMATION



PREFIX	DISTRIBUTION	WATTAGE	VOLTAGE	FINISH	OPTIONS
<b>example</b> 111	<b>FT</b>	<b>50HPS</b>	<b>120</b>	<b>BRP</b>	<b>F</b>
111	FT <sup>1</sup> Forward Throw WT <sup>1</sup> Wide Throw MT <sup>2</sup> Medium Throw Please refer to notes below for lamp types	35HPS <sup>4</sup> 50HPS <sup>4</sup> 70HPS 50MH <sup>4</sup> 70MH T39MH <sup>4</sup> T70MH T39CMHE <sup>4</sup> 26QF 32TRF 42TRF INC <sup>3,5</sup>	120 277 347  Consult factory for other voltages	BRP Bronze BLP Black WP White NP Natural Aluminum BGP Beige OC Optional Color (see Color Selection Guide) SC Special Color (color chip required)	F Fusing (120V, 208V, 240V, 277V) <sup>4</sup> SL Solite Diffusing Lens (For daytime obscuring of optical system and lamp. Can reduce spacing capability of sconces) PCB Button Type Photocontrol WLU Wet Location door for inverted mounting WG Wire Guard EMR Emergency Remote Ballast, 42W Fluorescent Only WS Wall Mount Box for Surface Conduit

1. T39MH, T70MH, T39CMHE only  
2. Fluorescent and ED17 lamps only  
3. Available in 120V only  
4. Not available with 347V  
5. BT 15-150W max.

T39MH, T70MH and T39CMHE types utilize T6-G12 based lamps, which are supplied with the luminaire.

# EMERGENCY LIGHTING

PREFIX	DISTRIBUTION	WATTAGE	VOLTAGE	FINISH	RING <sup>1</sup>	LED RING <sup>1</sup>	OPTIONS
<b>example</b> 101EM	<b>MT</b>	<b>42TRF</b>	<b>120</b>	<b>BRP</b>	<b>AR</b>	<b>LER</b>	<b>F</b>
101EM 102EM 103EM 104EM 106EM 107EM 108EM	MT Medium Throw	42TRF (2)26QF	120 277 347 (Canada only)	BRP Bronze BLP Black WP White NP Natural Aluminum BGP Beige OC Optional Color (see Color Selection Guide) SC Special Color (color chip required)	AR Aluminum Ring SR Stainless Steel Ring (Brushed) OR Optional Color Ring LR Less Ring	LER (Red) LEO (Orange) LEA (Amber) LEG (Green) LEB (Blue)	B84C <sup>2</sup> B94C-CAN <sup>2</sup> PCB SL WG WS Bodine Emergency Pack (must be ordered here or supplied by others) Bodine Emergency Pack (Canada only) Button Type Photocontrol Solite <sup>®</sup> Diffusing Lens Wire Guard (N/A 103, 104, 105, 106, 108) Surface Conduit
101EMR 102EMR 103EMR 104EMR 106EMR 107EMR 108EMR 111EMR <sup>3</sup>	EM = Integral Emergency Ballast (Fluorescent Only) EMR = Remote Emergency Ballast						1. 108 series only. 2. EMR series only. Not included standard. 3. 111EMR available with 42TRF only.

Note: For emergency luminaires requiring two sources of supply, refer to Q924 option on page 33.



# 141 ORDERING INFORMATION



PREFIX	DISTRIBUTION	WATTAGE	VOLTAGE	FINISH	OPTIONS
<b>example</b> 141	<b>FT</b>	<b>250HPS</b>	<b>120</b>	<b>BRP</b>	<b>F</b>
141	FT Forward Throw WT Wide Throw	250HPS 400HPS 250MH 400MH* 250 PSMH 320 PSMH 350 PSMH 400 PSMH*	120 208 240 277 347 480	BRP Bronze Paint BLP Black Paint WP White Paint NP Natural Aluminum Paint BGP Beige Paint OC Optional Color (see Color Selection Guide) SC Special Color Paint (provide color chip)	F Fusing SL Solite Diffusing Lens (For daytime obscuring of optical system and lamp. Can reduce spacing capability of sconces) UT 5P Uptilt Bracket for FT optics PCB Button Type Photocontrol (not available on 480V) QS Quartz Standby (150W max. quartz wattage) WS Wall Mt. Box for Surface Conduit WS/UT Wall Mt. Box for Surface Conduit with 5P Uptilt Bracket for FT optics WG Wire Guard

\* Uses reduced jacket E28 lamp

Prior to ordering, consult submittal data on [www.sitelighting.com](http://www.sitelighting.com) for the most current information.

Prior to ordering, consult submittal data on [www.sitelighting.com](http://www.sitelighting.com) for the most current information.

## Remote Mount Installation

EMR luminaires are supplied with an integral LED charge indicator and test switch. A 7.5' whip is provided for wiring to a Bodine B84C fluorescent emergency ballast, supplied by the contractor, or ordered from Gardco as an option. The emergency ballast is remotely installed in the plenum safely away from outside temperature extremes.

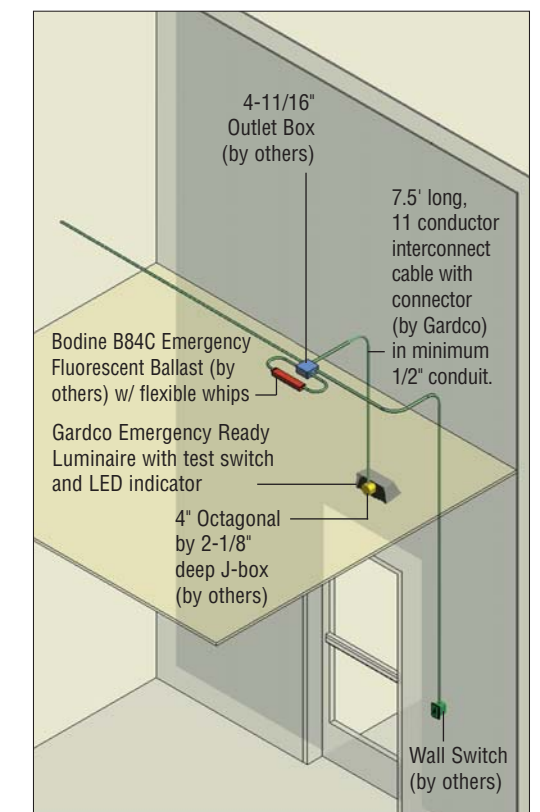
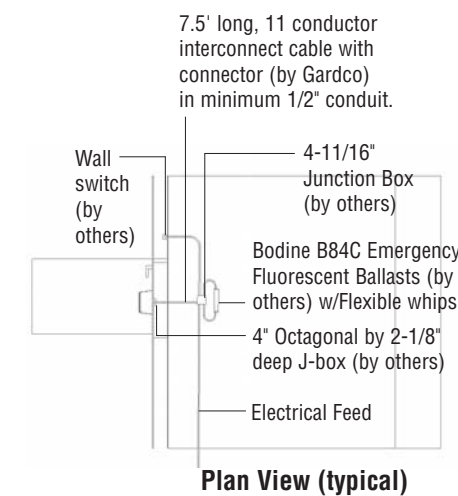
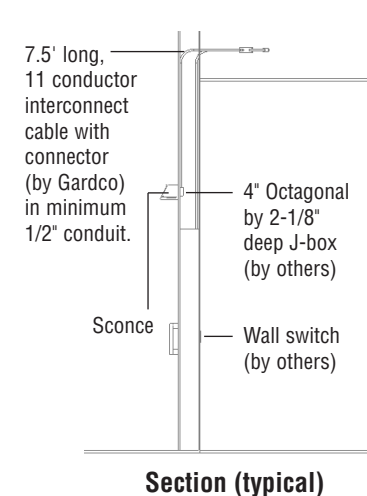

# SPECIFICATIONS

**GENERAL:** Gardco Sconces are wall mounted cutoff luminaires for high intensity discharge and fluorescent lamps. The 103 and 105 introduce moderate uplight when vertical footcandles above the luminaire are desired. Circa 108 provides the option of an LED accent ring. Internal components are totally enclosed in a rain-tight, dust-tight and corrosion resistant housing. Housing, back plate and door frame are diecast aluminum. Optical choices are available for downlighting, uplighting, or both. Luminaires are primarily suitable for wet locations. When inverted, sconces can be used in damp locations unless a WLU option is available.

**HOUSING:** All housings are diecast aluminum. 105 housing is diecast with a high-impact resistant acrylic uplight diffuser. 103 diecast housing includes a prismatic tempered glass uplight top lens which is mechanically secured and silicone sealed. 108 includes an adornment ring which can be painted to match or accent the luminaire finish or, can be specified as an illuminated LED ring. Downlight only products have fully cast tops. Memory retentive gasket seals housing with door frame to exclude moisture, dust, insects and pollutants from optical systems. Black diecast ribbed backplate dissipates heat for longer lamp and ballast life.

**DOOR FRAME:** Single piece diecast aluminum door frame integrates to all housing forms. Door frame is hinged and secured to housing with (2) captive stainless steel fasteners. Heat and impact resistant 1/8" tempered glass lens and one-piece gasket are mechanically secured to door frame.

**OPTICAL SYSTEMS:** Reflectors are composed of specular extruded and Alzak® faceted components, electro-polished, anodized and sealed. Reflector segments are set in arc tube image duplicating patterns to achieve the wide throw, forward throw or medium throw downlight distributions. 105 utilizes an inner glass diffuser and a honeycomb louver or modified forward throw optics for uniform, consistent glow.

**LED RING:** The 108 luminaire may be provided with a decorative acrylic rod shaped to follow contour of luminaire and is illuminated at each end by light emitting diode (LED) illuminator assemblies.

The rod will have reflective coating causing an even brightness along its length resembling luminous tube lighting. There are no breaks, discrete spots, or other discontinuities visible in the intended viewing angle of 60P to 90P above nadir.

The method of rod attachment to luminaire allows for thermal expansion and contraction from -70P to +120FP without causing damage to the assembly. The rod does not use adhesives for structural support.

The illuminator assembly at each end consists of a polycarbonate thermoplastic housing which encloses LEDs. The housing is potted with a water-clear compound, after assembly, which totally encapsulates all components to protect against water and other environmental contamination.

Electrical supply powering each illuminator directly or indirectly shall be 30 volts RMS or less and be supplied by an isolation transformer. Primary wavelengths for the available colors shall be: Red – 626-635 nm; Orange – 605-609 nm; Amber – 509-592 nm; Blue – 465-470 nm, or Green – 520-525nm.

**ELECTRICAL** (Please refer to page 35 for additional Emergency Sconce specifications): Each HID ballast is high power factor and is capable of providing reliable lamp starting to -20PF (-29PC). Magnetic ballast is of the separate component type, solid state ballast is provided with integral enclosure. Fluorescent ballasts have a lamp starting temperature of 0PF (-18PC) and are solid state.

**LAMPHOLDER:** Pulse rated medium base sockets are glazed porcelain with nickel plated screw shell. Fluorescent sockets are high temperature plastic (PBT) with brass contacts. T6 lamps use a G12 base, pulse rated porcelain socket.

**FINISH:** Each luminaire receives a fade and abrasion resistant, electrostatically applied thermal cured, textured TGIC polyester powdercoat finish.

**SUPPLY CONNECTION:** Via recessed J-box by others (4sq., 3-0, 4-0 recessed) 90PC supply wire minimum. Surface cast aluminum box option for surface conduit. Four threaded openings provided. Wall mount over conduit stub-out using surface box. With 100 Series and 141 SuperSconce, a 5P up tilt option available with either mounting.

**LABELS:** All fixtures bear UL or CUL (where applicable) labels. Lens down application is Wet Location and lens up is Damp Location, except when using the optional inverted Wet Location components.



The WS option allows for mounting sconces using surface conduit. The sconce mounts over a factory supplied surface junction box allowing for use in retrofit situations or where surface conduit is required.

# DIMENSIONS

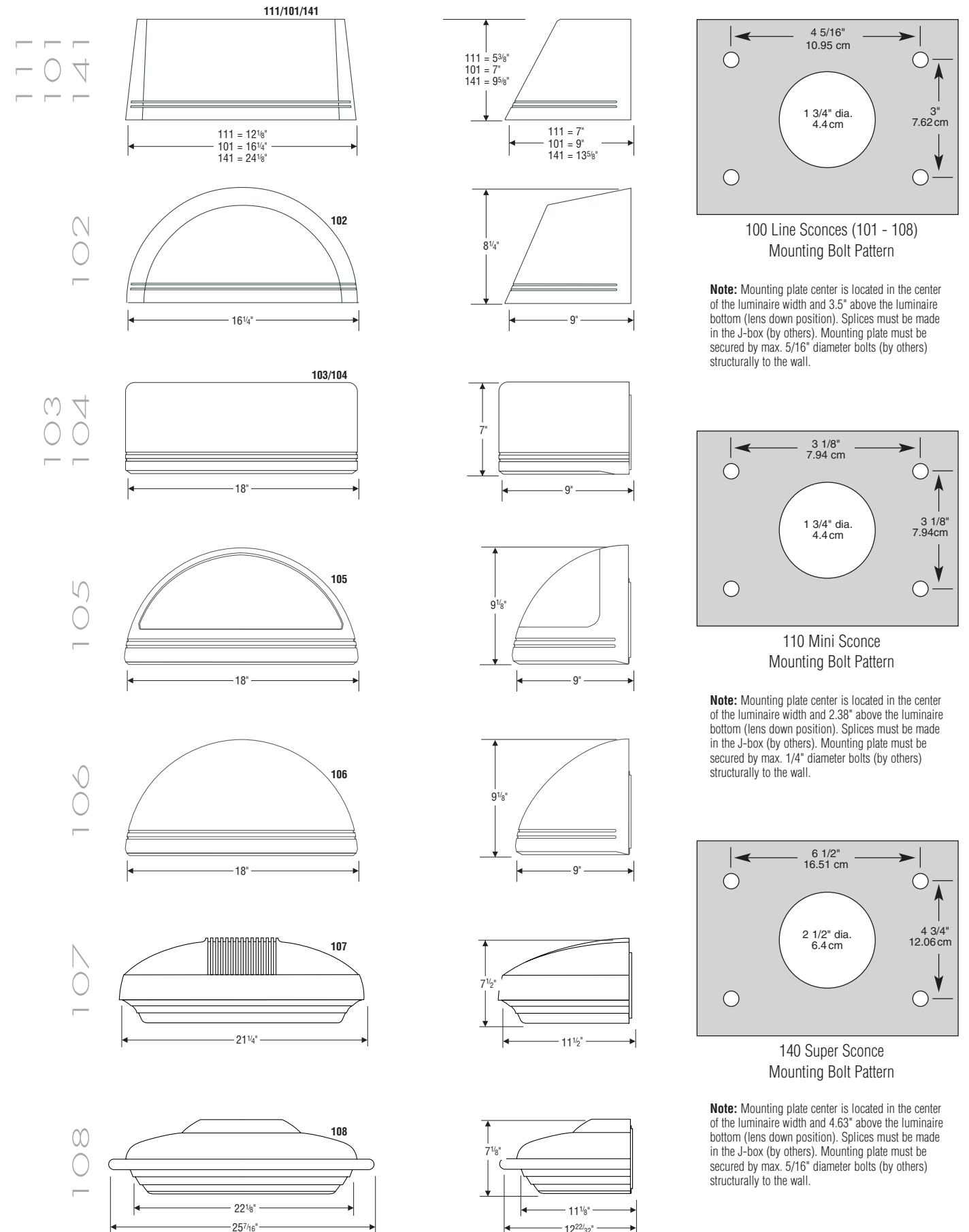

Designer Floodlights



Cylinders



Step & Aisle Lights



Fascia Plates



2661 Alvarado Street  
San Leandro, CA 94577  
800/227-0758  
510/357-6900 in California  
Fax: 510/357-3088  
[www.sitelighting.com](http://www.sitelighting.com)

© Gardco Copyright 2003  
A Genlyte Company  
All Rights Reserved.  
International Copyright Secured.

79103-23/1003-1004