

Notes:

Job:

Type:

FASCIA PLATES

600 SERIES

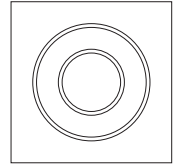

GENERAL DESCRIPTION: The Gardco Fascia Plates are wall mounted luminaires utilizing compact fluorescent, incandescent, and high intensity discharge lamps. Fascia Plates are graceful architectural accents in the daytime and serve as elegant markers or signage at night. Faces are square or round, perforated or center cut, painted or finished by others in tile. White glass lens diffuses light to produce a soft luminous glow. These luminaires are suitable for outdoor applications and feature rugged die cast housings, silicone seals and gaskets, and polyester powdercoat finishes.

ORDERING

PREFIX	LENS	WATTAGE	VOLTAGE	LIGHT SHAPE	PLATES	FINISH	COLORED FILTERS	OPTIONS
<input type="text"/>	<input type="text"/>	<input type="text"/>	<input type="text"/>	<input type="text"/>	<input type="text"/>	<input type="text"/>	<input type="text"/>	<input type="text"/>

Enter the order code into the appropriate box above. Note: Gardco reserves the right to refuse a configuration. Not all combinations and configurations are valid. Refer to notes below for exclusions and limitations. For questions or concerns, please consult the factory.

PREFIX

600D	Drywall Only <i>Insulation must be spaced off 3" from all sides of unit</i>
600C	Concrete Only <i>Allows for installation in poured concrete</i>
600U	Universal <i>Allows for insulation in contact with housing (fluorescent only)</i>
610S	Surface Mount <i>Fluorescent or Incandescent only. No "Diamond" Shapes</i>

LENS

D Diffuse Glass

WATTAGE

70MH	70HPS	26QF⁴	INC <i>150w maximum</i>
100MH	100HPS	32TRF⁴	
150MH^{1,2}	150HPS^{1,3}	42TRF⁴	

*MH Metal Halide
HPS High Pressure Sodium
QF Quad Tube Compact Fluorescent
TRF Triple Tube Compact Fluorescent
INC Incandescent*

*1. Available on 600C only
2. Available with reactor ballast, 277V only
3. Available with reactor ballast, 120V only
4. Electronic ballast available in 120V through 277V or 347V only and 50 or 60 hz .
0° F starting temperature*

VOLTAGE

120
277
347

347V not available in 150MH or 150HPS

LIGHT SHAPE

360	360° Distribution
180U	180° Uplight Distribution
180D	180° Downlight

PLATES

RS	Round Solid	ST	Square Tile
SS	Square Solid	DT	Diamond Tile
DS	Diamond Solid	RL	Round Logo
RP	Round Perforated	SL	Square Logo
SP	Square Perforated	DL	Diamond Logo
DP	Diamond Perforated		

RE1 - RE5 Round Embossed:

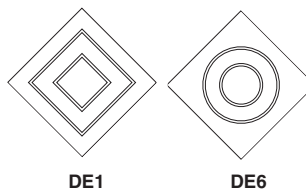
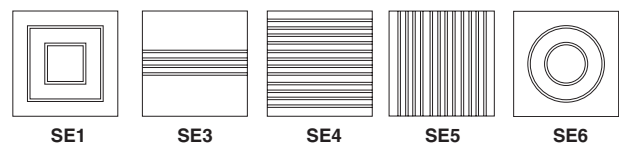
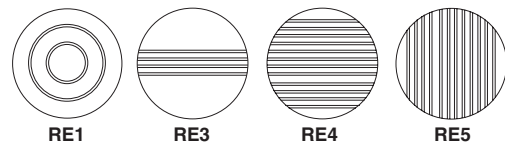

FINISH

BRP	Bronze Paint
BLP	Black Paint
WP	White Paint
NP	Natural Aluminum Paint
BGP	Beige Paint
OC	Optional Color Paint <i>Specify RAL designation as shown. ex: OC-RAL7024</i>
SC	Special Color Paint <i>Specify. Must supply color chip</i>

COLORED FILTERS

XX	No Color		
Flat		Radiused	
RD	Red	RR	Red
FP	Fluorescent Pink	FR	Fluorescent Pink
BD	Dark Blue	DR	Dark Blue
YM	Yellow	YR	Yellow
AM	Amber	AR	Amber
BL	Light Blue	LR	Light Blue
PL	Pearl	PR	Pearl
GD	Dark Green	GR	Dark Green
MR	Mirror	SR	Light Smoke
SL	Light Smoke	BE	Bronze
BR	Bronze	WR	White
DW	White		

OPTIONS

F	Fusing
WS	Wall Mounted Box for Surface Conduit <i>610S only</i>

Gardco Lighting reserves the right to change materials or modify the design of its product without notification as part of the company's continuing product improvement program.

© Copyright Gardco Lighting 2001-2007. All Rights Reserved. International Copyright Secured.

A Genlyte Company

Gardco Lighting
1611 Clovis Barker Road
San Marcos, TX 78666

(800) 227-0758
(512) 753-1000
FAX: (512) 753-7855
www.sitelighting.com



79115-95/0707

FASCIA PLATES

600 SERIES

SPECIFICATIONS

MOUNTING: Wall mount only, outdoor and indoor.

FACEPLATES: Solid, perforated, embossed and custom logo faceplates are one-piece aluminum. Faceplate assemblies are secured to housing with three (3) tamper-resistant hex socket-head screws. Standoffs are machined stainless steel. Ceramic tile tray accepts nine (9) 4 1/4" (10.80cm) square ceramic or stone tile (supplied and set by others) and can be specified with or without center color filter (filter supplied as same size as one tile).

LOGO PLATES: All logos are custom manufactured by Gardco Lighting from a "DXF" file supplied by customer. Gardco will provide electronic file for approval of proportion and reproduction. Logo will be backlit in white (standard) or optional color filters can be selected (Logo in one color filter only).

COLOR FILTER: Color filters, round or square, are nominal 1/8" (.32cm) acrylic.

LENS: Single-piece diffuse white molded glass. Single piece die-cut silicone gasket secures seal between the diecast surface plate and lens.

REFLECTOR: White powdercoat painted spun aluminum.

HOUSING: Housing is corrosion resistant diecast aluminum. Finish is white powdercoat paint. Individual housings must be specified and are suitable for installation in all types of wall construction including concrete and masonry and drywall. Housing mounting application is recessed behind mounting surface.

J-BOX

Recessed Units 600C/600D/600U: Diecast aluminum. Factory installed, field-adjustable to two different mounting positions.

Surface Mounted Units 610S: Recessed J-Box required (by others). Mounting plate mounts over the recessed J-Box and must be attached to structure. WS option is required if no recessed J-Box is present.

ELECTRICAL: HID units include high power factor ballast. Suitable for -20°F/-29°C starting temperature. Fluorescent models feature an electronic solid state ballast as standard. Accepts (1) 26W, 32W, 42W lamps. Incandescent unit includes a medium base socket with nickel plated screw shell.

FINISH: Standard finish is fade and abrasion resistant, electrostatically applied, thermally cured TGIC textured polyester powdercoat paint.

LABELS: All luminaires bear either UL or CUL (where applicable) Wet Location labels.

DIMENSIONS

600 D/C/U

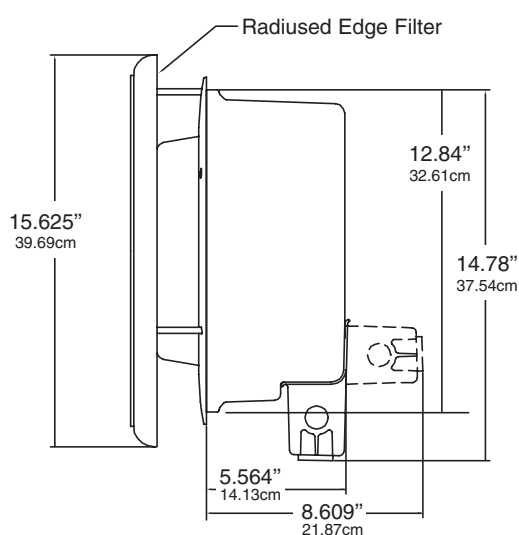
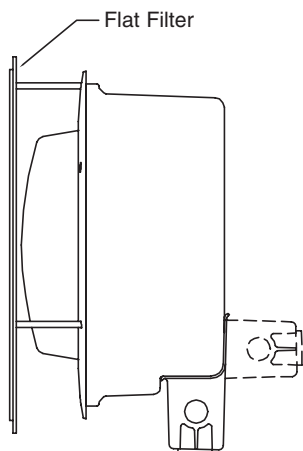

610 S

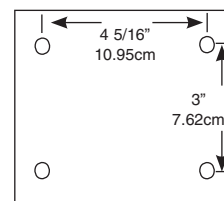
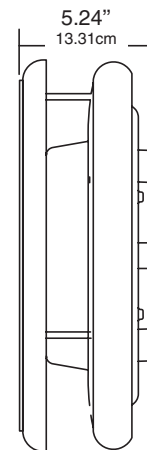

Mounting Bolt Pattern

Center J-Box within hole pattern
5/16" (.79cm) maximum fastener size

Gardco Lighting reserves the right to change materials or modify the design of its product without notification as part of the company's continuing product improvement program.

© Copyright Gardco Lighting 2001-2007. All Rights Reserved. International Copyright Secured.

A Genlyte Company

Gardco Lighting
1611 Clovis Barker Road
San Marcos, TX 78666

(800) 227-0758
(512) 753-1000
FAX: (512) 753-7855
www.sitelighting.com



79115-95/0707