

LED Medical

Fail-Safe



EATON

Powering Business Worldwide

Patient Room

Recessed Ceiling



MAE

MAE Medical Ambient Exam

MAO Medical Ambient Open

The MAE is ideal for today's ever-changing, fast-paced healthcare facility. Use the MAE for general ambient lighting and exam functions or add the LED reading light option and combine three functions in one attractive 2' x 2' or 2' x 4' fixture.

The MAO, with a linear-ribbed, center acrylic basket and matte-white painted reflectors, is the perfect choice when only ambient illumination is needed.



MAO

- Ideal in patient rooms for general ambient, exam or reading functions
- MAE available with frosted linear, ribbed, acrylic exam and ambient lenses with prisms inward
- MAO available with frosted, ribbed acrylic lens, or smooth clear lens with perforated inlay
- Available in 2' x 2' and 2' x 4' sizes
- Matte white powder coat paint standard with Anti-microbial paint optional
- Available with low voltage controller with EM pack available
- LED reading lights available in MAE

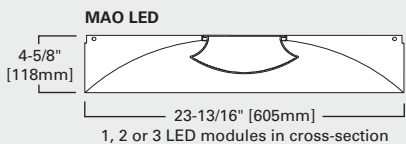
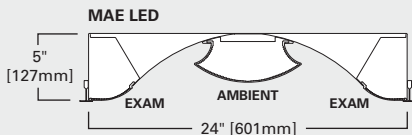

Patient Room

Surface Wall



MPBL Medical Patient Bed Light

The low-profile, aesthetically pleasing wall-mount MPBL, with its soft curves and matte white finish, is sure to enhance any environment. The MPBL is constructed of an aluminum extruded housing, die-cast end caps and linear-ribbed diffuse acrylic lenses. Several choices of up/down lumen packages and thoughtful options make the MBPL the ideal choice for the lighting challenges of healthcare facilities.

- Ideal for patient rooms when wall-mount illumination is preferred
- Aesthetically-pleasing fixture provides an upgrade to any space
- Die-cast aluminum end caps
- Optional flat end caps available
- Dedicated LED divider for independent up/down switching
- Extruded aluminum rail and housing for durability and aesthetics
- Matte white, architectural paint standard with anti-microbial paint optional.
- Available in 2' and 4' lengths
- Frosted, linear ribbed lens with prisms inward
- Pull chain, low voltage controller, dimmable LED night light available

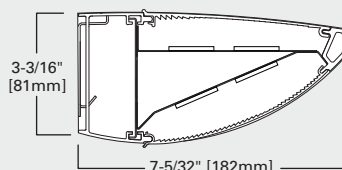

Patient Room

Recessed Ceiling



MNAE Medical Narrow Ambient Exam

The fully enclosed MNAE, typically positioned along both sides of the bed, offers 5 functions – including exam, ambient, night light, reading light, and chart light. This 8" wide fixture is available in lengths from 36" to 60", depending on your desired number of functions and illumination level. NSF listed and IP65 optional, let the MNAE provide the flexibility to accomplish multiple functions in the ever changing healthcare environment.

- LED MR16 reading and/or chart light, with full rotation and swivel
- Choose from 3 illumination levels for the ambient and exam function
- IP65 optional for dust and water ingress protection
- NSF listing and anti-microbial finish available
- Amber night light available
- Low voltage relay for patient control

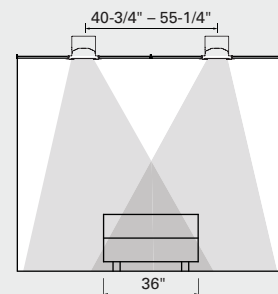
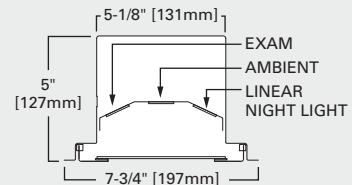

TYPICAL APPLICATION

Patient Room

Surface Wall



Circadian Night Lights

Circadian night lights provide uniform distribution of light on the floor – just right for patient rooms, bathrooms and corridors. Fitting into a standard junction box (single-gang, handy box, 2-inch minimum inside width) for easy installation, the Circadian Series offers up to 30 lumens of illumination. It ships standard with three colored lenses (amber, red, blue).

- Fits standard junction box for easy installation
- Die-cast aluminum face plate
- White, black, and brushed nickel powder-coat paint standard
- Standard gasket for wet location applications (MHN, MLN, MSN)
- MCL standard with on/off push-button with photocell available.

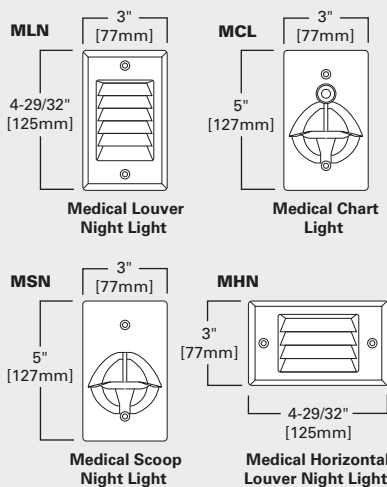

Special Environment

Recessed Ceiling or Surface Wall



Ceiling

CV Changing Views

Choose from wall or recessed ceiling visual therapy LED luminaires. Make a bold statement with a recessed ceiling product fitted with the image of your choice or, use one of many available sizes of the wall mount with a wide-ranging selection of visual images.



Wall

- Recessed extruded aluminum LED light box for standard grid ceilings
- Choice of several images
- 2' x 2', 2' x 4' or 4' x 4' ceiling, or several surface wall sizes to choose from
- Choose Individual images or create a single image using multiple fixtures
- Non-dimmable or dimming (0-10V DC or line voltage) transformers available
- MRI option available

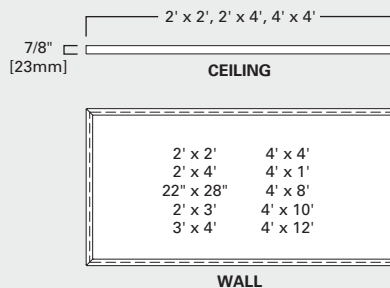

Special Environment

Recessed Ceiling



FLD6A/FSR6LM

FFLD6A/FSBT6

Downlight Medical

Choose from a 6-inch regressed lens or flush lens medical downlight for patient rooms, laboratories and general administrative areas. Lenses are available in tempered glass, acrylic, or polycarbonate. One-piece, continuous gasketing provides for IP66 compliance. Up to 3000 lumens are available in a variety of color temperatures.

- 1000, 1500, 2000 or 3000 lumen packages
- 6" aperture
- Low-iridescent specular or matte white reflector finish
- Anti-microbial paint standard for matte white finish
- IP66 rated
- NSF rated
- Glass, acrylic, or polycarbonate lens; up to 0.187" thick
- RFI grid lens available for operating room applications

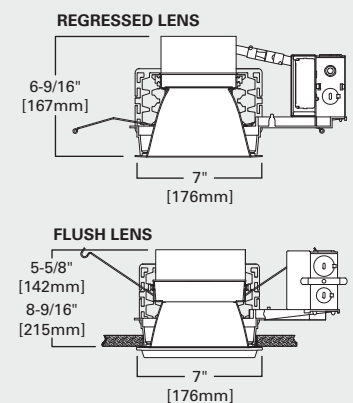

Special Environment

Surface, Wall or Ceiling



FWLDL

FWL Wall LED

FWLDL Wall Downlight LED

Use the up/down FWL on the wall over a bed, over a bathroom vanity or in a corridor. When uplight is not preferred, specify the FWLDL. Less than 4-inches deep, both the FWL and FWLDL meet ADA requirements. Constructed of heavy-duty steel and incorporating a polycarbonate lens, the products are a durable and long-lasting choice.



FWL

- Available in 18", 2' and 4' lengths
- ADA compliant; 3-3/4" height.
- Variety of lens choices up to 3/8" thick
- Wall or ceiling mount
- FWLDL for downlight only option
- Installs easily with dedicated back pan
- Matte white powder coat paint standard. Anti-microbial paint optional
- Dedicated LED divider (FWL) for up/down switching

FWL LED

FWLDL LED

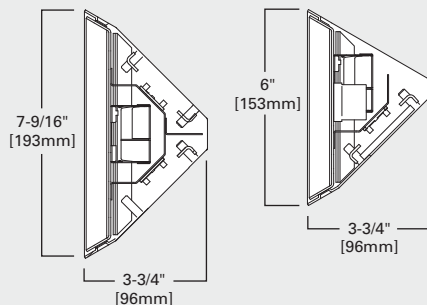

Special Environment

Recessed Ceiling



SGI Sealed and Gasketed Indirect

The SGI can be used in a variety of applications. The clear bottom acrylic lens enables wet location listing and NSF listing, making it an ideal choice for food preparation, laboratories, kitchens and medical facilities. Specify the SGI, with a clear polycarbonate lens and tamper-proof hardware, to use it in mental health facilities, detention centers, public gathering areas and schools.

- Sealed and gasketed fixture for medical, correctional and food processing facilities
- Clear acrylic or polycarbonate lens up to 0.250" thick
- Extruded aluminum door frame
- Matte white powder-coat paint standard with anti-microbial available
- NSF rated
- Wet location under covered ceiling and IP65 optional
- Linear-ribbed, frosted acrylic diffuser
- Stainless steel aircraft cables secure door to housing with optional piano hinge
- Tamper-proof hardware optional

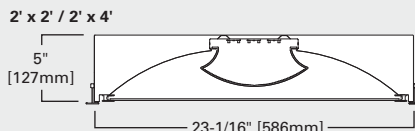
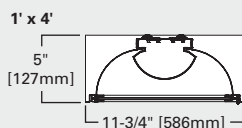

General / Administrative

Surface Undercabinet



UCL Undercabinet LED

UCLV Undercabinet Vandal

The versatile UCL is available in lengths of 1 to 4 feet, serving as an excellent choice for applications, including general administration areas, laboratories and more. Use the UCLV product, with a captive polycarbonate lens and tamper proof hardware, in applications that require a vandal resistant undercabinet fixture.

- Available 1', 2', 3' and 4' lengths
- Prismatic and linear ribbed acrylic shielding choices
- Standard steel construction, painted after fabrication
- Stainless steel and aluminum construction available
- UCLV available with 0.125", 0.156" and 0.187" thick captive polycarbonate lens
- UCLV standard with four (4) tamper-proof screws
- Occupancy sensor available
- Rocker switch and grounded convenience outlet available

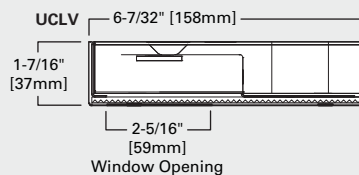
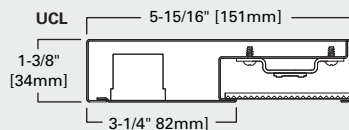

Operating Room

Recessed Ceiling



ORM Operating Room Medical

The 0-10V dimming varies the light levels depending on the activity being performed in the operating room. Light levels are comparable to T5 and T8 technology, allowing the ORM to reliably provide supplemental task lighting in the surgical suite. Choose the MILSTD461F option to avoid interference with any of the sensitive electronic equipment in today's sophisticated surgery suites.

Fail-Safe LED Medical

LED technology from Fail-Safe is suited for today's demanding healthcare facilities. From reducing energy and maintenance costs to being environmentally conscious, LED medical products from Fail-Safe put your project in the very best light.



- MILSTD461F compliant
- Seam-welded construction
- IP65 rated
- Aluminum housing standard
- Stainless-steel aircraft cables secure door to housing
- Continuous piano hinge available to attach door to housing
- Asymmetric/symmetric lens provides supplemental task lighting to the surgical table
- Closed-cell silicone gasket seals door to housing, and lens to door frame
- Smooth acrylic clear lens under primary lens for ease of cleaning

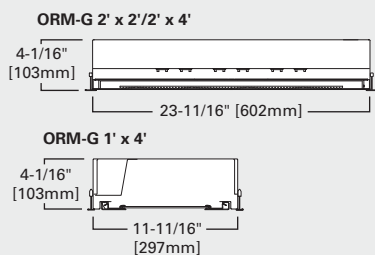

The LD3 linear LED module is the latest high performance linear module from Eaton's Cooper Lighting business. Designed and tested to the most rigorous standards, the LD3 offers high CRI, multiple color temperature, long-life and the reliability that you have come to know and respect from Eaton's Cooper Lighting business.

The following features are typical of Fail-Safe linear LED products:

- Designed and built in the U.S.A.
- CRI > 85
- Color temperatures of 3000K, 3500K, 4000K and 5000K
- Standard 0-10V dimming driver with Fifth Light™ (DALI) option
- Every product 100% electrically tested
- Optional anti-microbial paint
- Low-voltage controllers for switching ease
- Closed-cell gasketing
- Heavy-gauge material for superior durability
- Metal parts painted after fabrication to facilitate safe and easy installation, and to inhibit corrosion

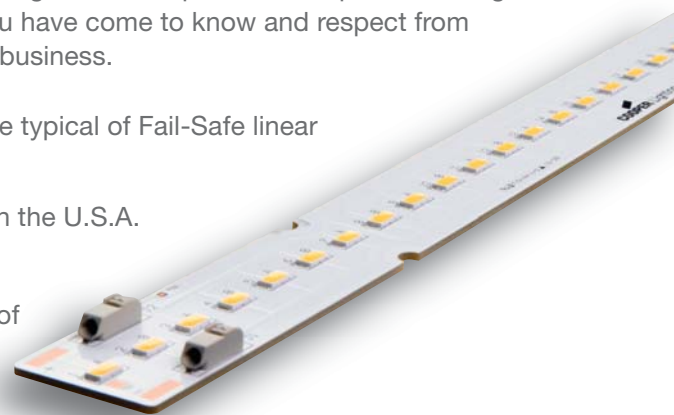

powered by
fifthlight
technology

**Our Lighting
Product Lines**

Halo
Halo Commercial
Portfolio
Iris
RSA
Metalux
Corelite
Neo-Ray
Fail-Safe
MWS
Ametrix
Shaper
io
Lumark
McGraw-Edison
Invue
Lumière
Streetworks
AtLite
Sure-Lites

**Our Controls
Product Lines**

Greengate
iLumin
Zero 88
Fifth Light Technology
iLight (International Only)

Eaton
1121 Highway 74 South
Peachtree City, GA 30269
P: 770-486-4800
www.eaton.com/lighting

Canada Sales
5925 McLaughlin Road
Mississauga, Ontario L5R 1B8
P: 905-501-3000
F: 905-501-3172

© 2015 Eaton
All Rights Reserved
Printed in USA
Publication No. ADC130341
August 6, 2015

Eaton is a registered trademark.

All other trademarks are property
of their respective owners.

Product availability, specifications,
and compliances are subject to
change without notice.