

PARTS & ASSEMBLY SHEET







Fixture Name: Waverly 3500-BA4 PW

This fixture assembled PO: _____ Date: _____

Notice: Please review the parts listing and check for all parts before assembling the fixture. If any parts are missing or damaged, please note on this sheet and contact the place of purchase to arrange for replacement parts.

PARTS LIST

Company Name: _____ Co. Account #: _____
below to be filled out by retailer

Mounting Strap  1ea 4"X3"	Junction Box Screw  2ea 8/32"X1"	Mounting Screw  2ea 8/32"X38mm
Wire Connector  3ea P3 Orange	Hex Nut  2ea 8/32"X3.5mm	Deco Nut (round nut)  2ea 9X10mm
Green Ground Screw  1ea 8/32"X10mm		

Part Needed _____	Quantity _____
Part Needed _____	Quantity _____
Reason why (missing, scratched, broken glass, bent, bad finish)	
Comments _____	

FIXTURE ASSEMBLY INSTRUCTIONS

Read and review installation instruction sheet before assembling the fixture.

1. Slide the Glass Shade (H) over Socket (I) and secure Glass Shade (H) by threading the Socket Ring (J) to Socket (I) until tight.

2. Install light bulb in accordance with fixture's specifications.

(DO NOT EXCEED THE MAXIMUM WATTAGE RATING!)

NOTE: INSTALL THE GLASS ASSEMBLY AFTER THE FIXTURE IS HUNG.

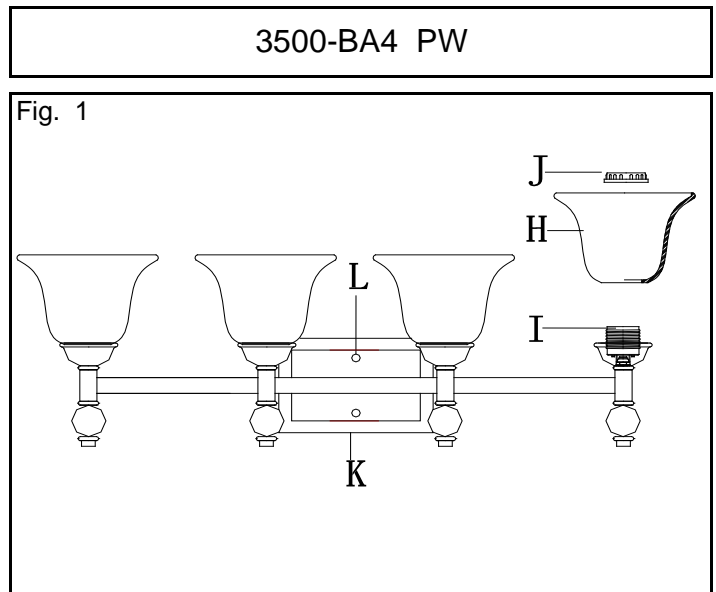

For Customer Service, contact the place of purchase to arrange for replacement parts.

WARNING ! SHUT OFF POWER AT FUSE OR CIRCUIT BREAKER.

HANGING THE FIXTURE (Fig. 1)

- Carefully remove the new fixture from the carton and the yellow bag that holds all your parts. Check that all parts are included as shown in the illustration and on the Parts and Assembly Sheet.
- Shut off power at the circuit breaker and remove the old fixture from wall, including the old mounting strap.
- Mounting Strap (A) contains several pairs of threaded holes. Find the pair of holes that match the spacing in your fixture Back Plate (K) and thread the two Mounting Screws (B) half way into Mounting Strap (A).
- Place Mounting Strap (A) over Junction Box (E) so Mounting Screws (B) are vertical or horizontal, as required by fixture type.
- Attach Mounting Strap (A) to Junction Box (E) by using the two Mounting Screws (D). Tighten the screws securely.

CONNECTING THE WIRES (Fig. 2)

- Attach the power supply wires to the fixture lead wires by connecting BLACK to BLACK (or SMOOTH) and WHITE to WHITE (or RIBBED).
 - Attach the GROUND wire (GREEN or COPPER) from the Junction Box and the fixture Ground wire to the green Ground Screw on the Mounting Bracket (A) or connect both wires together using the correct size of wire connectors.
- NOTE: Twist the wires together in the same direction you twist the wire connector onto the wires.
- Tuck these wire connections neatly into the Junction Box.

FINISHING THE INSTALLATION (Fig. 3)

- Place Fixture Back Plate (J), over Mounting screws (B), so that the screws protrude through the holes in Back Plate (J).
- Thread Deco Nuts (H) onto Mounting Screws (B) and continue turning until Back Plate (J) is snug against the wall.
- Install the glass as per the fixture assembly instructions

YOUR INSTALLATION IS NOW COMPLETE. RETURN POWER TO THE JUNCTION BOX AND TEST THE FIXTURE.

Fig. 1

JUNCTION BOX

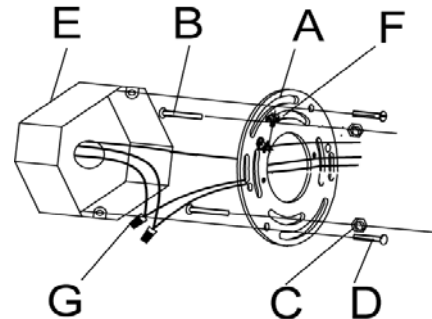

Fig. 2

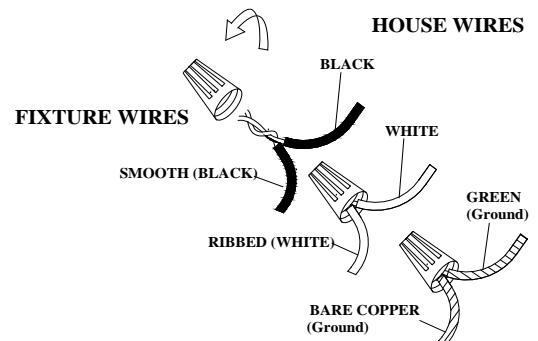

Fig. 3

