

Haworth prices in
this book will increase
on June 1, 2014 by:
6.5% – Very Task Chair
4% – All other seating
products

Seating

North America Price List – March 2013



Electronic Update Page – Seating Price List

- The table below lists all of the updates and addendums added to this price list since the original version was created.
- All **Update** pages will replace the existing pages within the document.
- All **New** pages will be placed at the back of the document.

Link	Date	Page	Description
Click Here	June 2013	352	Update – Pricing Corrections.
Click Here	August 2013	384	Update – October 1, 2012 Haworth Product Non-Obsolescence and Warranty Policy was replaced with August 1, 2013 version.
Click Here	September 2013	45-47	Update – “Arm to arm” removed from the Ganging option bullet point.
Click Here	September 2013	313-314	Update – Pricing corrections in column “E” and column “F”.
Click Here	September 2013	367	Update – RUSH symbol added to MG-M, MG-PA, MG-P and MG-S fabrics.
Click Here	September 2013	78	Update – “Stacking Heights:” changed to “Stacking dimensions:” and Dimensions for “10 chairs on the floor” updated.
Click Here	May 2014	1A-5A	New – Harbor Work Lounge Price List pages added.
Click Here	May 2014	360 and 365-369	Update – Harbor Work Lounge content added to the finish pages.
Click Here	June 2014	All Price List Pages	Update – Haworth prices in this book will increase on June 1, 2014 by: 6.5% – Very Task Chair, 4% – All other seating products.
Click Here	July 2014	2A-5A	Update – Cal 133 information added to Harbor Work Lounge Price Pages.
Click Here	August 2014	296	Update – GSA contract information added.
Click Here	August 2014	2A	Update – Price correction for Harbor Work Lounge faux Leather Grade B.
Click Here	October 2014	28-44	Update – Correction to the GSA SIN number.
Click Here	October 2014	311-369	Update – Formatting changes to sync the Seating Price List pages with the Haworth Collection price list pages (4% price increase must be applied to all pricing).



This Haworth North American price book contains US list prices. Canadian customers can convert the US list price into their Canadian equivalent by going to www.Haworth.com/Canada to find the current Canadian multipliers. These multiplier factors allow you to convert the US list price into a Canadian list price.

HAWORTH

Table of Contents

Product Directory	7-19	Sled-Base Chair without Arms	190
Task Seating		Stacking Dolly	193
Accolade® Seating		Stool with Arms	192
General Guidelines for Product Specification	216	Stool without Arms	192
General Specifications	213-215	Tandem Seating and Tables Dimensions	195
High-Back Chair with Cantilever Arms	217	Tandem Seating and Tables Specifications	194
High-Back Chair without Arms	218	Tandem Tables and Connecting Bars	196
Mid-Back Chair with Cantilever Arms	219		
Mid-Back Chair without Arms	220	Lively®	
Sled-Base Side Chair	221	General Guidelines for Product Specification	94
		General Specifications	94-98
Improv® Series		Lively-At-A-Glance	93
General Guidelines for Product Specification	133	Task Chair with 4D Arms	99
General Specifications	129-132	Task Chair with Height Adjustable Arms	100
Book Rack	193	Task Chair with Fixed Arms	101
High-Back Chair with Arms	134	Task Chair without Arms	102
High-Back Chair with Height Adjustable Arms	135	Side Chair with Arms	103
High-Back Chair without Arms	136	Side Chair without Arms	104
Improv H.E. High-Back Chair with Flipper Arms	152-153		
Improv H.E. High-Back Chair with Height Adjustable Task Arms	150-151	LOOK®	
Improv H.E. High-Back Chair with Height and Width Adjustable 3-D Arms	154	General Specifications	199-200
Improv H.E. High-Back Chair with Task Arms	148-149	High-Back Chair with Fixed Arms	202
Improv H.E. High-Back Chair without Arms	155	High-Back Chair with Height Adjustable Arms	203
Improv H.E. Mid-Back Chair with Flipper Arms	160-161	High-Back Chair with Height and Width Adjustable Arms	204
Improv H.E. Mid-Back Chair with Height Adjustable Task Arms	158-159	High-Back Chair without Arms	201
Improv H.E. Mid-Back Chair with Height and Width Adjustable 3-D Arms	162	Lounge Chair	211
Improv H.E. Mid-Back Chair with Task Arms	156-157	Mid-Back Chair with Fixed Arms	206
Improv H.E. Mid-Back Chair without Arms	163	Mid-Back Chair with Height Adjustable Arms	207
Improv H.E. Stool with Flipper Arms	168-169	Mid-Back Chair with Height and Width Adjustable Arms	208
Improv H.E. Stool with Height Adjustable Task Arms	166-167	Mid-Back Chair without Arms	205
Improv H.E. Stool with Height and Width Adjustable 3-D Arms	170	Side Chair with Arms	210
Improv H.E. Stool with Task Arms	164-165	Side Chair without Arms	209
Improv H.E. Stool without Arms	171		
Improv H.E. XL Chair with Flipper Arms	144-145	Very® Seating	
Improv H.E. XL Chair with Height Adjustable Task Arms	142-143	General Specifications	45, 49, 59, 63, 73, 79-83
Improv H.E. XL Chair with Task Arms	140-141	Conference Chair - Perforated with Arms	60
Improv H.E. XL Chair without Arms	147	Conference Chair - Perforated without Arms	61
Improv S.E. Mesh-Back Chair with Flipper Arms	178-179	Conference Stool - Perforated	62
Improv S.E. Mesh-Back Chair with Height Adjustable Task Arms	176-177	Conference Stool - Tetro Back	76
Improv S.E. Mesh-Back Chair with Height and Width Adjustable 3-D Arms	180	Conference Chair - Tetro Back with Arms	74
Improv S.E. Mesh-Back Chair with Task Arms	174-175	Conference Chair - Tetro Back without Arms	75
Improv S.E. Mesh-Back Chair without Arms	172	Ganging Connector	77
Improv Tag General Specifications	181	Seminar Chair - Perforated with Arms	55
Improv Tag, Mesh Back Chair with Fixed-Height Task Arms	183	Seminar Chair - Perforated without Arms	56
Improv Tag, Mesh Back Chair with Height-Adjustable Task Arms	184	Seminar Chair - Tetro Back with Storage Rack	72
Improv Tag, Mesh Back Chair with Height- and Width-Adjustable 3-D Arms	185	Seminar Chair - Tetro Back with Tablet Arm	71
Improv Tag, Mesh Back Chair without Arms	182	Seminar Chair - Tetro Back with Arms	69
Leg-Base Stacking Chair with Arms	186	Seminar Chair - Tetro Back without Arms	70
Leg-Base Stacking Chair with Tablet Arm	188	Seminar Chair with Storage Rack	58
Leg-Base Stacking Chair without Arms	187	Seminar Chair with Tablet Arm	57
Mid-Back Chair with Arms	137	Side Chair - Perforated with Arms	50
Mid-Back Chair with Height Adjustable Arms	138	Side Chair - Perforated without Arms	51
Mid-Back Chair without Arms	139	Side Chair - Perforated with Storage Rack with Arms	53
Occasional Tables	197	Side Chair - Perforated with Tablet Arm	52
Sled-Base Chair with Arms	189	Side Chair - Tetro Back with Arms	64
Sled-Base Chair with Tablet Arm	191	Side Chair - Tetro Back without Arms	65
		Side Chair - Tetro Back with Storage Rack	67
		Side Chair - Tetro Back with Tablet Arm	66
		Side Stool - Perforated	54
		Side Stool - Tetro Back	68
		Stacking Carts	78
		Task Chair with 4D Arms	84-85
		Task Chair with Fixed Arms	88-89
		Task Chair with Height Adjustable Arms	86-87
		Task Chair without Arms	90-91

Table of Contents

Wire Stacker Storage Rack	77
Wire Stacker Tablet Arm	77
Wire Stacker with Arms	46
Wire Stacker without Arms	47
Wire Stool	48

X99® Seating

General Guidelines for Product Specification	107
General Specifications	105-108
Advanced Seminar Chair	127-128
Executive Chair with 3D Arms	109-111
Executive Chair with Loop Arms	112-113
Executive Chair without Arms	114-115
Guest Chair	124
Seminar Chair	125
Seminar Chair without Arms	126
Task Chair with 3D Arms	117-119
Task Chair with Loop Arms	120-121
Task Chair without Arms	122-123

Zody® Seating

General Guidelines for Product Specification	22
General Specifications	23-27
4 Leg Base Chair	44
Sled Base Chair	43
TASK Chair with 4D Arms	28-30
TASK Chair with Fixed Arms	36-38
TASK Chair with Height Adjustable Arms	32-34
TASK Chair without Arms	40-42
Zody-At-A-Glance	21

Executive Seating

Monaco®

General Guidelines for Product Specification	224
General Specifications	223-224
Large High-Back Chair with Enclosed Arms	226
Large High-Back Chair with Open Arms	225
Large Mid-Back Chair with Enclosed Arms	230
Large Mid-Back Chair with Open Arms	229
Medium High-Back Chair with Enclosed Arms	228
Medium High-Back Chair with Open Arms	227
Medium Mid-Back Chair with Enclosed Arms	232
Medium Mid-Back Chair with Open Arms	231

Prescott™ Series

High-Back Chair, Fully-Upholstered Arm/Polypropylene Base	238
High-Back Chair, Fully-Upholstered Arm with Wood Arm Trim/Polypropylene Base	238
High-Back Chair, Fully-Upholstered Arm with Wood Arm Trim/Wood Base	239
High-Back Chair, Fully-Upholstered Arm/Wood Base	238
Mid-Back Chair, Fully-Upholstered Arm/Polypropylene Base	239
Mid-Back Chair, Fully-Upholstered Arm with Wood Arm Trim/Polypropylene Base	239
Mid-Back Chair, Fully-Upholstered Arm with Wood Arm Trim/Wood Base	240
Mid-Back Chair, Fully-Upholstered Arm/Wood Base	240

System 58

General Guidelines for Product Specification	234
General Specifications	233-234
High-Back Executive Chair with Arms	235

Mid-Back Executive Chair	236
Sled-Base Side Chair	237

Stack Seating

System 12

General Guidelines for Product Specification	241
General Specifications	241
Book Rack	243
High-Density Stacking Chair with Arms	242
High-Density Stacking Chair without Arms	242
Stacking Cart	243
Tablet Board	243

Wood Side Seating and Tables

General Guidelines for Product Specification	245
General Specifications	245

Candor® Seating

Classic Fully Upholstered Seat and 3/4 Back	246
Classic Fully Upholstered Seat and Back	246
Classic Fully Upholstered Seat and Slat Back	246
Modern Fully Upholstered Seat and 1/2 Back	247
Modern Fully Upholstered Seat and Back	247
Modern Fully Upholstered Seat and Slat Back	247

Composites™ Seating Series

Arc Arm, Circle Back	248
Arc Arm, Slat Back	248
Arc Arm, Upholstered Back	248
Cascade Arm, Circle Back	250
Cascade Arm, Slat Back	250
Cascade Arm, Upholstered Back	250
Contour Arm, Cross Back	251
Contour Arm, Hourglass Back	251
Contour Arm, Upholstered Back	251
Repose Arm, Cross Back	249
Repose Arm, Hourglass Back	249
Repose Arm, Upholstered Back	249
Stacking Chair, Arc Arm, Slat Back	252
Stacking Chair, Arc Arm, Upholstered Back	252
Stool, Armless, Slat Back	253
Stool, Armless, Upholstered Back	253

Forenze™ Seating

Cabriole Arm, Slat Back	267
Cabriole Arm, Star Back	267
Cabriole Arm, Upholstered Back	267
Curve Arm, Ellipse Back	265
Curve Arm, Upholstered Back	265
Curve Arm, Wave Back	265
Scroll Arm, Slat Back	266
Scroll Arm, Star Back	266
Scroll Arm, Upholstered Back	266
Serpentine Arm, Ellipse Back	264
Serpentine Arm, Upholstered Back	264
Serpentine Arm, Wave Back	264

Hello® Seating

Guest Seating Fixed Arms, Metal Legs	269
Guest Seating Fixed Arms, Wood Legs	268
Stools Fixed Arms, Metal Legs	270

Table of Contents

Tally™ Series

End Components, Left Arm Frame	260
End Components, Right Arm Frame	260
End Components, Table/Bench Leg	260
Guest Chair	254
Interior Components, Arm — Chair-to-Chair	261
Interior Components, Arm — Chair Left/Table/Bench Right	261
Interior Components, Arm — Chair Right/Table/Bench Left	261
Interior Components, Bench	262
Interior Components, Corner Table	263
Interior Components, Seat and Back	261
Interior Components, “T” Tables	263
Interior Components, Tables	262
Interior Components, “X” Table	263
Modular Specifications	259
Seat, Seat, Seat, Seat	256
Seat, Seat, Seat, Table	258
Seat, Seat, Table	256
Seat, Seat, Table, Seat	257
Seat, Table, Seat	256
Seat, Table, Seat, Seat	257
Stacking Chair	254
Table, Seat, Seat	255
Table, Seat, Seat, Seat	257
Three Seats	255
Two Seats	255

Lounge

Cassis™ Seating

Lounge Chair	282
Settee	282
Sofa	282

Galerie™ Collection

Leg-Base Chair, Fully-Upholstered	297
Lounge Chair	297
Settee	297
Sofa	297
Occasional Tables	298-299

Hello Seating

Cup Holder	273
Lounge with Legs, Standard Arm	271
Mini-mobile	273
Mobile Lounge, Standard Arm	272
Tablet Arm	273

Tempo™ Series

Add-on In-Line Table	295
Add-on Radius Corner Table	295
Add-on Seat with Right Arm	293
Add-on Seat without Arm	293
Add-on Square Corner Table	295
Bariatric Lounge Seating	296
Fully Upholstered Lounge Seating and Tables	284
Left End Table	294
Modular Seating Dimensions	290
Modular Seating Specifications	289
Open Lounge Seating	283
Preconfigured Seating, Seat, Seat	285
Preconfigured Seating, Seat, Seat, Seat	285
Preconfigured Seating, Seat, Seat, Seat, Seat	287
Preconfigured Seating, Seat, Seat, Seat, Table	288
Preconfigured Seating, Seat, Seat, Table	286

Preconfigured Seating, Seat, Seat, Table, Seat	287
Preconfigured Seating, Seat, Table, Seat	285
Preconfigured Seating, Seat, Table, Seat, Seat	287
Preconfigured Seating, Table, Seat, Seat	286
Preconfigured Seating, Table, Seat, Seat, Seat	288
Right End Table	294
Starter Seat with Left Arm	291
Starter Seat with Right and Left Arms	291
Starter Seat with Right Arm	291
Starter Seat without Arms	292

ToDo®

General Specifications	274-275
Cup Holder	280
Double, Stationary	278
Grommet Cover	280
Ottoman	281
Single, Mobile	277
Single, Stationary	276
Triple, Stationary	279
Wood Tablet with Arm	280

Tuxedo™ Series

Lounge Chair	300
Settee	300
Sofa	300

Public Seating, Education Seating and Stools

Seating and Tables

General Guidelines for Product Specification	302
General Specifications	301-302
K100 Series, Corner Connecting Tables	306
K100 Series, Ganging Clip	303
K100 Series, Public Seating Specifications	304
K100 Series, Seats and Table	305
K100 Series, Support Beams	307-308
K120 Series, Ganging Clip	303
K120 Series, Sled Base with Arms, Open-Frame Base	303
Scamps™ Series, Chair with Arms	309
Scamps Series, Round Table	309
Tilt Stool	310

Haworth Collection

b_sit Chair	312
Collaborate — Seating	313-314
Collaborate — Occasional Tables	315-316
DSC Axis 10000 Bench	319-320
DSC Axis 106 Chair Accessories	318
DSC Axis 106 Chair without Arms	317
Exchange Chair	321
K700 Stool	322
LTB Lounge	325-330
LTB Lounge Applications	323-324
m_sit Lounge	331
m_sit Tables	332
Penelope Chair	333
Plia Chair	334
q_bic Lounge	335-337
q_bic Tables	338
s_con Chairs	339-344
SE04 Lounge	345-351
SE04 Tables	352
Shetland	353-354

Table of Contents

Finishes and Fabrics

COM Information	369
Fabric Pattern Usage Matrix	365
Finish/Color Legends	360-364
Haworth European Product	359
Haworth Fabrics/Color Legend	367-368
Haworth Finish/Color Legend	355
Imported Fabric Collections	358
Nano-Tex and Durablock Approved Fabric Matrix	366
Plains and Nature Leather/Color Legend	368
Seating Fabric Legend	356-357

Terms of Sale

North America	370-373
---------------------	---------

Index	374-383
--------------------	---------

Lifetime Product Warranty	Inside Back Cover
--	-------------------

Product Directory

Zody Seating TASK Chairs — pages 28-42



SZT-20-702MA1 SZT-20-402MA1 SZT-20-102MA1 SZT-20-002MA1

Zody Seating — pages 43-44

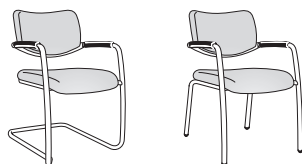

SZG-22-1S SZG-22-1H

Very Wire Stacker — pages 46-48

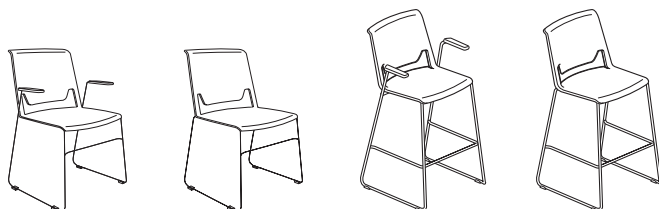

SCH-44-3S SCH-44-0S SCW-44-3S SCW-44-0S

Very Side Chair — Perforated — pages 50-51

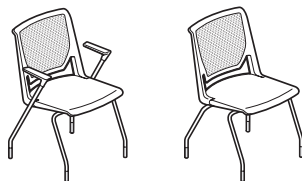

SCS-44-3H SCS-44-0H

Very Side Chair/Stool — Perforated Back — pages 52-54

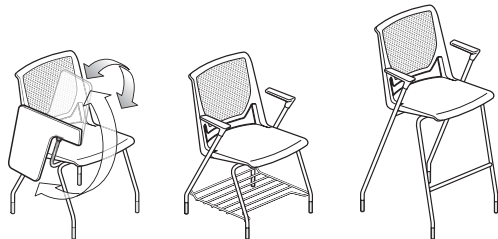

SCS-44-RH SCK-44-3H SCL-44-3H

Very Seminar Chair — Perforated — pages 55-56

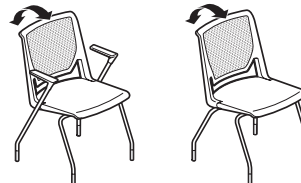

SCM-44-3H SCM-44-0H

Very Seminar with Tablet Arm/Storage Rack — pages 57-58

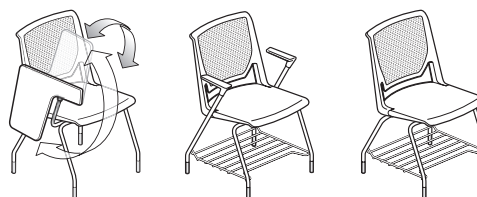

SCM-44-RH SCB-44-3H SCB-44-0H

Very Conference Chair — Perforated — pages 60-61



SCC-44-11 SCC-44-01

Very Conference Stool — Perforated — page 62



SCF-44-11 SCF-44-01

Very Side Chair — Tetro Back — pages 64-65

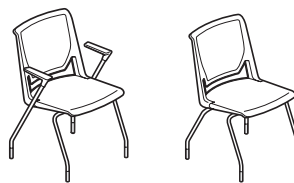

SCS-45-3H SCS-45-0H

Product Directory

Very Side Chair with Tablet Arm — Tetro Back — page 66



SCS-45-RH

Very Side Chair with Storage Rack — Tetro Back — page 67



SCK-45-3H

Very Side Stool — Tetro Back — page 68



SCL-45-3H



SCL-45-0H

Very Seminar Chair — Tetro Back — pages 69-70



SCM-45-3H



SCM-45-0H

Very Seminar with Tablet Arm — Tetro Back — page 71



SCM-45-RH

Very Seminar with Storage Rack — Tetro Back — page 72



SCB-45-3H

Very Conference Chair — Tetro Back — pages 74-75



SCC-45-11



SCC-45-01

Very Conference Stool — Tetro Back — page 76



SCF-45-11



SCF-45-01

Very Accessories — pages 77-78



SCHR-1



SCHA-R



SCT-1



SCT-3
SCT-4

Very Task Chairs — pages 84-91



SCT-20-7011



SCT-20-4011



SCT-20-1011



SCT-20-0011

Product Directory

Lively Task Chairs — pages 99-102

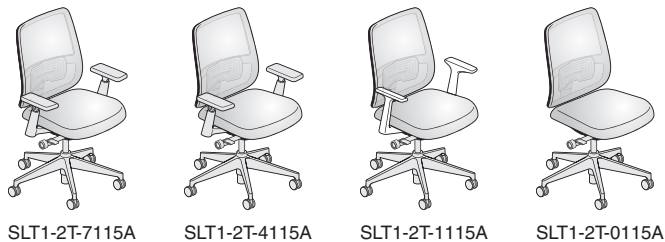

SLT1-2T-7115A SLT1-2T-4115A SLT1-2T-1115A SLT1-2T-0115A

Lively Side Chair — pages 103-104



SLS1-2T-1H SLS1-2T-11 SLS1-2T-0H SLS1-2T-01

X99 Executive Seating — pages 109-115



X611-2W40 X611-2140 X611-2040
X611-2W44 X611-2144 X611-2044

X99 Task & Guest Seating — pages 117-124

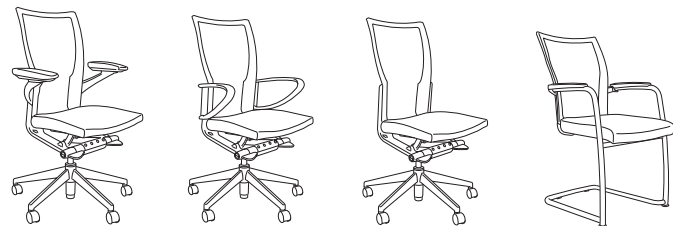

X621-2W40 X621-2140 X621-2040 X630-3100
X621-2W44 X621-2144 X621-2044

X99 Seminar Chairs — pages 125-128

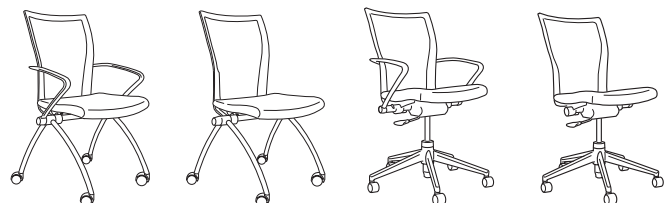

X640-0140 X640-0040 X641-2140 X641-2040

Improv Series High-Back Chairs — pages 134-136



M221-1142 M221-1742 M221-1042

Improv Series Mid-Back Chair — pages 137-139



M211-1142 M211-1742 M211-1042

Improv Series H.E. XL Chairs — pages 140-147



M271-1442 M271-1742 M271-1H42 M271-1042

Improv Series H.E. High-Back Chairs — pages 148-154



M251-1442 M251-1742 M251-1H42 M251-1W42

Improv Series H.E. High-Back Chairs — page 155



M251-1042

Improv Series H.E. Mid-Back Chairs — pages 156-159

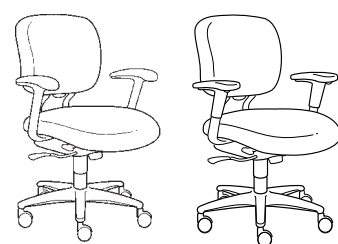

M231-1442 M231-1742

Product Directory

Improv Series H.E. Mid-Back Chairs — pages 160-163



M231-1H42 M231-1W42 M231-1042

Improv Series H.E. Stools — pages 164-170



M2E1-1442 M2E1-1742 M2E1-1H42 M2E1-1W42

Improv Series H.E. Stools — page 171



M2E1-1042

Improv Series S.E. Mesh Back Chair without Arms — page 172

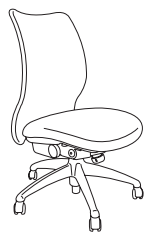

M235-3042

Improv Series S.E. Mesh-Back Chair with Arms — pages 174-180



M235-3442 M235-3742 M235-3H42 M235-3W42

Improv Tag Mesh Back Chairs — pages 182-185

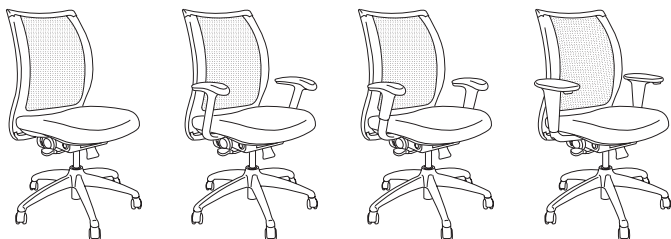

F235-2042 F235-2442 F235-2742 F235-2W42

Improv Series Leg-Base Stacking Chairs — page 186

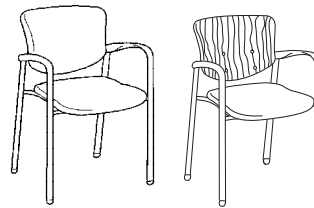

M600-2110 M600-2310

Improv Series Leg-Base Stacking Chairs without Arms — page 187

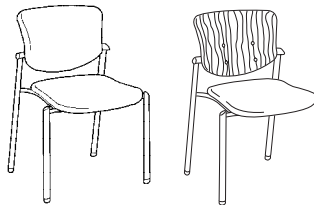

M600-2100 M600-2300

Improv Series Leg Base Chair with Tablet Arm — page 188



M600-2190

Improv Series Sled-Base Chairs — pages 189-190

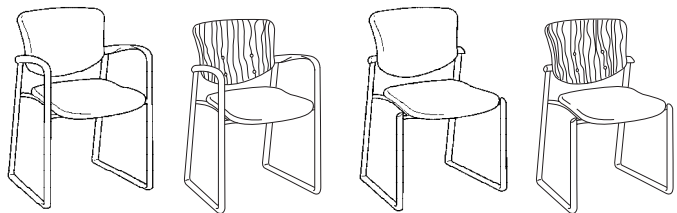

M601-2110 M601-2310 M601-2100 M601-2300

Improv Series Sled-Base Chair with Tablet Arm — page 191

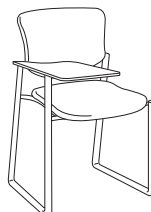

M601-2190

Product Directory

Improv Series Stools — page 192

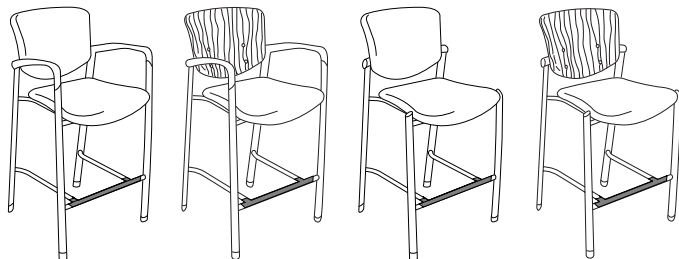

M600-8110 M600-8310 M600-8100 M600-8300

Improv Series Stacking Dolly and Book Rack — page 193

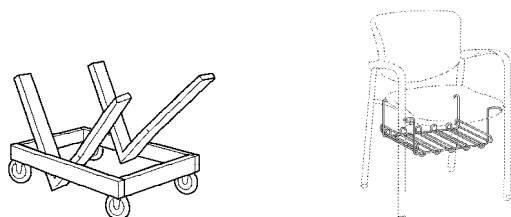

MPRV-CART MPRV-RACK

Improv Series Tandem In-Line Table — page 196

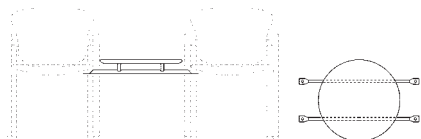

MTI1-20

Improv Series Tandem End-of-Run Table — page 196

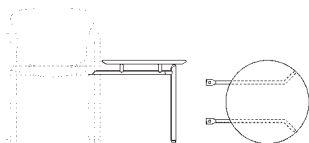

MTE1-20

Improv Series Occasional Tables — page 197



MTR1-20 MTV1-2048

LOOK High-Back Chairs — pages 201-204



Z851-1042 Z851-1442 Z851-1742 Z851-1W42

LOOK Mid-Back Chairs — pages 205-208



Z831-1042 Z831-1442 Z831-1742 Z831-1W42

LOOK Side Chairs — pages 209-210

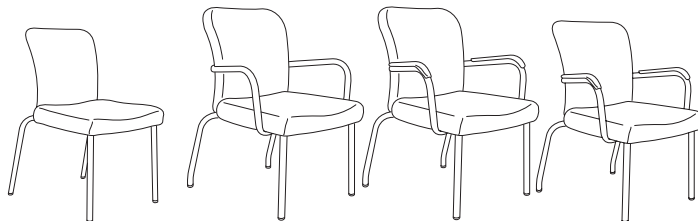

Z600-2100 Z600-2210 Z600-2230 Z600-2130

LOOK Lounge Chairs — page 211



Z600-2440

Accolade High-Back Chairs — pages 217-218

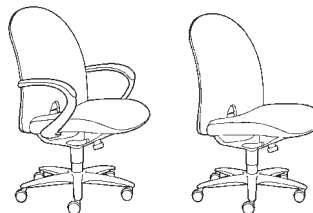

A871-1142 A871-1042

Product Directory

Accolade Mid-Back Chairs — pages 219-220

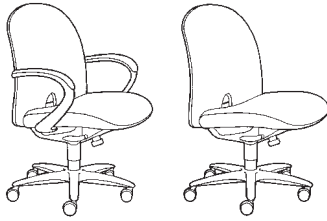

A831-1142

A831-1042

Accolade Sled-Base Side Chairs — page 221

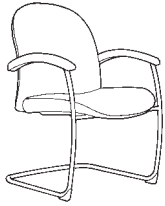

A802-3110

Monaco High-Back Chairs — pages 225-228

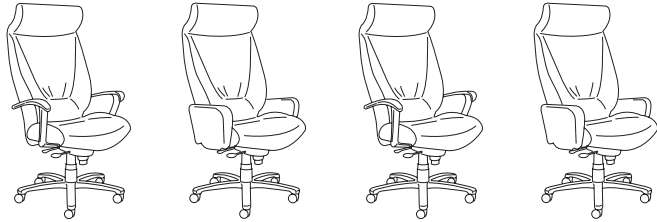

D811-2240

D811-2640

D821-2240

D821-2640

Monaco Mid-Back Chairs — pages 229-232



D831-2240

D831-2640

D841-2240

D841-2640

System 58 Chairs — pages 235-237

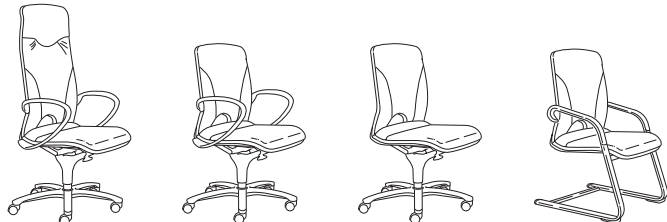

5811-2141

5831-2141

5831-2041

5838-2100

Prescott Series — pages 238-239

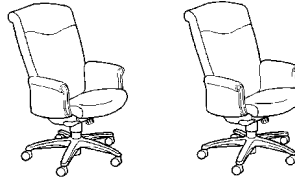

5215-32

5210-32

Prescott Series — pages 239-240



5225-32

5220-32

System 12 High-Density Stacking Chairs — page 242

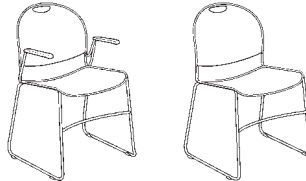

1201-2110

1200-2100

System 12 Accessories — page 243

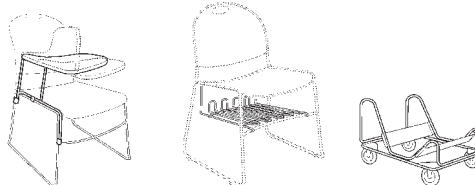

TABR-12

BOOK-12

CART-12

Wood Seating

Candor Classic Seating — page 246



SAS-22-A1B

SAS-22-A2B

SAS-2W-A4B

Candor Modern Seating — page 247



SAS-22-A1A

SAS-22-A3A

SAS-2W-A4A

Product Directory

Composites Arc Arm Models — page 248

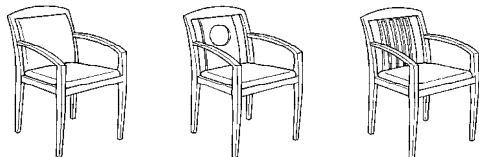

4045-00 4145-00 4245-00

Composites Repose Arm Models — page 249

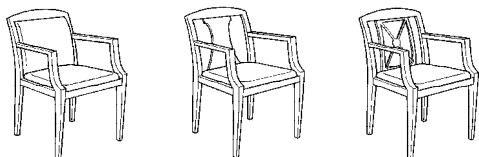

4046-00 4146-00 4246-00

Composites Cascade Arm Models — page 250

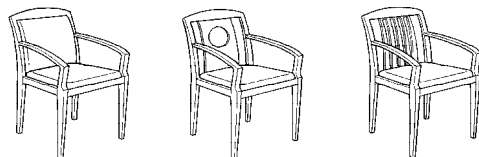

4047-00 4147-00 4247-00

Composites Contour Arm Models — page 251

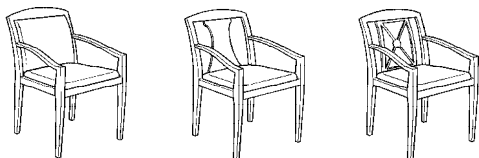

4048-00 4148-00 4248-00

Composites Stacking Chairs — page 252

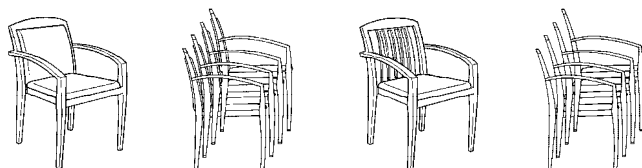

4043-00 4243-00

Composites Stools — page 253

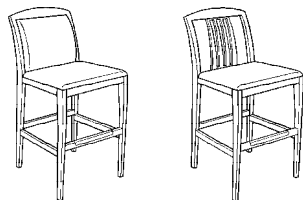

4049-00 4249-00

Tally Series Guest/Occasional Seating — page 254

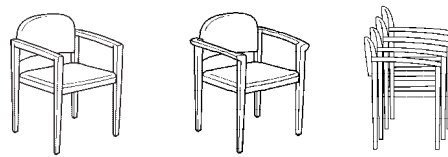

3110-GEST 3110-STAK

Tally Series Public Seating — page 255

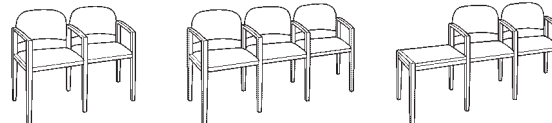

3110-SS 3110-SSS 3110-TSS

Tally Series Public Seating — page 256

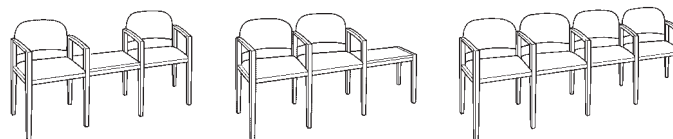

3110-ST5 3110-SST 3110-SSSS

Tally Series Public Seating — page 257

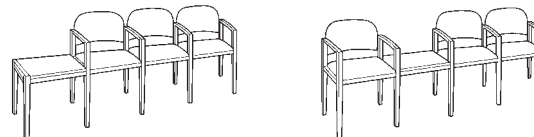

3110-TSSS 3110-STSS

Tally Series Public Seating — pages 257-258

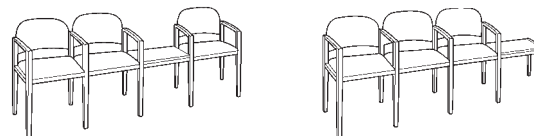

3110-SSTS 3110-SSST

Tally Series Public Seating Modular End Components — page 260

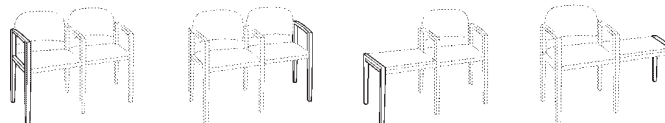

3110-ERA 3110-ELA 3110-ET (Right application) 3110-ET (Left application)

Tally Series Public Seating Modular Interior Components — page 261

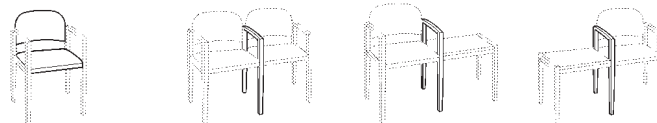

3110-ISB 3110-IAC 3110-IACR 3110-IACL

Product Directory

Tally Series Public Seating Modular Interior Components — page 262

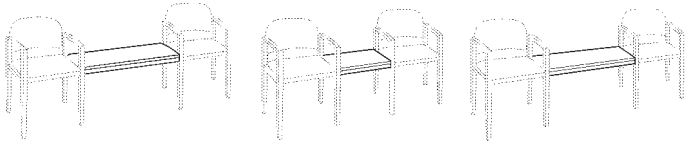

3110-IBCH

3110-IT

3110-IDT

Tally Series Modular Interior Components — page 263

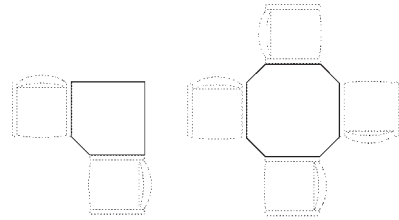

3110-ICT

3110-IXT

Tally Series Modular Interior Components — page 263

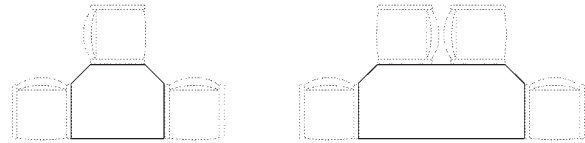

3110-ITT

3110-IDTT

Forenze Serpentine Arm Models — page 264



8381-00

8281-00

8181-00

Forenze Curve Arm Models — page 265



8382-00

8282-00

8182-00

Forenze Scroll Arm Models — page 266



8583-00

8483-00

8183-00

Forenze Cabriole Arm Models — page 267



8584-00

8484-00

8184-00

Hello Guest Seating/Stools — pages 268-270

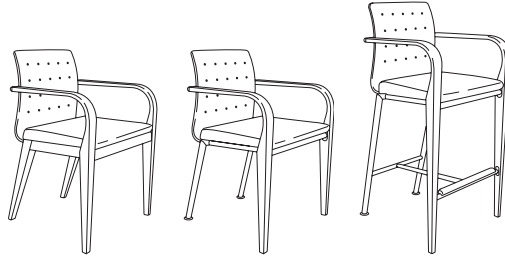

4851-0011-W

4851-0011

4852-0011

Hello Lounge Seating with Legs — page 271

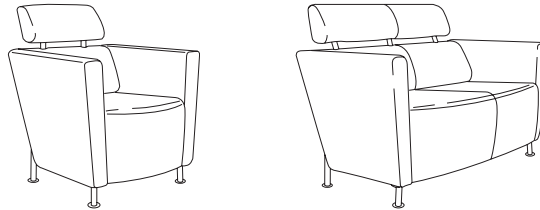

4854-0011

4854-0012

Hello Mobile Lounge Seating — page 272



4855-0043

4855-0043-S

4855-0043-GSX

Hello Seating Accessories — page 273



4858-0001

4858-0002

Product Directory

Hello Seating Mini-Mobile — page 273

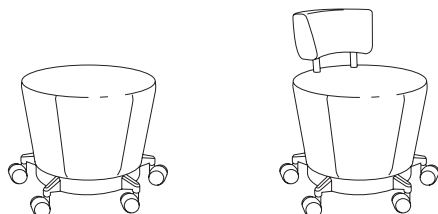

4856-0043

4856-0043-A

ToDo Stationary & Mobile Seating — pages 276-277

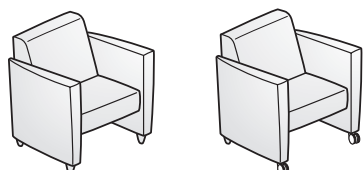

TQ84-0011

TQ85-0011

ToDo Stationary Seating — pages 278-279

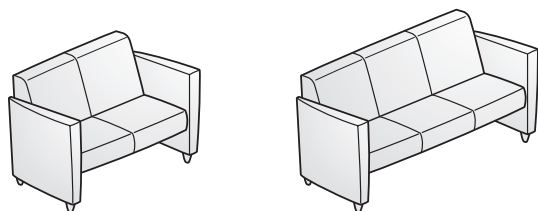

TQ84-0012

TQ84-0013

ToDo Accessories — page 280

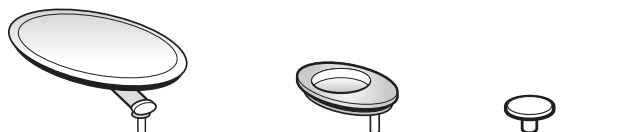

Wood Tablet
TQ90-0001

Cup Holder
TQ90-0003

Grommet Cover
TQ90-0006

ToDo Ottoman — page 281

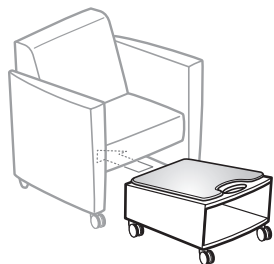

TQ90-0004

Cassis Lounge Seating — page 282

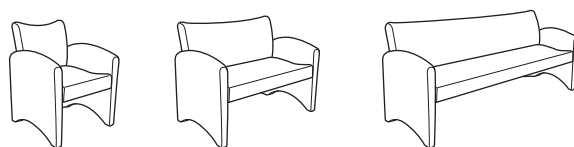

SCL1-0000-2H

SCL2-0000-2H

SCL3-0000-2H

Tempo Open Frame Lounge — page 283

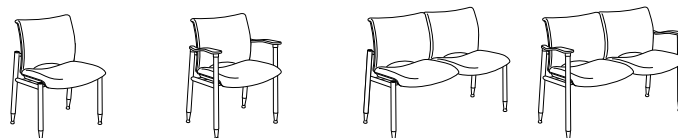

KL01-7200

KL01-7210/7220

KL02-7200

KL02-7210/7220

Tempo Fully Upholstered Lounge — page 284

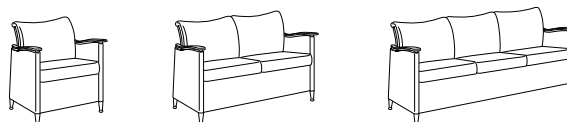

KLU1-7220

KLU2-7220

KLU3-7220

Tempo Series Occasional Tables — page 284



KLT8-1818

KLT1-3030

Tempo Preconfigured Seating — page 285

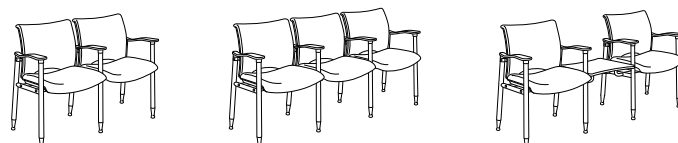

KLP2-7210

KLP3-7210

KLPJ-7210

Tempo Preconfigured Seating — page 286

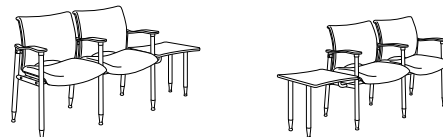

KLPK-7210

KLPL-7210

Tempo Preconfigured Seating — page 287

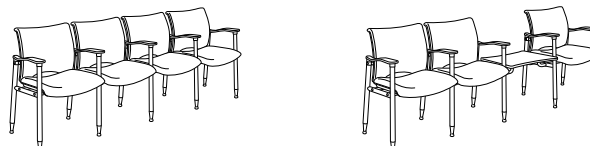

KLP4-7210

KLPM-7210

Product Directory

Tempo Preconfigured Seating — page 287



KLPN-7210

Tempo Preconfigured Seating — page 288



KLPP-7210



KLPQ-7210

Tempo Modular Starter Seats — pages 291-292



KLCS-7210-R

KLCS-7210-L

KLCS-7210-B

KLCS-7200-N

Tempo Modular Add-on Seats — page 293



KLCA-7210-R



KLCA-7200-N

Tempo Modular Starter Tables — page 294



KLCE-7TQ0-R



KLCE-7TQ0-L

Tempo Modular Add-on Tables — page 295



KLCI-7TQ0



KLCC-7TQ0



KLCC-7TA0

Tempo Bariatric Lounge Seating — page 296



KLB1-7200



KLB1-7220

Galerie Collection Lounge Seating — page 297



4080-00

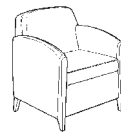

180-0028

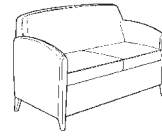

180-0053

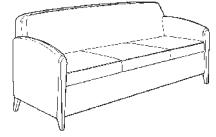

180-0075

Galerie 5800 Series Tables — page 298

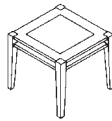

5818-1816

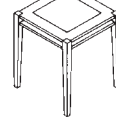

5818-1822

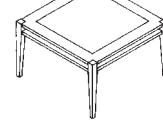

5826-2616

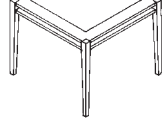

5826-2622

Galerie 5900 Series Tables — page 299

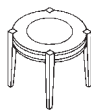

5918-1816

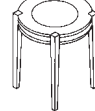

5918-1822

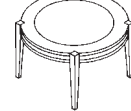

5926-2616

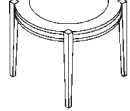

5926-2622

Tuxedo Series Lounge Seating — page 300

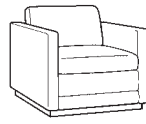

2006-0031

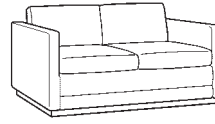

2006-0056

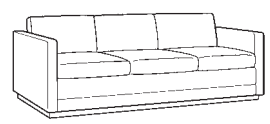

2006-0072

K120 Series Guest/Occasional Seating — page 303

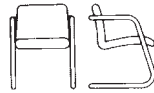

K120-2210

K100 Series/Public Seating — page 305



K156-221



K156-220

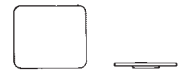

KPT9-2124

K100 Series/Public Seating — page 306

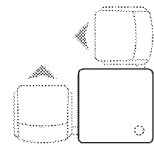

KPT0-2929

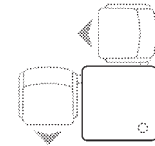

KPT1-2929

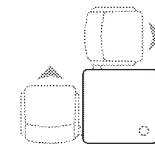

KPT2-2929

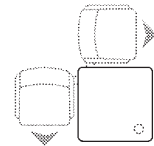

KPT3-2929

Product Directory

K100 Series/Public Seating Beams — pages 307-308

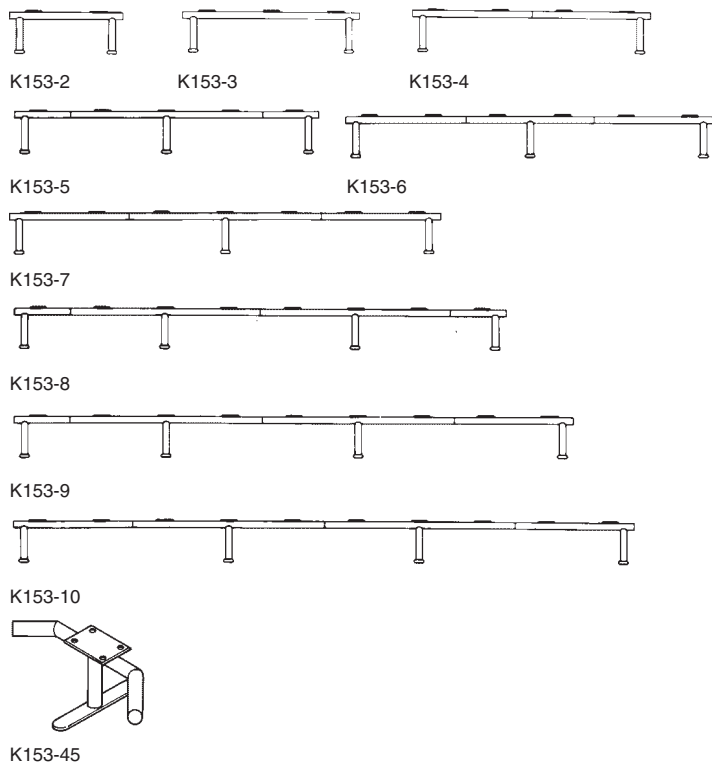

K100 Scamps Series Children's Furniture — page 309

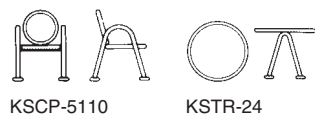

Tilt Stool — page 310

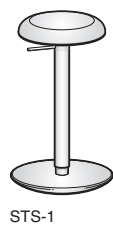

Haworth Collection — b_sit Chair — page 312

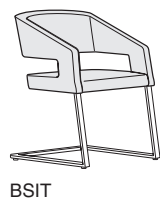

Haworth Collection — Collaborate Lounge Chair — page 313



Haworth Collection — Collaborate Guest Chair — page 314



Haworth Collection — Collaborate Occasional Tables — pages 315-316

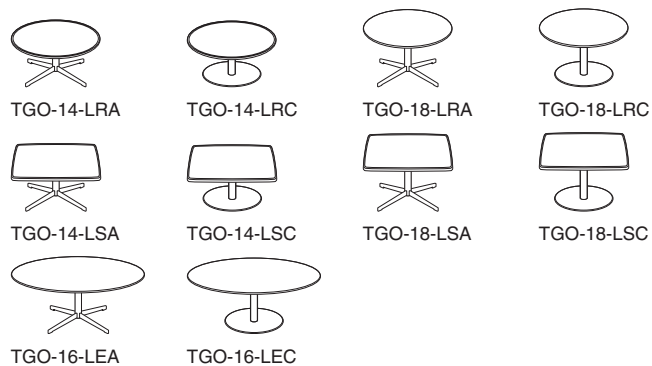

Haworth Collection — DSC Axis 106 Chair — pages 317-318

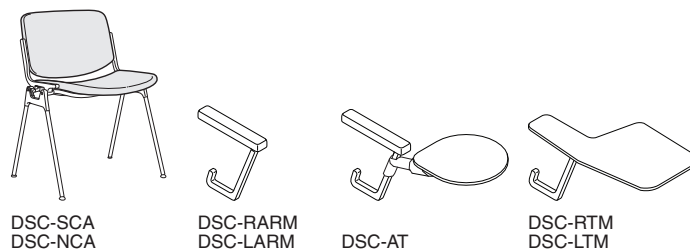

Haworth Collection — DSC Axis 10000 Bench — pages 319-320

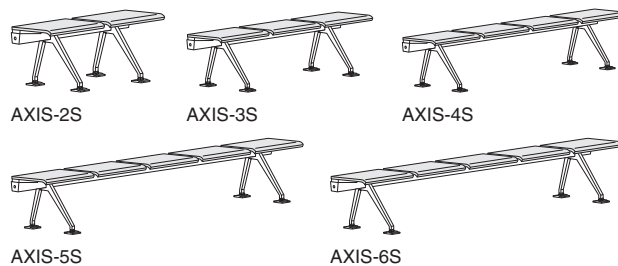

Product Directory

Haworth Collection — Exchange Chair — page 321



Dial-SL
Dial-ST

Haworth Collection — K700 Stool — page 322

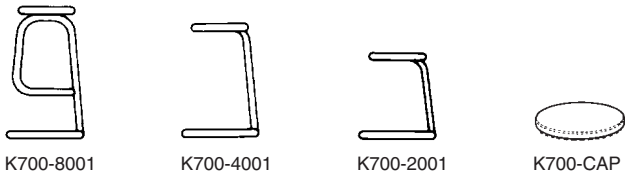

K700-8001 K700-4001 K700-2001 K700-CAP

Haworth Collection — LTB Lounge Seating — pages 325-328

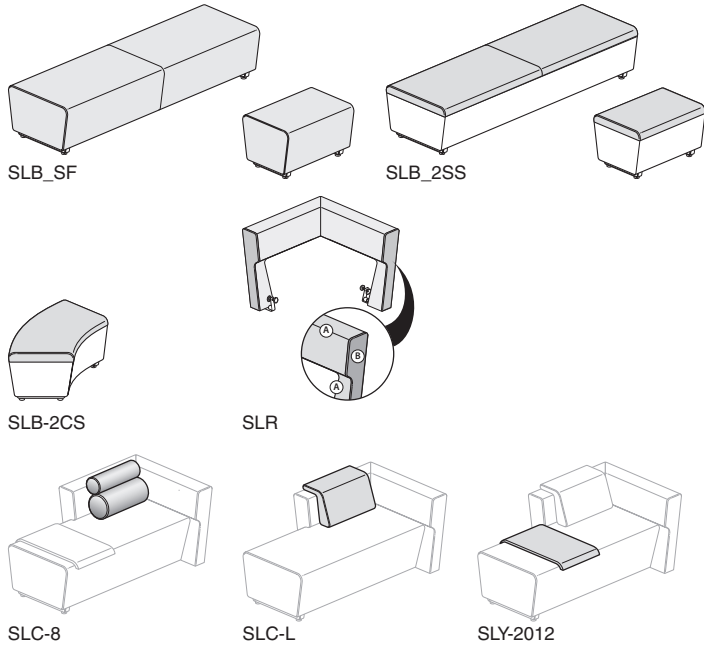

SLB_SF SLB_2SS SLB-2CS SLR SLC-8 SLC-L SLY-2012

Haworth Collection — LTB Lounge Tables — page 329

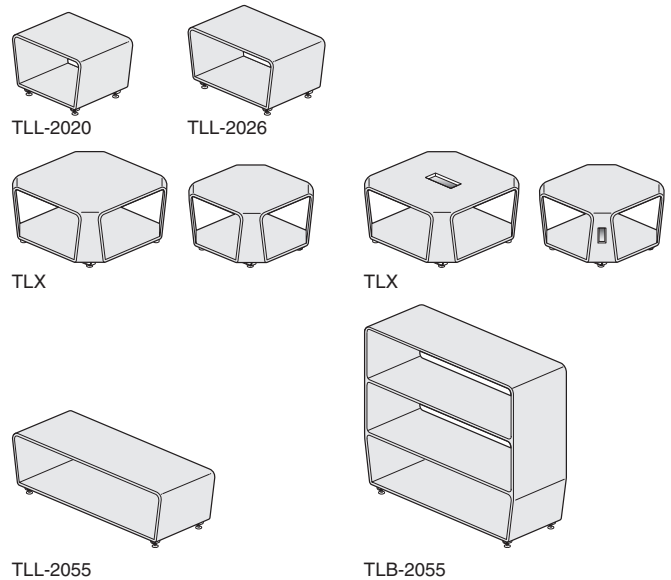

TLL-2020 TLL-2026 TLX TLX TLL-2055 TLB-2055

Haworth Collection — LTB — page 330

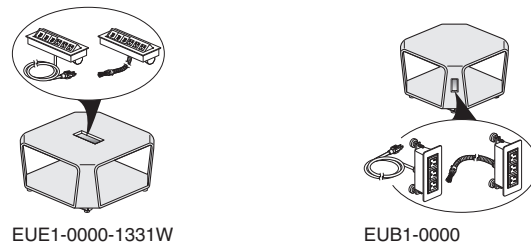

EUE1-0000-1331W EUB1-0000

Haworth Collection — m_sit Lounge — page 331

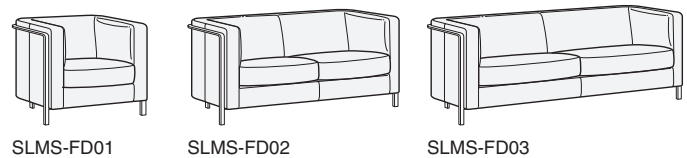

SLMS-FD01 SLMS-FD02 SLMS-FD03

Haworth Collection — m_sit Tables — page 332

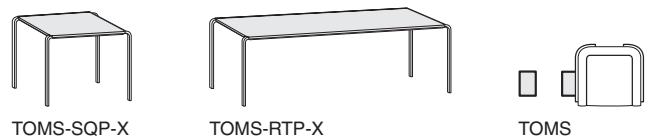

TOMS-SQP-X TOMS-RTP-X TOMS

Haworth Collection — Penelope Chair — page 333



CAST-0028

Product Directory

Haworth Collection — Plii Chair — page 334



CAST-0016
CAST-0017

Haworth Collection — q_bic Lounge — pages 335-337

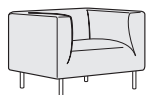

SLQB-FD01-P
SLQB-FD01-C

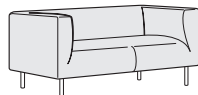

SLQB-FD02-P
SLQB-FD02-C

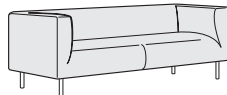

SLQB-FD03-P
SLQB-FD03-C

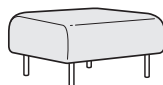

SLQB-BCSM-P
SLQB-BCSM-C

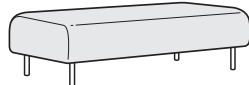

SLQB-BCLG-P
SLQB-BCLG-C

Haworth Collection — q_bic Tables — page 338



TOQB-SQGP
TOQB-SQGC

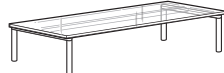

TOQB-RTGP
TOQB-RTGC

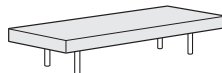

TOQB-RTW



TOQB-SQT

Haworth Collection — s_con Chairs — pages 339-343



SCON-EHB



SCON-SWC



SCON-SBC



SCON-HBC

Haworth Collection — s_con Chairs — page 344



SCON-STC

Haworth Collection — SE04 Lounge — pages 345-348

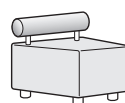

SLSE-TR01
SLSE-TRT1

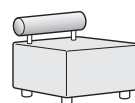

SLSE-SQ01
SLSE-SQT1

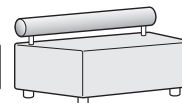

SLSE-TR02
SLSE-TRT2

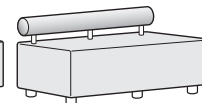

SLS-SQ02
SLS-SQT2

Haworth Collection — SE04 Lounge — pages 349-351

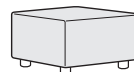

SLSE-SQB1-8P
SLSE-SQB1-8B

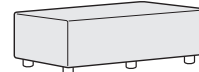

SLSE-SQB2-8P
SLSE-SQB2-8B



SLSE-CUB1-8P
SLSE-CUB1-8B

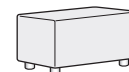

SLSE-CUB2-8P
SLSE-CUB2-8B

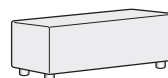

SLSE-CUB3-8P
SLSE-CUB3-8B

Haworth Collection — SE04 Tables — page 352

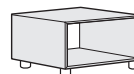

TOSE-SQW

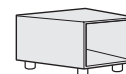

TOSE-TRW

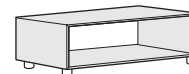

TOSE-RTW

Haworth Collection — Shetland — pages 353-354

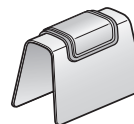

HCCL-SLBP-2

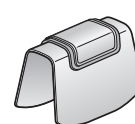

HCCL-SLRP-2

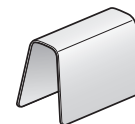

HCCL-SBBP-0

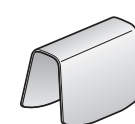

HCCL-SBRP-0



HCCL-SLDU-1

This page intentionally blank

Zody-At-A-Glance

Designer	ITO Design and Haworth Design Studio
Awards/Achievements	<p>NeoCon Silver, Best of NeoCon, Seating: Ergonomic Desk/Task, June 2005, USA</p> <p>IIDEX/NeoCon Gold, Seating: Desk/Workstation Chairs, September 2005, Canada</p> <p>Cradle to Cradle™ Gold Certified Product by MBDC (McDonough Braungart Design Chemistry, LLC), October, 2005, USA</p> <p>BIFMA level 3 certified.</p>
Zody	A high-performing chair that blends science-based wellness and comfort with sustainability and international design.

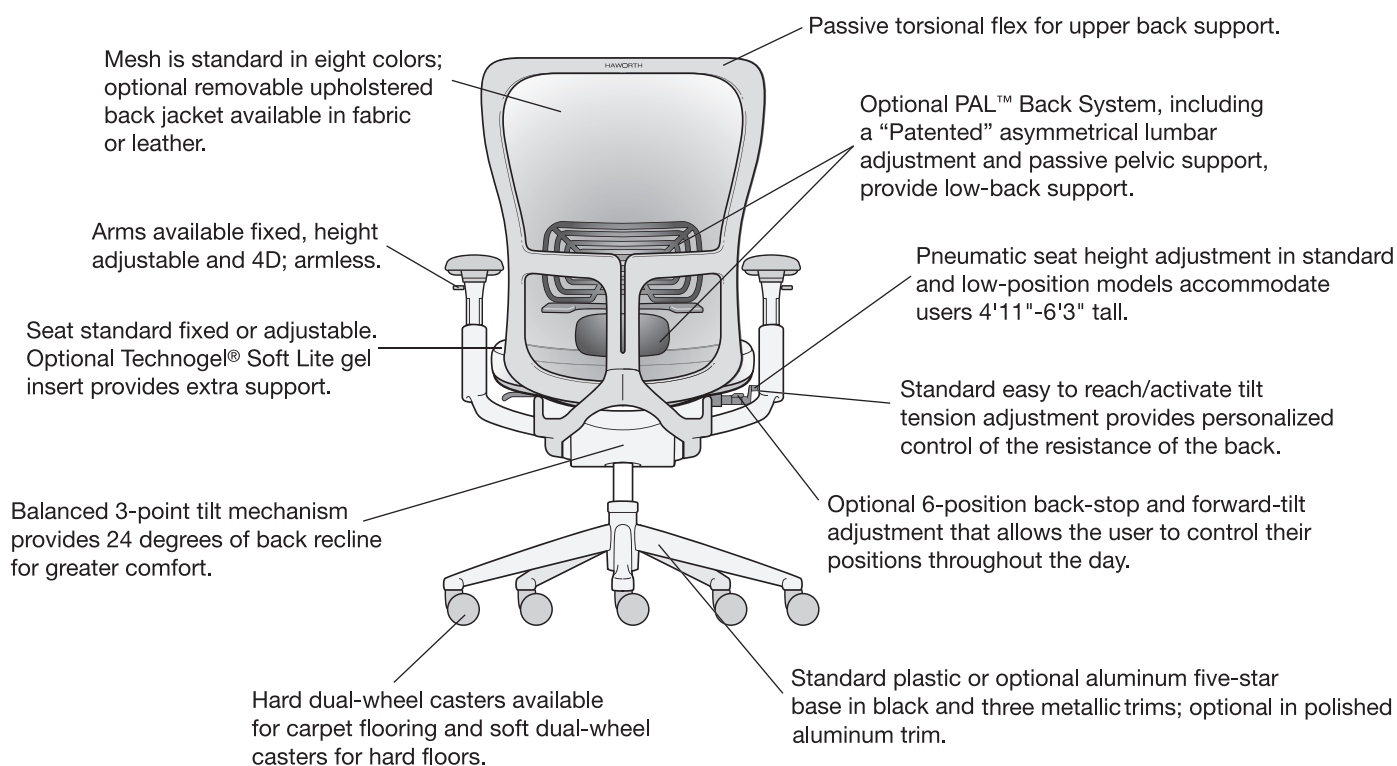

Zody-At-A-Glance

General Specifications

General Guidelines for Product Specification

Zody seating specification numbers are based on an alpha-numeric logic that identifies a product by model and certain characteristics.

For example, a product number that reads **SZT-20-702MA5** identifies the product as a Zody mesh back chair with 4D arms, no lumbar, pneumatic seat height adjustment, foam adjustable seat and standard base with hard casters. The numeric logic for this model with fabric and finish codes is shown below:

Mesh Back

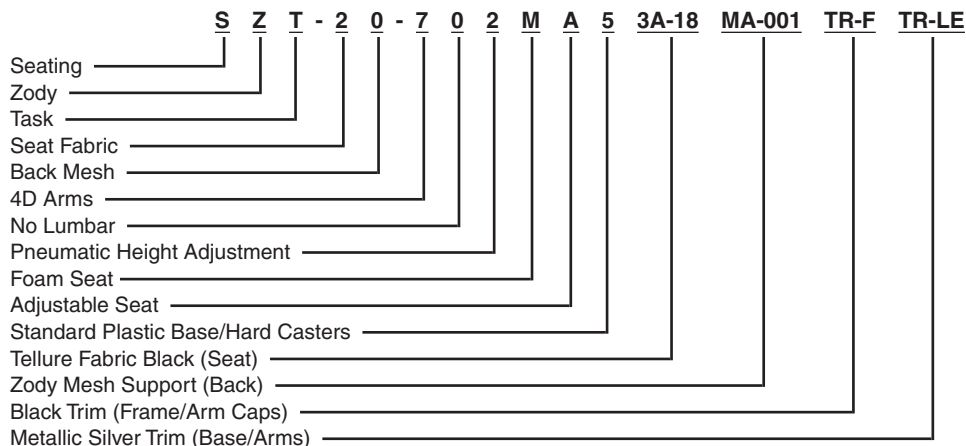

Mesh Back with Upholstered Back Jacket

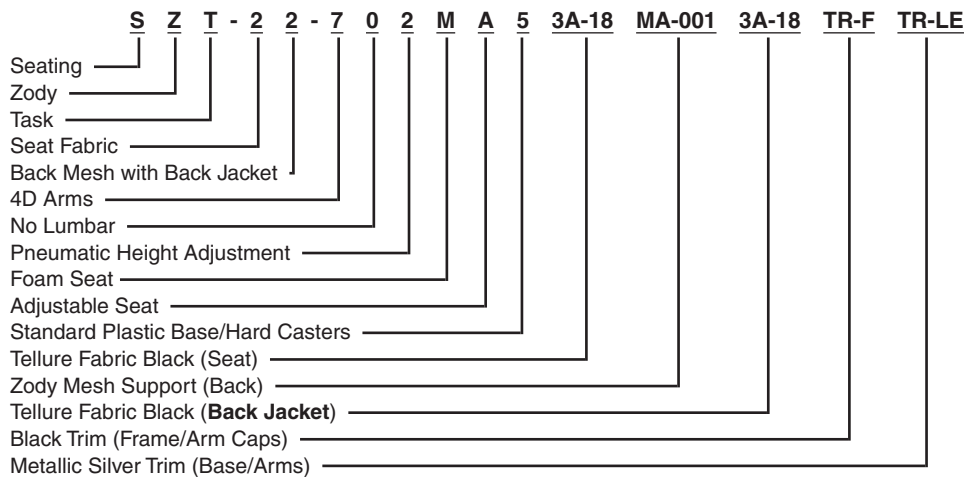

There are exceptions to this logic; therefore, always refer to the price charts for product numbers rather than attempting to construct them. Product number modification instructions for additional options appear in footnoted copy for each applicable model.

Beyond the printed product number, fabric and finish codes are required to complete an order specification. To communicate your order clearly, list the product number and fabric/finish codes in the sequence outlined on each price page.

Zody-At-A-Glance

General Specifications

Environmental Factors	<ul style="list-style-type: none"> • Zody is a Cradle to Cradle™ Gold Certified Product, as determined by MBDC (McDonough Braungart Design Chemistry, LLC). Zody has been evaluated for its human health, environmental health, lifecycle attributes, renewable energy, water stewardship and social responsibility characteristics against stringent certification criteria and is considered an ecologically intelligent product. • Greenguard Children and Schools certified for low emissions. • BIFMA level 3 certified 2012. • Zody has up to 51% recycled content and is up to 98% recyclable. • Zody is produced in an ISO 14001 certified manufacturing facility. • Zody is assembled using renewable power. Haworth has purchased 100% Green-e certified American wind power credits to offset the energy consumed in manufacturing the product. • Components are identified with ISO recycling symbols and material information to assist in the recycling effort, where practical. • Haworth will take back Zody chairs after their useful life and recycle the components. Please contact Haworth's Material Recovery Center at (616)393-1215. • Optional Trivalent chrome finish provides safer and more environmentally friendly alternative for customers requiring the attributes of a chrome finish.
COM & COL General Information	<p>To order a COM fabric (Customer's Own Material), contact the Haworth Inquiry Center (1.800.426.8562), your local Haworth dealer, or go to haworth.com/surfaces > COM Library to find out if the COM you have selected has already been tested and approved. The surface collection site also has information on the Haworth+ alliance program with Carnegie, Luna Textiles, and Maharam as well as our industry-leading Pre-Approved COM program.</p> <p>Approved COMs are placed into Grades based on the fabric pricing; if the fabric pricing exceeds our Grades, they will be priced at Grade A + cost of fabric + 4% handling (North America). Haworth will purchase all COMs unless instructed otherwise. (Leather will also be purchased by Haworth; if the leather pricing exceeds our Grades, cost will be based on fabric Grade E + cost of leather + 4% handling.)</p> <p>If no information is available on the COM you are looking for, refer to the COM section and forms on the surface collection site for information on how to process your test request.</p>
Finishes and Fabrics	A complete listing of finishes and fabrics for Zody seating is available in the back of the price list.
Shipping Weights (Including packaging)	<ul style="list-style-type: none"> • Chairs with arms: 55 pounds/1 chair per carton/17.3 cubic feet • Chairs without arms: 51 pounds/1 chair per carton/17.3 cubic feet • Chairs with sled base: 24 pounds/1 chair per carton/17.3 cubic feet • Chairs with leg base: 21 pounds/1 chair per carton/17.3 cubic feet
RUSH	Select Zody seating models marked with a  symbol to denote availability on the RUSH program. Refer to the fabric and finish options for each product.
Nano-Tex®	<p>To specify add "P" to end of product number. Example: SZT-22-702MA1P</p> <p>Not available on mesh, faux leather, or leather. For available fabrics see matrix in the back of the book.</p>

Zody

General Specifications

STANDARD MOBILITY AND ADJUSTABILITY

Balanced 3-point tilt

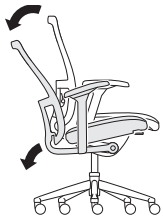

Features:

- Balanced 3-point tilt mechanism.
- Back reclines 24° from the upright position.
- Seat pan moves downward 3° from the initial position.

Benefits:

- Comfortable relaxed posture.
- Recline allows for the opening of the users' chest cavity providing good airflow to promote alertness.
- Users' feet remain flat on the floor.

Tilt Tension Control

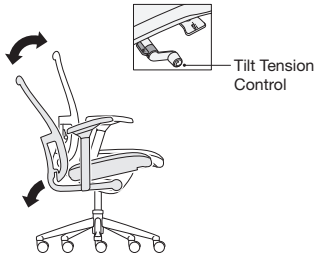

Feature:

- Easy-to-reach and easy-to-activate side-mounted tilt tension control regulates the amount of resistance felt when leaning back in the chair and the effort required to recline the chair backwards.

Benefit:

- Personalized support to accommodate users of different body types and different work styles.

Seat Height Adjustment

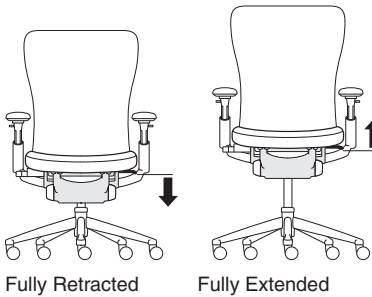

Features:

- Pneumatic seat height adjustment.
- Seat height adjusts 5"(127mm) from 16" to 21"(406mm to 533mm) in standard models. Low-position adjusts 14 to 17"(356 to 432mm).

Benefits:

- Ensures the comfort of the lower limbs by avoiding pressure on the underside of the thigh caused by a seat pan that is too high, or decreased thigh-to-torso angle if the seat pan is too low.
- Accommodates for users between approximately 4'11"(1499mm) and 6'3"(1905mm) tall to provide good leg circulation.
- Seat height adjustment also is important in setting the proper hand position and allowing for a proper sitting eye height.

Seat Depth Adjustment

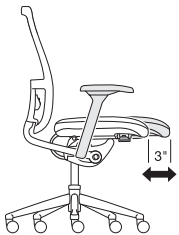

Features:

- 3"(76mm) of seat depth range. (Fixed seat also available.)
- Available with conventional foam material or optional Technogel® Soft Lite gel insert.
- Waterfall edge.

Benefit:

- Supports the thighs, allows users to rest against the seat back for back support, and avoids pressure on the back of the knees of small to tall users.

Upper Back Torsional Movement



Feature:

- Passive 2"(51mm) of torsional flex in the upper back.
- Patented mesh with built in tension zones for added comfort.

Benefit:

- Increases users' mobility and comfort when reaching sideways for objects.

Zody

General Specifications

OPTIONAL MOBILITY AND ADJUSTABILITY

PAL Back System**Features:**

- PAL Back System includes Asymmetrical Lumbar Adjustment and passive pelvic support.
- Asymmetrical Lumbar Adjustment adjusts 4"(102mm) in height; support level can be adjusted independently for right or left-hand side of users' body.
- Passive pelvic support.

Benefits:

- Lumbar adjustment maintains the natural curvature of the spine at the lower back and allows users to choose the support that feels right for them.
- Passive pelvic support rotates the pelvis forward to maintain the natural spine shape.

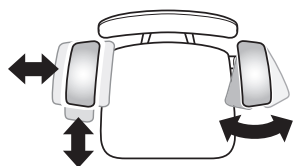
4D Arm**Features:**

- Optional 4D arm.
- Arm adjusts in 4 ways:
 - Height adjustment: 4"(102mm)
 - Side-to-side arm cap adjustment range: 3"(76mm) [1.5"(38mm) each arm cap]
 - Front-to-back adjustment range: 3 1/2"(89mm)
 - Pivoting: In 20°; out 20°

Benefits:

- Arms support the muscular system of users' neck and shoulders and proper arm support provides back relief. Arms can be an aid in standing or sitting down.
- Height adjustment accommodates for users with varying elbow rest heights so that users avoid lifting their shoulders or leaning sideways to get arm support.
- Front-to-back adjustment adjusts the armrest length, which is important because it allows users to get close to the worksurface while maintaining the effective use of the backrest.
- Side-to-side adjustment ensures a comfortable resting position for the arms with proper support of the forearm while allowing for easy entry/exit of the chair.
- Pivoting provides proper support of the forearm when performing tasks involving keying and mousing.

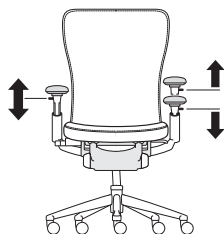
Adjustable Height Arm**Feature:**

- Optional height adjustable arms adjust 4"(102mm) vertically.

Benefit:

- Height adjustment accommodates users with varying elbow rest heights so that users avoid lifting their shoulders or leaning sideways to get arm support.

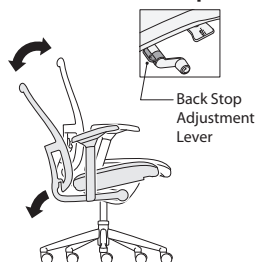
Tilt with Back Stop**Features:**

- Optional back stop;
 - Back stops in 6 positions - upright and every 4° backward.
 - Tilt limiter.

Benefit:

- Allows users the choice of selecting an upright position or limiting the amount of recline while performing different tasks.

Zody

General Specifications

OPTIONAL MOBILITY AND ADJUSTABILITY (continued)

Forward Tilt

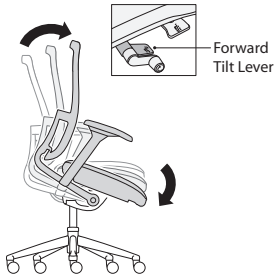

Features:

- Optional forward tilt.
- Seat pan moves downward 5° from the initial position.

Benefit:

- Allows the user the opportunity to vary their posture throughout the day.

Back Stop/Forward Tilt

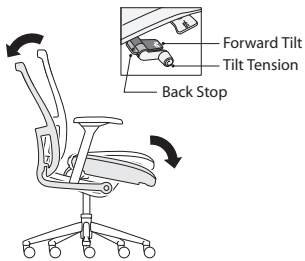

Feature:

- Optional back-stop and forward tilt.
- Back stops in 6 positions, upright and every 4° backward.

Benefit:

- Allows users to vary their posture for maximum comfort and for changes in task requirements.

Base

Standard Plastic Base and Optional Aluminum Base

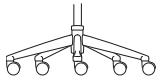

Low Position Base (Aluminum only)

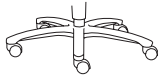

Ergonomic Standards Guidelines

- All Zody models meet or exceed all ANSI/BIFMA durability standards for office seating
- Zody meets the following ergonomic standards/guidelines:
 - BSR/HFES 100-2002
 - BIFMA G1-2002
 - CSA-Z412-2000
 - CAN/CGSB 44.232-2002
 - HFES 2007

ZodyGeneral Specifications
UPHOLSTERY / AESTHETIC OPTIONS**Leather Upholstery****Seat:** Stitched double seams. Vertically in the center and on the edges of the seat cushion.**Back:** Vertical stitched double seams on the upholstered back jacket with leather or Customers Own Leather (COL).**Upholstered Back Jacket****Front View:**

Leather Jacket

**Back View:****Features**

- Removable.
- Back jacket covers the inside back of the chairs allowing a back view of the mesh. Jacket consists of padding covered with fabric or leather upholstery.
- Available in fabric, faux leather, leather, COM and COL.

Head Rest**Features**

- Height-adjustable 2.5" to fit a wide range of users, headrest is TPU material, like Zody arm.
- Available in two finishes; Black or Smoke, coordinates with the chairs arm rest color specified.
- See Zody price pages for specification (available on all models).

Specification Example: SZE-22-722MA1 (Zody with headrest, 4D arm).

To add a head rest to an existing model in the field order service part: Back and Head rest replacement, see e-Parts.

Zody

Task Chair with 4D Arms



SZT-20-702MA1

Dimensions*

- *SH: 16-21"
(406mm-533mm)
- H: 38-43"(965mm-1092mm)
- D: 29"(737mm)
- W: 29"(737mm)
- *SW: 19 1/4"(489mm)
- *AH: 6.8-10.8"
(173mm-274mm)
- *SD: 16-19"(406mm-483mm)

Low position seat height:
14-17"(356mm-432mm)

* All measurements taken with the BIFMA chair measuring device.

Features

- Back: Soft mesh only or mesh back with upholstered back jacket.
 - Seat: Standard upholstered with foam or optional foam with Technogel® Soft Lite gel insert.
 - Seat Type: Standard adjustable [3"(76mm) range] or optional fixed.
 - Base: Standard Plastic painted five-star base or optional painted aluminum or polished aluminum.
 - Plastic base available in Black, or painted Metallic silver, Metallic Champagne and Metallic Gunmetal.
 - Aluminum base available with painted Black, Metallic silver, Metallic Champagne, Metallic Gunmetal, or optional Polished Aluminum.
 - Arms: 4D with soft arm caps.
 - Mechanism: Balanced 3-point tilt; standard tilt tension.
 - Height adjustment: Pneumatic or low-position pneumatic.
 - Optional Back Stop: Tilt stop in 6 positions.
 - Optional Forward Tilt: 5 degrees downward from initial position.
 - Optional Back Stop with Forward Tilt
 - Optional Asymmetrical Lumbar Adjustment: 4"(102mm) height adjustment; support level can be adjusted independently for right or left hand side of users body. Optional PAL Back System: Passive pelvic support.
 - Casters: Standard with hard casters; optional soft casters.
 - COM yardage / COL square footage:
 - Mesh back model: .75/20
 - Mesh back/upholstered back jacket: 1.5/40
- Available on RUSH.

NOTE: When specifying fabric or leather back jacket; must also specify mesh surface color for outside back.

For different fabric grades on seat and upholstered back jacket, pricing will be determined by the sum of the upcharges of the selected jacket fabric grades (i.e. when choosing a Grade B fabric for the seat and a Grade D for the back, the final price will reflect the upcharge for a Grade B seat plus the upcharge for a Grade D back jacket.)

To Order with Mesh Back Specify:

- 1) Product number, including:

1 Base/Caster Option:

Aluminum Base

- 1 Aluminum Base, Hard Caster, add **\$30.00** to list
- 2 Aluminum Base, Soft Caster, add **\$30.00** to list
- 3 Aluminum Low Base, Hard Caster, add **\$30.00** to list
- 4 Aluminum Low Base, Soft Caster, add **\$30.00** to list

Plastic Base

- 5 Plastic Std. Base, Hard Caster
 - 6 Plastic Std. Base, Soft Caster
- 2) Fabric surface and color (seat).
 - 3) Mesh surface and color (back).
 - 4) Trim color for frame/arm caps.
 - 5) Trim color for base/arms.
(Add **\$175.35** for polished aluminum.)

To Order with Fabric or Leather Upholstered Back Jacket Specify:

- 1) Product number, including:

1 Base/Caster Option:

Aluminum Base

- 1 Aluminum Base, Hard Caster, add **\$30.00** to list
- 2 Aluminum Base, Soft Caster, add **\$30.00** to list
- 3 Aluminum Low Base, Hard Caster, add **\$30.00** to list
- 4 Aluminum Low Base, Soft Caster, add **\$30.00** to list

Plastic Base

- 5 Plastic Std. Base, Hard Caster
- 6 Plastic Std. Base, Soft Caster

- 2) Fabric surface and color (seat).
- 3) Mesh surface color (back).
- 4) Fabric surface and color (back jacket).
- 5) Trim color for frame/arm caps.
- 6) Trim color for base/arms.
(Add **\$175.35** for polished aluminum.)

Leather Seat with Mesh Back:

Change fourth digit in product number to **1**; fifth digit to **0**.

Example: SZT-10-702MA5

Leather Seat with Leather Upholstered Back Jacket:

Change fourth digit in product number to **1**; fifth digit to **1**.

Example: SZT-11-702MA5

Faux Leather Seat with Mesh Back:

Change the fourth digit in product number to **3**.

Example: SZT-30-702MA5

Faux Leather Seat with Faux Leather Upholstered Back Jacket:

Change the fourth and fifth digits in product number to **33**.

Example: SZT-33-702MA5

Zody
Task Chair with 4D Arms

Upholstered Foam Seat	Adjustments	Number	①	Fabric Grade								Leather Grade A	Leather Grade B
				A	B	C	D	E	F	G	H		
No Lumbar Adjustment - Mesh Back w/Plastic Base													
	Pneumatic	SZT-20-702MA	■	\$1065.60	\$1097.10	\$1130.70	\$1147.50	\$1160.10	\$1190.55	\$1217.85	\$1292.40	\$1343.85	\$1480.60
	Back Stop	SZT-20-701MA	■	1135.95	1167.45	1201.05	1217.85	1230.45	1260.90	1288.20	1362.75	1414.20	1550.95
	Forward Tilt	SZT-20-703MA	■	1135.95	1167.45	1201.05	1217.85	1230.45	1260.90	1288.20	1362.75	1414.20	1550.95
	Back Stop/ Forward Tilt	SZT-20-704MA	■	1158.00	1189.50	1223.10	1239.90	1252.50	1282.95	1310.25	1384.80	1436.25	1573.00
No Lumbar Adjustment - Upholstered Back Jacket w/Plastic Base													
	Pneumatic	SZT-22-702MA	■	\$1169.55	\$1232.55	\$1299.75	\$1333.35	\$1358.55	\$1419.45	\$1474.05	\$1623.15	\$1726.05	\$1999.55
	Back Stop	SZT-22-701MA	■	1239.90	1302.90	1370.10	1403.70	1428.90	1489.80	1544.40	1693.50	1796.40	2069.90
	Forward Tilt	SZT-22-703MA	■	1239.90	1302.90	1370.10	1403.70	1428.90	1489.80	1544.40	1693.50	1796.40	2069.90
	Back Stop/ Forward Tilt	SZT-22-704MA	■	1261.95	1324.95	1392.15	1425.75	1450.95	1511.85	1566.45	1715.55	1818.45	2091.95
Lumbar Adjustment - Mesh Back w/Plastic Base													
	Pneumatic	SZT-20-712MA	■	\$1158.00	\$1189.50	\$1223.10	\$1239.90	\$1252.50	\$1282.95	\$1310.25	\$1384.80	\$1436.25	\$1573.00
	Back Stop	SZT-20-711MA	■	1228.35	1259.85	1293.45	1310.25	1322.85	1353.30	1380.60	1455.15	1506.60	1643.35
	Forward Tilt	SZT-20-713MA	■	1228.35	1259.85	1293.45	1310.25	1322.85	1353.30	1380.60	1455.15	1506.60	1643.35
	Back Stop/ Forward Tilt	SZT-20-714MA	■	1250.40	1281.90	1315.50	1332.30	1344.90	1375.35	1402.65	1477.20	1528.65	1665.40
Lumbar Adjustment - Upholstered Back Jacket w/Plastic Base													
	Pneumatic	SZT-22-712MA	■	\$1261.95	\$1324.95	\$1392.15	\$1425.75	\$1450.95	\$1511.85	\$1566.45	\$1715.55	\$1818.45	\$2091.95
	Back Stop	SZT-22-711MA	■	1332.30	1395.30	1462.50	1496.10	1521.30	1582.20	1636.80	1785.90	1888.80	2162.30
	Forward Tilt	SZT-22-713MA	■	1332.30	1395.30	1462.50	1496.10	1521.30	1582.20	1636.80	1785.90	1888.80	2162.30
	Back Stop/ Forward Tilt	SZT-22-714MA	■	1354.35	1417.35	1484.55	1518.15	1543.35	1604.25	1658.85	1807.95	1910.85	2184.35
PAL Back System - Mesh Back w/Plastic Base													
	Pneumatic	SZT-20-722MA	■	\$1182.15	\$1213.65	\$1247.25	\$1264.05	\$1276.65	\$1307.10	\$1334.40	\$1408.95	\$1460.40	\$1597.15
	Back Stop	SZT-20-721MA	■	1252.50	1284.00	1317.60	1334.40	1347.00	1377.45	1404.75	1479.30	1530.75	1667.50
	Forward Tilt	SZT-20-723MA	■	1252.50	1284.00	1317.60	1334.40	1347.00	1377.45	1404.75	1479.30	1530.75	1667.50
	Back Stop/ Forward Tilt	SZT-20-724MA	■	1274.55	1306.05	1339.65	1356.45	1369.05	1399.50	1426.80	1501.35	1552.80	1689.55
PAL Back System - Upholstered Back Jacket w/Plastic Base													
	Pneumatic	SZT-22-722MA	■	\$1286.10	\$1349.10	\$1416.30	\$1449.90	\$1475.10	\$1536.00	\$1590.60	\$1739.70	\$1842.60	\$2116.10
	Back Stop	SZT-22-721MA	■	1356.45	1419.45	1486.65	1520.25	1545.45	1606.35	1660.95	1810.05	1912.95	2186.45
	Forward Tilt	SZT-22-723MA	■	1356.45	1419.45	1486.65	1520.25	1545.45	1606.35	1660.95	1810.05	1912.95	2186.45
	Back Stop/ Forward Tilt	SZT-22-724MA	■	1378.50	1441.50	1508.70	1542.30	1567.50	1628.40	1683.00	1832.10	1935.00	2208.50

The following options require modification of the product number.

- Soft casters To specify, change the 11th digit from a 1 (hard caster) to a 2 (soft caster); **Example:** SZT-20-702MA2
- Aluminum Base To specify, change the 11th digit from a 5 to a 1 (hard caster) or 2 (soft caster) and add **\$30.00** list
- Low position pneumatic To specify, change the 11th digit from a 1 to a 3 (hard caster) or from a 2 to a 4 (soft caster);
Examples: SZT-20-702MA3 is a low base with hard casters
SZT-20-702MA4 is a low base with soft casters
NOTE: Polished aluminum trim not available with this option.
- Fixed seat To specify, change the 10th digit from A to X; **Example:** SZT-20-702MX1
- CAL 133 To specify, add **F** to the end of the product number; **Example:** SZT-20-712MA1F (add **\$129.15** list)
- Headrest To specify, change the 3rd digit from a T to an E; **Example:** SZE-22-702MA1 with headrest (add **\$54.60** list)
- Nano-Tex To specify, add **P** to end of the product number (add **\$32.55** list).

NOTE: CAL 133 is available on chairs with black frame and foam seat with or without the Lumbar option.
CAL 133 is not available on chairs with PAL back system.

For available fabrics see matrix in the back of the book or at Haworth.com/surfaces.

Zody

Task Chair with 4D Arms

Upholstered Gel Insert Seat	Adjustments	Number	①	Fabric Grade								Leather Grade A	Leather Grade B
				A	B	C	D	E	F	G	H		
No Lumbar Adjustment - Mesh Back w/Plastic Base													
	Pneumatic	SZT-20-702EA	■	\$1152.75	\$1184.25	\$1217.85	\$1234.65	\$1247.25	\$1277.70	\$1305.00	\$1379.55	\$1431.00	\$1567.75
	Back Stop	SZT-20-701EA	■	1223.10	1254.60	1288.20	1305.00	1317.60	1348.05	1375.35	1449.90	1501.35	1638.10
	Forward Tilt	SZT-20-703EA	■	1223.10	1254.60	1288.20	1305.00	1317.60	1348.05	1375.35	1449.90	1501.35	1638.10
	Back Stop/ Forward Tilt	SZT-20-704EA	■	1245.15	1276.65	1310.25	1327.05	1339.65	1370.10	1397.40	1471.95	1523.40	1660.15
No Lumbar Adjustment - Upholstered Back Jacket w/Plastic Base													
	Pneumatic	SZT-22-702EA	■	\$1256.70	\$1319.70	\$1386.90	\$1420.50	\$1445.70	\$1506.60	\$1561.20	\$1710.30	\$1813.20	\$2086.70
	Back Stop	SZT-22-701EA	■	1327.05	1390.05	1457.25	1490.85	1516.05	1576.95	1631.55	1780.65	1883.55	2157.05
	Forward Tilt	SZT-22-703EA	■	1327.05	1390.05	1457.25	1490.85	1516.05	1576.95	1631.55	1780.65	1883.55	2157.05
	Back Stop/ Forward Tilt	SZT-22-704EA	■	1349.10	1412.10	1479.30	1512.90	1538.10	1599.00	1653.60	1802.70	1905.60	2179.10
Lumbar Adjustment - Mesh Back w/Plastic Base													
	Pneumatic	SZT-20-712EA	■	\$1245.15	\$1276.65	\$1310.25	\$1327.05	\$1339.65	\$1370.10	\$1397.40	\$1471.95	\$1523.40	\$1660.15
	Back Stop	SZT-20-711EA	■	1315.50	1347.00	1380.60	1397.40	1410.00	1440.45	1467.75	1542.30	1593.75	1730.50
	Forward Tilt	SZT-20-713EA	■	1315.50	1347.00	1380.60	1397.40	1410.00	1440.45	1467.75	1542.30	1593.75	1730.50
	Back Stop/ Forward Tilt	SZT-20-714EA	■	1337.55	1369.05	1402.65	1419.45	1432.05	1462.50	1489.80	1564.35	1615.80	1752.55
Lumbar Adjustment - Upholstered Back Jacket w/Plastic Base													
	Pneumatic	SZT-22-712EA	■	\$1349.10	\$1412.10	\$1479.30	\$1512.90	\$1538.10	\$1599.00	\$1653.60	\$1802.70	\$1905.60	\$2179.10
	Back Stop	SZT-22-711EA	■	1419.45	1482.45	1549.65	1583.25	1608.45	1669.35	1723.95	1873.05	1975.95	2249.45
	Forward Tilt	SZT-22-713EA	■	1419.45	1482.45	1549.65	1583.25	1608.45	1669.35	1723.95	1873.05	1975.95	2249.45
	Back Stop/ Forward Tilt	SZT-22-714EA	■	1441.50	1504.50	1571.70	1605.30	1630.50	1691.40	1746.00	1895.10	1998.00	2271.50
PAL Back System - Mesh Back w/Plastic Base													
	Pneumatic	SZT-20-722EA	■	\$1269.30	\$1300.80	\$1334.40	\$1351.20	\$1363.80	\$1394.25	\$1421.55	\$1496.10	\$1547.55	\$1684.30
	Back Stop	SZT-20-721EA	■	1339.65	1371.15	1404.75	1421.55	1434.15	1464.60	1491.90	1566.45	1617.90	1754.65
	Forward Tilt	SZT-20-723EA	■	1339.65	1371.15	1404.75	1421.55	1434.15	1464.60	1491.90	1566.45	1617.90	1754.65
	Back Stop/ Forward Tilt	SZT-20-724EA	■	1361.70	1393.20	1426.80	1443.60	1456.20	1486.65	1513.95	1588.50	1639.95	1776.70
PAL Back System - Upholstered Back Jacket w/Plastic Base													
	Pneumatic	SZT-22-722EA	■	\$1373.25	\$1436.25	\$1503.45	\$1537.05	\$1562.25	\$1623.15	\$1677.75	\$1826.85	\$1929.75	\$2203.25
	Back Stop	SZT-22-721EA	■	1443.60	1506.60	1573.80	1607.40	1632.60	1693.50	1748.10	1897.20	2000.10	2273.60
	Forward Tilt	SZT-22-723EA	■	1443.60	1506.60	1573.80	1607.40	1632.60	1693.50	1748.10	1897.20	2000.10	2273.60
	Back Stop/ Forward Tilt	SZT-22-724EA	■	1465.65	1528.65	1595.85	1629.45	1654.65	1715.55	1770.15	1919.25	2022.15	2295.65

The following options require modification of the product number.

Soft casters	To specify, change the 11th digit from a 1 (hard caster) to a 2 (soft caster); Example: SZT-20-702EA2
Aluminum Base	To specify, change the 11th digit from a 5 to a 1 (hard caster) or 2 (soft caster) and add \$30.00 list
Low position pneumatic	To specify, change the 11th digit from a 1 to a 3 (hard caster) or from a 2 to a 4 (soft caster); Examples: SZT-20-702EA3 is a low base with hard casters SZT-20-702EA4 is a low base with soft casters NOTE: Polished aluminum trim not available with this option.
Fixed seat	To specify, change the 10th digit from A to X; Example: SZT-20-702EX1
Headrest	To specify, change the 3rd digit from a T to an E; Example: SZE-22-702EA1 with headrest (add \$54.60 list)
Nano-TEX	To specify, add P to end of the product number (add \$32.55 list). NOTE: For available fabrics see matrix in the back of the book.

This page intentionally blank

Zody

Task Chair with Height Adjustable Arms



SZT-20-402MA1

Dimensions*

- *SH: 16-21"
(406mm-533mm)
- H: 38-43"(965mm-1092mm)
- D: 29"(737mm)
- W: 29"(737mm)
- *SW: 19 1/4"(489mm)
- *AH: 6.8-10.8"
(173mm-274mm)
- *SD: 16-19"(406mm-483mm)

Low position seat height:
14-17"(356mm-432mm)

* All measurements taken with the BIFMA chair measuring device.

Features

- Back: Soft mesh only or mesh back with upholstered back jacket.
 - Seat: Standard upholstered with foam or optional foam with Technogel® Soft Lite gel insert.
 - Seat Type: Standard adjustable [3"(76mm) range] or optional fixed.
 - Base: Standard Plastic painted five-star base or optional painted aluminum or polished aluminum.
 - Plastic base available in Black, or painted Metallic silver, Metallic Champagne and Metallic Gunmetal.
 - Aluminum base available with painted Black, Metallic silver, Metallic Champagne, Metallic Gunmetal, or optional Polished Aluminum.
 - Arms: Height-adjustable with soft arm caps.
 - Mechanism: Balanced 3-point tilt; standard tilt tension.
 - Height adjustment: Pneumatic or low-position pneumatic.
 - Optional Back Stop: Tilt stop in 6 positions.
 - Optional Forward Tilt: 5 degrees downward from initial position.
 - Optional Back Stop with Forward Tilt
 - Optional Asymmetrical Lumbar Adjustment: 4"(102mm) height adjustment; support level can be adjusted independently for right or left hand side of users body. Optional PAL Back System: Passive pelvic support.
 - Casters: Standard with hard casters; optional soft casters.
 - COM yardage / COL square footage:
 - Mesh back model: 0.75/20
 - Mesh back/upholstered back jacket: 1.5/40
- Available on RUSH.

NOTE: When specifying fabric or leather back jacket; must also specify mesh surface color for outside back.

For different fabric grades on seat and upholstered back jacket, pricing will be determined by the sum of the upcharges of the selected jacket fabric grades (i.e. when choosing a Grade B fabric for the seat and a Grade D for the back, the final price will reflect the upcharge for a Grade B seat plus the upcharge for a Grade D back jacket.)

To Order with Mesh Back Specify:

- 1) Product number, including:

1 Base/Caster Option:

Aluminum Base

- 1 Aluminum Base, Hard Caster, add **\$30.00** to list
- 2 Aluminum Base, Soft Caster, add **\$30.00** to list
- 3 Aluminum Low Base, Hard Caster, add **\$30.00** to list
- 4 Aluminum Low Base, Soft Caster, add **\$30.00** to list

Plastic Base

- 5 Plastic Std. Base, Hard Caster
 - 6 Plastic Std. Base, Soft Caster
- 2) Fabric surface and color (seat).
 - 3) Mesh surface and color (back).
 - 4) Trim color for frame/arm caps.
 - 5) Trim color for base/arms.
(Add **\$175.35** for polished aluminum.)

To Order with Fabric or Leather Upholstered Back Jacket Specify:

- 1) Product number, including:

1 Base/Caster Option:

Aluminum Base

- 1 Aluminum Base, Hard Caster, add **\$30.00** to list
- 2 Aluminum Base, Soft Caster, add **\$30.00** to list
- 3 Aluminum Low Base, Hard Caster, add **\$30.00** to list
- 4 Aluminum Low Base, Soft Caster, add **\$30.00** to list

Plastic Base

- 5 Plastic Std. Base, Hard Caster
- 6 Plastic Std. Base, Soft Caster

- 2) Fabric surface and color (seat).
- 3) Mesh surface color (back).
- 4) Fabric surface and color (back jacket).
- 5) Trim color for frame/arm caps.
- 6) Trim color for base/arms.
(Add **\$175.35** for polished aluminum.)

Leather Seat with Mesh Back:

Change fourth digit in product number to **1**; fifth digit to **0**.

Example: SZT-10-402MA5

Leather Seat with Leather Upholstered Back Jacket:

Change fourth digit in product number to **1**; fifth digit to **1**.

Example: SZT-11-402MA5

Faux Leather Seat with Mesh Back:

Change the fourth digit in product number to **3**.

Example: SZT-30-402MA5

Faux Leather Seat with Faux Leather Upholstered Back Jacket:

Change the fourth and fifth digits in product number to **33**.

Example: SZT-33-402MA5

Zody

Task Chair with Height Adjustable Arms

Upholstered Foam Seat	Adjustments	Number	①	Fabric Grade								Leather Grade A	Leather Grade B
				A	B	C	D	E	F	G	H		
No Lumbar Adjustment - Mesh w/Plastic Base													
	Pneumatic	SZT-20-402MA	■	\$1030.95	\$1062.45	\$1096.05	\$1112.85	\$1125.45	\$1155.90	\$1183.20	\$1257.75	\$1309.20	\$1445.95
	Back Stop	SZT-20-401MA	■	1101.30	1132.80	1166.40	1183.20	1195.80	1226.25	1253.55	1328.10	1379.55	1516.30
	Forward Tilt	SZT-20-403MA	■	1101.30	1132.80	1166.40	1183.20	1195.80	1226.25	1253.55	1328.10	1379.55	1516.30
	Back Stop/ Forward Tilt	SZT-20-404MA	■	1123.35	1154.85	1188.45	1205.25	1217.85	1248.30	1275.60	1350.15	1401.60	1538.35
No Lumbar Adjustment - Upholstered Back Jacket w/Plastic Base													
	Pneumatic	SZT-22-402MA	■	\$1134.90	\$1197.90	\$1265.10	\$1298.70	\$1323.90	\$1384.80	\$1439.40	\$1588.50	\$1691.40	\$1964.90
	Back Stop	SZT-22-401MA	■	1205.25	1268.25	1335.45	1369.05	1394.25	1455.15	1509.75	1658.85	1761.75	2035.25
	Forward Tilt	SZT-22-403MA	■	1205.25	1268.25	1335.45	1369.05	1394.25	1455.15	1509.75	1658.85	1761.75	2035.25
	Back Stop/ Forward Tilt	SZT-22-404MA	■	1227.30	1290.30	1357.50	1391.10	1416.30	1477.20	1531.80	1680.90	1783.80	2057.30
Lumbar Adjustment - Mesh w/Plastic Base													
	Pneumatic	SZT-20-412MA	■	\$1123.35	\$1154.85	\$1188.45	\$1205.25	\$1217.85	\$1248.30	\$1275.60	\$1350.15	\$1401.60	\$1538.35
	Back Stop	SZT-20-411MA	■	1193.70	1225.20	1258.80	1275.60	1288.20	1318.65	1345.95	1420.50	1471.95	1608.70
	Forward Tilt	SZT-20-413MA	■	1193.70	1225.20	1258.80	1275.60	1288.20	1318.65	1345.95	1420.50	1471.95	1608.70
	Back Stop/ Forward Tilt	SZT-20-414MA	■	1215.75	1247.25	1280.85	1297.65	1310.25	1340.70	1368.00	1442.55	1494.00	1630.75
Lumbar Adjustment - Upholstered Back Jacket w/Plastic Base													
	Pneumatic	SZT-22-412MA	■	\$1227.30	\$1290.30	\$1357.50	\$1391.10	\$1416.30	\$1477.20	\$1531.80	\$1680.90	\$1783.80	\$2057.30
	Back Stop	SZT-22-411MA	■	1297.65	1360.65	1427.85	1461.45	1486.65	1547.55	1602.15	1751.25	1854.15	2127.65
	Forward Tilt	SZT-22-413MA	■	1297.65	1360.65	1427.85	1461.45	1486.65	1547.55	1602.15	1751.25	1854.15	2127.65
	Back Stop/ Forward Tilt	SZT-22-414MA	■	1319.70	1382.70	1449.90	1483.50	1508.70	1569.60	1624.20	1773.30	1876.20	2149.70
PAL Back System - Mesh w/Plastic Base													
	Pneumatic	SZT-20-422MA	■	\$1147.50	\$1179.00	\$1212.60	\$1229.40	\$1242.00	\$1272.45	\$1299.75	\$1374.30	\$1425.75	\$1562.50
	Back Stop	SZT-20-421MA	■	1217.85	1249.35	1282.95	1299.75	1312.35	1342.80	1370.10	1444.65	1496.10	1632.85
	Forward Tilt	SZT-20-423MA	■	1217.85	1249.35	1282.95	1299.75	1312.35	1342.80	1370.10	1444.65	1496.10	1632.85
	Back Stop/ Forward Tilt	SZT-20-424MA	■	1239.90	1271.40	1305.00	1321.80	1334.40	1364.85	1392.15	1466.70	1518.15	1654.90
PAL Back System - Upholstered Back Jacket w/Plastic Base													
	Pneumatic	SZT-22-422MA	■	\$1251.45	\$1314.45	\$1381.65	\$1415.25	\$1440.45	\$1501.35	\$1555.95	\$1705.05	\$1807.95	\$2081.45
	Back Stop	SZT-22-421MA	■	1321.80	1384.80	1452.00	1485.60	1510.80	1571.70	1626.30	1775.40	1878.30	2151.80
	Forward Tilt	SZT-22-423MA	■	1321.80	1384.80	1452.00	1485.60	1510.80	1571.70	1626.30	1775.40	1878.30	2151.80
	Back Stop/ Forward Tilt	SZT-22-424MA	■	1343.85	1406.85	1474.05	1507.65	1532.85	1593.75	1648.35	1797.45	1900.35	2173.85

The following options require modification of the product number.

Soft casters	To specify, change the 11th digit from a 1 (hard caster) to a 2 (soft caster); Example: SZT-20-402MA2
Aluminum Base	To specify, change the 11th digit from a 5 to a 1 (hard caster) or 2 (soft caster) and add \$30.00 list
Low position pneumatic	To specify, change the 11th digit from a 1 to a 3 (hard caster) or from a 2 to a 4 (soft caster); Examples: SZT-20-402MA3 is a low base with hard casters SZT-20-402MA4 is a low base with soft casters NOTE: Polished aluminum trim not available with this option.
Fixed seat	To specify, change the 10th digit from A to X; Example: SZT-20-402MX1
CAL 133	To specify, add F to the end of the product number; Example: SZT-20-401MA1F (add \$129.15 list)
Headrest	To specify, change the 3rd digit from a T to an E; Example: SZE-22-402MA1 with headrest (add \$54.60 list)
Nano-Tex	To specify, add P to end of the product number (add \$32.55 list).

NOTE: CAL 133 is available on chairs with black frame and foam seat with or without the Lumbar option.
CAL 133 is not available on chairs with PAL back system.

For available fabrics see matrix in the back of the book or at Haworth.com/surfaces.

Zody

Task Chair with Height Adjustable Arms

Upholstered Gel Insert Seat	Adjustments	Number	①	Fabric Grade								Leather Grade A	Leather Grade B
				A	B	C	D	E	F	G	H		
No Lumbar Adjustment - Mesh w/Plastic Base													
	Pneumatic	SZT-20-402EA	■	\$1118.10	\$1149.60	\$1183.20	\$1200.00	\$1212.60	\$1243.05	\$1270.35	\$1344.90	\$1396.35	\$1533.10
	Back Stop	SZT-20-401EA	■	1188.45	1219.95	1253.55	1270.35	1282.95	1313.40	1340.70	1415.25	1466.70	1603.45
	Forward Tilt	SZT-20-403EA	■	1188.45	1219.95	1253.55	1270.35	1282.95	1313.40	1340.70	1415.25	1466.70	1603.45
	Back Stop/ Forward Tilt	SZT-20-404EA	■	1210.50	1242.00	1275.60	1292.40	1305.00	1335.45	1362.75	1437.30	1488.75	1625.50
No Lumbar Adjustment - Upholstered Back Jacket w/Plastic Base													
	Pneumatic	SZT-22-402EA	■	\$1222.05	\$1285.05	\$1352.25	\$1385.85	\$1411.05	\$1471.95	\$1526.55	\$1675.65	\$1778.55	\$2052.05
	Back Stop	SZT-22-401EA	■	1292.40	1355.40	1422.60	1456.20	1481.40	1542.30	1596.90	1746.00	1848.90	2122.40
	Forward Tilt	SZT-22-403EA	■	1292.40	1355.40	1422.60	1456.20	1481.40	1542.30	1596.90	1746.00	1848.90	2122.40
	Back Stop/ Forward Tilt	SZT-22-404EA	■	1314.45	1377.45	1444.65	1478.25	1503.45	1564.35	1618.95	1768.05	1870.95	2144.45
Lumbar Adjustment - Mesh w/Plastic Base													
	Pneumatic	SZT-20-412EA	■	\$1210.50	\$1242.00	\$1275.60	\$1292.40	\$1305.00	\$1335.45	\$1362.75	\$1437.30	\$1488.75	\$1625.50
	Back Stop	SZT-20-411EA	■	1280.85	1312.35	1345.95	1362.75	1375.35	1405.80	1433.10	1507.65	1559.10	1695.85
	Forward Tilt	SZT-20-413EA	■	1280.85	1312.35	1345.95	1362.75	1375.35	1405.80	1433.10	1507.65	1559.10	1695.85
	Back Stop/ Forward Tilt	SZT-20-414EA	■	1302.90	1334.40	1368.00	1384.80	1397.40	1427.85	1455.15	1529.70	1581.15	1717.90
Lumbar Adjustment - Upholstered Back Jacket w/Plastic Base													
	Pneumatic	SZT-22-412EA	■	\$1314.45	\$1377.45	\$1444.65	\$1478.25	\$1503.45	\$1564.35	\$1618.95	\$1768.05	\$1870.95	\$2144.45
	Back Stop	SZT-22-411EA	■	1384.80	1447.80	1515.00	1548.60	1573.80	1634.70	1689.30	1838.40	1941.30	2214.80
	Forward Tilt	SZT-22-413EA	■	1384.80	1447.80	1515.00	1548.60	1573.80	1634.70	1689.30	1838.40	1941.30	2214.80
	Back Stop/ Forward Tilt	SZT-22-414EA	■	1406.85	1469.85	1537.05	1570.65	1595.85	1656.75	1711.35	1860.45	1963.35	2236.85
PAL Back System - Mesh w/Plastic Base													
	Pneumatic	SZT-20-422EA	■	\$1234.65	\$1266.15	\$1299.75	\$1316.55	\$1329.15	\$1359.60	\$1386.90	\$1461.45	\$1512.90	\$1649.65
	Back Stop	SZT-20-421EA	■	1305.00	1336.50	1370.10	1386.90	1399.50	1429.95	1457.25	1531.80	1583.25	1720.00
	Forward Tilt	SZT-20-423EA	■	1305.00	1336.50	1370.10	1386.90	1399.50	1429.95	1457.25	1531.80	1583.25	1720.00
	Back Stop/ Forward Tilt	SZT-20-424EA	■	1327.05	1358.55	1392.15	1408.95	1421.55	1452.00	1479.30	1553.85	1605.30	1742.05
PAL Back System - Upholstered Back Jacket w/Plastic Base													
	Pneumatic	SZT-22-422EA	■	\$1338.60	\$1401.60	\$1468.80	\$1502.40	\$1527.60	\$1588.50	\$1643.10	\$1792.20	\$1895.10	\$2168.60
	Back Stop	SZT-22-421EA	■	1408.95	1471.95	1539.15	1572.75	1597.95	1658.85	1713.45	1862.55	1965.45	2238.95
	Forward Tilt	SZT-22-423EA	■	1408.95	1471.95	1539.15	1572.75	1597.95	1658.85	1713.45	1862.55	1965.45	2238.95
	Back Stop/ Forward Tilt	SZT-22-424EA	■	1431.00	1494.00	1561.20	1594.80	1620.00	1680.90	1735.50	1884.60	1987.50	2261.00

The following options require modification of the product number.

Soft casters	To specify, change the 11th digit from a 1 (hard caster) to a 2 (soft caster); Example: SZT-20-402EA2
Aluminum Base	To specify, change the 11th digit from a 5 to a 1 (hard caster) or 2 (soft caster) and add \$30.00 list
Low position pneumatic	To specify, change the 11th digit from a 1 to a 3 (hard caster) or from a 2 to a 4 (soft caster); Examples: SZT-20-402EA3 is a low base with hard casters SZT-20-402EA4 is a low base with soft casters NOTE: Polished aluminum trim not available with this option.
Fixed seat	To specify, change the 10th digit from A to X; Example: SZT-20-402EX1
Headrest	To specify, change the 3rd digit from a T to an E; Example: SZE-22-402EA1 with headrest (add \$54.60 list)
Nano-Tex	To specify, add P to end of the product number (add \$32.55 list).

NOTE: For available fabrics see matrix in the back of the book.

This page intentionally blank

Zody

Task Chair with Fixed Arms



SZT-20-102MA1

Dimensions*

*SH: 16-21"
(406mm-533mm)
H: 38-43"(965mm-1092mm)
D: 29"(737mm)
W: 29"(737mm)
*SW: 19 1/4"(489mm)
*AH: 9"(229mm)
*SD: 16-19"(406mm-483mm)
Low position seat height:
14-17"(356mm-432mm)

* All measurements taken with the BIFMA chair measuring device.

Features

- Back: Soft mesh only or mesh back with upholstered back jacket.
 - Seat: Standard upholstered with foam or optional foam with Technogel® Soft Lite gel insert.
 - Seat Type: Standard adjustable [3"(76mm) range] or optional fixed.
 - Base: Standard Plastic painted five-star base or optional painted aluminum or polished aluminum.
 - Plastic base available in Black, or painted Metallic silver, Metallic Champagne and Metallic Gunmetal.
 - Aluminum base available with painted Black, Metallic silver, Metallic Champagne, Metallic Gunmetal, or optional Polished Aluminum.
 - Arms: Fixed with soft arm caps.
 - Mechanism: Balanced 3-point tilt; standard tilt tension.
 - Height adjustment: Pneumatic or low-position pneumatic.
 - Optional Back Stop: Tilt stop in 6 positions.
 - Optional Forward Tilt: 5 degrees downward from initial position.
 - Optional Back Stop with Forward Tilt
 - Optional Asymmetrical Lumbar Adjustment: 4"(102mm) height adjustment; support level can be adjusted independently for right or left hand side of users body. Optional PAL Back System: Passive pelvic support.
 - Casters: Standard with hard casters; optional soft casters.
 - COM yardage / COL square footage:
 - Mesh back model: 0.75/20
 - Mesh back/upholstered back jacket: 1.5/40
- Available on RUSH.

NOTE: When specifying fabric or leather back jacket; must also specify mesh surface color for outside back.

For different fabric grades on seat and upholstered back jacket, pricing will be determined by the sum of the upcharges of the selected jacket fabric grades (i.e. when choosing a Grade B fabric for the seat and a Grade D for the back, the final price will reflect the upcharge for a Grade B seat plus the upcharge for a Grade D back jacket.)

To Order with Mesh Back Specify:

- 1) Product number, including:

1 Base/Caster Option:

Aluminum Base

- 1 Aluminum Base, Hard Caster, add **\$30.00** to list
- 2 Aluminum Base, Soft Caster, add **\$30.00** to list
- 3 Aluminum Low Base, Hard Caster, add **\$30.00** to list
- 4 Aluminum Low Base, Soft Caster, add **\$30.00** to list

Plastic Base

- 5 Plastic Std. Base, Hard Caster
 - 6 Plastic Std. Base, Soft Caster
- 2) Fabric surface and color (seat).
3) Mesh surface and color (back).
4) Trim color for frame/arm caps.
5) Trim color for base/arms.
(Add **\$175.35** for polished aluminum.)

To Order with Fabric or Leather Upholstered Back Jacket Specify:

- 1) Product number, including:

1 Base/Caster Option:

Aluminum Base

- 1 Aluminum Base, Hard Caster, add **\$30.00** to list
- 2 Aluminum Base, Soft Caster, add **\$30.00** to list
- 3 Aluminum Low Base, Hard Caster, add **\$30.00** to list
- 4 Aluminum Low Base, Soft Caster, add **\$30.00** to list

Plastic Base

- 5 Plastic Std. Base, Hard Caster
- 6 Plastic Std. Base, Soft Caster

- 2) Fabric surface and color (seat).
3) Mesh surface color (back).
4) Fabric surface and color (back jacket).
5) Trim color for frame/arm caps.
6) Trim color for base/arms.
(Add **\$175.35** for polished aluminum.)

Leather Seat with Mesh Back:

Change fourth digit in product number to **1**; fifth digit to **0**.

Example: SZT-10-102MA5

Leather Seat with Leather Upholstered Back Jacket:

Change fourth digit in product number to **1**; fifth digit to **1**.

Example: SZT-11-102MA5

Faux Leather Seat with Mesh Back:

Change the fourth digit in product number to **3**.

Example: SZT-30-102MA5

Faux Leather Seat with Faux Leather Upholstered Back Jacket:

Change the fourth and fifth digits in product number to **33**.

Example: SZT-33-102MA5

Zody
Task Chair with Fixed Arms

Upholstered Foam Seat	Adjustments	Number	①	Fabric Grade								Leather Grade A	Leather Grade B
				A	B	C	D	E	F	G	H		
No Lumbar Adjustment - Mesh Back w/Plastic Base													
	Pneumatic	SZT-20-102MA	■	\$ 959.55	\$ 991.05	\$1024.65	\$1041.45	\$1054.05	\$1084.50	\$1111.80	\$1186.35	\$1237.80	\$1374.55
	Back Stop	SZT-20-101MA	■	1029.90	1061.40	1095.00	1111.80	1124.40	1154.85	1182.15	1256.70	1308.15	1444.90
	Forward Tilt	SZT-20-103MA	■	1029.90	1061.40	1095.00	1111.80	1124.40	1154.85	1182.15	1256.70	1308.15	1444.90
	Back Stop/ Forward Tilt	SZT-20-104MA	■	1051.95	1083.45	1117.05	1133.85	1146.45	1176.90	1204.20	1278.75	1330.20	1466.95
No Lumbar Adjustment - Upholstered Back Jacket w/Plastic Base													
	Pneumatic	SZT-22-102MA	■	\$1063.50	\$1126.50	\$1193.70	\$1227.30	\$1252.50	\$1313.40	\$1368.00	\$1517.10	\$1620.00	\$1893.50
	Back Stop	SZT-22-101MA	■	1133.85	1196.85	1264.05	1297.65	1322.85	1383.75	1438.35	1587.45	1690.35	1963.85
	Forward Tilt	SZT-22-103MA	■	1133.85	1196.85	1264.05	1297.65	1322.85	1383.75	1438.35	1587.45	1690.35	1963.85
	Back Stop/ Forward Tilt	SZT-22-104MA	■	1155.90	1218.90	1286.10	1319.70	1344.90	1405.80	1460.40	1609.50	1712.40	1985.90
Lumbar Adjustment - Mesh Back w/Plastic Base													
	Pneumatic	SZT-20-112MA	■	\$1051.95	\$1083.45	\$1117.05	\$1133.85	\$1146.45	\$1176.90	\$1204.20	\$1278.75	\$1330.20	\$1466.95
	Back Stop	SZT-20-111MA	■	1122.30	1153.80	1187.40	1204.20	1216.80	1247.25	1274.55	1349.10	1400.55	1537.30
	Forward Tilt	SZT-20-113MA	■	1122.30	1153.80	1187.40	1204.20	1216.80	1247.25	1274.55	1349.10	1400.55	1537.30
	Back Stop/ Forward Tilt	SZT-20-114MA	■	1144.35	1175.85	1209.45	1226.25	1238.85	1269.30	1296.60	1371.15	1422.60	1559.35
Lumbar Adjustment - Upholstered Back Jacket w/Plastic Base													
	Pneumatic	SZT-22-112MA	■	\$1155.90	\$1218.90	\$1286.10	\$1319.70	\$1344.90	\$1405.80	\$1460.40	\$1609.50	\$1712.40	\$1985.90
	Back Stop	SZT-22-111MA	■	1226.25	1289.25	1356.45	1390.05	1415.25	1476.15	1530.75	1679.85	1782.75	2056.25
	Forward Tilt	SZT-22-113MA	■	1226.25	1289.25	1356.45	1390.05	1415.25	1476.15	1530.75	1679.85	1782.75	2056.25
	Back Stop/ Forward Tilt	SZT-22-114MA	■	1248.30	1311.30	1378.50	1412.10	1437.30	1498.20	1552.80	1701.90	1804.80	2078.30
PAL Back System - Mesh Back w/Plastic Base													
	Pneumatic	SZT-20-122MA	■	\$1076.10	\$1107.60	\$1141.20	\$1158.00	\$1170.60	\$1201.05	\$1228.35	\$1302.90	\$1354.35	\$1491.10
	Back Stop	SZT-20-121MA	■	1146.45	1177.95	1211.55	1228.35	1240.95	1271.40	1298.70	1373.25	1424.70	1561.45
	Forward Tilt	SZT-20-123MA	■	1146.45	1177.95	1211.55	1228.35	1240.95	1271.40	1298.70	1373.25	1424.70	1561.45
	Back Stop/ Forward Tilt	SZT-20-124MA	■	1168.50	1200.00	1233.60	1250.40	1263.00	1293.45	1320.75	1395.30	1446.75	1583.50
PAL Back System - Upholstered Back Jacket w/Plastic Base													
	Pneumatic	SZT-22-122MA	■	\$1180.05	\$1243.05	\$1310.25	\$1343.85	\$1369.05	\$1429.95	\$1484.55	\$1633.65	\$1736.55	\$2010.05
	Back Stop	SZT-22-121MA	■	1250.40	1313.40	1380.60	1414.20	1439.40	1500.30	1554.90	1704.00	1806.90	2080.40
	Forward Tilt	SZT-22-123MA	■	1250.40	1313.40	1380.60	1414.20	1439.40	1500.30	1554.90	1704.00	1806.90	2080.40
	Back Stop/ Forward Tilt	SZT-22-124MA	■	1272.45	1335.45	1402.65	1436.25	1461.45	1522.35	1576.95	1726.05	1828.95	2102.45

The following options require modification of the product number.

- Soft casters To specify, change the 11th digit from a 1 (hard caster) to a 2 (soft caster); **Example:** SZT-20-102MA2
- Aluminum Base To specify, change the 11th digit from a 5 to a 1 (hard caster) or 2 (soft caster) and add **\$30.00** list
- Low position pneumatic To specify, change the 11th digit from a 1 to a 3 (hard caster) or from a 2 to a 4 (soft caster);
Examples: SZT-20-102MA3 is a low base with hard casters
SZT-20-102MA4 is a low base with soft casters
- Fixed seat **NOTE:** Polished aluminum trim not available with this option.
- CAL 133 To specify, change the 10th digit from A to X; **Example:** SZT-20-102MX1
- Headrest To specify, add **F** to the end of the product number; **Example:** SZT-22-101MA1F (add **\$129.15** list)
- Nano-Tex To specify, change the 3rd digit from a T to an E; **Example:** SZE-22-102MA1 with headrest (add **\$54.60** list)

NOTE: CAL 133 is available on chairs with black frame and foam seat with or without the Lumbar option.
CAL 133 is not available on chairs with PAL back system.

For available fabrics see matrix in the back of the book or at Haworth.com/surfaces.

Zody

Task Chair with Fixed Arms

Upholstered Gel Insert Seat	Adjustments	Number	①	Fabric Grade								Leather Grade A	Leather Grade B
				A	B	C	D	E	F	G	H		
No Lumbar Adjustment - Mesh Back w/Plastic Base													
	Pneumatic	SZT-20-102EA	■	\$1046.70	\$1078.20	\$1111.80	\$1128.60	\$1141.20	\$1171.65	\$1198.95	\$1273.50	\$1324.95	\$1461.70
	Back Stop	SZT-20-101EA	■	1117.05	1148.55	1182.15	1198.95	1211.55	1242.00	1269.30	1343.85	1395.30	1532.05
	Forward Tilt	SZT-20-103EA	■	1117.05	1148.55	1182.15	1198.95	1211.55	1242.00	1269.30	1343.85	1395.30	1532.05
	Back Stop/ Forward Tilt	SZT-20-104EA	■	1139.10	1170.60	1204.20	1221.00	1233.60	1264.05	1291.35	1365.90	1417.35	1554.10
No Lumbar Adjustment - Upholstered Back Jacket w/Plastic Base													
	Pneumatic	SZT-22-102EA	■	\$1150.65	\$1213.65	\$1280.85	\$1314.45	\$1339.65	\$1400.55	\$1455.15	\$1604.25	\$1707.15	\$1980.65
	Back Stop	SZT-22-101EA	■	1221.00	1284.00	1351.20	1384.80	1410.00	1470.90	1525.50	1674.60	1777.50	2051.00
	Forward Tilt	SZT-22-103EA	■	1221.00	1284.00	1351.20	1384.80	1410.00	1470.90	1525.50	1674.60	1777.50	2051.00
	Back Stop/ Forward Tilt	SZT-22-104EA	■	1243.05	1306.05	1373.25	1406.85	1432.05	1492.95	1547.55	1696.65	1799.55	2073.05
Lumbar Adjustment - Mesh Back w/Plastic Base													
	Pneumatic	SZT-20-112EA	■	\$1139.10	\$1170.60	\$1204.20	\$1221.00	\$1233.60	\$1264.05	\$1291.35	\$1365.90	\$1417.35	\$1554.10
	Back Stop	SZT-20-111EA	■	1209.45	1240.95	1274.55	1291.35	1303.95	1334.40	1361.70	1436.25	1487.70	1624.45
	Forward Tilt	SZT-20-113EA	■	1209.45	1240.95	1274.55	1291.35	1303.95	1334.40	1361.70	1436.25	1487.70	1624.45
	Back Stop/ Forward Tilt	SZT-20-114EA	■	1231.50	1263.00	1296.60	1313.40	1326.00	1356.45	1383.75	1458.30	1509.75	1646.50
Lumbar Adjustment - Upholstered Back Jacket w/Plastic Base													
	Pneumatic	SZT-22-112EA	■	\$1243.05	\$1306.05	\$1373.25	\$1406.85	\$1432.05	\$1492.95	\$1547.55	\$1696.65	\$1799.55	\$2073.05
	Back Stop	SZT-22-111EA	■	1313.40	1376.40	1443.60	1477.20	1502.40	1563.30	1617.90	1767.00	1869.90	2143.40
	Forward Tilt	SZT-22-113EA	■	1313.40	1376.40	1443.60	1477.20	1502.40	1563.30	1617.90	1767.00	1869.90	2143.40
	Back Stop/ Forward Tilt	SZT-22-114EA	■	1335.45	1398.45	1465.65	1499.25	1524.45	1585.35	1639.95	1789.05	1891.95	2165.45
PAL Back System - Mesh Back w/Plastic Base													
	Pneumatic	SZT-20-122EA	■	\$1163.25	\$1194.75	\$1228.35	\$1245.15	\$1257.75	\$1288.20	\$1315.50	\$1390.05	\$1441.50	\$1578.25
	Back Stop	SZT-20-121EA	■	1233.60	1265.10	1298.70	1315.50	1328.10	1358.55	1385.85	1460.40	1511.85	1648.60
	Forward Tilt	SZT-20-123EA	■	1233.60	1265.10	1298.70	1315.50	1328.10	1358.55	1385.85	1460.40	1511.85	1648.60
	Back Stop/ Forward Tilt	SZT-20-124EA	■	1255.65	1287.15	1320.75	1337.55	1350.15	1380.60	1407.90	1482.45	1533.90	1670.65
PAL Back System - Upholstered Back Jacket w/Plastic Base													
	Pneumatic	SZT-22-122EA	■	\$1267.20	\$1330.20	\$1397.40	\$1431.00	\$1456.20	\$1517.10	\$1571.70	\$1720.80	\$1823.70	\$2097.20
	Back Stop	SZT-22-121EA	■	1337.55	1400.55	1467.75	1501.35	1526.55	1587.45	1642.05	1791.15	1894.05	2167.55
	Forward Tilt	SZT-22-123EA	■	1337.55	1400.55	1467.75	1501.35	1526.55	1587.45	1642.05	1791.15	1894.05	2167.55
	Back Stop/ Forward Tilt	SZT-22-124EA	■	1359.60	1422.60	1489.80	1523.40	1548.60	1609.50	1664.10	1813.20	1916.10	2189.60

The following options require modification of the product number.

Soft casters	To specify, change the 11th digit from a 1 (hard caster) to a 2 (soft caster); Example: SZT-20-102EA2
Aluminum Base	To specify, change the 11th digit from a 5 to a 1 (hard caster) or 2 (soft caster) and add \$30.00 list
Low position pneumatic	To specify, change the 11th digit from a 1 to a 3 (hard caster) or from a 2 to a 4 (soft caster); Examples: SZT-20-102EA3 is a low base with hard casters SZT-20-102EA4 is a low base with soft casters NOTE: Polished aluminum trim not available with this option.
Fixed seat	To specify, change the 10th digit from A to X; Example: SZT-20-102EX1
Headrest	To specify, change the 3rd digit from a T to an E; Example: SZE-22-102EA1 with headrest (add \$54.60 list)
Nano-TEX	To specify, add P to end of the product number (add \$32.55 list).
	For available fabrics see matrix in the back of the book.

This page intentionally blank

Zody

Task Chair without Arms



SZT-20-002MA1

Dimensions*

*SH: 16-21"
(406mm-533mm)
H: 38-43"(965mm-1092mm)
D: 29"(737mm)
W: 29"(737mm)
*SW: 19 1/4"(489mm)
*SD: 16-19"(406mm-483mm)

Low position seat height:
14-17"(356mm-432mm)

* All measurements taken with the BIFMA chair measuring device.

Features

- Back: Soft mesh only or mesh back with upholstered back jacket.
 - Seat: Standard upholstered with foam or optional foam with Technogel® Soft Lite gel insert.
 - Seat Type: Standard adjustable [3"(76mm) range] or optional fixed.
 - Base: Standard Plastic painted five-star base or optional painted aluminum or polished aluminum.
 - Plastic base available in Black, or painted Metallic silver, Metallic Champagne and Metallic Gunmetal.
 - Aluminum base available with painted Black, Metallic silver, Metallic Champagne, Metallic Gunmetal, or optional Polished Aluminum.
 - Mechanism: Balanced 3-point tilt; standard tilt tension.
 - Height adjustment: Pneumatic or low-position pneumatic.
 - Optional Back Stop: Tilt stop in 6 positions.
 - Optional Forward Tilt: 5 degrees downward from initial position.
 - Optional Back Stop with Forward Tilt
 - Optional Asymmetrical Lumbar Adjustment: 4"(102mm) height adjustment; support level can be adjusted independently for right or left hand side of users body. Optional PAL Back System: Passive pelvic support
 - Casters: Standard with hard casters; optional soft casters.
 - COM yardage / COL square footage:
 - Mesh back model: 0.75/20
 - Mesh back/upholstered back jacket: 1.5/40
- Available on RUSH.

NOTE: When specifying fabric or leather back jacket; must also specify mesh surface color for outside back.

For different fabric grades on seat and upholstered back jacket, pricing will be determined by the sum of the upcharges of the selected jacket fabric grades (i.e. when choosing a Grade B fabric for the seat and a Grade D for the back, the final price will reflect the upcharge for a Grade B seat plus the upcharge for a Grade D back jacket.)

To Order with Mesh Back Specify:

1) Product number, including:

1 Base/Caster Option:

Aluminum Base

- 1 Aluminum Base, Hard Caster, add **\$30.00** to list
- 2 Aluminum Base, Soft Caster, add **\$30.00** to list
- 3 Aluminum Low Base, Hard Caster, add **\$30.00** to list
- 4 Aluminum Low Base, Soft Caster, add **\$30.00** to list

Plastic Base

- 5 Plastic Std. Base, Hard Caster
 - 6 Plastic Std. Base, Soft Caster
- 2 Fabric surface and color (seat).
 - 3 Mesh surface and color (back).
 - 4 Trim color for frame.
 - 5 Trim color for base.
(Add **\$175.35** for polished aluminum.)

To Order with Fabric or Leather Upholstered Back Jacket Specify:

1) Product number, including:

1 Base/Caster Option:

Aluminum Base

- 1 Aluminum Base, Hard Caster, add **\$30.00** to list
- 2 Aluminum Base, Soft Caster, add **\$30.00** to list
- 3 Aluminum Low Base, Hard Caster, add **\$30.00** to list
- 4 Aluminum Low Base, Soft Caster, add **\$30.00** to list

Plastic Base

- 5 Plastic Std. Base, Hard Caster
- 6 Plastic Std. Base, Soft Caster

- 2 Fabric surface and color (seat).
- 3 Mesh surface color (back).
- 4 Fabric surface and color (back jacket).
- 5 Trim color for frame.
- 6 Trim color for base.
(Add **\$175.35** for polished aluminum.)

Leather Seat with Mesh Back:

Change fourth digit in product number to **1**; fifth digit to **0**.

Example: SZT-10-002MA5

Leather Seat with Leather Upholstery Back Jacket:

Change fourth digit in product number to **1**; fifth digit to **1**.

Example: SZT-11-002MA5

Faux Leather Seat with Mesh Back:

Change the fourth digit in product number to **3**.

Example: SZT-10-002MA5

Faux Leather Seat with Faux Leather Upholstery Back Jacket:

Change the fourth and fifth digits in product number to **33**.

Example: SZT-33-002MA5

Zody
Task Chair without Arms

Upholstered Foam Seat	Adjustments	Number	①	Fabric Grade								Leather Grade A	Leather Grade B
				A	B	C	D	E	F	G	H		
No Lumbar Adjustment - Mesh Back w/Plastic Base													
	Pneumatic	SZT-20-002MA	■	\$ 843.00	\$ 874.50	\$ 908.10	\$ 924.90	\$ 937.50	\$ 967.95	\$ 995.25	\$1069.80	\$1121.25	\$1258.00
	Back Stop	SZT-20-001MA	■	913.35	944.85	978.45	995.25	1007.85	1038.30	1065.60	1140.15	1191.60	1328.35
	Forward Tilt	SZT-20-003MA	■	913.35	944.85	978.45	995.25	1007.85	1038.30	1065.60	1140.15	1191.60	1328.35
	Back Stop/ Forward Tilt	SZT-20-004MA	■	935.40	966.90	1000.50	1017.30	1029.90	1060.35	1087.65	1162.20	1213.65	1350.40
No Lumbar Adjustment - Upholstered Back Jacket w/Plastic Base													
	Pneumatic	SZT-22-002MA	■	\$ 946.95	\$1009.95	\$1077.15	\$1110.75	\$1135.95	\$1196.85	\$1251.45	\$1400.55	\$1503.45	\$1776.95
	Back Stop	SZT-22-001MA	■	1017.30	1080.30	1147.50	1181.10	1206.30	1267.20	1321.80	1470.90	1573.80	1847.30
	Forward Tilt	SZT-22-003MA	■	1017.30	1080.30	1147.50	1181.10	1206.30	1267.20	1321.80	1470.90	1573.80	1847.30
	Back Stop/ Forward Tilt	SZT-22-004MA	■	1039.35	1102.35	1169.55	1203.15	1228.35	1289.25	1343.85	1492.95	1595.85	1869.35
Lumbar Adjustment - Mesh Back w/Plastic Base													
	Pneumatic	SZT-20-012MA	■	\$ 935.40	\$ 966.90	\$1000.50	\$1017.30	\$1029.90	\$1060.35	\$1087.65	\$1162.20	\$1213.65	\$1350.40
	Back Stop	SZT-20-011MA	■	1005.75	1037.25	1070.85	1087.65	1100.25	1130.70	1158.00	1232.55	1284.00	1420.75
	Forward Tilt	SZT-20-013MA	■	1005.75	1037.25	1070.85	1087.65	1100.25	1130.70	1158.00	1232.55	1284.00	1420.75
	Back Stop/ Forward Tilt	SZT-20-014MA	■	1027.80	1059.30	1092.90	1109.70	1122.30	1152.75	1180.05	1254.60	1306.05	1442.80
Lumbar Adjustment - Upholstered Back Jacket w/Plastic Base													
	Pneumatic	SZT-22-012MA	■	\$1039.35	\$1102.35	\$1169.55	\$1203.15	\$1228.35	\$1289.25	\$1343.85	\$1492.95	\$1595.85	\$1869.35
	Back Stop	SZT-22-011MA	■	1109.70	1172.70	1239.90	1273.50	1298.70	1359.60	1414.20	1563.30	1666.20	1939.70
	Forward Tilt	SZT-22-013MA	■	1109.70	1172.70	1239.90	1273.50	1298.70	1359.60	1414.20	1563.30	1666.20	1939.70
	Back Stop/ Forward Tilt	SZT-22-014MA	■	1131.75	1194.75	1261.95	1295.55	1320.75	1381.65	1436.25	1585.35	1688.25	1961.75
PAL Back System - Mesh Back w/Plastic Base													
	Pneumatic	SZT-20-022MA	■	\$ 959.55	\$ 991.05	\$1024.65	\$1041.45	\$1054.05	\$1084.50	\$1111.80	\$1186.35	\$1237.80	\$1374.55
	Back Stop	SZT-20-021MA	■	1029.90	1061.40	1095.00	1111.80	1124.40	1154.85	1182.15	1256.70	1308.15	1444.90
	Forward Tilt	SZT-20-023MA	■	1029.90	1061.40	1095.00	1111.80	1124.40	1154.85	1182.15	1256.70	1308.15	1444.90
	Back Stop/ Forward Tilt	SZT-20-024MA	■	1051.95	1083.45	1117.05	1133.85	1146.45	1176.90	1204.20	1278.75	1330.20	1466.95
PAL Back System - Upholstered Back Jacket w/Plastic Base													
	Pneumatic	SZT-22-022MA	■	\$1063.50	\$1126.50	\$1193.70	\$1227.30	\$1252.50	\$1313.40	\$1368.00	\$1517.10	\$1620.00	\$1893.50
	Back Stop	SZT-22-021MA	■	1133.85	1196.85	1264.05	1297.65	1322.85	1383.75	1438.35	1587.45	1690.35	1963.85
	Forward Tilt	SZT-22-023MA	■	1133.85	1196.85	1264.05	1297.65	1322.85	1383.75	1438.35	1587.45	1690.35	1963.85
	Back Stop/ Forward Tilt	SZT-22-024MA	■	1155.90	1218.90	1286.10	1319.70	1344.90	1405.80	1460.40	1609.50	1712.40	1985.90

The following options require modification of the product number.

- Soft casters To specify, change the 11th digit from a 1 (hard caster) to a 2 (soft caster); **Example:** SZT-20-002MA2
- Aluminum Base To specify, change the 11th digit from a 5 to a 1 (hard caster) or 2 (soft caster) and add **\$30.00** list
- Low position pneumatic To specify, change the 11th digit from a 1 to a 3 (hard caster) or from a 2 to a 4 (soft caster);
Examples: SZT-20-002MA3 is a low base with hard casters
SZT-20-002MA4 is a low base with soft casters
NOTE: Polished aluminum trim not available with this option.
- Fixed seat To specify, change the 10th digit from A to X; **Example:** SZT-20-002MX1
- CAL 133 To specify, add **F** to the end of the product number; **Example:** SZT-20-002MA1F (add **\$129.15** list)
- Headrest To specify, change the 3rd digit from a T to an E; **Example:** SZE-22-002MA1 with headrest (add **\$54.60** list)
- Nano-Tex To specify, add **P** to end of the product number (add **\$32.55** list).

NOTE: CAL 133 is available on chairs with black frame and foam seat with or without the Lumbar option.
CAL 133 is not available on chairs with PAL back system.

For available fabrics see matrix in the back of the book or at Haworth.com/surfaces.

Zody

Task Chair without Arms

Upholstered Gel Insert Seat	Adjustments	Number	①	Fabric Grade								Leather Grade A	Leather Grade B
				A	B	C	D	E	F	G	H		
No Lumbar Adjustment - Mesh Back w/Plastic Base													
Pneumatic		SZT-20-002EA	■	\$ 930.15	\$ 961.65	\$ 995.25	\$1012.05	\$1024.65	\$1055.10	\$1082.40	\$1156.95	\$1208.40	\$1345.15
Back Stop		SZT-20-001EA	■	1000.50	1032.00	1065.60	1082.40	1095.00	1125.45	1152.75	1227.30	1278.75	1415.50
Forward Tilt		SZT-20-003EA	■	1000.50	1032.00	1065.60	1082.40	1095.00	1125.45	1152.75	1227.30	1278.75	1415.50
Back Stop/ Forward Tilt		SZT-20-004EA	■	1022.55	1054.05	1087.65	1104.45	1117.05	1147.50	1174.80	1249.35	1300.80	1437.55
No Lumbar Adjustment - Upholstered Back Jacket w/Plastic Base													
Pneumatic		SZT-22-002EA	■	\$1034.10	\$1097.10	\$1164.30	\$1197.90	\$1223.10	\$1284.00	\$1338.60	\$1487.70	\$1590.60	\$1864.10
Back Stop		SZT-22-001EA	■	1104.45	1167.45	1234.65	1268.25	1293.45	1354.35	1408.95	1558.05	1660.95	1934.45
Forward Tilt		SZT-22-003EA	■	1104.45	1167.45	1234.65	1268.25	1293.45	1354.35	1408.95	1558.05	1660.95	1934.45
Back Stop/ Forward Tilt		SZT-22-004EA	■	1126.50	1189.50	1256.70	1290.30	1315.50	1376.40	1431.00	1580.10	1683.00	1956.50
Lumbar Adjustment - Mesh Back w/Plastic Base													
Pneumatic		SZT-20-012EA	■	\$1022.55	\$1054.05	\$1087.65	\$1104.45	\$1117.05	\$1147.50	\$1174.80	\$1249.35	\$1300.80	\$1437.55
Back Stop		SZT-20-011EA	■	1092.90	1124.40	1158.00	1174.80	1187.40	1217.85	1245.15	1319.70	1371.15	1507.90
Forward Tilt		SZT-20-013EA	■	1092.90	1124.40	1158.00	1174.80	1187.40	1217.85	1245.15	1319.70	1371.15	1507.90
Back Stop/ Forward Tilt		SZT-20-014EA	■	1114.95	1146.45	1180.05	1196.85	1209.45	1239.90	1267.20	1341.75	1393.20	1529.95
Lumbar Adjustment - Upholstered Back Jacket w/Plastic Base													
Pneumatic		SZT-22-012EA	■	\$1126.50	\$1189.50	\$1256.70	\$1290.30	\$1315.50	\$1376.40	\$1431.00	\$1580.10	\$1683.00	\$1956.50
Back Stop		SZT-22-011EA	■	1196.85	1259.85	1327.05	1360.65	1385.85	1446.75	1501.35	1650.45	1753.35	2026.85
Forward Tilt		SZT-22-013EA	■	1196.85	1259.85	1327.05	1360.65	1385.85	1446.75	1501.35	1650.45	1753.35	2026.85
Back Stop/ Forward Tilt		SZT-22-014EA	■	1218.90	1281.90	1349.10	1382.70	1407.90	1468.80	1523.40	1672.50	1775.40	2048.90
PAL Back System - Mesh Back w/Plastic Base													
Pneumatic		SZT-20-022EA	■	\$1046.70	\$1078.20	\$1111.80	\$1128.60	\$1141.20	\$1171.65	\$1198.95	\$1273.50	\$1324.95	\$1461.70
Back Stop		SZT-20-021EA	■	1117.05	1148.55	1182.15	1198.95	1211.55	1242.00	1269.30	1343.85	1395.30	1532.05
Forward Tilt		SZT-20-023EA	■	1117.05	1148.55	1182.15	1198.95	1211.55	1242.00	1269.30	1343.85	1395.30	1532.05
Back Stop/ Forward Tilt		SZT-20-024EA	■	1139.10	1170.60	1204.20	1221.00	1233.60	1264.05	1291.35	1365.90	1417.35	1554.10
PAL Back System - Upholstered Back Jacket w/Plastic Base													
Pneumatic		SZT-22-022EA	■	\$1150.65	\$1213.65	\$1280.85	\$1314.45	\$1339.65	\$1400.55	\$1455.15	\$1604.25	\$1707.15	\$1980.65
Back Stop		SZT-22-021EA	■	1221.00	1284.00	1351.20	1384.80	1410.00	1470.90	1525.50	1674.60	1777.50	2051.00
Forward Tilt		SZT-22-023EA	■	1221.00	1284.00	1351.20	1384.80	1410.00	1470.90	1525.50	1674.60	1777.50	2051.00
Back Stop/ Forward Tilt		SZT-22-024EA	■	1243.05	1306.05	1373.25	1406.85	1432.05	1492.95	1547.55	1696.65	1799.55	2073.05

The following options require modification of the product number.

Soft casters	To specify, change the 11th digit from a 1 (hard caster) to a 2 (soft caster); Example: SZT-20-002EA2
Aluminum Base	To specify, change the 11th digit from a 5 to a 1 (hard caster) or 2 (soft caster) and add \$30.00 list
Low position pneumatic	To specify, change the 11th digit from a 1 to a 3 (hard caster) or from a 2 to a 4 (soft caster); Examples: SZT-20-002EA3 is a low base with hard casters SZT-20-002EA4 is a low base with soft casters NOTE: Polished aluminum trim not available with this option.
Fixed seat	To specify, change the 10th digit from A to X; Example: SZT-20-002EX1
Headrest	To specify, change the 3rd digit from a T to an E; Example: SZE-22-002EA1 with headrest (add \$54.60 list)
Nano-TEX	To specify, add P to end of the product number (add \$32.55 list).
	For available fabrics see matrix in the back of the book.

Zody

Sled Base



SZG-22-1

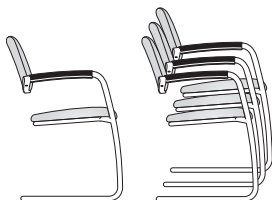

Dimensions*

- *SH: 18" (457mm)
- H: 32.5" (826mm)
- D: 22.1" (501mm)
- W: 21" (533mm)
- *SW: 16.8" (427mm)
- *SD: 17" (432mm)
- *AH: 26" (660mm)

* All measurements taken with the BIFMA chair measuring device.

Features

- Back: Upholstered or Wood (Beech)
Fully cantilevered
- Seat: Upholstered
- Base: Sled
- Glide options: Plastic (S) or Felt (J)
(Felt glides for use on hard floors. Glides are retrofittable. See e-Parts.)
- Felt glides are black color.
- Optional Trivalent chrome frame
- Stacking: 4-high
- COM Yardage / COL square footage
Back: 0.75/15.2
Seat: 0.75/15.2
- Available on RUSH.

To Order, Specify:

- 1) Product number, including:
 - ❶ **Sled Base Glides:**
 - S** Plastic
 - J** Felt
- 2) Seat surface and color
- 3) Back surface and color
- 4) Arm cap trim color
- 5) Base trim color
Trivalent chrome (KR-V)
add **\$175.35** list

Seat	Back	Number ❶	Fabric Grade								Leather Grade A	Leather Grade B		
			A	B	C	D	E	F	G	H				
Fabric	Fabric	SZG-22-1	■	■	\$718.20	\$777.00	\$844.20	\$877.80	\$903.00	\$961.80	\$1016.40	\$1167.60	N/A	N/A
Fabric	Wood	SZG-2W-1	■	■	\$806.40	\$835.80	\$869.40	\$886.20	\$898.80	\$928.20	\$ 955.50	\$1031.10	N/A	N/A
Leather	Leather	SZG-11-1	■	■	N/A	N/A	N/A	N/A	N/A	N/A	N/A	N/A	\$1270.50	\$1542.00
Leather	Wood	SZG-1W-1	■	■	N/A	N/A	N/A	N/A	N/A	N/A	N/A	N/A	\$1082.55	\$1128.40

The following options require modification of the product number.

- CAL 133
- Nano-Tex
- DuraBlock™

To specify, add **F** to the end of the product number; **Example:** SZG-22-1SF (add **\$48.30** list)
 To specify, add **P** to end of the product number (add **\$32.55** list).
 To specify, add **D** to end of the product number (add **\$44.10** list).

NOTE: For different fabric grades on seat and back, pricing will be determined by the sum of the upcharges of the selected fabric grades (i.e. when choosing a Grade B fabric for the seat and a Grade D for the back, the final price will reflect the upcharge for a Grade B seat plus the upcharge for a Grade D back).

For available fabrics see matrix in the back of the book or at Haworth.com/surfaces.

Zody

4 Leg



SZG-22-1



Dimensions*

- *SH: 18" (457mm)
- H: 32.5" (826mm)
- D: 22.13" (562mm)
- W: 21" (533mm)
- *SW: 16.4" (417mm)
- *SD: 17" (432mm)
- *AH: 26" (660mm)

* All measurements taken with the BIFMA chair measuring device.

Features

- Back: Upholstered or Wood (Beech)
Fully cantilevered
- Seat: Upholstered
- Base: 4 Legs
- Optional Glide: Plastic (H) or Felt (K)
(Felt glides for use on hard floors. Glides are retrofittable. See e-Parts.)
- Felt glides are black color.
- Optional Trivalent chrome frame
- Stacking: 6-high
- COM Yardage / COL square footage
Back: 0.75/15.2
Seat: 0.75/15.2
- Available on RUSH.

To Order, Specify:

- 1) Product number, including:
 - ❶ **Leg Base Glides:**
 - H Plastic
 - K Felt
- 2) Seat surface and color
- 3) Back surface and color
- 4) Arm cap trim color
- 5) Base trim color
Trivalent chrome (KR-V)
add \$175.35 list

Seat	Back	Number	❶	Fabric Grade								Leather Grade A	Leather Grade B
				A	B	C	D	E	F	G	H		
Fabric	Fabric	SZG-22-1	■	\$601.65	\$660.45	\$727.65	\$761.25	\$786.45	\$845.25	\$899.85	\$1051.05	N/A	N/A
Fabric	Wood	SZG-2W-1	■	\$689.85	\$719.25	\$752.85	\$769.65	\$782.25	\$811.65	\$838.95	\$ 914.55	N/A	N/A
Leather	Leather	SZG-11-1	■	N/A	N/A	N/A	N/A	N/A	N/A	N/A	N/A	\$1153.95	\$1425.65
Leather	Wood	SZG-1W-1	■	N/A	N/A	N/A	N/A	N/A	N/A	N/A	N/A	\$ 966.00	\$1101.85

The following options require modification of the product number.

- CAL 133
- Nano-Tex
- DuraBlock

To specify, add **F** to the end of the product number; **Example:** SZG-22-1HF (add \$48.30 list)

To specify, add **P** to end of the product number (add \$32.55 list).

To specify, add **D** to end of the product number (add \$44.10 list).

NOTE: For different fabric grades on seat and back, pricing will be determined by the sum of the upcharges of the selected fabric grades (i.e. when choosing a Grade B fabric for the seat and a Grade D for the back, the final price will reflect the upcharge for a Grade B seat plus the upcharge for a Grade D back).

For available fabrics see matrix in the back of the book or at Haworth.com/surfaces.

Very Wire Stacker

General Specifications

Features and Options (Wire Stacker and Wire Stool)

Wire Stacker Chair

- 11mm solid steel rod frame
- Single piece high-strength polymer shell seat and back
- Clear nylon glides
- Frame finishes include: painted or Trivalent chrome
- Optional upholstered foam pad on seat or seat and back
- Fog or black trim arm caps
- Arm or armless version available
- Stacks 10-high on the floor, upholstered or non-upholstered, arm or armless; stacks 40-high non-upholstered, arm or armless on a cart; stacks 25-high upholstered, arm or armless on a cart.
- Seat: Stitched double seams. Vertically in the center and on the edges of the leather and faux leather seat cushion. FOR the WIRE STACKER only.
- Ganging option: arm chair to armless, armless to armless.
- Chairs with arms: 16 lbs.
- Chairs without arms: 15 lbs.

Wire Stacker Stool

- Chrome frame
- Stacks 10-high on the floor.
- Single piece high-strength polymer shell seat and back
- Clear nylon glides
- Fog or black trim arm caps
- Arm or armless version available

General Guidelines for Product Specification

	<u>S</u>	<u>C</u>	<u>H - 2</u>	<u>2 - 3</u>	<u>S</u>	<u>3A-18</u>	<u>3A-18</u>	<u>TR-FA</u>	<u>TR-F</u>	<u>KR-V</u>
Product Type	_____									
(S) Seating	_____									
Product Line	_____									
(C) Very	_____									
Model	_____									
(H) Wire Stack	_____									
(W) Stool	_____									
Seat Upholstery	_____									
(1) Leather	_____									
(2) Fabric	_____									
(3) Faux Leather	_____									
(4) Polymer	_____									
Back Upholstery	_____									
(1) Leather	_____									
(2) Fabric	_____									
(3) Faux Leather	_____									
(4) Polymer	_____									
Arm/Caps	_____									
(0) No Arms	_____									
(3) Fixed Arms, Hard Caps	_____									
Base Frame	_____									
(9) Plastic Glide, Ganging*	_____									
(S) Plastic Glide, Non-ganging*	_____									
Seat Upholstery	_____									
Tellure	_____									
Back Upholstery	_____									
Tellure	_____									
Shell Color	_____									
Tomato	_____									
Trim Color	_____									
Black	_____									
Frame Trim Color	_____									
Trivalent Chrome	_____									

*Wire Stacker Chair only

Very

Wire Stacker

With Arms

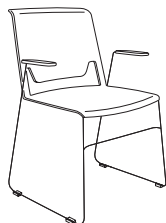

SCH-44-3S

Dimensions

- SH: 17.3"(440mm)*
- H: 30.6"(778mm)
- D: 23.3"(591mm)
- W: 23"(584mm)
- SW: 18.8"(476mm)*
- SD: 17.3"(439mm)*
- AH: 8.5"(216mm)*
- Between Arms:
19.2"(487mm)

* All measurements taken with the BIFMA chair measuring device.

Features

- 11 mm steel rod frame.
 - Single high-strength polymer shell seat and back with an optional upholstery pad.
 - Upholstered seat features 0.5"(12.7mm) foam pad.
 - Upholstered back features 0.5"(12.7mm) foam pad.
 - Arms: Black or Fog glass-filled polypropylene arm caps.
 - Frame: Available painted or trivalent chrome.
 - High impact clear nylon glides available with or without ganging option.
 - Stacks 10-high on the floor, upholstered or non-upholstered, arm or armless; stacks 40-high non-upholstered, arm or armless on a cart; stacks 25-high upholstered, arm or armless on a cart.
 - Ganging option: Arm to armless or armless to armless.
 - COM yardage / COL square footage:
Fully Upholstered: 1.5/17.0
Upholstered seat: 0.8/10.6
- Available on RUSH.

To Order, Specify:

1) Product number, including;

1 Seat or Seat Pad Option:

- 1 Leather
- 2 Fabric
- 3 Faux Leather
- 4 Polymer

2 Back or Back Pad Option:

- 1 Leather
- 2 Fabric
- 3 Faux Leather
- 4 Polymer

- 2) Fabric surface and color (seat).
- 3) Fabric surface and color (back).
- 4) Shell color - required for upholstered and non-upholstered.
- 5) Trim for arm caps and plastic components.
- 6) Frame trim color.

Ganging	Number 1 2	Price	Fabric Grade		C	D	E	F	G	H	Leather Grade A	Leather Grade B
			A	B								
Polymer Shell Without Optional Upholstered Pad												
Non-Ganging	SCH- 4 4 -3S	\$246.48	N/A	N/A	N/A	N/A	N/A	N/A	N/A	N/A	N/A	N/A
Ganging Glide	SCH- 4 4 -39	255.84	N/A	N/A	N/A	N/A	N/A	N/A	N/A	N/A	N/A	N/A
Polymer Shell With Upholstered Seat Pad												
Non-Ganging	SCH- 4 -3S	N/A	\$295.36	\$325.52	\$357.76	\$372.32	\$385.84	\$412.88	\$438.88	\$507.52	\$434.72	\$559.36
Ganging Glide	SCH- 4 -39	N/A	304.72	334.88	367.12	381.68	395.20	422.24	448.24	516.88	444.08	568.72
Polymer Shell With Upholstered Seat and Back Pads												
Non-Ganging	SCH- -3S	N/A	\$354.64	\$414.96	\$479.44	\$508.56	\$535.60	\$589.68	\$641.68	\$778.96	\$633.36	\$882.64
Ganging Glide	SCH- -39	N/A	364.00	424.32	488.80	517.92	544.96	599.04	651.04	788.32	642.72	892.00

The following options require modification of the product number.

CAL 133
Nano-TEX

To specify, add **F** to the end of the product number; **Example:** SCH-22-3SF (add \$59.28 list)
To specify, add **P** to end of the product number (add \$32.24 list).

NOTE: CAL 133 is available on SCH-22 or SCH-33 fully upholstered fabric or faux leather models only.

Nano-TEX is available on SCH-22, SCH-24, and SCH-25 models only.

For available fabrics see matrix in the back of the book or at Haworth.com/surfaces.

Very

Wire Stacker

Without Arms

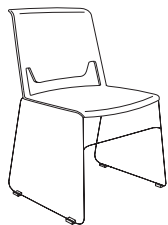

SCH-44-0S

Dimensions

SH: 17.3"(440mm)*
H: 30.6"(778mm)
D: 23.3"(591mm)
W: 21.8"(554mm)
SW: 18.8"(476mm)*
SD: 17.3"(439mm)*

* All measurements taken with the BIFMA chair measuring device.

Features

- 11 mm steel rod frame.
- Single piece high-strength polymer shell seat and back with an optional upholstery pad.
- Upholstered seat features 0.5"(12.7mm) foam pad.
- Upholstered back features 0.5"(12.7mm) foam pad.
- Frame: Available painted or trivalent chrome.
- High impact clear nylon glides available with or without ganging option.
- Stacks 10-high on the floor, upholstered or non-upholstered, arm or armless; stacks 40-high non-upholstered, arm or armless on a cart; stacks 25-high upholstered, arm or armless on a cart.
- Ganging option: Arm to armless or armless to armless.
- COM yardage / COL square footage:
Fully Upholstered: 1.5/17.0
Upholstered seat: 0.8/10.6
- Available on RUSH.

To Order, Specify:

- 1) Product number, including;
 - 1** Seat or Seat Pad Option:
 - 1 Leather
 - 2 Fabric
 - 3 Faux Leather
 - 4 Polymer
 - 2** Back or Back Pad Option:
 - 1 Leather
 - 2 Fabric
 - 3 Faux Leather
 - 4 Polymer
- 2) Fabric surface and color (seat).
- 3) Fabric surface and color (back).
- 4) Shell color - required for upholstered and non-upholstered.
- 5) Frame trim color.

Ganging	Number ①②	Price	Fabric Grade		C	D	E	F	G	H	Leather Grade A	Leather Grade B
			A	B								
Polymer Shell Without Optional Upholstered Pad												
Non-Ganging	SCH- 4 4 -0S ■	\$192.40	N/A	N/A	N/A	N/A	N/A	N/A	N/A	N/A	N/A	N/A
Ganging Glide	SCH- 4 4 -09	201.76	N/A	N/A	N/A	N/A	N/A	N/A	N/A	N/A	N/A	N/A
Polymer Shell With Upholstered Seat Pad												
Non-Ganging	SCH- ■ 4 -0S ■	N/A	\$241.28	\$271.44	\$303.68	\$318.24	\$331.76	\$358.80	\$384.80	\$453.44	\$380.64	\$505.28
Ganging Glide	SCH- ■ 4 -09	N/A	250.64	280.80	313.04	327.60	341.12	368.16	394.16	462.80	390.00	514.64
Polymer Shell With Upholstered Seat and Back Pads												
Non-Ganging	SCH- ■ ■ -0S	N/A	\$300.56	\$360.88	\$425.36	\$454.48	\$481.52	\$535.60	\$587.60	\$724.88	\$579.28	\$828.56
Ganging Glide	SCH- ■ ■ -09	N/A	309.92	370.24	434.72	463.84	490.88	544.96	596.96	734.24	588.64	837.92

The following options require modification of the product number.

CAL 133
Nano-TEX

To specify, add **F** to the end of the product number; **Example:** SCH-22-0SF (add \$59.28 list)
To specify, add **P** to end of the product number (add \$32.24 list).

NOTE: CAL 133 is available on SCH-22 or SCH-33 full upholstered fabric or faux leather models only.
Nano-TEX is available on SCH-22, SCH-24, and SCH-25 models only
For available fabrics see matrix in the back of the book or at Haworth.com/surfaces.

Very

Wire Stool

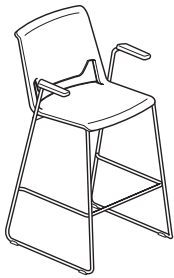

SCW-44-3S

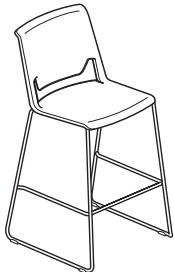

SCW-44-0S

Dimensions

SH: 29.75"(756mm)
 H: 43"(1092mm)
 W: 23"(587mm)
 D: 23"(587mm)
 SW: 18.68"(475mm)
 SD: 17.3"(439mm)

Between Arms:
 19.2"(488mm)

Features

- 11 mm steel rod frame.
- Single piece high -strength polymer shell seat and back with an optional upholstery pad.
- 10 shell color options.
- Upholstered seat features 0.5"(12.7mm) foam pad.
- Upholstered back features 0.5"(12.7mm) foam pad.
- Arms: Black or Fog glass-filled polypropylene arm caps.
- Base: trivalent chrome.
- High impact clear nylon glides.
- Stacks 10 high on the floor.
- Upholstered option.
- 29.75"(756mm) seated height. The foot rest is 11.84"(300.7mm) from the floor.
- COM yardage / COL square footage:
 Fully Upholstered: 1.5/12.5
 Upholstered seat: .8/7.5

To Order, Specify:

1) Product number.

1 Seat or Seat Pad Option:

- 1 Leather
- 2 Fabric
- 3 Faux Leather
- 4 Polymer

2 Back or Back Pad Option:

- 1 Leather
- 2 Fabric
- 3 Faux Leather
- 4 Polymer

- 2) Fabric surface and color (seat).
- 3) Fabric surface and color (back).
- 4) Shell color - required for upholstered and non-upholstered.
- 5) Trim for arm caps (if specified).
- 6) Frame trim color (KR-V only).

Nano-Text Upholstery:

Add a **P** to the end of the catalog code, and add \$32.24 list.

Example: SCW-22-3SP

Description	Number ①②	Price	Fabric Grade								Leather Grade A	Leather Grade B	
			A	B	C	D	E	F	G	H			
Polymer Shell Without Optional Upholstered Pad													
With Arms	SCW- 44 -3S	\$418.08	N/A	N/A	N/A	N/A	N/A	N/A	N/A	N/A	N/A	N/A	N/A
Without Arms	SCW- 44 -0S	364.00	N/A	N/A	N/A	N/A	N/A	N/A	N/A	N/A	N/A	N/A	N/A
Polymer Shell With Upholstered Seat Pad													
With Arms	SCW- 4 -3S	N/A	\$466.96	\$497.12	\$529.36	\$543.92	\$557.44	\$584.48	\$610.48	\$679.12	\$606.32	\$ 730.96	
Without Arms	SCW- 4 -0S	N/A	412.88	443.04	475.28	489.84	503.36	530.40	556.40	625.04	552.24	676.88	
Polymer Shell With Upholstered Seat and Back Pads													
With Arms	SCW- 4 -3S	N/A	\$526.24	\$586.56	\$651.04	\$680.16	\$707.20	\$761.28	\$813.28	\$950.56	\$804.96	\$1054.24	
Without Arms	SCW- 4 -0S	N/A	472.16	532.48	596.96	626.08	653.12	707.20	759.20	896.48	750.88	1000.16	

Very Perforated Side, Seminar and Side Stool

General Specifications

Features and Options (Side, Seminar and Side Chair)

Side and Seminar Chair

- Back: High-strength polymer back with perforations for added flexibility and an optional upholstered foam pad
- Seat: High-strength polymer seat with an optional upholstered foam pad
- Casters: Hard (black), soft (black) or two-tone (fog and gray)
- Glides: Plastic or felt
- Frame finishes include: painted or trivalent chrome
- Weight assisted recline mechanism (Seminar model only)
- Fog or black trim arm caps and glides available
- Arm or armless version available
- Optional Laminate Tablet arm
- Optional Storage rack
- Stacking cart (8-high capacity)
- Stacks 5-high on the floor or 8-high (arms - 69" high x 46" wide x 24" deep), (armless - 57" high x 44" wide x 24" deep) on cart.
- 22mm 14-gauge steel leg tube
- Seminar Chair with intuitive reclining back.

Side Stool

- Back: High-strength polymer back with perforations for added flexibility and an optional upholstered foam pad
- Seat: High-strength polymer seat with an optional upholstered polyurethane foam pad
- Glides: Plastic or felt
- Frame finishes include: painted or trivalent chrome
- Fog or black trim arm caps and glides available
- Arm or armless version available
- Stacks 5-high on the floor

General Guidelines for Product Specification

	S	C	M	- 2	2 - 3	1	3A-18	3A-18	TR-FA	TR-F	TR-LE
Product Type	_____										
(S) Seating	_____										
Product Line	_____										
(C) Very	_____										
Model	_____										
(M) Seminar	_____										
(S) Side	_____										
(L) Side Stool	_____										
Seat Upholstery	_____										
(1) Leather	_____										
(2) Fabric	_____										
(3) Faux Leather	_____										
(4) Polymer	_____										
Back Upholstery	_____										
(1) Leather	_____										
(2) Fabric	_____										
(3) Faux Leather	_____										
(4) Polymer	_____										
Arm/Caps	_____										
(0) No Arms	_____										
(3) Fixed Arms, Hard Caps	_____										
Base/Caster	_____										
(H) 4-Leg, Plastic Glides	_____										
(K) 4-Leg, Felt Glides	_____										
(1) 4-Leg, Hard Casters*	_____										
(2) 4-Leg, Soft Casters*	_____										
(T) 4-Leg, Two-Tone Casters*	_____										
Seat Upholstery	_____										
Tellure	_____										
Back Upholstery	_____										
Tellure	_____										
Shell Color	_____										
Tomato	_____										
Trim Color	_____										
Black	_____										
Frame Trim Color	_____										
Metallic Silver	_____										

*Side and Seminar chairs only.

Very

Side Chair – Perforated

With Arms

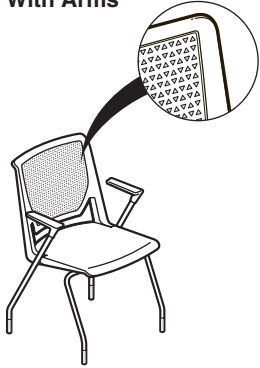

SCS-44-3H

Dimensions

- SH: 18.2"(461mm)*
- H: 33.9"(861mm)
- D: 22"(559mm)
- W: 23.5"(597mm)
- SW: 19.2"(487mm)*
- SD: 17.5"(443mm)*
- AH: 8.9"(226mm)*
- Between Arms:
19.6"(498mm)

* All measurements taken with the BIFMA chair measuring device.

Features

- Back: High-strength polymer back with flexing perforations and an optional upholstered foam pad.
- Seat: High-strength polymer seat with an optional upholstered pad.
- Upholstered seat features 1"(25.4mm) foam pad.
- Upholstered back features 0.5"(12.7mm) foam pad.
- Arms: Black or Fog glass-filled polypropylene arm caps.
- Frame: Available painted or trivalent chrome.
- Casters: Hard (black), soft (black) or two-tone (fog and gray).
- Glides: Plastic or felt.
- Stacks 5-high on the floor and 8-high on a cart
- COM yardage / COL square footage:
Fully Upholstered: 1.5/17.0
Upholstered seat: 0.75/9.5
- Available on RUSH.

To Order, Specify:

1) Product number, including;

1 Seat or Seat Pad Option:

- 1 Leather
- 2 Fabric
- 3 Faux Leather
- 4 Polymer

2 Back or Back Pad Option:

- 1 Leather
- 2 Fabric
- 3 Faux Leather
- 4 Polymer

3 Glide or Caster Option:

- H Plastic Glide
- K Felt Glide
- 1 Hard Casters, add **\$37.44** list
- 2 Soft Casters, add **\$37.44** list
- T Two-Tone Casters, add **\$37.44** list

- 2) Fabric surface and color (seat).
- 3) Fabric surface and color (back).
- 4) Shell color – required for upholstered and non-upholstered.
- 5) Trim for arm caps, glides and plastic components.
- 6) Frame trim color.
- Trivalent Chrome (KR-V) add **\$161.20** list.

Number ① ② ③	Price	Fabric Grade										Leather Grade A	Leather Grade B
		A	B	C	D	E	F	G	H				
Polymer Shell Without Optional Upholstered Pad													
SCS- 4 4 -3 ■	\$289.12	N/A	N/A	N/A	N/A	N/A	N/A	N/A	N/A	N/A	N/A	N/A	N/A
Polymer Shell With Upholstered Seat Pad													
SCS- ■ 4 -3 ■	N/A	\$335.92	\$366.08	\$398.32	\$412.88	\$426.40	\$453.44	\$479.44	\$548.08	\$475.28	\$599.92		
Polymer Shell With Upholstered Seat and Back Pads													
SCS- ■ ■ -3 ■	N/A	\$380.54	\$440.86	\$505.34	\$534.46	\$561.50	\$615.58	\$667.58	\$804.86	\$659.26	\$908.54		

The following options require modification of the product number.

CAL 133
Nano-Tex

To specify, add **F** to the end of the product number; **Example:** SCS-22-34**F** (add **\$59.28** list)
To specify, add **P** to end of the product number (add **\$32.24** list).

NOTE: CAL 133 is available on SCS-22 or SCS-33 fully upholstered fabric or faux leather upholstered models only.

Nano-Tex is available on SCS-22, SCS-24, and SCS-25 models only.

For available fabrics see matrix in the back of the book or at Haworth.com/surfaces.

Very

Side Chair – Perforated

Without Arms

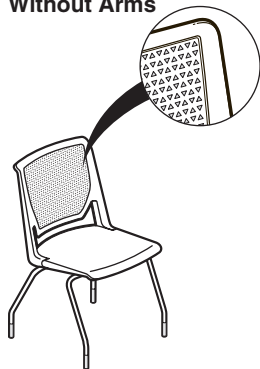

SCS-44-0H

Dimensions

- SH: 18.2"(461mm)*
- H: 33.9"(861mm)
- D: 22"(559mm)
- W: 22.3"(566mm)
- SW: 19.2"(487mm)*
- SD: 17.5"(443mm)*

* All measurements taken with the BIFMA chair measuring device.

Features

- Back: High-strength polymer back with flexing perforations and an optional upholstered foam pad.
 - Seat: High-strength polymer seat with an optional upholstery pad.
 - Upholstered seat features 1"(25.4mm) foam pad.
 - Upholstered back features 0.5"(12.7mm) foam pad.
 - Frame: Available painted or trivalent chrome.
 - Casters: Hard (black), soft (black) or two-tone (fog and gray).
 - Glides: Plastic or felt.
 - Stacks 5-high on the floor and 8-high on a cart
 - COM yardage / COL square footage:
Fully Upholstered: 1.5/17
Upholstered seat: 0.75/9.5
- Available on RUSH.

To Order, Specify:

1) Product number, including;

1 Seat or Seat Pad Option:

- 1 Leather
- 2 Fabric
- 3 Faux Leather
- 4 Polymer

2 Back or Back Pad Option:

- 1 Leather
- 2 Fabric
- 3 Faux Leather
- 4 Polymer

3 Glide or Caster Option:

- H Plastic Glide
- K Felt Glide
- 1 Hard Casters, add **\$37.44** list
- 2 Soft Casters, add **\$37.44** list
- T Two-Tone Casters, add **\$37.44** list

- 2) Fabric surface and color (seat).
 - 3) Fabric surface and color (back).
 - 4) Shell color – required for upholstered and non-upholstered.
 - 5) Add glide and plastic component trim color.
 - 6) Frame trim color.
- Trivalent Chrome (KR-V) add **\$161.20** list.

Number ① ② ③	Price	Fabric Grade		C	D	E	F	G	H	Leather Grade A	Leather Grade B
		A	B								
Polymer Shell Without Optional Upholstered Pad											
SCS- 4 4 -0 ■	\$235.04	N/A	N/A	N/A	N/A	N/A	N/A	N/A	N/A	N/A	N/A
Polymer Shell With Upholstered Seat Pad											
SCS- ■ 4 -0 ■	N/A	\$281.84	\$312.00	\$344.24	\$358.80	\$372.32	\$399.36	\$425.36	\$494.00	\$421.20	\$545.84
Polymer Shell With Upholstered Seat and Back Pads											
SCS- ■ ■ -0 ■	N/A	\$326.46	\$386.78	\$451.26	\$480.38	\$507.42	\$561.50	\$613.50	\$750.78	\$605.18	\$854.46

The following options require modification of the product number.

- CAL 133
- Nano-TEX

To specify, add **F** to the end of the product number; **Example:** SCS-22-0HF (add **\$59.28** list)
To specify, add **P** to end of the product number (add **\$32.24** list).

NOTE: CAL 133 is available on SCS-22 or SCS-33 fully upholstered fabric or faux leather models only.

Nano-TEX is available on SCS-22, SCS-24, and SCS-25 models only.

For available fabrics see matrix in the back of the book or at Haworth.com/surfaces.

Very

Side Chair with Tablet Arm – Perforated Back

Side With Tablet Arm

SCS-44-RH

Dimensions

SH: 18.2"(461mm)*
 H: 33.9"(861mm)
 W: 23.5"(597mm)
 D: 22"(559mm)
 SW: 19.2"(487mm)*
 SD: 17.5"(443mm)*

Features

- Back: High-strength polymer back with flexing perforations and an optional upholstery pad.
- Seat: High-strength polymer with an optional upholstery pad.
- Upholstered seat features 1"(25.4mm) foam pad.
- Upholstered back features 0.5"(12.7mm) foam pad.
- Arm cap: Black.
- Tablet assembly painted black.
- Clearance from tablet to chair back 12.5"(318mm)-15.5"(394mm) angled.
- Flips up and fold away laminate tablet with matching laminate underside.
- Left or right-hand configurations.
- Tablet arm size: 15"W x 9.8"D (Sized to accommodate laptops).
- Base: available painted or optional trivalent chrome.
- Glides or Casters.
- Standard with hard casters, black or two-tone.
- Optional black soft casters.
- COM yardage / COL square footage:
 Fully Upholstered: 1.5/13
 Upholstered seat: .75/7.25

*All measurements taken with the BIFMA chair measuring device.

To Order, Specify:

1) Product number.

1 Seat or Seat Pad Option:

- 1 Leather
- 2 Fabric
- 3 Faux Leather
- 4 Polymer

2 Back or Back Pad Option:

- 1 Leather
- 2 Fabric
- 3 Faux Leather
- 4 Perforated Polymer

3 Arm or Tablet Option:

- R Right-Hand Tablet Arm
- L Left-Hand Tablet Arm

4 Glide or Caster Option:

- H Plastic Glide
- K Felt Glide
- 1 Hard Casters, add **\$37.44** list
- 2 Soft Casters, add **\$37.44** list
- T Two-Tone Casters, add **\$37.44** list

2) Fabric surface and color (seat).

3) Fabric surface and color (back).

4) Shell color - required for upholstered and non-upholstered.

5) Trim for arm caps (if specified) and glides.

6) Frame trim color.

Trivalent Chrome (KR-V) add **\$161.20** list.

7) Laminate for tablet (if specified).

Nano-Tex Upholstery:

Add a **P** to the end of the catalog code, and add **\$32.24** list.

Example: SCS-22-RHP

Description	Number 1 2 3 4	Price	Fabric Grade								Leather Grade A	Leather Grade B
			A	B	C	D	E	F	G	H		
Without Optional Upholstered Pad												
SCS- 4 4 - ■ ■		\$417.04	N/A	N/A	N/A	N/A	N/A	N/A	N/A	N/A	N/A	N/A
With Upholstered Seat Pad												
SCS- ■ 4 - ■ ■		N/A	\$463.84	\$494.00	\$526.24	\$540.80	\$554.32	\$581.36	\$607.36	\$676.00	\$603.20	\$ 727.84
With Upholstered Seat and Back Pads												
SCS- ■ ■ - ■ ■		N/A	\$508.46	\$568.78	\$633.26	\$662.38	\$689.42	\$743.50	\$795.50	\$932.78	\$787.18	\$1036.46

Very

Side Chair with Storage Rack – Perforated Back

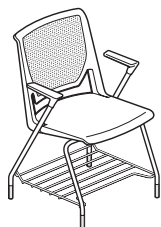

SCK-44-3H

Dimensions

SH: 18.2"(461mm)*
 H: 33.9"(861mm)
 W: 23.5"(597mm)
 D: 22"(559mm)
 SW: 19.2"(487mm)*
 SD: 17.5"(443mm)*
 AH: 8.9"(226mm)*

Between Arms:
 19.6"(498mm)

Features

- Back: High-strength polymer back with flexing perforations and an optional upholstery pad.
- Seat: Injection-molded with an optional upholstery pad.
- Upholstered seat features 1"(25.4mm) foam pad.
- Upholstered back features 0.5"(12.7mm) foam pad.
- Storage rack ships unassembled (chrome only).
- Arms: Black or Fog arm caps when no tablet is specified.
- Optional Tablet arm:
 - Tablet assembly painted black.
 - Flips up and fold away laminate tablet with matching laminate underside.
 - Left or right-hand configurations.
 - Tablet arm size: 15"W x 9.8"D (Sized to accommodate laptops).
- Base: available painted or optional trivalent chrome.
- Glides or Casters: Standard with hard casters, black or two-tone.
- Optional black soft casters.
- COM yardage / COL square footage:
 - Fully Upholstered: 1.5/13
 - Upholstered seat: .75/7.25

*All measurements taken with the BIFMA chair measuring device.

To Order, Specify:

1) Product number.

1 Seat or Seat Pad Option:

- 1 Leather
- 2 Fabric
- 3 Faux Leather
- 4 Polymer

2 Back or Back Pad Option:

- 1 Leather
- 2 Fabric
- 3 Faux Leather
- 4 Perforated Polymer

3 Arm or Cap Option:

- R Right-Hand Tablet Arm, add **\$182.00** list
- L Left-Hand Tablet Arm, add **\$182.00** list
- 0 No Arms
- 3 Fixed Arm, Hard Caps, add **\$54.08** list

4 Glide or Caster Option:

- H Plastic Glide
- K Felt Glide
- 1 Hard Casters, add **\$37.44** list
- 2 Soft Casters, add **\$37.44** list
- T Two-Tone Casters, add **\$37.44** list

- 2) Fabric surface and color (seat).
- 3) Fabric surface and color (back).
- 4) Shell color - required for upholstered and non-upholstered.
- 5) Trim for arm caps (if specified) and glides.
- 6) Frame trim color.
Trivalent Chrome (KR-V) add **\$161.20** list.
- 7) Laminate for tablet (if specified).

Nano-Tex Upholstery:

Add a **P** to the end of the catalog code, and add **\$32.24** list.

Example: SCK-22-RHP

Description	Number ①②③④	Price	Fabric Grade								Leather Grade A	Leather Grade B
			A	B	C	D	E	F	G	H		
Without Optional Upholstered Pad												
	SCK- 4 4 - ■ ■	\$302.64	N/A	N/A	N/A	N/A	N/A	N/A	N/A	N/A	N/A	N/A
With Upholstered Seat Pad												
	SCK- ■ 4 - ■ ■	N/A	\$349.44	\$379.60	\$411.84	\$426.40	\$439.92	\$466.96	\$492.96	\$561.60	\$488.80	\$613.44
With Upholstered Seat and Back Pads												
	SCK- ■ ■ - ■ ■	N/A	\$394.06	\$454.38	\$518.86	\$547.98	\$575.02	\$629.10	\$681.10	\$818.38	\$672.78	\$922.06

Very

Side Stool – Perforated Back

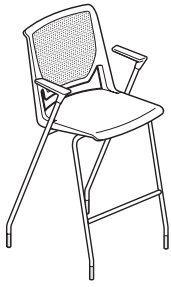

SCL-44-3H

Dimensions

SH: 29.75"(756mm)
 H: 46.25"(1175mm)
 W: 23.75"(604mm)
 D: 23"(587mm)
 SW: 18.75"(477mm)
 SD: 17.2"(434mm)
 AH: 8.9"(226mm)

Between Arms:
 19.6"(498mm)

Features

- Back options: High-strength polymer with flexing perforations and an optional upholstery pad.
- Seat: Injection-molded high-strength polymer seat with an optional upholstery pad.
- Upholstered seat features 1"(25.4mm) foam pad.
- Upholstered back features 0.5"(12.7mm) foam pad.
- Arms: Black or Fog high-strength polymer arm caps.
- Base: available painted or optional trivalent chrome.
- Standard with glides.
- Stacks 5 high on the floor.
- COM yardage / COL square footage:
 Fully Upholstered: 1.5/13
 Upholstered seat: .75/7.25

To Order, Specify:

1) Product number.

1 Seat or Seat Pad Option:

- 1 Leather
- 2 Fabric
- 3 Faux Leather
- 4 Polymer

2 Back or Back Pad Option:

- 1 Leather
- 2 Fabric
- 3 Faux Leather
- 4 Perforated Polymer

3 Glide Option:

- H Plastic Glide
- K Felt Glide

- 2) Fabric surface and color (seat).
 - 3) Fabric surface and color (back).
 - 4) Shell color - required for upholstered and non-upholstered.
 - 5) Trim for arm caps (if specified) and glides.
 - 6) Frame trim color.
- Trivalent Chrome (KR-V) add **\$161.20** list.

Nano-Tex Upholstery:

Add a **P** to the end of the catalog code, and add **\$32.24** list.

Example: SCL-22-3HP

Description	Number 1 2 3	Price	Fabric Grade		C	D	E	F	G	H	Leather Grade A	Leather Grade B
			A	B								
Without Optional Upholstered Pad												
With Arms	SCL- 44 -3	\$600.08	N/A	N/A	N/A	N/A	N/A	N/A	N/A	N/A	N/A	N/A
Without Arms	SCL- 44 -0	546.00	N/A	N/A	N/A	N/A	N/A	N/A	N/A	N/A	N/A	N/A
With Upholstered Seat Pad												
With Arms	SCL- 4 -3	N/A	\$646.88	\$677.04	\$709.28	\$723.84	\$737.36	\$764.40	\$790.40	\$ 859.04	\$786.24	\$ 910.88
Without Arms	SCL- 4 -0	N/A	592.80	622.96	655.20	669.76	683.28	710.32	736.32	804.96	732.16	856.80
With Upholstered Seat and Back Pads												
With Arms	SCL- -3	N/A	\$691.50	\$751.82	\$816.30	\$845.42	\$872.46	\$926.54	\$978.54	\$1115.82	\$786.24	\$ 910.88
Without Arms	SCL- -0	N/A	637.42	697.74	762.22	791.34	818.38	872.46	924.46	1061.74	916.14	1165.42

Very Seminar Chair – Perforated

With Arms

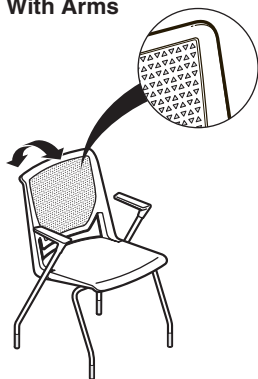

SCM-44-3H

Dimensions

- SH: 18.2”(461mm)*
- H: 33.9”(861mm)
- D: 22”(559mm)
- W: 23.5”(597mm)
- SW: 19.2”(487mm)*
- SD: 17.5”(443mm)*
- AH: 8.9”(226mm)*
- Between Arms: 19.6”(498mm)

* All measurements taken with the BIFMA chair measuring device.

Features

- Back: High-strength polymer back with flexing perforations and an optional upholstered foam pad.
- Seat: High-strength polymer seat with an optional upholstery pad.
- Weight assisted recline mechanism.
- Upholstered seat features 1”(25.4mm) foam pad.
- Upholstered back features 0.5”(12.7mm) foam pad.
- Arms: Black or Fog glass-filled polypropylene arm caps.
- Frame: Available painted or trivalent chrome.
- Casters: Hard (black), soft (black) or two-tone (fog and gray).
- Glides: Plastic or felt.
- Stacks 5-high on the floor and 8-high on a cart
- COM yardage / COL square footage:
Fully Upholstered: 1.5/17
Upholstered seat: 0.75/9.5
- Available on RUSH.

To Order, Specify:

- 1) Product number, including;
 - 1 Seat or Seat Pad Option:**
 - 1 Leather
 - 2 Fabric
 - 3 Faux Leather
 - 4 Polymer
 - 2 Back or Back Pad Option:**
 - 1 Leather
 - 2 Fabric
 - 3 Faux Leather
 - 4 Polymer
 - 3 Glide or Caster Option:**
 - H Plastic Glide
 - K Felt Glide
 - 1 Hard Casters, add **\$47.84** list
 - 2 Soft Casters, add **\$47.84** list
 - T Two-Tone Casters, add **\$47.84** list
- 2) Fabric surface and color (seat).
- 3) Fabric surface and color (back).
- 4) Shell color – required for upholstered and non-upholstered.
- 5) Trim for arm caps, glides, and plastic components.
- 6) Frame trim color.
Trivalent Chrome (KR-V) add **\$161.20** list.

Number ① ② ③	Price	Fabric Grade										Leather Grade A	Leather Grade B
		A	B	C	D	E	F	G	H				
Polymer Shell Without Optional Upholstered Pad													
SCM- 4 4 -3 ■	\$498.16	N/A	N/A	N/A	N/A	N/A	N/A	N/A	N/A	N/A	N/A	N/A	N/A
Polymer Shell With Upholstered Seat Pad													
SCM- ■ 4 -3 ■	N/A	\$549.12	\$579.28	\$611.52	\$626.08	\$639.60	\$666.64	\$692.64	\$ 761.28	\$688.48	\$ 813.12		
Polymer Shell With Upholstered Seat and Back Pads													
SCM- ■ ■ -3 ■	N/A	\$612.56	\$672.88	\$737.36	\$766.48	\$793.52	\$847.60	\$899.60	\$1036.88	\$891.28	\$1140.56		

The following options require modification of the product number.

CAL 133
Nano-TEX

To specify, add **F** to the end of the product number; **Example:** SCM-22-3HF (add **\$59.28** list)
To specify, add **P** to end of the product number (add **\$32.24** list).

NOTE: CAL 133 is available on SCM-22 or SCM-33 fully upholstered fabric or faux leather models only.
Nano-TEX is available on SCM-22, SCM-24, and SCM-25 models only.
For available fabrics see matrix in the back of the book or at Haworth.com/surfaces.

Very

Seminar Chair – Perforated

Without Arms

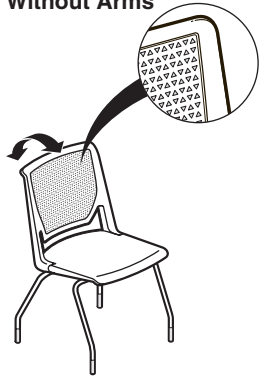

SCM-44-0H

Dimensions

SH: 18.2"(461mm)*
 H: 33.9"(861mm)
 D: 22"(559mm)
 W: 22.3"(566mm)
 SW: 19.2"(487mm)*
 SD: 17.5"(443mm)*

* All measurements taken with the BIFMA chair measuring device.

Features

- Back: High-strength polymer back with flexing perforations and an optional upholstered foam pad.
 - Seat: High-strength polymer seat with an optional upholstery pad.
 - Weight assisted recline mechanism.
 - Upholstered seat features 1"(25.4mm) foam pad.
 - Upholstered back features 0.5"(12.7mm) foam pad.
 - Arms: Black or Fog glass-filled polypropylene arm caps.
 - Frame: Available painted or trivalent chrome.
 - Casters: Hard (black), soft (black) or two-tone (fog and gray).
 - Glides: Plastic or felt.
 - Stacks 5-high on the floor and 8-high on a cart
 - COM yardage / COL square footage:
 Fully Upholstered: 1.5/17
 Upholstered seat: 0.75/9.5
- Available on RUSH.

To Order, Specify:

1) Product number, including;

1 Seat or Seat Pad Option:

- 1 Leather
- 2 Fabric
- 3 Faux Leather
- 4 Polymer

2 Back or Back Pad Option:

- 1 Leather
- 2 Fabric
- 3 Faux Leather
- 4 Polymer

3 Glide or Caster Option:

- H Plastic Glide
- K Felt Glide
- 1 Hard Casters, add **\$47.84** list
- 2 Soft Casters, add **\$47.84** list
- T Two-Tone Casters, add **\$47.84** list

- 2) Fabric surface and color (seat).
 - 3) Fabric surface and color (back).
 - 4) Shell color – required for upholstered and non-upholstered.
 - 5) Glide and plastic component trim color.
 - 6) Frame trim color.
- Trivalent Chrome (KR-V) add **\$161.20** list.

Number ① ② ③	Price	Fabric Grade		C	D	E	F	G	H	Leather Grade A	Leather Grade B
		A	B								
Polymer Shell Without Optional Upholstered Pad											
SCM- 4 4 -0 ■	\$444.08	N/A	N/A	N/A	N/A	N/A	N/A	N/A	N/A	N/A	N/A
Polymer Shell With Upholstered Seat Pad											
SCM- ■ 4 -0 ■	N/A	\$495.04	\$525.20	\$557.44	\$572.00	\$585.52	\$612.56	\$638.56	\$707.20	\$634.40	\$ 759.04
Polymer Shell With Upholstered Seat and Back Pads											
SCM- ■ ■ -0 ■	N/A	\$558.48	\$618.80	\$683.28	\$712.40	\$739.44	\$793.52	\$845.52	\$982.80	\$837.20	\$1086.48

The following options require modification of the product number.

CAL 133
 Nano-TEX

To specify, add **F** to the end of the product number; **Example:** SCM-22-0HF (add **\$59.28** list)
 To specify, add **P** to end of the product number (add **\$32.24** list).

NOTE: CAL 133 is available on SCM-22 or SCM-33 fully upholstered fabric or faux leather models only.

Nano-TEX is available on SCM-22, SCM-24, and SCM-25 models only.

For available fabrics see matrix in the back of the book or at Haworth.com/surfaces.

Very

Seminar with Tablet Arm – Perforated Back

Seminar With Tablet Arm

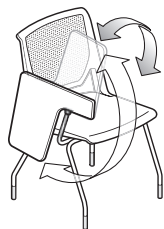

SCM-44-RH

Dimensions

- SH: 18.2"(461mm)*
- H: 33.9"(861mm)
- W: 23.5"(597mm)
- D: 22"(559mm)
- SW: 19.2"(487mm)*
- SD: 17.5"(443mm)*

Features

- Back: High-strength polymer back with flexing perforations and an optional upholstery pad.
- Seat: High-strength polymer with an optional upholstery pad.
- Weight assisted recline mechanism.
- Upholstered seat features 1"(25.4mm) foam pad.
- Upholstered back features 0.5"(12.7mm) foam pad.
- Arm caps: Black.
- Tablet assembly painted black.
- Clearance from tablet to chair back 12.5"(318mm)-15.5"(394mm) angled.
- Flips up and fold away laminate tablet with matching laminate underside.
- Left or right-hand configurations.
- Tablet arm size: 15"W x 9.8"D (Sized to accommodate laptops).
- Base: available painted or optional trivalent chrome.
- Glides or Casters.
- Standard with hard casters, black or two-tone.
- Optional black soft casters.
- COM yardage / COL square footage:
Fully Upholstered: 1.5/13
Upholstered seat: .75/7.25

*All measurements taken with the BIFMA chair measuring device.

To Order, Specify:

1) Product number.

1 Seat or Seat Pad Option:

- 1 Leather
- 2 Fabric
- 3 Faux Leather
- 4 Polymer

2 Back or Back Pad Option:

- 1 Leather
- 2 Fabric
- 3 Faux Leather
- 4 Perforated Polymer

3 Arm or Tablet Option:

- R Right-Hand Tablet Arm
- L Left-Hand Tablet Arm

4 Glide or Caster Option:

- H Plastic Glide
- K Felt Glide
- 1 Hard Casters, add **\$47.84** list
- 2 Soft Casters, add **\$47.84** list
- T Two-Tone Casters, add **\$47.84** list

- 2) Fabric surface and color (seat).
- 3) Fabric surface and color (back).
- 4) Shell color - required for upholstered and non-upholstered.
- 5) Trim for arm caps (if specified) and glides.
- 6) Frame trim color.
Trivalent Chrome (KR-V) add **\$161.20** list.
- 7) Laminate for tablet (if specified).

Nano-Tex Upholstery:

Add a **P** to the end of the catalog code, and add **\$32.24** list.

Example: SCM-22-RHP

Description	Number ① ② ③ ④	Price	Fabric Grade								Leather Grade A	Leather Grade B
			A	B	C	D	E	F	G	H		
Without Optional Upholstered Pad												
	SCM- 4 4 - ■ ■	\$626.08	N/A	N/A	N/A	N/A	N/A	N/A	N/A	N/A	N/A	N/A
With Upholstered Seat Pad												
	SCM- ■ 4 - ■ ■	N/A	\$677.04	\$707.20	\$739.44	\$754.00	\$767.52	\$794.56	\$ 820.56	\$ 889.20	\$ 816.40	\$ 941.04
With Upholstered Seat and Back Pads												
	SCM- ■ ■ - ■ ■	N/A	\$740.48	\$800.80	\$865.28	\$894.40	\$921.44	\$975.52	\$1027.52	\$1164.80	\$1019.20	\$1268.48

Very

Seminar with Storage Rack – Perforated Back

Seminar With Storage Rack



SCB-44-3H

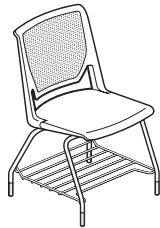

SCB-44-0H

Dimensions

SH: 18.2"(461mm)*
 H: 33.9"(861mm)
 W: 23.5"(597mm)
 D: 22"(559mm)
 SW: 19.2"(487mm)*
 SD: 17.5"(443mm)*
 AH: 8.9"(226mm)*

Between Arms:
 19.6"(498mm)

Features

- Back: High-strength polymer back with flexing perforations and an optional upholstery pad.
- Seat: High-strength polymer seat with an optional upholstery pad.
- Weight assisted recline mechanism.
- Upholstered seat features 1"(25.4mm) foam pad.
- Upholstered back features 0.5"(12.7mm) foam pad.
- Arms: Black or Fog arm caps.
- Storage rack available in Chrome only.
- Tablet assembly painted black.
- Flips up and fold away laminate tablet with matching laminate underside.
- Left or right-hand configurations.
- Tablet arm size: 15"W x 9.8"D (Sized to accommodate laptops).
- Ships with chair, unassembled.
- Base: available painted or optional trivalent chrome.
- Glides or Casters: Standard with hard casters, black or two-tone.
- Optional black soft casters.
- COM yardage / COL square footage:
 Fully Upholstered: 1.5/13
 Upholstered seat: .75/7.25

*All measurements taken with the BIFMA chair measuring device.

To Order, Specify:

1) Product number.

1 Seat or Seat Pad Option:

- 1 Leather
- 2 Fabric
- 3 Faux Leather
- 4 Polymer Back or Back Pad

2 Back or Back Pad Option:

- 1 Leather
- 2 Fabric Faux Leather
- 4 Perforated Polymer

3 Arm or Cap Option:

- R Right-Hand Tablet Arm, add **\$182.00** list
- L Left-Hand Tablet Arm, add **\$182.00** list
- 0 No Arms
- 3 Fixed Arm, Hard Caps, add **\$54.08** list

4 Glide or Caster Option:

- H Plastic Glide
- K Felt Glide
- 1 Hard Casters, add **\$47.84** list
- 2 Soft Casters, add **\$47.84** list
- T Two-Tone Casters, add **\$47.84** list

- 2) Fabric surface and color (seat).
- 3) Fabric surface and color (back).
- 4) Shell color - required for upholstered and non-upholstered.
- 5) Trim for arm caps (if specified) and glides.
- 6) Frame trim color.
 Trivalent Chrome (KR-V) add **\$161.20** list.

Nano-Tex Upholstery:

Add a **P** to the end of the catalog code, and add **\$32.24** list.

Example: SCB-22-RHP

Description	Number 1 2 3 4	Price	Fabric Grade								Leather Grade A	Leather Grade B
			A	B	C	D	E	F	G	H		
Without Optional Upholstered Pad												
SCB- 4 4 -		\$511.68	N/A	N/A	N/A	N/A	N/A	N/A	N/A	N/A	N/A	N/A
With Upholstered Seat Pad												
SCB- 4 4 -		N/A	\$562.64	\$592.80	\$625.04	\$639.60	\$653.12	\$680.16	\$706.16	\$ 774.80	\$702.00	\$ 826.64
With Upholstered Seat and Back Pads												
SCB- 4 4 -		N/A	\$626.08	\$686.40	\$750.88	\$780.00	\$807.04	\$861.12	\$913.12	\$1050.40	\$904.80	\$1154.08

Very Perforated Conference Chair and Conference Stool

General Specifications

Features and Options (Conference Chair and Conference Stool)

- Back: High-strength polymer back with flexing perforations and an optional upholstered foam pad
- Seat: High-strength polymer seat with an optional upholstered polyurethane foam pad
- Five-star base with casters: hard (black), soft (black) or two-tone (fog and gray)
- Base: painted aluminum, polished aluminum or plastic (fog or black)
- Frame finishes include: painted or polished aluminum
- Weight assisted recline mechanism
- Pneumatic height adjustment
- Fog or black trim arm caps
- Arm or armless version available
- Adjustable footring in brushed aluminum (stool only)

General Guidelines for Product Specification

	S	C	C - 2	2 - 1	1	3A-18	3A-18	TR-FA	TR-F	TR-LE
Conference										
Product Type	_____	_____	_____	_____	_____	_____	_____	_____	_____	_____
(S) Seating	_____	_____	_____	_____	_____	_____	_____	_____	_____	_____
Product Line	_____	_____	_____	_____	_____	_____	_____	_____	_____	_____
(C) Very	_____	_____	_____	_____	_____	_____	_____	_____	_____	_____
Model	_____	_____	_____	_____	_____	_____	_____	_____	_____	_____
(C) Conference	_____	_____	_____	_____	_____	_____	_____	_____	_____	_____
(F) Stool	_____	_____	_____	_____	_____	_____	_____	_____	_____	_____
Seat Upholstery	_____	_____	_____	_____	_____	_____	_____	_____	_____	_____
(1) Leather	_____	_____	_____	_____	_____	_____	_____	_____	_____	_____
(2) Fabric	_____	_____	_____	_____	_____	_____	_____	_____	_____	_____
(3) Faux Leather	_____	_____	_____	_____	_____	_____	_____	_____	_____	_____
(4) Polymer	_____	_____	_____	_____	_____	_____	_____	_____	_____	_____
Back Upholstery	_____	_____	_____	_____	_____	_____	_____	_____	_____	_____
(1) Leather	_____	_____	_____	_____	_____	_____	_____	_____	_____	_____
(2) Fabric	_____	_____	_____	_____	_____	_____	_____	_____	_____	_____
(3) Faux Leather	_____	_____	_____	_____	_____	_____	_____	_____	_____	_____
(4) Polymer	_____	_____	_____	_____	_____	_____	_____	_____	_____	_____
Arm/Caps	_____	_____	_____	_____	_____	_____	_____	_____	_____	_____
(0) No Arms	_____	_____	_____	_____	_____	_____	_____	_____	_____	_____
(1) Fixed Arms, Soft Caps	_____	_____	_____	_____	_____	_____	_____	_____	_____	_____
Base/Caster	_____	_____	_____	_____	_____	_____	_____	_____	_____	_____
(1) Aluminum Standard Base, Hard Caster	_____	_____	_____	_____	_____	_____	_____	_____	_____	_____
(2) Aluminum Standard Base, Soft Caster	_____	_____	_____	_____	_____	_____	_____	_____	_____	_____
(3) Aluminum Low Base, Hard Caster	_____	_____	_____	_____	_____	_____	_____	_____	_____	_____
(4) Aluminum Low Base, Soft Caster	_____	_____	_____	_____	_____	_____	_____	_____	_____	_____
(5) Plastic Standard Base, Hard Caster	_____	_____	_____	_____	_____	_____	_____	_____	_____	_____
(6) Plastic Standard Base, Soft Caster	_____	_____	_____	_____	_____	_____	_____	_____	_____	_____
(7) Plastic Low Base, Hard Caster	_____	_____	_____	_____	_____	_____	_____	_____	_____	_____
(8) Plastic Low Base, Soft Caster	_____	_____	_____	_____	_____	_____	_____	_____	_____	_____
(N) Plastic Low Base, Two-Tone Casters	_____	_____	_____	_____	_____	_____	_____	_____	_____	_____
(P) Plastic Standard Base, Two-Tone Casters	_____	_____	_____	_____	_____	_____	_____	_____	_____	_____
(R) Aluminum Low Base, Two-Tone Casters	_____	_____	_____	_____	_____	_____	_____	_____	_____	_____
(T) Aluminum Standard Base, Two-Tone Casters	_____	_____	_____	_____	_____	_____	_____	_____	_____	_____
Seat Upholstery	_____	_____	_____	_____	_____	_____	_____	_____	_____	_____
Tellure	_____	_____	_____	_____	_____	_____	_____	_____	_____	_____
Back Upholstery	_____	_____	_____	_____	_____	_____	_____	_____	_____	_____
Tellure	_____	_____	_____	_____	_____	_____	_____	_____	_____	_____
Shell Color	_____	_____	_____	_____	_____	_____	_____	_____	_____	_____
Tomato	_____	_____	_____	_____	_____	_____	_____	_____	_____	_____
Trim Color	_____	_____	_____	_____	_____	_____	_____	_____	_____	_____
Black	_____	_____	_____	_____	_____	_____	_____	_____	_____	_____
Frame Trim Color	_____	_____	_____	_____	_____	_____	_____	_____	_____	_____
Metallic Silver	_____	_____	_____	_____	_____	_____	_____	_____	_____	_____

Very

Conference Chair - Perforated

With Arms

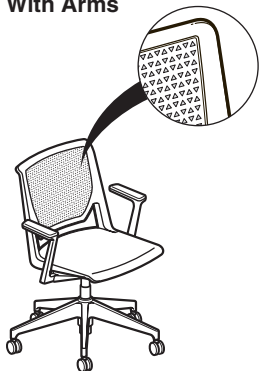

SCC-44-11

Dimensions

SH: 15.5"(394mm)-
20.5"(521mm)*
H: 36.9"(937mm)
D: 26.7"(678mm)
W: 21.8"(554mm)
SW: 19.2"(487mm)*
SD: 17.5"(443mm)*
AH: 8.7"(220mm)*
Between Arms:
20.8"(528mm)

Low position base:
SH: 10.4"(264mm)-
14.4"(366mm)*

* All measurements taken with the BIFMA chair measuring device.

Features

- Back: High-strength polymer with flexing perforations and an optional upholstered foam pad.
- Seat: High-strength polymer with an optional upholstered foam pad.
- Upholstered seat features 1"(25.4mm) foam pad.
- Upholstered back features 0.5"(12.7mm) foam pad.
- Arms: Black or Fog glass-filled polypropylene hard arm caps.
- Base: Standard five-star all aluminum or all plastic base. Optional low-base range 14.4"(366mm)-19.4(493mm).
- 5"(127mm) height adjustment.
- Weight assisted recline mechanism.
- Casters: Hard (black), soft (black) or two-tone (fog and gray).
- Back tilts backward 14° from the upright position. Additional recline achieved in flexible back.
- Painted or optional polished aluminum.
- COM yardage / COL square footage:
Fully Upholstered: 1.5/17
Upholstered seat: 0.75/9.5

■ Available on RUSH.

To Order, Specify (cont'd):

③ Base/Caster Option:

Aluminum Base

- 1 Aluminum Std. Base, Hard Caster
- 2 Aluminum Std. Base, Soft Caster
- 3 Aluminum Low Base, Hard Caster
- 4 Aluminum Low Base, Soft Caster

Plastic Base

- 5 Plastic Std. Base, Hard Caster
- 6 Plastic Std. Base, Soft Caster
- 7 Plastic Low Base, Hard Caster
- 8 Plastic Low Base, Soft Caster

Two-Tone Casters

- N Plastic Low Base, Two-Tone Casters
- P Plastic Std. Base, Two-Tone Casters
- R Aluminum Low Base, Two-Tone Casters
- T Aluminum Std. Base, Two-Tone Casters

- 2) Fabric surface and color (seat).
- 3) Fabric surface and color (back).
- 4) Shell color – required for upholstered and non-upholstered.
- 5) Trim for arm caps, plastic components and base (plastic base only).
- 6) Trim color for aluminum components (aluminum base, control housing, and frame).

Polished Aluminum (PM-P) add \$161.20 list.

To Order, Specify:

- 1) Product number, including;

① Seat or Seat Pad Option:

- 1 Leather
- 2 Fabric
- 3 Faux Leather
- 4 Polymer

② Back or Back Pad Option:

- 1 Leather
- 2 Fabric
- 3 Faux Leather
- 4 Polymer

Number ① ② ③	Price	Fabric Grade								Leather Grade A	Leather Grade B
		A	B	C	D	E	F	G	H		
Polymer Shell - Aluminum Base Without Optional Upholstered Pad											
SCC- 4 4 -1 ■	\$804.96	N/A	N/A	N/A	N/A	N/A	N/A	N/A	N/A	N/A	N/A
Polymer Shell - Aluminum Base With Upholstered Seat Pad											
SCC- 4 -1 ■	N/A	\$861.12	\$891.28	\$ 923.52	\$ 938.08	\$ 951.60	\$ 978.64	\$1004.64	\$1073.28	\$1000.48	\$1125.12
Polymer Shell - Aluminum Base With Upholstered Seat and Back Pads											
SCC- ■ -1 ■	N/A	\$931.84	\$992.16	\$1056.64	\$1085.76	\$1112.80	\$1166.88	\$1218.88	\$1356.16	\$1210.56	\$1459.84

Number ① ② ③	Price	Fabric Grade								Leather Grade A	Leather Grade B
		A	B	C	D	E	F	G	H		
Polymer Shell - Plastic Base Without Optional Upholstered Pad											
SCC- 4 4 -1 ■	\$697.84	N/A	N/A	N/A	N/A	N/A	N/A	N/A	N/A	N/A	N/A
Polymer Shell - Plastic Base With Upholstered Seat Pad											
SCC- 4 -1 ■	N/A	\$754.00	\$784.16	\$816.40	\$830.96	\$ 844.48	\$ 871.52	\$ 897.52	\$ 966.16	\$ 893.36	\$1018.00
Polymer Shell - Plastic Base With Upholstered Seat and Back Pads											
SCC- ■ -1 ■	N/A	\$824.72	\$885.04	\$949.52	\$978.64	\$1005.68	\$1059.76	\$1111.76	\$1249.04	\$1103.44	\$1352.72

The following options require modification of the product number.

CAL 133
Nano-Tex

To specify, add **F** to the end of the product number; **Example:** SCC-22-11F (add \$59.28 list)
To specify, add **P** to end of the product number (add \$32.25 list).

NOTE: CAL 133 is available on SCC-22 or SCC-33 fully upholstered fabric or faux leather models only.

Nano-Tex is available on SCC-22, SCC-24, and SCC-25 models only.

For available fabrics see matrix in the back of the book or at Haworth.com/surfaces.

Very

Conference Chair - Perforated

Without Arms

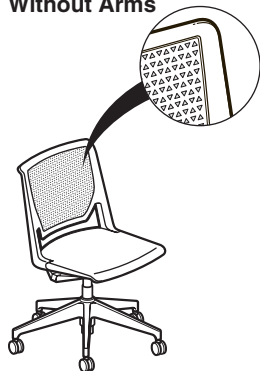

SCC-44-01

Dimensions

SH: 15.5"(394mm)-20.5"(521mm)*
 Low position base:
 SH: 10.4"(264mm)-14.4"(366mm)*
 H: 36.9"(937mm)
 D: 26.7"(678mm)
 W: 21.8"(554mm)
 SW: 19.2"(487mm)*
 SD: 17.5"(443mm)*

Low position base:
 SH: 10.4"(264mm)-14.4"(366mm)*

* All measurements taken with the BIFMA chair measuring device.

Features

- Back: High-strength polymer with flexing perforations and an optional upholstered foam pad.
- Seat: High-strength polymer with an optional upholstered foam pad.
- Upholstered seat features 1"(25.4mm) foam pad.
- Upholstered back features 0.5"(12.7mm) foam pad.
- Base: Standard five-star all aluminum or all plastic base. Optional low-base range 14.4"(366mm)-19.4"(493mm).
- 5"(127mm) height adjustment.
- Weight assisted recline mechanism.
- Casters: Hard (black), soft (black) or two-tone (fog and gray).
- Back tilts backward 14° from the upright position. Additional recline achieved in flexible back.
- Painted or optional polished aluminum.
- COM yardage / COL square footage:
 Fully Upholstered: 1.5/17
 Upholstered seat: 0.75/9.5

■ Available on RUSH.

To Order, Specify (cont'd):

3 Base/Caster Option:

Aluminum Base

- 1** Aluminum Std. Base, Hard Caster
- 2** Aluminum Std. Base, Soft Caster
- 3** Aluminum Low Base, Hard Caster
- 4** Aluminum Low Base, Soft Caster

Plastic Base

- 5** Plastic Std. Base, Hard Caster
- 6** Plastic Std. Base, Soft Caster
- 7** Plastic Low Base, Hard Caster
- 8** Plastic Low Base, Soft Caster

Two-Tone Casters

- N** Plastic Low Base, Two-Tone Casters
- P** Plastic Std. Base, Two-Tone Casters
- R** Aluminum Low Base, Two-Tone Casters
- T** Aluminum Std. Base, Two-Tone Casters

To Order, Specify:

1) Product number, including;

1 Seat or Seat Pad Option:

- 1** Leather
- 2** Fabric
- 3** Faux Leather
- 4** Polymer

2 Back or Back Pad Option:

- 1** Leather
- 2** Fabric
- 3** Faux Leather
- 4** Polymer

- 2) Fabric surface and color (seat).
- 3) Fabric surface and color (back).
- 4) Shell color – required for upholstered and non-upholstered.
- 5) Trim for plastic components and base (plastic base only).
- 6) Trim color for aluminum components (aluminum base, control housing, and frame).

Polished Aluminum (PM-P) add \$161.20 list.

Number 1 2 3	Price	Fabric Grade								Leather Grade A	Leather Grade B
		A	B	C	D	E	F	G	H		
Polymer Shell - Aluminum Base Without Optional Upholstered Pad											
SCC- 4 4 -0	\$740.48	N/A	N/A	N/A	N/A	N/A	N/A	N/A	N/A	N/A	N/A
Polymer Shell - Aluminum Base With Upholstered Seat Pad											
SCC- 4 -0	N/A	\$796.64	\$826.80	\$859.04	\$ 873.60	\$ 887.12	\$ 914.16	\$ 940.16	\$1008.80	\$ 936.00	\$1060.64
Polymer Shell - Aluminum Base With Upholstered Seat and Back Pads											
SCC- -0	N/A	\$867.36	\$927.68	\$992.16	\$1021.28	\$1048.32	\$1102.40	\$1154.40	\$1291.68	\$1146.08	\$1395.36

Number 1 2 3	Price	Fabric Grade								Leather Grade A	Leather Grade B
		A	B	C	D	E	F	G	H		
Polymer Shell - Plastic Base Without Optional Upholstered Pad											
SCC- 4 4 -0	\$633.36	N/A	N/A	N/A	N/A	N/A	N/A	N/A	N/A	N/A	N/A
Polymer Shell - Plastic Base With Upholstered Seat Pad											
SCC- 4 -0	N/A	\$689.52	\$719.68	\$751.92	\$766.48	\$780.00	\$807.04	\$ 833.04	\$ 901.68	\$ 828.88	\$ 953.52
Polymer Shell - Plastic Base With Upholstered Seat and Back Pads											
SCC- -0	N/A	\$760.24	\$820.56	\$885.04	\$914.16	\$941.20	\$995.28	\$1047.28	\$1184.56	\$1038.96	\$1288.24

The following options require modification of the product number.

CAL 133
 Nano-Tex

To specify, add **F** to the end of the product number; **Example:** SCC-22-01F (add \$59.28 list)
 To specify, add **P** to end of the product number (add \$32.24 list).

NOTE: CAL 133 is available on SCC-22 or SCC-33 fully upholstered fabric or faux leather models only.

Nano-Tex is available on SCC-22, SCC-24, and SCC-25 models only.

For available fabrics see matrix in the back of the book or at Haworth.com/surfaces.

Very

Conference Stool – Perforated Back



SCF-44-11



SCF-44-01

Dimensions

SH: 23"-32"
(584mm-813mm)
W: 21.8"(554mm)
D: 26.7"(678mm)
SW: 18.75"(477mm)
SD: 17.2"(434mm)
AH: 8.7"(221mm)

Between Arms:
20.8"(528mm)

Features

- Back: High-strength polymer back with flexing perforations and an optional upholstery pad.
- Seat: High-strength polymer seat with an optional upholstery pad.
- Weight assisted recline mechanism.
- Upholstered seat features 1"(25.4mm) foam pad.
- Upholstered back features 0.5"(12.7mm) foam pad.
- Arms: Black or Fog hard arm caps.
- Base: Standard five-star all aluminum or all plastic base.
- Footring: Brushed Aluminum finish.
- Adjustable footring: adjusts 4"(102mm) up and down.
- Casters: Standard with hard casters, black or two-tone.
- Optional black soft casters.
- COM yardage / COL square footage:
Fully Upholstered: 1.5/13
Upholstered seat: .75/7.25

To Order, Specify:

1) Product number.

1 Seat or Seat Pad Option:

- 1 Leather
- 2 Fabric
- 3 Faux Leather
- 4 Polymer

2 Back or Back Pad Option:

- 1 Leather
- 2 Fabric
- 3 Faux Leather
- 4 Perforated Polymer

3 Arm or Cap Option:

- 0 No Arms
- 1 Fixed Arm, Hard Caps, add \$128.96 list

4 Base or Caster Option:

Aluminum Base

- 1 Aluminum Std. Base, Hard Casters
- 2 Aluminum Std. Base, Soft Casters
- T Aluminum Std. Base, Two-Tone Casters

Plastic Base

- 5 Plastic Std. Base, Hard Casters
- 6 Plastic Std. Base, Soft Casters
- P Plastic Std. Base, Two-Tone Casters

- 2) Fabric surface and color (seat).
- 3) Fabric surface and color (back).
- 4) Shell color - required for upholstered and non-upholstered.
- 5) Trim for arm caps (if specified). (base if plastic is specified above).
- 6) Frame trim color- Aluminum components (base if aluminum and arm uprights).

Nano-TEX Upholstery:

Add a **P** to the end of the catalog code, and add \$32.24 list.

Example: SCF-22-RHP

Description	Number				Price	Fabric Grade							Leather Grade A	Leather Grade B	
	1	2	3	4		A	B	C	D	E	F	G			H
Aluminum Base Without Optional Upholstered Pad															
SCF- 4 4 -					\$1045.20	N/A	N/A	N/A	N/A	N/A	N/A	N/A	N/A	N/A	
Aluminum Base With Upholstered Seat Pad															
SCF- 4 -					N/A	\$1101.36	\$1131.52	\$1163.76	\$1178.32	\$1191.84	\$1218.88	\$1244.88	\$1313.52	\$1240.72	\$1365.36
Aluminum Base With Upholstered Seat and Back Pads															
SCF- - -					N/A	\$1172.08	\$1232.40	\$1296.88	\$1326.00	\$1353.04	\$1407.12	\$1459.12	\$1596.40	\$1450.80	\$1700.08
Plastic Base Without Optional Upholstered Pad															
SCF- 4 4 -					\$ 938.08	N/A	N/A	N/A	N/A	N/A	N/A	N/A	N/A	N/A	N/A
Aluminum Base With Upholstered Seat Pad															
SCF- 4 -					N/A	\$ 994.24	\$1024.40	\$1056.64	\$1071.20	\$1084.72	\$1111.76	\$1137.76	\$1206.40	\$1133.60	\$1258.24
Aluminum Base With Upholstered Seat and Back Pads															
SCF- - -					N/A	\$1064.96	\$1125.28	\$1189.76	\$1218.88	\$1245.92	\$1300.00	\$1352.00	\$1489.28	\$1343.68	\$1592.96

Very Tetro Back Side, Seminar Chair and Side Stool

General Specifications

**Features and Options
(Side Chair, Seminar Chair and
Side Stool)**

Side and Seminar Chair

- Back: High-strength polymer back with injection molded technology
- Seat: High-strength polymer seat with an optional upholstered foam pad
- Casters: Hard (black), soft (black) or two-tone (fog and gray)
- Glides: Plastic or felt
- Frame finishes include: painted or trivalent chrome
- Weight assisted recline mechanism (Seminar model only)
- Fog or black trim arm caps and glides available
- Arm or armless version available
- Stacks 5-high on the floor or 8-high (71.75" high by 48.25" wide by 25.5" deep) on cart

Side Stool

- Back: High-strength polymer back with injection molded technology
- Seat: High-strength polymer seat with an optional upholstered foam pad
- Glides: Plastic or felt
- Frame finishes include: painted or trivalent chrome
- Fog or black trim arm caps and glides available
- Arm or armless version available
- Stacks 5-high on the floor

**General Guidelines for
Product Specification**

Side and Seminar

	<u>S</u>	<u>C</u>	<u>M</u>	<u>-</u>	<u>2</u>	<u>5</u>	<u>-</u>	<u>3</u>	<u>1</u>	<u>3A-18</u>	<u>TR-FA</u>	<u>TR-F</u>	<u>TR-LE</u>
Product Type	_____												
(S) Seating	_____												
Product Line	_____												
(C) Very	_____												
Model	_____												
(M) Seminar	_____												
(S) Side	_____												
(L) Side Stool	_____												
Seat Upholstery	_____												
(1) Leather	_____												
(2) Fabric	_____												
(3) Faux Leather	_____												
(4) Polymer	_____												
Back	_____												
(5) Tetro Back	_____												
Arm/Caps	_____												
(0) No Arms	_____												
(3) Fixed Arms, Hard Caps	_____												
Base/Caster	_____												
(H) 4-Leg, Plastic Glides	_____												
(K) 4-Leg, Felt Glides	_____												
(1) 4-Leg, Hard Casters*	_____												
(2) 4-Leg, Soft Casters*	_____												
(T) 4-Leg, Two-Tone Casters*	_____												
Seat Upholstery	_____												
Tellure	_____												
Shell Color	_____												
Tomato	_____												
Trim Color	_____												
Black	_____												
Frame Trim Color	_____												
Metallic Silver	_____												

*Side and Seminar chairs only

Very

Side Chair – Tetro Back

With Arms

SCS-45-3H

Dimensions

SH: 18.2"(461mm)*
 H: 33.9"(861mm)
 D: 22"(559mm)
 W: 23.5"(597mm)
 SW: 19.2"(487mm)*
 SD: 17.5"(443mm)*
 AH: 8.9"(226mm)*
 Between Arms:
 19.6"(498mm)

Features

- Back: High-strength polymer back with injection molded technology.
- Seat: High-strength polymer seat with an optional upholstery pad.
- Upholstered seat features 1"(25.4mm) foam pad.
- Arms: Black or Fog glass-filled polypropylene arm caps.
- Frame: available painted or trivalent chrome.
- Casters: Hard (black), soft (black) or two-tone (fog and gray).
- Glides: Plastic or felt.
- Stacks 5 high on the floor and 8 high on a cart
- COM yardage / COL square footage:
 Upholstered seat: .75/ 7.25

*All measurements taken with the BIFMA chair measuring device.

To Order, Specify:

1) Product number, including;

① Seat or Seat Pad Option:

- 1 Leather
- 2 Fabric
- 3 Faux Leather
- 4 Polymer

② Glide or Caster Option:

- H Plastic Glide
- K Felt Glide
- 1 Hard Casters, add **\$37.44** list
- 2 Soft Casters, add **\$37.44** list
- T Two-Tone Casters, add **\$37.44** list

2) Fabric surface and color (seat).

3) Shell color – required for upholstered and non-upholstered.

4) Trim for arm caps, glides and plastic components.

5) Frame trim color.

Trivalent Chrome (KR-V) add **\$161.20** list.

Number ① ②	Price	Fabric Grade		C	D	E	F	G	H	Leather Grade A	Leather Grade B
		A	B								
Tetro Back Without Optional Upholstered Pad											
SCS- 4 5 -3 ■	\$318.24	N/A	N/A	N/A	N/A	N/A	N/A	N/A	N/A	N/A	N/A
Tetro Back With Upholstered Seat Pad											
SCS- ■ 5 -3 ■	N/A	\$365.04	\$395.20	\$427.44	\$442.00	\$455.52	\$482.56	\$508.56	\$577.20	\$504.40	\$629.04

Very

Side Chair – Tetro Back

Without Arms



SCS-45-0H

Dimensions

- SH: 18.2"(461mm)*
- H: 33.9"(861mm)
- D: 22"(559mm)
- W: 22.3"(566mm)
- SW: 19.2"(487mm)*
- SD: 17.5"(443mm)*

Features

- Back: High-strength polymer back with injection molded technology.
- Seat: High-strength polymer seat with an optional upholstered pad.
- Upholstered seat features 1"(25.4mm) foam pad.
- Frame: available painted or trivalent chrome.
- Casters: Hard (black), soft (black) or two-tone (fog and gray).
- Glides: Plastic or felt.
- Stacks 5 high on the floor and 8 high on a cart
- COM yardage / COL square footage:
Upholstered seat: .75/ 7.25

*All measurements taken with the BIFMA chair measuring device.

To Order, Specify:

1) Product number, including;

1 Seat or Seat Pad Option:

- 1 Leather
- 2 Fabric
- 3 Faux Leather
- 4 Polymer

2 Glide or Caster Option:

- H Plastic Glide
- K Felt Glide
- 1 Hard Casters, add **\$37.44** list
- 2 Soft Casters, add **\$37.44** list
- T Two-Tone Casters, add **\$37.44** list

- 2) Fabric surface and color (seat).
 - 3) Shell color – required for upholstered and non-upholstered.
 - 4) Add glide and plastic component trim color.
 - 5) Frame trim color.
- Trivalent Chrome (KR-V) add **\$161.20** list.

Number ① ②	Price	Fabric Grade		C	D	E	F	G	H	Leather Grade A	Leather Grade B
		A	B								
Tetro Back Without Optional Upholstered Pad											
SCS- 4 5 -0 ■	\$264.16	N/A	N/A	N/A	N/A	N/A	N/A	N/A	N/A	N/A	N/A
Tetro Back With Upholstered Seat Pad											
SCS- ■ 5 -0 ■	N/A	\$310.96	\$341.12	\$373.36	\$387.92	\$401.44	\$428.48	\$454.48	\$523.12	\$450.32	\$574.96

Very

Side Chair with Tablet Arm – Tetro Back

Side With Tablet Arm

SCS-45-RH

Dimensions

SH: 18.2"(461mm)
 H: 33.9"(861mm)
 W: 23.5"(597mm)
 D: 22"(559mm)
 SW: 19.2"(487mm)
 SD: 17.5"(443mm)

Features

- Back: High-strength polymer back with injection molded technology.
- Seat: High-strength polymer with an optional upholstery pad.
- Upholstered seat features 1"(25.4mm) foam pad.
- Arm cap: Black.
- Tablet assembly painted black.
- Flips up and fold away laminate tablet with matching laminate underside.
- Left or right-hand configurations.
- Tablet arm size: 15"W x 9.8"D (Sized to accommodate laptops).
- Clearance from tablet to chair back 12.5"(318mm)-15.5"(394mm) angled.
- Base: available painted or optional trivalent chrome.
- Glides or Casters.
- Standard with hard casters, black or two-tone.
- Optional black soft casters.
- COM yardage / COL square footage:
 Fully Upholstered: 1.5/13
 Upholstered seat: .75/7.25

*All measurements taken with the BIFMA chair measuring device.

To Order, Specify:

1) Product number.

1 Seat or Seat Pad Option:

- 1** Leather
- 2** Fabric
- 3** Faux Leather
- 4** Polymer

2 Arm or Tablet Option:

- R** Right-Hand Tablet Arm
- L** Left-Hand Tablet Arm

3 Glide or Caster Option:

- H** Plastic Glide
- K** Felt Glide
- 1** Hard Casters, add **\$37.44** list
- 2** Soft Casters, add **\$37.44** list
- T** Two-Tone Casters, add **\$37.44** list

2) Fabric surface and color (seat).

3) Shell color - required for upholstered and non-upholstered.

4) Glide and plastic component trim color.

5) Frame trim color.

Trivalent Chrome (KR-V) add **\$161.20** list.

6) Laminate for tablet (if specified).

Nano-Tex Upholstery:

Add a **P** to the end of the catalog code, and add **\$32.24** list.

Example: SCS-25-RHP

Description	Number 1 2 3	Price	Fabric Grade								Leather Grade A	Leather Grade B
			A	B	C	D	E	F	G	H		
Tetro Back Without Optional Upholstered Pad												
	SCS- 4 5- ■ ■	\$446.16	N/A	N/A	N/A	N/A	N/A	N/A	N/A	N/A	N/A	N/A
Tetro Back With Upholstered Seat Pad												
	SCS- ■ 5- ■ ■	N/A	\$492.96	\$523.12	\$555.36	\$569.92	\$583.44	\$610.48	\$636.48	\$705.12	\$632.32	\$756.96

Very

Side Chair with Storage Rack – Tetro Back

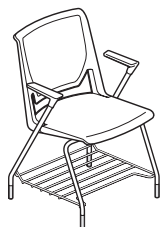

SCK-45-3H

Dimensions

SH: 18.2"(461mm)*
 H: 33.9"(861mm)
 W: 23.5"(597mm)
 D: 22"(559mm)
 SW: 19.2"(487mm)*
 SD: 17.5"(443mm)*
 AH: 8.9"(226mm)*

Between Arms:
 19.6"(498mm)

Features

- Back: High-strength polymer back with injection molded technology.
- Seat: Injection-molded high-strength polymer seat with an optional upholstery pad.
- Upholstered seat features 1"(25.4mm) foam pad.
- Storage rack ships unassembled (chrome only).
- Arms: Black or Fog arm caps when no tablet is specified.
- Optional Tablet arm:
 - Tablet assembly painted black.
 - Flips up and fold away laminate tablet with matching laminate underside.
 - Left or right-hand configurations.
 - Tablet arm size: 15"W x 9.8"D (Sized to accommodate laptops).
- Base: available painted or optional trivalent chrome.
- Glides or Casters: Standard with hard casters, black or two-tone.
- Optional black soft casters.
- COM yardage / COL square footage:
 - Fully Upholstered: 1.5/13
 - Upholstered seat: .75/7.25

*All measurements taken with the BIFMA chair measuring device.

To Order, Specify:

1) Product number.

1 Seat or Seat Pad Option:

- 1** Leather
- 2** Fabric
- 3** Faux Leather
- 4** Polymer

2 Arm or Cap Option:

- R** Right-Hand Tablet Arm, add **\$182.00** list
- L** Left-Hand Tablet Arm, add **\$182.00** list
- 0** No Arms
- 3** Fixed Arm, Hard Caps, add **\$54.08** list

3 Glide or Caster Option:

- H** Plastic Glide
- K** Felt Glide
- 1** Hard Casters, add **\$37.44** list
- 2** Soft Casters, add **\$37.44** list
- T** Two-Tone Casters, add **\$37.44** list

- 2) Fabric surface and color (seat).
- 3) Shell color - required for upholstered and non-upholstered.
- 4) Trim for arm caps (if specified) and glides.
- 5) Frame trim color.
Trivalent Chrome (KR-V) add **\$161.20** list.
- 6) Laminate for tablet (if specified).

Nano-Tex Upholstery:

Add a **P** to the end of the catalog code, and add **\$32.24** list.

Example: SCK-25-0HP

Description	Number			Price	Fabric Grade								Leather Grade A	Leather Grade B
	1	2	3		A	B	C	D	E	F	G	H		
Tetro Back Without Optional Upholstered Pad														
	SCK-	4	5-	\$331.76	N/A	N/A	N/A	N/A	N/A	N/A	N/A	N/A	N/A	
Tetro Back With Upholstered Seat Pad														
	SCK-	5-		N/A	\$378.56	\$408.72	\$440.96	\$455.52	\$469.04	\$496.08	\$522.08	\$590.72	\$642.56	

Very

Side Stool – Tetro Back

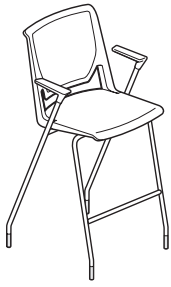

SCL-45-3H

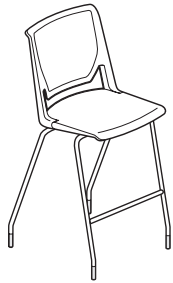

SCL-45-0H

Dimensions

SH: 29.75"(756mm)
 H: 46.25"(1175mm)
 W: 23.75"(604mm)
 D: 23"(587mm)
 SW: 18.75"(477mm)
 SD: 17.2"(434mm)
 AH: 8.9"(226mm)

Between Arms:
 19.6"(498mm)

Features

- Back: High-strength polymer back with injection molded technology.
- Seat: High-strength polymer seat with an optional upholstered pad.
- Upholstered seat features 1"(25.4mm) foam pad.
- Arms: Black or Fog high-strength polymer arm caps.
- Base: available painted or optional trivalent chrome.
- Stack 5 high on the floor.
- Standard with glides, Black or Fog.
- COM yardage / COL square footage:
 Fully Upholstered: 1.5/13
 Upholstered seat: .75/7.25

To Order, Specify:

1) Product number.

1 Seat or Seat Pad Option:

- 1 Leather
- 2 Fabric
- 3 Faux Leather
- 4 Polymer

2 Glide Option:

- H Plastic Glide
- K Felt Glide

- 2) Fabric surface and color (seat).
- 3) Shell color - required for upholstered and non-upholstered.
- 4) Trim for arm caps (if specified) and glides.
- 5) Frame trim color.
 Trivalent Chrome (KR-V) add **\$161.20** list.

Nano-Tex Upholstery:

Add a **P** to the end of the catalog code, and add **\$32.24** list.

Example: SCL-25-0HP

Description	Number		Price	Fabric Grade		C	D	E	F	G	H	Leather Grade A	Leather Grade B
	1	2		A	B								
Tetro Back Without Optional Upholstered Pad													
With Arms	SCL- 4	5-3	\$629.20	N/A	N/A	N/A	N/A	N/A	N/A	N/A	N/A	N/A	N/A
Without Arms	SCL- 4	5-0	575.12	N/A	N/A	N/A	N/A	N/A	N/A	N/A	N/A	N/A	N/A
Tetro Back With Upholstered Seat Pad													
With Arms	SCL-	5-3	N/A	\$676.00	\$706.16	\$738.40	\$752.96	\$766.48	\$793.52	\$819.52	\$888.16	\$815.36	\$940.00
Without Arms	SCL-	5-0	N/A	621.92	652.08	684.32	698.88	712.40	739.44	765.44	834.08	761.28	885.92

Very Seminar Chair – Tetro Back

With Arms



SCM-45-3H

Dimensions

- SH: 18.2"(461mm)*
- H: 33.9"(861mm)
- D: 22"(559mm)
- W: 23.5"(597mm)
- SW: 19.2"(487mm)*
- SD: 17.5"(443mm)*
- AH: 8.9"(226mm)*
- Between Arms:
19.6"(498mm)

Features

- Back: High-strength polymer back with injection molded technology.
- Seat: High-strength polymer seat with an optional upholstery pad.
- Weight assisted recline mechanism.
- Upholstered seat features 1"(25.4mm) foam pad.
- Arms: Black or Fog glass-filled polypropylene arm caps.
- Frame: available painted or trivalent chrome.
- Casters: Hard (black), soft (black) or two-tone (fog and gray).
- Glides: Plastic or felt.
- Stacks 5 high on the floor and 8 high on a cart
- COM yardage / COL square footage:
Upholstered seat: .75/7.25

*All measurements taken with the BIFMA chair measuring device.

To Order, Specify:

1) Product number, including;

1 Seat or Seat Pad Option:

- 1 Leather
- 2 Fabric
- 3 Faux Leather
- 4 Polymer

2 Glide or Caster Option:

- H Plastic Glide
- K Felt Glide
- 1 Hard Casters, add **\$47.84** list
- 2 Soft Casters, add **\$47.84** list
- T Two-Tone Casters, add **\$47.84** list

- 2) Fabric surface and color (seat).
- 3) Shell color – required for upholstered and non-upholstered.
- 4) Trim for arm caps, glides, and plastic components.
- 5) Frame trim color.
Trivalent Chrome (KR-V) add **\$161.20** list.

Description	Number		Price	Fabric Grade								Leather Grade A	Leather Grade B
	1	2		A	B	C	D	E	F	G	H		
Tetro Back Without Optional Upholstered Pad													
SCM- 4 5 -3			\$528.32	N/A	N/A	N/A	N/A	N/A	N/A	N/A	N/A	N/A	N/A
Tetro Back With Upholstered Seat Pad													
SCM- 5 -3			N/A	\$579.28	\$609.44	\$641.68	\$656.24	\$669.76	\$696.80	\$722.80	\$791.44	\$718.64	\$843.28

Very

Seminar Chair – Tetro Back

Without Arms



SCM-45-0H

Dimensions

SH: 18.2"(461mm)*
 H: 33.9"(861mm)
 D: 22"(559mm)
 W: 22.3"(566mm)
 SW: 19.2"(487mm)*
 SD: 17.5"(443mm)*

Features

- Back: High-strength polymer back with injection molded technology.
- Seat: High-strength polymer seat with an optional upholstery pad.
- Weight assisted recline mechanism.
- Upholstered seat features 1"(25.4mm) foam pad.
- Arms: Black or Fog glass-filled polypropylene arm caps.
- Frame: available painted or trivalent chrome.
- Casters: Hard (black), soft (black) or two-tone (fog and gray).
- Glides: Plastic or felt.
- Stacks 5 high on the floor and 8 high on a cart
- COM yardage / COL square footage:
 Upholstered seat: .75/7.25

*All measurements taken with the BIFMA chair measuring device.

To Order, Specify:

1) Product number, including;

① Seat or Seat Pad Option:

- 1 Leather
- 2 Fabric
- 3 Faux Leather
- 4 Polymer

② Glide or Caster Option:

- H Plastic Glide
- K Felt Glide
- 1 Hard Casters, add **\$47.84** list
- 2 Soft Casters, add **\$47.84** list
- T Two-Tone Casters, add **\$47.84** list

2) Fabric surface and color (seat).

3) Shell color – required for upholstered and non-upholstered.

4) Glide and plastic component trim color.

5) Frame trim color.

Trivalent Chrome (KR-V) add **\$161.20** list.

Description	Number		Price	Fabric Grade		C	D	E	F	G	H	Leather Grade A	Leather Grade B
	①	②		A	B								
Tetro Back Without Optional Upholstered Pad													
SCM- 4 5 -0	■		\$474.24	N/A	N/A	N/A	N/A	N/A	N/A	N/A	N/A	N/A	N/A
Tetro Back With Upholstered Seat Pad													
SCM- ■ 5 -0	■	■	N/A	\$525.20	\$555.36	\$587.60	\$602.16	\$615.68	\$642.72	\$668.72	\$737.36	\$664.56	\$789.20

Very

Seminar with Tablet Arm – Tetro Back

Seminar With Tablet Arm

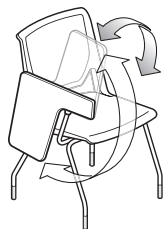

SCM-45-RH

Dimensions

- SH: 18.2"(461mm)*
- H: 33.9"(861mm)
- W: 23.5"(597mm)
- D: 22"(559mm)
- SW: 19.2"(487mm)*
- SD: 17.5"(443mm)*

Features

- Back: High-strength polymer back with injection molded technology.
- Seat: High-strength polymer with an optional upholstery pad.
- Weight assisted recline mechanism.
- Upholstered seat features 1"(25.4mm) foam pad.
- Arm caps: Black.
- Tablet assembly painted black.
- Clearance from tablet to chair back 12.5"(318mm)-15.5"(394mm) angled.
- Flips up and fold away laminate tablet with matching laminate underside.
- Left or right-hand configurations.
- Tablet arm size: 15"W x 9.8"D (Sized to accommodate laptops).
- Base: available painted or optional trivalent chrome.
- Glides or Casters.
- Standard with hard casters, black or two-tone.
- Optional black soft casters.
- COM yardage / COL square footage:
Fully Upholstered: 1.5/13
Upholstered seat: .75/7.25

*All measurements taken with the BIFMA chair measuring device.

To Order, Specify:

- 1) Product number.
- 1 Seat or Seat Pad Option:**
 - 1** Leather
 - 2** Fabric
 - 3** Faux Leather
 - 4** Polymer
- 2 Arm or Tablet Option:**
 - R** Right-Hand Tablet Arm
 - L** Left-Hand Tablet Arm
- 3 Glide or Caster Option:**
 - H** Plastic Glide
 - K** Felt Glide
 - 1** Hard Casters, add **\$47.84** list
 - 2** Soft Casters, add **\$47.84** list
 - T** Two-Tone Casters, add **\$47.84** list
- 2) Fabric surface and color (seat).
- 3) Shell color - required for upholstered and non-upholstered.
- 4) Glide and plastic component trim color.
- 5) Frame trim color.
Trivalent Chrome (KR-V) add **\$161.20** list.
- 6) Laminate for tablet (if specified).

Nano-Tex Upholstery:

Add a **P** to the end of the catalog code, and add **\$32.24** list.
Example: SCM-25-RHP

Description	Number ① ② ③	Price	Fabric Grade								Leather Grade A	Leather Grade B
			A	B	C	D	E	F	G	H		
Tetro Back Without Optional Upholstered Pad												
	SCM- 4 5- ■ ■	\$656.24	N/A	N/A	N/A	N/A	N/A	N/A	N/A	N/A	N/A	N/A
Tetro Back With Upholstered Seat Pad												
	SCM- ■ 5- ■ ■	N/A	\$707.20	\$737.36	\$769.60	\$784.16	\$797.68	\$824.72	\$850.72	\$919.36	\$846.56	\$971.20

Very

Seminar with Storage Rack – Tetro Back

Seminar With Storage Rack



SCB-45-3H

Dimensions

SH: 18.2"(461mm)*
 H: 33.9"(861mm)
 W: 23.5"(597mm)
 D: 22"(559mm)
 SW: 19.2"(487mm)*
 SD: 17.5"(443mm)*
 AH: 8.9"(226mm)*

Between Arms:
 19.6"(498mm)

Features

- Back: High-strength polymer back with back with injection molded technology.
- Seat: High-strength polymer seat with an optional upholstery pad.
- Weight assisted recline mechanism.
- Upholstered seat features 1"(25.4mm) foam pad.
- Arms: Black or Fog arm caps.
- Storage rack available in Chrome only.
- Ships with chair, unassembled.
- Tablet assembly painted black.
- Flips up and fold away laminate tablet with matching laminate underside.
- Left or right-hand configurations.
- Tablet arm size: 15"W x 9.8"D (Sized to accommodate laptops).
- Base: available painted or optional trivalent chrome.
- Glides or Casters: Standard with hard casters, black or two-tone.
- Optional black soft casters.
- Weight: COM yardage / COL square footage:
 Fully Upholstered: 1.5/13
 Upholstered seat: .75/7.25

*All measurements taken with the BIFMA chair measuring device.

To Order, Specify:

1) Product number.

1 Seat or Seat Pad Option:

- 1 Leather
- 2 Fabric
- 3 Faux Leather
- 4 Polymer

2 Arm or Cap Option:

- R Right-Hand Tablet Arm, add **\$182.00** list
- L Left-Hand Tablet Arm, add **\$182.00** list
- 0 No Arms
- 3 Fixed Arm, Hard Caps, add **\$54.08** list

3 Glide or Caster Option:

- H Plastic Glide
- K Felt Glide
- 1 Hard Casters, add **\$47.84** list
- 2 Soft Casters, add **\$47.84** list
- T Two-Tone Casters, add **\$47.84** list

- 2) Fabric surface and color (seat).
- 3) Shell color - required for upholstered and non-upholstered.
- 4) Trim for arm caps (if specified) and glides.
- 5) Frame trim color.
 Trivalent Chrome (KR-V) add **\$161.20** list.
- 6) Laminate for tablet (if specified).

Nano-Tex Upholstery:

Add a **P** to the end of the catalog code, and add **\$32.24** list.

Example: SCB-25-RHP

Description	Number			Price	Fabric Grade		C	D	E	F	G	H	Leather Grade A	Leather Grade B
	1	2	3		A	B								
Tetro Back Without Optional Upholstered Pad														
	SCB- 4	5-	■ ■	\$541.84	N/A	N/A	N/A	N/A	N/A	N/A	N/A	N/A	N/A	N/A
Tetro Back With Upholstered Seat Pad														
	SCB-	■	5-	■ ■ ■	N/A	\$592.80	\$622.96	\$655.20	\$669.76	\$683.28	\$710.32	\$736.32	\$804.96	\$856.80

Very Tetro Back Conference Chair and Conference Stool

General Specifications

**Features and Options
(Conference Chair and
Conference Stool)**

- Back: High-strength polymer back with injection molded technology
- Seat: High-strength polymer seat with an optional upholstered foam pad
- Five-star base with casters: hard (black), soft (black) or two-tone (fog and gray)
- Base: painted aluminum, polished aluminum or plastic (fog or black)
- Frame finishes include: painted or polished aluminum
- Weight assisted recline mechanism
- Standard Pneumatic height adjustment
- Fog or black trim arm caps
- Arm or armless version available
- Adjustable footring in brushed aluminum (stool only)

**General Guidelines for
Product Specification**

	<u>S</u>	<u>C</u>	<u>C</u>	<u>-</u>	<u>2</u>	<u>5</u>	<u>-</u>	<u>1</u>	<u>1</u>	<u>3A-18</u>	<u>TR-FA</u>	<u>TR-F</u>	<u>TR-LE</u>
Product Type	_____												
(S) Seating	_____												
Product Line	_____												
(C) Very	_____												
Model	_____												
(C) Conference	_____												
(F) Stool	_____												
Seat Upholstery	_____												
(1) Leather	_____												
(2) Fabric	_____												
(3) Faux Leather	_____												
(4) Polymer	_____												
Back Upholstery	_____												
(5) Tetro Back	_____												
Arm/Caps	_____												
(0) No Arms	_____												
(1) Fixed Arms, Soft Caps	_____												
Base/Caster	_____												
(1) Aluminum Standard Base, Hard Caster	_____												
(2) Aluminum Standard Base, Soft Caster	_____												
(3) Aluminum Low Base, Hard Caster	_____												
(4) Aluminum Low Base, Soft Caster	_____												
(5) Plastic Standard Base, Hard Caster	_____												
(6) Plastic Standard Base, Soft Caster	_____												
(7) Plastic Low Base, Hard Caster	_____												
(8) Plastic Low Base, Soft Caster	_____												
(N) Plastic Low Base, Two-Tone Casters	_____												
(P) Plastic Standard Base, Two-Tone Casters	_____												
(R) Aluminum Low Base, Two-Tone Casters	_____												
(T) Aluminum Standard Base, Two-Tone Casters	_____												
Seat Upholstery	_____												
Tellure	_____												
Shell Color	_____												
Tomato	_____												
Trim Color	_____												
Black	_____												
Frame Trim Color	_____												
Metallic Silver	_____												

Very

Conference Chair - Tetra Back

With Arms



SCC-45-11

Dimensions

SH: 15.5"(394mm)-
20.5"(521mm)*
H: 36.9"(937mm)
D: 26.7"(678mm)
W: 21.8"(554mm)
SW: 19.2"(487mm)*
SD: 17.5"(443mm)*
AH: 8.7"(220mm)*
Between Arms:
20.8"(528mm)

Features

- Back: High-strength polymer with injection molded technology.
- Seat: High-strength polymer with an optional upholstered foam pad.
- Upholstered seat features 1"(25.4mm) foam pad.
- Arms: Black or Fog glass-filled polypropylene soft arm caps.
- Base: Standard five-star all aluminum or all plastic base. Optional low-base range 14.4"(366mm)-19.4(493mm).
- 5"(127mm) height adjustment.
- Weight assisted recline mechanism.
- Casters: Hard (black), soft (black) or two-tone (fog and gray).
- Back tilts backward 14° from the upright position. Additional recline achieved in flexible back.
- Painted or optional polished aluminum.
- COM yardage / COL square footage:
Upholstered seat: .75/7.25

*All measurements taken with the BIFMA chair measuring device.

To Order, Specify:

1) Product number, including;

① Seat or Seat Pad Option:

- 1 Leather
- 2 Fabric
- 3 Faux Leather
- 4 Polymer

② Base/Caster Option:

Aluminum Base

- 1 Aluminum Std. Base, Hard Caster
- 2 Aluminum Std. Base, Soft Caster
- 3 Aluminum Low Base, Hard Caster
- 4 Aluminum Low Base, Soft Caster

Plastic Base

- 5 Plastic Std. Base, Hard Caster
- 6 Plastic Std. Base, Soft Caster
- 7 Plastic Low Base, Hard Caster
- 8 Plastic Low Base, Soft Caster

Two-Tone Casters

- N Plastic Low Base, Two-Tone Casters
- P Plastic Std. Base, Two-Tone Casters
- R Aluminum Low Base, Two-Tone Casters
- T Aluminum Std. Base, Two-Tone Casters

- 2) Fabric surface and color (seat).
- 3) Shell color – required for upholstered and non-upholstered.
- 4) Trim for arm caps, plastic components and base (plastic base only).
- 5) Trim color for frame, aluminum base and control housing.

Polished Aluminum (PM-P) add \$161.20 list.

Tetra Back - Aluminum Base	Number		Price	Fabric Grade								Leather Grade A	Leather Grade B	
	①	②		A	B	C	D	E	F	G	H			
Without Optional Upholstered Pad														
	SCC-	4 5 -1	\$835.12	N/A	N/A	N/A	N/A	N/A	N/A	N/A	N/A	N/A	N/A	N/A
With Upholstered Seat Pad														
	SCC-	5 -1	N/A	\$891.28	\$921.44	\$953.68	\$968.24	\$981.76	\$1008.80	\$1034.80	\$1103.44	\$1030.64	\$1155.28	

Tetra Back - Plastic Base	Number		Price	Fabric Grade								Leather Grade A	Leather Grade B	
	①	②		A	B	C	D	E	F	G	H			
Without Optional Upholstered Pad														
	SCC-	4 5 -1	\$728.00	N/A	N/A	N/A	N/A	N/A	N/A	N/A	N/A	N/A	N/A	N/A
With Upholstered Seat Pad														
	SCC-	5 -1	N/A	\$784.16	\$814.32	\$846.56	\$861.12	\$874.64	\$901.68	\$927.68	\$996.32	\$923.52	\$1048.16	

Very

Conference Chair - Tetro Back

Without Arms



SCC-45-01

Dimensions

SH: 15.5"(394mm)-
20.5"(521mm)*
H: 36.9"(937mm)
D: 26.7"(678mm)
W: 19.4"(493mm)
SW: 19.2"(487mm)*
SD: 17.5"(443mm)*

Features

- Back: High-strength polymer with injection molded technology.
- Seat: High-strength polymer with an optional upholstered foam pad.
- Upholstered seat features 1"(25.4mm) foam pad.
- Base: Standard five-star all aluminum or all plastic base. Optional low-base range 14.4"(366mm)-19.4(493mm)
- 5"(127mm) height adjustment.
- Weight assisted recline mechanism.
- Casters: Hard (black), soft (black) or two-tone (fog and gray).
- Back tilts backward 14° from the upright position. Additional recline achieved in flexible back.
- Painted or optional polished aluminum.
- COM yardage / COL square footage:
Upholstered seat: .75/7.25

*All measurements taken with the BIFMA chair measuring device.

To Order, Specify:

1) Product number, including;

① Seat or Seat Pad Option:

- 1 Leather
- 2 Fabric
- 3 Faux Leather
- 4 Polymer

② Base/Caster Option:

Aluminum Base

- 1 Aluminum Std. Base, Hard Caster
- 2 Aluminum Std. Base, Soft Caster
- 3 Aluminum Low Base, Hard Caster
- 4 Aluminum Low Base, Soft Caster

Plastic Base

- 5 Plastic Std. Base, Hard Caster
- 6 Plastic Std. Base, Soft Caster
- 7 Plastic Low Base, Hard Caster
- 8 Plastic Low Base, Soft Caster

Two-Tone Casters

- N Plastic Low Base, Two-Tone Casters
- P Plastic Std. Base, Two-Tone Casters
- R Aluminum Low Base, Two-Tone Casters
- T Aluminum Std. Base, Two-Tone Casters

- 2) Fabric surface and color (seat).
3) Shell color – required for upholstered and non-upholstered.
4) Trim for arm caps, plastic components and base (plastic base only).
5) Trim color for frame, aluminum base and control housing.
Polished Aluminum (PM-P) add \$161.20 list.

Tetro Back - Aluminum Base	Number		Price	Fabric Grade								Leather Grade A	Leather Grade B	
	①	②		A	B	C	D	E	F	G	H			
Without Optional Upholstered Pad														
	SCC-	4 5 -0	\$770.64	N/A	N/A	N/A	N/A	N/A	N/A	N/A	N/A	N/A	N/A	N/A
With Upholstered Seat Pad														
	SCC-	5 -0	N/A	\$826.80	\$856.96	\$889.20	\$903.76	\$917.28	\$944.32	\$970.32	\$1038.96	\$966.16	\$1090.80	

Tetro Back - Plastic Base	Number		Price	Fabric Grade								Leather Grade A	Leather Grade B	
	①	②		A	B	C	D	E	F	G	H			
Without Optional Upholstered Pad														
	SCC-	4 5 -0	\$663.52	N/A	N/A	N/A	N/A	N/A	N/A	N/A	N/A	N/A	N/A	N/A
With Upholstered Seat Pad														
	SCC-	5 -0	N/A	\$719.68	\$749.84	\$782.08	\$796.64	\$810.16	\$837.20	\$863.20	\$931.84	\$859.04	\$983.68	

Very

Conference Stool – Tetro Back



SCF-45-11



SCF-45-01

Dimensions

SH: 23"-32"
(584mm-813mm)
W: 21.8"(554mm)
D: 26.7"(678mm)
SW: 18.7"(477mm)
SD: 17.2"(434mm)
AH: 8.7"(221mm)

Between Arms:
19.6"(498mm)

Features

- Back: High-strength polymer with injection molded technology.
- Seat: High-strength polymer with an optional upholstered foam pad.
- Weight assisted recline mechanism.
- Upholstered seat features 1"(25.4mm) foam pad.
- Arms: Black or Fog hard arm caps.
- Base: Standard five-star all aluminum or all plastic base.
- Footring: Brushed Aluminum finish.
- Adjustable footring: adjusts 4"(102mm) up and down.
- Casters: Standard with hard casters, black or two-tone.
- Optional black soft casters.
- COM yardage / COL square footage:
Fully Upholstered: 1.5/13
Upholstered seat: .75/7.25

To Order, Specify:

1) Product number.

1 Seat or Seat Pad Option:

- 1 Leather
- 2 Fabric
- 3 Faux Leather
- 4 Polymer

2 Arm or Cap Option:

- 0 No Arms
- 1 Fixed Arm, Hard Caps, add \$128.96 list

3 Base or Caster Option:

Aluminum Base

- 1 Aluminum Std. Base, Hard Casters
- 2 Aluminum Std. Base, Soft Casters
- T Aluminum Std. Base, Two-Tone Casters

Plastic Base

- 5 Plastic Std. Base, Hard Casters
- 6 Plastic Std. Base, Soft Casters
- P Plastic Std. Base, Two-Tone Casters

- 2) Fabric surface and color (seat).
- 3) Fabric surface and color (back).
- 4) Shell color - required for upholstered and non-upholstered.
- 5) Trim for arm caps (if specified). (base if plastic is specified above).
- 6) Frame trim color- Aluminum components (base if aluminum and arm uprights).

Polished Aluminum (PM-P) add \$161.20 list.

Nano-Tex Upholstery:

Add a **P** to the end of the catalog code, and add \$32.24 list.

Example: SCF-25-11P

Description	Number			Price	Fabric Grade						Leather Grade A	Leather Grade B		
	1	2	3		A	B	C	D	E	F			G	H
Aluminum Base Without Optional Upholstered Pad														
SCF- 4 5-	■	■		\$1075.36	N/A	N/A	N/A	N/A	N/A	N/A	N/A	N/A	N/A	
Aluminum Base With Upholstered Seat Pad														
SCF- 5-	■	■		N/A	\$1131.52	\$1161.68	\$1193.92	\$1208.48	\$1222.00	\$1249.04	\$1275.04	\$1343.68	\$1270.88	\$1395.52
Plastic Base Without Optional Upholstered Pad														
SCF- 4 5-	■	■		\$ 968.24	N/A	N/A	N/A	N/A	N/A	N/A	N/A	N/A	N/A	
Plastic Base With Upholstered Seat Pad														
SCF- 5-	■	■		N/A	\$1024.40	\$1054.56	\$1086.80	\$1101.36	\$1114.88	\$1141.92	\$1167.92	\$1236.56	\$1163.76	\$1288.40

	Description	Number	Price
Wire Stacker Storage Rack	Storage Rack	SCHR-1	\$67.60



SCHR-1

Features

- Chrome only.
- Recommended for use with Chrome chairs for durability and common finishes.
- Ships separate from chair (installation clips included).

To Order, Specify:

- 1) Product number.
(No finish specification required.)

Wire Stacker Tablet Arm	Right Tablet Arm	SCHA-R	\$145.60
	Left Tablet Arm	SCHA-L	\$145.60

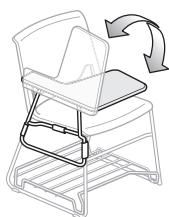

SCHA-R

Features

- Ships unassembled.
- Flips up for access.
- Tablet assembly chrome.
- Clearance from tablet to chair back 12.5"(318mm)-15.5"(394mm) angled.
- Recommended for use with Chrome chairs for durability and common finishes.
- Laminate tablet with matching laminate underside.
- Tablet arm size: 15"W x 9.8"D (Sized to accommodate laptops).
- Left or right-hand configurations.

To Order, Specify:

- 1) Product number.
- 2) Laminate surface specification.

Note: Tool from 2474-7601 required for installation. Every order for 1-30 chairs will come with 1 installation tool (ie, a 90 chair order will come with 3 tools).

Ganging Connector	Arm to Armless and Armless to Armless	SCSG-1	\$13.52
	Arm to Arm	SCSG-2	\$14.17

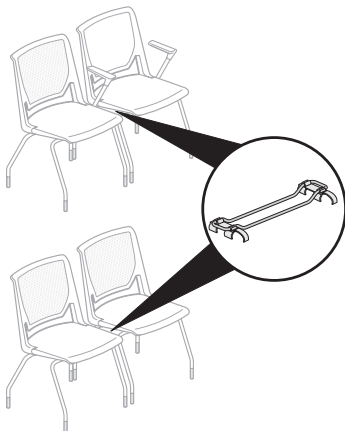

SCSG-1

Features

- Field retrofittable.
- Recommended for use on chairs with glides only.
- Release for fire safety.

To Order, Specify:

- 1) Product number.
(No finish specification required.)

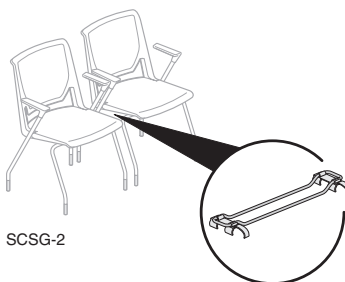

SCSG-2

Very

Accessories

	Description	Number	Price
Stacking Carts	Stacking Cart	SCT-1	\$409.76



SCT-1

Features

- Stacking dimensions:
 - With or Without Arms:**
 - 40 chairs on cart (75 1/2" high x 39 1/2" deep x 24" wide)
 - 10 chairs on the floor (39 1/4" high x 23" wide x 33" deep)
 - Upholstered Seat:**
 - 25 maximum stack quality on cart
 - 25 armless on cart (61" high x 40 1/2" deep x 24" wide)
 - 25 with arms on cart (69" high x 38" deep x 24" wide)
- Standard in black finish color only.
- Not for use with Wire Stacker stools.

To Order, Specify:

- Product number.
(No color specification required.)

Stacking Carts	Side/Seminar Chairs with Arms	SCT-3	\$343.20
	Side/Seminar Chairs without Arms	SCT-4	343.20

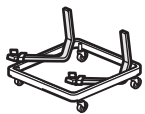
SCT-3
SCT-4

Features

- Permits stacking 8-high.
- Standard in black finish color only.
- Cart Only Dimensions:**
 - SCT-3**
25.5"(648mm) x 27"(685mm) x 13.8"(352mm)
(wt: 10.09kg)
 - SCT-4**
25.5"(648mm) x 30"(772mm) x 14.1"(359mm)
(wt: 10.09kg)
- Not for use with Side Stools.

To Order, Specify:

- Product number.
(No color specification required.)

Very Task

General Specifications

At-A-Glance

The Very Task chair offers state-of-the-art ergonomic support, at a sensible price point. Very Task offers Haworth's patented asymmetrical lumbar along with supporting mesh. A clean simple aesthetic, with unlimited choices, allowing you to personalize how you want to sit and work.

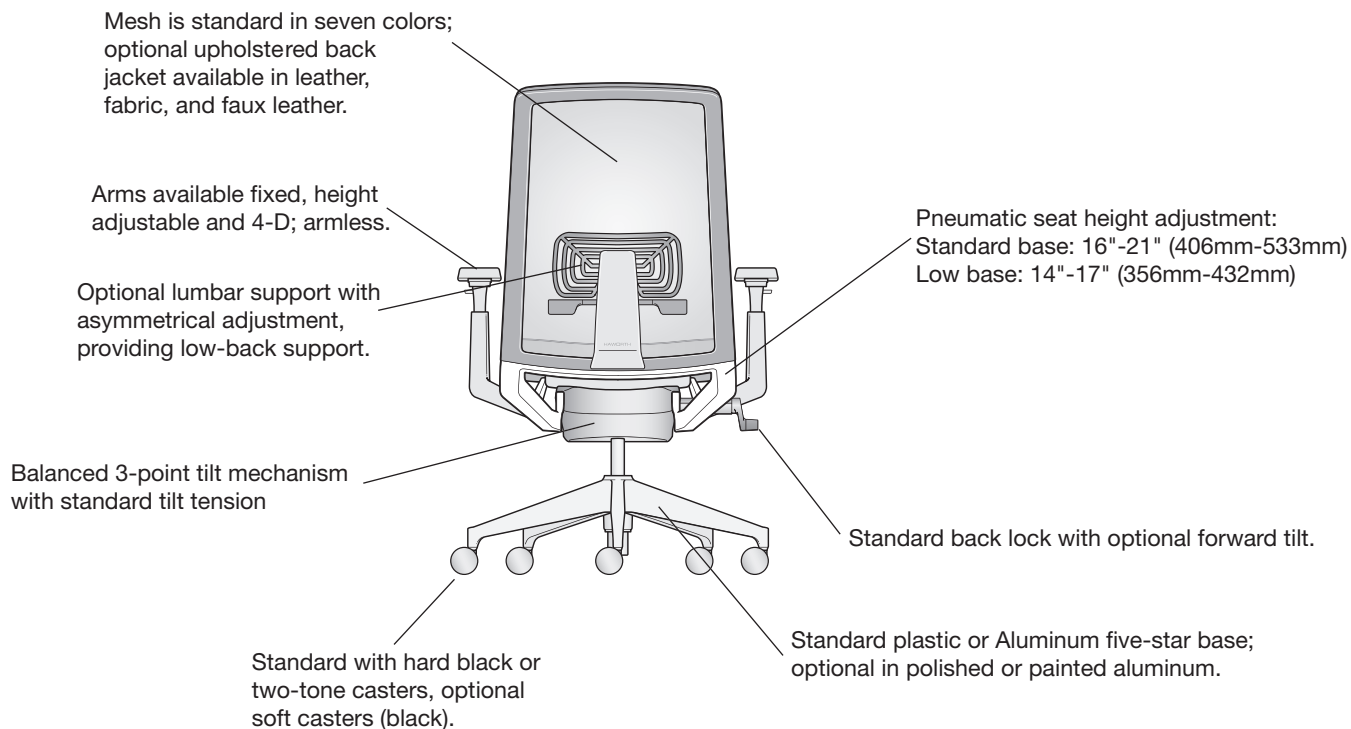

Very Task

General Specifications

Features and Options (Task Chair)

- Back: Mesh with optional upholstered back jacket.
- Seat: Standard upholstered with foam.
- Seat Type: Standard depth adjustable range 16"-19" (406mm-483mm).
- Base: Standard plastic or optional painted five-star aluminum base or optional polished aluminum.
- Optional low base 14"-17"(356mm-432mm) (not available in high polished)
- Arms: 4D, Height Adjustable arms, fixed arms with soft arm caps. Armless model available.
- Mechanism: Balanced 3-point tilt; standard tilt tension.
- Height adjustment: Pneumatic or low-position pneumatic.
- Standard Back lock.
- Optional Forward Tilt: 5 degrees downward from initial position.
- Optional Adjustable Lumbar: 4" adjustment, flexible support.
- Optional Headrest: Height adjustable with articulating movement.
- Casters: Five-star base with casters: hard (black or two-tone (fog and gray), soft (black).
- Very task chairs are warranted for persons up to 300 lbs. for 12 years 24/7.

General Guidelines for Product Specification

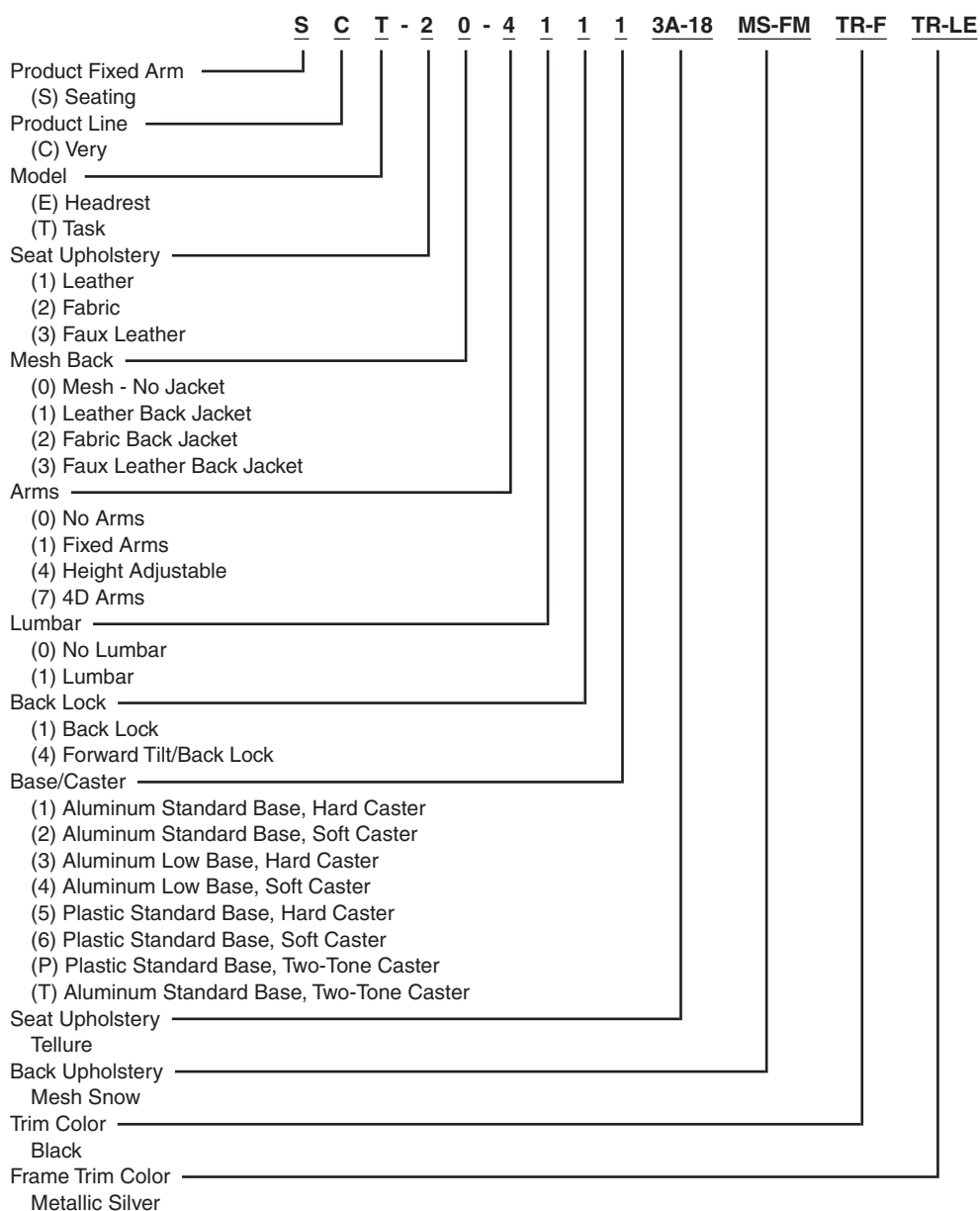

Very Task

General Specifications

Environmental Factors	<ul style="list-style-type: none"> • Very Task is BIFMA level 2 certified. • Greenguard Children and Schools certified for low emissions. • Very has up to 65% recycled content and is up to 98% recyclable. • Very is produced in an ISO 14001 certified manufacturing facility. • Very Task is part of the Haworth Take Back Program. • Haworth will take back Very chairs after their useful life and recycle the components. Please contact Haworth's Material Recovery Center at (616)393-1215.
COM & COL General Information	<p>To order a COM fabric (Customer's Own Material), contact the Haworth Inquiry Center (1.800.426.8562), your local Haworth dealer, or go to haworth.com/surfaces > COM Library to find out if the COM you have selected has already been tested and approved. The surface collection site also has information on the Haworth+ alliance program with Carnegie, Luna Textiles, and Maharam as well as our industry-leading Pre-Approved COM program.</p> <p>Approved COMs are placed into Grades based on the fabric pricing; if the fabric pricing exceeds our Grades, they will be priced at Grade A + cost of fabric + 4% handling (North America). Haworth will purchase all COMs unless instructed otherwise. (Leather will also be purchased by Haworth; if the leather pricing exceeds our Grades, cost will be based on fabric Grade E + cost of leather + 4% handling.)</p> <p>If no information is available on the COM you are looking for, refer to the COM section and forms on the surface collection site for information on how to process your test request.</p>
Finishes and Fabrics	A complete listing of finishes and fabrics for Very seating is available in the back of the price list.
Shipping Weights (Including packaging)	<ul style="list-style-type: none"> • Chairs with arms: 55.2 pounds/1 chair per carton/17.37 cubic feet • Chairs without arms: 51.2 pounds/1 chair per carton/17.37 cubic feet
Seat	Stitched double seams. Vertically in the center and on the edges of the leather seat cushion.
Back	Vertical stitched double seams on the upholstered back jacket with leather and faux leather or Customers Own Leather or COM faux leather.

Very Task

General Specifications

STANDARD MOBILITY AND ADJUSTABILITY

Balanced 3-point tilt

**Features:**

- Balanced 3-point tilt mechanism.
- Back reclines 20° from the upright position.
- Seat pan moves downward 3° from the initial position.
- 2:1 recline ratio.

Benefits:

- Comfortable relaxed posture.
- Recline allows for the opening of the users' chest cavity providing good airflow to promote alertness.
- Users' feet remain flat on the floor.

Tilt Tension Control

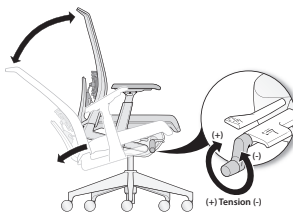
**Feature:**

- Easy-to-reach and easy-to-activate side-mounted unlimited tilt tension control regulates the amount of resistance felt when leaning back in the chair and the effort required to recline the chair backwards.

Benefit:

- Personalized support to accommodate users of different body types and different work styles.

Seat Height Adjustment

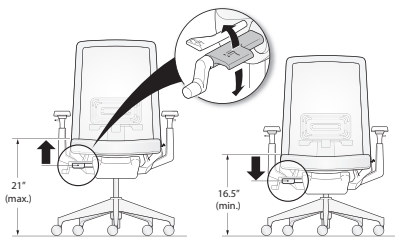
**Features:**

- Pneumatic seat height adjustment.
- Seat height adjusts 5"(127mm) from 16" to 21"(406mm to 533mm) in standard models. Low-position adjusts 14" to 17"(356 to 432mm).

Benefits:

- Ensures the comfort of the lower limbs by avoiding pressure on the underside of the thigh caused by a seat pan that is too high, or decreased thigh-to-torso angle if the seat pan is too low.
- Seat height adjustment also is important in setting the proper hand position and allowing for a proper sitting eye height.

Seat Depth Adjustment

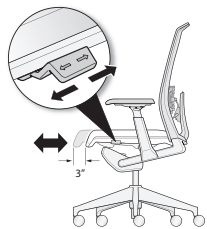
**Features:**

- 3"(76mm) of seat depth range.

Benefit:

- Supports the thighs, allows users to rest against the seat back for back support, and avoids pressure on the back of the knees of small to tall users.

Back Lock

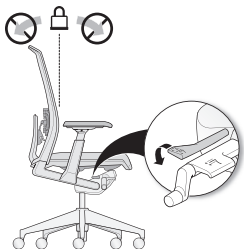
**Feature:**

- Single position Back Lock.

Benefit:

- Allows users to lock the back of the chair in the upright position for tasking application.

Very Task

General Specifications

OPTIONAL MOBILITY AND ADJUSTABILITY

Lumbar Support**Features:**

- Asymmetrical Left/right Lumbar Adjustment adjusts 4"(102mm) in height, flexible lumbar support with depth adjustment.

Benefits:

- Lumbar adjustment maintains the natural curvature of the spine at the lower back and allows users to choose the support that feels right for them.

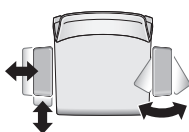
4D Arm**Features:**

- Optional 4D arm.
- Arm adjusts in 4 ways:
 - Height adjustment: 4"(102mm)
 - Side-to-side arm cap adjustment range: 3"(76mm) [1.5"(38.1mm) each arm cap]
 - Front-to-back adjustment range: 3 1/2"(89mm)
 - Pivoting: In 20°; out 20°

Benefits:

- Arms support the muscular system of users' neck and shoulders and proper arm support provides back relief. Arms can be an aid in standing or sitting down.
- Height adjustment accommodates for users with varying elbow rest heights so that users avoid lifting their shoulders or leaning sideways to get arm support.
- Front-to-back adjustment adjusts the armrest length, which is important because it allows users to get close to the worksurface while maintaining the effective use of the backrest.
- Side-to-side adjustment ensures a comfortable resting position for the arms with proper support of the forearm while allowing for easy entry/exit of the chair.
- Pivoting provides proper support of the forearm when performing tasks involving keying and mousing.

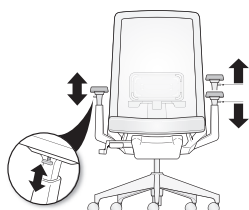
Adjustable Height Arm**Feature:**

- Optional height adjustable arms adjust 4"(102mm) vertically.

Benefit:

- Height adjustment accommodates users with varying elbow rest heights so that users avoid lifting their shoulders or leaning sideways to get arm support.

Forward Tilt**Features:**

- Optional forward tilt.
- 5°

Benefit:

- Allows users the ability to elect an upright forward position.

Headrest**Features:**

- Height adjustable 4.2"(107mm), articulating movement of headrest pad and mount to fit a wide range of users.
- Headrest is TPU material. Available in two finishes; Black or fog, coordinates with the chairs arm rest color specified.
- See price pages for specification (available on all models).
- To add a head rest to an existing model in the field order service part: Back and Headrest placement, see e-Parts.

Very Task

Task Chair with 4D Arms



SCT-20-7011

Dimensions*

SH: 16-21"(406mm-533mm)
 H: 39-44"(991mm-1118mm)
 D: 26"(660mm)
 W: 27"(686mm)
 SW: 19"(483mm)

Low Base:
 14-17"(356mm-432mm)

* All measurements taken with the BIFMA chair measuring device.

Features

- Back: Soft mesh or mesh back with upholstered back jacket.
- Seat: Standard upholstered foam (3 lbs. polyurethane foam construction).
- Seat Depth Adjustment: Standard adjustable range 16"-19" (406mm-483mm).
- Base: Plastic base or optional painted five-star aluminum or polished aluminum base.
- Arms: 4D with soft arm caps. Arm adjusts up and down, side to side.
- Mechanism: Balanced 3-point tilt; standard tilt tension.
- Back Lock: Single position upright back lock.
- Optional Forward Tilt: 5 degrees downward from initial position.
- Optional Asymmetrical Lumbar Adjustment: 4"(102mm) height adjustment; support level can be adjusted independently for right or left hand side of users body.
- Casters: Standard with hard black or two-tone casters; optional soft casters.
- COM yardage / COL square footage:
 Mesh back model: 0.83/20
 Mesh back/upholstered back jacket: 1.5/40

NOTE: When specifying a back jacket; must also specify mesh surface color for outside of back. Back jacket is not field retrofittable. To add a back jacket in the field, see e-Parts for replacement back with an attached jacket.

■ Available on RUSH.

To Order, Specify:

1) Product number, including:

1 Base/Caster Option:**Aluminum Base**

- 1** Aluminum Std. Base, Hard Caster
- 2** Aluminum Std. Base, Soft Caster
- T** Aluminum Std. Base, Two-Tone Casters
- 3** Aluminum Low Base, Hard Caster
- 4** Aluminum Low Base, Soft Caster

Plastic Base

- 5** Plastic Std. Base, Hard Caster
- 6** Plastic Std. Base, Soft Caster
- P** Plastic Std. Base, Two-Tone Casters

2) Fabric surface and color (seat).

3) Mesh surface and color (back).

4) Back Jacket (if applicable) Fabric surface and color.

5) Base

A. Aluminum

1. Trim color for plastic components (arm caps, control cover, adjustment levers, 4D or height adjustable arm uprights).
2. Trim color for aluminum base, back uprights, fixed arm uprights if specified. (Add **\$161.20** for polished aluminum.)

B. Plastic

1. Trim color for frame (trim color for base frame, plastic adjustment levers, control cover, and plastic base). (Add **\$161.20** for polished aluminum.)
2. Trim color for aluminum components (back uprights and fixed arm uprights if specified).

Leather Seat with Mesh Back:

Change the fourth digit in the product number to 1.

Example: SCT-10-7011

Leather Seat with Leather Upholstered Back Jacket:

Change the fourth and fifth digits in the product number to 11.

Example: SCT-11-7011

Faux Leather Seat with Mesh Back:

Change the fourth digit in the product number to 3.

Example: SCT-30-7011

Nano-Tex Upholstery:

Change the tenth digit in the product number to **P**, and add **\$32.24** list.

Example: SCT-20-7011**P**

Note: Nano-Tex is available on SCT-20 and SCT-22 models only.

Very Task

Task Chair with 4D Arms

Upholstered Seat Adjustments	Number ①	Fabric Grade								Leather Grade A	Leather Grade B
		A	B	C	D	E	F	G	H		
Plastic Base - Mesh Back											
Back Lock	SCT-20-701	\$ 792.48	\$ 821.60	\$ 852.80	\$ 867.36	\$ 879.84	\$ 906.88	\$ 931.84	\$ 998.40	\$1057.68	\$1187.48
Forward Tilt/Back Lock	SCT-20-704	849.68	878.80	910.00	924.56	937.04	964.08	989.04	1055.60	1114.88	1244.68
Plastic Base - Upholstered Back Jacket											
Back Lock	SCT-22-701	\$ 901.68	\$ 959.92	\$1022.32	\$1051.44	\$1076.40	\$1130.48	\$1180.40	\$1313.52	\$1432.08	\$1561.88
Forward Tilt/Back Lock	SCT-22-704	958.88	1017.12	1079.52	1108.64	1133.60	1187.68	1237.60	1370.72	1489.28	1619.08
Plastic Base with Lumbar Adjustment - Mesh Back											
Back Lock	SCT-20-711	\$ 865.28	\$ 894.40	\$ 925.60	\$ 940.16	\$ 952.64	\$ 979.68	\$1004.64	\$1071.20	\$1130.48	\$1260.28
Forward Tilt/Back Lock	SCT-20-714	922.48	951.60	982.80	997.36	1009.84	1036.88	1061.84	1128.40	1187.68	1317.48
Plastic Base with Lumbar Adjustment - Upholstered Back Jacket											
Back Lock	SCT-22-711	\$ 974.48	\$1032.72	\$1095.12	\$1124.24	\$1149.20	\$1203.28	\$1253.20	\$1386.32	\$1504.88	\$1634.68
Forward Tilt/Back Lock	SCT-22-714	1031.68	1089.92	1152.32	1181.44	1206.40	1260.48	1310.40	1443.52	1562.08	1691.88
Aluminum Base - Mesh Back											
Back Lock	SCT-20-701	\$ 844.48	\$ 873.60	\$ 904.80	\$ 919.36	\$ 931.84	\$ 958.88	\$ 983.84	\$1050.40	\$1109.68	\$1239.48
Forward Tilt/Back Lock	SCT-20-704	901.68	930.80	962.00	976.56	989.04	1016.08	1041.04	1107.60	1166.88	1296.68
Aluminum Base - Upholstered Back Jacket											
Back Lock	SCT-22-701	\$ 953.68	\$1011.92	\$1074.32	\$1103.44	\$1128.40	\$1182.48	\$1232.40	\$1365.52	\$1484.08	\$1613.88
Forward Tilt/Back Lock	SCT-22-704	1010.88	1069.12	1131.52	1160.64	1185.60	1239.68	1289.60	1422.72	1541.28	1671.08
Aluminum Base with Lumbar Adjustment - Mesh Back											
Back Lock	SCT-20-711	\$ 917.28	\$ 946.40	\$ 977.60	\$ 992.16	\$1004.64	\$1031.68	\$1056.64	\$1123.20	\$1182.48	\$1312.28
Forward Tilt/Back Lock	SCT-20-714	974.48	1003.60	1034.80	1049.36	1061.84	1088.88	1113.84	1180.40	1239.68	1369.48
Aluminum Base with Lumbar Adjustment - Upholstered Back Jacket											
Back Lock	SCT-22-711	\$1026.48	\$1084.72	\$1147.12	\$1176.24	\$1201.20	\$1255.28	\$1305.20	\$1438.32	\$1556.88	\$1686.68
Forward Tilt/Back Lock	SCT-22-714	1083.68	1141.92	1204.32	1233.44	1258.40	1312.48	1362.40	1495.52	1614.08	1743.88

The following options require modification of the product number.

CAL 133
HeadrestTo specify, add **F** to the end of the product number; **Example:** SCT-20-7011F (add \$122.72 list)
To specify, change the 3rd digit from a T to an E. **Example:** SCE-22-7112 with headrest (add \$72.80 list)**NOTE:** CAL 133 is available on SCT-20 models only.

Very Task

Task Chair with Height Adjustable Arms



SCT-20-4011

Dimensions*

SH: 16-21"(406mm-533mm)
 H: 39-44"(991mm-1118mm)
 D: 26"(660mm)
 W: 27"(686mm)
 SW: 19"(483mm)

Low Base:
 14-17"(356mm-432mm)

* All measurements taken with the BIFMA chair measuring device.

Features

- Back: Soft mesh only or mesh back with upholstered back jacket.
- Seat: Standard upholstered foam (3 lbs. polyurethane foam construction).
- Seat Depth Adjustment: Standard adjustable range 16"-19" (406mm-483mm).
- Base: Plastic base or optional painted five-star aluminum or polished aluminum base.
- Arms: Height-adjustable arms with plastic uprights (black or fog) with soft arm caps.
- Mechanism: Balanced 3-point tilt; standard tilt tension.
- Back Lock: Single position upright back lock.
- Optional Forward Tilt: 5 degrees downward from initial position.
- Optional Asymmetrical Lumbar Adjustment: 4"(102mm) height adjustment; support level can be adjusted independently for right or left hand side of users body.
- Casters: Standard with hard black or two-tone casters; optional soft casters.
- COM yardage / COL square footage:
 Mesh back model: 0.83/20
 Mesh back/upholstered back jacket: 1.5/40

NOTE: When specifying a back jacket; must also specify mesh surface color for outside of back. Back jacket is not field retrofittable. To add a back jacket in the field, see e-Parts for replacement back with an attached jacket.

■ Available on RUSH.

To Order, Specify:

1) Product number, including:

1 Base/Caster Option:

Aluminum Base

- 1** Aluminum Std. Base, Hard Caster
- 2** Aluminum Std. Base, Soft Caster
- T** Aluminum Std. Base, Two-Tone Casters
- 3** Aluminum Low Base, Hard Caster
- 4** Aluminum Low Base, Soft Caster

Plastic Base

- 5** Plastic Std. Base, Hard Caster
- 6** Plastic Std. Base, Soft Caster
- P** Plastic Std. Base, Two-Tone Casters

2) Fabric surface and color (seat).

3) Mesh surface and color (back).

4) Back Jacket (if applicable) Fabric surface and color.

5) Base

A. Aluminum

1. Trim color for plastic components (arm caps, control cover, adjustment levers, 4D or height adjustable arm uprights).
2. Trim color for aluminum base, back uprights, fixed arm uprights if specified. (Add **\$161.20** for polished aluminum.)

B. Plastic

1. Trim color for frame (trim color for base frame, plastic adjustment levers, control cover, and plastic base). (Add **\$161.20** for polished aluminum.)
2. Trim color for aluminum components (back uprights and fixed arm uprights if specified).

Leather Seat with Mesh Back:

Change the fourth digit in the product number to 1.

Example: SCT-10-4011

Leather Seat with Leather Upholstered Back Jacket:

Change the fourth and fifth digits in the product number to 11.

Example: SCT-11-4011

Faux Leather Seat with Mesh Back:

Change the fourth digit in the product number to 3.

Example: SCT-30-4011

Nano-Tex Upholstery:

Change the tenth digit in the product number to **P**, and add **\$32.24** list.

Example: SCT-20-4011**P**

Note: Nano-Tex is available on SCT-20 and SCT-22 models only.

Very Task

Task Chair with Height Adjustable Arms

Upholstered Foam Seat Adjustments	Number ①	Fabric Grade								Leather Grade A	Leather Grade B
		A	B	C	D	E	F	G	H		
Plastic Base - Mesh Back											
Back Lock	SCT-20-401	\$ 740.48	\$ 769.60	\$ 800.80	\$ 815.36	\$ 827.84	\$ 854.88	\$ 879.84	\$ 946.40	\$1005.68	\$1135.48
Forward Tilt/Back Lock	SCT-20-404	797.68	826.80	858.00	872.56	885.04	912.08	937.04	1003.60	1062.88	1192.68
Plastic Base - Upholstered Back Jacket											
Back Lock	SCT-22-401	\$ 849.68	\$ 907.92	\$ 970.32	\$ 999.44	\$1024.40	\$1078.48	\$1128.40	\$1261.52	\$1380.08	\$1509.88
Forward Tilt/Back Lock	SCT-22-404	906.88	965.12	1027.52	1056.64	1081.60	1135.68	1185.60	1318.72	1437.28	1567.08
Plastic Base with Lumbar Adjustment - Mesh Back											
Back Lock	SCT-20-411	\$ 813.28	\$ 842.40	\$ 873.60	\$ 888.16	\$ 900.64	\$ 927.68	\$ 952.64	\$1019.20	\$1078.48	\$1208.28
Forward Tilt/Back Lock	SCT-20-414	870.48	899.60	930.80	945.36	957.84	984.88	1009.84	1076.40	1135.68	1265.48
Plastic Base with Lumbar Adjustment - Upholstered Back Jacket											
Back Lock	SCT-22-411	\$ 922.48	\$ 980.72	\$1043.12	\$1072.24	\$1097.20	\$1151.28	\$1201.20	\$1334.32	\$1452.88	\$1582.68
Forward Tilt/Back Lock	SCT-22-414	979.68	1037.92	1100.32	1129.44	1154.40	1208.48	1258.40	1391.52	1510.08	1639.88
Aluminum Base - Mesh Back											
Back Lock	SCT-20-401	\$ 792.48	\$ 821.60	\$ 852.80	\$ 867.36	\$ 879.84	\$ 906.88	\$ 931.84	\$ 998.40	\$1057.68	\$1187.48
Forward Tilt/Back Lock	SCT-20-404	849.68	878.80	910.00	924.56	937.04	964.08	989.04	1055.60	1114.88	1244.68
Aluminum Base - Upholstered Back Jacket											
Back Lock	SCT-22-401	\$ 901.68	\$ 959.92	\$1022.32	\$1051.44	\$1076.40	\$1130.48	\$1180.40	\$1313.52	\$1432.08	\$1561.88
Forward Tilt/Back Lock	SCT-22-404	958.88	1017.12	1079.52	1108.64	1133.60	1187.68	1237.60	1370.72	1489.28	1619.08
Aluminum Base with Lumbar Adjustment - Mesh Back											
Back Lock	SCT-20-411	\$ 865.28	\$ 894.40	\$ 925.60	\$ 940.16	\$ 952.64	\$ 979.68	\$1004.64	\$1071.20	\$1130.48	\$1260.28
Forward Tilt/Back Lock	SCT-20-414	922.48	951.60	982.80	997.36	1009.84	1036.88	1061.84	1128.40	1187.68	1317.48
Aluminum Base with Lumbar Adjustment - Upholstered Back Jacket											
Back Lock	SCT-22-411	\$ 974.48	\$1032.72	\$1095.12	\$1124.24	\$1149.20	\$1203.28	\$1253.20	\$1386.32	\$1504.88	\$1634.68
Forward Tilt/Back Lock	SCT-22-414	1031.68	1089.92	1152.32	1181.44	1206.40	1260.48	1310.40	1443.52	1562.08	1691.88

The following options require modification of the product number.

CAL 133
Headrest

To specify, add **F** to the end of the product number; **Example:** SCT-20-4011F (add \$122.72 list)
To specify, change the 3rd digit from a T to an E. **Example:** SCE-22-7112 with headrest (add \$72.80 list)

NOTE: CAL 133 is available on SCT-20 models only.

Very Task

Task Chair with Fixed Arms



SCT-20-1011

Dimensions*

SH: 16-21"(406mm-533mm)
 H: 39-44"(991mm-1118mm)
 D: 26"(660mm)
 W: 27"(686mm)
 SW: 19"(483mm)

Low Base:
 14-17"(356mm-432mm)

* All measurements taken with the BIFMA chair measuring device.

Features

- Back: Soft mesh only or mesh back with upholstered back jacket.
- Seat: Standard upholstered foam (3 lbs. polyurethane foam construction).
- Seat Depth Adjustment: Standard adjustable range 16"-19" (406mm-483mm).
- Seat Type: Standard adjustable 3"(76mm) range.
- Base: Plastic base or optional painted five-star aluminum or polished aluminum base.
- Arms: Fixed height arms with aluminum uprights in either painted or polished, soft arm caps.
- Mechanism: Balanced 3-point tilt; standard tilt tension.
- Back Lock: Single position upright back lock.
- Optional Forward Tilt: 5 degrees downward from initial position.
- Optional Asymmetrical Lumbar Adjustment: 4"(102mm) height adjustment; support level can be adjusted independently for right or left hand side of users body.
- Casters: Standard with hard black or two-tone casters; optional soft casters.
- COM yardage / COL square footage:
 Mesh back model: 0.83/20
 Mesh back/upholstered back jacket: 1.5/40

NOTE: When specifying a back jacket; must also specify mesh surface color for outside of back. Back jacket is not field retrofittable. To add a back jacket in the field, see e-Parts for replacement back with an attached jacket.

■ Available on RUSH.

To Order, Specify:

1) Product number, including:

1 Base/Caster Option:

Aluminum Base

- 1** Aluminum Std. Base, Hard Caster
- 2** Aluminum Std. Base, Soft Caster
- T** Aluminum Std. Base, Two-Tone Casters
- 3** Aluminum Low Base, Hard Caster
- 4** Aluminum Low Base, Soft Caster

Plastic Base

- 5** Plastic Std. Base, Hard Caster
- 6** Plastic Std. Base, Soft Caster
- P** Plastic Std. Base, Two-Tone Casters

2) Fabric surface and color (seat).

3) Mesh surface and color (back).

4) Back Jacket (if applicable) Fabric surface and color.

5) Base

A. Aluminum

1. Trim color for plastic components (arm caps, control cover, adjustment levers, 4D or height adjustable arm uprights).
2. Trim color for aluminum base, back uprights, fixed arm uprights if specified. (Add **\$161.20** for polished aluminum.)

B. Plastic

1. Trim color for frame (trim color for base frame, plastic adjustment levers, control cover, and plastic base). (Add **\$161.20** for polished aluminum.)
2. Trim color for aluminum components (back uprights and fixed arm uprights if specified).

Leather Seat with Mesh Back:

Change the fourth digit in the product number to 1.

Example: SCT-10-1011

Leather Seat with Leather Upholstered Back Jacket:

Change the fourth and fifth digits in the product number to 11.

Example: SCT-11-1011

Faux Leather Seat with Mesh Back:

Change the fourth digit in the product number to 3.

Example: SCT-30-1011

Nano-Tex Upholstery:

Change the tenth digit in the product number to **P**, and add **\$32.24** list.

Example: SCT-20-1011**P**

Note: Nano-Tex is available on SCT-20 and SCT-22 models only.

Very Task

Task Chair with Fixed Arms

Upholstered Foam Seat Adjustments	Number ①	Fabric Grade								Leather Grade A	Leather Grade B
		A	B	C	D	E	F	G	H		
Plastic Base - Mesh Back											
Back Lock	SCT-20-101	\$ 730.08	\$ 759.20	\$ 790.40	\$ 804.96	\$ 817.44	\$ 844.48	\$ 869.44	\$ 936.00	\$ 995.28	\$1125.08
Forward Tilt/Back Lock	SCT-20-104	787.28	816.40	847.60	862.16	874.64	901.68	926.64	993.20	1052.48	1182.28
Plastic Base - Upholstered Back Jacket											
Back Lock	SCT-22-101	\$ 839.28	\$ 897.52	\$ 959.92	\$ 989.04	\$1014.00	\$1068.08	\$1118.00	\$1251.12	\$1369.68	\$1499.48
Forward Tilt/Back Lock	SCT-22-104	896.48	954.72	1017.12	1046.24	1071.20	1125.28	1175.20	1308.32	1426.88	1556.68
Plastic Base with Lumbar Adjustment - Mesh Back											
Back Lock	SCT-20-111	\$ 802.88	\$ 832.00	\$ 863.20	\$ 877.76	\$ 890.24	\$ 917.28	\$ 942.24	\$1008.80	\$1068.08	\$1197.88
Forward Tilt/Back Lock	SCT-20-114	860.08	889.20	920.40	934.96	947.44	974.48	999.44	1066.00	1125.28	1255.08
Plastic Base with Lumbar Adjustment - Upholstered Back Jacket											
Back Lock	SCT-22-111	\$ 912.08	\$ 970.32	\$1032.72	\$1061.84	\$1086.80	\$1140.88	\$1190.80	\$1323.92	\$1442.48	\$1572.28
Forward Tilt/Back Lock	SCT-22-114	969.28	1027.52	1089.92	1119.04	1144.00	1198.08	1248.00	1381.12	1499.68	1629.48
Aluminum Base - Mesh Back											
Back Lock	SCT-20-101	\$ 782.08	\$ 811.20	\$ 842.40	\$ 856.96	\$ 869.44	\$ 896.48	\$ 921.44	\$ 988.00	\$1047.28	\$1177.08
Forward Tilt/Back Lock	SCT-20-104	839.28	868.40	899.60	914.16	926.64	953.68	978.64	1045.20	1104.48	1234.28
Aluminum Base - Upholstered Back Jacket											
Back Lock	SCT-22-101	\$ 891.28	\$ 949.52	\$1011.92	\$1041.04	\$1066.00	\$1120.08	\$1170.00	\$1303.12	\$1421.68	\$1551.48
Forward Tilt/Back Lock	SCT-22-104	948.48	1006.72	1069.12	1098.24	1123.20	1177.28	1227.20	1360.32	1478.88	1608.68
Aluminum Base with Lumbar Adjustment - Mesh Back											
Back Lock	SCT-20-111	\$ 854.88	\$ 884.00	\$ 915.20	\$ 929.76	\$ 942.24	\$ 969.28	\$ 994.24	\$1060.80	\$1120.08	\$1249.88
Forward Tilt/Back Lock	SCT-20-114	912.08	941.20	972.40	986.96	999.44	1026.48	1051.44	1118.00	1177.28	1307.08
Aluminum Base with Lumbar Adjustment - Upholstered Back Jacket											
Back Lock	SCT-22-111	\$ 964.08	\$1022.32	\$1084.72	\$1113.84	\$1138.80	\$1192.88	\$1242.80	\$1375.92	\$1494.48	\$1624.28
Forward Tilt/Back Lock	SCT-22-114	1021.28	1079.52	1141.92	1171.04	1196.00	1250.08	1300.00	1433.12	1551.68	1681.48

The following options require modification of the product number.

CAL 133
Headrest

To specify, add **F** to the end of the product number; **Example:** SCT-20-1011F (add \$122.72 list)
To specify, change the 3rd digit from a T to an E. **Example:** SCE-22-7112 with headrest (add \$72.80 list)

NOTE: CAL 133 is available on SCT-20 models only.

Very Task

Task Chair without Arms



SCT-20-0011

Dimensions*

SH: 16-21"(406mm-533mm)
 H: 39-44"(991mm-1118mm)
 D: 26"(660mm)
 W: 27"(686mm)
 SW: 19"(483mm)

Low Base:
 14-17"(356mm-432mm)

* All measurements taken with the BIFMA chair measuring device.

Features

- Back: Soft mesh only or mesh back with upholstered back jacket.
- Seat: Standard upholstered foam (3 lbs. polyurethane foam construction).
- Seat Depth Adjustment: Standard Adjustable range 16"-19" (406mm-483mm).
- Seat Type: Standard adjustable 3"(76mm) range.
- Base: Plastic base or optional painted five-star aluminum or polished aluminum base.
- Mechanism: Balanced 3-point tilt; standard tilt tension.
- Back Lock: Single position upright back lock.
- Optional Forward Tilt: 5 degrees downward from initial position.
- Optional Asymmetrical Lumbar Adjustment: 4"(102mm) height adjustment; support level can be adjusted independently for right or left hand side of users body.
- Casters: Standard with hard black or two-tone casters; optional soft casters.
- COM yardage / COL square footage:
 Mesh back model: 0.83/20
 Mesh back/upholstered back jacket: 1.5/40

NOTE: When specifying a back jacket; must also specify mesh surface color for outside of back. Back jacket is not field retrofittable. To add a back jacket in the field, see e-Parts for replacement back with an attached jacket.

■ Available on RUSH.

To Order, Specify:

1) Product number, including:

1 Base/Caster Option:**Aluminum Base**

- 1** Aluminum Std. Base, Hard Caster
- 2** Aluminum Std. Base, Soft Caster
- T** Aluminum Std. Base, Two-Tone Casters
- 3** Aluminum Low Base, Hard Caster
- 4** Aluminum Low Base, Soft Caster

Plastic Base

- 5** Plastic Std. Base, Hard Caster
- 6** Plastic Std. Base, Soft Caster
- P** Plastic Std. Base, Two-Tone Casters

2) Fabric surface and color (seat).

3) Mesh surface and color (back).

4) Back Jacket (if applicable) Fabric surface and color.

5) Base

A. Aluminum

- 1. Trim color for plastic components (arm caps, control cover, adjustment levers, 4D or height adjustable arm uprights).
- 2. Trim color for aluminum base, back uprights, fixed arm uprights if specified. (Add **\$161.20** for polished aluminum.)

B. Plastic

- 1. Trim color for frame (trim color for base frame, plastic adjustment levers, control cover, and plastic base). (Add **\$161.20** for polished aluminum.)
- 2. Trim color for aluminum components (back uprights and fixed arm uprights if specified).

Leather Seat with Mesh Back:

Change the fourth digit in the product number to 1.

Example: SCT-10-0011

Leather Seat with Leather Upholstered Back Jacket:

Change the fourth and fifth digits in the product number to 11.

Example: SCT-11-0011

Faux Leather Seat with Mesh Back:

Change the fourth digit in the product number to 3.

Example: SCT-30-0011

Nano-Tex Upholstery:

Change the tenth digit in the product number to **P**, and add **\$32.24** list.

Example: SCT-20-0011**P**

Note: Nano-Tex is available on SCT-20 and SCT-22 models only.

Very Task

Task Chair without Arms

Upholstered Foam Seat Adjustments	Number ①	Fabric Grade								Leather Grade A	Leather Grade B
		A	B	C	D	E	F	G	H		
Plastic Base - Mesh Back											
Back Lock	SCT-20-001	\$610.48	\$639.60	\$ 670.80	\$ 685.36	\$ 697.84	\$ 724.88	\$ 749.84	\$ 816.40	\$ 875.68	\$1005.48
Forward Tilt/Back Lock	SCT-20-004	667.68	696.80	728.00	742.56	755.04	782.08	807.04	873.60	932.88	1062.68
Plastic Base - Upholstered Back Jacket											
Back Lock	SCT-22-001	\$719.68	\$777.92	\$ 840.32	\$ 869.44	\$ 894.40	\$ 948.48	\$ 998.40	\$1131.52	\$1250.08	\$1379.88
Forward Tilt/Back Lock	SCT-22-004	776.88	835.12	897.52	926.64	951.60	1005.68	1055.60	1188.72	1307.28	1437.08
Plastic Base with Lumbar Adjustment - Mesh Back											
Back Lock	SCT-20-011	\$683.28	\$712.40	\$ 743.60	\$ 758.16	\$ 770.64	\$ 797.68	\$ 822.64	\$ 889.20	\$ 948.48	\$1078.28
Forward Tilt/Back Lock	SCT-20-014	740.48	769.60	800.80	815.36	827.84	854.88	879.84	946.40	1005.68	1135.48
Plastic Base with Lumbar Adjustment - Upholstered Back Jacket											
Back Lock	SCT-22-011	\$792.48	\$850.72	\$ 913.12	\$ 942.24	\$ 967.20	\$1021.28	\$1071.20	\$1204.32	\$1322.88	\$1452.68
Forward Tilt/Back Lock	SCT-22-014	849.68	907.92	970.32	999.44	1024.40	1078.48	1128.40	1261.52	1380.08	1509.88
Aluminum Base - Mesh Back											
Back Lock	SCT-20-001	\$662.48	\$691.60	\$ 722.80	\$ 737.36	\$ 749.84	\$ 776.88	\$ 801.84	\$ 868.40	\$ 927.68	\$1057.48
Forward Tilt/Back Lock	SCT-20-004	719.68	748.80	780.00	794.56	807.04	834.08	859.04	925.60	984.88	1114.68
Aluminum Base - Upholstered Back Jacket											
Back Lock	SCT-22-001	\$771.68	\$829.92	\$ 892.32	\$ 921.44	\$ 946.40	\$1000.48	\$1050.40	\$1183.52	\$1302.08	\$1431.88
Forward Tilt/Back Lock	SCT-22-004	828.88	887.12	949.52	978.64	1003.60	1057.68	1107.60	1240.72	1359.28	1489.08
Aluminum Base with Lumbar Adjustment - Mesh Back											
Back Lock	SCT-20-011	\$735.28	\$764.40	\$ 795.60	\$ 810.16	\$ 822.64	\$ 849.68	\$ 874.64	\$ 941.20	\$1000.48	\$1130.28
Forward Tilt/Back Lock	SCT-20-014	792.48	821.60	852.80	867.36	879.84	906.88	931.84	998.40	1057.68	1187.48
Aluminum Base with Lumbar Adjustment - Upholstered Back Jacket											
Back Lock	SCT-22-011	\$844.48	\$902.72	\$ 965.12	\$ 994.24	\$1019.20	\$1073.28	\$1123.20	\$1256.32	\$1374.88	\$1504.68
Forward Tilt/Back Lock	SCT-22-014	901.68	959.92	1022.32	1051.44	1076.40	1130.48	1180.40	1313.52	1432.08	1561.88

The following options require modification of the product number.

CAL 133
Headrest

To specify, add **F** to the end of the product number; **Example:** SCT-20-0111F (add \$122.72 list)

To specify, change the 3rd digit from a T to an E. **Example:** SCE-22-7112 with headrest (add \$72.80 list)

NOTE: CAL 133 is available on SCT-20 models only.

This page intentionally blank

Lively-At-A-Glance

Designer

Steve Nemeth and the Haworth Design Studio

Lively

Lively provides a seating collection that is affordable without compromise. It offers daylong comfort, worry-free quality and a light-scale aesthetic.

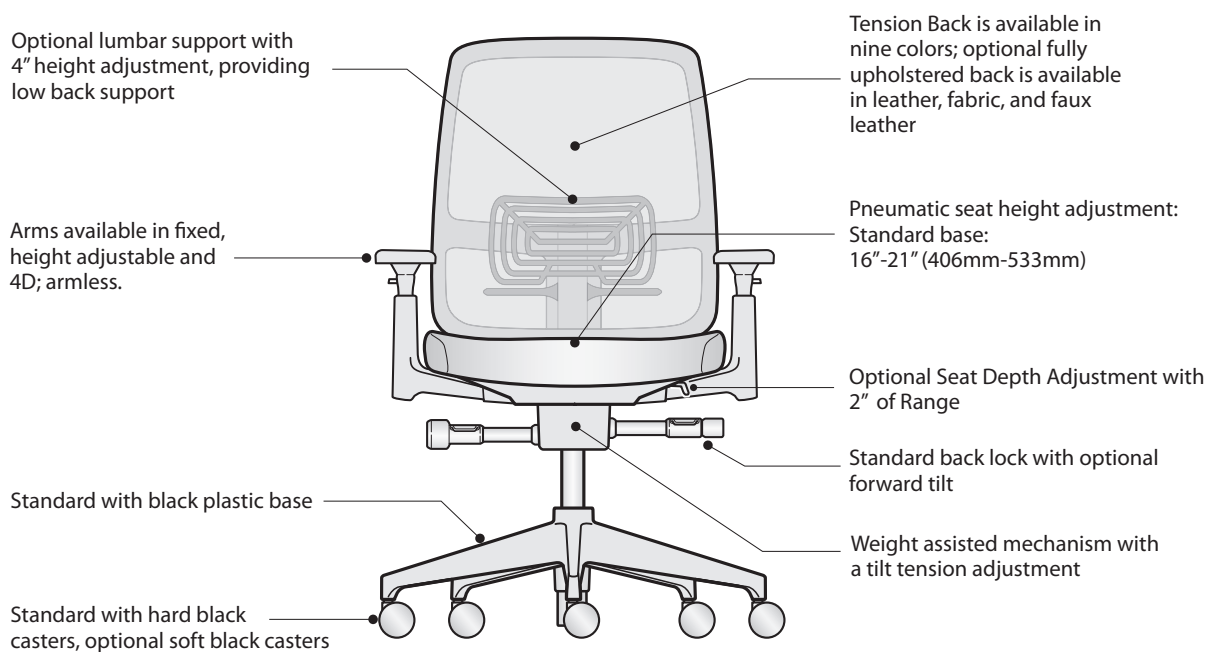

Lively Task

General Specifications

Features and Options (Task Chair)

- Back: Tension back or fully upholstered.
- Seat: Standard upholstered with foam.
- Base: Black plastic.
- Arms: 4D, Height Adjustable, or Fixed arms. Armless model available.
- Mechanism: Weight assisted mechanism with tilt tension adjustment.
- Height Adjustment: Pneumatic.
- Standard back lock.
- Optional Forward Tilt: 5° downward from initial position.
- Optional Adjustable Lumbar: 4" adjustment, flexible support.
- Optional Seat Depth Adjustment: Adjustable range is 16.75"-19"(425mm-483mm).
- Casters: Five-Star base with casters; hard (black) or soft (black).
- Lively Task chairs are warranted for persons up to 325 lbs. for 12 years 24/7.

General Guidelines for Product Specification

	<u>S</u>	<u>L</u>	<u>T</u>	<u>1-2</u>	<u>T - 4</u>	<u>1</u>	<u>1</u>	<u>1</u>	<u>A</u>	<u>3A-18</u>	<u>3T-41</u>	<u>TR-F</u>
Product Type	_____	_____	_____	_____	_____	_____	_____	_____	_____	_____	_____	_____
(S) Seating	_____	_____	_____	_____	_____	_____	_____	_____	_____	_____	_____	_____
Product Line	_____	_____	_____	_____	_____	_____	_____	_____	_____	_____	_____	_____
(L) Lively	_____	_____	_____	_____	_____	_____	_____	_____	_____	_____	_____	_____
Model	_____	_____	_____	_____	_____	_____	_____	_____	_____	_____	_____	_____
(T) Task	_____	_____	_____	_____	_____	_____	_____	_____	_____	_____	_____	_____
Seat Upholstery	_____	_____	_____	_____	_____	_____	_____	_____	_____	_____	_____	_____
(1) Leather	_____	_____	_____	_____	_____	_____	_____	_____	_____	_____	_____	_____
(2) Fabric	_____	_____	_____	_____	_____	_____	_____	_____	_____	_____	_____	_____
(3) Faux Leather	_____	_____	_____	_____	_____	_____	_____	_____	_____	_____	_____	_____
Back Upholstery	_____	_____	_____	_____	_____	_____	_____	_____	_____	_____	_____	_____
(1) Leather	_____	_____	_____	_____	_____	_____	_____	_____	_____	_____	_____	_____
(2) Fabric	_____	_____	_____	_____	_____	_____	_____	_____	_____	_____	_____	_____
(3) Faux Leather	_____	_____	_____	_____	_____	_____	_____	_____	_____	_____	_____	_____
(T) Tension	_____	_____	_____	_____	_____	_____	_____	_____	_____	_____	_____	_____
Arms	_____	_____	_____	_____	_____	_____	_____	_____	_____	_____	_____	_____
(0) No Arms	_____	_____	_____	_____	_____	_____	_____	_____	_____	_____	_____	_____
(1) Fixed Arms	_____	_____	_____	_____	_____	_____	_____	_____	_____	_____	_____	_____
(4) Height Adjustable	_____	_____	_____	_____	_____	_____	_____	_____	_____	_____	_____	_____
(7) 4D Arms	_____	_____	_____	_____	_____	_____	_____	_____	_____	_____	_____	_____
Lumbar	_____	_____	_____	_____	_____	_____	_____	_____	_____	_____	_____	_____
(0) No Lumbar	_____	_____	_____	_____	_____	_____	_____	_____	_____	_____	_____	_____
(1) Lumbar	_____	_____	_____	_____	_____	_____	_____	_____	_____	_____	_____	_____
Back Lock	_____	_____	_____	_____	_____	_____	_____	_____	_____	_____	_____	_____
(1) Back Lock	_____	_____	_____	_____	_____	_____	_____	_____	_____	_____	_____	_____
(4) Forward Tilt/Back Lock	_____	_____	_____	_____	_____	_____	_____	_____	_____	_____	_____	_____
Casters	_____	_____	_____	_____	_____	_____	_____	_____	_____	_____	_____	_____
(5) Hard Casters	_____	_____	_____	_____	_____	_____	_____	_____	_____	_____	_____	_____
(6) Soft Casters	_____	_____	_____	_____	_____	_____	_____	_____	_____	_____	_____	_____
Seat	_____	_____	_____	_____	_____	_____	_____	_____	_____	_____	_____	_____
(A) Adjustable	_____	_____	_____	_____	_____	_____	_____	_____	_____	_____	_____	_____
(X) Fixed	_____	_____	_____	_____	_____	_____	_____	_____	_____	_____	_____	_____
Seat Upholstery	_____	_____	_____	_____	_____	_____	_____	_____	_____	_____	_____	_____
Tellure	_____	_____	_____	_____	_____	_____	_____	_____	_____	_____	_____	_____
Back Upholstery	_____	_____	_____	_____	_____	_____	_____	_____	_____	_____	_____	_____
Tension	_____	_____	_____	_____	_____	_____	_____	_____	_____	_____	_____	_____
Trim Color	_____	_____	_____	_____	_____	_____	_____	_____	_____	_____	_____	_____
Black	_____	_____	_____	_____	_____	_____	_____	_____	_____	_____	_____	_____

Lively Task

General Specifications

Environmental Factors

- Greenguard Children and Schools certified for low emissions.
- Lively is produced in an ISO 14001 certified manufacturing facility.
- Haworth will take back Lively chairs after their useful life and recycle the components. Please contact Haworth's Material Recovery Center at (616)393-1215.
- Lively has 52% recycled content and is up to 97% recyclable.

**COM & COL
General Information**

To order a COM fabric (Customer's Own Material), contact the Haworth Inquiry Center (1.800.426.8562), your local Haworth dealer, or go to haworth.com/surfaces > COM Library to find out if the COM you have selected has already been tested and approved. The surface collection site also has information on the Haworth+ alliance program with Carnegie, Luna Textiles, and Maharam as well as our industry-leading Pre-Approved COM program.

Approved COMs are placed into Grades based on the fabric pricing; if the fabric pricing exceeds our Grades, they will be priced at Grade A + cost of fabric + 4% handling (North America). Haworth will purchase all COMs unless instructed otherwise. (Leather will also be purchased by Haworth; if the leather pricing exceeds our Grades, cost will be based on fabric Grade E + cost of leather + 4% handling.)

If no information is available on the COM you are looking for, refer to the COM section and forms on the surface collection site for information on how to process your test request.

Finishes and Fabrics

A complete listing of finishes and fabrics for Lively seating is available in the surface materials section of the Seating price list.

**Shipping Weights
(Including packaging)**

- Chairs with arms: 42 pounds/1 chair per carton
- Chairs without arms: 38.8 pounds/1 chair per carton

Lively

General Specifications

STANDARD MOBILITY AND ADJUSTABILITY

Weight Assisted Tilt Tension Mechanism

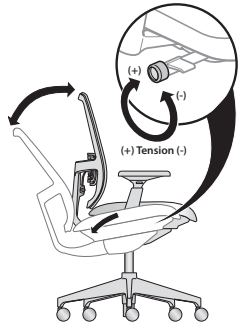

Features:

- Back reclines 24° from the upright position.
- Responds to users weight in combination with the tilt tension to maximize comfort.

Benefits:

- Comfortable relaxed posture.
- Recline allows for the opening of the users' chest cavity providing good airflow to promote alertness.

Seat Height Adjustment

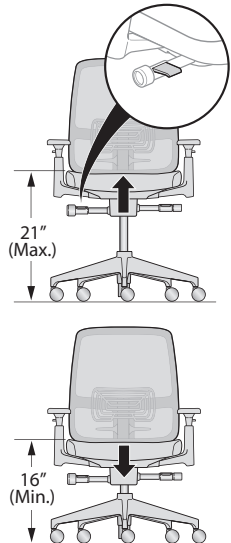

Features:

- Pneumatic seat height adjustment.
- Seat height adjusts 5"(127mm) from 16" to 21"(406mm to 533mm).

Benefits:

- Ensures the comfort of the lower limbs by avoiding pressure on the underside of the thigh caused by a seat pan that is too high, or decreased thigh-to-torso angle if the seat pan is too low.
- Seat height adjustment also is important in setting the proper hand position and allowing for a proper sitting eye height.

Back Lock

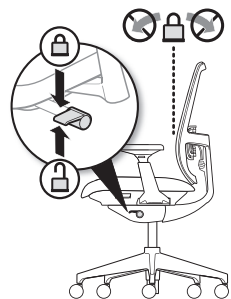

Features:

- Single position Back Lock.

Benefit:

- Allows users to lock the back of the chair in the upright position for tasking application.

Lively

General Specifications
OPTIONAL MOBILITY AND ADJUSTABILITY

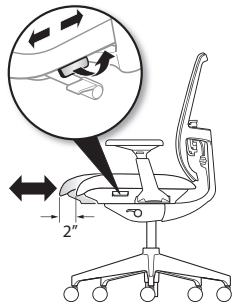
Seat Depth Adjustment**Features:**

- 2"(51mm) of seat depth range.

Benefit:

- Supports the thighs, allows users to rest against the seat back for back support, and avoids pressure on the back of the knees of small to tall users.

Forward Tilt**Feature:**

- Optional forward tilt.
- Seat pan moves downward 5° from initial position.

Benefit:

- Promotes a healthy spinal posture where your back stays in contact with the chair as a user sits on the front of their chair.

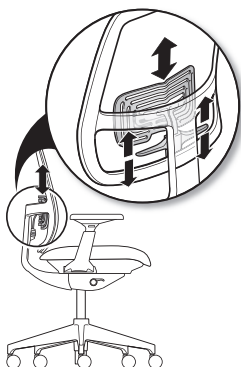
Lumbar Support**Features:**

- Lumbar adjustment adjusts 4"(102mm) in height.

Benefits:

- Lumbar adjustment maintains the natural curvature of the spine at the lower back and allows users to choose the support that feels right for them.

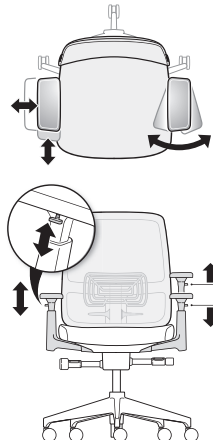
4D Arm**Features:**

- Optional 4D arm.
- Arm adjusts in 4 ways:
 - Height adjustment: 4"(102mm)
 - Side-to-side arm cap adjustment range: 3"(76mm) [1 1/2"(38mm) each arm cap]
 - Front-to-back adjustment range: 3 1/2"(89mm)
 - Pivoting: In 20°; out 20°

Benefits:

- Arms support the muscular system of users' neck and shoulders and proper arm support provides back relief. Arms can be an aid in standing or sitting down.
- Height adjustment accommodates for users with varying elbow rest heights so that users avoid lifting their shoulders or leaning sideways to get arm support.
- Side-to-side adjustment ensures a comfortable resting position for the arms with proper support of the forearm while allowing for easy entry/exit of the chair.
- Front-to-back adjustment adjusts the armrest length, which is important because it allows users to get close to the worksurface while maintaining the effective use of the backrest.
- Pivoting provides proper support of the forearm when performing tasks involving keying and mousing.

Lively

General Specifications

OPTIONAL MOBILITY AND ADJUSTABILITY (continued)

Height Adjustable Arm

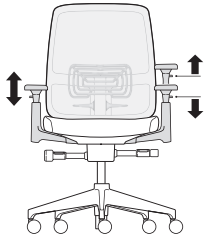

Features:

- Optional height adjustable arms adjust 4" (102mm) vertically.

Benefit:

- Height adjustment accommodates users with varying elbow rest heights so that users avoid lifting their shoulders or leaning sideways to get arm support.
-

Leather Upholstery



Seat:

- Stitched double seams. Vertically in the center and on the edges of the seat cushion.

Back:

- Vertical stitched double seams on the upholstered back with leather or Customer's Own Leather (COL).

LIVELY

Task Chair with 4D Arms



SLT1-2T-7115A

Dimensions*

- SH: 16"-21"
(406mm-533mm)
- H: 36"-41"
(914mm-1041mm)
- D: 24"(610mm)
- W: 28"(711mm)
- SW: 19"(483mm)

* All measurements taken with the BIFMA chair measuring device.

Features

- Back: Tension back or fully upholstered.
- Tension back is fabric suspended between a frame.
- Fully upholstered back features a slim foam pad.
- Seat: Standard upholstered foam.
- Base: Black plastic base.
- Arms: 4D with soft arm caps. Arm adjusts up and down, side to side, front to back and pivot.
- Mechanism: Weight assisted mechanism with tilt tension adjustment.
- Back-Lock: Single position upright back lock.
- Optional Forward Tilt: 5° downward from initial position.
- Optional Seat Depth Adjustment: 16.75"-19"(425mm-483mm).
- Optional Adjustable Lumbar: 4"(102mm) height adjustment, flexible lumbar support.
- Casters: Standard with hard black casters; optional soft casters.
- COM yardage / COL square footage:
Tension back model: 0.66/4.1
Fully upholstered model: 0.75/8.2

To Order, Specify:

1) Product number, including;

① Seat or Seat Pad Option:

- X Fixed Seat
- A Adjustable Seat, add \$30.00 list

2) Surface and color (seat).

3) Surface and color for tension back material (back).

4) Surface and color for fabric on fully upholstered (back).

5) Base.

Note: When specifying a fully upholstered chair; must also specify a tension back color for outside of back.

Leather Seat with Tension Back:

Change the fifth digit in the product number to 1.

Example: SLT1-1T-7115A.

Leather Seat with Leather Back:

Change the fifth and sixth digits in the product number to 11.

Example: SLT1-11-7115A.

Faux Leather Seat with Tension Back:

Change the fifth digit in the product number to 3.

Example: SLT1-3T-7115A.

Upholstered Seat Adjustments	Number ①	Fabric Grade								Leather Grade A	Leather Grade B
		A	B	C	D	E	F	G	H		
No Lumbar Adjustment - Tension Back											
Back Lock	SLT1-2T-7015	\$644.00	\$672.00	\$702.00	\$716.00	\$728.00	\$ 754.00	\$ 778.00	\$ 842.00	\$ 899.00	\$1024.00
Forward Tilt/Back Lock	SLT1-2T-7045	674.00	702.00	732.00	746.00	758.00	784.00	808.00	872.00	929.00	1054.00
No Lumbar Adjustment - Fully Upholstered											
Back Lock	SLT1-22-7015	\$744.00	\$800.00	\$860.00	\$888.00	\$912.00	\$ 964.00	\$1012.00	\$1140.00	\$1254.00	\$1504.00
Forward Tilt/Back Lock	SLT1-22-7045	774.00	830.00	890.00	918.00	942.00	994.00	1042.00	1170.00	1284.00	1534.00
Lumbar Adjustment - Tension Back											
Back Lock	SLT1-2T-7115	\$694.00	\$722.00	\$752.00	\$766.00	\$778.00	\$ 804.00	\$ 828.00	\$ 892.00	\$ 949.00	\$1074.00
Forward Tilt/Back Lock	SLT1-2T-7145	724.00	752.00	782.00	796.00	808.00	834.00	858.00	922.00	979.00	1104.00
Lumbar Adjustment - Fully Upholstered											
Back Lock	SLT1-22-7115	\$794.00	\$850.00	\$910.00	\$938.00	\$962.00	\$1014.00	\$1062.00	\$1190.00	\$1304.00	\$1554.00
Forward Tilt/Back Lock	SLT1-22-7145	824.00	880.00	940.00	968.00	992.00	1044.00	1092.00	1220.00	1334.00	1584.00

The following options require modification of the product number.

- Soft Casters
- CAL 133
- Nano-TEX

- To specify, change the 10th digit from a 5 to a 6; **Example:** SLT1-22-7016A
- To specify, add F to the end of the product number; **Example:** SLT1-22-7015AF (add \$118.00 list)
- To specify, add P to end of the product number; **Example:** SLT1-22-7015AP (add \$31.00 list)

NOTE: Nano-TEX is available on SLT1-2T and SLT1-22 models only.

LIVELY

Task Chair with Height Adjustable Arms



SLT1-2T-4115A

Dimensions*

SH: 16"-21"
(406mm-533mm)
H: 36"-41"
(914mm-1041mm)
D: 24"(610mm)
W: 28"(711mm)
SW: 19"(483mm)

* All measurements taken with the BIFMA chair measuring device.

Features

- Back: Tension back or fully upholstered.
- Tension back is fabric suspended between a frame.
- Fully upholstered back features a slim foam pad.
- Seat: Standard upholstered foam.
- Base: Black plastic base.
- Arms: Height adjustable arms with plastic uprights (black) with soft arm caps.
- Mechanism: Weight assisted mechanism with tilt tension adjustment.
- Back-Lock: Single position upright back lock.
- Optional Forward Tilt: 5° downward from initial position.
- Optional Seat Depth Adjustment: 16.75"-19"(425mm-483mm).
- Optional Adjustable Lumbar: 4"(102mm) height adjustment, flexible lumbar support.
- Casters: Standard with hard black casters; optional soft casters.
- COM yardage / COL square footage:
Tension back model: 0.66/4.1
Fully upholstered model: 0.75/8.2

To Order, Specify:

1) Product number, including;

① Seat or Seat Pad Option:

- Fixed Seat
 Adjustable Seat, add **\$30.00** list

2) Surface and color (seat).

3) Surface and color for tension back material (back).

4) Surface and color for fabric on fully upholstered (back).

5) Base.

Note: When specifying a fully upholstered chair; must also specify a tension back color for outside of back.

Leather Seat with Tension Back:

Change the fifth digit in the product number to **1**.

Example: SLT1-1T-4115A.

Leather Seat with Leather Back:

Change the fifth and sixth digits in the product number to **11**.

Example: SLT1-11-4115A.

Faux Leather Seat with Tension Back:

Change the fifth digit in the product number to **3**.

Example: SLT1-3T-4115A.

Upholstered Seat Adjustments	Number ①	Fabric Grade								Leather Grade A	Leather Grade B
		A	B	C	D	E	F	G	H		
No Lumbar Adjustment - Tension Back											
Back Lock	SLT1-2T-4015	\$619.00	\$647.00	\$677.00	\$691.00	\$703.00	\$ 729.00	\$ 753.00	\$ 817.00	\$ 874.00	\$ 999.00
Forward Tilt/Back Lock	SLT1-2T-4045	649.00	677.00	707.00	721.00	733.00	759.00	783.00	847.00	904.00	1029.00
No Lumbar Adjustment - Fully Upholstered											
Back Lock	SLT1-22-4015	\$719.00	\$775.00	\$835.00	\$863.00	\$887.00	\$ 939.00	\$ 987.00	\$1115.00	\$1229.00	\$1479.00
Forward Tilt/Back Lock	SLT1-22-4045	749.00	805.00	865.00	893.00	917.00	969.00	1017.00	1145.00	1259.00	1509.00
Lumbar Adjustment - Tension Back											
Back Lock	SLT1-2T-4115	\$669.00	\$697.00	\$727.00	\$741.00	\$753.00	\$ 779.00	\$ 803.00	\$ 867.00	\$ 924.00	\$1049.00
Forward Tilt/Back Lock	SLT1-2T-4145	699.00	727.00	757.00	771.00	783.00	809.00	833.00	897.00	954.00	1079.00
Lumbar Adjustment - Fully Upholstered											
Back Lock	SLT1-22-4115	\$769.00	\$825.00	\$885.00	\$913.00	\$937.00	\$ 989.00	\$1037.00	\$1165.00	\$1279.00	\$1529.00
Forward Tilt/Back Lock	SLT1-22-4145	799.00	855.00	915.00	943.00	967.00	1019.00	1067.00	1195.00	1309.00	1559.00

The following options require modification of the product number.

Soft Casters
CAL 133
Nano-TEX

To specify, change the 10th digit from a **5** to a **6**; **Example:** SLT1-22-4016A

To specify, add **F** to the end of the product number; **Example:** SLT1-22-4015AF (add **\$118.00** list)

To specify, add **P** to end of the product number; **Example:** SLT1-22-4015AP (add **\$31.00** list)

NOTE: Nano-TEX is available on SLT1-2T and SLT1-22 models only.

LIVELY

Task Chair with Fixed Arms



SLT1-2T-1115A

Dimensions*

- SH: 16"-21"
(406mm-533mm)
- H: 36"-41"
(914mm-1041mm)
- D: 24"(610mm)
- W: 28"(711mm)
- SW: 19"(483mm)

* All measurements taken with the BIFMA chair measuring device.

Features

- Back: Tension back or fully upholstered.
- Tension back is fabric suspended between a frame.
- Fully upholstered back features a slim foam pad.
- Seat: Standard upholstered foam.
- Base: Black plastic base.
- Arms: Black plastic fixed arms.
- Mechanism: Weight assisted mechanism with tilt tension adjustment.
- Back-Lock: Single position upright back lock.
- Optional Forward Tilt: 5° downward from initial position.
- Optional Seat Depth Adjustment: 16.75"-19"(425mm-483mm).
- Optional Adjustable Lumbar: 4"(102mm) height adjustment, flexible lumbar support.
- Casters: Standard with hard black casters; optional soft casters.
- COM yardage / COL square footage:
Tension back model: 0.66/4.1
Fully upholstered model: 0.75/8.2

To Order, Specify:

- 1) Product number, including;

1 Seat or Seat Pad Option:

- Fixed Seat
- Adjustable Seat, add **\$30.00** list

- 2) Surface and color (seat).
- 3) Surface and color for tension back material (back).
- 4) Surface and color for fabric on fully upholstered (back).
- 5) Base.

Note: When specifying a fully upholstered chair; must also specify a tension back color for outside of back.

Leather Seat with Tension Back:

Change the fifth digit in the product number to 1.

Example: SLT1-1T-1115A.

Leather Seat with Leather Back:

Change the fifth and sixth digits in the product number to 11.

Example: SLT1-11-1115A.

Faux Leather Seat with Tension Back:

Change the fifth digit in the product number to 3.

Example: SLT1-3T-1115A.

Upholstered Seat Adjustments	Number ①	Fabric Grade								Leather Grade A	Leather Grade B
		A	B	C	D	E	F	G	H		
No Lumbar Adjustment - Tension Back											
Back Lock	SLT1-2T-1015	\$574.00	\$602.00	\$632.00	\$646.00	\$658.00	\$684.00	\$ 708.00	\$ 772.00	\$ 829.00	\$ 954.00
Forward Tilt/Back Lock	SLT1-2T-1045	604.00	632.00	662.00	676.00	688.00	714.00	738.00	802.00	859.00	984.00
No Lumbar Adjustment - Fully Upholstered											
Back Lock	SLT1-22-1015	\$674.00	\$730.00	\$790.00	\$818.00	\$842.00	\$894.00	\$ 942.00	\$1070.00	\$1184.00	\$1434.00
Forward Tilt/Back Lock	SLT1-22-1045	704.00	760.00	820.00	848.00	872.00	924.00	972.00	1100.00	1214.00	1464.00
Lumbar Adjustment - Tension Back											
Back Lock	SLT1-2T-1115	\$624.00	\$652.00	\$682.00	\$696.00	\$708.00	\$734.00	\$ 758.00	\$ 822.00	\$ 879.00	\$1004.00
Forward Tilt/Back Lock	SLT1-2T-1145	654.00	682.00	712.00	726.00	738.00	764.00	788.00	852.00	909.00	1034.00
Lumbar Adjustment - Fully Upholstered											
Back Lock	SLT1-22-1115	\$724.00	\$780.00	\$840.00	\$868.00	\$892.00	\$944.00	\$ 992.00	\$1120.00	\$1234.00	\$1484.00
Forward Tilt/Back Lock	SLT1-22-1145	754.00	810.00	870.00	898.00	922.00	974.00	1022.00	1150.00	1264.00	1514.00

The following options require modification of the product number.

- Soft Casters
- CAL 133
- Nano-Tex

- To specify, change the 10th digit from a 5 to a 6; **Example:** SLT1-22-1016A
- To specify, add **F** to the end of the product number; **Example:** SLT1-22-1015AF (add **\$118.00** list)
- To specify, add **P** to end of the product number; **Example:** SLT1-22-1015AP (add **\$31.00** list)

NOTE: Nano-Tex is available on SLT1-2T and SLT1-22 models only.

LIVELY

Task Chair without Arms



SLT1-2T-0115A

Dimensions*

SH: 16"-21"
(406mm-533mm)
H: 36"-41"
(914mm-1041mm)
D: 24"(610mm)
W: 28"(711mm)
SW: 19"(483mm)

* All measurements taken with the BIFMA chair measuring device.

Features

- Back: Tension back or fully upholstered.
- Tension back is fabric suspended between a frame.
- Fully upholstered back features a slim foam pad.
- Seat: Standard upholstered foam.
- Base: Black plastic base.
- Mechanism: Weight assisted mechanism with tilt tension adjustment.
- Back-Lock: Single position upright back lock.
- Optional Forward Tilt: 5° downward from initial position.
- Optional Seat Depth Adjustment: 16.75"-19"(425mm-483mm).
- Optional Adjustable Lumbar: 4"(102mm) height adjustment, flexible lumbar support.
- Casters: Standard with hard black casters; optional soft casters.
- COM yardage / COL square footage:
Tension back model: 0.66/4.1
Fully upholstered model: 0.75/8.2

To Order, Specify:

1) Product number, including;

① Seat or Seat Pad Option:

- Fixed Seat
 Adjustable Seat, add **\$30.00** list

2) Surface and color (seat).

3) Surface and color for tension back material (back).

4) Surface and color for fabric on fully upholstered (back).

5) Base.

Note: When specifying a fully upholstered chair; must also specify a tension back color for outside of back.

Leather Seat with Tension Back:

Change the fifth digit in the product number to **1**.

Example: SLT1-1T-0115A.

Leather Seat with Leather Back:

Change the fifth and sixth digits in the product number to **11**.

Example: SLT1-11-0115A.

Faux Leather Seat with Tension Back:

Change the fifth digit in the product number to **3**.

Example: SLT1-3T-0115A.

Upholstered Seat Adjustments	Number ①	Fabric Grade								Leather Grade A	Leather Grade B
		A	B	C	D	E	F	G	H		
No Lumbar Adjustment - Tension Back											
Back Lock	SLT1-2T-0015	\$524.00	\$552.00	\$582.00	\$596.00	\$608.00	\$634.00	\$658.00	\$ 722.00	\$ 779.00	\$ 904.00
Forward Tilt/Back Lock	SLT1-2T-0045	554.00	582.00	612.00	626.00	638.00	664.00	688.00	752.00	809.00	934.00
No Lumbar Adjustment - Fully Upholstered											
Back Lock	SLT1-22-0015	\$624.00	\$680.00	\$740.00	\$768.00	\$792.00	\$844.00	\$892.00	\$1020.00	\$1134.00	\$1384.00
Forward Tilt/Back Lock	SLT1-22-0045	654.00	710.00	770.00	798.00	822.00	874.00	922.00	1050.00	1164.00	1414.00
Lumbar Adjustment - Tension Back											
Back Lock	SLT1-2T-0115	\$574.00	\$602.00	\$632.00	\$646.00	\$658.00	\$684.00	\$708.00	\$ 772.00	\$ 829.00	\$ 954.00
Forward Tilt/Back Lock	SLT1-2T-0145	604.00	632.00	662.00	676.00	688.00	714.00	738.00	802.00	859.00	984.00
Lumbar Adjustment - Fully Upholstered											
Back Lock	SLT1-22-0115	\$674.00	\$730.00	\$790.00	\$818.00	\$842.00	\$894.00	\$942.00	\$1070.00	\$1184.00	\$1434.00
Forward Tilt/Back Lock	SLT1-22-0145	704.00	760.00	820.00	848.00	872.00	924.00	972.00	1100.00	1214.00	1464.00

The following options require modification of the product number.

Soft Casters
CAL 133
Nano-TEX

To specify, change the 10th digit from a **5** to a **6**; **Example:** SLT1-22-0016A

To specify, add **F** to the end of the product number; **Example:** SLT1-22-0015AF (add **\$118.00** list)

To specify, add **P** to end of the product number; **Example:** SLT1-22-0015AP (add **\$31.00** list)

NOTE: Nano-TEX is available on SLT1-2T and SLT1-22 models only.

LIVELY

Side Chair

With Arms



SLS1-2T-1H



SLS1-2T-11

Dimensions*

SH: 18"(457mm)
 H: 33"(838mm)
 D: 24.5"(622mm)
 W: 21.5"(536mm)
 SW: 19.5"(495mm)

* All measurements taken with the BIFMA chair measuring device.

Features

- Back: Tension back or fully upholstered.
- Tension back is fabric suspended between a frame.
- Fully upholstered back features a slim foam pad.
- Seat: Standard upholstered foam.
- Base: Steel painted in black or metallic silver.
- Arms: Fixed arms with black plastic arm cap.
- Side chair with glides can stack 5 high on the floor.
- Side chair with casters does NOT stack.
- COM yardage / COL square footage:
 Tension back model: 0.75/4.1
 Fully upholstered model: 0.75/8.2

To Order, Specify:

1) Product number, including;

1) Glide or Caster Option:

- K** Felt Glide
- H** Plastic Glide
- 1** Hard Casters add **\$15.00** list
- 2** Soft Casters add **\$15.00** list

- 2) Surface and color (seat).
- 3) Surface and color for tension back material (back).
- 4) Surface and color for fabric on fully upholstered (back).
- 5) Frame color.

Note: When specifying a fully upholstered chair; must also specify a tension back color for outside of back.

Leather Seat with Tension Back:

Change the fifth digit in the product number to 1.

Example: SLS1-1T-1H.

Leather Seat with Leather Back:

Change the fifth and sixth digits in the product number to 11.

Example: SLS1-11-1H.

Faux Leather Seat with Tension Back:

Change the fifth digit in the product number to 3.

Example: SLS1-3T-1H.

Upholstered Seat	Number 1	Fabric Grade								Leather Grade A	Leather Grade B
		A	B	C	D	E	F	G	H		
Tension Back	SLS1-2T-1	\$369.00	\$398.00	\$429.00	\$443.00	\$456.00	\$482.00	\$507.00	\$573.00	\$503.00	\$623.00
Fully Upholstered	SLS1-22-1	\$384.00	\$442.00	\$504.00	\$532.00	\$558.00	\$610.00	\$660.00	\$792.00	\$652.00	\$892.00

The following options require modification of the product number.

CAL 133
 Nano-TEX

To specify, add **F** to the end of the product number; **Example:** SLS1-2T-1HF (add **\$57.00** list)
 To specify, add **P** to end of the product number; **Example:** SLS1-22-1HP (add **\$31.00** list)

LIVELY

Side Chair

Without Arms



SLS1-2T-0H

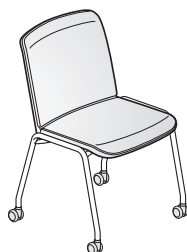

SLS1-2T-01

Dimensions*

SH: 18"(457mm)
 H: 33"(838mm)
 D: 24.5"(622mm)
 W: 21.5"(536mm)
 SW: 19.5"(495mm)

* All measurements taken with the BIFMA chair measuring device.

Features

- Back: Tension back or fully upholstered.
- Tension back is fabric suspended between a frame.
- Fully upholstered back features a slim foam pad.
- Seat: Standard upholstered foam.
- Base: Steel painted in black or metallic silver.
- Side chair with glides can stack 5 high on the floor.
- Side chair with casters does NOT stack.
- COM yardage / COL square footage:
 Tension back model: 0.75/4.1
 Fully upholstered model: 0.75/8.2

To Order, Specify:

1) Product number, including;

① Glide or Caster Option:

- K** Felt Glide
- H** Plastic Glide
- 1** Hard Casters add **\$15.00** list
- 2** Soft Casters add **\$15.00** list

- 2) Surface and color (seat).
- 3) Surface and color for tension back material (back).
- 4) Surface and color for fabric on fully upholstered (back).
- 5) Frame color.

Note: When specifying a fully upholstered chair; must also specify a tension back color for outside of back.

Leather Seat with Tension Back:

Change the fifth digit in the product number to 1.

Example: SLS1-1T-0H.

Leather Seat with Leather Back:

Change the fifth and sixth digits in the product number to 11.

Example: SLS1-11-0H.

Faux Leather Seat with Tension Back:

Change the fifth digit in the product number to 3.

Example: SLS1-3T-0H.

Upholstered Seat	Number ①	Fabric Grade								Leather Grade A	Leather Grade B
		A	B	C	D	E	F	G	H		
Tension Back	SLS1-2T-0	\$319.00	\$348.00	\$379.00	\$393.00	\$406.00	\$432.00	\$457.00	\$523.00	\$453.00	\$573.00
Fully Upholstered	SLS1-22-0	334.00	392.00	454.00	482.00	508.00	560.00	610.00	742.00	602.00	842.00

The following options require modification of the product number.

CAL 133
 Nano-Text

To specify, add **F** to the end of the product number; **Example:** SLS1-2T-0HF (add **\$57.00** list)
 To specify, add **P** to end of the product number; **Example:** SLS1-22-0HP (add **\$31.00** list)

**Features and Options
(Task and Executive)**

- Upholstered seat
- Soft mesh or upholstered back
- Soft mesh consists of chenille, poly-filament blend
- Pneumatic seat-height adjustment
- Optional low-position pneumatic seat-height adjustment: range 15"-18"(381-457mm) (steel base only)
- Optional height-and-depth adjustable lumbar
- Optional 3-position seat-depth adjustment (seat depth range: 16"-18"(406-457mm))
- Back stop, lockable in the upright position
- Tuck-away tilt tension adjustment
- Free-floating forward tilt
- 3-point tilt mechanism
- 3-dimensional arms, loop arms or armless
- Standard soft arm caps, upholstered (fabric or leather) arm caps, or vinyl gel arm caps
- Aluminum or flat welded steel five-star base
- Finishes include: powder-coated paint (black or silver) and chrome
- Hard dual-wheel casters for carpeted floors (black)
- Optional soft dual-wheel casters for resilient floor surfaces (black)
- Contoured headrest on executive chair
- All **X99** models meet or exceed all ANSI/BIFMA durability standards for office seating

Mobility and Adjustability



- Back reclines 25° from the upright position
- Seat pan moves downward 3° from the initial position
- 3-dimensional arm adjustment
- Arm height adjustment: 4"(102mm)
- Arm cap slide range: 2.4"(61mm)
- Arm cap pivot range: 30° (18° in/12° out)

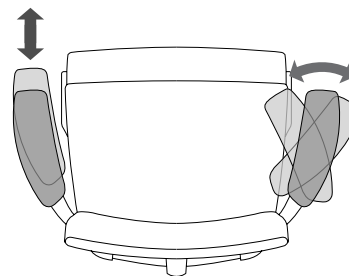
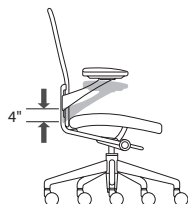

Height-and-depth adjustable lumbar - mesh or upholstered back

- 4"(102mm) vertical adjustment; 1"(25mm) depth adjustment

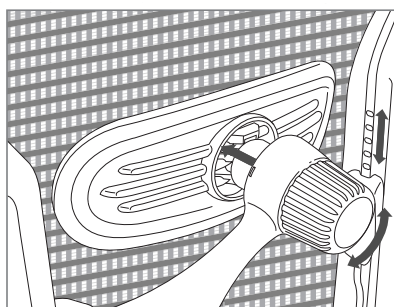

Lumbar Adjustment, Mesh Back

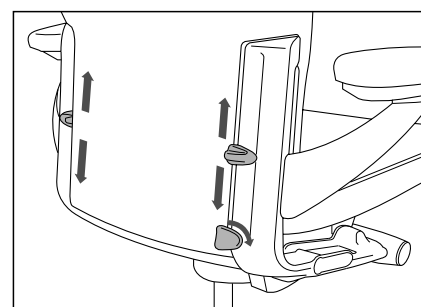

Lumbar Adjustment, Upholstered Back



Standard Aluminum Base

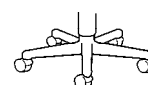

Optional Steel Base

X99

General Specifications

- 3-position seat-depth up to 3.5 inches of adjustment

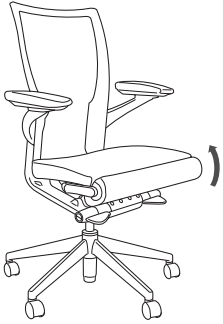

Features and Options (Guest Chair)

- Upholstered seat
- Soft mesh or upholstered back
- Soft mesh consists of chenille, poly-filament blend
- Black polypropylene arm caps
- Aluminum uprights with welded steel frame
- Finishes include: powder-coated paint (black or silver) and chrome
- Black nylon glides
- Stacks up to 4-high

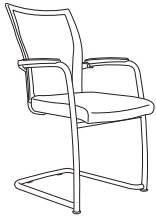

Shipping Weights (including packaging)

- Executive chair: 60 pounds/1 chair per carton/23.8 cubic feet
- Task chair: 52 pounds/1 chair per carton/19.7 cubic feet
- Guest chair with sled base: 35 pounds/1 chair per carton/19.5 cubic feet
- Seminar chair: 34 pounds/1 chair per carton/18.7 cubic feet
- Advanced Seminar chair: 40 pounds/1 chair per carton/16.0 cubic feet

X99

General Specifications

General Guidelines for Product Specification

X99 specification numbers are based on an alpha-numeric logic that identifies a product by model and specific characteristics.

For instance, a product number that reads **X621-1Y41** identifies the product as an **X99** Task Chair, with 3-dimensional arms, mesh back and fabric upholstery seat, pneumatic height adjustment, and hard casters.

The numeric logic for this model with fabric and finish codes is shown below:

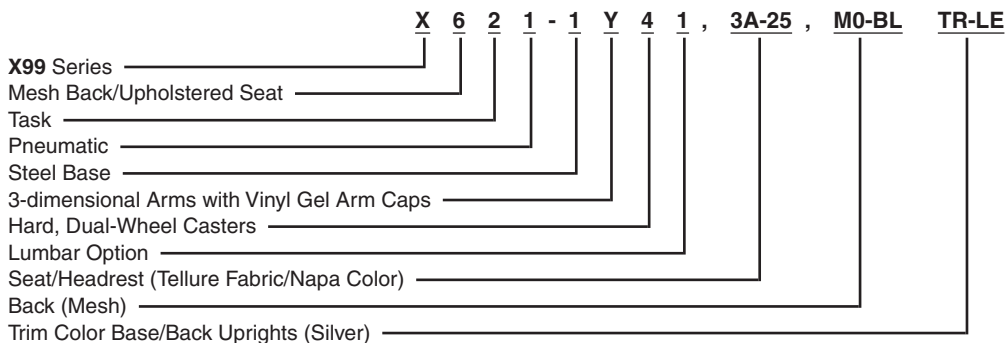

There are exceptions to this logic; therefore, always refer to the price charts for product numbers rather than attempting to construct them. Product number modification instructions for additional options appear in footnoted copy for each applicable model.

Beyond the printed product number, fabric and finish codes are required to complete an order specification. To communicate your order clearly, list the product number and finish codes in the sequence outlined on each price page.

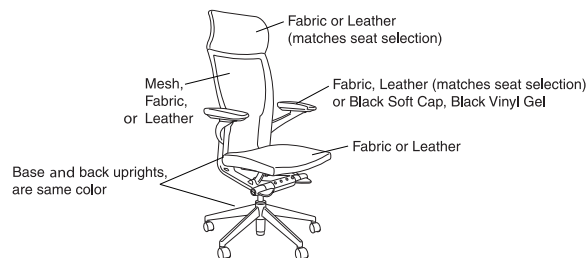

Note:

- Fully upholstered models require fabric/leather for seat and back to match. No dual fabrics or materials.
- Arms are black only.

COM & COL General Information

To order a COM fabric (Customer's Own Material), contact the Haworth Inquiry Center (1.800.426.8562), your local Haworth dealer, or go to haworth.com/surfaces > COM Library to find out if the COM you have selected has already been tested and approved. The surface collection site also has information on the Haworth+ alliance program with Carnegie, Luna Textiles, and Maharam as well as our industry-leading Pre-Approved COM program.

Approved COMs are placed into Grades based on the fabric pricing; if the fabric pricing exceeds our Grades, they will be priced at Grade A + cost of fabric + 4% handling (North America). Haworth will purchase all COMs unless instructed otherwise. (Leather will also be purchased by Haworth; if the leather pricing exceeds our Grades, cost will be based on fabric Grade E + cost of leather + 4% handling.)

If no information is available on the COM you are looking for, refer to the COM section and forms on the surface collection site for information on how to process your test request.

X99

General Specifications

Finishes and Fabrics

A complete listing of finishes and fabrics for **X99** seating is available on pages 363 and 365-368.

Environmental Factors

Material Off Gassing

In an effort to ensure air quality standards, all **X99** parts suppliers are required to provide Material Data Sheets and/or other documentation, verifying their products do not emit volatile organic compounds (VOC). In addition, the powder-coat paint process used in the manufacturing of **X99** seating is free of VOCs. Our manufacturing processes have also eliminated all use of chlorofluorocarbons (CFCs) and ozone depleting chemicals (ODCs) in the chair's construction.

Recycling

All **X99** seating fabric scraps are recycled, reducing the amount of material sent to landfills, and all chair components disassemble easily to increase the potential for recycling. In addition, all thermo-plastic parts are 100% reprocessible, and all raw materials used in its manufacturing can be recycled at the end of the useful life of the product. Recyclable parts are identified with the recycle symbol where practical.

X99

Executive with 3-dimensional Arms

Deep Seat



X611-2W44

Dimensions*

*SH: 16" - 20.5"
(406mm - 521mm)
H: 47" - 51.5"
(1194mm - 1308mm)
D: 25"(635mm)
W: 26"(660mm)
*SW: 18.6"(472mm)
*AH: 6.3" - 10.8"
(160mm - 274mm)
*SD: 17.5"(445mm)

Low-position pneumatic
seat-height adjustment
range:
15-18"(381mm-457mm)

Features

- Back: Soft mesh or upholstered.
- Seat: Standard upholstered.
- Base: Five star aluminum base standard; optional steel base available, see below.
- Arm caps: Soft, upholstered or vinyl gel with pivoting and sliding capability.
- Casters: Standard with hard casters; for optional soft casters, see below.
- Mechanism: 3-point tilt.
- Height adjustment: Pneumatic or low position pneumatic; see below.
- Arm adjustment: 4"(102mm) height adjustment.
- Back stop: Single position.
- Free-floating forward tilt.
- Adjustable lumbar models available, with 1"(25mm) depth and 4"(102mm) height adjustment.
- COM yardage / COL square footage:
Mesh back model: 1.0/15
Fully upholstered model: 2.0/40
- Available on RUSH.

* Measurements taken with the BIFMA chair measuring device.

To Order, Specify:

- 1) Product number.
- 2) Fabric surface and color (seat/headrest/arm cap).
- 3) Fabric or mesh surface and color (back).
- 4) Trim color for base/back uprights. (Add **\$299.25** for chrome finish.)

Leather Upholstery Option:

Leather upholstery option requires modification of the product number. Change the second digit in the product number as follows:

Leather Seat with Mesh Back:

Change second digit in mesh back model to **5**.

Example: X511-2W44

Leather Seat with Leather Back:

Change second digit in upholstered back model to **7**.

Example: X711-2W44

Deep Seat	Back	Arm Caps	Number	Fabric Grade								Leather Grade A	Leather Grade B
				A	B	C	D	E	F	G	H		
Pneumatic Height													
Upholstered	Mesh	Soft	X611-2W44 ■	\$1756.65	\$1791.30	\$1824.90	\$1842.75	\$1856.40	\$1929.90	\$1967.70	\$2070.60	\$2046.45	\$2184.65
		Upholstered	X611-2X44 ■	1810.20	1844.85	1878.45	1896.30	1909.95	1983.45	2021.25	2124.15	2100.00	2238.20
		Vinyl Gel	X611-2Y44 ■	1810.20	1844.85	1878.45	1896.30	1909.95	1983.45	2021.25	2124.15	2100.00	2238.20
Upholstered	Upholstered	Soft	X811-2W44	\$1822.80	\$1892.10	\$1959.30	\$1995.00	\$2022.30	\$2169.30	\$2244.90	\$2450.70	\$2402.40	\$2678.80
		Upholstered	X811-2X44	1876.35	1945.65	2012.85	2048.55	2075.85	2222.85	2298.45	2504.25	2455.95	2732.35
		Vinyl Gel	X811-2Y44	1876.35	1945.65	2012.85	2048.55	2075.85	2222.85	2298.45	2504.25	2455.95	2732.35
Pneumatic Height Adjustment with Lumbar													
Upholstered	Mesh	Soft	X611-2W45 ■	\$1824.90	\$1859.55	\$1893.15	\$1911.00	\$1924.65	\$1998.15	\$2035.95	\$2138.85	\$2114.70	\$2252.90
		Upholstered	X611-2X45 ■	1878.45	1913.10	1946.70	1964.55	1978.20	2051.70	2089.50	2192.40	2168.25	2306.45
		Vinyl Gel	X611-2Y45 ■	1878.45	1913.10	1946.70	1964.55	1978.20	2051.70	2089.50	2192.40	2168.25	2306.45
Upholstered	Upholstered	Soft	X811-2W45	\$1891.05	\$1960.35	\$2027.55	\$2063.25	\$2090.55	\$2237.55	\$2313.15	\$2518.95	\$2470.65	\$2747.05
		Upholstered	X811-2X45	1944.60	2013.90	2081.10	2116.80	2144.10	2291.10	2366.70	2572.50	2524.20	2800.60
		Vinyl Gel	X811-2Y45	1944.60	2013.90	2081.10	2116.80	2144.10	2291.10	2366.70	2572.50	2524.20	2800.60

Soft Caster Option:

Soft caster option requires modification of the product number. Change the seventh digit in the product number from **4** to **2**.

Example: X611-2W24.

Steel Base Option:

Steel base option requires modification of the product number. Change the fifth digit in the product number to **1**.

Example: X611-1W44.

NOTE: Steel base comes with plastic covers and has a flat shape.

Low-position Pneumatic Option:

Low-position pneumatic option requires modification of the product number. To specify, change the fourth digit in the product number to **3**, and the fifth digit to **1**.

Example: X613-1W44.

NOTE: Low-position pneumatic option available on **Steel Base** chairs only.

CAL 133 Option:

CAL 133 option is available on mesh back models with upholstered arm caps only. To specify, add **-F** to the product number and add **\$101.85** list.

X99

Executive with 3-dimensional Arms

Standard Seat



X611-2W40

Dimensions*

- *SH: 16" - 20.5"
(406mm - 521mm)
- H: 47" - 51.5"
(1194mm - 1308mm)
- D: 25"(635mm)
- W: 26"(660mm)
- *SW: 18.6"(472mm)
- *AH: 6.3" - 10.8"
(160mm - 274mm)
- *SD: 16"(407mm)

Low-position pneumatic seat-height adjustment range:
15-18"(381mm-457mm)

Features

- Back: Soft mesh or upholstered.
- Seat: Standard upholstered.
- Base: Five star aluminum base standard; optional steel base available, see page 111.
- Arm caps: Soft, upholstered or vinyl gel with pivoting and sliding capability.
- Casters: Standard with hard casters; for optional soft casters, see page 111.
- Mechanism: 3-point tilt.
- Height adjustment: Pneumatic or low position pneumatic; see page 111.
- Arm adjustment: 4"(102mm) height adjustment.
- Back stop: Single position.
- Free-floating forward tilt.
- Adjustable lumbar models available, with 1"(25mm) depth and 4"(102mm) height adjustment.
- 3-position seat-depth adjustment models are available with a 3 1/2"(89mm) range.
- COM yardage / COL square footage:
Mesh back model: 1.0/15
Fully upholstered model: 2.0/40

■ Available on RUSH.

* Measurements taken with the BIFMA chair measuring device.

To Order, Specify:

- 1) Product number.
- 2) Fabric surface and color (seat/headrest/arm cap).
- 3) Fabric or mesh surface and color (back).
- 4) Trim color for base/back uprights. (Add \$299.25 for chrome finish.)

Leather Upholstery Option:

Leather upholstery option requires modification of the product number. Change the second digit in the product number as follows:

Leather Seat with Mesh Back:

Change second digit in mesh back model to 5.

Example: X511-2W40

Leather Seat with Leather Back:

Change second digit in upholstered back model to 7.

Example: X711-2W40

Standard Seat	Back	Arm Caps	Number	Fabric Grade								Leather Grade A	Leather Grade B
				A	B	C	D	E	F	G	H		
Pneumatic Height Adjustment													
Upholstered	Mesh	Soft	X611-2W40 ■	\$1756.65	\$1791.30	\$1824.90	\$1842.75	\$1856.40	\$1929.90	\$1967.70	\$2070.60	\$2046.45	\$2184.65
		Upholstered	X611-2X40 ■	1810.20	1844.85	1878.45	1896.30	1909.95	1983.45	2021.25	2124.15	2100.00	2238.20
		Vinyl Gel	X611-2Y40 ■	1810.20	1844.85	1878.45	1896.30	1909.95	1983.45	2021.25	2124.15	2100.00	2238.20
Upholstered	Upholstered	Soft	X811-2W40	\$1822.80	\$1892.10	\$1959.30	\$1995.00	\$2022.30	\$2169.30	\$2244.90	\$2450.70	\$2402.40	\$2678.80
		Upholstered	X811-2X40	1876.35	1945.65	2012.85	2048.55	2075.85	2222.85	2298.45	2504.25	2455.95	2732.35
		Vinyl Gel	X811-2Y40	1876.35	1945.65	2012.85	2048.55	2075.85	2222.85	2298.45	2504.25	2455.95	2732.35
Pneumatic Height Adjustment with Lumbar													
Upholstered	Mesh	Soft	X611-2W41 ■	\$1824.90	\$1859.55	\$1893.15	\$1911.00	\$1924.65	\$1998.15	\$2035.95	\$2138.85	\$2114.70	\$2252.90
		Upholstered	X611-2X41 ■	1878.45	1913.10	1946.70	1964.55	1978.20	2051.70	2089.50	2192.40	2168.25	2306.45
		Vinyl Gel	X611-2Y41 ■	1878.45	1913.10	1946.70	1964.55	1978.20	2051.70	2089.50	2192.40	2168.25	2306.45
Upholstered	Upholstered	Soft	X811-2W41	\$1891.05	\$1960.35	\$2027.55	\$2063.25	\$2090.55	\$2237.55	\$2313.15	\$2518.95	\$2470.65	\$2747.05
		Upholstered	X811-2X41	1944.60	2013.90	2081.10	2116.80	2144.10	2291.10	2366.70	2572.50	2524.20	2800.60
		Vinyl Gel	X811-2Y41	1944.60	2013.90	2081.10	2116.80	2144.10	2291.10	2366.70	2572.50	2524.20	2800.60

X99

Executive with 3-dimensional Arms

Standard Seat

Standard Seat	Back	Arm Caps	Number	Fabric Grade								Leather Grade A	Leather Grade B
				A	B	C	D	E	F	G	H		
Pneumatic Height Adjustment with Seat Depth Adjustment													
Upholstered	Mesh	Soft	X611-2W42	\$1893.15	\$1927.80	\$1961.40	\$1979.25	\$1992.90	\$2066.40	\$2104.20	\$2207.10	\$2182.95	\$2321.15
		Upholstered	X611-2X42	1946.70	1981.35	2014.95	2032.80	2046.45	2119.95	2157.75	2260.65	2236.50	2374.70
		Vinyl Gel	X611-2Y42	1946.70	1981.35	2014.95	2032.80	2046.45	2119.95	2157.75	2260.65	2236.50	2374.70
Upholstered	Upholstered	Soft	X811-2W42	\$1959.30	\$2028.60	\$2095.80	\$2131.50	\$2158.80	\$2305.80	\$2381.40	\$2587.20	\$2538.90	\$2815.30
		Upholstered	X811-2X42	2012.85	2082.15	2149.35	2185.05	2212.35	2359.35	2434.95	2640.75	2592.45	2868.85
		Vinyl Gel	X811-2Y42	2012.85	2082.15	2149.35	2185.05	2212.35	2359.35	2434.95	2640.75	2592.45	2868.85
Pneumatic Height Adjustment with Lumbar and Seat Depth Adjustment													
Upholstered	Mesh	Soft	X611-2W43	\$1961.40	\$1996.05	\$2029.65	\$2047.50	\$2061.15	\$2134.65	\$2172.45	\$2275.35	\$2251.20	\$2389.40
		Upholstered	X611-2X43	2014.95	2049.60	2083.20	2101.05	2114.70	2188.20	2226.00	2328.90	2304.75	2442.95
		Vinyl Gel	X611-2Y43	2014.95	2049.60	2083.20	2101.05	2114.70	2188.20	2226.00	2328.90	2304.75	2442.95
Upholstered	Upholstered	Soft	X811-2W43	\$2027.55	\$2096.85	\$2164.05	\$2199.75	\$2227.05	\$2374.05	\$2449.65	\$2655.45	\$2607.15	\$2883.55
		Upholstered	X811-2X43	2081.10	2150.40	2217.60	2253.30	2280.60	2427.60	2503.20	2709.00	2660.70	2937.10
		Vinyl Gel	X811-2Y43	2081.10	2150.40	2217.60	2253.30	2280.60	2427.60	2503.20	2709.00	2660.70	2937.10

Soft Caster Option:

Soft caster option requires modification of the product number. Change the seventh digit in the product number from 4 to 2.

Example: X611-2W20.

Steel Base Option:

Steel base option requires modification of the product number. Change the fifth digit in the product number to 1.

Example: X611-1W40.

NOTE: Steel base comes with plastic covers and has a flat shape.

Low-position Pneumatic Option:

Low-position pneumatic option requires modification of the product number. To specify, change the fourth digit in the product number to 3, and the fifth digit to 1.

Example: X613-1W40.

NOTE: Low-position pneumatic option available on **Steel Base** chairs only.

CAL 133 Option:

CAL 133 option is available on mesh back models with upholstered arm caps only. To specify, add -F to the product number and add \$101.85 list.

X99

Executive with Loop Arms

Deep Seat



X611-2144

Dimensions*

- *SH: 16" - 20.5"
(406mm - 521mm)
- H: 47" - 51.5"
(1194mm - 1308mm)
- D: 25"(635mm)
- W: 26"(660mm)
- *SW: 18.6"(472mm)
- *AH: 7.3"(185mm)
- *SD: 17.5"(445mm)

Low-position pneumatic seat-height adjustment range:
15-18"(381mm-457mm)

Features

- Back: Soft mesh or upholstered.
- Seat: Standard upholstered.
- Base: Five star aluminum base standard; optional steel base available, see below.
- Arms: Fixed loop with black polypropylene arm caps.
- Casters: Standard with hard casters; for optional soft casters, see below.
- Mechanism: 3-point tilt.
- Height adjustment: Pneumatic or low-position pneumatic; see below.
- Back stop: Single position.
- Free-floating forward tilt.
- Adjustable lumbar models available, with 1"(25mm) depth and 4"(102mm) height adjustment.
- COM yardage / COL square footage:
Mesh back model: 1.0/15
Fully upholstered model: 2.0/40
- Available on RUSH.

* Measurements taken with the BIFMA chair measuring device.

To Order, Specify:

- 1) Product number.
- 2) Fabric surface and color (seat/headrest/arm cap).
- 3) Fabric or mesh surface and color (back).
- 4) Trim color for base/back uprights.
(Add **\$299.25** for chrome finish.)

Leather Upholstery Option:

Leather upholstery option requires modification of the product number. Change the second digit in the product number as follows:

Leather Seat with Mesh Back:

Change second digit in mesh back model to **5**.

Example: X511-2144

Leather Seat with Leather Back:

Change second digit in upholstered back model to **7**.

Example: X711-2144

Deep Seat	Back	Arm Caps	Number	Fabric Grade								Leather Grade A	Leather Grade B
				A	B	C	D	E	F	G	H		
Pneumatic Height													
Upholstered	Mesh	Standard	X611-2144	\$1621.20	\$1655.85	\$1689.45	\$1707.30	\$1720.95	\$1794.45	\$1832.25	\$1935.15	\$1911.00	\$2049.20
Upholstered	Upholstered	Standard	X811-2144	1687.35	1756.65	1823.85	1859.55	1886.85	2033.85	2109.45	2315.25	2266.95	2543.35
Pneumatic Height Adjustment with Lumbar													
Upholstered	Mesh	Standard	X611-2145	\$1689.45	\$1724.10	\$1757.70	\$1775.55	\$1789.20	\$1862.70	\$1900.50	\$2003.40	\$1979.25	\$2117.45
Upholstered	Upholstered	Standard	X811-2145	1755.60	1824.90	1892.10	1927.80	1955.10	2102.10	2177.70	2383.50	2335.20	2611.60

Soft Caster Option:

Soft caster option requires modification of the product number. Change the seventh digit in the product number from **4** to **2**.

Example: X611-2124.

Steel Base Option:

Steel base option requires modification of the product number. Change the fifth digit in the product number to **1**.

Example: X611-1144.

NOTE: Steel base comes with plastic covers and has a flat shape.

Low-position Pneumatic Option:

Low-position pneumatic option requires modification of the product number. To specify, change the fourth digit in the product number to **3**, and the fifth digit to **1**.

Example: X613-1144.

NOTE: Low-position pneumatic option available on **Steel Base** chairs only.

X99

Executive with Loop Arms

Standard Seat



X611-2140

Dimensions*

- *SH: 16" - 20.5"
(406mm - 521mm)
- H: 47" - 51.5"
(1194mm - 1308mm)
- D: 25"(635mm)
- W: 26"(660mm)
- *SW: 18.6"(472mm)
- *AH: 7.3"(185mm)
- *SD: 16"(407mm)

Low-position pneumatic seat-height adjustment range:
15-18"(381mm-457mm)

Features

- Back: Soft mesh or upholstered.
 - Seat: Standard upholstered.
 - Base: Five star aluminum base standard; optional steel base available, see below.
 - Arms: Fixed loop with black polypropylene arm caps.
 - Casters: Standard with hard casters; for optional soft casters, see below.
 - Mechanism: 3-point tilt.
 - Height adjustment: Pneumatic or low-position pneumatic; see below.
 - Back stop: Single position.
 - Free-floating forward tilt.
 - Adjustable lumbar models available, with 1"(25mm) depth and 4"(102mm) height adjustment.
 - 3-position seat-depth adjustment models are available with a 3 1/2"(89mm) range.
 - COM yardage / COL square footage:
Mesh back model: 1.0/15
Fully upholstered model: 2.0/40
- Available on RUSH.

* Measurements taken with the BIFMA chair measuring device.

To Order, Specify:

- 1) Product number.
- 2) Fabric surface and color (seat/headrest/arm cap).
- 3) Fabric or mesh surface and color (back).
- 4) Trim color for base/back uprights. (Add **\$299.25** for chrome finish.)

Leather Upholstery Option:

Leather upholstery option requires modification of the product number. Change the second digit in the product number as follows:

Leather Seat with Mesh Back:

Change second digit in mesh back model to **5**.

Example: X511-2140

Leather Seat with Leather Back:

Change second digit in upholstered back model to **7**.

Example: X711-2140

Standard Seat	Back	Arm Caps	Number	Fabric Grade								Leather Grade A	Leather Grade B
				A	B	C	D	E	F	G	H		
Pneumatic Height Adjustment													
Upholstered	Mesh	Standard	X611-2140	■ \$1621.20	\$1655.85	\$1689.45	\$1707.30	\$1720.95	\$1794.45	\$1832.25	\$1935.15	\$1911.00	\$2049.20
Upholstered	Upholstered	Standard	X811-2140	1687.35	1756.65	1823.85	1859.55	1886.85	2033.85	2109.45	2315.25	2266.95	2543.35
Pneumatic Height Adjustment with Lumbar													
Upholstered	Mesh	Standard	X611-2141	■ \$1689.45	\$1724.10	\$1757.70	\$1775.55	\$1789.20	\$1862.70	\$1900.50	\$2003.40	\$1979.25	\$2117.45
Upholstered	Upholstered	Standard	X811-2141	1755.60	1824.90	1892.10	1927.80	1955.10	2102.10	2177.70	2383.50	2335.20	2611.60
Pneumatic Height Adjustment with Seat Depth Adjustment													
Upholstered	Mesh	Standard	X611-2142	■ \$1757.70	\$1792.35	\$1825.95	\$1843.80	\$1857.45	\$1930.95	\$1968.75	\$2071.65	\$2047.50	\$2185.70
Upholstered	Upholstered	Standard	X811-2142	1823.85	1893.15	1960.35	1996.05	2023.35	2170.35	2245.95	2451.75	2403.45	2679.85
Pneumatic Height Adjustment with Lumbar and Seat Depth Adjustment													
Upholstered	Mesh	Standard	X611-2143	■ \$1825.95	\$1860.60	\$1894.20	\$1912.05	\$1925.70	\$1999.20	\$2037.00	\$2139.90	\$2115.75	\$2253.95
Upholstered	Upholstered	Standard	X811-2143	1892.10	1961.40	2028.60	2064.30	2091.60	2238.60	2314.20	2520.00	2471.70	2748.10

Soft Caster Option:

Soft caster option requires modification of the product number. Change the seventh digit in the product number from **4** to **2**.

Example: X611-2120.

Steel Base Option:

Steel base option requires modification of the product number. Change the fifth digit in the product number to **1**.

Example: X611-1140.

NOTE: Steel base comes with plastic covers and has a flat shape.

Low-position Pneumatic Option:

Low-position pneumatic option requires modification of the product number. To specify, change the fourth digit in the product number to **3**, and the fifth digit to **1**.

Example: X613-1140.

NOTE: Low-position pneumatic option available on **Steel Base** chairs only.

X99

Executive without Arms

Deep Seat



X611-2044

Dimensions*

- *SH: 16" - 20.5"
(406mm - 521mm)
- H: 47" - 51.5"
(1194mm - 1308mm)
- D: 25"(635mm)
- W: 26"(660mm)
- *SW: 18.6"(472mm)
- *SD: 17.5"(445mm)

Low-position pneumatic seat-height adjustment range:

15-18"(381mm-457mm)

Features

- Back: Soft mesh or upholstered.
- Seat: Standard upholstered.
- Base: Five star aluminum base standard; optional steel base available, see below.
- Casters: Standard with hard casters; for optional soft casters, see below.
- Mechanism: 3-point tilt.
- Height adjustment: Pneumatic or low-position pneumatic; see below.
- Back stop: Single position.
- Free-floating forward tilt.
- Adjustable lumbar models available, with 1"(25mm) depth and 4"(102mm) height adjustment.
- COM yardage / COL square footage:
Mesh back model: 1.0/15
Fully upholstered model: 2.0/40

* Measurements taken with the BIFMA chair measuring device.

To Order, Specify:

- 1) Product number.
- 2) Fabric surface and color (seat/headrest).
- 3) Fabric or mesh surface and color (back).
- 4) Trim color for base/back uprights.
(Add **\$299.25** for chrome finish.)

Leather Upholstery Option:

Leather upholstery option requires modification of the product number. Change the second digit in the product number as follows:

Leather Seat with Mesh Back:

Change second digit in mesh back model to **5**.

Example: X511-2044

Leather Seat with Leather Back:

Change second digit in upholstered back model to **7**.

Example: X711-2044

Deep Seat	Back	Number	Fabric Grade		C	D	E	F	G	H	Leather Grade A	Leather Grade B
			A	B								
Pneumatic Height												
Upholstered	Mesh	X611-2044	\$1483.65	\$1518.30	\$1551.90	\$1569.75	\$1583.40	\$1656.90	\$1694.70	\$1797.60	\$1773.45	\$1911.65
Upholstered	Upholstered	X811-2044	1549.80	1619.10	1686.30	1722.00	1749.30	1896.30	1971.90	2177.70	2129.40	2405.80
Pneumatic Height Adjustment with Lumbar												
Upholstered	Mesh	X611-2045	\$1551.90	\$1586.55	\$1620.15	\$1638.00	\$1651.65	\$1725.15	\$1762.95	\$1865.85	\$1841.70	\$1979.90
Upholstered	Upholstered	X811-2045	1618.05	1687.35	1754.55	1790.25	1817.55	1964.55	2040.15	2245.95	2197.65	2474.05

Soft Caster Option:

Soft caster option requires modification of the product number. Change the seventh digit in the product number from **4** to **2**.

Example: X611-2024.

CAL 133 Option:

CAL 133 option is available on mesh back models with upholstered arm caps only. To specify, add **-F** to the product number and add **\$101.85** list.

Steel Base Option:

Steel base option requires modification of the product number. Change the fifth digit in the product number to **1**.

Example: X611-1044.

NOTE: Steel base comes with plastic covers and has a flat shape.

Low-position Pneumatic Option:

Low-position pneumatic option requires modification of the product number. To specify, change the fourth digit in the product number to **3**, and the fifth digit to **1**.

Example: X613-1044.

NOTE: Low-position pneumatic option available on **Steel Base** chairs only.

X99

Executive without Arms

Standard Seat

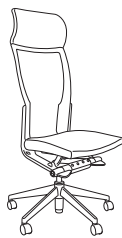

X611-2040

Dimensions*

*SH: 16" - 20.5"
(406mm - 521mm)
H: 47" - 51.5"
(1194mm - 1308mm)
D: 25"(635mm)
W: 26"(660mm)
*SW: 18.6"(472mm)
*SD: 16"(407mm)

Low-position pneumatic
seat-height adjustment
range:
15-18"(381mm-457mm)

Features

- Back: Soft mesh or upholstered.
- Seat: Standard upholstered.
- Base: Five star aluminum base standard; optional steel base available, see below.
- Casters: Standard with hard casters; for optional soft casters, see below.
- Mechanism: 3-point tilt.
- Height adjustment: Pneumatic or low-position pneumatic; see below.
- Back stop: Single position.
- Free-floating forward tilt.
- Adjustable lumbar models available, with 1"(25mm) depth and 4"(102mm) height adjustment.
- 3-position seat-depth adjustment models are available with a 3 1/2"(89mm) range.
- COM yardage / COL square footage:
Mesh back model: 1.0/15
Fully upholstered model: 2.0/40

* Measurements taken with the BIFMA chair measuring device.

To Order, Specify:

- 1) Product number.
- 2) Fabric surface and color (seat/headrest).
- 3) Fabric or mesh surface and color (back).
- 4) Trim color for base/back uprights.
(Add **\$299.25** for chrome finish.)

Leather Upholstery Option:

Leather upholstery option requires modification of the product number. Change the second digit in the product number as follows:

Leather Seat with Mesh Back:

Change second digit in mesh back model to 5.

Example: X511-2040

Leather Seat with Leather Back:

Change second digit in upholstered back model to 7.

Example: X711-2040

Standard Seat	Back	Number	Fabric Grade		C	D	E	F	G	H	Leather Grade A	Leather Grade B
			A	B								
Pneumatic Height Adjustment												
Upholstered	Mesh	X611-2040	\$1483.65	\$1518.30	\$1551.90	\$1569.75	\$1583.40	\$1656.90	\$1694.70	\$1797.60	\$1773.45	\$1911.65
Upholstered	Upholstered	X811-2040	1549.80	1619.10	1686.30	1722.00	1749.30	1896.30	1971.90	2177.70	2129.40	2405.80
Pneumatic Height Adjustment with Lumbar												
Upholstered	Mesh	X611-2041	\$1551.90	\$1586.55	\$1620.15	\$1638.00	\$1651.65	\$1725.15	\$1762.95	\$1865.85	\$1841.70	\$1979.90
Upholstered	Upholstered	X811-2041	1618.05	1687.35	1754.55	1790.25	1817.55	1964.55	2040.15	2245.95	2197.65	2474.05
Pneumatic Height Adjustment with Seat Depth Adjustment												
Upholstered	Mesh	X611-2042	\$1620.15	\$1654.80	\$1688.40	\$1706.25	\$1719.90	\$1793.40	\$1831.20	\$1934.10	\$1909.95	\$2048.15
Upholstered	Upholstered	X811-2042	1686.30	1755.60	1822.80	1858.50	1885.80	2032.80	2108.40	2314.20	2265.90	2542.30
Pneumatic Height Adjustment with Lumbar and Seat Depth Adjustment												
Upholstered	Mesh	X611-2043	\$1688.40	\$1723.05	\$1756.65	\$1774.50	\$1788.15	\$1861.65	\$1899.45	\$2002.35	\$1978.20	\$2116.40
Upholstered	Upholstered	X811-2043	1754.55	1823.85	1891.05	1926.75	1954.05	2101.05	2176.65	2382.45	2334.15	2610.55

Soft Caster Option:

Soft caster option requires modification of the product number. Change the seventh digit in the product number from 4 to 2.

Example: X611-2020.

CAL 133 Option:

CAL 133 option is available on mesh back models with upholstered arm caps only. To specify, add -F to the product number and add **\$101.85** list.

Steel Base Option:

Steel base option requires modification of the product number. Change the fifth digit in the product number to 1.

Example: X611-1040.

NOTE: Steel base comes with plastic covers and has a flat shape.

Low-position Pneumatic Option:

Low-position pneumatic option requires modification of the product number. To specify, change the fourth digit in the product number to 3, and the fifth digit to 1.

Example: X613-1040.

NOTE: Low-position pneumatic option available on **Steel Base** chairs only.

This page intentionally blank

X99

Task Chair with 3-dimensional Arms

Deep Seat



X621-2W44

Dimensions*

- *SH: 16" - 20.5"
(406mm - 521mm)
- H: 38.5" - 43"
(978mm - 1092mm)
- D: 25"(635mm)
- W: 26"(660mm)
- *SW: 18.6"(472mm)
- *AH: 6.3" - 10.8"
(160mm - 274mm)
- *SD: 17.5"(445mm)

Low-position pneumatic seat-height adjustment range:
15-18"(381mm-457mm)

Features

- Back: Soft mesh or upholstered.
 - Seat: Standard upholstered.
 - Base: Five star aluminum base standard; optional steel base available, see below.
 - Arm caps: Soft, upholstered or vinyl gel with pivoting and sliding capability.
 - Casters: Standard with hard casters; for optional soft casters, see below.
 - Mechanism: 3-point tilt.
 - Height adjustment: Pneumatic or low-position pneumatic; see below.
 - Arm adjustment: 4"(102mm) height adjustment.
 - Back stop: Single position.
 - Free-floating forward tilt.
 - Adjustable lumbar models available, with 1"(25mm) depth and 4"(102mm) height adjustment.
 - COM yardage / COL square footage:
Mesh back model: 0.75/15
Fully upholstered model: 1.75/25
- Available on RUSH.

* Measurements taken with the BIFMA chair measuring device.

To Order, Specify:

- 1) Product number.
- 2) Fabric surface and color (seat/arm cap).
- 3) Fabric or mesh surface and color (back).
- 4) Trim color for base/back uprights.
(Add \$299.25 for chrome finish.)

Leather Upholstery Option:

Leather upholstery option requires modification of the product number. Change the second digit in the product number as follows:

Leather Seat with Mesh Back:

Change second digit in mesh back model to 5.

Example: X521-2W44

Leather Seat with Leather Back:

Change second digit in upholstered back model to 7.

Example: X721-2W44

Deep Seat	Back	Arm Caps	Number	Fabric Grade		C	D	E	F	G	H	Leather Grade A	Leather Grade B	
				A	B									
Pneumatic Height														
Upholstered	Mesh	Soft	X621-2W44 ■	\$1618.05	\$1652.70	\$1686.30	\$1704.15	\$1717.80	\$1748.25	\$1776.60	\$1854.30	\$1907.85	\$2046.05	
			Upholstered	X621-2X44 ■	1671.60	1706.25	1739.85	1757.70	1771.35	1801.80	1830.15	1907.85	1961.40	2099.60
			Vinyl Gel	X621-2Y44 ■	1671.60	1706.25	1739.85	1757.70	1771.35	1801.80	1830.15	1907.85	1961.40	2099.60
Upholstered	Upholstered	Soft	X821-2W44	\$1686.30	\$1755.60	\$1822.80	\$1858.50	\$1885.80	\$1946.70	\$2003.40	\$2158.80	\$2265.90	\$2542.30	
			Upholstered	X821-2X44	1739.85	1809.15	1876.35	1912.05	1939.35	2000.25	2056.95	2212.35	2319.45	2595.85
			Vinyl Gel	X821-2Y44	1739.85	1809.15	1876.35	1912.05	1939.35	2000.25	2056.95	2212.35	2319.45 ■	2595.85
Pneumatic Height Adjustment with Lumbar														
Upholstered	Mesh	Soft	X621-2W45 ■	\$1686.30	\$1720.95	\$1754.55	\$1772.40	\$1786.05	\$1816.50	\$1844.85	\$1922.55	\$1976.10	\$2114.30	
			Upholstered	X621-2X45 ■	1739.85	1774.50	1808.10	1825.95	1839.60	1870.05	1898.40	1976.10	2029.65	2167.85
			Vinyl Gel	X621-2Y45 ■	1739.85	1774.50	1808.10	1825.95	1839.60	1870.05	1898.40	1976.10	2029.65	2167.85
Upholstered	Upholstered	Soft	X821-2W45	\$1754.55	\$1823.85	\$1891.05	\$1926.75	\$1954.05	\$2014.95	\$2071.65	\$2227.05	\$2334.15	\$2610.55	
			Upholstered	X821-2X45	1808.10	1877.40	1944.60	1980.30	2007.60	2068.50	2125.20	2280.60	2387.70	2664.10
			Vinyl Gel	X821-2Y45	1808.10	1877.40	1944.60	1980.30	2007.60	2068.50	2125.20	2280.60	2387.70 ■	2664.10

Soft Caster Option:

Soft caster option requires modification of the product number. Change the seventh digit in the product number from 4 to 2.
Example: X621-2W24.

CAL 133 Option:

CAL 133 option is available on mesh back models with upholstered arm caps only. To specify, add -F to the product number and add \$101.85 list.

Nano-Tex Option:

To specify, add -P to end of the product number and add \$33.60 list.
Example: X621-2W44-P.

For available fabrics see matrix in the back of the book or at Haworth.com/surfaces.

Steel Base Option:

Steel base option requires modification of the product number. Change the fifth digit in the product number to 1.
Example: X621-1W44.

NOTE: Steel base comes with plastic covers and has a flat shape.

Low-position Pneumatic Option:

Low-position pneumatic option requires modification of the product number. To specify, change the fourth digit in the product number to 3, and the fifth digit to 1.
Example: X623-1W44.

NOTE: Low-position pneumatic option available on **Steel Base** chairs only.

X99

Task Chair with 3-dimensional Arms

Standard Seat



X621-2W40

Dimensions*

- *SH: 16" - 20.5"
(406mm - 521mm)
- H: 38.5" - 43"
(978mm - 1092mm)
- D: 25"(635mm)
- W: 26"(660mm)
- *SW: 18.6"(472mm)
- *AH: 6.3" - 10.8"
(160mm - 274mm)
- *SD: 16"(407mm)

Low-position pneumatic seat-height adjustment range:
15-18"(381mm-457mm)

Features

- Back: Soft mesh or upholstered.
- Seat: Standard upholstered.
- Base: Five star aluminum base standard; optional steel base available, see page 119.
- Arm caps: Soft, upholstered or vinyl gel with pivoting and sliding capability.
- Casters: Standard with hard casters; for optional soft casters, see page 119.
- Mechanism: 3-point tilt.
- Height adjustment: Pneumatic or low-position pneumatic; see page 119.
- Arm adjustment: 4"(102mm) height adjustment.
- Back stop: Single position.
- Free-floating forward tilt.
- Adjustable lumbar models available, with 1"(25mm) depth and 4"(102mm) height adjustment.
- 3-position seat-depth adjustment models are available with a 3 1/2"(89mm) range.
- COM yardage / COL square footage:
Mesh back model: 0.75/15
Fully upholstered model: 1.75/25

■ Available on RUSH.

* Measurements taken with the BIFMA chair measuring device.

To Order, Specify:

- 1) Product number.
- 2) Fabric surface and color (seat/arm cap).
- 3) Fabric or mesh surface and color (back).
- 4) Trim color for base/back uprights. (Add **\$299.25** for chrome finish.)

Leather Upholstery Option:

Leather upholstery option requires modification of the product number. Change the second digit in the product number as follows:

Leather Seat with Mesh Back:

Change second digit in mesh back model to **5**.

Example: X521-2W40

Leather Seat with Leather Back:

Change second digit in upholstered back model to **7**.

Example: X721-2W40

Standard Seat	Back	Arm Caps	Number	Fabric Grade		C	D	E	F	G	H	Leather Grade A	Leather Grade B
				A	B								
Pneumatic Height Adjustment													
Upholstered	Mesh	Soft	X621-2W40 ■	\$1618.05	\$1652.70	\$1686.30	\$1704.15	\$1717.80	\$1748.25	\$1776.60	\$1854.30	\$1907.85	\$2046.05
		Upholstered	X621-2X40 ■	1671.60	1706.25	1739.85	1757.70	1771.35	1801.80	1830.15	1907.85	1961.40	2099.60
		Vinyl Gel	X621-2Y40 ■	1671.60	1706.25	1739.85	1757.70	1771.35	1801.80	1830.15	1907.85	1961.40	2099.60
Upholstered	Upholstered	Soft	X821-2W40	\$1686.30	\$1755.60	\$1822.80	\$1858.50	\$1885.80	\$1946.70	\$2003.40	\$2158.80	\$2265.90	\$2542.30
		Upholstered	X821-2X40	1739.85	1809.15	1876.35	1912.05	1939.35	2000.25	2056.95	2212.35	2319.45	2595.85
		Vinyl Gel	X821-2Y40	1739.85	1809.15	1876.35	1912.05	1939.35	2000.25	2056.95	2212.35	2319.45 ■	2595.85
Pneumatic Height Adjustment with Lumbar													
Upholstered	Mesh	Soft	X621-2W41 ■	\$1686.30	\$1720.95	\$1754.55	\$1772.40	\$1786.05	\$1816.50	\$1844.85	\$1922.55	\$1976.10	\$2114.30
		Upholstered	X621-2X41 ■	1739.85	1774.50	1808.10	1825.95	1839.60	1870.05	1898.40	1976.10	2029.65	2167.85
		Vinyl Gel	X621-2Y41 ■	1739.85	1774.50	1808.10	1825.95	1839.60	1870.05	1898.40	1976.10	2029.65	2167.85
Upholstered	Upholstered	Soft	X821-2W41	\$1754.55	\$1823.85	\$1891.05	\$1926.75	\$1954.05	\$2014.95	\$2071.65	\$2227.05	\$2334.15	\$2610.55
		Upholstered	X821-2X41	1808.10	1877.40	1944.60	1980.30	2007.60	2068.50	2125.20	2280.60	2387.70	2664.10
		Vinyl Gel	X821-2Y41	1808.10	1877.40	1944.60	1980.30	2007.60	2068.50	2125.20	2280.60	2387.70 ■	2664.10

X99

Task Chair with 3-dimensional Arms

Standard Seat

Seat	Back	Arm Caps	Number	Fabric Grade								Leather Grade A	Leather Grade B
				A	B	C	D	E	F	G	H		
Pneumatic Height Adjustment with Seat Depth Adjustment													
Upholstered	Mesh	Soft	X621-2W42	\$1755.60	\$1790.25	\$1823.85	\$1841.70	\$1855.35	\$1885.80	\$1914.15	\$1991.85	\$2045.40	\$2183.60
		Upholstered	X621-2X42	1809.15	1843.80	1877.40	1895.25	1908.90	1939.35	1967.70	2045.40	2098.95	2237.15
		Vinyl Gel	X621-2Y42	1809.15	1843.80	1877.40	1895.25	1908.90	1939.35	1967.70	2045.40	2098.95	2237.15
Upholstered	Upholstered	Soft	X821-2W42	\$1823.85	\$1893.15	\$1960.35	\$1996.05	\$2023.35	\$2084.25	\$2140.95	\$2296.35	\$2403.45	\$2679.85
		Upholstered	X821-2X42	1877.40	1946.70	2013.90	2049.60	2076.90	2137.80	2194.50	2349.90	2457.00	2733.40
		Vinyl Gel	X821-2Y42	1877.40	1946.70	2013.90	2049.60	2076.90	2137.80	2194.50	2349.90	2457.00	2733.40
Pneumatic Height Adjustment with Lumbar and Seat Depth Adjustment													
Upholstered	Mesh	Soft	X621-2W43	\$1823.85	\$1858.50	\$1892.10	\$1909.95	\$1923.60	\$1954.05	\$1982.40	\$2060.10	\$2113.65	\$2251.85
		Upholstered	X621-2X43	1877.40	1912.05	1945.65	1963.50	1977.15	2007.60	2035.95	2113.65	2167.20	2305.40
		Vinyl Gel	X621-2Y43	1877.40	1912.05	1945.65	1963.50	1977.15	2007.60	2035.95	2113.65	2167.20	2305.40
Upholstered	Upholstered	Soft	X821-2W43	\$1892.10	\$1961.40	\$2028.60	\$2064.30	\$2091.60	\$2152.50	\$2209.20	\$2364.60	\$2471.70	\$2748.10
		Upholstered	X821-2X43	1945.65	2014.95	2082.15	2117.85	2145.15	2206.05	2262.75	2418.15	2525.25	2801.65
		Vinyl Gel	X821-2Y43	1945.65	2014.95	2082.15	2117.85	2145.15	2206.05	2262.75	2418.15	2525.25	2801.65

Soft Caster Option:

Soft caster option requires modification of the product number. Change the seventh digit in the product number from 4 to 2.

Example: X621-2W20.

CAL 133 Option:

CAL 133 option is available on mesh back models with upholstered arm caps only. To specify, add -F to the product number and add \$101.85 list.

Nano-Tex Option:

To specify, add -P to end of the product number and add \$33.60 list.

Example: X621-2W40-P.

For available fabrics see matrix in the back of the book or at Haworth.com/surfaces.

Steel Base Option:

Steel base option requires modification of the product number. Change the fifth digit in the product number to 1.

Example: X621-1W40.

NOTE: Steel base comes with plastic covers and has a flat shape.

Low-position Pneumatic Option:

Low-position pneumatic option requires modification of the product number. To specify, change the fourth digit in the product number to 3, and the fifth digit to 1.

Example: X623-1W40.

NOTE: Low-position pneumatic option available on **Steel Base** chairs only.

X99

Task Chair with Loop Arms

Deep Seat



X621-2144

Dimensions*

- *SH: 16" - 20.5"
(406mm - 521mm)
 - H: 38.5" - 43"
(978mm-1092mm)
 - D: 25"(635mm)
 - W: 26"(660mm)
 - *SW: 18.6"(472mm)
 - *AH: 7.3"(185mm)
 - *SD: 17.5"(445mm)
- Low-position pneumatic seat-height adjustment range:
15-18"(381mm-457mm)

Features

- Back: Soft mesh or upholstered.
- Seat: Standard upholstered.
- Base: Five star aluminum base standard; optional steel base available, see below.
- Arms: Fixed loop with black polypropylene arm caps.
- Casters: Standard with hard casters; for optional soft casters, see below.
- Mechanism: 3-point tilt.
- Height adjustment: Pneumatic or low-position pneumatic; see below.
- Back stop: Single position.
- Free-floating forward tilt.
- Adjustable lumbar models available, with 1"(25mm) depth and 4"(102mm) height adjustment.
- COM yardage / COL square footage:
Mesh back model: 0.75/15
Fully upholstered model: 1.75/25

■ Available on RUSH.

* Measurements taken with the BIFMA chair measuring device.

To Order, Specify:

- 1) Product number.
- 2) Fabric surface and color (seat/arm cap).
- 3) Fabric or mesh surface and color (back).
- 4) Trim color for base/back uprights. (Add **\$299.25** for chrome finish.)

Leather Upholstery Option:

Leather upholstery option requires modification of the product number. Change the second digit in the product number as follows:

Leather Seat with Mesh Back:

Change second digit in mesh back model to **5**.

Example: X521-2144

Leather Seat with Leather Back:

Change second digit in upholstered back model to **7**.

Example: X721-2144

Deep Seat	Back	Arm Caps	Number	Fabric Grade								Leather Grade A	Leather Grade B
				A	B	C	D	E	F	G	H		
Pneumatic Height													
Upholstered	Mesh	Standard	X621-2144 ■	\$1483.65	\$1518.30	\$1551.90	\$1569.75	\$1583.40	\$1613.85	\$1642.20	\$1719.90	\$1773.45	\$1911.65
Upholstered	Upholstered	Standard	X821-2144	1551.90	1621.20	1688.40	1724.10	1751.40	1812.30	1869.00	2024.40	2131.50 ■	2407.90
Pneumatic Height Adjustment with Lumbar													
Upholstered	Mesh	Standard	X621-2145 ■	\$1551.90	\$1586.55	\$1620.15	\$1638.00	\$1651.65	\$1682.10	\$1710.45	\$1788.15	\$1841.70	\$1979.90
Upholstered	Upholstered	Standard	X821-2145	1620.15	1689.45	1756.65	1792.35	1819.65	1880.55	1937.25	2092.65	2199.75 ■	2476.15

Soft Caster Option:

Soft caster option requires modification of the product number. Change the seventh digit in the product number from **4** to **2**.

Example: X621-2124.

Nano-Tex Option:

To specify, add **-P** to end of the product number and add **\$33.60** list.

Example: X621-2144-P

For available fabrics see matrix in the back of the book or at Haworth.com/surfaces.

Steel Base Option:

Steel base option requires modification of the product number. Change the fifth digit in the product number to **1**.

Example: X621-1144.

NOTE: Steel base comes with plastic covers and has a flat shape.

Low-position Pneumatic Option:

Low-position pneumatic option requires modification of the product number. To specify, change the fourth digit in the product number to **3**, and the fifth digit to **1**.

Example: X623-1144.

NOTE: Low-position pneumatic option available on **Steel Base** chairs only.

X99

Task Chair with Loop Arms

Standard Seat



X621-2140

Dimensions*

- *SH: 16" - 20.5"
(406mm - 521mm)
- H: 38.5" - 43"
(978mm-1092mm)
- D: 25"(635mm)
- W: 26"(660mm)
- *SW: 18.6"(472mm)
- *AH: 7.3"(185mm)
- *SD: 16"(407mm)

Low-position pneumatic seat-height adjustment range:
15-18"(381mm-457mm)

Features

- Back: Soft mesh or upholstered.
- Seat: Standard upholstered.
- Base: Five star aluminum base standard; optional steel base available, see below.
- Arms: Fixed loop with black polypropylene arm caps.
- Casters: Standard with hard casters; for optional soft casters, see below.
- Mechanism: 3-point tilt.
- Height adjustment: Pneumatic or low-position pneumatic; see below.
- Back stop: Single position.
- Free-floating forward tilt.
- Adjustable lumbar models available, with 1"(25mm) depth and 4"(102mm) height adjustment.
- 3-position seat-depth adjustable models are available with a 3 1/2"(89mm) range.
- COM yardage / COL square footage:
Mesh back model: 0.75/15
Fully upholstered model: 1.75/25

■ Available on RUSH.

* Measurements taken with the BIFMA chair measuring device.

To Order, Specify:

- 1) Product number.
- 2) Fabric surface and color (seat/arm cap).
- 3) Fabric or mesh surface and color (back).
- 4) Trim color for base/back uprights. (Add \$299.25 for chrome finish.)

Leather Upholstery Option:

Leather upholstery option requires modification of the product number. Change the second digit in the product number as follows:

Leather Seat with Mesh Back:

Change second digit in mesh back model to 5.

Example: X521-2140

Leather Seat with Leather Back:

Change second digit in upholstered back model to 7.

Example: X721-2140

Standard Seat	Back	Arm Caps	Number	Fabric Grade								Leather Grade A	Leather Grade B
				A	B	C	D	E	F	G	H		
Pneumatic Height Adjustment													
Upholstered	Mesh	Standard	X621-2140	■ \$1483.65	\$1518.30	\$1551.90	\$1569.75	\$1583.40	\$1613.85	\$1642.20	\$1719.90	\$1773.45	\$1911.65
Upholstered	Upholstered	Standard	X821-2140	\$1551.90	\$1621.20	\$1688.40	\$1724.10	\$1751.40	\$1812.30	\$1869.00	\$2024.40	\$2131.50	\$2407.90
Pneumatic Height Adjustment with Lumbar													
Upholstered	Mesh	Standard	X621-2141	■ \$1551.90	\$1586.55	\$1620.15	\$1638.00	\$1651.65	\$1682.10	\$1710.45	\$1788.15	\$1841.70	\$1979.90
Upholstered	Upholstered	Standard	X821-2141	\$1620.15	\$1689.45	\$1756.65	\$1792.35	\$1819.65	\$1880.55	\$1937.25	\$2092.65	\$2199.75	\$2476.15
Pneumatic Height Adjustment with Seat Depth Adjustment													
Upholstered	Mesh	Standard	X621-2142	■ \$1621.20	\$1655.85	\$1689.45	\$1707.30	\$1720.95	\$1751.40	\$1779.75	\$1857.45	\$1911.00	\$2049.20
Upholstered	Upholstered	Standard	X821-2142	\$1689.45	\$1758.75	\$1825.95	\$1861.65	\$1888.95	\$1949.85	\$2006.55	\$2161.95	\$2269.05	\$2545.45
Pneumatic Height Adjustment with Lumbar and Seat Depth Adjustment													
Upholstered	Mesh	Standard	X621-2143	■ \$1689.45	\$1724.10	\$1757.70	\$1775.55	\$1789.20	\$1819.65	\$1848.00	\$1925.70	\$1979.25	\$2117.45
Upholstered	Upholstered	Standard	X821-2143	\$1757.70	\$1827.00	\$1894.20	\$1929.90	\$1957.20	\$2018.10	\$2074.80	\$2230.20	\$2337.30	\$2613.70

Soft Caster Option:

Soft caster option requires modification of the product number. Change the seventh digit in the product number from 4 to 2.

Example: X621-2120.

Nano-Tex Option:

To specify, add -P to end of the product number and add \$33.60 list.

Example: X621-2140-P

For available fabrics see matrix in the back of the book or at Haworth.com/surfaces.

Steel Base Option:

Steel base option requires modification of the product number. Change the fifth digit in the product number to 1.

Example: X621-1140.

NOTE: Steel base comes with plastic covers and has a flat shape.

Low-position Pneumatic Option:

Low-position pneumatic option requires modification of the product number. To specify, change the fourth digit in the product number to 3, and the fifth digit to 1.

Example: X623-1140.

NOTE: Low-position pneumatic option available on **Steel Base** chairs only.

X99

Task Chair without Arms

Deep Seat



X621-2044

Dimensions*

- *SH: 16" - 20.5"
(406mm - 521mm)
- H: 38.5" - 43"
(978mm-1092mm)
- D: 25"(635mm)
- W: 26"(660mm)
- *SW: 18.6"(472mm)
- *SD: 17.5"(445mm)

Low-position pneumatic seat-height adjustment range:
15-18"(381mm-457mm)

Features

- Back: Soft mesh or upholstered.
- Seat: Standard upholstered.
- Base: Five star aluminum base standard; optional steel base available, see below.
- Casters: Standard with hard casters; for optional soft casters, see below.
- Mechanism: 3-point tilt.
- Height adjustment: Pneumatic or low-position pneumatic; see below.
- Back stop: Single position.
- Free-floating forward tilt.
- Adjustable lumbar models available, with 1"(25mm) depth and 4"(102mm) height adjustment.
- COM yardage / COL square footage:
Mesh back model: 0.75/15
Fully upholstered model: 1.75/25

* Measurements taken with the BIFMA chair measuring device.

To Order, Specify:

- 1) Product number.
- 2) Fabric surface and color (seat).
- 3) Fabric or mesh surface and color (back).
- 4) Trim color for base/back uprights. (Add **\$299.25** for chrome finish.)

Leather Upholstery Option:

Leather upholstery option requires modification of the product number. Change the second digit in the product number as follows:

Leather Seat with Mesh Back:

Change second digit in mesh back model to **5**.

Example: X521-2044

Leather Seat with Leather Back:

Change second digit in upholstered back model to **7**.

Example: X721-2044

Deep Seat	Back	Number	Fabric Grade								Leather Grade A	Leather Grade B
			A	B	C	D	E	F	G	H		
Pneumatic Height												
Upholstered	Mesh	X621-2044	\$1346.10	\$1380.75	\$1414.35	\$1432.20	\$1445.85	\$1476.30	\$1504.65	\$1582.35	\$1635.90	\$1774.10
Upholstered	Upholstered	X821-2044	1414.35	1483.65	1550.85	1586.55	1613.85	1674.75	1731.45	1886.85	1993.95	2270.35
Pneumatic Height Adjustment with Lumbar												
Upholstered	Mesh	X621-2045	\$1414.35	\$1449.00	\$1482.60	\$1500.45	\$1514.10	\$1544.55	\$1572.90	\$1650.60	\$1704.15	\$1842.35
Upholstered	Upholstered	X821-2045	1482.60	1551.90	1619.10	1654.80	1682.10	1743.00	1799.70	1955.10	2062.20	2338.60

Soft Caster Option:

Soft caster option requires modification of the product number. Change the seventh digit in the product number from **4** to **2**.
Example: X621-2024.

CAL 133 Option:

CAL 133 option is available on mesh back models only. To specify, add **-F** to the product number and add **\$101.85** list.

Nano-Tex Option:

To specify, add **-P** to end of the product number and add **\$33.60** list.
Example: X621-2044-P

For available fabrics see matrix in the back of the book or at Haworth.com/surfaces.

Steel Base Option:

Steel base option requires modification of the product number. Change the fifth digit in the product number to **1**.
Example: X621-1044.

NOTE: Steel base comes with plastic covers and has a flat shape.

Low-position Pneumatic Option:

Low-position pneumatic option requires modification of the product number. To specify, change the fourth digit in the product number to **3**, and the fifth digit to **1**.
Example: X623-1044.

NOTE: Low-position pneumatic option available on **Steel Base** chairs only.

X99

Task Chair without Arms

Standard Seat



X621-2040

Dimensions*

*SH: 16" - 20.5"
(406mm - 521mm)
H: 38.5" - 43"
(978mm-1092mm)
D: 25"(635mm)
W: 26"(660mm)
*SW: 18.6"(472mm)
*SD: 16"(407mm)

Seat depth adjustment
model:
16"-18"(407mm-457mm)

Low-position pneumatic
seat-height adjustment
range:
15-18"(381mm-457mm)

Features

- Back: Soft mesh or upholstered.
- Seat: Standard upholstered.
- Base: Five star aluminum base standard; optional steel base available, see below.
- Casters: Standard with hard casters; for optional soft casters, see below.
- Mechanism: 3-point tilt.
- Height adjustment: Pneumatic or low-position pneumatic; see below.
- Back stop: Single position.
- Free-floating forward tilt.
- Adjustable lumbar models available, with 1"(25mm) depth and 4"(102mm) height adjustment.
- 3-position seat-depth adjustment models are available with a 3 3/4"(95mm) range.
- COM yardage / COL square footage:
Mesh back model: 0.75/15
Fully upholstered model: 1.75/25

* Measurements taken with the BIFMA chair measuring device.

To Order, Specify:

- 1) Product number.
- 2) Fabric surface and color (seat).
- 3) Fabric or mesh surface and color (back).
- 4) Trim color for base/back uprights. (Add **\$299.25** for chrome finish.)

Leather Upholstery Option:

Leather upholstery option requires modification of the product number. Change the second digit in the product number as follows:

Leather Seat with Mesh Back:

Change second digit in mesh back model to **5**.

Example: X521-2040

Leather Seat with Leather Back:

Change second digit in upholstered back model to **7**.

Example: X721-2040

Seat	Back	Number	Fabric Grade								Leather Grade A	Leather Grade B
			A	B	C	D	E	F	G	H		
Pneumatic Height Adjustment												
Upholstered	Mesh	X621-2040	\$1346.10	\$1380.75	\$1414.35	\$1432.20	\$1445.85	\$1476.30	\$1504.65	\$1582.35	\$1635.90	\$1774.10
Upholstered	Upholstered	X821-2040	1414.35	1483.65	1550.85	1586.55	1613.85	1674.75	1731.45	1886.85	1993.95	2270.35
Pneumatic Height Adjustment with Lumbar												
Upholstered	Mesh	X621-2041	\$1414.35	\$1449.00	\$1482.60	\$1500.45	\$1514.10	\$1544.55	\$1572.90	\$1650.60	\$1704.15	\$1842.35
Upholstered	Upholstered	X821-2041	1482.60	1551.90	1619.10	1654.80	1682.10	1743.00	1799.70	1955.10	2062.20	2338.60
Pneumatic Height Adjustment with Seat Depth Adjustment												
Upholstered	Mesh	X621-2042	\$1483.65	\$1518.30	\$1551.90	\$1569.75	\$1583.40	\$1613.85	\$1642.20	\$1719.90	\$1773.45	\$1911.65
Upholstered	Upholstered	X821-2042	1551.90	1621.20	1688.40	1724.10	1751.40	1812.30	1869.00	2024.40	2131.50	2407.90
Pneumatic Height Adjustment with Lumbar and Seat Depth Adjustment												
Upholstered	Mesh	X621-2043	\$1551.90	\$1586.55	\$1620.15	\$1638.00	\$1651.65	\$1682.10	\$1710.45	\$1788.15	\$1841.70	\$1979.90
Upholstered	Upholstered	X821-2043	1620.15	1689.45	1756.65	1792.35	1819.65	1880.55	1937.25	2092.65	2199.75	2476.15

Soft Caster Option:

Soft caster option requires modification of the product number. Change the seventh digit in the product number from **4** to **2**.

Example: X621-2020.

CAL 133 Option:

CAL 133 option is available on mesh back models only. To specify, add **-F** to the product number and add **\$101.85** list.

Nano-Tex Option:

To specify, add **-P** to end of the product number and add **\$33.60** list.

Example: X621-2040-P

For available fabrics see matrix in the back of the book or at Haworth.com/surfaces.

Steel Base Option:

Steel base option requires modification of the product number. Change the fifth digit in the product number to **1**.

Example: X621-1040.

NOTE: Steel base comes with plastic covers and has a flat shape.

Low-position Pneumatic Option:

Low-position pneumatic option requires modification of the product number. To specify, change the fourth digit in the product number to **3**, and the fifth digit to **1**.

Example: X623-1040.

NOTE: Low-position pneumatic option available on **Steel Base** chairs only.

X99

Guest Chair



X630-3100

Dimensions*

- *SH: 18"(457mm)
- H: 36"(914)
- D: 24"(610mm)
- W: 22"(559mm)
- *SW: 19"(483mm)
- *SD: 18"(457mm)
- *AH: 8"(203mm)

Features

- Back: Soft mesh or upholstered.
- Seat: Standard upholstered.
- Arms: Black polypropylene arm caps.
- Black glides only.
- Aluminum uprights with welded steel frame.
- COM yardage / COL square footage:
 Mesh back model: 0.5/15
 Fully upholstered model: 1.4/25

■ Available on RUSH.

* Measurements taken with the BIFMA chair measuring device.

To Order, Specify:

- 1) Product number.
- 2) Fabric surface and color (seat).
- 3) Fabric or mesh surface and color (back).
- 4) Trim color for frame.
(Add **\$177.45** for chrome finish.)

Leather Upholstery Option:

Leather upholstery option requires modification of the product number. Change the second digit in the product number as follows:

Leather Seat with Mesh Back:

Change second digit in mesh back model to **5**.

Example: X530-3100

Leather Seat with Leather Back:

Change second digit in upholstered back model to **7**.

Example: X730-3100

Seat	Back	Arm Caps	Number	Fabric Grade								Leather Grade A	Leather Grade B
				A	B	C	D	E	F	G	H		
Upholstered	Mesh	Standard	X630-3100	■ \$884.10	\$ 918.75	\$ 952.35	\$ 970.20	\$ 983.85	\$1014.30	\$1042.65	\$1120.35	\$1173.90	\$1312.10
Upholstered	Upholstered	Standard	X830-3100	951.30	1020.60	1087.80	1123.50	1150.80	1211.70	1268.40	1423.80	1530.90	1807.30

CAL 133 Option:

CAL 133 option is available on mesh back models only. To specify, add **-F** to the product number and add **\$101.85** list.

Nano-Tex Option:

To specify, add **-P** to end of the product number and add **\$33.60** list.
Example: X630-3100-**P**

For available fabrics see matrix in the back of the book.

DuraBlock Option:

To specify, add **-D** to end of the product number and add **\$44.10** list.
Example: X630-3100-**D**

For available fabrics see matrix in the back of the book.

X99

Seminar Chair

With Arms

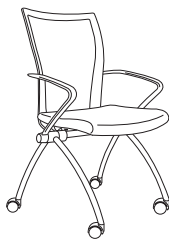

X840-0140

Dimensions*

- *SH: 18"(457mm)
- H: 36"(914mm)
- D: 24"(610mm)
- W: 22"(559mm)
- *SW: 19"(483mm)
- *SD: 18"(457mm)
- *AH: 8"(203mm)

Features

- Back: Soft mesh or upholstered.
- Seat: Standard upholstered, with folding seat.
- Arms: Black polypropylene arm caps.
- Casters: Standard with hard casters; or optional soft casters, see below.
- Optional black glides, see below.
- Aluminum uprights with welded steel frame.
- Each nested chair adds 7.5"(191mm) of floor space.
- COM yardage / COL square footage:
Mesh back model: 0.5/15
Fully upholstered model: 1.4/25
- Casters shipped unassembled.

■ Available on RUSH.

* Measurements taken with the BIFMA chair measuring device.

To Order, Specify:

- 1) Product number.
- 2) Fabric surface and color (seat).
- 3) Fabric or mesh surface and color (back).
- 4) Trim color for frame.
(Add **\$299.25** for chrome finish.)

Leather Upholstery Option:

Leather upholstery option requires modification of the product number. Change the second digit in the product number as follows:

Leather Seat with Mesh Back:

Change second digit in mesh back model to 5.

Example: X540-0140

Leather Seat with Leather Back:

Change second digit in upholstered back model to 7.

Example: X740-0140

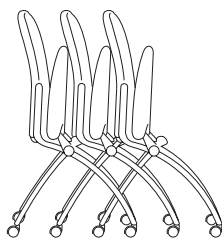

Seat	Back	Arm Caps	Number	Fabric Grade								Leather Grade A	Leather Grade B
				A	B	C	D	E	F	G	H		
Upholstered	Mesh	Standard	X640-0140 ■	\$850.50	\$885.15	\$ 918.75	\$ 936.60	\$ 950.25	\$ 980.70	\$1009.05	\$1086.75	\$1140.30	\$1278.50
Upholstered	Upholstered	Standard	X840-0140	917.70	987.00	1054.20	1089.90	1117.20	1178.10	1234.80	1390.20	1497.30	1773.70

Soft Caster Option:

Soft caster option requires modification of the product number. Change the seventh digit in the product number from 4 to 2.

Example: X640-0120.

Glide Option:

Glide option requires modification of the product number. Change the seventh digit in the product number from 4 to 0.

Example: X640-0100.

X99

Seminar Chair

Without Arms



X640-0040

Dimensions*

- *SH: 18"(457mm)
- H: 36"(914mm)
- D: 24"(610mm)
- W: 22"(559mm)
- *SW: 19"(483mm)
- *SD: 18"(457mm)

Features

- Back: Soft mesh or upholstered.
- Seat: Standard upholstered, with folding seat.
- Casters: Standard with hand casters; or optional soft casters, see below.
- Optional black glides, see below.
- Aluminum uprights with welded steel frame.
- COM yardage / COL square footage:
 - Mesh back model: 0.5/15
 - Fully upholstered model: 1.4/25
- Casters shipped unassembled.

* Measurements taken with the BIFMA chair measuring device.

To Order, Specify:

- 1) Product number.
- 2) Fabric surface and color (seat).
- 3) Fabric surface and color (back). (Specify M0-BL for mesh back).
- 4) Trim color for frame. (Add **\$299.25** for chrome finish.)

Leather Upholstery Option:

Leather upholstery option requires modification of the product number. Change the second digit in the product number as follows:

Leather Seat with Mesh Back:

Change second digit in mesh back model to **5**.

Example: X540-0040

Leather Seat with Leather Back:

Change second digit in upholstered back model to **7**.

Example: X740-0040

Seat	Back	Number	Fabric Grade								Leather Grade A	Leather Grade B
			A	B	C	D	E	F	G	H		
Upholstered	Mesh	X640-0040	\$795.90	\$830.55	\$864.15	\$ 882.00	\$ 895.65	\$ 926.10	\$ 954.45	\$1032.15	\$1085.70	\$1223.90
Upholstered	Upholstered	X840-0040	863.10	932.40	999.60	1035.30	1062.60	1123.50	1180.20	1335.60	1442.70	1719.10

Soft Caster Option:

Soft caster option requires modification of the product number. Change the seventh digit in the product number from **4** to **2**.

Example: X640-0020.

Nano-Tex Option:

To specify, add **-P** to end of product number and add **\$33.60** list.

Example: X640-0040-**P**

For available fabrics see matrix in the back of the book.

Glide Option:

Glide option requires modification of the product number. Change the seventh digit in the product number from **4** to **0**.

Example: X640-0000.

DuraBlock Option:

To specify, add **-D** to end of product number and add **\$44.10** list.

Example: X640-0040-**D**

For available fabrics see matrix in the back of the book.

CAL 133 Option:

CAL 133 option is available on mesh back models only. To specify, add **-F** to the product number and add **\$101.85** list.

X99

Advanced Seminar Chair

With Arms

X641-2140

Dimensions*

*SH: 16" - 21"
(406mm - 533mm)
H: 33 1/2" - 38 1/2"
(851mm - 978mm)
D: 26 1/2"(673mm)
W: 26 1/2"(673mm)
*SW: 18 1/2"(470mm)
*SD: 16"(406mm)
*AH: 8"(203mm)

Features

- Back: Soft mesh or upholstered.
 - Seat: Standard upholstered.
 - Arms: Black polypropylene arm caps.
 - Base: Five-star aluminum base.
 - Casters: Standard with hard casters; or optional soft casters, see below.
 - Back tilts backward 21° from the upright position.
 - Optional chrome finish chairs are standard with chrome base, uprights and back crossbar.
 - COM yardage / COL square footage:
Mesh back model: 0.5/15
Fully upholstered model: 1.4/25
- Available on RUSH.

* Measurements taken with the BIFMA chair measuring device.

To Order, Specify:

- 1) Product number.
- 2) Fabric surface and color (seat).
- 3) Fabric or mesh surface and color (back).
- 4) Trim color for frame.
(Add **\$299.25** for chrome finish.)

Leather Upholstery Option:

Leather upholstery option requires modification of the product number. Change the second digit in the product number as follows:

Leather Seat with Mesh Back:

Change second digit in mesh back model to **5**.

Example: X541-2140

Leather Seat with Leather Back:

Change second digit in upholstered back model to **7**.

Example: X741-2140

Seat	Back	Arm Caps	Number	Fabric Grade								Leather Grade A	Leather Grade B
				A	B	C	D	E	F	G	H		
Upholstered	Mesh	Standard	X641-2140	\$ 985.95	\$1020.60	\$1054.20	\$1072.05	\$1085.70	\$1116.15	\$1144.50	\$1222.20	\$1275.75	\$1413.95
Upholstered	Upholstered	Standard	X841-2140	1053.15	1122.45	1189.65	1225.35	1252.65	1313.55	1370.25	1525.65	1632.75	1909.15

Soft Caster Option:

Soft caster option requires modification of the product number. Change the seventh digit in the product number from **4** to **2**.

Example: X641-2120.

X99

Advanced Seminar Chair

Without Arms



X641-2040

Dimensions*

- *SH: 16" - 21"
(406mm - 533mm)
- H: 33 1/2" - 38 1/2"
(851mm - 978mm)
- D: 26 1/2" (673mm)
- W: 26 1/2" (673mm)
- *SW: 18 1/2" (470mm)
- *SD: 16" (406mm)

Features

- Back: Soft mesh or upholstered.
- Seat: Standard upholstered.
- Base: Five-star aluminum base.
- Casters: Standard with hand casters; or optional soft casters, see below.
- Back tilts backward 21° from the upright position.
- Optional chrome finish chairs are standard with chrome base, uprights and back crossbar.
- COM yardage / COL square footage:
Mesh back model: 0.5/15
Fully upholstered model: 1.4/25
- Available on RUSH.

* Measurements taken with the BIFMA chair measuring device.

To Order, Specify:

- 1) Product number.
- 2) Fabric surface and color (seat).
- 3) Fabric surface and color (back).
- 4) Trim color for frame.
(Add **\$299.25** for chrome finish.)

Leather Upholstery Option:

Leather upholstery option requires modification of the product number. Change the second digit in the product number as follows:

Leather Seat with Mesh Back:

Change second digit in mesh back model to **5**.

Example: X541-2040

Leather Seat with Leather Back:

Change second digit in upholstered back model to **7**.

Example: X741-2040

Seat	Back	Number	Fabric Grade								Leather Grade A	Leather Grade B
			A	B	C	D	E	F	G	H		
Upholstered	Mesh	X641-2040 ■	\$932.40	\$ 967.05	\$1000.65	\$1018.50	\$1032.15	\$1062.60	\$1090.95	\$1168.65	\$1222.20	\$1360.40
Upholstered	Upholstered	X841-2040	999.60	1068.90	1136.10	1171.80	1199.10	1260.00	1316.70	1472.10	1579.20	1855.60

Soft Caster Option:

Soft caster option requires modification of the product number. Change the seventh digit in the product number from **4** to **2**.
Example: X641-2020.

CAL 133 Option:

CAL 133 option is available on mesh back models only. To specify, add **-F** to the product number and add **\$101.85** list.

Nano-Tex Option:

To specify, add **-P** to end of product number and add **\$33.60** list.

Example: X641-2040-P

For available fabrics see matrix in the back of the book.

Improv Series

General Specifications

Features and Options (Desk Chairs)

Improv Series desk chairs features:

- Molded-polyfoam, contoured seat and back cushions
- Polypropylene or upholstered outer shell
- Five-star welded steel base with plastic cover
- Hard, dual-wheel casters for carpeted floors (black)
- Optional soft, dual-wheel casters for resilient floor surfaces (black)
- Pneumatic height adjustment
- Optional high arc plastic base
- Loop arms, height-adjustable arms or armless
- Standard hard arm caps or upholstered (fabric, leather, or soft black vinyl) arm caps
- Optional two-stage seat height adjustment and low-position seat height adjustment
- Improv does not offer Nano-TEX or DuraBlock on the fully upholstered back chair models.
- Tilt tension

Improv Series desk chairs meet or exceed all ANSI/BIFMA durability standards for office seating.

Mobility and Adjustability (Desk Chairs)

The following features are available on Improv Series desk chair models.



- ▶ Synchronized-tilt (standard)
 - Back and seat recline at a 2:1 ratio with no front seat rise
 - Back tilts backwards 15° from the upright position
 - Seat pan moves downward 7° from the initial position



- ▶ Synchronized-tilt with back-lock
 - Back and seat recline at a 2:1 ratio with no front seat rise
 - Back is lockable in two positions within tilt range
 - Back tilts backwards 15° from the upright position
 - Seat pan moves downward 7° from the initial position
 - Back is lockable in two positions within tilt range, full upright and 5° recline

▶ Two-stage seat height adjustment

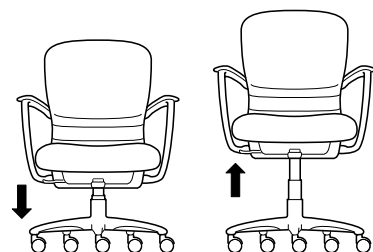

Fully Retracted (.7"(18mm) below standard) Fully Extended (1.9"(48mm) above standard)

▶ Low-position seat height adjustment

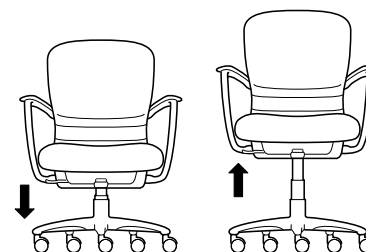

Fully Retracted (1"(25mm) below standard) Fully Extended (1"(25mm) above standard)

▶ Optional high arc base

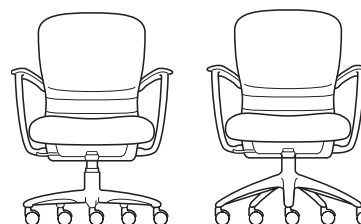

Standard Steel Base High Arc Base

Improv Series

General Specifications

Features and Options (Improv H.E.)

Improv H.E. chairs features:

- Molded-polyfoam, contoured seat and back cushions
- Separate seat and back cushions
- Polypropylene outer shell
- Five-star base with black casters only
- Hard dual-wheel casters (standard) or soft dual-wheel casters (optional)
- Pneumatic seat height adjustment

- Flipper arms, height-adjustable task arms, task arms, 3-D arms or armless
- Optional two-stage seat height adjustment or low-position seat height adjustment
- Optional adjustable air lumbar
- Optional high arc plastic base
- Optional H.E. XL chair for users up to 500 pounds

Mobility and Adjustability (Improv H.E., Tag and S.E.)

The following features are available on Improv H.E. and S.E. chair models (Refer to price page for specific features).



- Synchronized-tilt (standard)
 - Back and seat recline at a 2:1 ratio with no front seat rise
 - Back tilts backward 20° from the upright position
 - Seat pan moves downward 10° from the initial position



- Synchronized-tilt with back-lock
 - Back and seat recline at a 2:1 ratio with no front seat rise
 - Back is lockable in two positions within tilt range
 - Back tilts backward 20° from the upright position
 - Seat pan moves downward 10° from the initial position



- Forward-tilt
 - Both chair back and seat pan are lockable in three forward positions (1°, 3°, and 5°)

- Adjustable Air Lumbar (H.E. only)
 - Back lumbar has up to 1.5"(38mm) of in/out deflection.

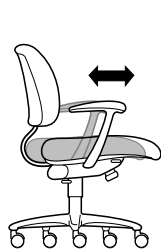

- Seat pan and arms slide horizontally within a 3"(76mm) range

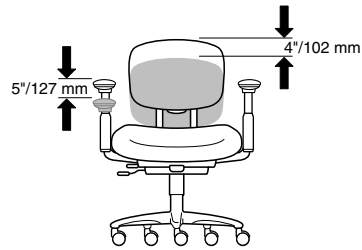

- Back adjusts vertically within a 4"(102mm) range (H.E. only)
- Flipper arms adjust vertically within a 5"(127mm) range

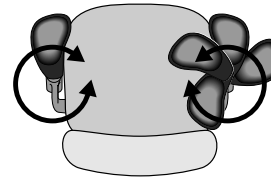

- Flipper arms rotate 360°

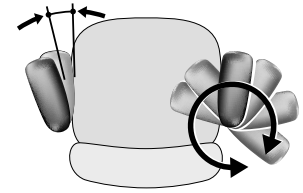

- 3D arms adjust vertically within a 4"(102mm) range and rotate 360°.

- Two-stage seat height adjustment

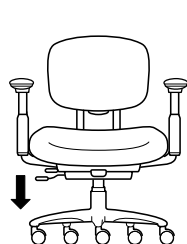

Fully Retracted
(.7"(18mm) below standard)

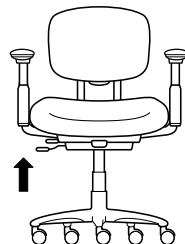

Full Extended
(1.9"(48mm) above standard)

- Low-position seat height adjustment

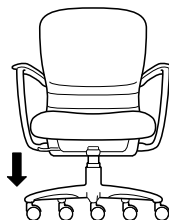

Fully Retracted
(1"(25mm) below standard)

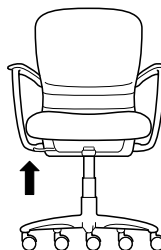

Fully Extended
(1"(25mm) above standard)

- Adjustable Air Lumbar (H.E. only)



- Back lumbar has up to 1.5"(38mm) of in/out deflection.

Improv Series

General Specifications

**Features and Options
(Improv S.E.)**

All Improv S.E. chairs feature

- Molded-polyfoam contoured seat
- Mesh “form fit” back available as round or square
- Five star plastic high arc base with black casters only
- Hard dual-wheel casters (standard) or soft dual-wheel casters (optional)
- Pneumatic seat height adjustment
- Flipper arms, height-adjustable task arms, task arms, 3-D arms or armless
- Optional two-stage seat height adjustment
- Optional low-position seat height adjustment
- Optional steel base

Mobility and adjustability - Refer to page 130

These two features are not available on Improv S.E.

- Adjustable air lumbar
- Vertical back adjustment

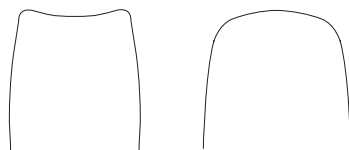
S.E. Back Shapes

Square

Round

**Features and Options
(Leg-Base and Sled-Base
Chairs)**

Improv Series leg-base and sled-base models feature

- 14-gauge elliptical steel tubing legs
- 14-gauge steel side and front stretchers (with arms, tablet and chairs with casters)
- 11-gauge steel front stretchers (without arms)
- Molded polyurethane seat and back foam
- Optional wood back
- Polypropylene or upholstered outer back shell, or full wood back
- High-density polyethylene floor glides (leg-base models)
- Leg base models available with caster option
- Glass-filled nylon sled-base runners with high-density polyethylene floor glides (sled-base models)
- Powder coated frame
- Ganging device option
- Leg-base models with arms stack 6-high (44”(1118mm)) on the floor and 10-high (62”(1575mm)) on the stacking dolly
- Leg-base armless models stack 6-high (44”(1118mm)) on the floor and 10-high (58”(1473mm)) on the stacking dolly
- Leg-base models with casters stack 5-high (42”(1067mm)) on the floor and 6-high (50”(1270mm)) on the stacking dolly
- Wood back model has same stacking capabilities as the leg-base models

Arm chair models feature:

- Glass reinforced polypropylene arms

Armless models feature:

- High-density polyethylene top caps on exposed legs

Tablet arm models feature:

- Right- or left-hand flip-up tablet arm
- 11”(279mm) or 14”(356mm) tablet arms
- Plywood core with high-pressure laminate surface and clear lacquered edge

All Improv table models feature:

- 1”(25mm)-thick particle board core top with laminate or veneer finished surface
- Bullnose PVC or chamfered hardwood edges
- 14-gauge oval steel tube legs
- 3/4” diameter steel stretchers
- High-density polyethylene floor glides
- High-density polyethylene leg top caps

Improv series chairs meet or exceed ANSI/BIFMA durability standards for office seating.

Improv Series

General Specifications

Shipping Weights (Leg-Base and Sled-Base Chairs)	<p>The following weights include packaging materials</p> <ul style="list-style-type: none"> • All leg-base and sled-base chairs 25 lbs. per chair/9.6 cubic ft. (up to 3 chairs per carton) • 20"(508mm) diameter tables 19 lbs./5.3 cubic ft. • 24" x 48"(610mm x 1219mm) oval tables 35 lbs./11 cubic ft. • Chairs without tablet arms are packaged three (3) per carton • Chairs with tablet arms are packaged two (2) per carton • Chairs with leather seats are packaged one (1) per carton <p>NOTE: Models with casters: add one (1) pound per chair</p>
Features and Options (Stools)	<p>All Improv Series stools feature</p> <ul style="list-style-type: none"> • 14-gauge elliptical steel tubing legs • 14-gauge steel side and front stretchers • 14-gauge steel foot rest with lightly textured protective nylon cover • Molded polyurethane seat foam, 1 3/8"(35mm) thick • Molded polyurethane back foam, 7/8"(22mm) thick • Optional wood back • Polypropylene (3/4"(19mm)) or upholstered (1 1/4"(32mm)) seat and back shell • High-density polyethylene floor glides • Glass reinforced polypropylene arms or high-density polyethylene top caps on exposed legs • Powder coated frame
Shipping Weights (Stools)	<p>The following weights do not include packaging materials.</p> <p>Stool with arms: 30 lbs./13.608k Stool without arms: 27 lbs./12.247k</p>
COM & COL General Information	<p>To order a COM fabric (Customer's Own Material), contact the Haworth Inquiry Center (1.800.426.8562), your local Haworth dealer, or go to haworth.com/surfaces > COM Library to find out if the COM you have selected has already been tested and approved. The surface collection site also has information on the Haworth+ alliance program with Carnegie, Luna Textiles, and Maharam as well as our industry-leading Pre-Approved COM program.</p> <p>Approved COMs are placed into Grades based on the fabric pricing; if the fabric pricing exceeds our Grades, they will be priced at Grade A + cost of fabric + 4% handling (North America). Haworth will purchase all COMs unless instructed otherwise. (Leather will also be purchased by Haworth; if the leather pricing exceeds our Grades, cost will be based on fabric Grade E + cost of leather + 4% handling.)</p> <p>If no information is available on the COM you are looking for, refer to the COM section and forms on the surface collection site for information on how to process your test request.</p>
Flammability Requirements	<p>Improv Series models are available with an optional fire retardant construction to comply with California Bulletin #133. Refer to the price pages for ordering information. Refer to the Haworth.com/surfaces for a listing of the approved fabrics.</p>
Environmental Factors	<p><u>Material Off Gassing</u></p> <p>In an effort to ensure air quality standards, all Improv parts suppliers are required to provide Material Data Sheets and/or other documentation, verifying that their products do not emit volatile organic compounds (VOCs). In addition, the powder-coat paint process used in the manufacturing of Improv seating is free of VOCs. Our manufacturing processes have also eliminated all use of chlorofluorocarbons (CFCs) and ozone depleting chemicals (ODCs) in the chair's construction.</p> <p><u>Recycling</u></p> <p>All fabric scraps are recycled, reducing the amount of material sent to landfills, and all chair components disassemble easily to increase the potential for recycling. In addition, all thermo-plastic parts are 100% reprocessible, and all raw materials used in its manufacturing can be recycled at the end of the useful life of the product. Recyclable parts are identified with the recycle symbol where practical.</p>

Improv Series

General Specifications

General Guidelines for Product Specification

Improv Series seating specification numbers are based on an alpha-numeric logic that identifies a product by model and certain characteristics.

For example, a product number that reads **M221-2241** identifies the product as an Improv high-back chair with seamless upholstered outer shell, pneumatic seat height adjustment, upholstered arms, back-lock, and hard dual-wheel casters.

The alpha-numeric logic for this model complete with fabric and finish codes is shown below:

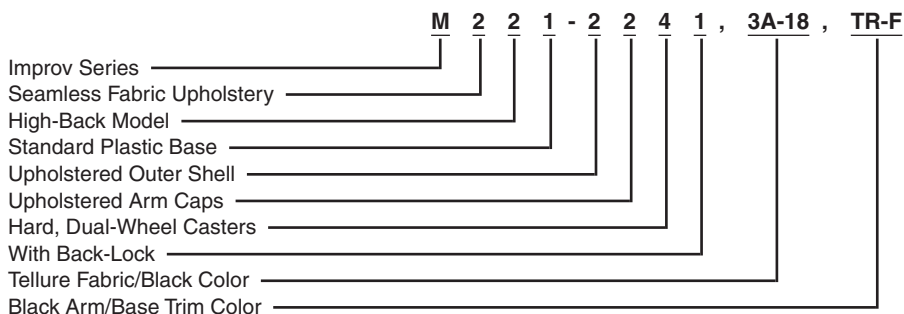

A ninth-digit suffix of the product number will indicate functional option, such as -F for CAL 133 option.

A product number that reads **M245-3942** identifies the product as an Improv S.E. chair with square mesh back, high arc plastic base, soft black vinyl arms, with forward tilt, and hard dual-wheel casters.

The alpha-numeric logic for this model complete with fabric and finish codes is shown below:

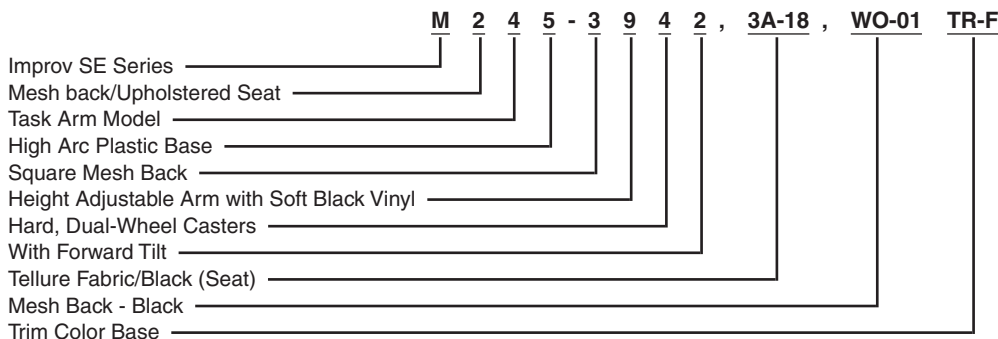

There are exceptions to this logic; therefore, always refer to the price charts for product numbers rather than attempting to construct them. Product number modification instructions for additional options appear in footnoted copy for each applicable model.

Beyond the printed product number, fabric and finish codes are required to complete an order specification. To communicate your order clearly, list the product number and fabric/finish codes in the sequence outlined on each price page.

RUSH

Select Improv Series seating models are marked with a **■** symbol to denote availability on the RUSH program. Refer to the fabric and finish options for each product.

Finishes and Fabrics

A complete listing of finishes and fabrics for Improv Series desk chairs can be found in the back of the price list.

Improv Series

High-Back Chair with Arms



M221-1142

Dimensions

SH: 15" - 20"
(381mm-508mm)
H: 37 1/2"(953mm)
D: 25"(635mm)
W: 25 1/2"(648mm)
SW: 20 1/2"(521mm)
SD: 16 1/2"(419mm)
AH: 8 11/16"(221mm)
Two-stage seat height:
.7"(18mm) below
standard
1.9"(48mm) above
standard

Features

- Outer Shells: Polypropylene or upholstered.
- Arm Caps: Standard, upholstered fabric or soft black vinyl.
- Casters: Standard with hard casters; or optional soft casters, see below.
- Standard plastic base or optional high arc, or steel base.
- Mechanism: Swivel with synchronized-tilt.
- Height Adjustment: Pneumatic, pneumatic with two-stage seat height, or pneumatic with low position seat height option.
- Optional Back-Lock: Lockable in two positions.
- Tilt tension.
- Fire retardant construction is available to comply with California Bulletin #133, see below.
- COM yardage / COL square footage:
Polypropylene shell: 2.0/44
Upholstered shell: 3.0/66
- Available on RUSH with hard casters.

To Order, Specify:

- 1) Product number.
- 2) Fabric surface and color. (NOTE: For leather upholstery, see below.)
- 3) Trim color for shell (if applicable), arms and base.

Shells	Arms/Caps	Number	Fabric Grade								Leather Grade A	Leather Grade B
			A	B	C	D	E	F	G	H		
Pneumatic Height Adjustment												
Polypropylene	Standard	M221-1142 ■	\$ 951.30	\$1018.50	\$1085.70	\$1121.40	\$1150.80	\$1299.90	\$1375.50	\$1581.30	\$1526.70	\$1683.30
	Upholstered	M221-1242 ■	999.60	1066.80	1134.00	1169.70	1199.10	1348.20	1423.80	1629.60	1575.00	1731.60
	Soft Black Vinyl	M221-1342 ■	999.60	1066.80	1134.00	1169.70	1199.10	1348.20	1423.80	1629.60	1575.00	1731.60
Upholstered	Standard	M221-2142 ■	\$1192.80	\$1276.80	\$1365.00	\$1411.20	\$1451.10	\$1715.70	\$1829.10	\$2135.70	\$1963.50	\$2134.80
	Upholstered	M221-2242 ■	1241.10	1325.10	1413.30	1459.50	1499.40	1764.00	1877.40	2184.00	2011.80	2183.10
	Soft Black Vinyl	M221-2342 ■	1241.10	1325.10	1413.30	1459.50	1499.40	1764.00	1877.40	2184.00	2011.80	2183.10
Pneumatic Height Adjustment/Back-Lock												
Polypropylene	Standard	M221-1141 ■	\$ 999.60	\$1066.80	\$1134.00	\$1169.70	\$1199.10	\$1348.20	\$1423.80	\$1629.60	\$1575.00	\$1731.60
	Upholstered	M221-1241 ■	1047.90	1115.10	1182.30	1218.00	1247.40	1396.50	1472.10	1677.90	1623.30	1779.90
	Soft Black Vinyl	M221-1341 ■	1047.90	1115.10	1182.30	1218.00	1247.40	1396.50	1472.10	1677.90	1623.30	1779.90
Upholstered	Standard	M221-2141 ■	\$1241.10	\$1325.10	\$1413.30	\$1459.50	\$1499.40	\$1764.00	\$1877.40	\$2184.00	\$2011.80	\$2183.10
	Upholstered	M221-2241 ■	1289.40	1373.40	1461.60	1507.80	1547.70	1812.30	1925.70	2232.30	2060.10	2231.40
	Soft Black Vinyl	M221-2341 ■	1289.40	1373.40	1461.60	1507.80	1547.70	1812.30	1925.70	2232.30	2060.10	2231.40

The following options require modification of the product number.

- Low-position seat height - Plastic
- Two-stage seat height- HAB
- High arc base
- Steel base - Standard
- Steel base - Low height
- Soft casters
- Leather upholstery
- CAL 133
- Nano-Tex

- To specify, change the 4th digit from a 1 to a 4; **Example:** M224-1142
- To specify, change the 4th digit from a 1 to a 3; **Example:** M223-1142 (add \$87.15 list)
- To specify, change the 4th digit from a 1 to a 5; **Example:** M225-1142
- To specify, change the 4th digit from a 1 to a 6; **Example:** M226-1142
- To specify, change the 4th digit from a 1 to a 7; **Example:** M227-1142
- To specify, change the 7th digit from a 4 to a 2; **Example:** M221-1122
- To specify, change the 2nd digit from a 2 to a 1; **Example:** M121-1142
- To specify, add **-F** to the end of the product number; **Example:** M221-1142-F (add \$101.85 list)
- To specify, add **-P** to end of the product number; **Example:** M221-1141-P (add \$33.60 list)

NOTE: Nano-Tex on upholstered poly back only.

For available fabrics see matrix in the back of the book or at Haworth.com/surfaces.

Improv Series

High-Back Chair with Height Adjustable Arms



M221-1742

Dimensions

SH: 15" - 20"
(381mm-508mm)
H: 37 1/2"(953mm)
D: 25"(635mm)
W: 27 1/4"(692mm)
SW: 20 1/2"(521mm)
SD: 16 1/2"(419mm)
AH: 7" - 11"
(179mm-279mm)

Two-stage seat height:
.7"(18mm) below
standard
1.9"(48mm) above
standard

Features

- Outer Shells: Polypropylene or upholstered.
- Arm Caps: Standard, upholstered fabric or soft black vinyl.
- Arm Adjustment Controls: Fingertip activation.
- Arm Adjustment: 4"(102mm) height adjustment at a 13° angle.
- Casters: Standard with hard casters; or optional soft casters, see below.
- Standard plastic base or optional high arc, or steel base.
- Mechanism: Swivel with synchronized-tilt.
- Height Adjustment: Pneumatic, pneumatic with two-stage seat height, or pneumatic with low position seat height option.
- Optional Back-Lock: Lockable in two positions.
- Tilt tension.
- COM yardage / COL square footage:
Polypropylene shell: 2.0/44
Upholstered shell: 3.0/66

To Order, Specify:

- 1) Product number.
- 2) Fabric surface and color.
(NOTE: For leather upholstery, see below.)
- 3) Trim color for shell (if applicable), arms and base.

Shells	Arms/Caps	Number	Fabric Grade								Leather Grade A	Leather Grade B
			A	B	C	D	E	F	G	H		
Pneumatic Height Adjustment												
Polypropylene	Standard	M221-1742	\$1063.65	\$1130.85	\$1198.05	\$1233.75	\$1263.15	\$1412.25	\$1487.85	\$1693.65	\$1639.05	\$1795.65
	Upholstered	M221-1842	1111.95	1179.15	1246.35	1282.05	1311.45	1460.55	1536.15	1741.95	1687.35	1843.95
	Soft Black Vinyl	M221-1942	1111.95	1179.15	1246.35	1282.05	1311.45	1460.55	1536.15	1741.95	1687.35	1843.95
Upholstered	Standard	M221-2742	\$1305.15	\$1389.15	\$1477.35	\$1523.55	\$1563.45	\$1828.05	\$1941.45	\$2248.05	\$2075.85	\$2247.15
	Upholstered	M221-2842	1353.45	1437.45	1525.65	1571.85	1611.75	1876.35	1989.75	2296.35	2124.15	2295.45
	Soft Black Vinyl	M221-2942	1353.45	1437.45	1525.65	1571.85	1611.75	1876.35	1989.75	2296.35	2124.15	2295.45
Pneumatic Height Adjustment/Back-Lock												
Polypropylene	Standard	M221-1741	\$1111.95	\$1179.15	\$1246.35	\$1282.05	\$1311.45	\$1460.55	\$1536.15	\$1741.95	\$1687.35	\$1843.95
	Upholstered	M221-1841	1160.25	1227.45	1294.65	1330.35	1359.75	1508.85	1584.45	1790.25	1735.65	1892.25
	Soft Black Vinyl	M221-1941	1160.25	1227.45	1294.65	1330.35	1359.75	1508.85	1584.45	1790.25	1735.65	1892.25
Upholstered	Standard	M221-2741	\$1353.45	\$1437.45	\$1525.65	\$1571.85	\$1611.75	\$1876.35	\$1989.75	\$2296.35	\$2124.15	\$2295.45
	Upholstered	M221-2841	1401.75	1485.75	1573.95	1620.15	1660.05	1924.65	2038.05	2344.65	2172.45	2343.75
	Soft Black Vinyl	M221-2941	1401.75	1485.75	1573.95	1620.15	1660.05	1924.65	2038.05	2344.65	2172.45	2343.75

The following options require modification of the product number.

Low-position seat height - Plastic
Two-stage seat height- HAB
High arc base
Steel base - Standard height
Steel base - Low height
Soft casters
Leather upholstery
CAL 133
Nano-Tex

To specify, change the 4th digit from a 1 to a 4; **Example:** M224-1742
To specify, change the 4th digit from a 1 to a 3; **Example:** M223-1742 (add \$87.15 list)
To specify, change the 4th digit from a 1 to a 5; **Example:** M225-1742
To specify, change the 4th digit from a 1 to a 6; **Example:** M226-1742
To specify, change the 4th digit from a 1 to a 7; **Example:** M227-1742
To specify, change the 7th digit from a 4 to a 2; **Example:** M221-1722
To specify, change the 2nd digit from a 2 to a 1; **Example:** M121-1742
To specify, add **-F** to the end of the product number; **Example:** M221-1742-F (add \$101.85 list)
To specify, add **-P** to the end of the product number; **Example:** M221-1742-P (add \$33.60 list)

NOTE: Nano-Tex on upholstered poly back only.

For available fabrics see matrix in the back of the book or at Haworth.com/surfaces.

Improv Series

High-Back Chair without Arms



M221-1042

Dimensions

SH: 15" - 20"
(381mm-508mm)
H: 37 1/2"(953mm)
D: 25"(635mm)
W: 20 1/2"(521mm)
SW: 20 1/2"(521mm)
SD: 16 1/2"(419mm)

Two-stage seat height:
.7"(18mm) below
standard
1.9"(48mm) above
standard

Features

- Outer Shells: Polypropylene or upholstered.
 - Casters: Standard with hard casters; or optional soft casters, see below.
 - Standard plastic base or optional high arc, or steel base.
 - Mechanism: Swivel with synchronized-tilt.
 - Height Adjustment: Pneumatic, pneumatic with two-stage seat height, or pneumatic with low-position seat height option.
 - Optional Back-Lock: Lockable in two positions.
 - Tilt tension.
 - Fire retardant construction is available to comply with California Bulletin #133, see below.
 - COM yardage / COL square footage:
Polypropylene shell: 2.0/44
Upholstered shell: 3.0/66
- Available on RUSH with hard casters.

To Order, Specify:

- 1) Product number.
- 2) Fabric surface and color. (NOTE: For leather upholstery, see below.)
- 3) Trim color for shell (if applicable) and base.

Shells	Number	Fabric Grade		C	D	E	F	G	H	Leather Grade A	Leather Grade B
		A	B								
Pneumatic Height Adjustment											
Polypropylene	M221-1042 ■	\$ 872.55	\$ 939.75	\$1006.95	\$1042.65	\$1072.05	\$1221.15	\$1296.75	\$1502.55	\$1447.95	\$1604.55
Upholstered	M221-2042 ■	1114.05	1198.05	1286.25	1332.45	1372.35	1636.95	1750.35	2056.95	1884.75	2056.05
Pneumatic Height Adjustment/Back-Lock											
Polypropylene	M221-1041 ■	\$ 920.85	\$ 988.05	\$1055.25	\$1090.95	\$1120.35	\$1269.45	\$1345.05	\$1550.85	\$1496.25	\$1652.85
Upholstered	M221-2041 ■	1162.35	1246.35	1334.55	1380.75	1420.65	1685.25	1798.65	2105.25	1933.05	2104.35

The following options require modification of the product number.

Low-position seat height - Plastic	To specify, change the 4th digit from a 1 to a 4; Example: M224-1042
Two-stage seat height- HAB	To specify, change the 4th digit from a 1 to a 3; Example: M223-1042 (add \$87.15 list)
High arc base	To specify, change the 4th digit from a 1 to a 5; Example: M225-1042
Steel base - Standard height	To specify, change the 4th digit from a 1 to a 6; Example: M226-1042
Steel base - Low height	To specify, change the 4th digit from a 1 to a 7; Example: M227-1042
Soft casters	To specify, change the 7th digit from a 4 to a 2; Example: M221-1022
Leather upholstery	To specify, change the 2nd digit from a 2 to a 1; Example: M121-1042
CAL 133	To specify, add -F to the end of the product number; Example: M221-1042-F (add \$101.85 list)
Nano-Tex	To specify, add -P to the end of the product number; Example: M221-1042-P (add \$33.60 list)

NOTE: Nano-Tex on upholstered poly back only.

For available fabrics see matrix in the back of the book or at Haworth.com/surfaces.

Improv Series

Mid-Back Chair with Arms



M211-1142

Dimensions

SH: 15" - 20"
(381mm-508mm)
H: 34 1/2"(876mm)
D: 25"(635mm)
W: 25 1/2"(648mm)
SW: 20 1/2"(521mm)
SD: 16 1/2"(419mm)
AH: 8 11/16"(221mm)
Two-stage seat height:
.7"(18mm) below
standard
1.9"(48mm) above
standard

Features

- Outer Shells: Polypropylene or upholstered.
- Arm Caps: Standard, upholstered fabric or soft black vinyl.
- Casters: Standard with hard casters; or optional soft casters, see below.
- Standard plastic base or optional high arc, or steel base.
- Mechanism: Swivel with synchronized-tilt.
- Height Adjustment: Pneumatic, pneumatic with two-stage seat height, or pneumatic with low-position seat height option.
- Optional Back-Lock: Lockable in two positions.
- Tilt tension.
- Fire retardant construction is available to comply with California Bulletin #133, see below.
- COM yardage / COL square footage:
Polypropylene shell: 1.75/39
Upholstered shell: 2.75/61
- Available on RUSH with hard casters.

To Order, Specify:

- 1) Product number.
- 2) Fabric surface and color. (NOTE: For leather upholstery, see below.)
- 3) Trim color for shell (if applicable), arms and base.

Shells	Arms/Caps	Number	Fabric Grade								Leather Grade A	Leather Grade B
			A	B	C	D	E	F	G	H		
Pneumatic Height Adjustment												
Polypropylene	Standard	M211-1142	\$ 840.00	\$ 907.20	\$ 974.40	\$1010.10	\$1039.50	\$1188.60	\$1264.20	\$1470.00	\$1415.40	\$1572.00
	Upholstered	M211-1242	888.30	955.50	1022.70	1058.40	1087.80	1236.90	1312.50	1518.30	1463.70	1620.30
	Soft Black Vinyl	M211-1342	888.30	955.50	1022.70	1058.40	1087.80	1236.90	1312.50	1518.30	1463.70	1620.30
Upholstered	Standard	M211-2142	\$1081.50	\$1165.50	\$1253.70	\$1299.90	\$1339.80	\$1604.40	\$1717.80	\$2024.40	\$1852.20	\$2023.50
	Upholstered	M211-2242	1129.80	1213.80	1302.00	1348.20	1388.10	1652.70	1766.10	2072.70	1900.50	2071.80
	Soft Black Vinyl	M211-2342	1129.80	1213.80	1302.00	1348.20	1388.10	1652.70	1766.10	2072.70	1900.50	2071.80
Pneumatic Height Adjustment/Back-Lock												
Polypropylene	Standard	M211-1141	\$ 888.30	\$ 955.50	\$1022.70	\$1058.40	\$1087.80	\$1236.90	\$1312.50	\$1518.30	\$1463.70	\$1620.30
	Upholstered	M211-1241	936.60	1003.80	1071.00	1106.70	1136.10	1285.20	1360.80	1566.60	1512.00	1668.60
	Soft Black Vinyl	M211-1341	936.60	1003.80	1071.00	1106.70	1136.10	1285.20	1360.80	1566.60	1512.00	1668.60
Upholstered	Standard	M211-2141	\$1129.80	\$1213.80	\$1302.00	\$1348.20	\$1388.10	\$1652.70	\$1766.10	\$2072.70	\$1900.50	\$2071.80
	Upholstered	M211-2241	1178.10	1262.10	1350.30	1396.50	1436.40	1701.00	1814.40	2121.00	1948.80	2120.10
	Soft Black Vinyl	M211-2341	1178.10	1262.10	1350.30	1396.50	1436.40	1701.00	1814.40	2121.00	1948.80	2120.10

The following options require modification of the product number.

- | | |
|------------------------------------|---|
| Low-position seat height - Plastic | To specify, change the 4th digit from a 1 to a 4; Example: M214-1142 |
| Two-stage seat height- HAB | To specify, change the 4th digit from a 1 to a 3; Example: M213-1142 (add \$87.15 list) |
| High arc base | To specify, change the 4th digit from a 1 to a 5; Example: M215-1142 |
| Steel base - Standard height | To specify, change the 4th digit from a 1 to a 6; Example: M216-1142 |
| Steel base - Low height | To specify, change the 4th digit from a 1 to a 7; Example: M217-1142 |
| Soft casters | To specify, change the 7th digit from a 4 to a 2; Example: M211-1122 |
| Leather upholstery | To specify, change the 2nd digit from a 2 to a 1; Example: M111-1142 |
| CAL 133 | To specify, add -F to the end of the product number; Example: M211-1142-F (add \$101.85 list) |
| Nano-Tex | To specify, add -P to the end of the product number; Example: M211-1142-P (add \$33.60 list) |

NOTE: Nano-Tex on upholstered poly back only.

For available fabrics see matrix in the back of the book or at Haworth.com/surfaces.

Improv Series

Mid-Back Chair with Height Adjustable Arms



M211-1742

Dimensions

SH: 15" - 20"
(381mm-508mm)
H: 34 1/2"(876mm)
D: 25"(635mm)
W: 27 1/4"(692mm)
SW: 20 1/2"(521mm)
SD: 16 1/2"(419mm)
AH: 7" - 11"
(179mm-279mm)

Two-stage seat height:
.7"(18mm) below
standard
1.9"(48mm) above
standard

Features

- Outer Shells: Polypropylene or upholstered.
- Arms: Standard, upholstered fabric or soft black vinyl arm caps.
- Arm Adjustment Controls: Fingertip activation.
- Casters: Standard with hard casters; for optional soft casters, see below.
- Standard plastic base or optional high arc, or steel base.
- Mechanism: Swivel with synchronized-tilt.
- Height Adjustment: Pneumatic, pneumatic with two-stage seat height, or pneumatic with low-position seat height option.
- Arm Adjustment: 4"(102mm) height adjustment at a 13° angle.
- Optional Back-Lock: Lockable in two positions.
- Tilt tension.
- COM yardage / COL square footage:
Polypropylene shell: 1.75/39
Upholstered shell: 2.75/61
- Available on RUSH with hard casters.

To Order, Specify:

- 1) Product number.
- 2) Fabric surface and color. (NOTE: For leather upholstery, see below.)
- 3) Trim color for shell (if applicable), arms and base.

Shells	Arms/Caps	Number	Fabric Grade								Leather Grade A	Leather Grade B
			A	B	C	D	E	F	G	H		
Pneumatic Height Adjustment												
Polypropylene	Standard	M211-1742	\$ 952.35	\$1019.55	\$1086.75	\$1122.45	\$1151.85	\$1300.95	\$1376.55	\$1582.35	\$1527.75	\$1684.35
	Upholstered	M211-1842	1000.65	1067.85	1135.05	1170.75	1200.15	1349.25	1424.85	1630.65	1576.05	1732.65
	Soft Black Vinyl	M211-1942	1000.65	1067.85	1135.05	1170.75	1200.15	1349.25	1424.85	1630.65	1576.05	1732.65
Upholstered	Standard	M211-2742	\$1193.85	\$1277.85	\$1366.05	\$1412.25	\$1452.15	\$1716.75	\$1830.15	\$2136.75	\$1964.55	\$2135.85
	Upholstered	M211-2842	1242.15	1326.15	1414.35	1460.55	1500.45	1765.05	1878.45	2185.05	2012.85	2184.15
	Soft Black Vinyl	M211-2942	1242.15	1326.15	1414.35	1460.55	1500.45	1765.05	1878.45	2185.05	2012.85	2184.15
Pneumatic Height Adjustment/Back-Lock												
Polypropylene	Standard	M211-1741	\$1000.65	\$1067.85	\$1135.05	\$1170.75	\$1200.15	\$1349.25	\$1424.85	\$1630.65	\$1576.05	\$1732.65
	Upholstered	M211-1841	1048.95	1116.15	1183.35	1219.05	1248.45	1397.55	1473.15	1678.95	1624.35	1780.95
	Soft Black Vinyl	M211-1941	1048.95	1116.15	1183.35	1219.05	1248.45	1397.55	1473.15	1678.95	1624.35	1780.95
Upholstered	Standard	M211-2741	\$1242.15	\$1326.15	\$1414.35	\$1460.55	\$1500.45	\$1765.05	\$1878.45	\$2185.05	\$2012.85	\$2184.15
	Upholstered	M211-2841	1290.45	1374.45	1462.65	1508.85	1548.75	1813.35	1926.75	2233.35	2061.15	2232.45
	Soft Black Vinyl	M211-2941	1290.45	1374.45	1462.65	1508.85	1548.75	1813.35	1926.75	2233.35	2061.15	2232.45

The following options require modification of the product number.

Low-position seat height - Plastic
Two-stage seat height- HAB
High arc base
Steel base - Standard height
Steel base - Low height
Soft casters
Leather upholstery
CAL 133
Nano-Tex

To specify, change the 4th digit from a 1 to a 4; **Example:** M214-1742
To specify, change the 4th digit from a 1 to a 3; **Example:** M213-1742 (add \$87.15 list)
To specify, change the 4th digit from a 1 to a 5; **Example:** M215-1742
To specify, change the 4th digit from a 1 to a 6; **Example:** M216-1742
To specify, change the 4th digit from a 1 to a 7; **Example:** M217-1742
To specify, change the 7th digit from a 4 to a 2; **Example:** M211-1722
To specify, change the 2nd digit from a 2 to a 1; **Example:** M111-1742
To specify, add -F to the end of the product number; **Example:** M211-1742-F (add \$101.85 list)
To specify, add -P to the end of the product number; **Example:** M211-1742-P (add \$33.60 list)

NOTE: Nano-Tex on upholstered poly back only.
For available fabrics see matrix in the back of the book or at Haworth.com/surfaces.

Improv Series

Mid-Back Chair without Arms



M211-1042

Dimensions

SH: 15" - 20"
(381mm-508mm)
H: 34 1/2"(876mm)
D: 25"(635mm)
W: 20 1/2"(521mm)
SW: 20 1/2"(521mm)
SD: 16 1/2"(419mm)

Two-stage seat height:
.7"(18mm) below
standard
1.9"(48mm) above
standard

Features

- Outer Shells: Polypropylene or upholstered.
- Casters: Standard with hard casters; or optional soft casters, see below.
- Standard plastic base or optional high arc, or steel base.
- Mechanism: Swivel with synchronized-tilt.
- Height Adjustment: Pneumatic, pneumatic with two-stage seat height, or pneumatic with low-position seat height option.
- Optional Back-Lock: Lockable in two positions.
- Tilt tension.
- Fire retardant construction is available to comply with California Bulletin #133, see below.
- COM yardage / COL square footage:
Polypropylene shell: 1.75/39
Upholstered shell: 2.75/61
- Available on RUSH with hard casters.

To Order, Specify:

- 1) Product number.
- 2) Fabric surface and color. (NOTE: For leather upholstery, see below.)
- 3) Trim color for shell (if applicable) and base.

Shells	Number	Fabric Grade								Leather Grade A	Leather Grade B
		A	B	C	D	E	F	G	H		
Pneumatic Height Adjustment											
Polypropylene	M211-1042 ■	\$ 761.25	\$ 828.45	\$ 895.65	\$ 931.35	\$ 960.75	\$ 1109.85	\$ 1185.45	\$ 1391.25	\$ 1336.65	\$ 1493.25
Upholstered	M211-2042 ■	1002.75	1086.75	1174.95	1221.15	1261.05	1525.65	1639.05	1945.65	1773.45	1944.75
Pneumatic Height Adjustment/Back-Lock											
Polypropylene	M211-1041 ■	\$ 809.55	\$ 876.75	\$ 943.95	\$ 979.65	\$ 1009.05	\$ 1158.15	\$ 1233.75	\$ 1439.55	\$ 1384.95	\$ 1541.55
Upholstered	M211-2041 ■	1051.05	1135.05	1223.25	1269.45	1309.35	1573.95	1687.35	1993.95	1821.75	1993.05

The following options require modification of the product number.

Low-position seat height - Plastic	To specify, change the 4th digit from a 1 to a 4; Example: M214-1042
Two-stage seat height- HAB	To specify, change the 4th digit from a 1 to a 3; Example: M213-1042 (add \$87.15 list)
High arc base	To specify, change the 4th digit from a 1 to a 5; Example: M215-1042
Steel base - Standard height	To specify, change the 4th digit from a 1 to a 6; Example: M216-1042
Steel base - Low height	To specify, change the 4th digit from a 1 to a 7; Example: M217-1042
Soft casters	To specify, change the 7th digit from a 4 to a 2; Example: M211-1022
Leather upholstery	To specify, change the 2nd digit from a 2 to a 1; Example: M111-1042
CAL 133	To specify, add -F to the end of the product number; Example: M211-1042-F (add \$101.85 list)
Nano-Tex	To specify, add -P to the end of the product number; Example: M211-1042-P (add \$33.60 list)

NOTE: Nano-Tex on upholstered poly back only.

For available fabrics see matrix in the back of the book or at Haworth.com/surfaces.

Improv Series

Improv H.E. XL Chair with Task Arms



M271-1442

Dimensions

SH: 16" - 20 1/2"
(406mm - 521mm)
H: 36 1/2" - 45"
(957mm - 1143mm)
D: 23 1/2" - 26 1/2"
(597mm - 673mm)
W: 30"(762mm)
SW: 23 3/4"(603mm)
SD: 16" - 19"
(406mm - 483mm)
AH: 9.6"(244mm)

Features

- Accommodates up to 500 pounds.
- Outer Shells: Polypropylene or upholstered.
- Arms: Standard, upholstered fabric or soft black vinyl arm caps.
- Casters: Standard with hard casters.
- Mechanism: Swivel with synchronized-tilt.
- Height Adjustment: Pneumatic.
- Optional Back-Lock: Lockable in two positions.
- Optional Forward Tilt: Lockable in 3 positions.
- Tilt tension.
- Optional Adjustable Air Lumbar additional 1 1/2"(38mm) of lumbar support.
- Seat pan can be adjusted manually 3"(76mm).
- Fire retardant construction is available to comply with California Bulletin #133.
- COM yardage / COL square footage:
Polypropylene shell: 2.41/51
Upholstered shell: 3.31/75

To Order, Specify:

- 1) Product number.
- 2) Fabric surface and color. (NOTE: For leather upholstery, see page 141.)
- 3) Trim color for shell, arms and base.

* All measurements taken with the BIFMA chair measuring device.

Shells	Arms/Caps	Number	Fabric Grade		C	D	E	F	G	H	Leather Grade A	Leather Grade B
			A	B								
Pneumatic Height Adjustment												
Polypropylene	Standard	M271-1442	\$1909.95	\$1976.10	\$2045.40	\$2080.05	\$2110.50	\$2171.40	\$2227.05	\$2381.40	\$2488.50	\$2646.95
	Upholstered	M271-1542	1955.10	2021.25	2090.55	2125.20	2155.65	2216.55	2272.20	2426.55	2533.65	2692.10
	Soft Black Vinyl	M271-1642	1955.10	2021.25	2090.55	2125.20	2155.65	2216.55	2272.20	2426.55	2533.65	2692.10
Upholstered	Standard	M271-2442	\$2019.15	\$2085.30	\$2154.60	\$2189.25	\$2219.70	\$2280.60	\$2336.25	\$2490.60	\$2796.15	\$2954.60
	Upholstered	M271-2542	2064.30	2130.45	2199.75	2234.40	2264.85	2325.75	2381.40	2535.75	2841.30	2999.75
	Soft Black Vinyl	M271-2642	2064.30	2130.45	2199.75	2234.40	2264.85	2325.75	2381.40	2535.75	2841.30	2999.75
Pneumatic Height Adjustment/Back-Lock												
Polypropylene	Standard	M271-1441	\$1955.10	\$2021.25	\$2090.55	\$2125.20	\$2155.65	\$2216.55	\$2272.20	\$2426.55	\$2533.65	\$2692.10
	Upholstered	M271-1541	2000.25	2066.40	2135.70	2170.35	2200.80	2261.70	2317.35	2471.70	2578.80	2737.25
	Soft Black Vinyl	M271-1641	2000.25	2066.40	2135.70	2170.35	2200.80	2261.70	2317.35	2471.70	2578.80	2737.25
Upholstered	Standard	M271-2441	\$2064.30	\$2130.45	\$2199.75	\$2234.40	\$2264.85	\$2325.75	\$2381.40	\$2535.75	\$2841.30	\$2999.75
	Upholstered	M271-2541	2109.45	2175.60	2244.90	2279.55	2310.00	2370.90	2426.55	2580.90	2886.45	3044.90
	Soft Black Vinyl	M271-2641	2109.45	2175.60	2244.90	2279.55	2310.00	2370.90	2426.55	2580.90	2886.45	3044.90
Pneumatic Height Adjustment/Forward-Tilt												
Polypropylene	Standard	M281-1442	\$1954.05	\$2020.20	\$2089.50	\$2124.15	\$2154.60	\$2215.50	\$2271.15	\$2425.50	\$2532.60	\$2691.05
	Upholstered	M281-1542	1999.20	2065.35	2134.65	2169.30	2199.75	2260.65	2316.30	2470.65	2577.75	2736.20
	Soft Black Vinyl	M281-1642	1999.20	2065.35	2134.65	2169.30	2199.75	2260.65	2316.30	2470.65	2577.75	2736.20
Upholstered	Standard	M281-2442	\$2063.25	\$2129.40	\$2198.70	\$2233.35	\$2263.80	\$2324.70	\$2380.35	\$2534.70	\$2840.25	\$2998.70
	Upholstered	M281-2542	2108.40	2174.55	2243.85	2278.50	2308.95	2369.85	2425.50	2579.85	2885.40	3043.85
	Soft Black Vinyl	M281-2642	2108.40	2174.55	2243.85	2278.50	2308.95	2369.85	2425.50	2579.85	2885.40	3043.85

Improv Series

Improv H.E. XL Chair with Task Arms

Shells	Arms/Caps	Number	Fabric Grade								Leather Grade A	Leather Grade B
			A	B	C	D	E	F	G	H		
Pneumatic Height Adjustment with Adjustable Air Lumbar												
Polypropylene	Standard	M271-1444	\$2019.15	\$2085.30	\$2154.60	\$2189.25	\$2219.70	\$2280.60	\$2336.25	\$2490.60	\$2597.70	\$2756.15
	Upholstered	M271-1544	2064.30	2130.45	2199.75	2234.40	2264.85	2325.75	2381.40	2535.75	2642.85	2801.30
	Soft Black Vinyl	M271-1644	2064.30	2130.45	2199.75	2234.40	2264.85	2325.75	2381.40	2535.75	2642.85	2801.30
Upholstered	Standard	M271-2444	\$2128.35	\$2194.50	\$2263.80	\$2298.45	\$2328.90	\$2389.80	\$2445.45	\$2599.80	\$2905.35	\$3063.80
	Upholstered	M271-2544	2173.50	2239.65	2308.95	2343.60	2374.05	2434.95	2490.60	2644.95	2950.50	3108.95
	Soft Black Vinyl	M271-2644	2173.50	2239.65	2308.95	2343.60	2374.05	2434.95	2490.60	2644.95	2950.50	3108.95
Pneumatic Height Adjustment/Back-Lock with Adjustable Air Lumbar												
Polypropylene	Standard	M271-1443	\$2064.30	\$2130.45	\$2199.75	\$2234.40	\$2264.85	\$2325.75	\$2381.40	\$2535.75	\$2642.85	\$2801.30
	Upholstered	M271-1543	2109.45	2175.60	2244.90	2279.55	2310.00	2370.90	2426.55	2580.90	2688.00	2846.45
	Soft Black Vinyl	M271-1643	2109.45	2175.60	2244.90	2279.55	2310.00	2370.90	2426.55	2580.90	2688.00	2846.45
Upholstered	Standard	M271-2443	\$2173.50	\$2239.65	\$2308.95	\$2343.60	\$2374.05	\$2434.95	\$2490.60	\$2644.95	\$2950.50	\$3108.95
	Upholstered	M271-2543	2218.65	2284.80	2354.10	2388.75	2419.20	2480.10	2535.75	2690.10	2995.65	3154.10
	Soft Black Vinyl	M271-2643	2218.65	2284.80	2354.10	2388.75	2419.20	2480.10	2535.75	2690.10	2995.65	3154.10
Pneumatic Height Adjustment/Forward-Tilt with Adjustable Air Lumbar												
Polypropylene	Standard	M281-1444	\$2063.25	\$2129.40	\$2198.70	\$2233.35	\$2263.80	\$2324.70	\$2380.35	\$2534.70	\$2641.80	\$2800.25
	Upholstered	M281-1544	2108.40	2174.55	2243.85	2278.50	2308.95	2369.85	2425.50	2579.85	2686.95	2845.40
	Soft Black Vinyl	M281-1644	2108.40	2174.55	2243.85	2278.50	2308.95	2369.85	2425.50	2579.85	2686.95	2845.40
Upholstered	Standard	M281-2444	\$2172.45	\$2238.60	\$2307.90	\$2342.55	\$2373.00	\$2433.90	\$2489.55	\$2643.90	\$2949.45	\$3107.90
	Upholstered	M281-2544	2217.60	2283.75	2353.05	2387.70	2418.15	2479.05	2534.70	2689.05	2994.60	3153.05
	Soft Black Vinyl	M281-2644	2217.60	2283.75	2353.05	2387.70	2418.15	2479.05	2534.70	2689.05	2994.60	3153.05

The following options require modification of the product number.

Faux Leather upholstery
 Leather upholstery
 CAL 133
 Nano-Tex

To specify, change the 2nd digit from a 2 to a 3; **Example:** M371-1542

To specify, change the 2nd digit from a 2 to a 1; **Example:** M171-1542

To specify, add **-F** to the end of the product number; **Example:** M271-2542-F (add \$101.85 list)

To specify, add **-P** to the end of the product number; **Example:** M271-1442-P (add \$33.60 list)

NOTE: CAL 133 is available on all fully upholstered models and chairs with black (TR-F) polypropylene shells backs.

Nano-Tex on upholstered poly back only.

For available fabrics see matrix in the back of the book or at Haworth.com/surfaces.

Improv Series

Improv H.E. XL Chair with Height Adjustable Task Arms



M271-1742

Dimensions

SH: 16" - 20 1/2"
(406mm - 521mm)
H: 36 1/2" - 45"
(957mm - 1143mm)
D: 23 1/2" - 26 1/2"
(597mm - 673mm)
W: 30"(762mm)
SW: 23 3/4"(603mm)
SD: 16" - 19"
(406mm - 483mm)
AH: 6.9" - 10.8"
(175mm - 274mm)

Features

- Accommodates up to 500 pounds.
- Outer Shells: Polypropylene or upholstered.
- Arms: Standard, upholstered fabric or soft black vinyl arm caps.
- Arm Adjustment Controls: Fingertip activation.
- Arm Adjustment: 4"(102mm) height adjustment.
- Casters: Standard with hard casters.
- Mechanism: Swivel with synchronized-tilt.
- Height Adjustment: Pneumatic.
- Optional Back-Lock: Lockable in two positions.
- Optional Forward Tilt: Lockable in 3 positions.
- Tilt tension
- Optional Adjustable Air Lumbar: additional 1 1/2"(38mm) of lumbar support.
- Seat pan can be adjusted manually 3"(76mm).
- Fire retardant construction is available to comply with California Bulletin #133.
- COM yardage / COL square footage:
Polypropylene shell: 2.41/51
Upholstered shell: 3.31/75

To Order, Specify:

- 1) Product number.
- 2) Fabric surface and color. (NOTE: For leather upholstery, see page 143.)
- 3) Trim color for shell, arms and base.

* All measurements taken with the BIFMA chair measuring device.

Shells	Arms/Caps	Number	Fabric Grade		C	D	E	F	G	H	Leather Grade A	Leather Grade B
			A	B								
Pneumatic Height Adjustment												
Polypropylene	Standard	M271-1742	\$2004.45	\$2070.60	\$2139.90	\$2174.55	\$2205.00	\$2265.90	\$2321.55	\$2475.90	\$2583.00	\$2741.45
	Upholstered	M271-1842	2049.60	2115.75	2185.05	2219.70	2250.15	2311.05	2366.70	2521.05	2628.15	2786.60
	Soft Black Vinyl	M271-1942	2049.60	2115.75	2185.05	2219.70	2250.15	2311.05	2366.70	2521.05	2628.15	2786.60
Upholstered	Standard	M271-2742	\$2113.65	\$2179.80	\$2249.10	\$2283.75	\$2314.20	\$2375.10	\$2430.75	\$2585.10	\$2890.65	\$3049.10
	Upholstered	M271-2842	2158.80	2224.95	2294.25	2328.90	2359.35	2420.25	2475.90	2630.25	2935.80	3094.25
	Soft Black Vinyl	M271-2942	2158.80	2224.95	2294.25	2328.90	2359.35	2420.25	2475.90	2630.25	2935.80	3094.25
Pneumatic Height Adjustment/Back-Lock												
Polypropylene	Standard	M271-1741	\$2049.60	\$2115.75	\$2185.05	\$2219.70	\$2250.15	\$2311.05	\$2366.70	\$2521.05	\$2628.15	\$2786.60
	Upholstered	M271-1841	2094.75	2160.90	2230.20	2264.85	2295.30	2356.20	2411.85	2566.20	2673.30	2831.75
	Soft Black Vinyl	M271-1941	2094.75	2160.90	2230.20	2264.85	2295.30	2356.20	2411.85	2566.20	2673.30	2831.75
Upholstered	Standard	M271-2741	\$2158.80	\$2224.95	\$2294.25	\$2328.90	\$2359.35	\$2420.25	\$2475.90	\$2630.25	\$2935.80	\$3094.25
	Upholstered	M271-2841	2203.95	2270.10	2339.40	2374.05	2404.50	2465.40	2521.05	2675.40	2980.95	3139.40
	Soft Black Vinyl	M271-2941	2203.95	2270.10	2339.40	2374.05	2404.50	2465.40	2521.05	2675.40	2980.95	3139.40
Pneumatic Height Adjustment/Forward-Tilt												
Polypropylene	Standard	M281-1742	\$2048.55	\$2114.70	\$2184.00	\$2218.65	\$2249.10	\$2310.00	\$2365.65	\$2520.00	\$2627.10	\$2785.55
	Upholstered	M281-1842	2093.70	2159.85	2229.15	2263.80	2294.25	2355.15	2410.80	2565.15	2672.25	2830.70
	Soft Black Vinyl	M281-1942	2093.70	2159.85	2229.15	2263.80	2294.25	2355.15	2410.80	2565.15	2672.25	2830.70
Upholstered	Standard	M281-2742	\$2157.75	\$2223.90	\$2293.20	\$2327.85	\$2358.30	\$2419.20	\$2474.85	\$2629.20	\$2934.75	\$3093.20
	Upholstered	M281-2842	2202.90	2269.05	2338.35	2373.00	2403.45	2464.35	2520.00	2674.35	2979.90	3138.35
	Soft Black Vinyl	M281-2942	2202.90	2269.05	2338.35	2373.00	2403.45	2464.35	2520.00	2674.35	2979.90	3138.35

Improv Series

Improv H.E. XL Chair with Height Adjustable Task Arms

Shells	Arms/Caps	Number	Fabric Grade								Leather Grade A	Leather Grade B
			A	B	C	D	E	F	G	H		
Pneumatic Height Adjustment with Adjustable Air Lumbar												
Polypropylene	Standard	M271-1744	\$2113.65	\$2179.80	\$2249.10	\$2283.75	\$2314.20	\$2375.10	\$2430.75	\$2585.10	\$2692.20	\$2850.65
	Upholstered	M271-1844	2158.80	2224.95	2294.25	2328.90	2359.35	2420.25	2475.90	2630.25	2737.35	2895.80
	Soft Black Vinyl	M271-1944	2158.80	2224.95	2294.25	2328.90	2359.35	2420.25	2475.90	2630.25	2737.35	2895.80
Upholstered	Standard	M271-2744	\$2222.85	\$2289.00	\$2358.30	\$2392.95	\$2423.40	\$2484.30	\$2539.95	\$2694.30	\$2999.85	\$3158.30
	Upholstered	M271-2844	2268.00	2334.15	2403.45	2438.10	2468.55	2529.45	2585.10	2739.45	3045.00	3203.45
	Soft Black Vinyl	M271-2944	2268.00	2334.15	2403.45	2438.10	2468.55	2529.45	2585.10	2739.45	3045.00	3203.45
Pneumatic Height Adjustment/Back-Lock with Adjustable Air Lumbar												
Polypropylene	Standard	M271-1743	\$2158.80	\$2224.95	\$2294.25	\$2328.90	\$2359.35	\$2420.25	\$2475.90	\$2630.25	\$2737.35	\$2895.80
	Upholstered	M271-1843	2203.95	2270.10	2339.40	2374.05	2404.50	2465.40	2521.05	2675.40	2782.50	2940.95
	Soft Black Vinyl	M271-1943	2203.95	2270.10	2339.40	2374.05	2404.50	2465.40	2521.05	2675.40	2782.50	2940.95
Upholstered	Standard	M271-2743	\$2268.00	\$2334.15	\$2403.45	\$2438.10	\$2468.55	\$2529.45	\$2585.10	\$2739.45	\$3045.00	\$3203.45
	Upholstered	M271-2843	2313.15	2379.30	2448.60	2483.25	2513.70	2574.60	2630.25	2784.60	3090.15	3248.60
	Soft Black Vinyl	M271-2943	2313.15	2379.30	2448.60	2483.25	2513.70	2574.60	2630.25	2784.60	3090.15	3248.60
Pneumatic Height Adjustment/Forward-Tilt with Adjustable Air Lumbar												
Polypropylene	Standard	M281-1744	\$2157.75	\$2223.90	\$2293.20	\$2327.85	\$2358.30	\$2419.20	\$2474.85	\$2629.20	\$2736.30	\$2894.75
	Upholstered	M281-1844	2202.90	2269.05	2338.35	2373.00	2403.45	2464.35	2520.00	2674.35	2781.45	2939.90
	Soft Black Vinyl	M281-1944	2202.90	2269.05	2338.35	2373.00	2403.45	2464.35	2520.00	2674.35	2781.45	2939.90
Upholstered	Standard	M281-2744	\$2266.95	\$2333.10	\$2402.40	\$2437.05	\$2467.50	\$2528.40	\$2584.05	\$2738.40	\$3043.95	\$3202.40
	Upholstered	M281-2844	2312.10	2378.25	2447.55	2482.20	2512.65	2573.55	2629.20	2783.55	3089.10	3247.55
	Soft Black Vinyl	M281-2944	2312.10	2378.25	2447.55	2482.20	2512.65	2573.55	2629.20	2783.55	3089.10	3247.55

The following options require modification of the product number.

Faux Leather upholstery
 Leather upholstery
 CAL 133
 Nano-TEX

To specify, change the 2nd digit from a 2 to a 3; **Example:** M371-1842

To specify, change the 2nd digit from a 2 to a 1; **Example:** M171-1842

To specify, add **-F** to the end of the product number; **Example:** M271-2842-F (add \$101.85 list)

To specify, add **-P** to the end of the product number; **Example:** M271-1744-P (add \$33.60 list)

NOTE: CAL 133 is available on all fully upholstered models and chairs with black (TR-F) polypropylene shells backs.

Nano-TEX on upholstered poly back only.

For available fabrics see matrix in the back of the book or at Haworth.com/surfaces.

Improv Series

Improv H.E. XL Chair with Flipper Arms



M271-1H42

Dimensions

SH: 16" - 20 1/2"
(406mm - 521mm)
H: 36 1/2" - 45"
(957mm - 1143mm)
D: 23 1/2" - 26 1/2"
(597mm - 673mm)
W: 30"(762mm)
SW: 23 3/4"(603mm)
SD: 16" - 19"
(406mm - 483mm)
AH: 6.2" - 11.1"
(157mm-282mm)

Features

- Accommodates up to 500 pounds.
- Outer Shells: Polypropylene or upholstered.
- Arms: Standard, upholstered fabric or black vinyl gel arm caps.
- Arm Adjustment Controls: Fingertip activation.
- Arm Adjustment: 5"(127mm) height adjustment.
- Arm Pad Rotation: 360°
- Casters: Standard with hard casters.
- Mechanism: Swivel with synchronized-tilt.
- Height Adjustment: Pneumatic.
- Optional Back-Lock: Lockable in two positions.
- Optional Forward Tilt: Lockable in 3 positions.
- Tilt tension.
- Optional Adjustable Air Lumbar additional 1 1/2"(38mm) of lumbar support.
- Seat pan can be adjusted manually 3"(76mm).
- Fire retardant construction is available to comply with California Bulletin #133.
- COM yardage / COL square footage:
Polypropylene shell: 2.41/51
Upholstered shell: 3.31/75

To Order, Specify:

- 1) Product number.
- 2) Fabric surface and color.
(NOTE: For leather upholstery, see page 145.)
- 3) Trim color for shell, arms and base.

* All measurements taken with the BIFMA chair measuring device.

Shells	Arms/Caps	Number	Fabric Grade								Leather Grade A	Leather Grade B
			A	B	C	D	E	F	G	H		
Pneumatic Height Adjustment												
Polypropylene	Standard	M271-1H42	\$2197.65	\$2263.80	\$2333.10	\$2367.75	\$2398.20	\$2459.10	\$2514.75	\$2669.10	\$2776.20	\$2934.65
	Vinyl Gel	M271-1G42	2255.40	2321.55	2390.85	2425.50	2455.95	2516.85	2572.50	2726.85	2833.95	2992.40
	Upholstered	M271-1U42	2296.35	2362.50	2431.80	2466.45	2496.90	2557.80	2613.45	2767.80	2874.90	3033.35
Upholstered	Standard	M271-2H42	\$2306.85	\$2373.00	\$2442.30	\$2476.95	\$2507.40	\$2568.30	\$2623.95	\$2778.30	\$3083.85	\$3242.30
	Vinyl Gel	M271-2G42	2364.60	2430.75	2500.05	2534.70	2565.15	2626.05	2681.70	2836.05	3141.60	3300.05
	Upholstered	M271-2U42	2405.55	2471.70	2541.00	2575.65	2606.10	2667.00	2722.65	2877.00	3182.55	3341.00
Pneumatic Height Adjustment/Back-Lock												
Polypropylene	Standard	M271-1H41	\$2242.80	\$2308.95	\$2378.25	\$2412.90	\$2443.35	\$2504.25	\$2559.90	\$2714.25	\$2821.35	\$2979.80
	Vinyl Gel	M271-1G41	2300.55	2366.70	2436.00	2470.65	2501.10	2562.00	2617.65	2772.00	2879.10	3037.55
	Upholstered	M271-1U41	2341.50	2407.65	2476.95	2511.60	2542.05	2602.95	2658.60	2812.95	2920.05	3078.50
Upholstered	Standard	M271-2H41	\$2352.00	\$2418.15	\$2487.45	\$2522.10	\$2552.55	\$2613.45	\$2669.10	\$2823.45	\$3129.00	\$3287.45
	Vinyl Gel	M271-2G41	2409.75	2475.90	2545.20	2579.85	2610.30	2671.20	2726.85	2881.20	3186.75	3345.20
	Upholstered	M271-2U41	2450.70	2516.85	2586.15	2620.80	2651.25	2712.15	2767.80	2922.15	3227.70	3386.15
Pneumatic Height Adjustment/Forward-Tilt												
Polypropylene	Standard	M281-1H42	\$2241.75	\$2307.90	\$2377.20	\$2411.85	\$2442.30	\$2503.20	\$2558.85	\$2713.20	\$2820.30	\$2978.75
	Vinyl Gel	M281-1G42	2299.50	2365.65	2434.95	2469.60	2500.05	2560.95	2616.60	2770.95	2878.05	3036.50
	Upholstered	M281-1U42	2340.45	2406.60	2475.90	2510.55	2541.00	2601.90	2657.55	2811.90	2919.00	3077.45
Upholstered	Standard	M281-2H42	\$2350.95	\$2417.10	\$2486.40	\$2521.05	\$2551.50	\$2612.40	\$2668.05	\$2822.40	\$3127.95	\$3286.40
	Vinyl Gel	M281-2G42	2408.70	2474.85	2544.15	2578.80	2609.25	2670.15	2725.80	2880.15	3185.70	3344.15
	Upholstered	M281-2U42	2449.65	2515.80	2585.10	2619.75	2650.20	2711.10	2766.75	2921.10	3226.65	3385.10

Improv Series

Improv H.E. XL Chair with Flipper Arms

Shells	Arms/Caps	Number	Fabric Grade								Leather Grade A	Leather Grade B
			A	B	C	D	E	F	G	H		
Pneumatic Height Adjustment with Adjustable Air Lumbar												
Polypropylene	Standard	M271-1H44	\$2306.85	\$2373.00	\$2442.30	\$2476.95	\$2507.40	\$2568.30	\$2623.95	\$2778.30	\$2885.40	\$3043.85
	Vinyl Gel	M271-1G44	2364.60	2430.75	2500.05	2534.70	2565.15	2626.05	2681.70	2836.05	2943.15	3101.60
	Upholstered	M271-1U44	2405.55	2471.70	2541.00	2575.65	2606.10	2667.00	2722.65	2877.00	2984.10	3142.55
Upholstered	Standard	M271-2H44	\$2416.05	\$2482.20	\$2551.50	\$2586.15	\$2616.60	\$2677.50	\$2733.15	\$2887.50	\$3193.05	\$3351.50
	Vinyl Gel	M271-2G44	2473.80	2539.95	2609.25	2643.90	2674.35	2735.25	2790.90	2945.25	3250.80	3409.25
	Upholstered	M271-2U44	2514.75	2580.90	2650.20	2684.85	2715.30	2776.20	2831.85	2986.20	3291.75	3450.20
Pneumatic Height Adjustment/Back-Lock with Adjustable Air Lumbar												
Polypropylene	Standard	M271-1H43	\$2352.00	\$2418.15	\$2487.45	\$2522.10	\$2552.55	\$2613.45	\$2669.10	\$2823.45	\$2930.55	\$3089.00
	Vinyl Gel	M271-1G43	2409.75	2475.90	2545.20	2579.85	2610.30	2671.20	2726.85	2881.20	2988.30	3146.75
	Upholstered	M271-1U43	2450.70	2516.85	2586.15	2620.80	2651.25	2712.15	2767.80	2922.15	3029.25	3187.70
Upholstered	Standard	M271-2H43	\$2461.20	\$2527.35	\$2596.65	\$2631.30	\$2661.75	\$2722.65	\$2778.30	\$2932.65	\$3238.20	\$3396.65
	Vinyl Gel	M271-2G43	2518.95	2585.10	2654.40	2689.05	2719.50	2780.40	2836.05	2990.40	3295.95	3454.40
	Upholstered	M271-2U43	2559.90	2626.05	2695.35	2730.00	2760.45	2821.35	2877.00	3031.35	3336.90	3495.35
Pneumatic Height Adjustment/Forward-Tilt with Adjustable Air Lumbar												
Polypropylene	Standard	M281-1H44	\$2350.95	\$2417.10	\$2486.40	\$2521.05	\$2551.50	\$2612.40	\$2668.05	\$2822.40	\$2929.50	\$3087.95
	Vinyl Gel	M281-1G44	2408.70	2474.85	2544.15	2578.80	2609.25	2670.15	2725.80	2880.15	2987.25	3145.70
	Upholstered	M281-1U44	2449.65	2515.80	2585.10	2619.75	2650.20	2711.10	2766.75	2921.10	3028.20	3186.65
Upholstered	Standard	M281-2H44	\$2460.15	\$2526.30	\$2595.60	\$2630.25	\$2660.70	\$2721.60	\$2777.25	\$2931.60	\$3237.15	\$3395.60
	Vinyl Gel	M281-2G44	2517.90	2584.05	2653.35	2688.00	2718.45	2779.35	2835.00	2989.35	3294.90	3453.35
	Upholstered	M281-2U44	2558.85	2625.00	2694.30	2728.95	2759.40	2820.30	2875.95	3030.30	3335.85	3494.30

The following options require modification of the product number.

Faux Leather upholstery
 Leather upholstery
 CAL 133
 Nano-TEX

To specify, change the 2nd digit from a 2 to a 3; **Example:** M371-1H42

To specify, change the 2nd digit from a 2 to a 1; **Example:** M171-1H42

To specify, add **-F** to the end of the product number; **Example:** M271-2U42-F (add \$101.85 list)

To specify, add **-P** to the end of the product number; **Example:** M271-1H44-P (add \$33.60 list)

NOTE: CAL 133 is available on all fully upholstered models and chairs with black (TR-F) polypropylene shells backs.

CAL 133 is not available on chairs with vinyl gel arm caps.

Nano-TEX on upholstered poly back only.

For available fabrics see matrix in the back of the book or at Haworth.com/surfaces.

This page intentionally blank

Improv Series

Improv H.E. XL Chair without Arms



M271-1042

Dimensions

SH: 16" - 20 1/2"
(406mm - 521mm)
H: 36 1/2" - 45"
(957mm-1143mm)
D: 23 1/2" - 26 1/2"
(597mm - 673mm)
W: 30"(762mm)
SW: 23 3/4"(603mm)
SD: 16" - 19"
(406mm - 483mm)

Features

- Accommodates up to 500 pounds.
- Outer Shells: Polypropylene or upholstered.
- Casters: Standard with hard casters.
- Mechanism: Swivel with synchronized-tilt.
- Height Adjustment: Pneumatic.
- Optional Adjustable Air Lumbar models available: additional 1 1/2"(38mm) of lumbar support.
- Optional Back-Lock: Lockable in two positions.
- Optional Forward Tilt: Lockable in 3 positions.
- Tilt tension.
- Seat pan can be manually adjusted 3"(76mm).
- Fire retardant construction is available to comply with California Bulletin #133, see below.
- COM yardage / COL square footage:
Polypropylene shell: 2.41/51
Upholstered shell: 3.31/75

To Order, Specify:

- 1) Product number.
- 2) Fabric surface and color.
(NOTE: For leather upholstery, see below.)
- 3) Trim color for shell and base.

* All measurements taken with the BIFMA chair measuring device.

Shells	Number	Fabric Grade								Leather Grade A	Leather Grade B
		A	B	C	D	E	F	G	H		
Pneumatic Height Adjustment											
Polypropylene	M271-1042	\$1821.75	\$1887.90	\$1957.20	\$1991.85	\$2022.30	\$2083.20	\$2138.85	\$2293.20	\$2400.30	\$2558.75
Upholstered	M271-2042	1930.95	1997.10	2066.40	2101.05	2131.50	2192.40	2248.05	2402.40	2707.95	2866.40
Pneumatic Height Adjustment/Back-Lock											
Polypropylene	M271-1041	\$1866.90	\$1933.05	\$2002.35	\$2037.00	\$2067.45	\$2128.35	\$2184.00	\$2338.35	\$2445.45	\$2603.90
Upholstered	M271-2041	1976.10	2042.25	2111.55	2146.20	2176.65	2237.55	2293.20	2447.55	2753.10	2911.55
Pneumatic Height Adjustment/Forward-Tilt											
Polypropylene	M281-1042	\$1865.85	\$1932.00	\$2001.30	\$2035.95	\$2066.40	\$2127.30	\$2182.95	\$2337.30	\$2444.40	\$2602.85
Upholstered	M281-2042	1975.05	2041.20	2110.50	2145.15	2175.60	2236.50	2292.15	2446.50	2752.05	2910.50
Pneumatic Height Adjustment with Adjustable Air Lumbar											
Polypropylene	M271-1044	\$1930.95	\$1997.10	\$2066.40	\$2101.05	\$2131.50	\$2192.40	\$2248.05	\$2402.40	\$2509.50	\$2667.95
Upholstered	M271-2044	2040.15	2106.30	2175.60	2210.25	2240.70	2301.60	2357.25	2511.60	2817.15	2975.60
Pneumatic Height Adjustment/Back-Lock with Adjustable Air Lumbar											
Polypropylene	M271-1043	\$1976.10	\$2042.25	\$2111.55	\$2146.20	\$2176.65	\$2237.55	\$2293.20	\$2447.55	\$2554.65	\$2713.10
Upholstered	M271-2043	2085.30	2151.45	2220.75	2255.40	2285.85	2346.75	2402.40	2556.75	2862.30	3020.75
Pneumatic Height Adjustment/Forward-Tilt with Adjustable Air Lumbar											
Polypropylene	M281-1044	\$1975.05	\$2041.20	\$2110.50	\$2145.15	\$2175.60	\$2236.50	\$2292.15	\$2446.50	\$2553.60	\$2712.05
Upholstered	M281-2044	2084.25	2150.40	2219.70	2254.35	2284.80	2345.70	2401.35	2555.70	2861.25	3019.70

The following options require modification of the product number.

- Faux Leather upholstery
- Leather upholstery
- CAL 133
- Nano-Tex

- To specify, change the 2nd digit from a 2 to a 3; **Example:** M371-2042
- To specify, change the 2nd digit from a 2 to a 1; **Example:** M171-2042
- To specify, add **-F** to the end of the product number; **Example:** M271-2042-F (add **\$101.85** list)
- To specify, add **-P** to the end of the product number; **Example:** M271-1042-P (add **\$33.60** list)

NOTE: CAL 133 is available on all fully upholstered models and chairs with black (TR-F) polypropylene shells backs.

Nano-Tex on upholstered poly back only.

For available fabrics see matrix in the back of the book or at Haworth.com/surfaces.

Improv Series

Improv H.E. High-Back Chair with Task Arms



M251-1442

Dimensions

SH: 16" - 21"
(406mm-533mm)
H: 36 1/2" - 45"
(957mm - 1143mm)
D: 24" - 27 1/4"
(610mm - 692mm)
W: 25"(635mm)
SW: 19.2"(488mm)
SD: 16" - 19"
(406mm - 483mm)
AH: 9.6"(244mm)

Two-stage seat height:
.7"(18mm) below
standard
1.9"(48mm) above
standard

Features

- Outer Shells: Polypropylene or upholstered.
- Arms: Standard, upholstered fabric or soft black vinyl arm caps.
- 3"(76mm) sliding seat pan.
- Casters: Standard with hard casters; or optional soft casters.
- Standard plastic base or optional high arc, or steel base.
- Mechanism: Swivel with synchronized-tilt.
- Height Adjustment: Pneumatic, pneumatic with two-stage seat height, or pneumatic with low-position seat height option.
- Optional Back-Lock: Lockable in two positions.
- Optional Forward Tilt: Lockable in 3 positions.
- Tilt tension.
- Optional Adjustable Air Lumbar: additional 1 1/2"(38mm) of lumbar support.
- Fire retardant construction is available to comply with California Bulletin #133.
- COM yardage / COL square footage:
Polypropylene shell: 2.13/45
Upholstered shell: 2.75/62

■ Available on RUSH.

* All measurements taken with the BIFMA chair measuring device.

To Order, Specify:

- 1) Product number.
- 2) Fabric surface and color. (NOTE: For leather upholstery, see page 149.)
- 3) Trim color for shell, arms and base.

Shells	Arms/Caps	Number	Fabric Grade		C	D	E	F	G	H	Leather Grade A	Leather Grade B
			A	B								
Pneumatic Height Adjustment												
Polypropylene	Standard	M251-1442	\$ 957.60	\$1023.75	\$1093.05	\$1127.70	\$1158.15	\$1219.05	\$1274.70	\$1429.05	\$1536.15	\$1694.60
	Upholstered	M251-1542	1002.75	1068.90	1138.20	1172.85	1203.30	1264.20	1319.85	1474.20	1581.30	1739.75
	Soft Black Vinyl	M251-1642	1002.75	1068.90	1138.20	1172.85	1203.30	1264.20	1319.85	1474.20	1581.30	1739.75
Upholstered	Standard	M251-2442	\$1066.80	\$1132.95	\$1202.25	\$1236.90	\$1267.35	\$1328.25	\$1383.90	\$1538.25	\$1843.80	\$2002.25
	Upholstered	M251-2542	1111.95	1178.10	1247.40	1282.05	1312.50	1373.40	1429.05	1583.40	1888.95	2047.40
	Soft Black Vinyl	M251-2642	1111.95	1178.10	1247.40	1282.05	1312.50	1373.40	1429.05	1583.40	1888.95	2047.40
Pneumatic Height Adjustment/Back-Lock												
Polypropylene	Standard	M251-1441	\$1002.75	\$1068.90	\$1138.20	\$1172.85	\$1203.30	\$1264.20	\$1319.85	\$1474.20	\$1581.30	\$1739.75
	Upholstered	M251-1541	1047.90	1114.05	1183.35	1218.00	1248.45	1309.35	1365.00	1519.35	1626.45	1784.90
	Soft Black Vinyl	M251-1641	1047.90	1114.05	1183.35	1218.00	1248.45	1309.35	1365.00	1519.35	1626.45	1784.90
Upholstered	Standard	M251-2441	\$1111.95	\$1178.10	\$1247.40	\$1282.05	\$1312.50	\$1373.40	\$1429.05	\$1583.40	\$1888.95	\$2047.40
	Upholstered	M251-2541	1157.10	1223.25	1292.55	1327.20	1357.65	1418.55	1474.20	1628.55	1934.10	2092.55
	Soft Black Vinyl	M251-2641	1157.10	1223.25	1292.55	1327.20	1357.65	1418.55	1474.20	1628.55	1934.10	2092.55
Pneumatic Height Adjustment/Forward-Tilt												
Polypropylene	Standard	M261-1442	\$1001.70	\$1067.85	\$1137.15	\$1171.80	\$1202.25	\$1263.15	\$1318.80	\$1473.15	\$1580.25	\$1738.70
	Upholstered	M261-1542	1046.85	1113.00	1182.30	1216.95	1247.40	1308.30	1363.95	1518.30	1625.40	1783.85
	Soft Black Vinyl	M261-1642	1046.85	1113.00	1182.30	1216.95	1247.40	1308.30	1363.95	1518.30	1625.40	1783.85
Upholstered	Standard	M261-2442	\$1110.90	\$1177.05	\$1246.35	\$1281.00	\$1311.45	\$1372.35	\$1428.00	\$1582.35	\$1887.90	\$2046.35
	Upholstered	M261-2542	1156.05	1222.20	1291.50	1326.15	1356.60	1417.50	1473.15	1627.50	1933.05	2091.50
	Soft Black Vinyl	M261-2642	1156.05	1222.20	1291.50	1326.15	1356.60	1417.50	1473.15	1627.50	1933.05	2091.50

Improv Series

Improv H.E. High-Back Chair with Task Arms

Shells	Arms/Caps	Number	Fabric Grade								Leather Grade A	Leather Grade B
			A	B	C	D	E	F	G	H		
Pneumatic Height Adjustment with Adjustable Air Lumbar												
Polypropylene	Standard	M251-1444	\$1066.80	\$1132.95	\$1202.25	\$1236.90	\$1267.35	\$1328.25	\$1383.90	\$1538.25	\$1645.35	\$1803.80
	Upholstered	M251-1544	1111.95	1178.10	1247.40	1282.05	1312.50	1373.40	1429.05	1583.40	1690.50	1848.95
	Soft Black Vinyl	M251-1644	1111.95	1178.10	1247.40	1282.05	1312.50	1373.40	1429.05	1583.40	1690.50	1848.95
Upholstered	Standard	M251-2444	\$1176.00	\$1242.15	\$1311.45	\$1346.10	\$1376.55	\$1437.45	\$1493.10	\$1647.45	\$1953.00	\$2111.45
	Upholstered	M251-2544	1221.15	1287.30	1356.60	1391.25	1421.70	1482.60	1538.25	1692.60	1998.15	2156.60
	Soft Black Vinyl	M251-2644	1221.15	1287.30	1356.60	1391.25	1421.70	1482.60	1538.25	1692.60	1998.15	2156.60
Pneumatic Height Adjustment/Back-Lock with Adjustable Air Lumbar												
Polypropylene	Standard	M251-1443	\$1111.95	\$1178.10	\$1247.40	\$1282.05	\$1312.50	\$1373.40	\$1429.05	\$1583.40	\$1690.50	\$1848.95
	Upholstered	M251-1543	1157.10	1223.25	1292.55	1327.20	1357.65	1418.55	1474.20	1628.55	1735.65	1894.10
	Soft Black Vinyl	M251-1643	1157.10	1223.25	1292.55	1327.20	1357.65	1418.55	1474.20	1628.55	1735.65	1894.10
Upholstered	Standard	M251-2443	\$1221.15	\$1287.30	\$1356.60	\$1391.25	\$1421.70	\$1482.60	\$1538.25	\$1692.60	\$1998.15	\$2156.60
	Upholstered	M251-2543	1266.30	1332.45	1401.75	1436.40	1466.85	1527.75	1583.40	1737.75	2043.30	2201.75
	Soft Black Vinyl	M251-2643	1266.30	1332.45	1401.75	1436.40	1466.85	1527.75	1583.40	1737.75	2043.30	2201.75
Pneumatic Height Adjustment/Forward-Tilt with Adjustable Air Lumbar												
Polypropylene	Standard	M261-1444	\$1110.90	\$1177.05	\$1246.35	\$1281.00	\$1311.45	\$1372.35	\$1428.00	\$1582.35	\$1689.45	\$1847.90
	Upholstered	M261-1544	1156.05	1222.20	1291.50	1326.15	1356.60	1417.50	1473.15	1627.50	1734.60	1893.05
	Soft Black Vinyl	M261-1644	1156.05	1222.20	1291.50	1326.15	1356.60	1417.50	1473.15	1627.50	1734.60	1893.05
Upholstered	Standard	M261-2444	\$1220.10	\$1286.25	\$1355.55	\$1390.20	\$1420.65	\$1481.55	\$1537.20	\$1691.55	\$1997.10	\$2155.55
	Upholstered	M261-2544	1265.25	1331.40	1400.70	1435.35	1465.80	1526.70	1582.35	1736.70	2042.25	2200.70
	Soft Black Vinyl	M261-2644	1265.25	1331.40	1400.70	1435.35	1465.80	1526.70	1582.35	1736.70	2042.25	2200.70

The following options require modification of the product number.

Two-stage seat height	To specify, change the 4th digit from a 1 to a 3; Example: M253-1442 (add \$87.15 list)
High arc base	To specify, change the 4th digit from a 1 to a 5; Example: M255-1442
Steel base - Standard height	To specify, change the 4th digit from a 1 to a 6; Example: M256-1442
Steel base - Low height	To specify, change the 4th digit from a 1 to a 7; Example: M257-1442
Plastic base - Low height	To specify, change the 4th digit from a 1 to a 4; Example: M254-1442
Soft casters	To specify, change the 7th digit from a 4 to a 2; Example: M251-1422
Faux Leather upholstery	To specify, change the 2nd digit from a 2 to a 3; Example: M351-1442
Leather upholstery	To specify, change the 2nd digit from a 2 to a 1; Example: M151-1442
CAL 133	To specify, add -F to the end of the product number; Example: M251-2542-F (add \$101.85 list)
Nano-Tex	To specify, add -P to the end of the product number; Example: M251-1444-P (add \$33.60 list)

NOTE: CAL 133 is available on all fully upholstered models and chairs with black (TR-F) polypropylene shells backs.

High arc base available in black only.

Nano-Tex on upholstered poly back only.

For available fabrics see matrix in the back of the book or at Haworth.com/surfaces.

Improv Series

Improv H.E. High-Back Chair with Height Adjustable Task Arms



M251-1742

Dimensions

SH: 16" - 21"
(406mm - 533mm)
H: 36 1/2" - 45"
(957mm - 1143mm)
D: 24" - 27 1/4"
(610mm - 692mm)
W: 25"(635mm)
SW: 19.2"(488mm)
SD: 16" - 19"
(406mm - 483mm)
AH: 6.9" - 10.8"
(175mm - 274mm)

Two-stage seat height:
.7"(18mm) below
standard
1.9"(48mm) above
standard

Features

- Outer Shells: Polypropylene or upholstered.
- Arms: Standard, upholstered fabric or soft black vinyl arm caps.
- Arm Adjustment Controls: Fingertip activation.
- Arm Adjustment: 4"(102mm) height adjustment.
- 3"(76mm) sliding seat pan.
- Casters: Standard with hard casters; or optional soft casters.
- Standard plastic base or optional high arc, or steel base.
- Mechanism: Swivel with synchronized-tilt.
- Height Adjustment: Pneumatic, pneumatic with two-stage seat height, or pneumatic with low-position seat height option.
- Optional Back-Lock: Lockable in two positions.
- Optional Forward Tilt: Lockable in 3 positions.
- Tilt tension.
- Optional Adjustable Air Lumbar: additional 1 1/2"(38mm) of lumbar support.
- Fire retardant construction is available to comply with California Bulletin #133.
- COM yardage / COL square footage:
Polypropylene shell: 2.13/45
Upholstered shell: 2.75/62

■ Available on RUSH.

* All measurements taken with the BIFMA chair measuring device.

To Order, Specify:

- 1) Product number.
- 2) Fabric surface and color. (NOTE: For leather upholstery, see page 151.)
- 3) Trim color for shell, arms and base.

Shells	Arms/Caps	Number	Fabric Grade								Leather Grade A	Leather Grade B
			A	B	C	D	E	F	G	H		
Pneumatic Height Adjustment												
Polypropylene	Standard	M251-1742	■ \$1052.10	\$1118.25	\$1187.55	\$1222.20	\$1252.65	\$1313.55	\$1369.20	\$1523.55	\$1630.65	\$1789.10
	Upholstered	M251-1842	■ 1097.25	1163.40	1232.70	1267.35	1297.80	1358.70	1414.35	1568.70	1675.80	1834.25
	Soft Black Vinyl	M251-1942	■ 1097.25	1163.40	1232.70	1267.35	1297.80	1358.70	1414.35	1568.70	1675.80	1834.25
Upholstered	Standard	M251-2742	■ \$1161.30	\$1227.45	\$1296.75	\$1331.40	\$1361.85	\$1422.75	\$1478.40	\$1632.75	\$1938.30	\$2096.75
	Upholstered	M251-2842	■ 1206.45	1272.60	1341.90	1376.55	1407.00	1467.90	1523.55	1677.90	1983.45	2141.90
	Soft Black Vinyl	M251-2942	■ 1206.45	1272.60	1341.90	1376.55	1407.00	1467.90	1523.55	1677.90	1983.45	2141.90
Pneumatic Height Adjustment/Back-Lock												
Polypropylene	Standard	M251-1741	■ \$1097.25	\$1163.40	\$1232.70	\$1267.35	\$1297.80	\$1358.70	\$1414.35	\$1568.70	\$1675.80	\$1834.25
	Upholstered	M251-1841	■ 1142.40	1208.55	1277.85	1312.50	1342.95	1403.85	1459.50	1613.85	1720.95	1879.40
	Soft Black Vinyl	M251-1941	■ 1142.40	1208.55	1277.85	1312.50	1342.95	1403.85	1459.50	1613.85	1720.95	1879.40
Upholstered	Standard	M251-2741	■ \$1206.45	\$1272.60	\$1341.90	\$1376.55	\$1407.00	\$1467.90	\$1523.55	\$1677.90	\$1983.45	\$2141.90
	Upholstered	M251-2841	■ 1251.60	1317.75	1387.05	1421.70	1452.15	1513.05	1568.70	1723.05	2028.60	2187.05
	Soft Black Vinyl	M251-2941	■ 1251.60	1317.75	1387.05	1421.70	1452.15	1513.05	1568.70	1723.05	2028.60	2187.05
Pneumatic Height Adjustment/Forward-Tilt												
Polypropylene	Standard	M261-1742	■ \$1096.20	\$1162.35	\$1231.65	\$1266.30	\$1296.75	\$1357.65	\$1413.30	\$1567.65	\$1674.75	\$1833.20
	Upholstered	M261-1842	■ 1141.35	1207.50	1276.80	1311.45	1341.90	1402.80	1458.45	1612.80	1719.90	1878.35
	Soft Black Vinyl	M261-1942	■ 1141.35	1207.50	1276.80	1311.45	1341.90	1402.80	1458.45	1612.80	1719.90	1878.35
Upholstered	Standard	M261-2742	■ \$1205.40	\$1271.55	\$1340.85	\$1375.50	\$1405.95	\$1466.85	\$1522.50	\$1676.85	\$1982.40	\$2140.85
	Upholstered	M261-2842	■ 1250.55	1316.70	1386.00	1420.65	1451.10	1512.00	1567.65	1722.00	2027.55	2186.00
	Soft Black Vinyl	M261-2942	■ 1250.55	1316.70	1386.00	1420.65	1451.10	1512.00	1567.65	1722.00	2027.55	2186.00

Improv Series

Improv H.E. High-Back Chair with Height Adjustable Task Arms

Shells	Arms/Caps	Number	Fabric Grade								Leather Grade A	Leather Grade B
			A	B	C	D	E	F	G	H		
Pneumatic Height Adjustment with Adjustable Air Lumbar												
Polypropylene	Standard	M251-1744	\$1161.30	\$1227.45	\$1296.75	\$1331.40	\$1361.85	\$1422.75	\$1478.40	\$1632.75	\$1739.85	\$1898.30
	Upholstered	M251-1844	1206.45	1272.60	1341.90	1376.55	1407.00	1467.90	1523.55	1677.90	1785.00	1943.45
	Soft Black Vinyl	M251-1944	1206.45	1272.60	1341.90	1376.55	1407.00	1467.90	1523.55	1677.90	1785.00	1943.45
Upholstered	Standard	M251-2744	\$1270.50	\$1336.65	\$1405.95	\$1440.60	\$1471.05	\$1531.95	\$1587.60	\$1741.95	\$2047.50	\$2205.95
	Upholstered	M251-2844	1315.65	1381.80	1451.10	1485.75	1516.20	1577.10	1632.75	1787.10	2092.65	2251.10
	Soft Black Vinyl	M251-2944	1315.65	1381.80	1451.10	1485.75	1516.20	1577.10	1632.75	1787.10	2092.65	2251.10
Pneumatic Height Adjustment/Back-Lock with Adjustable Air Lumbar												
Polypropylene	Standard	M251-1743	\$1206.45	\$1272.60	\$1341.90	\$1376.55	\$1407.00	\$1467.90	\$1523.55	\$1677.90	\$1785.00	\$1943.45
	Upholstered	M251-1843	1251.60	1317.75	1387.05	1421.70	1452.15	1513.05	1568.70	1723.05	1830.15	1988.60
	Soft Black Vinyl	M251-1943	1251.60	1317.75	1387.05	1421.70	1452.15	1513.05	1568.70	1723.05	1830.15	1988.60
Upholstered	Standard	M251-2743	\$1315.65	\$1381.80	\$1451.10	\$1485.75	\$1516.20	\$1577.10	\$1632.75	\$1787.10	\$2092.65	\$2251.10
	Upholstered	M251-2843	1360.80	1426.95	1496.25	1530.90	1561.35	1622.25	1677.90	1832.25	2137.80	2296.25
	Soft Black Vinyl	M251-2943	1360.80	1426.95	1496.25	1530.90	1561.35	1622.25	1677.90	1832.25	2137.80	2296.25
Pneumatic Height Adjustment/Forward-Tilt with Adjustable Air Lumbar												
Polypropylene	Standard	M261-1744	\$1205.40	\$1271.55	\$1340.85	\$1375.50	\$1405.95	\$1466.85	\$1522.50	\$1676.85	\$1783.95	\$1942.40
	Upholstered	M261-1844	1250.55	1316.70	1386.00	1420.65	1451.10	1512.00	1567.65	1722.00	1829.10	1987.55
	Soft Black Vinyl	M261-1944	1250.55	1316.70	1386.00	1420.65	1451.10	1512.00	1567.65	1722.00	1829.10	1987.55
Upholstered	Standard	M261-2744	\$1314.60	\$1380.75	\$1450.05	\$1484.70	\$1515.15	\$1576.05	\$1631.70	\$1786.05	\$2091.60	\$2250.05
	Upholstered	M261-2844	1359.75	1425.90	1495.20	1529.85	1560.30	1621.20	1676.85	1831.20	2136.75	2295.20
	Soft Black Vinyl	M261-2944	1359.75	1425.90	1495.20	1529.85	1560.30	1621.20	1676.85	1831.20	2136.75	2295.20

The following options require modification of the product number.

Two-stage seat height	To specify, change the 4th digit from a 1 to a 3; Example: M253-1742 (add \$87.15 list)
High arc base	To specify, change the 4th digit from a 1 to a 5; Example: M255-1742
Steel base - Standard height	To specify, change the 4th digit from a 1 to a 6; Example: M256-1742
Steel base - Low height	To specify, change the 4th digit from a 1 to a 7; Example: M257-1742
Plastic base - Low height	To specify, change the 4th digit from a 1 to a 4; Example: M254-1742
Soft casters	To specify, change the 7th digit from a 4 to a 2; Example: M251-1722
Faux Leather upholstery	To specify, change the 2nd digit from a 2 to a 3; Example: M351-1742
Leather upholstery	To specify, change the 2nd digit from a 2 to a 1; Example: M151-1742
CAL 133	To specify, add -F to the end of the product number; Example: M251-2842- F (add \$101.85 list)
Nano-Tex	To specify, add -P to the end of the product number; Example: M251-1744- P (add \$33.60 list)

NOTE: CAL 133 is available on all fully upholstered models and chairs with black (TR-F) polypropylene shells backs.

High arc base available in black only.

Nano-Tex on upholstered poly back only.

For available fabrics see matrix in the back of the book or at Haworth.com/surfaces.

Improv Series

Improv H.E. High-Back Chair with Flipper Arms



M251-1H42

NOTE:
M261-1G42 offers the best value package of options for this model.

Dimensions

SH: 16" - 21"
(406mm - 533mm)
H: 36 1/2" - 45"
(957mm-1143mm)
D: 24" - 27 1/4"
(610mm - 692mm)
W: 26 1/2"(673mm)
SW: 19.2"(488mm)
SD: 16" - 19"
(406mm - 483mm)
AH: 6.2" - 11.3"
(157mm-287mm)

Two-stage seat height:
.7"(18mm) below
standard
1.9"(48mm) above
standard

Features

- Outer Shells: Polypropylene or upholstered.
- Arms: Standard, upholstered fabric or black vinyl gel arm caps.
- Arm Adjustment Controls: Fingertip activation.
- Arm Adjustment: 5"(127mm) height adjustment.
- Arm Pad Rotation: 360°.
- 3"(76mm) sliding seat pan.
- Casters: Standard with hard casters; for optional soft casters.
- Standard plastic base or optional high arc, or steel base.
- Mechanism: Swivel with synchronized-tilt.
- Height Adjustment: Pneumatic, pneumatic with two-stage seat height, or pneumatic with low-position seat height option.
- Optional Back-Lock: Lockable in two positions.
- Optional Forward Tilt: Lockable in 3 positions.
- Tilt tension.
- Optional Adjustable Air Lumbar: additional 1 1/2"(38mm) of lumbar support.
- Fire retardant construction is available to comply with California Bulletin #133.
- COM yardage / COL square footage:
Polypropylene shell: 2.13/45
Upholstered shell: 2.75/62
- Available on RUSH.

To Order, Specify:

- 1) Product number.
- 2) Fabric surface and color.
(NOTE: For leather upholstery, see page 153.)
- 3) Trim color for shell, arms and base.

* All measurements taken with the BIFMA chair measuring device.

Shells	Arms/Caps	Number	Fabric Grade								Leather Grade A	Leather Grade B
			A	B	C	D	E	F	G	H		
Pneumatic Height Adjustment												
Polypropylene	Standard	M251-1H42	\$1245.30	\$1311.45	\$1380.75	\$1415.40	\$1445.85	\$1506.75	\$1562.40	\$1716.75	\$1823.85	\$1982.30
	Vinyl Gel	M251-1G42	1303.05	1369.20	1438.50	1473.15	1503.60	1564.50	1620.15	1774.50	1881.60	2040.05
	Upholstered	M251-1U42	1344.00	1410.15	1479.45	1514.10	1544.55	1605.45	1661.10	1815.45	1922.55	2081.00
Upholstered	Standard	M251-2H42	\$1354.50	\$1420.65	\$1489.95	\$1524.60	\$1555.05	\$1615.95	\$1671.60	\$1825.95	\$2131.50	\$2289.95
	Vinyl Gel	M251-2G42	1412.25	1478.40	1547.70	1582.35	1612.80	1673.70	1729.35	1883.70	2189.25	2347.70
	Upholstered	M251-2U42	1453.20	1519.35	1588.65	1623.30	1653.75	1714.65	1770.30	1924.65	2230.20	2388.65
Pneumatic Height Adjustment/Back-Lock												
Polypropylene	Standard	M251-1H41	\$1290.45	\$1356.60	\$1425.90	\$1460.55	\$1491.00	\$1551.90	\$1607.55	\$1761.90	\$1869.00	\$2027.45
	Vinyl Gel	M251-1G41	1348.20	1414.35	1483.65	1518.30	1548.75	1609.65	1665.30	1819.65	1926.75	2085.20
	Upholstered	M251-1U41	1389.15	1455.30	1524.60	1559.25	1589.70	1650.60	1706.25	1860.60	1967.70	2126.15
Upholstered	Standard	M251-2H41	\$1399.65	\$1465.80	\$1535.10	\$1569.75	\$1600.20	\$1661.10	\$1716.75	\$1871.10	\$2176.65	\$2335.10
	Vinyl Gel	M251-2G41	1457.40	1523.55	1592.85	1627.50	1657.95	1718.85	1774.50	1928.85	2234.40	2392.85
	Upholstered	M251-2U41	1498.35	1564.50	1633.80	1668.45	1698.90	1759.80	1815.45	1969.80	2275.35	2433.80
Pneumatic Height Adjustment/Forward-Tilt												
Polypropylene	Standard	M261-1H42	\$1289.40	\$1355.55	\$1424.85	\$1459.50	\$1489.95	\$1550.85	\$1606.50	\$1760.85	\$1867.95	\$2026.40
	Vinyl Gel	M261-1G42	1347.15	1413.30	1482.60	1517.25	1547.70	1608.60	1664.25	1818.60	1925.70	2084.15
	Upholstered	M261-1U42	1388.10	1454.25	1523.55	1558.20	1588.65	1649.55	1705.20	1859.55	1966.65	2125.10
Upholstered	Standard	M261-2H42	\$1398.60	\$1464.75	\$1534.05	\$1568.70	\$1599.15	\$1660.05	\$1715.70	\$1870.05	\$2175.60	\$2334.05
	Vinyl Gel	M261-2G42	1456.35	1522.50	1591.80	1626.45	1656.90	1717.80	1773.45	1927.80	2233.35	2391.80
	Upholstered	M261-2U42	1497.30	1563.45	1632.75	1667.40	1697.85	1758.75	1814.40	1968.75	2274.30	2432.75

Improv Series

Improv H.E. High-Back Chair with Flipper Arms

Shells	Arms/Caps	Number	Fabric Grade								Leather Grade A	Leather Grade B
			A	B	C	D	E	F	G	H		
Pneumatic Height Adjustment with Adjustable Air Lumbar												
Polypropylene	Standard	M251-1H44	\$1354.50	\$1420.65	\$1489.95	\$1524.60	\$1555.05	\$1615.95	\$1671.60	\$1825.95	\$1933.05	\$2091.50
	Vinyl Gel	M251-1G44	1412.25	1478.40	1547.70	1582.35	1612.80	1673.70	1729.35	1883.70	1990.80	2149.25
	Upholstered	M251-1U44	1453.20	1519.35	1588.65	1623.30	1653.75	1714.65	1770.30	1924.65	2031.75	2190.20
Upholstered	Standard	M251-2H44	\$1463.70	\$1529.85	\$1599.15	\$1633.80	\$1664.25	\$1725.15	\$1780.80	\$1935.15	\$2240.70	\$2399.15
	Vinyl Gel	M251-2G44	1521.45	1587.60	1656.90	1691.55	1722.00	1782.90	1838.55	1992.90	2298.45	2456.90
	Upholstered	M251-2U44	1562.40	1628.55	1697.85	1732.50	1762.95	1823.85	1879.50	2033.85	2339.40	2497.85
Pneumatic Height Adjustment/Back-Lock with Adjustable Air Lumbar												
Polypropylene	Standard	M251-1H43	\$1399.65	\$1465.80	\$1535.10	\$1569.75	\$1600.20	\$1661.10	\$1716.75	\$1871.10	\$1978.20	\$2136.65
	Vinyl Gel	M251-1G43	1457.40	1523.55	1592.85	1627.50	1657.95	1718.85	1774.50	1928.85	2035.95	2194.40
	Upholstered	M251-1U43	1498.35	1564.50	1633.80	1668.45	1698.90	1759.80	1815.45	1969.80	2076.90	2235.35
Upholstered	Standard	M251-2H43	\$1508.85	\$1575.00	\$1644.30	\$1678.95	\$1709.40	\$1770.30	\$1825.95	\$1980.30	\$2285.85	\$2444.30
	Vinyl Gel	M251-2G43	1566.60	1632.75	1702.05	1736.70	1767.15	1828.05	1883.70	2038.05	2343.60	2502.05
	Upholstered	M251-2U43	1607.55	1673.70	1743.00	1777.65	1808.10	1869.00	1924.65	2079.00	2384.55	2543.00
Pneumatic Height Adjustment/Forward-Tilt with Adjustable Air Lumbar												
Polypropylene	Standard	M261-1H44	\$1398.60	\$1464.75	\$1534.05	\$1568.70	\$1599.15	\$1660.05	\$1715.70	\$1870.05	\$1977.15	\$2135.60
	Vinyl Gel	M261-1G44	1456.35	1522.50	1591.80	1626.45	1656.90	1717.80	1773.45	1927.80	2034.90	2193.35
	Upholstered	M261-1U44	1497.30	1563.45	1632.75	1667.40	1697.85	1758.75	1814.40	1968.75	2075.85	2234.30
Upholstered	Standard	M261-2H44	\$1507.80	\$1573.95	\$1643.25	\$1677.90	\$1708.35	\$1769.25	\$1824.90	\$1979.25	\$2284.80	\$2443.25
	Vinyl Gel	M261-2G44	1565.55	1631.70	1701.00	1735.65	1766.10	1827.00	1882.65	2037.00	2342.55	2501.00
	Upholstered	M261-2U44	1606.50	1672.65	1741.95	1776.60	1807.05	1867.95	1923.60	2077.95	2383.50	2541.95

The following options require modification of the product number.

Two-stage seat height	To specify, change the 4th digit from a 1 to a 3; Example: M253-1H42 (add \$87.15 list)
High arc base	To specify, change the 4th digit from a 1 to a 5; Example: M255-1H42
Steel base - Standard height	To specify, change the 4th digit from a 1 to a 6; Example: M256-1H42
Steel base - Low height	To specify, change the 4th digit from a 1 to a 7; Example: M257-1H42
Plastic base - Low height	To specify, change the 4th digit from a 1 to a 4; Example: M254-1H42
Soft casters	To specify, change the 7th digit from a 4 to a 2; Example: M251-1H22
Faux Leather upholstery	To specify, change the 2nd digit from a 2 to a 3; Example: M351-1H42
Leather upholstery	To specify, change the 2nd digit from a 2 to a 1; Example: M151-1H42
CAL 133	To specify, add -F to the end of the product number; Example: M251-2U42-F (add \$101.85 list)
Nano-Tex	To specify, add -P to the end of the product number; Example: M251-1H44-P (add \$33.60 list)

NOTE: CAL 133 is available on all fully upholstered models and chairs with black (TR-F) polypropylene shells backs.

CAL 133 is not available on chairs with vinyl gel arm caps.

High arc base available in black only.

Nano-Tex on upholstered poly back only.

For available fabrics see matrix in the back of the book or at Haworth.com/surfaces.

Improv Series

Improv H.E. High-Back Chair with Height and Width Adjustable 3-D Arms



M251-1W42

Dimensions

- SH: 16" - 21"
(406mm - 533mm)
- H: 36 1/2" - 45"
(957mm - 1143mm)
- D: 24" - 27 1/4"
(610mm - 692mm)
- W: 25"(635mm)
- SW: 19.2"(488mm)
- SD: 16" - 19"
(406mm - 483mm)
- AH: 3 3/4" - 7 3/4"
(95mm-197mm)
- AW: 25 1/2" - 29 1/4"
(647mm-743mm)

Two-stage seat height:
.7"(18mm) below
standard
1.9"(48mm) above
standard

Features

- Outer Shells: Polypropylene or upholstered.
- Arms: Molded black vinyl.
- 3"(76mm) sliding seat pan.
- Casters: Standard with hard casters; or optional soft casters, see below.
- Standard plastic base or optional high arc, or steel base.
- Mechanism: Swivel with synchronized-tilt.
- Height Adjustment: Pneumatic, pneumatic with two-stage seat height, or pneumatic with low-position seat height option.
- Arm Adjustment: 4"(102mm) height adjustment.
- Arm Width Adjustment: 1 1/2"(38mm) per arm in-out adjustment.
- Arm Pad Rotation: 360°.
- Arm Adjustment Controls: Fingertip activation.
- Optional Back-Lock: Lockable in two positions.
- Optional Forward Tilt: Lockable in 3 positions.
- Tilt tension.
- Optional Adjustable Air Lumbar: additional 1 1/2"(38mm) of lumbar support.
- COM yardage / COL square footage:
Polypropylene shell: 2.13/45
Upholstered shell: 2.75/62

To Order, Specify:

- 1) Product number.
- 2) Fabric surface and color.
(NOTE: For leather upholstery, see below.)
- 3) Trim color for shell, arms and base.

* All measurements taken with the BIFMA chair measuring device.

Shells	Arms/Caps	Number	Fabric Grade								Leather Grade A	Leather Grade B
			A	B	C	D	E	F	G	H		
Pneumatic Height Adjustment												
Polypropylene	Molded Black Vinyl	M251-1W42	\$1168.65	\$1234.80	\$1304.10	\$1338.75	\$1369.20	\$1430.10	\$1485.75	\$1640.10	\$1747.20	\$1905.65
Upholstered	Molded Black Vinyl	M251-2W42	1277.85	1344.00	1413.30	1447.95	1478.40	1539.30	1594.95	1749.30	2054.85	2213.30
Pneumatic Height Adjustment/Back-Lock												
Polypropylene	Molded Black Vinyl	M251-1W41	\$1213.80	\$1279.95	\$1349.25	\$1383.90	\$1414.35	\$1475.25	\$1530.90	\$1685.25	\$1792.35	\$1950.80
Upholstered	Molded Black Vinyl	M251-2W41	1323.00	1389.15	1458.45	1493.10	1523.55	1584.45	1640.10	1794.45	2100.00	2258.45
Pneumatic Height Adjustment/Forward-Tilt												
Polypropylene	Molded Black Vinyl	M261-1W42	\$1212.75	\$1278.90	\$1348.20	\$1382.85	\$1413.30	\$1474.20	\$1529.85	\$1684.20	\$1791.30	\$1949.75
Upholstered	Molded Black Vinyl	M261-2W42	1321.95	1388.10	1457.40	1492.05	1522.50	1583.40	1639.05	1793.40	2098.95	2257.40
Pneumatic Height Adjustment with Adjustable Air Lumbar												
Polypropylene	Molded Black Vinyl	M251-1W44	\$1277.85	\$1344.00	\$1413.30	\$1447.95	\$1478.40	\$1539.30	\$1594.95	\$1749.30	\$1856.40	\$2014.85
Upholstered	Molded Black Vinyl	M251-2W44	1387.05	1453.20	1522.50	1557.15	1587.60	1648.50	1704.15	1858.50	2164.05	2322.50
Pneumatic Height Adjustment/Back-Lock with Adjustable Air Lumbar												
Polypropylene	Molded Black Vinyl	M251-1W43	\$1323.00	\$1389.15	\$1458.45	\$1493.10	\$1523.55	\$1584.45	\$1640.10	\$1794.45	\$1901.55	\$2060.00
Upholstered	Molded Black Vinyl	M251-2W43	1432.20	1498.35	1567.65	1602.30	1632.75	1693.65	1749.30	1903.65	2209.20	2367.65
Pneumatic Height Adjustment/Forward-Tilt with Adjustable Air Lumbar												
Polypropylene	Molded Black Vinyl	M261-1W44	\$1321.95	\$1388.10	\$1457.40	\$1492.05	\$1522.50	\$1583.40	\$1639.05	\$1793.40	\$1900.50	\$2058.95
Upholstered	Molded Black Vinyl	M261-2W44	1431.15	1497.30	1566.60	1601.25	1631.70	1692.60	1748.25	1902.60	2208.15	2366.60

The following options require modification of the product number.

- Two-stage seat height
- High arc base
- Steel base - Standard height
- Steel base - Low height
- Plastic base - Low height
- Soft casters
- Faux Leather upholstery
- Leather upholstery
- CAL 133
- Nano-Tex

- To specify, change the 4th digit from a 1 to a 3; **Example:** M253-1W42 (add \$87.15 list)
- To specify, change the 4th digit from a 1 to a 5; **Example:** M255-1W42
- To specify, change the 4th digit from a 1 to a 6; **Example:** M256-1W42
- To specify, change the 4th digit from a 1 to a 7; **Example:** M257-1W42
- To specify, change the 4th digit from a 1 to a 4; **Example:** M254-1W42
- To specify, change the 7th digit from a 4 to a 2; **Example:** M251-1W22
- To specify, change the 2nd digit from a 2 to a 3; **Example:** M351-1W42
- To specify, change the 2nd digit from a 2 to a 1; **Example:** M151-1W42
- To specify, add **-F** to the end of the product number; **Example:** M251-2W42-F (add \$101.85 list)
- To specify, add **-P** to the end of the product number; **Example:** M251-1W42-P (add \$33.60 list)

NOTE: CAL 133 is available on all fully upholstered models and chairs with black (TR-F) polypropylene shells backs.

High arc base available in black only.

Nano-Tex on upholstered poly back only.

For available fabrics see matrix in the back of the book or at Haworth.com/surfaces.

Improv Series

Improv H.E. High-Back Chair without Arms



M251-1042

Dimensions

SH: 16" - 21"
(406mm - 533mm)
H: 36 1/2" - 45"
(957mm-1143mm)
D: 24" - 27 1/4"
(610mm - 692mm)
W: 26 1/2"(673mm)
SW: 19.2"(488mm)
SD: 16" - 19"
(406mm - 483mm)

Two-stage seat height:
.7"(18mm) below
standard
1.9"(48mm) above
standard

Features

- Outer Shells: Polypropylene or upholstered.
- Casters: Standard with hard casters; or optional soft casters, see below.
- 3"(76mm) sliding seat pan.
- Standard plastic base or optional high arc, or steel base.
- Mechanism: Swivel with synchronized-tilt.
- Height Adjustment: Pneumatic or pneumatic with two-stage seat height, see below.
- Optional Back-Lock: Lockable in two positions.
- Optional Forward Tilt: Lockable in 3 positions.
- Tilt tension.
- Optional Adjustable Air Lumbar: additional 1 1/2"(38mm) of lumbar support.
- Fire retardant construction is available to comply with California Bulletin #133, see below.
- COM yardage / COL square footage:
Polypropylene shell: 2.13/45
Upholstered shell: 2.75/62
- Available on RUSH.

To Order, Specify:

- 1) Product number.
- 2) Fabric surface and color.
(NOTE: For leather upholstery, see below.)
- 3) Trim color for shell and base.

* All measurements taken with the BIFMA chair measuring device.

Shells	Number	Fabric Grade								Leather Grade A	Leather Grade B
		A	B	C	D	E	F	G	H		
Pneumatic Height Adjustment											
Polypropylene	M251-1042	\$ 869.40	\$ 935.55	\$1004.85	\$1039.50	\$1069.95	\$1130.85	\$1186.50	\$1340.85	\$1447.95	\$1606.40
Upholstered	M251-2042	978.60	1044.75	1114.05	1148.70	1179.15	1240.05	1295.70	1450.05	1755.60	1914.05
Pneumatic Height Adjustment/Back-Lock											
Polypropylene	M251-1041	\$ 914.55	\$ 980.70	\$1050.00	\$1084.65	\$1115.10	\$1176.00	\$1231.65	\$1386.00	\$1493.10	\$1651.55
Upholstered	M251-2041	1023.75	1089.90	1159.20	1193.85	1224.30	1285.20	1340.85	1495.20	1800.75	1959.20
Pneumatic Height Adjustment/Forward-Tilt											
Polypropylene	M261-1042	\$ 913.50	\$ 979.65	\$1048.95	\$1083.60	\$1114.05	\$1174.95	\$1230.60	\$1384.95	\$1492.05	\$1650.50
Upholstered	M261-2042	1022.70	1088.85	1158.15	1192.80	1223.25	1284.15	1339.80	1494.15	1799.70	1958.15
Pneumatic Height Adjustment with Adjustable Air Lumbar											
Polypropylene	M251-1044	\$ 978.60	\$1044.75	\$1114.05	\$1148.70	\$1179.15	\$1240.05	\$1295.70	\$1450.05	\$1557.15	\$1715.60
Upholstered	M251-2044	1087.80	1153.95	1223.25	1257.90	1288.35	1349.25	1404.90	1559.25	1864.80	2023.25
Pneumatic Height Adjustment/Back-Lock with Adjustable Air Lumbar											
Polypropylene	M251-1043	\$1023.75	\$1089.90	\$1159.20	\$1193.85	\$1224.30	\$1285.20	\$1340.85	\$1495.20	\$1602.30	\$1760.75
Upholstered	M251-2043	1132.95	1199.10	1268.40	1303.05	1333.50	1394.40	1450.05	1604.40	1909.95	2068.40
Pneumatic Height Adjustment/Forward-Tilt with Adjustable Air Lumbar											
Polypropylene	M261-1044	\$1022.70	\$1088.85	\$1158.15	\$1192.80	\$1223.25	\$1284.15	\$1339.80	\$1494.15	\$1601.25	\$1759.70
Upholstered	M261-2044	1131.90	1198.05	1267.35	1302.00	1332.45	1393.35	1449.00	1603.35	1908.90	2067.35

The following options require modification of the product number.

- | | |
|------------------------------|--|
| Two-stage seat height | To specify, change the 4th digit from a 1 to a 3; Example: M253-1042 (add \$87.15 list) |
| High arc base | To specify, change the 4th digit from a 1 to a 5; Example: M255-1042 |
| Steel base - Standard height | To specify, change the 4th digit from a 1 to a 6; Example: M256-1042 |
| Steel base - Low height | To specify, change the 4th digit from a 1 to a 7; Example: M257-1042 |
| Plastic base - Low height | To specify, change the 4th digit from a 1 to a 4; Example: M254-1042 |
| Soft casters | To specify, change the 7th digit from a 4 to a 2; Example: M251-1022 |
| Faux Leather upholstery | To specify, change the 2nd digit from a 2 to a 3; Example: M351-1042 |
| Leather upholstery | To specify, change the 2nd digit from a 2 to a 1; Example: M151-1042 |
| CAL 133 | To specify, add -F to the end of the product number; Example: M251-2042-F (add \$101.85 list) |
| Nano-Tex | To specify, add -P to the end of the product number; Example: M251-1042-P (add \$33.60 list) |

NOTE: CAL 133 is available on all fully upholstered models and chairs with black (TR-F) polypropylene shells backs.

High arc base available in black only.

Nano-Tex on upholstered poly back only.

For available fabrics see matrix in the back of the book or at Haworth.com/surfaces.

Improv Series

Improv H.E. Mid-Back Chair with Task Arms



M231-1442

Dimensions

SH: 16" - 21"
(406mm - 533mm)
H: 34" - 42 1/2"
(864mm - 1080mm)
D: 23" - 25 1/2"
(584mm - 648mm)
W: 25"(635mm)
SW: 19.2"(488mm)
SD: 16" - 19"
(406mm - 483mm)
AH: 9 5/8"(244mm)

Two-stage seat height:
.7"(18mm) below
standard
1.9"(48mm) above
standard

Features

- Outer Shells: Polypropylene or upholstered.
- Arms: Standard, upholstered fabric or soft black vinyl arm caps.
- Casters: Standard with hard casters; or optional soft casters.
- 3"(76mm) sliding seat pan.
- Standard plastic base or optional high arc, or steel base.
- Mechanism: Swivel with synchronized-tilt.
- Height Adjustment: Pneumatic, pneumatic with two-stage seat height, or pneumatic with low-position seat height.
- Optional Back-Lock: Lockable in two positions.
- Optional Forward Tilt: Lockable in 3 positions.
- Tilt tension.
- Optional Adjustable Air Lumbar: additional 1 1/2"(38mm) of lumbar support.
- Fire retardant construction is available to comply with California Bulletin #133.
- COM yardage / COL square footage:
Polypropylene shell: 1.50/39
Upholstered shell: 2.25/45

■ Available on RUSH with hard casters.

* All measurements taken with the BIFMA chair measuring device.

To Order, Specify:

- 1) Product number.
- 2) Fabric surface and color. (NOTE: For leather upholstery, see page 157.)
- 3) Trim color for shell, arms and base.

Shells	Arms/Caps	Number	Fabric Grade		C	D	E	F	G	H	Leather Grade A	Leather Grade B
			A	B								
Pneumatic Height Adjustment												
Polypropylene	Standard	M231-1442	\$ 887.25	\$ 953.40	\$1022.70	\$1057.35	\$1087.80	\$1148.70	\$1204.35	\$1358.70	\$1465.80	\$1624.25
	Upholstered	M231-1542	932.40	998.55	1067.85	1102.50	1132.95	1193.85	1249.50	1403.85	1510.95	1669.40
	Soft Black Vinyl	M231-1642	932.40	998.55	1067.85	1102.50	1132.95	1193.85	1249.50	1403.85	1510.95	1669.40
Upholstered	Standard	M231-2442	\$ 996.45	\$1062.60	\$1131.90	\$1166.55	\$1197.00	\$1257.90	\$1313.55	\$1467.90	\$1773.45	\$1931.90
	Upholstered	M231-2542	1041.60	1107.75	1177.05	1211.70	1242.15	1303.05	1358.70	1513.05	1818.60	1977.05
	Soft Black Vinyl	M231-2642	1041.60	1107.75	1177.05	1211.70	1242.15	1303.05	1358.70	1513.05	1818.60	1977.05
Pneumatic Height Adjustment/Back-Lock												
Polypropylene	Standard	M231-1441	\$ 932.40	\$ 998.55	\$1067.85	\$1102.50	\$1132.95	\$1193.85	\$1249.50	\$1403.85	\$1510.95	\$1669.40
	Upholstered	M231-1541	977.55	1043.70	1113.00	1147.65	1178.10	1239.00	1294.65	1449.00	1556.10	1714.55
	Soft Black Vinyl	M231-1641	977.55	1043.70	1113.00	1147.65	1178.10	1239.00	1294.65	1449.00	1556.10	1714.55
Upholstered	Standard	M231-2441	\$1041.60	\$1107.75	\$1177.05	\$1211.70	\$1242.15	\$1303.05	\$1358.70	\$1513.05	\$1818.60	\$1977.05
	Upholstered	M231-2541	1086.75	1152.90	1222.20	1256.85	1287.30	1348.20	1403.85	1558.20	1863.75	2022.20
	Soft Black Vinyl	M231-2641	1086.75	1152.90	1222.20	1256.85	1287.30	1348.20	1403.85	1558.20	1863.75	2022.20
Pneumatic Height Adjustment/Forward-Tilt												
Polypropylene	Standard	M241-1442	\$ 931.35	\$ 997.50	\$1066.80	\$1101.45	\$1131.90	\$1192.80	\$1248.45	\$1402.80	\$1509.90	\$1668.35
	Upholstered	M241-1542	976.50	1042.65	1111.95	1146.60	1177.05	1237.95	1293.60	1447.95	1555.05	1713.50
	Soft Black Vinyl	M241-1642	976.50	1042.65	1111.95	1146.60	1177.05	1237.95	1293.60	1447.95	1555.05	1713.50
Upholstered	Standard	M241-2442	\$1040.55	\$1106.70	\$1176.00	\$1210.65	\$1241.10	\$1302.00	\$1357.65	\$1512.00	\$1817.55	\$1976.00
	Upholstered	M241-2542	1085.70	1151.85	1221.15	1255.80	1286.25	1347.15	1402.80	1557.15	1862.70	2021.15
	Soft Black Vinyl	M241-2642	1085.70	1151.85	1221.15	1255.80	1286.25	1347.15	1402.80	1557.15	1862.70	2021.15

Improv Series

Improv H.E. Mid-Back Chair with Task Arms

Shells	Arms/Caps	Number	Fabric Grade								Leather Grade A	Leather Grade B
			A	B	C	D	E	F	G	H		
Pneumatic Height Adjustment with Adjustable Air Lumbar												
Polypropylene	Standard	M231-1444	\$ 996.45	\$1062.60	\$1131.90	\$1166.55	\$1197.00	\$1257.90	\$1313.55	\$1467.90	\$1575.00	\$1733.45
	Upholstered	M231-1544	1041.60	1107.75	1177.05	1211.70	1242.15	1303.05	1358.70	1513.05	1620.15	1778.60
	Soft Black Vinyl	M231-1644	1041.60	1107.75	1177.05	1211.70	1242.15	1303.05	1358.70	1513.05	1620.15	1778.60
Upholstered	Standard	M231-2444	\$1105.65	\$1171.80	\$1241.10	\$1275.75	\$1306.20	\$1367.10	\$1422.75	\$1577.10	\$1882.65	\$2041.10
	Upholstered	M231-2544	1150.80	1216.95	1286.25	1320.90	1351.35	1412.25	1467.90	1622.25	1927.80	2086.25
	Soft Black Vinyl	M231-2644	1150.80	1216.95	1286.25	1320.90	1351.35	1412.25	1467.90	1622.25	1927.80	2086.25
Pneumatic Height Adjustment/Back-Lock with Adjustable Air Lumbar												
Polypropylene	Standard	M231-1443	\$1041.60	\$1107.75	\$1177.05	\$1211.70	\$1242.15	\$1303.05	\$1358.70	\$1513.05	\$1620.15	\$1778.60
	Upholstered	M231-1543	1086.75	1152.90	1222.20	1256.85	1287.30	1348.20	1403.85	1558.20	1665.30	1823.75
	Soft Black Vinyl	M231-1643	1086.75	1152.90	1222.20	1256.85	1287.30	1348.20	1403.85	1558.20	1665.30	1823.75
Upholstered	Standard	M231-2443	\$1150.80	\$1216.95	\$1286.25	\$1320.90	\$1351.35	\$1412.25	\$1467.90	\$1622.25	\$1927.80	\$2086.25
	Upholstered	M231-2543	1195.95	1262.10	1331.40	1366.05	1396.50	1457.40	1513.05	1667.40	1972.95	2131.40
	Soft Black Vinyl	M231-2643	1195.95	1262.10	1331.40	1366.05	1396.50	1457.40	1513.05	1667.40	1972.95	2131.40
Pneumatic Height Adjustment/Forward-Tilt with Adjustable Air Lumbar												
Polypropylene	Standard	M241-1444	\$1040.55	\$1106.70	\$1176.00	\$1210.65	\$1241.10	\$1302.00	\$1357.65	\$1512.00	\$1619.10	\$1777.55
	Upholstered	M241-1544	1085.70	1151.85	1221.15	1255.80	1286.25	1347.15	1402.80	1557.15	1664.25	1822.70
	Soft Black Vinyl	M241-1644	1085.70	1151.85	1221.15	1255.80	1286.25	1347.15	1402.80	1557.15	1664.25	1822.70
Upholstered	Standard	M241-2444	\$1149.75	\$1215.90	\$1285.20	\$1319.85	\$1350.30	\$1411.20	\$1466.85	\$1621.20	\$1926.75	\$2085.20
	Upholstered	M241-2544	1194.90	1261.05	1330.35	1365.00	1395.45	1456.35	1512.00	1666.35	1971.90	2130.35
	Soft Black Vinyl	M241-2644	1194.90	1261.05	1330.35	1365.00	1395.45	1456.35	1512.00	1666.35	1971.90	2130.35

The following options require modification of the product number.

Low-position seat height - Plastic	To specify, change the 4th digit from a 1 to a 4; Example: M234-1442
Two-stage seat height- HAB	To specify, change the 4th digit from a 1 to a 3; Example: M233-1442 (add \$87.15 list)
High arc base	To specify, change the 4th digit from a 1 to a 5; Example: M235-1442
Steel base - Standard height	To specify, change the 4th digit from a 1 to a 6; Example: M236-1442
Steel base - Low height	To specify, change the 4th digit from a 1 to a 7; Example: M237-1442
Soft casters	To specify, change the 7th digit from a 4 to a 2; Example: M231-1422
Faux Leather upholstery	To specify, change the 2nd digit from a 2 to a 3; Example: M331-1442
Leather upholstery	To specify, change the 2nd digit from a 2 to a 1; Example: M131-1442
CAL 133	To specify, add -F to the end of the product number; Example: M231-2542-F (add \$101.85 list)
Nano-Tex	To specify, add -P to the end of the product number; Example: M231-1444-P (add \$33.60 list)

NOTE: CAL 133 is available on all fully upholstered models and chairs with black (TR-F) polypropylene shells backs.

High arc base available in black only.

Nano-Tex on upholstered poly back only.

For available fabrics see matrix in the back of the book or at Haworth.com/surfaces.

Improv Series

Improv H.E. Mid-Back Chair with Height Adjustable Task Arms



M231-1742

Dimensions

SH: 16" - 21"
(406mm - 533mm)
H: 34" - 42 1/2"
(864mm - 1080mm)
D: 23" - 25 1/2"
(584mm - 648mm)
W: 25"(635mm)
SW: 19.2"(488mm)
SD: 16" - 19"
(406mm - 483mm)
AH: 4.6" - 8.4"
(117mm-213mm)

Two-stage seat height:
.7"(18mm) below
standard
1.9"(48mm) above
standard

Features

- Outer Shells: Polypropylene or upholstered.
 - Arms: Standard, upholstered fabric or soft black vinyl arm caps.
 - Arm Adjustment Controls: Fingertip activation.
 - Casters: Standard with hard casters; or optional soft casters.
 - 3"(76mm) sliding seat pan.
 - Standard plastic base or optional high arc, or steel base.
 - Mechanism: Swivel with synchronized-tilt.
 - Height Adjustment: Pneumatic, pneumatic with two-stage seat height, or pneumatic with low-position seat height option.
 - Arm Adjustment: 4"(102mm) height adjustment.
 - Optional Back-Lock: Lockable in two positions.
 - Optional Forward Tilt: Lockable in 3 positions.
 - Tilt tension.
 - Optional Adjustable Air Lumbar: additional 1 1/2"(38mm) of lumbar support.
 - Fire retardant construction is available to comply with California Bulletin #133.
 - COM yardage / COL square footage:
Polypropylene shell: 1.50/39
Upholstered shell: 2.25/45
- Available on RUSH with hard casters.

To Order, Specify:

- 1) Product number.
- 2) Fabric surface and color.
(NOTE: For leather upholstery, see page 159.)
- 3) Trim color for shell, arms and base.

* All measurements taken with the BIFMA chair measuring device.

Shells	Arms/Caps	Number	Fabric Grade								Leather Grade A	Leather Grade B
			A	B	C	D	E	F	G	H		
Pneumatic Height Adjustment												
Polypropylene	Standard	M231-1742	\$ 981.75	\$1047.90	\$1117.20	\$1151.85	\$1182.30	\$1243.20	\$1298.85	\$1453.20	\$1560.30	\$1718.75
	Upholstered	M231-1842	1026.90	1093.05	1162.35	1197.00	1227.45	1288.35	1344.00	1498.35	1605.45	1763.90
	Soft Black Vinyl	M231-1942	1026.90	1093.05	1162.35	1197.00	1227.45	1288.35	1344.00	1498.35	1605.45	1763.90
Upholstered	Standard	M231-2742	\$1090.95	\$1157.10	\$1226.40	\$1261.05	\$1291.50	\$1352.40	\$1408.05	\$1562.40	\$1867.95	\$2026.40
	Upholstered	M231-2842	1136.10	1202.25	1271.55	1306.20	1336.65	1397.55	1453.20	1607.55	1913.10	2071.55
	Soft Black Vinyl	M231-2942	1136.10	1202.25	1271.55	1306.20	1336.65	1397.55	1453.20	1607.55	1913.10	2071.55
Pneumatic Height Adjustment/Back-Lock												
Polypropylene	Standard	M231-1741	\$1026.90	\$1093.05	\$1162.35	\$1197.00	\$1227.45	\$1288.35	\$1344.00	\$1498.35	\$1605.45	\$1763.90
	Upholstered	M231-1841	1072.05	1138.20	1207.50	1242.15	1272.60	1333.50	1389.15	1543.50	1650.60	1809.05
	Soft Black Vinyl	M231-1941	1072.05	1138.20	1207.50	1242.15	1272.60	1333.50	1389.15	1543.50	1650.60	1809.05
Upholstered	Standard	M231-2741	\$1136.10	\$1202.25	\$1271.55	\$1306.20	\$1336.65	\$1397.55	\$1453.20	\$1607.55	\$1913.10	\$2071.55
	Upholstered	M231-2841	1181.25	1247.40	1316.70	1351.35	1381.80	1442.70	1498.35	1652.70	1958.25	2116.70
	Soft Black Vinyl	M231-2941	1181.25	1247.40	1316.70	1351.35	1381.80	1442.70	1498.35	1652.70	1958.25	2116.70
Pneumatic Height Adjustment/Forward-Tilt												
Polypropylene	Standard	M241-1742	\$1025.85	\$1092.00	\$1161.30	\$1195.95	\$1226.40	\$1287.30	\$1342.95	\$1497.30	\$1604.40	\$1762.85
	Upholstered	M241-1842	1071.00	1137.15	1206.45	1241.10	1271.55	1332.45	1388.10	1542.45	1649.55	1808.00
	Soft Black Vinyl	M241-1942	1071.00	1137.15	1206.45	1241.10	1271.55	1332.45	1388.10	1542.45	1649.55	1808.00
Upholstered	Standard	M241-2742	\$1135.05	\$1201.20	\$1270.50	\$1305.15	\$1335.60	\$1396.50	\$1452.15	\$1606.50	\$1912.05	\$2070.50
	Upholstered	M241-2842	1180.20	1246.35	1315.65	1350.30	1380.75	1441.65	1497.30	1651.65	1957.20	2115.65
	Soft Black Vinyl	M241-2942	1180.20	1246.35	1315.65	1350.30	1380.75	1441.65	1497.30	1651.65	1957.20	2115.65

Improv Series

Improv H.E. Mid-Back Chair with Height Adjustable Task Arms

Shells	Arms/Caps	Number	Fabric Grade								Leather Grade A	Leather Grade B
			A	B	C	D	E	F	G	H		
Pneumatic Height Adjustment with Adjustable Air Lumbar												
Polypropylene	Standard	M231-1744	\$1090.95	\$1157.10	\$1226.40	\$1261.05	\$1291.50	\$1352.40	\$1408.05	\$1562.40	\$1669.50	\$1827.95
	Upholstered	M231-1844	1136.10	1202.25	1271.55	1306.20	1336.65	1397.55	1453.20	1607.55	1714.65	1873.10
	Soft Black Vinyl	M231-1944	1136.10	1202.25	1271.55	1306.20	1336.65	1397.55	1453.20	1607.55	1714.65	1873.10
Upholstered	Standard	M231-2744	\$1200.15	\$1266.30	\$1335.60	\$1370.25	\$1400.70	\$1461.60	\$1517.25	\$1671.60	\$1977.15	\$2135.60
	Upholstered	M231-2844	1245.30	1311.45	1380.75	1415.40	1445.85	1506.75	1562.40	1716.75	2022.30	2180.75
	Soft Black Vinyl	M231-2944	1245.30	1311.45	1380.75	1415.40	1445.85	1506.75	1562.40	1716.75	2022.30	2180.75
Pneumatic Height Adjustment/Back-Lock with Adjustable Air Lumbar												
Polypropylene	Standard	M231-1743	\$1136.10	\$1202.25	\$1271.55	\$1306.20	\$1336.65	\$1397.55	\$1453.20	\$1607.55	\$1714.65	\$1873.10
	Upholstered	M231-1843	1181.25	1247.40	1316.70	1351.35	1381.80	1442.70	1498.35	1652.70	1759.80	1918.25
	Soft Black Vinyl	M231-1943	1181.25	1247.40	1316.70	1351.35	1381.80	1442.70	1498.35	1652.70	1759.80	1918.25
Upholstered	Standard	M231-2743	\$1245.30	\$1311.45	\$1380.75	\$1415.40	\$1445.85	\$1506.75	\$1562.40	\$1716.75	\$2022.30	\$2180.75
	Upholstered	M231-2843	1290.45	1356.60	1425.90	1460.55	1491.00	1551.90	1607.55	1761.90	2067.45	2225.90
	Soft Black Vinyl	M231-2943	1290.45	1356.60	1425.90	1460.55	1491.00	1551.90	1607.55	1761.90	2067.45	2225.90
Pneumatic Height Adjustment/Forward-Tilt with Adjustable Air Lumbar												
Polypropylene	Standard	M241-1744	\$1135.05	\$1201.20	\$1270.50	\$1305.15	\$1335.60	\$1396.50	\$1452.15	\$1606.50	\$1713.60	\$1872.05
	Upholstered	M241-1844	1180.20	1246.35	1315.65	1350.30	1380.75	1441.65	1497.30	1651.65	1758.75	1917.20
	Soft Black Vinyl	M241-1944	1180.20	1246.35	1315.65	1350.30	1380.75	1441.65	1497.30	1651.65	1758.75	1917.20
Upholstered	Standard	M241-2744	\$1244.25	\$1310.40	\$1379.70	\$1414.35	\$1444.80	\$1505.70	\$1561.35	\$1715.70	\$2021.25	\$2179.70
	Upholstered	M241-2844	1289.40	1355.55	1424.85	1459.50	1489.95	1550.85	1606.50	1760.85	2066.40	2224.85
	Soft Black Vinyl	M241-2944	1289.40	1355.55	1424.85	1459.50	1489.95	1550.85	1606.50	1760.85	2066.40	2224.85

The following options require modification of the product number.

Low-position seat height - Plastic	To specify, change the 4th digit from a 1 to a 4; Example: M234-1742
Two-stage seat height- HAB	To specify, change the 4th digit from a 1 to a 3; Example: M233-1742 (add \$87.15 list)
High arc base	To specify, change the 4th digit from a 1 to a 5; Example: M235-1742
Steel base - Standard height	To specify, change the 4th digit from a 1 to a 6; Example: M236-1742
Steel base - Low height	To specify, change the 4th digit from a 1 to a 7; Example: M237-1742
Soft casters	To specify, change the 7th digit from a 4 to a 2; Example: M231-1722
Faux Leather upholstery	To specify, change the 2nd digit from a 2 to a 3; Example: M331-1742
Leather upholstery	To specify, change the 2nd digit from a 2 to a 1; Example: M131-1742
CAL 133	To specify, add -F to the end of the product number; Example: M231-2842-F (add \$101.85 list)
Nano-Tex	To specify, add -P to the end of the product number; Example: M231-1744-P (add \$33.60 list)

NOTE: CAL 133 is available on all fully upholstered models and chairs with black (TR-F) polypropylene shells backs.

High arc base available in black only.

Nano-Tex on upholstered poly back only.

For available fabrics see matrix in the back of the book or at Haworth.com/surfaces.

Improv Series

Improv H.E. Mid-Back Chair with Flipper Arms



M231-1H42

NOTE:
M241-1G42 offers the best value package of options for this model.

Dimensions

SH: 16" - 21"
(406mm - 533mm)
H: 34" - 42 1/2"
(864mm-1080mm)
D: 23" - 25 1/2"
(584mm - 648mm)
W: 26 1/2"(673mm)
SW: 19.2"(488mm)
SD: 16" - 19"
(406mm - 483mm)
AH: 6.2" - 11.3"
(157mm-287mm)

Two-stage seat height:
.7"(18mm) below
standard
1.9"(48mm) above
standard

Features

- Outer Shells: Polypropylene or upholstered.
- Arms: Standard, upholstered fabric or black vinyl gel arm caps.
- Arm Adjustment Controls: Fingertip activation.
- 3"(76mm) Sliding seat pan.
- Casters: Standard with hard casters; or optional soft casters.
- Standard plastic base or optional high arc, or steel base.
- Mechanism: Swivel with synchronized-tilt.
- Height Adjustment: Pneumatic, pneumatic with two-stage seat height, or pneumatic with low-position seat height option.
- Arm Adjustment: 5"(127mm) height adjustment.
- Arm Pad Rotation: 360°.
- Optional Back-Lock: Lockable in two positions.
- Optional Forward Tilt: Lockable in 3 positions.
- Tilt tension.
- Optional Adjustable Air Lumbar: additional 1 1/2"(38mm) of lumbar support.
- Fire retardant construction is available to comply with California Bulletin #133.
- COM yardage / COL square footage:
Polypropylene shell: 1.50/39
Upholstered shell: 2.25/45
- Available on RUSH with hard casters.

* All measurements taken with the BIFMA chair measuring device.

To Order, Specify:

- 1) Product number.
- 2) Fabric surface and color.
(NOTE: For leather upholstery, see page 161.)
- 3) Trim color for shell, arms and base.

Shells	Arms/Caps	Number	Fabric Grade		C	D	E	F	G	H	Leather Grade A	Leather Grade B
			A	B								
Pneumatic Height Adjustment												
Polypropylene	Standard	M231-1H42	■ \$1174.95	\$1241.10	\$1310.40	\$1345.05	\$1375.50	\$1436.40	\$1492.05	\$1646.40	\$1753.50	\$1911.95
	Vinyl Gel	M231-1G42	■ 1232.70	1298.85	1368.15	1402.80	1433.25	1494.15	1549.80	1704.15	1811.25	1969.70
	Upholstered	M231-1U42	■ 1273.65	1339.80	1409.10	1443.75	1474.20	1535.10	1590.75	1745.10	1852.20	2010.65
Upholstered	Standard	M231-2H42	■ \$1284.15	\$1350.30	\$1419.60	\$1454.25	\$1484.70	\$1545.60	\$1601.25	\$1755.60	\$2061.15	\$2219.60
	Vinyl Gel	M231-2G42	■ 1341.90	1408.05	1477.35	1512.00	1542.45	1603.35	1659.00	1813.35	2118.90	2277.35
	Upholstered	M231-2U42	■ 1382.85	1449.00	1518.30	1552.95	1583.40	1644.30	1699.95	1854.30	2159.85	2318.30
Pneumatic Height Adjustment/Back-Lock												
Polypropylene	Standard	M231-1H41	■ \$1220.10	\$1286.25	\$1355.55	\$1390.20	\$1420.65	\$1481.55	\$1537.20	\$1691.55	\$1798.65	\$1957.10
	Vinyl Gel	M231-1G41	■ 1277.85	1344.00	1413.30	1447.95	1478.40	1539.30	1594.95	1749.30	1856.40	2014.85
	Upholstered	M231-1U41	■ 1318.80	1384.95	1454.25	1488.90	1519.35	1580.25	1635.90	1790.25	1897.35	2055.80
Upholstered	Standard	M231-2H41	■ \$1329.30	\$1395.45	\$1464.75	\$1499.40	\$1529.85	\$1590.75	\$1646.40	\$1800.75	\$2106.30	\$2264.75
	Vinyl Gel	M231-2G41	■ 1387.05	1453.20	1522.50	1557.15	1587.60	1648.50	1704.15	1858.50	2164.05	2322.50
	Upholstered	M231-2U41	■ 1428.00	1494.15	1563.45	1598.10	1628.55	1689.45	1745.10	1899.45	2205.00	2363.45
Pneumatic Height Adjustment/Forward-Tilt												
Polypropylene	Standard	M241-1H42	■ \$1219.05	\$1285.20	\$1354.50	\$1389.15	\$1419.60	\$1480.50	\$1536.15	\$1690.50	\$1797.60	\$1956.05
	Vinyl Gel	M241-1G42	■ 1276.80	1342.95	1412.25	1446.90	1477.35	1538.25	1593.90	1748.25	1855.35	2013.80
	Upholstered	M241-1U42	■ 1317.75	1383.90	1453.20	1487.85	1518.30	1579.20	1634.85	1789.20	1896.30	2054.75
Upholstered	Standard	M241-2H42	■ \$1328.25	\$1394.40	\$1463.70	\$1498.35	\$1528.80	\$1589.70	\$1645.35	\$1799.70	\$2105.25	\$2263.70
	Vinyl Gel	M241-2G42	■ 1386.00	1452.15	1521.45	1556.10	1586.55	1647.45	1703.10	1857.45	2163.00	2321.45
	Upholstered	M241-2U42	■ 1426.95	1493.10	1562.40	1597.05	1627.50	1688.40	1744.05	1898.40	2203.95	2362.40

Improv Series

Improv H.E. Mid-Back Chair with Flipper Arms

Shells	Arms/Caps	Number	Fabric Grade								Leather Grade A	Leather Grade B
			A	B	C	D	E	F	G	H		
Pneumatic Height Adjustment with Adjustable Air Lumbar												
Polypropylene	Standard	M231-1H44	\$1284.15	\$1350.30	\$1419.60	\$1454.25	\$1484.70	\$1545.60	\$1601.25	\$1755.60	\$1862.70	\$2021.15
	Vinyl Gel	M231-1G44	1341.90	1408.05	1477.35	1512.00	1542.45	1603.35	1659.00	1813.35	1920.45	2078.90
	Upholstered	M231-1U44	1382.85	1449.00	1518.30	1552.95	1583.40	1644.30	1699.95	1854.30	1961.40	2119.85
Upholstered	Standard	M231-2H44	\$1393.35	\$1459.50	\$1528.80	\$1563.45	\$1593.90	\$1654.80	\$1710.45	\$1864.80	\$2170.35	\$2328.80
	Vinyl Gel	M231-2G44	1451.10	1517.25	1586.55	1621.20	1651.65	1712.55	1768.20	1922.55	2228.10	2386.55
	Upholstered	M231-2U44	1492.05	1558.20	1627.50	1662.15	1692.60	1753.50	1809.15	1963.50	2269.05	2427.50
Pneumatic Height Adjustment/Back-Lock with Adjustable Air Lumbar												
Polypropylene	Standard	M231-1H43	\$1329.30	\$1395.45	\$1464.75	\$1499.40	\$1529.85	\$1590.75	\$1646.40	\$1800.75	\$1907.85	\$2066.30
	Vinyl Gel	M231-1G43	1387.05	1453.20	1522.50	1557.15	1587.60	1648.50	1704.15	1858.50	1965.60	2124.05
	Upholstered	M231-1U43	1428.00	1494.15	1563.45	1598.10	1628.55	1689.45	1745.10	1899.45	2006.55	2165.00
Upholstered	Standard	M231-2H43	\$1438.50	\$1504.65	\$1573.95	\$1608.60	\$1639.05	\$1699.95	\$1755.60	\$1909.95	\$2215.50	\$2373.95
	Vinyl Gel	M231-2G43	1496.25	1562.40	1631.70	1666.35	1696.80	1757.70	1813.35	1967.70	2273.25	2431.70
	Upholstered	M231-2U43	1537.20	1603.35	1672.65	1707.30	1737.75	1798.65	1854.30	2008.65	2314.20	2472.65
Pneumatic Height Adjustment/Forward-Tilt with Adjustable Air Lumbar												
Polypropylene	Standard	M241-1H44	\$1328.25	\$1394.40	\$1463.70	\$1498.35	\$1528.80	\$1589.70	\$1645.35	\$1799.70	\$1906.80	\$2065.25
	Vinyl Gel	M241-1G44	1386.00	1452.15	1521.45	1556.10	1586.55	1647.45	1703.10	1857.45	1964.55	2123.00
	Upholstered	M241-1U44	1426.95	1493.10	1562.40	1597.05	1627.50	1688.40	1744.05	1898.40	2005.50	2163.95
Upholstered	Standard	M241-2H44	\$1437.45	\$1503.60	\$1572.90	\$1607.55	\$1638.00	\$1698.90	\$1754.55	\$1908.90	\$2214.45	\$2372.90
	Vinyl Gel	M241-2G44	1495.20	1561.35	1630.65	1665.30	1695.75	1756.65	1812.30	1966.65	2272.20	2430.65
	Upholstered	M241-2U44	1536.15	1602.30	1671.60	1706.25	1736.70	1797.60	1853.25	2007.60	2313.15	2471.60

The following options require modification of the product number.

Low-position seat height - Plastic	To specify, change the 4th digit from a 1 to a 4; Example: M234-1H42
Two-stage seat height- HAB	To specify, change the 4th digit from a 1 to a 3; Example: M233-1H42 (add \$87.15 list)
High arc base	To specify, change the 4th digit from a 1 to a 5; Example: M235-1H42
Steel base - Standard height	To specify, change the 4th digit from a 1 to a 6; Example: M236-1H42
Steel base - Low height	To specify, change the 4th digit from a 1 to a 7; Example: M237-1H42
Soft casters	To specify, change the 7th digit from a 4 to a 2; Example: M231-1H22
Faux Leather upholstery	To specify, change the 2nd digit from a 2 to a 3; Example: M331-1H42
Leather upholstery	To specify, change the 2nd digit from a 2 to a 1; Example: M131-1H42
CAL 133	To specify, add -F to the end of the product number; Example: M231-1H42-F (add \$101.85 list)
Nano-Tex	To specify, add -P to the end of the product number; Example: M231-1H44-P (add \$33.60 list)

NOTE: CAL 133 is available on all fully upholstered models and chairs with black (TR-F) polypropylene shells backs.

CAL 133 is not available on chairs with vinyl gel arm caps.

High arc base available in black only.

Nano-Tex on upholstered poly back only.

For available fabrics see matrix in the back of the book or at Haworth.com/surfaces.

Improv Series

Improv H.E. Mid-Back Chair with Height and Width Adjustable 3-D Arms



M231-1W42

Dimensions

- SH: 16" - 21"
(406mm - 533mm)
- H: 34" - 42 1/2"
(864mm - 1080mm)
- D: 23" - 25 1/2"
(584mm - 648mm)
- W: 25"(635mm)
- SW: 19.2"(488mm)
- SD: 16" - 19"
(406mm - 483mm)
- AH: 3 3/4" - 7 3/4"
(95mm-197mm)
- AW: 25 1/2" - 29 1/4"
(648mm-743mm)

Two-stage seat height:
.7"(18mm) below
standard
1.9"(48mm) above
standard

Features

- Outer Shells: Polypropylene or upholstered.
- Arms: Molded black vinyl.
- 3"(76mm) Sliding seat pan.
- Casters: Standard with hard casters; or optional soft casters, see below.
- Standard plastic base or optional high arc, or steel base.
- Mechanism: Swivel with synchronized-tilt.
- Height Adjustment: Pneumatic, pneumatic with two-stage seat height, or pneumatic with low-position seat height option.
- Arm Adjustment: 4"(102mm) height adjustment.
- Arm Width Adjustment: 1 1/2"(38mm) each arm in-out adjustment.
- Arm Pad Rotation: 360°.
- Arm Adjustment Controls: Fingertip activation.
- Optional Back-Lock: Lockable in two positions.
- Optional Forward Tilt: Lockable in 3 positions.
- Tilt tension.
- Optional Adjustable Air Lumbar: additional 1 1/2"(38mm) of lumbar support.
- COM yardage / COL square footage:
Polypropylene shell: 1.50/39
Upholstered shell: 2.25/45

To Order, Specify:

- 1) Product number.
- 2) Fabric surface and color.
(NOTE: For leather upholstery, see below.)
- 3) Trim color for shell, arms and base.

* All measurements taken with the BIFMA chair measuring device.

Shells	Arms/Caps	Number	Fabric Grade								Leather Grade A	Leather Grade B
			A	B	C	D	E	F	G	H		
Pneumatic Height Adjustment												
Polypropylene	Molded Black Vinyl	M231-1W42	\$1098.30	\$1164.45	\$1233.75	\$1268.40	\$1298.85	\$1359.75	\$1415.40	\$1569.75	\$1676.85	\$1835.30
Upholstered	Molded Black Vinyl	M231-2W42	1207.50	1273.65	1342.95	1377.60	1408.05	1468.95	1524.60	1678.95	1984.50	2142.95
Pneumatic Height Adjustment/Back-Lock												
Polypropylene	Molded Black Vinyl	M231-1W41	\$1143.45	\$1209.60	\$1278.90	\$1313.55	\$1344.00	\$1404.90	\$1460.55	\$1614.90	\$1722.00	\$1880.45
Upholstered	Molded Black Vinyl	M231-2W41	1252.65	1318.80	1388.10	1422.75	1453.20	1514.10	1569.75	1724.10	2029.65	2188.10
Pneumatic Height Adjustment/Forward-Tilt												
Polypropylene	Molded Black Vinyl	M241-1W42	\$1142.40	\$1208.55	\$1277.85	\$1312.50	\$1342.95	\$1403.85	\$1459.50	\$1613.85	\$1720.95	\$1879.40
Upholstered	Molded Black Vinyl	M241-2W42	1251.60	1317.75	1387.05	1421.70	1452.15	1513.05	1568.70	1723.05	2028.60	2187.05
Pneumatic Height Adjustment with Adjustable Air Lumbar												
Polypropylene	Molded Black Vinyl	M231-1W44	\$1207.50	\$1273.65	\$1342.95	\$1377.60	\$1408.05	\$1468.95	\$1524.60	\$1678.95	\$1786.05	\$1944.50
Upholstered	Molded Black Vinyl	M231-2W44	1316.70	1382.85	1452.15	1486.80	1517.25	1578.15	1633.80	1788.15	2093.70	2252.15
Pneumatic Height Adjustment/Back-Lock with Adjustable Air Lumbar												
Polypropylene	Molded Black Vinyl	M231-1W43	\$1252.65	\$1318.80	\$1388.10	\$1422.75	\$1453.20	\$1514.10	\$1569.75	\$1724.10	\$1831.20	\$1989.65
Upholstered	Molded Black Vinyl	M231-2W43	1361.85	1428.00	1497.30	1531.95	1562.40	1623.30	1678.95	1833.30	2138.85	2297.30
Pneumatic Height Adjustment/Forward-Tilt with Adjustable Air Lumbar												
Polypropylene	Molded Black Vinyl	M241-1W44	\$1251.60	\$1317.75	\$1387.05	\$1421.70	\$1452.15	\$1513.05	\$1568.70	\$1723.05	\$1830.15	\$1988.60
Upholstered	Molded Black Vinyl	M241-2W44	1360.80	1426.95	1496.25	1530.90	1561.35	1622.25	1677.90	1832.25	2137.80	2296.25

The following options require modification of the product number.

- Low-position seat height - Plastic
- Two-stage seat height- HAB
- High arc base
- Steel base - Standard height
- Steel base - Low height
- Soft casters
- Faux Leather upholstery
- Leather upholstery
- CAL 133
- Nano-Tex

- To specify, change the 4th digit from a 1 to a 4; **Example:** M234-1W42
- To specify, change the 4th digit from a 1 to a 3; **Example:** M233-1W42 (add \$87.15 list)
- To specify, change the 4th digit from a 1 to a 5; **Example:** M235-1W42
- To specify, change the 4th digit from a 1 to a 6; **Example:** M236-1W42
- To specify, change the 4th digit from a 1 to a 7; **Example:** M237-1W42
- To specify, change the 7th digit from a 4 to a 2; **Example:** M231-1W22
- To specify, change the 2nd digit from a 2 to a 3; **Example:** M331-1W42
- To specify, change the 2nd digit from a 2 to a 1; **Example:** M131-1W42
- To specify, add **-F** to the end of the product number; **Example:** M231-2W42-F (add \$101.85 list)
- To specify, add **-P** to the end of the product number; **Example:** M231-1W42-P (add \$33.60 list)

NOTE: CAL 133 is available on all fully upholstered models and chairs with black (TR-F) polypropylene shells backs.

High arc base available in black only.

Nano-Tex on upholstered poly back only.

For available fabrics see matrix in the back of the book or at Haworth.com/surfaces.

Improv Series

Improv H.E. Mid-Back Chair without Arms

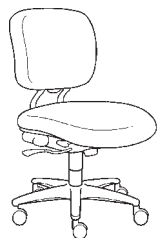

M231-1042

Dimensions

- SH: 16" - 21"
(406mm - 533mm)
- H: 34" - 42 1/2"
(864mm - 1080mm)
- D: 23" - 25 1/2"
(584mm - 648mm)
- W: 26 1/2"(673mm)
- SW: 19.2"(488mm)
- SD: 16" - 19"
(406mm - 483mm)

Two-stage seat height:
.7"(18mm) below standard
1.9"(48mm) above standard

Features

- Outer Shells: Polypropylene or upholstered.
- 3"(76mm) Sliding seat pan.
- Casters: Standard with hard casters; or optional soft casters, see below.
- Standard plastic base or optional high arc, or steel base.
- Mechanism: Swivel with synchronized-tilt.
- Height Adjustment: Pneumatic, pneumatic with two-stage seat height, or pneumatic with low-position seat height option.
- Optional Back-Lock: Lockable in two positions.
- Optional Forward Tilt: Lockable in 3 positions.
- Tilt tension.
- Optional Adjustable Air Lumbar models available: additional 1 1/2"(38mm) of lumbar support.
- Fire retardant construction is available to comply with California Bulletin #133, see below.
- COM yardage / COL square footage:
Polypropylene shell: 1.50/39
Upholstered shell: 2.25/45
- Available on RUSH with hard casters.

To Order, Specify:

- 1) Product number.
- 2) Fabric surface and color. (NOTE: For leather upholstery, see below.)
- 3) Trim color for shell and base.

* All measurements taken with the BIFMA chair measuring device.

Shells	Number	Fabric Grade		C	D	E	F	G	H	Leather Grade A	Leather Grade B
		A	B								
Pneumatic Height Adjustment											
Polypropylene	M231-1042 ■	\$ 799.05	\$ 865.20	\$ 934.50	\$ 969.15	\$ 999.60	\$1060.50	\$1116.15	\$1270.50	\$1377.60	\$1536.05
Upholstered	M231-2042 ■	908.25	974.40	1043.70	1078.35	1108.80	1169.70	1225.35	1379.70	1685.25	1843.70
Pneumatic Height Adjustment/Back-Lock											
Polypropylene	M231-1041 ■	\$ 844.20	\$ 910.35	\$ 979.65	\$1014.30	\$1044.75	\$1105.65	\$1161.30	\$1315.65	\$1422.75	\$1581.20
Upholstered	M231-2041 ■	953.40	1019.55	1088.85	1123.50	1153.95	1214.85	1270.50	1424.85	1730.40	1888.85
Pneumatic Height Adjustment/Forward-Tilt											
Polypropylene	M241-1042 ■	\$ 843.15	\$ 909.30	\$ 978.60	\$1013.25	\$1043.70	\$1104.60	\$1160.25	\$1314.60	\$1421.70	\$1580.15
Upholstered	M241-2042 ■	952.35	1018.50	1087.80	1122.45	1152.90	1213.80	1269.45	1423.80	1729.35	1887.80
Pneumatic Height Adjustment with Adjustable Lumbar											
Polypropylene	M231-1044	\$ 908.25	\$ 974.40	\$1043.70	\$1078.35	\$1108.80	\$1169.70	\$1225.35	\$1379.70	\$1486.80	\$1645.25
Upholstered	M231-2044	1017.45	1083.60	1152.90	1187.55	1218.00	1278.90	1334.55	1488.90	1794.45	1952.90
Pneumatic Height Adjustment/Back-Lock with Adjustable Air Lumbar											
Polypropylene	M231-1043	\$ 953.40	\$1019.55	\$1088.85	\$1123.50	\$1153.95	\$1214.85	\$1270.50	\$1424.85	\$1531.95	\$1690.40
Upholstered	M231-2043	1062.60	1128.75	1198.05	1232.70	1263.15	1324.05	1379.70	1534.05	1839.60	1998.05
Pneumatic Height Adjustment/Forward-Tilt with Adjustable Air Lumbar											
Polypropylene	M241-1044	\$ 952.35	\$1018.50	\$1087.80	\$1122.45	\$1152.90	\$1213.80	\$1269.45	\$1423.80	\$1530.90	\$1689.35
Upholstered	M241-2044	1061.55	1127.70	1197.00	1231.65	1262.10	1323.00	1378.65	1533.00	1838.55	1997.00

The following options require modification of the product number.

- Low-position seat height - Plastic To specify, change the 4th digit from a 1 to a 4; **Example:** M234-1042
- Two-stage seat height- HAB To specify, change the 4th digit from a 1 to a 3; **Example:** M233-1042 (add \$87.15 list)
- High arc base To specify, change the 4th digit from a 1 to a 5; **Example:** M235-1042
- Steel base - Standard height To specify, change the 4th digit from a 1 to a 6; **Example:** M236-1042
- Steel base - Low height To specify, change the 4th digit from a 1 to a 7; **Example:** M237-1042
- Soft casters To specify, change the 7th digit from a 4 to a 2; **Example:** M231-1022
- Faux Leather upholstery To specify, change the 2nd digit from a 2 to a 3; **Example:** M331-1042
- Leather upholstery To specify, change the 2nd digit from a 2 to a 1; **Example:** M131-1042
- CAL 133 To specify, add **-F** to the end of the product number; **Example:** M231-2042-F (add \$101.85 list)
- Nano-Tex To specify, add **-P** to the end of the product number; **Example:** M231-1042-P (add \$33.60 list)

NOTE: CAL 133 is available on all fully upholstered models and chairs with black (TR-F) polypropylene shells backs.

High arc base available in black only.

Nano-Tex on upholstered poly back only.

For available fabrics see matrix in the back of the book or at Haworth.com/surfaces.

Improv Series

Improv H.E. Stool with Task Arms



M2E1-1442

Dimensions

SH: 24" - 32"
(610mm - 813mm)
H: 42" - 54"
(1067mm - 1372mm)
D: 23" - 25 1/2"
(584mm - 648mm)
W: 25"(635mm)
SW: 19.2"(488mm)
SD: 18"(459mm)
AH: 9.6"(244mm)

Features

- Outer Shells: Polypropylene or upholstered.
- Arms: Standard, upholstered fabric or soft black vinyl arm caps.
- Casters: Standard with hard casters; or optional soft casters or glides.
- Mechanism: Swivel with synchronized-tilt.
- Height Adjustment: Pneumatic
- Optional Back-Lock: Lockable in two positions.
- Tilt tension.
- Optional Adjustable Air Lumbar: additional 1 1/2"(38mm) of lumbar support.
- Forward tilt not available on stools.
- Seat pan can be manually adjusted 3"(76mm).
Foot ring adjustment: 6 1/2" - 15"
(165mm - 381mm).
- Foot ring available in chrome only; ring support will match base color.
- Fire retardant construction is available to comply with California Bulletin #133.
- COM yardage / COL square footage:
Polypropylene shell: 1.75/39
Upholstered shell: 2.25/45

To Order, Specify:

- 1) Product number.
- 2) Fabric surface and color.
(NOTE: For leather upholstery, see page 165.)
- 3) Trim color for shell, arms and base.

* All measurements taken with the BIFMA chair measuring device.

Shells	Arms/Caps	Number	Fabric Grade								Leather Grade A	Leather Grade B
			A	B	C	D	E	F	G	H		
Pneumatic Height Adjustment												
Polypropylene	Standard	M2E1-1442	\$1361.85	\$1428.00	\$1497.30	\$1531.95	\$1562.40	\$1623.30	\$1678.95	\$1833.30	\$1940.40	\$2098.85
	Upholstered	M2E1-1542	1407.00	1473.15	1542.45	1577.10	1607.55	1668.45	1724.10	1878.45	1985.55	2144.00
	Soft Black Vinyl	M2E1-1642	1407.00	1473.15	1542.45	1577.10	1607.55	1668.45	1724.10	1878.45	1985.55	2144.00
Upholstered	Standard	M2E1-2442	\$1471.05	\$1537.20	\$1606.50	\$1641.15	\$1671.60	\$1732.50	\$1788.15	\$1942.50	\$2248.05	\$2406.50
	Upholstered	M2E1-2542	1516.20	1582.35	1651.65	1686.30	1716.75	1777.65	1833.30	1987.65	2293.20	2451.65
	Soft Black Vinyl	M2E1-2642	1516.20	1582.35	1651.65	1686.30	1716.75	1777.65	1833.30	1987.65	2293.20	2451.65
Pneumatic Height Adjustment/Back-Lock												
Polypropylene	Standard	M2E1-1441	\$1407.00	\$1473.15	\$1542.45	\$1577.10	\$1607.55	\$1668.45	\$1724.10	\$1878.45	\$1985.55	\$2144.00
	Upholstered	M2E1-1541	1452.15	1518.30	1587.60	1622.25	1652.70	1713.60	1769.25	1923.60	2030.70	2189.15
	Soft Black Vinyl	M2E1-1641	1452.15	1518.30	1587.60	1622.25	1652.70	1713.60	1769.25	1923.60	2030.70	2189.15
Upholstered	Standard	M2E1-2441	\$1516.20	\$1582.35	\$1651.65	\$1686.30	\$1716.75	\$1777.65	\$1833.30	\$1987.65	\$2293.20	\$2451.65
	Upholstered	M2E1-2541	1478.00	1561.35	1627.50	1696.80	1731.45	1761.90	1822.80	1878.45	2032.80	2338.35
	Soft Black Vinyl	M2E1-2641	1478.00	1561.35	1627.50	1696.80	1731.45	1761.90	1822.80	1878.45	2032.80	2338.35

Improv Series

Improv H.E. Stool with Task Arms

Shells	Arms/Caps	Number	Fabric Grade								Leather Grade A	Leather Grade B
			A	B	C	D	E	F	G	H		
Pneumatic Height Adjustment with Adjustable Air Lumbar												
Polypropylene	Standard	M2E1-1444	\$1471.05	\$1537.20	\$1606.50	\$1641.15	\$1671.60	\$1732.50	\$1788.15	\$1942.50	\$2049.60	\$2208.05
	Upholstered	M2E1-1544	1516.20	1582.35	1651.65	1686.30	1716.75	1777.65	1833.30	1987.65	2094.75	2253.20
	Soft Black Vinyl	M2E1-1644	1516.20	1582.35	1651.65	1686.30	1716.75	1777.65	1833.30	1987.65	2094.75	2253.20
Upholstered	Standard	M2E1-2444	\$1580.25	\$1646.40	\$1715.70	\$1750.35	\$1780.80	\$1841.70	\$1897.35	\$2051.70	\$2357.25	\$2515.70
	Upholstered	M2E1-2544	1625.40	1691.55	1760.85	1795.50	1825.95	1886.85	1942.50	2096.85	2402.40	2560.85
	Soft Black Vinyl	M2E1-2644	1625.40	1691.55	1760.85	1795.50	1825.95	1886.85	1942.50	2096.85	2402.40	2560.85
Pneumatic Height Adjustment/Back-Lock with Adjustable Air Lumbar												
Polypropylene	Standard	M2E1-1443	\$1516.20	\$1582.35	\$1651.65	\$1686.30	\$1716.75	\$1777.65	\$1833.30	\$1987.65	\$2094.75	\$2253.20
	Upholstered	M2E1-1543	1561.35	1627.50	1696.80	1731.45	1761.90	1822.80	1878.45	2032.80	2139.90	2298.35
	Soft Black Vinyl	M2E1-1643	1561.35	1627.50	1696.80	1731.45	1761.90	1822.80	1878.45	2032.80	2139.90	2298.35
Upholstered	Standard	M2E1-2443	\$1625.40	\$1691.55	\$1760.85	\$1795.50	\$1825.95	\$1886.85	\$1942.50	\$2096.85	\$2402.40	\$2560.85
	Upholstered	M2E1-2543	1670.55	1736.70	1806.00	1840.65	1871.10	1932.00	1987.65	2142.00	2447.55	2606.00
	Soft Black Vinyl	M2E1-2643	1670.55	1736.70	1806.00	1840.65	1871.10	1932.00	1987.65	2142.00	2447.55	2606.00

The following options require modification of the product number.

Glides

To specify, change the 7th digit from a 4 to a 0; **Example:** M2E1-1402

Soft casters

To specify, change the 7th digit from a 4 to a 2; **Example:** M2E1-1422

Faux Leather upholstery

To specify, change the 2nd digit from a 2 to a 3; **Example:** M3E1-1442

Leather upholstery

To specify, change the 2nd digit from a 2 to a 1; **Example:** M1E1-1442

CAL 133

To specify, add **-F** to the end of the product number; **Example:** M2E1-2542-F (add **\$101.85** list)

Nano-Tex

To specify, add **-P** to the end of the product number; **Example:** M2E1-1444-P (add **\$33.60** list)

NOTE: CAL 133 is available on all fully upholstered models and chairs with black (TR-F) polypropylene shells backs.

Nano-Tex on upholstered poly back only.

For available fabrics see matrix in the back of the book or at Haworth.com/surfaces.

Improv Series

Improv H.E. Stool with Height Adjustable Task Arms



M2E1-1742

Dimensions

SH: 24" - 32"
(610mm - 813mm)
H: 42" - 54"
(1067mm - 1372mm)
D: 23" - 25 1/2"
(584mm - 648mm)
W: 25"(635mm)
SW: 19.2"(488mm)
SD: 18"(458mm)
AH: 6.9" - 10.8"
(175mm - 274mm)

Features

- Outer Shells: Polypropylene or upholstered.
- Arms: Standard, upholstered fabric or soft black vinyl arm caps.
- Arm Adjustment Controls: Fingertip activation.
- Standard with hard casters; or optional soft casters or glides.
- Mechanism: Swivel with synchronized-tilt.
- Height Adjustment: Pneumatic
- Arm Adjustment: 5"(127mm) height adjustment.
- Optional Back-Lock: Lockable in two positions.
- Tilt tension.
- Optional Adjustable Air Lumbar: additional 1 1/2"(38mm) of lumbar support.
- Forward tilt not available on stools.
- Seat pan can be manually adjusted 3"(76mm).
- Foot ring adjustment: 6 1/2" - 15" (165mm - 381mm).
- Foot ring available in chrome only; ring support will match base color.
- Fire retardant construction is available to comply with California Bulletin #133.
- COM yardage / COL square footage:
Polypropylene shell: 1.75/39
Upholstered shell: 2.25/45

* All measurements taken with the BIFMA chair measuring device.

To Order, Specify:

- 1) Product number.
- 2) Fabric surface and color.
(NOTE: For leather upholstery, see page 167.)
- 3) Trim color for shell, arms and base.

Shells	Arms/Caps	Number	Fabric Grade		C	D	E	F	G	H	Leather Grade A	Leather Grade B
			A	B								
Pneumatic Height Adjustment												
Polypropylene	Standard	M2E1-1742	\$1456.35	\$1522.50	\$1591.80	\$1626.45	\$1656.90	\$1717.80	\$1773.45	\$1927.80	\$2034.90	\$2193.35
	Upholstered	M2E1-1842	1501.50	1567.65	1636.95	1671.60	1702.05	1762.95	1818.60	1972.95	2080.05	2238.50
	Soft Black Vinyl	M2E1-1942	1501.50	1567.65	1636.95	1671.60	1702.05	1762.95	1818.60	1972.95	2080.05	2238.50
Upholstered	Standard	M2E1-2742	\$1565.55	\$1631.70	\$1701.00	\$1735.65	\$1766.10	\$1827.00	\$1882.65	\$2037.00	\$2342.55	\$2501.00
	Upholstered	M2E1-2842	1610.70	1676.85	1746.15	1780.80	1811.25	1872.15	1927.80	2082.15	2387.70	2546.15
	Soft Black Vinyl	M2E1-2942	1610.70	1676.85	1746.15	1780.80	1811.25	1872.15	1927.80	2082.15	2387.70	2546.15
Pneumatic Height Adjustment/Back-Lock												
Polypropylene	Standard	M2E1-1741	\$1501.50	\$1567.65	\$1636.95	\$1671.60	\$1702.05	\$1762.95	\$1818.60	\$1972.95	\$2080.05	\$2238.50
	Upholstered	M2E1-1841	1546.65	1612.80	1682.10	1716.75	1747.20	1808.10	1863.75	2018.10	2125.20	2283.65
	Soft Black Vinyl	M2E1-1941	1546.65	1612.80	1682.10	1716.75	1747.20	1808.10	1863.75	2018.10	2125.20	2283.65
Upholstered	Standard	M2E1-2741	\$1610.70	\$1676.85	\$1746.15	\$1780.80	\$1811.25	\$1872.15	\$1927.80	\$2082.15	\$2387.70	\$2546.15
	Upholstered	M2E1-2841	1655.85	1722.00	1791.30	1825.95	1856.40	1917.30	1972.95	2127.30	2432.85	2591.30
	Soft Black Vinyl	M2E1-2941	1655.85	1722.00	1791.30	1825.95	1856.40	1917.30	1972.95	2127.30	2432.85	2591.30

Improv Series

Improv H.E. Stool with Height Adjustable Task Arms

Shells	Arms/Caps	Number	Fabric Grade								Leather Grade A	Leather Grade B
			A	B	C	D	E	F	G	H		
Pneumatic Height Adjustment with Adjustable Air Lumbar												
Polypropylene	Standard	M2E1-1744	\$1565.55	\$1631.70	\$1701.00	\$1735.65	\$1766.10	\$1827.00	\$1882.65	\$2037.00	\$2144.10	\$2302.55
	Upholstered	M2E1-1844	1610.70	1676.85	1746.15	1780.80	1811.25	1872.15	1927.80	2082.15	2189.25	2347.70
	Soft Black Vinyl	M2E1-1944	1610.70	1676.85	1746.15	1780.80	1811.25	1872.15	1927.80	2082.15	2189.25	2347.70
Upholstered	Standard	M2E1-2744	\$1674.75	\$1740.90	\$1810.20	\$1844.85	\$1875.30	\$1936.20	\$1991.85	\$2146.20	\$2451.75	\$2610.20
	Upholstered	M2E1-2844	1719.90	1786.05	1855.35	1890.00	1920.45	1981.35	2037.00	2191.35	2496.90	2655.35
	Soft Black Vinyl	M2E1-2944	1719.90	1786.05	1855.35	1890.00	1920.45	1981.35	2037.00	2191.35	2496.90	2655.35
Pneumatic Height Adjustment/Back-Lock with Adjustable Air Lumbar												
Polypropylene	Standard	M2E1-1743	\$1610.70	\$1676.85	\$1746.15	\$1780.80	\$1811.25	\$1872.15	\$1927.80	\$2082.15	\$2189.25	\$2347.70
	Upholstered	M2E1-1843	1655.85	1722.00	1791.30	1825.95	1856.40	1917.30	1972.95	2127.30	2234.40	2392.85
	Soft Black Vinyl	M2E1-1943	1655.85	1722.00	1791.30	1825.95	1856.40	1917.30	1972.95	2127.30	2234.40	2392.85
Upholstered	Standard	M2E1-2743	\$1719.90	\$1786.05	\$1855.35	\$1890.00	\$1920.45	\$1981.35	\$2037.00	\$2191.35	\$2496.90	\$2655.35
	Upholstered	M2E1-2843	1765.05	1831.20	1900.50	1935.15	1965.60	2026.50	2082.15	2236.50	2542.05	2700.50
	Soft Black Vinyl	M2E1-2943	1765.05	1831.20	1900.50	1935.15	1965.60	2026.50	2082.15	2236.50	2542.05	2700.50

The following options require modification of the product number.

Glides

To specify, change the 7th digit from a 4 to a 0; **Example:** M2E1-1702

Soft casters

To specify, change the 7th digit from a 4 to a 2; **Example:** M2E1-1722

Faux Leather upholstery

To specify, change the 2nd digit from a 2 to a 3; **Example:** M3E1-1742

Leather upholstery

To specify, change the 2nd digit from a 2 to a 1; **Example:** M1E1-1742

CAL 133

To specify, add **-F** to the end of the product number; **Example:** M2E1-2842-F (add **\$101.85** list)

Nano-Tex

To specify, add **-P** to the end of the product number; **Example:** M2E1-1744-P (add **\$33.60** list)

NOTE: CAL 133 is available on all fully upholstered models and chairs with black (TR-F) polypropylene shells backs.

Nano-Tex on upholstered poly back only.

For available fabrics see matrix in the back of the book or at Haworth.com/surfaces.

Improv Series

Improv H.E. Stool with Flipper Arms



M2E1-1H42

Dimensions

SH: 24" - 32"
(610mm - 813mm)
H: 42" - 54"
(1067mm - 1372mm)
D: 23" - 25 1/2"
(584mm - 648mm)
W: 26 1/2"(673mm)
SW: 19.2"(488mm)
SD: 18"(458mm)
AH: 6.2" - 11.3"
(157mm - 282mm)

Features

- Outer Shells: Polypropylene or upholstered.
- Arms: Standard, upholstered fabric or black vinyl arm caps.
- Arm Adjustment Controls: Fingertip activation.
- Arm Adjustment: 5"(127mm) height adjustment, 360° rotation.
- Standard with hard casters; or optional soft casters or glides.
- Mechanism: Swivel with synchronized-tilt.
- Height Adjustment: Pneumatic.
- Optional Back-Lock: Lockable in two positions.
- Tilt tension.
- Optional Adjustable Air Lumbar: additional 1 1/2"(38mm) of lumbar support.
- Forward tilt not available on stools.
- Seat pan can be manually adjusted 3"(76mm).
- Foot ring adjustment: 6 1/2" - 15" (165mm - 381mm).
- Foot ring available in chrome only; ring support will match base color.
- Fire retardant construction is available to comply with California Bulletin #133.
- COM yardage / COL square footage:
Polypropylene shell: 1.75/39
Upholstered shell: 2.25/45

* All measurements taken with the BIFMA chair measuring device.

To Order, Specify:

- 1) Product number.
- 2) Fabric surface and color.
(NOTE: For leather upholstery, see page 169.)
- 3) Trim color for shell, arms and base.

Shells	Arms/Caps	Number	Fabric Grade		C	D	E	F	G	H	Leather Grade A	Leather Grade B
			A	B								
Pneumatic Height Adjustment												
Polypropylene	Standard	M2E1-1H42	\$1649.55	\$1715.70	\$1785.00	\$1819.65	\$1850.10	\$1911.00	\$1966.65	\$2121.00	\$2228.10	\$2386.55
	Vinyl Gel	M2E1-1G42	1707.30	1773.45	1842.75	1877.40	1907.85	1968.75	2024.40	2178.75	2285.85	2444.30
	Upholstered	M2E1-1U42	1748.25	1814.40	1883.70	1918.35	1948.80	2009.70	2065.35	2219.70	2326.80	2485.25
Upholstered	Standard	M2E1-2H42	\$1758.75	\$1824.90	\$1894.20	\$1928.85	\$1959.30	\$2020.20	\$2075.85	\$2230.20	\$2535.75	\$2694.20
	Vinyl Gel	M2E1-2G42	1816.50	1882.65	1951.95	1986.60	2017.05	2077.95	2133.60	2287.95	2593.50	2751.95
	Upholstered	M2E1-2U42	1857.45	1923.60	1992.90	2027.55	2058.00	2118.90	2174.55	2328.90	2634.45	2792.90
Pneumatic Height Adjustment/Back-Lock												
Polypropylene	Standard	M2E1-1H41	\$1694.70	\$1760.85	\$1830.15	\$1864.80	\$1895.25	\$1956.15	\$2011.80	\$2166.15	\$2273.25	\$2431.70
	Vinyl Gel	M2E1-1G41	1752.45	1818.60	1887.90	1922.55	1953.00	2013.90	2069.55	2223.90	2331.00	2489.45
	Upholstered	M2E1-1U41	1793.40	1859.55	1928.85	1963.50	1993.95	2054.85	2110.50	2264.85	2371.95	2530.40
Upholstered	Standard	M2E1-2H41	\$1803.90	\$1870.05	\$1939.35	\$1974.00	\$2004.45	\$2065.35	\$2121.00	\$2275.35	\$2580.90	\$2739.35
	Vinyl Gel	M2E1-2G41	1861.65	1927.80	1997.10	2031.75	2062.20	2123.10	2178.75	2333.10	2638.65	2797.10
	Upholstered	M2E1-2U41	1902.60	1968.75	2038.05	2072.70	2103.15	2164.05	2219.70	2374.05	2679.60	2838.05

Improv Series

Improv H.E. Stool with Flipper Arms

Shells	Arms/Caps	Number	Fabric Grade								Leather Grade A	Leather Grade B
			A	B	C	D	E	F	G	H		
Pneumatic Height Adjustment with Adjustable Air Lumbar												
Polypropylene	Standard	M2E1-1H44	\$1758.75	\$1824.90	\$1894.20	\$1928.85	\$1959.30	\$2020.20	\$2075.85	\$2230.20	\$2337.30	\$2495.75
	Vinyl Gel	M2E1-1G44	1816.50	1882.65	1951.95	1986.60	2017.05	2077.95	2133.60	2287.95	2395.05	2553.50
	Upholstered	M2E1-1U44	1857.45	1923.60	1992.90	2027.55	2058.00	2118.90	2174.55	2328.90	2436.00	2594.45
Upholstered	Standard	M2E1-2H44	\$1867.95	\$1934.10	\$2003.40	\$2038.05	\$2068.50	\$2129.40	\$2185.05	\$2339.40	\$2644.95	\$2803.40
	Vinyl Gel	M2E1-2G44	1925.70	1991.85	2061.15	2095.80	2126.25	2187.15	2242.80	2397.15	2702.70	2861.15
	Upholstered	M2E1-2U44	1966.65	2032.80	2102.10	2136.75	2167.20	2228.10	2283.75	2438.10	2743.65	2902.10
Pneumatic Height Adjustment/Back-Lock with Adjustable Air Lumbar												
Polypropylene	Standard	M2E1-1H43	\$1803.90	\$1870.05	\$1939.35	\$1974.00	\$2004.45	\$2065.35	\$2121.00	\$2275.35	\$2382.45	\$2540.90
	Vinyl Gel	M2E1-1G43	1861.65	1927.80	1997.10	2031.75	2062.20	2123.10	2178.75	2333.10	2440.20	2598.65
	Upholstered	M2E1-1U43	1902.60	1968.75	2038.05	2072.70	2103.15	2164.05	2219.70	2374.05	2481.15	2639.60
Upholstered	Standard	M2E1-2H43	\$1913.10	\$1979.25	\$2048.55	\$2083.20	\$2113.65	\$2174.55	\$2230.20	\$2384.55	\$2690.10	\$2848.55
	Vinyl Gel	M2E1-2G43	1970.85	2037.00	2106.30	2140.95	2171.40	2232.30	2287.95	2442.30	2747.85	2906.30
	Upholstered	M2E1-2U43	2011.80	2077.95	2147.25	2181.90	2212.35	2273.25	2328.90	2483.25	2788.80	2947.25

The following options require modification of the product number.

Glides

Soft casters

Faux Leather upholstery

Leather upholstery

CAL 133

Nano-Tex

To specify, change the 7th digit from a 4 to a 0; **Example:** M2E1-1H02

To specify, change the 7th digit from a 4 to a 2; **Example:** M2E1-1H22

To specify, change the 2nd digit from a 2 to a 3; **Example:** M3E1-1H42

To specify, change the 2nd digit from a 2 to a 1; **Example:** M1E1-1H42

To specify, add **-F** to the end of the product number; **Example:** M2E1-2U42-F (add \$101.85 list)

To specify, add **-P** to the end of the product number; **Example:** M2E1-1H44-P (add \$33.60 list)

NOTE: CAL 133 is available on all fully upholstered models and chairs with black (TR-F) polypropylene shells backs.

Nano-Tex on upholstered poly back only.

For available fabrics see matrix in the back of the book or at Haworth.com/surfaces.

Improv Series

Improv H.E. Stool with Height and Width Adjustable 3-D Arms



M2E1-1W42

Dimensions

- SH: 24" - 32"
(610mm - 813mm)
- H: 42" - 54"
(1067mm - 1372mm)
- D: 23" - 25 1/2"
(584mm - 648mm)
- W: 25" (635mm)
- SW: 19.2" (488mm)
- SD: 18" (458mm)
- AH: 3 3/4" - 7 3/4"
(95mm - 197mm)
- AW: 25 1/2" - 29 1/4"
(648mm - 743mm)

Features

- Outer Shells: Polypropylene or upholstered.
- Arms: Molded black vinyl arm caps.
- Standard with hard casters; or optional soft casters or glides, see below.
- Mechanism: Swivel with synchronized-tilt.
- Height Adjustment: Pneumatic
- Arm Adjustment: 5" (127mm) height adjustment.
- Arm Width Adjustment: 1 1/2" (38mm) each arm in-out adjustment.
- Arm Pad Rotation: 360°.
- Arm Adjustment Controls: Fingertip activation.
- Optional Back-Lock: Lockable in two positions.
- Tilt tension.
- Optional Adjustable Air Lumbar: additional 1 1/2" (38mm) of lumbar support.
- Forward tilt not available on stools.
- Seat pan can be manually adjusted 3" (76mm).
- Foot ring adjustment: 6 1/2" - 15" (165mm - 381mm).
- Foot ring available in chrome only; ring support will match base color.
- COM yardage / COL square footage:
Polypropylene shell: 1.75/39
Upholstered shell: 2.25/45

To Order, Specify:

- 1) Product number.
- 2) Fabric surface and color.
(NOTE: For leather upholstery, see below.)
- 3) Trim color for shell, arms and base.

* All measurements taken with the BIFMA chair measuring device.

Shells	Arms/Caps	Number	Fabric Grade								Leather Grade A	Leather Grade B
			A	B	C	D	E	F	G	H		
Pneumatic Height Adjustment												
Polypropylene	Molded Black Vinyl	M2E1-1W42	\$1572.90	\$1639.05	\$1708.35	\$1743.00	\$1773.45	\$1834.35	\$1890.00	\$2044.35	\$2151.45	\$2309.90
Upholstered	Molded Black Vinyl	M2E1-2W42	1682.10	1748.25	1817.55	1852.20	1882.65	1943.55	1999.20	2153.55	2459.10	2617.55
Pneumatic Height Adjustment/Back-Lock												
Polypropylene	Molded Black Vinyl	M2E1-1W41	\$1618.05	\$1684.20	\$1753.50	\$1788.15	\$1818.60	\$1879.50	\$1935.15	\$2089.50	\$2196.60	\$2355.05
Upholstered	Molded Black Vinyl	M2E1-2W41	1727.25	1793.40	1862.70	1897.35	1927.80	1988.70	2044.35	2198.70	2504.25	2662.70
Pneumatic Height Adjustment with Adjustable Air Lumbar												
Polypropylene	Molded Black Vinyl	M2E1-1W44	\$1682.10	\$1748.25	\$1817.55	\$1852.20	\$1882.65	\$1943.55	\$1999.20	\$2153.55	\$2260.65	\$2419.10
Upholstered	Molded Black Vinyl	M2E1-2W44	1791.30	1857.45	1926.75	1961.40	1991.85	2052.75	2108.40	2262.75	2568.30	2726.75
Pneumatic Height Adjustment/Back-Lock with Adjustable Air Lumbar												
Polypropylene	Molded Black Vinyl	M2E1-1W43	\$1727.25	\$1793.40	\$1862.70	\$1897.35	\$1927.80	\$1988.70	\$2044.35	\$2198.70	\$2305.80	\$2464.25
Upholstered	Molded Black Vinyl	M2E1-2W43	1836.45	1902.60	1971.90	2006.55	2037.00	2097.90	2153.55	2307.90	2613.45	2771.90

The following options require modification of the product number.

- Glide To specify, change the 7th digit from a 4 to a 0; **Example:** M2E1-1W02
 - Soft casters To specify, change the 7th digit from a 4 to a 2; **Example:** M2E1-1W22
 - Faux Leather upholstery To specify, change the 2nd digit from a 2 to a 3; **Example:** M3E1-1W42
 - Leather upholstery To specify, change the 2nd digit from a 2 to a 1; **Example:** M1E1-1W42
 - CAL 133 To specify, add **-F** to the end of the product number; **Example:** M2E1-2W42-F (add \$101.85 list)
 - Nano-Tex To specify, add **-P** to the end of the product number; **Example:** M2E1-1W42-P (add \$33.60 list)
- NOTE:** CAL 133 is available on all fully upholstered models and chairs with black (TR-F) polypropylene shells backs.
- Nano-Tex on upholstered poly back only.
- For available fabrics see matrix in the back of the book or at Haworth.com/surfaces.

Improv Series

Improv H.E. Stool without Arms

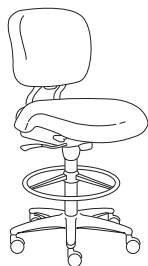

M2E1-1042

Dimensions

SH: 24" - 32"
(610mm - 813mm)
H: 42" - 54"
(1067mm - 1372mm)
D: 23" - 25 1/2"
(584mm - 648mm)
W: 21"(533mm)
SW: 19.2"(488mm)
SD: 18"(457mm)

Features

- Outer Shells: Polypropylene or upholstered.
- Standard with hard casters; or optional soft casters or glides, see below.
- Mechanism: Swivel with synchronized-tilt.
- Height Adjustment: Pneumatic
- Optional Back-Lock: Lockable in two positions.
- Tilt tension.
- Optional Adjustable Air Lumbar: additional 1 1/2"(38mm) of lumbar support.
- Forward tilt not available on stools.
- Seat pan can be manually adjusted 3"(76mm).
- Foot ring adjustment: 6 1/2" - 15" (165mm - 381mm).
- Foot ring available in chrome only; ring support will match base color.
- Fire retardant construction is available to comply with California Bulletin #133, see below.
- COM yardage / COL square footage:
Polypropylene shell: 1.75/39
Upholstered shell: 2.25/45

To Order, Specify:

- 1) Product number.
- 2) Fabric surface and color.
(NOTE: For leather upholstery, see below.)
- 3) Trim color for shell, arms and base.

* All measurements taken with the BIFMA chair measuring device.

Shells	Arms/Caps	Number	Fabric Grade								Leather Grade A	Leather Grade B
			A	B	C	D	E	F	G	H		
Pneumatic Height Adjustment												
Polypropylene		M2E1-1042	\$1273.65	\$1339.80	\$1409.10	\$1443.75	\$1474.20	\$1535.10	\$1590.75	\$1745.10	\$1852.20	\$2010.65
Upholstered		M2E1-2042	1382.85	1449.00	1518.30	1552.95	1583.40	1644.30	1699.95	1854.30	2159.85	2318.30
Pneumatic Height Adjustment/Back-Lock												
Polypropylene		M2E1-1041	\$1318.80	\$1384.95	\$1454.25	\$1488.90	\$1519.35	\$1580.25	\$1635.90	\$1790.25	\$1897.35	\$2055.80
Upholstered		M2E1-2041	1428.00	1494.15	1563.45	1598.10	1628.55	1689.45	1745.10	1899.45	2205.00	2363.45
Pneumatic Height Adjustment with Adjustable Air Lumbar												
Polypropylene		M2E1-1044	\$1382.85	\$1449.00	\$1518.30	\$1552.95	\$1583.40	\$1644.30	\$1699.95	\$1854.30	\$1961.40	\$2119.85
Upholstered		M2E1-2044	1492.05	1558.20	1627.50	1662.15	1692.60	1753.50	1809.15	1963.50	2269.05	2427.50
Pneumatic Height Adjustment/Back-Lock with Adjustable Air Lumbar												
Polypropylene		M2E1-1043	\$1428.00	\$1494.15	\$1563.45	\$1598.10	\$1628.55	\$1689.45	\$1745.10	\$1899.45	\$2006.55	\$2165.00
Upholstered		M2E1-2043	1537.20	1603.35	1672.65	1707.30	1737.75	1798.65	1854.30	2008.65	2314.20	2472.65

The following options require modification of the product number.

Glides
Soft casters
Faux Leather upholstery
Leather upholstery
CAL 133
Nano-Tex

To specify, change the 7th digit from a 4 to a 0; **Example:** M2E1-1002
To specify, change the 7th digit from a 4 to a 2; **Example:** M2E1-1022
To specify, change the 2nd digit from a 2 to a 3; **Example:** M3E1-1042
To specify, change the 2nd digit from a 2 to a 1; **Example:** M1E1-1042
To specify, add **-F** to the end of the product number; **Example:** M2E1-2042-F (add \$101.85 list)
To specify, add **-P** to the end of the product number; **Example:** M2E1-1042-P (add \$33.60 list)

NOTE: CAL 133 is available on all fully upholstered models and chairs with black (TR-F) polypropylene shells backs.

Nano-Tex on upholstered poly back only.

For available fabrics see matrix in the back of the book or at Haworth.com/surfaces.

Improv Series

Improv S.E. Mesh Back Chair without Arms



M235-3042



Square

Round

Dimensions*

SH: 16" - 21"
(406mm - 533mm)
H: 37" - 42"
(940mm-1067mm)
D: 25" - 27.5"
(635mm - 699mm)
W: 25"(635mm)
SW: 19.2"(488mm)
SD: 15.5" - 18"
(394mm - 457mm)

Two-stage seat height:
.7"(18mm) below
standard
1.9"(48mm) above
standard

Features

- Back: Soft mesh.
 - Seat: Standard upholstered.
 - Base: Five star, high arc plastic base standard: optional steel base available.
 - 3"(76mm) sliding seat pan.
 - Casters: Standard with hard casters; or optional soft casters, see below.
 - Mechanism: Swivel with synchronized-tilt.
 - Height Adjustment: Pneumatic or pneumatic with two-stage or low-position seat height, see below.
 - Optional Back-Lock: Lockable in 2 positions.
 - Optional Lumbar provides 3"(76mm) of vertical and 1"(25mm) of depth adjustment, black trim only.
 - Optional Forward Tilt: Lockable in 3 positions.
 - Tilt tension.
 - COM yardage / COL square footage:
Upholstered seat: 0.75/20
- Available on RUSH.

To Order, Specify:

- 1) Product number.
- 2) Fabric surface and color (seat).
- 3) Fabric surface and color (mesh back).
Black Mesh: WO-01
- 4) Trim color for base.

* All measurements taken with the BIFMA chair measuring device.

Seat	Back	Number	Fabric Grade		C	D	E	F	G	H	Leather Grade A	Leather Grade B
			A	B								
Pneumatic Height Adjustment												
Upholstered	Square Mesh	M235-3042	\$ 858.90	\$ 925.05	\$ 985.95	\$1029.00	\$1059.45	\$1077.30	\$1123.50	\$1252.65	\$1437.45	\$1595.90
	Round Mesh	M235-4042	858.90	925.05	985.95	1029.00	1059.45	1077.30	1123.50	1252.65	1437.45	1595.90
Pneumatic Height Adjustment/Back-Lock												
Upholstered	Square Mesh	M235-3041	\$ 904.05	\$ 970.20	\$1031.10	\$1074.15	\$1104.60	\$1122.45	\$1168.65	\$1297.80	\$1482.60	\$1641.05
	Round Mesh	M235-4041	904.05	970.20	1031.10	1074.15	1104.60	1122.45	1168.65	1297.80	1482.60	1641.05
Pneumatic Height Adjustment/Forward-Tilt												
Upholstered	Round Mesh	M245-3042	\$ 904.05	\$ 970.20	\$1031.10	\$1074.15	\$1104.60	\$1122.45	\$1168.65	\$1297.80	\$1482.60	\$1641.05
	Square Mesh	M245-4042	904.05	970.20	1031.10	1074.15	1104.60	1122.45	1168.65	1297.80	1482.60	1641.05
Pneumatic Height/Lumbar												
Upholstered	Square Mesh	M235-3044	\$ 972.30	\$1038.45	\$1099.35	\$1142.40	\$1172.85	\$1190.70	\$1236.90	\$1366.05	\$1550.85	\$1709.30
	Round Mesh	M235-4044	972.30	1038.45	1099.35	1142.40	1172.85	1190.70	1236.90	1366.05	1550.85	1709.30
Pneumatic Height/Back-Lock/Lumbar												
Upholstered	Square Mesh	M235-3043	\$1017.45	\$1083.60	\$1144.50	\$1187.55	\$1218.00	\$1235.85	\$1282.05	\$1411.20	\$1596.00	\$1754.45
	Round Mesh	M235-4043	1017.45	1083.60	1144.50	1187.55	1218.00	1235.85	1282.05	1411.20	1596.00	1754.45
Pneumatic Height/Forward-Tilt/Lumbar												
Upholstered	Round Mesh	M245-3044	\$1017.45	\$1083.60	\$1144.50	\$1187.55	\$1218.00	\$1235.85	\$1282.05	\$1411.20	\$1596.00	\$1754.45
	Square Mesh	M245-4044	1017.45	1083.60	1144.50	1187.55	1218.00	1235.85	1282.05	1411.20	1596.00	1754.45

The following options require modification of the product number.

- Low-position seat height - Plastic
- Two-stage seat height- HAB
- Steel base - Standard height
- Steel base - Low height
- Soft casters
- Faux Leather upholstery
- Leather upholstery
- Nano-Tex

- To specify, change the 4th digit from a 5 to a 4; **Example:** M234-3042
- To specify, change the 4th digit from a 5 to a 3; **Example:** M233-3042 (add \$89.25 list)
- To specify, change the 4th digit from a 5 to a 6; **Example:** M236-3042
- To specify, change the 4th digit from a 5 to a 7; **Example:** M237-3042
- To specify, change the 7th digit from a 4 to a 2; **Example:** M235-3022
- To specify, change the 2nd digit from a 2 to a 3; **Example:** M335-3042
- To specify, change the 2nd digit from a 2 to a 1; **Example:** M135-3042
- To specify, add -P to the end of the product number; **Example:** M235-3042-P (add \$33.60 list)

NOTE: Nano-Tex on upholstered seat only.

For available fabrics see matrix in the back of the book or at Haworth.com/surfaces.

This page intentionally blank

Improv Series

Improv S.E. Mesh-Back Chair with Task Arms



M235-3442

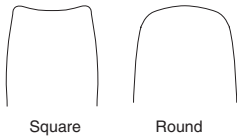

Dimensions*

- SH: 16" - 21"
(406mm - 533mm)
- H: 37" - 42"
(940mm-1067mm)
- D: 25" - 27.5"
(635mm- 699mm)
- W: 25"(635mm)
- SW: 19.2"(488mm)
- SD: 15.5" - 18"
(394mm - 457mm)
- AH: 6.2" - 11.1"
(157mm - 282mm)

Two-stage seat height:
.7"(18mm) below
standard
1.9"(48mm) above
standard

Features

- Back: Soft mesh.
- Seat: Standard upholstered.
- Base: Five star, high arc plastic base standard; optional steel base available.
- Arms: Standard, upholstered fabric or optional vinyl arm caps.
- 3"(76mm) sliding seat pan.
- Casters: Standard with hard casters; or optional soft casters, see page 175.
- Mechanism: Swivel with synchronized-tilt.
- Height Adjustment: Pneumatic or pneumatic with two-stage or low-position seat height, see page 175.
- Optional Back-Lock: Lockable in 2 positions.
- Optional Forward Tilt: Lockable in 3 positions.
- Tilt tension.
- COM yardage / COL square footage:
Upholstered seat/arms: 0.75/20
- Available on RUSH.

To Order, Specify:

- 1) Product number.
- 2) Fabric surface and color (seat/arm caps).
- 3) Fabric surface and color (mesh back).
Black Mesh: WO-01
- 4) Trim color for base.

* All measurements taken with the BIFMA chair measuring device.

Seat	Back	Arms/Caps	Number	Fabric Grade								Leather Grade A	Leather Grade B
				A	B	C	D	E	F	G	H		
Pneumatic Height Adjustment													
Upholstered	Square Mesh	Standard	M235-3442	\$ 946.05	\$1012.20	\$1073.10	\$1116.15	\$1146.60	\$1164.45	\$1210.65	\$1339.80	\$1524.60	\$1683.05
		Upholstered	M235-3542	991.20	1057.35	1118.25	1161.30	1191.75	1209.60	1255.80	1384.95	1569.75	1728.20
		Soft Black Vinyl	M235-3642	991.20	1057.35	1118.25	1161.30	1191.75	1209.60	1255.80	1384.95	1569.75	1728.20
Upholstered	Round Mesh	Standard	M235-4442	\$ 946.05	\$1012.20	\$1073.10	\$1116.15	\$1146.60	\$1164.45	\$1210.65	\$1339.80	\$1524.60	\$1683.05
		Upholstered	M235-4542	991.20	1057.35	1118.25	1161.30	1191.75	1209.60	1255.80	1384.95	1569.75	1728.20
		Soft Black Vinyl	M235-4642	991.20	1057.35	1118.25	1161.30	1191.75	1209.60	1255.80	1384.95	1569.75	1728.20
Pneumatic Height Adjustment/Back-Lock													
Upholstered	Square Mesh	Standard	M235-3441	\$ 991.20	\$1057.35	\$1118.25	\$1161.30	\$1191.75	\$1209.60	\$1255.80	\$1384.95	\$1569.75	\$1728.20
		Upholstered	M235-3541	1036.35	1102.50	1163.40	1206.45	1236.90	1254.75	1300.95	1430.10	1614.90	1773.35
		Soft Black Vinyl	M235-3641	1036.35	1102.50	1163.40	1206.45	1236.90	1254.75	1300.95	1430.10	1614.90	1773.35
Upholstered	Round Mesh	Standard	M235-4441	\$ 991.20	\$1057.35	\$1118.25	\$1161.30	\$1191.75	\$1209.60	\$1255.80	\$1384.95	\$1569.75	\$1728.20
		Upholstered	M235-4541	1036.35	1102.50	1163.40	1206.45	1236.90	1254.75	1300.95	1430.10	1614.90	1773.35
		Soft Black Vinyl	M235-4641	1036.35	1102.50	1163.40	1206.45	1236.90	1254.75	1300.95	1430.10	1614.90	1773.35
Pneumatic Height Adjustment/Forward-Tilt													
Upholstered	Square Mesh	Standard	M245-3442	\$ 991.20	\$1057.35	\$1118.25	\$1161.30	\$1191.75	\$1209.60	\$1255.80	\$1384.95	\$1569.75	\$1728.20
		Upholstered	M245-3542	1036.35	1102.50	1163.40	1206.45	1236.90	1254.75	1300.95	1430.10	1614.90	1773.35
		Soft Black Vinyl	M245-3642	1036.35	1102.50	1163.40	1206.45	1236.90	1254.75	1300.95	1430.10	1614.90	1773.35
Upholstered	Round Mesh	Standard	M245-4442	\$ 991.20	\$1057.35	\$1118.25	\$1161.30	\$1191.75	\$1209.60	\$1255.80	\$1384.95	\$1569.75	\$1728.20
		Upholstered	M245-4542	1036.35	1102.50	1163.40	1206.45	1236.90	1254.75	1300.95	1430.10	1614.90	1773.35
		Soft Black Vinyl	M245-4642	1036.35	1102.50	1163.40	1206.45	1236.90	1254.75	1300.95	1430.10	1614.90	1773.35

Improv Series

Improv S.E. Mesh-Back Chair with Task Arms

Seat	Back	Arms/Caps	Number	Fabric Grade								Leather Grade A	Leather Grade B
				A	B	C	D	E	F	G	H		
Pneumatic Height/Lumbar													
Upholstered	Square Mesh	Standard	M235-3444	\$1059.45	\$1125.60	\$1186.50	\$1229.55	\$1260.00	\$1277.85	\$1324.05	\$1453.20	\$1638.00	\$1796.45
		Upholstered	M235-3544	1104.60	1170.75	1231.65	1274.70	1305.15	1323.00	1369.20	1498.35	1683.15	1841.60
		Soft Black Vinyl	M235-3644	1104.60	1170.75	1231.65	1274.70	1305.15	1323.00	1369.20	1498.35	1683.15	1841.60
Upholstered	Round Mesh	Standard	M235-4444	\$1059.45	\$1125.60	\$1186.50	\$1229.55	\$1260.00	\$1277.85	\$1324.05	\$1453.20	\$1638.00	\$1796.45
		Upholstered	M235-4544	1104.60	1170.75	1231.65	1274.70	1305.15	1323.00	1369.20	1498.35	1683.15	1841.60
		Soft Black Vinyl	M235-4644	1104.60	1170.75	1231.65	1274.70	1305.15	1323.00	1369.20	1498.35	1683.15	1841.60
Pneumatic Height/Back-Lock/Lumbar													
Upholstered	Square Mesh	Standard	M235-3443	\$1104.60	\$1170.75	\$1231.65	\$1274.70	\$1305.15	\$1323.00	\$1369.20	\$1498.35	\$1683.15	\$1841.60
		Upholstered	M235-3543	1149.75	1215.90	1276.80	1319.85	1350.30	1368.15	1414.35	1543.50	1728.30	1886.75
		Soft Black Vinyl	M235-3643	1149.75	1215.90	1276.80	1319.85	1350.30	1368.15	1414.35	1543.50	1728.30	1886.75
Upholstered	Round Mesh	Standard	M235-4443	\$1104.60	\$1170.75	\$1231.65	\$1274.70	\$1305.15	\$1323.00	\$1369.20	\$1498.35	\$1683.15	\$1841.60
		Upholstered	M235-4543	1149.75	1215.90	1276.80	1319.85	1350.30	1368.15	1414.35	1543.50	1728.30	1886.75
		Soft Black Vinyl	M235-4643	1149.75	1215.90	1276.80	1319.85	1350.30	1368.15	1414.35	1543.50	1728.30	1886.75
Pneumatic Height/Forward-Tilt/Lumbar													
Upholstered	Square Mesh	Standard	M245-3444	\$1104.60	\$1170.75	\$1231.65	\$1274.70	\$1305.15	\$1323.00	\$1369.20	\$1498.35	\$1683.15	\$1841.60
		Upholstered	M245-3544	1149.75	1215.90	1276.80	1319.85	1350.30	1368.15	1414.35	1543.50	1728.30	1886.75
		Soft Black Vinyl	M245-3644	1149.75	1215.90	1276.80	1319.85	1350.30	1368.15	1414.35	1543.50	1728.30	1886.75
Upholstered	Round Mesh	Standard	M245-4444	\$1104.60	\$1170.75	\$1231.65	\$1274.70	\$1305.15	\$1323.00	\$1369.20	\$1498.35	\$1683.15	\$1841.60
		Upholstered	M245-4544	1149.75	1215.90	1276.80	1319.85	1350.30	1368.15	1414.35	1543.50	1728.30	1886.75
		Soft Black Vinyl	M245-4644	1149.75	1215.90	1276.80	1319.85	1350.30	1368.15	1414.35	1543.50	1728.30	1886.75

The following options require modification of the product number.

Low-position seat height - Plastic	To specify, change the 4th digit from a 5 to a 4; Example: M234-3442
Two-stage seat height- HAB	To specify, change the 4th digit from a 5 to a 3; Example: M233-3442 (add \$89.25 list)
Steel base - Standard height	To specify, change the 4th digit from a 5 to a 6; Example: M236-3442
Steel base - Low height	To specify, change the 4th digit from a 5 to a 7; Example: M237-3442
Soft casters	To specify, change the 7th digit from a 4 to a 2; Example: M235-3422
Faux Leather upholstery	To specify, change the 2nd digit from a 2 to a 3; Example: M335-3442
Leather upholstery	To specify, change the 2nd digit from a 2 to a 1; Example: M135-3442
Nano-Tex	To specify, add -P to the end of the product number; Example: M235-3442-P (add \$33.60 list)

NOTE: Nano-Tex on upholstered seat only.

For available fabrics see matrix in the back of the book or at Haworth.com/surfaces.

Improv Series

Improv S.E. Mesh-Back Chair with Height Adjustable Task Arms



M235-3742

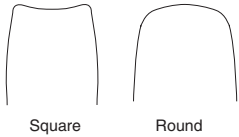

Dimensions*

SH: 16" - 21"
(406mm - 533mm)
H: 37" - 42"
(940mm-1067mm)
D: 25" - 27.5"
(635mm- 699mm)
W: 25"(635mm)
SW: 19.2"(488mm)
SD: 15.5" - 18"
(394mm - 457mm)
AH: 6.2" - 11.1"
(157mm - 282mm)

Two-stage seat height:
.7"(18mm) below
standard
1.9"(48mm) above
standard

Features

- Back: Soft mesh.
- Seat: Standard upholstered.
- Base: Five star, high arc plastic base standard: optional steel base available.
- Arms: Standard, upholstered fabric or optional vinyl arm caps.
- Arm Adjustment Controls: Fingertip activation.
- Arm Adjustment: 4"(102mm) height adjustment.
- 3"(76mm) sliding seat pan.
- Casters: Standard with hard casters; or optional soft casters, see page 177.
- Mechanism: Swivel with synchronized-tilt.
- Height Adjustment: Pneumatic or pneumatic with two-stage or low-position seat height, see page 177.
- Optional Back-Lock: Lockable in 2 positions.
- Optional Forward Tilt: Lockable in 3 positions.
- Tilt tension.
- COM yardage / COL square footage:
Upholstered seat: 0.75/20
- Available on RUSH.

To Order, Specify:

- 1) Product number.
- 2) Fabric surface and color (seat/arm caps).
- 3) Fabric surface and color (mesh back).
Black Mesh: WO-01
- 4) Trim color for base.

* All measurements taken with the BIFMA chair measuring device.

Seat	Back	Arms/Caps	Number	Fabric Grade								Leather Grade A	Leather Grade B
				A	B	C	D	E	F	G	H		
Pneumatic Height Adjustment													
Upholstered	Square Mesh	Standard	M235-3742	\$1042.65	\$1108.80	\$1169.70	\$1212.75	\$1243.20	\$1261.05	\$1307.25	\$1436.40	\$1621.20	\$1779.65
		Upholstered	M235-3842	1087.80	1153.95	1214.85	1257.90	1288.35	1306.20	1352.40	1481.55	1666.35	1824.80
		Soft Black Vinyl	M235-3942	1087.80	1153.95	1214.85	1257.90	1288.35	1306.20	1352.40	1481.55	1666.35	1824.80
Upholstered	Round Mesh	Standard	M235-4742	\$1042.65	\$1108.80	\$1169.70	\$1212.75	\$1243.20	\$1261.05	\$1307.25	\$1436.40	\$1621.20	\$1779.65
		Upholstered	M235-4842	1087.80	1153.95	1214.85	1257.90	1288.35	1306.20	1352.40	1481.55	1666.35	1824.80
		Soft Black Vinyl	M235-4942	1087.80	1153.95	1214.85	1257.90	1288.35	1306.20	1352.40	1481.55	1666.35	1824.80
Pneumatic Height Adjustment/Back-Lock													
Upholstered	Square Mesh	Standard	M235-3741	\$1087.80	\$1153.95	\$1214.85	\$1257.90	\$1288.35	\$1306.20	\$1352.40	\$1481.55	\$1666.35	\$1824.80
		Upholstered	M235-3841	1132.95	1199.10	1260.00	1303.05	1333.50	1351.35	1397.55	1526.70	1711.50	1869.95
		Soft Black Vinyl	M235-3941	1132.95	1199.10	1260.00	1303.05	1333.50	1351.35	1397.55	1526.70	1711.50	1869.95
Upholstered	Round Mesh	Standard	M235-4741	\$1087.80	\$1153.95	\$1214.85	\$1257.90	\$1288.35	\$1306.20	\$1352.40	\$1481.55	\$1666.35	\$1824.80
		Upholstered	M235-4841	1132.95	1199.10	1260.00	1303.05	1333.50	1351.35	1397.55	1526.70	1711.50	1869.95
		Soft Black Vinyl	M235-4941	1132.95	1199.10	1260.00	1303.05	1333.50	1351.35	1397.55	1526.70	1711.50	1869.95
Pneumatic Height Adjustment/Forward-Tilt													
Upholstered	Square Mesh	Standard	M245-3742	\$1087.80	\$1153.95	\$1214.85	\$1257.90	\$1288.35	\$1306.20	\$1352.40	\$1481.55	\$1666.35	\$1824.80
		Upholstered	M245-3842	1132.95	1199.10	1260.00	1303.05	1333.50	1351.35	1397.55	1526.70	1711.50	1869.95
		Soft Black Vinyl	M245-3942	1132.95	1199.10	1260.00	1303.05	1333.50	1351.35	1397.55	1526.70	1711.50	1869.95
Upholstered	Round Mesh	Standard	M245-4742	\$1087.80	\$1153.95	\$1214.85	\$1257.90	\$1288.35	\$1306.20	\$1352.40	\$1481.55	\$1666.35	\$1824.80
		Upholstered	M245-4842	1132.95	1199.10	1260.00	1303.05	1333.50	1351.35	1397.55	1526.70	1711.50	1869.95
		Soft Black Vinyl	M245-4942	1132.95	1199.10	1260.00	1303.05	1333.50	1351.35	1397.55	1526.70	1711.50	1869.95

Improv Series

Improv S.E. Mesh-Back Chair with Height Adjustable Task Arms

Seat	Back	Arms/Caps	Number	Fabric Grade								Leather Grade A	Leather Grade B
				A	B	C	D	E	F	G	H		
Pneumatic Height/Lumbar													
Upholstered	Square Mesh	Standard	M235-3744	\$1156.05	\$1222.20	\$1283.10	\$1326.15	\$1356.60	\$1374.45	\$1420.65	\$1549.80	\$1734.60	\$1893.05
		Upholstered	M235-3844	1201.20	1267.35	1328.25	1371.30	1401.75	1419.60	1465.80	1594.95	1779.75	1938.20
		Soft Black Vinyl	M235-3944	1201.20	1267.35	1328.25	1371.30	1401.75	1419.60	1465.80	1594.95	1779.75	1938.20
Upholstered	Round Mesh	Standard	M235-4744	\$1156.05	\$1222.20	\$1283.10	\$1326.15	\$1356.60	\$1374.45	\$1420.65	\$1549.80	\$1734.60	\$1893.05
		Upholstered	M235-4844	1201.20	1267.35	1328.25	1371.30	1401.75	1419.60	1465.80	1594.95	1779.75	1938.20
		Soft Black Vinyl	M235-4944	1201.20	1267.35	1328.25	1371.30	1401.75	1419.60	1465.80	1594.95	1779.75	1938.20
Pneumatic Height/Back-Lock/Lumbar													
Upholstered	Square Mesh	Standard	M235-3743	\$1201.20	\$1267.35	\$1328.25	\$1371.30	\$1401.75	\$1419.60	\$1465.80	\$1594.95	\$1779.75	\$1938.20
		Upholstered	M235-3843	1246.35	1312.50	1373.40	1416.45	1446.90	1464.75	1510.95	1640.10	1824.90	1983.35
		Soft Black Vinyl	M235-3943	1246.35	1312.50	1373.40	1416.45	1446.90	1464.75	1510.95	1640.10	1824.90	1983.35
Upholstered	Round Mesh	Standard	M235-4743	\$1201.20	\$1267.35	\$1328.25	\$1371.30	\$1401.75	\$1419.60	\$1465.80	\$1594.95	\$1779.75	\$1938.20
		Upholstered	M235-4843	1246.35	1312.50	1373.40	1416.45	1446.90	1464.75	1510.95	1640.10	1824.90	1983.35
		Soft Black Vinyl	M235-4943	1246.35	1312.50	1373.40	1416.45	1446.90	1464.75	1510.95	1640.10	1824.90	1983.35
Pneumatic Height/Forward-Tilt/Lumbar													
Upholstered	Square Mesh	Standard	M245-3744	\$1201.20	\$1267.35	\$1328.25	\$1371.30	\$1401.75	\$1419.60	\$1465.80	\$1594.95	\$1779.75	\$1938.20
		Upholstered	M245-3844	1246.35	1312.50	1373.40	1416.45	1446.90	1464.75	1510.95	1640.10	1824.90	1983.35
		Soft Black Vinyl	M245-3944	1246.35	1312.50	1373.40	1416.45	1446.90	1464.75	1510.95	1640.10	1824.90	1983.35
Upholstered	Round Mesh	Standard	M245-4744	\$1201.20	\$1267.35	\$1328.25	\$1371.30	\$1401.75	\$1419.60	\$1465.80	\$1594.95	\$1779.75	\$1938.20
		Upholstered	M245-4844	1246.35	1312.50	1373.40	1416.45	1446.90	1464.75	1510.95	1640.10	1824.90	1983.35
		Soft Black Vinyl	M245-4944	1246.35	1312.50	1373.40	1416.45	1446.90	1464.75	1510.95	1640.10	1824.90	1983.35

The following options require modification of the product number.

Low-position seat height Plastic	To specify, change the 4th digit from a 5 to a 4; Example: M234-3742
Two-stage seat height - HAB	To specify, change the 4th digit from a 5 to a 3; Example: M233-3742 (add \$89.25 list)
Steel base - Standard height	To specify, change the 4th digit from a 5 to a 6; Example: M236-3742
Steel base - Low height	To specify, change the 4th digit from a 5 to a 7; Example: M237-3742
Soft casters	To specify, change the 7th digit from a 4 to a 2; Example: M235-3722
Faux Leather upholstery	To specify, change the 2nd digit from a 2 to a 3; Example: M335-3742
Leather upholstery	To specify, change the 2nd digit from a 2 to a 1; Example: M135-3742
Nano-Tex	To specify, add -P to the end of the product number; Example: M235-3742-P (add \$33.60 list)

NOTE: Nano-Tex on upholstered seat only.

For available fabrics see matrix in the back of the book or at Haworth.com/surfaces.

Improv Series

Improv S.E. Mesh-Back Chair with Flipper Arms



M235-3H42

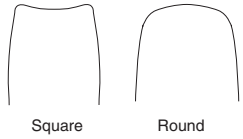

Dimensions*

- SH: 16" - 21"
(406mm - 533mm)
- H: 37" - 42"
(940mm-1067mm)
- D: 25" - 27.5"
(635mm- 699mm)
- W: 25"(635mm)
- SW: 19.2"(488mm)
- SD: 15.5" - 18"
(394mm - 457mm)
- AH: 6.2" - 11.1"
(157mm - 282mm)

Two-stage seat height:
.7"(18mm) below
standard
1.9"(48mm) above
standard

* All measurements
taken with the
BIFMA chair
measuring device.

Features

- Back: Soft mesh.
 - Seat: Standard upholstered.
 - Base: Five star, high arc plastic base standard: optional steel base available.
 - Arms: Standard, upholstered fabric or optional vinyl arm caps.
 - Arm Adjustment Controls: Fingertip activation.
 - Arm Adjustment: 5"(127mm) height adjustment.
 - Arm Pad Rotation: 350°.
 - 3"(76mm) sliding seat pan.
 - Casters: Standard with hard casters; or optional soft casters, see page 179.
 - Mechanism: Swivel with synchronized-tilt.
 - Height Adjustment: Pneumatic or pneumatic with two-stage or low-position seat height, see page 179.
 - Optional Back-Lock: Lockable in 2 positions.
 - Optional Forward Tilt: Lockable in 3 positions.
 - Tilt tension.
 - COM yardage / COL square footage:
Upholstered seat: 0.75/20
- Available on RUSH.

To Order, Specify:

- 1) Product number.
- 2) Fabric surface and color (seat/arm caps).
- 3) Fabric surface and color (mesh back).
Black Mesh: WO-01
- 4) Trim color for base.

Seat	Back	Arms/Caps	Number	Fabric Grade								Leather Grade A	Leather Grade B
				A	B	C	D	E	F	G	H		
Pneumatic Height Adjustment													
Upholstered	Square Mesh	Standard	M235-3H42	\$1233.75	\$1299.90	\$1360.80	\$1403.85	\$1434.30	\$1452.15	\$1498.35	\$1627.50	\$1812.30	\$1970.75
		Vinyl Gel	M235-3G42	\$1294.65	\$1360.80	\$1421.70	\$1464.75	\$1495.20	\$1513.05	\$1559.25	\$1688.40	\$1873.20	\$2031.65
		Upholstered	M235-3U42	\$1339.80	\$1405.95	\$1466.85	\$1509.90	\$1540.35	\$1558.20	\$1604.40	\$1733.55	\$1918.35	\$2076.80
Upholstered	Round Mesh	Standard	M235-4H42	\$1233.75	\$1299.90	\$1360.80	\$1403.85	\$1434.30	\$1452.15	\$1498.35	\$1627.50	\$1812.30	\$1970.75
		Vinyl Gel	M235-4G42	\$1294.65	\$1360.80	\$1421.70	\$1464.75	\$1495.20	\$1513.05	\$1559.25	\$1688.40	\$1873.20	\$2031.65
		Upholstered	M235-4U42	\$1339.80	\$1405.95	\$1466.85	\$1509.90	\$1540.35	\$1558.20	\$1604.40	\$1733.55	\$1918.35	\$2076.80
Pneumatic Height Adjustment/Back-Lock													
Upholstered	Square Mesh	Standard	M235-3H41	\$1278.90	\$1345.05	\$1405.95	\$1449.00	\$1479.45	\$1497.30	\$1543.50	\$1672.65	\$1857.45	\$2015.90
		Vinyl Gel	M235-3G41	\$1339.80	\$1405.95	\$1466.85	\$1509.90	\$1540.35	\$1558.20	\$1604.40	\$1733.55	\$1918.35	\$2076.80
		Upholstered	M235-3U41	\$1384.95	\$1451.10	\$1512.00	\$1555.05	\$1585.50	\$1603.35	\$1649.55	\$1778.70	\$1963.50	\$2121.95
Upholstered	Round Mesh	Standard	M235-4H41	\$1278.90	\$1345.05	\$1405.95	\$1449.00	\$1479.45	\$1497.30	\$1543.50	\$1672.65	\$1857.45	\$2015.90
		Vinyl Gel	M235-4G41	\$1339.80	\$1405.95	\$1466.85	\$1509.90	\$1540.35	\$1558.20	\$1604.40	\$1733.55	\$1918.35	\$2076.80
		Upholstered	M235-4U41	\$1384.95	\$1451.10	\$1512.00	\$1555.05	\$1585.50	\$1603.35	\$1649.55	\$1778.70	\$1963.50	\$2121.95
Pneumatic Height Adjustment/Forward-Tilt													
Upholstered	Square Mesh	Standard	M245-3H42	\$1278.90	\$1345.05	\$1405.95	\$1449.00	\$1479.45	\$1497.30	\$1543.50	\$1672.65	\$1857.45	\$2015.90
		Vinyl Gel	M245-3G42	\$1339.80	\$1405.95	\$1466.85	\$1509.90	\$1540.35	\$1558.20	\$1604.40	\$1733.55	\$1918.35	\$2076.80
		Upholstered	M245-3U42	\$1384.95	\$1451.10	\$1512.00	\$1555.05	\$1585.50	\$1603.35	\$1649.55	\$1778.70	\$1963.50	\$2121.95
Upholstered	Round Mesh	Standard	M245-4H42	\$1278.90	\$1345.05	\$1405.95	\$1449.00	\$1479.45	\$1497.30	\$1543.50	\$1672.65	\$1857.45	\$2015.90
		Vinyl Gel	M245-4G42	\$1339.80	\$1405.95	\$1466.85	\$1509.90	\$1540.35	\$1558.20	\$1604.40	\$1733.55	\$1918.35	\$2076.80
		Upholstered	M245-4U42	\$1384.95	\$1451.10	\$1512.00	\$1555.05	\$1585.50	\$1603.35	\$1649.55	\$1778.70	\$1963.50	\$2121.95

Improv Series

Improv S.E. Mesh-Back Chair with Flipper Arms

Seat	Back	Arms/Caps	Number	Fabric Grade								Leather Grade A	Leather Grade B
				A	B	C	D	E	F	G	H		
Pneumatic Height/Lumbar													
Upholstered	Square Mesh	Standard	M235-3H44	\$1347.15	\$1413.30	\$1474.20	\$1517.25	\$1547.70	\$1565.55	\$1611.75	\$1740.90	\$1925.70	\$2084.15
		Vinyl Gel	M235-3G44	1408.05	1474.20	1535.10	1578.15	1608.60	1626.45	1672.65	1801.80	1986.60	2145.05
		Upholstered	M235-3U44	1453.20	1519.35	1580.25	1623.30	1653.75	1671.60	1717.80	1846.95	2031.75	2190.20
Upholstered	Round Mesh	Standard	M235-4H44	\$1347.15	\$1413.30	\$1474.20	\$1517.25	\$1547.70	\$1565.55	\$1611.75	\$1740.90	\$1925.70	\$2084.15
		Vinyl Gel	M235-4G44	1408.05	1474.20	1535.10	1578.15	1608.60	1626.45	1672.65	1801.80	1986.60	2145.05
		Upholstered	M235-4U44	1453.20	1519.35	1580.25	1623.30	1653.75	1671.60	1717.80	1846.95	2031.75	2190.20
Pneumatic Height/Back-Lock/Lumbar													
Upholstered	Square Mesh	Standard	M235-3H43	\$1392.30	\$1458.45	\$1519.35	\$1562.40	\$1592.85	\$1610.70	\$1656.90	\$1786.05	\$1970.85	\$2129.30
		Vinyl Gel	M235-3G43	1453.20	1519.35	1580.25	1623.30	1653.75	1671.60	1717.80	1846.95	2031.75	2190.20
		Upholstered	M235-3U43	1498.35	1564.50	1625.40	1668.45	1698.90	1716.75	1762.95	1892.10	2076.90	2235.35
Upholstered	Round Mesh	Standard	M235-4H43	\$1392.30	\$1458.45	\$1519.35	\$1562.40	\$1592.85	\$1610.70	\$1656.90	\$1786.05	\$1970.85	\$2129.30
		Vinyl Gel	M235-4G43	1453.20	1519.35	1580.25	1623.30	1653.75	1671.60	1717.80	1846.95	2031.75	2190.20
		Upholstered	M235-4U43	1498.35	1564.50	1625.40	1668.45	1698.90	1716.75	1762.95	1892.10	2076.90	2235.35
Pneumatic Height/Forward-Tilt/Lumbar													
Upholstered	Square Mesh	Standard	M245-3H44	\$1392.30	\$1458.45	\$1519.35	\$1562.40	\$1592.85	\$1610.70	\$1656.90	\$1786.05	\$1970.85	\$2129.30
		Vinyl Gel	M245-3G44	1453.20	1519.35	1580.25	1623.30	1653.75	1671.60	1717.80	1846.95	2031.75	2190.20
		Upholstered	M245-3U44	1498.35	1564.50	1625.40	1668.45	1698.90	1716.75	1762.95	1892.10	2076.90	2235.35
Upholstered	Round Mesh	Standard	M245-4H44	\$1392.30	\$1458.45	\$1519.35	\$1562.40	\$1592.85	\$1610.70	\$1656.90	\$1786.05	\$1970.85	\$2129.30
		Vinyl Gel	M245-4G44	1453.20	1519.35	1580.25	1623.30	1653.75	1671.60	1717.80	1846.95	2031.75	2190.20
		Upholstered	M245-4U44	1498.35	1564.50	1625.40	1668.45	1698.90	1716.75	1762.95	1892.10	2076.90	2235.35

The following options require modification of the product number.

Low-position seat height - Plastic	To specify, change the 4th digit from a 5 to a 4; Example: M234-3H42
Two-stage seat height- HAB	To specify, change the 4th digit from a 5 to a 3; Example: M233-3H42 (add \$89.25 list)
Steel base - Standard height	To specify, change the 4th digit from a 5 to a 6; Example: M236-3H42
Steel base - Low height	To specify, change the 4th digit from a 5 to a 7; Example: M237-3H42
Soft casters	To specify, change the 7th digit from a 4 to a 2; Example: M235-3H22
Faux Leather upholstery	To specify, change the 2nd digit from a 2 to a 3; Example: M335-3H42
Leather upholstery	To specify, change the 2nd digit from a 2 to a 1; Example: M135-3H42
Nano-Tex	To specify, add -P to the end of the product number; Example: M235-3H42-P (add \$33.60 list)

NOTE: Nano-Tex on upholstered seat only.

For available fabrics see matrix in the back of the book or at Haworth.com/surfaces.

Improv Series

Improv S.E. Mesh-Back Chair with Height and Width Adjustable 3-D Arms



M235-3W42

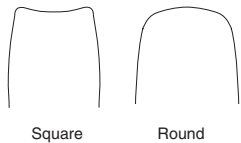

Dimensions*

SH: 16" - 21"
(406mm - 533mm)
H: 37" - 42"
(940mm-1067mm)
D: 25" - 27.5"
(635mm - 699mm)
W: 25"(635mm)
SW: 19.2"(488mm)
SD: 15.5" - 18"
(394mm - 457mm)
AH: 6.2" - 11.1"
(157mm - 282mm)

Two-stage seat height:
.7"(18mm) below
standard
1.9"(48mm) above
standard

Features

- Back: Soft mesh.
- Seat: Standard upholstered.
- Base: Five star, high arc plastic base standard; optional steel base available.
- Arms: Molded black vinyl arm caps.
- Arm Adjustment Controls: Fingertip activation.
- Arm Adjustment: 4"(102mm) height adjustment.
- Arm Width Adjustment: 1 1/2"(38mm) each arm in-out adjustment.
- 3"(76mm) sliding seat pan.
- Casters: Standard with hard casters; or optional soft casters, see below.
- Mechanism: Swivel with synchronized-tilt.
- Height Adjustment: Pneumatic or pneumatic with two-stage or low-position seat height, see below.
- Optional Back-Lock: Lockable in 2 positions.
- Optional Forward Tilt: Lockable in 3 positions.
- Tilt tension.
- COM yardage / COL square footage:
Upholstered seat: 0.75/20

To Order, Specify:

- 1) Product number.
- 2) Fabric surface and color (seat).
- 3) Fabric surface and color (mesh back).
Black Mesh: WO-01
- 4) Trim color for base.

* All measurements taken with the BIFMA chair measuring device.

Seat	Back	Arms/Caps	Number	Fabric Grade								Leather Grade A	Leather Grade B
				A	B	C	D	E	F	G	H		
Pneumatic Height Adjustment													
Upholstered	Square Mesh	Molded Black Vinyl	M235-3W42	\$1162.35	\$1228.50	\$1289.40	\$1332.45	\$1362.90	\$1380.75	\$1426.95	\$1556.10	\$1740.90	\$1899.35
	Round Mesh	Molded Black Vinyl	M235-4W42	1162.35	1228.50	1289.40	1332.45	1362.90	1380.75	1426.95	1556.10	1740.90	1899.35
Pneumatic Height Adjustment/Back-Lock													
Upholstered	Square Mesh	Molded Black Vinyl	M235-3W41	\$1207.50	\$1273.65	\$1334.55	\$1377.60	\$1408.05	\$1425.90	\$1472.10	\$1601.25	\$1786.05	\$1944.50
	Round Mesh	Molded Black Vinyl	M235-4W41	1207.50	1273.65	1334.55	1377.60	1408.05	1425.90	1472.10	1601.25	1786.05	1944.50
Pneumatic Height Adjustment/Forward-Tilt													
Upholstered	Square Mesh	Molded Black Vinyl	M245-3W42	\$1207.50	\$1273.65	\$1334.55	\$1377.60	\$1408.05	\$1425.90	\$1472.10	\$1601.25	\$1786.05	\$1944.50
	Round Mesh	Molded Black Vinyl	M245-4W42	1207.50	1273.65	1334.55	1377.60	1408.05	1425.90	1472.10	1601.25	1786.05	1944.50
Pneumatic Height/Lumbar													
Upholstered	Square Mesh	Molded Black Vinyl	M235-3W44	\$1275.75	\$1341.90	\$1402.80	\$1445.85	\$1476.30	\$1494.15	\$1540.35	\$1669.50	\$1854.30	\$2012.75
	Round Mesh	Molded Black Vinyl	M235-4W44	1275.75	1341.90	1402.80	1445.85	1476.30	1494.15	1540.35	1669.50	1854.30	2012.75
Pneumatic Height/Back-Lock/Lumbar													
Upholstered	Square Mesh	Molded Black Vinyl	M235-3W43	\$1320.90	\$1387.05	\$1447.95	\$1491.00	\$1521.45	\$1539.30	\$1585.50	\$1714.65	\$1899.45	\$2057.90
	Round Mesh	Molded Black Vinyl	M235-4W43	1320.90	1387.05	1447.95	1491.00	1521.45	1539.30	1585.50	1714.65	1899.45	2057.90
Pneumatic Height/Forward-Tilt/Lumbar													
Upholstered	Square Mesh	Molded Black Vinyl	M245-3W44	\$1320.90	\$1387.05	\$1447.95	\$1491.00	\$1521.45	\$1539.30	\$1585.50	\$1714.65	\$1899.45	\$2057.90
	Round Mesh	Molded Black Vinyl	M245-4W44	1320.90	1387.05	1447.95	1491.00	1521.45	1539.30	1585.50	1714.65	1899.45	2057.90

The following options require modification of the product number.

- Low-position seat height - Plastic
- Two-stage seat height- HAB
- Steel base - Standard height
- Steel base - Low height
- Soft casters
- Faux Leather upholstery
- Leather upholstery
- Nano-Tex

- To specify, change the 4th digit from a 5 to a 4; **Example:** M234-3W42
- To specify, change the 4th digit from a 5 to a 3; **Example:** M233-3W42 (add \$89.25 list)
- To specify, change the 4th digit from a 5 to a 6; **Example:** M236-3W42
- To specify, change the 4th digit from a 5 to a 7; **Example:** M237-3W42
- To specify, change the 7th digit from a 4 to a 2; **Example:** M235-3W22
- To specify, change the 2nd digit from a 2 to a 3; **Example:** M335-3W42
- To specify, change the 2nd digit from a 2 to a 1; **Example:** M135-3W42
- To specify, add **-P** to the end of the product number; **Example:** M235-3W42-P (add \$33.60 list)

NOTE: Nano-Tex on upholstered seat only.

For available fabrics see matrix in the back of the book or at Haworth.com/surfaces.

Improv Tag

General Specifications

Features and Options

All Improv Tag chairs feature:

- Molded-polyfoam contoured seat
- Mesh “form-fit” back
- Five-star plastic high arc base with black casters
- Hard dual-wheel casters (standard) or soft dual-wheel casters (optional)
- Pneumatic seat height adjustment
- Task arms, height-adjustable task arms, 3-D arms or armless
- Tilt tension
- Optional low-position seat height adjustment with steel base
- Optional back-lock
 - Back and seat recline at a 2:1 ration with no front seat rise
 - Back is lockable in two positions within tilt range
 - Back tilts backward 20 degrees from the upright position
 - Seat pan moves downward 10 degrees from the initial position
 - Back-lock and forward-tilt options cannot be specified on the same chair
- Optional forward-tilt
 - Both chair back and seat pan are lockable in three forward positions (1, 3 and 5 degrees)
 - Forward-tilt and back-lock options cannot be specified on the same chair
- Optional height and depth adjustable lumbar

COM & COL General Information

To order a COM fabric (Customer’s Own Material), contact the Haworth Inquiry Center (1.800.426.8562), your local Haworth dealer, or go to haworth.com/surfaces > COM Library to find out if the COM you have selected has already been tested and approved. The surface collection site also has information on the Haworth+ alliance program with Carnegie, Luna Textiles, and Maharam as well as our industry-leading Pre-Approved COM program.

Approved COMs are placed into Grades based on the fabric pricing; if the fabric pricing exceeds our Grades, they will be priced at Grade A + cost of fabric + 4% handling (North America). Haworth will purchase all COMs unless instructed otherwise. (Leather will also be purchased by Haworth; if the leather pricing exceeds our Grades, cost will be based on fabric Grade E + cost of leather + 4% handling.)

If no information is available on the COM you are looking for, refer to the COM section and forms on the surface collection site for information on how to process your test request.

General Guidelines for Product Specification

The alpha-numeric logic for an Improv Tag chair complete with fabric and finish codes is shown below:

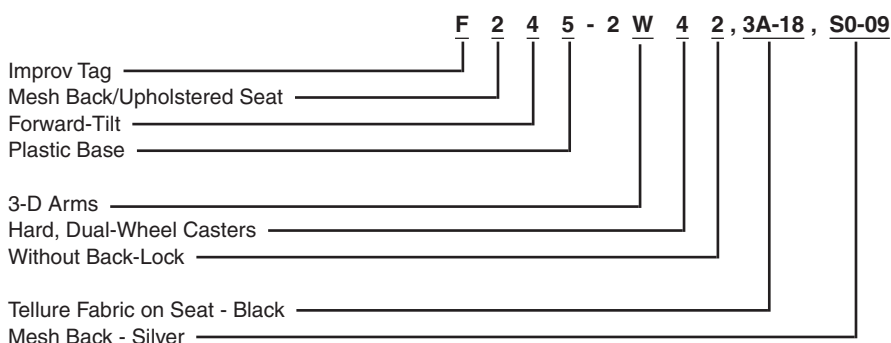

Improv Tag

Mesh Back without Arms



F235-2042

Dimensions

SH: 16" - 21"
(406mm-533mm)
H: 37" - 42"
(940mm-1067mm)
D: 25" - 27 1/2"
(635mm-699mm)
W: 25"(635mm)
SW: 20"(508mm)
SD: 15 1/2" - 18"
(394mm-457mm)

Features

- Soft mesh back.
 - Upholstered seat.
 - Pneumatic height adjustment.
 - Sliding seat.
 - Tilt tension.
 - Standard with hard casters; optional soft casters available.
 - Standard with five-star high arc plastic base; optional steel base available.
 - Optional back-lock.
 - Optional lumbar adjustment.
 - Optional forward-tilt.
 - Optional low-position seat height/steel base.
 - COM yardage / COL square footage:
Upholstered Seat: 0.75/20.0
- Available on RUSH.

To Order, Specify:

- 1) Product number.
- 2) Seat fabric.
- 3) Mesh back fabric.
TR-F Black trim (no need to specify).

Description	Number	Fabric Grade								Leather Grade A	Leather Grade B
		A	B	C	D	E	F	G	H		
Pneumatic Height	F235-2042 ■	\$ 929.25	\$ 995.40	\$1056.30	\$1099.35	\$1129.80	\$1147.65	\$1193.85	\$1323.00	\$1507.80	\$1666.25
Pneumatic Height/Back-Lock	F235-2041 ■	977.55	1043.70	1104.60	1147.65	1178.10	1195.95	1242.15	1371.30	1556.10	1714.55
Pneumatic Height/Back-Lock/Lumbar	F235-2043	1088.85	1155.00	1215.90	1258.95	1289.40	1307.25	1353.45	1482.60	1667.40	1825.85
Pneumatic Height/Lumbar	F235-2044	1040.55	1106.70	1167.60	1210.65	1241.10	1258.95	1305.15	1434.30	1619.10	1777.55
Pneumatic Height/Forward-Tilt	F245-2042 ■	976.50	1042.65	1103.55	1146.60	1177.05	1194.90	1241.10	1370.25	1555.05	1713.50
Pneumatic Height/Forward-Tilt/Lumbar	F245-2044	1087.80	1153.95	1214.85	1257.90	1288.35	1306.20	1352.40	1481.55	1666.35	1824.80

The following options require modification of the product number.

Low position seat height/plastic base	To specify, change the 4th digit from a 5 to a 4; Example: F234-2042
Steel base - Low height	To specify, change the 4th digit from a 5 to a 7; Example: F237-2042
Soft casters	To specify, change the 7th digit from a 4 to a 2; Example: F235-2022
Faux Leather seat	To specify, change the 2nd digit from a 2 to a 3; Example: F335-2042
Leather seat	To specify, change the 2nd digit from a 2 to a 1; Example: F135-2042
CAL 133	To specify, add -F to the end of the product number; Example: F235-2042-F (add \$101.85 list)
Nano-Tex	To specify, add -P to the end of the product number; Example: F235-2042-P (add \$33.60 list)

NOTE: Nano-Tex on upholstered seat only.

For available fabrics see matrix in the back of the book or at Haworth.com/surfaces.

Improv Tag

Mesh Back with Fixed-Height Task Arms



F235-2442

Dimensions

SH: 16" - 21"
(406mm-533mm)
H: 37" - 42"
(940mm-1067mm)
D: 25" - 27 1/2"
(635mm-699mm)
W: 25"(635mm)
SW: 20"(508mm)
SD: 15 1/2" - 18"
(394mm-457mm)

Features

- Soft mesh back.
- Upholstered seat.
- Pneumatic height adjustment.
- Fixed-height task arms.
- Sliding seat.
- Tilt tension.
- Standard with hard casters; optional soft casters available.
- Standard with five-star high arc plastic base; optional steel base available.
- Optional back-lock.
- Optional lumbar adjustment.
- Optional forward-tilt.
- Optional low position seat height/steel base.
- COM yardage / COL square footage:
Upholstered Seat: 0.75/20.0
- Available on RUSH.

To Order, Specify:

- 1) Product number.
- 2) Seat fabric.
- 3) Mesh back fabric.
TR-F Black trim (no need to specify).

Description	Arm Cap	Number	Fabric Grade						Leather Grade A	Leather Grade B		
			A	B	C	D	E	F			G	H
Pneumatic Height												
Standard		F235-2442 ■	\$1022.70	\$1088.85	\$1149.75	\$1192.80	\$1223.25	\$1241.10	\$1287.30	\$1416.45	\$1601.25	\$1759.70
Upholstered		F235-2542 ■	1073.10	1139.25	1200.15	1243.20	1273.65	1291.50	1337.70	1466.85	1651.65	1810.10
Vinyl		F235-2642 ■	1073.10	1139.25	1200.15	1243.20	1273.65	1291.50	1337.70	1466.85	1651.65	1810.10
Pneumatic Height/Back-Lock												
Standard		F235-2441 ■	\$1071.00	\$1137.15	\$1198.05	\$1241.10	\$1271.55	\$1289.40	\$1335.60	\$1464.75	\$1649.55	\$1808.00
Upholstered		F235-2541 ■	1121.40	1187.55	1248.45	1291.50	1321.95	1339.80	1386.00	1515.15	1699.95	1858.40
Vinyl		F235-2641 ■	1121.40	1187.55	1248.45	1291.50	1321.95	1339.80	1386.00	1515.15	1699.95	1858.40
Pneumatic Height/Back-Lock/Lumbar												
Standard		F235-2443	\$1182.30	\$1248.45	\$1309.35	\$1352.40	\$1382.85	\$1400.70	\$1446.90	\$1576.05	\$1760.85	\$1919.30
Upholstered		F235-2543	1232.70	1298.85	1359.75	1402.80	1433.25	1451.10	1497.30	1626.45	1811.25	1969.70
Vinyl		F235-2643	1232.70	1298.85	1359.75	1402.80	1433.25	1451.10	1497.30	1626.45	1811.25	1969.70
Pneumatic Height/Lumbar												
Standard		F235-2444	\$1134.00	\$1200.15	\$1261.05	\$1304.10	\$1334.55	\$1352.40	\$1398.60	\$1527.75	\$1712.55	\$1871.00
Upholstered		F235-2544	1184.40	1250.55	1311.45	1354.50	1384.95	1402.80	1449.00	1578.15	1762.95	1921.40
Vinyl		F235-2644	1184.40	1250.55	1311.45	1354.50	1384.95	1402.80	1449.00	1578.15	1762.95	1921.40
Pneumatic Height/Forward-Tilt												
Standard		F245-2442 ■	\$1069.95	\$1136.10	\$1197.00	\$1240.05	\$1270.50	\$1288.35	\$1334.55	\$1463.70	\$1648.50	\$1806.95
Upholstered		F245-2542 ■	1120.35	1186.50	1247.40	1290.45	1320.90	1338.75	1384.95	1514.10	1698.90	1857.35
Vinyl		F245-2642 ■	1120.35	1186.50	1247.40	1290.45	1320.90	1338.75	1384.95	1514.10	1698.90	1857.35
Pneumatic Height/Forward-Tilt/Lumbar												
Standard		F245-2444	\$1181.25	\$1247.40	\$1308.30	\$1351.35	\$1381.80	\$1399.65	\$1445.85	\$1575.00	\$1759.80	\$1918.25
Upholstered		F245-2544	1231.65	1297.80	1358.70	1401.75	1432.20	1450.05	1496.25	1625.40	1810.20	1968.65
Vinyl		F245-2644	1231.65	1297.80	1358.70	1401.75	1432.20	1450.05	1496.25	1625.40	1810.20	1968.65

The following options require modification of the product number.

Low position seat height/plastic base	To specify, change the 4th digit from a 5 to a 4; Example: F234-2543
Steel base - Low height	To specify, change the 4th digit from a 5 to a 7; Example: F237-2543
Soft casters	To specify, change the 7th digit from a 4 to a 2; Example: F235-2522
Faux Leather seat	To specify, change the 2nd digit from a 2 to a 3; Example: F345-2644
Leather seat	To specify, change the 2nd digit from a 2 to a 1; Example: F135-2544
CAL 133	To specify, add -F to the end of the product number; Example: F235-2442-F (add \$101.85 list)
Nano-Tex	To specify, add -P to the end of the product number; Example: F235-2442-P (add \$33.60 list)

NOTE: Nano-Tex on upholstered seat only.

For available fabrics see matrix in the back of the book or at Haworth.com/surfaces.

Improv Tag

Mesh Back with Height-Adjustable Task Arms



F235-2742

Dimensions

SH: 16" - 21"
(406mm-533mm)
H: 37" - 42"
(940mm-1067mm)
D: 25" - 27 1/2"
(635mm-699mm)
W: 25"(635mm)
SW: 20"(508mm)
SD: 15 1/2" - 18"
(394mm-457mm)

Features

- Soft mesh back.
- Upholstered seat.
- Pneumatic height adjustment.
- Height-adjustable task arms.
- Sliding seat.
- Tilt tension.
- Standard with hard casters; optional soft casters available.
- Standard with five-star high arc plastic base; optional steel base available.
- Optional back-lock.
- Optional lumbar adjustment.
- Optional forward-tilt.
- Optional low position seat height/steel base.
- COM yardage / COL square footage:
Upholstered Seat: 0.75/20.0
- Available on RUSH.

To Order, Specify:

- 1) Product number.
- 2) Seat fabric.
- 3) Mesh back fabric.
TR-F Black trim (no need to specify).

Description	Arm Cap	Number	Fabric Grade			C	D	E	F	G	H	Leather Grade A	Leather Grade B
			A	B									
Pneumatic Height													
Standard		F235-2742 ■	\$1126.65	\$1192.80	\$1253.70	\$1296.75	\$1327.20	\$1345.05	\$1391.25	\$1520.40	\$1705.20	\$1863.65	
Upholstered		F235-2842 ■	1177.05	1243.20	1304.10	1347.15	1377.60	1395.45	1441.65	1570.80	1755.60	1914.05	
Vinyl		F235-2942 ■	1177.05	1243.20	1304.10	1347.15	1377.60	1395.45	1441.65	1570.80	1755.60	1914.05	
Pneumatic Height/Back-Lock													
Standard		F235-2741 ■	\$1174.95	\$1241.10	\$1302.00	\$1345.05	\$1375.50	\$1393.35	\$1439.55	\$1568.70	\$1753.50	\$1911.95	
Upholstered		F235-2841 ■	1225.35	1291.50	1352.40	1395.45	1425.90	1443.75	1489.95	1619.10	1803.90	1962.35	
Vinyl		F235-2941 ■	1225.35	1291.50	1352.40	1395.45	1425.90	1443.75	1489.95	1619.10	1803.90	1962.35	
Pneumatic Height/Back-Lock/Lumbar													
Standard		F235-2743	\$1286.25	\$1352.40	\$1413.30	\$1456.35	\$1486.80	\$1504.65	\$1550.85	\$1680.00	\$1864.80	\$2023.25	
Upholstered		F235-2843	1336.65	1402.80	1463.70	1506.75	1537.20	1555.05	1601.25	1730.40	1915.20	2073.65	
Vinyl		F235-2943	1336.65	1402.80	1463.70	1506.75	1537.20	1555.05	1601.25	1730.40	1915.20	2073.65	
Pneumatic Height/Lumbar													
Standard		F235-2744	\$1237.95	\$1304.10	\$1365.00	\$1408.05	\$1438.50	\$1456.35	\$1502.55	\$1631.70	\$1816.50	\$1974.95	
Upholstered		F235-2844	1288.35	1354.50	1415.40	1458.45	1488.90	1506.75	1552.95	1682.10	1866.90	2025.35	
Vinyl		F235-2944	1288.35	1354.50	1415.40	1458.45	1488.90	1506.75	1552.95	1682.10	1866.90	2025.35	
Pneumatic Height/Forward-Tilt													
Standard		F245-2742 ■	\$1173.90	\$1240.05	\$1300.95	\$1344.00	\$1374.45	\$1392.30	\$1438.50	\$1567.65	\$1752.45	\$1910.90	
Upholstered		F245-2842 ■	1224.30	1290.45	1351.35	1394.40	1424.85	1442.70	1488.90	1618.05	1802.85	1961.30	
Vinyl		F245-2942 ■	1224.30	1290.45	1351.35	1394.40	1424.85	1442.70	1488.90	1618.05	1802.85	1961.30	
Pneumatic Height/Forward-Tilt/Lumbar													
Standard		F245-2744	\$1285.20	\$1351.35	\$1412.25	\$1455.30	\$1485.75	\$1503.60	\$1549.80	\$1678.95	\$1863.75	\$2022.20	
Upholstered		F245-2844	1335.60	1401.75	1462.65	1505.70	1536.15	1554.00	1600.20	1729.35	1914.15	2072.60	
Vinyl		F245-2944	1335.60	1401.75	1462.65	1505.70	1536.15	1554.00	1600.20	1729.35	1914.15	2072.60	

The following options require modification of the product number.

- | | |
|---------------------------------------|---|
| Low position seat height/plastic base | To specify, change the 4th digit from a 5 to a 4; Example: F234-2843 |
| Steel base - Low height | To specify, change the 4th digit from a 5 to a 7; Example: F237-2843 |
| Soft casters | To specify, change the 7th digit from a 4 to a 2; Example: F235-2822 |
| Faux Leather seat | To specify, change the 2nd digit from a 2 to a 3; Example: F345-2944 |
| Leather seat | To specify, change the 2nd digit from a 2 to a 1; Example: F135-2844 |
| CAL 133 | To specify, add -F to the end of the product number; Example: F235-2743-F (add \$101.85 list) |
| Nano-Tex | To specify, add -P to the end of the product number; Example: F235-2742-P (add \$33.60 list) |

NOTE: Nano-Tex on upholstered seat only.

For available fabrics see matrix in the back of the book or at Haworth.com/surfaces.

Improv Tag

Mesh Back with Height- and Width-Adjustable 3-D Arms



F235-2W42

Dimensions

SH: 16" - 21"
(406mm-533mm)
H: 37" - 42"
(940mm-1067mm)
D: 25" - 27 1/2"
(635mm-699mm)
W: 25"(635mm)
SW: 20"(508mm)
SD: 15 1/2" - 18"
(394mm-457mm)

Features

- Soft mesh back.
- Upholstered seat.
- Pneumatic height adjustment.
- Height- and width-adjustable 3-D arms with molded black vinyl arm caps.
- Sliding seat.
- Tilt tension.
- Standard with hard casters; optional soft casters available.
- Standard with five-star high arc plastic base; optional steel base available.
- Optional back-lock.
- Optional lumbar adjustment.
- Optional forward-tilt.
- Optional low position seat height/steel base.
- COM yardage / COL square footage:
Upholstered Seat: 0.75/20.0

To Order, Specify:

- 1) Product number.
- 2) Seat fabric.
- 3) Mesh back fabric.
TR-F Black trim (no need to specify).

Description	Number	Fabric Grade								Leather Grade A	Leather Grade B
		A	B	C	D	E	F	G	H		
Pneumatic Height	F235-2W42	\$1254.75	\$1320.90	\$1381.80	\$1424.85	\$1455.30	\$1473.15	\$1519.35	\$1648.50	\$1833.30	\$1991.75
Pneumatic Height/Back-Lock	F235-2W41	1303.05	1369.20	1430.10	1473.15	1503.60	1521.45	1567.65	1696.80	1881.60	2040.05
Pneumatic Height/Back-Lock/Lumbar	F235-2W43	1414.35	1480.50	1541.40	1584.45	1614.90	1632.75	1678.95	1808.10	1992.90	2151.35
Pneumatic Height/Lumbar	F235-2W44	1366.05	1432.20	1493.10	1536.15	1566.60	1584.45	1630.65	1759.80	1944.60	2103.05
Pneumatic Height/Forward-Tilt	F245-2W42	1302.00	1368.15	1429.05	1472.10	1502.55	1520.40	1566.60	1695.75	1880.55	2039.00
Pneumatic Height/Forward-Tilt/Lumbar	F245-2W44	1413.30	1479.45	1540.35	1583.40	1613.85	1631.70	1677.90	1807.05	1991.85	2150.30

The following options require modification of the product number.

Low position seat height/plastic base	To specify, change the 4th digit from a 5 to a 4; Example: F234-2W42
Steel base - Low height	To specify, change the 4th digit from a 5 to a 7; Example: F237-2W42
Soft casters	To specify, change the 7th digit from a 4 to a 2; Example: F235-2W22
Faux Leather seat	To specify, change the 2nd digit from a 2 to a 3; Example: F345-2W42
Leather seat	To specify, change the 2nd digit from a 2 to a 1; Example: F135-2W42
CAL 133	To specify, add -F to the end of the product number; Example: F235-2W43-F (add \$101.85 list)
Nano-Tex	To specify, add -P to the end of the product number; Example: F235-2W42-P (add \$33.60 list)

NOTE: Nano-Tex on upholstered seat only.

For available fabrics see matrix in the back of the book or at Haworth.com/surfaces.

Improv Series

Leg-Base Stacking Chairs

With Arms

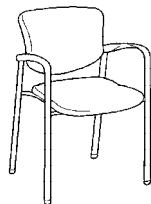

M600-2110

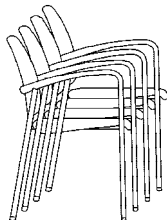

Dimensions

- H: 32"(813mm)
- W: 22"(559mm)
- D: 21 1/2"(546mm)
- SH: 18"(457mm)
- SD: 18"(457mm)
- SW: 19"(483mm)
- AH: 25 3/4"(654mm)

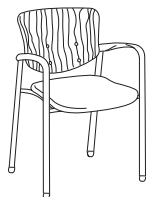

M600-2310

Features

- Optional: Full wood back.
- Optional: Legs with casters.
- Polypropylene or upholstered outer back shell.
- With glides, stacks 6-high (44"(1118mm)) on floor or 10-high (62"(1575mm)) on stacking dolly.
- With casters, stacks 5-high (42"(1067mm)) on floor or 6-high (50"(1270mm)) on dolly.
- Arms and molded floor glides match frame color except when ordering Metallic trim; molded components are available in black or smoke and must be specified.
- Non-gangling or gangling options. NOTE: An arm chair adjacent to a tablet arm cannot be ganged together.
- Optional book rack, see page 193.
- Fire retardant construction is available to comply with California Bulletin #133, see below.
- COM yardage/COL square footage:
Polypropylene back shell/upholstered seat: 0.75/15
Upholstered shell/seat: 1.25/28
Upholstered seat (wood back): 0.5

■ Available on RUSH.

* All measurements taken with the BIFMA chair measuring device.

To Order, Specify:

- 1) Product number.
- 2) Fabric surface and color.
- 3) Frame/arms trim color.
- 4) Arm and glide trim color for metallic frame black or smoke option only.

To Order Chair with Wood Back, Specify:

- 1) Product number.
- 2) Fabric surface and color (seat).
- 3) Frame trim color.
- 4) Arm and glide trim color for metallic frame black or smoke option only.
- 5) Wood back finish color.

Outer/Inner Back Shell	Gangling	Number	Fabric Grade								Leather Grade A	Leather Grade B
			A	B	C	D	E	F	G	H		
Polypropylene/Upholstered	Non-gangling	M600-2110 ■	\$415.84	\$445.00	\$456.88	\$483.88	\$508.72	\$549.76	\$578.92	\$658.84	\$702.04	\$ 843.84
	Gangling	M600-2110-5	465.52	494.68	506.56	533.56	558.40	599.44	628.60	708.52	751.72	893.52
Upholstered/Upholstered	Non-gangling	M600-2210 ■	\$474.16	\$513.04	\$538.96	\$576.76	\$616.72	\$657.76	\$691.24	\$792.76	\$865.12	\$1086.84
	Gangling	M600-2210-5	523.84	562.72	588.64	626.44	666.40	707.44	740.92	842.44	914.80	1136.52
Wood Back	Non-gangling	M600-2310 ■	\$519.52	\$548.68	\$560.56	\$587.56	\$612.40	\$653.44	\$682.60	\$762.52	\$805.72	\$ 947.52
	Gangling	M600-2310-5	569.20	598.36	610.24	637.24	662.08	703.12	732.28	812.20	855.40	997.20

The following options require modification of the product number.

- Metallic trim color
- Hard casters
- Soft casters
- CAL 133
- Nano-TEX
- DuraBlock

To specify, add **-M** after the 8th digit; **Example:** M600-2110-M

To specify, change the 8th digit from a 0 to a 2; **Example:** M600-2112 (add \$55.08 list)

To specify, change the 8th digit from a 0 to a 4; **Example:** M600-2114 (add \$55.08 list)

To specify, add **-F** to the end of the product number; **Example:** M600-2210-F (add \$55.08 list)

To specify, add **-P** to the end of the product number; **Example:** M600-2110-P (add \$34.56 list)

To specify, add **-D** to the end of the product number; **Example:** M600-2110-D (add \$45.36 list)

NOTE: CAL 133 is available on fully upholstered outer back and wood back chair models only.

Caster option chairs also available on RUSH.

Casters should not be used on thick pile carpet applications.

On upholstered poly back and wood back models only.

For available fabrics see matrix in the back of the book or at Haworth.com/surfaces.

Improv Series

Leg-Base Stacking Chairs

Without Arms

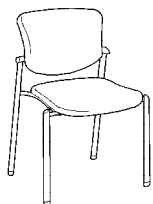

M600-2100

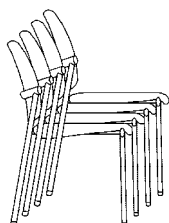

Dimensions

H: 32"(813mm)
 W: 22"(559mm)
 D: 21 1/2"(546mm)
 SH: 18"(457mm)
 SD: 18"(457mm)
 SW: 19"(483mm)

Features

- Optional: Full wood back.
- Polypropylene or upholstered outer back shell.
- Stacks 6-high (44"(1118mm)) on floor or 10-high (58"(1473mm)) on stacking dolly.
- High-density polyethylene leg caps and molded floor glides match frame color except when ordering Metallic trim; molded components are available in black or smoke and must be specified.
- Non-gangling or gangling options.
- Optional book rack, see page 193.
- Fire retardant construction is available to comply with California Bulletin #133, see below.
- COM yardage/COL square footage:
 Polypropylene back shell/upholstered seat: 0.75/15
 Upholstered shell/seat: 1.25/28
 Upholstered seat (wood back): 0.5

To Order, Specify:

- 1) Product number.
- 2) Fabric surface and color.
- 3) Frame trim color.
- 4) Leg caps and glides color for metallic frame black or smoke option only.

To Order Chair with Wood Back, Specify:

- 1) Product number.
- 2) Fabric surface and color (seat).
- 3) Frame trim color.
- 4) Leg caps and glides color for metallic frame black or smoke option only.
- 5) Wood back finish color.



M600-2300

Outer/Inner Back Shell	Gangling	Number	Fabric Grade								Leather Grade A	Leather Grade B
			A	B	C	D	E	F	G	H		
Polypropylene/Upholstered	Non-gangling	M600-2100	\$391.00	\$420.16	\$432.04	\$459.04	\$483.88	\$524.92	\$554.08	\$634.00	\$677.20	\$ 819.00
	Gangling	M600-2100-5	440.68	469.84	481.72	508.72	533.56	574.60	603.76	683.68	726.88	868.68
Upholstered/Upholstered	Non-gangling	M600-2200	\$449.32	\$488.20	\$514.12	\$551.92	\$591.88	\$632.92	\$666.40	\$767.92	\$840.28	\$1062.00
	Gangling	M600-2200-5	499.00	537.88	563.80	601.60	641.56	682.60	716.08	817.60	889.96	1111.68
Wood Back	Non-gangling	M600-2300	\$494.68	\$523.84	\$535.72	\$562.72	\$587.56	\$628.60	\$657.76	\$737.68	\$780.88	\$ 922.68
	Gangling	M600-2300-5	544.36	573.52	585.40	612.40	637.24	678.28	707.44	787.36	830.56	972.36

The following options require modification of the product number.

Metallic trim color
 CAL 133
 Nano-Tex
 DuraBlock

To specify, add **-M** after the 8th digit; **Example:** M600-2100-**M**

To specify, add **-F** to the end of the product number; **Example:** M600-2200-**F** (add \$55.08 list)

To specify, add **-P** to the end of the product number; **Example:** M600-2100-**P** (add \$34.56 list)

To specify, add **-D** to the end of the product number; **Example:** M600-2100-**D** (add \$45.36 list)

NOTE: CAL 133 is available on fully upholstered outer back and wood back chair models only.

On upholstered poly back and wood back models only.

For available fabrics see matrix in the back of the book or at Haworth.com/surfaces.

Improv Series

Leg-Base Stacking Chair with Tablet Arm

With Tablet Arm

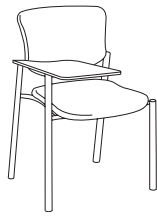

M600-2190
(Right-hand shown)

Dimensions

H: 32"(813mm)
W: 23 1/4"(591mm)
D: 26 3/4"(679mm)
SH: 18"(457mm)
SD: 18"(457mm)
SW: 19"(483mm)
AH: 27"(686mm)

Features

- Polypropylene or upholstered outer back shell.
- Leg caps, tablet arm and molded floor glides match frame color except when ordering Metallic trim; molded components are available in black or smoke and must be specified.
- Non-ganging or ganging options. NOTE: A tablet arm adjacent to another tablet arm or arm chair cannot be ganged together.
- Tablet is plywood core with high-pressure laminate surface and clear lacquered edge.
- Tablet flips up for easier access to seat.
- Optional book rack, see page 193.
- Fire retardant construction is available to comply with California Bulletin #133, see below.
- COM yardage/COL square footage:
Polypropylene back shell: 0.75/15
Upholstered back shell: 1.25/28

To Order, Specify:

- 1) Product number.
- 2) Fabric surface and color.
- 3) Frame trim color.
- 4) Leg caps, tablet arm and glides color for metallic frame black or smoke option only.
- 5) Tablet laminate surface color.

Outer Back Shell	Ganging	11"(279mm)		Fabric Grade								Leather Grade A	Leather Grade B
		Tablet	Number	A	B	C	D	E	F	G	H		
Polypropylene	Non-ganging	Right-hand	M600-2190	\$571.36	\$600.52	\$612.40	\$639.40	\$664.24	\$705.28	\$734.44	\$814.36	\$ 857.56	\$ 999.36
		Left-hand	M600-2180	571.36	600.52	612.40	639.40	664.24	705.28	734.44	814.36	857.56	999.36
	Ganging	Right-hand	M600-2190-5	621.04	650.20	662.08	689.08	713.92	754.96	784.12	864.04	907.24	1049.04
		Left-hand	M600-2180-5	621.04	650.20	662.08	689.08	713.92	754.96	784.12	864.04	907.24	1049.04
Upholstered	Non-ganging	Right-hand	M600-2290	\$629.68	\$668.56	\$694.48	\$732.28	\$772.24	\$813.28	\$846.76	\$948.28	\$1020.64	\$1242.36
		Left-hand	M600-2280	629.68	668.56	694.48	732.28	772.24	813.28	846.76	948.28	1020.64	1242.36
	Ganging	Right-hand	M600-2290-5	679.36	718.24	744.16	781.96	821.92	862.96	896.44	997.96	1070.32	1292.04
		Left-hand	M600-2280-5	679.36	718.24	744.16	781.96	821.92	862.96	896.44	997.96	1070.32	1292.04

Outer Back Shell	Ganging	14"(356mm)		Fabric Grade								Leather Grade A	Leather Grade B
		Tablet	Number	A	B	C	D	E	F	G	H		
Polypropylene	Non-ganging	Right-hand	M600-2170	\$598.36	\$627.52	\$639.40	\$666.40	\$691.24	\$732.28	\$761.44	\$ 841.36	\$ 884.56	\$1026.36
		Left-hand	M600-2160	598.36	627.52	639.40	666.40	691.24	732.28	761.44	841.36	884.56	1026.36
	Ganging	Right-hand	M600-2170-5	648.04	677.20	689.08	716.08	740.92	781.96	811.12	891.04	934.24	1076.04
		Left-hand	M600-2160-5	648.04	677.20	689.08	716.08	740.92	781.96	811.12	891.04	934.24	1076.04
Upholstered	Non-ganging	Right-hand	M600-2270	\$656.68	\$695.56	\$721.48	\$759.28	\$799.24	\$840.28	\$873.76	\$ 975.28	\$1047.64	\$1269.36
		Left-hand	M600-2260	656.68	695.56	721.48	759.28	799.24	840.28	873.76	975.28	1047.64	1269.36
	Ganging	Right-hand	M600-2270-5	706.36	745.24	771.16	808.96	848.92	889.96	923.44	1024.96	1097.32	1319.04
		Left-hand	M600-2260-5	706.36	745.24	771.16	808.96	848.92	889.96	923.44	1024.96	1097.32	1319.04

The following options require modification of the product number.

Metallic trim color
CAL 133

To specify, add **-M** after the 8th digit; **Example:** M600-2190-M

To specify, add **-F** to the end of the product number; **Example:** M600-2290-F (add \$55.08 list)

NOTE: CAL 133 is available on fully upholstered outer back and wood back chair models only.

Improv Series

Sled-Base Chairs

With Arms, Non-Stacking

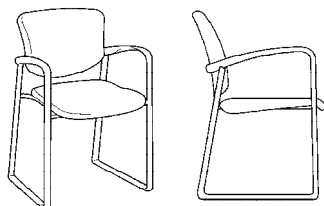

M601-2110

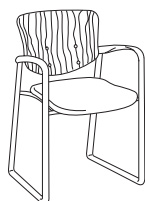

M601-2310

Dimensions

H: 32"(813mm)
 W: 22"(559mm)
 D: 21 1/2"(546mm)
 SH: 18"(457mm)
 SD: 18"(457mm)
 SW: 19"(483mm)
 AH: 25 3/4"(654mm)

Features

- Optional: Full wood back.
- Polypropylene or upholstered outer back shell.
- Non-stacking.
- Arms and nylon sled-base runners match frame color except when ordering Metallic trim; molded components are available black or smoke and must be specified.
- Non-gangng or gangng options. NOTE: An arm chair adjacent to a tablet arm cannot be gangnged together.
- Optional book rack, see page 193.
- Fire retardant construction is available to comply with California Bulletin #133, see below.
- COM yardage/COL square footage:
 Polypropylene back shell/upholstered seat: 0.75/15
 Upholstered shell/seat: 1.25/28
 Upholstered seat (wood back): 0.5
- Available on RUSH.

To Order, Specify:

- 1) Product number.
- 2) Fabric surface and color.
- 3) Frame trim color.
- 4) Arm and sled base runners for metallic frame black or smoke option only.

To Order Chair with Wood Back, Specify:

- 1) Product number.
- 2) Fabric surface and color (seat).
- 3) Frame trim color.
- 4) Arm and sled base runners for metallic frame black or smoke option only.
- 5) Wood back finish color.

Outer/Inner Back Shell	Gangng	Number	Fabric Grade								Leather Grade A	Leather Grade B
			A	B	C	D	E	F	G	H		
Polypropylene/Upholstered	Non-gangng	M601-2110 ■	\$541.12	\$570.28	\$582.16	\$609.16	\$634.00	\$675.04	\$704.20	\$784.12	\$ 827.32	\$ 969.12
	Gangng	M601-2110-5	590.80	619.96	631.84	658.84	683.68	724.72	753.88	833.80	877.00	1018.80
Upholstered/Upholstered	Non-gangng	M601-2210 ■	\$599.44	\$638.32	\$664.24	\$702.04	\$742.00	\$783.04	\$816.52	\$918.04	\$ 990.40	\$1212.12
	Gangng	M601-2210-5	649.12	688.00	713.92	751.72	791.68	832.72	866.20	967.72	1040.08	1261.80
Wood Back	Non-gangng	M601-2310 ■	\$644.80	\$673.96	\$685.84	\$712.84	\$737.68	\$778.72	\$807.88	\$887.80	\$ 931.00	\$1072.80
	Gangng	M601-2310-5	694.48	723.64	735.52	762.52	787.36	828.40	857.56	937.48	980.68	1122.48

The following options require modification of the product number.

Metallic trim color
 CAL 133
 Nano-TEX
 DuraBlock

To specify, add **-M** after the 8th digit; **Example:** M601-2110-M

To specify, add **-F** to the end of the product number; **Example:** M601-2210-F (add \$55.08 list)

To specify, add **-P** to the end of the product number; **Example:** M601-2110-P (add \$34.56 list)

To specify, add **-D** to the end of the product number; **Example:** M601-2110-D (add \$45.36 list)

NOTE: CAL 133 is available on fully upholstered outer back and wood back chair models only.

On upholstered poly back and wood back models only.

For available fabrics see matrix in the back of the book or at Haworth.com/surfaces.

Improv Series

Sled-Base Chairs

Without Arms, Non-Stacking

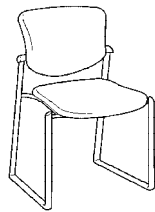

M601-2100

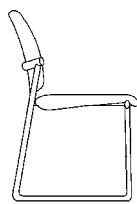

Dimensions

- H: 32"(813mm)
- W: 22"(559mm)
- D: 21 1/2"(546mm)
- SH: 18"(457mm)
- SD: 18"(457mm)
- SW: 19"(483mm)

Features

- Optional: Full wood back.
- Polypropylene or upholstered outer back shell.
- Non-stacking.
- High-density polyethylene leg caps and nylon sled-base runners match frame color except when ordering Metallic trim; molded components are available in black or smoke and must be specified.
- Wood back chairs have four color-matched bolts: black, graphite, smoke and Metallic trim chairs are standard with black bolts, and grey tone and stone chairs are standard with bronze bolts.
- Non-ganging or ganging options.
- Optional book rack, see page 193.
- Fire retardant construction is available to comply with California Bulletin #133, see below.
- COM yardage/COL square footage:
Polypropylene back shell/upholstered seat: 0.75/15
Upholstered back shell/seat: 1.25/28
Upholstered seat (wood back): 0.5

To Order, Specify:

- 1) Product number.
- 2) Fabric surface and color.
- 3) Frame trim color.
- 4) Leg caps and sled base runners color for metallic frame black or smoke option only.

To Order Chair with Wood Back, Specify:

- 1) Product number.
- 2) Fabric surface and color (seat).
- 3) Frame trim color.
- 4) Leg caps and sled base runners color for metallic frame black or smoke option only.
- 5) Wood back finish color.

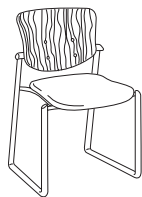

M601-2300

Outer/Inner Back Shell	Ganging	Number	Fabric Grade								Leather Grade A	Leather Grade B
			A	B	C	D	E	F	G	H		
Polypropylene/Upholstered	Non-ganging	M601-2100	\$516.28	\$545.44	\$557.32	\$584.32	\$609.16	\$650.20	\$679.36	\$759.28	\$ 802.48	\$ 944.28
	Ganging	M601-2100-5	565.96	595.12	607.00	634.00	658.84	699.88	729.04	808.96	852.16	993.96
Upholstered/Upholstered	Non-ganging	M601-2200	\$574.60	\$613.48	\$639.40	\$677.20	\$717.16	\$758.20	\$791.68	\$893.20	\$ 965.56	\$1187.28
	Ganging	M601-2200-5	624.28	663.16	689.08	726.88	766.84	807.88	841.36	942.88	1015.24	1236.96
Wood Back	Non-ganging	M601-2300	\$619.96	\$649.12	\$661.00	\$688.00	\$712.84	\$753.88	\$783.04	\$862.96	\$ 906.16	\$1047.96
	Ganging	M601-2300-5	669.64	698.80	710.68	737.68	762.52	803.56	832.72	912.64	955.84	1097.64

The following options require modification of the product number.

- Metallic trim color
- CAL 133
- Nano-Tex
- DuraBlock

To specify, add **-M** after the 8th digit; **Example:** M601-2100-**M**

To specify, add **-F** to the end of the product number; **Example:** M601-2200-**F** (add \$55.08 list)

To specify, add **-P** to the end of the product number; **Example:** M601-2100-**P** (add \$34.56 list)

To specify, add **-D** to the end of the product number; **Example:** M601-2100-**D** (add \$45.36 list)

NOTE: CAL 133 is available on fully upholstered outer back and wood back chair models only.

On upholstered poly back and wood back models only.

For available fabrics see matrix in the back of the book or at Haworth.com/surfaces.

Improv Series

Sled-Base Chair with Tablet Arm

Non-Stacking

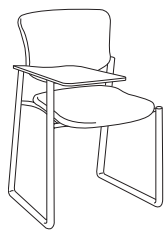

M601-2190
(Right-hand shown)



Dimensions

- H: 32"(813mm)
- W: 23 1/4"(591mm)
- D: 26 3/4"(679mm)
- H: 18"(457mm)
- SD: 18"(457mm)
- SW: 19"(483mm)
- AH: 27"(686mm)

Features

- Polypropylene or upholstered outer back shell.
- Non-stacking.
- High-density polyethylene leg caps, tablet arm and nylon sled-base runners match frame color except when ordering Metallic trim; molded components are available in black or smoke and must be specified.
- Non-ganging or ganging options. NOTE: A tablet arm adjacent to another tablet arm or arm chair cannot be ganged together.
- Tablet is plywood core with high-pressure laminate surface and clear lacquered edge.
- Tablet flips up for easier access to seat.
- Optional book rack, see page 193.
- Fire retardant construction is available to comply with California Bulletin #133, see below.
- COM yardage/COL square footage:
Polypropylene back shell: 0.75/15
Upholstered back shell: 1.25/28

To Order, Specify:

- 1) Product number.
- 2) Fabric surface and color.
- 3) Frame trim color.
- 4) Leg caps, tablet arm and steel base runners color for metallic frame black or smoke option only.
- 5) Tablet laminate surface color.

Outer Back Shell	Ganging	11"(279mm) Tablet		Fabric Grade								Leather Grade A	Leather Grade B
		Right-hand	Left-hand	A	B	C	D	E	F	G	H		
Polypropylene	Non-ganging	Right-hand	M601-2190	\$696.64	\$725.80	\$737.68	\$764.68	\$789.52	\$830.56	\$ 859.72	\$ 939.64	\$ 982.84	\$1124.64
		Left-hand	M601-2180	696.64	725.80	737.68	764.68	789.52	830.56	859.72	939.64	982.84	1124.64
	Ganging	Right-hand	M601-2190-5	746.32	775.48	787.36	814.36	839.20	880.24	909.40	989.32	1032.52	1174.32
		Left-hand	M601-2180-5	746.32	775.48	787.36	814.36	839.20	880.24	909.40	989.32	1032.52	1174.32
Upholstered	Non-ganging	Right-hand	M601-2290	\$754.96	\$793.84	\$819.76	\$857.56	\$897.52	\$938.56	\$ 972.04	\$1073.56	\$1145.92	\$1367.64
		Left-hand	M601-2280	754.96	793.84	819.76	857.56	897.52	938.56	972.04	1073.56	1145.92	1367.64
	Ganging	Right-hand	M601-2290-5	804.64	843.52	869.44	907.24	947.20	988.24	1021.72	1123.24	1195.60	1417.32
		Left-hand	M601-2280-5	804.64	843.52	869.44	907.24	947.20	988.24	1021.72	1123.24	1195.60	1417.32

Outer Back Shell	Ganging	14"(356mm) Tablet		Fabric Grade								Leather Grade A	Leather Grade B
		Right-hand	Left-hand	A	B	C	D	E	F	G	H		
Polypropylene	Non-ganging	Right-hand	M601-2170	\$723.64	\$752.80	\$764.68	\$791.68	\$816.52	\$ 857.56	\$ 886.72	\$ 966.64	\$1009.84	\$1151.64
		Left-hand	M601-2160	723.64	752.80	764.68	791.68	816.52	857.56	886.72	966.64	1009.84	1151.64
	Ganging	Right-hand	M601-2170-5	773.32	802.48	814.36	841.36	866.20	907.24	936.40	1016.32	1059.52	1201.32
		Left-hand	M601-2160-5	773.32	802.48	814.36	841.36	866.20	907.24	936.40	1016.32	1059.52	1201.32
Upholstered	Non-ganging	Right-hand	M601-2270	\$781.96	\$820.84	\$846.76	\$884.56	\$924.52	\$ 965.56	\$ 999.04	\$1100.56	\$1172.92	\$1394.64
		Left-hand	M601-2260	781.96	820.84	846.76	884.56	924.52	965.56	999.04	1100.56	1172.92	1394.64
	Ganging	Right-hand	M601-2270-5	831.64	870.52	896.44	934.24	974.20	1015.24	1048.72	1150.24	1222.60	1444.32
		Left-hand	M601-2260-5	831.64	870.52	896.44	934.24	974.20	1015.24	1048.72	1150.24	1222.60	1444.32

The following options require modification of the product number.

- Metallic trim color
- CAL 133
- Nano-TEX
- DuraBlock

To specify, add **-M** after the 8th digit; **Example:** M601-2190-M

To specify, add **-F** to the end of the product number; **Example:** M601-2290-F (add \$55.08 list)

To specify, add **-P** to the end of the product number; **Example:** M601-2190-P (add \$34.56 list)

To specify, add **-D** to the end of the product number; **Example:** M601-2190-D (add \$45.36 list)

NOTE: CAL 133 is available on fully upholstered outer back and wood back chair models only.

On upholstered poly back and wood back models only.

For available fabrics see matrix in the back of the book or at Haworth.com/surfaces.

Improv Series

Stools

With Arms

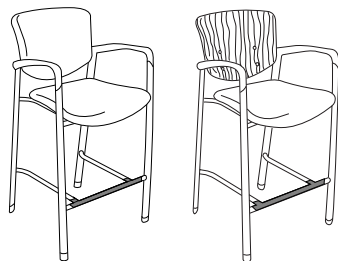

M600-8110

M600-8310

Dimensions

SH: 27 1/2"(699mm)
 H: 41 1/4"(1048mm)
 D: 23"(584mm)
 W: 22"(559mm)
 SW: 19"(483mm)
 SD: 18"(457mm)
 BW: 18 1/4"(464mm)
 AH: 35 1/2"(902mm)
 FH: 10 1/2"(267mm)

Features

- Optional: Full wood back.
- Polypropylene or upholstered outer back shell.
- Arms and molded floor glides match frame color except when ordering Metallic trim; molded components are available in black or smoke and must be specified.
- Wood back chairs have four color-matched bolts: black, graphite, smoke and Metallic trim chairs are standard with black bolts, and grey tone, stone and tan chairs are standard with blackened bronze bolts.
- Distance between the arms is 19 1/4"(489mm).
- Foot rest nylon cover is available in charcoal finish color only.
- Fire retardant construction is available to comply with California Bulletin #133, see below.
- COM yardage/COL square footage:
 Polypropylene shell: 0.75/15
 Upholstered shell: 1.25/28
 Upholstered seat (wood back): 0.5

To Order, Specify:

- 1) Product number.
- 2) Fabric surface and color.
- 3) Frame trim color.
- 4) Arms and glides color for metallic frame black or smoke option only.

To Order Stool with Wood Back, Specify:

- 1) Product number.
- 2) Fabric surface and color (seat).
- 3) Frame trim color.
- 4) Arms and glides color for metallic frame black or smoke option only.
- 5) Wood back finish color.

■ Available on RUSH.

Outer/Inner Back Shell	Number	Fabric Grade								Leather Grade A	Leather Grade B
		A	B	C	D	E	F	G	H		
Polypropylene/Upholstered	M600-8110 ■	\$730.12	\$759.28	\$771.16	\$798.16	\$823.00	\$864.04	\$ 893.20	\$ 973.12	\$1016.32	\$1158.12
Upholstered/Upholstered	M600-8210 ■	788.44	827.32	853.24	891.04	931.00	972.04	1005.52	1107.04	1179.40	1401.12
Wood Back	M600-8310 ■	833.80	862.96	874.84	901.84	926.68	967.72	996.88	1076.80	1120.00	1261.80

The following options require modification of the product number.

Metallic trim color
 CAL 133

To specify, add **-M** after the 8th digit; **Example:** M600-8110-M

To specify, add **-F** to the end of the product number; **Example:** M600-8210-F (add \$55.08 list)

NOTE: CAL 133 is available on fully upholstered outer back and wood back chair models only.

Without Arms

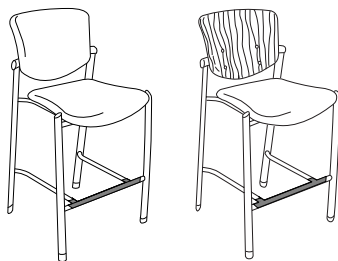

M600-8100

M600-8300

Dimensions

SH: 27 1/2"(699mm)
 H: 41 1/4"(1048mm)
 D: 23"(584mm)
 W: 22"(559mm)
 SW: 19"(483mm)
 SD: 18"(457mm)
 BW: 18 1/4"(464mm)
 FH: 10 1/2"(267mm)

Features

- Optional: Full wood back.
- Polypropylene or upholstered outer back shell.
- High-density polyethylene leg caps and molded floor glides match frame color except when ordering Metallic trim; molded components are available in black or smoke and must be specified.
- Wood back chairs have four color-matched bolts: black, graphite, smoke and Metallic trim chairs are standard with black bolts, and grey tone, stone and tan chairs are standard with blackened bronze bolts.
- Foot rest nylon cover is available in charcoal finish color only.
- Fire retardant construction is available to comply with California Bulletin #133, see below.
- COM yardage/COL square footage:
 Polypropylene shell: 0.75/15
 Upholstered shell: 1.25/28
 Upholstered seat (wood back): 0.5

To Order, Specify:

- 1) Product number.
- 2) Fabric surface and color.
- 3) Frame trim color.
- 4) Leg caps and glides color for metallic frame black or smoke option only.

To Order Stool with Wood Back, Specify:

- 1) Product number.
- 2) Fabric surface and color (seat).
- 3) Frame trim color.
- 4) Leg caps and glides color for metallic frame black or smoke option only.
- 5) Wood back finish color.

■ Available on RUSH.

Polypropylene/Upholstered	M600-8100 ■	\$705.28	\$734.44	\$746.32	\$773.32	\$798.16	\$839.20	\$868.36	\$ 948.28	\$ 991.48	\$1133.28
Upholstered/Upholstered	M600-8200 ■	763.60	802.48	828.40	866.20	906.16	947.20	980.68	1082.20	1154.56	1376.28
Wood Back	M600-8300 ■	808.96	838.12	850.00	877.00	901.84	942.88	972.04	1051.96	1095.16	1236.96

The following options require modification of the product number.

Metallic trim color
 CAL 133
 Nano-Tex
 DuraBlock

To specify, add **-M** after the 8th digit; **Example:** M600-8100-M

To specify, add **-F** to the end of the product number; **Example:** M600-8200-F (add \$55.08 list)

To specify, add **-P** to the end of the product number; **Example:** M600-8100-P (add \$34.56 list)

To specify, add **-D** to the end of the product number; **Example:** M600-8100-D (add \$45.36 list)

NOTE: CAL 133 is available on fully upholstered outer back and wood back chair models only.

On upholstered poly back and wood back models only.

For available fabrics see matrix in the back of the book or at Haworth.com/surfaces.

Improv Series

Accessories

	Height	Width	Depth	Number	Price
Stacking Dolly	15"(381mm)	24 1/4"(616mm)	28"(711mm)	MPRV-CART 	\$326.48

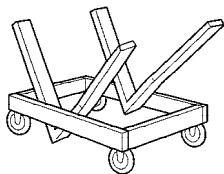

MPRV-CART

Features

- 3"(76mm) hard rubber casters.
- Recommended stacking limit is 10 chairs high (58"(1473mm) armless, 62"(1575mm) with arms, 6-high on casters (50"(1270mm)).
- Entire depth with chairs stacked is 39 3/4"(1009mm).
- Standard in black finish color only.
- Ships assembled.

 Available on RUSH.

To Order, Specify:

- 1) Product number.
(No finish specification required.)

Book Rack	6 3/4"(159mm)	15 1/4"(387mm)	14 1/2"(368mm)	MPRV-RACK	\$58.30
------------------	---------------	----------------	----------------	-----------	----------------

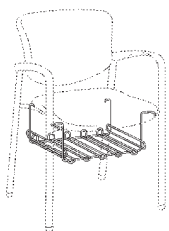

MPRV-RACK

Features

- Field attachable to an Improv leg-base or sled-base side chair.
- Standard in chrome finish only.

To Order, Specify:

- 1) Product number.
(No finish specification required.)

Improv Series

Tandem Seating and Tables

Specification and Ordering Information

Specify standard Improv Series chair models, tandem tables, and chair-to-chair connecting bars to create a continuous seating configuration.

Use the following guidelines when specifying and ordering Improv seating and tables for tandem configurations:

- 1) Specify the desired chair models from pages 186-191.
 - All chair models are designed to accept both table and chair-to-chair connecting bars.
 - NOTE: It is not necessary to order ganging chair models to create a tandem configuration.
- 2) Specify chair-to-chair connecting bars from page 196.
 - One set of connecting bars will join two chairs in tandem.
 - Exceptions:
 - Tablet arm cannot be connected adjacent to an arm chair.
 - Tablet arm cannot be connected adjacent to another tablet arm.
- 3) Specify tandem table models from page 196.
 - Select in-line or end-of-run tables based on desired configuration. Tandem table models include all table-to-chair connecting hardware.
 - Tandem tables cannot be connected to each other.

Specification Example

The following example illustrates a tandem seating and table configuration.

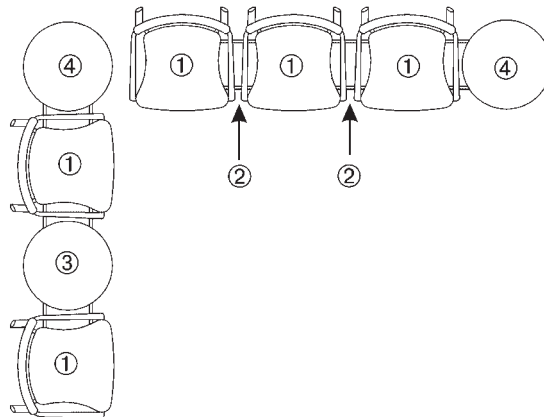

Item	Qty	Number	Description
1	5	M600-2210	Leg-Base Arm Chairs
2	2	MPRV-BARS	Chair-to-Chair Connecting Bars
3	1	MT11-20	In-Line Tandem Table
4	2	MTE1-20	End-of-Run Tandem Tables

Improv Series

Tandem Seating and Tables

Calculating Tandem Seating Dimensions

Use the following dimensions to determine the footprint of an Improv Series tandem seating configuration.

- 1) All arm and armless chair models are 22" (559mm) wide and 21 1/2" (546mm) deep. Tablet arm chair models are 26 3/4" (679mm) deep. When a tablet arm chair ends a seating configuration, add 1 3/4" (44mm) to the total configuration width.

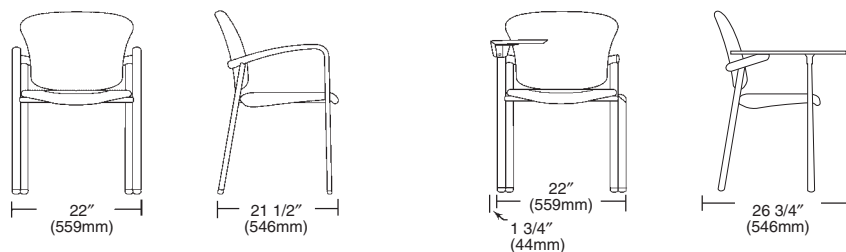

- 2) Add 1 1/4" (32mm) to the width of the seating run for every chair-to-chair connecting bar.

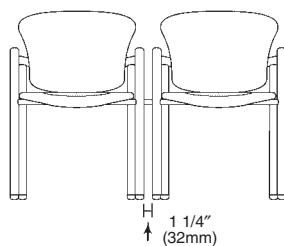

- 3) For every in-line table, add 18 3/4" (476mm) to the width of the seating run.

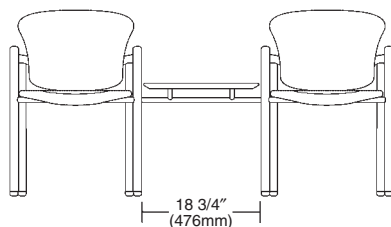

- 4) For every end-of-run table, add 19 3/8" (492mm) to the width of the seating run.

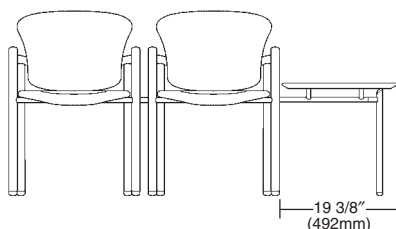

Improv Series

Tandem Tables and Connecting Bars

	Height	Width	Depth	Table Top/Edge	Number	Price
In-Line Table	20"(508mm)	18 3/4"(476mm)	20"(508mm)	Laminate/Bullnose PVC	MTI1-20	\$375.90
				Laminate/Chamfered Hardwood	MTI2-20	500.85
				Wood/Chamfered Hardwood	MTI3-20	555.45

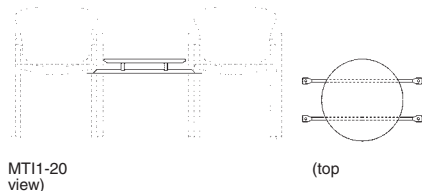

Features

- Table suspends between two Improv chairs in a tandem configuration.
- Table top diameter is 20"(508mm).
- Width shown is distance between front legs of adjoining chairs.
- Price includes installation hardware.

To Order, Specify:

- 1) Product number.
- 2) Laminate or wood surface color.
- 3) PVC or hardwood edge finish color. (Laminate table tops only.)
- 4) Support frame trim color.

To order table with Metallic trim color add **-M** after sixth digit.

Example: MTI1-20-M

End-of-Run Table	20"(508mm)	19 3/8"(492mm)	20"(508mm)	Laminate/Bullnose PVC	MTE1-20	\$452.55
				Laminate/Chamfered Hardwood	MTE2-20	577.50
				Wood/Chamfered Hardwood	MTE3-20	630.00

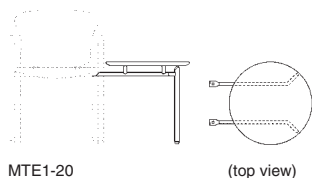

Features

- Table attaches to the end of an Improv chair in a tandem configuration.
- Table top diameter is 20"(508mm).
- Width shown is distance between front leg of adjoining chair to outermost edge of table.
- Molded floor guides match frame color except when ordering Metallic trim; molded components are available in black or smoke and must be specified.
- Price includes installation hardware.

To Order, Specify:

- 1) Product number.
- 2) Laminate or wood surface color.
- 3) PVC or hardwood edge finish color. (Laminate table tops only.)
- 4) Support frame trim color.
- 5) Glides color for metallic frame black or smoke only.

To order table with Metallic trim color add **-M** after sixth digit.

Example: MTE1-20-M

Chair-to-Chair Connecting Bars	1 1/4"(32mm)	MPRV-BARS	\$48.76
---------------------------------------	--------------	-----------	----------------



MPRV-BARS

Features

- Connects two Improv Series chairs side-by-side with the following exceptions:
 - A tablet arm adjacent to an arm chair.
 - A tablet arm adjacent to another tablet arm.
- Width shown is distance between front legs of adjoining chairs.
- Each chair-to-chair connection requires two connecting bars.
- Price includes two (2) bars.

To Order, Specify:

- 1) Product number.
- 2) Trim color.

To order connecting bars with Metallic trim color add **-M** after eighth digit.

Example: MPRV-BARS-M

Improv Series

Occasional Tables

Height	Table Top/Edge	Number	Laminate		Wood Surface
			A	B	
16"(406mm)	Laminate/Bullnose PVC	MTR1-20-1	\$452.55	\$511.35	N/A
	Laminate/Chamfered Hardwood	MTR2-20-1	612.15	670.95	N/A
Wood only	Wood/Chamfered Hardwood	MTR3-20-1	N/A	N/A	630.00
20"(508mm)	Laminate/Bullnose PVC	MTR1-20-2	\$452.55	\$511.35	N/A
	Laminate/Chamfered Hardwood	MTR2-20-2	612.15	670.90	N/A
Wood only	Wood/Chamfered Hardwood	MTR3-20-2	N/A	N/A	630.00

Round Table



MTR1-20

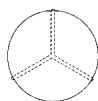

(top view)

Features

- Table top diameter is 20"(508mm).
- Oval steel tube legs with color-matched high-density polyethylene floor glides and leg polypropylene caps except when ordering Metallic trim; molded components are available in black or smoke and must be specified.
- Shipped fully assembled.

NOTE: Due to the differences in the material properties, the MDF edge will display a darker stain in comparison with the veneer surface.

- Available on RUSH.

To Order, Specify:

- 1) Product number.
- 2) Laminate or wood surface color.
- 3) PVC or hardwood edge finish color. (Laminate table tops only.)
- 4) Frame trim color.
- 5) Glides and leg caps for metallic frame; black or smoke option only.

To order table with Metallic trim color add **M** after seventh digit.

Example: MTR1-20-1M

Height	Width	Depth	Table Top/Edge	Number	Laminate		Wood Surface
					A	B	
16"(406mm)	20"(508mm)	48"(1219mm)	Laminate/Bullnose PVC	MTV1-2048-1	\$570.15	\$628.95	N/A
			Laminate/Chamfered Hardwood	MTV2-2048-1	846.30	905.10	N/A
Wood only			Wood/Chamfered Hardwood	MTV3-2048-1	N/A	N/A	854.70
20"(508mm)	20"(508mm)	48"(1219mm)	Laminate/Bullnose PVC	MTV1-2048-2	\$570.15	\$628.95	N/A
			Laminate/Chamfered Hardwood	MTV2-2048-2	846.30	905.10	N/A
Wood only			Wood/Chamfered Hardwood	MTV3-2048-2	N/A	N/A	854.70

Oval Table

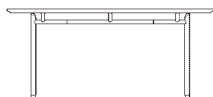

MTV1-2048

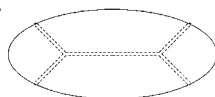

(top view)

Features

- Oval steel tube legs with color-matched high-density polyethylene glides and leg polypropylene caps except when ordering Metallic trim; molded components are available in black or smoke and must be specified.
- Shipped fully assembled.

NOTE: Due to the differences in the material properties, the MDF edge will display a darker stain in comparison with the veneer surface.

To Order, Specify:

- 1) Product number.
- 2) Laminate or wood surface color.
- 3) PVC or hardwood edge finish color. (Laminate table tops only.)
- 4) Frame trim color.
- 5) Glides and leg caps for metallic frame; black or smoke option only.

To order table with Metallic trim color add **M** after ninth digit.

Example: MTV1-2048-1M

Table Top Edge Details

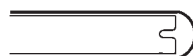

Bullnose PVC

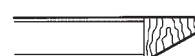

Chamfered Hardwood

This page intentionally blank

LOOK Seating

General Specifications

COM & COL General Information

To order a COM fabric (Customer's Own Material), contact the Haworth Inquiry Center (1.800.426.8562), your local Haworth dealer, or go to haworth.com/surfaces > COM Library to find out if the COM you have selected has already been tested and approved. The surface collection site also has information on the Haworth+ alliance program with Carnegie, Luna Textiles, and Maharam as well as our industry-leading Pre-Approved COM program.

Approved COMs are placed into Grades based on the fabric pricing; if the fabric pricing exceeds our Grades, they will be priced at Grade A + cost of fabric + 4% handling (North America). Haworth will purchase all COMs unless instructed otherwise. (Leather will also be purchased by Haworth; if the leather pricing exceeds our Grades, cost will be based on fabric Grade E + cost of leather + 4% handling.)

If no information is available on the COM you are looking for, refer to the COM section and forms on the surface collection site for information on how to process your test request.

General Guidelines for Product Specification

LOOK seating specification numbers are based on an alpha-numeric logic that identifies a product by model and certain characteristics.

For example, a product number that reads **Z841-1741** identifies the product as a Mid-Back LOOK chair with forward tilt, fabric upholstery, pneumatic height adjustment, upholstered shell, height adjustable arms, pivoting arm pads, hard dual casters, and back lock.

The alpha-numeric logic for this model complete with fabric and finish codes is shown below:

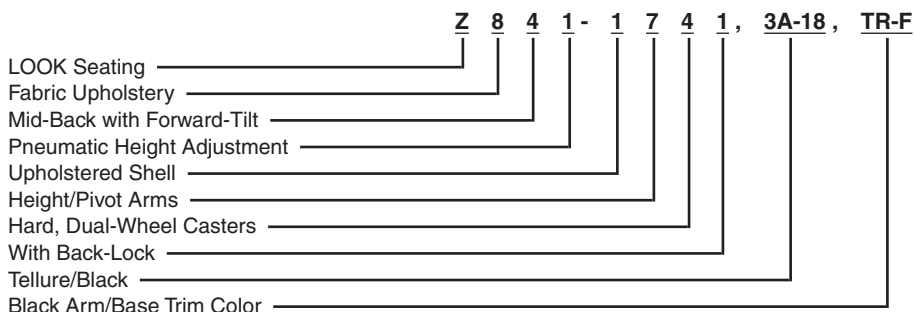

Replace second digit in product number with 7 for leather. Example: Z741-1741.

Beyond the printed product number, fabric and finish codes are required to complete an order specification. To communicate your order clearly, list the product number and fabric/finish codes in the sequence outlined on each price page.

Finishes and Fabrics

A complete listing of finishes and fabrics for LOOK seating can be found in the back of the price list.

Features and Options (High- and Mid-Back Chairs)

LOOK chairs features:

- Molded-polyfoam, contoured seat and back cushions
- Separate seat and back cushions
- Five-star base with black casters only
- Hard dual-wheel casters (standard) or soft dual-wheel casters (optional)
- Pneumatic seat height adjustment
- Width adjustable arms, height adjustable arms, fixed arms, armless
- Tilt tension

LOOK Seating

General Specifications

Mobility and Adjustability (High- and Mid-Back Chairs)

The following features are available on LOOK chair models.

- Synchronized-tilt (standard)
- Back and seat recline at a 2:1 ratio with no front seat rise
- Back tilts backward 20° from the upright position
- Seat pan moves downward 10° from the initial position
- Synchronized-tilt with back-lock
- Back is lockable in four positions within tilt range
- Forward-tilt
- Both chair back and seat pan are lockable in one forward position (3°)
- Seat pan slides horizontally within a 2”(51mm) range
- Back adjusts vertically within a 3”(76mm) range
- Height adjustable arm adjust vertically within a 4”(102mm) range
- Adjustable arms rotate 360°
- Width adjustable arms adjust vertically within a 4”(102mm) range and rotate 360°, and go in/out 2”(51mm).

Features and Options (Side Chairs)

LOOK Series side chair models feature:

- 14-gauge round steel tubing legs
- Double shell seat and back construction
- Molded polyurethane seat and back foam
- Fully upholstered back shell, or full plastic back
- High-density polyethylene floor glides (leg-base models)
- All models available with caster option
- Powder coated frame: available in black and three metallic colors
- Side chair without arms models stack 6-high (44”(1118mm)) on the floor
- Side chair with arms models stack 4-high on the floor
- Side chair with casters stacks 4-high on the floor
- Lounge chair stacks 2-high on the floor

Arm chair models feature:

- Round tubing
- Optional plastic arm cap

Lounge models feature:

- Inner arm shell with foam and upholstery

LOOK series chairs meet or exceed ANSI/BIFMA durability standards for office seating.

LOOK Seating

High-Back Chair without Arms



Z851-1042

Dimensions*

- SH: 16" - 20.75"
(406mm - 527mm)
- H: 43.5"(1105mm)
- D: 26.5"(673mm)
- W: 26.25"(667mm)
- SW: 18.5"(470mm)
- SD: 15"- 17"
(381mm - 432mm)

Features

- Outer Shell: Upholstered
- Casters: Standard with hard casters; or optional soft casters, see below.
- Mechanism: Swivel with synchronized-tilt.
- Height Adjustment: Pneumatic
- 2"(51mm) Seat depth adjustment.
- 3"(76mm) Back height adjustment.
- Optional Back-Lock: Lockable in four positions.
- Optional forward tilt is 3°.
- Tilt tension.
- User Instructions: Embossed on stainless steel inserts on levers. Instructions in braille on underside of levers.
- COM yardage / COL square footage: 2.0/30

To Order, Specify:

- 1) Product number.
- 2) Fabric surface and color.
- 3) Trim color for arms and base (TR-F Black only).

Leather Upholstery

Leather upholstery requires modification of the product number. Change the second digit in the product number from **8** to **7** and specify the leather surface and color.
Example: Z851-1042 = chair with fabric.
 Z751-1042 = chair with leather.

* All measurements taken with the BIFMA chair measuring device.

Outer Shell	Number	Fabric Grade								Leather Grade A	Leather Grade B
		A	B	C	D	E	F	G	H		
Pneumatic Height Adjustment											
Upholstered	Z851-1042	\$739.88	\$807.72	\$873.44	\$901.00	\$ 941.28	\$1097.10	\$1172.36	\$1383.30	\$1227.48	\$1379.88
Pneumatic Height Adjustment/Back-Lock/Forward Tilt											
Upholstered	Z861-1041	\$834.22	\$902.06	\$967.78	\$995.34	\$1035.62	\$1191.44	\$1266.70	\$1477.64	\$1321.82	\$1474.22

Soft Caster Option

Soft caster option requires modification of the product number. Change the seventh digit in the product number from **4** to **2**.

Example: Z851-1022 = chair with soft casters.

Nano-Tex Option

To specify add **-P** to end of the product number.

Example: Z851-1042-P (add \$33.92 list)

NOTE: For available fabrics see matrix in the back of the book.

LOOK Seating

High-Back Chair with Fixed Arms



Z851-1442

Dimensions*

SH: 16" - 20.75"
(406mm - 527mm)
H: 43.5"(1105mm)
D: 26.5"(673mm)
W: 26.25"(667mm)
SW: 18.5"(470mm)
SD: 15"- 17"
(381mm - 432mm)
AH: 9"(229mm)
AW: 18.75"(476mm)

Features

- Outer Shell: Upholstered
 - Arm Caps: Soft black vinyl.
 - Casters: Standard with hard casters; or optional soft casters, see below.
 - Mechanism: Swivel with synchronized-tilt.
 - Height Adjustment: Pneumatic
 - 2"(51mm) Seat depth adjustment.
 - 3"(76mm) Back height adjustment.
 - Optional Back-Lock: Lockable in four positions.
 - Optional forward tilt is 3°.
 - Tilt tension.
 - User Instructions: Embossed on stainless steel inserts on levers. Instructions in braille on underside of levers.
 - COM yardage / COL square footage: 2.0/30
- Available on RUSH.

* All measurements taken with the BIFMA chair measuring device.

To Order, Specify:

- 1) Product number.
- 2) Fabric surface and color.
- 3) Trim color for arms and base (TR-F Black only).

Leather Upholstery

Leather upholstery requires modification of the product number. Change the second digit in the product number from **8** to **7** and specify the leather surface and color.

Example: Z851-1442 = chair with fabric.
Z751-1442 = chair with leather.

Outer Shell	Arm Cap	Number	Fabric Grade			C	D	E	F	G	H	Leather Grade A	Leather Grade B
			A	B									
Pneumatic Height Adjustment													
Upholstered	Soft Black Vinyl	Z851-1442	\$824.68	\$892.52	\$ 958.24	\$ 985.80	\$1026.08	\$1181.90	\$1257.16	\$1468.10	\$1312.28	\$1464.68	
Pneumatic Height Adjustment/Back-Lock/Forward Tilt													
Upholstered	Soft Black Vinyl	Z861-1441	\$919.02	\$986.86	\$1052.58	\$1080.14	\$1120.42	\$1276.24	\$1351.50	\$1562.44	\$1406.62	\$1559.02	

Soft Caster Option

Soft caster option requires modification of the product number. Change the seventh digit in the product number from **4** to **2**.

Example: Z851-1422 = chair with soft casters.

Nano-Tex Option

To specify add **-P** to end of the product number.

Example: Z851-1442-P (add \$33.92 list)

NOTE: For available fabrics see matrix in the back of the book.

LOOK Seating

High-Back Chair with Height Adjustable Arms



Z851-1742

Dimensions*

- SH: 16" - 20.75"
(406mm - 527mm)
- H: 43.5"(1105mm)
- D: 26.5"(673mm)
- W: 26.25"(667mm)
- SW: 18.5"(470mm)
- SD: 15" - 17"
(381mm - 432mm)
- AH: 8" - 12"
(203mm - 305mm)
- AW: 18.75"(476mm)

Features

- Outer Shell: Upholstered
- Arm Caps: Soft black vinyl.
- Arm Height Adjustment: 4"(102mm) adjustment.
- Arm Adjustment Controls: Fingertip activation.
- Arm Pad Rotation: 360°
- Casters: Standard with hard casters; or optional soft casters, see below.
- Mechanism: Swivel with synchronized-tilt.
- Height Adjustment: Pneumatic
- 2"(51mm) Seat depth adjustment.
- 3"(76mm) Back height adjustment.
- Optional Back-Lock: Lockable in four positions.
- Optional forward tilt is 3°.
- Tilt tension.
- User Instructions: Embossed on stainless steel inserts on levers. Instructions in braille on underside of levers.
- COM yardage / COL square footage: 2.0/30
- Available on RUSH.

To Order, Specify:

- 1) Product number.
- 2) Fabric surface and color.
- 3) Trim color for arms and base (TR-F Black only).

Leather Upholstery

Leather upholstery requires modification of the product number. Change the second digit in the product number from **8** to **7** and specify the leather surface and color.
Example: Z851-1742 = chair with fabric.
 Z751-1742 = chair with leather.

* All measurements taken with the BIFMA chair measuring device.

Outer Shell	Arm Cap	Number	Fabric Grade		C	D	E	F	G	H	Leather Grade A	Leather Grade B
			A	B								
Pneumatic Height Adjustment												
Upholstered	Soft Black Vinyl	Z851-1742	\$ 925.38	\$ 993.22	\$1058.94	\$1086.50	\$1126.78	\$1282.60	\$1357.86	\$1568.80	\$1412.98	\$1565.38
Pneumatic Height Adjustment/Back-Lock/Forward Tilt												
Upholstered	Soft Black Vinyl	Z861-1741	\$1019.72	\$1087.56	\$1153.28	\$1180.84	\$1221.12	\$1376.94	\$1452.20	\$1663.14	\$1507.32	\$1659.72

Soft Caster Option

Soft caster option requires modification of the product number. Change the seventh digit in the product number from **4** to **2**.

Example: Z851-1722 = chair with soft casters.

Nano-Tex Option

To specify add **-P** to end of the product number.

Example: Z851-1742-P (add \$33.92 list)

NOTE: For available fabrics see matrix in the back of the book.

LOOK Seating

High-Back Chair with Height and Width Adjustable Arms



Z851-1W42

Dimensions*

SH: 16" - 20.75"
(406mm - 527mm)
H: 43.5"(1105mm)
D: 26.5"(673mm)
W: 26.25"(667mm)
SW: 18.5"(470mm)
SD: 15" - 17"
(381mm - 432mm)
AH: 8" - 12"
(203mm - 305mm)
AW: 18.5" - 20.5"
(470mm - 521mm)

Features

- Outer Shell: Upholstered
 - Arm Caps: Soft black vinyl.
 - Arm Height Adjustment: 4"(102mm) adjustment.
 - Arm Width Adjustment: 2"(51mm) adjustment.
 - Arm Adjustment Controls: Fingertip activation.
 - Arm Pad Rotation: 360°
 - Casters: Standard with hard casters; or optional soft casters, see below.
 - Mechanism: Swivel with synchronized-tilt.
 - Height Adjustment: Pneumatic
 - 2"(51mm) Seat depth adjustment.
 - 3"(76mm) Back height adjustment.
 - Optional Back-Lock: Lockable in four positions.
 - Optional forward tilt is 3°.
 - Tilt tension.
 - User Instructions: Embossed on stainless steel inserts on levers. Instructions in braille on underside of levers.
 - COM yardage / COL square footage: 2.0/30
- Available on RUSH.

To Order, Specify:

- 1) Product number.
- 2) Fabric surface and color.
- 3) Trim color for arms and base (TR-F Black only).

Leather Upholstery

Leather upholstery requires modification of the product number. Change the second digit in the product number from **8** to **7** and specify the leather surface and color.

Example: Z851-1W42 = chair with fabric.
Z751-1W42 = chair with leather.

* All measurements taken with the BIFMA chair measuring device.

Outer Shell	Arm Cap	Number	Fabric Grade								Leather Grade A	Leather Grade B
			A	B	C	D	E	F	G	H		
Pneumatic Height Adjustment												
Upholstered	Soft Black Vinyl	Z851-1W42 ■	\$ 956.12	\$1023.96	\$1089.68	\$1117.24	\$1157.52	\$1313.34	\$1388.60	\$1599.54	\$1443.72	\$1596.12
Pneumatic Height Adjustment/Back-Lock/Forward Tilt												
Upholstered	Soft Black Vinyl	Z861-1W41 ■	\$1050.46	\$1118.30	\$1184.02	\$1211.58	\$1251.86	\$1407.68	\$1482.94	\$1693.88	\$1538.06	\$1690.46

Soft Caster Option

Soft caster option requires modification of the product number. Change the seventh digit in the product number from **4** to **2**.

Example: Z851-1W22 = chair with soft casters.

Nano-Tex Option

To specify add **-P** to end of the product number.

Example: Z851-1W42-P (add \$33.92 list)

NOTE: For available fabrics see matrix in the back of the book.

LOOK Seating

Mid-Back Chair without Arms



Z831-1042

Dimensions*

SH: 16" - 20.75"
(406mm - 527mm)
H: 40"(1016mm)
D: 26.5"(673mm)
W: 26.25"(667mm)
SW: 18.5"(470mm)
SD: 15" - 17"
(381mm - 432mm)

Features

- Outer Shell: Upholstered
 - Casters: Standard with hard casters; or optional soft casters, see below.
 - Mechanism: Swivel with synchronized-tilt.
 - Height Adjustment: Pneumatic
 - 2"(51mm) Seat depth adjustment.
 - 3"(76mm) Back height adjustment.
 - Optional Back-Lock: Lockable in four positions.
 - Optional forward tilt is 3°.
 - Tilt tension.
 - User Instructions: Embossed on stainless steel inserts on levers. Instructions in braille on underside of levers.
 - COM yardage / COL square footage: 1.5/30
- Available on RUSH.

To Order, Specify:

- 1) Product number.
- 2) Fabric surface and color.
- 3) Trim color for arms and base (TR-F Black only).

Leather Upholstery

Leather upholstery requires modification of the product number. Change the second digit in the product number from **8** to **7** and specify the leather surface and color.
Example: Z831-1042 = chair with fabric.
Z731-1042 = chair with leather.

*All measurements taken with the BIFMA chair measuring device.

Outer Shell	Number	Fabric Grade		C	D	E	F	G	H	Leather Grade A	Leather Grade B
		A	B								
Pneumatic Height Adjustment											
Upholstered	Z831-1042 ■	\$673.10	\$740.94	\$806.66	\$834.22	\$874.50	\$ 938.10	\$ 993.22	\$1150.10	\$1160.70	\$1313.10
Pneumatic Height Adjustment/Back-Lock/Forward Tilt											
Upholstered	Z841-1041 ■	\$767.44	\$835.28	\$901.00	\$928.56	\$968.84	\$1032.44	\$1087.56	\$1244.44	\$1255.04	\$1407.44

Soft Caster Option

Soft caster option requires modification of the product number. Change the seventh digit in the product number from **4** to **2**.

Example: Z831-1022 = chair with soft casters.

Nano-Tex Option

To specify add **-P** to end of the product number.

Example: Z831-1042-P (add \$33.92 list)

NOTE: For available fabrics see matrix in the back of the book.

LOOK Seating

Mid-Back Chair with Fixed Arms



Z831-1442

Dimensions*

SH: 16" - 20.75"
(406mm - 527mm)
H: 40"(1016mm)
D: 26.5"(673mm)
W: 26.25"(667mm)
SW: 18.5"(470mm)
SD: 15" - 17"
(381mm - 432mm)
AH: 9"(229mm)
AW: 18.75"(476mm)

Features

- Outer Shell: Upholstered
 - Arm Caps: Soft black vinyl.
 - Casters: Standard with hard casters; or optional soft casters, see below.
 - Mechanism: Swivel with synchronized-tilt.
 - Height Adjustment: Pneumatic
 - 2"(51mm) Seat depth adjustment.
 - 3"(76mm) Back height adjustment.
 - Optional Back-Lock: Lockable in four positions.
 - Optional forward tilt is 3°.
 - Tilt tension.
 - User Instructions: Embossed on stainless steel inserts on levers. Instructions in braille on underside of levers.
 - COM yardage / COL square footage: 1.5/30
- Available on RUSH.

*All measurements taken with the BIFMA chair measuring device.

To Order, Specify:

- 1) Product number.
- 2) Fabric surface and color.
- 3) Trim color for arms and base (TR-F Black only).

Leather Upholstery

Leather upholstery requires modification of the product number. Change the second digit in the product number from **8** to **7** and specify the leather surface and color.
Example: Z831-1442 = chair with fabric.
Z731-1442 = chair with leather.

Outer Shell	Arm Cap	Number	Fabric Grade								Leather Grade A	Leather Grade B
			A	B	C	D	E	F	G	H		
Pneumatic Height Adjustment												
Upholstered	Soft Black Vinyl	Z831-1442	■ \$757.90	\$825.74	\$891.46	\$ 919.02	\$ 959.30	\$1022.90	\$1078.02	\$1234.90	\$1245.50	\$1397.90
Pneumatic Height Adjustment/Back-Lock/Forward Tilt												
Upholstered	Soft Black Vinyl	Z841-1441	■ \$852.24	\$920.08	\$985.80	\$1013.36	\$1053.64	\$1117.24	\$1172.36	\$1329.24	\$1339.84	\$1492.24

Soft Caster Option

Soft caster option requires modification of the product number. Change the seventh digit in the product number from **4** to **2**.

Example: Z831-1422 = chair with soft casters.

Nano-Tex Option

To specify add **-P** to end of the product number.

Example: Z831-1442-P (add **\$33.92** list)

NOTE: For available fabrics see matrix in the back of the book.

LOOK Seating

Mid-Back Chair with Height Adjustable Arms



Z831-1742

Dimensions*

SH: 16" - 20.75"
(406mm - 527mm)
H: 40"(1016mm)
D: 26.5"(673mm)
W: 26.25"(667mm)
SW: 18.5"(470mm)
SD: 15" - 17"
(381mm - 432mm)
AH: 8" - 12"
(203mm - 305mm)
AW: 18.75"(476mm)

Features

- Outer Shell: Upholstered
- Arm Caps: Soft black vinyl.
- Arm Height Adjustment: 4"(102mm) adjustment.
- Arm Adjustment Controls: Fingertip activation.
- Arm Pad Rotation: 360°
- Casters: Standard with hard casters; or optional soft casters, see below.
- Mechanism: Swivel with synchronized-tilt.
- Height Adjustment: Pneumatic
- 2"(51mm) Seat depth adjustment.
- 3"(76mm) Back height adjustment.
- Optional Back-Lock: Lockable in four positions.
- Optional forward tilt is 3°.
- Tilt tension.
- User Instructions: Embossed on stainless steel inserts on levers. Instructions in braille on underside of levers.
- COM yardage / COL square footage: 1.5/30
- Available on RUSH.

To Order, Specify:

- 1) Product number.
- 2) Fabric surface and color.
- 3) Trim color for arms and base (TR-F Black only).

Leather Upholstery

Leather upholstery requires modification of the product number. Change the second digit in the product number from **8** to **7** and specify the leather surface and color.

Example: Z831-1742 = chair with fabric.
Z731-1742 = chair with leather.

*All measurements taken with the BIFMA chair measuring device.

Outer Shell	Arm Cap	Number	Fabric Grade							Leather Grade A	Leather Grade B	
			A	B	C	D	E	F	G			H
Pneumatic Height Adjustment												
Upholstered	Soft Black Vinyl	Z831-1742	\$858.60	\$ 926.44	\$ 992.16	\$1019.72	\$1060.00	\$1123.60	\$1178.72	\$1335.60	\$1346.20	\$1498.60
Pneumatic Height Adjustment/Back-Lock/Forward Tilt												
Upholstered	Soft Black Vinyl	Z841-1741	\$952.94	\$1020.78	\$1086.50	\$1114.06	\$1154.34	\$1217.94	\$1273.06	\$1429.94	\$1440.54	\$1592.94

Soft Caster Option

Soft caster option requires modification of the product number. Change the seventh digit in the product number from **4** to **2**.

Example: Z831-1722 = chair with soft casters.

Nano-Tex Option

To specify add **-P** to end of the product number.

Example: Z831-1742-P (add \$33.92 list)

NOTE: For available fabrics see matrix in the back of the book.

LOOK Seating

Mid-Back Chair with Height and Width Adjustable Arms



Z831-1W42

Dimensions*

SH: 16" - 20.75"
(406mm - 527mm)
H: 40"(1016mm)
D: 26.5"(673mm)
W: 26.25"(667mm)
SW: 18.5"(470mm)
SD: 15" - 17"
(381mm - 432mm)
AH: 8" - 12"
(203mm - 305mm)
AW: 18.5"-20.5"
(470mm - 521mm)

Features

- Outer Shell: Upholstered
 - Arm Caps: Soft black vinyl.
 - Arm Height Adjustment: 4"(102mm) adjustment.
 - Arm Width Adjustment: 2"(51mm) adjustment.
 - Arm Adjustment Controls: Fingertip activation.
 - Arm Pad Rotation: 360°
 - Casters: Standard with hard casters; or optional soft casters, see below.
 - Mechanism: Swivel with synchronized-tilt.
 - Height Adjustment: Pneumatic
 - 2"(51mm) Seat depth adjustment.
 - 3"(76mm) Back height adjustment.
 - Optional Back-Lock: Lockable in four positions.
 - Optional forward tilt is 3°.
 - Tilt tension.
 - User Instructions: Embossed on stainless steel inserts on levers. Instructions in braille on underside of levers.
 - COM yardage / COL square footage: 1.5/30
- Available on RUSH.

*All measurements taken with the BIFMA chair measuring device.

To Order, Specify:

- 1) Product number.
- 2) Fabric surface and color.
- 3) Trim color for arms and base (TR-F Black only).

Leather Upholstery

Leather upholstery requires modification of the product number. Change the second digit in the product number from **8** to **7** and specify the leather surface and color.

Example: Z831-1W42 = chair with fabric.
Z731-1W42 = chair with leather.

Outer Shell	Arm Cap	Number	Fabric Grade								Leather Grade A	Leather Grade B
			A	B	C	D	E	F	G	H		
Pneumatic Height Adjustment												
Upholstered	Soft Black Vinyl	Z831-1W42 ■	\$889.34	\$ 957.18	\$1022.90	\$1050.46	\$1090.74	\$1154.34	\$1209.46	\$1366.34	\$1376.94	\$1529.34
Pneumatic Height Adjustment/Back-Lock/Forward Tilt												
Upholstered	Soft Black Vinyl	Z841-1W41 ■	\$983.68	\$1051.52	\$1117.24	\$1144.80	\$1185.08	\$1248.68	\$1303.80	\$1460.68	\$1471.28	\$1623.68

Soft Caster Option

Soft caster option requires modification of the product number. Change the seventh digit in the product number from **4** to **2**.

Example: Z831-1W22 = chair with soft casters.

Nano-Tex Option

To specify add **-P** to end of the product number.

Example: Z831-1W42-P (add \$33.92 list)

NOTE: For available fabrics see matrix in the back of the book.

LOOK Seating

Side Chairs

Without Arms



Z600-2100

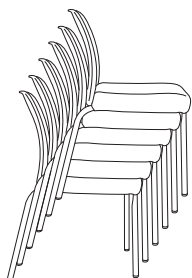

Dimensions*

H: Upholstered:
33.75"(857mm)
Polypropylene:
32.25"(819mm)
W: 20.37"(517mm)
D: 24"(610mm)
SH: 18"(457mm)
SD: 18.25"(463mm)
SW: 18.75"(476mm)

Features

- Polypropylene or upholstered back shell.
- Optional: Legs with casters
- Stacks 6-high on floor.
- Back flex is 2"(51mm).
- Molded floor glides are standard in black
- COM Yardage/COL square footage:
Polypropylene Back Shell: 0.85/16
Upholstered Back Shell: 1.85/35

* All measurements taken with the BIFMA chair measuring device.

To Order, Specify:

- 1) Product number.
- 2) Back surface and color.
- 3) Frame trim color.

To Order Chair with Polypropylene Back, Specify:

- 1) Product number.
- 2) Fabric surface and color (seat).
- 3) Polypropylene back finish color.
- 4) Frame trim color.

Back	Number	Fabric Grade								Leather Grade A	Leather Grade B
		A	B	C	D	E	F	G	H		
Polypropylene	Z600-2100	\$308.20	\$347.30	\$384.10	\$400.20	\$424.35	\$471.50	\$504.85	\$601.45	\$587.65	\$ 736.20
Upholstered	Z600-2200	353.05	428.95	507.15	537.05	583.05	706.10	783.15	989.00	911.95	1209.05

Caster Option

Caster option requires modification of the product number.

Hard Caster Option

Hard caster option requires modification of the product number. Change the eighth digit in the product number from **0** to **4** and add **\$54.60** list.

Example: Z600-2104

Soft Caster Option

Soft caster option requires modification of the product number. Change the eighth digit in the product number from **0** to **2** and add **\$54.60** list.

Example: Z600-2102

Nano-Tex Option

To specify add **-P** to end of the product number.

Example: Z600-2100-P (add **\$33.60** list)

DuraBlock Option

To specify add **-D** to end of the product number.

Example: Z600-2100-D (add **\$44.10** list)

NOTE: For available fabrics see matrix in the back of the book.

LOOK Seating

Side Chairs

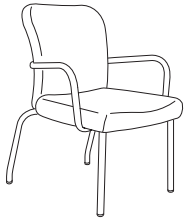
With Arms

Z600-2210

Dimensions*

H: Upholstered:
33.75"(857mm)
Polypropylene:
32.25"(819mm)
W: 24"(610mm)
D: 24"(610mm)
SH: 18"(457mm)
SD: 18.25"(463mm)
SW: 18.75"(476mm)

Features

- Polypropylene or upholstered back shell.
- Optional: Legs with casters
- Chairs with arms and glides stack 6-high.
- Chairs with arms and casters stack 3-high.
- Back flex is 2"(51mm).
- Arms formed from steel tubular frame.
- Arm caps and molded floor glides are standard in black.
- COM Yardage/COL square footage:
Polypropylene Back Shell: 0.85/16
Upholstered Back Shell: 1.85/35

* All measurements taken with the BIFMA chair measuring device.

To Order, Specify:

- 1) Product number.
- 2) Back surface and color.
- 3) Frame/arm trim color.

To Order Chair with Polypropylene Back, Specify:

- 1) Product number.
- 2) Fabric surface and color (seat).
- 3) Polypropylene back finish color.
- 4) Frame/arm trim color.

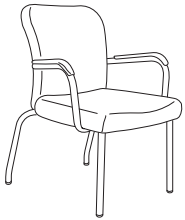

Z600-2230

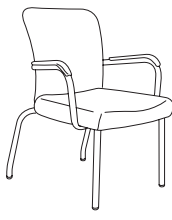

Z600-2130

Back	Arms	Number	Fabric Grade		C	D	E	F	G	H	Leather Grade A	Leather Grade B
			A	B								
Polypropylene	Standard	Z600-2110	\$346.15	\$385.25	\$422.05	\$438.15	\$462.30	\$509.45	\$542.80	\$ 639.40	\$625.60	\$ 774.15
	Arm Caps	Z600-2130	369.15	408.25	445.05	461.15	485.30	532.45	565.80	662.40	648.60	797.15
Upholstered	Standard	Z600-2210	\$391.00	\$466.90	\$545.10	\$575.00	\$621.00	\$744.05	\$821.10	\$1026.95	\$949.90	\$1247.00
	Arm Caps	Z600-2230	414.00	489.90	568.10	598.00	644.00	767.05	844.10	1049.95	972.90	1270.00

Caster Option

Caster option requires modification of the product number.

Hard Caster Option

Hard caster option requires modification of the product number. Change the eighth digit in the product number from **0** to **4** and add **\$54.60** list.
Example: Z600-2114

Soft Caster Option

Soft caster option requires modification of the product number. Change the eighth digit in the product number from **0** to **2** and add **\$54.60** list.
Example: Z600-2112

Nano-Tex Option

To specify add **-P** to end of the product number.
Example: Z600-2110-**P** (add **\$33.60** list)

DuraBlock Option

To specify add **-D** to end of the product number.
Example: Z600-2110-**D** (add **\$44.10** list)

NOTE: For available fabrics see matrix in the back of the book.

LOOK Seating

Lounge Chairs

Lounge Chair

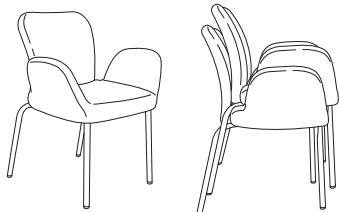

Z600-2440

Dimensions*

H: 33.75"(857mm)
 W: 25"(635mm)
 D: 24"(610mm)
 SH: 18"(457mm)
 SD: 18.25"(463mm)
 SW: 18.15"(461mm)

Features

- Fully upholstered inner and outer back.
- Optional: Legs with casters
- Stacks 2-high on floor.
- Back flex is 2"(51mm).
- Fully upholstered panel arms.
- Molded floor glides are standard in black.
- COM yardage / COL square footage: 2.35/48

* All measurements taken with the BIFMA chair measuring device.

To Order, Specify:

- 1) Product number.
- 2) Back surface and color.
- 3) Frame trim color.

Back	Arms	Number	Fabric Grade		C	D	E	F	G	H	Leather Grade A	Leather Grade B
			A	B								
Upholstered	Panel	Z600-2440	\$690.00	\$765.90	\$844.10	\$874.00	\$920.00	\$1137.35	\$1235.10	\$1499.60	\$1248.90	\$1546.00

Caster Option

Caster option requires modification of the product number.

Hard Caster Option

Hard caster option requires modification of the product number. Change the eighth digit in the product number from **0** to **4** and add **\$54.60** list.

Example: Z600-2444

Soft Caster Option

Soft caster option requires modification of the product number. Change the eighth digit in the product number from **0** to **2** and add **\$54.60** list.

Example: Z600-2442

Nano-Tex Option

To specify add **-P** to end of the product number.

Example: Z600-2440-P (add **\$33.60** list)

DuraBlock Option

To specify add **-D** to end of the product number.

Example: Z600-2440-D (add **\$44.10** list)

NOTE: For available fabrics see matrix in the back of the book.

This page intentionally blank

Accolade Seating

General Specifications

**Features and Options
(Mid-Back and High-Back)**

Accolade models feature:

- Tilt-tension adjustment
- Double shell construction
- Slab polyurethane foam, contoured seat and back cushions
- Polypropylene or upholstered outer shell
- Five-star welded steel base with plastic cover
- Hard, dual-wheel casters for carpeted floors (black only)
- Soft, dual-wheel casters for resilient floor surfaces (black only)
- Standard hard arm caps, upholstered (fabric or leather) arm caps, or upholstered black vinyl arm caps

Accolade seating meets or exceeds all ANSI/BIFMA durability standards for office seating.

Pneumatic chair models comply with ANSI/HFS 100-1988 standards for Visual Display Terminal seating.

Mobility and Adjustability

High-back and Mid-back models feature:

- Pneumatic seat height adjustment
- Back height adjustment
- Synchronized-tilt mechanism
- Optional back-lock (six-position)
- Optional standard forward-tilt
- Optional cantilever arms
- Optional low-position seat height adjustment (1"(25mm) below standard)

Sled-base models feature:

- Fixed height
- Front stabilizer nylon glides (black finish only)

Accolade Seating

General Specifications

Mobility and Adjustability (continued)

The following features are available on Accolade seating models. Refer to the price pages for available options on a specific model.

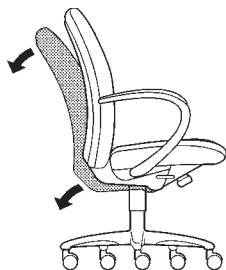

- Synchronized-tilt (standard)
 - Back and seat recline at a 2:1 ratio with no front seat rise
 - Back tilts backward 16° from the upright position
 - Seat pan moves downward 8° from the initial position

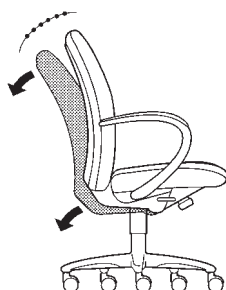

- Synchronized-tilt with back-lock
 - Back and seat recline at a 2:1 ratio with no front seat rise
 - Back is lockable in six positions within tilt range
 - Back tilts backward 16° from the upright position
 - Seat pan moves downward 8° from the initial position

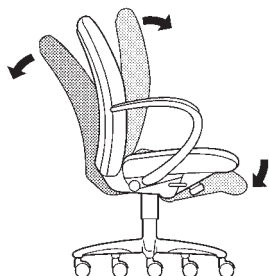

- Synchronized-tilt with standard forward-tilt
 - Back and seat recline at a 2:1 ratio with no front seat rise
 - Seat and back move forward by rotating knob adjustment
 - Seat pitch is 7° and back pitch is 15° forward from standard pitch
 - Back reclines in the forward-tilt mode
 - Back tilts backward 16° from the upright position

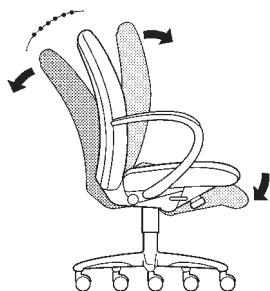

- Synchronized-tilt with standard forward-tilt and back-lock
 - Back and seat recline at a 2:1 ratio with no front seat rise
 - Back is lockable in six positions within tilt range
 - Seat and back move forward by rotating knob adjustment
 - Seat pitch is 7° and back pitch is 15° forward from standard pitch
 - Back reclines in the forward-tilt mode
 - Back tilts backward 16° from the upright position

Accolade Seating

General Specifications

COM & COL**General Information**

To order a COM fabric (Customer's Own Material), contact the Haworth Inquiry Center (1.800.426.8562), your local Haworth dealer, or go to haworth.com/surfaces > COM Library to find out if the COM you have selected has already been tested and approved. The surface collection site also has information on the Haworth+ alliance program with Carnegie, Luna Textiles, and Maharam as well as our industry-leading Pre-Approved COM program.

Approved COMs are placed into Grades based on the fabric pricing; if the fabric pricing exceeds our Grades, they will be priced at Grade A + cost of fabric + 4% handling (North America). Haworth will purchase all COMs unless instructed otherwise. (Leather will also be purchased by Haworth; if the leather pricing exceeds our Grades, cost will be based on fabric Grade E + cost of leather + 4% handling.)

If no information is available on the COM you are looking for, refer to the COM section and forms on the surface collection site for information on how to process your test request.

Flammability Requirements

Accolade chair models are available with an optional fire retardant construction to comply with California Bulletin #133. Refer to the price pages for ordering information. Refer to Haworth.com/surfaces for a listing of the approved fabrics.

Environmental FactorsMaterial Off Gassing

In an effort to ensure air quality standards, all Accolade parts suppliers are required to provide Material Data Sheets and/or other documentation, verifying that their products do not emit volatile organic compounds (VOCs). In addition, the powder-coat paint process used in the manufacturing of Accolade seating is free of VOCs. Our manufacturing processes have also eliminated all use of chlorofluorocarbons (CFCs) and ozone depleting chemicals (ODCs) in the chair's construction.

Recycling

All fabric scraps are recycled, reducing the amount of material sent to landfills, and all chair components disassemble easily to increase the potential for recycling. In addition, Accolade's inner seat shell is constructed of 100% reprocessed polypropylene, and all raw materials used in its manufacturing can be recycled at the end of the useful life of the product.

Accolade Seating

General Specifications

General Guidelines for Product Specification

Accolade seating specification numbers are based on an alpha-numeric logic that identifies a product by model and certain characteristics.

For example, a product number that reads **A871-2142** identifies the product as an Accolade high-back chair fabric upholstery, pneumatic seat height adjustment, fully-upholstered shells, and hard dual-wheel casters.

The alpha-numeric logic for this model complete with fabric and finish codes is shown below:

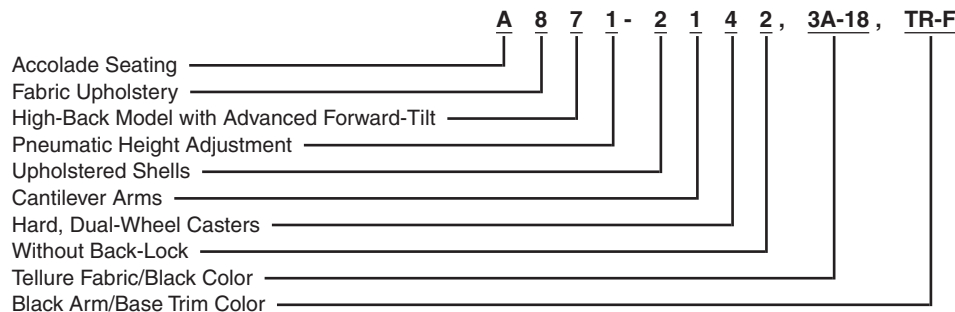

Replace second digit in product number with 7 for leather. Example: A771-2142.

A ninth digit suffix of the product number will indicate functional options, such as **-F** for CAL 133 option. There are exceptions to this logic; therefore, always refer to the price charts for product numbers rather than attempting to construct them. Product number modification instructions for additional options appear in footnoted copy for each applicable model.

Beyond the printed product number, fabric and finish codes are required to complete an order specification. To communicate your order clearly, list the product number and fabric/finish codes in the sequence outlined on each price page.

RUSH

Select Accolade seating models are marked with a **■** symbol to denote availability on the RUSH program. Refer to the fabric and finish options for each product.

Finishes and Fabrics

A complete listing of finishes and fabrics for Accolade seating can be found in the back of the price list.

Accolade Seating

High-Back Chair with Cantilever Arms

Synchronized-Tilt



A871-1142

Dimensions

SH: 16" - 21"
(406mm-533mm)
H: 37 1/4" - 43 3/4"
(946mm-1111mm)
D: 24"(610mm)
W: 26 1/2"(673mm)
SW: 22 1/2"(572mm)
SD: 17"(432mm)
AH: 7.8"(198mm)

Forward seat pitch:
Standard forward tilt: 7°

*Some models may vary.

Standard forward tilt:
SH: 17 1/2" - 22"
(445mm-559mm)

Features

- Outer Shells: Polypropylene or upholstered.
- Arms: Standard, upholstered fabric or black vinyl arm caps.
- Base: Standard plastic base or optional steel base.
- Casters: Standard with hard casters; or optional soft casters.
- Mechanism: Swivel with synchronized-tilt.
- Height Adjustment: Pneumatic or pneumatic with low-position seat height option.
- Back height adjustment: 2 1/4"(57mm)
- Tilt tension.
- Fire retardant construction is available to comply with California Bulletin #133.
- COM yardage / COL square footage:
Polypropylene shell: 2.0/40
Upholstered shell: 2.35/47

■ Available on RUSH with hard casters.

To Order, Specify:

- 1) Product number.
(NOTE: For leather upholstery, see below.)
- 2) Fabric surface and color.
- 3) Trim color for shell
(if applicable), arms and base.

Shells	Arms/Caps	Number	Fabric Grade								Leather Grade A	Leather Grade B
			A	B	C	D	E	F	G	H		
Pneumatic Height Adjustment												
Polypropylene	Standard	A871-1142	\$1282.93	\$1351.60	\$1422.45	\$1458.42	\$1490.03	\$1600.12	\$1666.61	\$1854.09	\$1879.16	\$2042.93
	Upholstered	A871-1242	1391.93	1460.60	1531.45	1567.42	1599.03	1709.12	1775.61	1963.09	1988.16	2151.93
	Upholstered Black Vinyl	A871-1342	1391.93	1460.60	1531.45	1567.42	1599.03	1709.12	1775.61	1963.09	1988.16	2151.93
Upholstered	Standard	A871-2142	\$1491.12	\$1578.32	\$1669.88	\$1717.84	\$1759.26	\$1898.78	\$1985.98	\$2225.78	\$2290.09	\$2468.12
	Upholstered	A871-2242	1600.12	1687.32	1778.88	1826.84	1868.26	2007.78	2094.98	2334.78	2399.09	2577.12
	Upholstered Black Vinyl	A871-2342	1600.12	1687.32	1778.88	1826.84	1868.26	2007.78	2094.98	2334.78	2399.09	2577.12
Pneumatic Height Adjustment/Back-Lock												
Polypropylene	Standard	A871-1141	\$1375.58	\$1444.25	\$1515.10	\$1551.07	\$1582.68	\$1692.77	\$1759.26	\$1946.74	\$1971.81	\$2135.58
	Upholstered	A871-1241	1484.58	1553.25	1624.10	1660.07	1691.68	1801.77	1868.26	2055.74	2080.81	2244.58
	Upholstered Black Vinyl	A871-1341	1484.58	1553.25	1624.10	1660.07	1691.68	1801.77	1868.26	2055.74	2080.81	2244.58
Upholstered	Standard	A871-2141	\$1583.77	\$1670.97	\$1762.53	\$1810.49	\$1851.91	\$1991.43	\$2078.63	\$2318.43	\$2382.74	\$2560.77
	Upholstered	A871-2241	1692.77	1779.97	1871.53	1919.49	1960.91	2100.43	2187.63	2427.43	2491.74	2669.77
	Upholstered Black Vinyl	A871-2341	1692.77	1779.97	1871.53	1919.49	1960.91	2100.43	2187.63	2427.43	2491.74	2669.77
Pneumatic Height Adjustment/Standard Forward-Tilt (Seat Height: 17 1/2"-22"(445mm-559mm))												
Polypropylene	Standard	A886-1142	\$1508.56	\$1577.23	\$1648.08	\$1684.05	\$1715.66	\$1825.75	\$1892.24	\$2079.72	\$2104.79	\$2268.56
	Upholstered	A886-1242	1617.56	1686.23	1757.08	1793.05	1824.66	1934.75	2001.24	2188.72	2213.79	2377.56
	Upholstered Black Vinyl	A886-1342	1617.56	1686.23	1757.08	1793.05	1824.66	1934.75	2001.24	2188.72	2213.79	2377.56
Upholstered	Standard	A886-2142	\$1716.75	\$1803.95	\$1895.51	\$1943.47	\$1984.89	\$2124.41	\$2211.61	\$2451.41	\$2515.72	\$2693.75
	Upholstered	A886-2242	1825.75	1912.95	2004.51	2052.47	2093.89	2233.41	2320.61	2560.41	2624.72	2802.75
	Upholstered Black Vinyl	A886-2342	1825.75	1912.95	2004.51	2052.47	2093.89	2233.41	2320.61	2560.41	2624.72	2802.75
Pneumatic Height Adjustment/Standard Forward-Tilt/Back-Lock (Seat Height: 17 1/2"-22"(445mm-559mm))												
Polypropylene	Standard	A886-1141	\$1601.21	\$1669.88	\$1740.73	\$1776.70	\$1808.31	\$1918.40	\$1984.89	\$2172.37	\$2197.44	\$2361.21
	Upholstered	A886-1241	1710.21	1778.88	1849.73	1885.70	1917.31	2027.40	2093.89	2281.37	2306.44	2470.21
	Upholstered Black Vinyl	A886-1341	1710.21	1778.88	1849.73	1885.70	1917.31	2027.40	2093.89	2281.37	2306.44	2470.21
Upholstered	Standard	A886-2141	\$1809.40	\$1896.60	\$1988.16	\$2036.12	\$2077.54	\$2217.06	\$2304.26	\$2544.06	\$2608.37	\$2786.40
	Upholstered	A886-2241	1918.40	2005.60	2097.16	2145.12	2186.54	2326.06	2413.26	2653.06	2717.37	2895.40
	Upholstered Black Vinyl	A886-2341	1918.40	2005.60	2097.16	2145.12	2186.54	2326.06	2413.26	2653.06	2717.37	2895.40

The following options require modification of the product number.

- Low-position seat height - Plastic
- Steel base - Standard height
- Steel base - Low height
- Soft casters
- CAL 133
- Leather Upholstery

- To specify, change the 4th digit from a 1 to a 4; **Example:** A874-1142.
- To specify, change the 4th digit from a 1 to a 6; **Example:** A876-1142.
- To specify, change the 4th digit from a 1 to a 7; **Example:** A877-1142.
- To specify, change the 7th digit from a 4 to a 2; **Example:** A871-1122.
- To specify, add -F to the product number; **Example:** A871-1142-F (add \$105.73 list).
- To specify, change the 2nd digit from an 8 to a 7 and specify the leather surface and color. **Examples:** A871-1142 = chair with fabric; A771-1142 = chair with leather.

NOTE: Forward tilt available on steel base only, models: A746, A786, A846, A886.

Low-position seat height - plastic is not available on chairs with forward tilt.

Accolade Seating

High-Back Chair without Arms

Synchronized-Tilt

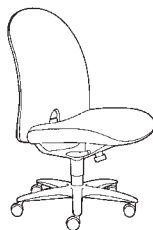

A871-1042

Dimensions

SH: 16" - 21"^{**}
(406mm-533mm)
H: 37 1/4" - 43 3/4"
(946mm-1111mm)
D: 24"(610mm)
W: 26 1/2"(673mm)
SW: 22 1/2"(572mm)
SD: 17"(432mm)

Forward seat pitch:
Standard forward tilt: 7°
Advanced forward tilt: 5°

^{*}Some models may vary.

Standard forward tilt:
SH: 17 1/2" - 22"
(445mm-559mm)

Features

- Outer Shells: Polypropylene or upholstered.
- Base: Standard plastic base or optional steel base.
- Casters: Standard with hard casters; or optional soft casters, see below.
- Mechanism: Swivel with synchronized-tilt.
- Height Adjustment: Pneumatic or pneumatic with low-position seat height option.
- Back height adjustment: 2 1/4"(57mm).
- Tilt tension.
- Fire retardant construction is available to comply with California Bulletin #133, see below.
- COM yardage / COL square footage:
Polypropylene shell: 2.0/40
Upholstered shell: 2.35/47

To Order, Specify:

- 1) Product number.
(NOTE: For leather upholstery, see below.)
- 2) Fabric surface and color.
- 3) Trim color for shell
(if applicable) and base.

Shell	Number	Fabric Grade								Leather Grade A	Leather Grade B
		A	B	C	D	E	F	G	H		
Pneumatic Height Adjustment											
Polypropylene	A871-1042	\$1118.34	\$1187.01	\$1257.86	\$1293.83	\$1325.44	\$1435.53	\$1502.02	\$1689.50	\$1714.57	\$1878.34
Upholstered	A871-2042	1326.53	1413.73	1505.29	1553.25	1594.67	1734.19	1821.39	2061.19	2125.50	2303.53
Pneumatic Height Adjustment/Back-Lock											
Polypropylene	A871-1041	\$1210.99	\$1279.66	\$1350.51	\$1386.48	\$1418.09	\$1528.18	\$1594.67	\$1782.15	\$1807.22	\$1970.99
Upholstered	A871-2041	1419.18	1506.38	1597.94	1645.90	1687.32	1826.84	1914.04	2153.84	2218.15	2396.18
Pneumatic Height Adjustment/Standard Forward-Tilt (Seat Height: 17 1/2" - 22"(445mm-559mm))											
Polypropylene	A886-1042	\$1343.97	\$1412.64	\$1483.49	\$1519.46	\$1551.07	\$1661.16	\$1727.65	\$1915.13	\$1940.20	\$2103.97
Upholstered	A886-2042	1552.16	1639.36	1730.92	1778.88	1820.30	1959.82	2047.02	2286.82	2351.13	2529.16
Pneumatic Height Adjustment/Standard Forward-Tilt/Back-Lock (Seat Height: 17 1/2" - 22"(445mm-559mm))											
Polypropylene	A886-1041	\$1436.62	\$1505.29	\$1576.14	\$1612.11	\$1643.72	\$1753.81	\$1820.30	\$2007.78	\$2032.85	\$2196.62
Upholstered	A886-2041	1644.81	1732.01	1823.57	1871.53	1912.95	2052.47	2139.67	2379.47	2443.78	2621.81

The following options require modification of the product number.

Low-position seat height - Plastic

To specify, change the 4th digit from a 1 to a 4; **Example:** A874-1042.

Steel base - Standard height

To specify, change the 4th digit from a 1 to a 6; **Example:** A876-1042.

Steel base - Low height

To specify, change the 4th digit from a 1 to a 7; **Example:** A877-1042.

Soft casters

To specify, change the 7th digit from a 4 to a 2; **Example:** A871-1022.

CAL 133

To specify, add **-F** to the product number; **Example:** A871-1042-F (add \$105.73 list).

Leather Upholstery

To specify, change the 2nd digit from an 8 to a 7 and specify the leather surface and color. **Examples:** A871-1042 = chair with fabric; A771-1042 = chair with leather.

NOTE: Forward tilt available on steel base only, models: A746, A786, A846, A886.

Low-position seat height - plastic is not available on chairs with forward tilt.

Accolade Seating

Mid-Back Chair with Cantilever Arms

Synchronized-Tilt



A831-1142

Dimensions

SH: 16" - 21"
(406mm-533mm)
H: 33 3/4" - 40 1/4"
(857mm-1022mm)
D: 24"(610mm)
W: 24 1/2"(622mm)
SW: 20 1/2"(521mm)
SD: 16 1/2"(419mm)
AH: 7.8"(198mm)

Forward seat pitch:
Standard forward tilt: 7°

*Some models may vary.

Standard forward tilt:
SH: 17 1/2" - 22"
(445mm-559mm)

Features

- Outer Shells: Polypropylene or upholstered.
- Arms: Standard, upholstered fabric or black vinyl arm caps.
- Casters: Standard with hard casters; or optional soft casters.
- Mechanism: Swivel with synchronized-tilt.
- Height Adjustment: Pneumatic or pneumatic with low-position seat height option.
- Back height adjustment: 2 1/4"(57mm).
- Tilt tension.
- Fire retardant construction is available to comply with California Bulletin #133.
- COM yardage / COL square footage:
Polypropylene shell: 1.75/35
Upholstered shell: 2.25/45

◆ Available on RUSH with hard casters.

To Order, Specify:

- 1) Product number.
(NOTE: For leather upholstery, see below.)
- 2) Fabric surface and color.
- 3) Trim color for shell
(if applicable), arms and base.

Shell	Arms/Caps	Number	Fabric Grade								Leather Grade A	Leather Grade B
			A	B	C	D	E	F	G	H		
Pneumatic Height Adjustment												
Polypropylene	Standard	A831-1142	◆ \$1169.57	\$1238.24	\$1309.09	\$1345.06	\$1376.67	\$1486.76	\$1553.25	\$1740.73	\$1765.80	\$1929.57
	Upholstered	A831-1242	◆ 1278.57	1347.24	1418.09	1454.06	1485.67	1595.76	1662.25	1849.73	1874.80	2038.57
	Upholstered Black Vinyl	A831-1342	◆ 1278.57	1347.24	1418.09	1454.06	1485.67	1595.76	1662.25	1849.73	1874.80	2038.57
Upholstered	Standard	A831-2142	◆ \$1377.76	\$1464.96	\$1556.52	\$1604.48	\$1645.90	\$1785.42	\$1872.62	\$2112.42	\$2176.73	\$2354.76
	Upholstered	A831-2242	◆ 1486.76	1573.96	1665.52	1713.48	1754.90	1894.42	1981.62	2221.42	2285.73	2463.76
	Upholstered Black Vinyl	A831-2342	◆ 1486.76	1573.96	1665.52	1713.48	1754.90	1894.42	1981.62	2221.42	2285.73	2463.76
Pneumatic Height Adjustment/Back-Lock												
Polypropylene	Standard	A831-1141	◆ \$1262.22	\$1330.89	\$1401.74	\$1437.71	\$1469.32	\$1579.41	\$1645.90	\$1833.38	\$1858.45	\$2022.22
	Upholstered	A831-1241	◆ 1371.22	1439.89	1510.74	1546.71	1578.32	1688.41	1754.90	1942.38	1967.45	2131.22
	Upholstered Black Vinyl	A831-1341	◆ 1371.22	1439.89	1510.74	1546.71	1578.32	1688.41	1754.90	1942.38	1967.45	2131.22
Upholstered	Standard	A831-2141	◆ \$1470.41	\$1557.61	\$1649.17	\$1697.13	\$1738.55	\$1878.07	\$1965.27	\$2205.07	\$2269.38	\$2447.41
	Upholstered	A831-2241	◆ 1579.41	1666.61	1758.17	1806.13	1847.55	1987.07	2074.27	2314.07	2378.38	2556.41
	Upholstered Black Vinyl	A831-2341	◆ 1579.41	1666.61	1758.17	1806.13	1847.55	1987.07	2074.27	2314.07	2378.38	2556.41
Pneumatic Height Adjustment/Standard Forward-Tilt (Seat Height: 17 1/2" - 22"(445mm-559mm))												
Polypropylene	Standard	A846-1142	\$1395.20	\$1463.87	\$1534.72	\$1570.69	\$1602.30	\$1712.39	\$1778.88	\$1966.36	\$1991.43	\$2155.20
	Upholstered	A846-1242	1504.20	1572.87	1643.72	1679.69	1711.30	1821.39	1887.88	2075.36	2100.43	2264.20
	Upholstered Black Vinyl	A846-1342	1504.20	1572.87	1643.72	1679.69	1711.30	1821.39	1887.88	2075.36	2100.43	2264.20
Upholstered	Standard	A846-2142	\$1603.39	\$1690.59	\$1782.15	\$1830.11	\$1871.53	\$2011.05	\$2098.25	\$2338.05	\$2402.36	\$2580.39
	Upholstered	A846-2242	1712.39	1799.59	1891.15	1939.11	1980.53	2120.05	2207.25	2447.05	2511.36	2689.39
	Upholstered Black Vinyl	A846-2342	1712.39	1799.59	1891.15	1939.11	1980.53	2120.05	2207.25	2447.05	2511.36	2689.39
Pneumatic Height Adjustment/Standard Forward-Tilt/Back-Lock (Seat Height: 17 1/2" - 22"(445mm-559mm))												
Polypropylene	Standard	A846-1141	\$1487.85	\$1556.52	\$1627.37	\$1663.34	\$1694.95	\$1805.04	\$1871.53	\$2059.01	\$2084.08	\$2247.85
	Upholstered	A846-1241	1596.85	1665.52	1736.37	1772.34	1803.95	1914.04	1980.53	2168.01	2193.08	2356.85
	Upholstered Black Vinyl	A846-1341	1596.85	1665.52	1736.37	1772.34	1803.95	1914.04	1980.53	2168.01	2193.08	2356.85
Upholstered	Standard	A846-2141	\$1696.04	\$1783.24	\$1874.80	\$1922.76	\$1964.18	\$2103.70	\$2190.90	\$2430.70	\$2495.01	\$2673.04
	Upholstered	A846-2241	1805.04	1892.24	1983.80	2031.76	2073.18	2212.70	2299.90	2539.70	2604.01	2782.04
	Upholstered Black Vinyl	A846-2341	1805.04	1892.24	1983.80	2031.76	2073.18	2212.70	2299.90	2539.70	2604.01	2782.04

The following options require modification of the product number.

- Low-position seat height - Plastic
- Steel base - Standard height
- Steel base - Low height
- Soft casters
- CAL 133
- Leather Upholstery

To specify, change the 4th digit from a 1 to a 4; **Example:** A834-1142.

To specify, change the 4th digit from a 1 to a 6; **Example:** A836-1142.

To specify, change the 4th digit from a 1 to a 7; **Example:** A837-1142.

To specify, change the 7th digit from a 4 to a 2; **Example:** A831-1122.

To specify, add -F to the product number; **Example:** A831-1142-F (add \$105.73 list).

To specify, change the 2nd digit from an 8 to a 7 and specify the leather surface and color. **Examples:** A831-1142 = chair with fabric; A731-1142 = chair with leather.

NOTE: Forward tilt available on steel base only, models: A746, A786, A846, A886.

Low-position seat height - plastic is not available on chairs with forward tilt.

Accolade Seating

Mid-Back Chair without Arms

Synchronized-Tilt



A831-1042

Dimensions

SH: 16" - 21"^{**}
(406mm-533mm)
H: 33 3/4" - 40 1/4"
(845mm-1022mm)
D: 24"(610mm)
W: 24 1/2"(622mm)
SW: 20 1/2"(521mm)
SD: 16 1/2"(419mm)

Forward seat pitch:
Standard forward tilt: 7°

*Some models may vary.

Standard forward tilt:
SH: 17 1/2" - 22"
(445mm-559mm)

Features

- Outer Shells: Polypropylene or upholstered.
- Casters: Standard with hard casters; or optional soft casters, see below.
- Mechanism: Swivel with synchronized-tilt.
- Height Adjustment: Pneumatic or pneumatic with low-position seat height option.
- Back height adjustment: 2 1/4"(57mm).
- Tilt tension.
- Fire retardant construction is available to comply with California Bulletin #133, see below.
- COM yardage / COL square footage: Polypropylene shell: 1.75/35 Upholstered shell: 2.25/45

■ Available on RUSH with hard casters.

To Order, Specify:

- 1) Product number.
(NOTE: For leather upholstery, see below.)
- 2) Fabric surface and color.
- 3) Trim color for shell (if applicable), and base.

Shell	Number	Fabric Grade								Leather Grade A	Leather Grade B
		A	B	C	D	E	F	G	H		
Pneumatic Height Adjustment											
Polypropylene	A831-1042 ■	\$1004.98	\$1073.65	\$1144.50	\$1180.47	\$1212.08	\$1322.17	\$1388.66	\$1576.14	\$1601.21	\$1764.98
Upholstered	A831-2042 ■	1213.17	1300.37	1391.93	1439.89	1481.31	1620.83	1708.03	1947.83	2012.14	2190.17
Pneumatic Height Adjustment/Back-Lock											
Polypropylene	A831-1041 ■	\$1097.63	\$1166.30	\$1237.15	\$1273.12	\$1304.73	\$1414.82	\$1481.31	\$1668.79	\$1693.86	\$1857.63
Upholstered	A831-2041 ■	1305.82	1393.02	1484.58	1532.54	1573.96	1713.48	1800.68	2040.48	2104.79	2282.82
Pneumatic Height Adjustment/Standard Forward-Tilt (Seat Height: 17 1/2" - 22"(445mm-559mm))											
Polypropylene	A846-1042	\$1230.61	\$1299.28	\$1370.13	\$1406.10	\$1437.71	\$1547.80	\$1614.29	\$1801.77	\$1826.84	\$1990.61
Upholstered	A846-2042	1438.80	1526.00	1617.56	1665.52	1706.94	1846.46	1933.66	2173.46	2237.77	2415.80
Pneumatic Height Adjustment/Standard Forward-Tilt/Back-Lock (Seat Height: 17 1/2" - 22"(445mm-559mm))											
Polypropylene	A846-1041	\$1323.26	\$1391.93	\$1462.78	\$1498.75	\$1530.36	\$1640.45	\$1706.94	\$1894.42	\$1919.49	\$2083.26
Upholstered	A846-2041	1531.45	1618.65	1710.21	1758.17	1799.59	1939.11	2026.31	2266.11	2330.42	2508.45

The following options require modification of the product number.

- Low-position seat height - Plastic
- Steel base - Standard height
- Steel base - Low height
- Soft casters
- CAL 133
- Leather Upholstery

To specify, change the 4th digit from a 1 to a 4; **Example:** A834-1042.
 To specify, change the 4th digit from a 1 to a 6; **Example:** A836-1042
 To specify, change the 4th digit from a 1 to a 7; **Example:** A837-1042
 To specify, change the 7th digit from a 4 to a 2; **Example:** A831-1022
 To specify, add -F to the product number; **Example:** A831-1042-F (add \$105.73 list).
 To specify, change the 2nd digit from an 8 to a 7 and specify the leather surface and color. **Examples:** A831-1042 = chair with fabric; A731-1042 = chair with leather.

NOTE: Forward tilt available on steel base only, models: A746, A786, A846, A886.

Low-position seat height - plastic is not available on chairs with forward tilt.

Accolade Seating

Sled-Base Side Chair

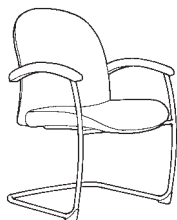

A802-3110

Dimensions

SH: 18 1/2"(470mm)
 H: 36 1/4"(921mm)
 D: 27"(686mm)
 W: 24"(610mm)
 SW: 20 1/2"(521mm)
 SD: 16 1/2"(419mm)
 AH: 26"(660mm)

Features

- Outer Shells: Polypropylene or upholstered.
 - Arms: Black polypropylene, upholstered fabric or black vinyl arm caps.
 - Black glides only.
 - Fire retardant construction is available to comply with California Bulletin #133, see below.
 - COM yardage / COL square footage:
 Polypropylene shell: 2.0/40
 Upholstered shell: 2.25/45
- Available on RUSH.

To Order, Specify:

- 1) Product number.
 (NOTE: For leather upholstery, see below.)
- 2) Fabric surface and color.
- 3) Trim color for shell
 (if applicable), arms and base.

Leather Upholstery

Leather upholstery requires modification of the product number. Change the second digit from a **8** to **7** and specify the leather surface and color.

Examples: A802-3110 = chair with fabric; A702-3110 = chair with leather.

Shell	Arms/Caps	Number	Fabric Grade								Leather Grade A	Leather Grade B
			A	B	C	D	E	F	G	H		
Polypropylene	Black Polypropylene	A802-3110 ■	\$ 830.58	\$ 899.25	\$ 970.10	\$1006.07	\$1037.68	\$1192.46	\$1269.85	\$1484.58	\$1426.81	\$1590.58
	Upholstered	A802-3210 ■	939.58	1008.25	1079.10	1115.07	1146.68	1301.46	1378.85	1593.58	1535.81	1699.58
	Upholstered Black Vinyl	A802-3310 ■	939.58	1008.25	1079.10	1115.07	1146.68	1301.46	1378.85	1593.58	1535.81	1699.58
Upholstered	Black Polypropylene	A802-4110 ■	\$1037.68	\$1124.88	\$1216.44	\$1264.40	\$1305.82	\$1445.34	\$1532.54	\$1772.34	\$1837.74	\$2015.77
	Upholstered	A802-4210 ■	1146.68	1233.88	1325.44	1373.40	1414.82	1554.34	1641.54	1881.34	1946.74	2124.77
	Upholstered Black Vinyl	A802-4310 ■	1146.68	1233.88	1325.44	1373.40	1414.82	1554.34	1641.54	1881.34	1946.74	2124.77

CAL 133 Option

CAL 133 option is available on all chair models. To specify, add **-F** to the product number and add **\$105.73** list.

This page intentionally blank

Monaco

General Specifications

Design: 5D Studio

Features and Options

All Monaco models feature:

- Optional large or medium scales
- Fully-upholstered seat and back
- Five-star base
- Pneumatic height adjustment with 6-position back lock
- 3"(76mm) back height adjustment
- Optional adjustable lumbar support — 1 1/2"(38mm)

Mobility and Adjustability

Five-star base models feature:

- Cast aluminum base
- Molded-polyfoam contoured seat and back cushions
- Cast aluminum arms
- Hard, dual-wheel casters for carpeted floors
- Soft, dual-wheel casters for resilient floor surfaces
- Pneumatic height adjustment
- Synchronized tilt recline with tension control and 6-position back lock

Synchronized tilt

- Back reclines at a two-to-one ratio to the pitch of the seat
- Front-edge seat height maintained through tilt mode
- Lockable in six positions within the tilt range (back lock)

Value Packs

Monaco chairs are offered in 6, 8 and 10-Chair "Value Packs" for your convenience. Value packs allow you to order one part number for your entire conference room. Value packs are offered at a reduced list price.



6-Chair Value Pack for Monaco Large High-Back Chairs

Monaco

General Specifications

COM & COL

General Information

To order a COM fabric (Customer's Own Material), contact the Haworth Inquiry Center (1.800.426.8562), your local Haworth dealer, or go to haworth.com/surfaces > COM Library to find out if the COM you have selected has already been tested and approved. The surface collection site also has information on the Haworth+ alliance program with Carnegie, Luna Textiles, and Maharam as well as our industry-leading Pre-Approved COM program.

Approved COMs are placed into Grades based on the fabric pricing; if the fabric pricing exceeds our Grades, they will be priced at Grade A + cost of fabric + 4% handling (North America). Haworth will purchase all COMs unless instructed otherwise. (Leather will also be purchased by Haworth; if the leather pricing exceeds our Grades, cost will be based on fabric Grade E + cost of leather + 4% handling.)

If no information is available on the COM you are looking for, refer to the COM section and forms on the surface collection site for information on how to process your test request.

Flammability Requirements

Monaco chair models are available with an optional fire retardant construction to comply with California Bulletin #133. Refer to the price pages for ordering information. Refer to Haworth.com/surfaces for a listing of the approved fabrics.

General Guidelines for Product Specification

Monaco specification numbers are based on a numeric logic that identifies a product by model and certain characteristics.

For instance, a product number that reads **D811-2240** identifies the product as a Large High-Back Monaco Chair, with fabric upholstery, pneumatic height adjustment, open arms, hard casters, and without lumbar adjustment.

The numeric logic for this model with fabric and finish codes is shown below:

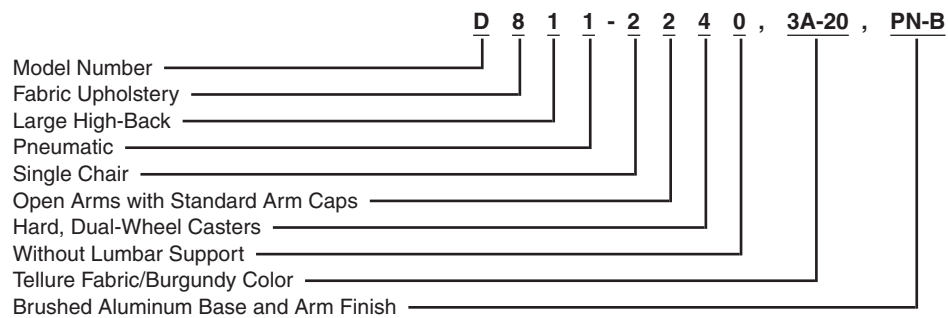

A ninth-digit suffix of the product number will indicate functional options, such as **-F** for CAL 133 option. There are exceptions to this logic; therefore, always refer to the price charts for product numbers rather than attempting to construct them. Product number modification instructions for additional options appear in footnoted copy for each applicable model.

Beyond the printed product number, fabric and finish codes are required to complete an order specification. To communicate your order clearly, list the product number and finish codes in the sequence outlined on each price page.

RUSH

Select Monaco seating models are marked with a **■** symbol to denote availability on the RUSH program. Refer to the fabric and finish options for each product.

Finishes and Fabrics

A complete listing of finishes and fabrics for Monaco seating is available in the back of the price list.

Monaco

Large High-Back Chair with Open Arms



D811-2240

NOTE:
CAD symbol for Value Packs shows one chair but represents quantity of chairs within Value Pack.

Dimensions

SH: 16" - 20 1/2"
(406mm-521mm)
H: 48 1/2" - 56"
(1232mm-1422mm)
D: 26"(660mm)
W: 30"(762mm)
SW: 23 1/2"(597mm)
SD: 21 1/2"(546mm)
AH: 26 1/3" - 31 1/3"
(577mm-689mm)

Features

- Pneumatic height adjustment.
- Flexible headrest.
- Fully-upholstered shell.
- Standard with 6-position back lock.
- Five-star, cast aluminum base with dual-wheel casters.
- Casters and column standard in black finish color.
- Arms available with standard black soft or upholstered caps.
- Standard with 3"(76mm) of back height adjustment.
- COM yardage: 4.0
- COL square footage: 72.0
- Available on RUSH.

To Order, Specify:

- 1) Product number.
- 2) Fabric surface and color.
- 3) Base and arm trim color. Add **\$75.26** for Brushed Aluminum (PN-B) finish.

Leather Upholstery

Leather upholstery requires modification of the product number. Change the second digit in the product number from **8** to **7** and specify the leather surface and color.
Examples: D811-2240 = chair with fabric; D711-2240 = chair with leather.

Arms/ Caps	Quantity	Number	Fabric Grade		C	D	E	F	G	H	Leather Grade A	Leather Grade B
			A	B								
Without Lumbar Support - Standard												
	1 chair	D811-2240 ■	\$ 2768.72	\$ 2867.30	\$ 2927.72	\$ 3086.72	\$ 3157.74	\$ 3457.72	\$ 3605.06	\$ 4014.22	\$ 3927.30	\$ 4416.72
	6-chair Value Pack	D811-A240	15621.22	16212.70	16575.22	17529.22	17955.34	19755.22	20639.26	23094.22	22572.70	25509.22
	8-chair Value Pack	D811-B240	20822.64	21611.28	22094.64	23366.64	23934.80	26334.64	27513.36	30786.64	30091.28	34006.64
	10-chair Value Pack	D811-C240	26319.80	27305.60	27909.80	29499.80	30210.00	33209.80	34683.20	38774.80	37905.60	42799.80
Without Lumbar Support - Upholstered												
	1 chair	D811-2340 ■	\$ 2836.56	\$ 2935.14	\$ 2995.56	\$ 3154.56	\$ 3225.58	\$ 3525.56	\$ 3672.90	\$ 4082.06	\$ 3995.14	\$ 4484.56
	6-chair Value Pack	D811-A340	16028.26	16619.74	16982.26	17936.26	18362.38	20162.26	21046.30	23501.26	22979.74	25916.26
	8-chair Value Pack	D811-B340	21365.36	22154.00	22637.36	23909.36	24477.52	26877.36	28056.08	31329.36	30634.00	34549.36
	10-chair Value Pack	D811-C340	26998.20	27984.00	28588.20	30178.20	30888.40	33888.20	35361.60	39453.20	38584.00	43478.20
With Lumbar Support - Standard												
	1 chair	D811-2241 ■	\$ 2930.90	\$ 3029.48	\$ 3089.90	\$ 3248.90	\$ 3319.92	\$ 3619.90	\$ 3767.24	\$ 4176.40	\$ 4089.48	\$ 4578.90
	6-chair Value Pack	D811-A241	16594.30	17185.78	17548.30	18502.30	18928.42	20728.30	21612.34	24067.30	22572.70	25509.22
	8-chair Value Pack	D811-B241	22120.08	22908.72	23392.08	24664.08	25232.24	27632.08	28810.80	32084.08	31388.72	35304.08
	10-chair Value Pack	D811-C241	27941.60	28927.40	29531.60	31121.60	31831.80	34831.60	36305.00	40396.60	39527.40	44421.60
With Lumbar Support - Upholstered												
	1 chair	D811-2341 ■	\$ 2998.74	\$ 3097.32	\$ 3157.74	\$ 3316.74	\$ 3387.76	\$ 3687.74	\$ 3835.08	\$ 4244.24	\$ 4157.32	\$ 4646.74
	6-chair Value Pack	D811-A341	17001.34	17592.82	17955.34	18909.34	19335.46	21135.34	22019.38	24474.34	23952.82	26889.34
	8-chair Value Pack	D811-B341	22662.80	23451.44	23934.80	25206.80	25774.96	28174.80	29353.52	32626.80	31931.44	35846.80
	10-chair Value Pack	D811-C341	28620.00	29605.80	30210.00	31800.00	32510.20	35510.00	36983.40	41075.00	40205.80	45100.00

Soft Caster Option

Soft caster option requires modification of the product number. Change the seventh digit in the product number from **4** to **2**.

Examples: D811-2240 = chair with hard casters; D811-2220 = chair with soft casters.

CAL 133 Option

CAL 133 option is available on all chair models in leather. To specify, add **-F** to the product number and add **\$539.54** list.

Nano-Text Option

To specify, add **-P** to end of the product number and add **\$55.12** list.

Example: D811-2240-P

NOTE: Nano-Text is not available on leather.

For available fabrics see matrix in the back of the book.

Monaco

Large High-Back Chair with Enclosed Arms



D811-2640

NOTE:

CAD symbol for Value Packs shows one chair but represents quantity of chairs within Value Pack.

Dimensions

- SH: 16" - 20 1/2" (406mm-521mm)
- H: 48 1/2" - 56" (1232mm-1422mm)
- D: 26"(660mm)
- W: 30"(762mm)
- SW: 23 1/2"(597mm)
- SD: 21 1/2"(546mm)
- AH: 26 1/3" - 31 1/3" (577mm-689mm)

Features

- Pneumatic height adjustment.
- Flexible headrest.
- Fully-upholstered shell.
- Standard with 6-position back lock.
- Five-star, cast aluminum base with dual-wheel casters.
- Casters and column standard in black finish color.
- Arms enclosed.
- Standard with 3"(76mm) of back height adjustment.
- COM yardage: 4.0
- COL square footage: 72.0
- Available on RUSH.

To Order, Specify:

- 1) Product number.
- 2) Fabric surface and color.
- 3) Base trim color. Add **\$75.26** for Brushed Aluminum (PN-B) finish.

Leather Upholstery

Leather upholstery requires modification of the product number. Change the second digit in the product number from **8** to **7** and specify the leather surface and color.

Examples: D811-2640 = chair with fabric; D711-2640 = chair with leather.

Arms/ Caps	Quantity	Number	Fabric Grade		C	D	E	F	G	H	Leather Grade A	Leather Grade B
			A	B								
Without Lumbar Support - Standard												
	1 chair	D811-2640 ■	\$ 2768.72	\$ 2867.30	\$ 2927.72	\$ 3086.72	\$ 3157.74	\$ 3457.72	\$ 3605.06	\$ 4014.22	\$ 3927.30	\$ 4416.72
	6-chair Value Pack	D811-A640	15621.22	16212.70	16575.22	17529.22	17955.34	19755.22	20639.26	23094.22	22572.70	25509.22
	8-chair Value Pack	D811-B640	20822.64	21611.28	22094.64	23366.64	23934.80	26334.64	27513.36	30786.64	30091.28	34006.64
	10-chair Value Pack	D811-C640	26319.80	27305.60	27909.80	29499.80	30210.00	33209.80	34683.20	38774.80	37905.60	42799.80
With Lumbar Support - Standard												
	1 chair	D811-2641 ■	\$ 2930.90	\$ 3029.48	\$ 3089.90	\$ 3248.90	\$ 3319.92	\$ 3619.90	\$ 3767.24	\$ 4176.40	\$ 4089.48	\$ 4578.90
	6-chair Value Pack	D811-A641	16594.30	17185.78	17548.30	18502.30	18928.42	20728.30	21612.34	24067.30	23545.78	26482.30
	8-chair Value Pack	D811-B641	22120.08	22908.72	23392.08	24664.08	25232.24	27632.08	28810.80	32084.08	31388.72	35304.08
	10-chair Value Pack	D811-C641	27941.60	28927.40	29531.60	31121.60	31831.80	34831.60	36305.00	40396.60	39527.40	44421.60

Soft Caster Option

Soft caster option requires modification of the product number. Change the seventh digit in the product number from **4** to **2**.

Examples: D811-2640 = chair with hard casters; D811-2620 = chair with soft casters.

CAL 133 Option

CAL 133 option is available on all chair models in leather. To specify, add **-F** to the product number and add **\$539.54** list.

Nano-Tex Option

To specify, add **-P** to end of the product number and add **\$55.12** list.

Example: D811-2640-P

NOTE: Nano-Tex is not available on leather.

For available fabrics see matrix in the back of the book.

Monaco

Medium High-Back Chair with Open Arms



D821-2240

NOTE:
CAD symbol for Value Packs shows one chair but represents quantity of chairs within Value Pack.

Dimensions

SH: 16" - 20 1/2"
(406mm-521mm)
H: 45" - 52 1/2"
(1143mm-1334mm)
D: 23 1/2"(597mm)
W: 26"(660mm)
SW: 22"(559mm)
SD: 20"(508mm)
AH: 26 1/3" - 31 1/3"
(577mm-689mm)

Features

- Pneumatic height adjustment.
- Flexible headrest.
- Fully-upholstered shell.
- Standard with 6-position back lock.
- Five-star, cast aluminum base with dual-wheel casters.
- Casters and column standard in black finish color.
- Arms available with standard black soft or upholstered caps.
- Standard with 3"(76mm) of back height adjustment.
- COM yardage: 3.75
- COL square footage: 67.5
- Available on RUSH.

To Order, Specify:

- 1) Product number.
- 2) Fabric surface and color.
- 3) Base and arm trim color. Add **\$75.26** for Brushed Aluminum (PN-B) finish.

Leather Upholstery

Leather upholstery requires modification of the product number. Change the second digit in the product number from **8** to **7** and specify the leather surface and color.
Examples: D821-2240 = chair with fabric; D721-2240 = chair with leather.

Arms/ Caps	Quantity	Number	Fabric Grade		C	D	E	F	G	H	Leather Grade A	Leather Grade B
			A	B								
Without Lumbar Support - Standard												
	1 chair	D821-2240 ■	\$ 2768.72	\$ 2867.30	\$ 2927.72	\$ 3086.72	\$ 3157.74	\$ 3457.72	\$ 3605.06	\$ 4014.22	\$ 3927.30	\$ 4416.72
	6-chair Value Pack	D821-A240	15621.22	16212.70	16575.22	17529.22	17955.34	19755.22	20639.26	23094.22	22572.70	25509.22
	8-chair Value Pack	D821-B240	20822.64	21611.28	22094.64	23366.64	23934.80	26334.64	27513.36	30786.64	30091.28	34006.64
	10-chair Value Pack	D821-C240	26319.80	27305.60	27909.80	29499.80	30210.00	33209.80	34683.20	38774.80	37905.60	42799.80
Without Lumbar Support - Upholstered												
	1 chair	D821-2340 ■	\$ 2836.56	\$ 2935.14	\$ 2995.56	\$ 3154.56	\$ 3225.58	\$ 3525.56	\$ 3672.90	\$ 4082.06	\$ 3995.14	\$ 4484.56
	6-chair Value Pack	D821-A340	16028.26	16619.74	16982.26	17936.26	18362.38	20162.26	21046.30	23501.26	22979.74	25916.26
	8-chair Value Pack	D821-B340	21365.36	22154.00	22637.36	23909.36	24477.52	26877.36	28056.08	31329.36	30634.00	34549.36
	10-chair Value Pack	D821-C340	26998.20	27984.00	28588.20	30178.20	30888.40	33888.20	35361.60	39453.20	38584.00	43478.20
With Lumbar Support - Standard												
	1 chair	D821-2241 ■	\$ 2930.90	\$ 3029.48	\$ 3089.90	\$ 3248.90	\$ 3319.92	\$ 3619.90	\$ 3767.24	\$ 4176.40	\$ 4089.48	\$ 4578.90
	6-chair Value Pack	D821-A241	16594.30	17185.78	17548.30	18502.30	18928.42	20728.30	21612.34	24067.30	23545.78	26482.30
	8-chair Value Pack	D821-B241	22120.08	22908.72	23392.08	24664.08	25232.24	27632.08	28810.80	32084.08	31388.72	35304.08
	10-chair Value Pack	D821-C241	27941.60	28927.40	29531.60	31121.60	31831.80	34831.60	36305.00	40396.60	39527.40	44421.60
With Lumbar Support - Upholstered												
	1 chair	D821-2341 ■	\$ 2998.74	\$ 3097.32	\$ 3157.74	\$ 3316.74	\$ 3387.76	\$ 3687.74	\$ 3835.08	\$ 4244.24	\$ 4157.32	\$ 4646.74
	6-chair Value Pack	D821-A341	17001.34	17592.82	17955.34	18909.34	19335.46	21135.34	22019.38	24474.34	23952.82	26889.34
	8-chair Value Pack	D821-B341	22662.80	23451.44	23934.80	25206.80	25774.96	28174.80	29353.52	32626.80	31931.44	35846.80
	10-chair Value Pack	D821-C341	28620.00	29605.80	30210.00	31800.00	32510.20	35510.00	36983.40	41075.00	40205.80	45100.00

Soft Caster Option

Soft caster option requires modification of the product number. Change the seventh digit in the product number from **4** to **2**.

Examples: D821-2240 = chair with hard casters; D821-2220 = chair with soft casters.

CAL 133 Option

CAL 133 option is available on all chair models in leather. To specify, add **-F** to the product number and add **\$539.54** list.

Nano-Text Option

To specify, add **-P** to end of the product number and add **\$55.12** list.

Example: D821-2240-P

NOTE: Nano-Text is not available on leather.

For available fabrics see matrix in the back of the book.

Monaco

Medium High-Back Chair with Enclosed Arms



D821-2640

Dimensions

SH: 16" - 20 1/2"
(406mm-521mm)
H: 45" - 52 1/2"
(1143mm-1334mm)
D: 23 1/2"(597mm)
W: 26"(660mm)
SW: 22"(559mm)
SD: 20"(508mm)
AH: 26 1/3" - 31 1/3"
(577mm-689mm)

Features

- Pneumatic height adjustment.
- Flexible headrest.
- Fully-upholstered shell.
- Standard with 6-position back lock.
- Five-star, cast aluminum base with dual-wheel casters.
- Casters and column standard in black finish color.
- Arms enclosed.
- Standard with 3"(76mm) of back height adjustment.
- COM yardage: 3.75
- COL square footage: 67.5
- Available on RUSH.

To Order, Specify:

- 1) Product number.
- 2) Fabric surface and color.
- 3) Base trim color. Add **\$75.26** for Brushed Aluminum (PN-B) finish.

Leather Upholstery

Leather upholstery requires modification of the product number. Change the second digit in the product number from **8** to **7** and specify the leather surface and color.

Examples: D821-2640 = chair with fabric; D721-2640 = chair with leather.

NOTE:

CAD symbol for Value Packs shows one chair but represents quantity of chairs within Value Pack.

Arms/ Caps	Quantity	Number	Fabric Grade		C	D	E	F	G	H	Leather Grade A	Leather Grade B
			A	B								
Without Lumbar Support - Standard												
	1 chair	D821-2640 ■	\$ 2768.72	\$ 2867.30	\$ 2927.72	\$ 3086.72	\$ 3157.74	\$ 3457.72	\$ 3605.06	\$ 4014.22	\$ 3927.30	\$ 4416.72
	6-chair Value Pack	D821-A640	15621.22	16212.70	16575.22	17529.22	17955.34	19755.22	20639.26	23094.22	22572.70	25509.22
	8-chair Value Pack	D821-B640	20822.64	21611.28	22094.64	23366.64	23934.80	26334.64	27513.36	30786.64	30091.28	34006.64
	10-chair Value Pack	D821-C640	26319.80	27305.60	27909.80	29499.80	30210.00	33209.80	34683.20	38774.80	37905.60	42799.80
With Lumbar Support - Standard												
	1 chair	D821-2641 ■	\$ 2930.90	\$ 3029.48	\$ 3089.90	\$ 3248.90	\$ 3319.92	\$ 3619.90	\$ 3767.24	\$ 4176.40	\$ 4089.48	\$ 4578.90
	6-chair Value Pack	D821-A641	16594.30	17185.78	17548.30	18502.30	18928.42	20728.30	21612.34	24067.30	23545.78	26482.30
	8-chair Value Pack	D821-B641	22120.08	22908.72	23392.08	24664.08	25232.24	27632.08	28810.80	32084.08	31388.72	35304.08
	10-chair Value Pack	D821-C641	27941.60	28927.40	29531.60	31121.60	31831.80	34831.60	36305.00	40396.60	39527.40	44421.60

Soft Caster Option

Soft caster option requires modification of the product number. Change the seventh digit in the product number from **4** to **2**.

Examples: D821-2640 = chair with hard casters; D821-2620 = chair with soft casters.

CAL 133 Option

CAL 133 option is available on all chair models in leather. To specify, add **-F** to the product number and add **\$539.54** list.

Nano-Tex Option

To specify, add **-P** to end of the product number and add **\$55.12** list.

Example: D821-2640-P

NOTE: Nano-Tex is not available on leather.

For available fabrics see matrix in the back of the book.

Monaco

Large Mid-Back Chair with Open Arms



D831-2240

Dimensions

SH: 16" - 20 1/2"
(406mm-521mm)
H: 41 1/2" - 49 1/2"
(1054mm-1257mm)
D: 26"(660mm)
W: 30"(762mm)
SW: 23 1/2"(597mm)
SD: 21 1/2"(546mm)
AH: 26 1/3" - 31 1/3"
(577mm-689mm)

Features

- Pneumatic height adjustment.
- Fully-upholstered shell.
- Standard with 6-position back lock.
- Five-star, cast aluminum base with dual-wheel casters.
- Casters and column standard in black finish color.
- Arms available with standard black soft or upholstered caps.
- Standard with 3"(76mm) of back height adjustment.
- COM yardage: 3.25
- COL square footage: 58.5
- Available on RUSH.

To Order, Specify:

- 1) Product number.
- 2) Fabric surface and color.
- 3) Base and arm trim color. Add **\$75.26** for Brushed Aluminum (PN-B) finish.

Leather Upholstery

Leather upholstery requires modification of the product number. Change the second digit in the product number from **8** to **7** and specify the leather surface and color.

Examples: D831-2240 = chair with fabric; D731-2240 = chair with leather.

NOTE:

CAD symbol for Value Packs shows one chair but represents quantity of chairs within Value Pack.

Arms/ Caps	Quantity	Number	Fabric Grade								Leather Grade A	Leather Grade B
			A	B	C	D	E	F	G	H		
Without Lumbar Support - Standard												
	1 chair	D831-2240	\$ 2653.18	\$ 2743.28	\$ 2800.52	\$ 2946.80	\$ 3011.46	\$ 3212.86	\$ 3309.32	\$ 3665.48	\$ 3703.64	\$ 4185.18
	6-chair Value Pack	D831-A240	14927.98	15468.58	15812.02	16689.70	17077.66	18286.06	18864.82	21001.78	21230.74	24119.98
	8-chair Value Pack	D831-B240	19898.32	20619.12	21077.04	22247.28	22764.56	24375.76	25147.44	27996.72	28302.00	32154.32
	10-chair Value Pack	D831-C240	25164.40	26065.40	26637.80	28100.60	28747.20	30761.20	31725.80	35287.40	35669.00	40484.40
Without Lumbar Support - Upholstered												
	1 chair	D831-2340	\$ 2721.02	\$ 2811.12	\$ 2868.36	\$ 3014.64	\$ 3079.30	\$ 3280.70	\$ 3377.16	\$ 3733.32	\$ 3771.48	\$ 4253.02
	6-chair Value Pack	D831-A340	15335.02	15875.62	16219.06	17096.74	17484.70	18693.10	19271.86	21408.82	21637.78	24527.02
	8-chair Value Pack	D831-B340	20441.04	21161.84	21619.76	22790.00	23307.28	24918.48	25690.16	28539.44	28844.72	32697.04
	10-chair Value Pack	D831-C340	25842.80	26743.80	27316.20	28779.00	29425.60	31439.60	32404.20	35965.80	36347.40	41162.80
With Lumbar Support - Standard												
	1 chair	D831-2241	\$ 2815.36	\$ 2905.46	\$ 2962.70	\$ 3108.98	\$ 3173.64	\$ 3375.04	\$ 3471.50	\$ 3827.66	\$ 3865.82	\$ 4347.36
	6-chair Value Pack	D831-A241	15901.06	16441.66	16785.10	17662.78	18050.74	19259.14	19837.90	21974.86	22203.82	25093.06
	8-chair Value Pack	D831-B241	21195.76	21916.56	22374.48	23544.72	24062.00	25673.20	26444.88	29294.16	29599.44	33451.76
	10-chair Value Pack	D831-C241	26786.20	27687.20	28259.60	29722.40	30369.00	32383.00	33347.60	36909.20	37290.80	42106.20
With Lumbar Support - Upholstered												
	1 chair	D831-2341	\$ 2883.20	\$ 2973.30	\$ 3030.54	\$ 3176.82	\$ 3241.48	\$ 3442.88	\$ 3539.34	\$ 3895.50	\$ 3933.66	\$ 4415.20
	6-chair Value Pack	D831-A341	16308.10	16848.70	17192.14	18069.82	18457.78	19666.18	20244.94	22381.90	22610.86	25500.10
	8-chair Value Pack	D831-B341	21738.48	22459.28	22917.20	24087.44	24604.72	26215.92	26987.60	29836.88	30142.16	33994.48
	10-chair Value Pack	D831-C341	27464.60	28365.60	28938.00	30400.80	31047.40	33061.40	34026.00	37587.60	37969.20	42784.60

Soft Caster Option

Soft caster option requires modification of the product number. Change the seventh digit in the product number from **4** to **2**.

Examples: D831-2240 = chair with hard casters; D831-2220 = chair with soft casters.

CAL 133 Option

CAL 133 option is available on all chair models in leather. To specify, add **-F** to the product number and add **\$539.54** list.

Nano-Tex Option

To specify, add **-P** to end of the product number and add **\$55.12** list.

Example: D831-2240-P

NOTE: Nano-Tex is not available on leather.

For available fabrics see matrix in the back of the book.

Monaco

Large Mid-Back Chair with Enclosed Arms



D831-2640

Dimensions

SH: 16" - 20 1/2"
(406mm-521mm)
H: 41 1/2" - 49 1/2"
(1054mm-1257mm)
D: 26"(660mm)
W: 30"(762mm)
SW: 23 1/2"(597mm)
SD: 21 1/2"(546mm)
AH: 26 1/3" - 31 1/3"
(577mm-689mm)

Features

- Pneumatic height adjustment.
- Fully-upholstered shell.
- Standard with 6-position back lock.
- Five-star, cast aluminum base with dual-wheel casters.
- Casters and column standard in black finish color.
- Arms enclosed.
- Standard with 3"(76mm) of back height adjustment.
- COM yardage: 3.50
- COL square footage: 63.0
- Available on RUSH.

To Order, Specify:

- 1) Product number.
- 2) Fabric surface and color.
- 3) Base trim color. Add **\$75.26** for Brushed Aluminum (PN-B) finish.

Leather Upholstery

Leather upholstery requires modification of the product number. Change the second digit in the product number from **8** to **7** and specify the leather surface and color.

Examples: D831-2640 = chair with fabric; D731-2640 = chair with leather.

NOTE:

CAD symbol for Value Packs shows one chair but represents quantity of chairs within Value Pack.

Arms/ Caps	Quantity	Number	Fabric Grade								Leather Grade A	Leather Grade B
			A	B	C	D	E	F	G	H		
Without Lumbar Support - Standard												
	1 chair	D831-2640 ■	\$ 2653.18	\$ 2743.28	\$ 2800.52	\$ 2946.80	\$ 3011.46	\$ 3212.86	\$ 3309.32	\$ 3665.48	\$ 3703.64	\$ 4185.18
	6-chair Value Pack	D831-A640	14927.98	15468.58	15812.02	16689.70	17077.66	18286.06	18864.82	21001.78	21230.74	24119.98
	8-chair Value Pack	D831-B640	19898.32	20619.12	21077.04	22247.28	22764.56	24375.76	25147.44	27996.72	28302.00	32154.32
	10-chair Value Pack	D831-C640	25164.40	26065.40	26637.80	28100.60	28747.20	30761.20	31725.80	35287.40	35669.00	40484.40
With Lumbar Support - Standard												
	1 chair	D831-2641 ■	\$ 2815.36	\$ 2905.46	\$ 2962.70	\$ 3108.98	\$ 3173.64	\$ 3375.04	\$ 3471.50	\$ 3827.66	\$ 3865.82	\$ 4347.36
	6-chair Value Pack	D831-A641	15901.06	16441.66	16785.10	17662.78	18050.74	19259.14	19837.90	21974.86	22203.82	25093.06
	8-chair Value Pack	D831-B641	21195.76	21916.56	22374.48	23544.72	24062.00	25673.20	26444.88	29294.16	29599.44	33451.76
	10-chair Value Pack	D831-C641	26786.20	27687.20	28259.60	29722.40	30369.00	32383.00	33347.60	36909.20	37290.80	42106.20

Soft Caster Option

Soft caster option requires modification of the product number. Change the seventh digit in the product number from **4** to **2**.

Examples: D831-2640 = chair with hard casters; D831-2620 = chair with soft casters.

CAL 133 Option

CAL 133 option is available on all chair models in leather. To specify, add **-F** to the product number and add **\$539.54** list.

Nano-Tex Option

To specify, add **-P** to end of the product number and add **\$55.12** list.

Example: D831-2640-P

NOTE: Nano-Tex is not available on leather.

For available fabrics see matrix in the back of the book.

Monaco

Medium Mid-Back Chair with Open Arms



D841-2240

Dimensions

SH: 16" - 20 1/2"
(406mm-521mm)
H: 39" - 46 3/4"
(991mm-1187mm)
D: 23 1/2"(597mm)
W: 26"(660mm)
SW: 22"(559mm)
SD: 20"(508mm)
AH: 26 1/3" - 31 1/3"
(577mm-689mm)

Features

- Pneumatic height adjustment.
- Fully-upholstered shell.
- Standard with 6-position back lock.
- Five-star, cast aluminum base with dual-wheel casters.
- Casters and column standard in black finish color.
- Arms available with standard black soft or upholstered caps.
- Standard with 3"(76mm) of back height adjustment.
- COM yardage: 3.00
- COL square footage: 54.0
- Available on RUSH.

To Order, Specify:

- 1) Product number.
- 2) Fabric surface and color.
- 3) Base and arm trim color. Add **\$75.26** for Brushed Aluminum (PN-B) finish.

Leather Upholstery

Leather upholstery requires modification of the product number. Change the second digit in the product number from **8** to **7** and specify the leather surface and color.

Examples: D841-2240 = chair with fabric; D741-2240 = chair with leather.

NOTE:

CAD symbol for Value Packs shows one chair but represents quantity of chairs within Value Pack.

Arms/ Caps	Quantity	Number	Fabric Grade								Leather Grade A	Leather Grade B
			A	B	C	D	E	F	G	H		
Without Lumbar Support - Standard												
	1 chair	D841-2240 ■	\$ 2653.18	\$ 2743.28	\$ 2800.52	\$ 2946.80	\$ 3011.46	\$ 3212.86	\$ 3309.32	\$ 3665.48	\$ 3703.64	\$ 4185.18
	6-chair Value Pack	D841-A240	14927.98	15468.58	15812.02	16689.70	17077.66	18286.06	18864.82	21001.78	21230.74	24119.98
	8-chair Value Pack	D841-B240	19898.32	20619.12	21077.04	22247.28	22764.56	24375.76	25147.44	27996.72	28302.00	32154.32
	10-chair Value Pack	D841-C240	25164.40	26065.40	26637.80	28100.60	28747.20	30761.20	31725.80	35287.40	35669.00	40484.40
Without Lumbar Support - Upholstered												
	1 chair	D841-2340 ■	\$ 2721.02	\$ 2811.12	\$ 2868.36	\$ 3014.64	\$ 3079.30	\$ 3280.70	\$ 3377.16	\$ 3733.32	\$ 3771.48	\$ 4253.02
	6-chair Value Pack	D841-A340	15335.02	15875.62	16219.06	17096.74	17484.70	18693.10	19271.86	21408.82	21637.78	24527.02
	8-chair Value Pack	D841-B340	20441.04	21161.84	21619.76	22790.00	23307.28	24918.48	25690.16	28539.44	28844.72	32697.04
	10-chair Value Pack	D841-C340	25842.80	26743.80	27316.20	28779.00	29425.60	31439.60	32404.20	35965.80	36347.40	41162.80
With Lumbar Support - Standard												
	1 chair	D841-2241 ■	\$ 2815.36	\$ 2905.46	\$ 2962.70	\$ 3108.98	\$ 3173.64	\$ 3375.04	\$ 3471.50	\$ 3827.66	\$ 3865.82	\$ 4347.36
	6-chair Value Pack	D841-A241	15901.06	16441.66	16785.10	17662.78	18050.74	19259.14	19837.90	21974.86	22203.82	25093.06
	8-chair Value Pack	D841-B241	21195.76	21916.56	22374.48	23544.72	24062.00	25673.20	26444.88	29294.16	29599.44	33451.76
	10-chair Value Pack	D841-C241	26786.20	27687.20	28259.60	29722.40	30369.00	32383.00	33347.60	36909.20	37290.80	42106.20
With Lumbar Support - Upholstered												
	1 chair	D841-2341 ■	\$ 2883.20	\$ 2973.30	\$ 3030.54	\$ 3176.82	\$ 3241.48	\$ 3442.88	\$ 3539.34	\$ 3895.50	\$ 3933.66	\$ 4415.20
	6-chair Value Pack	D841-A341	16308.10	16848.70	17192.14	18069.82	18457.78	19666.18	20244.94	22381.90	22610.86	25500.10
	8-chair Value Pack	D841-B341	21738.48	22459.28	22917.20	24087.44	24604.72	26215.92	26987.60	29836.88	30142.16	33994.48
	10-chair Value Pack	D841-C341	27464.60	28365.60	28938.00	30400.80	31047.40	33061.40	34026.00	37587.60	37969.20	42784.60

Soft Caster Option

Soft caster option requires modification of the product number. Change the seventh digit in the product number from **4** to **2**.

Examples: D841-2240 = chair with hard casters; D841-2220 = chair with soft casters.

CAL 133 Option

CAL 133 option is available on all chair models in leather. To specify, add **-F** to the product number and add **\$539.54** list.

Nano-Tex Option

To specify, add **-P** to end of the product number and add **\$55.12** list.

Example: D841-2240-P

NOTE: Nano-Tex is not available on leather.

For available fabrics see matrix in the back of the book.

Monaco

Medium Mid-Back Chair with Enclosed Arms



D841-2640

Dimensions

SH: 16" - 20 1/2"
(406mm-521mm)
H: 39" - 46 3/4"
(991mm-1187mm)
D: 23 1/2"(597mm)
W: 26"(660mm)
SW: 22"(559mm)
SD: 20"(508mm)
AH: 26 1/3" - 31 1/3"
(577mm-689mm)

Features

- Pneumatic height adjustment.
- Fully-upholstered shell.
- Standard with 6-position back lock.
- Five-star, cast aluminum base with dual-wheel casters.
- Casters and column standard in black finish color.
- Arms enclosed.
- Standard with 3"(76mm) of back height adjustment.
- COM yardage: 3.25
- COL square footage: 58.5
- Available on RUSH.

To Order, Specify:

- 1) Product number.
- 2) Fabric surface and color.
- 3) Base trim color. Add **\$75.26** for Brushed Aluminum (PN-B) finish.

Leather Upholstery

Leather upholstery requires modification of the product number. Change the second digit in the product number from **8** to **7** and specify the leather surface and color.

Examples: D841-2640 = chair with fabric; D741-2640 = chair with leather.

NOTE:

CAD symbol for Value Packs shows one chair but represents quantity of chairs within Value Pack.

Arms/ Caps	Quantity	Number	Fabric Grade								Leather Grade A	Leather Grade B
			A	B	C	D	E	F	G	H		
Without Lumbar Support - Standard												
	1 chair	D841-2640 ■	\$ 2653.18	\$ 2743.28	\$ 2800.52	\$ 2946.80	\$ 3011.46	\$ 3212.86	\$ 3309.32	\$ 3665.48	\$ 3703.64	\$ 4185.18
	6-chair Value Pack	D841-A640	14927.98	15468.58	15812.02	16689.70	17077.66	18286.06	18864.82	21001.78	21230.74	24119.98
	8-chair Value Pack	D841-B640	19898.32	20619.12	21077.04	22247.28	22764.56	24375.76	25147.44	27996.72	28302.00	32154.32
	10-chair Value Pack	D841-C640	25164.40	26065.40	26637.80	28100.60	28747.20	30761.20	31725.80	35287.40	35669.00	40484.40
With Lumbar Support - Standard												
	1 chair	D841-2641 ■	\$ 2815.36	\$ 2905.46	\$ 2962.70	\$ 3108.98	\$ 3173.64	\$ 3375.04	\$ 3471.50	\$ 3827.66	\$ 3865.82	\$ 4347.36
	6-chair Value Pack	D841-A641	15901.06	16441.66	16785.10	17662.78	18050.74	19259.14	19837.90	21974.86	22203.82	25093.06
	8-chair Value Pack	D841-B641	21195.76	21916.56	22374.48	23544.72	24062.00	25673.20	26444.88	29294.16	29599.44	33451.76
	10-chair Value Pack	D841-C641	26786.20	27687.20	28259.60	29722.40	30369.00	32383.00	33347.60	36909.20	37290.80	42106.20

Soft Caster Option

Soft caster option requires modification of the product number. Change the seventh digit in the product number from **4** to **2**.

Examples: D841-2640 = chair with hard casters; D841-2620 = chair with soft casters.

CAL 133 Option

CAL 133 option is available on all chair models in leather. To specify, add **-F** to the product number and add **\$539.54** list.

Nano-Tex Option

To specify, add **-P** to end of the product number and add **\$55.12** list.

Example: D841-2640-P

NOTE: Nano-Tex is not available on leather.

For available fabrics see matrix in the back of the book.

System 58

General Specifications

Design: Simon Desanta

Features and Options

System 58 models feature:

- Fully-upholstered seat and back
- Five-star cast aluminum base or sled base
- Pneumatic height adjustment with 4-position back lock
- Molded-polyfoam contoured seat and back cushions
- Glass-filled nylon arms
- Hard, dual-wheel casters for carpeted floors

Mobility and Adjustability

- Pneumatic height adjustment
- Biosynchronized tilt
- Back reclines at a two-to-one ratio to the pitch of the seat
 - Front-edge seat height maintained through tilt mode
 - Lockable in four positions within the tilt range (back lock)
- Sled base models feature:
- Glides for carpeted or hard floor surfaces
 - Fixed height

Value Packs

System 58 chairs are offered in 6, 8 and 10 Chair "Value Packs" for your convenience. Value packs allow you to order one part number for your entire conference room. Value packs are offered at a reduced list price.

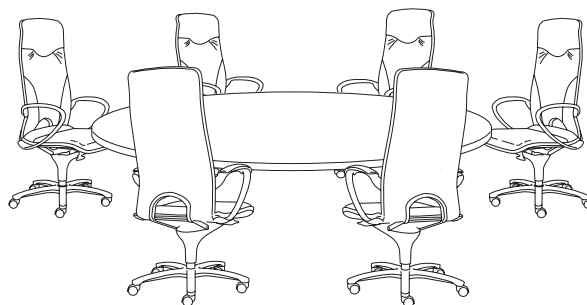

6-Chair Value Pack for System 58 Executive High-Back Chairs

System 58

General Specifications

Design: Simon Desanta

COM & COL General Information

To order a COM fabric (Customer's Own Material), contact the Haworth Inquiry Center (1.800.426.8562), your local Haworth dealer, or go to haworth.com/surfaces > COM Library to find out if the COM you have selected has already been tested and approved. The surface collection site also has information on the Haworth+ alliance program with Carnegie, Luna Textiles, and Maharam as well as our industry-leading Pre-Approved COM program.

Approved COMs are placed into Grades based on the fabric pricing; if the fabric pricing exceeds our Grades, they will be priced at Grade A + cost of fabric + 4% handling (North America). Haworth will purchase all COMs unless instructed otherwise. (Leather will also be purchased by Haworth; if the leather pricing exceeds our Grades, cost will be based on fabric Grade E + cost of leather + 4% handling.)

If no information is available on the COM you are looking for, refer to the COM section and forms on the surface collection site for information on how to process your test request.

General Guidelines for Product Specification

System 58 specification numbers are based on a numeric logic that identifies a product by model and certain characteristics.

For instance, a product number that reads **5811-2141** identifies the product as a System 58 Executive Chair, with fabric upholstery, pneumatic height adjustment, and hard casters.

The numeric logic for this model with fabric and finish codes is shown below:

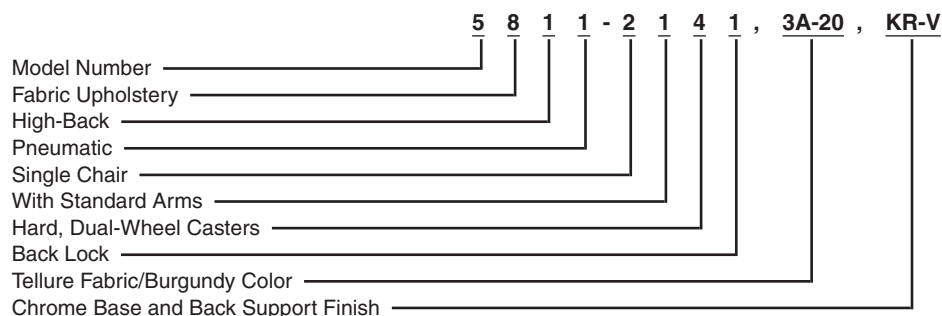

A ninth-digit suffix of the product number will indicate functional options, such as **-F** for CAL 133 option.

There are exceptions to this logic; therefore, always refer to the price charts for product numbers rather than attempting to construct them. Product number modification instructions for additional options appear in footnoted copy for each applicable model.

Beyond the printed product number, fabric and finish codes are required to complete an order specification. To communicate your order clearly, list the product number and finish codes in the sequence outlined on each price page.

RUSH

Select System 58 seating models are marked with a **■** symbol to denote availability on the RUSH program. Refer to the fabric and finish options for each product.

Finishes and Fabrics

A complete listing of finishes and fabrics for System 58 seating is available in the back of the price list.

System 58

High-Back Executive Chair with Arms



5811

NOTE:
CAD symbol for Value Packs shows one chair but represents quantity of chairs within Value Pack.

Dimensions

SH: 16" - 20 1/2"
(406mm-521mm)
H: 48" - 53"
(1219mm-1346mm)
D: 24"(610mm)
W: 25"(635mm)
SW: 20"(508mm)
SD: 17.7"(450mm)

Features

- Pneumatic height adjustment.
 - Fully-upholstered shell.
 - Standard with 4-position back lock.
 - Five-star aluminum base with hard dual-wheel casters.
 - Casters and column standard in black finish color.
 - Base and back support trim available in all finishes.
 - Arms available standard in black or with upholstered arm caps.
 - COM yardage: 3.3
 - COL square footage: 55.0
- Available on RUSH.

To Order Standard Arms and Base, Specify:

- 1) Product number.
- 2) Fabric surface and color.
- 3) Base and back support trim color. Add **\$120.84** list per chair for chrome (KR-V) finish. Add **\$75.26** for Brushed Aluminum (PN-B) finish.

For Value Packs, multiply the upcharge by the number of chairs in the Value Pack.

Leather Upholstery

Leather upholstery requires modification of the product number. Change the second digit in the product number from **8** to **7** and specify the leather surface and color.

Examples: 5811-2141 = chair with fabric; 5711-2141 = chair with leather.

Arms/ Caps	Quantity	Number	Fabric Grade								Leather Grade A	Leather Grade B
			A	B	C	D	E	F	G	H		
Standard	1 chair	5811-2141 ■	\$ 2226.00	\$ 2350.02	\$ 2480.40	\$ 2603.36	\$ 2727.38	\$ 2795.22	\$ 2917.12	\$ 3253.14	\$ 3210.74	\$ 3689.00
	6-chair Value Pack	5811-A141	12550.40	13294.52	14076.80	14814.56	15558.68	15965.72	16697.12	18713.24	18458.84	21328.40
	8-chair Value Pack	5811-B141	16734.22	17726.38	18769.42	19753.10	20745.26	21287.98	22263.18	24951.34	24612.14	28438.22
	10-chair Value Pack	5811-C141	20918.04	22158.24	23462.04	24691.64	25931.84	26610.24	27829.24	31189.44	30765.44	35548.04
Upholstered	1 chair	5811-2241 ■	\$ 2307.62	\$ 2431.64	\$ 2562.02	\$ 2684.98	\$ 2809.00	\$ 2876.84	\$ 2998.74	\$ 3334.76	\$ 3292.36	\$ 3770.62
	6-chair Value Pack	5811-A241	13040.12	13784.24	14566.52	15304.28	16048.40	16455.44	17186.84	19202.96	18948.56	21818.12
	8-chair Value Pack	5811-B241	17387.18	18379.34	19422.38	20406.06	21398.22	21940.94	22916.14	25604.30	25265.10	29091.18
	10-chair Value Pack	5811-C241	21734.24	22974.44	24278.24	25507.84	26748.04	27426.44	28645.44	32005.64	31581.64	36364.24

Soft Caster Option

Soft caster option requires modification of the product number. Change the seventh digit in the product number from **4** to **2**.

Examples: 5811-2141 = chair with hard casters; 5811-2121 = chair with soft casters.

Nano-Tex Option

To specify, add **-P** to end of the product number and add **\$55.12** list.

Example: 5811-2141-P

NOTE: Nano-Tex is not available on leather.

For available fabrics see matrix in the back of the book.

System 58

Mid-Back Executive Chair



5831
with arms



without arms

NOTE:

CAD symbol for Value Packs shows one chair but represents quantity of chairs within Value Pack.

Dimensions

SH: 16" - 20 1/2" (406mm-521mm)
 H: 37 1/2" - 42" (953mm-1067mm)
 D: 24"(610mm)
 W: 25"(635mm)
 SW: 20"(508mm)
 SD: 17.7"(450mm)

Features

- Pneumatic height adjustment.
- Fully-upholstered shell.
- Standard with 4-position back lock.
- Five-star aluminum base with hard dual-wheel casters.
- Casters and column standard in black finish color.
- Base and back support trim available in all finishes.
- Arms available standard in black or with upholstered arm caps.
- COM yardage: 2.7
- COL square footage: 55.0
- Available on RUSH.

To Order Standard Arms and Base, Specify:

- 1) Product number.
- 2) Fabric surface and color.
- 3) Base and back support trim color. Add **\$120.84** list per chair for chrome (KR-V) finish. Add **\$75.26** for Brushed Aluminum (PN-B) finish.

For Value Packs, multiply the upcharge by the number of chairs in the Value Pack.

Leather Upholstery

Leather upholstery requires modification of the product number. Change the second digit in the product number from **8** to **7** and specify the leather surface and color.

Examples: 5831-2141 = chair with fabric; 5731-2141 = chair with leather.

Arms/ Caps	Quantity	Number	Fabric Grade								Leather Grade A	Leather Grade B
			A	B	C	D	E	F	G	H		
Standard	1 chair	5831-2141	\$ 1887.86	\$ 1974.78	\$ 2061.70	\$ 2150.74	\$ 2239.78	\$ 2353.20	\$ 2452.84	\$ 2729.50	\$ 2495.24	\$ 2945.86
	6-chair Value Pack	5831-A141	10521.56	11043.08	11564.60	12098.84	12633.08	13313.60	13911.44	15571.40	14165.84	16869.56
	8-chair Value Pack	5831-B141	14029.10	14724.46	15419.82	16132.14	16844.46	17751.82	18548.94	20762.22	18888.14	22493.10
	10-chair Value Pack	5831-C141	17536.64	18405.84	19275.04	20165.44	21055.84	22190.04	23186.44	25953.04	23610.44	28116.64
Upholstered	1 chair	5831-2241	\$ 1969.48	\$ 2056.40	\$ 2143.32	\$ 2232.36	\$ 2321.40	\$ 2434.82	\$ 2534.46	\$ 2811.12	\$ 2576.86	\$ 3027.48
	6-chair Value Pack	5831-A241	11011.28	11532.80	12054.32	12588.56	13122.80	13803.32	14401.16	16061.12	14655.56	17359.28
	8-chair Value Pack	5831-B241	14682.06	15377.42	16072.78	16785.10	17497.42	18404.78	19201.90	21415.18	19541.10	23146.06
	10-chair Value Pack	5831-C241	18352.84	19222.04	20091.24	20981.64	21872.04	23006.24	24002.64	26769.24	24426.64	28932.84
Without Arms	1 chair	5831-2041	\$ 1786.10	\$ 1873.02	\$ 1959.94	\$ 2048.98	\$ 2138.02	\$ 2251.44	\$ 2351.08	\$ 2627.74	\$ 2393.48	\$ 2844.10
	6-chair Value Pack	5831-A041	9911.00	10432.52	10954.04	11488.28	12022.52	12703.04	13300.88	14960.84	13555.28	16259.00
	8-chair Value Pack	5831-B041	13215.02	13910.38	14605.74	15318.06	16030.38	16937.74	17734.86	19948.14	18074.06	21679.02
	10-chair Value Pack	5831-C041	16519.04	17388.24	18257.44	19147.84	20038.24	21172.44	22168.84	24935.44	22592.84	27099.04

Soft Caster Option

Soft caster option requires modification of the product number. Change the seventh digit in the product number from **4** to **2**.

Examples: 5831-2141 = chair with hard casters; 5831-2121 = chair with soft casters.

Nano-Tex Option

To specify, add **-P** to end of the product number and add **\$55.12** list.

Example: 5831-2141-P

NOTE: Nano-Tex is not available on leather.

For available fabrics see matrix in the back of the book.

System 58

Sled-Base Side Chair



5838-2100

Dimensions

SH: 18" (457mm)
 H: 38 1/2" (978mm)
 D: 24" (610mm)
 W: 25" (635mm)
 SW: 20" (508mm)
 SD: 18 3/4" (476mm)

Features

- Fixed height.
- Fully-upholstered shell.
- Metal frame and back support trim available in black and chrome finishes.
- Available with black polypropylene arm caps only.
- Standard with black glides for use on hard surface floors.
- COM yardage: 2.7
- COL square footage: 55.0
- Available on RUSH.

To Order Standard Arms and Frame, Specify:

- 1) Product number.
- 2) Fabric surface and color.
- 3) Frame and back support trim color. Add **\$228.96** list per chair for chrome (KR-V) finish.

Leather Upholstery

Leather upholstery requires modification of the product number. Change the second digit in the product number from **8** to **7** and specify the leather surface and color.

Examples: 5838-2100 = chair with fabric; 5738-2100 = chair with leather.

Arm/Caps	Number	Fabric Grade		C	D	E	F	G	H	Leather Grade A	Leather Grade B
		A	B								
Standard	5838-2100 ■	\$1247.62	\$1334.54	\$1421.46	\$1510.50	\$1599.54	\$1712.96	\$1812.60	\$2089.26	\$1887.86	\$2340.62

Nano-Tex Option

To specify, add **-P** to end of the product number and add **\$32.86** list.

Example: 5838-2100-P

NOTE: Nano-Tex is not available on leather.

For available fabrics see matrix in the back of the book.

Prescott Series

Swivel Seating

	Number	Fabric Grade								Leather Grade A	Leather Grade B
		A	B	C	D	E	F	G	H		

High-Back Chair, Fully-Upholstered Arm/Polypropylene Base

Dimensions
 SH: 16" - 21"
 (406mm-533mm)
 H: 43 1/2" - 48"
 (1105mm-1219mm)
 D: 28"(711mm)
 W: 28"(711mm)
 AH: 25 1/4" - 29 3/4"
 (641mm-756mm)
 SW: 20 1/2"(521mm)
 SD: 17"(432mm)



5215-32

Features

- Seat and back panel curved, 8-Ply curved plywood.
- Seat panel webbed with wide support webbing.
- Seat contoured foam, back molded polyurethane foam.
- Upholstered ABS outer shell.
- Rigid molded urethane arms.
- Five-star steel base with black polypropylene base cap.
- Hard dual-wheel casters standard.
- Synchronized-tilt (2:1 ratio) with 6-position back-lock.
- Back height adjustment: 3"(76mm).
- Pneumatic seat height adjustment.
- COM yardage: 3.50
- COL square footage: 63.0

To Order, Specify:

- 1) Product number.
- 2) Fabric surface and color.
- 3) Base cap finish color (NY-B).

■ Available on RUSH.

High-Back Chair, Fully-Upholstered Arm with Wood Arm Trim/ Polypropylene Base

SH: 16" - 21"
 (406mm-533mm)
 H: 43 1/2" - 48"
 (1105mm-1219mm)
 D: 28"(711mm)
 W: 28"(711mm)
 AH: 25 1/4" - 29 3/4"
 (641mm-756mm)
 SW: 20 1/2"(521mm)
 SD: 17"(432mm)



5210-32

5210-32	\$1791.30	\$1889.96	\$1950.06	\$2107.69	\$2179.13	\$2390.05	\$2519.33	\$2874.27	\$3077.26	\$3605.70
---------	-----------	-----------	-----------	-----------	-----------	-----------	-----------	-----------	-----------	-----------

Features

- Maple arm trim.
- Seat and back panel curved, 8-Ply curved plywood.
- Seat panel webbed with wide support webbing.
- Seat contoured foam, back molded polyurethane foam.
- Upholstered ABS outer shell.
- Rigid molded urethane arms.
- Five-star steel base with black polypropylene base cap.
- Hard dual-wheel casters standard.
- Synchronized-tilt (2:1 ratio) with 6-position back-lock.
- Back height adjustment: 3"(76mm).
- Pneumatic seat height adjustment.
- COM yardage: 3.50
- COL square footage: 63.0

To Order, Specify:

- 1) Product number.
- 2) Fabric surface and color.
- 3) Arm wood finish color.
- 4) Base cap finish color (NY-B).

High-Back Chair, Fully-Upholstered Arm/Wood Base

SH: 16" - 21"
 (406mm-533mm)
 H: 43 1/2" - 48"
 (1105mm-1219mm)
 D: 28"(711mm)
 W: 28"(711mm)
 AH: 25 1/4" - 29 3/4"
 (641mm-756mm)
 SW: 20 1/2"(521mm)
 SD: 17"(432mm)



5215-32

5215-32	\$2051.70	\$2150.36	\$2210.46	\$2368.09	\$2439.53	\$2650.45	\$2779.73	\$3134.67	\$3337.66	\$3866.10
---------	-----------	-----------	-----------	-----------	-----------	-----------	-----------	-----------	-----------	-----------

Features

- Maple base.
- Seat and back panel curved, 8-Ply curved plywood.
- Seat panel webbed with wide support webbing.
- Seat contoured foam, back molded polyurethane foam.
- Upholstered ABS outer shell.
- Rigid molded urethane arms.
- Five-star steel base with wood base caps.
- Hard dual-wheel casters standard.
- Synchronized-tilt (2:1 ratio) with 6-position back lock.
- Back height adjustment: 3"(76mm).
- Pneumatic seat height adjustment.
- COM yardage: 3.50
- COL square footage: 63.0



To Order, Specify:

- 1) Product number.
- 2) Fabric surface and color.
- 3) Base wood finish color.

Nano-Text Option
 To specify, add **-P** to end of the product number and add **\$54.60** list.
Example: 5215-32-**P**
NOTE: Nano-Text is not available on leather.
 For available fabrics see matrix in the back of the book.

Prescott Series

Swivel Seating

	Dimensions	Number	Fabric Grade								Leather Grade A	Leather Grade B
			A	B	C	D	E	F	G	H		
High-Back Chair, Fully-Upholstered Arm with Wood Arm Trim/Wood Base  5210-32	SH: 16" - 21" (406mm-533mm) H: 43 1/2" - 48" (1105mm-1219mm) D: 28"(711mm) W: 28"(711mm) AH: 25 1/4" - 29 3/4" (641mm-756mm) SW: 20 1/2"(521mm) SD: 17"(432mm)	5210-32	\$2100.00	\$2198.66	\$2258.76	\$2416.39	\$2487.83	\$2698.75	\$2828.03	\$3182.97	\$3385.96	\$3914.40
	Features <ul style="list-style-type: none"> • Maple arm trim, maple base. • Seat and back panel curved, 8-ply curved plywood. • Seat panel webbed with wide support webbing. • Seat contoured foam, back molded polyurethane foam. • Upholstered ABS outer shell. • Rigid molded urethane arms. • Five-star steel base with wood base caps. • Hard dual-wheel casters standard. • Synchronized-tilt (2:1 ratio) with 6-position back-lock. • Back height adjustment: 3"(76mm). • Pneumatic seat height adjustment. • COM yardage: 3.50 • COL square footage: 63.0 										To Order, Specify: <ol style="list-style-type: none"> 1) Product number. 2) Fabric surface and color. 3) Arm/base wood finish color. 	
Mid-Back Chair, Fully-Upholstered Arm/Polypropylene Base  5225-32	SH: 16" - 21" (406mm-533mm) H: 39 1/2" - 44" (1003mm-1118mm) D: 28"(711mm) W: 28"(711mm) AH: 25 1/4" - 29 3/4" (641mm-756mm) SW: 20 1/2"(521mm) SD: 17"(432mm)	5225-32	\$1659.00	\$1750.35	\$1806.00	\$1951.95	\$2018.10	\$2213.40	\$2333.10	\$2661.75	\$2849.70	\$3339.00
	Features <ul style="list-style-type: none"> • Seat and back panel curved, 8-ply curved plywood. • Seat panel webbed with wide support webbing. • Seat contoured foam, back molded polyurethane foam. • Upholstered ABS outer shell. • Rigid molded urethane arms. • Five-star steel base with black polypropylene base cap. • Hard dual-wheel casters standard. • Synchronized-tilt (2:1 ratio) with 6-position back-lock. • Back height adjustment: 3"(76mm). • Pneumatic seat height adjustment. • COM yardage: 3.25 • COL square footage: 58.5 Available on RUSH.										To Order, Specify: <ol style="list-style-type: none"> 1) Product number. 2) Fabric surface and color. 3) Base cap finish color (NY-B). 	
Mid-Back Chair, Fully-Upholstered Arm with Wood Arm Trim/Polypropylene Base  5220-32	SH: 16" - 21" (406mm-533mm) H: 39 1/2" - 44" (1003mm-1118mm) D: 28"(711mm) W: 28"(711mm) AH: 25 1/4" - 29 3/4" (641mm-756mm) SW: 20 1/2"(521mm) SD: 17"(432mm)	5220-32	\$1707.30	\$1798.65	\$1854.30	\$2000.25	\$2066.40	\$2261.70	\$2381.40	\$2710.05	\$2898.00	\$3387.30
	Features <ul style="list-style-type: none"> • Maple arm trim. • Seat and back panel curved, 8-ply curved plywood. • Seat panel webbed with wide support webbing. • Seat contoured foam, back molded polyurethane foam. • Upholstered ABS outer shell. • Rigid molded urethane arms. • Five-star steel base with black polypropylene base cap. • Hard dual-wheel casters standard. • Synchronized-tilt (2:1 ratio) with 6-position back-lock. • Back height adjustment: 3"(76mm). • Pneumatic seat height adjustment. • COM yardage: 3.25 • COL square footage: 58.5 										To Order, Specify: <ol style="list-style-type: none"> 1) Product number. 2) Fabric surface and color. 3) Arm wood finish color. 4) Base cap finish color (NY-B). 	
	Nano-Tex Option To specify, add -P to end of the product number and add \$54.60 list. Example: 5210-32-P NOTE: Nano-Tex is not available on leather. For available fabrics see matrix in the back of the book.											

Prescott Series

Swivel Seating

	Number	Fabric Grade								Leather Grade A	Leather Grade B	
		A	B	C	D	E	F	G	H			
Mid-Back Chair, Fully-Upholstered Arm/Wood Base  5225-32	Dimensions SH: 16" - 21" (406mm-533mm) H: 39 1/2" - 44" (1003mm-1118mm) D: 28"(711mm) W: 28"(711mm) AH: 25 1/4" - 29 3/4" (641mm-756mm) SW: 20 1/2"(521mm) SD: 17"(432mm)	5225-32	\$1967.70	\$2059.05	\$2114.70	\$2260.65	\$2326.80	\$2522.10	\$2641.80	\$2970.45	\$3158.40	\$3647.70
	Features <ul style="list-style-type: none"> • Maple arm trim, maple base. • Seat and back panel curved, 8-ply curved plywood. • Seat panel webbed with wide support webbing. • Seat contoured foam, back molded polyurethane foam. • Upholstered ABS outer shell. • Rigid molded urethane arms. • Five-star steel base with wood base caps. • Hard dual-wheel casters standard. • Synchronized-tilt (2:1 ratio) with 6-position tilt lock. • Back height adjustment: 3"(76mm). • Pneumatic seat height adjustment. • COM yardage: 3.25 • COL square footage: 58.5 ■ Available on RUSH.											To Order, Specify: <ol style="list-style-type: none"> 1) Product number. 2) Fabric surface and color. 3) Base wood finish color.

Mid-Back Chair, Fully-Upholstered Arm with Wood Arm Trim/Wood Base  5220-32	Dimensions SH: 16" - 21" (406mm-533mm) H: 39 1/2" - 44" (1003mm-1118mm) D: 28"(711mm) W: 28"(711mm) AH: 25 1/4" - 29 3/4" (641mm-756mm) SW: 20 1/2"(521mm) SD: 17"(432mm)	5220-32	\$2016.00	\$2107.35	\$2163.00	\$2308.95	\$2375.10	\$2570.40	\$2690.10	\$3018.75	\$3206.70	\$3696.00
	Features <ul style="list-style-type: none"> • Maple arm trim, maple base. • Seat and back panel curved, 8-ply curved plywood. • Seat panel webbed with wide support webbing. • Seat contoured foam, back molded polyurethane foam. • Upholstered ABS outer shell. • Rigid molded urethane arms. • Five-star steel base with wood base caps. • Hard dual-wheel casters standard. • Synchronized-tilt (2:1 ratio) with 6-position tilt lock. • Back height adjustment: 3"(76mm). • Pneumatic seat height adjustment. • COM yardage: 3.25 • COL square footage: 58.5 											To Order, Specify: <ol style="list-style-type: none"> 1) Product number. 2) Fabric surface and color. 3) Arm/base wood finish color. Nano-Tex Option To specify, add -P to end of the product number and add \$54.60 list. Example: 5225-32- P NOTE: Nano-Tex is not available on leather. For available fabrics see matrix in the back of the book.

System 12

General Specifications

Features and Options

Armless and arm versions feature:

- 11mm solid steel frame
- Textured injection-molded polypropylene seat and back
- High impact nylon glides
- Painted or chrome-finish frame
- Stacking cart (40-high capacity)
- Upholstered versions with 1/2"(13mm) foam pad on seat
- Optional tablet board or book rack

Chairs with arms feature:

- Black plastic arm caps

General Guidelines for Product Specification

System 12 specification numbers are based on a numeric logic that identifies a product by model and certain characteristics.

For instance, a product number that reads **1201-2110** identifies the product as a System 12 High-Density Stacking Chair, with arms, fixed height, polypropylene shell, and glides.

The numeric logic for this model with finish codes is shown below:

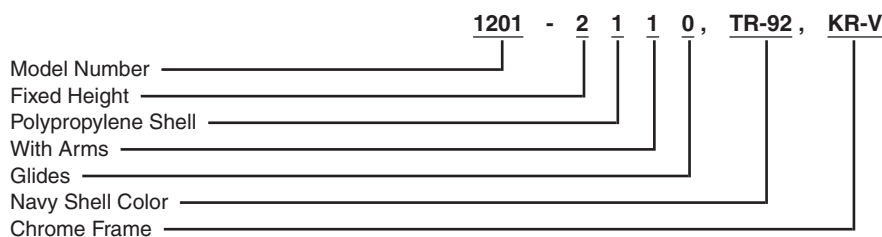

There are exceptions to this logic; therefore, always refer to the price charts for product numbers rather than attempting to construct them. Product number modification instructions for additional options appear in footnoted copy for each applicable model.

Beyond the printed product number, finish codes are required to complete an order specification. To communicate your order clearly, list the product number and finish codes in the sequence outlined on each price page.

COM & COL General Information

To order a COM fabric (Customer's Own Material), contact the Haworth Inquiry Center (1.800.426.8562), your local Haworth dealer, or go to haworth.com/surfaces > COM Library to find out if the COM you have selected has already been tested and approved. The surface collection site also has information on the Haworth+ alliance program with Carnegie, Luna Textiles, and Maharam as well as our industry-leading Pre-Approved COM program.

Approved COMs are placed into Grades based on the fabric pricing; if the fabric pricing exceeds our Grades, they will be priced at Grade A + cost of fabric + 4% handling (North America). Haworth will purchase all COMs unless instructed otherwise. (Leather will also be purchased by Haworth; if the leather pricing exceeds our Grades, cost will be based on fabric Grade E + cost of leather + 4% handling.)

If no information is available on the COM you are looking for, refer to the COM section and forms on the surface collection site for information on how to process your test request.

RUSH

Select System 12 models are marked with a  symbol to denote availability on the RUSH program. Refer to the finish options for each product.

Finishes

A complete listing of fabrics and finishes for System 12 seating can be found in the back of the price list.

System 12

High-Density Stacking Chair

Designer: Steve Nemeth

With Arms

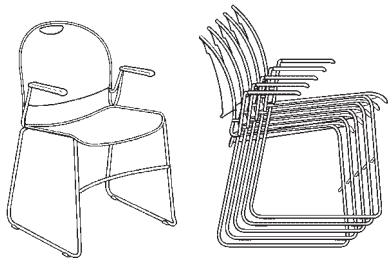

1201-2110

Dimensions

SH: 17"(432mm)
 H: 32"(813mm)
 W: 22"(559mm)
 D: 22 1/2"(572mm)
 SW: 17 1/2"(445mm)
 SD: 17 1/4"(438mm)
 AH: 24 3/4"(629mm)
 Between Arms:
 19"(483mm)

Features

- 11mm solid steel rod frame.
- Injection-molded textured polypropylene seat and back with upholstered option.
- Upholstered seat features 1/2"(13mm) foam pad.
- Integrated handle in back for easy mobility.
- Arms with black plastic caps.
- High impact nylon glides available with or without ganging option.
- Stackable 40-high with polypropylene shells; 69"(1753mm) high on stacking cart, or 22-high with upholstered shells; 66"(1676mm) high on stacking cart.
- Standard packaging - four per carton polypropylene and three per carton upholstered.
- Painted or chrome finish frame.
- Weight: 13.3 lbs.
- NOTE: Gang arm chairs only to armless chairs.
- COM yardage: 0.70
- Available on RUSH.

To Order, Specify:

- 1) Product number.
- 2) Fabric surface and color (if applicable).
- 3) Polypropylene shell color.
- 4) Frame trim color or chrome (KR-V).

Inside Shells	Ganging	Number	Price	Fabric Grade							
				A	B	C	D	E	F	G	H
Polypropylene	Non-Ganging	1201-2110 ■	\$282.31	N/A	N/A	N/A	N/A	N/A	N/A	N/A	N/A
	Ganging Glides	1201-2111	291.31	N/A	N/A	N/A	N/A	N/A	N/A	N/A	N/A
Upholstered	Non-Ganging	1221-2110 ■	N/A	\$410.93	\$433.82	\$450.17	\$471.97	\$489.41	\$534.10	\$562.44	\$635.47
	Ganging Glides	1221-2111	N/A	419.93	442.82	459.17	480.97	498.41	543.10	571.44	644.47

Without Arms

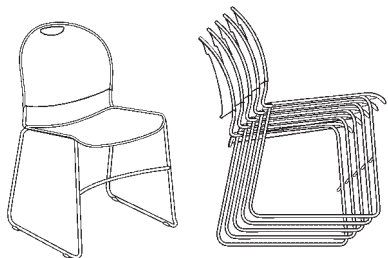

1200-2100

Dimensions

SH: 17"(432mm)
 H: 32"(813mm)
 W: 19 3/4"(502mm)
 D: 22 1/2"(572mm)
 SW: 17 1/2"(445mm)
 SD: 17 1/4"(438mm)

Features

- 11mm solid steel rod frame.
- Injection-molded textured polypropylene seat and back with upholstered option.
- Upholstered seat features 1/2"(13mm) foam pad.
- Integrated handle in back for easy mobility.
- High impact nylon glides available with or without ganging option.
- Stackable 40-high with polypropylene shells; 69"(1753mm) high on stacking cart, or 22-high with upholstered shells; 66"(1676mm) high on stacking cart.
- Standard packaging - four per carton polypropylene and three per carton upholstered.
- Painted or chrome finish frame.
- Weight: 10.8 lbs.
- NOTE: Gang armless chairs to either arm or armless chairs.
- COM yardage: 0.70
- Available on RUSH.

To Order, Specify:

- 1) Product number.
- 2) Fabric surface and color (if applicable).
- 3) Polypropylene shell color.
- 4) Frame trim color or chrome (KR-V).

Inside Shells	Ganging	Number	Price	Fabric Grade							
				A	B	C	D	E	F	G	H
Polypropylene	Non-Ganging	1200-2100 ■	\$188.57	N/A	N/A	N/A	N/A	N/A	N/A	N/A	N/A
	Ganging Glides	1200-2101	197.57	N/A	N/A	N/A	N/A	N/A	N/A	N/A	N/A
Upholstered	Non-Ganging	1220-2100 ■	N/A	\$317.19	\$340.08	\$356.43	\$378.23	\$395.67	\$440.36	\$468.70	\$541.73
	Ganging Glides	1220-2101	N/A	326.19	349.08	365.43	387.23	404.67	449.36	477.70	550.73

System 12

Accessories

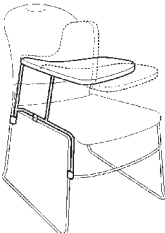
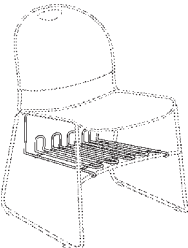
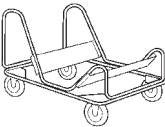
	Height	Width	Depth	Description	Number	Price
Tablet Board	9 3/8"(238mm)	11 5/8"(295mm)	20 1/2"(521mm)	Right-hand	TABR-12	\$155.87
				Left-hand	TABL-12	155.87
				Features	To Order, Specify:	
TABR-12				<ul style="list-style-type: none"> • Retrofits to armless chairs only. • Particle board construction with high-pressure laminate top. • Price includes tablet board, support frame, and attachment clips. • Frame will be chrome finish only. • Flip up board does not articulate. • Cannot stack chairs with tablet boards attached. • Adds 1 1/2"(38mm) to chair width. 	<ol style="list-style-type: none"> 1) Product number. 2) Laminate finish color. <ul style="list-style-type: none"> H-34 Beige H-8J Charcoal H-3J Graphite 	
Book Rack	5 1/4"(133mm)	16 1/2"(419mm)	13 7/8"(352mm)		BOOK-12	\$74.88
				Features	To Order, Specify:	
BOOK-12				<ul style="list-style-type: none"> • Retrofits to arm or armless chair. • Standard in chrome finish only. • Cannot stack chairs with book rack attached. 	<ol style="list-style-type: none"> 1) Product number. (No finish specification required.) 	
Stacking Cart	21 1/4"(540mm)	21 1/4"(540mm)	28 1/2"(724mm)	Non-upholstered chairs only	CART-12 ■	\$459.98
				Upholstered chairs only	CART-12U ■	459.98
CART-12				Features	To Order, Specify:	
				<ul style="list-style-type: none"> • CART-12 permits stacking 40-high (69"(1753mm)) and provides mobility. • CART-12U permits stacking 22-high (66"(1676mm)) and provides mobility. • Standard in black finish color only. ■ Available on RUSH. 	<ol style="list-style-type: none"> 1) Product number. (No color specification required.) 	

This page intentionally blank

Wood Seating

General Specifications

Features and Options	<p>Guest, occasional, and lounge models feature frames constructed solid hardwood, laminated plywood, laminated hardwood core and premium veneers, or rigid polyurethane.</p> <p>Office seating models feature an inner frame construction of tubular steel or solid hardwood or laminated plywood or molded plywood. Swivel bases are standard with hard dual-wheel casters.</p> <p>Exposed wood surfaces are finished with two top coats of pre-catalyst nitrocellulose lacquer for a durable finish.</p> <p>Refer to the appropriate seating model for applicable features and options.</p>
COM & COL General Information	<p>To order a COM fabric (Customer's Own Material), contact the Haworth Inquiry Center (1.800.426.8562), your local Haworth dealer, or go to haworth.com/surfaces > COM Library to find out if the COM you have selected has already been tested and approved. The surface collection site also has information on the Haworth + alliance program with Carnegie, Luna Textiles, and Maharam as well as our industry-leading Pre-Approved COM program.</p> <p>Approved COMs are placed into Grades based on the fabric pricing; if the fabric pricing exceeds our Grades, they will be priced at Grade A + cost of fabric + 4% handling (North America). Haworth will purchase all COMs unless instructed otherwise. (Leather will also be purchased by Haworth; if the leather pricing exceeds our Grades, cost will be based on fabric Grade E + cost of leather + handling.)</p> <p>If no information is available on the COM you are looking for, refer to the COM section and forms on the surface collection site for information on how to process your test request.</p>
Flammability Requirements	<p>Select chair models meet CAL 133 Standard and are available with an optional fire-retardant construction to comply with California Bulletin #133. Refer to the price pages for ordering information. Refer to Haworth.com/surfaces for a listing of the approved fabrics.</p>
General Guidelines for Product Specification	<p>Seating specification numbers are based on a numeric logic that identifies a product by model and certain characteristics.</p> <p>For instance, a product number that reads SAS-22-A1B identifies the product as a Candor Classic Seating with fully upholstered seat and back.</p> <p>The numeric logic for this model with finish codes is shown below:</p> <div style="text-align: center; margin: 10px 0;"> <p>SAS-22, A1B, 3A, 3A-06, M3-CA1</p> </div> <p>Candor Classic Chair Fully Upholstered Seat and Back Tellure - Nickel Seat Fabric Tellure - Nickel Back Fabric Beech - Amber on Beech</p> <p>A ninth-digit suffix of the product code will indicate functional options, such as -F for CAL 133 option. There are exceptions to this logic; therefore, always refer to the price charts for product numbers rather than attempting to construct them. Product number modification instructions for additional options appear in footnoted copy for each applicable model.</p> <p>Beyond the printed product number, fabric and finish codes are required to complete an order specification. To communicate your order clearly, list the product number and finish codes in the sequence outlined on each price page.</p>
RUSH	<p>Select seating models are marked with a R symbol to denote availability on the RUSH program. Refer to the fabric and finish options for each model. A maximum order quantity of 25 units applies to all contemporary RUSH seating models. Refer to the RUSH price book for further details.</p>
Finishes and Fabrics	<p>A complete listing of finishes/fabrics can be found in the back of the price list.</p>

Candor Classic Seating

Number ①②	Fabric Grade		C	D	E	F	G	H	Leather Grade A	Leather Grade B
	A	B								
SAS- ■ ■ -A1B ■	\$782.25	\$803.25	\$811.65	\$832.65	\$845.25	\$990.15	\$1032.15	\$1158.15	\$1063.65	\$1314.25

Fully Upholstered
Seat and Back

SAS-22-A1B

Dimensions

SH: 17.8"(452mm)
H: 32.75"(832mm)
D: 23.25"(591mm)
W: 21"(533mm)
AH: 25"(635mm)
SW: 17.8"(452mm)
SD: 17.15"(436mm)

Features

- Open arms.
- Upholstered seat and back.
- Steamed beech hardwood frame. Seat frame rails are mortise and tenoned, cross locked with dowels, reinforced with corner blocks.
- Seat is HR foam over a webbed panel.
- The upholstered back frame insert is padded with foam.
- COM yardage: 1.5
- COL square footage: 27.0

■ Available on RUSH with matching seat and back upholstery.

Cal 133 Option: Add -F to product number and add \$99.75 list.

To Order, Specify:

1) Product number, including:

① Seat Option:

- 1 Leather
- 2 Fabric
- 3 Faux Leather

② Back Option:

- 1 Leather
- 2 Fabric
- 3 Faux Leather

- 2) Fabric surface and color (seat).
- 3) Fabric surface and color (back).
- 4) Arm/frame finish color.

SAS- ■ ■ -A2B ■	\$782.25	\$803.25	\$811.65	\$832.65	\$845.25	\$990.15	\$1032.15	\$1158.15	\$1063.65	\$1314.25
-----------------	----------	----------	----------	----------	----------	----------	-----------	-----------	-----------	-----------

Fully Upholstered
Seat and 3/4 Back

SAS-22-A2B

Dimensions

SH: 17.8"(452mm)
H: 32.50"(826mm)
D: 23.50"(597mm)
W: 21"(533mm)
AH: 25"(635mm)
SW: 17.8"(452mm)
SD: 17.15"(436mm)

Features

- Open arms.
- Upholstered seat and back.
- Steamed beech hardwood frame. Seat frame rails are mortise and tenoned, cross locked with dowels, reinforced with corner blocks.
- Seat is HR foam over a webbed panel.
- The upholstered back frame insert is padded with foam.
- COM yardage: 1.38
- COL square footage: 25.0

■ Available on RUSH with matching seat and back upholstery.

Cal 133 Option: Add -F to product number and add \$99.75 list.

To Order, Specify:

1) Product number, including:

① Seat Option:

- 1 Leather
- 2 Fabric
- 3 Faux Leather

② Back Option:

- 1 Leather
- 2 Fabric
- 3 Faux Leather

- 2) Fabric surface and color (seat).
- 3) Fabric surface and color (back).
- 4) Arm/frame finish color.

SAS- ■ W-A4B ■	\$730.80	\$741.30	\$745.50	\$756.00	\$762.30	\$834.75	\$855.75	\$918.75	\$871.50	\$996.80
----------------	----------	----------	----------	----------	----------	----------	----------	----------	----------	----------

Fully Upholstered
Seat and Slat Back

SAS-2W-A4B

Dimensions

SH: 17.8"(452mm)
H: 32.50"(826mm)
D: 23.50"(597mm)
W: 21"(533mm)
AH: 25"(635mm)
SW: 17.8"(452mm)
SD: 19"(483mm)

Features

- Open arms.
- Upholstered seat.
- Steamed beech hardwood frame. Seat frame rails are mortise and tenoned, cross locked with dowels, reinforced with corner blocks.
- Seat is HR foam over a webbed panel.
- COM yardage: 0.88
- COL square footage: 16.0

■ Available on RUSH with matching seat and back upholstery.

Cal 133 Option: Add -F to product number and add \$99.75 list.

Nano-Tex Option: To specify, add -P to end of the product number and add \$32.55 list.

Example: SAS-2W-A4B-P

DuraBlock Option: To specify add -D to end of the product number and add \$43.05 list.

Example: SAS-22-A1B-D

NOTE: Nano-Tex and DuraBlock are not available on leather or faux leather.

For available fabrics see matrix in the back of the book.

To Order, Specify:

1) Product number, including:

① Seat Option:

- 1 Leather
- 2 Fabric
- 3 Faux Leather

② Back Option:

- W Wood

- 2) Fabric surface and color.
- 3) Arm/frame finish color.

Candor Modern Seating

Number ①②	Fabric Grade		C	D	E	F	G	H	Leather Grade A	Leather Grade B
	A	B								
SAS- ■ ■ -A1A ■	\$782.25	\$803.25	\$811.65	\$832.65	\$845.25	\$990.15	\$1032.15	\$1158.15	\$1063.65	\$1314.25

**Fully Upholstered
Seat and Back**

SAS-22-A1A

Dimensions

SH: 17.8"(452mm)
H: 32.75"(832mm)
D: 23.50"(597mm)
W: 21"(533mm)
AH: 25"(635mm)
SW: 17.8"(452mm)
SD: 17"(432mm)

Features

- Open arms.
- Upholstered seat and back.
- Steamed beech hardwood frame. Seat frame rails are mortise and tenoned, cross locked with dowels, reinforced with corner blocks.
- Seat is HR foam over a webbed panel.
- The upholstered back frame insert is padded with foam.
- COM yardage: 1.5
- COL square footage: 27.0

■ Available on RUSH with matching seat and back upholstery.

Cal 133 Option: Add -F to product number and add \$99.75 list.

To Order, Specify:

1) Product number, including:

① Seat Option:

- 1 Leather
- 2 Fabric
- 3 Faux Leather

② Back Option:

- 1 Leather
- 2 Fabric
- 3 Faux Leather

- 2) Fabric surface and color (seat).
- 3) Fabric surface and color (back).
- 4) Arm/frame finish color.

SAS- ■ ■ -A3A ■	\$782.25	\$803.25	\$811.65	\$832.65	\$845.25	\$990.15	\$1032.15	\$1158.15	\$1063.65	\$1314.25
-----------------	----------	----------	----------	----------	----------	----------	-----------	-----------	-----------	-----------

**Fully Upholstered
Seat and 1/2 Back**

SAS-22-A3A

Dimensions

SH: 17.8"(452mm)
H: 32.50"(826mm)
D: 23"(584mm)
W: 21"(533mm)
AH: 25"(635mm)
SW: 17.8"(452mm)
SD: 17"(432mm)

Features

- Open arms.
- Upholstered seat and back.
- Steamed beech hardwood frame. Seat frame rails are mortise and tenoned, cross locked with dowels, reinforced with corner blocks.
- Seat is HR foam over a webbed panel.
- The upholstered back frame insert is padded with foam.
- COM yardage: 1.25
- COL square footage: 22.5

■ Available on RUSH with matching seat and back upholstery.

Cal 133 Option: Add -F to product number and add \$99.75 list.

To Order, Specify:

1) Product number, including:

① Seat Option:

- 1 Leather
- 2 Fabric
- 3 Faux Leather

② Back Option:

- 1 Leather
- 2 Fabric
- 3 Faux Leather

- 2) Fabric surface and color (seat).
- 3) Fabric surface and color (back).
- 4) Arm/frame finish color.

SAS- ■ W-A4A ■	\$730.80	\$741.30	\$745.50	\$756.00	\$762.30	\$834.75	\$855.75	\$918.75	\$871.50	\$996.80
----------------	----------	----------	----------	----------	----------	----------	----------	----------	----------	----------

**Fully Upholstered
Seat and Slat Back**

SAS-2W-A4A

Dimensions

SH: 17.8"(452mm)
H: 32.50"(826mm)
D: 23"(584mm)
W: 21"(533mm)
AH: 25"(635mm)
SW: 17.8"(452mm)
SD: 19"(483mm)

Features

- Open arms.
- Upholstered seat.
- Steamed beech hardwood frame. Seat frame rails are mortise and tenoned, cross locked with dowels, reinforced with corner blocks.
- Seat is HR foam over a webbed panel.
- COM yardage: 0.88
- COL square footage: 16.0

■ Available on RUSH with matching seat and back upholstery.

Cal 133 Option: Add -F to product number and add \$99.75 list.

Nano-Tex Option: To specify, add -P to end of the product number and add \$32.55 list.

Example: SAS-2W-A4A-P

DuraBlock Option: To specify add -D to end of the product number and add \$43.05 list.

Example: SAS-22-A1A-D

NOTE: Nano-Tex and DuraBlock are not available on leather or faux leather.

For available fabrics see matrix in the back of the book.

To Order, Specify:

1) Product number, including:

① Seat Option:

- 1 Leather
- 2 Fabric
- 3 Faux Leather

② Back Option:

- W Wood

- 2) Fabric surface and color.
- 3) Arm/frame finish color.

Composites Seating Series

Guest/Occasional Seating

Base/ Frame	Number	Fabric Grade		C	D	E	F	G	H	Leather Grade A	Leather Grade B
		A	B								
Maple	4045-00	\$999.60	\$1034.25	\$1065.75	\$1118.25	\$1149.75	\$1169.70	\$1206.45	\$1308.30	\$1681.05	\$1844.60

Arc Arm, Upholstered Back

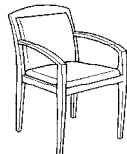

4045-00

Dimensions

SH: 18 1/2"(470mm)
H: 33 3/4"(857mm)
D: 23"(584mm)
W: 22 3/8"(568mm)
AH: 24" - 26"
(610mm-660mm)
SW: 19 1/2"(495mm)
SD: 18"(457mm)

Features

- Open arms.
- Upholstered seat and back.
- Maple hardwood frame. Seat frame rails are mortise and tenoned, cross locked with dowels, reinforced with corner blocks.
- Seat is HR foam over a webbed panel.
- The upholstered back frame insert is webbed and padded with foam.
- Available with fire-retardant construction to comply with California Bulletin #133.
- COM yardage: 1.25
- COL square footage: 22.5
- Available on RUSH.

To Order, Specify:

- 1) Product number.
- 2) Fabric surface and color.
- 3) Arm/frame finish color.

CAL 133 Option:

Add **-F** to the product number, and add **\$102.90** list.

Maple	4145-00	\$999.60	\$1020.60	\$1029.00	\$1052.10	\$1065.75	\$1111.95	\$1137.15	\$1203.30	\$1304.10	\$1442.60
-------	---------	----------	-----------	-----------	-----------	-----------	-----------	-----------	-----------	-----------	-----------

Arc Arm, Circle Back

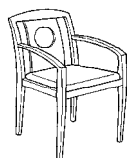

4145-00

Dimensions

SH: 18 1/2"(470mm)
H: 33 3/4"(857mm)
D: 23"(584mm)
W: 22 3/8"(568mm)
AH: 24" - 26"
(610mm-660mm)
SW: 19 1/2"(495mm)
SD: 18"(457mm)

Features

- Open arms.
- Upholstered seat.
- Maple hardwood frame. Seat frame rails are mortise and tenoned, cross locked with dowels, reinforced with corner blocks.
- Seat is HR foam over a webbed panel.
- Available with fire-retardant construction to comply with California Bulletin #133.
- COM yardage: 0.66
- COL square footage: 12.0
- Available on RUSH.

To Order, Specify:

- 1) Product number.
- 2) Fabric surface and color.
- 3) Arm/frame finish color.

CAL 133 Option:

Add **-F** to the product number, and add **\$102.90** list.

Maple	4245-00	\$999.60	\$1020.60	\$1029.00	\$1052.10	\$1065.75	\$1111.95	\$1137.15	\$1203.30	\$1304.10	\$1442.60
-------	---------	----------	-----------	-----------	-----------	-----------	-----------	-----------	-----------	-----------	-----------

Arc Arm, Slat Back

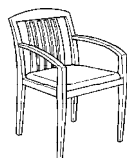

4245-00

Dimensions

SH: 18 1/2"(470mm)
H: 33 3/4"(857mm)
D: 23"(584mm)
W: 22 3/8"(568mm)
AH: 24" - 26"
(610mm-660mm)
SW: 19 1/2"(495mm)
SD: 18"(457mm)

Features

- Open arms.
- Upholstered seat.
- Maple hardwood frame. Seat frame rails are mortise and tenoned, cross locked with dowels, reinforced with corner blocks.
- Seat is HR foam over a webbed panel.
- Available with fire-retardant construction to comply with California Bulletin #133.
- COM yardage: 0.66
- COL square footage: 12.0
- Available on RUSH.

To Order, Specify:

- 1) Product number.
- 2) Fabric surface and color.
- 3) Arm/frame finish color.

CAL 133 Option:

Add **-F** to the product number, and add **\$102.90** list.

Nano-Tex Option: To specify, add **-P** to end of the product number and add **\$32.55** list.

Example: 4245-00-P

DuraBlock Option: To specify add **-D** to end of the product number and add **\$43.05** list.

Example: 4245-00-D

NOTE: Nano-Tex and DuraBlock are not available on leather or faux leather.

For available fabrics see matrix in the back of the book.

Composites Seating Series

Guest/Occasional Seating

Base/ Frame	Number	Fabric Grade		C	D	E	F	G	H	Leather Grade A	Leather Grade B
		A	B								
Maple	4046-00	\$999.60	\$1034.25	\$1065.75	\$1118.25	\$1149.75	\$1169.70	\$1206.45	\$1308.30	\$1681.05	\$1844.60

**Repose Arm,
Upholstered Back**

4046-00

Dimensions

SH: 18 1/2"(470mm)
H: 33 3/4"(857mm)
D: 23"(584mm)
W: 22 3/8"(568mm)
AH: 25 1/2"(648mm)
SW: 19 1/2"(495mm)
SD: 18"(457mm)

Features

- Open arms.
- Upholstered seat and back.
- Maple hardwood frame. Seat frame rails are mortise and tenoned, cross locked with dowels, reinforced with corner blocks.
- Seat is HR foam over a webbed panel.
- The upholstered back frame insert is webbed and padded with foam.
- Available with fire-retardant construction to comply with California Bulletin #133.
- COM yardage: 1.25
- COL square footage: 22.5
- Available on RUSH.

To Order, Specify:

- 1) Product number.
- 2) Fabric surface and color.
- 3) Arm/frame finish color.

CAL 133 Option:

Add **-F** to the product number, and add **\$102.90** list.

Maple	4146-00	\$999.60	\$1020.60	\$1029.00	\$1052.10	\$1065.75	\$1111.95	\$1137.15	\$1203.30	\$1304.10	\$1442.60
-------	---------	----------	-----------	-----------	-----------	-----------	-----------	-----------	-----------	-----------	-----------

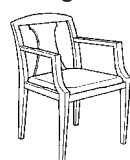
**Repose Arm,
Hourglass Back**

4146-00

Dimensions

SH: 18 1/2"(470mm)
H: 33 3/4"(857mm)
D: 23"(584mm)
W: 22 3/8"(568mm)
AH: 25 1/2"(648mm)
SW: 19 1/2"(495mm)
SD: 18"(457mm)

Features

- Open arms.
- Upholstered seat.
- Maple hardwood frame. Seat frame rails are mortise and tenoned, cross locked with dowels, reinforced with corner blocks.
- Seat is HR foam over a webbed panel.
- Available with fire-retardant construction to comply with California Bulletin #133.
- COM yardage: 0.66
- COL square footage: 12.0
- Available on RUSH.

To Order, Specify:

- 1) Product number.
- 2) Fabric surface and color.
- 3) Arm/frame finish color.

CAL 133 Option:

Add **-F** to the product number, and add **\$102.90** list.

Maple	4246-00	\$999.60	\$1020.60	\$1029.00	\$1052.10	\$1065.75	\$1111.95	\$1137.15	\$1203.30	\$1304.10	\$1442.60
-------	---------	----------	-----------	-----------	-----------	-----------	-----------	-----------	-----------	-----------	-----------

**Repose Arm,
Cross Back**

4246-00

Dimensions

SH: 18 1/2"(470mm)
H: 33 3/4"(857mm)
D: 23"(584mm)
W: 22 3/8"(568mm)
AH: 25 1/2"(648mm)
SW: 19 1/2"(495mm)
SD: 18"(457mm)

Features

- Open arms.
- Upholstered seat.
- Maple hardwood frame. Seat frame rails are mortise and tenoned, cross locked with dowels, reinforced with corner blocks.
- Seat is HR foam over a webbed panel.
- Available with fire-retardant construction to comply with California Bulletin #133.
- COM yardage: 0.66
- COL square footage: 12.0
- Available on RUSH.

To Order, Specify:

- 1) Product number.
- 2) Fabric surface and color.
- 3) Arm/frame finish color.

CAL 133 Option:

Add **-F** to the product number, and add **\$102.90** list.

Nano-Tex Option: To specify, add **-P** to end of the product number and add **\$32.55** list.

Example: 4046-00-P

DuraBlock Option: To specify add **-D** to end of the product number and add **\$43.05** list.

Example: 4046-00-D

NOTE: Nano-Tex and DuraBlock are not available on leather or faux leather.

For available fabrics see matrix in the back of the book.

Composites Seating Series

Guest/Occasional Seating

Base/ Frame	Number	Fabric Grade		C	D	E	F	G	H	Leather Grade A	Leather Grade B
		A	B								
Maple	4047-00	\$999.60	\$1034.25	\$1065.75	\$1118.25	\$1149.75	\$1169.70	\$1206.45	\$1308.30	\$1681.05	\$1844.60

Cascade Arm, Upholstered Back

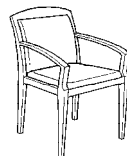

4047-00

Dimensions

SH: 18 1/2"(470mm)

H: 33 3/4"(857mm)

D: 23"(584mm)

W: 22 3/8"(568mm)

AH: 22 1/2" - 26 1/4"

(572mm-667mm)

SW: 19 1/2"(495mm)

SD: 18"(457mm)

Features

- Open arms.
- Upholstered seat and back.
- Maple hardwood frame. Seat frame rails are mortise and tenoned, cross locked with dowels, reinforced with corner blocks.
- Seat is HR foam over a webbed panel.
- The upholstered back frame insert is webbed and padded with foam.
- Available with fire-retardant construction to comply with California Bulletin #133.
- COM yardage: 1.25
- COL square footage: 22.5
- Available on RUSH.

To Order, Specify:

- 1) Product number.
- 2) Fabric surface and color.
- 3) Arm/frame finish color.

CAL 133 Option:

Add **-F** to the product number, and add **\$102.90** list.

Maple	4147-00	\$999.60	\$1020.60	\$1029.00	\$1052.10	\$1065.75	\$1111.95	\$1137.15	\$1203.30	\$1304.10	\$1442.60
-------	---------	----------	-----------	-----------	-----------	-----------	-----------	-----------	-----------	-----------	-----------

Cascade Arm, Circle Back

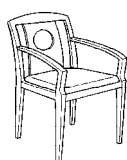

4147-00

Dimensions

SH: 18 1/2"(470mm)

H: 33 3/4"(857mm)

D: 23"(584mm)

W: 22 3/8"(568mm)

AH: 22 1/2" - 26 1/4"

(572mm-667mm)

SW: 19 1/2"(495mm)

SD: 18"(457mm)

Features

- Open arms.
- Upholstered seat.
- Maple hardwood frame. Seat frame rails are mortise and tenoned, cross locked with dowels, reinforced with corner blocks.
- Seat is HR foam over a webbed panel.
- Available with fire-retardant construction to comply with California Bulletin #133.
- COM yardage: 0.66
- COL square footage: 12.0
- Available on RUSH.

To Order, Specify:

- 1) Product number.
- 2) Fabric surface and color.
- 3) Arm/frame finish color.

CAL 133 Option:

Add **-F** to the product number, and add **\$102.90** list.

Maple	4247-00	\$999.60	\$1020.60	\$1029.00	\$1052.10	\$1065.75	\$1111.95	\$1137.15	\$1203.30	\$1304.10	\$1442.60
-------	---------	----------	-----------	-----------	-----------	-----------	-----------	-----------	-----------	-----------	-----------

Cascade Arm, Slat Back

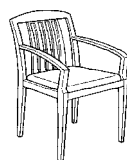

4247-00

Dimensions

SH: 18 1/2"(470mm)

H: 33 3/4"(857mm)

D: 23"(584mm)

W: 22 3/8"(568mm)

AH: 22 1/2" - 26 1/4"

(572mm-667mm)

SW: 19 1/2"(495mm)

SD: 18"(457mm)

Features

- Open arms.
- Upholstered seat.
- Maple hardwood frame. Seat frame rails are mortise and tenoned, cross locked with dowels, reinforced with corner blocks.
- Seat is HR foam over a webbed panel.
- Available with fire-retardant construction to comply with California Bulletin #133.
- COM yardage: 0.66
- COL square footage: 12.0
- Available on RUSH.

To Order, Specify:

- 1) Product number.
- 2) Fabric surface and color.
- 3) Arm/frame finish color.

CAL 133 Option:

Add **-F** to the product number, and add **\$102.90** list.

Nano-Tex Option: To specify, add **-P** to end of the product number and add **\$32.55** list.

Example: 4047-00-P

DuraBlock Option: To specify add **-D** to end of the product number and add **\$43.05** list.

Example: 4047-00-D

NOTE: Nano-Tex and DuraBlock are not available on leather or faux leather.

For available fabrics see matrix in the back of the book.

Composites Seating Series

Guest/Occasional Seating

Base/ Frame	Number	Fabric Grade		C	D	E	F	G	H	Leather Grade A	Leather Grade B
		A	B								
Maple	4048-00	\$999.60	\$1034.25	\$1065.75	\$1118.25	\$1149.75	\$1169.70	\$1206.45	\$1308.30	\$1681.05	\$1844.60

**Contour Arm,
Upholstered Back**

4048-00

Dimensions

SH: 18 1/2"(470mm)

H: 33 3/4"(857mm)

D: 23"(584mm)

W: 22 3/8"(568mm)

AH: 22 7/8"-26-3/8"

(581mm-670mm)

SW: 19 1/2"(495mm)

SD: 18"(457mm)

Features

- Open arms.
- Upholstered seat and back.
- Maple hardwood frame. Seat frame rails are mortise and tenoned, cross locked with dowels, reinforced with corner blocks.
- Seat is HR foam over a webbed panel.
- The upholstered back frame insert is webbed and padded with foam.
- Available with fire-retardant construction to comply with California Bulletin #133.
- COM yardage: 1.25
- COL square footage: 22.5
- Available on RUSH.

To Order, Specify:

- 1) Product number.
- 2) Fabric surface and color.
- 3) Arm/frame finish color.

CAL 133 Option:

Add **-F** to the product number, and add **\$102.90** list.

Maple	4148-00	\$999.60	\$1020.60	\$1029.00	\$1052.10	\$1065.75	\$1111.95	\$1137.15	\$1203.30	\$1304.10	\$1442.60
-------	---------	----------	-----------	-----------	-----------	-----------	-----------	-----------	-----------	-----------	-----------

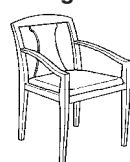
**Contour Arm,
Hourglass Back**

4148-00

Dimensions

SH: 18 1/2"(470mm)

H: 33 3/4"(857mm)

D: 23"(584mm)

W: 22 3/8"(568mm)

AH: 22 7/8"-26-3/8"

(581mm-670mm)

SW: 19 1/2"(495mm)

SD: 18"(457mm)

Features

- Open arms.
- Upholstered seat.
- Maple hardwood frame. Seat frame rails are mortise and tenoned, cross locked with dowels, reinforced with corner blocks.
- Seat is HR foam over a webbed panel.
- Available with fire-retardant construction to comply with California Bulletin #133.
- COM yardage: 0.66
- COL square footage: 12.0
- Available on RUSH.

To Order, Specify:

- 1) Product number.
- 2) Fabric surface and color.
- 3) Arm/frame finish color.

CAL 133 Option:

Add **-F** to the product number, and add **\$102.90** list.

Maple	4248-00	\$999.60	\$1020.60	\$1029.00	\$1052.10	\$1065.75	\$1111.95	\$1137.15	\$1203.30	\$1304.10	\$1442.60
-------	---------	----------	-----------	-----------	-----------	-----------	-----------	-----------	-----------	-----------	-----------

**Contour Arm,
Cross Back**

4248-00

Dimensions

SH: 18 1/2"(470mm)

H: 33 3/4"(857mm)

D: 23"(584mm)

W: 22 3/8"(568mm)

AH: 22 7/8"-26-3/8"

(581mm-670mm)

SW: 19 1/2"(495mm)

SD: 18"(457mm)

Features

- Open arms.
- Upholstered seat.
- Maple hardwood frame. Seat frame rails are mortise and tenoned, cross locked with dowels, reinforced with corner blocks.
- Seat is HR foam over a webbed panel.
- Available with fire-retardant construction to comply with California Bulletin #133.
- COM yardage: 0.66
- COL square footage: 12.0
- Available on RUSH.

To Order, Specify:

- 1) Product number.
- 2) Fabric surface and color.
- 3) Arm/frame finish color.

CAL 133 Option:

Add **-F** to the product number, and add **\$102.90** list.

Nano-Tex Option: To specify, add **-P** to end of the product number and add **\$32.55** list.

Example: 4048-00-P

DuraBlock Option: To specify add **-D** to end of the product number and add **\$43.05** list.

Example: 4048-00-D

NOTE: Nano-Tex and DuraBlock are not available on leather or faux leather.

For available fabrics see matrix in the back of the book.

Composites Seating Series

Guest/Occasional Seating

Base/ Frame	Number	Fabric Grade		C	D	E	F	G	H	Leather Grade A	Leather Grade B
		A	B								
Maple	4043-00	\$999.60	\$1034.25	\$1065.75	\$1118.25	\$1149.75	\$1169.70	\$1206.45	\$1308.30	\$1681.05	\$1844.60

Stacking Chair, Arc Arm, Upholstered Back

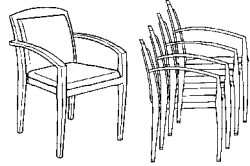

4043-00

Dimensions

SH: 18 1/2" (470mm)
 H: 33 5/8" (854mm)
 D: 21 3/4" (552mm)
 W: 22 1/4" (565mm)
 SW: 18" (457mm)
 SD: 18" (457mm)
 AH: 25 7/8" (657mm)

Features

- Open arms.
- Upholstered seat and back.
- Maple hardwood frame. Seat frame rails are mortise and tenoned, cross locked with dowels, reinforced with corner blocks.
- Seat is HR foam over a webbed panel.
- The upholstered back frame insert is webbed and padded with foam.
- Recommended stacking limit is 4 chairs high.
- Available with fire-retardant construction to comply with California Bulletin #133.
- COM yardage: 1.13
- COL square footage: 20.3

To Order, Specify:

- 1) Product number.
- 2) Fabric surface and color.
- 3) Frame finish color.

CAL 133 Option:

Add **-F** to the product number, and add **\$102.90** list.

Maple	4243-00	\$999.60	\$1020.60	\$1029.00	\$1052.10	\$1065.75	\$1111.95	\$1137.15	\$1203.30	\$1304.10	\$1442.60
-------	---------	----------	-----------	-----------	-----------	-----------	-----------	-----------	-----------	-----------	-----------

Stacking Chair, Arc Arm, Slat Back

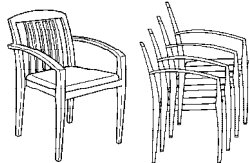

4243-00

Dimensions

SH: 18 1/2" (470mm)
 H: 33 5/8" (854mm)
 D: 21 3/4" (552mm)
 W: 22 1/4" (565mm)
 SW: 18" (457mm)
 SD: 18" (457mm)
 AH: 25 7/8" (657mm)

Features

- Open arms.
- Upholstered seat.
- Maple hardwood frame. Seat frame rails are mortise and tenoned, cross locked with dowels, reinforced with corner blocks.
- Seat is HR foam over a webbed panel.
- Recommended stacking limit is 4 chairs high.
- Available with fire-retardant construction to comply with California Bulletin #133.
- COM yardage: 0.66
- COL square footage: 12.0

To Order, Specify:

- 1) Product number.
- 2) Fabric surface and color.
- 3) Frame finish color.

CAL 133 Option:

Add **-F** to the product number, and add **\$102.90** list.

Nano-Tex Option: To specify, add **-P** to end of the product number and add **\$32.55** list.

Example: 4043-00-P

DuraBlock Option: To specify add **-D** to end of the product number and add **\$43.05** list.

Example: 4043-00-D

NOTE: Nano-Tex and DuraBlock are not available on leather or faux leather.

For available fabrics see matrix in the back of the book.

Composites Seating Series

Occasional Seating

Base/ Frame	Number	Fabric Grade		C	D	E	F	G	H	Leather Grade A	Leather Grade B
		A	B								
Maple	4049-00	\$999.60	\$1034.25	\$1065.75	\$1118.25	\$1149.75	\$1169.70	\$1206.45	\$1308.30	\$1681.05	\$1844.60

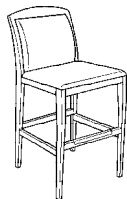
**Stool, Armless,
Upholstered Back**

4049-00

Dimensions

SH: 28"(711mm)
H: 41 1/8"(1045mm)
D: 19 7/8"(505mm)
W: 18 1/2"(470mm)
SW: 18 1/2"(470mm)
SD: 15 1/4"(387mm)

Features

- Upholstered seat and back.
- Maple hardwood frame. Seat frame rails are mortise and tenoned, cross locked with dowels, reinforced with corner blocks.
- Seat is HR foam over a webbed panel.
- The upholstered back frame insert is webbed and padded with foam.
- Standard with brass kick plate. No finish specification required.
- Available with fire-retardant construction to comply with California Bulletin #133.
- COM yardage: 1.00
- COL square footage: 18.0

To Order, Specify:

- 1) Product number.
- 2) Fabric surface and color.
- 3) Frame finish color.

CAL 133 Option:

Add **-F** to the product number, and add **\$102.90** list.

Maple	4249-00	\$999.60	\$1020.60	\$1029.00	\$1052.10	\$1065.75	\$1111.95	\$1137.15	\$1203.30	\$1304.10	\$1442.60
-------	---------	----------	-----------	-----------	-----------	-----------	-----------	-----------	-----------	-----------	-----------

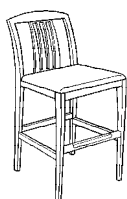
**Stool, Armless,
Slat Back**

4249-00

Dimensions

SH: 28"(711mm)
H: 41 1/8"(1045mm)
D: 19 7/8"(505mm)
W: 18 1/2"(470mm)
SW: 18 1/2"(470mm)
SD: 15 1/4"(387mm)

Features

- Upholstered seat.
- Maple hardwood frame. Seat frame rails are mortise and tenoned, cross locked with dowels, reinforced with corner blocks.
- Seat is HR foam over a webbed panel.
- Standard with brass kick plate. No finish specification required.
- Available with fire-retardant construction to comply with California Bulletin #133.
- COM yardage: 0.66
- COL square footage: 12.0

Nano-Tex Option: To specify, add **-P** to end of the product number and add **\$32.55** list.

Example: 4049-00-**P**

DuraBlock Option: To specify add **-D** to end of the product number and add **\$43.05** list.

Example: 4049-00-**D**

NOTE: Nano-Tex and DuraBlock are not available on leather or faux leather.

For available fabrics see matrix in the back of the book.

To Order, Specify:

- 1) Product number.
- 2) Fabric surface and color.
- 3) Frame finish color.

CAL 133 Option:

Add **-F** to the product number, and add **\$102.90** list.

Tally Series

Guest/Occasional Seating

Base/ Frame	Number	Fabric Grade		C	D	E	F	G	H	Leather Grade A	Leather Grade B
		A	B								
Maple	3110-GEST	\$909.30	\$935.55	\$950.25	\$988.05	\$1006.95	\$1097.25	\$1137.15	\$1248.45	\$1268.40	\$1409.30

Guest Chair

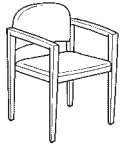

3110-GEST

Dimensions

SH: 18 1/2"(470mm)
 H: 32"(813mm)
 D: 23 1/4"(591mm)
 W: 22 1/2"(572mm)
 AH: 24 1/2"(622mm)
 front
 26 1/4"(667mm)
 back
 SW: 19"(483mm)
 SD: 19"(483mm)

Features

- Open arms and back.
- Upholstered seat and back.
- Maple hardwood frame. Seat frame rails are mortise and tenoned, reinforced with corner blocks.
- Seat is HR foam over a webbed panel.
- Back is HR foam over a rigid urethane molded frame.
- Available with fire-retardant construction to comply with California Bulletin #133.
- COM yardage: 1.0
- COL square footage: 18.0
- Available on RUSH.

To Order, Specify:

- 1) Product number.
- 2) Fabric surface and color.
- 3) Arm/frame finish color.

Maple	3110-STAK	\$909.30	\$935.55	\$950.25	\$988.05	\$1006.95	\$1097.25	\$1137.15	\$1248.45	\$1268.40	\$1409.30
-------	-----------	----------	----------	----------	----------	-----------	-----------	-----------	-----------	-----------	-----------

Stacking Chair

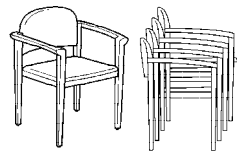

3110-STAK

Dimensions

SH: 18 1/2"(470mm)
 H: 32"(813mm)
 D: 23 1/4"(591mm)
 W: 24 1/2"(622mm)
 AH: 24 3/4"(629mm)
 front
 26 1/2"(673mm)
 back
 SW: 18 1/4"(464mm)
 SD: 19"(483mm)

Features

- Upholstered seat and back.
- Maple hardwood frame. Seat frame rails are mortise and tenoned, reinforced with corner blocks.
- Seat is HR foam over a webbed panel.
- Back is HR foam over a rigid urethane molded frame.
- Recommended stacking limit is 4 chairs high; overall height 41"(1041mm).
- Available with fire-retardant construction to comply with California Bulletin #133.
- COM yardage: 1.0
- COL square footage: 18.0

To Order, Specify:

- 1) Product number.
- 2) Fabric surface and color.
- 3) Arm/frame finish color.

Nano-Tex Option: To specify, add **-P** to end of the product number and add **\$32.55** list.

Example: 3110-GEST-P

DuraBlock Option: To specify add **-D** to end of the product number and add **\$43.05** list.

Example: 3110-GEST-D

NOTE: Nano-Tex and DuraBlock are not available on leather or faux leather.

For available fabrics see matrix in the back of the book.

Tally Series

Public Seating

Base/ Frame	Number	Fabric Grade		C	D	E	F	G	H	Leather Grade A	Leather Grade B
		A	B								
Maple	3110-SS	\$1669.50	\$1716.75	\$1755.60	\$1821.75	\$1864.80	\$2010.75	\$2085.30	\$2286.90	\$2385.60	\$2551.50

Two Seats

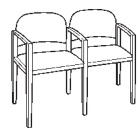

3110-SS

Dimensions

SH: 18 1/2"(470mm)
H: 32"(813mm)
D: 23 1/4"(591mm)
W: 43 1/4"(1099mm)
AH: 24 1/2"(622mm)
front
26 1/4"(667mm)
back

Features

- Configuration includes two seats.
- Open arms and backs.
- Upholstered seats and backs.
- Maple hardwood frame. Seat frame rails are mortise and tenoned, reinforced with corner blocks.
- Seats are HR foam over a webbed panel.
- Backs are HR foam over a rigid urethane molded frame.
- Ships assembled as a single unit.
- Seats and backs are removable for field reconfiguration.
- Available with fire-retardant construction to comply with California Bulletin #133.
- COM yardage: 2.0
- COL square footage: 36.0

■ Available on RUSH.

To Order, Specify:

- 1) Product number.
- 2) Fabric surface and color.
- 3) Arm/frame finish color.

Maple	3110-SSS	\$2386.65	\$2457.53	\$2515.80	\$2615.03	\$2679.60	\$2898.53	\$3010.35	\$3312.75	\$3460.80	\$3709.65
-------	----------	-----------	-----------	-----------	-----------	-----------	-----------	-----------	-----------	-----------	-----------

Three Seats

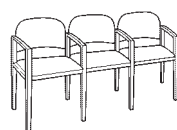

3110-SSS

Dimensions

SH: 18 1/2"(470mm)
H: 32"(813mm)
D: 23 1/4"(591mm)
W: 64"(1626mm)
AH: 24 1/2"(622mm)
front
26 1/4"(667mm)
back

Features

- Configuration includes three seats.
- Open arms and backs.
- Upholstered seats and backs.
- Maple hardwood frame. Seat frame rails are mortise and tenoned, reinforced with corner blocks.
- Seats are HR foam over a webbed panel.
- Backs are HR foam over a rigid urethane molded frame.
- Ships assembled as a single unit.
- Seats and backs are removable for field reconfiguration.
- Available with fire-retardant construction to comply with California Bulletin #133.
- COM yardage: 3.0
- COL square footage: 54.0

■ Available on RUSH.

To Order, Specify:

- 1) Product number.
- 2) Fabric surface and color.
- 3) Arm/frame finish color.

Maple	3110-TSS	\$2408.70	\$2455.95	\$2494.80	\$2560.95	\$2604.00	\$2749.95	\$2824.50	\$3026.10	\$3124.80	\$3290.70
-------	----------	-----------	-----------	-----------	-----------	-----------	-----------	-----------	-----------	-----------	-----------

Table, Seat, Seat

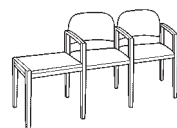

3110-TSS

Dimensions

SH: 18 1/2"(470mm)
H: 32"(813mm)
D: 23 1/4"(591mm)
W: 64"(1626mm)
AH: 24 1/2"(622mm)
front
26 1/4"(667mm)
back

Features

- Configuration includes from left-to-right: table, seat, seat.
- Open arms and backs.
- Upholstered seats and backs.
- Maple hardwood frame. Seat frame rails are mortise and tenoned, reinforced with corner blocks.
- Table frame rails are dado and rabbet, reinforced with corner blocks.
- Seats are HR foam over a webbed panel.
- Backs are HR foam over a rigid urethane molded frame.
- Ships assembled as a single unit.
- Seats and backs are removable for field reconfiguration.
- Available with fire-retardant construction to comply with California Bulletin #133.
- COM yardage: 2.0
- COL square footage: 36.0

Nano-Tex Option: To specify, add **-P** to end of the product number and add **\$65.10** list.

Example: 3110-SS-P

DuraBlock Option: To specify add **-D** to end of the product number and add **\$86.10** list.

Example: 3110-SS-D

NOTE: Nano-Tex and DuraBlock are not available on leather or faux leather.

For available fabrics see matrix in the back of the book.

To Order, Specify:

- 1) Product number.
- 2) Fabric surface and color.
- 3) Arm/frame finish color.

Tally Series

Public Seating

Base/ Frame	Number	Fabric Grade		C	D	E	F	G	H	Leather Grade A	Leather Grade B
		A	B								
Maple	3110-ST5	\$2448.60	\$2495.85	\$2534.70	\$2600.85	\$2643.90	\$2789.85	\$2864.40	\$3066.00	\$3164.70	\$3330.60

Seat, Table, Seat

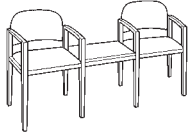

3110-ST5

Dimensions

SH: 18 1/2"(470mm)
H: 32"(813mm)
D: 23 1/4"(591mm)
W: 64"(1626mm)
AH: 24 1/2"(622mm)
front
26 1/4"(667mm)
back

Features

- Configuration includes from left-to-right: seat, table, seat.
- Open arms and backs.
- Upholstered seats and backs.
- Maple hardwood frame. Seat frame rails are mortise and tenoned, reinforced with corner blocks.
- Table frame rails are dado and rabbet, reinforced with corner blocks.
- Seats are HR foam over a webbed panel.
- Backs are HR foam over a rigid urethane molded frame.
- Ships assembled as a single unit.
- Seats and backs are removable for field reconfiguration.
- Available with fire-retardant construction to comply with California Bulletin #133.
- COM yardage: 2.0
- COL square footage: 36.0

To Order, Specify:

- 1) Product number.
- 2) Fabric surface and color.
- 3) Arm/frame finish color.

Maple	3110-SST	\$2408.70	\$2455.95	\$2494.80	\$2560.95	\$2604.00	\$2749.95	\$2824.50	\$3026.10	\$3124.80	\$3290.70
-------	----------	-----------	-----------	-----------	-----------	-----------	-----------	-----------	-----------	-----------	-----------

Seat, Seat, Table

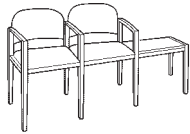

3110-SST

Dimensions

SH: 18 1/2"(470mm)
H: 32"(813mm)
D: 23 1/4"(591mm)
W: 64"(1626mm)
AH: 24 1/2"(622mm)
front
26 1/4"(667mm)
back

Features

- Configuration includes from left-to-right: seat, seat, table.
- Open arms and backs.
- Upholstered seats and backs.
- Maple hardwood frame. Seat frame rails are mortise and tenoned, reinforced with corner blocks.
- Table frame rails are dado and rabbet, reinforced with corner blocks.
- Seats are HR foam over a webbed panel.
- Backs are HR foam over a rigid urethane molded frame.
- Ships assembled as a single unit.
- Seats and backs are removable for field reconfiguration.
- Available with fire-retardant construction to comply with California Bulletin #133.
- COM yardage: 2.0
- COL square footage: 36.0

To Order, Specify:

- 1) Product number.
- 2) Fabric surface and color.
- 3) Arm/frame finish color.

Maple	3110-SSSS	\$3134.25	\$3228.75	\$3306.45	\$3438.75	\$3524.85	\$3816.75	\$3965.85	\$4369.05	\$4566.45	\$4898.25
-------	-----------	-----------	-----------	-----------	-----------	-----------	-----------	-----------	-----------	-----------	-----------

Seat, Seat, Seat, Seat

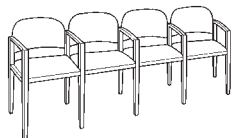

3110-SSSS

Dimensions

SH: 18 1/2"(470mm)
H: 32"(813mm)
D: 23 1/4"(591mm)
W: 84 3/4"(2153mm)
AH: 24 1/2"(622mm)
front
26 1/4"(667mm)
back

Features

- Configuration includes four seats.
- Open arms and backs.
- Upholstered seats and backs.
- Maple hardwood frame. Seat frame rails are mortise and tenoned, reinforced with corner blocks.
- Seats are HR foam over a webbed panel.
- Backs are HR foam over a rigid urethane molded frame.
- Ships assembled as a single unit.
- Seats and backs are removable for field reconfiguration.
- Available with fire-retardant construction to comply with California Bulletin #133.
- COM yardage: 4.0
- COL square footage: 72.0

To Order, Specify:

- 1) Product number.
- 2) Fabric surface and color.
- 3) Arm/frame finish color.

Nano-Tex Option: To specify, add **-P** to end of the product number and add **\$130.20** list.

Example: 3110-SSSS-P

DuraBlock Option: To specify add **-D** to end of the product number and add **\$172.20** list.

Example: 3110-SSSS-D

NOTE: Nano-Tex and DuraBlock are not available on leather or faux leather.

For available fabrics see matrix in the back of the book.

Tally Series

Public Seating

Base/ Frame	Number	Fabric Grade		C	D	E	F	G	H	Leather Grade A	Leather Grade B
		A	B								
Maple	3110-TSSS	\$3147.90	\$3218.78	\$3277.05	\$3376.28	\$3440.85	\$3659.78	\$3771.60	\$4074.00	\$4222.05	\$4470.90

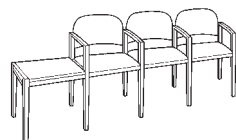
Table, Seat, Seat,
Seat

3110-TSSS

Dimensions

SH: 18 1/2"(470mm)
H: 32"(813mm)
D: 23 1/4"(591mm)
W: 84 3/4"(2153mm)
AH: 24 1/2"(622mm)
front
26 1/4"(667mm)
back

Features

- Configuration includes from left-to-right: table, seat, seat, seat.
- Open arms and backs.
- Upholstered seats and backs.
- Maple hardwood frame. Seat frame rails are mortise and tenoned, reinforced with corner blocks.
- Table frame rails are dado and rabbet, reinforced with corner blocks.
- Seats are HR foam over a webbed panel.
- Backs are HR foam over a rigid urethane molded frame.
- Ships assembled as a single unit.
- Seats and backs are removable for field reconfiguration.
- Available with fire-retardant construction to comply with California Bulletin #133.
- COM yardage: 3.0
- COL square footage: 54.0

To Order, Specify:

- 1) Product number.
- 2) Fabric surface and color.
- 3) Arm/frame finish color.

Maple	3110-STSS	\$3195.15	\$3266.03	\$3324.30	\$3423.53	\$3488.10	\$3707.03	\$3818.85	\$4121.25	\$4269.30	\$4518.15
-------	-----------	-----------	-----------	-----------	-----------	-----------	-----------	-----------	-----------	-----------	-----------

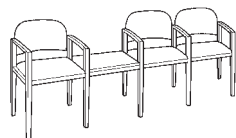
Seat, Table, Seat,
Seat

3110-STSS

Dimensions

SH: 18 1/2"(470mm)
H: 32"(813mm)
D: 23 1/4"(591mm)
W: 84 3/4"(2153mm)
AH: 24 1/2"(622mm)
front
26 1/4"(667mm)
back

Features

- Configuration includes from left-to-right: seat, table, seat, seat.
- Open arms and backs.
- Upholstered seats and backs.
- Maple hardwood frame. Seat frame rails are mortise and tenoned, reinforced with corner blocks.
- Table frame rails are dado and rabbet, reinforced with corner blocks.
- Seats are HR foam over a webbed panel.
- Backs are HR foam over a rigid urethane molded frame.
- Ships assembled as a single unit.
- Seats and backs are removable for field reconfiguration.
- Available with fire-retardant construction to comply with California Bulletin #133.
- COM yardage: 3.0
- COL square footage: 54.0

To Order, Specify:

- 1) Product number.
- 2) Fabric surface and color.
- 3) Arm/frame finish color.

Maple	3110-SSTS	\$3195.15	\$3266.03	\$3324.30	\$3423.53	\$3488.10	\$3707.03	\$3818.85	\$4121.25	\$4269.30	\$4518.15
-------	-----------	-----------	-----------	-----------	-----------	-----------	-----------	-----------	-----------	-----------	-----------

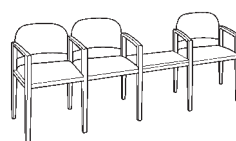
Seat, Seat, Table,
Seat

3110-SSTS

Dimensions

SH: 18 1/2"(470mm)
H: 32"(813mm)
D: 23 1/4"(591mm)
W: 84 3/4"(2153mm)
AH: 24 1/2"(622mm)
front
26 1/4"(667mm)
back

Features

- Configuration includes from left-to-right: seat, seat, table, seat.
- Open arms and backs.
- Upholstered seats and backs.
- Maple hardwood frame. Seat frame rails are mortise and tenoned, reinforced with corner blocks.
- Table frame rails are dado and rabbet, reinforced with corner blocks.
- Seats are HR foam over a webbed panel.
- Backs are HR foam over a rigid urethane molded frame.
- Ships assembled as a single unit.
- Seats and backs are removable for field reconfiguration.
- Available with fire-retardant construction to comply with California Bulletin #133.
- COM yardage: 3.0
- COL square footage: 54.0

To Order, Specify:

- 1) Product number.
- 2) Fabric surface and color.
- 3) Arm/frame finish color.

Nano-Tex Option: To specify, add **-P** to end of the product number and add **\$97.65** list.

Example: 3110-SSTS-P

DuraBlock Option: To specify add **-D** to end of the product number and add **\$129.15** list.

Example: 3110-SSTS-D

NOTE: Nano-Tex and DuraBlock are not available on leather or faux leather.

For available fabrics see matrix in the back of the book.

Tally Series

Public Seating

Base/ Frame	Number	Fabric Grade		C	D	E	F	G	H	Leather Grade A	Leather Grade B
		A	B								
Maple	3110-SSST	\$3147.90	\$3218.78	\$3277.05	\$3376.28	\$3440.85	\$3659.78	\$3771.60	\$4074.00	\$4222.05	\$4470.90

Seat, Seat, Seat, Table

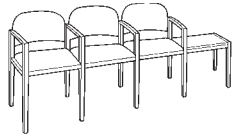

3110-SSST

Dimensions

SH: 18 1/2"(470mm)
 H: 32"(813mm)
 D: 23 1/4"(591mm)
 W: 84 3/4"(2153mm)
 AH: 24 1/2"(622mm)
 front
 26 1/4"(667mm)
 back

Features

- Configuration includes from left-to-right: seat, seat, seat, table.
- Open arms and backs.
- Upholstered seats and backs.
- Maple hardwood frame. Seat frame rails are mortise and tenoned, reinforced with corner blocks.
- Table frame rails are dado and rabbet, reinforced with corner blocks.
- Seats are HR foam over a webbed panel.
- Backs are HR foam over a rigid urethane molded frame.
- Ships assembled as a single unit.
- Seats and backs are removable for field reconfiguration.
- Available with fire-retardant construction to comply with California Bulletin #133.
- COM yardage: 3.0
- COL square footage: 54.0

Nano-Tex Option: To specify, add **-P** to end of the product number and add **\$97.65** list.

Example: 3110-SSST-P

DuraBlock Option: To specify add **-D** to end of the product number and add **\$129.15** list.

Example: 3110-SSST-D

NOTE: Nano-Tex and DuraBlock are not available on leather or faux leather.

For available fabrics see matrix in the back of the book.

To Order, Specify:

- 1) Product number.
- 2) Fabric surface and color.
- 3) Arm/frame finish color.

Tally Series — Modular

Public Seating

Specification and Ordering Information

The Tally Series modular seating and table components are divided into two groups; end components and interior components.

- End components begin and end a seating configuration. (The first letter in an end component product number is an **E**. **Example:** 3110-ELA, see page 260).
- Interior components connect to end components, and build the configuration. (The first letter in an interior component product number is an **I**. **Example:** 3110-IAC, see pages 261-263).

Use the following guidelines when specifying and ordering the Tally Series modular seating and table components:

- 1) Develop a layout drawing (plan view) of each modular seating configuration. Label each component with the corresponding product number, see examples below.
Note: Your labeled drawing is not required with the purchase order; however, it is essential for on-site assembly of the components.
- 2) Working left-to-right as you sit in the seating configuration, specify the first end component (left arm or table/bench leg).
- 3) Add to the first end component by specifying an interior component (seat and back, table or bench). Continue the configuration by alternating interior seats and backs/benches/tables and interior arms.
- 4) Complete the configuration with an end component (right arm or table/bench leg).
- 5) Specify the appropriate fabric surface/color code, and the frame wood finish color code.

Configuration Examples

Example #1

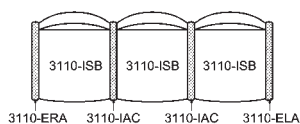

Example #2

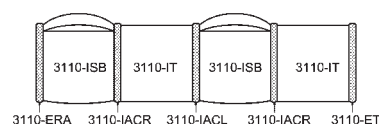

Example #3

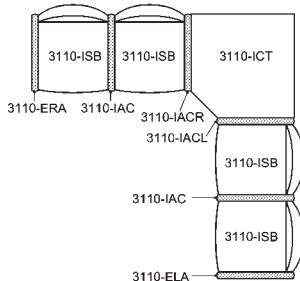

Example #4

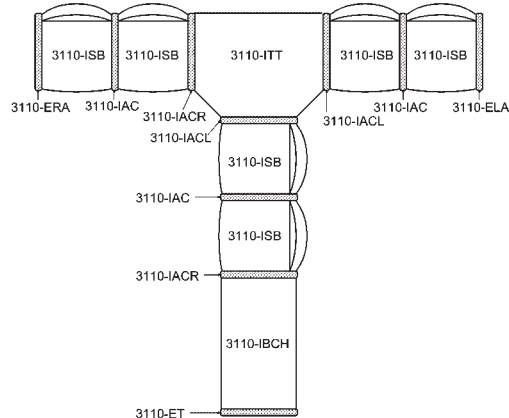



General Information

- Tally Series modular seating and table components are manufactured and shipped unassembled for field assembly.
- Detailed assembly instructions are included with individual units.
- Final product configuration drawings are the responsibility of the customer/specifier, but are not required for placement of order.
- All Tally Series modular components may be knocked down for reconfiguration or repair in the field.

Tally Series — Modular End Components

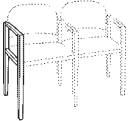
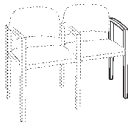
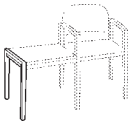
Public Seating

		Frame	Number	Price
End Component, Right Arm Frame	Dimensions	Maple	3110-ERA	\$273.00
	H: 26 1/4"(667mm) D: 19 7/8"(505mm) W: 1 3/4"(44mm)	Features		
		To Order, Specify:		
		<ul style="list-style-type: none"> • Maple hardwood frame. • Connects to the right side of a seat and back. 		<ol style="list-style-type: none"> 1) Product number. 2) Wood finish color.
3110-ERA (As seated)				
End Component, Left Arm Frame	Dimensions	Maple	3110-ELA	\$273.00
	H: 26 1/4"(667mm) D: 19 7/8"(505mm) W: 1 3/4"(44mm)	Features		
		To Order, Specify:		
		<ul style="list-style-type: none"> • Maple hardwood frame. • Connects to the left side of a seat and back. 		<ol style="list-style-type: none"> 1) Product number. 2) Wood finish color.
3110-ELA (As seated)				
End Component, Table/Bench Leg	Dimensions	Maple	3110-ET	\$256.20
	H: 18 1/4"(464mm) D: 19 1/2"(495mm) W: 1 3/4"(44mm)	Features		
		To Order, Specify:		
		<ul style="list-style-type: none"> • Maple hardwood frame. • Non-handed. • Connects to either the right or left side of a table top or bench. 		<ol style="list-style-type: none"> 1) Product number. 2) Wood finish color.
3110-ET (Right application)				
				
	(Left application)			

Tally Series — Modular Interior Components

Public Seating

Frame	Number	Fabric Grade		C	D	E	F	G	H	Leather Grade A	Leather Grade B
		A	B								
Upholstered	3110-ISB	\$454.65	\$480.90	\$495.60	\$533.40	\$552.30	\$642.60	\$682.50	\$793.80	\$813.75	\$954.65

**Interior Component,
Seat Support Frame
and Back**

3110-ISB

Dimensions

Seat:

H: 18 1/2"(470mm)

D: 18 3/8"(467mm)

W: 19"(483mm)

Back:

H: 11 5/8"(295mm)

D: 5"(127mm)

W: 19"(483mm)

Features

- Upholstered seat and back.
- Seat frame rails are mortise and tenoned, reinforced with corner blocks.
- Seat is HR foam over a webbed panel.
- Back is HR foam over a rigid urethane molded frame.
- Available with fire-retardant construction to comply with California Bulletin #133.
- Connects to a right and left arm frame.
- COM yardage: 1.0
- COL square footage: 18.0

To Order, Specify:

- 1) Product number.
- 2) Wood finish color.
- 3) Fabric surface and color.

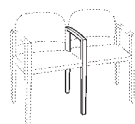
**Interior Component,
Arm — Chair-to-
Chair**

3110-IAC

Dimensions

H: 26 1/4"(667mm)

D: 19 7/8"(505mm)

W: 1 3/4"(44mm)

Frame

Maple

Number

3110-IAC

Price**\$291.90****Features**

- Maple hardwood frame.
- Connects two (2) seats and backs together.

To Order, Specify:

- 1) Product number.
- 2) Wood finish color.

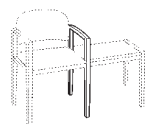
**Interior Component,
Arm — Chair Right/
Table/Bench Left**
3110-IACR
(As seated)**Dimensions**

H: 26 1/4"(667mm)

D: 19 7/8"(505mm)

W: 1 3/4"(44mm)

Frame

Maple

Number

3110-IACR

Price**\$291.90****Features**

- Maple hardwood frame.
- Connects a seat and back to a table or bench.

To Order, Specify:

- 1) Product number.
- 2) Wood finish color.

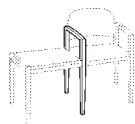
**Interior Component,
Arm — Chair Left/
Table/Bench Right**
3110-IACL
(As seated)**Dimensions**

H: 26 1/4"(667mm)

D: 19 7/8"(505mm)

W: 1 3/4"(44mm)

Frame

Maple

Number

3110-IACL

Price**\$291.90****Features**

- Maple hardwood frame.
- Connects a seat and back to a table or bench.

To Order, Specify:

- 1) Product number.
- 2) Wood finish color.

Tally Series — Modular Interior Components

Public Seating

Base/ Frame	Number	Fabric Grade		C	D	E	F	G	H	Leather Grade A	Leather Grade B
		A	B								
Upholstered	3110-IBCH	\$583.80	\$605.85	\$616.35	\$642.60	\$658.35	\$673.05	\$695.10	\$715.05	\$854.70	\$962.85

Interior Component, Bench and Support Frame

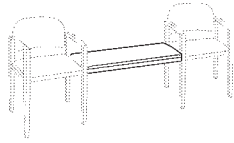

3110-IBCH

Dimensions

H: 18 1/2"(470mm)
D: 18 3/4"(476mm)
W: 38 3/8"(975mm)

Features

- Upholstered seat.
- Maple hardwood frame. Bench frame rails double dowelled, reinforced with corner blocks.
- Seat is HR foam over plywood.
- Available with fire-retardant construction to comply with California Bulletin #133.
- Connects to a table/bench leg or seat/table/bench arm.
- COM yardage: 0.75
- COL square footage: 13.5

To Order, Specify:

- 1) Product number.
- 2) Fabric surface and color.
- 3) Wood finish color.

Interior Component, Tables and Support Frame

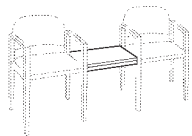

3110-IT (Single Table)

Dimensions

H: 17 3/4"(451mm)
D: 18 3/4"(476mm)
W: 18 7/8"(479mm)
or 38 3/8"
(975mm)

Frame

Frame	Number	Price
Maple	3110-IT	\$401.10
Maple	3110-IDT	574.35

Features

- Maple veneer or laminate.
- Top is 1"(25mm) thick with solid 1/8"(3mm) maple or 3mm PVC edge banding.
- Three-ply construction.
- Maple hardwood frame.
- Double table frame rails are double dowelled, reinforced with corner blocks.
- Single table frame rails are dado and rabbet, reinforced with corner blocks.

To Order Wood Top, Specify:

- 1) Product number.
- 2) Wood finish color.

To Order Laminate Top, Specify:

- 1) Product number.
- 2) Wood finish color.
- 3) Laminate color.

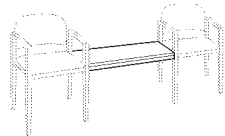

3110-IDT (Double Table)

Tally Series — Modular Interior Components

Public Seating

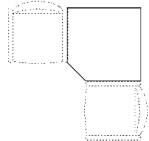
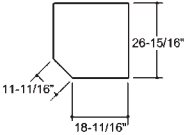
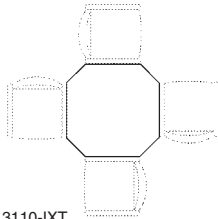
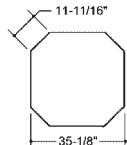
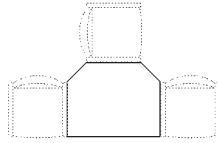
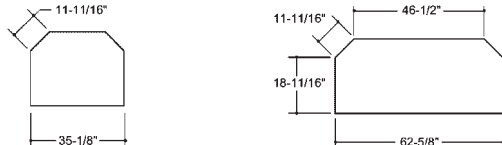
Interior Component,	Dimensions	Frame	Number	Price	
Corner Table and Support Frame  3110-ICT	H: 17 3/4"(451mm) D: 26 15/16"(684mm) W: 26 15/16"(684mm)	Maple	3110-ICT	\$621.60	
		Features <ul style="list-style-type: none"> • Maple veneer or laminate. • Top is 1"(25mm) thick with solid 1/8"(3mm) maple or 3mm PVC edge banding. • Three-ply construction. • Maple hardwood frame. • Table frame rails are dado and rabbet, reinforced with corner blocks. • Connects two (2) seats or benches in a right angle configuration. • Includes corner support leg. 	To Order Wood Top, Specify: <ol style="list-style-type: none"> 1) Product number. 2) Wood finish color. To Order Laminate Top, Specify: <ol style="list-style-type: none"> 1) Product number. 2) Wood finish color. 3) Laminate color. 		
					
"X" Table and Support Frame  3110-IXT	H: 17 3/4"(451mm) D: 35 1/8"(892mm) W: 35 1/8"(892mm)	Maple	3110-IXT	\$889.35	
		Features <ul style="list-style-type: none"> • Maple veneer or laminate. • Top is 1"(25mm) thick with solid 1/8"(3mm) maple or 3mm PVC edge banding. • Three-ply construction. • Maple hardwood frame. • Table frame rails are dado and rabbet, reinforced with corner blocks. • Connects four (4) seats in an "X" shaped configuration. 	To Order Wood Top, Specify: <ol style="list-style-type: none"> 1) Product number. 2) Wood finish color. To Order Laminate Top, Specify: <ol style="list-style-type: none"> 1) Product number. 2) Wood finish color. 3) Laminate color. 		
					
"T" Tables and Support Frame  3110-ITT (Single "T" Table)	H: 17 3/4"(451mm) D: 26 15/16"(684mm) W: 35 1/8"(892mm) or 62 5/8"(1591mm)	Maple	3110-ITT	\$ 695.10	
		Maple	3110-IDTT	1179.15	
(Double "T" Table) 3110-IDTT		Features <ul style="list-style-type: none"> • Maple veneer or laminate. • Top is 1"(25mm) thick with solid 1/8"(3mm) maple or 3mm PVC edge banding. • Three-ply construction. • Maple hardwood frame. • Table frame rails are dado and rabbet, reinforced with corner blocks. • 3110-ITT connects three (3) seats in a single "T" shaped configuration. • 3110-IDTT connects four (4) seats in a double "T" shaped configuration. • Includes intermediate support leg. 	To Order Wood Top, Specify: <ol style="list-style-type: none"> 1) Product number. 2) Wood finish color. To Order Laminate Top, Specify: <ol style="list-style-type: none"> 1) Product number. 2) Wood finish color. 3) Laminate color. 		
					

Forenze Seating

Guest/Occasional Seating

Base/ Frame	Number	Fabric Grade		C	D	E	F	G	H	Leather Grade A	Leather Grade B
		A	B								
Maple	8381-00	\$1073.10	\$1093.05	\$1101.45	\$1122.45	\$1137.15	\$1243.20	\$1279.95	\$1381.80	\$1360.80	\$1497.10

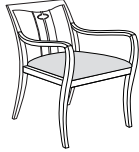
**Serpentine Arm,
Ellipse Back**

8381-00

Dimensions

SH: 18 1/4"(464mm)
H: 32 5/8"(829mm)
D: 22 3/4"(578mm)
W: 22 3/4"(578mm)
AH: 26 1/2"(673mm)
SW: 19 1/2"(495mm)
SD: 18 5/8"(473mm)

Features

- Open arms.
- Upholstered seat.
- Maple hardwood frame. Seat frame rails are mortise and tenoned, cross locked with dowels.
- Seat is 1 3/4"(45mm) HR foam over a webbed panel.
- COM yardage: 0.75
- COL square footage: 13.5
- Available on RUSH.

To Order, Specify:

- 1) Product number.
- 2) Fabric surface and color.
- 3) Wood finish color.

CAL 133 Option:

Add **-F** to the product number, and add **\$94.50** list.

Maple	8281-00	\$1073.10	\$1093.05	\$1101.45	\$1122.45	\$1137.15	\$1243.20	\$1279.95	\$1381.80	\$1360.80	\$1497.10
-------	---------	-----------	-----------	-----------	-----------	-----------	-----------	-----------	-----------	-----------	-----------

**Serpentine Arm,
Wave Back**

8281-00

Dimensions

SH: 18 1/4"(464mm)
H: 32 5/8"(829mm)
D: 22 3/4"(578mm)
W: 22 3/4"(578mm)
AH: 26 1/2"(673mm)
SW: 19 1/2"(495mm)
SD: 18 5/8"(473mm)

Features

- Open arms.
- Upholstered seat.
- Maple hardwood frame. Seat frame rails are mortise and tenoned, cross locked with dowels.
- Seat is 1 3/4"(45mm) HR foam over a webbed panel.
- COM yardage: 0.75
- COL square footage: 13.5

To Order, Specify:

- 1) Product number.
- 2) Fabric surface and color.
- 3) Arm/frame finish color.

CAL 133 Option:

Add **-F** to the product number, and add **\$94.50** list.

Maple	8181-00	\$1073.10	\$1106.70	\$1137.15	\$1186.50	\$1218.00	\$1287.30	\$1332.45	\$1459.50	\$1722.00	\$1896.10
-------	---------	-----------	-----------	-----------	-----------	-----------	-----------	-----------	-----------	-----------	-----------

**Serpentine Arm,
Upholstered Back**

8181-00

Dimensions

SH: 18 1/4"(464mm)
H: 32 5/8"(829mm)
D: 23 1/4"(591mm)
W: 22 3/4"(578mm)
AH: 26 1/2"(673mm)
SW: 19 1/2"(495mm)
SD: 18 1/4"(464mm)

Features

- Open arms.
- Upholstered seat and back.
- Maple hardwood frame. Seat frame rails are mortise and tenoned, cross locked with dowels.
- Seat is 1 3/4"(45mm) HR foam over a webbed panel.
- The upholstered back frame insert is webbed and padded with 1"(25mm) thick foam.
- COM yardage: 1.25
- COL square footage: 22.5
- Available on RUSH.

To Order, Specify:

- 1) Product number.
- 2) Fabric surface and color.
- 3) Wood finish color.

CAL 133 Option:

Add **-F** to the product number, and add **\$94.50** list.

Nano-Tex Option: To specify, add **-P** to end of the product number and add **\$32.55** list.

Example: 8381-00-P

DuraBlock Option: To specify add **-D** to end of the product number and add **\$43.05** list.

Example: 8381-00-D

NOTE: Nano-Tex and DuraBlock are not available on leather or faux leather.

For available fabrics see matrix in the back of the book.

Forenze Seating

Guest/Occasional Seating

Base/ Frame	Number	Fabric Grade		C	D	E	F	G	H	Leather Grade A	Leather Grade B
		A	B								
Maple	8382-00	\$1073.10	\$1093.05	\$1101.45	\$1122.45	\$1137.15	\$1243.20	\$1279.95	\$1381.80	\$1360.80	\$1497.10

**Curve Arm,
Ellipse Back**

8382-00

Dimensions

SH: 18 1/4"(464mm)
H: 32 5/8"(829mm)
D: 22 3/4"(578mm)
W: 22 3/4"(578mm)
AH: 26 3/8"(670mm)
SW: 19 1/2"(495mm)
SD: 18 5/8"(473mm)

Features

- Open arms.
- Upholstered seat.
- Maple hardwood frame. Seat frame rails are mortise and tenoned, cross locked with dowels.
- Seat is 1 3/4"(45mm) HR foam over a webbed panel.
- COM yardage: 0.75
- COL square footage: 13.5
- Available on RUSH.

To Order, Specify:

- 1) Product number.
- 2) Fabric surface and color.
- 3) Wood finish color.

CAL 133 Option:

Add **-F** to the product number, and add **\$94.50** list.

Maple	8282-00	\$1073.10	\$1093.05	\$1101.45	\$1122.45	\$1137.15	\$1243.20	\$1279.95	\$1381.80	\$1360.80	\$1497.10
-------	---------	-----------	-----------	-----------	-----------	-----------	-----------	-----------	-----------	-----------	-----------

**Curve Arm,
Wave Back**

8282-00

Dimensions

SH: 18 1/4"(464mm)
H: 32 5/8"(829mm)
D: 22 3/4"(578mm)
W: 22 3/4"(578mm)
AH: 26 3/8"(670mm)
SW: 19 1/2"(495mm)
SD: 18 5/8"(473mm)

Features

- Open arms.
- Upholstered seat.
- Maple hardwood frame. Seat frame rails are mortise and tenoned, cross locked with dowels.
- Seat is 1 3/4"(45mm) HR foam over a webbed panel.
- COM yardage: 0.75
- COL square footage: 13.5

To Order, Specify:

- 1) Product number.
- 2) Fabric surface and color.
- 3) Wood finish color.

CAL 133 Option:

Add **-F** to the product number, and add **\$94.50** list.

Maple	8182-00	\$1073.10	\$1106.70	\$1137.15	\$1186.50	\$1218.00	\$1287.30	\$1332.45	\$1459.50	\$1722.00	\$1896.10
-------	---------	-----------	-----------	-----------	-----------	-----------	-----------	-----------	-----------	-----------	-----------

**Curve Arm,
Upholstered Back**

8182-00

Dimensions

SH: 18 1/4"(464mm)
H: 32 5/8"(829mm)
D: 23 1/4"(591mm)
W: 22 3/4"(578mm)
AH: 26 3/8"(670mm)
SW: 19 1/2"(495mm)
SD: 18 1/4"(464mm)

Features

- Open arms.
- Upholstered seat and back.
- Maple hardwood frame. Seat frame rails are mortise and tenoned, cross locked with dowels.
- Seat is 1 3/4"(45mm) HR foam over a webbed panel.
- The upholstered back frame insert is webbed and padded with 1"(25mm) thick foam.
- COM yardage: 1.25
- COL square footage: 22.5
- Available on RUSH.

To Order, Specify:

- 1) Product number.
- 2) Fabric surface and color.
- 3) Wood finish color.

CAL 133 Option:

Add **-F** to the product number, and add **\$94.50** list.

Nano-Tex Option: To specify, add **-P** to end of the product number and add **\$32.55** list.

Example: 8382-00-P

DuraBlock Option: To specify add **-D** to end of the product number and add **\$43.05** list.

Example: 8382-00-D

NOTE: Nano-Tex and DuraBlock are not available on leather or faux leather.

For available fabrics see matrix in the back of the book.

Forenze Seating

Guest/Occasional Seating

Base/ Frame	Number	Fabric Grade		C	D	E	F	G	H	Leather Grade A	Leather Grade B
		A	B								
Maple	8583-00	\$1073.10	\$1093.05	\$1101.45	\$1122.45	\$1137.15	\$1243.20	\$1279.95	\$1381.80	\$1360.80	\$1497.10

Scroll Arm,
Star Back

8583-00

Dimensions

SH: 18 1/4"(464mm)
H: 32 5/8"(829mm)
D: 22 3/4"(578mm)
W: 22 3/4"(578mm)
AH: 26 3/8"(670mm)
SW: 19 1/2"(495mm)
SD: 18 5/8"(473mm)

Features

- Open arms.
- Upholstered seat.
- Maple hardwood frame. Seat frame rails are mortise and tenoned, cross locked with dowels.
- Seat is 1 3/4"(45mm) HR foam over a webbed panel.
- COM yardage: 0.75
- COL square footage: 13.5
- Available on RUSH.

To Order, Specify:

- 1) Product number.
- 2) Fabric surface and color.
- 3) Wood finish color.

CAL 133 Option:

Add **-F** to the product number, and add **\$94.50** list.

Maple	8483-00	\$1073.10	\$1093.05	\$1101.45	\$1122.45	\$1137.15	\$1243.20	\$1279.95	\$1381.80	\$1360.80	\$1497.10
-------	---------	-----------	-----------	-----------	-----------	-----------	-----------	-----------	-----------	-----------	-----------

Scroll Arm,
Slat Back

8483-00

Dimensions

SH: 18 1/4"(464mm)
H: 32 5/8"(829mm)
D: 22 3/4"(578mm)
W: 22 3/4"(578mm)
AH: 26 3/8"(670mm)
SW: 19 1/2"(495mm)
SD: 18 5/8"(473mm)

Features

- Open arms.
- Upholstered seat.
- Maple hardwood frame. Seat frame rails are mortise and tenoned, cross locked with dowels.
- Seat is 1 3/4"(45mm) HR foam over a webbed panel.
- COM yardage: 0.75
- COL square footage: 13.5

To Order, Specify:

- 1) Product number.
- 2) Fabric surface and color.
- 3) Wood finish color

CAL 133 Option:

Add **-F** to the product number, and add **\$94.50** list.

Maple	8183-00	\$1073.10	\$1106.70	\$1137.15	\$1186.50	\$1218.00	\$1287.30	\$1332.45	\$1459.50	\$1722.00	\$1896.10
-------	---------	-----------	-----------	-----------	-----------	-----------	-----------	-----------	-----------	-----------	-----------

Scroll Arm,
Upholstered Back

8183-00

Dimensions

SH: 18 1/4"(464mm)
H: 32 5/8"(829mm)
D: 23 1/4"(591mm)
W: 22 3/4"(578mm)
AH: 26 3/8"(670mm)
SW: 19 1/2"(495mm)
SD: 18 1/4"(464mm)

Features

- Open arms.
- Upholstered seat and back.
- Maple hardwood frame. Seat frame rails are mortise and tenoned, cross locked with dowels.
- Seat is 1 3/4"(45mm) HR foam over a webbed panel.
- The upholstered back frame insert is webbed and padded with 1"(25mm) thick foam.
- COM yardage: 1.25
- COL square footage: 22.5
- Available on RUSH.

To Order, Specify:

- 1) Product number.
- 2) Fabric surface and color.
- 3) Wood finish color.

CAL 133 Option:

Add **-F** to the product number, and add **\$94.50** list.

Nano-Tex Option: To specify, add **-P** to end of the product number and add **\$32.55** list.

Example: 8583-00-P

DuraBlock Option: To specify add **-D** to end of the product number and add **\$43.05** list.

Example: 8583-00-D

NOTE: Nano-Tex and DuraBlock are not available on leather or faux leather.

For available fabrics see matrix in the back of the book.

Forenze Seating

Guest/Occasional Seating

Base/ Frame	Number	Fabric Grade		C	D	E	F	G	H	Leather Grade A	Leather Grade B
		A	B								
Maple	8584-00	\$1073.10	\$1093.05	\$1101.45	\$1122.45	\$1137.15	\$1243.20	\$1279.95	\$1381.80	\$1360.80	\$1497.10

**Cabriole Arm,
Star Back**

8584-00

Dimensions

SH: 18 1/4"(464mm)
 H: 32 5/8"(829mm)
 D: 22 3/4"(578mm)
 W: 22 3/4"(578mm)
 AH: 26 1/2"(673mm)
 SW: 19 1/2"(495mm)
 SD: 18 5/8"(473mm)

Features

- Open arms.
 - Upholstered seat.
 - Maple hardwood frame. Seat frame rails are mortise and tenoned, cross locked with dowels.
 - Seat is 1 3/4"(45mm) HR foam over a webbed panel.
 - COM yardage: 0.75
 - COL square footage: 13.5
- Available on RUSH.

To Order, Specify:

- 1) Product number.
- 2) Fabric surface and color.
- 3) Wood finish color.

CAL 133 Option:

Add **-F** to the product number, and add **\$94.50** list.

Maple	8484-00	\$1073.10	\$1093.05	\$1101.45	\$1122.45	\$1137.15	\$1243.20	\$1279.95	\$1381.80	\$1360.80	\$1497.10
-------	---------	-----------	-----------	-----------	-----------	-----------	-----------	-----------	-----------	-----------	-----------

**Cabriole Arm,
Slat Back**

8484-00

Dimensions

SH: 18 1/4"(464mm)
 H: 32 5/8"(829mm)
 D: 22 3/4"(578mm)
 W: 22 3/4"(578mm)
 AH: 26 1/2"(673mm)
 SW: 19 1/2"(495mm)
 SD: 18 5/8"(473mm)

Features

- Open arms.
- Upholstered seat.
- Maple hardwood frame. Seat frame rails are mortise and tenoned, cross locked with dowels.
- Seat is 1 3/4"(45mm) HR foam over a webbed panel.
- COM yardage: 0.75
- COL square footage: 13.5

To Order, Specify:

- 1) Product number.
- 2) Fabric surface and color.
- 3) Wood finish color.

CAL 133 Option:

Add **-F** to the product number, and add **\$94.50** list.

Maple	8184-00	\$1073.10	\$1106.70	\$1137.15	\$1186.50	\$1218.00	\$1287.30	\$1332.45	\$1459.50	\$1722.00	\$1896.10
-------	---------	-----------	-----------	-----------	-----------	-----------	-----------	-----------	-----------	-----------	-----------

**Cabriole Arm,
Upholstered Back**

8184-00

Dimensions

SH: 18 1/4"(464mm)
 H: 32 5/8"(829mm)
 D: 23 1/4"(591mm)
 W: 22 3/4"(578mm)
 AH: 26 1/2"(673mm)
 SW: 19 1/2"(495mm)
 SD: 18 1/4"(464mm)

Features

- Open arms.
 - Upholstered seat and back.
 - Maple hardwood frame. Seat frame rails are mortise and tenoned, cross locked with dowels.
 - Seat is 1 3/4"(45mm) HR foam over a webbed panel.
 - The upholstered back frame insert is webbed and padded with 1"(25mm) thick foam.
 - COM yardage: 1.25
 - COL square footage: 22.5
- Available on RUSH.

To Order, Specify:

- 1) Product number.
- 2) Fabric surface and color.
- 3) Wood finish color.

CAL 133 Option:

Add **-F** to the product number, and add **\$94.50** list.

Nano-Tex Option: To specify, add **-P** to end of the product number and add **\$32.55** list.

Example: 8584-00-P

DuraBlock Option: To specify add **-D** to end of the product number and add **\$43.05** list.

Example: 8584-00-D

NOTE: Nano-Tex and DuraBlock are not available on leather or faux leather.

For available fabrics see matrix in the back of the book.

Hello Seating

Guest Seating

Fixed Arm, Wood Legs



4851-0011-W

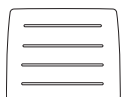

4851-0012-W

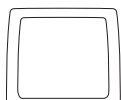

4851-0013-W

Dimensions

SH: 18 1/4"(464mm)
 H: 33"(838mm)
 D: 20 1/2"(521mm)
 W: 22"(559mm)
 AH: 8"(203mm)
 SW: 18"(457mm)
 SD: 17 1/4"(438mm)

Features

- Wood or upholstered back.
- Wood legs.
- Upholstered seat.
- Non-stacking.
- Maple frame construction.
- Metal back arm attachment.
- Open arms.
- Back Options include wood slat, wood perforated or upholstered.
- COM yardage / COL square footage:
 Upholstered seat or upholstered seat/back: 0.75/13.5
- Available on RUSH.

To Order Chair with Wood Back, Specify:

- 1) Product number.
- 2) Fabric surface and color (seat).
- 3) Wood finish color (back and legs).
- 4) Trim color for back attachment. (Available in TR-LE Metallic Silver Only)

To Order Chair with Upholstered Back, Specify:

- 1) Product number.
- 2) Fabric surface and color.
- 3) Wood finish color (back and legs).
- 4) Trim color for back attachment. (Available in TR-LE Metallic Silver Only)

Leather Upholstery

Leather upholstery requires modification of the product number. Change the second digit to **7** and specify leather surface and color. **Example:** 4751-0011-W

CAL 133 Option:

Add **-F** to the product number, and add **\$92.40** list.

Description	Number	Fabric Grade								Leather Grade A	Leather Grade B
		A	B	C	D	E	F	G	H		
Wood Perforated Back	4851-0011-W ■	\$1067.85	\$1087.80	\$1096.20	\$1117.20	\$1131.90	\$1282.05	\$1327.20	\$1454.25	\$1355.55	\$1514.85
Wood Slat Back	4851-0012-W ■	1067.85	1087.80	1096.20	1117.20	1131.90	1282.05	1327.20	1454.25	1355.55	1514.85
Upholstered Back	4851-0013-W	1328.25	1348.20	1356.60	1377.60	1392.30	1542.45	1587.60	1714.65	1615.95	1775.25

Nano-Tex Option

To specify, add **-P** to end of the product number and add **\$32.55** list.

Example: 4851-0011-W-P

DuraBlock Option

To specify add **-D** to end of the product number and add **\$43.05** list.

Example: 4851-0011-W-D

NOTE: Nano-Tex and DuraBlock are not available on leather or faux leather.

For available fabrics see matrix in the back of the book.

Hello Seating

Guest Seating

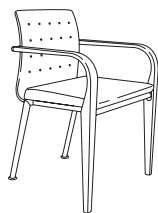
**Fixed Arm,
Metal Legs**

4851-0011

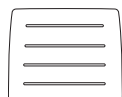

4851-0012

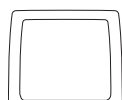

4851-0013

Dimensions

SH: 18 1/4"(464mm)
 H: 33"(838mm)
 D: 20 1/2"(521mm)
 W: 22"(559mm)
 AH: 8"(203mm)
 SW: 18"(457mm)
 SD: 17 1/4"(438mm)

Features

- Wood or upholstered back.
- Wood front legs with metal rear legs.
- Upholstered seat.
- Non-stacking.
- Maple frame construction.
- Metal back arm attachment.
- Open arms.
- Back Options include wood slat, wood perforated or upholstered.
- COM yardage / COL square footage:
 Upholstered seat or upholstered seat / back: 0.75/13.5
- Available on RUSH.

**To Order Chair with
Wood Back, Specify:**

- 1) Product number.
- 2) Fabric surface and color (seat).
- 3) Wood finish color for back, arms, and front legs.
- 4) Trim color for rear legs and back attachment.
(Available in TR-LE Metallic Silver Only)

**To Order Chair with
Upholstered Back, Specify:**

- 1) Product number.
- 2) Fabric surface and color.
- 3) Wood finish color for back, arms, and front legs.
- 4) Trim color for rear legs and back attachment.
(Available in TR-LE Metallic Silver Only)

Leather Upholstery

Leather upholstery requires modification of the product number. Change the second digit to **7** and specify leather surface and color.
Example: 4751-0011

CAL 133 Option:

Add **-F** to the product number, and add **\$92.40** list.

Description	Number	Fabric Grade								Leather Grade A	Leather Grade B
		A	B	C	D	E	F	G	H		
Wood Perforated Back	4851-0011 ■	\$ 972.30	\$ 992.25	\$1000.65	\$1021.65	\$1036.35	\$1186.50	\$1231.65	\$1358.70	\$1260.00	\$1419.30
Wood Slat Back	4851-0012 ■	972.30	992.25	1000.65	1021.65	1036.35	1186.50	1231.65	1358.70	1260.00	1419.30
Upholstered Back	4851-0013	1232.70	1252.65	1261.05	1282.05	1296.75	1446.90	1492.05	1619.10	1520.40	1679.70

Nano-Tex Option

To specify, add **-P** to end of the product number and add **\$32.55** list.

Example: 4851-0011-P

DuraBlock Option

To specify add **-D** to end of the product number and add **\$43.05** list.

Example: 4851-0011-D

NOTE: Nano-Tex and DuraBlock are not available on leather or faux leather.

For available fabrics see matrix in the back of the book.

Hello Seating

Stools

Fixed Arm, Metal Legs

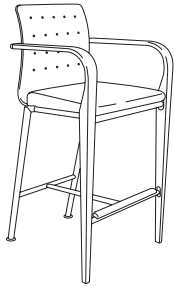

4852-0011

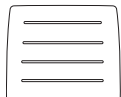

4852-0012

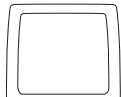

4852-0013

Dimensions

SH: 28 1/2"(724mm)
 H: 44"(1118mm)
 D: 21"(533mm)
 W: 20 3/4"(527mm)
 AH: 8 1/2"(216mm)
 SW: 17 1/4"(438mm)
 SD: 17 1/4"(438mm)

Features

- Wood or upholstered back.
- Upholstered seat.
- Maple frame construction.
- Metal back leg construction.
- Open arms.
- Metal back arm attachment.
- Foot rest nylon cover available in black only.
- Back Options include wood slat, wood perforated or upholstered.
- COM yardage / COL square footage:
 Upholstered seat or upholstered seat/back: 0.75/13.5
- Available on RUSH.

To Order Chair with Wood Back, Specify:

- 1) Product number.
- 2) Fabric surface and color (seat).
- 3) Wood finish color for back, arms, and front legs.
- 4) Trim color for rear legs and back attachment.
 (Available in TR-LE Metallic Silver Only)

To Order Chair with Upholstered Back, Specify:

- 1) Product number.
- 2) Fabric surface and color.
- 3) Wood finish color for back, arms, and front legs.
- 4) Trim color for rear legs and back attachment.
 (Available in TR-LE Metallic Silver Only)

Leather Upholstery

Leather upholstery requires modification of the product number. Change the second digit to **7** and specify leather surface and color.
Example: 4752-0011

CAL 133 Option:

Add **-F** to the product number, and add **\$92.40** list.

Description	Number	Fabric Grade								Leather Grade A	Leather Grade B
		A	B	C	D	E	F	G	H		
Wood Perforated Back	4852-0011 ■	\$1244.25	\$1264.20	\$1272.60	\$1293.60	\$1308.30	\$1458.45	\$1503.60	\$1630.65	\$1531.95	\$1691.25
Wood Slat Back	4852-0012 ■	1244.25	1264.20	1272.60	1293.60	1308.30	1458.45	1503.60	1630.65	1531.95	1691.25
Upholstered Back	4852-0013	1504.65	1524.60	1533.00	1554.00	1568.70	1718.85	1764.00	1891.05	1792.35	1951.65

Nano-Tex Option

To specify, add **-P** to end of the product number and add **\$32.55** list.
Example: 4852-0011-P

DuraBlock Option

To specify add **-D** to end of the product number and add **\$43.05** list.
Example: 4852-0011-D

NOTE: Nano-Tex and DuraBlock are not available on leather or faux leather.

For available fabrics see matrix in the back of the book.

Hello Seating

Lounge with Legs

Standard Arm

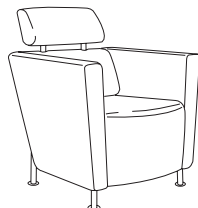

4854-0011

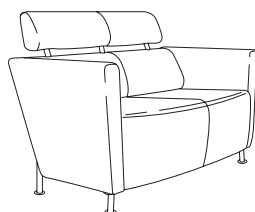

4854-0012

Dimensions

Lounge Chair
 SH: 17 1/2"(445mm)
 H: 35"(889mm)
 D: 30 1/4"(768mm)
 W: 30 1/2"(775mm)
 AH: 9 1/2"(241mm)
 SW: 21 1/4"(540mm)
 SD: 20 1/4"(514mm)

Settee

SH: 17 1/2"(445mm)
 H: 35"(889mm)
 D: 30 1/4"(768mm)
 W: 56 1/2"(1435mm)
 AH: 9 1/2"(241mm)
 SW: 46 3/4"(1187mm)
 SD: 20 1/4"(514mm)

Features

- Available as single cushion lounge chair or double cushion settee.
 - Upholstered back/seat.
 - Passive lumbar back support.
 - Interior frame has glued and doweled joints, reinforced with screws and cleats.
 - Exposed metal legs.
 - Optional two fabrics/one fabric two colors available on seat and back.
 - Optional grommets available in both arms to accommodate accessories.
 - Optional accessories include cup holder and tablet arm.
 - Legs, back support uprights and optional grommets are available in TR-LE Metallic Silver only.
 - Settee in leather requires a vertical seam.
 - COM yardage / COL square footage:
 One Seat Lounge: 4.25/76.5
 Seat: 1.0/18.0
 Back and Arms: 3.25/58.7
 Two Seat Lounge: 7.0/126.0
 Seat: 1.75/31.5
 Back and Arms: 5.25/94.5
- Available on RUSH.

To Order, Specify:

- 1) Product number.
- 2) Fabric surface and color.
 or 2a. Fabric surface and color for seat.
 2b. Fabric surface and color for back and arms
- 3) Trim color for legs, back support uprights (grommets)
(Available in TR-LE Metallic Silver Only)

Leather Upholstery

Leather upholstery requires modification of the product number. Change the second digit to **7** and specify leather surface and color.
Example: 4754-0011

Description	Number	Fabric Grade								Leather Grade A	Leather Grade B
		A	B	C	D	E	F	G	H		
Lounge chair w/o grommets	4854-0011 ■	\$1671.60	\$1814.40	\$1936.20	\$2207.10	\$2284.80	\$2397.15	\$2552.55	\$2982.00	\$4466.70	\$6007.60
Lounge chair with grommets	4854-0011-G	1750.35	1893.15	2014.95	2285.85	2363.55	2475.90	2631.30	3060.75	4545.45	6086.35
Lounge chair with two fabrics/colors	4854-0011-T ■	1671.60	1957.20	2200.80	2742.60	2898.00	3122.70	3433.50	4292.40	7261.80	8802.70
Lounge chair with grommets/ two fabrics/two colors of same fabric	4854-0011-GT	1750.35	2035.95	2279.55	2821.35	2976.75	3201.45	3512.25	4371.15	7340.55	8881.45
Settee w/o grommets	4854-0012 ■	\$2386.65	\$2529.45	\$2651.25	\$2922.15	\$2999.85	\$3582.60	\$3839.85	\$4545.45	\$5181.75	\$6722.65
Settee with grommets	4854-0012-G	2465.40	2608.20	2730.00	3000.90	3078.60	3661.35	3918.60	4624.20	5260.50	6801.40
Settee with two fabrics/colors	4854-0012-T ■	2386.65	2672.25	2915.85	3457.65	3613.05	4778.55	5293.05	6704.25	7976.85	9517.75
Settee with grommets/ two fabrics/ two colors of same fabrics	4854-0012-GT	2465.40	2751.00	2994.60	3536.40	3691.80	4857.30	5371.80	6783.00	8055.60	9596.50

Nano-Tex Option

To specify, add **-P** to end of the product number and add **\$54.60** list.

Example: 4854-0011-P

DuraBlock Option

To specify, add **-D** to end of the product number and add **\$86.10** list.

Example: 4854-0011-D

NOTE: Nano-Tex and DuraBlock are not available on leather or faux leather.

For available fabrics see matrix in the back of the book.

Hello Seating

Mobile Lounge

Standard Arm

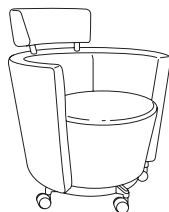

4855-0043

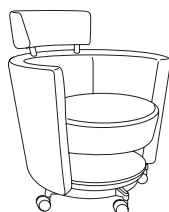

4855-0043-S



4855-0043-GSX

Dimensions

SH: 17 1/4"(438mm)
 H: 34 3/4"(883mm)
 D: 26"(660mm)
 W: 30 3/4"(781mm)
 AH: 9 1/2"(241mm)
 SW: 18 3/4"(476mm)
 SD: 19 1/2"(495mm)

Features

- Upholstered back/seat.
- 360° swivel base standard.
- Passive lumbar back support.
- Casters: Standard with two-tone hard casters.
- Optional two-tone soft casters.
- Optional two fabrics/two colors of same fabric available on seat and back.
- Optional grommets to accommodate cup holder or tablet arm.
- Optional shelf model available with lower molded plywood storage shelf.
- Optional fully-loaded mobile lounge includes accessories as listed below.
- Optional accessories include cup holder and tablet arm.
- Swivel base, back support uprights and optional grommets are available in TR-LE Metallic Silver only.
- COM yardage / COL square footage:
 Lounge: 4.0/72.0
 Seat: 1.0/18.0
 Back and Arms: 3.75/67.5
- Lounge w/Shelf: 4.0/72.0
 Seat: 1.0/18.0
 Back and Arms: 3.75/67.5

■ Available on RUSH.

To Order, Specify:

- 1) Product number.
- 2) Fabric surface and color.
 or 2a. Fabric surface and color for seat.
 2b. Fabric surface and color for back and arms.
- 3) Trim color for base (grommets, cup holder).
(Available in TR-LE Metallic Silver Only)
- 4) Wood finish color for shelf (tablet arm/cup holder).

Leather Upholstery

Leather upholstery requires modification of the product number. Change the second digit to **7** and specify leather surface and color.
Example: 4755-0043

Description	Number	Fabric Grade								Leather Grade A	Leather Grade B
		A	B	C	D	E	F	G	H		
Upholstered/One Fabric and Color											
Upholstered	4855-0043	\$1647.45	\$1759.80	\$1857.45	\$1875.30	\$1893.15	\$2329.95	\$2475.90	\$2881.20	\$2352.00	\$2739.45
Upholstered/grommet	4855-0043-G	1726.20	1838.55	1936.20	1954.05	1971.90	2408.70	2554.65	2959.95	2430.75	2818.20
Upholstered/shelf	4855-0043-S	1841.70	1954.05	2051.70	2069.55	2087.40	2524.20	2670.15	3075.45	2546.25	2933.70
Upholstered/grommet/shelf	4855-0043-GS	1920.45	2032.80	2130.45	2148.30	2166.15	2602.95	2748.90	3154.20	2625.00	3012.45
Upholstered/Two Fabrics or One Fabric, Two Colors											
Upholstered	4855-0043-T	\$1647.45	\$1872.15	\$2067.45	\$2103.15	\$2138.85	\$3012.45	\$3304.35	\$4114.95	\$3056.55	\$3831.45
Upholstered/grommet	4855-0043-GT	1726.20	1950.90	2146.20	2181.90	2217.60	3091.20	3383.10	4193.70	3135.30	3910.20
Upholstered/shelf	4855-0043-ST	1841.70	2066.40	2261.70	2297.40	2333.10	3206.70	3498.60	4309.20	3250.80	4025.70
Upholstered/grommet/shelf	4855-0043-GST	1920.45	2145.15	2340.45	2376.15	2411.85	3285.45	3577.35	4387.95	3329.55	4104.45
Fully-Loaded Mobile Lounge											
Includes grommet, tablet arm, cup holder	4855-0043-GX	\$2031.75	\$2144.10	\$2241.75	\$2259.60	\$2277.45	\$2714.25	\$2860.20	\$3265.50	\$2736.30	\$3123.75
Includes grommet, shelf, tablet arm and cup holder	4855-0043-GSX	2226.00	2338.35	2436.00	2453.85	2471.70	2908.50	3054.45	3459.75	2930.55	3318.00
Includes grommet, tablet arm, cup holder in two fabrics/two colors	4855-0043-GTX	2031.75	2256.45	2451.75	2487.45	2523.15	3396.75	3688.65	4499.25	3440.85	4215.75
Includes grommet, shelf, tablet arm and cup holder in two fabrics/two colors of same fabric	4855-0043-GSTX	2226.00	2450.70	2646.00	2681.70	2717.40	3591.00	3882.90	4693.50	3635.10	4410.00

Soft Caster Option

Soft caster option requires modification of the product number. To specify, add **-2** to the product code.

Example: 4855-0043-2GST

Fully-Loaded Option*

Fully-Loaded Model Option requires modification of the product number.

To specify, add **-X** to the product code

Example: 4855-0043-GX

Nano-Tex Option

To specify, add **-P** to end of the product number and add **\$54.60** list.

Example: 4855-0043-SP

DuraBlock Option

To specify, add **-D** to end of the product number and add **\$86.10** list.

Example: 4855-0043-SD

NOTE: Nano-Tex and DuraBlock are not available on leather or faux leather.

For available fabrics see matrix in the back of the book.

Hello Seating

Accessories



4858-0001
(Tablet Arm)



4858-0002
(Cup Holder)

Dimensions

Tablet Arm:
W: 12.68"(322.1mm)
L: 15"(381mm)

Cup Holder:
W: 5.47"(138.94mm)
L: 7.47"(189.61mm)

Features

- Plywood construction.
- Accessories are non-handed.
- Tablet arm and cup holder supports are available in TR-LE Metallic Silver only.
- Available on RUSH.

To Order, Specify:

- 1) Product number.
- 2) Wood finish color.
- 3) Trim color for metal trim.
(Available in TR-LE Metallic Silver Only)

Description	Number	Price
Fold Away Tablet Arm	4858-0001 ■	\$214.20
Cup Holder	4858-0002 ■	121.80

Mini-mobile

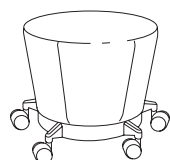

4856-0043

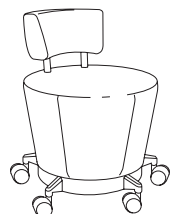

4856-0043-A

Dimensions

SH: 17 1/2"(445mm)
SD: 19 1/2"(495mm)

H: 26 3/4"(679mm)
AH: 9 1/4"(235mm)
OH: 26"(660mm)

Features

- Available as single upholstered seat or seat with arm bolster.
- Casters: Standard with two-tone hard casters.
- Optional two-tone soft casters.
- Optional arm bolster.
- Optional two fabrics / colors of same fabric available on arm bolster and seat.
- COM yardage / COL square footage:
Mini-mobile: 1.0/18.0
Mini w/ Arm Bolster: 1.5/27.0
Arm Bolster: 0.5/9.0
- Available on RUSH.

To Order, Specify:

- 1) Product number.
- 2) Fabric surface and color.
or 2a. Fabric surface and color for seat.
2b. Fabric surface and color for arm bolster.
- 3) Trim color for base.
(Available in TR-LE Metallic Silver Only)

Leather Upholstery

Leather upholstery requires modification of the product number. Change the second digit to **7** and specify leather surface and color.
Example: 4756-0043

Description	Number	Fabric Grade								Leather Grade A	Leather Grade B
		A	B	C	D	E	F	G	H		
Upholstered/One Fabric and Color											
Armless	4856-0043 ■	\$731.85	\$ 844.20	\$ 941.85	\$ 959.70	\$ 977.55	\$ 988.05	\$1043.70	\$1194.90	\$1436.40	\$1823.85
Includes Arm Bolster	4856-0043-A ■	953.40	1065.75	1163.40	1181.25	1199.10	1209.60	1265.25	1416.45	1657.95	2045.40
Upholstered/Two Fabrics or One Fabric, Two Colors											
Includes Arm Bolster	4856-0043-AT	953.40	1178.10	1373.40	1409.10	1444.80	1465.80	1577.10	1879.50	2362.50	3137.40

Soft Caster Option

Soft caster option requires modification of the product number. To specify, add -2 to the product code.

Example: 4856-0043-2A

Nano-Tex Option

To specify, add -P to end of the product number and add \$32.55 list.

Example: 4856-0043-AP

DuraBlock Option

To specify, add -D to end of the product number and add \$43.05 list.

Example: 4856-0043-AD

NOTE: Nano-Tex and DuraBlock are not available on leather or faux leather.

For available fabrics see matrix in the back of the book.

ToDo

General Specifications

Features and Options**Frame**

- Combination of hardwood rails, premium grade plywood and engineering grade oriented strand board
- The seat, back and arms use a box construction method. Each box is then fastened together using metal T-nuts.
- Optional back handle (single seat only)

Cushioning

- High-density foam
- Webbed seat and back

Upholstery

- One Fabric
- Two Fabrics (first fabric on seat, back and ottoman; second fabric on arm structures)
- Faux Leather
- Leather

Seat Options

- Single
- Double
- Triple

Base Options

- Stationary
 - 2 metal legs front and rear
- Mobile (single seat only)
 - 2 twin-wheel casters front, 2 metal legs rear

Accessory Options

- Tablet
- Cup holder
- Grommet cover

Grommet Options

- None (no cut-outs in arms)
- Right Arm (as seated)
- Left Arm (as seated)
- Both Arms

Ottoman or Shelf Option

- Open compartment (standard)
- Painted or Wood Veneer Shelf
 - chairs with a shelf will not accept an ottoman
- Painted or Wood Veneer Mobile Ottoman
 - Upholstered
 - Non-upholstered wood top
 - 4 twin-wheel casters
 - chairs with an ottoman will not accept a shelf
 - ottoman nests under single seat with open compartment only

COM & COL General Information

To order a COM fabric (Customer's Own Material), contact the Haworth Inquiry Center (1.800.426.8562), your local Haworth dealer, or go to haworth.com/surfaces > COM Library to find out if the COM you have selected has already been tested and approved. The surface collection site also has information on the Haworth + alliance program with Carnegie, Luna Textiles, and Maharam as well as our industry-leading Pre-Approved COM program.

Approved COMs are placed into Grades based on the fabric pricing; if the fabric pricing exceeds our Grades, they will be priced at Grade A + cost of fabric + 4% handling (North America). Haworth will purchase all COMs unless instructed otherwise. (Leather will also be purchased by Haworth; if the leather pricing exceeds our Grades, cost will be based on fabric Grade E + cost of leather + handling.)

If no information is available on the COM you are looking for, refer to the COM section and forms on the surface collection site for information on how to process your test request.

Specification Guidelines

- When more than two fabrics are specified on a ToDo chair contact Haworth Specials for pricing and lead time.
- Mixing of materials such as vinyl and fabric on chair contact specials for pricing.
- When ordering a chair with both the two fabric option and an upholstered ottoman, the fabric on the ottoman will match the fabric on the chair seat and back indicated in the first fabric code. The chair arms will be upholstered in the second fabric code.
- If an upholstered ottoman fabric must match the chair arms or is a third fabric choice, the ottoman must be ordered separately.
- Chairs with a shelf will not accept an ottoman.
- Chairs with an ottoman will not accept a shelf.
- **A grommet option (suffix -R, -L or -B) must be included in the ToDo chair specification in order to accept tablet arms or cup holders.**
- Tablet arms and cup holders must be ordered separately.

To insure order accuracy and acceptance, features and options must be specified in the following order (top-down):

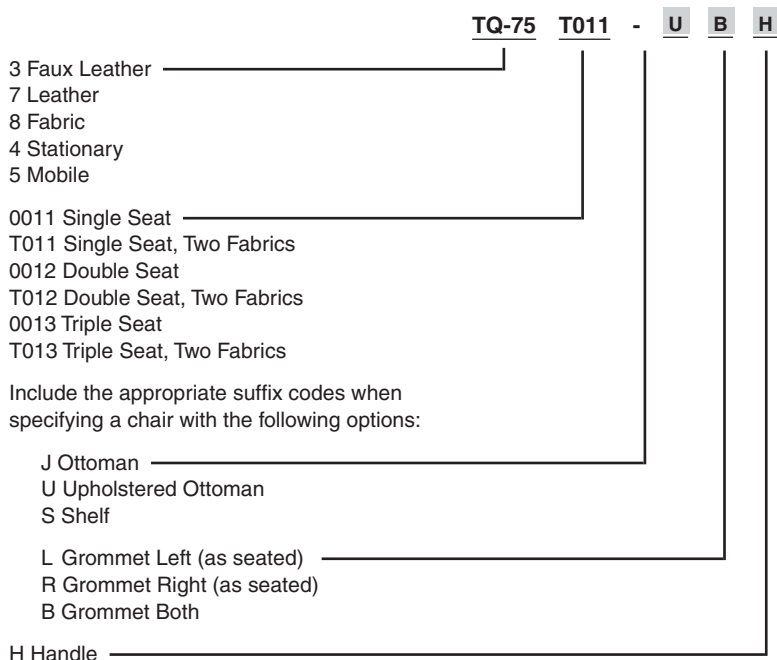

- ToDo Leather, Mobile, Single Seat with two fabrics, Upholstered Ottoman, Grommet Both, Handle

Examples:

TQ84-0012-SL, NQ-8, TR-M01, H3-1

ToDo Fabric, Stationary, Double Seat, Shelf, Grommet Left
 Moodring Fabric Joy
 Switch Silver trim on feet
 Lameer™ Snow on Shelf

TQ85-0011-BHF, ED-99, TR-F

ToDo Fabric, Mobile, Single Seat, Grommet Both, Handle
 Novial fabric Black
 Black trim on feet, grommets and handle
 CAL 133 required (when -F is specified, always verify fabric selected is CAL 133 approved, refer to page 0).

ToDo

Single, Stationary

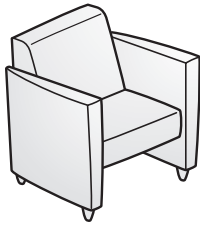

TQ84-0011

Dimensions

Overall:

H 31 1/4"(794mm)
W 30"(762mm)
D 29 1/4"(743mm)

Seat:

H 17 1/2"(445mm)
W 21 1/2"(546mm)
D 19"(483mm)

Arm:

H 24 1/8"(613mm)

Features

- Standard without grommets.
- COM yardage / COL square footage:
ToDo Single: 5.0/96.0
Seat and Back: 4.0/72.0
Arms Only: 3.0/54.0
Ottoman: 0.5/11.0

Specification Tips

- For help in specifying multiple options, refer to page 275.
- When specifying mixed grade fabrics, list price will not exceed the highest grade fabric specified.
- Chairs with a shelf will not accept an ottoman, and chairs with an ottoman will not accept a shelf.
- **A grommet option (suffix -R, -L or -B) must be included in the ToDo chair specification in order to accept tablet arms or cup holders.**
- Cup holders and tablet must be ordered separately. To specify, refer to page 280.
- Available on RUSH.

To Order, Specify:

- 1) Product number.
- 2) Fabric or
 - a. Fabric for seat, back and upholstered ottoman.
 - b. Fabric for arms.
- 3) Trim color for feet, grommets and handle.
- 4) Wood Veneer finish color for shelf or ottoman.

Description	Number	Fabric Grade		C	D	E	F	G	H	Leather Grade A	Leather Grade B
		A	B								
One Fabric											
Standard	TQ84-0011 ■	\$2084.25	\$2151.45	\$2260.65	\$2334.15	\$2590.35	\$2936.85	\$3117.45	\$3623.55	\$3256.05	\$3904.25
With Ottoman	TQ84-0011-J	2722.65	2789.85	2899.05	2972.55	3228.75	3575.25	3755.85	4261.95	3894.45	4542.65
With Upholstered Ottoman	TQ84-0011-U	2846.55	2913.75	3022.95	3096.45	3352.65	3699.15	3879.75	4385.85	4018.35	4666.55
With Shelf	TQ84-0011-S	2247.00	2314.20	2423.40	2496.90	2753.10	3099.60	3280.20	3786.30	3418.80	4067.00
With Grommet Right	TQ84-0011-R ■	2115.75	2182.95	2292.15	2365.65	2621.85	2968.35	3148.95	3655.05	3287.55	3935.75
With Grommet Left	TQ84-0011-L ■	2115.75	2182.95	2292.15	2365.65	2621.85	2968.35	3148.95	3655.05	3287.55	3935.75
With Grommet Both	TQ84-0011-B ■	2147.25	2214.45	2323.65	2397.15	2653.35	2999.85	3180.45	3686.55	3319.05	3967.25
With Handle	TQ84-0011-H ■	2150.40	2217.60	2326.80	2400.30	2656.50	3003.00	3183.60	3689.70	3322.20	3970.40
Two Fabrics											
Standard	TQ84-T011	\$2155.65	\$2222.85	\$2332.05	\$2405.55	\$2661.75	\$3008.25	\$3188.85	\$3694.95	\$3327.45	\$3975.65
With Ottoman	TQ84-T011-J	2794.05	2861.25	2970.45	3043.95	3300.15	3646.65	3827.25	4333.35	3965.85	4614.05
With Upholstered Ottoman	TQ84-T011-U	2917.95	2985.15	3094.35	3167.85	3424.05	3770.55	3951.15	4457.25	4089.75	4737.95
With Shelf	TQ84-T011-S	2318.40	2385.60	2494.80	2568.30	2824.50	3171.00	3351.60	3857.70	3490.20	4138.40
With Grommet Right	TQ84-T011-R	2187.15	2254.35	2363.55	2437.05	2693.25	3039.75	3220.35	3726.45	3358.95	4007.15
With Grommet Left	TQ84-T011-L	2187.15	2254.35	2363.55	2437.05	2693.25	3039.75	3220.35	3726.45	3358.95	4007.15
With Grommet Both	TQ84-T011-B	2218.65	2285.85	2395.05	2468.55	2724.75	3071.25	3251.85	3757.95	3390.45	4038.65
With Handle	TQ84-T011-H	2221.80	2289.00	2398.20	2471.70	2727.90	3074.40	3255.00	3761.10	3393.60	4041.80

The following options require modification of the product number.

Faux Leather	To specify, change the 3rd digit from an 8 to a 3; Example: TQ34-0011
Leather	To specify, change the 3rd digit from an 8 to a 7; Example: TQ74-0011
Nano-Tex	To specify, add -P to the end of the product number; Example: TQ84-0011-P (add \$54.60 list)
DuraBlock	To specify, add -D to the end of the product number; Example: TQ84-0011-D (add \$86.10 list)

For available fabrics see matrix in the back of the book.

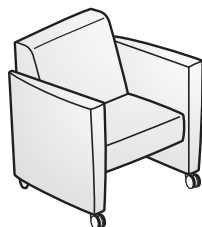

TQ85-0011

Dimensions**Overall:**

H	31 1/4"(794mm)
W	30"(762mm)
D	29 1/4"(743mm)

Seat:

H	17 1/2"(445mm)
W	21 1/2"(546mm)
D	19"(483mm)

Arm:

H	24 1/4"(613mm)
---	----------------

Features

- Standard without grommets.
- COM yardage / COL square footage:
ToDo Single: 5.0/96.0
Seat and Back: 4.0/72.0
Arms Only: 3.0/54.0
Ottoman: 0.5/11.0

Specification Tips

- For help in specifying multiple options, refer to page 275.
- When specifying mixed grade fabrics, list price will not exceed the highest grade fabric specified.
- Chairs with a shelf will not accept an ottoman, and chairs with an ottoman will not accept a shelf.
- **A grommet option (suffix -R, -L or -B) must be included in the ToDo chair specification in order to accept tablet arms or cup holders.**
- Cup holders and tablet must be ordered separately. To specify, refer to page 280.
- Available on RUSH.

To Order, Specify:

- 1) Product number.
- 2) Fabric or
a. Fabric for seat, back and upholstered ottoman.
b. Fabric for arms.
- 3) Trim color for feet, grommets and handle.
- 4) Wood Veneer finish color for shelf or ottoman.

Description	Number	Fabric Grade								Leather Grade A	Leather Grade B
		A	B	C	D	E	F	G	H		
One Fabric											
Standard	TQ85-0011 ■	\$2084.25	\$2151.45	\$2263.81	\$2338.35	\$2590.35	\$2936.85	\$3121.65	\$3626.71	\$3257.11	\$3902.25
With Ottoman	TQ85-0011-J	2722.65	2789.85	2902.21	2976.75	3228.75	3575.25	3760.05	4265.11	3895.51	4540.65
With Upholstered Ottoman	TQ85-0011-U	2846.55	2913.75	3026.11	3100.65	3352.65	3699.15	3883.95	4389.01	4019.41	4664.55
With Shelf	TQ85-0011-S	2247.00	2314.20	2426.56	2501.10	2753.10	3099.60	3284.40	3789.46	3419.86	4065.00
With Grommet Right	TQ85-0011-R ■	2115.75	2182.95	2295.31	2369.85	2621.85	2968.35	3153.15	3658.21	3288.61	3933.75
With Grommet Left	TQ85-0011-L ■	2115.75	2182.95	2295.31	2369.85	2621.85	2968.35	3153.15	3658.21	3288.61	3933.75
With Grommet Both	TQ85-0011-B ■	2147.25	2214.45	2326.81	2401.35	2653.35	2999.85	3184.65	3689.71	3320.11	3965.25
With Handle	TQ85-0011-H ■	2150.40	2217.60	2329.96	2404.50	2656.50	3003.00	3187.80	3692.86	3323.26	3968.40
Two Fabrics											
Standard	TQ85-T011	\$2155.65	\$2222.85	\$2335.21	\$2409.75	\$2661.75	\$3008.25	\$3193.05	\$3698.11	\$3328.51	\$3973.65
With Ottoman	TQ85-T011-J	2794.05	2861.25	2973.61	3048.15	3300.15	3646.65	3831.45	4336.51	3966.91	4612.05
With Upholstered Ottoman	TQ85-T011-U	2917.95	2985.15	3097.51	3172.05	3424.05	3770.55	3955.35	4460.41	4090.81	4735.95
With Shelf	TQ85-T011-S	2318.40	2385.60	2497.96	2572.50	2824.50	3171.00	3355.80	3860.86	3491.26	4136.40
With Grommet Right	TQ85-T011-R	2187.15	2254.35	2366.71	2441.25	2693.25	3039.75	3224.55	3729.61	3360.01	4005.15
With Grommet Left	TQ85-T011-L	2187.15	2254.35	2366.71	2441.25	2693.25	3039.75	3224.55	3729.61	3360.01	4005.15
With Grommet Both	TQ85-T011-B	2218.65	2285.85	2398.21	2472.75	2724.75	3071.25	3256.05	3761.11	3391.51	4036.65
With Handle	TQ85-T011-H	2221.80	2289.00	2401.36	2475.90	2727.90	3074.40	3259.20	3764.26	3394.66	4039.80

The following options require modification of the product number.

Faux Leather	To specify, change the 3rd digit from an 8 to a 3; Example: TQ35-0011
Leather	To specify, change the 3rd digit from an 8 to a 7; Example: TQ75-0011
Nano-Tex	To specify, add -P to the end of the product number; Example: TQ85-0011-P (\$54.60 list)
DuraBlock	To specify, add -D to the end of the product number; Example: TQ85-0011-D (add \$86.10 list)

For available fabrics see matrix in the back of the book.

ToDo

Double, Stationary

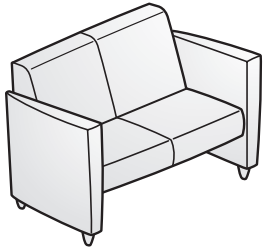

TQ84-0012

Dimensions

Overall:

H	31 1/4"(794mm)
W	51"(1295mm)
D	30 3/4"(781mm)

Seat:

H	17 1/2"(445mm)
W	42 1/2"(1080mm)
D	20 1/2"(521mm)

Arm:

H	24 1/8"(613mm)
---	----------------

Features

- Standard without grommets.
- COM yardage / COL square footage:
ToDo Double: 8.0/144.0
Seat and Back: 7.0/126.0
Arms Only: 3.0/54.0

Specification Tips

- For help in specifying multiple options, refer to page 275.
- When specifying mixed grade fabrics, list price will not exceed the highest grade fabric specified.
- **A grommet option (suffix -R, -L or -B) must be included in the ToDo chair specification in order to accept tablet arms or cup holders.**
- Cup holders and tablet must be ordered separately. To specify, refer to page 280.
- Handle and ottoman options are not available on the ToDo Double.
- Available on RUSH.

To Order, Specify:

- 1) Product number.
- 2) Fabric or
 - a. Fabric for seat and back.
 - b. Fabric for arms.
- 3) Trim color for feet and grommets.
- 4) Wood Veneer finish color for shelf.

Description	Number	Fabric Grade								Leather Grade A	Leather Grade B
		A	B	C	D	E	F	G	H		
One Fabric											
Standard	TQ84-0012 ■	\$3058.65	\$3165.75	\$3346.35	\$3466.05	\$3865.05	\$4423.65	\$4717.65	\$5526.15	\$4933.95	\$5968.65
With Shelf	TQ84-0012-S	3221.40	3328.50	3509.10	3628.80	4027.80	4586.40	4880.40	5688.90	5096.70	6131.40
With Grommet Right	TQ84-0012-R ■	3090.15	3197.25	3377.85	3497.55	3896.55	4455.15	4749.15	5557.65	4965.45	6000.15
With Grommet Left	TQ84-0012-L ■	3090.15	3197.25	3377.85	3497.55	3896.55	4455.15	4749.15	5557.65	4965.45	6000.15
With Grommet Both	TQ84-0012-B ■	3121.65	3228.75	3409.35	3529.05	3928.05	4486.65	4780.65	5589.15	4996.95	6031.65
Two Fabrics											
Standard	TQ84-T012	\$3174.15	\$3281.25	\$3461.85	\$3581.55	\$3980.55	\$4539.15	\$4833.15	\$5641.65	\$5049.45	\$6084.15
With Shelf	TQ84-T012-S	3336.90	3444.00	3624.60	3744.30	4143.30	4701.90	4995.90	5804.40	5212.20	6246.90
With Grommet Right	TQ84-T012-R	3205.65	3312.75	3493.35	3613.05	4012.05	4570.65	4864.65	5673.15	5080.95	6115.65
With Grommet Left	TQ84-T012-L	3205.65	3312.75	3493.35	3613.05	4012.05	4570.65	4864.65	5673.15	5080.95	6115.65
With Grommet Both	TQ84-T012-B	3237.15	3344.25	3524.85	3644.55	4043.55	4602.15	4896.15	5704.65	5112.45	6147.15

The following options require modification of the product number.

Faux Leather	To specify, change the 3rd digit from an 8 to a 3; Example: TQ34-0012
Leather	To specify, change the 3rd digit from an 8 to a 7; Example: TQ74-0012
Nano-TEX	To specify, add -P to the end of the product number; Example: TQ84-0012-P (add \$109.20 list)
DuraBlock	To specify, add -D to the end of the product number; Example: TQ84-0012-D (add \$172.20 list)
	For available fabrics see matrix in the back of the book.

ToDo

Triple, Stationary

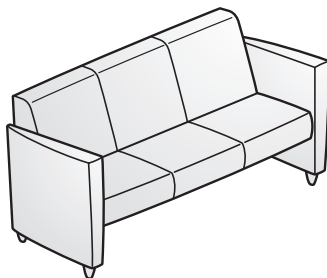

TQ84-0013

Dimensions

Overall:
 H 31 1/4"(794mm)
 W 73"(1854mm)
 D 30 3/4"(781mm)
 Seat:
 H 17 1/2"(445mm)
 W 64 1/2"(1638mm)
 D 20 1/2"(521mm)
 Arm:
 H 24 1/8"(613mm)

Features

- Standard without grommets.
- COM yardage / COL square footage:
 ToDo Triple: 11.0/198.0
 Seat and Back: 9.0/162.0
 Arms Only: 3.0/54.0

To Order, Specify:

- 1) Product number.
- 2) Fabric or
 - a. Fabric for seat and back.
 - b. Fabric for arms.
- 3) Trim color for feet and grommets.
- 4) Wood Veneer finish color for shelf.

Specification Tips

- For help in specifying multiple options, refer to page 275.
- When specifying mixed grade fabrics, list price will not exceed the highest grade fabric specified.
- **A grommet option (suffix -R, -L or -B) must be included in the ToDo chair specification in order to accept tablet arms or cup holders.**
- Cup holders and tablet must be ordered separately. To specify, refer to page 280.
- Handle and ottoman options are not available on the ToDo Triple.
- Available on RUSH.

Description	Number	Fabric Grade								Leather Grade A	Leather Grade B
		A	B	C	D	E	F	G	H		
One Fabric											
Standard	TQ84-0013 ■	\$3768.45	\$3902.85	\$4123.35	\$4276.65	\$4780.65	\$5647.95	\$6049.05	\$7254.45	\$6114.15	\$7406.45
With Shelf	TQ84-0013-S	3931.20	4065.60	4286.10	4439.40	4943.40	5810.70	6211.80	7417.20	6276.90	7569.20
With Grommet Right	TQ84-0013-R ■	3799.95	3934.35	4154.85	4308.15	4812.15	5679.45	6080.55	7285.95	6145.65	7437.95
With Grommet Left	TQ84-0013-L ■	3799.95	3934.35	4154.85	4308.15	4812.15	5679.45	6080.55	7285.95	6145.65	7437.95
With Grommet Both	TQ84-0013-B ■	3831.45	3965.85	4186.35	4339.65	4843.65	5710.95	6112.05	7317.45	6177.15	7469.45
Two Fabrics											
Standard	TQ84-T013	\$3918.60	\$4053.00	\$4273.50	\$4426.80	\$4930.80	\$5798.10	\$6199.20	\$7404.60	\$6264.30	\$7556.60
With Shelf	TQ84-T013-S	4081.35	4215.75	4436.25	4589.55	5093.55	5960.85	6361.95	7567.35	6427.05	7719.35
With Grommet Right	TQ84-T013-R	3950.10	4084.50	4305.00	4458.30	4962.30	5829.60	6230.70	7436.10	6295.80	7588.10
With Grommet Left	TQ84-T013-L	3950.10	4084.50	4305.00	4458.30	4962.30	5829.60	6230.70	7436.10	6295.80	7588.10
With Grommet Both	TQ84-T013-B	3981.60	4116.00	4336.50	4489.80	4993.80	5861.10	6262.20	7467.60	6327.30	7619.60

The following options require modification of the product number.

- Faux Leather To specify, change the 3rd digit from an 8 to a 3; **Example:** TQ34-0013
 - Leather To specify, change the 3rd digit from an 8 to a 7; **Example:** TQ74-0013
 - Nano-Tex To specify, add **-P** to the end of the product number; **Example:** TQ84-0013-P (add \$163.80 list)
 - DuraBlock To specify, add **-D** to the end of the product number; **Example:** TQ84-0013-D (add \$258.30 list)
- For available fabrics see matrix in the back of the book.

ToDo

Accessories

Important! Specify for a ToDo chair with grommets. Product number suffix must include R, L or B.

Wood Tablet with Arm

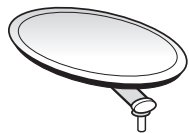

TQ90-0001

Dimensions
 W 11 1/2"(292mm)
 L 19 1/2"(495mm)

■ Available on RUSH.

To Order, Specify:

- 1) Product number.
- 2) Trim color for arm assembly.
- 3) Wood finish color.

Description	Number	Wood Finish Price
Wood Tablet with Arm	TQ90-0001 ■	\$248.85

Cup Holder



TQ90-0003

Dimensions
 W 4 1/2"(114mm)
 L 7"(178mm)

■ Available on RUSH.

To Order, Specify:

- 1) Product number.
- 2) Trim color for arm assembly.
- 3) Wood finish color.

Description	Number	Wood Finish Price
Cup Holder	TQ90-0003 ■	\$144.90

Grommet Cover



TQ90-0006

■ Available on RUSH.

To Order, Specify:

- 1) Product number.
- 2) Trim color.

Description	Number	Painted Price
Grommet Cover	TQ90-0006 ■	\$51.45

▲ Specification Tip:

- A grommet option (suffix -R, -L or -B) must be included in the ToDo chair specification in order to accept tablet arms or cup holders.

Example: TQ85-0011-JR will accept an accessory on the right arm.

ToDo

Ottoman

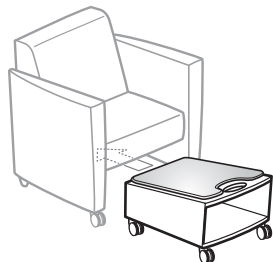

TQ90-0004

Dimensions

W 20"(508mm)
 L 21"(533mm)
 H 11"(279mm)

Specification Tip

- Chairs with a shelf will not accept an ottoman.

To Order, Specify:

- 1) Product number.
- 2) Fabric.
- 3) Trim color.
- 4) Wood Veneer finish color.

Description	Number	Painted	Fabric Grade								Leather Grade A	Leather Grade B	
			A	B	C	D	E	F	G	H			
Non-Upholstered	TQ90-0004	\$638.40											
Upholstered	TQ80-0005		\$762.30	\$795.90	\$831.60	\$866.25	\$898.80	\$927.15	\$958.65	\$991.20	\$1076.25	\$1250.30	

The following options require modification of the product number.

Faux Leather
 Leather

To specify, change the 3rd digit from an 8 to a **3**; **Example:** TQ30-0005
 To specify, change the 3rd digit from an 8 to a **7**; **Example:** TQ70-0005

Cassiss

Lounge Seating

Base/ Frame	Number	Fabric Grade								Leather Grade A	Leather Grade B
		A	B	C	D	E	F	G	H		
Fully Upholstered	SCL1-0000-2H	\$1218.00	\$1285.20	\$1397.55	\$1472.10	\$1611.75	\$1958.25	\$2208.15	\$2471.70	\$2178.75	\$2709.00

Lounge Chair



SCL1-0000-2H

Dimensions

SH: 18 1/2"(470mm)
 H: 33 3/8"(848mm)
 D: 28 1/2"(724mm)
 W: 29"(737mm)
 AH: 26 3/8"(670mm)
 SW: 20"(508mm)
 SD: 21"(533mm)

Features

- Fully upholstered arm panels, seat and back.
- Hardwood frame has solid tab joint construction.
- Single seat cushion with elastic webbing seat box construction.
- COM yardage: 4.25
- COL square footage: 77.0
- Available on RUSH.

To Order, Specify:

- 1) Product number.
- 2) Fabric surface and color.

Fully Upholstered	SCL2-0000-2H	\$1969.80	\$2063.25	\$2184.00	\$2266.95	\$2386.65	\$2779.35	\$3102.75	\$3282.30	\$3223.50	\$3914.80
-------------------	--------------	-----------	-----------	-----------	-----------	-----------	-----------	-----------	-----------	-----------	-----------

Settee

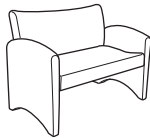

SCL2-0000-2H

Dimensions

SH: 18 1/2"(470mm)
 H: 33 3/8"(848mm)
 D: 28 1/2"(724mm)
 W: 52 1/4"(1327mm)
 AH: 26 3/8"(670mm)
 SW: 43 1/4"(1099mm)
 SD: 21"(533mm)

Features

- Fully upholstered arm panels, seat and back.
- Hardwood frame has solid tab joint construction.
- Single seat cushion with elastic webbing seat box construction.
- COM yardage: 5.25
- COL square footage: 94.5
- Available on RUSH.

To Order, Specify:

- 1) Product number.
- 2) Fabric surface and color.

Fully Upholstered	SCL3-0000-2H	\$2744.70	\$2922.15	\$3041.85	\$3137.40	\$3256.05	\$3675.00	\$4057.20	\$4356.45	\$4247.25	\$5074.70
-------------------	--------------	-----------	-----------	-----------	-----------	-----------	-----------	-----------	-----------	-----------	-----------

Sofa

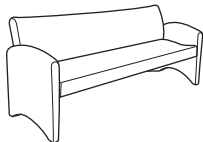

SCL3-0000-2H

Dimensions

SH: 18 1/2"(470mm)
 H: 33 3/8"(848mm)
 D: 28 1/2"(724mm)
 W: 73"(1854mm)
 AH: 26 3/8"(670mm)
 SW: 64"(1626mm)
 SD: 21"(533mm)

Features

- Fully upholstered arm panels, seat and back.
- Hardwood frame has solid tab joint construction.
- Single seat cushion with elastic webbing seat box construction.
- COM yardage: 6.75
- COL square footage: 121.5
- Available on RUSH.

To Order, Specify:

- 1) Product number.
- 2) Fabric surface and color.

Nano-Tex Option:

To specify, add **P** to the end of the product number.

Example: SCL3-0000-2HP
 Lounge Chair - add **\$54.60** list
 Settee - add **\$109.20** list
 Sofa - add **\$163.80** list

DuraBlock Option:

To specify, add **D** to the end of the product number.

Example: SCL3-0000-2HD
 Lounge Chair - add **\$86.10** list
 Settee - add **\$172.20** list
 Sofa - add **\$258.30** list

For available fabrics see matrix in the back of the book.

Tempo Series

Lounge Seating

Description	Number	Fabric Grade								Leather Grade A	Leather Grade B
		A	B	C	D	E	F	G	H		
Without Arms	KL01-7200	\$ 792.75	\$ 888.30	\$ 960.75	\$ 990.15	\$1004.85	\$1092.00	\$1155.00	\$1332.45	\$1390.20	\$1718.75
Black Urethane Arms	KL01-7210	954.45	1050.00	1122.45	1151.85	1166.55	1253.70	1316.70	1494.15	1551.90	1880.45
Wood Arms	KL01-7220	1318.80	1414.35	1486.80	1516.20	1530.90	1618.05	1681.05	1858.50	1916.25	2244.80

Open Frame Lounge — One Seat



KL01-7200



KL01-7210

Dimensions

SH: 17 1/2"(445mm)
 H: 33 3/4"(857mm)
 D: 25 1/2"(648mm)
 W: 23"(584mm)
 - Without arms
 24 1/2"(622mm)
 - With arms
 AH: 26 1/4"(667mm)

Features

- Available without arms, or with black integral skinned urethane arms or maple ply arms.
- Available with fire-retardant construction to comply with California Bulletin #133.
- Shipped assembled.
- Carton weight / size:
 KL01-7200: 37 lbs./13 cubic ft.
 KL01-7210: 44 lbs./13 cubic ft.
 KL01-7220: 39 lbs./13 cubic ft.
- COM yardage: 1.75
- COL square footage: 43.0
- Available on RUSH.

To Order, Specify:

- 1) Product number.
- 2) Fabric surface and color.
- 3) Frame finish color.
- 4) Arm wood finish color, if specified.

CAL 133 Option:

Add **-F** to the product number, and add **\$50.40** list.

Nano-Tex Option:

To specify, add **-P** to the end of the product number and add **\$32.55** list.
Example: KL01-7200-P

DuraBlock Option:

To specify, add **-D** to the end of the product number and add **\$43.05** list.
Example: KL01-7200-D

For available fabrics see matrix in the back of the book.

Without Arms	KL02-7200	\$1625.40	\$1820.70	\$1962.45	\$2021.25	\$2052.75	\$2222.85	\$2350.95	\$2697.45	\$2818.20	\$3475.40
Black Urethane Arms	KL02-7210	1787.10	1982.40	2124.15	2182.95	2214.45	2384.55	2512.65	2859.15	2979.90	3637.10
Wood Arms	KL02-7220	2151.45	2346.75	2488.50	2547.30	2578.80	2748.90	2877.00	3223.50	3344.25	4001.45

Open Frame Lounge — Two Seats

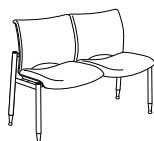

KL02-7200

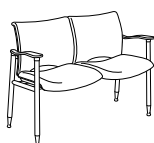

KL02-7210

Dimensions

SH: 17 1/2"(445mm)
 H: 33 3/4"(857mm)
 D: 25 1/2"(648mm)
 W: 43"(1092mm)
 - Without arms
 44 1/2"(1130mm)
 - With arms
 AH: 26 1/4"(667mm)

Features

- Available without arms, or with black integral skinned urethane arms or maple ply arms.
- Available with fire-retardant construction to comply with California Bulletin #133.
- Shipped assembled.
- Carton weight / size:
 KL02-7200: 71 lbs./24 cubic ft.
 KL02-7210: 78 lbs./24 cubic ft.
 KL02-7220: 73 lbs./24 cubic ft.
- COM yardage: 3.5
- COL square footage: 86.0
- Available on RUSH.

To Order, Specify:

- 1) Product number.
- 2) Fabric surface and color.
- 3) Frame finish color.
- 4) Arm wood finish color, if specified.

CAL 133 Option:

Add **-F** to the product number, and add **\$100.80** list.

Nano-Tex Option:

To specify, add **-P** to the end of the product number and add **\$65.10** list.
Example: KL02-7200-P

DuraBlock Option:

To specify, add **-D** to the end of the product number and add **\$86.10** list.
Example: KL02-7200-D

For available fabrics see matrix in the back of the book.

Tempo Series

Lounge Seating and Tables

Description	Number	Fabric Grade		C	D	E	F	G	H	Leather Grade A	Leather Grade B
		A	B								
One Seat	KLU1-7220	\$1932.00	\$2168.25	\$2341.50	\$2415.00	\$2449.65	\$2743.65	\$2917.95	\$3397.80	\$4413.15	\$ 5781.00
Two Seats	KLU2-7220	2907.45	3241.35	3486.00	3587.85	3638.25	4230.45	4515.00	5297.25	5865.30	7497.00
Three Seats	KLU3-7220	3807.30	4237.80	4554.90	4684.05	4751.25	5471.55	5829.60	6814.50	7801.50	10004.00

Fully Upholstered



KLU1-7220

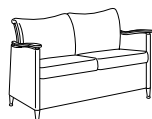

KLU2-7220

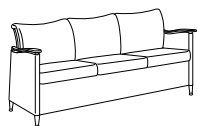

KLU3-7220

Dimensions

SH: 17 1/2"(445mm)
 H: 33 3/4"(857mm)
 D: 29 1/2"(749mm)
 W: 30 1/4"(768mm)
 - One seat
 52 1/4"(1327mm)
 - Two seats
 74 1/4"(1886mm)
 - Three seats
 AH: 26 1/2"(673mm)
 SW: 21 3/4"(552mm)
 - One seat
 43 3/4"(1111mm)
 - Two seats
 65 3/4"(1670mm)
 - Three seats

Features

- Fully-upholstered arms with maple arm rests.
- Available with fire-retardant construction to comply with California Bulletin #133.
- Shipped assembled.
- Carton weight / size:
 KLU1-7220: 68 lbs./15 cubic ft.
 KLU2-7220: 98 lbs./28 cubic ft.
 KLU3-7220: 113 lbs./41 cubic ft.
- COM yardage: 4.75 (one seat), 7.75 (two seats), 9.75 (three seats)
- COL square footage: 117.0 (one seat), 191.0 (two seats), 240.0 (three seats)

To Order, Specify:

- Product number.
- Fabric surface and color.
- Arm wood finish color.

CAL 133 Option:

Add **-F** to the product number, and add the following upcharge:

- \$142.80 list for one seat lounge
- \$225.75 list for two seat lounge
- \$330.75 list for three seat lounge

Nano-Tex Option:

To specify, add **-P** to the end of the product number and add:

- \$54.60 list for one seat lounge
- \$109.20 list for two seat lounge
- \$163.80 list for three seat lounge

Example: KLU1-7220-P

DuraBlock Option:

To specify, add **-D** to the end of the product number and add:

- \$86.10 list for one seat lounge
- \$172.20 list for two seat lounge
- \$258.30 list for three seat lounge

Example: KLU1-7220-D

For available fabrics see matrix in the back of the book.

End Table



KLT8-1818

Height	Depth	Width	Number	Laminate		Wood
				A	B	Surface
23"(584mm)	18"(457mm)	18"(457mm)	KLT8-1818	\$ 957.60	\$1016.40	\$1105.65
	22"(559mm)	22"(559mm)	KLT8-2222	1015.35	1074.15	1163.40

Features

- Available in laminate top with black PVC edge or veneer top with color-matched wood edge.
- Shipped assembled.
- Carton weight / size:
 KLT8-1818: 13 lbs./5 cubic ft.
 KLT8-2222: 18 lbs./8 cubic ft.

To Order, Specify:

- Product number.
- Laminate color or maple wood finish.
- Leg/frame finish color.

Coffee Table

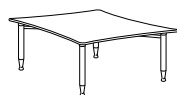

KLT1-3030

15"(381mm)	30"(762mm)	30"(762mm)	KLT1-3030	\$1074.15	\$1173.90	\$1222.20
	36"(914mm)	36"(914mm)	KLT1-3636	1128.75	1228.50	1276.80

Features

- Available in laminate top with black PVC edge or veneer top with color-matched wood edge.
- Shipped assembled.
- Carton weight / size:
 KLT1-3030: 30 lbs./11 cubic ft.
 KLT1-3636: 40 lbs./13 cubic ft.

To Order, Specify:

- Product number.
- Laminate color or maple wood finish.
- Leg/frame finish color.

Tempo Series

Preconfigured Seating

Description	Number	Fabric Grade		C	D	E	F	G	H	Leather Grade A	Leather Grade B
		A	B								
Urethane Arms	KLP2-7210	\$2055.90	\$2241.75	\$2375.10	\$2430.75	\$2461.20	\$2653.35	\$2781.45	\$3135.30	\$3251.85	\$3911.90
Wood Arms	KLP2-7220	2578.80	2764.65	2898.00	2953.65	2984.10	3176.25	3304.35	3658.20	3774.75	4434.80

Seat, Seat



KLP2-7210

Dimensions

SH: 17 1/2"(445mm)
 H: 33 3/4"(857mm)
 D: 25 1/2"(648mm)
 W: 46"(1168mm)
 AH: 26 1/4"(667mm)
 SW: 19 1/2"(495mm)

Features

- Configuration includes two (2) seats and three (3) arms.
- Arms are available in a black integral skinned urethane or maple ply.
- Available with fire-retardant construction to comply with California Bulletin #133.
- Some assembly required.
- Carton weight / size:
 KLP2-7210: 80 lbs./24 cubic ft.
 KLP2-7220: 83 lbs./24 cubic ft.
- COM yardage: 3.5
- COL square footage: 86.0

To Order, Specify:

- 1) Product number.
- 2) Fabric surface and color.
- 3) Frame finish color.
- 4) Arm wood finish color, if specified.

CAL 133 Option:

Add **-F** to the product number, and add **\$100.40** list.

NOTE:

This configuration can be field reconfigured using modular components, see page 289.

Urethane Arms	KLP3-7210	\$2947.35	\$3226.13	\$3426.15	\$3509.63	\$3555.30	\$3843.53	\$4035.68	\$4566.45	\$4741.28	\$5731.35
Wood Arms	KLP3-7220	3639.30	3918.08	4118.10	4201.58	4247.25	4535.48	4727.63	5258.40	5433.23	6423.30

Seat, Seat, Seat

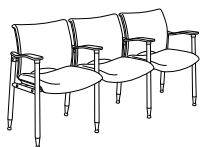

KLP3-7210

Dimensions

SH: 17 1/2"(445mm)
 H: 33 3/4"(857mm)
 D: 25 1/2"(648mm)
 W: 67 5/8"(1718mm)
 AH: 26 1/4"(667mm)
 SW: 19 1/2"(495mm)

Features

- Configuration includes three (3) seats and four (4) arms.
- Arms are available in a black integral skinned urethane or maple ply.
- Available with fire-retardant construction to comply with California Bulletin #133.
- Some assembly required.
- Carton weight / size:
 KLP3-7210: 102 lbs./34 cubic ft.
 KLP3-7220: 105 lbs./34 cubic ft.
- COM yardage: 5.25
- COL square footage: 129.0

To Order, Specify:

- 1) Product number.
- 2) Fabric surface and color.
- 3) Frame finish color.
- 4) Arm wood finish color, if specified.

CAL 133 Option:

Add **-F** to the product number, and add **\$151.20** list.

NOTE:

This configuration can be field reconfigured using modular components, see page 289.

Urethane Arms/ Laminate Top	KLPJ-7210	\$2979.90	\$3165.75	\$3299.10	\$3354.75	\$3385.20	\$3577.35	\$3705.45	\$4059.30	\$4175.85	\$4835.90
Wood Arms/ Wood Top	KLPJ-7220	3812.55	3998.40	4131.75	4187.40	4217.85	4410.00	4538.10	4891.95	5008.50	5668.55

Seat, Table, Seat



KLPJ-7210

Dimensions

SH: 17 1/2"(445mm)
 H: 33 3/4"(857mm)
 D: 25 1/2"(648mm)
 W: 67 5/8"(1718mm)
 AH: 26 1/4"(667mm)
 SW: 19 1/2"(495mm)

Features

- Configuration includes two (2) seats, four (4) arms and an in-line table.
- Arms are available in a black integral skinned urethane or maple ply.
- Table is available in laminate top with black PVC edge or veneer top with color-matched wood edge.
- Available with fire-retardant construction to comply with California Bulletin #133.
- Some assembly required.
- Carton weight / size:
 KLPJ-7210: 95 lbs./34 cubic ft.
 KLPJ-7220: 90 lbs./34 cubic ft.
- COM yardage: 3.5
- COL square footage: 86.0

To Order, Specify:

- 1) Product number.
- 2) Fabric surface and color.
- 3) Frame finish color.
- 4) Table laminate color or arm/table wood finish color.

CAL 133 Option:

Add **-F** to the product number, and add **\$100.40** list.

Nano-TEX Option:

To specify, add **-P** to the end of the product number and add:
\$65.10 list for two seat
\$97.65 list for three seat
Example: KLP2-7210-P

DuraBlock Option:

To specify, add **-D** to the end of the product number and add:
\$86.10 list for two seat
\$129.15 list for three seat
Example: KLP2-7210-D

For available fabrics see matrix in the back of the book.

Tempo Series

Preconfigured Seating

Description	Number	Fabric Grade		C	D	E	F	G	H	Leather Grade A	Leather Grade B
		A	B								
Urethane Arms/ Laminate Top	KLPK-7210	\$2826.60	\$3012.45	\$3145.80	\$3201.45	\$3231.90	\$3424.05	\$3552.15	\$3906.00	\$4022.55	\$4682.60
Wood Arms/ Wood Top	KLPK-7220	3486.00	3671.85	3805.20	3860.85	3891.30	4083.45	4211.55	4565.40	4681.95	5342.00

Table, Seat, Seat



KLPK-7210

Dimensions

SH: 17 1/2"(445mm)
H: 33 3/4"(857mm)
D: 25 1/2"(648mm)
W: 68"(1727mm)
AH: 26 1/4"(667mm)
SW: 19 1/2"(495mm)

Features

- Configuration includes two (2) seats, three arms and left end table.
- Arms are available in a black integral skinned urethane or maple ply.
- Table is available in laminate top with black PVC edge or veneer top with color-matched wood edge.
- Available with fire-retardant construction to comply with California Bulletin #133.
- Some assembly required.
- Carton weight / size:
KLPK-7210: 95 lbs./34 cubic ft.
KLPK-7220: 90 lbs./34 cubic ft.
- COM yardage: 3.5
- COL square footage: 86.0

To Order, Specify:

- 1) Product number.
- 2) Fabric surface and color.
- 3) Frame finish color.
- 4) Table laminate color *or* arm/table wood finish color.

CAL 133 Option:

Add **-F** to the product number, and add **\$100.40** list.

NOTE:

This configuration can be field reconfigured using modular components, see page 289.

Urethane Arms/ Laminate Top	KLPL-7210	\$2826.60	\$3012.45	\$3145.80	\$3201.45	\$3231.90	\$3424.05	\$3552.15	\$3906.00	\$4022.55	\$4682.60
Wood Arms/ Wood Top	KLPL-7220	3486.00	3671.85	3805.20	3860.85	3891.30	4083.45	4211.55	4565.40	4681.95	5342.00

Seat, Seat, Table



KLPL-7210

Dimensions

SH: 17 1/2"(445mm)
H: 33 3/4"(857mm)
D: 25 1/2"(648mm)
W: 68"(1727mm)
AH: 26 1/4"(667mm)
SW: 19 1/2"(495mm)

Features

- Configuration includes two (2) seats, three (3) arms and right end table.
- Arms are available in a black integral skinned urethane or maple ply.
- Table is available in laminate top with black PVC edge or veneer top with color-matched wood edge.
- Available with fire-retardant construction to comply with California Bulletin #133.
- Some assembly required.
- Carton weight / size:
KLPL-7210: 95 lbs./34 cubic ft.
KLPL-7220: 90 lbs./34 cubic ft.
- COM yardage: 3.5
- COL square footage: 86.0

To Order, Specify:

- 1) Product number.
- 2) Fabric surface and color.
- 3) Frame finish color.
- 4) Table laminate color *or* arm/table wood finish color.

CAL 133 Option:

Add **-F** to the product number, and add **\$100.40** list.

Nano-TEX Option:

To specify, add **-P** to the end of the product number and add **\$65.10** list.
Example: KLPK-7210-P

DuraBlock Option:

To specify, add **-D** to the end of the product number and add **\$86.10** list.
Example: KLPK-7210-D

For available fabrics see matrix in the back of the book.

Tempo Series

Preconfigured Seating

Description	Number	Fabric Grade		C	D	E	F	G	H	Leather Grade A	Leather Grade B
		A	B								
Urethane Arms	KLP4-7210	\$3839.85	\$4211.55	\$4478.25	\$4589.55	\$4650.45	\$5034.75	\$5290.95	\$5998.65	\$6231.75	\$7551.85
Wood Arms	KLP4-7220	4705.05	5076.75	5343.45	5454.75	5515.65	5899.95	6156.15	6863.85	7096.95	8417.05

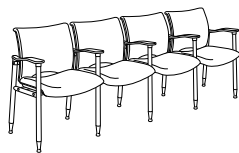
Seat, Seat,
Seat, Seat

KLP4-7210

NOTE:

This configuration can be field reconfigured using modular components, see page 289.

Dimensions

SH: 17 1/2"(445mm)
H: 33 3/4"(857mm)
D: 25 1/2"(648mm)
W: 89"(2261mm)
AH: 26 1/4"(667mm)
SW: 19 1/2"(495mm)

Features

- Configuration includes four (4) seats and five (5) arms.
- Arms are available in a black integral skinned urethane or maple ply.
- Available with fire-retardant construction to comply with California Bulletin #133.
- Some assembly required.
- Carton weight / size:
KLP4-7210: 127 lbs./45 cubic ft.
KLP4-7220: 124 lbs./45 cubic ft.
- COM yardage: 7.0
- COL square footage: 173.0

To Order, Specify:

- 1) Product number.
- 2) Fabric surface and color.
- 3) Frame finish color.
- 4) Arm wood finish color, if specified.

CAL 133 Option:

Add **-F** to the product number, and add **\$201.60** list.

Urethane Arms/ Laminate Top	KLPM-7210	\$3871.35	\$4150.13	\$4350.15	\$4433.63	\$4479.30	\$4767.53	\$4959.68	\$5490.45	\$5665.28	\$6655.35
Wood Arms/ Wood Top	KLPM-7220	4874.10	5152.88	5352.90	5436.38	5482.05	5770.28	5962.43	6493.20	6668.03	7658.10

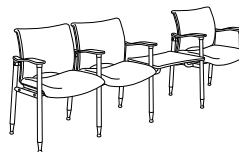
Seat, Table,
Seat, Seat

KLPM-7210

NOTE:

This configuration can be field reconfigured using modular components, see page 289.

Dimensions

SH: 17 1/2"(445mm)
H: 33 3/4"(857mm)
D: 25 1/2"(648mm)
W: 89"(2261mm)
AH: 26 1/4"(667mm)
SW: 19 1/2"(495mm)

Features

- Configuration includes three (3) seats, five (5) arms and an in-line table.
- Arms are available in a black integral skinned urethane or maple ply.
- Table is available in laminate top with black PVC edge or veneer top with color-matched wood edge.
- Available with fire-retardant construction to comply with California Bulletin #133.
- Some assembly required.
- Carton weight / size:
KLPM-7210: 121 lbs./45 cubic ft.
KLPM-7220: 114 lbs./45 cubic ft.
- COM yardage: 5.25
- COL square footage: 129.0

To Order, Specify:

- 1) Product number.
- 2) Fabric surface and color.
- 3) Frame finish color.
- 4) Table laminate color *or* arm/table wood finish color.

CAL 133 Option:

Add **-F** to the product number, and add **\$151.20** list.

Urethane Arms/ Laminate Top	KLPN-7210	\$3871.35	\$4150.13	\$4350.15	\$4433.63	\$4479.30	\$4767.53	\$4959.68	\$5490.45	\$5665.28	\$6655.35
Wood Arms/ Wood Top	KLPN-7220	4874.10	5152.88	5352.90	5436.38	5482.05	5770.28	5962.43	6493.20	6668.03	7658.10

Seat, Seat,
Table, Seat

KLPN-7210

NOTE:

This configuration can be field reconfigured using modular components, see page 289.

Dimensions

SH: 17 1/2"(445mm)
H: 33 3/4"(857mm)
D: 25 1/2"(648mm)
W: 89"(2261mm)
AH: 26 1/4"(667mm)
SW: 19 1/2"(495mm)

Features

- Configuration includes three (3) seats, five (5) arms and an in-line table.
- Arms are available in a black integral skinned urethane or maple ply.
- Table is available in laminate top with black PVC edge or veneer top with color-matched wood edge.
- Available with fire-retardant construction to comply with California Bulletin #133.
- Some assembly required.
- Carton weight / size:
KLPN-7210: 121 lbs./45 cubic ft.
KLPN-7220: 114 lbs./45 cubic ft.
- COM yardage: 5.25
- COL square footage: 129.0

To Order, Specify:

- 1) Product number.
- 2) Fabric surface and color.
- 3) Frame finish color.
- 4) Table laminate color *or* arm/table wood finish color.

CAL 133 Option:

Add **-F** to the product number, and add **\$151.20** list.

Nano-TEX Option:

To specify, add **-P** to the end of the product number and add:

\$97.65 list for three seat

\$130.20 list for four seat

Example: KLP4-7210-P

DuraBlock Option:

To specify, add **-D** to the end of the product number and add:

\$129.15 list for three seat

\$172.20 list for four seat

Example: KLP4-7210-D

For available fabrics see matrix in the back of the book.

Tempo Series

Preconfigured Seating

Description	Number	Fabric Grade		C	D	E	F	G	H	Leather Grade A	Leather Grade B
		A	B								
Urethane Arms/ Laminate Top	KLPP-7210	\$3719.10	\$3997.88	\$4197.90	\$4281.38	\$4327.05	\$4615.28	\$4807.43	\$5338.20	\$5513.03	\$6503.10
Wood Arms/ Wood Top	KLPP-7220	4550.70	4829.48	5029.50	5112.98	5158.65	5446.88	5639.03	6169.80	6344.63	7334.70

Table, Seat, Seat, Seat



KLPP-7210

Dimensions

SH: 17 1/2"(445mm)
H: 33 3/4"(857mm)
D: 25 1/2"(648mm)
W: 89 1/2"(2273mm)
AH: 26 1/4"(667mm)
SW: 19 1/2"(495mm)

Features

- Configuration includes three (3) seats, four (4) arms and left end table.
- Arms are available in a black integral skinned urethane or maple ply.
- Table is available in laminate top with black PVC edge or veneer top with color-matched wood edge.
- Available with fire-retardant construction to comply with California Bulletin #133.
- Some assembly required.
- Carton weight / size:
KLPP-7210: 121 lbs./45 cubic ft.
KLPP-7220: 114 lbs./45 cubic ft.
- COM yardage: 5.25
- COL square footage: 129

To Order, Specify:

- 1) Product number.
- 2) Fabric surface and color.
- 3) Frame finish color.
- 4) Table laminate color *or* arm/table wood finish color.

CAL 133 Option:

Add **-F** to the product number, and add **\$151.20** list.

NOTE:

This configuration can be field reconfigured using modular components, see page 289.

Urethane Arms/ Laminate Top	KLPQ-7210	\$3719.10	\$3997.88	\$4197.90	\$4281.38	\$4327.05	\$4615.28	\$4807.43	\$5338.20	\$5513.03	\$6503.10
Wood Arms/ Wood Top	KLPQ-7220	4550.70	4829.48	5029.50	5112.98	5158.65	5446.88	5639.03	6169.80	6344.63	7334.70

Seat, Seat, Seat, Table

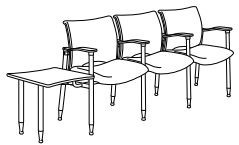

KLPQ-7210

Dimensions

SH: 17 1/2"(445mm)
H: 33 3/4"(857mm)
D: 25 1/2"(648mm)
W: 89 1/2"(2273mm)
AH: 26 1/4"(667mm)
SW: 19 1/2"(495mm)

Features

- Configuration includes three (3) seats, four (4) arms and right end table.
- Arms are available in a black integral skinned urethane or maple ply.
- Table is available in laminate top with black PVC edge or veneer top with color-matched wood edge.
- Available with fire-retardant construction to comply with California Bulletin #133.
- Some assembly required.
- Carton weight / size:
KLPQ-7210: 121 lbs./45 cubic ft.
KLPQ-7220: 114 lbs./45 cubic ft.
- COM yardage: 5.25
- COL square footage: 129

To Order, Specify:

- 1) Product number.
- 2) Fabric surface and color.
- 3) Frame finish color.
- 4) Table laminate color *or* arm/table wood finish color.

CAL 133 Option:

Add **-F** to the product number, and add **\$151.20** list.

Nano-Tex Option:

To specify, add **-P** to the end of the product number and add **\$97.65** list.
Example: KLPP-7210-**P**

DuraBlock Option:

To specify, add **-D** to the end of the product number and add **\$129.15** list.
Example: KLPP-7210-**D**

For available fabrics see matrix in the back of the book.

Tempo Series

Modular Seating Specifications

Specification and Ordering Information

Tempo Series modular seating components are divided into two groups; *starter components* and *add-on components*.

- Starter Components include seats and end tables. Starter seats have four (4) legs and provide a starting point for a configuration and support one end of an in-line table, corner table or end table.
- Add-on Components include seats and in-line tables. Add-on seats have two (2) legs on the right side (as you sit in the seat) and connect to starter seats or other add-on components.

Specification Tip: *Modular components can be added to existing preconfigured seating units to create unique configurations. See pages 291-295.*

- 1) Develop a layout drawing (plan view) of each seating configuration. Label each component with the corresponding product number, see example below.

NOTE: Your labeled drawing is not required with the purchase order; however, it is essential for on-site assembly of the components.

- 2) Working left-to-right **as you sit in the seating configuration**, specify a starter seat or table.
- 3) Continue your configuration with add-on seats, in-line tables, corner tables and starter seats for support of tables. Possible options include arm and armless combinations.
- 4) Complete your configuration with a starter seat, right end table or add-on seat.
- 5) Specify the appropriate fabric surface/color code, frame finish color code, table top finish code, and wood arm finish.

Configuration Example

The following example illustrates a modular seating configuration:

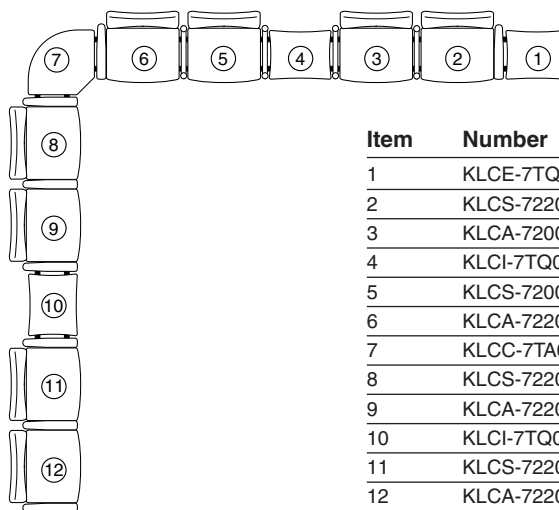

Item	Number	Description
1	KLCE-7TQ0-L	Starter end table, left-hand
2	KLCS-7220-L	Starter seat with left arm
3	KLCA-7200	Add-on seat without arm
4	KLCL-7TQ0	Add-on in-line table
5	KLCS-7200	Starter seat without arms
6	KLCA-7220-R	Add-on seat with right arm
7	KLCC-7TA0	Add-on corner table
8	KLCS-7220-B	Starter seat with left and right arms
9	KLCA-7220-R	Add-on seat with right arm
10	KLCL-7TQ0	Add-on in-line table
11	KLCS-7220-B	Starter seat with left and right arms
12	KLCA-7220-R	Add-on seat with right arm

Specification Tip: *Use a combination of preconfigured and modular components to reduce the number of specified products.*

Specification Tips

The following additional tips should be considered when planning and specifying Tempo modular seating:

- There is no restriction on the number of seats and tables connected in a row.
- Place an in-line table between two seats. Two (2) in-line tables cannot be connected side-by-side.
- Alternating arm and armless seats can be specified within a configuration. Two starter seats with arms cannot be connected.
- All seats must face the same direction within a configuration.
- Corner tables require the support of a seat on either end. It is recommended that square corner tables (*KLCC-7TQ0*) be placed in the corner of a room or a protected area to reduce or prevent contact with the 90° table edge.
- Tempo modular seating components are manufactured and shipped in one-seat units to be field attached.
NOTE: Tempo preconfigured seating requires some assembly.
- Detailed assembly instructions are included with individual units.
- Final product configuration drawings are the responsibility of the customer/specifier, but are not required for placement of the order.
- Tempo modular components may be knocked down for reconfiguration or repair in the field.

Tempo Series

Modular Seating Dimensions

Calculating Modular Seating Dimensions

Use the following dimensions to determine the footprint of a Tempo Series modular seating configuration.

- 1) All arm and armless seating models are 25 1/2"(648mm) deep. For seat widths refer to the individual starter and add-on seats.

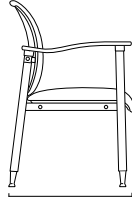

25 1/2" (648mm)

- 2) For every in-line table, add 20"(508mm) to the width of the seating run.

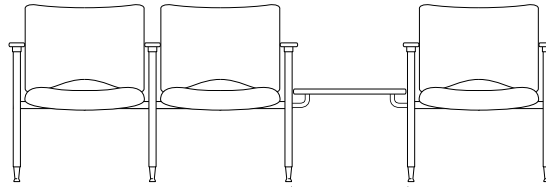

20" (508mm)

- 3) For every end table, add 23 1/2"(597mm) to the width of the seating run.

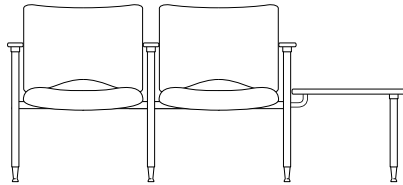

23 1/2" (597mm)

- 4) For every corner table, add 35"(889mm) to the width of the seating run in both directions.

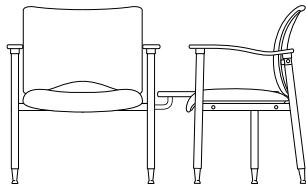

35" (889mm)

Tempo Series

Modular Starter Seating

Description	Number	Fabric Grade		C	D	E	F	G	H	Leather Grade A	Leather Grade B
		A	B								
Urethane Arm	KLCS-7210-R	\$1010.10	\$1105.65	\$1178.10	\$1207.50	\$1222.20	\$1309.35	\$1372.35	\$1549.80	\$1607.55	\$1936.10
Wood Arm	KLCS-7220-R	1191.75	1287.30	1359.75	1389.15	1403.85	1491.00	1554.00	1731.45	1789.20	2117.75

Starter Seat with Right Arm



KLCS-7210-R

Dimensions

SH: 17 1/2"(445mm)
H: 33 3/4"(857mm)
D: 25 1/2"(648mm)
W: 24 1/8"(616mm)
AH: 26 1/4"(667mm)
SW: 19 1/2"(495mm)

Features

- Includes a seat, back, right arm (from seated position) and support framework.
- Accepts add-on components (tables, arm and armless seats).
- Arm is available in a black integral skinned urethane or maple ply.
- Available with fire-retardant construction to comply with California Bulletin #133.
- Shipped assembled as a one-seat unit.
- Carton weight / size:
KLCS-7210-R: 43 lbs./13 cubic ft.
KLCS-7220-R: 38 lbs./13 cubic ft.
- COM yardage: 1.75
- COL square footage: 43.0

To Order, Specify:

- 1) Product number.
- 2) Fabric surface and color.
- 3) Frame finish color.
- 4) Wood finish color, if specified.

CAL 133 Option:

Add **F** to the end of the product number, and add **\$50.40** list.

Urethane Arm	KLCS-7210-L	\$1010.10	\$1105.65	\$1178.10	\$1207.50	\$1222.20	\$1309.35	\$1372.35	\$1549.80	\$1607.55	\$1936.10
Wood Arm	KLCS-7220-L	1191.75	1287.30	1359.75	1389.15	1403.85	1491.00	1554.00	1731.45	1789.20	2117.75

Starter Seat with Left Arm



KLCS-7210-L

Dimensions

SH: 17 1/2"(445mm)
H: 33 3/4"(857mm)
D: 25 1/2"(648mm)
W: 24 1/8"(616mm)
AH: 26 1/4"(667mm)
SW: 19 1/2"(495mm)

Features

- Includes a seat, back, left arm (from seated position) and support framework.
- Accepts add-on components (tables, arm and armless seats).
- Arm is available in a black integral skinned urethane or maple ply.
- Available with fire-retardant construction to comply with California Bulletin #133.
- Shipped assembled as a one-seat unit.
- Carton weight / size:
KLCS-7210-L: 43 lbs./13 cubic ft.
KLCS-7220-L: 38 lbs./13 cubic ft.
- COM yardage: 1.75
- COL square footage: 43.0

To Order, Specify:

- 1) Product number.
- 2) Fabric surface and color.
- 3) Frame finish color.
- 4) Wood finish color, if specified.

CAL 133 Option:

Add **F** to the end of the product number, and add **\$50.40** list.

Urethane Arms	KLCS-7210-B	\$1219.05	\$1314.60	\$1387.05	\$1416.45	\$1431.15	\$1518.30	\$1581.30	\$1758.75	\$1816.50	\$2145.05
Wood Arms	KLCS-7220-B	1579.20	1674.75	1747.20	1776.60	1791.30	1878.45	1941.45	2118.90	2176.65	2505.20

Starter Seat with Right and Left Arms



KLCS-7210-B

Dimensions

SH: 17 1/2"(445mm)
H: 33 3/4"(857mm)
D: 25 1/2"(648mm)
W: 24 3/4"(629mm)
AH: 26 1/4"(667mm)
SW: 19 1/2"(495mm)

Features

- Includes a seat, back, left and right arms and support framework.
- Accepts add-on components (tables, arm and armless seats).
- Arms are available in a black integral skinned urethane or maple ply.
- Available with fire-retardant construction to comply with California Bulletin #133.
- Shipped assembled as a one-seat unit.
- Carton weight / size:
KLCS-7210-B: 46 lbs./13 cubic ft.
KLCS-7220-B: 41 lbs./13 cubic ft.
- COM yardage: 1.75
- COL square footage: 43.0

To Order, Specify:

- 1) Product number.
- 2) Fabric surface and color.
- 3) Frame finish color.
- 4) Wood finish color, if specified.

CAL 133 Option:

Add **F** to the end of the product number, and add **\$50.40** list.

Nano-Tex Option:

To specify, add **P** to the end of the product number and add **\$32.55** list.
Example: KLCS-7210-RP

DuraBlock Option:

To specify, add **D** to the end of the product number and add **\$43.05** list.
Example: KLCS-7210-RD

For available fabrics see matrix in the back of the book.

Tempo Series

Modular Starter Seating

Description	Number	Fabric Grade		C	D	E	F	G	H	Leather Grade A	Leather Grade B
		A	B								
Without Arms	KLCS-7200-N	\$930.30	\$1025.85	\$1098.30	\$1127.70	\$1142.40	\$1229.55	\$1292.55	\$1470.00	\$1527.75	\$1856.30

Starter Seat without Arms

KLCS-7200-N

Dimensions

SH: 17 1/2"(445mm)

H: 33 3/4"(857mm)

D: 25 1/2"(648mm)

W: 23 1/4"(590mm)

SW: 19 1/2"(495mm)

Features

- Includes seat, back and support framework.
- Accepts add-on components (tables, arm and armless seats).
- Available with fire-retardant construction to comply with California Bulletin #133.
- Shipped assembled as a one-seat unit.
- Carton weight/size: 39 lbs./13 cubic ft.
- COM yardage: 1.75
- COL square footage: 43.0

To Order, Specify:

- 1) Product number.
- 2) Fabric surface and color.
- 3) Frame finish color.

CAL 133 Option:

Add **F** to the end of the product number, and add **\$50.40** list.

Nano-Text Option:

To specify, add **P** to the end of the product number and add **\$32.55** list.

Example: KLCS-7200-NP

DuraBlock Option:

To specify, add **D** to the end of the product number and add **\$43.05** list.

Example: KLCS-7200-ND

For available fabrics see matrix in the back of the book.

Tempo Series

Modular Add-on Seating

Description	Number	Fabric Grade								Leather Grade A	Leather Grade B
		A	B	C	D	E	F	G	H		
Urethane Arm	KLCA-7210-R	\$ 937.65	\$1033.20	\$1105.65	\$1135.05	\$1149.75	\$1236.90	\$1299.90	\$1477.35	\$1535.10	\$1863.65
Wood Arm	KLCA-7220-R	1120.35	1215.90	1288.35	1317.75	1332.45	1419.60	1482.60	1660.05	1717.80	2046.35

Add-on Seat with Right Arm



KLCA-7210-R

Dimensions

SH: 17 1/2"(445mm)
 H: 33 3/4"(857mm)
 D: 25 1/2"(648mm)
 W: 22 7/8"(581mm)
 AH: 26 1/4"(667mm)
 SW: 19 1/2"(495mm)

Features

- Includes a seat, back, right arm (from seated position) and support framework.
- Requires the support of add-on or starter components.
- Arm is available in a black integral skinned urethane or maple ply.
- Available with fire-retardant construction to comply with California Bulletin #133.
- Shipped assembled as a one-seat unit.
- Carton weight / size:
 - KLCA-7210-R: 34 lbs./13 cubic ft.
 - KLCA-7220-R: 31 lbs./13 cubic ft.
- COM yardage: 1.75
- COL square footage: 43.0

To Order, Specify:

- 1) Product number.
- 2) Fabric surface and color.
- 3) Frame finish color.
- 4) Wood finish color, if specified.

CAL 133 Option:

Add **F** to the end of the product number, and add **\$50.40** list.

Without Arm	KLCA-7200-N	\$784.35	\$879.90	\$952.35	\$981.75	\$996.45	\$1083.60	\$1146.60	\$1324.05	\$1381.80	\$1710.35
-------------	-------------	----------	----------	----------	----------	----------	-----------	-----------	-----------	-----------	-----------

Add-on Seat without Arm



KLCA-7200-N

Dimensions

SH: 17 1/2"(445mm)
 H: 33 3/4"(857mm)
 D: 25 1/2"(648mm)
 W: 22 1/4"(565mm)
 SW: 19 1/2"(495mm)

Features

- Includes a seat, back, and support framework.
- Requires the support of add-on or starter components.
- Available with fire-retardant construction to comply with California Bulletin #133.
- Shipped assembled as a one-seat unit.
- Carton weight/size: 29 lbs./13 cubic ft.
- COM yardage: 1.75
- COL square footage: 43.0

To Order, Specify:

- 1) Product number.
- 2) Fabric surface and color.
- 3) Frame finish color.

CAL 133 Option:

Add **F** to the end of the product number, and add **\$50.40** list.

Nano-Tex Option:

To specify, add **P** to the end of the product number and add **\$32.55** list.
Example: KLCA-7210-NP

DuraBlock Option:

To specify, add **-D** to the end of the product number and add **\$43.05** list.
Example: KLCA-7210-ND

For available fabrics see matrix in the back of the book.

Tempo Series

Modular Starter Tables

		Description	Number	Laminate Surface	Veneer Surface
 KLCE-7TQ0-R	Right End Table Dimensions H: 18"(457mm) D: 21 1/4"(540mm) - Table top W: 22 5/8"(575mm) - Table top	Right-hand	KLCE-7TQ0-R	\$809.55	\$952.35
	Features <ul style="list-style-type: none"> • Includes table top, one (1) leg and support framework. • Available in laminate top with black PVC edge or veneer top with color-matched wood edge. • Requires the support of an add-on or starter seat. • Table top and framework shipped assembled. Legs require field assembly. • Carton weight/size: 14 lbs./2.5 cubic ft. 	To Order, Specify: <ol style="list-style-type: none"> 1) Product number. 2) Laminate color or wood finish. 3) Frame finish color. 			

NOTE:

This table can be added to a preconfigured seating unit.

 KLCE-7TQ0-L	Left End Table Dimensions H: 18"(457mm) D: 21 1/4"(540mm) - Table top W: 22 5/8"(575mm) - Table top	Left-hand	KLCE-7TQ0-L	\$809.55	\$952.35
	Features <ul style="list-style-type: none"> • Includes table top, one (1) leg and support framework. • Available in laminate top with black PVC edge or veneer top with color-matched wood edge. • Requires the support of an add-on or starter seat. • Table top and framework shipped assembled. Legs require field assembly. • Carton weight/size: 14 lbs./2.5 cubic ft. 	To Order, Specify: <ol style="list-style-type: none"> 1) Product number. 2) Laminate color or wood finish. 3) Frame finish color. 			

NOTE:

This table can be added to a preconfigured seating unit.

Tempo Series

Modular Add-on Tables

		Description	Number	Laminate Surface	Veneer Surface
	In-Line Table Dimensions H: 18"(457mm) D: 21 1/4"(540mm) - Table top W: 19 3/4"(502mm) - Table top	In-Line Table	KLCC-7TQ0	\$682.50	\$825.30
		Features <ul style="list-style-type: none"> • Includes table top and support framework. • Available in laminate top with black PVC edge or veneer top with color-matched wood edge. • Requires the support of two (2) starter seats or one (1) starter seat and one (1) add-on seat. • Shipped assembled. • Carton weight/size: 14 lbs./2.5 cubic ft. 		To Order, Specify: <ol style="list-style-type: none"> 1) Product number. 2) Laminate color or wood finish. 3) Frame finish color. 	

KLCC-7TQ0

NOTE:

This table can be added between two preconfigured seating units.

		Description	Number	Laminate Surface	Veneer Surface
	Square Corner Table Dimensions H: 18"(457mm) D: 32"(813mm) - Table top W: 32"(813mm) - Table top	Corner Table	KLCC-7TQ0	\$908.25	\$1051.05
		Features <ul style="list-style-type: none"> • Includes table top, support leg and framework. • Available in laminate top with black PVC edge or veneer top with color-matched wood edge. • Requires the support of two (2) starter seats or one (1) starter seat and one (1) add-on seat. • Table top and framework shipped assembled. Leg requires field assembly. • Carton weight/size: 25 lbs./4 cubic ft. 		To Order, Specify: <ol style="list-style-type: none"> 1) Product number. 2) Laminate color or wood finish. 3) Frame finish color. 	

KLCC-7TQ0

NOTE:

This table can be added between two preconfigured seating units.

		Description	Number	Laminate Surface	Veneer Surface
	Radius Corner Table Dimensions H: 18"(457mm) D: 32"(813mm) - Table top W: 32"(813mm) - Table top	Corner Table	KLCC-7TA0	\$908.25	\$1051.05
		Features <ul style="list-style-type: none"> • Includes table top, support leg and framework. • Available in laminate top with black PVC edge or veneer top with color-matched wood edge. • Requires the support of two (2) starter seats or one (1) starter seat and one (1) add-on seat. • Table top and framework shipped assembled. Leg requires field assembly. • Carton weight/size: 21 lbs./4 cubic ft. 		To Order, Specify: <ol style="list-style-type: none"> 1) Product number. 2) Laminate color or wood finish. 3) Frame finish color. 	

KLCC-7TA0

NOTE:

This table can be added between two preconfigured seating units.

Tempo Series

Bariatric Lounge Seating

Description	Number	Fabric Grade								Leather	
		A	B	C	D	E	F	G	H	Grade A	Grade B
Without Arms	KLB1-7200	\$1514.10	\$1726.20	\$1880.55	\$1947.75	\$1979.25	\$2240.70	\$2398.20	\$2826.60	\$2874.90	\$3625.10
Black Urethane Arms	KLB1-7210	1730.40	1942.50	2096.85	2164.05	2195.55	2457.00	2614.50	3042.90	3091.20	3841.40
Wood Arms	KLB1-7220	1730.40	1942.50	2096.85	2164.05	2195.55	2457.00	2614.50	3042.90	3091.20	3841.00

Open Frame Lounge — One Seat



KLB1-7200



KLB1-7220

Dimensions

SH: 18 1/4"(464mm)

H: 34 1/2"(876mm)

D: 26"(660mm)

W: 40 1/4"(1022mm)

with arms

36" (914mm)

without arms

AH: 26 1/4"(667mm)

SW: 31"(787mm)

SD: 18 3/4"(476mm)

Features

- Available without arms, black integral skinned urethane or maple ply arms.
- Tested to 750 pounds weight capacity.
- Shipped assembled.
- Carton weight/size:
KLB1-7200: 81 lbs./24 cubic ft.
KLB1-7220: 88 lbs./24 cubic ft.
- COM yardage: 3.5
- COL square footage: 86.0
- COL option is priced at Grade C price.

To Order, Specify:

- 1) Product number.
- 2) Fabric surface and color.
- 3) Frame finish color.
- 4) Arm wood finish color, if specified.

Nano-Tex Option:

Add **-P** to the product number, and add **\$54.60** list.

DuraBlock Option:

Add **-D** to the product number, and add **\$86.10** list.

Nano-Tex and DuraBlock options not available on leather, faux leather or Haworth+ upholstery options.

Galerie Collection

Lounge Seating

Base/ Frame	Number	Fabric Grade		C	D	E	F	G	H	Leather Grade A	Leather Grade B
		A	B								
Maple	4080-00 	\$1611.75	\$1694.70	\$1765.05	\$2059.05	\$2127.30	\$2209.20	\$2337.30	\$2691.15	\$3249.75	\$4487.75

Leg-Base Chair,
Fully Upholstered

4080-00

Dimensions

SH: 18 1/2"(470mm)
H: 33 3/4"(857mm)
D: 26"(660mm)
W: 27"(686mm)
AH: 26 1/2"(673mm)
SW: 18"(457mm)
SD: 18"(457mm)

Features

- Upholstered arm panels, seat and back.
- Seat frame rails are doweled and reinforced with corner blocks.
- Upholstered seat and back, polyester fiber and foam over wide support webbing.
- COM yardage: 3.5
- COL square footage: 63.0
- Available on RUSH.

 Product marked with this symbol available as GSA open market.

To Order, Specify:

- 1) Product number.
- 2) Fabric surface and color.
- 3) Frame finish color.

CAL 133 Option:

Add **-F** to the product number, and add **\$102.90** list.

Maple	180-0028 	\$2052.75	\$2195.55	\$2317.35	\$2588.25	\$2665.95	\$2905.35	\$3090.15	\$3595.20	\$4847.85	\$6388.75
-------	--	-----------	-----------	-----------	-----------	-----------	-----------	-----------	-----------	-----------	-----------

Lounge Chair



180-0028

Dimensions

SH: 18 1/2"(470mm)
H: 32 3/4"(832mm)
D: 28 1/4"(718mm)
W: 29 1/2"(749mm)
AH: 25 3/4"(654mm)
SW: 21"(533mm)
SD: 18 1/2"(470mm)

Features

- Interior frame has glued and doweled joints, reinforced with screws and cleats.
- Foam core seat and back cushions with spun polyester batting.
- Upholstered back cushions, loose reversible seat cushions over strip webbing.
- Exposed hard maple legs.
- COM yardage: 5.0
- COL square footage: 90.0
- Available on RUSH.

To Order, Specify:

- 1) Product number.
- 2) Fabric surface and color.
- 3) Arm/leg finish color.

Nano-TEX Option:

To specify, add **-P** to the end of the product number and add **\$54.60** list.
Example: 180-0028-P

DuraBlock Option:

To specify, add **-D** to the end of the product number and add **\$86.10** list.
Example: 180-0028-D

For available fabrics see matrix in the back of the book.

Maple	180-0053 	\$2731.05	\$2926.35	\$3095.40	\$3382.05	\$3516.45	\$4138.05	\$4441.50	\$5275.20	\$6448.05	\$8499.05
-------	--	-----------	-----------	-----------	-----------	-----------	-----------	-----------	-----------	-----------	-----------

Settee

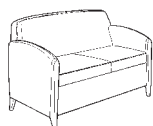

180-0053

Dimensions

SH: 18 1/2"(470mm)
H: 32 3/4"(832mm)
D: 28 1/2"(724mm)
W: 54 1/2"(1384mm)
AH: 25 3/4"(654mm)
SW: 45 1/4"(1149mm)
SD: 18 1/2"(470mm)

Features

- Interior frame has glued and doweled joints, reinforced with screws and cleats.
- Foam core seat and back cushions with spun polyester batting.
- Upholstered back cushions, loose reversible seat cushions over strip webbing.
- Exposed hard maple legs.
- COM yardage: 8.25
- COL square footage: 148.50
- Available on RUSH.

To Order, Specify:

- 1) Product number.
- 2) Fabric surface and color.
- 3) Arm/leg finish color.

Nano-TEX Option:

To specify, add **-P** to the end of the product number and add **\$108.15** list.
Example: 180-0053-P

DuraBlock Option:

To specify, add **-D** to the end of the product number and add **\$173.25** list.
Example: 180-0053-D

For available fabrics see matrix in the back of the book.

Maple	180-0075	\$3067.05	\$3293.85	\$3488.10	\$3815.70	\$4140.15	\$4689.30	\$5038.95	\$5996.55	\$7731.15	\$10305.05
-------	----------	-----------	-----------	-----------	-----------	-----------	-----------	-----------	-----------	-----------	------------

Sofa



180-0075

Dimensions

SH: 18 1/2"(470mm)
H: 32 3/4"(832mm)
D: 28 1/2"(724mm)
W: 76 1/2"(1943mm)
AH: 25 3/4"(654mm)
SW: 67 1/4"(1708mm)
SD: 18 1/2"(470mm)

Features

- Interior frame has glued and doweled joints, reinforced with screws and cleats.
- Foam core seat and back cushions with spun polyester batting.
- Upholstered back cushions, loose reversible seat cushions over strip webbing.
- Exposed hard maple legs.
- COM yardage: 9.50
- COL square footage: 171.0

To Order, Specify:

- 1) Product number.
- 2) Fabric surface and color.
- 3) Arm/leg finish color.

Nano-TEX Option:

To specify, add **-P** to the end of the product number and add **\$162.75** list.
Example: 180-0075-P

DuraBlock Option:

To specify, add **-D** to the end of the product number and add **\$259.35** list.
Example: 180-0075-D

For available fabrics see matrix in the back of the book.

Galerie Collection

Occasional Tables

	Height	Depth	Width	Number	Wood Price	Glass Top Inset Price
5800 Series Tables	16"(406mm)	18"(457mm)	18"(457mm)	5818-1816	\$1480.50	1702.05
	22"(559mm)	18"(457mm)	18"(457mm)	5818-1822	1497.30	1718.85
	16"(406mm)	26"(660mm)	26"(660mm)	5826-2616	1567.65	1810.20
	22"(559mm)	26"(660mm)	26"(660mm)	5826-2622	1584.45	1827.00

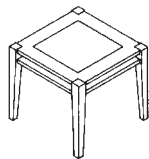

5818-1816

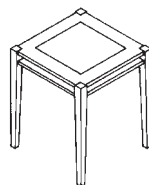

5818-1822

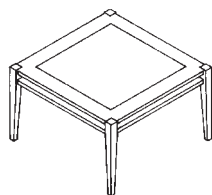

5826-2616

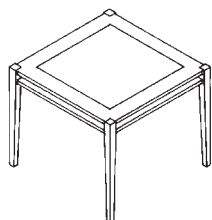

5826-2622

Features

- Square tables feature a reverse-diamond veneer pattern inset.
- Glass inset option is 3/8"(10mm)-thick frosted glass with a green tint.
- Standard with maple veneer insets and maple solids.

To Order, Specify:

- 1) Product number.
- 2) Wood finish color.

Glass Option:

To specify glass top inset add **-G** suffix to the product number and refer to pricing listed above.

Wood Finishes	
Maple	
Amber	M2-CA1
Beech	M2-W04
American	M2-W23
Classic	M2-83
Cordovan	M2-W13
Crown	M2-W24
Espresso	M2-W15
Golden	M2-W08
Light Anegre	M2-W07
Light Cherry	M2-W06
Mahogany Satin	M2-CAA
Medium Cherry	M2-U
Natural	M2-N
Retro	M2-W31
Sand	M2-AD

Galerie Collection

Occasional Tables

	Height	Depth	Width	Number	Wood Price	Glass Top Inset Price
5900 Series Tables	16"(406mm)	18"(457mm)	18"(457mm)	5918-1816	\$1379.70	\$1585.50
	22"(559mm)	18"(457mm)	18"(457mm)	5918-1822	1396.50	1602.30
	16"(406mm)	26"(660mm)	26"(660mm)	5926-2616	1509.90	1738.80
	22"(559mm)	26"(660mm)	26"(660mm)	5926-2622	1526.70	1755.60

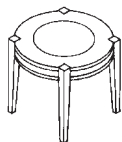

5918-1816

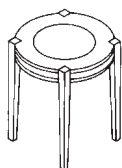

5918-1822

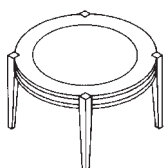

5926-2616

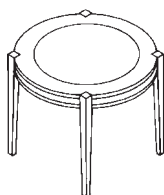

5926-2622

Features

- Round tables feature a straight-grain veneer pattern inset.
- Glass inset option is 3/8"(10mm)-thick frosted glass with a green tint.
- Standard with maple veneer insets and maple solids.

To Order, Specify:

- 1) Product number.
- 2) Wood finish color.

Glass Option:

To specify glass top inset add **-G** suffix to the product number and refer to pricing listed above.

Wood Finishes	
Maple	
Amber	M2-CA1
Beech	M2-W04
American	M2-W23
Classic	M2-83
Cordovan	M2-W13
Crown	M2-W24
Espresso	M2-W15
Golden	M2-W08
Light Anegre	M2-W07
Light Cherry	M2-W06
Mahogany Satin	M2-CAA
Medium Cherry	M2-U
Natural	M2-N
Retro	M2-W31
Sand	M2-AD

Tuxedo Series

Lounge Seating

Base/ Frame	Number	Fabric Grade		C	D	E	F	G	H	Leather Grade A	Leather Grade B
		A	B								
Fully upholstered	2006-0031	\$2930.55	\$3127.95	\$3298.05	\$3584.70	\$3768.45	\$4040.40	\$4278.75	\$4935.00	\$6693.75	\$8769.55

Lounge Chair

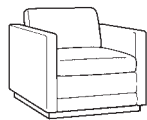

2006-0031

Dimensions

SH: 18"(457mm)
H: 29"(737mm)
D: 34"(864mm)
W: 32"(813mm)
AH: 24"(610mm)
SW: 24 1/2"(622mm)
SD: 23"(584mm)

Features

- 2"(51mm) black plinth base.
- Interior frame has glued and doweled joints, reinforced with screws and cleats.
- Reversible seat and back cushions.
- Cushions are foam core wrapped in spun-polyester fiber over 3"(76mm) strip webbing.
- Back is foam over wide support webbing.
- COM yardage: 6.50
- COL square footage: 117.0

To Order, Specify:

- 1) Product number.
- 2) Fabric surface and color.

Nano-Text Option:

To specify, add **-P** to the end of the product number and add **\$54.60** list.
Example: 2006-0031-P

DuraBlock Option:

To specify, add **-D** to the end of the product number and add **\$86.10** list.
Example: 2006-0031-D

For available fabrics see matrix in the back of the book.

Fully upholstered	2006-0056	\$3932.25	\$4193.70	\$4477.20	\$4678.80	\$4777.50	\$5470.50	\$5799.15	\$6708.45	\$8952.30	\$11721.25
-------------------	-----------	-----------	-----------	-----------	-----------	-----------	-----------	-----------	-----------	-----------	------------

Settee

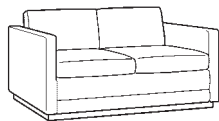

2006-0056

Dimensions

SH: 18"(457mm)
H: 29"(737mm)
D: 34"(864mm)
W: 57"(1448mm)
AH: 24"(610mm)
SW: 49"(1245mm)
SD: 23"(584mm)

Features

- 2"(51mm) black plinth base.
- Interior frame has glued and doweled joints, reinforced with screws and cleats.
- Reversible seat and back cushions.
- Cushions are foam core wrapped in spun-polyester fiber over 3"(76mm) strip webbing.
- Back is foam over wide support webbing.
- COM yardage: 9.0
- COL square footage: 162.0

To Order, Specify:

- 1) Product number.
- 2) Fabric surface and color.

Nano-Text Option:

To specify, add **-P** to the end of the product number and add **\$109.20** list.
Example: 2006-0056-P

DuraBlock Option:

To specify, add **-D** to the end of the product number and add **\$172.20** list.
Example: 2006-0056-D

For available fabrics see matrix in the back of the book.

Fully upholstered	2006-0072	\$4772.25	\$5059.95	\$5343.45	\$5821.20	\$5873.70	\$6734.70	\$7157.85	\$8318.10	\$11046.00	\$14505.25
-------------------	-----------	-----------	-----------	-----------	-----------	-----------	-----------	-----------	-----------	------------	------------

Sofa



2006-0072

Dimensions

SH: 18"(457mm)
H: 29"(737mm)
D: 34"(864mm)
W: 73"(1854mm)
AH: 24"(610mm)
SW: 65"(1651mm)
SD: 23"(584mm)

Features

- 2"(51mm) black plinth base.
- Interior frame has glued and doweled joints, reinforced with screws and cleats.
- Reversible seat and back cushions.
- Cushions are foam core wrapped in spun-polyester fiber over 3"(76mm) strip webbing.
- Back is foam over wide support webbing.
- COM yardage: 11.50
- COL square footage: 207.0

To Order, Specify:

- 1) Product number.
- 2) Fabric surface and color.

Nano-Text Option:

To specify, add **-P** to the end of the product number and add **\$163.80** list.
Example: 2006-0072-P

DuraBlock Option:

To specify, add **-D** to the end of the product number and add **\$258.30** list.
Example: 2006-0072-D

For available fabrics see matrix in the back of the book.

K100 Series and Scamps

Features and Options

Seating models feature:

Tubular steel frames available in full range of powder paint finish colors, including a polished chrome option. Frame sizes range from 1"(25mm) to 2 1/2"(64mm) outside diameter.

All products meet or exceed ANSI/BIFMA standards.

Seat and Back Options:

- Fully-upholstered seats and backs feature a molded polyurethane foam cushion supported by an inner steel armature, or a molded plywood shell. Selected seating models feature a zippered seat cover for easy field replacement of upholstery.
- Scamps Series features laminate seats and backs with PVC edges.

Base Options:

- Sled base models standard with floor glides.
- Leg base models standard with floor glides.
- 8"(203mm) x 8"(203mm) steel floor mounting plate for permanent attachment to the floor surface, available on select seating models.
- K100 Series public seating models available with three base styles: floor-mount steel base, cast aluminum base, or tubular steel base.

K100 Series and Scamps

General Specifications

COM & COL General Information

To order a COM fabric (Customer's Own Material), contact the Haworth Inquiry Center (1.800.426.8562), your local Haworth dealer, or go to haworth.com/surfaces > COM Library to find out if the COM you have selected has already been tested and approved. The surface collection site also has information on the Haworth + alliance program with Carnegie, Luna Textiles, and Maharam as well as our industry-leading Pre-Approved COM program.

Approved COMs are placed into Grades based on the fabric pricing; if the fabric pricing exceeds our Grades, they will be priced at Grade A + cost of fabric + 4% handling (North America). Haworth will purchase all COMs unless instructed otherwise. (Leather will also be purchased by Haworth; if the leather pricing exceeds our Grades, cost will be based on fabric Grade E + cost of leather + handling.)

If no information is available on the COM you are looking for, refer to the COM section and forms on the surface collection site for information on how to process your test request.

Flammability Requirements

Flammability standards met by seating fabrics are identified on the fabric selection color cards. Upholstery foam is compounded to meet specifications of Federal Motor Vehicle Safety Standard 302 and California 117. Select seating models are available with an optional fire retardant construction for compliance with California Bulletin #133 and the City of Boston Fire Code. Refer to the price charts for ordering information.

Environmental Factors

Material Off Gassing

In an effort to ensure air quality standards, all parts suppliers are required to provide Material Data Sheets and/or other documentation, verifying that their products do not emit volatile organic components (VOC). In addition, the powder-coat paint process used in the manufacturing of seating is free of VOCs. Our manufacturing processes have also eliminated all use of chlorofluorocarbons (CFCs) and ozone depleting chemicals (ODCs) in the product's construction.

Recycling

All fabric scraps are recycled, reducing the amount of material sent to landfills, and all components disassemble easily to increase the potential for recycling. Recycled parts are identified with the recycle symbol where practical.

General Guidelines for Product Specification

Seating specification numbers are based on an alpha-numeric logic that identifies a product by model and certain characteristics.

The following identifies the alpha-numeric logic for Tempo Series lounge seating models. Beyond the printed product number, fabric and finish codes are required to complete an order specification.

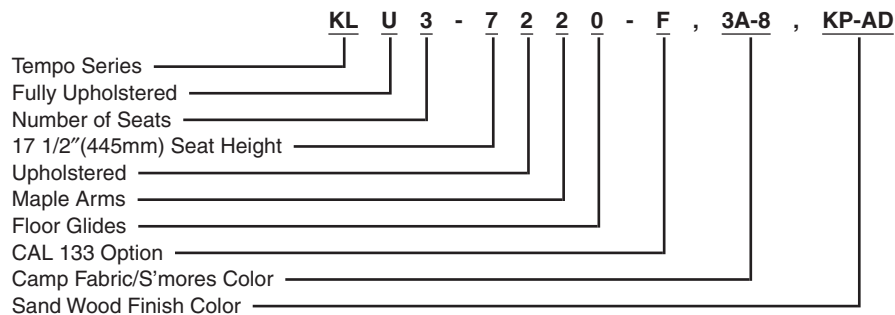

A ninth-digit suffix of the product code will indicate functional options, such as -F for CAL 133 option. There are exceptions to this logic; therefore, always refer to the price charts for product numbers rather than attempting to construct them. Product number modification instructions for additional options appear in footnoted copy for each applicable model.

Beyond the printed product number, fabric and finish codes are required to complete an order specification. To communicate your order clearly, list the product number and finish codes in the sequence outlined on each price page.

RUSH

Select seating models are marked with a  symbol to denote availability on the RUSH program. Refer to the fabric and finish options for each model.

Finishes and Fabrics

A complete listing of finishes/fabrics for seating can be found in the back of the price list.

K120 Series

Guest/Occasional Seating

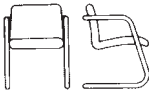
	Number	Fabric Grade							
		A	B	C	D	E	F	G	H
K120 Series	K120-2210	\$507.74	\$581.94	\$637.06	\$660.38	\$672.04	\$679.46	\$716.56	\$819.38
Dimensions									
Sled Base with Arms Open-Frame Base	SH: 18"(457mm) (fabric)								
	H: 30"(762mm)								
	D: 23"(584mm)								
	W: 22"(559mm)								
	AH: 25 1/2"(648mm)								
	Features								
K120-2210 (Formerly 100/200)	<ul style="list-style-type: none"> • Frame dimension is 1 1/2"(38mm) O.D. tubular steel. • Fully-upholstered seat and back. • Chairs are standard with glides. • Ganging clips available. See below. • Available with fire-retardant construction to comply with California Bulletin #133. • Carton weight/size: 31 lbs./10.5 cubic ft. • COM yardage: 1.25 								
	To Order, Specify:								
	1) Product number.								
	2) Fabric surface and color.								
	3) Kinkote frame trim color or Chrome (KR-V). Add \$113.42 list for Chrome finish.								
	CAL 133 Option:								
	Add -F to the product number, and add \$55.12 list.								

	Number	Price
Ganging Clip	KGNG-150	\$15.90
	Features	
KGNG-150	<ul style="list-style-type: none"> • Row seating ganging clip for 1 1/2"(38mm) O.D. frame. • Two recommended per connection. • Standard in Kintone (flat black) color only. 	
	To Order, Specify:	
	1) Product number. (No finish specification required.)	

K100 Series

Public Seating

Specification and Ordering Information

Use the following guidelines when specifying and ordering K100 Public Seating. A sketch of the product layout is not required to process an order for K100 products.

1. K100 Series seats mount to K100 Series beams.
2. In K100 series, seats and in-line tables occupy one position on the beam. Calculate the total of these units to ensure they match the number of beam positions specified, as indicated in the beam model number. For example, K153-3 includes three mounting positions and requires a combination of three seats and/or in-line tables.
3. Corner tables have their own support beam and hardware and do not occupy a position on the beam. The tables connect two beams together at right angles, and are not available for the freestanding end of the beam. Refer to page 306 for corner table models and their proper applications.
4. Public seating configurations can also include corners created by specifying either a 45° corner beam, which accommodates one seat, or an in-line table.
5. Although a drawing is not required to process an order, Haworth recommends ordering from a layout drawing to ensure accuracy in seat-count and corner table selection.

K100 Series Layout

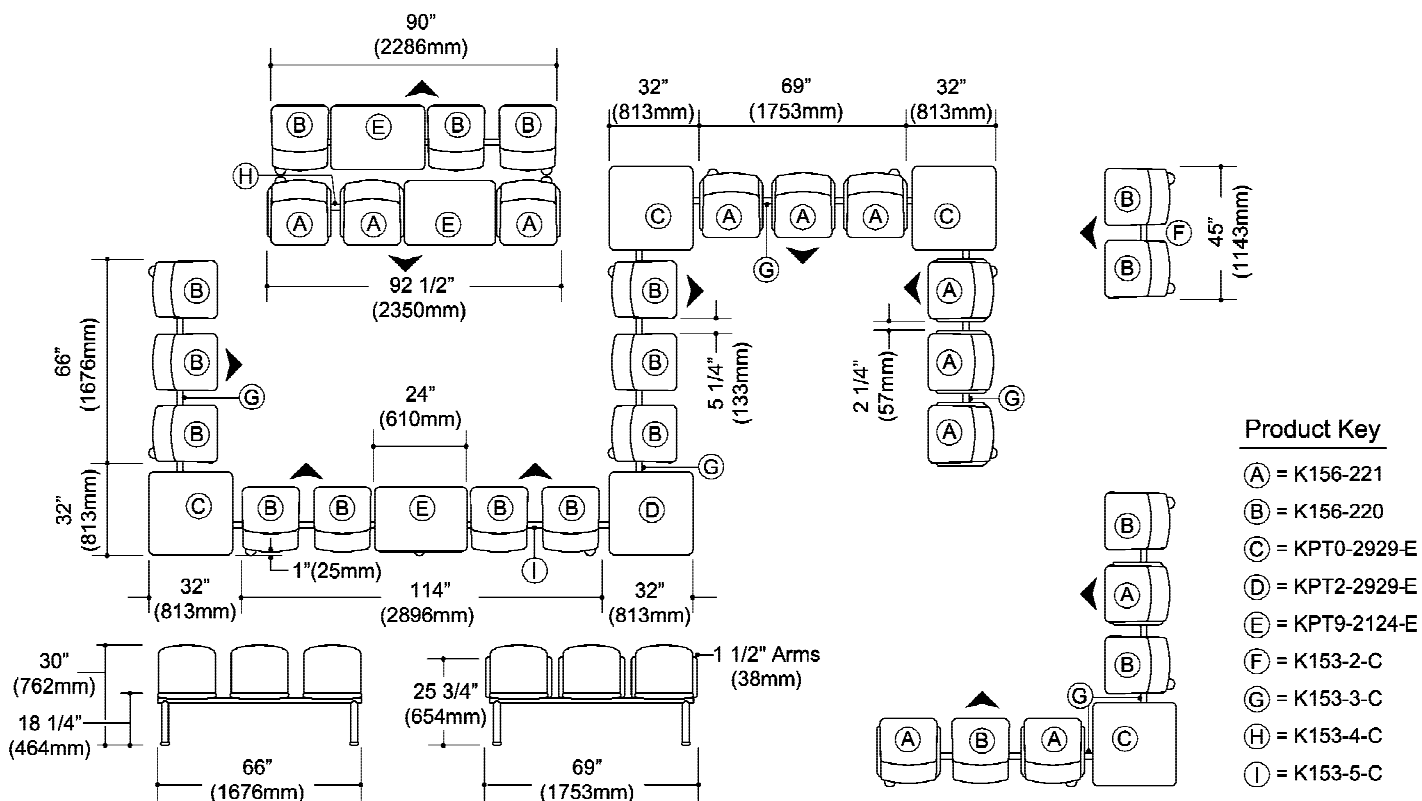

K100 Series

Public Seating — Beam Mounted Components

	Dimensions	Number	Fabric Grade							
			A	B	C	D	E	F	G	H
K100 Series <i>Seat with Arms</i>  K156-221 (Formerly 100/506)	SH: 18"(457mm) H: 30"(762mm) D: 25"(635mm) W: 22"(559mm)	K156-221	\$534.24	\$608.44	\$663.56	\$686.88	\$632.82	\$705.96	\$743.06	\$845.88
Features			To Order, Specify:							
<ul style="list-style-type: none"> • Connecting plate for beam mount standard in black finish color. • Fully-upholstered seat and back. • Available with fire retardant construction to comply with California Bulletin #133. • Carton weight/size: 20 lbs./6.3 cubic ft. • COM yardage: 1.25 			<ol style="list-style-type: none"> 1) Product number. 2) Fabric surface and color. 3) Kinkote arm trim color or Chrome (KR-V). Add \$98.58 list for Chrome finish. 							
			CAL 133 Option: Add -F to the product number, and add \$55.12 list to each seat.							

	Dimensions	Number	Fabric Grade							
			A	B	C	D	E	F	G	H
K100 Series <i>Armless Seat</i>  K156-220 (Formerly 100/505)	SH: 18"(457mm) H: 30"(762mm) D: 23"(584mm) W: 19"(483mm)	K156-220	\$410.22	\$484.42	\$539.54	\$562.86	\$574.52	\$581.94	\$619.04	\$721.86
Features			To Order, Specify:							
<ul style="list-style-type: none"> • Connecting plate for beam mount standard in black finish color. • Fully-upholstered seat and back. • Available with fire retardant construction to comply with California Bulletin #133. • Carton weight/size: 15 lbs./6.3 cubic ft. • COM yardage: 1.25 			<ol style="list-style-type: none"> 1) Product number. 2) Fabric surface and color. 							
			CAL 133 Option: Add -F to the product number, and add \$55.12 list to each seat.							

	Dimensions	Table Edge			Laminate Surface
		Number	Number	Number	
K100 Series <i>In-Line Table</i>  KPT9-2124 (Formerly 100/508)	D: 21"(533mm) W: 24"(610mm)				
		Bullnose PVC	KPT9-2124-E		\$255.46
		1/4"(6mm)-thick PVC	KPT9-2124-F		255.46
Features			To Order, Specify:		
<ul style="list-style-type: none"> • For use with K100 seating and beams. • Connecting plate for beam mount standard in black finish color. • Interchangeable with seat unit at any mounting location along the support beam. • 1/4"(6mm)-thick PVC edge standard in Kintone (flat black) color only. 			<ol style="list-style-type: none"> 1) Product number. 2) Table surface laminate color. 3) PVC edge color (optional). 		

K100 Series

Public Seating

		Table Edge	Number	Laminate Surface
K100 Series	Dimensions	Bullnose PVC	KPT0-2929-E	\$510.92
<i>Corner Connecting Table, Configuration #1</i>	D: 29"(737mm) W: 29"(737mm)	1/4"(6mm)-thick PVC	KPT0-2929-F	510.92

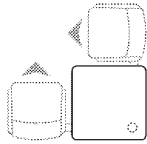
KPT0-2929
(Formerly 100/510)**Features**

- Used to join a variety of right-angle seating configurations.
- Connects to the ends of two beams, page 307.
- List price includes support structure and beam connectors.
- Arrows alongside illustration indicate seat direction.
- 1/4"(6mm)-thick PVC edge standard in Kintone (flat black) color only.

To Order, Specify:

- 1) Product number.
- 2) Table surface laminate color.
- 3) PVC edge color (optional).
- 4) Kinkote support structure trim color.

K100 Series	Dimensions	Bullnose PVC	KPT1-2929-E	\$510.92
<i>Corner Connecting Table, Configuration #2</i>	D: 29"(737mm) W: 29"(737mm)	1/4"(6mm)-thick PVC	KPT1-2929-F	510.92

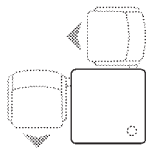
KPT1-2929
(Formerly 100/511)**Features**

- Used to join a variety of right-angle seating configurations.
- Connects to the ends of two beams, page 307.
- List price includes support structure and beam connectors.
- Arrows alongside illustration indicate seat direction.
- 1/4"(6mm)-thick PVC edge standard in Kintone (flat black) color only.

To Order, Specify:

- 1) Product number.
- 2) Table surface laminate color.
- 3) PVC edge color (optional).
- 4) Kinkote support structure trim color.

K100 Series	Dimensions	Bullnose PVC	KPT2-2929-E	\$510.92
<i>Corner Connecting Table, Configuration #3</i>	D: 29"(737mm) W: 29"(737mm)	1/4"(6mm)-thick PVC	KPT2-2929-F	510.92

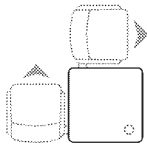
KPT2-2929
(Formerly 100/512)**Features**

- Used to join a variety of right-angle seating configurations.
- Connects to the ends of two beams, page 307.
- List price includes support structure and beam connectors.
- Arrows alongside illustration indicate seat direction.
- 1/4"(6mm)-thick PVC edge standard in Kintone (flat black) color only.

To Order, Specify:

- 1) Product number.
- 2) Table surface laminate color.
- 3) PVC edge color (optional).
- 4) Kinkote support structure trim color.

K100 Series	Dimensions	Bullnose PVC	KPT3-2929-E	\$510.92
<i>Corner Connecting Table, Configuration #4</i>	D: 29"(737mm) W: 29"(737mm)	1/4"(6mm)-thick PVC	KPT3-2929-F	510.92

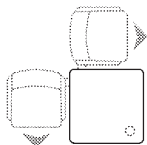
KPT3-2929
(Formerly 100/513)**Features**

- Used to join a variety of right-angle seating configurations.
- Connects to the ends of two beams, page 307.
- List price includes support structure and beam connectors.
- Arrows alongside illustration indicate seat direction.
- 1/4"(6mm)-thick PVC edge standard in Kintone (flat black) color only.

To Order, Specify:

- 1) Product number.
- 2) Table surface laminate color.
- 3) PVC edge color (optional).
- 4) Kinkote support structure trim color.

K100 Series

Public Seating

		Number	Base	Price
Two Seat Beam  K153-2	Dimensions H: 16"(406mm) D: 23"(584mm) W: 42"(1067mm)	K153-2-C	Cast Base	\$709.14
		K153-2-T	Tube Base	683.70
		K153-2-F	Floor Mount Base	656.14

Three Seat Beam  K153-3	Dimensions H: 16"(406mm) D: 23"(584mm) W: 66"(1676mm)	K153-3-C	Cast Base	\$770.62
		K153-3-T	Tube Base	745.18
		K153-3-F	Floor Mount Base	717.62

Four Seat Beam  K153-4	Dimensions H: 16"(406mm) D: 23"(584mm) W: 90"(2286mm)	K153-4-C	Cast Base	\$853.30
		K153-4-T	Tube Base	827.86
		K153-4-F	Floor Mount Base	800.30

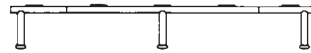
Five Seat Beam  K153-5	Dimensions H: 16"(406mm) D: 23"(584mm) W: 114"(2896mm)	K153-5-C	Cast Base	\$1181.90
		K153-5-T	Tube Base	1136.32
		K153-5-F	Floor Mount Base	1099.22

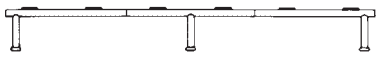
Six Seat Beam  K153-6	Dimensions H: 16"(406mm) D: 23"(584mm) W: 138"(3505mm)	K153-6-C	Cast Base	\$1270.94
		K153-6-T	Tube Base	1225.36
		K153-6-F	Floor Mount Base	1188.26

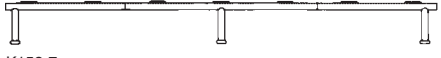
Seven Seat Beam  K153-7	Dimensions H: 16"(406mm) D: 23"(584mm) W: 162"(4115mm)	K153-7-C	Cast Base	\$1328.18
		K153-7-T	Tube Base	1282.60
		K153-7-F	Floor Mount Base	1245.50

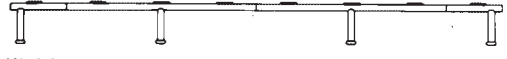
Eight Seat Beam  K153-8	Dimensions H: 16"(406mm) D: 23"(584mm) W: 186"(4724mm)	K153-8-C	Cast Base	\$1651.48
		K153-8-T	Tube Base	1593.18
		K153-8-F	Floor Mount Base	1542.30

Base Options

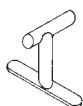

Cast Base (-C)
Chrome foot only



Tube Base(-T)



Floor Mount Base (-F)
Base mounting plate is 8"(203mm) x 8"(203mm).

To Order, Specify:

- 1) Product number.
- 2) Kinkote beam and base trim color.

K100 Series

Public Seating

		Number	Base	Price
Nine Seat Beam  K153-9	Dimensions H: 16"(406mm) D: 23"(584mm) W: 210"(5334mm)	K153-9-C	Cast Base	\$1722.50
		K153-9-T	Tube Base	1664.20
		K153-9-F	Floor Mount Base	1613.32

Ten Seat Beam  K153-10	Dimensions H: 16"(406mm) D: 23"(584mm) W: 234"(5944mm)	K153-10-C	Cast Base	\$1794.58
		K153-10-T	Tube Base	1736.28
		K153-10-F	Floor Mount Base	1685.40

45° Corner Beam  K153-45	Dimensions H: 16"(406mm) D: 23"(584mm) W: 50"(1270mm)	K153-45-C	Cast Base	\$753.66
		K153-45-T	Tube Base	744.12
		K153-45-F	Floor Mount Base	725.04

Seating configuration represents the location of the chairs only. Suspended corner bar accepts one seat only.

Base Options

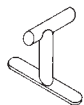

Cast Base (-C)
Chrome foot only

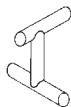

Tube Base (-T)

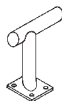



Floor Mount Base (-F)
Base mounting plate is 8"(203mm) x 8"(203mm).

To Order, Specify:

- 1) Product number.
- 2) Kinkote beam and base trim color.

Scamps Series

Children's Furniture

		Number	Price
Chair with Arms	Dimensions	KSCP-5110	\$460.04
	SH: 14"(356mm) H: 25"(635mm) D: 19"(483mm) W: 15 3/4"(400mm) AH: 20"(508mm)	Features <ul style="list-style-type: none"> • Recommended for ages 4 to 7. • Frame dimension is 1 1/8"(29mm) O.D. tubular steel. • Back and seat are laminate construction with PVC edges. (Available in standard laminates only.) • Feet are capped with integral skinned urethane glides in black only. • Carton weight/size: 22 lbs./5.8 cubic ft. 	To Order, Specify: <ol style="list-style-type: none"> 1) Product number. 2) Laminate color. 3) PVC edge color. 4) Kinkote frame trim color.
KSCP-5110 (Formerly 700/201)			
Scamps Series	Dimensions	KSTR-24	\$526.82
Round Table	H: 24"(610mm) D: 24"(610mm) W: 24"(610mm)	Features <ul style="list-style-type: none"> • Shipped K.D. • Frame dimension is 1 1/8"(29mm) O.D. tubular steel. • Table surface is laminate construction with PVC edge. (Available in standard laminates only.) • Feet are capped with nylon glides in black only. • Carton weight/size: 30 lbs./6.8 cubic ft. 	To Order, Specify: <ol style="list-style-type: none"> 1) Product number. 2) Laminate color. 3) PVC edge color. 4) Kinkote frame trim color.
			
KSTR-24 (Formerly 700/300)			

Tilt

Stool



STS-1

Dimensions

SH: 23.5"-34.75"
(597mm-883mm)
Seat: 12"(305mm)
Diameter
Base: 14"(356mm)
Diameter
Col.: 2"(51mm)
Diameter

Number

STS-1

Price**\$1167.00****Features**

- Base: Overmolded structural urethane covered with steel.
- Base is rounded to allow movement and allow user to lean on stool.
- Seat: Urethane with an MDF substrate.
- Seat available in black only.
- Steel column with pneumatic height adjustment.
- Available in four trim colors. Black (TR-F), Graphite (TR-J), Accent Orange (TR-1E) or Smooth Plaster (TR-PLS).

To Order, Specify:

- 1) Product number.
- 2) Trim color.

Specification Tips

- Plant feet firmly on the floor while leaning on the seat.
- Rounded base allows movement in any direction.



Haworth Collection

b_sit

Design: Martin Ballendat — Imported from Europe

Guest Seating

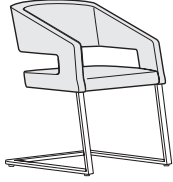

BSIT

Dimensions

SH: 18.5"(470mm)

TH: 32.2"(820mm)

TD: 25.1"(640mm)

TW: 22.8"(580mm)

SD: 20.4"(520mm)

Features

- Back: Molded wood shell fully upholstered.
- Seat: Molded wood shell fully upholstered.
- Arms: Fully upholstered.
- Base: Steel sled base, high polished chrome, matte chrome, or powder-coated black.
- Glides: Available in plastic or felt.
- COM yardage: 2.5
- COL square footage: 45

To Order, Specify:

1) Product number, including:

1 Price Group Option:

 COM or COL 3 Fabric 8 Leather

2 Surface Option:

 M COM Fabric N COL Leather C Collection 39 F Collection 97 (Leather)

3 Glide Option:

 P Plastic F Felt

2) Fabric color.

Leather Upholstery

Change the **seventh** digit in the product number from **F** to **L**.**Example:** BSIT-PDL = chair with leather.

Base	Number ①②③	(COM)	(COL)	Fabric	Leather
Painted	BSIT-PDF <input type="checkbox"/> - <input type="checkbox"/> <input type="checkbox"/>	\$2225.00	\$2365.00	\$2313.00	\$2795.00
High Gloss Chrome	BSIT-GCF <input type="checkbox"/> - <input type="checkbox"/> <input type="checkbox"/>	2358.00	2498.00	2446.00	2928.00
Matte Chrome	BSIT-MCF <input type="checkbox"/> - <input type="checkbox"/> <input type="checkbox"/>	2393.00	2533.00	2481.00	2963.00

Haworth Collection

Collaborate — Seating

Design: Stanley Felderman and Nancy Keatinge — Made in U.S.A.

Lounge Chair



SGL-22-H



SGL-22-C



SGL-22-A

Dimensions

SH: 16.0"(406mm)
TH: 28.5"(724mm)
TD: 26.5"(673mm)
TW: 32.7"(831mm)

Features

- Back: Fully upholstered.
- Seat: Fully upholstered.
- Back and Seat: Single stitched fabric upholstery and double stitched leather upholstery.
- Four Leg Base: Steel with trivalent chrome.
- Disc Base: Painted or Steel with trivalent chrome.
- Star Base: Steel with trivalent chrome.
- 180° self returning swivel.
- Steel frame with 100% recycled material filler panels (60% post consumer and 40% post industrial) covered with foam and upholstered.
- COM yardage: 2.75
- COL square footage: 49.5

Specification Tip

- Linear fabric is not recommended due to the manner in which fabric is applied.

To Order, Specify:

1) Product number, including:

① Seating Material Option:

- 1 Leather
- 2 Fabric
- 3 Faux Leather

② Back Material Option:

- 1 Leather
- 2 Fabric
- 3 Faux Leather

③ Base / Glide Option:

- H Four Leg Base/Hard Glide
- K Four Leg Base/Soft Glide
- C Disc Base/Hard Glide
- E Disc Base/Soft Glide
- A Star Base/Hard Glide
- B Star Base/Soft Glide

2) Seat fabric color.

3) Back fabric color.

4) Base finish.

Note: Add \$70.00 list upcharge for chrome option on disc base.

Description	Base Finish	Number ① ② ③	Fabric Grade							Leather Grade A	Leather Grade B
			A	B	C	D	E	F	G		
Four Leg Base	Chrome	SGL-■ ■ - ■	\$2025.00	\$2115.00	\$2189.00	\$2273.00	\$2357.00	\$2244.50	\$2525.00	\$2505.00	\$2641.00
Disc Base	Painted or Chrome	SGL-■ ■ - ■	2225.00	2315.00	2389.00	2473.00	2557.00	2444.50	2725.00	2705.00	2841.00
Star Base	Chrome	SGL-■ ■ - ■	2425.00	2515.00	2589.00	2673.00	2757.00	2644.50	2925.00	2905.00	3041.00

Haworth Collection

Collaborate — Seating

Design: Stanley Felderman and Nancy Keatinge — Made in U.S.A.

Guest Chair



SGG-22-H



SGG-22-C



SGG-22-A

Dimensions

SH: 18"(457mm)
 TH: 30.5"(775mm)
 TD: 22"(559mm)
 TW: 25.4"(645mm)

Features

- Back: Fully upholstered.
- Seat: Fully upholstered.
- Back and Seat: Single stitched fabric upholstery and double stitched leather upholstery.
- Four Leg Base: Steel with trivalent chrome.
- Disc Base: Painted or Steel with trivalent chrome.
- Star Base: Steel with trivalent chrome.
- 180° self returning swivel.
- Steel frame with 100% recycled material filler panels (60% post consumer and 40% post industrial) covered with foam and upholstered.
- COM yardage: 2.25
- COL square footage: 40.5

Specification Tip

- Linear fabric is not recommended due to the manner in which fabric is applied.

To Order, Specify:

1) Product number, including:

① Seating Material Option:

- 1** Leather
- 2** Fabric
- 3** Faux Leather

② Back Material Option:

- 1** Leather
- 2** Fabric
- 3** Faux Leather

③ Glide Option:

- H** Four Leg Base/Hard Glide
- K** Four Leg Base/Soft Glide
- C** Disc Base/Hard Glide
- E** Disc Base/Soft Glide
- A** Star Base/Hard Glide
- B** Star Base/Soft Glide

- 2) Seat fabric color.
 3) Back fabric color.
 4) Base finish.

Note: Add \$70.00 list upcharge for chrome option on disc base.

Description	Base Finish	Number ① ② ③	Fabric Grade					Leather Grade A	Leather Grade B		
			A	B	C	D	E				
Four Leg Base	Chrome	SGG-■ ■ - ■	\$1800.00	\$1870.00	\$1944.00	\$2028.00	\$2112.00	\$2009.50	\$2280.00	\$2260.00	\$2394.00
Disc Base	Painted or Chrome	SGG-■ ■ - ■	2000.00	2070.00	2144.00	2228.00	2312.00	2209.50	2480.00	2460.00	2594.00
Star Base	Chrome	SGG-■ ■ - ■	2200.00	2270.00	2344.00	2428.00	2512.00	2409.50	2680.00	2660.00	2794.00

Haworth Collection

Collaborate — Occasional Tables

Design: Stanley Felderman and Nancy Keatinge – Made in U.S.A.

Round Table



TGO-14-LRA



TGO-18-LRA

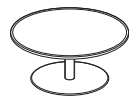

TGO-14-LRC



TGO-18-LRC

Features

- Table top available in Laminate, Wood or Stone.
- Base available with Star base or Disc base.
- Star base available in Trivalent chrome with hard or soft glide options.
- Disc base available painted or in Trivalent chrome with hard or soft glide options.

To Order, Specify:

1) Product number, including:

① Surface Option:

- L** Laminate
- W** Wood
- M** Stone

② Base/Glide Option:

- A** Star Base/Hard Glide
- B** Star Base/Soft Glide
- C** Disc Base/Hard Glide
- E** Disc Base/Soft Glide

2) Table Finish.

3) Base Finish.

Note: Add \$70.00 list upcharge for Trivalent chrome option on Disc base.

Height	Diameter	Number ① ②	Laminate	Specialty Wood	Stone 1	Stone 3
Star Base						
14"(356mm)	28"(711mm)	TGO-14- ■ R ■	\$1120.00	\$2140.00	\$2120.00	\$2720.00
18"(457mm)		TGO-18- ■ R ■	1220.00	2240.00	2220.00	2820.00
Disc Base						
14"(356mm)	28"(711mm)	TGO-14- ■ R ■	\$1320.00	\$2340.00	\$2320.00	\$2920.00
18"(457mm)		TGO-18- ■ R ■	1420.00	2440.00	2420.00	3020.00

Square Table



TGO-14-LSA



TGO-18-LSA

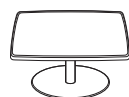

TGO-14-LSC



TGO-18-LSC

Features

- Table top available in Laminate, Wood or Stone.
- Base available with Star base or Disc base.
- Star base available in Trivalent chrome with hard or soft glide options.
- Disc base available painted or in Trivalent chrome with hard or soft glide options.

To Order, Specify:

1) Product number, including:

① Surface Option:

- L** Laminate
- W** Wood
- M** Stone

② Base/Glide Option:

- A** Star Base/Hard Glide
- B** Star Base/Soft Glide
- C** Disc Base/Hard Glide
- E** Disc Base/Soft Glide

2) Table Finish.

3) Base Finish.

Note: Add \$70.00 list upcharge for Trivalent chrome option on Disc base.

Height	Width	Depth	Number ① ②	Laminate	Specialty Wood	Stone 1	Stone 3
Star Base							
14"(356mm)	24"(610mm)	24"(610mm)	TGO-14- ■ S ■	\$ 970.00	\$1990.00	\$1970.00	\$2570.00
18"(457mm)			TGO-18- ■ S ■	1070.00	2090.00	2070.00	2670.00
Disc Base							
14"(356mm)	24"(610mm)	24"(610mm)	TGO-14- ■ S ■	\$1170.00	\$2190.00	\$2170.00	\$2770.00
18"(457mm)			TGO-18- ■ S ■	1270.00	2290.00	2270.00	2870.00

Haworth Collection

Collaborate — Occasional Tables

Design: Stanley Felderman and Nancy Keatinge – Made in U.S.A.

Ellipse Table



TGO-16-LEA

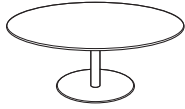

TGO-16-LEC

Features

- Table top available in Laminate, Wood or Stone.
- Base available with Star base or Disc base.
- Star base available in Trivalent chrome with hard or soft glide options.
- Disc base available painted or in Trivalent chrome with hard or soft glide options.

To Order, Specify:

1) Product number, including:

① Surface Option:

- L** Laminate
- W** Wood
- M** Stone

② Base/Glide Option:

- A** Star Base/Hard Glide
- B** Star Base/Soft Glide
- C** Disc Base/Hard Glide
- E** Disc Base/Soft Glide

2) Table Finish.

3) Base Finish.

Note: Add **\$70.00** list upcharge for Trivalent chrome option on Disc base.

Height	Width	Depth	Number ① ②	Laminate	Specialty Wood	Stone 1	Stone 3
Star Base							
16"(406mm)	40"(1016mm)	26"(660mm)	TGO-16- ■ E ■	\$1270.00	\$2350.00	\$2270.00	\$2870.00
Disc Base							
16"(406mm)	40"(1016mm)	26"(660mm)	TGO-16- ■ E ■	\$1470.00	\$2550.00	\$2470.00	\$3070.00

Haworth Collection

DSC Axis 106

Design: Giancarlo Piretti — Imported from Europe

Chair without Arms



DSC-SCA
DSC-NCA

Standard

Dimensions

SH: 19"(470mm)
TH: 30"(770mm)
TD: 22"(560mm)
TW: 22"(570mm)
SW: 19"(470mm)
SD: 18"(460mm)
BH: 15"(390mm)

Narrow

Dimensions

SH: 19"(470mm)
TH: 30"(770mm)
TD: 21"(530mm)
TW: 21"(540mm)
SW: 17"(440mm)
SD: 17"(440mm)
BH: 15"(390mm)

Features

- Seat: Molded plywood with natural beech veneer or upholstered over foam padding.
- Back: Molded plywood with natural birch veneer or upholstered over foam padding.
- Frame: Steel under-frame with epoxy polyester resin finish.
- Legs: Steel legs covered in scratch resistant plastic gray covers.
- Glides: Black nylon self-leveling glides (suitable for carpet and non-carpet surfaces).
- Optional accessories ordered separately include: Armrests, folding writing tablet, anti-panic fold-away writing tablet, document racks, place markers and chair dollies.
- Stacks 8 high on the floor, 12 high on a cart.
- COM yardage: 1

To Order, Specify:

1) Product number, including:

① Price Group Option:

- X COM Fabric
- 1 Collection 82
- 3 Collection 39
- W Beech Wood (Clear Finish Only)

② Surface Option:

- M COM Fabric
- B Collection 82
- C Collection 39
- V Beech Wood (Clear Finish Only)

2) Fabric color.

Description	Number ① ②	(COM)	Fabric Collection		
			82	39	Wood
Standard Chair	DSC-SCA <input type="checkbox"/> - <input type="checkbox"/>	\$612.00	\$658.64	\$800.68	\$570.66
Narrow Chair	DSC-NCA <input type="checkbox"/> - <input type="checkbox"/>	612.00	658.64	800.68	559.00

Haworth Collection

DSC Axis 106

Design: Giancarlo Piretta — Imported from Europe

	Description	Number ①	(COM)	Fabric Collection	
				82	39
Armrest	Right Armrest	DSC-RARM-■	\$156.00	\$171.00	\$200.00
	Left Armrest	DSC-LARM-■	156.00	171.00	200.00

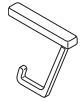
DSC-RARM
DSC-LARM**Feature**

- COM yardage: .15

To Order, Specify:

- 1) Product number, including:

① Surface Option:

- M** COM Fabric
- B** Collection 82
- C** Collection 39

- 2) Fabric color.

	Description	Number ① ② ③	(COM)	Fabric Collection	
				82	39
Anti-Panic Writing Tablet with Armrest	Fabric Arm Rest	DSC-AT ■ ■ - ■	\$442.00	\$522.00	\$696.00

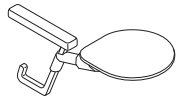

DSC-AT

Feature

- COM yardage: .15

To Order, Specify:

- 1) Product number, including:

① Writing Tablet Finish Option:

- B** Black Melamine
- W** White Melamine

② Price Group Option:

- X** COM Fabric
- 1** Collection 82
- 3** Collection 39

③ Surface Option:

- M** COM Fabric
- B** Collection 82
- C** Collection 39

- 2) Fabric color.

	Description	Number ①	Price
	Left Writing Tablet	DSC-LTM ■	207.00

DSC-RTM
DSC-LTM**To Order, Specify:**

- 1) Product number, including:

① Writing Tablet Finish Option:

- B** Black Melamine
- W** White Melamine

Accessories	Description	Number	Price
	Transport dolly for standard chairs	DSC-DOL	\$644.00
	Transport dolly for narrow chairs	DSC-DOLS	644.00
	Black plastic ganging device for chairs with anti-panic tablet	DSC-AG01	19.00
	Ganging device for chairs in row with one accessory only (armrest or tablet)	DSC-G001	12.00
	Anti-panic ganging device connecting chairs with one accessory only (armrest or tablet)	DSC-AC01	107.00
	Black painted document rack	DSC-RCKB	44.00
	Grey painted document rack	DSC-RCKG	44.00



To Order, Specify:

- 1) Product number.

Haworth Collection

DSC Axis 10000 Bench — Fabric Seat
Design: Centro Studi Castelli — Imported from Europe

Fabric Collection

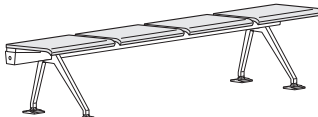
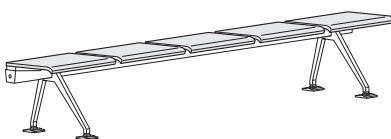
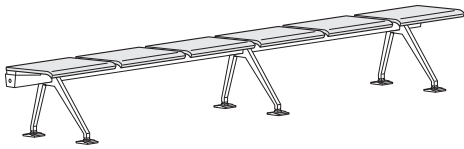
		Description	Number ① ②	(COM)	82	39	
Two Seat Bench — Fabric Seat  AXIS-2SA AXIS-2SG	Dimensions H: 17.7"(450mm) D: 21.3"(540mm) W: 38.2"(970mm)	Aluminum Light Silver Base	AXIS-2SA		\$1540.00	\$1576.00	\$1629.00
		Graphite Grey Base	AXIS-2SG		1540.00	1576.00	1629.00
Three Seat Bench — Fabric Seat  AXIS-3SA AXIS-3SG	Dimensions H: 17.7"(450mm) D: 21.3"(540mm) W: 58.3"(1481mm)	Aluminum Light Silver Base	AXIS-3SA		\$1909.00	\$1963.00	\$2042.50
		Graphite Grey Base	AXIS-3SG		1909.00	1963.00	2042.50
Four Seat Bench — Fabric Seat  AXIS-4SA AXIS-4SG	Dimensions H: 17.7"(450mm) D: 21.3"(540mm) W: 78.3"(1989mm)	Aluminum Light Silver Base	AXIS-4SA		\$2448.00	\$2520.00	\$2626.00
		Graphite Grey Base	AXIS-4SG		2448.00	2520.00	2626.00
Five Seat Bench — Fabric Seat  AXIS-5SA AXIS-5SG	Dimensions H: 17.7"(450mm) D: 21.3"(540mm) W: 98.4"(2499mm)	Aluminum Light Silver Base	AXIS-5SA		\$2812.00	\$2902.00	\$3034.50
		Graphite Grey Base	AXIS-5SG		2812.00	2902.00	3034.50
Six Seat Bench — Fabric Seat  AXIS-6SA AXIS-6SG	Dimensions H: 17.7"(450mm) D: 21.3"(540mm) W: 118.5"(3010mm)	Aluminum Light Silver Base	AXIS-6SA		\$3674.00	\$3782.00	\$3941.00
		Graphite Grey Base	AXIS-6SG		3674.00	3782.00	3941.00

Features

- Available as a 2, 3, 4, 5 or 6 seat bench.
- Seat options: Fully upholstered seat of polyurethane foam padding over plywood veneer.
- Base: Polished die-cast aluminum.
- COM yardage: .71 yds. per seat

To Order, Specify:

1) Product number, including:

① Price Group Option:

- COM Fabric
- 1 Collection 82
- 3 Collection 39

② Surface Option:

- M COM Fabric
- B Collection 82
- C Collection 39

2) Fabric color.

Haworth Collection

DSC Axis 10000 Bench — Steel or Wood Seat

Design: Centro Studi Castelli — Imported from Europe

Two Seat Bench — Steel or Wood Seat



AXIS-2SGA AXIS-2SGG
AXIS-2SAA AXIS-2SAG
AXIS-2SVA AXIS-2SVG

Dimensions

H: 17.7"(450mm)
D: 21.3"(540mm)
W: 38.2"(970mm)

Base Description	Seat Description	Number	Price
Aluminum Light Silver Base	Graphite Grey Seat	AXIS-2SGA	\$1509.00
	Light Silver Seat	AXIS-2SAA	1509.00
	Wood Seat	AXIS-2SVA	1248.00
Graphite Grey Base	Graphite Grey Seat	AXIS-2SGG	\$1509.00
	Light Silver Seat	AXIS-2SAG	1509.00
	Wood Seat	AXIS-2SVG	1248.00

Three Seat Bench — Steel or Wood Seat



AXIS-3SGA AXIS-3SGG
AXIS-3SAA AXIS-3SAG
AXIS-3SVA AXIS-3SVG

Dimensions

H: 17.7"(450mm)
D: 21.3"(540mm)
W: 58.3"(1481mm)

Aluminum Light Silver Base	Graphite Grey Seat	AXIS-3SGA	\$1706.00
	Light Silver Seat	AXIS-3SAA	1706.00
	Wood Seat	AXIS-3SVA	1472.00
Graphite Grey Base	Graphite Grey Seat	AXIS-3SGG	\$1706.00
	Light Silver Seat	AXIS-3SAG	1706.00
	Wood Seat	AXIS-3SVG	\$1472.00

Four Seat Bench — Steel or Wood Seat

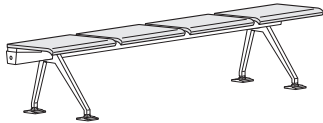

AXIS-4SGA AXIS-4SGG
AXIS-4SAA AXIS-4SAG
AXIS-4SVA AXIS-4SVG

Dimensions

H: 17.7"(450mm)
D: 21.3"(540mm)
W: 78.3"(1989mm)

Aluminum Light Silver Base	Graphite Grey Seat	AXIS-4SGA	\$2177.00
	Light Silver Seat	AXIS-4SAA	2177.00
	Wood Seat	AXIS-4SVA	1865.00
Graphite Grey Base	Graphite Grey Seat	AXIS-4SGG	\$2177.00
	Light Silver Seat	AXIS-4SAG	2177.00
	Wood Seat	AXIS-4SVG	1865.00

Five Seat Bench — Steel or Wood Seat

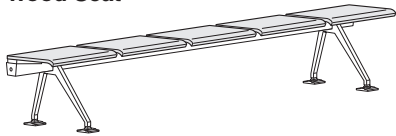

AXIS-5SGA AXIS-5SGG
AXIS-5SAA AXIS-5SAG
AXIS-5SVA AXIS-5SVG

Dimensions

H: 17.7"(450mm)
D: 21.3"(540mm)
W: 98.4"(2499mm)

Aluminum Light Silver Base	Graphite Grey Seat	AXIS-5SGA	\$2473.00
	Light Silver Seat	AXIS-5SAA	2473.00
	Wood Seat	AXIS-5SVA	2083.00
Graphite Grey Base	Graphite Grey Seat	AXIS-5SGG	\$2473.00
	Light Silver Seat	AXIS-5SAG	2473.00
	Wood Seat	AXIS-5SVG	2083.00

Six Seat Bench — Steel or Wood Seat

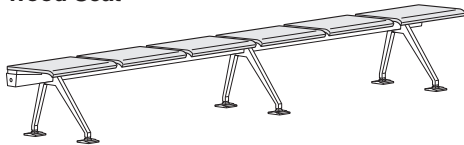

AXIS-6SGA AXIS-6SGG
AXIS-6SAA AXIS-6SAG
AXIS-6SVA AXIS-6SVG

Dimensions

H: 17.7"(450mm)
D: 21.3"(540mm)
W: 118.5"(3010mm)

Aluminum Light Silver Base	Graphite Grey Seat	AXIS-6SGA	\$3267.00
	Light Silver Seat	AXIS-6SAA	3267.00
	Wood Seat	AXIS-6SVA	2800.00
Graphite Grey Base	Graphite Grey Seat	AXIS-6SGG	\$3267.00
	Light Silver Seat	AXIS-6SAG	3267.00
	Wood Seat	AXIS-6SVG	2800.00

Features

- Available as a 2, 3, 4, 5 or 6 seat bench.
- Seat options: Press bent steel with powder coat paint in two colors (aluminum light silver and graphite grey) or Natural Beech wood veneer, sealed with a transparent protective finish.
- Base: Polished die-cast aluminum.

To Order, Specify:

- 1) Product number.
(No finish specification required.)

Haworth Collection

Exchange

Design: art.collection team — Imported from Europe

Guest Seating



DIAL-SL
DIAL-ST

Dimensions

SH: 18.5"(470mm)
TH: 33.0"(840mm)
TD: 22.4"(570mm)
TW: 22.0"(560mm)
SW: 18.1"(460mm)
SD: 16.5"(420mm)
BH: 15.3"(390mm)

Features

- Seat: Upholstered.
- Back: Upholstered.
- Base: Polished chrome.
- Glides: Plastic or felt.
- Arms: Caps in black plastic, black stained wood, or black leather.
- Black leather armrest only available on leather chair.
- Stacking: Optional version 4 high.
- COM yardage: 1.2
- COL square footage: 21.6

To Order, Specify:

1) Product number, including:

1 Price Group Option:

- COM or COL
 3 Fabric
 8 Leather

2 Surface Option:

- M COM Fabric
 N COL Leather
 C Fabric
 F Leather

3 Glide Option:

- P Plastic
 F Felt

2) Fabric color.

Description	Number 1 2 3	(COM)	(COL)	Fabric	Leather
Non-Stacking					
Black Plastic Armrest	DIAL-SLP - -	\$1470.00	\$1531.00	\$1575.00	\$1883.00
Black Wood Armrest	DIAL-SLW - -	1755.00	1755.00	1860.00	2168.00
Black Leather Armrest	DIAL-SLL - -	N/A	N/A	N/A	2193.00
Stacking					
Black Plastic Armrest	DIAL-STP - -	\$1405.00	\$1466.00	\$1510.00	\$1818.00

Connecting Element	Number	Price
DIAL-CE	DIAL-CE	\$47.00



To Order, Specify:

1) Product number.
(No finish specification required.)

Haworth Collection

K700 Stool

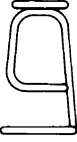
Design: Kinetics Design Studio Team — Made in U.S.A.

		Description	Number	Price
 K700-8001	Stool with Footrest Dimensions SH: 28"(711mm) D: 17"(432mm) W: 16"(406mm) S: 12"(305mm)	28"(711mm) Seat Height with Footrest Features <ul style="list-style-type: none"> • Seat: Upholstered seat cap purchased separately. • Frame: 1 1/2"(38mm) O.D. tubular steel. 	K700-8001	\$387.00
		To Order, Specify: <ol style="list-style-type: none"> 1) Product number. 2) Frame trim color. Chrome (KR-V), add \$61.00 list. 		
 K700-4001	Stool without Footrest Dimensions SH: 24"(610mm) D: 17"(432mm) W: 16"(406mm) S: 12"(305mm)	24"(610mm) Seat Height Features <ul style="list-style-type: none"> • Seat: Upholstered seat cap purchased separately. • Frame: 1 1/2"(38mm) O.D. tubular steel. 	K700-4001	\$370.00
		To Order, Specify: <ol style="list-style-type: none"> 1) Product number. 2) Frame trim color. Chrome (KR-V), add \$61.00 list. 		
 K700-2001	Stool without Footrest Dimensions SH: 18"(457mm) D: 17"(432mm) W: 16"(406mm) S: 12"(305mm)	18"(457mm) Seat Height Features <ul style="list-style-type: none"> • Seat: Upholstered seat cap purchased separately. • Frame: 1 1/2"(38mm) O.D. tubular steel. 	K700-2001	\$356.00
		To Order, Specify: <ol style="list-style-type: none"> 1) Product number. 2) Frame trim color. Chrome (KR-V), add \$61.00 list. 		

Upholstered Seat Cap	Dimensions	Fabric Grade									
		Description	Number	A	B	C	D	E	F	G	H
 K700-CAP	S: 12"(305mm)	Stool Cap	K700-CAP	\$ 63.00	\$82.00	\$91.00	\$96.00	\$97.00	\$99.00	\$105.00	\$111.00
		Features <ul style="list-style-type: none"> • Upholstered seat cap with sewn in foam. 		To Order, Specify: <ol style="list-style-type: none"> 1) Product number. 2) Fabric surface and color. 							

Haworth Collection

LTB Lounge

Design: Thierry Blet and Catherine Le Teo – Made in U.S.A.

LTB addresses the need to support evolving informal work styles, providing new ways to embrace task based or collaborative activities. More than just a new lounge, LTB offers a wide scope of applications and a variety of different settings that support different work activities and behaviors.

Applications:

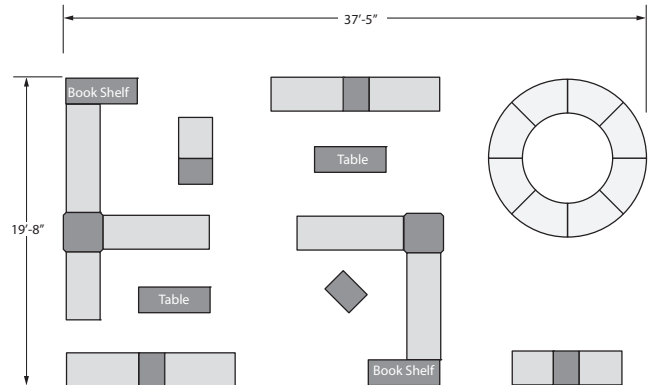
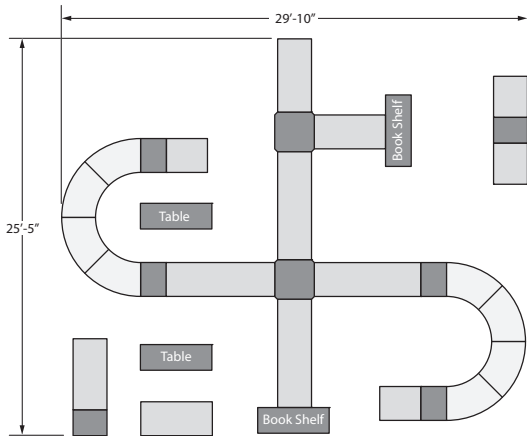
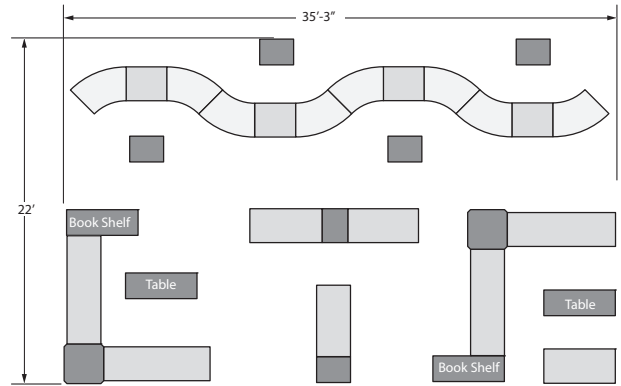
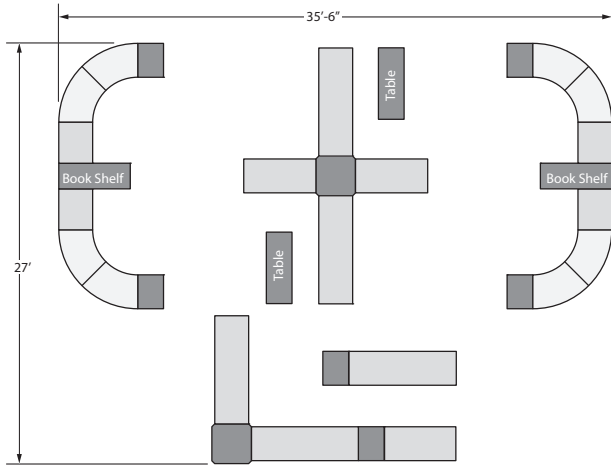

Haworth Collection

LTB Lounge

Design: Thierry Blet and Catherine Le Teo – Made in U.S.A.

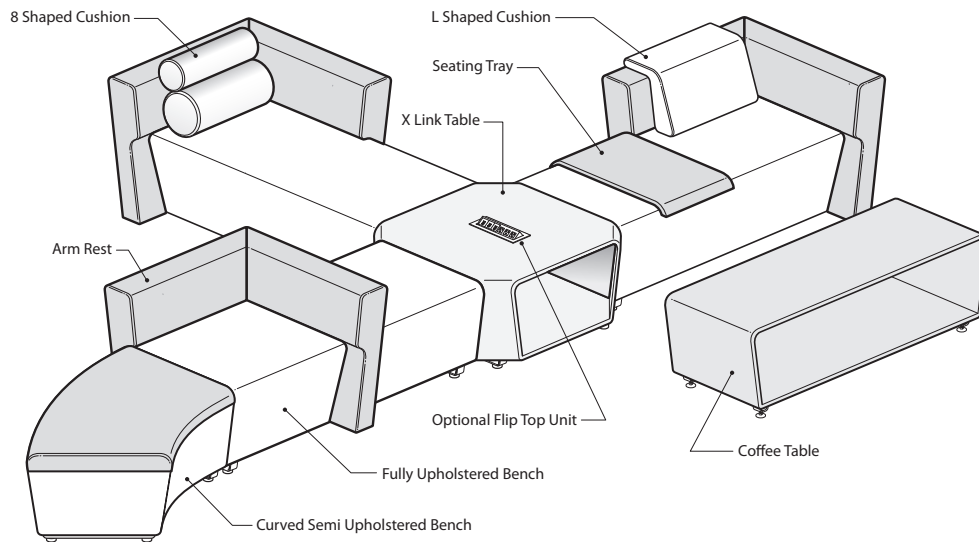

Arm/Bracket Application Guidelines

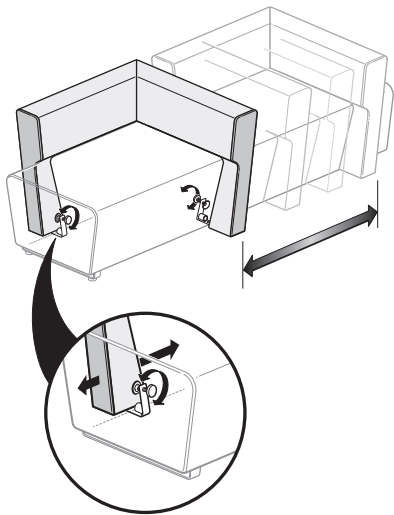

Arm/bracket allows for lateral adjustment and can be locked in place at any position along the bench.

Adjustable bracket – No tools required for lateral adjustment along bench.

Arm rest can be applied in multiple orientations along bench.

Arm rest for use on benches 55.1"(1400mm)W or greater.

The depth of the arm rest needs to coordinate the depth of the bench it is going to be applied to.

Cannot be used on curved benches.

Linear patterns are not recommended on arm rest.

Can specify a different fabric on the front of the arms than the rest of the arm rest.

Haworth Collection

LTB Lounge

Design: Thierry Blet and Catherine Le Teo – Made in U.S.A.

Straight Bench

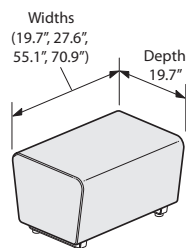
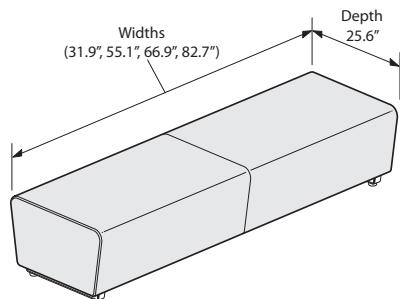

SLB_SF

Features

- Upholstered with a center seam on 55.1”(1400mm) and above.
- Base: Black plastic adjustable glides.
- COM yardage: See Fabric/Finish Specifications.
- COL yardage: See Fabric/Finish Specifications.

Specification Tip

- Benches have a corresponding table and arm rest that matches the depth of the benches.

To Order, Specify:

1) Product number, including:

1 Surface Option:

- 1 Leather
- 2 Fabric
- 3 Faux Leather

2) Fabric surface and color.

Height	Depth	Width	Number ①	Fabric Grade						Leather Grade A	Leather Grade B
				A	B	C	D	E	F		
Fully Upholstered											
16.7”(424mm)	19.7”(500mm)	19.7”(500mm)	SLB-2020- SF	\$ 700.00	\$ 740.00	\$ 780.00	\$ 820.00	\$ 860.00	\$ 900.00	\$ 900.00	\$1075.00
16.7”(424mm)	19.7”(500mm)	27.6”(701mm)	SLB-2028- SF	850.00	900.00	950.00	1000.00	1050.00	1100.00	1050.00	1225.00
16.7”(424mm)	19.7”(500mm)	55.1”(1400mm)	SLB-2055- SF	1000.00	1080.00	1160.00	1240.00	1320.00	1400.00	1750.00	2284.00
16.7”(424mm)	19.7”(500mm)	70.9”(1801mm)	SLB-2071- SF	1150.00	1230.00	1310.00	1390.00	1470.00	1550.00	2100.00	2595.00
16.7”(424mm)	25.6”(650mm)	31.9”(810mm)	SLB-2632- SF	\$1100.00	\$1150.00	\$1200.00	\$1250.00	\$1300.00	\$1350.00	\$1350.00	\$1528.00
16.7”(424mm)	25.6”(650mm)	55.1”(1400mm)	SLB-2655- SF	1250.00	1310.00	1370.00	1430.00	1490.00	1550.00	2100.00	2641.00
16.7”(424mm)	25.6”(650mm)	66.9”(1699mm)	SLB-2667- SF	1400.00	1480.00	1560.00	1640.00	1720.00	1800.00	2200.00	2684.00
16.7”(424mm)	25.6”(650mm)	82.7”(2101mm)	SLB-2683- SF	1550.00	1630.00	1710.00	1790.00	1870.00	1950.00	2500.00	2995.00

Haworth Collection

LTB Lounge

Design: Thierry Blet and Catherine Le Teo – Made in U.S.A.

Straight Bench

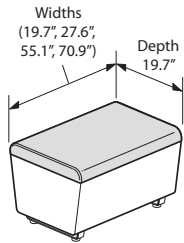
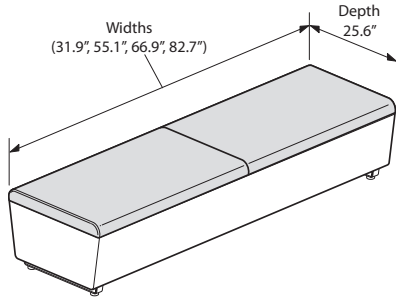

SLB-2SS

Features

- Fully upholstered cushion with painted fiberboard base.
- Cushion is upholstered with a center seam on 55.1\"(1400mm) and above.
- Seat cushion thickness is 2.6\"(66mm)
- Base: Black plastic adjustable glides.
- COM yardage: See Fabric/Finish Specifications.
- COL yardage: See Fabric/Finish Specifications.

Specification Tip

- Benches have a corresponding table and arm rest that matches the depth of the benches.

To Order, Specify:

1) Product number, including:

1 Surface Option:

- 1 Leather
- 2 Fabric
- 3 Faux Leather

2) Fabric surface and color.

3) Finish color.

Height	Depth	Width	Number ①	Fabric Grade						Leather Grade A	Leather Grade B
				A	B	C	D	E	F		
Semi Upholstered											
16.7\"(424mm)	19.7\"(500mm)	19.7\"(500mm)	SLB-2020-■ SS	\$ 800.00	\$ 840.00	\$ 880.00	\$ 920.00	\$ 960.00	\$1000.00	\$1000.00	\$1175.00
16.7\"(424mm)	19.7\"(500mm)	27.6\"(701mm)	SLB-2028-■ SS	950.00	1000.00	1050.00	1100.00	1150.00	1200.00	1150.00	1325.00
16.7\"(424mm)	19.7\"(500mm)	55.1\"(1400mm)	SLB-2055-■ SS	1100.00	1180.00	1260.00	1340.00	1420.00	1500.00	1850.00	2384.00
16.7\"(424mm)	19.7\"(500mm)	70.9\"(1801mm)	SLB-2071-■ SS	1250.00	1330.00	1410.00	1490.00	1570.00	1650.00	2200.00	2695.00
16.7\"(424mm)	25.6\"(650mm)	31.9\"(810mm)	SLB-2632-■ SS	\$1200.00	\$1250.00	\$1300.00	\$1350.00	\$1400.00	\$1450.00	\$1450.00	\$1628.00
16.7\"(424mm)	25.6\"(650mm)	55.1\"(1400mm)	SLB-2655-■ SS	1350.00	1410.00	1470.00	1530.00	1590.00	1650.00	2200.00	2741.00
16.7\"(424mm)	25.6\"(650mm)	66.9\"(1699mm)	SLB-2667-■ SS	1500.00	1580.00	1660.00	1740.00	1820.00	1900.00	2300.00	2784.00
16.7\"(424mm)	25.6\"(650mm)	82.7\"(2101mm)	SLB-2683-■ SS	1650.00	1730.00	1810.00	1890.00	1970.00	2050.00	2600.00	3095.00

Haworth Collection

LTB Lounge

Design: Thierry Blet and Catherine Le Teo – Made in U.S.A.

Curved Bench

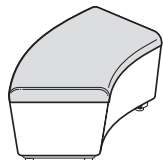

SLB-2CS

Features

- Fully upholstered cushion with painted fiberboard base.
- Cushion thickness is 2.6”(66mm).
- Base: Black plastic adjustable glides.
- Bench is a 45° angle.
- COM yardage: See Specification Guide
- COL yardage: See Specification Guide

Specification Tip

- Eight benches create a circle.

To Order, Specify:

- 1) Product number, including:
 - 1** Surface Option:
 - 1** Leather
 - 2** Fabric
 - 3** Faux Leather
- 2) Fabric surface and color.
- 3) Finish color.

Height	Depth	Width	Number ①	Fabric Grade						Leather Grade A	Leather Grade B	
				A	B	C	D	E	F			
Semi Upholstered												
16.7”(424mm)	19.7”(500mm)	55”(1397mm)	SLB-2055-	CS	\$1400.00	\$1480.00	\$1560.00	\$1640.00	\$1720.00	\$1800.00	\$2150.00	\$2684.00
16.7”(424mm)	25.6”(650mm)	55”(1397mm)	SLB-2655-	CS	\$1650.00	\$1710.00	\$1770.00	\$1830.00	\$1890.00	\$1950.00	\$2500.00	\$3041.00

Arm Rest

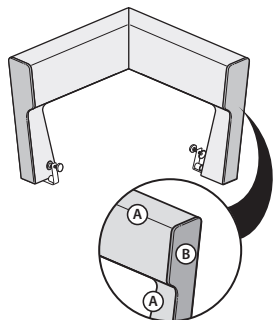

SLR

Features

- Fully upholstered.
- Adjustable bracket for lateral adjustment along bench - no tools required.
- COM yardage: Surface A - 3.25 yds, Surface B - 1 yd
- COL square footage: Surface A - 58.5 sq ft, Surface B - 18 sq ft

Specification Tips

- Can be applied in multiple orientations along bench.
- For use on benches 55.1”(1400mm)W or greater.
- Can specify a different fabric on the front of the arms than the rest of the arm rest.
- Depth of arm rest must coordinate with depth of bench it is going to be applied to.
- Cannot be used on curved benches.
- Linear patterns are not recommended.
- Arm Rest not available in leather.

To Order, Specify:

- 1) Product number, including:
 - 1** Surface Option:
 - 2** Fabric
 - 3** Faux Leather
- 2) Fabric surface and color for surface A.
- 3) Fabric surface and color for front of arms surface B.

Height	Depth	Number ①	Fabric Grade					
			A	B	C	D	E	F
26”(660mm)	19.7”(500mm)	SLR-20-	\$1080.00	\$1160.00	\$1240.00	\$1320.00	\$1440.00	\$1480.00
26”(660mm)	25.6”(650mm)	SLR-26-	\$1130.00	\$1210.00	\$1290.00	\$1370.00	\$1490.00	\$1530.00

Haworth Collection

LTB Lounge

Design: Thierry Blet and Catherine Le Teo – Made in U.S.A.

8-Shaped Cushion

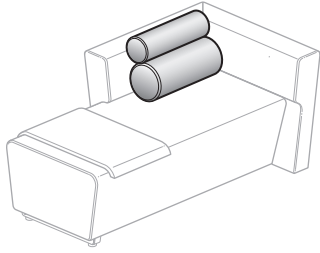

SLC-8

Features

- Fully upholstered cushion.
- Provides additional lumbar support for benches with arm rest.
- COM yardage: 1 yd
- COL square footage: 18 sq ft

To Order, Specify:

1) Product number, including:

1 Surface Option:

- 1 Leather
- 2 Fabric
- 3 Faux Leather

2) Fabric surface and color.

Width	Number 1	Fabric Grade						Leather Grade A	Leather Grade B
		A	B	C	D	E	F		
17.7"(450mm)	SLC-20-■ 8	\$250.00	\$280.00	\$310.00	\$340.00	\$370.00	\$400.00	\$425.00	\$544.00

L-Shaped Cushion

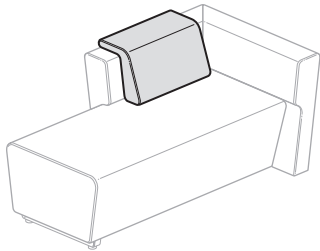

SLC-L

Features

- Fully upholstered cushion.
- Provides additional lumbar support for benches with arm rest.
- COM yardage: 1 yd
- COL square footage: 18 sq ft

To Order, Specify:

1) Product number, including:

1 Surface Option:

- 1 Leather
- 2 Fabric
- 3 Faux Leather

2) Fabric surface and color.

Width	Number 1	Fabric Grade						Leather Grade A	Leather Grade B
		A	B	C	D	E	F		
17.7"(450mm)	SLC-20-■ L	\$230.00	\$260.00	\$290.00	\$320.00	\$350.00	\$380.00	\$405.00	\$524.00

Seating Tray

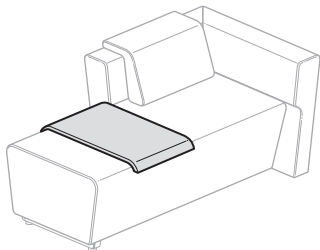

SLY-2012

Height	Depth	Width	Number	Wood	Painted
.47"(12mm)	19.7"(500mm)	11.8"(300mm)	SLY-2012	\$185.00	\$350.00
.47"(12mm)	25.6"(650mm)	11.8"(300mm)	SLY-2612	\$200.00	\$365.00

Feature

- Constructed of bended plywood available in painted or wood finish.

To Order, Specify:

- 1) Product number.
- 2) Finish and color.

Specification Tip

- Depth of seating tray needs to match depth of the bench it is being applied to.

Haworth Collection

LTB Lounge

Design: Thierry Blet and Catherine Le Teo – Made in U.S.A.

	Height	Depth	Width	Number	Price
Linear Table	16.7"(424mm)	19.7"(500mm)	19.7"(500mm)	TLL-2020	\$ 950.00
	16.7"(424mm)	25.6"(650mm)	19.7"(500mm)	TLL-2026	\$1050.00

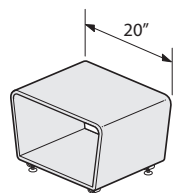

TLL-2020

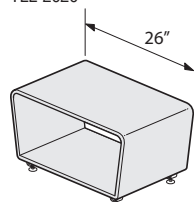

TLL-2026

Features

- Coordinates with the depths of the LTB benches.
- Base: Black plastic adjustable glides.

Specification Tips

- These tables have been designed to be placed at both ends of benches but can also be used as stand alone occasional tables.
- When using at the end of a bench make sure the depth of the table matches the depth of the bench.

To Order, Specify:

- 1) Product number.
- 2) Painted finish.

	Height	Depth	Width	Number	Price
X Link Table	16.7"(424mm)	19.7"(500mm)	19.7"(500mm)	TLX-2020- <input type="checkbox"/>	\$1223.24
	16.7"(424mm)	25.6"(650mm)	25.6"(650mm)	TLX-2626- <input type="checkbox"/>	\$1329.24

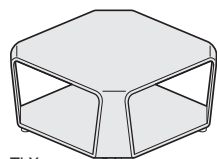
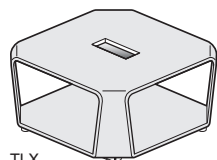
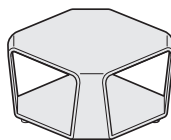
TLX
(No cutout)TLX
(With cutout)

Features

- Coordinates with the depths of the LTB benches.
- Base: Black plastic adjustable glides.
- Power/data access in the top of the tables available with separately specified flip top unit.
- Side power access available with 3 outlet power only.

Specification Tips

- Designed to create right-angled configurations or link 4 LTB benches together in a cross shaped configuration, but can also be used as stand alone occasional table.
- Flip Top Unit/Side Mount Power Unit specified separately.
- Only one cutout available per table.
- If ordering 3 outlet power must order side cutout.

To Order, Specify:

- 1) Product number, including:

I Cutout Options:

- N** No Cutout.
- X** 3 outlet, side cutout only, add \$28.62 list
- F** 4 outlet, single sided, center cutout, add \$28.62 list
- J** 6 outlet, single sided, center cutout, add \$28.62 list

- 2) Painted finish.

	Height	Depth	Width	Number	Price
Coffee Table	16.7"(424mm)	55.1"(1400mm)	19.7"(500mm)	TLL-2055	\$1600.00

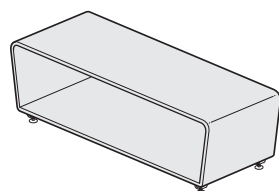

TLL-2055

Feature

- Base: Black plastic adjustable glides.

Specification Tip

- Table can be used as a stand alone occasional table or act as a division of space perpendicular of the benches.

To Order, Specify:

- 1) Product number.
- 2) Painted finish.

	Height	Depth	Width	Number	Price
Bookcase	47.2"(1199mm)	55.1"(1400mm)	19.7"(500mm)	TLB-2055	\$3500.00

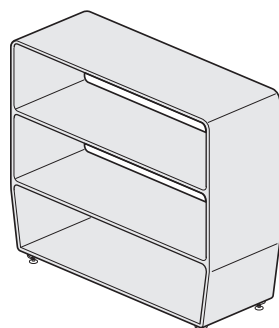

TLB-2055

Features

- Three shelf bookcase.
- Base: Black plastic adjustable glides.
- 12" of clearance between shelves.

Specification Tip

- Can be used as a stand alone bookcase or act as a division of space perpendicular of the benches.

To Order, Specify:

- 1) Product number.
- 2) Painted finish.

Haworth Collection

LTB Lounge

Design: Thierry Blet and Catherine Le Teo — Made in the U.S.A.

Flip Top Unit

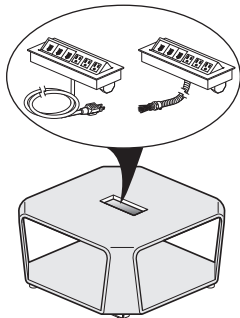

EUE1-0000-1331W



Bezel Width	Bezel Depth	Configuration	Cutout Code Options	Number	Price
Corded Single Sided Outlets					
8 5/16"(211mm)	4 3/8"(111mm)	2 Power, 2 Data	F,J	EUE1-0000-1221W	\$437.75
		3 Power, 1 Data	F,J	EUE1-0000-1311W	437.75
11 1/4"(286mm)	4 3/8"(111mm)	3 Power, 3 Data	F,J	EUE1-0000-1331W	\$437.75
		4 Power, 2 Data	F,J	EUE1-0000-1421W	437.75
Hardwire Single Sided Outlets					
8 5/16"(211mm)	4 3/8"(111mm)	2 Power, 2 Data	F,J	EUE1-0000-C221W	\$499.55
		3 Power, 3 Data	F,J	EUE1-0000-C311W	499.55

Features

- Flip top unit includes one flip top unit with power outlets, 15 Amp NEMA 5-15R configuration and communication openings, mounting clips, multiple data jack adapters to accommodate most varieties of field supplied data jacks, also includes blank data covers.
- Corded Flip Top Unit has 12 foot long, 15A cord with plug.
- Hardwire Flip Top Unit has 6 foot flexible metal conduit feed with wires for hardwire connection.
- Flip top unit is flush mounted with spring release cover.
- Flip top unit overall height is 2 3/4"(70mm) and will extend below the table tops.
- Standard in anodized finish.
- Field installed.
- Ships assembled.

To Order, Specify:

- 1) Product number.
(No finish specification required.)

Specification Tips

- Order flip top units to match center cutouts specified for the LTB X Link Table.
- Flip top unit plug-in cord drops down from bottom of unit to plug into external power outlet.
- **For use with 120 volt 60 hertz power source only.**
- **Electric application requires prior approval by authority having jurisdiction.**
- Corded flip top units with four receptacles utilize a fused plug that may block adjacent building receptacle outlet.
- Flip top unit can be retrofitted; requires field cutout and installation.

Side Mounted Power Unit

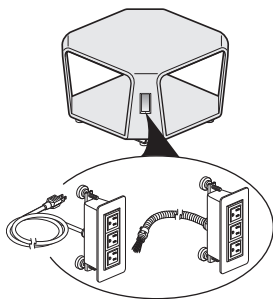

EUB1-0000



Bezel Width	Bezel Depth	Configuration	Cutout Code Options	Number	Price
Corded Side Mounted Outlets					
6 1/2"(165mm)	3"(76mm)	3 Power, 0 Data	X	EUB1-0000-130	\$437.75
Hardwire Side Mounted Outlets					
6 1/2"(165mm)	3"(76mm)	3 Power, 0 Data	X	EUB1-0000-C30V	\$500.75

Features

- Includes three spill resistant 15 Amp 5-15R outlets and mounting hardware.
- Corded unit includes a 6' or 12' long cord with 15 Amp NEMA 5-15P plug.
- Hardwired unit includes 6' flexible metal conduit with wires for connection to building electrical supply.
- Product complies with UL desk top spill test requirements.
- Side-mounted unit sits flush with the side of X Link Table.
- Side-mounted unit has an overall housing depth of 2 1/2"(64mm) and will extend into interior of table.

To Order, Specify:

- 1) Product number, including:

1 Cord Length:

- V 6' cord
- W 12' cord

(No finish specification required.)

Specification Tips

- For use with LTB X Link Table with side cutout option only.
- **For use with 120 volt 60 hertz power source only.**

Haworth Collection

m_sit Lounge

Design: Wolfgang C.R. Mezger — Made in U.S.A.

Lounge Chair

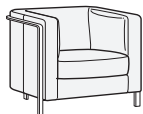

SLMS-FD01

Dimensions

SH: 16.0"(406mm)
TH: 27.6"(700mm)
TD: 30.3"(770mm)
TW: 31.9"(810mm)

Features

- Back: Fully upholstered.
- Seat: Seat cushions are reversible and filled with high density foam and polyester fiber over 3"(76mm) wide strip webbing.
- Base: Exposed steel legs with black plastic glides are available in painted or polished chrome finishes.
- COM yardage: 5.5
- COL square footage: 99

To Order, Specify:

- 1) Product number, including:

① Surface Option:

- 8** Fabric
- 3** Faux Leather
- 7** Leather

- 2) Fabric color.
3) Frame finish color.

Description	Number	①	Fabric Grade								Leather Grade A	Leather Grade B
			A	B	C	D	E	F	G	H		
Painted	SLMS-FD01-	P	\$2833.00	\$3088.00	\$3286.00	\$3567.00	\$4929.00	\$4051.00	\$4335.00	\$4929.00	\$6232.00	\$8107.00
Chrome	SLMS-FD01-	C	2988.00	3243.00	3441.00	3722.00	5084.00	4206.00	4490.00	5084.00	6387.00	8262.00

Settee

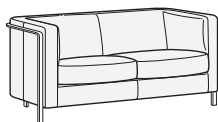

SLMS-FD02

Dimensions

SH: 16.0"(406mm)
TH: 27.6"(700mm)
TD: 30.3"(770mm)
TW: 59.8"(1520mm)

Features

- Back: Fully upholstered.
- Seat: Seat cushions are reversible and filled with high density foam and polyester fiber over 3"(76mm) wide strip webbing.
- Base: Exposed steel legs with black plastic glides are available in painted or polished chrome finishes.
- COM yardage: 7.5
- COL square footage: 135

To Order, Specify:

- 1) Product number, including:

① Surface Option:

- 8** Fabric
- 3** Faux Leather
- 7** Leather

- 2) Fabric color.
3) Frame finish color.

Description	Number	①	Fabric Grade								Leather Grade A	Leather Grade B
			A	B	C	D	E	F	G	H		
Painted	SLMS-FD02-	P	\$3863.00	\$4134.00	\$4404.00	\$4769.00	\$6760.00	\$5743.00	\$6155.00	\$6760.00	\$8112.00	\$10455.00
Chrome	SLMS-FD02-	C	4018.00	4289.00	4559.00	4924.00	6915.00	5898.00	6310.00	6915.00	8267.00	10610.00

Sofa

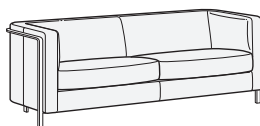

SLMS-FD03

Dimensions

SH: 16.0"(406mm)
TH: 27.6"(700mm)
TD: 30.3"(770mm)
TW: 77.6"(1970mm)

Features

- Back: Fully upholstered.
- Seat: Seat cushions are reversible and filled with high density foam and polyester fiber over 3"(76mm) wide strip webbing.
- Base: Exposed steel legs with black plastic glides are available in painted or polished chrome finishes.
- COM yardage: 9.5
- COL square footage: 171

To Order, Specify:

- 1) Product number, including:

① Surface Option:

- 8** Fabric
- 3** Faux Leather
- 7** Leather

- 2) Fabric color.
3) Frame finish color.

Description	Number	①	Fabric Grade								Leather Grade A	Leather Grade B
			A	B	C	D	E	F	G	H		
Painted	SLMS-FD03-	P	\$4584.00	\$4859.00	\$5134.00	\$5592.00	\$7792.00	\$6515.00	\$6941.00	\$7792.00	\$ 9993.00	\$12974.00
Chrome	SLMS-FD03-	C	4739.00	5014.00	5289.00	5747.00	5794.00	6670.00	7096.00	7947.00	10148.00	13129.00



Haworth Collection

m_sit Tables

Design: Wolfgang C.R. Mezger — Made in U.S.A.

		Description	Number	Price
Square  TOMS-SQP-X TOMS-SQC-X	Dimensions TW: 19.7"(500mm) TD: 19.7"(500mm) TH: 19.7"(500mm)	Painted	TOMS-SQP-X	\$1567.00
		Chrome	TOMS-SQC-X	1840.00
		Features <ul style="list-style-type: none"> Frame: Bent steel. Top: White satined acrylic plexiglass top. Finish: Painted or polished chrome. 	To Order, Specify: <ol style="list-style-type: none"> 1) Product number. 2) Trim color. 	

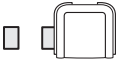
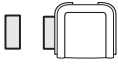
Rectangle  TOMS-RTP-X TOMS-RTC-X	Dimensions TW: 47.2"(1200mm) TD: 23.6"(600mm) TH: 13.8"(350mm)	Painted	TOMS-RTP-X	\$2595.00
		Chrome	TOMS-RTC-X	2868.00
		Features <ul style="list-style-type: none"> Frame: Bent steel. Top: White satined acrylic plexiglass top. Finish: Painted or polished chrome. 	To Order, Specify: <ol style="list-style-type: none"> 1) Product number. 2) Trim color. 	

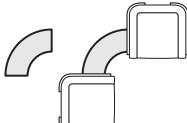
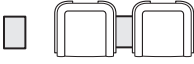
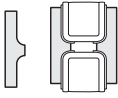
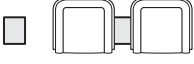
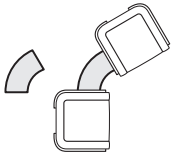
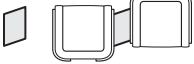
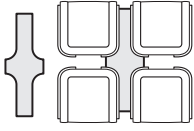
Connection Elements	Element	Number	Price
	Element 1	TOMS-ET01-X	\$130.00
	Element 2	TOMS-ET02-X	165.00
	Element 3	TOMS-ET03-X	308.00
	Element 4	TOMS-ET04-X	509.00
	Element 5	TOMS-ET05-X	208.00
	Element 6	TOMS-ET06-X	522.00
	Element 7	TOMS-ET07-X	177.00
	Element 8	TOMS-ET08-X	406.00
	Element 10	TOMS-ET10-X	247.00
	Element 11	TOMS-ET11-X	956.00

Features

- Top: White satined acrylic plexiglass top.
- Finish: Painted or polished chrome.

To Order, Specify:

- 1) Product number.
(No finish specification required.)

Haworth Collection

Penelope

Design: Charles Pollock — Imported from Europe

		Frame	Seat/Back	Number	Price
Stacking Chair	Dimensions	Chrome	Black Mesh	CAST-0028	\$1535.00
	H: 32"(813mm)	Features		To Order, Specify:	
	SH: 18"(457mm)	<ul style="list-style-type: none"> • Frame: Chrome-plated alloy hardened steel frame. • Seat/Back: Rounded steel wire mesh shell coated with black thermoplastic resins. • Black polyurethane arm caps. • Black nylon glides. • Stacks up to four high. 		1) Product number. (No finish specification required.)	
	D: 25"(635mm)				
	W: 23"(584mm)				



CAST-0028

Haworth Collection

Plia

Design: Giancarlo Piretti — Imported from Europe

		Frame	Seat/Back	Number	Price
Folding Chair	Dimensions H: 30"(762mm) SH: 17"(432mm) OD: 20"(508mm) FD: 1.75"(44.5mm) W: 19"(483mm)	Chrome Frame	Neutral (clear)	CAST-0016	\$485.00
			Smoke	CAST-0017	485.00
		Features		To Order, Specify:	
		<ul style="list-style-type: none"> • Seat: Neutral (clear) or translucent smoke. • Back: Neutral (clear) or translucent smoke. • Frame: Chrome plated steel. 		1) Product number. (No finish specification required.)	

CAST-0016
CAST-0017

			Number	Price
Wall Hook			CAST-0027	\$33.00
		Features	To Order, Specify:	
		<ul style="list-style-type: none"> • Attaches to wall and folds down for storage of up to 4 chairs. • Available in white only. 	1) Product number. (No finish specification required.)	

CAST-0027

Haworth Collection

q_bic
Design: Markus Denstädt — Made in U.S.A.

Lounge Chair

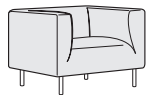

SLQB-FD01-P
SLQB-FD01-C

Dimensions

SH: 17"(432mm)
SD: 26"(660mm)
TH: 28"(711mm)
TD: 34"(869mm)
TW: 37"(930mm)

Features

- Fully upholstered arm panels, seat and back.
- Back: Fully upholstered. Lounge backs are filled with high density foam and polyester fiber over pasted kraftex board.
- Seat: Fully upholstered. Lounge seats are filled with high density foam and polyester fiber over 3"(76mm) wide strip webbing.
- Arms: Fully upholstered.
- Base: Steel legs with black plastic glides available in painted or polished chrome finish.
- COM yardage: 5.5
- COL square footage: 99

To Order, Specify:

- 1) Product number, including:

① Surface Option:

- 8** Fabric
- 3** Faux Leather
- 7** Leather

- 2) Fabric color.
- 3) Frame finish color.

COL Option:

Add the following upcharge, **\$378.00** list.

Fire Retardant Option:

Add **-F** to the product number, and add **\$204.00** list.

Description	Number	①	Fabric Grade								Leather Grade A	Leather Grade B
			A	B	C	D	E	F	G	H		
Painted	SLQB-FD01-	P	\$2225.00	\$2425.00	\$2603.00	\$2870.00	\$3004.00	\$3182.00	\$3337.00	\$3760.00	\$5006.00	\$6539.00
Chrome	SLQB-FD01-	C	2318.00	2518.00	2696.00	2963.00	3853.00	3275.00	3430.00	3853.00	5099.00	6632.00

Settee

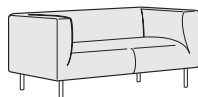

SLQB-FD02-P
SLQB-FD02-C

Dimensions

SH: 17"(432mm)
SD: 26"(660mm)
TH: 28"(711mm)
TD: 34"(869mm)
TW: 65"(1651mm)

Features

- Fully upholstered arm panels, seat and back.
- Back: Fully upholstered. Lounge backs are filled with high density foam and polyester fiber over pasted kraftex board.
- Seat: Fully upholstered. Lounge seats are filled with high density foam and polyester fiber over 3"(76mm) wide strip webbing.
- Arms: Fully upholstered.
- Base: Steel legs with black plastic glides available in painted or polished chrome finish.
- COM yardage: 7.5
- COL square footage: 135

To Order, Specify:

- 1) Product number, including:

① Surface Option:

- 8** Fabric
- 3** Faux Leather
- 7** Leather

- 2) Fabric color.
- 3) Frame finish color.

COL Option:

Add the following upcharge, **\$358.00** list.

Fire Retardant Option:

Add **-F** to the product number, and add **\$278.00** list.

Description	Number	①	Fabric Grade								Leather Grade A	Leather Grade B
			A	B	C	D	E	F	G	H		
Painted	SLQB-FD02-	P	\$3255.00	\$3451.00	\$3613.00	\$3971.00	\$4102.00	\$4882.00	\$5143.00	\$5663.00	\$6998.00	\$9062.00
Chrome	SLQB-FD02-	C	3348.00	3544.00	3706.00	4064.00	4195.00	4975.00	5236.00	5756.00	7091.00	9155.00

Haworth Collection

q_bic

Design: Markus Denstädt — Made in U.S.A.

Sofa

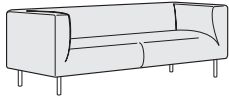
SLQB-FD03-P
SLQB-FD03-C

Dimensions

SH: 17"(432mm)
SD: 26"(660mm)
TH: 28"(711mm)
TD: 34"(869mm)
TW: 78"(1981mm)

Features

- Fully upholstered arm panels, seat and back.
- Back: Fully upholstered. Lounge backs are filled with high density foam and polyester fiber over pasted kraftex board.
- Seat: Fully upholstered. Lounge seats are filled with high density foam and polyester fiber over 3"(76mm) wide strip webbing.
- Arms: Fully upholstered.
- Base: Steel legs with black plastic glides available in painted or polished chrome finish.
- COM yardage: 9.5
- COL square footage: 171

To Order, Specify:

1) Product number, including:

① Surface Option:

- 8 Fabric
- 3 Faux Leather
- 7 Leather

2) Fabric color.

3) Frame finish color.

COL Option:

Add the following upcharge, **\$477.00** list.

Fire Retardant Option:

Add **-F** to the product number, and add **\$352.00** list.

Description	Number	①	Fabric Grade								Leather Grade A	Leather Grade B
			A	B	C	D	E	F	G	H		
Painted	SLQB-FD03-	P	\$3976.00	\$4215.00	\$4453.00	\$4850.00	\$4891.00	\$5606.00	\$5964.00	\$6918.00	\$8548.00	\$11070.00
Chrome	SLQB-FD03-	C	4069.00	4308.00	4546.00	4943.00	4984.00	5699.00	6057.00	7011.00	8641.00	11163.00

Haworth Collection

q_bic
Design: Markus Denstädt — Made in U.S.A.

Small Bench

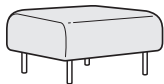

SLQB-BCSM-P
SLQB-BCSM-C

Dimensions

SH: 18.1"(460mm)
TH: 17.7"(450mm)
TD: 34.3"(870mm)
TW: 34.3"(870mm)

Features

- Seat: Fully upholstered. Lounge seats are filled with high density foam and polyester fiber over 3"(76mm) wide strip webbing.
- Base: Steel legs with black plastic glides available in painted or chrome finish.
- COM yardage: 2.75
- COL square footage: 49.5

To Order, Specify:

1) Product number, including:

① Surface Option:

- 8 Fabric
- 3 Faux Leather
- 7 Leather

2) Fabric color.

3) Frame finish color.

COL Option:

Add the following upcharge, **\$147.00** list.

Fire Retardant Option:

Add **-F** to the product number, and add **\$102.00** list.

Description	Number ①	Fabric Grade								Leather Grade A	Leather Grade B
		A	B	C	D	E	F	G	H		
Painted	SLQB-BCSM- <input type="checkbox"/> P	\$1040.00	\$1108.00	\$1187.00	\$1289.00	\$1391.00	\$1493.00	\$1595.00	\$1742.00	\$2048.00	\$2605.00
Chrome	SLQB-BCSM- <input type="checkbox"/> C	1133.00	1201.00	1280.00	1382.00	1484.00	1586.00	1688.00	1835.00	2141.00	2698.00

Large Bench

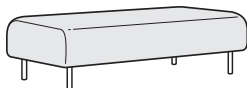

SLQB-BCLG-P
SLQB-BCLG-C

Dimensions

SH: 18.1"(460mm)
TH: 17.7"(450mm)
TD: 26"(660mm)
TW: 64.2"(1630mm)

Features

- Seat: Fully upholstered. Lounge seats are filled with high density foam and polyester fiber over 3"(76mm) wide strip webbing.
- Base: Steel legs with black plastic glides available in painted or chrome finish.
- COM yardage: 3.25
- COL square footage: 58.5

To Order, Specify:

1) Product number, including:

① Surface Option:

- 8 Fabric
- 3 Faux Leather
- 7 Leather

2) Fabric color.

3) Frame finish color.

COL Option:

Add the following upcharge, **\$180.00** list.

Fire Retardant Option:

Add **-F** to the product number, and add **\$121.00** list.

Description	Number ①	Fabric Grade								Leather Grade A	Leather Grade B
		A	B	C	D	E	F	G	H		
Painted	SLQB-BCLG- <input type="checkbox"/> P	\$1298.00	\$1381.00	\$1478.00	\$1604.00	\$1729.00	\$1854.00	\$1979.00	\$2160.00	\$2535.00	\$3217.00
Chrome	SLQB-BCLG- <input type="checkbox"/> C	1391.00	1474.00	1571.00	1697.00	2253.00	1947.00	2072.00	2253.00	2628.00	3310.00

Haworth Collection

q_bic

Design: Markus Denstädt — Made in U.S.A.

		Description	Number	Price
Steel and Glass Square Table	Dimensions H: 15"(381mm) W: 28.46"(724mm) L: 28.46"(724mm)	Painted	TOQB-SQGP	\$3207.00
		Chrome	TOQB-SQGC	3432.00
		Features	To Order, Specify:	
TOQB-SQGP TOQB-SQGC		<ul style="list-style-type: none"> Frame: Steel frame in painted or polished chrome finish. Top: Clear (tempered) glass. 	<ol style="list-style-type: none"> Product number. Glass color. Frame color. 	

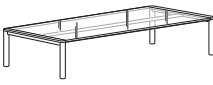
Steel and Glass Rectangle Table	Dimensions H: 15"(381mm) W: 28.46"(724mm) L: 49.2"(1250mm)	Painted	TOQB-RTGP	\$3735.00
		Chrome	TOQB-RTGC	3960.00
		Features	To Order, Specify:	
TOQB-RTGP TOQB-RTGC		<ul style="list-style-type: none"> Frame: Steel frame in painted or polished chrome finish. Top: Clear (tempered) glass. 	<ol style="list-style-type: none"> Product number. Glass color. Frame color. 	

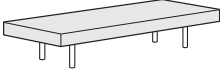
	Dimensions	Description	Number ①②		Painted	Chrome
Wood Rectangular Table	H: 8.6"(216mm) W: 23.6"(597mm) L: 55.1"(1400mm)	Veneer	TOQB-RTW-■ ■		\$2582.00	\$2675.00
		Features	To Order, Specify:			
TOQB-RTW		<ul style="list-style-type: none"> Finish: Wood veneer standard in 5 finishes. Frame: Steel frame painted or polished chrome finish. 	<ol style="list-style-type: none"> Product number, including: <ul style="list-style-type: none"> ① Wood Finish Option: <ul style="list-style-type: none"> B Beachwood E Ebony M Melba S Sorrel W Wenge ② Frame Finish Option: <ul style="list-style-type: none"> P Painted C Chrome Wood color. Frame color. 			

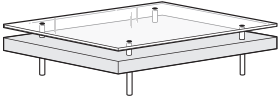
	Dimensions	Description	Number ①②		Painted	Chrome
Double Tier Square Table	H: 12"(305mm) W: 47.5"(1207mm) L: 47.5"(1207mm)	Veneer/glass top	TOQB-SQT-■ ■		\$4411.00	\$4504.00
		Features	To Order, Specify:			
TOQB-SQT		<ul style="list-style-type: none"> Option: Steel and glass tables, wood tables and Double tier tables. Finish: Match options of q_bic lounge chairs, wood veneer standard in 5 finishes. Frame: Steel frame in powder coat paint or polished chrome. Top: Clear (tempered) glass. 	<ol style="list-style-type: none"> Product number, including: <ul style="list-style-type: none"> ① Wood Finish Option: <ul style="list-style-type: none"> B Beachwood E Ebony M Melba S Sorrel W Wenge ② Frame Finish Option: <ul style="list-style-type: none"> P Painted C Chrome Wood color. Frame color. 			

Haworth Collection

s_con

Design: Lepper, Schmidt, Sommerlade — Imported from Europe

High Back Executive Chair



SCON-EHB

Dimensions

SH: 16.5"-20.8"
(420mm)-(530mm)
TH: 45"-49.8"
(1143mm-1265mm)
TD: 26.7"(680mm)
TW: 26.7"(680mm)
SD: 20"(508mm)
AH: 9.6"(245mm)

Features

- Back: Upholstered
- Seat: Upholstered
- Base: Available in painted, chrome, or polished aluminum.
- Arms: Aluminum loop armrest options include natural beech or leather.
- Comfort Plus upholstery.
- COM yardage: 1.1
- COL square footage: 19.8

To Order, Specify:

1) Product number, including:

1 Fabric Price Group Option:

- X COM or COL
- 1 Collection 82
- 3 Collection 39
- 8 Collection 97 (Leather)

2 Arm Cap Option:

- B Natural Beech
- L Leather (Available only with Leather upholstered chairs. Leather armrest will match leather chair), add **\$129.00** list

3 Surface Option:

- M COM
- N COL
- B Collection 82
- C Collection 39
- F Collection 97 (Leather)

4 Caster Option:

- S Soft
- H Hard

2) Fabric color.

3) Trim color.

Description	Number	① ② ③ ④				(COM)	(COL)	Fabric Collection		Leather Collection
								82	39	97
Painted Base	SCON-EHB	<input type="checkbox"/> -C	<input type="checkbox"/> P	<input type="checkbox"/>	<input type="checkbox"/>	\$2602.00	\$3030.00	\$2603.00	\$2655.00	\$3030.00
Polished Aluminum Base	SCON-EHB	<input type="checkbox"/> -C	<input type="checkbox"/> A	<input type="checkbox"/>	<input type="checkbox"/>	2701.00	3129.00	2702.00	2754.00	3129.00
Chrome Base	SCON-EHB	<input type="checkbox"/> -C	<input type="checkbox"/> C	<input type="checkbox"/>	<input type="checkbox"/>	2835.00	3263.00	2836.00	2888.00	3263.00

Haworth Collection

S_con

Design: Lepper, Schmidt, Sommerlade — Imported from Europe

Mid Back Executive Chair



SCON-EHB

Dimensions

SH: 16.5"-20.8"
(420mm)-(530mm)
TH: 45"-49.8"
(1143mm-1265mm)
TD: 26.7"(680mm)
TW: 26.7"(680mm)
SD: 20"(508mm)
AH: 9.6"(245mm)

Features

- Back: Upholstered
- Seat: Upholstered
- Base: Available in painted, chrome, or polished aluminum.
- Arms: Aluminum loop armrest options include natural beech or leather.
- COM yardage: 1.1
- COL square footage: 19.8

To Order, Specify:

1) Product number, including:

1 Fabric Price Group Option:

- X COM or COL
- 1 Collection 82
- 3 Collection 39
- 8 Collection 97 (Leather)

2 Arm Cap Option:

- B Natural Beech
- L Leather (Available only with Leather upholstered chairs. Leather armrest will match leather chair), add \$129.00 list

3 Surface Option:

- M COM
- N COL
- B Collection 82
- C Collection 39
- F Collection 97 (Leather)

4 Caster Option:

- S Soft
- H Hard

2) Fabric color.

3) Trim color.

Description	Number	1	2	3	4	(COM)	(COL)	Fabric Collection 82	Collection 39	Leather Collection 97
Painted Base	SCON-EHB	<input type="checkbox"/>	<input type="checkbox"/> S	<input type="checkbox"/> P	<input type="checkbox"/>	\$2602.00	\$3030.00	\$2603.00	\$2655.00	\$3030.00
Polished Aluminum Base	SCON-EHB	<input type="checkbox"/>	<input type="checkbox"/> S	<input type="checkbox"/> A	<input type="checkbox"/>	2701.00	3129.00	2702.00	2754.00	3129.00
Chrome Base	SCON-EHB	<input type="checkbox"/>	<input type="checkbox"/> S	<input type="checkbox"/> C	<input type="checkbox"/>	2835.00	3263.00	2836.00	2888.00	3263.00

Haworth Collection

s_con

Design: Lepper, Schmidt, Sommerlade — Imported from Europe

Low Back Task Chair



SCON-SWC

Dimensions

SH: 16.5"-20.8"
(420mm)-(530mm)
TH: 35.8"-40.1"
(910mm)-(1020mm)
TD: 26.7"(680mm)
TW: 26.7"(680mm)
SD: 19.2"(490mm)
AH: 9.6"(245mm)

Features

- Back: Upholstered.
- Seat: Upholstered.
- Base: Available in painted, polished chrome, or polished aluminum.
- Arm: Arm rest options include natural beech or leather.
- COM yardage: .8
- COL square footage: 14.4

To Order, Specify:

1) Product number, including:

1 Fabric Price Group Option:

- X COM or COL
- 1 Collection 82
- 3 Collection 39
- 8 Collection 97 (Leather)

2 Arm Cap Option:

- B Natural Beech
- L Black Leather (Available only with Leather upholstered chairs), add \$129.00 list

3 Surface Option:

- M COM
- N COL
- B Collection 82
- C Collection 39
- F Collection 97 (Leather)

4 Caster Option:

- S Soft
- H Hard

2) Fabric color.

3) Trim color.

Description	Number	Options				(COM)	(COL)	Fabric Collection		Leather Collection
		1	2	3	4			82	39	
Painted Base	SCON-SWC	<input type="checkbox"/> S	<input type="checkbox"/> P	<input type="checkbox"/>	<input type="checkbox"/>	\$2337.00	\$2765.00	\$2338.00	\$2390.00	\$2765.00
Polished Aluminum Base	SCON-SWC	<input type="checkbox"/> S	<input type="checkbox"/> A	<input type="checkbox"/>	<input type="checkbox"/>	2436.00	2864.00	2437.00	2489.00	2864.00
Chrome Base	SCON-SWC	<input type="checkbox"/> S	<input type="checkbox"/> C	<input type="checkbox"/>	<input type="checkbox"/>	2570.00	2998.00	2571.00	2623.00	2998.00

Haworth Collection

S_con

Design: Lepper, Schmidt, Sommerlade — Imported from Europe

Standard Back Sled Base Conference Chair



SCON-SBC

Dimensions

SH: 18.1"(460mm)
 TH: 35.4"(900mm)
 TD: 22.8"(580mm)
 TW: 22"(560mm)
 SD: 19.2"(490mm)
 AH: 8.7"(222mm)

Features

- Back: Upholstered.
- Seat: Upholstered.
- Base: Steel tube sled base.
- Arm: Arm rest options include natural beech or leather.
- COM yardage: .8
- COL square footage: 14.4

To Order, Specify:

1) Product number, including:

① Fabric Price Group Option:

- X COM or COL
- 1 Collection 82
- 3 Collection 39
- 8 Collection 97 (Leather)

② Arm Cap Option:

- B Natural Beech
- L Black Leather, (Available only with Leather upholstered chairs, add \$129.00 list)

③ Surface Option:

- M COM Fabric
- N COL
- B Collection 82
- C Collection 39
- F Collection 97 (Leather)

④ Glide Option:

- P Plastic
- F Felt

2) Fabric color.

3) Arm/frame finish color.

Description	Number ① ②③④	(COM)	(COL)	Fabric Collection		Leather Collection
				82	39	97
Painted Base	SCON-SBC <input type="checkbox"/> -SA <input type="checkbox"/> <input type="checkbox"/> <input type="checkbox"/>	\$1911.00	\$2259.00	\$1926.00	\$1975.00	\$2259.00
Polished Aluminum Base	SCON-SBC <input type="checkbox"/> -AA <input type="checkbox"/> <input type="checkbox"/> <input type="checkbox"/>	2010.00	2358.00	2025.00	2074.00	2358.00
Chrome Base	SCON-SBC <input type="checkbox"/> -CA <input type="checkbox"/> <input type="checkbox"/> <input type="checkbox"/>	2145.00	2493.00	2160.00	2209.00	2493.00

Haworth Collection

s_con

Design: Lepper, Schmidt, Sommerlade — Imported from Europe

High Back Sled Base Conference Chair



SCON-HBC

Dimensions

SH: 18.1"(460mm)
TH: 40.9"(1040mm)
TD: 22.8"(580mm)
TW: 22"(560mm)
SD: 19.2"(490mm)
AH: 8.7"(222mm)

Features

- Back: Upholstered.
- Seat: Upholstered.
- Base: Steel tube sled base.
- Arm: Arm rest options include natural beech or leather.
- COM yardage: 1.1
- COL square footage: 19.8

To Order, Specify:

1) Product number, including:

1 Fabric Price Group Option:

- X COM or COL
- 1 Collection 82
- 3 Collection 39
- 8 Collection 97 (Leather)

2 Arm Cap Option:

- B Natural Beech
- L Black Leather, (Available only with Leather upholstered chairs, add \$129.00 list)

3 Surface Option:

- M COM Fabric
- N COL
- B Collection 82
- C Collection 39
- F Collection 97 (Leather)

4 Glide Option:

- P Plastic
- F Felt

2) Fabric color.

3) Arm/frame finish color.

Description	Number 1 2 3 4	(COM)	(COL)	Fabric Collection		Leather Collection
				82	39	97
Painted Base	SCON-HBC -SA	\$1953.00	\$2301.00	\$1968.00	\$2017.00	\$2301.00
Polished Aluminum Base	SCON-HBC -AA	2052.00	2400.00	2067.00	2116.00	2400.00
Chrome Base	SCON-HBC -CA	2187.00	2535.00	2202.00	2251.00	2535.00

Haworth Collection

S_con

Design: Lepper, Schmidt, Sommerlade — Imported from Europe

Stacking Conference Chair



SCON-STC

Dimensions

SH: 18.1"(460mm)
 TH: 35.4"(900mm)
 TD: 22.8"(580mm)
 TW: 22.04"(560mm)
 SD: 19.2"(490mm)
 AH: 8.7"(222mm)

Features

- Back: Upholstered.
- Seat: Upholstered.
- Base: Steel tube sled base.
- Stacking: 4 high.
- COM yardage: .8
- COL square footage: 9.9

To Order, Specify:

1) Product number, including:

① Price Group Option:

- X COM or COL
 1 Collection 82
 3 Collection 39
 8 Collection 97 (Leather)

② Arm Cap Option:

- B Natural Beech
 L Black Leather, (Available only with Leather upholstered chairs), add \$129.00 list

③ Surface Option:

- M COM Fabric
 N COL
 B Collection 82
 C Collection 39
 F Collection 97 (Leather)

④ Glide Option:

- P Plastic
 F Felt

2) Fabric color.

3) Arm/frame finish color.

Description	Number ① ②③④	(COM)	(COL)	Fabric Collection		Leather Collection
				82	39	97
Painted Base	SCON-STC <input type="checkbox"/> -SA <input type="checkbox"/> <input type="checkbox"/> <input type="checkbox"/>	\$1997.00	\$2345.00	\$2012.00	\$2061.00	\$2345.00
Polished Aluminum Base	SCON-STC <input type="checkbox"/> -AA <input type="checkbox"/> <input type="checkbox"/> <input type="checkbox"/>	2096.00	2444.00	2111.00	2160.00	2444.00
Chrome Base	SCON-STC <input type="checkbox"/> -CA <input type="checkbox"/> <input type="checkbox"/> <input type="checkbox"/>	2231.00	2579.00	2246.00	2295.00	2579.00

Haworth Collection

SE04 Lounge — One Color Upholstery
Design: José Serrano — Made in U.S.A.

Single Trapezoid

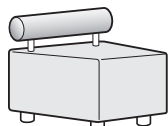

SLSE-TR01-P
SLSE-TR01-B

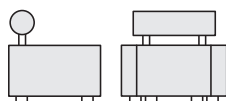

Dimensions

SH: 17.5"(445mm)
SW: 27.8"(706mm)
SD: 28"(711mm)

Features

- Upholstered armless lounge seating with attached bolster style back.
- Seat: Single unit.
- Base: Aluminum available in painted or anodized aluminum finishes.
- COM yardage: 3.75
- COL square footage: 67.5

Nano-Tex Option:

To specify, add **P** to the end of the product number.
Example: SLSE-TR01-8PP, add **\$52.00** list.

Durablock Option:

To specify, add **D** to the end of the product number.
Example: SLSE-TR01-8PD, add **\$82.00** list.

To Order, Specify:

- 1) Product number, including:

1 Surface Option:

- 8** Fabric
- 3** Faux Leather
- 7** Leather

- 2) Fabric surface and color.
- 3) Frame finish color.

COL Option:

Add the following upcharge, **\$224.00** list.

Fire Retardant Option:

Add **-F** to the product number, and add **\$130.00** list.

Description	Number	1	Fabric Grade								Leather Grade A	Leather Grade B
			A	B	C	D	E	F	G	H		
Painted Frame	SLSE-TR01-	P	\$1447.00	\$1521.00	\$1671.00	\$1805.00	\$1925.00	\$2059.00	\$2238.00	\$2612.00	\$3194.00	\$4157.00
Anodized Aluminum Frame	SLSE-TR01-	B	1493.00	1567.00	1717.00	1851.00	1971.00	2105.00	2284.00	2658.00	3240.00	4203.00

Single Square

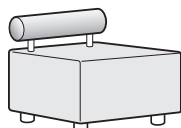

SLSE-SQ01-P
SLSE-SQ01-B

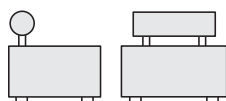

Dimensions

SH: 17.5"(445mm)
SW: 31.5"(800mm)
SD: 28"(711mm)

Features

- Upholstered armless lounge seating with attached bolster style back.
- Seat: Single unit.
- Base: Aluminum available in painted or anodized aluminum finishes.
- COM yardage: 3.75
- COL square footage: 67.5

Nano-Tex Option:

To specify, add **P** to the end of the product number.
Example: SLSE-SQ01-8PP, add **\$52.00** list.

Durablock Option:

To specify, add **D** to the end of the product number.
Example: SLSE-SQ01-8PD, add **\$82.00** list.

To Order, Specify:

- 1) Product number, including:

1 Surface Option:

- 8** Fabric
- 3** Faux Leather
- 7** Leather

- 2) Fabric surface and color.
- 3) Frame finish color.

COL Option:

Add the following upcharge, **\$224.00** list.

Fire Retardant Option:

Add **-F** to the product number, and add **\$139.00** list.

Description	Number	1	Fabric Grade								Leather Grade A	Leather Grade B
			A	B	C	D	E	F	G	H		
Painted Frame	SLSE-SQ01-	P	\$1447.00	\$1521.00	\$1671.00	\$1805.00	\$1925.00	\$2059.00	\$2238.00	\$2612.00	\$3194.00	\$4157.00
Anodized Aluminum Frame	SLSE-SQ01-	B	1493.00	1567.00	1717.00	1851.00	1971.00	2105.00	2284.00	2658.00	3240.00	4203.00

Haworth Collection

SE04 Lounge — Two Color Upholstery

Design: José Serrano — Made in U.S.A.

Single Trapezoid

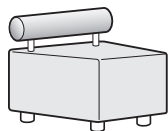
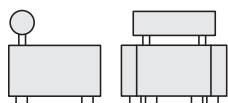
SLSE-TRT1-P
SLSE-TRT1-BT

Dimensions

SH: 17.5"(445mm)
SW: 27.8"(706mm)
SD: 28"(711mm)

Features

- Upholstered armless lounge seating with attached bolster style back.
- Seat: Single unit.
- Base: Aluminum available in painted or anodized aluminum finishes.
- Optional: Two fabrics / one fabric two colors available on seat and back bolster.
- COM yardage: 3/.75
- COL square footage: 54/13.5

Nano-Tex Option:

To specify, add **P** to the end of the product number.
Example: SLSE-TRT1-8PTD, add **\$52.00** list.

Durablock Option:

To specify, add **D** to the end of the product number.
Example: SLSE-TRT1-8PTD, add **\$82.00** list.

To Order, Specify:

1) Product number, including:

① Surface Option:

- 8** Fabric
- 3** Faux Leather
- 7** Leather

2) Fabric surface and color.
A. Seat color.
B. Bolster color.

3) Frame finish color.

COL Option:

Add the following upcharge, **\$224.00** list.

Fire Retardant Option:

Add **-F** to the product number, and add **\$130.00** list.

Description	Number	①	Fabric Grade								Leather Grade A	Leather Grade B
			A	B	C	D	E	F	G	H		
Painted Frame	SLSE-TRT1-	PT	\$1705.00	\$1853.00	\$2153.00	\$2421.00	\$2661.00	\$2929.00	\$3287.00	\$4035.00	\$5199.00	\$7125.00
Anodized Aluminum Frame	SLSE-TRT1-	BT	1751.00	1899.00	2199.00	2467.00	2707.00	2975.00	3333.00	4081.00	5245.00	7171.00

Single Square

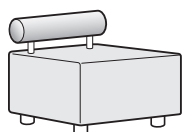
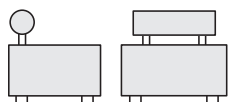
SLSE-SQT1-PT
SLSE-SQT1-BT

Dimensions

SH: 17.5"(445mm)
SW: 31.5"(800mm)
SD: 28"(711mm)

Features

- Upholstered armless lounge seating with attached bolster style back.
- Seat: Single unit.
- Base: Aluminum available in painted or anodized aluminum finishes.
- Optional: Two fabrics / one fabric two colors available on seat and back bolster.
- COM yardage: 3/.88
- COL square footage: 54/15.84

Nano-Tex Option:

To specify, add **P** to the end of the product number.
Example: SLSE-SQT1-8PTP, add **\$52.00** list.

Durablock Option:

To specify, add **D** to the end of the product number.
Example: SLSE-SQT1-8PTD, add **\$82.00** list.

To Order, Specify:

1) Product number, including:

① Surface Option:

- 8** Fabric
- 3** Faux Leather
- 7** Leather

2) Fabric surface and color.
A. Seat color.
B. Bolster color.

3) Frame finish color.

COL Option:

Add the following upcharge, **\$224.00** list.

Fire Retardant Option:

Add **-F** to the product number, and add **\$139.00** list.

Description	Number	①	Fabric Grade								Leather Grade A	Leather Grade B
			A	B	C	D	E	F	G	H		
Painted Frame	SLSE-SQT1-	PT	\$1705.00	\$1853.00	\$2153.00	\$2421.00	\$2661.00	\$2929.00	\$3287.00	\$4035.00	\$5199.00	\$7125.00
Anodized Aluminum Frame	SLSE-SQT1-	BT	1751.00	1899.00	2199.00	2467.00	2707.00	2975.00	3333.00	4081.00	5245.00	7171.00

NOTE:

For different fabric grades on seat and back bolster, pricing will be determined by the sum of the upcharges of the selected fabric grades. (i.e. when choosing Grade B fabric for the seat and Grade D fabric for the back bolster, the final price will reflect the upcharge for a Grade B seat plus the upcharge for the Grade D bolster.)

Haworth Collection

SE04 Lounge — One Color Upholstery
Design: José Serrano — Made in U.S.A.

Double Trapezoid

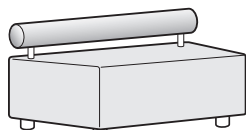

SLSE-TR02-P
SLSE-TR02-B

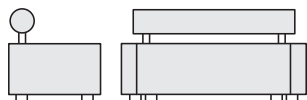

Dimensions

SH: 17.5"(445mm)
SW: 45.8"(1163mm)
SD: 28"(711mm)

Features

- Upholstered armless lounge seating with attached bolster style back.
- Seat: Double unit.
- Base: Aluminum available in painted or anodized aluminum finishes.
- COM yardage: 4.25
- COL square footage: 76.5

Nano-Tex Option:

To specify, add **P** to the end of the product number.
Example: SLSE-TR02-8PP, add **\$103.00** list.

Durablock Option:

To specify, add **D** to the end of the product number.
Example: SLSE-TR02-8PD, add **\$165.00** list.

To Order, Specify:

1) Product number, including:

① Surface Option:

- 8** Fabric
- 3** Faux Leather
- 7** Leather

2) Fabric surface and color.
3) Frame finish color.

COL Option:

Add the following upcharge, **\$243.00** list.

Fire Retardant Option:

Add **-F** to the product number, and add **\$148.00** list.

Description	Number	①	Fabric Grade								Leather Grade A	Leather Grade B
			A	B	C	D	E	F	G	H		
Painted Frame	SLSE-TR02-	P	\$2168.00	\$2434.00	\$2655.00	\$3164.00	\$3297.00	\$4138.00	\$4626.00	\$5379.00	\$4758.00	\$6187.00
Anodized Aluminum Frame	SLSE-TR02-	B	2214.00	2480.00	2701.00	3210.00	3343.00	4184.00	4672.00	5425.00	4804.00	6233.00

Double Square

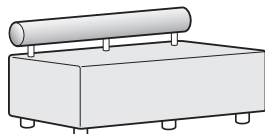

SLSE-SQ02-P
SLSE-SQ02-B

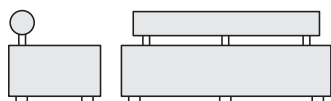

Dimensions

SH: 17.5"(445mm)
SW: 63.0"(1600mm)
SD: 28"(711mm)

Features

- Upholstered armless lounge seating with attached bolster style back.
- Seat: Double unit.
- Base: Aluminum available in painted or anodized aluminum finishes.
- COM yardage: 6
- COL square footage: 108

Nano-Tex Option:

To specify, add **P** to the end of the product number.
Example: SLSE-SQ02-8PP, add **\$103.00** list.

Durablock Option:

To specify, add **D** to the end of the product number.
Example: SLSE-SQ02-8PD, add **\$165.00** list.

To Order, Specify:

1) Product number, including:

① Surface Option:

- 8** Fabric
- 3** Faux Leather
- 7** Leather

2) Fabric surface and color.
3) Frame finish color.

COL Option:

Add the following upcharge, **\$243.00** list.

Fire Retardant Option:

Add **-F** to the product number, and add **\$222.00** list.

Description	Number	①	Fabric Grade								Leather Grade A	Leather Grade B
			A	B	C	D	E	F	G	H		
Painted Frame	SLSE-SQ02-	P	\$2168.00	\$2434.00	\$2655.00	\$3164.00	\$3297.00	\$4138.00	\$4626.00	\$5379.00	\$4758.00	\$6187.00
Anodized Aluminum Frame	SLSE-SQ02-	B	2214.00	2480.00	2701.00	3210.00	3343.00	4184.00	4672.00	5425.00	4804.00	6233.00

Haworth Collection

SE04 Lounge — Two Color Upholstery

Design: José Serrano — Made in U.S.A.

Double Trapezoid

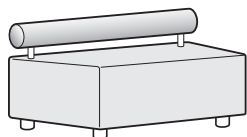

SLSE-TRT2-PT
SLSE-TRT2-BT

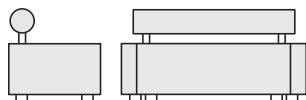

Dimensions

SH: 17.5"(445mm)
SW: 45.8"(1163mm)
SD: 28"(711mm)

Features

- Upholstered armless lounge seating with attached bolster style back.
- Seat: Double unit.
- Base: Aluminum available in painted or anodized aluminum finishes.
- Optional: Optional two fabrics / one fabric two colors available on seat and back bolster.
- COM yardage: 3.25/1
- COL square footage: 58.5/18

Nano-Tex Option:

To specify, add **P** to the end of the product number.
Example: SLSE-TRT2-8PTP, add **\$103.00** list.

Durablock Option:

To specify, add **D** to the end of the product number.
Example: SLSE-TRT2-8PTD, add **\$165.00** list.

To Order, Specify:

1) Product number, including:

1 Surface Option:

- 8** Fabric
- 3** Faux Leather
- 7** Leather

2) Fabric surface and color.
A. Seat color.
B. Bolster color.

3) Frame finish color.

COL Option:

Add the following upcharge, **\$243.00** list.

Fire Retardant Option:

Add **-F** to the product number, and add **\$148.00** list.

Description	Number ①	Fabric Grade								Leather Grade A	Leather Grade B
		A	B	C	D	E	F	G	H		
Painted Frame	SLSE-TRT2-PT	\$2426.00	\$2958.00	\$3400.00	\$4418.00	\$4684.00	\$6366.00	\$7342.00	\$8848.00	\$7606.00	\$10464.00
Anodized Aluminum Frame	SLSE-TRT2-BT	2472.00	3004.00	3446.00	4464.00	4730.00	6412.00	7388.00	8894.00	7652.00	10510.00

Double Square

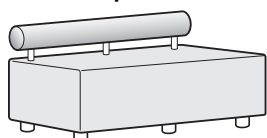

SLSE-SQT2-PT
SLSE-SQT2-BT

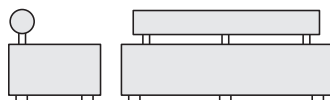

Dimensions

SH: 17.5"(445mm)
SW: 63.0"(1600mm)
SD: 28"(711mm)

Features

- Upholstered armless lounge seating with attached bolster style back.
- Seat: Double unit.
- Base: Aluminum available in painted or anodized aluminum finishes.
- Optional: Optional two fabrics / one fabric two colors available on seat and back bolster.
- COM yardage: 4.5/1.5
- COL square footage: 81/27

Nano-Tex Option:

To specify, add **P** to the end of the product number.
Example: SLSE-SQT2-8PTP, add **\$103.00** list.

Durablock Option:

To specify, add **D** to the end of the product number.
Example: SLSE-SQT2-8PTD, add **\$165.00** list.

To Order, Specify:

1) Product number, including:

1 Surface Option:

- 8** Fabric
- 3** Faux Leather
- 7** Leather

2) Fabric surface and color.
A. Seat color.
B. Bolster color.

3) Frame finish color.

COL Option:

Add the following upcharge, **\$243.00** list.

Fire Retardant Option:

Add **-F** to the product number, and add **\$222.00** list.

Description	Number ①	Fabric Grade								Leather Grade A	Leather Grade B
		A	B	C	D	E	F	G	H		
Painted Frame	SLSE-SQT2-PT	\$2426.00	\$2958.00	\$3400.00	\$4418.00	\$4684.00	\$6366.00	\$7342.00	\$8848.00	\$7606.00	\$10464.00
Anodized Aluminum Frame	SLSE-SQT2-BT	2472.00	3004.00	3446.00	4464.00	4730.00	6412.00	7388.00	8894.00	7652.00	10510.00

NOTE:

For different fabric grades on seat and back bolster, pricing will be determined by the sum of the upcharges of the selected fabric grades. (i.e. when choosing Grade B fabric for the seat and Grade D fabric for the back bolster, the final price will reflect the upcharge for a Grade B seat plus the upcharge for the Grade D bolster.)

Haworth Collection

SE04 Lounge

Design: José Serrano — Made in U.S.A.

Single Seat Bench

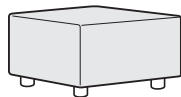
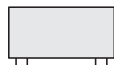
SLSE-SQB1-P
SLSE-SQB1-B

Dimensions

SH: 17.5"(445mm)
SW: 31.5"(800mm)
SD: 28"(711mm)

Features

- Seat: Single unit.
- Base: Aluminum legs and back stand-offs available in painted or anodized aluminum finishes.
- COM yardage: 3
- COL square footage: 54

To Order, Specify:

- 1) Product number, including:

① Surface Option:

- 8** Fabric
- 3** Faux Leather
- 7** Leather

- 2) Frame finish color.

Nano-Tex Option:

To specify, add **P** to the end of the product number.

Example: SLSE-SQT1-8BP, add \$52.00 for single seat.



Durablock Option:

To specify, add **D** to the end of the product number.

Example: SLSE-TRT2-3BD, add \$82.00 for single seat.

Fire Retardant Option:

Add **-F** to the product number, and add \$139.00 list.

Description	Number ①	Fabric Grade								Leather Grade A	Leather Grade B
		A	B	C	D	E	F	G	H		
Painted Frame	SLSE-SQB1-  P	\$906.00	\$951.00	\$1006.00	\$1123.00	\$1178.00	\$1278.00	\$1386.00	\$1586.00	\$1722.00	\$2171.00
Anodized Aluminum Frame	SLSE-SQB1-  B	952.00	997.00	1052.00	1169.00	1224.00	1324.00	1432.00	1632.00	1768.00	2217.00

Double Seat Bench

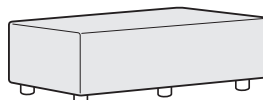
SLSE-SQB2-P
SLSE-SQB2-B

Dimensions

SH: 17.5"(445mm)
SW: 63.0"(1600mm)
SD: 28"(711mm)

Features

- Seat: Double unit.
- Base: Aluminum legs and back stand-offs available in painted or anodized aluminum finishes.
- COM yardage: 4.5
- COL square footage: 81

To Order, Specify:

- 1) Product number, including:

① Surface Option:

- 8** Fabric
- 3** Faux Leather
- 7** Leather

- 2) Frame finish color.

Nano-Tex Option:

To specify, add **P** to the end of the product number.

Example: SLSE-SQT1-8BP, add \$103.00 for single seat.



Durablock Option:

To specify, add **D** to the end of the product number.

Example: SLSE-TRT2-3BD, add \$165.00 for single seat.

Fire Retardant Option:

Add **-F** to the product number, and add \$222.00 list.

Description	Number ①	Fabric Grade								Leather Grade A	Leather Grade B
		A	B	C	D	E	F	G	H		
Painted Frame	SLSE-SQB2-  P	\$1318.00	\$1383.25	\$1463.00	\$1632.65	\$1712.40	\$1857.40	\$2014.00	\$2304.00	\$2501.20	\$3152.25
Anodized Aluminum Frame	SLSE-SQB2-  B	1364.00	1429.25	1509.00	1678.65	1758.40	1903.40	2060.00	2350.00	2547.20	3198.25

Haworth Collection

SE04 Lounge

Design: José Serrano — Made in U.S.A.

Single Cube

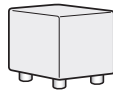

SLSE-CUB1-8P
SLSE-CUB1-8B



Dimensions
SH: 17.5"(445mm)
SW: 16"(406mm)
SD: 16"(406mm)

- Features**
- Seat: Single cushion unit.
 - Base: Aluminum legs available in painted or anodized aluminum finishes.
 - COM yardage: 1.3
 - COL square footage: 20.25

To Order, Specify:
1) Product number, including:

- ① Surface Option:**
- 8 Fabric
 - 3 Faux Leather
 - 7 Leather

2) Frame finish color.

Nano-Tex Option:
To specify, add **P** to the end of the product number.
Example: SLSE-CUB1-8BP, add \$31.00 for single seat.

Durablock Option:
To specify, add **D** to the end of the product number.
Example: SLSE-CUB1-8BD, add \$41.00 for single seat.

Fire Retardant Option:
Add **-F** to the product number, and add \$139.00 list.

Description	Number ①	Fabric Grade								Leather Grade A	Leather Grade B
		A	B	C	D	E	F	G	H		
Painted Frame	SLSE-CUB1- P	\$550.00	\$601.00	\$614.00	\$635.00	\$677.00	\$750.00	\$818.00	\$924.00	\$1342.00	\$1770.00
Anodized Aluminum Frame	SLSE-CUB1- B	\$596.00	\$647.00	\$660.00	\$681.00	\$723.00	\$796.00	\$864.00	\$970.00	\$1388.00	\$1816.00

Double Cube

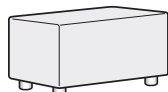

SLSE-CUB2-8P
SLSE-CUB2-8B



Dimensions
SH: 17.5"(445mm)
SW: 32"(813mm)
SD: 16"(406mm)

- Features**
- Seat: Single cushion unit.
 - Base: Aluminum legs available in painted or anodized aluminum finishes.
 - COM yardage: 1.63
 - COL square footage: 32.4

To Order, Specify:
1) Product number, including:

- ① Surface Option:**
- 8 Fabric
 - 3 Faux Leather
 - 7 Leather

2) Frame finish color.

Nano-Tex Option:
To specify, add **P** to the end of the product number.
Example: SLSE-CUB2-8BP, add \$52.00 for single seat.

Durablock Option:
To specify, add **D** to the end of the product number.
Example: SLSE-CUB2-8BD, add \$82.00 for single seat.

Fire Retardant Option:
Add **-F** to the product number, and add \$139.00 list.

Description	Number ①	Fabric Grade								Leather Grade A	Leather Grade B
		A	B	C	D	E	F	G	H		
Painted Frame	SLSE-CUB2- P	\$700.00	\$773.95	\$792.80	\$823.25	\$884.15	\$ 990.00	\$1088.60	\$1242.30	\$1848.40	\$2469.00
Anodized Aluminum Frame	SLSE-CUB2- B	\$746.00	\$819.95	\$838.80	\$869.25	\$930.15	\$1036.00	\$1134.60	\$1288.30	\$1894.40	\$2515.00

Haworth Collection

SE04 Lounge
Design: José Serrano — Made in U.S.A.

Triple Cube

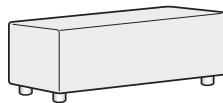

SLSE-CUB3-8P
SLSE-CUB3-8B



Dimensions

SH: 17.5"(445mm)
SW: 48"(1219mm)
SD: 16"(406mm)

Features

- Seat: Single cushion unit.
- Base: Aluminum legs available in painted or anodized aluminum finishes.
- COM yardage: 2.13
- COL square footage: 42.2

To Order, Specify:

1) Product number, including:

1 Surface Option:

- 8 Fabric
- 3 Faux Leather
- 7 Leather

2) Frame finish color.

Nano-Tex Option:

To specify, add **P** to the end of the product number.

Example: SLSE-CUB3-8BP, add \$52.00 for single seat.

Durablock Option:

To specify, add **D** to the end of the product number.

Example: SLSE-CUB3-8BD, add \$82.00 for single seat.

Fire Retardant Option:

Add **-F** to the product number, and add \$139.00 list.

Description	Number ①	Fabric Grade								Leather Grade A	Leather Grade B
		A	B	C	D	E	F	G	H		
Painted Frame	SLSE-CUB3- P	\$850.00	\$946.90	\$ 971.60	\$1011.50	\$1091.30	\$1230.00	\$1359.20	\$1560.60	\$2354.80	\$3168.00
Anodized Aluminum Frame	SLSE-CUB3- B	896.00	992.90	1017.60	1057.50	1137.30	1276.00	1405.20	1606.60	2400.80	3214.00



Haworth Collection

SE04 Tables

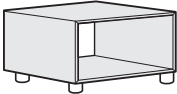
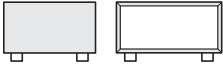
Design: José Serrano — Made in U.S.A.

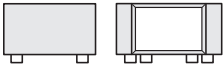
		Description	Number ①②	Painted	Anodized Aluminum
Wood Table — Square  TOSE-SQW 	Dimensions TW: 28.0"(711mm) TD: 28.0"(711mm) TH: 16.9"(430mm)	Square	TOSE-SQW-■ ■	\$2173.00	\$2173.00
		Features <ul style="list-style-type: none"> • Double-cut wood veneers available in five finishes. • Legs: Aluminum with felt glides, painted or anodized aluminum finish. 	To Order, Specify: <ol style="list-style-type: none"> 1) Product number, including: <ul style="list-style-type: none"> ① Wood Finish Option: <ul style="list-style-type: none"> B Beachwood E Ebony M Melba S Sorrel W Wenge ② Frame Finish Option: <ul style="list-style-type: none"> P Painted B Anodized Aluminum 2) Wood color. 3) Frame color. 		

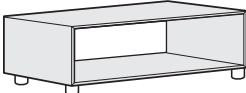
		Description	Number ①②	Painted	Anodized Aluminum
Wood Table — Trapezoid  TOSE-TRW 	Dimensions TW: 37.4"(950mm) TD: 28.0"(711mm) TH: 16.9"(430mm)	Trapezoid	TOSE-TRW-■ ■	\$2173.00	\$2173.00
		Features <ul style="list-style-type: none"> • Double-cut wood veneers available in five finishes. • Legs: Aluminum with felt glides, painted or anodized aluminum finish. 	To Order, Specify: <ol style="list-style-type: none"> 1) Product number, including: <ul style="list-style-type: none"> ① Wood Finish Option: <ul style="list-style-type: none"> B Beachwood E Ebony M Melba S Sorrel W Wenge ② Frame Finish Option: <ul style="list-style-type: none"> P Painted B Anodized Aluminum 2) Wood color. 3) Frame color. 		

		Description	Number ①②	Painted	Anodized Aluminum
Wood Table — Rectangle  TOSE-RTW 	Dimensions TW: 51.1"(1300mm) TD: 28.0"(711mm) TH: 16.9"(430mm)	Rectangle	TOSE-RTW-■ ■	\$2173.00	\$2173.00
		Features <ul style="list-style-type: none"> • Double-cut wood veneers available in five finishes. • Legs: Aluminum with felt glides, painted or anodized aluminum. 	To Order, Specify: <ol style="list-style-type: none"> 1) Product number, including: <ul style="list-style-type: none"> ① Wood Finish Option: <ul style="list-style-type: none"> B Beachwood E Ebony M Melba S Sorrel W Wenge ② Frame Finish Option: <ul style="list-style-type: none"> P Painted B Anodized Aluminum 2) Wood color. 3) Frame color. 		

Haworth Collection

Shetland

Design: Haworth Design Studio – Made in U.S.A.

With Saddle

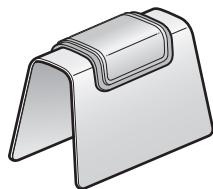

HCCL-SLBP-2

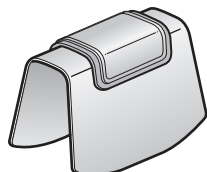

HCCL-SLRP-2

Dimensions

L: 32.0"(807mm)
W: 16.5"(420mm)
H: 20.0"(508mm)

SD: 10.0"(262mm)
SL: 28.0"(711mm)

Features

- Bench and Rocker available in painted Polar (white) surface or Natural Walnut veneer.
- Nine ply Poplar and Sycamore alternating construction for elegant edge detail.
- Rocker unit allows for 10° of movement in both directions.
- Saddle features white double stitching details with foam.
- Saddle is removable and features a non-skid bottom layer.

To Order, Specify:

1) Product number, including:

❶ Saddle Option:

- 1 Leather
- 2 Fabric
- 3 Faux Leather

2) Bench/Rocker color.

3) Saddle finish and color.

Description	Finish	Number ❶	Fabric Grade			Leather Grade B
			C	D	E	
Bench	Polar	HCCL-SLBP-■	\$1075.00	\$1100.00	\$1125.00	\$1310.00
	Natural Walnut	HCCL-SLBW-■	1175.00	1200.00	1225.00	1410.00
Rocker	Polar	HCCL-SLRP-■	\$1075.00	\$1100.00	\$1125.00	\$1310.00
	Natural Walnut	HCCL-SLRW-■	1175.00	1200.00	1225.00	1410.00

Without Saddle

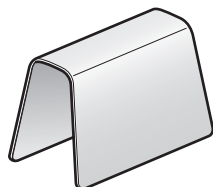

HCCL-SBBP-0

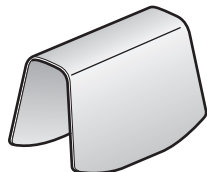

HCCL-SBRP-0

Dimensions

L: 32.0"(807mm)
W: 16.5"(420mm)
H: 20.0"(508mm)

Features

- Bench and Rocker available in painted Polar (white) surface or Natural Walnut veneer.
- Nine ply Poplar and Sycamore alternating construction for elegant edge detail.
- Rocker unit allows for 10° of movement in both directions.
- Saddle can be ordered separately and added at any time.

To Order, Specify:

- 1) Product number.
- 2) Bench/Rocker color.

Description	Finish	Number	Price
Bench	Polar	HCCL-SBBP-0	\$655.00
	Natural Walnut	HCCL-SBBW-0	755.00
Rocker	Polar	HCCL-SBRP-0	\$655.00
	Natural Walnut	HCCL-SBRW-0	755.00

Shetland

Shetland
 Design: Haworth Design Studio – Made in U.S.A.

Saddle

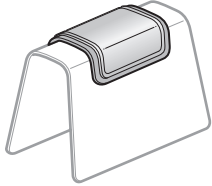

HCCL-SLDU-1

Features

- White double stitching.
- Foam padding.
- Sits on top of the bench and features a non-skid bottom layer to prevent sliding.

To Order, Specify:

1) Product number, including:

① Saddle Option:

- 1** Leather
- 2** Fabric
- 3** Faux Leather

2) Fabric and color.

Depth	Width	Number ①	Fabric Grade C	D	E	Leather Grade B
10"(254mm)	28"(711mm)	HCCL-SLDU-■	\$595.00	\$620.00	\$645.00	\$830.00

Haworth Collection Finish/Color Legend

Collaborate Guest & Lounge

Base

KR-V Trivalent Chrome
 TR-TW Plaster (only available on disc base)
 TR-K Charcoal (only available on disc base)

Collaborate Tables

Base

KR-V Trivalent Chrome
 TR-TW Plaster (only available on disc base)
 TR-K Charcoal (only available on disc base)

Laminate

H-WL Linen

Specialty Wood

KK-ZW Zebra Wood
 KL-E Ebano
 KM-RW Rift White Oak

Stone 1

16-WJ White Gioia Marble

Stone 3

17-BG Black Granite

K700 Stool

KR-V Chrome
 TR-F Black
 TR-K Charcoal
 TR-J Graphite
 TR-E Smoke

LTB

Trim Colors

TR-PL Polar
 TR-VA Vapor
 TR-SY Stormy

Wood

M2-CA1 Amber
 M2-W23 American
 M2-83 Classic
 M2-W15 Espresso
 M2-U Medium Cherry
 M2-N Natural
 M2-AD Sand

m_sit Lounge and Table

TR-F Black
 KR-V Chrome
 TR-LE Metallic Silver
 TR-MC Metallic Champagne
 TR-MG Metallic Gunmetal

q_bic

Frame

TR-F Black
 KR-V Chrome
 TR-LE Metallic Silver
 TR-MC Metallic Champagne
 TR-MG Metallic Gunmetal

Glass

2G-1C Clear (Tempered)

Wood

WL-RL Beechwood
 WJ-RE Ebony
 WE-RT Melba
 WF-RC Sorrel
 WC-RW Wenge

s_con

TR-F Black
 PM-P Polished Aluminum
 KR-V Chrome

SE04

Frame

TR-F Black
 PN-B Brushed Aluminum
 TR-LE Metallic Silver
 TR-MC Metallic Champagne
 TR-MG Metallic Gunmetal

Wood

WL-RL Beechwood
 WJ-RE Ebony
 WE-RT Melba
 WF-RC Sorrel
 WC-RW Wenge

Shetland

Trim Colors

TR-PL Polar

Wood

XW-CL Clear Walnut

Haworth Collection Seating Fabric Legend

Haworth Imported Fabric Collection

Fabric Name (VAL Mask)	Grade	b_sit	DSC Axis 106	DSC Axis 10000	Exchange	m_sit	q_bic	s_con	SE04	Collaborate	LTB Benches	LTB Arm Rest	Shetland
Haworth													
Collection 82 (E2)			●	●				●					
Collection 39 (EH)		●	●	●	●			●					
Collection 97 (EK)		●			●			●					

Haworth North American Fabric Collection

Fabric Name (VAL Mask)	Grade	b_sit	DSC Axis 106	DSC Axis 10000	Exchange	m_sit	q_bic	s_con	SE04	Collaborate	LTB Benches	LTB Arm Rest	Shetland
Haworth													
Barque (07)	A					●	●		●	●	●	●	
Cobblestone (MG)	A					●	●		●	●	●		
Dottie (ME)	A					●	●		●	●	●		
Esoteria (3H)	A					●	●		●	●	●	●	
Gauge (1X)	A					●	●		●	●	●	●	
Interval (3F)	A					●	●		●	●	●	●	
Ravenna (3E)	A										●		
Tellure (3A)	A					●	●		●	●	●	●	
Twist (MM)	A					●	●		●	●	●		
Wellington Faux Leather (XJ)	A					●	●		●	●	●	●	
Zinger (NI)	A					●	●		●	●	●	●	
Cocktail (1W)	B					●	●		●	●	●		
Leef (ML)	B					●	●		●	●	●		
Moodring (NQ)	B										●		
Tech (MV)	B					●	●		●	●	●	●	
Cotswold (JB)	D					●	●		●	●	●	●	●
Brisa Faux Leather (XG)	E					●	●		●	●	●		●
Plains Leather (XP)	A					●	●		●	●	●		
Nature Leather (XE)	B					●	●		●	●	●		●

Customer's Own Material (COM): For general Customer's Own Material (COM) information including processes and forms, please refer to: Haworth.com > Surface Collection > Resources > COM. For information on approved COM's, please refer to: Haworth.com > Surface Collection > COM Library.

The fabric yardage requirements for C.O.M. (Customer's Own Material) given for each model are in lineal yards and based on 54"(1372mm) wide, no repeat usable fabric widths.

Haworth +: For information on the Haworth+ alliance program, including images and product availability, please refer to: Haworth.com > Surface Collection > Haworth+ Library

Haworth Collection Seating Fabric Legend

Haworth+ (Alliance) Offering		b_sit	DSC Axis 106	DSC Axis 10000	Exchange	m_sit	q_bic	s_con	SE04	Collaborate	LTB Benches	LTB Arm Rest	Shetland
Fabric Name (VAL Mask)	Grade												
Maharam													
Gradient (80)	C					●	●		●		●	●	
Marquee (82)	C					●	●		●				
Messenger (80)	C					●	●		●		●	●	
Metric (80)	C					●	●		●		●	●	
Coincide (84)	D					●	●		●				
Stack (84)	D					●	●		●				
Chance (8A)	E								●	●			
Dart (8D)	E								●	●			
Offset (8K)	G					●	●		●	●			
Luna													
Matchsticks (84)	D					●	●		●	●			
Mezzanine (84)	D					●	●		●	●			
Sparkle (83)	D					●	●		●		●	●	
Waffle (83)	D					●	●		●		●	●	
Whimsy (84)	D					●	●		●		●	●	
Dots Damask (8J)	G					●	●		●	●			
Flare (8K)	G					●	●		●	●			
Hardware (8K)	G					●	●		●	●			
Hatch (8J)	G					●	●		●				
Urban Grid (8K)	G					●	●		●	●			
Carnegie													
Departure (83)	D					●	●		●		●	●	
Coin Toss (8X)	E					●	●		●				
Rail Trail (8F)	F					●	●		●				
Trestle (8F)	F					●	●		●				
Wired (8K)	G					●	●		●	●			

In-Graded Pre-Approved COMs		b_sit	DSC Axis 106	DSC Axis 10000	Exchange	m_sit	q_bic	s_con	SE04	Collaborate	LTB Benches	LTB Arm Rest	Shetland
Fabric Name (VAL Mask)	Grade												
Maharam													
Maharam Divina 3 (7F)	F	●	●	●	●	●	●	●	●	●	●	●	
Maharam Divina Melange (7F)	F	●	●	●	●	●	●	●	●	●	●	●	
Carnegie													
Carnegie Dazzle (7G)	G	●	●	●	●	●	●	●	●	●	●	●	
Carnegie Wilderness (7H)	H	●	●	●	●	●	●	●	●	●	●	●	

Customer's Own Material (COM): For general Customer's Own Material (COM) information including processes and forms, please refer to: Haworth.com > Surface Collection > Resources > COM. For information on approved COM's, please refer to: Haworth.com > Surface Collection > COM Library.

The fabric yardage requirements for C.O.M. (Customer's Own Material) given for each model are in lineal yards and based on 54"(1372mm) wide, no repeat usable fabric widths.

Haworth +: For information on the Haworth+ alliance program, including images and product availability, please refer to: Haworth.com > Surface Collection > Haworth+ Library

Haworth Collection Imported Fabric Collections

Collection 39

95% Wool, 5% Polyamide

EH-999 Black
EH-025 Brown
EH-042 Coral
EH-006 Gold
EH-060 Grey
EH-007 Indigo
EH-009 Light Blue
EH-011 Light Green
EH-008 Maroon
EH-010 Navy Blue
EH-089 Red
EH-005 Tan

Collection 82

100% Xtreme FR

E2-074 Aqua
E2-011 Blue-Green
E2-094 Blue-Grey
E2-030 Burgundy
E2-172 Charcoal
E2-082 Cobalt
E2-169 Dusk
E2-045 Forest
E2-084 Plum
E2-076 Red
E2-079 Rose
E2-162 Royal Blue
E2-171 Smoke
E2-156 Spring Green
E2-071 Taupe

Collection 97 (Leather)

EK-371 Beige
EK-360 Black
EK-388 Chocolate
EK-355 Dark Grey
EK-321 Midnight
EK-328 Navy
EK-310 Red
EK-384 Umber
EK-370 White

Imported Products Warranty

The current North American Product Non-Obsolescence and Warranty Policy applies to all products in this price list with the exception of the items noted below.

European Product	Offering/ Construction	Applicable Warranty Period
b_sit	Seating	Five Years
BRAZO	Lighting	Ten Years
DSC Axis	Seating	Five Years
Exchange	Seating	Five Years
LIM	Lighting	Ten Years
Penelope	Seating	One Year
Plia	Seating	One Year
s_con	Seating	Five Years

Finish/Color Legends

Accolade Seating — pages 217-221

Trim Colors

TR-F	Black	■
TR-J	Graphite	
TR-G	Gray Tone	

Hello Seating — pages 268-273

Trim Colors

TR-LE	Metallic Silver
-------	-----------------

Improv Series Desk Chairs/Improv H.E. Chairs/Improv H.E. Stool — pages 134-171

Trim Colors

TR-F	Black	■
TR-J	Graphite	■
TR-G	Gray Tone	■

Note: Improv Desk and Improv H.E. Chairs with optional high arc base are available in TR-F (Black) trim only.

Improv S.E. and Improv Tag Chairs — pages 172-185

Trim Color

TR-F	Black
------	-------

Improv Series Leg-Base/Sled-Base Chairs, Stools and Tables — pages 186-197

Trim Colors	Grade A Solid Color Laminates	Grade A Patterned Laminates	Grade A Wood Grain Laminates	PVC Colors	Wood Finish Colors
TR-F Black ■	H-34 Beige	H-DH Barley Grain	H-AE Maple	TR-K0 Black	Maple
TR-J Graphite ■	H-AK Chalk	H-22 Grey Spex ■		TR-J Graphite ■	M2-CA1 Amber ■
TR-G Gray Tone ■	H-8J Charcoal	H-DA Oats Grain	Grade B	TR-G Gray Tone ■	M2-W23 American
TR-E Smoke	H-3J Graphite	H-EK Owl Nest	Wood Grain Laminates	TR-E Smoke ■	M2-83 Classic
	H-62 Gray Tone	H-EC Quail Nest	H-KA Brazilwood		M2-W15 Espresso
Metallic Trim Colors	H-WL Linen	H-ED Rhea Nest	H-KG Columbian Walnut		M2-U Medium Cherry ■
TR-MC Champagne	H-3P Platinum	H-EA Robins Nest	H-KC New Age Oak		M2-N Natural ■
TR-MG Gunmetal	H-AA Putty	H-DE Wheat Grain	H-KD River Cherry		M2-AD Sand
TR-LE Silver	H-3E Smoke	H-21 White Spex ■	H-KE Sanara		
	H-LC White Sand		H-KF Williamsburg Cherry		

ALERT: These materials are current, however they are being considered for future obsolescence due to low volume.

- Note:**
- Specifying a common stain color for casegoods, wood seating, and wood occasional tables will result in a suite of furniture which has a commercially acceptable finish match.
 - Different wood species are offered on the various casegoods, chairs, and tables. Each species offer unique texture, grain, and color of raw wood and veneer. Minor variations in finish color and texture may occur due to these natural characteristics of wood. This is part of the natural beauty of wood and is not considered to be a defect.

Grade A Wood Grain Laminates Medium Cherry H-AD

Wood Finish Colors Crown M2-W24

■ Available on RUSH.



Refer to RUSH Price List for available models/fabrics/finishes.

Finish/Color Legends

K100 Series Seating and Tables / Tempo Lounge / Scamps Series — pages 283-296, 303-309

Metal Finish/Color Legend

Grey Values

TR-F	Black (gloss level 25)
TR-K	Charcoal  (gloss level 25)
TR-J	Graphite  (gloss level 25)
TR-E	Smoke (gloss level 25)

Taupe Values (gloss level 25)

TR-G	Gray Tone 
TR-AA	Putty

Metallic

TR-MC	Metallic Champagne
TR-MG	Metallic Gunmetal
TR-LE	Metallic Silver

 Available on RUSH.

Refer to **RUSH Price List** for available models/fabrics/finishes.

Laminate/Color Legend

Grade A

Solid Color Laminates

H-34	Beige
H-AK	Chalk
H-8J	Charcoal
H-3J	Graphite
H-62	Gray Tone
H-WL	Linen
H-3P	Platinum
H-AA	Putty
H-3E	Smoke
H-LC	White Sand

Grade A

Patterned Laminates

H-DH	Barley Grain
H-22	Grey Spex 
H-DA	Oats Grain
H-EK	Owl Nest
H-EC	Quail Nest
H-ED	Rhea Nest
H-EA	Robins Nest
H-DE	Wheat Grain
H-21	White Spex 

Grade A

Wood Grain Laminates

H-AE	Maple
H-AM	Amber Cherry

Grade B

Wood Grain Laminates

H-KA	Brazilwood
H-KG	Columbian Walnut
H-KC	New Age Oak
H-KD	River Cherry
H-KE	Sanara
H-KF	Williamsburg Cherry

ALERT: These materials are current, however they are being considered for future obsolescence due to low volume.

**Grade A
Wood Grain Laminates**
Medium Cherry H-AD

Plastic Edge Color Legend

TR-R	Beige
TR-AK	Chalk
TR-K	Charcoal
TR-J	Graphite

TR-G	Gray Tone
TR-AA	Putty
TR-E	Smoke

Veneer/Color Legend

Maple

M2-CA1	Amber**
M2-W23	American**
M2-83	Classic**
M2-W15	Espresso
M2-U	Medium Cherry**
M2-N	Natural
M2-AD	Sand

ALERT: These materials are current, however they are being considered for future obsolescence due to low volume.

**Maple
Crown** M2-W24

Note: • Specifying a common stain color for casegoods, wood seating, and wood occasional tables will result in a suite of furniture which has a commercially acceptable finish match.
• Different wood species are offered on the various casegoods, chairs, and tables. Each species offer unique texture, grain, and color of raw wood and veneer. Minor variations in finish color and texture may occur due to these natural characteristics of wood. This is part of the natural beauty of wood and is not considered to be a defect.

**Available only on Tempo Series.

Lively — pages 99-104

Trim Colors

TR-F	Black
------	-------

Finish/Color Legends

LOOK Side Chair — pages 201-211

Polypropylene Shell Colors

TR-F Black
TR-W White

Trim Colors

TR-F Black ■
TR-MC Metallic Champagne
TR-MG Metallic Gunmetal
TR-LE Metallic Silver

ALERT: These materials are current, however they are being considered for future obsolescence due to low volume.

Polypropylene Shell Colors

TR-F Black
TR-MN Jupiter Light
TR-LB Neptune
TR-53 Pluto

Monaco Seating — pages 225-232

Trim Colors

TR-F Black ■
PN-B Brushed Aluminum ■

System 12 — pages 242-243

Trim Colors

TR-F Black ■
KR-V Chrome ■
TR-15 Light Gray
TR-3 Pebble Gray

Polypropylene Shell Colors

TR-F Black ■
TR-94 Burgundy ■
TR-110 Jupiter Green
TR-15 Light Gray
TR-108 Mars Red
TR-92 Navy ■
TR-106 Neptune Blue
TR-3 Pebble Gray
TR-109 Saturn Orange

ALERT: These materials are current, however they are being considered for future obsolescence due to low volume.

Polypropylene Shell Colors

TR-107 Sun Yellow
TR-93 Teal Green

System 58 Seating — pages 235-237

Trim Colors ⁽¹⁾

TR-F Black ■
PN-B Brushed Aluminum ■ ⁽²⁾
KR-V Chrome ■

⁽¹⁾ Arms are available in black trim only.

⁽²⁾ Not available on System 58 side chair.

■ Available on RUSH.

Refer to RUSH Price List for available models/fabrics/finishes.

Finish/Color Legends

ToDo Seating — pages 276-281**Trim Colors**

TR-F	Black
TR-M01	Switch Silver

ToDo**Maple Veneer Finish**

M2-CA1	Amber
M2-W23	American
M2-W04	Beech
M2-83	Classic
M2-W15	Espresso
M2-W06	Light Cherry
M2-W21	Mahogany Satin
M2-U	Medium Cherry
M2-N	Natural
M2-W12	Naturally Walnut
M2-W31	Retro
M2-AD	Sand

ALERT: These materials are current, however they are being considered for future obsolescence due to low volume.

Maple Veneer Finish

Cordovan	M2-W13
Crown	M2-W24

X99 — pages 109 -128**Trim Colors**

TR-F	Black
KR-V	Chrome*

Metallic Trim Colors

TR-MG	Gunmetal
TR-LE	Silver

Soft Mesh

M0-BE	Beach
M0-BL	Black
M0-CA	Camel
M0-FG	Fog
M0-ST	Storm

*Refer to price pages for chrome specification information and upcharge.

Zody — pages 28-44**Base and Arm Uprights****Trim Colors**

TR-F	Black
TR-LE	Metallic Silver
TR-MG	Metallic Gunmetal
TR-MC	Metallic Champagne
PM-P	Polished Aluminum
KR-V	Trivalent Chrome*

Arm Cap Trim Color**

TR-F	Black
TR-E	Smoke

Wood Back Finish Color

VT-W04	Beech
--------	-------

*Refer to price pages for Trivalent chrome specifications Zody side chair only information and upcharge.

**Available on Zody Guest models only.

Very Perforated, Tetro Back and Task — pages 45 -91**Perforated and Tetro Back****Polymer Colors**

TR-F	Black
TR-FL	Canvas
TR-FK	Cocoa
TR-FC	Ember
TR-7	Fog
TR-FN	Glacier
TR-FE	Grass
TR-FJ	Slate
TR-FM	Snow
TR-FA	Tomato

Trim Color

TR-F	Black
TR-7	Fog

Base Colors - Painted

TR-F	Black
TR-MC	Metallic Champagne
TR-MG	Metallic Gunmetal
TR-LE	Metallic Silver
PM-P	Polished Aluminum (conference chair only)
KR-V	Trivalent Chrome (wire stacker, side and seminar)

Base Colors - Plastic (conference chair only)

TR-F	Black
TR-7	Fog

Laminate /Color Legend**Grade A****Solid Color Laminates**

H-AA	Putty
H-AK	Chalk
H-LC	White Sand
H-WL	Linen
H-3E	Smoke
H-3J	Graphite
H-3P	Platinum
H-34	Beige
H-62	Gray Tone
H-8J	Charcoal

Grade A**Wood Color Laminate**

H-AE	Maple
H-AM	Amber Cherry

Grade B**Wood Color Laminate**

H-AD	Medium Cherry
------	---------------

Plastic Trim Color

TR-F	Black
TR-7	Fog

Aluminum Base and Components Colors

PMP	Polished Aluminum
TR-F	Black
TR-MC	Metallic Champagne
TR-MG	Metallic Gunmetal
TR-LE	Metallic Silver

Base Colors - Plastic

TR-F	Black
TR-7	Fog

Finish/Color Legends

Wood Seating — pages 238-240, 248-281, 297	Wood Seating						
	Composites	Forenze	Galerie	Hello	Prescott	Tally	ToDo
<p>The following matrix shows the standard finish offering for each seating product line.</p> <p>Because of the natural properties of wood, variations of grain pattern and finish color can be expected. Haworth carefully selects materials used in the manufacturing of products to promote consistent and acceptable color. Wood is susceptible to color change from exposure to UV rays. Haworth finishes include a UV stabilizer to reduce these effects.</p> <p>Natural finish on Maple is a clear coat only and will show all the characteristics of the wood.</p>							
Maple							
Amber (M2-CA1)*	●	●	●	●	●	●	●
American (M2-W23)	●	●	●	●	●	●	●
Beech (M2-W04)*	●	●	●	●	●	●	●
Classic (M2-83)*	●	●	●	●	●	●	●
Espresso (M2-W15)*	●	●	●	●	●	●	●
Light Cherry (M2-W06)*	●	●	●	●	●	●	●
Mahogany Satin (M2-W21)*	●	●	●	●	●	●	●
Medium Cherry (M2-U)*	●	●	●	●	●	●	●
Natural (M2-N)	●	●	●	●	●	●	●
Naturally Walnut (M2-W12)*	●	●	●	●	●	●	●
Retro (M2-W31)*	●	●	●	●	●	●	●
Sand (M2-AD)*	●	●	●	●	●	●	●

*Compatible wood finish color will complement wood casegoods finish color, not necessarily wood species characteristics.

Available on RUSH. Refer to price pages for available models.

Wood Seating — pages 246-247	Wood Seating
	Candor
Beech	
Amber (M3-CA1)	●
American (M3-W23)	●
Classic (M3-83)	●
Ebony (M3-RE)	●
Espresso (M3-W15)	●
Light Cherry (M3-W06)	●
Mahogany Satin (M3-W21)	●
Medium Cherry (M3-U)	●
Natural (M3-W04)	●
Natural Walnut (M3-W12)	●
Retro (M3-W31)	●
Sand (M3-AD)	●
Sorrel (M3-RC)	●
Wenge (M3-RW)	●

*Compatible wood finish color will complement wood casegoods finish color, not necessarily wood species characteristics.

Available on RUSH. Refer to price pages for available models.

ALERT: These materials are current, however they are being considered for future obsolescence due to low volume.

Maple	
Cordovan	M2-W13
Crown	M2-W24

Beech	
Cordovan	M3-W13
Crown	M3-380

Fabric Pattern Usage

Haworth seating models are restricted to fabric patterns that meet applicability standards for tailoring. A dot in the matrix below indicates fabric acceptability on seating series or specific models listed. Fabrics are listed alphabetically by grades.	Series/ Model																						
	Accolade	Cassis	Hello	Improv H.E./S.E.	Improv Tag	Improv Desk Chair	Improv Leg-Base/Sled-Base Stool - Upholstered Back	Improv Leg-Base/Sled-Base Stool - Plastic Back	K100 Series (All Other Models)	Lively	LOOK	Monaco	System 12	System 58	Tempo	ToDo	Very/Very Task	X99	Zody	Zody Guest	Wood (Candor)	Wood (Prescott)	Wood (All Other Models)
Grade: Pattern (Surface Code)																							
Haworth Fabrics																							
A: Barque	●	●	●	●	●	●	●	●	●	●	●	●	●	●	●	●	●	●	●	●	●	●	●
A: Cobblestone (MG)	●	●	●	●	●	●	●	●	●	●	●	●	●	●	●	●	●	●	●	●	●	●	●
A: Dottie (ME)	●	●	●	●	●	●	●	●	●	●	●	●	●	●	●	●	●	●	●	●	●	●	●
A: Esoteria (3H)	●	●	●	●	●	●	●	●	●	●	●	●	●	●	●	●	●	●	●	●	●	●	●
A: Gauge (1X)	●	●	●	●	●	●	●	●	●	●	●	●	●	●	●	●	●	●	●	●	●	●	●
A: Horizon (1N)	●	●	●	●	●	●	●	●	●	●	●	●	●	●	●	●	●	●	●	●	●	●	●
A: Interval (3F)	●	●	●	●	●	●	●	●	●	●	●	●	●	●	●	●	●	●	●	●	●	●	●
A: Ravenna (3E)	●	●	●	●	●	●	●	●	●	●	●	●	●	●	●	●	●	●	●	●	●	●	●
A: Tellure (3A)	●	●	●	●	●	●	●	●	●	●	●	●	●	●	●	●	●	●	●	●	●	●	●
A: Twist (MM)	●	●	●	●	●	●	●	●	●	●	●	●	●	●	●	●	●	●	●	●	●	●	●
A: Wellington Faux Leather (XJ)	●	●	●	●	●	●	●	●	●	●	●	●	●	●	●	●	●	●	●	●	●	●	●
A: Zinger (NI)	●	●	●	●	●	●	●	●	●	●	●	●	●	●	●	●	●	●	●	●	●	●	●
B: Cocktail (1W)	●	●	●	●	●	●	●	●	●	●	●	●	●	●	●	●	●	●	●	●	●	●	●
B: Jewel (MN)	●	●	●	●	●	●	●	●	●	●	●	●	●	●	●	●	●	●	●	●	●	●	●
B: Leef (ML)	●	●	●	●	●	●	●	●	●	●	●	●	●	●	●	●	●	●	●	●	●	●	●
B: Moodring (NQ)	●	●	●	●	●	●	●	●	●	●	●	●	●	●	●	●	●	●	●	●	●	●	●
B: Tech (MV)	●	●	●	●	●	●	●	●	●	●	●	●	●	●	●	●	●	●	●	●	●	●	●
D: Cotswold (JB)	●	●	●	●	●	●	●	●	●	●	●	●	●	●	●	●	●	●	●	●	●	●	●
E: Brisa Faux Leather (XG)	●	●	●	●	●	●	●	●	●	●	●	●	●	●	●	●	●	●	●	●	●	●	●
Leathers																							
A: Plains Leather (XP)	●	●	●	●	●	●	●	●	●	●	●	●	●	●	●	●	●	●	●	●	●	●	●
B: Nature Leather (XE)	●	●	●	●	●	●	●	●	●	●	●	●	●	●	●	●	●	●	●	●	●	●	●



Nano-Tex and DuraBlock Approved Fabric Matrix

***Information subject to change. Please refer to Haworth.com/surfaces > Nano-tex for most current information.**





	Series/ Model																			
	Candor®	Cassis™	Composites™	Forenze™	Galerie™	Hello®	Improv® Leg- or Sled-base - fully upholstered	Improv® Leg- or Sled-base - poly or wood shell	Improv® Stools - fully upholstered	Improv® Stools - poly or wood shell	Lively®	LOOK® Lounge & Side	q_bic™	SEO4™	Tally™	Tempo™	ToDo®	Tuxedo™	X99® Guest, Seminar, Advance Seminar & Task	Zody® Guest
Grade: Pattern (Surface Code)																				
Haworth Fabrics																				
A: Barque (07)	●	●	●	●	●	●	●	●	●	●	●	●	●	●	●	●	●	●	●	●
A: Cobblestone (MG)	●	●	●	●	●	●	●	●	●	●	●	●	●	●	●	●	●	●	●	●
A: Dottie (ME)	●	●	●	●	●	●	●	●	●	●	●	●	●	●	●	●	●	●	●	●
A: Esoteria (3H)	●	●	●	●	●	●	●	●	●	●	●	●	●	●	●	●	●	●	●	●
A: Gauge (1X)	●	●	●	●	●	●	●	●	●	●	●	●	●	●	●	●	●	●	●	●
A: Horizon (1N)	●	●	●	●	●	●	●	●	●	●	●	●	●	●	●	●	●	●	●	●
A: Interval (3F)	●	●	●	●	●	●	●	●	●	●	●	●	●	●	●	●	●	●	●	●
A: Ravenna (3E)	●	●	●	●	●	●	●	●	●	●	●	●	●	●	●	●	●	●	●	●
A: Tellure (3A)	●	●	●	●	●	●	●	●	●	●	●	●	●	●	●	●	●	●	●	●
A: Twist (MM)	●	●	●	●	●	●	●	●	●	●	●	●	●	●	●	●	●	●	●	●
A: Zinger (NI)	●	●	●	●	●	●	●	●	●	●	●	●	●	●	●	●	●	●	●	●
B: Cocktail (1W)	●	●	●	●	●	●	●	●	●	●	●	●	●	●	●	●	●	●	●	●
B: Jewel (MN)	●	●	●	●	●	●	●	●	●	●	●	●	●	●	●	●	●	●	●	●
B: Leef (ML)	●	●	●	●	●	●	●	●	●	●	●	●	●	●	●	●	●	●	●	●
B: Moodring (NQ)	●	●	●	●	●	●	●	●	●	●	●	●	●	●	●	●	●	●	●	●
B: Tech (MV)	●	●	●	●	●	●	●	●	●	●	●	●	●	●	●	●	●	●	●	●

Haworth Fabrics/Color Legend



- The following fabrics are available on select Haworth upholstered seating models. Refer to the fabric pattern usage matrix, page 365.
 - The  symbol denotes a fabric/color available on RUSH for all selected models.
 - Refer to RUSH Price List for available models/fabrics/finishes.
 - The † symbol denotes a fabric pattern available on Start it Up at standard lead time.
- Ⓧ = Directional fabric

Improv Tag Back Mesh †
53% Elastometric
47% Polyester
S0-25 Amber
S0-22 Fire
S0-24 Lava  (Black)
S0-13 Leaf
S0-09 Silver 
S0-20 Sky





Lively Tension Back
100% Polyester
3T-18 Black
3T-6 Nickel
3T-39 Steel
3T-43 Tomato
3T-40 Chocolate
3T-36 Grass
3T-33 Miami
3T-41 Sunflower
3T-42 Geranium

Very Task Mesh
100% Polyester
MS-F Black 
MS-FK Cocoa
MS-FC Ember
MS-7 Fog 
MS-FN Glacier 
MS-FJ Slate 
MS-FM Snow



X99 Soft Mesh
86% Polyester
14% Polyamide
M0-BE Beach
M0-BL Black
M0-CA Camel
M0-FG Fog
M0-ST Storm





Zody Back Mesh
100% Polyester
MA-001 Support 
MA-002 Comfort
MA-003 Wellness
MA-004 Relax 
MA-005 Gusto
MA-006 Refresh
MA-007 Soothe
MA-008 Peaceful







Fabric Grade: A Ⓧ
BARQUE
69% Polyester,
31% Recycled Polyester
(31% REPREVE®)
7-AH Ash
7-AS Aspen
7-BR Birch
7-BW Black Walnut
7-CN Chestnut
7-GO Golden Oak
7-RB Redbud
7-WL Willow



Fabric Grade: A Ⓧ
COBBLESTONE
65% Post Industrial
Recycled Polyester,
35% Post Consumer
Recycled Polyester
MG-A Alley
MG-AV Avenue
MG-C Courtyard
MG-M Metropolitan 
MG-PW Pathway
MG-PA Pavers 
MG-P Plaza 
MG-S Stickball 
MG-V Venezia

Fabric Grade: A Ⓧ
DOTTIE
89% Post Industrial
Recycled Polyester,
11% Post Consumer
Recycled Polyester
ME-CA Calico
ME-C Chads
ME-DD Dew Drops
ME-F Flecks
ME-M Morse
ME-P Pip
ME-PD Polka Dots
ME-R Roulette
ME-T Tabby
ME-Y Yahtzee

Fabric Grade: A Ⓧ
GAUGE
100% Recycled Polyester
1X-05 Depth 
1X-04 Gas 
1X-11 Narrow
1X-08 Pressure
1X-02 Rain 
1X-12 Sea
1X-13 Standard
1X-10 Test
1X-03 Time
1X-09 Water
1X-06 Weather
1X-01 Wind
1X-07 Wire

Fabric Grade: A Ⓧ
HORIZON
100% Polyester
1N-001 Beeline
1N-004 Birdseye
1N-003 Border 
1N-002 Compass 
1N-005 Panorama
1N-008 Skyline 
1N-006 Sweep
1N-007 Vista 

Fabric Grade: A Ⓧ
TELLURE †
100% Polyester
3A-31 Aegean
3A-18 Black 
3A-20 Burgundy 
3A-40 Chocolate
3A-28 Dynamo 
3A-22 Galaxy 
3A-42 Geranium
3A-36 Grass
3A-35 Ivory
3A-23 Jodhpurs 
3A-33 Miami
3A-19 Navy 
3A-06 Nickel 
3A-34 Ocean
3A-32 Sky
3A-38 Slate
3A-37 Spring
3A-39 Steel
3A-41 Sunflower
3A-43 Tomato



Fabric Grade: A Ⓧ
TWIST
80% Post Consumer
Recycled Polyester,
20% from Rayon Bamboo
MM-AS And Shout
MM-C Coil 
MM-CS Corkscrew 
MM-CU Curl
MM-D DNA
MM-I Ivy
MM-P Plot
MM-SW Sidewinder
MM-S Snail 
MM-SP Spire
MM-WH Whirlpool
MM-W Winding



Fabric Grade: A
WELLINGTON FAUX
LEATHER
100% Polyurethane
XJ-BL Black
XJ-BU Buff
XJ-EL Elephant
XJ-JA Java
XJ-PA Pacific
XJ-SA Sage
XJ-ST Storm
XJ-TA Tangelo
XJ-WI Wine

Fabric Grade: B Ⓧ
COCKTAIL
100% Eco-Intelligent®
Polyester
MBDC Cradle to
Cradle Gold
1W-12 Black Cow 
1W-08 Blue Moon
1W-13 Boilermaker
1W-01 Bubbly
1W-03 Gibson 
1W-04 Grasshopper
1W-07 Lounge
1W-16 Margarita
1W-10 Martini
1W-14 Mojito 
1W-11 Old Fashion
1W-06 Pink Squirrel
1W-15 Sidecar
1W-09 Stinger
1W-02 Stout
1W-05 Swizzle

Fabric Grade: B Ⓧ
JEWEL
77% Post Industrial
Recycled Polyester,
23% Post Consumer
Recycled Polyester
MN-AM Amber
MN-A Aquamarine
MN-C Citrine
MN-E Emerald
MN-G Garnet
MN-J Jade
MN-M Malachite
MN-R Ruby
MN-S Sapphire
MN-TE Tiger's Eye

Fabric Grade: B Ⓧ
LEEF
49% Post Industrial
Recycled Polyester
51% Post Consumer
Recycled Polyester
ML-A Aspen
ML-B Beet
ML-C Coca
ML-CN Coconut
ML-F Fennel
ML-HE Henna
ML-H Hosta
ML-HY Hydrangea
ML-M Moonflower
ML-PE Petunia
ML-P Pumpkin
ML-S Sunflower
ML-V Violet

Fabric Grade: B Ⓧ
MOODRING †
100% Recycled Polyester
NQ-4 Calm 
NQ-24 Cheerful
NQ-3 Cool 
NQ-21 Grounded
NQ-25 Happy
NQ-22 Inspired
NQ-23 Intense
NQ-8 Joy 
NQ-10 Liberate 
NQ-28 Peaceful
NQ-26 Restful
NQ-27 Zen

Fabric Grade: B Ⓧ
TECH
100% Post Consumer
Recycled Polyester
MV-AI A.I. 
MV-AN Anatomy
MV-A Aviation
MV-B Bionics
MV-C Cosmos
MV-D Disc
MV-E Electric
MV-F Forestry
MV-L Logic 
MV-P Optics
MV-RA Radio 
MV-R Rocket 
MV-SF Sci-Fi
MV-S Skill
MV-T Theory
MV-Z Zoology

Fabric Grade: D
COTSWOLD
100% Wool
JB-AN Anquilla
JB-BR Bottlegrass
JB-CA Camp
JB-DN Dandelion
JB-ED Editor Blue
JB-GS Goldfish
JB-HA Heart
JB-KE Kokanee
JB-NE Nettle Bellflower
JB-PL Pickeral Weed
JB-SA Sand
JB-SD Silver Dollar
JB-SU Silverbush
JB-SC Soft Charcoal
JB-TR Tree
JB-WE Wheaton

Haworth Fabrics/Color Legend

Fabric Grade: E
BRISA FAUX LEATHER †

- 100% Polyurethane face**
- XG-23 Apple Green
 - XG-22 Ash
 - XG-3 Aztec
 - XG-28 Birch
 - XG-25 Blossom
 - XG-12 Black Onyx
 - XG-5 Cambridge Blue
 - XG-26 Coffee Bean
 - XG-20 New Sand
 - XG-18 Night Navy
 - XG-21 Pompeian Red
 - XG-1 Salsa
 - XG-27 Shitake
 - XG-24 Skyway
 - XG-17 Sterling Blue
 - XG-13 White

Leather Grade: A †
PLAINS LEATHER

- XP-KX Atlantis
- XP-KC Black
- XP-KY Brown
- XP-KZ Smoke
- XP-KW Storm

Leather Grade: B †
NATURE LEATHER

- XE-AS Bark
- XE-AR Bittersweet
- XE-AP Chocolate
- XE-AJ Cream
- XE-AH Flint
- XE-AK Ink
- XE-AX Oats
- XE-AT Saddle
- XE-AM Seal
- XE-AL Shadow
- XE-AW Truffle
- XE-AN White

ALERT: These materials are current, however they are being considered for future obsolescence due to low volume.

- Fabric Grade: A (d)**
ESOTERIA †
52% Nylon,
31% Post Industrial
Recycled Polyester,
17% Post Consumer
Recycled Polyester
- 3H-17 Amulet
 - 3H-14 Antares
 - 3H-16 Borealis
 - 3H-06 Celestial
 - 3H-01 Cryptic
 - 3H-22 Draco
 - 3H-15 Enigma
 - 3H-02 Estuary
 - 3H-09 Ethereal
 - 3H-21 Mantra
 - 3H-11 Scirocco
 - 3H-19 Shiva
 - 3H-18 Tarot
 - 3H-20 Vedic
 - 3H-05 Visage

- Fabric Grade: A (d)**
INTERVAL †
56% Nylon
44% Recycled Polyester
- 3F-03 Adrian
 - 3F-08 Bayou
 - 3F-17 Binary
 - 3F-06 Carnelian
 - 3F-16 Charm
 - 3F-12 Chimera
 - 3F-18 Echo
 - 3F-14 Flaxen
 - 3F-01 Mink
 - 3F-13 Nutra
 - 3F-02 Polaris
 - 3F-19 Realis
 - 3F-15 Tarium

- Fabric Grade: A (d)**
RAVENNA †
56% Nylon,
44% Polyester
- 3E-02 Azurite
 - 3E-17 Basalt
 - 3E-19 Jade
 - 3E-18 Lode
 - 3E-01 Marquetry
 - 3E-04 Melange
 - 3E-12 Omnium
 - 3E-14 Oolite
 - 3E-05 Pastiche
 - 3E-07 Pietra
 - 3E-16 Sinter
 - 3E-08 Tesseræ

- Fabric Grade: A (d)**
ZINGER †
37% Recycled Polyester,
63% Polyester
(13% REPREVE®)
- NI-2 BBQ
 - NI-17 Beluga
 - NI-10 Bluegill
 - NI-8 Chips
 - NI-11 Classic
 - NI-16 Concord
 - NI-13 Frog
 - NI-15 Glade
 - NI-9 Grain
 - NI-12 Granny
 - NI-4 Gravel
 - NI-18 Kiwi
 - NI-20 Mulberry
 - NI-3 Onion
 - NI-6 Pacific
 - NI-1 Roan
 - NI-21 Tar
 - NI-7 Wagon
 - NI-19 Wicker
 - NI-5 Wolf

Haworth+
 For information on the Haworth+ alliance program, including images and product availability, please refer to:
Haworth.com > Surface Collection > Haworth+ Library

Customer's Own Material (COM)
 For general Customer's Own Material (COM) information including processes and forms, please refer to:
Haworth.com > Surface Collection > Resources > COM
 For information on approved COM's, please refer to:
Haworth.com > Surface Collection > COM Library

Seating COM Pattern Repeat Information
 Haworth will calculate and order COM yardage as needed for seating; however, for bid/quote purposes, please refer to the COM yardage requirements listed by each chair model. These numbers are based on solid or very small scale (under 1" repeat) fabrics.
 For fabrics with repeats listed below, additional yardage should be included in your calculations. The additional yardage allows for matching of patterns on the seating.

REPEAT SIZE	ADD ADDITIONAL YARDAGE TO YOUR CALCULATIONS
1"-5"	Add 5%
5"-7"	Add 10%
8"-14"	Add 20%
15"-19"	Add 25%
20"-27"	Add 30%
28"-36"	Add 50%

COM Yardage Requirements

Procedure

To determine if a COM fabric has been approved for use on Haworth product, contact the Haworth Inquiry Center (1.800.426.8562), your local Haworth dealer, or go to Haworth.com/surfaces > COM Library. Haworth will calculate and order fabric unless instructed otherwise. If the dealer is to provide the fabric, they will calculate the yardage needed themselves.

If the fabric is approved, and the directional orientation (directional rightway, directional railroad, or non-directional) of the tested fabric has been confirmed, then refer to the appropriate price page for yardage requirements.

COM Fabric Requirements

The fabric yardage requirements for COMs given for each model are in lineal yards and are based on 54"(1372mm) usable fabric widths. Approximate yardage requirements are shown for each model within the price pages.

For fabrics already approved, with a COM order entry code assigned, Haworth will determine and purchase the yardage needed. If the fabric will be provided by the dealer, and the pattern has a large repeat or stripes, additional yardage will be needed; see the COM Yardage Requirements at the end of this price guide OR contact the COM Department for more information.

COL Leather Requirements

The leather requirements for COL (Customer's Own Leather) will vary depending on the hide size and are based on square footage. Haworth will determine and purchase the leather needed.

Find total number of linear yards required for the order. Add the appropriate percentage shown below to the total yardage to accommodate fabric flaws, wrinkles and other imperfections.

Up to 500 yards	Add 10%
501 to 1000 yards	Add 5%
More than 1000 yards	Add 3%

Directional Rightway:

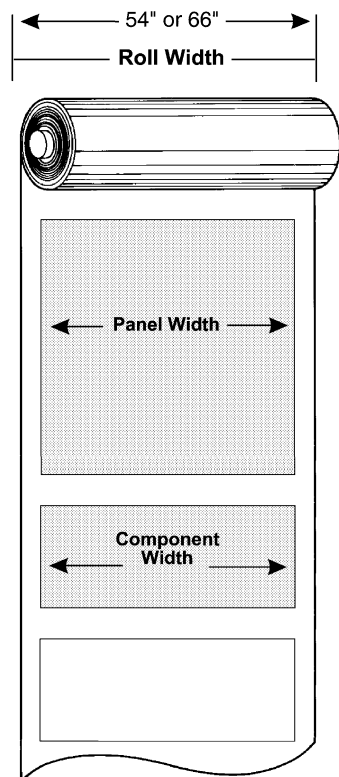

Directional Railroad:

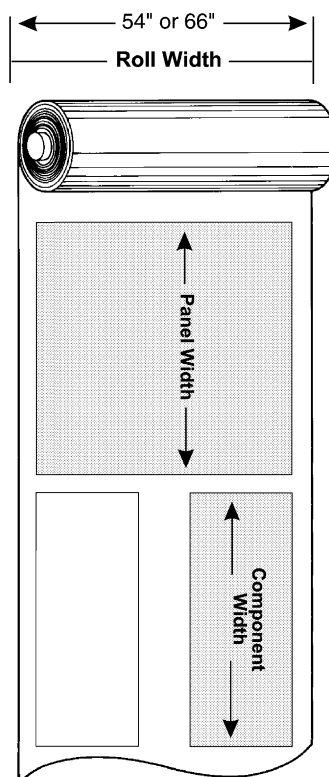

Non-Directional:

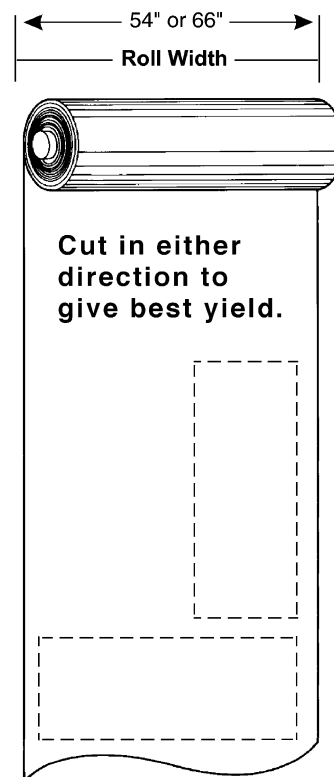

North American Terms of Sale

These Terms of Sale are part of a quotation, bid response, or other sales document issued by Haworth, Inc., Haworth, Ltd. ("Haworth").

These Terms of Sale do not cover products manufactured in North America shipping to non-North American countries nor do they cover products manufactured in non-North American countries shipping to North America. For those terms of sale, please contact Haworth's Global Trade and Compliance Department at 616.393.3000 or through Haworth.com.

A. Ordering Information

Haworth sells its products on the terms set forth in these standard Terms of Sale:

ORDERS MUST BE SUBMITTED IN WRITING OR ELECTRONICALLY (OrderLine) AS REPRESENTED BY A VALID PURCHASE ORDER, WHICH INCLUDES PRODUCT TOTAL.

An order is not binding upon Haworth until Haworth issues an order acknowledgment to the customer (the "Customer"), which will include price information and an anticipated shipping date.

1. Order Changes/Cancellations

For Specials, Customer's Own Material (C.O.M.), finish matches, custom colors, custom products, Master lock and key orders, and RUSH orders, no changes or cancellations are allowed 24 hours after order placement. Standard lock orders (key schedules) cannot be changed if they fall within 2 weeks of the acknowledged ship date. All other products require approval for changes or cancellations. A change/cancellation fee may apply. Contact Order Services for applicable charges.

Ship-to addresses changed within five (5) business days of shipment will incur fees to cover administrative costs due to re-labeling of product and/or reconsignment fees with the carrier.

Order cancellations are complete annulments of orders. Order changes are the deletion of line items or a change in size, color, quantity, ship-to address, or scope of work. There is no penalty for additions; however, any change may cause the order or the line items affected to be rescheduled. Order changes involving additional product and services which increase the value must be accompanied by an amended Purchase Order or other document as agreed.

ALL CHANGES MUST BE IN WRITING, REGARDLESS OF THE (DOLLAR) VALUE. CHANGES ARE NOT BINDING UPON HAWORTH UNTIL HAWORTH ISSUES AN ACKNOWLEDGMENT OF THE CHANGE.

2. C.O.M. (Customer's Own Material)

A Customer who requests a fabric, surface or finish material (C.O.M.) not in Haworth's standard finish offering must first confirm

approval of or request new approval for the C.O.M.

Haworth will determine feasibility of the material for manufacturability. For a description of the procedure to submit C.O.M. samples, contact Haworth's Order Services department. For testing information, see the C.O.M. section of the catalog, or call Haworth Order Services.

If Haworth agrees to use the C.O.M., (1) Haworth shall have no responsibility for the condition, quality, value, performance, physical properties, or any other aspect of the C.O.M.; and (2) Haworth shall have no liability for any damages, injuries, or losses to the Customer or to any third party that shall be caused by any C.O.M., and the Customer shall hold Haworth harmless for all such liability.

3. Valid/Complete Purchase Order

The following information is required in order to process an order with Haworth:

a. Customer Information

- i. **Sold To:** Legal name, complete address (if Haworth is to bill the end user, provide end user Purchase Order made out to Haworth, Inc., Haworth, Ltd.) and phone and fax number.
- ii. **Ship To:** Legal name and address.
- iii. **Purchase Order Number:** From the party Haworth will be billing.
- iv. **Authorized Signature:** All Purchase Orders must be signed by a duly authorized representative if a signature line is present. Electronically transmitted Purchase Orders will be accepted without a signature if dealer billed and the dealer has an electronic purchase payment agreement on file.
- v. **Contact Name and Phone Number:** Person Haworth should contact with any questions regarding the order.
- vi. **Shipping Contact:** Name and phone number of person to be contacted regarding shipping and delivery matters.
- vii. **Tagging Instructions:** This information will appear on all documentation received from Haworth including: cartons, acknowledgments, and invoices. Normally 1 tag is allowed per \$8,000.
- viii. **Price Agreement or National Sales Agreement Number**
- ix. **Product Total:** Net dollars.
- x. **Installation, Design, Project Management, and/or Service Fees**

b. Product Information

- i. **Quantity**
- ii. **Product Numbers**
- iii. **Colors**
- iv. **Specials:** Specify Inquiry and line number for new special products.

- v. **Customer's Own Material:** Order entry code, manufacturer, pattern, color, and who is ordering the C.O.M. fabric (Haworth, dealer or the Customer).
- vi. **Approval Drawings:** An authorized signature by a duly authorized representative is required for shop drawings when applicable.
- vii. A deposit may be required for custom materials.

c. Order Confirmation

All orders will be acknowledged.

B. Pricing Policies

1. Terms of Payment

Terms of payment and credit limits will be established based on financial information. Standard payment terms on open credit are net thirty (30) days from invoice date. Advance payments or other payment security may be required by Haworth. The account balance must be at or below the credit limit and current at all times (no past-due balances). Haworth reserves the right to delay or cancel any shipment to a Customer whose Haworth account balance is over the credit limit and/or past due. For walls and floors a deposit will be required.

2. Terms of Credit

Customer hereby authorizes Haworth to obtain such credit reports, financial information or other information as Haworth may request, including, without limitation, credit information from any financial institutions or others having a business relationship with the Customer. Customer hereby authorizes any credit references to answer Haworth's inquiries and provide such credit information and documentation as Haworth may request.

The Customer hereby releases and holds Haworth harmless for any inconvenience whatsoever, caused by any temporary or permanent withdrawal or restriction of credit privileges hereunder, or the enforcement of any of the provisions contained in this paragraph.

3. Past-Due Charges

Past-due balances will be increased by a maximum of 1.5% per month, or 18% annually, without forfeit of Haworth's right to immediate payment.

4. Applicable Prices

Prices and discounts are subject to change without notice or approval. In the event of an adjustment to pricing, National Sales Agreement (NSA) Customers will be notified in advance according to the terms of the NSA.

Applicable prices are those in effect at the time of the RECEIPT of an order; Haworth reserves the right to use the published pricing effective at the time of shipment, if the requested shipping date is more than 120 days after the order receipt date.

North American Terms of Sale

The price of any product sold to Customer by Haworth will be based upon the price for the products as follows:

Destination	Price List ("Catalog")
U.S.A.	U.S.A.
Canada	Canadian
Mexico	U.S.A.

5. C.O.M. (Customer's Own Material) Charges

Refer to appropriate Customer's Own Material (C.O.M.) form for applicable surface material charges.

6. Taxes

a. U.S.A.: Haworth prices do not include any sales, use or similar taxes. The Customer is responsible to remit directly to Haworth all such taxes when invoiced.

b. Canada: Prices listed in the Canadian catalogs include applicable customs duty. Prices do not include the Federal Goods and Services Tax or any provincial or other sales taxes. Any federal, provincial or other taxes or assessments based upon the sale or shipment of products or services sold applicable to the Customer at present or later imposed by federal, provincial or municipal agencies, shall be added and paid by the Customer.

c. Mexico: Prices listed in the U.S.A. catalogs do not include customs duty, value added or any other tax with respect to the sale, use, ownership, or value of any product or service provided by Haworth. Customer is responsible for all such taxes.

NOTE: For all countries a valid sales tax exemption certificate must be approved by and on file with Haworth prior to product shipment. Otherwise, sales tax will be due and payable to Haworth when such tax is invoiced to Customer.

7. Services

If, as a result of Customer request, the Haworth dealer or Haworth subsidiary provides planning/design services, storage, project management, special handling, set-up, installation and/or other services, the Customer will be charged at the local Haworth dealer/subsidiary's prevailing rates.

8. Termination by Haworth

Haworth may immediately terminate an order upon written notice in the event bankruptcy or insolvency proceedings are instituted by or against the Customer, or the Customer is adjudicated as bankrupt, becomes insolvent, makes an assignment for the benefit of creditors, or proposes or makes any arrangements for the liquidation of its debts, or a receiver or receiver and manager is appointed with respect to all or any part of the assets of the Customer.

C. Shipping and Delivery

Haworth will have the right to determine the method of shipment and routing of product.

This section does not apply to Haworth's TecCrete or TecFlor products. TecCrete and TecFlor are sold freight collect.

If, for any reason, a delivery has to be made to an intermediate location (i.e. a location other than the "Ship To" location noted on the order or ultimate end user location), all handling and re-delivery costs incurred would be at the Customer's expense.

1. U.S.A. - Contiguous

All deliveries will be CPT (Carriage Paid To) (ICC Incoterms 2010) Haworth's manufacturing facilities or distribution centers. Freight charges will be prepaid by Haworth on all orders to locations within the continental United States. Customer bears all risk of loss or damage to the goods when they are placed on Haworth's means of transport.

2. U.S.A. - Non-contiguous (Alaska, Hawaii and Puerto Rico)

All deliveries will be CIF (Cost, Insurance and Freight) (ICC Incoterms 2010). Haworth's catalog prices include ocean freight and insurance to the port of the final destination. Haworth has the right to determine the carrier, method of shipment and routing. Haworth will contract with the insurer and provide minimal insurance coverage (CIF @ 110%) made payable to the Customer. Customer is responsible to obtain greater insurance if so desired.

Customer bears all risk of loss or damage to the goods when the goods are effectively at the disposal of the Customer on board the vessel at the named port of destination. Proof of delivery is a clean on board bill of lading. Customer will be responsible for all on-carriage from the receiving port to the final destination.

3. Canada

All deliveries will be DDP (Delivered Duty Paid) (ICC Incoterms 2010). Haworth's catalog prices include delivery to Customer's named place, not unloaded from any arriving means of transport. Customer bears all risk of loss or damage to the goods when they are delivered to the Customer's named facility not unloaded. Haworth will assume responsibility to file all freight claims with the carrier for any loss/damage which may occur while product is in transit, and will promptly repair or replace any damaged or lost product. Haworth requires the Customer to report all freight damage and/or loss to both the carrier and to Haworth.

NOTE: Under all shipping terms (U.S.A. and Canada), any additional expense resulting from Customer's request for expedited transportation, special services, packaging, handling, routing, and/or shipping method will be billed to Customer.

4. Mexico

All deliveries will be DAP (Delivered to Place) (ICC Incoterms 2010). Haworth's catalog prices include freight charges for normal surface transportation to a United States point of exportation within the 48 contiguous states. Haworth has the right to determine the carrier, method of shipment and routing.

Customer bears all risk of loss or damage to the goods when the goods are delivered to the named United States point of exportation. Haworth will provide customs clearance facilitation and arrangement of local delivery through an Authorized Dealer in Mexico, on a separately negotiated basis. Otherwise the Customer will be responsible for all customs clearance formalities and on-carriage from the United States point of exportation to the final destination in Mexico.

5. Ship Dates and Delay

If Haworth cannot ship products as scheduled due to causes beyond its reasonable control (such as casualty, labor disputes, or accident; inability to obtain necessary labor, material or transportation; or changes requested by the Customer), the ship date will be extended to compensate for the delay as determined by Haworth.

6. Delivery Shortages and Damage

Product shortages and damage must be noted on delivery receipts at the time of delivery and reported to the carrier for correction.

Claims against Haworth for shortages, errors, or damage must be made within three (3) days of the date of delivery or the Customer waives the right to make such a claim. Signed Bill of Lading or Delivery Receipt must be sent in with claims.

7. Storage

Haworth may transfer product to storage at the Customer's risk and expense if the Customer is unable or unwilling to take delivery of product as originally scheduled. Upon such transfer to storage, the Customer assumes risk of loss. Haworth will invoice the Customer for storage fees and the Customer will make payments in accordance with Haworth's standard payment terms.

North American Terms of Sale

D. General Terms

1. Governing Law

For products purchased for delivery in the U.S. pursuant hereto, this Agreement shall be governed by and construed according to the laws of the State of Michigan. Where Products are purchased for delivery in Canada pursuant hereto, this Agreement shall be governed by and construed according to the laws of the Province of Alberta. In either case, the parties attorn to the exclusive jurisdiction of the courts of Michigan and Alberta, respectively for the purpose of hearing any disputes arising under this Agreement or with respect to any Products sold pursuant hereto, and agree that the provisions of the United Nations Convention on Contracts for the International Sale of Goods and any other provision or law which would have the effect of applying the laws of any jurisdiction other than Michigan or Alberta, as the case may be, shall be excluded.

2. Force Majeure

In the event that the performance of Customer or Haworth or its participating dealer assignee(s) would be prevented, restricted, interfered with or rendered commercially impracticable by reason of Force Majeure, then upon the giving of notice to the other parties, the party affected by the Force Majeure shall be excused from performing hereunder until the Force Majeure no longer prevents, restricts, interferes with, or renders such performance commercially impracticable.

"Force Majeure" shall mean: fire, explosion, breakdown of plant, epidemic, hailstorm, snow/ice storms en route, hurricane, tornado, cyclone, flood or power failure; war, revolution, civil or military disturbances, acts of public enemies, acts of terrorism, blockade or embargo; any law, order, proclamation, regulation, ordinance, demand or requirement of any applicable governmental authority or any subdivision, authority, or representative of any such government; labor difficulties, including without limitation, strikes, slowdowns, picketing or boycotts; or difficulties beyond Haworth's reasonable control in obtaining necessary raw materials, labor, fuels and electric power, components or facilities, and any other circumstances beyond the control of the party affected.

3. Delays by Customer

Where Haworth has not received adequate site dimensions, Product specifications, shipping information, installation particulars or other information required by Haworth to permit the efficient manufacture of any Products, or where site conditions are not in accordance with the Installation Requirements set forth, or are not otherwise suitable to permit effective and efficient installation, the manufacture and/or delivery of Products may be delayed, and such event shall constitute a delay by the Customer. When manufacture, delivery or installation is delayed by the Customer or at the Customer's

request: (i) Haworth may, at its option, present the invoice for the full price of the Products to the Customer as then due and payable; (ii) the Customer shall pay to Haworth all reasonable storage, handling and other reasonable incidental expenses incurred by Haworth in connection with such delay; and (iii) the Customer shall bear all risk of loss or damage to the Products being held by Haworth for the Customer.

4. Use and Installation of Products

Haworth recommends that its products be installed by certified, qualified and approved installers according to Haworth's written installation procedures. The Customer agrees to use Haworth products properly; not to remove or alter safety devices, warnings, or operation instructions placed on products by Haworth, and to instruct employees as to the proper care and use of the products according to printed instructions.

5. Warranty

Haworth's standard North American Lifetime Warranty will apply as appropriate. All product line warranty specifics are available in each catalog or upon request.

E. Services

Service requests for design, installation, relocation, storage, etc. are handled by the local Haworth dealer on a separately negotiated basis. Contact the local Haworth dealer, affiliate or area sales office for more details.

Scope of Work - Design

Customer acknowledges that the Products to be manufactured or procured by Haworth in connection with the order are or may be custom manufactured for the Customer and that Haworth may be required to perform extensive work in relation to the design and specification of such Products. Where Customer requests that Haworth create as-built drawings or make more than two material revisions to any particular Product design or specification, Customer agrees that Haworth shall be entitled to invoice Customer with respect to such additional work on the basis of Haworth's then prevailing rates for related design and specification services.

Installation Requirements

Where installation services are to be provided by Haworth, its Authorized Dealer or subcontractor, a document will be provided setting forth the scope of installation work to be performed (the "Scope of Work") and the price to be charged therefore. Unless otherwise specified in the scope of work, Haworth's installation services are limited to products sold by Haworth with the exception of lighting, under floor electrical and data.

General Conditions

(a) Sufficient time shall be allocated by the Customer following delivery of Products and prior to Customer's occupation of the premises to allow the installation of all Products during conventional working hours, Monday through Friday, 7:30 a.m. to 4:30 p.m. Where sufficient time is not allocated and Haworth is required or requested to perform installation work outside of such times, overtime charges shall be charged at Haworth's then prevailing rates. (b) Haworth shall be given free and exclusive access to; (i) a loading dock within 150' of the freight elevator or hoist, which loading dock shall be of sufficient size to enable full-size tractor-trailer deliveries to the premises (where required by Haworth); (ii) a freight elevator or hoist of sufficient size and capacity to allow the efficient movement of the Products; (iii) an unobstructed and safe pathway to the area where Products are to be stored or staged; (iv) a secure storage / staging area; (v) convenient trash facilities; (vi) adequate lighting; (vii) a work site that complies with applicable health and safety legislation. Where such areas and facilities are not available, Haworth shall be entitled to bill Customer for all amounts incurred by Haworth for double-handling, product movement, lifting, hoisting, trash removal and any other resulting charges. (c) The installation site shall be free and clear of existing furniture, debris, or other obstructions (including construction in progress) and shall otherwise be in the reasonable opinion of Haworth ready for installation of the Products. Any building where Products are to be installed shall be fully closed in, dry and protected from the natural elements, with temperatures between 40°F and 90°F (4°C and 32°C) and relative humidity not to exceed 70% at all times including receipt of products, during and after installation and shall be adequately heated and/or air-conditioned. Where unusual site conditions exist which impede or prevent the normal installation of any Products, applicable extra charges shall apply at prevailing rates. (d) Haworth's installation pricing is based upon the installation occurring as one continuous delivery and installation project. Phased installation pricing shall be provided by Haworth on a case by case basis. (e) Electrical hardwiring, plumbing and mechanical work is not included and shall be the responsibility of the Customer. (f) Except as may be otherwise specifically indicated, installation pricing does not apply to projects where union labor is required. Where Haworth has provided installation pricing on the basis that non-union labor be utilized, and where Haworth is required to use union labor or it otherwise becomes impractical to use non-union labor, or where Haworth is required by law to use prevailing wages, Haworth shall be entitled to charge the Customer for any cost differential between the anticipated cost of non-union labor and the actual cost of utilizing union or prevailing wage labor. (g) Haworth shall not be responsible for obtaining permits.

North American Terms of Sale

Project / Site Conditions

Lateral load bracing is not included in the scope of Haworth's work and shall not be performed by Haworth. In areas where Nexus™ or TecCrete flooring Products are to be installed by Haworth overhead construction must be completed prior to the commencement of such work to avoid damage to the panels and finishes. The existing subfloor must be smooth, mopped clean, free of moisture, dust, dirt and debris. Once installed, the access floor must be maintained in the same manner. The subfloor must have a maximum vertical elevation deviation of 0.375" (10mm) over a horizontal span of 10'-0" (3m), and without discontinuities in floor slope. For greater certainty, the scope of Haworth's installation work in such areas shall not be deemed to include any work required to level such subfloor, remove protrusions, remove pre-existing floor coverings or adhesives, or any other work which is required to remedy any conditions which may impede the efficient installation of Nexus™ flooring. Except as may be otherwise specifically indicated in the order, installation pricing for Nexus™ flooring Products and the Scope of Work in relation thereto shall not include any work required to remove and replace floor panels following their initial installation to provide tradespersons or others with access to the underpanel cable management cavity. In areas where movable walls are to be installed, all flooring (including carpeting) and ceiling components (including dropped ceiling grid components) shall be fully complete and ready for the installation of the movable wall products. Further, the existing floor (or other surface on which the movable wall panels are to be installed) shall have a maximum vertical deviation of 1.25" (30mm) and the dropped ceiling grid shall have a maximum vertical deviation of 0.375" (10mm) from the specifications to which such movable wall panels were designed and manufactured (collectively the "Permitted Tolerances"), and shall otherwise comply with any site condition assumptions made known to Haworth prior to the manufacture of such Products (the "Site Assumptions"). Where the Permitted Tolerances or Site Assumptions are not strictly adhered to or met, additional charges may be incurred in connection with site remediation and/or the modification or remanufacture of affected movable wall products, together with all resulting shipping and labor charges at Haworth's then prevailing rates for such Products and services.

Installation Change Orders

Where Customer requests work to be performed or materials to be provided which are not contemplated in the Scope of Work, or Customer otherwise requests Products or services not contemplated in the order (collectively "Extras"), prior to providing such Extras Haworth reserves the right to require the Customer to provide and sign a written Purchase Order or Change Order acceptable to Haworth describing the Extras and the amounts

to be charged therefore, and the Customer agrees to pay such charges.

Entire Agreement

The order and this Agreement (including applicable Schedules) constitute the sole agreement between the parties and supercede any prior understanding or written or oral agreements between the parties (excluding National Sales Agreements). No waiver of any of the provisions of these Standard Terms and Conditions shall be binding on Haworth unless expressly agreed in writing.

Revision Date: July 1, 2011

Index

Products are listed alphabetically in this index by alpha-numeric prefix/suffix codes.

Product Code	Product Description	Page
1201-2110	System 12 – High-Density Stacking Chair – With Arms	242
180-0028	Galerie Collection – Lounge Seating – Lounge Chair	297
180-0053	Galerie Collection – Lounge Seating – Settee	297
180-0075	Galerie Collection – Lounge Seating – Sofa	297
2006-0031	Tuxedo Series – Lounge Seating – Lounge Chair	300
2006-0056	Tuxedo Series – Lounge Seating – Settee	300
2006-0072	Tuxedo Series – Lounge Seating – Sofa	300
3110-ELA	Tally Series — Public Seating – Modular End Component, Left Arm Frame	260
3110-ERA	Tally Series — Public Seating – Modular End Component, Right Arm Frame	260
3110-ET	Tally Series — Public Seating – Modular End Component, Table/Bench Leg	260
3110-GEST	Tally Series – Guest/Occasional Seating – Guest Chair	254
3110-IAC	Tally Series — Public Seating – Modular Interior Component, Arm — Chair-to-Chair	261
3110-IACL	Tally Series — Public Seating – Modular Interior Components, Arm — Chair Left/ Table/Bench Right	261
3110-IACR	Tally Series — Public Seating – Modular Interior Component, Arm — Chair Right/ Table/Bench Left	261
3110-IBCH	Tally Series — Public Seating – Modular Interior Component, Bench and Support Frame	262
3110-ICT	Tally Series — Public Seating – Modular Interior Component, Corner Table and Support Frame	263
3110-IDT	Tally Series — Public Seating – Modular Interior Component, Tables and Support Frame	262
3110-IDTT	Tally Series — Public Seating – Modular Interior Component, “T” Tables and Support Frame	263
3110-ISB	Tally Series — Modular Interior Components – Public Seating – Interior Component, Seat Support Frame and Back	261
3110-IT	Tally Series — Modular Interior Components – Public Seating – Interior Component, Tables and Support Frame	262
3110-ITT	Tally Series — Modular Interior Components – Public Seating – Interior Component, “T” Tables and Support Frame	263
3110-IXT	Tally Series — Modular Interior Components – Public Seating – Interior Component, “X” Table and Support Frame	263
3110-SS	Tally Series – Public Seating – Two Seats	255
3110-SSS	Tally Series – Public Seating – Three Seats	255
3110-SSSS	Tally Series – Public Seating – Seat, Seat, Seat, Seat	256
3110-SSST	Tally Series – Public Seating – Seat, Seat, Seat, Table	258
3110-SST	Tally Series – Public Seating – Seat, Seat, Table	256
3110-SSTS	Tally Series – Public Seating – Seat, Seat, Table, Seat	257
3110-STAK	Tally Series – Guest/Occasional Seating – Stacking Chair	254
3110-STS	Tally Series – Public Seating – Seat, Table, Seat	256
3110-STSS	Tally Series – Public Seating – Seat, Table, Seat, Seat	257
3110-TSS	Tally Series – Public Seating – Table, Seat, Seat	255
3110-TSSS	Tally Series – Public Seating – Table, Seat, Seat, Seat	257
4043-00	Composites Seating Series – Guest/Occasional Seating – Stacking Chair, Arc Arm, Upholstered Back	252
4045-00	Composites Seating Series – Guest/Occasional Seating – Arc Arm, Upholstered Back	248
4046-00	Composites Seating Series – Guest/Occasional Seating – Repose Arm, Upholstered Back	249
4047-00	Composites Seating Series – Guest/Occasional Seating – Cascade Arm, Upholstered Back	250
4048-00	Composites Seating Series – Guest/Occasional Seating – Contour Arm, Upholstered Back	251
4049-00	Composites Seating Series – Occasional Seating – Stool, Armless, Upholstered Back	253
4080-00	Galerie Collection – Lounge Seating – Leg-Base Chair, Fully Upholstered	297
4145-00	Composites Seating Series – Guest/Occasional Seating – Arc Arm, Circle Back	248
4146-00	Composites Seating Series – Guest/Occasional Seating – Repose Arm, Hourglass Back	249
4147-00	Composites Seating Series – Guest/Occasional Seating – Cascade Arm, Circle Back	250
4148-00	Composites Seating Series – Guest/Occasional Seating – Contour Arm, Hourglass Back	251
4243-00	Composites Seating Series – Guest/Occasional Seating – Stacking Chair, Arc Arm, Slat Back	252
4245-00	Composites Seating Series – Guest/Occasional Seating – Arc Arm, Slat Back	248
4246-00	Composites Seating Series – Guest/Occasional Seating – Repose Arm, Cross Back	249
4247-00	Composites Seating Series – Guest/Occasional Seating – Cascade Arm, Slat Back	250

Index

Product Code	Product Description	Page
4248-00	Composites Seating Series – Guest/Occasional Seating – Contour Arm, Cross Back	251
4249-00	Composites Seating Series – Occasional Seating – Stool, Armless, Slat Back	253
4851-0011	Hello Seating – Guest Seating – Fixed Arm, Metal Legs	269
4851-0011-W	Hello Seating – Guest Seating – Fixed Arm, Wood Legs	268
4851-0012	Hello Seating – Guest Seating – Fixed Arm, Metal Legs	269
4851-0012-W	Hello Seating – Guest Seating – Fixed Arm, Wood Legs	268
4851-0013	Hello Seating – Guest Seating – Fixed Arm, Metal Legs	269
4851-0013-W	Hello Seating – Guest Seating – Fixed Arm, Wood Legs	268
4852-0011	Hello Seating – Stools – Fixed Arm, Metal Legs	270
4852-0012	Hello Seating – Stools – Fixed Arm, Metal Legs	270
4852-0013	Hello Seating – Stools – Fixed Arm, Metal Legs	270
4854-0011	Hello Seating – Lounge with Legs – Standard Arm	271
4854-0012	Hello Seating – Lounge with Legs –	271
4855-0043	Hello Seating – Mobile Lounge – Standard Arm	272
4855-0043-GSX	Hello Seating – Mobile Lounge – Fully Loaded – Standard Arm	272
4855-0043-S	Hello Seating – Mobile Lounge – Two Colors – Standard Arm	272
4856-0043	Hello Seating – One Color – Mini-mobile	273
4856-0043-A	Hello Seating – Two Colors – Mini-mobile	273
4858-0001	Hello Seating – Accessories – Tablet Arm	273
4858-0002	Hello Seating – Accessories – Cup Holder	273
5210-32	Prescott Series – Swivel Seating – High-Back Chair, Fully-Upholstered Arm with Wood Arm Trim/ Polypropylene Base	238
5210-32	Prescott Series – Swivel Seating – High-Back Chair, Fully-Upholstered Arm with Wood Arm Trim/Wood Base	239
5215-32	Prescott Series – Swivel Seating – High-Back Chair, Fully-Upholstered Arm/Polypropylene Base	238
5215-32	Prescott Series – Swivel Seating – High-Back Chair, Fully-Upholstered Arm/Wood Base	238
5220-32	Prescott Series – Swivel Seating – Mid-Back Chair, Fully-Upholstered Arm with Wood Arm Trim/ Polypropylene Base	239
5220-32	Prescott Series – Swivel Seating – Mid-Back Chair, Fully-Upholstered Arm with Wood Arm Trim/Wood Base	240
5225-32	Prescott Series – Swivel Seating – Mid-Back Chair, Fully-Upholstered Arm/Polypropylene Base	239
5225-32	Prescott Series – Swivel Seating – Mid-Back Chair, Fully-Upholstered Arm/Wood Base	240
5811	System 58 – High-Back Executive Chair with Arms	235
5818-1816	Galerie Collection – Occasional Tables – 5800 Series Tables	298
5818-1822	Galerie Collection – Occasional Tables – 5800 Series Tables	298
5826-2616	Galerie Collection – Occasional Tables – 5800 Series Tables	298
5826-2622	Galerie Collection – Occasional Tables – 5800 Series Tables	298
5831	System 58 – Mid-Back Executive Chair	236
5838-2100	System 58 – Sled-Base Side Chair	237
5918-1816	Galerie Collection – Occasional Tables – 5900 Series Tables	299
5918-1822	Galerie Collection – Occasional Tables – 5900 Series Tables	299
5926-2616	Galerie Collection – Occasional Tables – 5900 Series Tables	299
5926-2622	Galerie Collection – Occasional Tables – 5900 Series Tables	299
8181-00	Forenze Seating – Guest/Occasional Seating – Serpentine Arm, Upholstered Back	264
8182-00	Forenze Seating – Guest/Occasional Seating – Curve Arm, Upholstered Back	265
8183-00	Forenze Seating – Guest/Occasional Seating – Scroll Arm, Upholstered Back	266
8184-00	Forenze Seating – Guest/Occasional Seating – Cabriole Arm, Upholstered Back	267
8281-00	Forenze Seating – Guest/Occasional Seating – Serpentine Arm, Wave Back	264
8282-00	Forenze Seating – Guest/Occasional Seating – Curve Arm, Wave Back	265
8381-00	Forenze Seating – Guest/Occasional Seating – Serpentine Arm, Ellipse Back	264
8382-00	Forenze Seating – Guest/Occasional Seating – Curve Arm, Ellipse Back	265
8483-00	Forenze Seating – Guest/Occasional Seating – Scroll Arm, Slat Back	266
8484-00	Forenze Seating – Guest/Occasional Seating – Cabriole Arm, Slat Back	267
8583-00	Forenze Seating – Guest/Occasional Seating – Scroll Arm, Star Back	266

Index

<u>Product Code</u>	<u>Product Description</u>	<u>Page</u>
8584-00	Forenze Seating – Guest/Occasional Seating – Cabriole Arm, Star Back	267
A802-3110	Accolade Seating – Sled-Base Side Chair	221
A831-1042	Accolade Seating – Mid-Back Chair without Arms – Synchronized-Tilt	220
A831-1142	Accolade Seating – Mid-Back Chair with Cantilever Arms – Synchronized-Tilt	219
A871-1042	Accolade Seating – High-Back Chair without Arms – Synchronized-Tilt	218
A871-1142	Accolade Seating – High-Back Chair with Cantilever Arms – Synchronized-Tilt	217
AXIS-2SA	Haworth Collection – DSC Axis 10000 Bench – Two Seat Bench — Fabric Seat	319
AXIS-2SAA	Haworth Collection – DSC Axis 10000 Bench — Two Seat Bench — Steel or Wood Seat	320
AXIS-2SAG	Haworth Collection – DSC Axis 10000 Bench — Two Seat Bench — Steel or Wood Seat	320
AXIS-2SG	Haworth Collection – DSC Axis 10000 Bench – Two Seat Bench — Fabric Seat	319
AXIS-2SGA	Haworth Collection – DSC Axis 10000 Bench – Two Seat Bench — Steel or Wood Seat	320
AXIS-2SGG	Haworth Collection – DSC Axis 10000 Bench – Two Seat Bench — Steel or Wood Seat	320
AXIS-2SVA	Haworth Collection – DSC Axis 10000 Bench – Two Seat Bench — Steel or Wood Seat	320
AXIS-2SVG	Haworth Collection – DSC Axis 10000 Bench – Two Seat Bench — Steel or Wood Seat	320
AXIS-3SA	Haworth Collection – DSC Axis 10000 Bench – Three Seat Bench — Fabric Seat	319
AXIS-3SAA	Haworth Collection – DSC Axis 10000 Bench – Three Seat Bench — Steel or Wood Seat	320
AXIS-3SAG	Haworth Collection – DSC Axis 10000 Bench – Three Seat Bench — Steel or Wood Seat	320
AXIS-3SG	Haworth Collection – DSC Axis 10000 Bench – Three Seat Bench — Fabric Seat	319
AXIS-3SGA	Haworth Collection – DSC Axis 10000 Bench – Three Seat Bench — Steel or Wood Seat	320
AXIS-3SGG	Haworth Collection – DSC Axis 10000 Bench – Three Seat Bench — Steel or Wood Seat	320
AXIS-3SVA	Haworth Collection – DSC Axis 10000 Bench – Three Seat Bench — Steel or Wood Seat	320
AXIS-3SVG	Haworth Collection – DSC Axis 10000 Bench – Three Seat Bench — Steel or Wood Seat	320
AXIS-4SA	Haworth Collection – DSC Axis 10000 Bench – Four Seat Bench — Fabric Seat	319
AXIS-4SAA	Haworth Collection – DSC Axis 10000 Bench – Four Seat Bench — Steel or Wood Seat	320
AXIS-4SAG	Haworth Collection – DSC Axis 10000 Bench – Four Seat Bench — Steel or Wood Seat	320
AXIS-4SG	Haworth Collection – DSC Axis 10000 Bench – Four Seat Bench — Fabric Seat	319
AXIS-4SGA	Haworth Collection – DSC Axis 10000 Bench – Four Seat Bench — Steel or Wood Seat	320
AXIS-4SGG	Haworth Collection – DSC Axis 10000 Bench – Four Seat Bench — Steel or Wood Seat	320
AXIS-4SVA	Haworth Collection – DSC Axis 10000 Bench – Four Seat Bench — Steel or Wood Seat	320
AXIS-4SVG	Haworth Collection – DSC Axis 10000 Bench – Four Seat Bench — Steel or Wood Seat	320
AXIS-5SA	Haworth Collection – DSC Axis 10000 Bench – Five Seat Bench — Fabric Seat	319
AXIS-5SAA	Haworth Collection – DSC Axis 10000 Bench – Five Seat Bench — Steel or Wood Seat	320
AXIS-5SAG	Haworth Collection – DSC Axis 10000 Bench – Five Seat Bench — Steel or Wood Seat	320
AXIS-5SG	Haworth Collection – DSC Axis 10000 Bench – Five Seat Bench — Fabric Seat	319
AXIS-5SGA	Haworth Collection – DSC Axis 10000 Bench – Five Seat Bench — Steel or Wood Seat	320
AXIS-5SGG	Haworth Collection – DSC Axis 10000 Bench – Five Seat Bench — Steel or Wood Seat	320
AXIS-5SVA	Haworth Collection – DSC Axis 10000 Bench – Five Seat Bench — Steel or Wood Seat	320
AXIS-5SVG	Haworth Collection – DSC Axis 10000 Bench – Five Seat Bench — Steel or Wood Seat	320
AXIS-6SA	Haworth Collection – DSC Axis 10000 Bench – Six Seat Bench — Fabric Seat	319
AXIS-6SAA	Haworth Collection – DSC Axis 10000 Bench – Six Seat Bench — Steel or Wood Seat	320
AXIS-6SAG	Haworth Collection – DSC Axis 10000 Bench – Six Seat Bench — Steel or Wood Seat	320
AXIS-6SG	Haworth Collection – DSC Axis 10000 Bench – Six Seat Bench — Fabric Seat	319
AXIS-6SGA	Haworth Collection – DSC Axis 10000 Bench – Six Seat Bench — Steel or Wood Seat	320
AXIS-6SGG	Haworth Collection – DSC Axis 10000 Bench – Six Seat Bench — Steel or Wood Seat	320
AXIS-6SVA	Haworth Collection – DSC Axis 10000 Bench – Six Seat Bench — Steel or Wood Seat	320
AXIS-6SVG	Haworth Collection – DSC Axis 10000 Bench – Six Seat Bench — Steel or Wood Seat	320
BOOK-12	System 12 – Accessories – Book Rack	243
BSIT	Haworth Collection – Guest Seating	312
CART-12	System 12 – Accessories – Stacking Cart	243
CAST-0016	Haworth Collection – Plia – Folding Chair	334

Index

Product Code	Product Description	Page
CAST-0017	Haworth Collection – Plia – Folding Chair	334
CAST-0027	Haworth Collection – Plia – Wall Hook	334
CAST-0028	Haworth Collection – Penelope – Stacking Chair	333
D811-2240	Monaco – Large High-Back Chair with Open Arms	225
D811-2640	Monaco – Large High-Back Chair with Enclosed Arms	226
D821-2240	Monaco – Medium High-Back Chair with Open Arms	227
D821-2640	Monaco – Medium High-Back Chair with Enclosed Arms	228
D831-2240	Monaco – Large Mid-Back Chair with Open Arms	229
D831-2640	Monaco – Large Mid-Back Chair with Enclosed Arms	230
D841-2240	Monaco – Medium Mid-Back Chair with Open Arms	231
D841-2640	Monaco – Medium Mid-Back Chair with Enclosed Arms	232
DIAL-CE	Haworth Collection – Exchange – Connecting Element	321
DIAL-SL	Haworth Collection – Exchange – Guest Seating	321
DIAL-ST	Haworth Collection – Exchange – Guest Seating	321
DSC-AT	Haworth Collection – DSC Axis 106 – Anti-Panic Writing Tablet with Armrest	318
DSC-LARM	Haworth Collection – DSC Axis 106 – Armrest	318
DSC-LTM	Haworth Collection – DSC Axis 106 – Standard Writing Tablet	318
DSC-NCA	Haworth Collection – DSC Axis 106	317
DSC-RARM	Haworth Collection – DSC Axis 106 – Armrest	318
DSC-RTM	Haworth Collection – DSC Axis 106 – Standard Writing Tablet	318
DSC-SCA	Haworth Collection – DSC Axis 106	317
EUB1-0000	Haworth Collection – LTB Lounge – Bookcase	330
EUE1-0000-1331W	Haworth Collection – LTB Lounge – Bookcase	330
F235-2042	Improv Tag – Mesh Back without Arms	182
F235-2442	Improv Tag – Mesh Back with Fixed-Height Task Arms	183
F235-2742	Improv Tag – Mesh Back with Height-Adjustable Task Arms	184
F235-2W42	Improv Tag – Mesh Back with Height- and Width-Adjustable 3-D Arms	185
HCCL-SBBP-0	Haworth Collection – Shetland – Without Saddle	353
HCCL-SBRP-0	Haworth Collection – Shetland – Without Saddle	353
HCCL-SLBP-2	Haworth Collection – Shetland – With Saddle	353
HCCL-SLDU-1	Shetland – Saddle	354
HCCL-SLRP-2	Haworth Collection – Shetland – With Saddle	353
K120-2210	K120 Series – Guest/Occasional Seating – Sled Base with Arms Open-Frame Base	303
K153-10	K100 Series – Public Seating – Ten Seat Beam	308
K153-2	K100 Series – Public Seating – Two Seat Beam	307
K153-3	K100 Series – Public Seating – Three Seat Beam	307
K153-4	K100 Series – Public Seating – Four Seat Beam	307
K153-45	K100 Series – Public Seating – 45° Corner Beam	308
K153-5	K100 Series – Public Seating – Five Seat Beam	307
K153-6	K100 Series – Public Seating – Six Seat Beam	307
K153-7	K100 Series – Public Seating – Seven Seat Beam	307
K153-8	K100 Series – Public Seating – Eight Seat Beam	307
K153-9	K100 Series – Public Seating – Nine Seat Beam	308
K156-220	K100 Series – Public Seating – Beam Mounted Components – Armless Seat	305
K156-221	K100 Series – Public Seating – Beam Mounted Components – Seat with Arms	305
K700-2001	Haworth Collection – K700 Stool	322
K700-4001	Haworth Collection – K700 Stool	322
K700-8001	Haworth Collection – K700 Stool	322
K700-CAP	Haworth Collection – K700 Stool	322
KGNG-150	K120 Series – Guest/Occasional Seating – Ganging Clip	303

Index

Product Code	Product Description	Page
KL01-7200	Tempo Series – Lounge Seating – Open Frame Lounge — One Seat	283
KL01-7210	Tempo Series – Lounge Seating – Open Frame Lounge — One Seat – with Arms	283
KL02-7200	Tempo Series – Lounge Seating – Open Frame Lounge — Two Seats	283
KL02-7210	Tempo Series – Lounge Seating – Open Frame Lounge — Two Seats – with Arms	283
KLB1-7200	Tempo Series – Bariatric Lounge Seating – Open Frame Lounge — One Seat	296
KLB1-7220	Tempo Series – Bariatric Lounge Seating – Open Frame Lounge — One Seat – with Arms	296
KLCA-7200-N	Tempo Series – Modular Add-on Seating – Add-on Seat without Arm	293
KLCA-7210-R	Tempo Series – Modular Add-on Seating – Add-on Seat with Right Arm	293
KLCC-7TA0	Tempo Series – Modular Add-on Tables – Radius Corner Table	295
KLCC-7TQ0	Tempo Series – Modular Add-on Tables – Square Corner Table	295
KLCE-7TQ0-L	Tempo Series – Modular Starter Tables – Left End Table	294
KLCE-7TQ0-R	Tempo Series – Modular Starter Tables – Right End Table	294
KLCI-7TQ0	Tempo Series – Modular Add-on Tables – In-Line Table	295
KLCS-7200-N	Tempo Series – Modular Starter Seating – Starter Seat without Arms	292
KLCS-7210-B	Tempo Series – Modular Starter Seating – Starter Seat with Right and Left Arms	291
KLCS-7210-L	Tempo Series – Modular Starter Seating – Starter Seat with Left Arm	291
KLCS-7210-R	Tempo Series – Modular Starter Seating – Starter Seat with Right Arm	291
KLP2-7210	Tempo Series – Preconfigured Seating – Seat, Seat	285
KLP3-7210	Tempo Series – Preconfigured Seating – Seat, Seat, Seat	285
KLP4-7210	Tempo Series – Preconfigured Seating – Seat, Seat, Seat, Seat	287
KLPJ-7210	Tempo Series – Preconfigured Seating – Seat, Table, Seat	285
KLPK-7210	Tempo Series – Preconfigured Seating – Table, Seat, Seat	286
KLPL-7210	Tempo Series – Preconfigured Seating – Seat, Seat, Table	286
KLPM-7210	Tempo Series – Preconfigured Seating – Seat, Table, Seat, Seat	287
KLPN-7210	Tempo Series – Preconfigured Seating – Seat, Seat, Table, Seat	287
KLPP-7210	Tempo Series – Preconfigured Seating – Table, Seat, Seat, Seat	288
KLPQ-7210	Tempo Series – Preconfigured Seating – Seat, Seat, Seat, Table	288
KLT1-3030	Tempo Series – Lounge Seating and Tables – Coffee Table	284
KLT8-1818	Tempo Series – Lounge Seating and Tables – End Table	284
KLU1-7220	Tempo Series – Lounge Seating and Tables – Fully Upholstered	284
KLU2-7220	Tempo Series – Lounge Seating and Tables – Fully Upholstered – Two Seats	284
KLU3-7220	Tempo Series – Lounge Seating and Tables – Fully Upholstered – Three Seats	284
KPT0-2929	K100 Series – Public Seating – Corner Connecting Table, Configuration #1	306
KPT1-2929	K100 Series – Public Seating – Corner Connecting Table, Configuration #2	306
KPT2-2929	K100 Series – Public Seating – Corner Connecting Table, Configuration #3	306
KPT3-2929	K100 Series – Public Seating – Corner Connecting Table, Configuration #4	306
KPT9-2124	K100 Series – Public Seating – Beam Mounted Components – In-Line Table	305
KSCP-5110	Scamps Series – Children's Furniture – Chair with Arms	309
KSTR-24	Scamps Series – Children's Furniture – Round Table	309
M211-1042	Improv Series – Mid-Back Chair without Arms	139
M211-1142	Improv Series – Mid-Back Chair with Arms	137
M211-1742	Improv Series – Mid-Back Chair with Height Adjustable Arms	138
M221-1042	Improv Series – High-Back Chair without Arms	136
M221-1142	Improv Series – High-Back Chair with Arms	134
M221-1742	Improv Series – High-Back Chair with Height Adjustable Arms	135
M231-1042	Improv Series – Improv H.E. Mid-Back Chair without Arms	163
M231-1442	Improv Series – Improv H.E. Mid-Back Chair with Task Arms	156
M231-1742	Improv Series – Improv H.E. Mid-Back Chair with Height Adjustable Task Arms	158
M231-1H42	Improv Series – Improv H.E. Mid-Back Chair with Flipper Arms	160
M231-1W42	Improv Series – Improv H.E. Mid-Back Chair with Height and Width Adjustable 3-D Arms	162

Index

Product Code	Product Description	Page
M235-3042	Improv Series – Improv S.E. Mesh Back Chair without Arms	172
M235-3442	Improv Series – Improv S.E. Mesh-Back Chair with Task Arms	174
M235-3742	Improv Series – Improv S.E. Mesh-Back Chair with Height Adjustable Task Arms	176
M235-3H42	Improv Series – Improv S.E. Mesh-Back Chair with Flipper Arms	178
M235-3W42	Improv Series – Improv S.E. Mesh-Back Chair with Height and Width Adjustable 3-D Arms	180
M251-1042	Improv Series – Improv H.E. High-Back Chair without Arms	155
M251-1442	Improv Series – Improv H.E. High-Back Chair with Task Arms	148
M251-1742	Improv Series – Improv H.E. High-Back Chair with Height Adjustable Task Arms	150
M251-1H42	Improv Series – Improv H.E. High-Back Chair with Flipper Arms	152
M251-1W42	Improv Series – Improv H.E. High-Back Chair with Height and Width Adjustable 3-D Arms	154
M271-1042	Improv Series – Improv H.E. XL Chair without Arms	147
M271-1442	Improv Series – Improv H.E. XL Chair with Task Arms	140
M271-1742	Improv Series – Improv H.E. XL Chair with Height Adjustable Task Arms	142
M271-1H42	Improv Series – Improv H.E. XL Chair with Flipper Arms	144
M2E1-1042	Improv Series – Improv H.E. Stool without Arms	171
M2E1-1442	Improv Series – Improv H.E. Stool with Task Arms	164
M2E1-1742	Improv Series – Improv H.E. Stool with Height Adjustable Task Arms	166
M2E1-1H42	Improv Series – Improv H.E. Stool with Flipper Arms	168
M2E1-1W42	Improv Series – Improv H.E. Stool with Height and Width Adjustable 3-D Arms	170
M600-2100	Improv Series – Leg-Base Stacking Chairs – Without Arms	187
M600-2110	Improv Series – Leg-Base Stacking Chairs – With Arms	186
M600-2190	Improv Series – Leg-Base Stacking Chair with Tablet Arm – With Tablet Arm	188
M600-2300	Improv Series – Leg-Base Stacking Chairs – Without Arms	187
M600-2310	Improv Series – Leg-Base Stacking Chairs – With Arms	186
M600-8100	Improv Series – Stools – Without Arms	192
M600-8110	Improv Series – Stools – With Arms	192
M600-8300	Improv Series – Stools – Without Arms	192
M600-8310	Improv Series – Stools – With Arms	192
M601-2100	Improv Series – Sled-Base Chairs – Without Arms, Non-Stacking	190
M601-2110	Improv Series – Sled-Base Chairs – With Arms, Non-Stacking	189
M601-2190	Improv Series – Sled-Base Chair with Tablet Arm – Non-Stacking	191
M601-2300	Improv Series – Sled-Base Chairs – Without Arms, Non-Stacking	190
M601-2310	Improv Series – Sled-Base Chairs – With Arms, Non-Stacking	189
MPRV-BARS	Improv Series – Tandem Tables and Connecting Bars – Chair-to-Chair Connecting Bars	196
MPRV-CART	Improv Series – Accessories – Stacking Dolly	193
MPRV-RACK	Improv Series – Accessories – Book Rack	193
MTE1-20	Improv Series – Tandem Tables and Connecting Bars – End-of-Run Table	196
MTI1-20	Improv Series – Tandem Tables and Connecting Bars – In-Line Table	196
MTR1-20	Improv Series – Occasional Tables – Round Table	197
MTV1-2048	Improv Series – Occasional Tables – Oval Table	197
SAS-22-A1A	Candor Modern Seating – Fully Upholstered Seat and Back	247
SAS-22-A1B	Candor Classic Seating – Fully Upholstered Seat and Back	246
SAS-22-A2B	Candor Classic Seating – Fully Upholstered Seat and 3/4 Back	246
SAS-22-A3A	Candor Modern Seating – Fully Upholstered Seat and 1/2 Back	247
SAS-2W-A4A	Candor Modern Seating – Fully Upholstered Seat and Slat Back	247
SAS-2W-A4B	Candor Classic Seating – Fully Upholstered Seat and Slat Back	246
SCB-44-0H	Very – Seminar with Storage Rack – Perforated Back – Seminar With Storage Rack	58
SCB-44-3H	Very – Seminar with Storage Rack – Perforated Back – Seminar With Storage Rack	58
SCB-45-3H	Very – Seminar with Storage Rack – Tetro Back – Seminar With Storage Rack	72
SCC-44-01	Very – Conference Chair - Perforated – Without Arms	61

Index

Product Code	Product Description	Page
SCC-44-11	Very – Conference Chair - Perforated – With Arms	.60
SCC-45-01	Very – Conference Chair - Tetro Back – Without Arms	.75
SCC-45-11	Very – Conference Chair - Tetro Back – With Arms	.74
SCF-44-01	Very – Conference Stool – Perforated Back	.62
SCF-44-11	Very – Conference Stool – Perforated Back	.62
SCF-45-01	Very – Conference Stool – Tetro Back	.76
SCF-45-11	Very – Conference Stool – Tetro Back	.76
SCH-44-0S	Very – Wire Stacker – Without Arms	.47
SCH-44-3S	Very – Wire Stacker – With Arms	.46
SCHA-R	Very – Accessories – Wire Stacker Tablet Arm	.77
SCHR-1	Very – Accessories – Wire Stacker Storage Rack	.77
SCK-44-3H	Very – Side Chair with Storage Rack – Perforated Back	.53
SCK-45-3H	Very – Side Chair with Storage Rack – Tetro Back	.67
SCL1-0000-2H	Cassis – Lounge Seating – Lounge Chair	.282
SCL2-0000-2H	Cassis – Lounge Seating – Settee	.282
SCL3-0000-2H	Cassis – Lounge Seating – Sofa	.282
SCL-44-3H	Very – Side Stool – Perforated Back	.54
SCL-45-0H	Very – Side Stool – Tetro Back	.68
SCL-45-3H	Very – Side Stool – Tetro Back	.68
SCM-44-0H	Very – Seminar Chair – Perforated – Without Arms	.56
SCM-44-3H	Very – Seminar Chair – Perforated – With Arms	.55
SCM-44-RH	Very – Seminar with Tablet Arm – Perforated Back – Seminar With Tablet Arm	.57
SCM-45-0H	Very – Seminar Chair – Tetro Back – Without Arms	.70
SCM-45-3H	Very – Seminar Chair – Tetro Back – With Arms	.69
SCM-45-RH	Very – Seminar with Tablet Arm – Tetro Back – Seminar With Tablet Arm	.71
SCON-EHB	Haworth Collection – s_con Chairs	.339
SCON-EHB	Haworth Collection – s_con Chairs	.340
SCON-HBC	Haworth Collection – s_con Chairs	.343
SCON-SBC	Haworth Collection – s_con Chairs	.342
SCON-STC	Haworth Collection – s_con Chairs	.344
SCON-SWC	Haworth Collection – s_con Chairs	.341
SCS-44-0H	Very – Side Chair – Perforated – Without Arms	.51
SCS-44-3H	Very – Side Chair – Perforated – With Arms	.50
SCS-44-RH	Very – Side Chair with Tablet Arm – Perforated Back – Side With Tablet Arm	.52
SCS-45-0H	Very – Side Chair – Tetro Back – Without Arms	.65
SCS-45-3H	Very – Side Chair – Tetro Back – With Arms	.64
SCS-45-RH	Very – Side Chair with Tablet Arm – Tetro Back – Side With Tablet Arm	.66
SCSG-1	Very – Accessories – Ganging Connector	.77
SCSG-2	Very – Accessories – Ganging Connector	.77
SCT-1	Very – Accessories – Stacking Carts	.78
SCT-20-0011	Very Task – Task Chair without Arms	.90
SCT-20-1011	Very Task – Task Chair with Fixed Arms	.88
SCT-20-4011	Very Task – Task Chair with Height Adjustable Arms	.86
SCT-20-7011	Very Task – Task Chair with 4D Arms	.84
SCT-3	Very – Accessories – Stacking Carts	.78
SCT-4	Very – Accessories – Stacking Carts	.78
SCW-44-0S	Very – Wire Stool	.48
SCW-44-3S	Very – Wire Stool	.48
SGG-22-A	Haworth Collection – Collaborate — Seating – Guest Chair	.314
SGG-22-C	Haworth Collection – Collaborate — Seating – Guest Chair	.314

Index

Product Code	Product Description	Page
SGG-22-H	Haworth Collection – Collaborate — Seating – Guest Chair	314
SGL-22-A	Haworth Collection – Collaborate — Seating – Lounge Chair	313
SGL-22-C	Haworth Collection – Collaborate — Seating – Lounge Chair	313
SGL-22-H	Haworth Collection – Collaborate — Seating – Lounge Chair	313
SLB-2CS	Haworth Collection – LTB Lounge – Curved Bench	327
SLB-2SS	Haworth Collection – LTB Lounge – Straight Bench	326
SLB_SF	Haworth Collection – LTB Lounge – Straight Bench	325
SLC-8	Haworth Collection – LTB Lounge – 8-Shaped Cushion	328
SLC-L	Haworth Collection – LTB Lounge – L-Shaped Cushion	328
SLMS-FD01	Haworth Collection – m_sit Lounge – Lounge Chair	331
SLMS-FD02	Haworth Collection – m_sit Lounge – Settee	331
SLMS-FD03	Haworth Collection – m_sit Lounge – Sofa	331
SLQB-BCLG-C	Haworth Collection – q_bic – Large Bench	337
SLQB-BCLG-P	Haworth Collection – q_bic – Large Bench	337
SLQB-BCSM-C	Haworth Collection – q_bic – Small Bench	337
SLQB-BCSM-P	Haworth Collection – q_bic – Small Bench	337
SLQB-FD01-C	Haworth Collection – q_bic – Lounge Chair	335
SLQB-FD01-P	Haworth Collection – q_bic – Lounge Chair	335
SLQB-FD02-C	Haworth Collection – q_bic – Settee	335
SLQB-FD02-P	Haworth Collection – q_bic – Settee	335
SLQB-FD03-C	Haworth Collection – q_bic – Sofa	336
SLQB-FD03-P	Haworth Collection – q_bic – Sofa	336
SLR	Haworth Collection – LTB Lounge – Arm Rest	327
SLS1-2T-01	LIVELY – Side Chair – Without Arms	104
SLS1-2T-0H	LIVELY – Side Chair – Without Arms	104
SLS1-2T-11	LIVELY – Side Chair – With Arms	103
SLS1-2T-1H	LIVELY – Side Chair – With Arms	103
SLSE-CUB1-8B	Haworth Collection – SE04 Lounge – Single Cube	350
SLSE-CUB1-8P	Haworth Collection – SE04 Lounge – Single Cube	350
SLSE-CUB2-8B	Haworth Collection – SE04 Lounge – Double Cube	350
SLSE-CUB2-8P	Haworth Collection – SE04 Lounge – Double Cube	350
SLSE-CUB3-8B	Haworth Collection – SE04 Lounge – Triple Cube	351
SLSE-CUB3-8P	Haworth Collection – SE04 Lounge – Triple Cube	351
SLSE-SQ01-B	Haworth Collection – SE04 Lounge — One Color Upholstery – Single Square	345
SLSE-SQ01-P	Haworth Collection – SE04 Lounge — One Color Upholstery – Single Square	345
SLSE-SQ02-B	Haworth Collection – SE04 Lounge — One Color Upholstery – Double Square	347
SLSE-SQ02-P	Haworth Collection – SE04 Lounge — One Color Upholstery – Double Square	347
SLSE-SQB1-B	Haworth Collection – SE04 Lounge – Single Seat Bench	349
SLSE-SQB1-P	Haworth Collection – SE04 Lounge – Single Seat Bench	349
SLSE-SQB2-B	Haworth Collection – SE04 Lounge – Double Seat Bench	349
SLSE-SQB2-P	Haworth Collection – SE04 Lounge – Double Seat Bench	349
SLSE-SQT1-BT	Haworth Collection – SE04 Lounge — Two Color Upholstery – Single Square	346
SLSE-SQT1-PT	Haworth Collection – SE04 Lounge — Two Color Upholstery – Single Square	346
SLSE-SQT2-BT	Haworth Collection – SE04 Lounge — Two Color Upholstery – Double Square	348
SLSE-SQT2-PT	Haworth Collection – SE04 Lounge — Two Color Upholstery – Double Square	348
SLSE-TR01-B	Haworth Collection – SE04 Lounge — One Color Upholstery – Single Trapezoid	345
SLSE-TR01-P	Haworth Collection – SE04 Lounge — One Color Upholstery – Single Trapezoid	345
SLSE-TR02-B	Haworth Collection – SE04 Lounge — One Color Upholstery – Double Trapezoid	347
SLSE-TR02-P	Haworth Collection – SE04 Lounge — One Color Upholstery – Double Trapezoid	347
SLSE-TRT1-BT	Haworth Collection – SE04 Lounge — Two Color Upholstery – Single Trapezoid	346

Index

Product Code	Product Description	Page
SLSE-TRT1-P	Haworth Collection – SE04 Lounge — Two Color Upholstery – Single Trapezoid	346
SLSE-TRT2-BT	Haworth Collection – SE04 Lounge — Two Color Upholstery – Double Trapezoid	348
SLSE-TRT2-PT	Haworth Collection – SE04 Lounge — Two Color Upholstery – Double Trapezoid	348
SLT1-2T-0115A	LIVELY – Task Chair without Arms	102
SLT1-2T-1115A	LIVELY – Task Chair with Fixed Arms	101
SLT1-2T-4115A	LIVELY – Task Chair with Height Adjustable Arms	100
SLT1-2T-7115A	LIVELY – Task Chair with 4D Arms	99
SLY-2012	Haworth Collection – LTB Lounge – Seating Tray	328
STS-1	Tilt – Stool	310
SZG-22-1	ZODY – 4 Leg	44
SZG-22-1	ZODY – Sled Base	43
SZT-20-002MA1	ZODY – TASK Chair without Arms	40
SZT-20-102MA1	ZODY – TASK Chair with Fixed Arms	36
SZT-20-402MA1	ZODY – TASK Chair with Height Adjustable Arms	32
SZT-20-702MA1	Zody – TASK Chair with 4D Arms	28
TABR-12	System 12 – Accessories – Tablet Board	243
TGO-14-LRA	Haworth Collection – Collaborate — Occasional Tables – Round Table	315
TGO-14-LRC	Haworth Collection – Collaborate — Occasional Tables – Round Table	315
TGO-14-LSA	Haworth Collection – Collaborate — Occasional Tables – Square Table	315
TGO-14-LSC	Haworth Collection – Collaborate — Occasional Tables – Square Table	315
TGO-16-LEA	Haworth Collection – Collaborate — Occasional Tables – Ellipse Table	316
TGO-16-LEC	Haworth Collection – Collaborate — Occasional Tables – Ellipse Table	316
TGO-18-LRA	Haworth Collection – Collaborate — Occasional Tables – Round Table	315
TGO-18-LRC	Haworth Collection – Collaborate — Occasional Tables – Round Table	315
TGO-18-LSA	Haworth Collection – Collaborate — Occasional Tables – Square Table	315
TGO-18-LSC	Haworth Collection – Collaborate — Occasional Tables – Square Table	315
TLB-2055	Haworth Collection – LTB Lounge – Bookcase	329
TLL-2020	Haworth Collection – LTB Lounge – Linear Table	329
TLL-2026	Haworth Collection – LTB Lounge – Linear Table	329
TLL-2055	Haworth Collection – LTB Lounge – Coffee Table	329
TLX	Haworth Collection – LTB Lounge – X Link Table	329
TOMS-ET01-X	Haworth Collection – m_sit Tables – Connection Elements	332
TOMS-ET02-X	Haworth Collection – m_sit Tables – Connection Elements	332
TOMS-ET03-X	Haworth Collection – m_sit Tables – Connection Elements	332
TOMS-ET04-X	Haworth Collection – m_sit Tables – Connection Elements	332
TOMS-ET05-X	Haworth Collection – m_sit Tables – Connection Elements	332
TOMS-ET06-X	Haworth Collection – m_sit Tables – Connection Elements	332
TOMS-ET07-X	Haworth Collection – m_sit Tables – Connection Elements	332
TOMS-ET08-X	Haworth Collection – m_sit Tables – Connection Elements	332
TOMS-ET10-X	Haworth Collection – m_sit Tables – Connection Elements	332
TOMS-ET11-X	Haworth Collection – m_sit Tables – Connection Elements	332
TOMS-RTC-X	Haworth Collection – m_sit Tables – Rectangle	332
TOMS-RTP-X	Haworth Collection – m_sit Tables – Rectangle	332
TOMS-SQC-X	Haworth Collection – m_sit Tables – Square	332
TOMS-SQP-X	Haworth Collection – m_sit Tables – Square	332
TOQB-RTGC	Haworth Collection – q_bic – Rectangle	338
TOQB-RTGP	Haworth Collection – q_bic – Rectangle	338
TOQB-RTW	Haworth Collection – q_bic – Rectangular	338
TOQB-SQGC	Haworth Collection – q_bic – Square	338
TOQB-SQGP	Haworth Collection – q_bic – Square	338

Index

Product Code	Product Description	Page
TOQB-SQT	Haworth Collection – q_bic – Square	338
TOSE-RTW	Haworth Collection – SE04 Tables – Wood Table — Rectangle	352
TOSE-SQW	Haworth Collection – SE04 Tables – Wood Table — Square	352
TOSE-TRW	Haworth Collection – SE04 Tables – Wood Table — Trapezoid	352
TQ84-0011	ToDo – Single, Stationary	276
TQ84-0012	ToDo – Double, Stationary	278
TQ84-0013	ToDo – Triple, Stationary	279
TQ85-0011	ToDo – Single, Mobile	277
TQ90-0001	ToDo – Accessories – Wood Tablet with Arm	280
TQ90-0003	ToDo – Accessories – Cup Holder	280
TQ90-0004	ToDo – Ottoman	281
TQ90-0006	ToDo – Accessories – Grommet Cover	280
X611-2040	X99 – Executive without Arms	115
X611-2044	X99 – Executive without Arms	114
X611-2140	X99 – Executive with Loop Arms	113
X611-2144	X99 – Executive with Loop Arms	112
X611-2W40	X99 – Executive with 3-dimensional Arms	110
X611-2W44	X99 – Executive with 3-dimensional Arms	109
X621-2040	X99 – Task Chair without Arms	123
X621-2044	X99 – Task Chair without Arms	122
X621-2140	X99 – Task Chair with Loop Arms	121
X621-2144	X99 – Task Chair with Loop Arms	120
X621-2W40	X99 – Task Chair with 3-dimensional Arms	118
X621-2W44	X99 – Task Chair with 3-dimensional Arms	117
X630-3100	X99 – Guest Chair	124
X640-0040	X99 – Seminar Chair – Without Arms	126
X641-2040	X99 – Advanced Seminar Chair – Without Arms	128
X641-2140	X99 – Advanced Seminar Chair – With Arms	127
X840-0140	X99 – Seminar Chair – With Arms	125
Z600-2100	LOOK Seating – Side Chairs – Without Arms	209
Z600-2130	LOOK Seating – Side Chairs – With Arms	210
Z600-2210	LOOK Seating – Side Chairs – With Arms	210
Z600-2230	LOOK Seating – Side Chairs – With Arms	210
Z600-2440	LOOK Seating – Lounge Chairs – Lounge Chair	211
Z831-1042	LOOK Seating – Mid-Back Chair without Arms	205
Z831-1442	LOOK Seating – Mid-Back Chair with Fixed Arms	206
Z831-1742	LOOK Seating – Mid-Back Chair with Height Adjustable Arms	207
Z831-1W42	LOOK Seating – Mid-Back Chair with Height and Width Adjustable Arms	208
Z851-1042	LOOK Seating – High-Back Chair without Arms	201
Z851-1442	LOOK Seating – High-Back Chair with Fixed Arms	202
Z851-1742	LOOK Seating – High-Back Chair with Height Adjustable Arms	203
Z851-1W42	LOOK Seating – High-Back Chair with Height and Width Adjustable Arms	204

PRODUCT NON-OBSOLESCENCE AND WARRANTY POLICY

This North American Haworth Product Non-Obsolescence and Warranty Policy (the “policy”) applies to products manufactured after August 1, 2013. For products manufactured before this date please refer to the policy published in the NA Price List when purchased or contact your local Authorized Haworth Dealer*. All Haworth products are warranted for 24 hour / 7 day use over the length of the Applicable Warranty Period as set forth below.

Haworth, Inc. or Haworth, Ltd., (each called “Haworth”) will make a good faith effort to maintain product compatibility within our various generations of integrated product platforms to provide our customers with spaces that adapt to change. Under our non-obsolence policy, we commit to provide our customers with products of comparable function or operational characteristics for a term equal to the Applicable Warranty Period. Haworth fabrics and finishes must be updated periodically to maintain the market appeal of our products and respond to the demands and changing preferences of our customers. As a result, we or the manufacturer may discontinue some fabrics and finishes before expiration of the Applicable Warranty Period.

If a new product purchased or leased from Haworth or from an Authorized Haworth Dealer proves to be defective (as defined below) while the product is still in the possession of the initial purchaser or lessee and if they, within the Applicable Warranty Period, send notice of the defect to Haworth by electronic mail (customerservice@haworth.com), then, except as provided below, Haworth will, at Haworth’s option, either repair or replace the product, at Haworth’s expense, or refund the purchase price of the product. Except as provided below, a product shall be considered “defective” if Haworth finds that it is defective in material or workmanship and if the defect materially impairs the value of the product to the purchaser or lessee. The applicable warranty period begins on the day the product is manufactured. If a product that the purchaser or lessee references in a notice of defect was not installed by a Haworth Certified installer and/or reconfigured by a Haworth-trained installer, then the product may not be considered defective and Haworth will not be obligated to repair or replace it or to refund its price.

PRODUCTS / APPLICABLE WARRANTY PERIOD

LIFETIME

All Haworth products are warranted for lifetime *except products, components and materials described below:*

TWELVE YEARS

All Haworth NA manufactured seating is warranted for 24/7 multiple shift use by persons up to 325 lbs and includes the framework, mechanisms, seating foam, seat & back mesh and seating glides & casters.

All wood or wood framed products.

TEN YEARS

All wall products (excluding soft close door mechanisms warranted for Two Years), electrical components (excluding Power Base™ AI and workware products), electrical accessories, fixed task lighting (excluding LED lighting), adjustable keyboard pads, monitor arms and products that are at any time used in a classroom or educational environment (other than administration areas) *except as limited or described below:*

FIVE YEARS

Fabric scrims and fabrics rated Heavy Duty (A) under the Association of Contract Textiles Guidelines, leather, vertical use markerboard laminates, user-adjustable worksurface mechanisms, gel arm caps, thermofused laminates, slow close mechanisms, LED lighting, electronic ballasts used in task lighting, horizontal glass or thermoplastic table assemblies and Systems Accessories.

THREE YEARS

workware™ products, Hoop products (excludes any warranty for surface damage such as scratches, dents or abrasions), plastic ultraviolet light color fastness and fabrics rated General Contract (a) under the Association of Contract Textiles Guidelines.

ONE TO FIVE YEARS**

Products that are manufactured outside North America and sold into the North American market.

ONE YEAR

Horizontal use markerboard laminate, soft palm rest, mouse pad insert and translucent edging.

Each Haworth “specials” product will be warranted for the same applicable warranty period of the comparable catalogue product unless otherwise stated on the specials solutions department inquiry response.

All software is without warranty of any kind, either expressed or implied.

All service parts are warranted for two years or the remaining balance of the assembly’s original warranty period, whichever is longer.

*An Authorized Haworth Dealer is any dealer or retailer that sells and installs within their primary contracted area and/or under the DealerLink Program Agreement.

**The Applicable Warranty Period for each such product is specified in Haworth’s price list for the product.

A product will not be considered to be defective, and Haworth will not repair, or replace it or refund its price if the product (1) is a consumable product, such as a lamp; (2) is “Customer’s Own Material” (i.e. material specified by the purchaser or lessee that is not a standard Haworth product offering, such as Haworth Alliance fabrics); (3) is not installed and used as recommended in Haworth’s written specification, installation and user guides; (4) has been otherwise misused or suffered abusive damage or (5) is a product that is manufactured by a third-party supplier from whom Haworth purchases it for resale without incorporating it into Haworth product (in which case Haworth will assign to the purchaser or lessee any warranty that the manufacturer provides), unless otherwise specified by Haworth in writing.

A defect in material or workmanship does not include damage to a product, or failure of a product to operate or perform properly or to maintain appearance, caused by (a) normal wear and tear; (b) an Act of God or transportation; (c) a product alteration made without Haworth’s express written authorization; (d) the natural variation of color, grain or texture found in wood and leather; (e) the natural aging found in materials such as wood, fabric and leather which results in colors shifting during use; (f) dye lot variations in fabric, leather or wall covering (g) the natural patina of leather during use; (h) “puddling” of leather or faux leather; or (i) reverse crocking of dyes from clothing onto our seating materials.

EXCEPT AS STATED ABOVE, HAWORTH DOES NOT MAKE A WARRANTY AS TO ANY PRODUCT AND, IN PARTICULAR, DOES NOT MAKE A WARRANTY OF MERCHANTABILITY OR OF FITNESS FOR A PARTICULAR PURPOSE. Product repair or replacement or refund of the price, at Haworth’s option, in accordance with this Policy, is the purchaser’s or lessee’s exclusive remedy for a product defect. Haworth shall not have tort liability with respect to a product, and Haworth shall not be liable for any consequential, economic, indirect, special, punitive or incidental damages arising from a product defect. Haworth shall not be liable for repair or product placement due to improper installation or any defect in materials used for installation which are not manufactured, sold or supplied by Haworth.

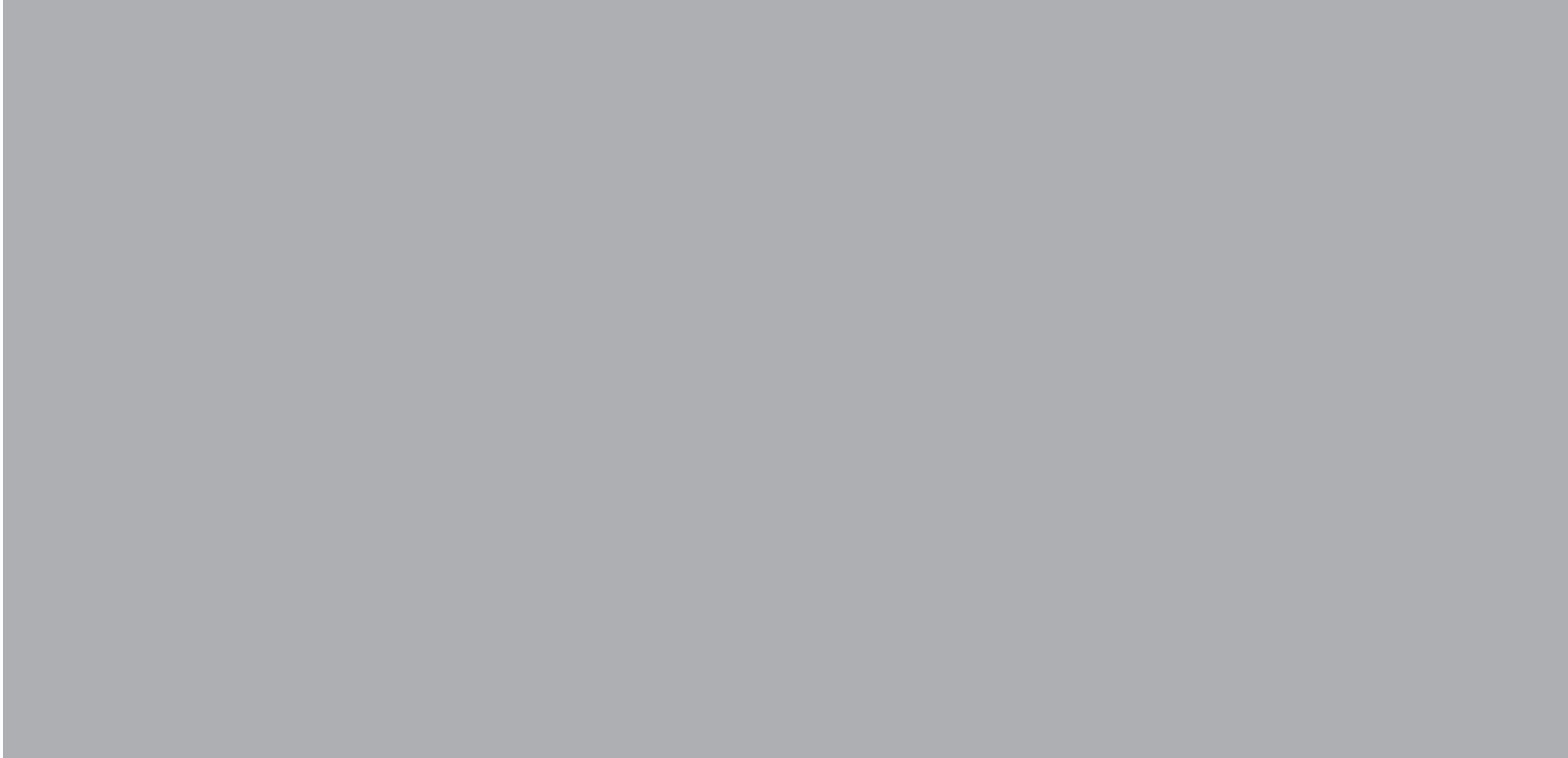

HAWORTH®

For more information call 800.344.2600 or 616.393.3000.

Haworth is a registered trademark of Haworth, Inc.

©Haworth, Inc. 2013 3.13 Item #0004

haworth.com | haworth-europe.com | haworth-asia.com

Harbor Work Lounge At-A-Glance

Designer

Nicolai Czumaj-Bront of the Haworth Design Studio

Awards/Achievements



Best of Neocon 2013: Silver - Seating/Collaborative Work
Good Design Award 2013 - Furniture

Inner Shell
(Upholstered Only)

Outer Shell
(Upholstered,
Laminate, Wood Veneer)

Caster Options:

- Hard or Soft (Black)

- Hard (Fog & Gray)

- Glide**

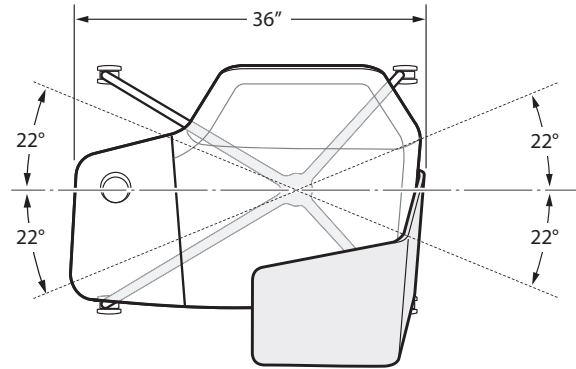
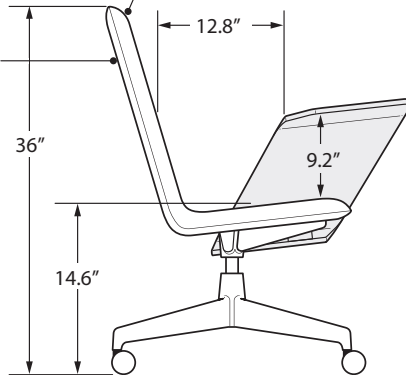
Fully Upholstered

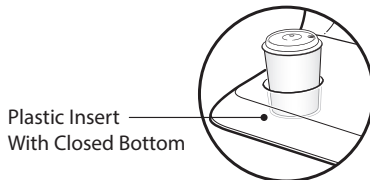

Cup Holder Fully Upholstered



Cup Holder Partially Upholstered

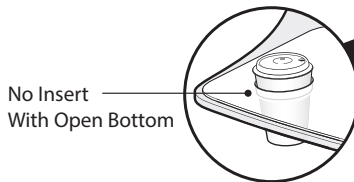

Partially Upholstered

Wing:
Available as Left
or Right handed.
Noble Fabric Only

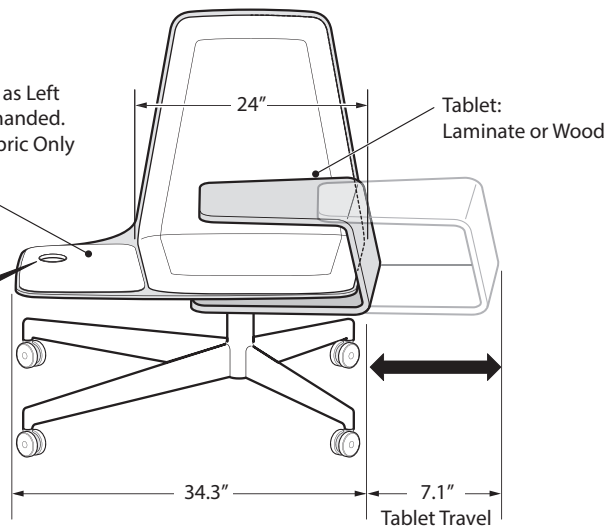

Harbor Work Lounge

Fully Upholstered, Cast Aluminum Base

Lounge Chair



SHL-22-1R10



SHL-22-1R12

Dimensions

SH: 14.6" (371mm)
 H: 36" (9147mm)
 W: 35.3" (897mm) w/o tablet
 36" (914mm) w/tablet
 SD: 16" (406mm)
 SW: 24" (610mm)

Features

- Includes: Upholstered outer and inner shell, right or left wing with cup holder, optional tablet arm and cast aluminum base.
- Fully upholstered lounge chair will be completely upholstered (No laminate or wood veneer visible). Upholstery must be the same material type for inner and outer shell.
- Outer Shell: Upholstered one-piece molded plywood shell.
- Inner Shell: Upholstered molded foam 1.25"(31.75mm) thick.
- Base: Cast-aluminum.
 - Standard painted in Black, Accent Orange, Smooth Plaster or with optional polished aluminum.
 - Swivels 22° in each direction and features a self-returning mechanism.
- Casters: Available with hard black, soft black or hard two-tone.
- Glides: Optional glides ship with plastic and felt tips.
- Seat Wing: Upholstered in Noble performance suede only. Handedness determined by seated position.
- Cup Holder: Available in Chalk or Black plastic.
- Tablet Arm: Optional tablet arm is a one-piece molded plywood form, available in laminate or wood veneer.
 - Laminate finishes include Linen, Putty or Charcoal.
 - Wood veneer finishes include Rift-Cut White Oak or Walnut.
 - Tablet slides 7.1"(180.3mm) to the side.
 - Available in right or left-hand configuration (opposite of seat wing specification).
- COM Yardage / COL square footage
 Inner/Outer Shell: 2.0/28

To Order, Specify:

1) Product number, including:

1 Base Option:

- 1** Hard Caster
- 2** Soft Caster
- T** Two-Tone
- G** Glides, add **\$145.00** list

2 Wing Option:

- R** Right Wing
- L** Left Wing

3 Tablet Option:

- 0** No Tablet
- 1** Wood Tablet, add **\$1380.00** list
- 2** Laminate Tablet, add **\$1380.00** list

- 2) Inner shell material.
- 3) Outer shell material.
- 4) Base color
Polished aluminum, add **\$75.00** list.
- 5) Wing surface and color.
- 6) Cup holder color.
- 7) Tablet surface and color.

	Number	Fabric Grade									Leather Grade A	Leather Grade B		
		1	2	3	A	B	C	D	E	F			G	H
Leather	SHL-11-			1	N/A	N/A	N/A	N/A	N/A	N/A	N/A	N/A	\$3110.00	\$3375.00
Fabric	SHL-22-			1	\$2035.00	\$2103.00	\$2174.00	\$2247.00	\$2356.00	\$2470.00	\$2589.00	\$2715.00	N/A	N/A
Faux Leather	SHL-33-			1	\$2035.00	\$2103.00	\$2174.00	\$2247.00	\$2356.00	\$2470.00	\$2589.00	\$2715.00	N/A	N/A

The following options require modification of the product number.

CAL 133

To specify, add **F** to the end of the product number; **Example:** SHL-22-1R10**F** (add **\$340.00** list)

NOTE: For available fabrics please refer to Surfaces.Haworth.com.

Harbor Work Lounge

Fully Upholstered, Cast Aluminum Base

Ottoman



SHO-22-G

Dimensions

H: 16.5"-19.5"
(419mm-495mm)
D: 17.9" (455mm)
W: 24.9" (632mm)

Features

- Includes: Fully upholstered surface, cup holder and cast aluminum base.
- Fully upholstered ottoman will be completely upholstered (no laminate or wood veneer visible).
- Surface: Upholstered one-piece molded plywood.
- Cushion: Upholstered molded foam 1.25"(31.75mm) thick.
- Cast Aluminum Base: Features 3.0"(76.2mm) height adjustment.
–Standard painted in Black, Accent Orange, Smooth Plaster or with optional polished aluminum.
- Cup holder: Swing out open hole cup holder standard in polished aluminum.
- Casters: Available with hard black, soft black or hard two-tone.
- Glides: Optional glides ship with plastic and felt tips.
- COM Yardage / COL square footage: 1.0/12

To Order, Specify:

- 1) Product number, including:
 - 1** Hard Caster
 - 2** Soft Caster
 - T** Two-Tone
 - G** Glides, add **\$145.00** list
- 2) Surface material.
- 3) Base color
Polished aluminum, add **\$75.00** list.

	Number ①	Fabric Grade								Leather Grade A	Leather Grade B
		A	B	C	D	E	F	G	H		
Leather	SHO-11-■	N/A	N/A	N/A	N/A	N/A	N/A	N/A	N/A	\$2062.00	\$2234.00
Fabric	SHO-22-■	\$1360.00	\$1405.00	\$1451.00	\$1499.00	\$1570.00	\$1644.00	\$1722.00	\$1804.00	N/A	N/A
Faux Leather	SHO-33-■	\$1360.00	\$1405.00	\$1451.00	\$1499.00	\$1570.00	\$1644.00	\$1722.00	\$1804.00	N/A	N/A

The following options require modification of the product number.

CAL 133

To specify, add **F** to the end of the product number; **Example:** SHO-22-1**F** (add **\$130.00** list)

NOTE: For available fabrics please refer to Surfaces.Haworth.com.

Harbor Work Lounge

Partially Upholstered, Cast Aluminum Base

Lounge Chair



SHL-25-1L10



SHL-25-1L12

Dimensions

SH: 14.4" (366mm)
 H: 35.5" (902mm)
 W: 34.3" (8714mm) w/o tablet
 35.5" (902mm) w/tablet
 SD: 16" (406mm)
 SW: 24" (610mm)

Features

- Includes: Laminate or wood veneer outer shell, fabric inner shell, right or left wing with cup holder, optional tablet arm and cast aluminum base.
- Outer Shell: One-piece molded plywood shell with exposed laminate or wood veneer.
- Inner Shell: Upholstered molded foam 1" (25.4 mm) thick with exposed laminate or wood veneer perimeter.
- Base: Cast-aluminum.
 - Standard painted in Black, Accent Orange, Smooth Plaster or with optional polished aluminum.
 - Swivels 22° in each direction and features a self-returning mechanism.
- Casters: Available with hard black, soft black or hard two-tone.
- Glides: Optional glides ship with plastic and felt tips.
- Seat Wing: Upholstered in Noble performance suede only. Handedness determined by seated position.
- Cup Holder: Open hole - no finish options.
- Tablet Arm: Optional tablet arm is a one-piece molded plywood form, available in laminate or wood veneer.
 - Laminate finishes include Linen, Putty or Charcoal.
 - Wood veneer finishes include Rift-Cut White Oak or Walnut.
 - Tablet slides 7.1"(180.3mm) to the side.
 - Available in right or left-hand configuration (opposite of seat wing specification).
- COM Yardage / COL square footage
 Inner Shell: 1.25/22

To Order, Specify:

1) Product number, including:

1 Base Option:

- 1** Hard Caster
- 2** Soft Caster
- T** Two-Tone
- G** Glides, add **\$145.00** list

2 Wing Option:

- R** Right Wing
- L** Left Wing

3 Tablet Option:

- 0** No Tablet
- 1** Wood Tablet, add **\$1380.00** list
- 2** Laminate Tablet, add **\$1380.00** list

- 2) Inner shell material.
- 3) Outer shell material.
- 4) Base color
Polished aluminum, add **\$75.00** list.
- 5) Wing surface and color.
- 6) Tablet surface and color.

	Number	Laminate Grade A Fabric Grade									Leather Grade A	Leather Grade B		
		1	2	3	A	B	C	D	E	F			G	H
Leather	SHL-15-	■	■	1 ■	N/A	N/A	N/A	N/A	N/A	N/A	N/A	N/A	\$3757.00	\$4022.00
Fabric	SHL-25-	■	■	1 ■	\$2682.00	\$2750.00	\$2821.00	\$2894.00	\$3003.00	\$3117.00	\$3236.00	\$3362.00	N/A	N/A
Faux Leather	SHL-35-	■	■	1 ■	\$2682.00	\$2750.00	\$2821.00	\$2894.00	\$3003.00	\$3117.00	\$3236.00	\$3362.00	N/A	N/A

	Number	Wood Fabric Grade									Leather Grade A	Leather Grade B		
		1	2	3	A	B	C	D	E	F			G	H
Leather	SHL-14-	■	■	1 ■	N/A	N/A	N/A	N/A	N/A	N/A	N/A	N/A	\$3799.00	\$4064.00
Fabric	SHL-24-	■	■	1 ■	\$2724.00	\$2792.00	\$2863.00	\$2936.00	\$3045.00	\$3159.00	\$3278.00	\$3404.00	N/A	N/A
Faux Leather	SHL-34-	■	■	1 ■	\$2724.00	\$2792.00	\$2863.00	\$2936.00	\$3045.00	\$3159.00	\$3278.00	\$3404.00	N/A	N/A

The following options require modification of the product number.

CAL 133

To specify, add **F** to the end of the product number; **Example:** SHL-25-1R10**F** (add **\$200.00** list)

NOTE: For available fabrics please refer to Surfaces.Haworth.com.

Harbor Work Lounge

Partially Upholstered, Cast Aluminum Base

Ottoman



SHO-25-G

Dimensions

H: 16.25"-19.25"
(413mm-489mm)
D: 17.9" (455mm)
W: 24.9" (632mm)

Features

- Includes: Laminate or wood veneer surface, fabric cushion, cup holder and cast aluminum base.
- Upholstered one-piece molded plywood.
- Cushion: Upholstered molded foam 1"(25.4mm) thick with exposed laminate or wood veneer perimeter.
- Cast Aluminum Base: Features 3.0"(76.2mm) height adjustment.
–Standard painted in Black, Accent Orange, Smooth Plaster or with optional polished aluminum.
- Cup holder: Swing out open hole cup holder standard in polished aluminum.
- Casters: Available with hard black, soft black or hard two-tone.
- Glides: Optional glides ship with plastic and felt tips.
- COM Yardage / COL square footage: 1.0/10

To Order, Specify:

- 1) Product number, including:
 - 1** Base Option:
 - 1** Hard Caster
 - 2** Soft Caster
 - T** Two-Tone
 - G** Glides, add **\$145.00** list
- 2) Inner surface material.
- 3) Outer surface material.
- 4) Base color
Polished aluminum, add **\$75.00** list.

	Number	Laminate Grade A								Leather Grade A	Leather Grade B
		Fabric Grade									
	1	A	B	C	D	E	F	G	H		
Leather	SHO-15-	N/A	N/A	N/A	N/A	N/A	N/A	N/A	N/A	\$2223.00	\$2395.00
Fabric	SHO-25-	\$1521.00	\$1566.00	\$1612.00	\$1660.00	\$1731.00	\$1805.00	\$1883.00	\$1965.00	N/A	N/A
Faux Leather	SHO-35-	\$1521.00	\$1566.00	\$1612.00	\$1660.00	\$1731.00	\$1805.00	\$1883.00	\$1965.00	N/A	N/A

	Number	Wood								Leather Grade A	Leather Grade B
		Fabric Grade									
	1	A	B	C	D	E	F	G	H		
Leather	SHO-14-	N/A	N/A	N/A	N/A	N/A	N/A	N/A	N/A	\$2247.00	\$2419.00
Fabric	SHO-24-	\$1545.00	\$1590.00	\$1636.00	\$1684.00	\$1755.00	\$1829.00	\$1907.00	\$1989.00	N/A	N/A
Faux Leather	SHO-34-	\$1545.00	\$1590.00	\$1636.00	\$1684.00	\$1755.00	\$1829.00	\$1907.00	\$1989.00	N/A	N/A

The following options require modification of the product number.

CAL 133

To specify, add **F** to the end of the product number; **Example:** SHO-25-1**F** (add **\$130.00** list)

NOTE: For available fabrics please refer to Surfaces.Haworth.com.