

M100 Linear Fluorescent Direct Surface, Pendant & Wall - STAGGERED LAMPS

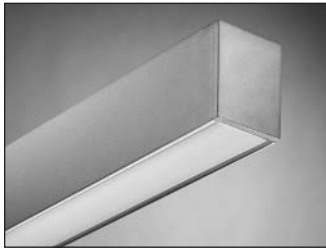

Project: _____ **Type:** _____ **Qty:** _____

M10S	---	---	---	---	---	---
Fixture Series	Lamp Type	Shielding	Mounting	Linear Footage	Finish	Voltage
---	---	---	---	---	---	---

Options (refer to separate data sheets for ordering codes and details)

Fixture Series	Lamp Type	Shielding	Mounting	Nominal Length	Finish	Voltage	Options
M10S M100 Direct Multi-Mount Form Staggered Lamps	1T5 F28T5	OD Extra Diffuse Lens	F Surface Mount	008 8 foot	WH White	120	(qty)EM Stand-by Battery Pack ¹ (prefix quantity, i.e. - 5EM)
	1T5HO F54T5HO	SD Satine Lens	C Cable	012 12 foot	BK Black	277	FS Single Fusing
	2T5 (2x)F28/T5		S Swivel Stem RS Rigid Stem W Wall Mount TE Telescoping Endcaps	For actual lengths see following page. For other lengths, configurations indicate nominal length rounded to the next highest foot. Factory will supply layout drawings. Individual fixtures cannot be field joined.	SV Silver SP Specify RAL#	347	DM Dimming ¹ (specify system) DMA Digital Addressable Dimming ¹ SI Satine Acrylic Inlay ³ FW Flex Whip (standard) FW1 Flex Whip (dimming) Track Eutrac Standard ² DL Suitable for Damp Locations Downlights (See MR16 spec sheets, pp.98-99)
¹ Must be low profile ballasts (1 1/2" W x 1 3/16" H); consult factory for details. ² Consult factory for details. ³ SA, MA, MP & PL shieldings only.							

Mounting Diagrams

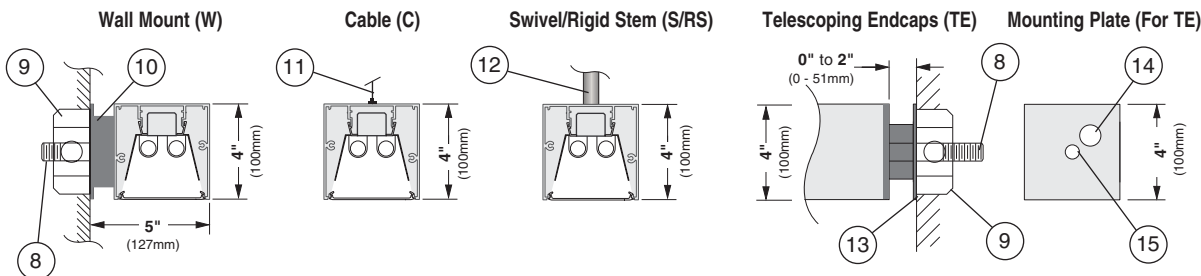

Track

Track insert including track available for all configurations, consult factory for details.

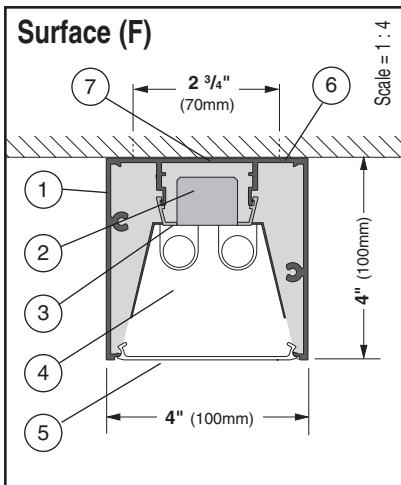
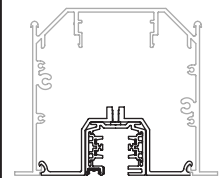

1. Housing - Continuous, 6063-T5 extruded aluminum profile up to 16 feet long. Joined with Connector Plus Joining System for ease of installation and to assure a uniform appearance.

2. Ballast - Electronic, high power factor, class "P", type "A" sound rating. Specify 120v, 277v, or 347v. Ballast is factory pre-wired with leads to one end of fixture. Consult factory for ballast options.

3. Gear Tray - Die formed gear tray with integral factory preset sliding covers to fill extrusion with light, with a matt white finish for even illumination. Geartray installs as complete electrical unit and is held in place with knurled dress nuts. It is fully accessible from below ceiling.

4. Lamps - As noted (by others). Other lamp lengths or wattages available, consult factory.

5. Shielding - Choose between OD Extra Diffuse Lens and SD Satine Lens. See page 8 for more details.

6. Ø 9/32" Mounting Holes (2) - Drilled at factory 6 1/4" from end of fixture and nominally every 24" Mounting hardware supplied and installed by others

7. Ø 7/8" Feed Hole - Drilled at factory 2 1/4" from end of fixture.

8. Ø 1/2" Threaded Rod and Mounting Hardware - To anchor End Cap Support Bracket/Wall Bracket, supplied and installed by others.

9. Outlet Box - (4" x 4") Supplied and installed by others at feed locations only.

10. Wall Bracket - Aluminum Wall Bracket provided nominally every 4'. See layout pages for details.

11. 1/16" Aircraft Cable Suspension - Supplied with chrome gripper for easy adjustment. 48" max suspension from ceiling to top of luminaire. (See p.100 for more details.)

12. 5/8" Steel Swivel Stem or Rigid Stem Suspension - Swivel Stem provides 30° swivel rotation and can be cut in field; Rigid Stem can not be cut in field. 48" max suspension from ceiling to top of luminaire. (See p. 100 for more details.)

13. End Cap Support Brackets - Welded flush to end of fixture. Supplied with extruded aluminum cover profile. Two lock-down screws on bottom of fixture.

14. Ø 7/8" Feed Hole - In wall plate offset from center.

15. Ø 9/16" Mounting Hole - Centered in wall plate.

Interior Luminaire Finish - Standard interior colors are White (WH), Black (BK) and Silver (SV). RAL colors (SP) are available, please specify RAL

SELUX Corp. © 2006
TEL: (845) 691-7723
FAX: (845) 691-6749
www.selux.com/usa
M10S-01 (v5.0)



Union Made Affiliated
with IBEW Local 363

In a continuing effort to offer the best product possible, we reserve the right to change, without notice, specifications or materials that in our opinion will not alter the function of the product. Specification sheets found at www.selux.com/usa are the most recent versions and supercede all other printed or electronic versions.

M10S (Single Staggered Lamps) Surface / Pendant / Wall Layout Dimensions

Nominal 8 foot individual - Bottom view

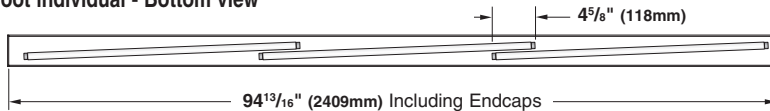

Nominal 12 foot individual - Bottom view

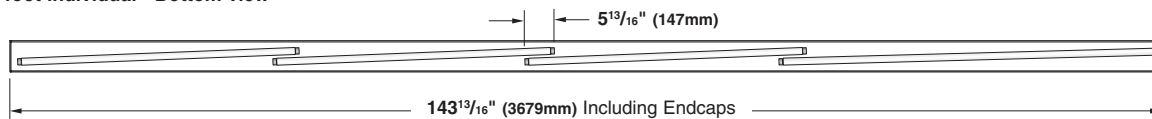

Nominal Pendant Mount - Bottom view (8 foot individual)

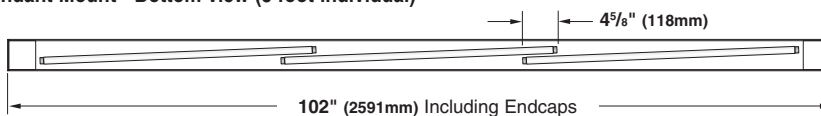

Nominal Pendant Mount - Bottom view (12 foot individual)

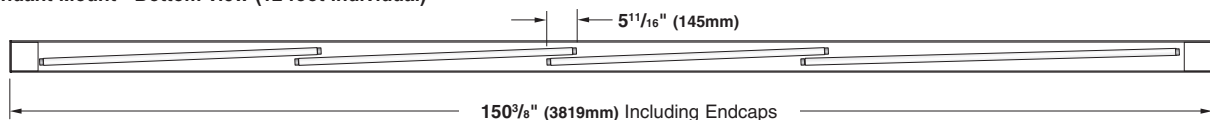

Typical Surface Mount - Side View (Fixture supplied with 7/8 knockout located 2 3/16" from end in top of fixture.)

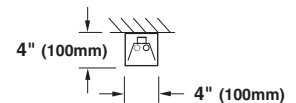
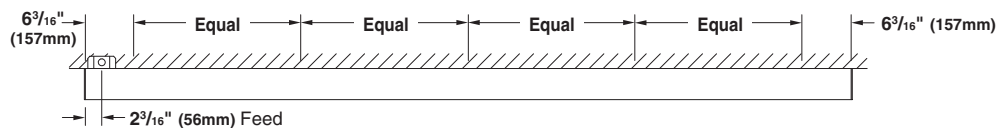

Typical Pendant Mount - Side View

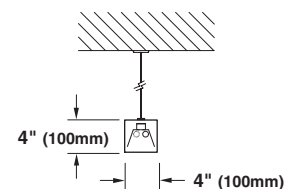
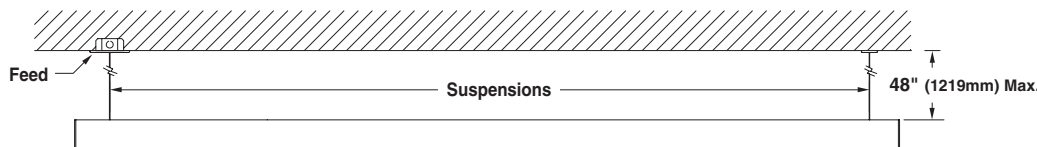

Typical Wall Mount - Top View

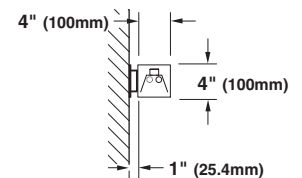
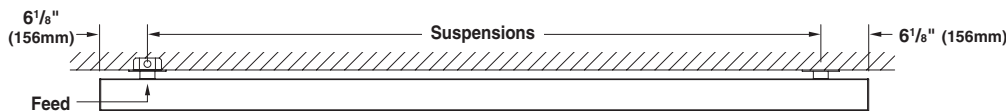

	T5 (1 or 2 lamp)			
	Including Endplates (Surface, Wall)	Including Endplates (Pendant)	Pendant Suspensions	Wall Suspensions
8 foot individual	94.84" (2409mm)	102.00" (2591mm)	96.00" (2438mm)	82.50" (2096mm)
12 foot individual	144.81" (3678mm)	150.38" (3819mm)	144.00" (3658mm)	132.46" (3364mm)

For other lengths, lamings, continuous runs or configurations please specify overall length (in feet), accessories desired and sketch/drawing of configuration. SELUX will detail project drawings upon order and supply submittal drawings for approval. Individual fixtures cannot be field joined. If you have any questions please contact SELUX customer service or applications engineering for assistance (1-800-SELUX-CS).