

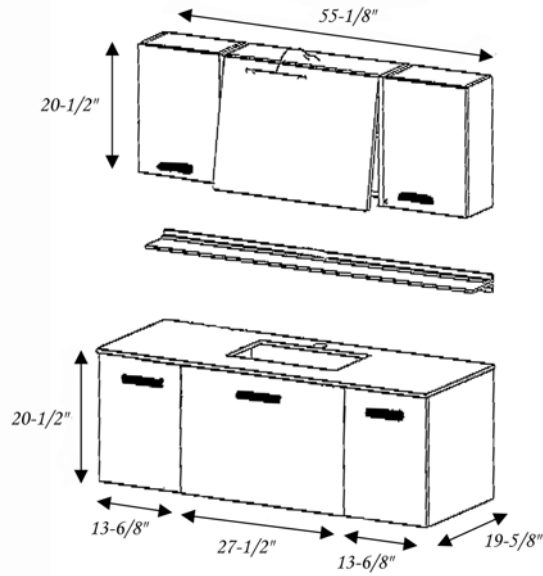

RAB BATH FURNITURE

REF # AB408



REF # AB409

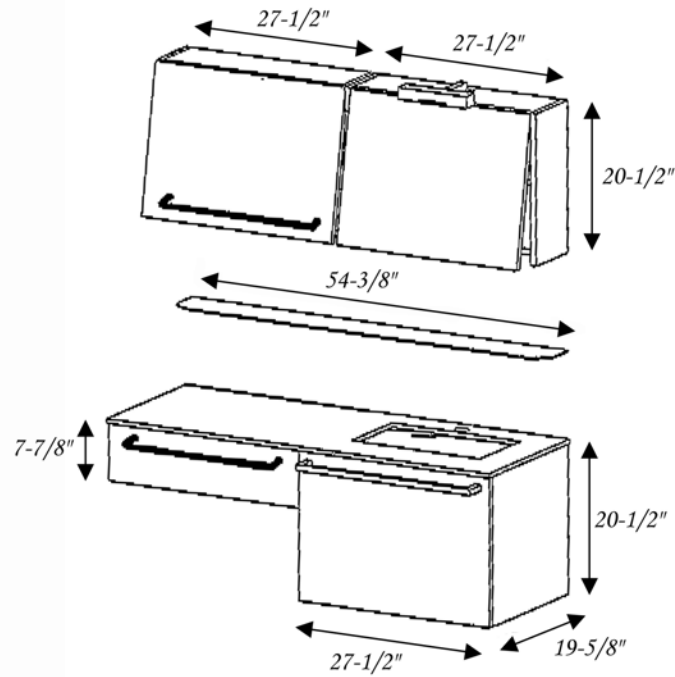

Project Information

Job Name: \_\_\_\_\_ Date: \_\_\_\_\_ Type of wood/Finish: \_\_\_\_\_

Comments: \_\_\_\_\_

Approved: \_\_\_\_\_