

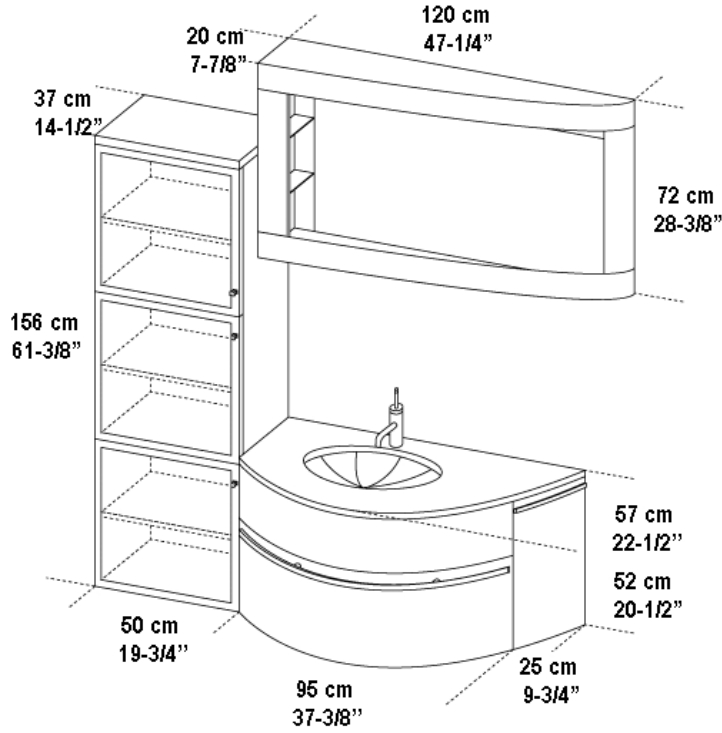

RAB BATH FURNITURE

REF # AB500



REF # AB501

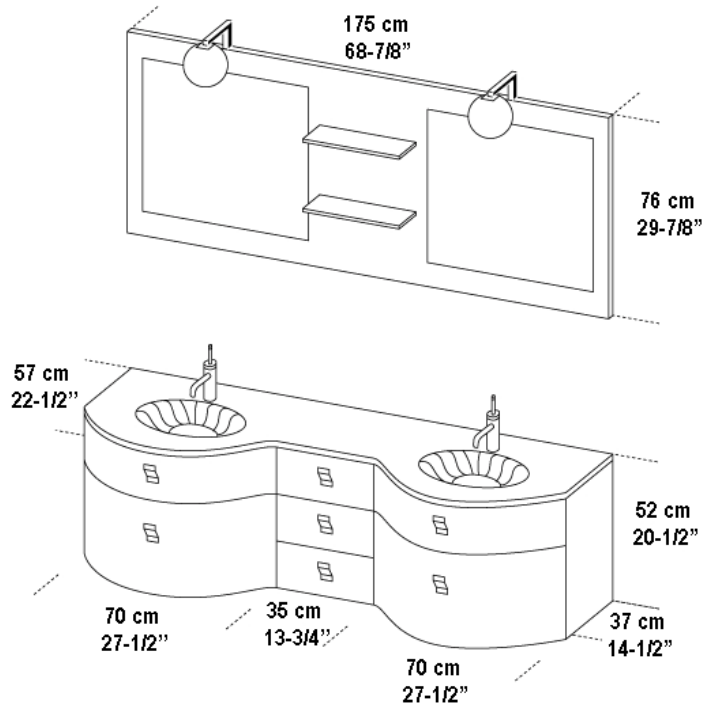

Project Information

Job Name: _____ Date: _____ Type of wood/Finish: _____

Comments: _____

Approved: _____