

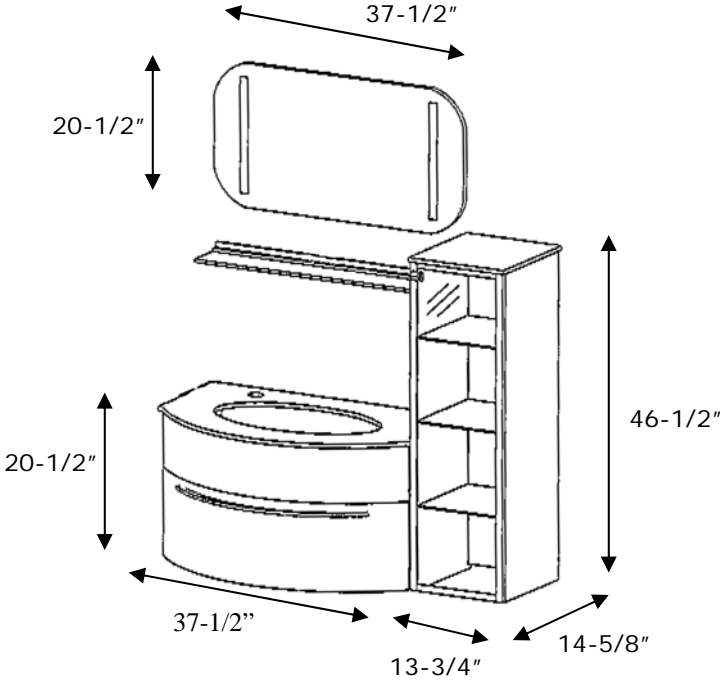

RAB BATH FURNITURE

REF # AB212



REF # AB213

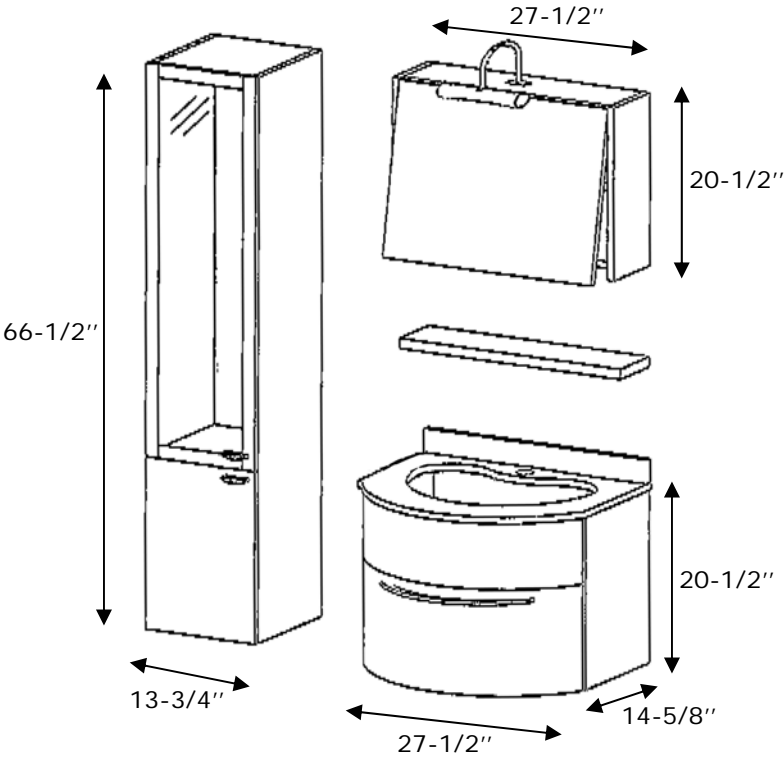

Project Information		
Job Name: _____	Date: _____	Type of wood/Finish: _____
Comments: _____		
Approved: _____		