

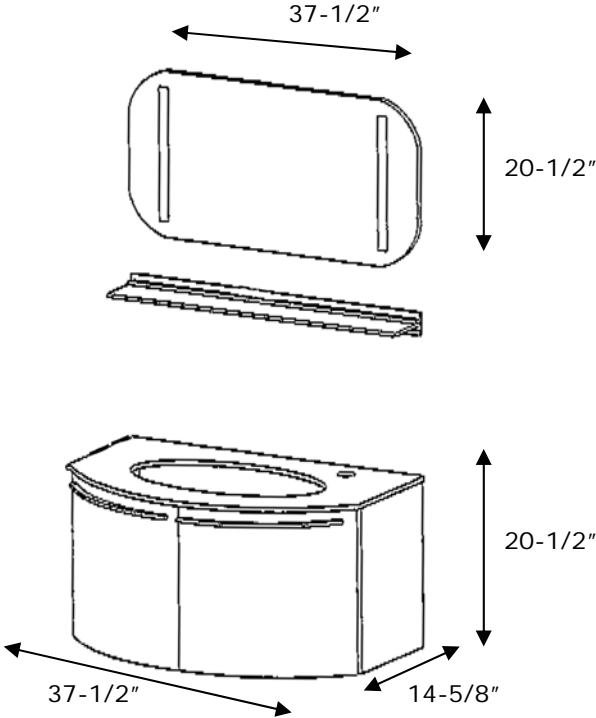

RAB BATH FURNITURE

REF # AB208



REF # AB209

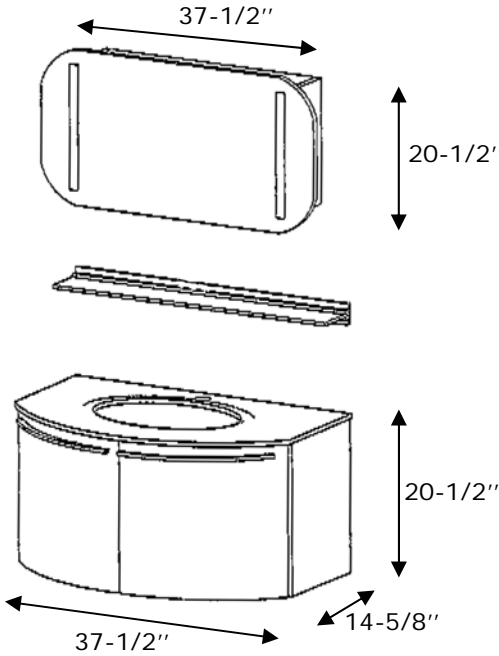

Project Information
 Job Name: _____ Date: _____ Type of wood/Finish: _____
 Comments: _____
 Approved: _____