

Simple™

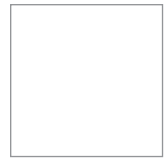

Collection features and benefits ..... 3

Terms and conditions ..... 4-5

General specifications ..... 6-7

Power/voice/data/av (PVD) service center ..... 8-9

Articulating table tops and bases ..... 10

Meeting Link™ for articulating tables ..... 11

**Simple™ Conference Table Tops and Bases**

    Round tables ..... 12

    Small rectangle tables ..... 13

    Electrical system for conference tables ..... 13

    Rectangle tables ..... 14

    Arc rectangle tables ..... 15

    Boat tables ..... 16

    Arc boat tables ..... 17

    Racetrack tables ..... 18

Viewpoint tables ..... 19

**Simple™ Elements**

    Storage credenzas/e-credenzas ..... 20

    Storage/display cabinets ..... 20

    Finishing tops ..... 20

    Buffet shelf ..... 20

Buffet credenzas ..... 21

Low credenzas ..... 22

    Wall mount buffet ..... 22

    Porcelain boards ..... 22

    Mount for plasma monitor ..... 23

    Hospitality cart ..... 23

    Lectern ..... 21

    Visual boards ..... 21

**Simple™ Preconfigured**

    Storage credenzas ..... 24-25

    Buffet credenzas ..... 24

    Mediawall ..... 24

    Storage/display cabinets ..... 25

**Configured Your Way**

That is the reason that Nevers introduced the Simple Collection. To allow you to easily specify the required product configurations and to easily specify multi-functional meeting and conferencing rooms with flexible products.

The key to Simple is interchangeable components in multiple sizes and finishes which perfectly suit any small enclave, team room, project room, full scale meeting or conference room.

It's also beautiful. Simple furniture is striking to look at in every finish and configuration. We build it to your specifications in the size, configuration, finish color, and base you select for the customers' space. Its design is cleanly contemporary and enduringly classic. Caseload tops and door fronts are offered in frosted glass, silver colorcoat and wood finishes. Table legs are produced in aluminum and wood and effectively house power cabling for the discreet containment of electrical and data cords. You can choose one piece or build entire rooms to your exact specifications knowing that the design is clean, current and capable.

**Conference Tables**

The Simple Conference Tables are stylized in a cleanly contemporary design that compliments any design format. The support structure allows all cabling for power and AV to be installed prior to the table top being attached. This eliminates damage to the top during installation and significantly reduces the complexity of cable routing and installation time.

**Caseloads**

Caseloads represent the ultimate form of multiplicity from simplicity. The collection consists of multiple versions of single wide and double wide cabinets that can be specified in an unlimited number of configurations with varying door materials and cabinet top options. The cabinets are designed to be specified and used in two ways. The first is as modular furniture. The cabinets may be specified as stand-alone modules that are simply butted together at installation to form the required piece—credenza, mediawall, storage tower. Modular cabinets enhance the contemporary styling of the space and allow the end user maximum flexibility for future growth, such as reconfiguring the room or using the cabinets in other rooms.

Secondly, the Simple cabinets may be specified with a common connecting top. This maintains the ease of configuring the cabinets to the customers' requirements, while presenting a more traditional single piece furniture appearance. For ease of specifying, the Simple cabinets are also offered as preconfigured cabinets in the most commonly requested configurations. It's simple, and it's specification-friendly. If you are in a hurry, let us plan the room for you with individual pieces specified and floor-planned in multi-application formats. That's simple, too.

The Simple Caseloads are offered in two depths. The 16" depth is the preferred cabinet for smaller rooms. The 22" depth is scaled for larger rooms and rooms requiring AV components and power accommodations. The double wide 22" deep e-cabinets are vented and ready to accept a rack mount for AV components. For simplicity in ordering and security for the end user, cabinets are standard with locks. Locks are not available on glass door cabinets.

As an added bonus, you will find the furniture in the Simple Collection to be competitively priced. The Simple Collection maintains our reputation for "high quality product designs, crafted only with the highest qualities of material and workmanship and delivered trouble-free as promised". It is through design engineering that we are able to offer the Simple Collection at surprisingly competitive pricing.

**Credit and Payment Terms**

Nevers Industries Inc policy does not allow for automatic open account terms for new customers, customers whose account is not current, individuals or residential accounts. *New customers are required to make a deposit for the full value of the merchandise ordered.* A credit application will be sent to each new customer. Credit will be established upon review of the responses given by the customer's references and will appear on future order acknowledgements. New customers are encouraged to begin establishing a credit rating with Nevers Industries Inc prior to placing an order. Our customers are responsible to provide the necessary current and accurate information. *Upon establishment of an open account, terms are Net 30. 1 1/2% per month service charge will be added to all past due accounts. Accounts that are 90 days past due will be subject to collection proceedings without any additional notice. Orders will not be processed for past due accounts until the amount due, including any service charges, is paid in full.* Standard product orders exceeding \$50,000 net will require a down payment of 33%. Custom orders will require a down payment of 50% and will not be scheduled for production until the down payment is received. Balance is then due before shipment. *A bank letter of credit may be required for any order over \$50,000 net.*

**Prices**

Our prices are list, freight prepaid, F.O.B. Plymouth, Minnesota, and are subject to change without notice. Quoted prices must be accepted within 30 days or re-quoted for date and approval. Freight is prepaid and allowed for normal ground transportation within the 48 contiguous states, must ship to dock location. Air freight, will calls, and special delivery will be quoted and invoiced separately. Prices do not include installation, storage, or sales tax.

**Packaging**

Nevers Industries Inc pricing includes packing for North American shipment. Whenever possible, Nevers will blanket-wrap your order; otherwise, all products will be packaged. Only environmentally safe packing materials are used. Large furniture pieces will be packed with wood reinforcements for added protection. For special packaging, crating or overseas shipment, please contact our Customer Service Department.

**Delivery**

Nevers Industries Inc will select the method of shipment, carrier and routing. Carrier selection is solicited to provide the best service to each customer in their particular location. All shipments are sent prepaid, FOB Plymouth, Minnesota. *Nevers Industries Inc liability ends when the carrier issues a receipt to Nevers Industries Inc. This is an acknowledgement by the transportation company that the shipment has been received by the freight company in good condition and title of the goods and risk of loss transfers to the buyer. The order shall be considered complete. Prepaid freight does not*

*change the F.O.B. status of the product and risks involved in the shipment. We reserve the right to make partial shipments.* Invoices relevant to the partial shipments are payable as they fall due.

**Freight Terms**

All orders under \$2,000 net are subject to a minimum order/ additional freight charge of \$300 net; Nevers Industries Inc also reserves the right to establish a freight and fuel surcharge fee to cover variable freight costs. This charge will be established at the time of order and acknowledgement date.

**Lead Times**

The lead time on an order begins when Nevers' Order Entry Department has verified the validity of the items ordered and has received at our manufacturing facility all COM materials supplied by others. All acknowledgments will contain current lead time information. If for some reason the buyer does not want it early, please list a Do Not Ship before date. We are not responsible for delays in scheduling or failure to make scheduled shipping date due to strikes, lockouts or other labor complications, war, riots, Acts of God, fires, accidents, restraints affecting shipment or credit, reduced supply or excessive cost of fuel or raw material, delays from suppliers, compliance with Government regulations, or other unforeseen contingencies. When delays in product delivery are caused by the purchaser, we reserve the right to draw up to 100% of the contract price and to charge to the purchaser any costs incurred by us due to such.

**Order Acknowledgement**

All orders are subject to final acceptance by Nevers Industries, Inc. Receipt of our acknowledgement indicates acceptance of your order subject to the terms and conditions set forth in Our Acknowledgement. If pricing on the purchase order is different than the acknowledged pricing, the acknowledgement will take precedent over the purchase order. Nevers Industries, Inc. attempts to clarify all orders. But in the event of any discrepancy, please notify Nevers Industries Inc immediately. Failure to notify Nevers of a discrepancy within five (5) days will constitute acceptance of the order as acknowledged. All orders are subject to credit approval at any time.

**Change Orders**

Nevers Industries, Inc. will make every attempt to honor any reasonable change request to standard product provided that the request is received prior to start of production. Change orders will be accepted only if the request is made in writing and received in time to make the change. Nevers Industries, Inc. reserves the right to increase our acknowledged price and ship date if necessary to make the requested changes. Nevers Industries Inc will make every reasonable effort to stop production, scheduling shipments, etc., upon receipt of written notification of changes, cancellations, or deferments of delivery.

Nevers will assess charges to the customer for change orders, cancellations, and delivery deferments as stipulated in the following:

**Change Orders:**

- Received prior to start of production will be charged \$200 net.
- Received after production has started involving design changes or reductions in quantity will not be accepted. The customer will receive the goods as ordered and be liable for the amount due.

**Cancellations:**

- Received prior to start of production will be assessed a \$500 net cancellation charge.
- Received after production has started will be assessed the total accumulated cost of the project plus a \$500 net cancellation charge.

**Deferred Shipments**

All merchandise will ship upon completion of production. If customer is unable to take delivery of merchandise when ready for shipment, Nevers Industries, Inc. may transfer the merchandise to storage. All cost for storage and freight will be at customer's expense. Transfer to storage will be considered delivery for all purposes including invoicing and payment. Customer will bear the risk of loss or damage during storage. Deferred shipment charges will be assessed from the completion date in accordance with Nevers policy for Storage by the Manufacturer.

**Storage By The Manufacturer**

No shipment can be postponed by the customer. Nevers Industries Inc reserves the right to transfer products to storage and issue its invoice for the products at that time. Such transfer to storage shall be deemed delivery to the customer for all purposes. Long term storage over 30 days may be subject to surcharges.

**Shipment Claims**

Legal title of merchandise passes to the buyer upon acceptance by the carrier. The buyer must inspect all cartons on arrival for visible or concealed damage. In the event of visible freight damage, the buyer must make a notation on the freight bill; immediately notify the carrier for an inspection; and file a freight claim. *Do not sign the receipt until the visual inspection is complete at the time of delivery. If concealed damage is discovered, the carrier must be notified within 15 days. Keep all packaging materials for inspection (do not destroy).* The buyer has the sole obligation of seeking recourse against the carrier. Caution: When a clear receipt is obtained by a carrier, the carrier is no longer responsible for damages or shortages. Damaged freight cannot

be refused by the consignee (buyer). Processing claims for damages and shortages are the responsibility of the buyer. At no time can claims be deducted from our invoices.

**Returns**

All Nevers Industries, Inc. products are made to order. Therefore, merchandise may not be returned without specific consent from Nevers Customer Service Department. Unauthorized returns will be refused by the shipping department.

**Miscellaneous**

All merchandise shown in our catalog is the property of Nevers Industries Inc. We reserve the sole right to manufacture and distribute it. All patterns, tools, and designs developed for the production of any product will remain the property of Nevers Industries Inc. All published dimensions are approximate and if the exact sizes are critical, we suggest that you request actual measurements. Price list data supersedes all other specifications, whether verbal or written, and may not be altered without the written consent of an officer of Nevers Industries Inc. Typing and clerical errors on any agreement, publication, correspondence, price list, or product literature pieces are subject to correction at any time without notice. Due to variations beyond our control, all wood and upholstery products are subject to slight variations in color, texture, and grain.

**Specifications**

Nevers Industries, Inc. reserves the right to change prices, specifications, fabrics, dimensions and finishes at any time without prior notice. This right to change also applies to discontinuing models at any time, catalog contents and price list contents.

**Warranty**

Nevers Industries, Inc. warrants its products to be free from defects in material and workmanship under normal and reasonable use and service for a period of ten years from the date of shipment to customer. Proprietary supporting products, which are manufactured by others and sold by Nevers Industries, Inc. carry the original manufacturer's warranty. The decision of defects in workmanship or materials or the decision of misuse or abuse remains with Nevers Industries, Inc. No warranties other than those contained herein will be implied and Nevers Industries, Inc. does not authorize any person to create any warranties other than those contained herein.

**AWI “A” Grade Wood Veneers**

Simple products are crafted in “A” grade wood veneers available in Mahogany, Black Walnut, White Oak, Cherry and Maple. Veneer panels are 3-ply balanced construction, are laid up with plain sliced face veneers and are balanced on back to minimize warping and to balance natural stresses. Cores are either 45# particleboard, or 55# medium density fiberboard, per ANSI standards 208.1 or 208.2. Face veneers meet or exceed AWI custom standards and are “A” grade. All “A” face veneers are center matched and either book or slip matched and are laid up to Nevers’ custom specifications.

**Wood Veneer Finishes**

Standard wood veneers finishing process is a multi-step procedure involving dyes, stains, toners, sealers, lacquer. For added protection and durability, the final topcoat on all horizontal surfaces is a catalyzed-blended, lacquer/ varnish finish. All finishing processes have been formulated to provide maximum durability and clarity, and to enhance the natural characteristics of each particular wood species. Standard finish is open pore. Semi-filled and filled finishes require an up charge and may extend the lead-time. Please contact Customer Service for pricing and availability on these and other wood species.

Note: Color variation will occur in the grain of all wood species. This is an inherent characteristic caused by the annual growth rings found in all hardwoods and by the manner in which the boards and veneers are cut across these growth rings. In some species, this color variation is very subtle. In other species this color variation is obvious and at times radical.

The process of finishing hardwood veneers determines whether these variations are enhanced or subdued. Natural finishes will show color variations in the grain and enhance the beauty of the wood to its fullest extent. Other stains, toners, and finishes tend to blend these variations, dependent upon the depth of color and the particular method of application.

**Color Index for AWI “A” Grade Wood Veneers**

Wood Species and Colors

Oak		Walnut	
Natural Oak	NO	American Walnut	AW
Medium Oak	MO	Dark Walnut	DW
Dark Oak	DO	Mahogany on Walnut	MW
Ebony on Oak	EO	Presidential Walnut	PW
		Espresso Walnut	EW

Mahogany		Cherry	
Light Mahogany	LM	Natural Cherry	NC
Brown Mahogany	BM	Amber Cherry	AC
Dark Mahogany	DM	Brown Cherry	BC
		Medium Cherry	MC
		Dark Cherry	DC
		Espresso Cherry	PC
		Cinnamon Cherry	CC

Maple		Ash	
Natural Maple	NP	Natural Ash	NA
Golden Maple	GP	Cocoa Ash	CA
Copper Maple	PP		Autumn
Maple	TP		
Ebony Maple	EP		
Honey Maple	YP		

Beech	
Natural Beech	NB

**Custom Wood Colors and Finishes**

Nevers offers the capability of matching your custom stains or finishes. Virtually any wood finish or color sample can be matched to your specifications. A finish or stain sample is required before the process of matching approval can begin. The upcharge for custom finishes varies with the type of finish and also with the quantity ordered. Please contact Customer Service for piecing and availability. For custom stain/color match—any order under \$2000 net there is a \$270 net up charge. Engineered wood veneers cannot be custom stained.

**Color Index for Engineered Veneers**

Wood Pattern and Colors

**ColorCoat**

Standard ColorCoat is a painted wood core of 48# medium density fiberboard, per ANSI standards 208.1 or 208.2. Special colors are available and may require an up charge and extend lead-time. Please contact Customer Service for pricing and availability.

**Optional Glass Tops**

Credenza glass tops are 3/8” thick and are etched on the back for a semi-transparent appearance. Optional adjustable glass shelves are clear. Optional buffet shelf glass tops are 1/2” thick and are etched on the back for a semitransparent appearance. HydroShield™ fingerprint protectant can be applied for \$17.00 per square foot. Call Customer Service for details.

**ColorCoat and Metal Colors**

Simple products ship standard with Silver Fog colorcoat and Platinum metal. For other colors please contact our Customer Service Department at **800-242-2443**. Fabric Color for Visual Boards Any C.F. Stinson—Pattern “Mira” series may be specified. If not specified, ships standard with Shadow.

**Furniture Care, Cleaning and Maintenance Instructions**

**WOOD SURFACES**

Your Nevers’ furniture requires only minimal care to ensure years of lasting beauty and performance. Any spilled liquids should be wiped up immediately with a dry soft cloth. On a weekly basis dust the wood surface, then clean with a damp, soft cloth, wiping in the direction of the wood grain. Surface should then be dried with a dry, soft cloth. On a semi-annual basis, after the weekly cleaning, clean the wood surfaces with a quality wood cleaner such as Guardsman Wood Cleaner. Products containing oil, ammonia or silicon should not be used. For specific questions about Furniture Care, Cleaning and Maintenance, contact Nevers Customer Service at **800-242-2443**.

**UNDERSTANDING NEVERS MEETING LINK™**

The Nevers Meeting Link System is comprised of Technology Centers and Power Centers

**Technology Centers**

Technology Centers conform to UL 183, 20 AMP plug is the standard for manufactured electrical systems. Nevers proprietary Technology Centers use modular power connections, are daisy chainable and are ideal for all installations where multiple electrical outlets connect to a single power in-feed. They are available in single or multiple circuits. Technology Centers can be hardwired or connected with a molded plug. Data and AV are easily integrated in Technology Centers.

**INSTALLATION:** Technology Centers are installed in the table base system *before* the top is placed. This provides electrical, data and audio visual contractors a convenient, well lit work area. The table top is placed on the base system *after* technology integration is complete. This helps prevent table top damage attributable to third party contractors.

**Power Centers**

Power Centers conform to UL962A, the standard for furniture power distribution units. Power centers connect directly to a power outlet with a molded plug. Power Centers are a flexible, cost effective solution for mobile or light duty applications. Power Centers do not connect in series. Data and basic AV connections are easily integrated in Power Centers.

**INSTALLATION:** Power Centers drop through the table top. They are the last part of the table to be installed. This is a quick and simple installation process for light duty power/voice/data applications.

**Pre-Configured Meeting Link™**

Nevers offers pre-configured Meeting Link solutions for all tables. This is an easy, trouble free method to specify power, voice and data connections. Whether you have light, medium or heavy applications, there is a convenient pre-configured solution.

**Custom Meeting Link™**

Meeting Link can be custom configured to meet any specific requirement. All Meeting Link products are available "a la cart" so you can develop a system that meets your clients exact needs.

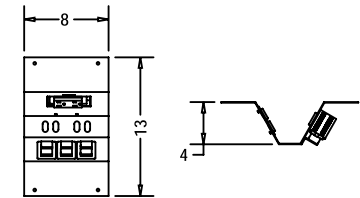
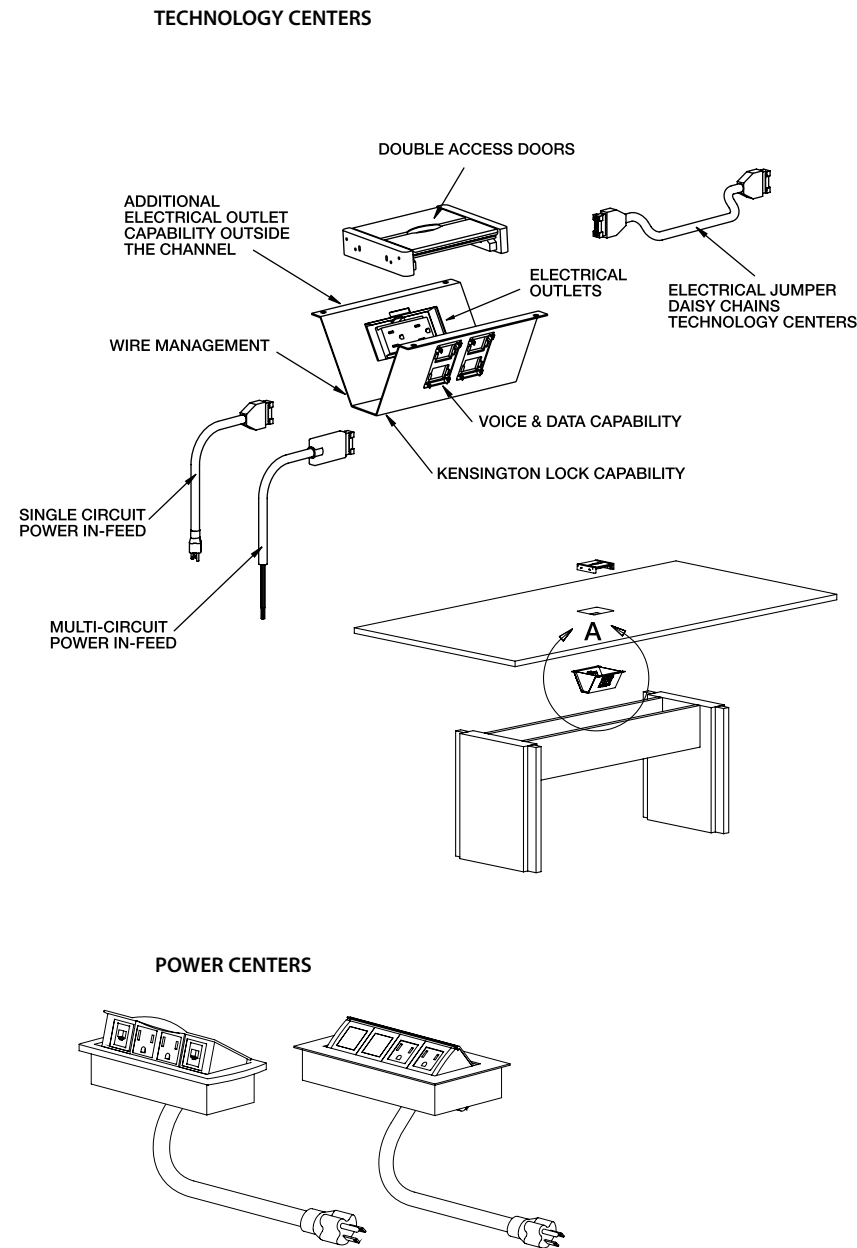

**Preconfigured Meeting Link™ System 3: Light Capacity**

Technology Center Dimensions: 8"l x 6"w

Table Length	Number of Technology Centers	Electrical Outlets	Voice, Data and AV Port Capacity
8'	1	2	6
10'	1	2	6
12'	2	4	12
14'	2	4	12
16'	2	4	12
18'	2	4	12
20'	3	6	18
22'	3	6	18
24'	3	6	18
26'	4	8	24

**Technology Centers for Customizing Meeting Link™ Capacities**

Please note – location drawing required\*

Technology Center Dimension	Number of Electrical Outlets	Voice, Data and AV Port Capacity
8"l x 6"w	2	6
12"l x 6"w	2	6

\* A drawing of the table top with the location of each Technology Center is required. If ordering multiple Technology Centers for 1 table, specify on drawing if ganging is required. For additional assistance in specifying/ordering Technology Centers, please contact customer service at 800.242.2443.

# Simple™ articulating table tops and bases

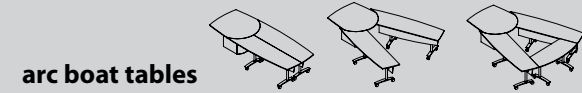

## arc boat tables

48" wide x 39" wide ends			wood projector end with silver metal C leg	modesty panels 12" high MP	meeting link for full table 03	meeting link for presentation end only 02
Length	Size	Model Number	Price	Price	Price	Price
8'	96" x 48"	M/E1/TAO/09648	<b>\$8,818</b>	<b>\$1,621</b>	<b>\$2,009</b>	<b>\$670</b>
10"	120" x 48"	M/E1/TAO/12048	<b>9,467</b>	<b>1,715</b>	<b>2,009</b>	<b>670</b>
12"	144" x 48"	M/E1/TAO/14448	<b>10,419</b>	<b>1,997</b>	<b>2,009</b>	<b>670</b>
14"	168" x 48"	M/E1/TAO/16848	<b>12,274</b>	<b>2,262</b>	<b>3,348</b>	<b>670</b>

## connector table

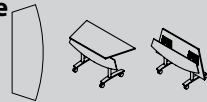

stationary top			with silver metal C leg	modesty panels 12" high MP
Length	Size	Model Number	Price	Price
4'	48" x 24"	M/E1/TCO/04824/ST	<b>\$2,100</b>	<b>\$782</b>
5"	60" x 24"	M/E1/TCO/06024/ST	<b>2,217</b>	<b>860</b>
6"	72" x 24"	M/E1/TCO/07224/ST	<b>2,346</b>	<b>909</b>

flip top				
Length	Size	Model Number	Price	Price
4'	96" x 48"	M/E1/TCO/04824/FT	<b>\$2,877</b>	<b>\$782</b>
5"	120" x 48"	M/E1/TCO/06024/FT	<b>3,037</b>	<b>860</b>
6"	144" x 48"	M/E1/TCO/07224/FT	<b>3,197</b>	<b>909</b>

## how to order

please specify	example
1. model number	M/TAO/16848
2. wood color	DC
3. optional modesty panel	MP
4. optional power/voice/data	03

notes:  
see page 6 for wood colors  
see page 8 for power/voice/data specifications

# meeting link™ for articulating tables

## specifications for preconfigured power/voice/data

table length	full table technology centers quantity	presentation end only technology centers quantity	table seating capacity length	closed capacity	open capacity	with connector table capacity
8'	3	1	8'	8	7	10
10"	3	1	10'	10	9	12
12"	3	1	12'	12	11	14
14"	3	1	14'	14	13	16

## specifications for each technology center

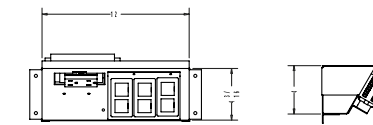

Dimensions: 12"l x 6"w  
 Number of outlets: two (2)  
 Voice/data/av connectors: capacity for up to 6 connectors  
 Technology center for presentation end includes: access grommet for connection to projector and permanent cord storage  
 Cover is brushed aluminum

## technology center connectors

Electrical jumper connects the technology centers

## table to floor connector

Single circuit power in-feed from table to floor with soft cord plug-in

## connectivity and docking station for projector built into table base

When ordered with any meeting link™ option

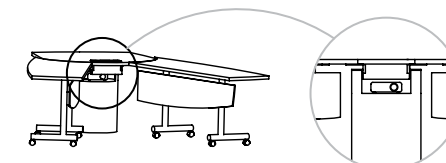

Projector mounts in base to allow immediate access. Easy table top connectivity for notebooks.

## optional: direct wire routing from wall to table without core drilling (ADA approved)

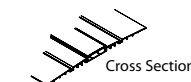

For specifying/pricing: call Nevers' customer service 1.800.242.2443 or visit [www.connectrac.com](http://www.connectrac.com)

round tables

diameter		drum base DB	metal base BS	metal base BT	power center power/voice/data 03
size	model number	price	price	price	price
42" dia	M/TA1/04200	<b>\$2,516</b>	<b>\$2,078</b>	<b>na</b>	<b>\$539</b>
48" dia	M/TA1/04800	<b>2,987</b>	<b>2,549</b>	<b>na</b>	<b>539</b>
54" dia	M/TA1/05400	<b>3,369</b>	<b>na</b>	<b>\$3,163</b>	<b>539</b>
60" dia	M/TA1/06000	<b>3,844</b>	<b>na</b>	<b>3,639</b>	<b>539</b>
72" dia	M/TA1/07200	<b>4,339</b>	<b>na</b>	<b>na</b>	<b>539</b>



small rectangle tables

			metal base MQ	metal base MR	power center power/voice/data 03
length	size	model number	price	price	price
4'	48" x 30"	M/TB1/04830	<b>\$2,415</b>	<b>na</b>	<b>\$539</b>
5'	60" x 30"	M/TB1/06030	<b>2,724</b>	<b>na</b>	<b>539</b>
6'	72" x 30"	M/TB1/07230	<b>2,803</b>	<b>na</b>	<b>539</b>
<b>36" wide</b>					
6'	72" x 36"	M/TB1/07236	<b>\$3,195</b>	<b>na</b>	<b>\$539</b>
7'	84" x 36"	M/TB1/08436	<b>3,347</b>	<b>na</b>	<b>539</b>
<b>42" wide</b>					
6'	72" x 42"	M/TB1/07242	<b>na</b>	<b>\$3,347</b>	<b>\$539</b>
7'	84" x 42"	M/TB1/08442	<b>na</b>	<b>3,677</b>	<b>539</b>



power center for round tables with drum bases

size	model number	number of power centers	electrical outlets	voice, data and av port capacity	price
42" dia	R/PC3/01	1	2	2	<b>\$539</b>
48" dia	R/PC3/01	1	2	2	<b>539</b>
54" dia	R/PC3/01	1	2	2	<b>539</b>
60" dia	R/PC3/01	1	2	2	<b>539</b>
72" dia	R/PC3/01	1	2	2	<b>539</b>

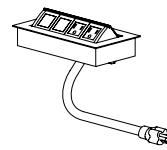

power center for small rectangle tables

top length	model number	number of power centers	electrical outlets	voice, data and av port capacity	price
4'	R/PC3/01	1	2	2	<b>\$539</b>
5'	R/PC3/01	1	2	2	<b>539</b>
6'	R/PC3/01	1	2	2	<b>539</b>
7'	R/PC3/01	1	2	2	<b>539</b>

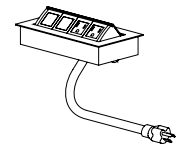

General Specifications:

1. Power in-feed is soft cord plug in.
2. For Meeting Link for metal bases, contact Customer Service.
3. Door frame is clear anodized aluminum.

When ordering please specify order number.

General Specifications:

1. Power in-feed is soft cord plug in.
2. Door frame is clear anodized aluminum.
3. 2" grommet - round R/GRM \$97

When ordering please specify order number.

how to order

please specify                      example

1. model number & base code M/TA1/06000/DB
2. wood color DC
3. optional power/voice/data 03

notes:  
see page 6 for wood colors  
see page 8 for power/voice/data specifications

how to order

please specify                      example

1. model number & base code M/TB1/08436/MR
2. wood color DC
3. optional power/voice/data 03

notes:  
see page 6 for wood colors  
see page 8 for power/voice/data specifications

rectangle tables

48" wide		half panel bases HB	panel bases PB	rectangle bases RB	combination half panel/bases HP	combination panel/rectangle bases PR	meeting link optional power/voice/data O3	
length	size	model number	price	price	price	price	price	
8'	96" x 48"	M/TC1/09648	\$5,286	\$4,836	\$5,077	na	\$670	
10'	120" x 48"	M/TC1/12048	6,021	5,571	5,849	na	670	
12'	144" x 48"	M/TC1/14448	7,656	6,981	7,330	\$7,464	\$7,225	1,339
14'	168" x 48"	M/TC1/16848	8,466	7,791	8,180	8,254	8,063	1,339
16'	192" x 48"	M/TC1/19248	9,276	8,601	9,031	9,044	8,901	1,339
18'	216" x 48"	M/TC1/21648	10,086	9,411	9,881	9,833	9,741	1,339
20'	240" x 48"	M/TC1/24048	11,721	10,821	11,362	11,427	11,200	2,009
22'	264" x 48"	M/TC1/26448	12,531	11,631	12,213	12,218	12,038	2,009
24'	288" x 48"	M/TC1/28848	13,341	12,441	13,063	13,008	12,877	2,009
26'	312" x 48"	M/TC1/31248	14,151	13,251	13,914	13,797	13,715	2,678

arc rectangle tables

48" wide		half panel bases HB	panel bases PB	rectangle bases RB	combination half panel panel bases HP	combination panel rectangle bases PR	meeting link optional power/voice/data O3	
length	size	model number	price	price	price	price	price	
8'	96" x 48"	M/TD1/09648	\$5,550	\$5,077	\$5,331	na	\$670	
10'	120" x 48"	M/TD1/12048	6,321	5,849	6,142	na	670	
12'	144" x 48"	M/TD1/14448	8,038	7,330	7,696	\$7,838	\$7,586	1,339
14'	168" x 48"	M/TD1/16848	8,889	8,180	8,589	8,667	8,467	1,339
16'	192" x 48"	M/TD1/19248	9,739	9,031	9,482	9,496	9,347	1,339
18'	216" x 48"	M/TD1/21648	10,590	9,881	10,376	10,326	10,228	1,339
20'	240" x 48"	M/TD1/24048	12,307	11,362	11,930	11,999	11,760	2,009
22'	264" x 48"	M/TD1/26448	13,158	12,213	12,823	12,828	12,640	2,009
24'	288" x 48"	M/TD1/28848	14,008	13,063	13,716	13,658	13,521	2,009
26'	312" x 48"	M/TD1/31248	14,859	13,914	14,609	14,487	14,401	2,678

54" wide

54" wide		half panel bases HB	panel bases PB	rectangle bases RB	combination half panel/bases HP	combination panel/rectangle bases PR	meeting link optional power/voice/data O3	
length	size	model number	price	price	price	price	price	
8'	96" x 54"	M/TC1/09654	\$5,861	\$5,382	\$5,651	na	\$670	
10'	120" x 54"	M/TC1/12054	6,690	6,209	6,520	na	670	
12'	144" x 54"	M/TC1/14454	8,477	7,758	8,145	\$8,265	\$8,029	1,339
14'	168" x 54"	M/TC1/16854	9,385	8,666	9,099	9,151	8,968	1,339
16'	192" x 54"	M/TC1/19254	10,293	9,573	10,053	10,036	10,849	1,339
18'	216" x 54"	M/TC1/21654	11,202	10,481	11,005	10,921	12,450	1,339
20'	240" x 54"	M/TC1/24054	12,989	12,029	12,631	12,665	13,390	2,009
22'	264" x 54"	M/TC1/26454	13,897	12,937	13,584	13,550	14,331	2,009
24'	288" x 54"	M/TC1/28854	14,806	13,846	14,538	14,435	14,331	2,009
26'	312" x 54"	M/TC1/31254	15,714	14,754	15,492	15,321	15,270	2,678

54" wide

54" wide		half panel bases HB	panel bases PB	rectangle bases RB	combination half panel panel bases HP	combination panel rectangle bases PR	meeting link optional power/voice/data O3	
length	size	model number	price	price	price	price	price	
8'	96" x 54"	M/TD1/09654	\$6,154	\$5,651	\$5,932	na	\$670	
10'	120" x 54"	M/TD1/12054	7,024	6,620	6,846	na	670	
12'	144" x 54"	M/TD1/14454	8,901	8,145	8,553	\$8,679	\$8,430	1,339
14'	168" x 54"	M/TD1/16854	9,855	9,099	9,554	9,609	9,418	1,339
16'	192" x 54"	M/TD1/19254	10,809	10,053	10,555	10,538	10,404	1,339
18'	216" x 54"	M/TD1/21654	11,761	11,005	11,556	11,467	11,391	1,339
20'	240" x 54"	M/TD1/24054	13,639	12,631	13,262	13,298	13,073	2,009
22'	264" x 54"	M/TD1/26454	14,593	13,584	14,264	14,228	14,059	2,009
24'	288" x 54"	M/TD1/28854	15,546	14,538	15,265	15,157	15,047	2,009
26'	312" x 54"	M/TD1/31254	16,499	15,492	16,266	16,087	16,034	2,678

60" wide

60" wide		half panel bases HB	panel bases PB	rectangle bases RB	combination half panel/bases HP	combination panel/rectangle bases PR	meeting link optional power/voice/data O3	
length	size	model number	price	price	price	price	price	
8'	96" x 60"	M/TC1/09660	\$6,307	\$5,828	\$6,118	na	\$670	
10'	120" x 60"	M/TC1/12060	7,179	6,699	7,034	na	670	
12'	144" x 60"	M/TC1/14460	9,012	8,291	8,706	\$8,786	\$8,582	1,339
14'	168" x 60"	M/TC1/16860	10,916	9,244	9,706	9,714	9,567	1,339
16'	192" x 60"	M/TC1/19260	10,916	10,195	10,705	10,642	10,553	1,339
18'	216" x 60"	M/TC1/21660	11,867	11,148	11,214	11,571	11,538	1,339
20'	240" x 60"	M/TC1/24060	13,700	12,740	13,377	13,357	13,186	2,009
22'	264" x 60"	M/TC1/26460	14,651	13,691	14,376	14,285	14,171	2,009
24'	288" x 60"	M/TC1/28860	15,604	14,644	15,376	15,213	15,156	2,009
26'	312" x 60"	M/TC1/31260	16,555	15,595	16,375	16,142	16,142	2,678

60" wide

60" wide		half panel bases HB	panel bases PB	rectangle bases RB	combination half panel panel bases HP	combination panel rectangle bases PR	meeting link optional power/voice/data O3	
length	size	model number	price	price	price	price	price	
8'	96" x 60"	M/TD1/09660	\$6,623	\$6,118	\$6,425	na	\$670	
10'	120" x 60"	M/TD1/12060	7,538	7,034	7,386	na	670	
12'	144" x 60"	M/TD1/14460	9,462	8,706	9,141	\$9,225	\$9,010	1,339
14'	168" x 60"	M/TD1/16860	10,462	9,706	10,191	10,200	10,045	1,339
16'	192" x 60"	M/TD1/19260	11,461	10,705	11,241	11,175	11,080	1,339
18'	216" x 60"	M/TD1/21660	12,461	11,705	12,290	12,149	12,114	1,339
20'	240" x 60"	M/TD1/24060	14,385	13,377	14,045	14,025	13,845	2,009
22'	264" x 60"	M/TD1/26460	15,384	14,376	15,095	14,999	14,879	2,009
24'	288" x 60"	M/TD1/28860	16,384	15,376	16,145	15,974	15,914	2,009
26'	312" x 60"	M/TD1/31260	17,384	16,375	17,194	16,948	16,948	2,678

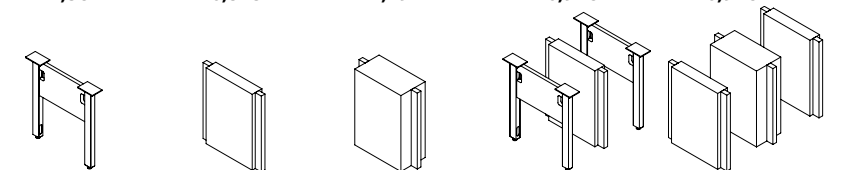
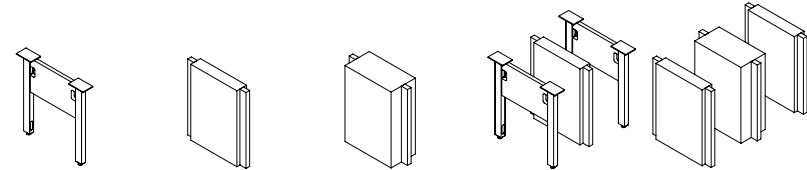

how to order

please specify  
 1. model number & base code M/TC1/16860/PR  
 2. wood color DC  
 3. optional power/voice/data 03/HW

combination base configurations

table length  
 12' - 18'  
 20' - 24'  
 26'

half panel/panel bases  
 2 half panel & 1 panel  
 2 half panel & 2 panel  
 3 half panel & 2 panel  
 (alternating half panel/panel)

panel/rectangle bases  
 2 panel & 1 rectangle  
 2 panel & 2 rectangle  
 3 panel & 2 rectangle  
 (alternating panel/rectangle)

how to order

please specify  
 1. model number & base code M/TD1/16860/PR  
 2. wood color DC  
 3. optional power/voice/data 03  
 notes:  
 see page 6 for wood colors  
 see page 8 for power/voice/data specifications

combination base configurations

table length  
 12' - 18'  
 20' - 24'  
 26'

half panel/panel bases  
 2 half panel & 1 panel  
 2 half panel & 2 panel  
 3 half panel & 2 panel  
 (alternating half panel/panel)

panel/rectangle bases  
 2 panel & 1 rectangle  
 2 panel & 2 rectangle  
 3 panel & 2 rectangle  
 (alternating panel/rectangle)



boat tables

48" w x 39" w ends			half panel bases HB	panel bases PB	rectangle bases RB	combination half panel bases HP	combination panel rectangle bases PR	meeting link optional power/voice/data O3
length	size	model number	price	price	price	price	price	price
8'	96" x 48"	M/TE1/09648	\$5,550	\$5,077	\$5,331	na	na	\$670
10'	120" x 48"	M/TE1/12048	6,321	5,849	6,142	na	na	670
12'	144" x 48"	M/TE1/14448	8,038	7,330	7,696	\$7,838	\$7,586	1,339
14'	168" x 48"	M/TE1/16848	8,889	8,180	8,589	8,667	8,467	1,339
16'	192" x 48"	M/TE1/19248	9,739	9,031	9,482	9,496	9,347	1,339
18'	216" x 48"	M/TE1/21648	10,590	9,881	10,376	10,326	10,228	1,339
20'	240" x 48"	M/TE1/24048	12,307	11,362	11,930	11,999	11,760	2,009
22'	264" x 48"	M/TE1/26448	13,158	12,213	12,823	12,828	12,640	2,009
24'	288" x 48"	M/TE1/28848	14,008	13,063	13,716	13,658	13,521	2,009
26'	312" x 48"	M/TE1/31248	14,859	13,914	14,609	14,487	14,401	2,678

arc boat tables

48" w x 39" w ends			half panel bases HB	panel bases PB	rectangle bases RB	combination half panel bases HP	combination panel rectangle bases PR	meeting link optional power/voice/data O3
length	size	model number	price	price	price	price	price	price
8'	96" x 48"	M/TF1/09648	\$5,828	\$5,331	\$5,598	na	na	\$670
10'	120" x 48"	M/TF1/12048	6,638	6,142	6,449	na	na	670
12'	144" x 48"	M/TF1/14448	8,440	7,696	8,082	\$8,230	\$7,966	1,339
14'	168" x 48"	M/TF1/16848	9,333	8,589	9,019	9,100	8,889	1,339
16'	192" x 48"	M/TF1/19248	10,227	9,482	9,957	9,971	9,814	1,339
18'	216" x 48"	M/TF1/21648	11,120	10,376	10,894	10,842	10,738	1,339
20'	240" x 48"	M/TF1/24048	12,922	11,930	12,527	12,599	12,348	2,009
22'	264" x 48"	M/TF1/26448	13,816	12,823	13,464	13,470	13,272	2,009
24'	288" x 48"	M/TF1/28848	14,709	13,716	14,402	14,340	14,197	2,009
26'	312" x 48"	M/TF1/31248	15,602	14,609	15,339	15,212	15,121	2,678

54" w x 42" w ends

8'	96" x 54"	M/TE1/09654	\$6,154	\$5,651	\$5,932	na	na	\$670
10'	120" x 54"	M/TE1/12054	7,024	6,620	6,846	na	na	670
12'	144" x 54"	M/TE1/14454	8,901	8,145	8,553	\$8,679	\$8,430	1,339
14'	168" x 54"	M/TE1/16854	9,855	9,099	9,554	9,609	9,418	1,339
16'	192" x 54"	M/TE1/19254	10,809	10,053	10,555	10,538	10,404	1,339
18'	216" x 54"	M/TE1/21654	11,761	11,005	11,556	11,467	11,391	1,339
20'	240" x 54"	M/TE1/24054	13,639	12,631	13,262	13,298	13,073	2,009
22'	264" x 54"	M/TE1/26454	14,593	13,584	14,264	14,228	14,059	2,009
24'	288" x 54"	M/TE1/28854	15,546	14,538	15,265	15,157	15,047	2,009
26'	312" x 54"	M/TE1/31254	16,499	15,492	16,266	16,087	16,034	2,678

54" w x 42" w ends

8'	96" x 54"	M/TF1/09654	\$6,462	\$5,932	\$6,229	na	na	\$670
10'	120" x 54"	M/TF1/12054	7,375	6,846	7,188	na	na	670
12'	144" x 54"	M/TF1/14454	9,346	8,553	10,031	\$9,113	\$8,852	1,339
14'	168" x 54"	M/TF1/16854	10,347	9,554	11,083	10,088	9,888	1,339
16'	192" x 54"	M/TF1/19254	11,349	10,555	12,134	11,065	10,924	1,339
18'	216" x 54"	M/TF1/21654	12,350	11,556	13,926	12,041	11,960	1,339
20'	240" x 54"	M/TF1/24054	14,321	13,262	13,926	13,963	13,727	2,009
22'	264" x 54"	M/TF1/26454	15,314	14,264	14,976	14,939	14,763	2,009
24'	288" x 54"	M/TF1/28854	16,323	15,265	16,028	15,915	15,799	2,009
26'	312" x 54"	M/TF1/31254	17,324	16,266	17,079	16,891	16,835	2,678

60" w x 44" w ends

8'	96" x 60"	M/TE1/09660	\$6,623	\$6,118	\$6,425	na	na	\$670
10'	120" x 60"	M/TE1/12060	7,538	7,034	7,386	na	na	670
12'	144" x 60"	M/TE1/14460	9,462	8,706	9,141	\$9,225	\$9,010	1,339
14'	168" x 60"	M/TE1/16860	10,462	9,706	10,191	10,200	10,045	1,339
16'	192" x 60"	M/TE1/19260	11,461	10,705	11,241	11,175	11,080	1,339
18'	216" x 60"	M/TE1/21660	12,461	11,705	12,290	12,149	12,114	1,339
20'	240" x 60"	M/TE1/24060	14,385	13,377	14,045	14,025	13,845	2,009
22'	264" x 60"	M/TE1/26460	15,384	14,376	15,095	14,999	14,879	2,009
24'	288" x 60"	M/TE1/28860	16,384	15,376	16,145	15,974	15,914	2,009
26'	312" x 60"	M/TE1/31260	17,384	16,375	17,194	16,948	16,948	2,678

60" w x 44" w ends

8'	96" x 60"	M/TF1/09660	\$6,954	\$6,425	\$6,746	na	na	\$670
10'	120" x 60"	M/TF1/12060	7,915	7,386	7,755	na	na	670
12'	144" x 60"	M/TF1/14460	9,935	9,141	9,598	\$9,687	\$9,461	1,339
14'	168" x 60"	M/TF1/16860	10,985	10,191	10,701	10,710	10,547	1,339
16'	192" x 60"	M/TF1/19260	12,034	11,241	11,802	11,733	11,634	1,339
18'	216" x 60"	M/TF1/21660	13,084	12,290	12,905	12,757	12,720	1,339
20'	240" x 60"	M/TF1/24060	15,104	14,045	14,747	14,726	14,537	2,009
22'	264" x 60"	M/TF1/26460	16,154	15,095	15,850	15,750	15,623	2,009
24'	288" x 60"	M/TF1/28860	17,199	16,145	16,952	16,772	16,710	2,009
26'	312" x 60"	M/TF1/31260	18,252	17,194	18,053	17,796	17,796	2,678

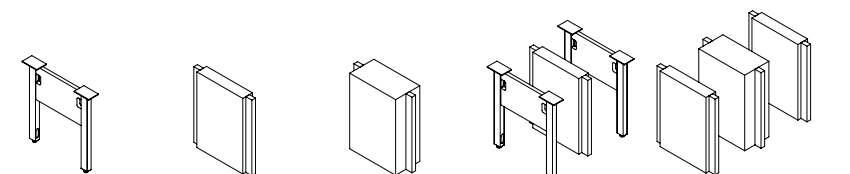
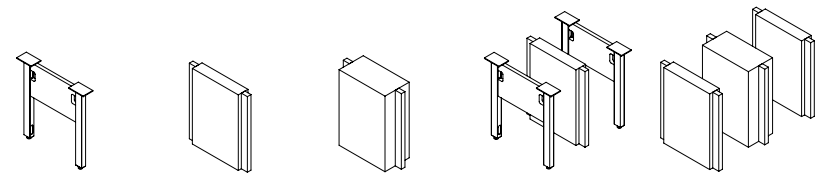

how to order

please specify example  
 1. model number & base code M/TE1/16860/PR  
 2. wood color DC  
 3. optional power/voice/data O3  
 notes:  
 see page 6 for wood colors  
 see page 8 for power/voice/data specifications

combination base configurations

table length half panel/panel bases panel/rectangle bases  
 12' - 18' 2 half panel & 1 panel 2 panel & 1 rectangle  
 20' - 24' 2 half panel & 2 panel 2 panel & 2 rectangle  
 26' 3 half panel & 2 panel 3 panel & 2 rectangle  
 (alternating half panel/panel)(alternating panel/rectangle)

how to order

please specify example  
 1. model number & base code M/TF1/16860/PR  
 2. wood color DC  
 3. optional power/voice/data O3  
 notes:  
 see page 6 for wood colors  
 see page 8 for power/voice/data specifications

combination base configurations

table length half panel/panel bases panel/rectangle bases  
 12' - 18' 2 half panel & 1 panel 2 panel & 1 rectangle  
 20' - 24' 2 half panel & 2 panel 2 panel & 2 rectangle  
 26' 3 half panel & 2 panel 3 panel & 2 rectangle  
 (alternating half panel/panel)(alternating panel/rectangle)

racetrack tables

48" wide			half drum bases HD	drum bases DB	combination half drum/rectangle bases DR	optional power/voice/data 03
length	size	mmodel number	price	price	price	price
8'	96" x 48"	M/TG1/09648	\$5,229	\$5,390	na	\$670
10'	120" x 48"	M/TG1/12048	5,942	6,126	na	670
12'	144" x 48"	M/TG1/14448	na	7,814	\$8,364	1,339
14'	168" x 48"	M/TG1/16848	na	8,624	9,334	1,339
16'	192" x 48"	M/TG1/19248	na	9,434	10,305	1,339
18'	216" x 48"	M/TG1/21648	na	10,244	11,275	1,339
20'	240" x 48"	M/TG1/24048	na	11,931	12,965	2,009
22'	264" x 48"	M/TG1/26448	na	12,741	13,935	2,009
24'	288" x 48"	M/TG1/28848	na	13,551	14,906	2,009
26'	312" x 48"	M/TG1/31248	na	14,361	15,877	2,678
<b>54" wide</b>						
8'	96" x 54"	M/TG1/09654	\$5,794	\$5,973	na	\$670
10'	120" x 54"	M/TG1/12054	6,598	6,802	na	670
12'	144" x 54"	M/TG1/14454	na	8,645	\$9,294	1,339
14'	168" x 54"	M/TG1/16854	na	9,554	10,382	1,339
16'	192" x 54"	M/TG1/19254	na	10,462	11,471	1,339
18'	216" x 54"	M/TG1/21654	na	11,369	12,558	1,339
20'	240" x 54"	M/TG1/24054	na	13,214	14,413	2,009
22'	264" x 54"	M/TG1/26454	na	14,122	15,501	2,009
24'	288" x 54"	M/TG1/28854	na	15,029	16,589	2,009
26'	312" x 54"	M/TG1/31254	na	15,938	17,677	2,678
<b>60" wide</b>						
8'	96" x 60"	M/TG1/09660	\$6,226	\$6,420	na	\$670
10'	120" x 60"	M/TG1/12060	7,973	7,291	na	670
12'	144" x 60"	M/TG1/14460	na	9,179	\$9,934	1,339
14'	168" x 60"	M/TG1/16860	na	10,131	11,074	1,339
16'	192" x 60"	M/TG1/19260	na	11,083	12,216	1,339
18'	216" x 60"	M/TG1/21660	na	12,036	13,356	1,339
20'	240" x 60"	M/TG1/24060	na	13,923	15,264	2,009
22'	264" x 60"	M/TG1/26460	na	14,876	16,404	2,009
24'	288" x 60"	M/TG1/28860	na	15,827	17,545	2,009
26'	312" x 60"	M/TG1/31260	na	16,780	18,686	2,678

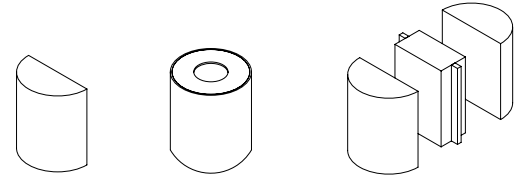

viewpoint tables

ends are 30" w and 60" w			half panel bases HB	panel bases PB	rectangle bases RB	combination half panel/panel bases HP	combination panel/rectangle bases PR	optional power/voice/data 03
length	size	model number	price	price	price	price	price	price
8'	96" x 60"	M/TH1/09660	\$6,305	\$5,817	\$6,182	na	na	\$670
10'	120" x 60"	M/TH1/12060	7,335	6,827	7,191	na	na	670
12'	144" x 60"	M/TH1/14460	9,623	8,897	9,434	\$9,422	\$9,237	1,339
14'	168" x 60"	M/TH1/16860	10,927	10,177	10,714	10,728	10,517	1,339
16'	192" x 60"	M/TH1/19260	11,944	11,173	11,709	11,743	11,513	1,339
18'	216" x 60"	M/TH1/21660	13,273	12,476	13,013	13,073	12,816	1,339
20'	240" x 60"	M/TH1/24060	15,121	14,109	14,824	15,061	14,766	2,009

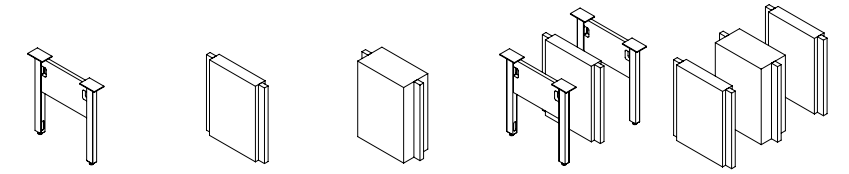

how to order

please specify example  
 1. model number & base code M/TG1/16860/PR  
 2. wood color DC  
 3. optional power/voice/data 03  
 notes:  
 see page 6 for wood colors  
 see page 8 for power/voice/data specifications

combination base configurations

table length half drum/rectangle bases  
 12' - 18' 2 half drum & 1 rectangle  
 20' - 24' 2 half drum & 1 rectangle  
 26' 2 half drum & 1 rectangle

how to order

please specify example  
 1. model number & base code M/TH1/16860/PR  
 2. wood color DC  
 3. optional power/voice/data 03  
 notes:  
 see page 6 for wood colors  
 see page 8 for power/voice/data specifications

combination base configurations

table length half panel/panel bases panel/rectangle bases  
 12' - 18' 2 half panel & 1 panel 2 panel & 1 rectangle  
 20' 2 half panel & 2 panel 2 panel & 2 rectangle

**storage credenzas/e-credenzas** units require finishing top—ends are color coat silver

single wide cabinet with one door and one shelf	double wide cabinet with two doors and one shelf	double wide e-cabinet equipment rack ready with one door one vented door and vented back	cabinet with box/recycle drawer and single door and shelf
16w 16d 30h M/CSA/01616 <b>\$1,353</b> 16w 22d 30h M/CSB/01622 <b>\$1,560</b> door hinged right -R	32w 16d 30h M/CSA/03216 <b>\$2,090</b> 32w 22d 30h M/CSB/03222 <b>\$2,411</b> equipment rack ready with vented bottom/back -E	32w 22d 30h M/CSC/03222 <b>\$2,174</b> vented door right -R	32w 16d 30h M/CSD/03216 <b>\$2,938</b> 32w 22d 30h M/CSE/03222 <b>\$3,251</b> drawers right -R

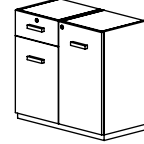
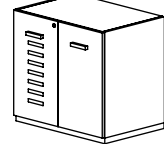
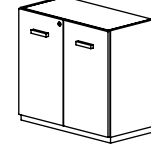
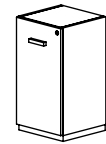

**buffet credenzas** units require finishing top—ends are color coat silver

double wide cabinet with open bookcase and one shelf	double wide buffet cabinet with pull out service shelf, two doors and one shelf	buffet cabinet with pull out service shelf, utensil/box/recycle drawers, door and shelf
32w 16d 30h M/BKG/03216 <b>\$1,284</b> 32w 22d 30h M/BKC/03222 <b>\$1,596</b>	32w 16d 35h M/CBA/03216 <b>\$2,711</b> 32w 22d 35h M/CBB/03222 <b>\$3,046</b>	32w 16d 35h M/CBC/03216 <b>\$3,493</b> 32w 22d 35h M/CBD/03222 <b>\$3,904</b> drawers right -R

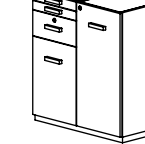
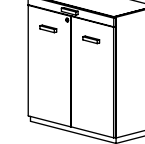
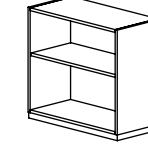

**storage/display cabinets** units require finishing top—ends are color coat silver

double wide cabinet with two wood doors and three shelves	double wide cabinet with open bookcase and three shelves	double wide cabinet with two glass doors and three clear glass shelves	single wide cabinet with wood door and four shelves	single wide cabinet with etched glass door and four clear glass shelves	double wide cabinet with two wood doors and four shelves	double wide cabinet with open bookcase and four shelves	double wide cabinet with etched glass doors and four clear glass shelves
32w 16d 66h M/MDP/03216 <b>\$3,034</b> 32w 22d 66h M/MDP/03222 <b>\$3,547</b>	32w 16d 66h M/MDQ/03216 <b>\$1,800</b> 32w 22d 66h M/MDQ/03222 <b>\$2,313</b>	32w 16d 66h M/MDW/03216 <b>\$3,524</b> 32w 22d 66h M/MDW/03222 <b>\$4,161</b>	16w 16d 78h M/MDD/01616 <b>\$2,185</b> 16w 22d 78h M/MDD/01622 <b>\$2,595</b> door hinged right -R	16w 16d 78h M/MDB/01616 <b>\$2,478</b> 16w 22d 78h M/MDB/01622 <b>\$2,857</b> door hinged right -R	32w 16d 78h M/MDI/03216 <b>\$3,392</b> 32w 22d 78h M/MDI/03222 <b>\$3,985</b>	32w 16d 78h M/MDF/03216 <b>\$2,016</b> 32w 22d 78h M/MDF/03222 <b>\$2,608</b>	32w 16d 78h M/MDG/03216 <b>\$4,164</b> 32w 22d 78h M/MDG/03222 <b>\$4,917</b>

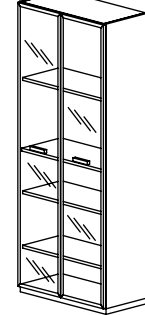
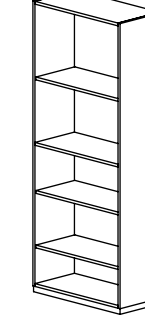
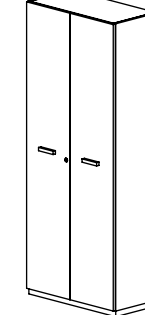
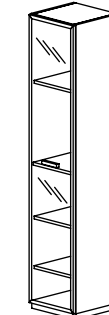
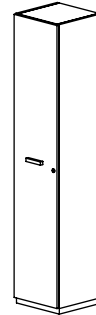
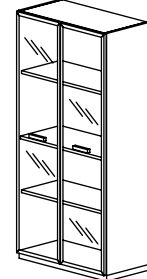
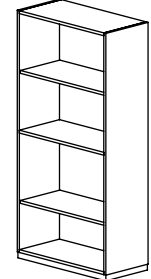
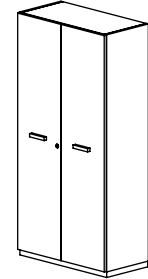

**finishing tops**

wood	etched glass 3/8" h with 3/8" h colorcoat plinth	etched glass shelf 1/2" h with 3" 1/2" h colorcoat plinth requires wood finishing top
16w 16d .75h M/WFT/01616 <b>\$269</b> 32w 16d .75h M/WFT/03216 <b>\$355</b> 48w 16d .75h M/WFT/04816 <b>\$435</b> 64w 16d .75h M/WFT/06416 <b>\$519</b> 16w 22d .75h M/WFT/01622 <b>\$300</b> 32w 22d .75h M/WFT/03222 <b>\$408</b> 48w 22d .75h M/WFT/04822 <b>\$515</b> 64w 22d .75h M/WFT/06422 <b>\$622</b> 80w 22d .75h M/WFT/08022 <b>\$730</b> 96w 22d .75h M/WFT/09622 <b>\$837</b>	16w 8d 4h M/BST/01608 <b>\$441</b> 32w 8d 4h M/BST/03208 <b>\$681</b> 48w 8d 4h M/BST/04808 <b>\$923</b> 64w 8d 4h M/BST/06408 <b>\$1,164</b> 16w 16d .75h M/EGT/01616 <b>\$455</b> 32w 16d .75h M/EGT/03216 <b>\$801</b> 48w 16d .75h M/EGT/04816 <b>\$1,147</b> 64w 16d .75h M/EGT/06416 <b>\$1,428</b> 16w 22d .75h M/EGT/01622 <b>\$476</b> 32w 22d .75h M/EGT/03222 <b>\$951</b> 48w 22d .75h M/EGT/04822 <b>\$1,428</b> 64w 22d .75h M/EGT/06422 <b>\$1,903</b>	

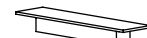

**buffet shelf** option for credenzas

**how to order**

- please specify example
- cabinet(s) from left to right
    - cabinet M/CSD/01616
    - cabinet M/CSA/01616
  - finishing top M/WFT/01616
  - wood color DC

**wood veneers and colors**

see page 6 for colors and model numbers

**low credenzas** ends are color coat silver

single wide cabinet ends open shelving middle

64w 16d 27h M/CNA/06416 **\$3,845**  
64w 22d 27h M/CNA/06422 **\$4,271**

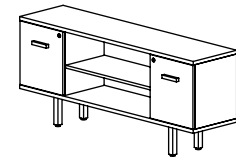

cabinet divider behind doors in middle 2 wood sliding doors

72w 16d 27h M/CNG/07216 **\$4,005**  
72w 22d 27h M/CNG/07222 **\$4,428**

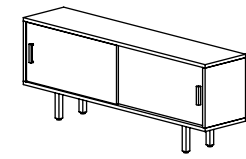

**wall mount buffet**

wall mount wood serving cabinet

64w 10d 9h M/WMB/06409 **\$996**



**hospitality cart** ends are color coat silver **lectern** ends are color coat silver

double wide cabinet with pull out serving shelf, bumper guard on bottom and four casters

32w 22d 36h M/HOC/03236 **\$3,061**

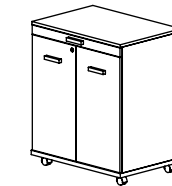

2 legs front, 2 casters back, raised etched glass water glass shelf, adjustable reading shelf, bumper guard on bottom

32w 22d 48h M/LEC/04832 **\$3,154**

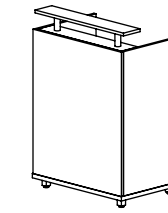

**wall mount for flat screen monitor**

vertical grain wood mounting face 3/4"d with 2"d cabinet behind for wire management

48w 8d 30h M/MPM/04808 **\$1,072**  
64w 8d 42h M/MPM/06408 **\$1,479**

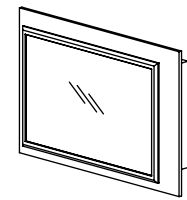

**porcelain boards**

porcelain enamel writing surface with colorcoat top and bottom trim and wood sides

72w 2.5d 48h M/SYS/07248 **\$1,759**  
96w 2.5d 48h M/SYS/09648 **\$2,197**

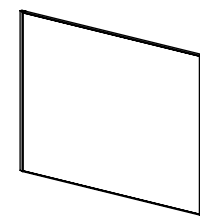

**visual boards**

wood doors with silver colorcoat trim top and porcelain enamel writing surface with pull down projection screen wood doors

48w 3.5d 49h M/VIS/04849 **\$1,706**

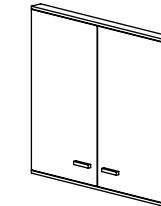

with silver colorcoat trim top and bottom porcelain enamel writing surface with pull down projection screen

72w 3.5d 49h M/VIS/07249 **\$2,074**

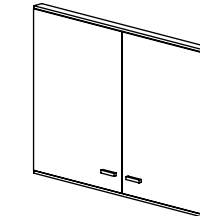

**how to order**

**wood veneers and colors**

please specify example

- 1. model M/VIS/07249
- 2. wood color DC

see page 6 for colors and model numbers

**storage credenzas** ends are color coat silver

single wide cabinet left  
double side cabinet right

48w 16d 30h M/CSA/04816 **\$3,256**  
48w 22d 30h M/CSB/04822 **\$3,777**

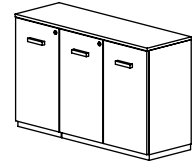

single wide cabinet left and right  
box drawer/recycle bin cabinet middle

48w 16d 30h M/CSD/04816 **\$4,104**  
48w 22d 30h M/CSE/04822 **\$4,617**

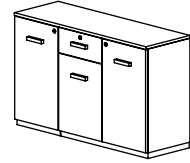

single wide cabinet left, double wide  
cabinet right with vented door and back  
for rack equipment

48w 22d 30h M/CSC/04822 **\$3,540**

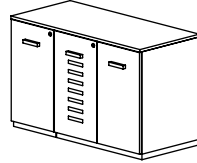

2 double wide cabinets, 22d version  
may be specified as e-credenza vented  
back and bottom for rack mount

64w 16d 30h M/CSA/06416 **\$3,994**  
64w 22d 30h M/CSB/06422 **\$4,628**

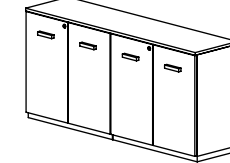

2 double wide cabinets  
with etched glass top

64w 16d 30h M/CGC/06416 **\$4,967**  
64w 22d 30h M/CGD/06422 **\$5,909**

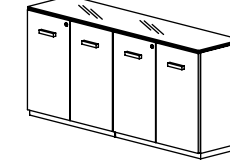

box drawer/recycle bin cabinet  
single wide cabinet  
double wide cabinet

64w 16d 30h M/CSD/06416 **\$4,841** 64w 22d 30h M/CSC/06422 **\$4,391**  
64w 22d 30h M/CSE/06422 **\$5,468**

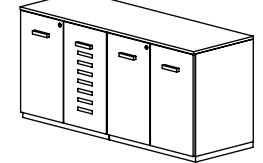
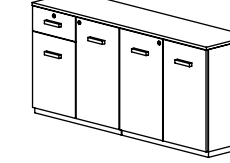

**buffet credenzas** ends are color coat silver

2 double wide cabinets with  
4h etched glass buffet shelf

64w 16d 34h M/CGA/06416 **\$5,158**  
64w 22d 34h M/CGB/06422 **\$5,792**

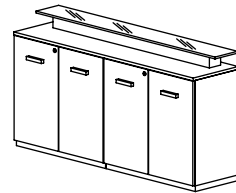

2 double wide cabinets with  
2 pull out serving shelves

64w 16d 35h M/CBA/06416 **\$5,236**  
64w 22d 35h M/CBB/06422 **\$5,899**

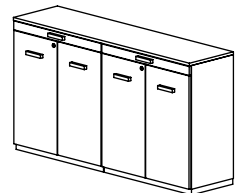

utensil drawer/box drawer/recycle bin cabinet  
single wide cabinet double wide cabinet and  
1 pull out serving shelves

64w 16d 35h M/CBC/06416 **\$6,018**  
64w 22d 35h M/CBD/06422 **\$6,758**

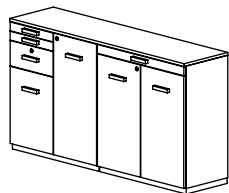

**storage/display cabinets** ends are color coat silver

double wide cabinet with wood doors  
double wide display cabinet

64w 16d 66h M/MDX/06416 **\$4,648**  
64w 22d 66h M/MDX/06422 **\$5,668**

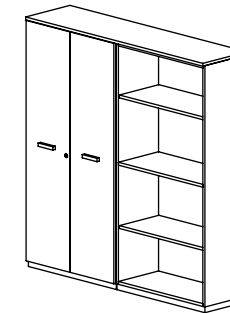

double wide cabinet with wood doors  
double wide cabinet with etched  
glass doors

64w 16d 66h M/MDZ/06416 **\$6,922**  
64w 22d 66h M/MDZ/06422 **\$7,941**

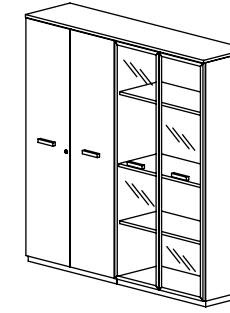

**mediawall** ends are color coat silver

mount for plasma monitor, 2 single wide  
cabinets with wood doors, 2 double wide  
cabinets with etched glass shelf

96w 16d 78h M/MDR/09616 **\$10,600**

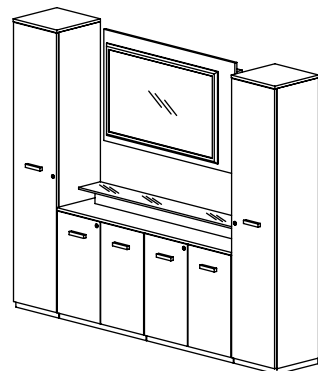

mount for plasma monitor, 2 single wide  
cabinets with etched glass doors and clear glass shelves  
low credenza with 2 sliding wood doors

104w 22d 78h M/MDR/10422 **\$11,400**

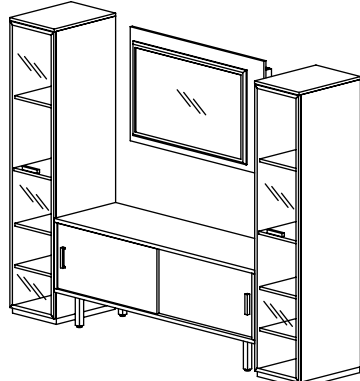

**how to order**

please specify example

1. product M/MDZ/06416
2. wood color DC

**wood veneers and colors**

see page 6 for colors and model numbers



NEVERS

The Complete Meeting Room™

14125 21st Avenue North, Minneapolis, Minnesota 55447

P: 763.553.1632 | 800.242.2443 | F: 763.553.1770 | 800.258.5591

[www.nevers.com](http://www.nevers.com)