

# Bix

DESIGN METRO DESIGN GROUP

Bix offers a system of seating and tables that can create a variety of lounge-based applications that address group or individual work needs. Each application provides convenient connections to power, voice, and data.

Group meeting area created with Bix furniture offers a sense of enclosure without walls for collaborating and provides social and physical comfort.

Side table offers a freestanding mobile tablet surface. It is available in vinyl or leather.

Back screen is available on select units to provide privacy and divide space. It is upholstered.

Seat is upholstered.

Arms are available on select seating units. They are upholstered.

Back is upholstered.

Sled base on a lounge chair is finished with paint. The back of the sled base does not extend past the chair back.

Tablet provides a surface for presenter's notes, laptop computer, or wireless mouse.

Leveling glides adjust for installations on uneven floors. Adjustability range is 3/4".

Service tray is optional.

Projection screen is available on podium seating for presentations and to divide space. It also accommodates Steelcase huddleboards.

Bolster is upholstered.

Storage drawer is available on select models to store equipment or presentation tools.

Face lock, keyed randomly, is standard on storage drawers to secure the items stored in it.

Legs and base are constructed with steel tubing and steel plates for structural integrity. They are finished with paint. They are either inset under the seating unit (sled base) or slant off the back of a unit (legs).

Actual Dimensions  
▶ See page 102

# Bix

DESIGN METRO DESIGN GROUP

## Product Details

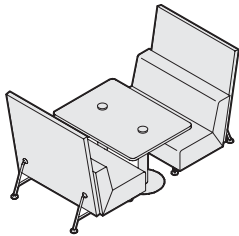

**Individual work-booth area** provides an alternative to a confined workstation. It offers a semi-private setting for temporary tasks that require projects to be spread out. It is created by grouping two straight sectionals or lounge chairs with a 27"H work-booth table.

*Tip: Extended corner sectionals or straight sections with arms should not be used in a work-booth application because access to the seating area is obstructed.*

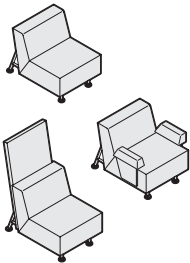

**Lounge chairs** are available with or without upholstered back screens. Models with upholstered arms are also available.

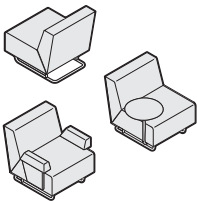

**Sled lounge chairs** feature a compact base that is designed for small spaces or to be used flush against the wall. They are available with or without upholstered arms or a tablet arm.

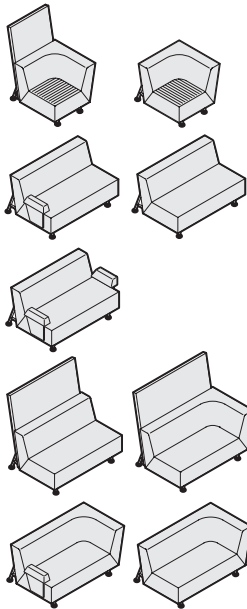

**Sectional seating** is offered in corner, extended corner, and straight units to provide a variety of configurations. They are offered with or without back screens and with or without arms. All sections include an integrated ganging device. Corner sectional units are handed. Handedness is determined by the location of the back screen or back support legs.

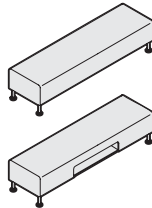

**Bench** provides a backless seating option. It can also be used as an alternative soft occasional table. An open storage space that is accessible from either side is available for storing magazine and media equipment. Bench can accommodate a service tray.

**18" seat height** is an available option on all lounge, sectional seating, bench, and podiums. This option should not be used in conjunction with work booth tables. It allows a higher sit for healthcare applications.

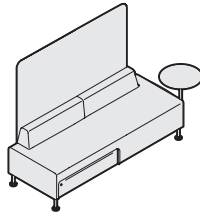

**Podium** serves as a focal point for lounge-based meeting spaces and provides comfortable seating for the presenter. A lockable storage drawer secures projection equipment or presentation tools. A fixed tablet arm provides a surface for presenter's notes, laptop computer, or wireless mouse. Podium can accommodate a service tray.

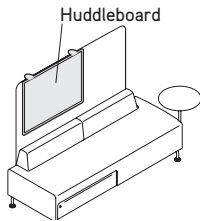

**Integrated projection screen** is available on select podium units for slides or projected digital media. It can also be used to divide an open space. The screen is a fine white mesh that allows light to filter through when the screen is used as a space divider. It also accommodates a Steelcase huddleboard.

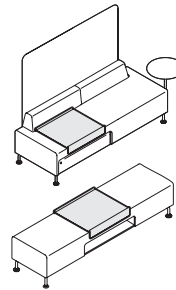

**Service tray** rests on benches and podium units for food service or to support projection equipment in a lounge-base meeting space. A dark gray vinyl mat provides a non-slip surface.

**Multiple fabrics** can be specified on lounge, sectional, and podium seating units for an additional fee per specified fabric.

- Seat cushion and sides of seat cushion - no additional fee
- Back cushion and sides of back cushion - additional fee
- Back screen (if selected) - no additional fee
- Armrest (if selected) - no additional fee

► See *Bix Multi-Fabric Diagram and Yardage Request Form*, page 118.

*Tip: Fabric for the seat and back is specified separate from the back screen, if selected. For a monochromatic look, specify the same fabric for both the seat and back and back screen.*

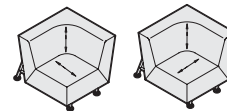

**30"W corner sectional units** are available with the two fabric direction options for the seat - railroaded or cut-right. Seat fabric direction is determined by its relationship to the back screen or back support legs.

*Tip: Seat fabric on extended corner and straight sections is always railroaded.*

► Page 120

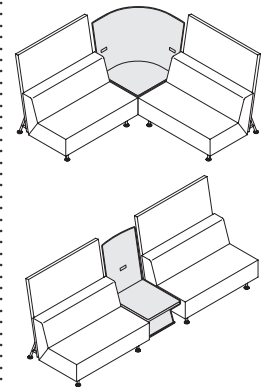

**Bridge tables** integrate with Bix sectional seating to create a range of lounge-based applications and are available with two top shapes - rectangular and corner. Translucent screens are available to create a sense of visual privacy for open space environments. The worksurface is available with or without a grommet and an optional power, voice, and data module. The rectangular table features an integrated 18"W x 12½"H tilted display surface for magazines or project folders.

*Tip: Bridge tables are used with sectional seating. They do not attach to benches or podiums.*

**Corner bridge tables** are offered in 20" table height option to be used with the 18" seat height option only.

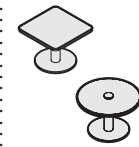

**Occasional tables** are freestanding 18"H tables that can be used a variety of lounge applications. They are available with a round, square, or rectangular top. The tops are available with or without a grommet and an optional power, voice, and data module.

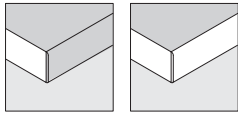

Plastic edge Wood edge

**Edge detail** is available in either plastic or wood edge.

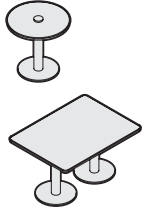

**Work-booth tables** are freestanding 27"H tables that are used with sectional seating to create a work-booth configuration. They are available with either a round or rectangular top. The tops are available with or without a grommet and an optional power, voice, and data module. Base features a low profile for foot clearance.



**Side table** offers a freestanding, mobile tablet surface. The tripod base allows it to be positioned close to a seating unit. The top is available in vinyl or leather.



**Back screen** is available on lounge and sectional seating. It is fully upholstered with a zipper detail. However, it is not removable. Back screens must be ordered with the chair. It cannot be retrofitted to an existing backless lounge chair or seating sections.

**Connections**

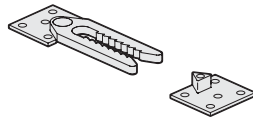

**Integrated ganging device**, included, connects sectional seating units together in the field. It is not intended for user reconfiguration.

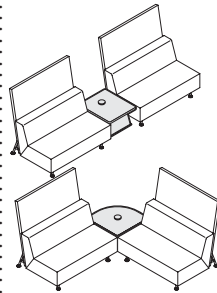

**Bridge tables** connect on both sides between sectional seating units. A rectangular top is used in an in-line configuration. A corner top is used in an L-shape configuration. *Exception: Bridge tables cannot attach to a seating unit with arms.*

**Lounge chairs** are independent and are not intended to connect to sectional units or bridge tables.

▶ See How To Plan, page 104

**Wiring & Cabling**

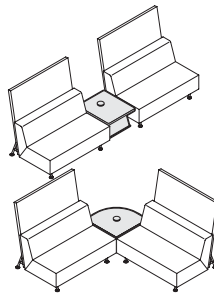

**Bridge tables** are available with a grommet, factory installed, to allow cords and cables to pass through the top. Wire management clips, attached to the underside of the top, are used to route cords and cables. A power, voice, and data module can be inserted in the grommet.

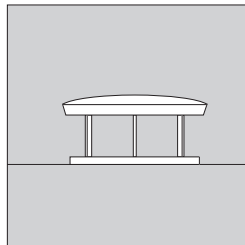
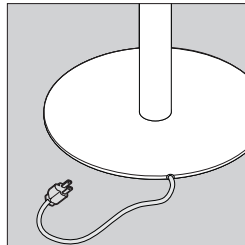

**Occasional and work-booth tables** are available with a factory-installed grommet located over each column and base to allow cords and cables to pass through the top. A power, voice, and data module can be inserted in each grommet location.

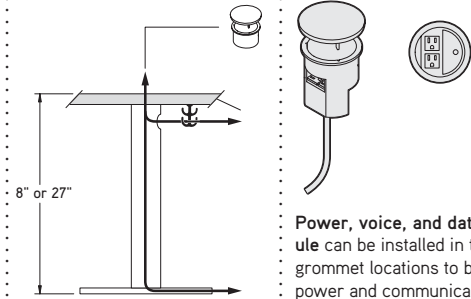

**Column and base of occasional and work-booth tables** are used to route and conceal cords. The cords pass through the worksurface down through the column and out through a mouse hole in the base plate. Bases have mouse holes facing four directions so cords can be directed to power and communication sources. Cords should be routed through the concealed channels and out the mouse holes during the installation of the table base.

**Hole at the top of each column** allows cords to be routed between tables directly below the worksurfaces. Wire management clips are included for routing purposes.

**Power, voice, and data module** can be installed in the grommet locations to bring power and communication to the worksurface. Each module is equipped with two 110volt electrical outlets and one snap-in voice/data module insert consisting of dual CAT 5 RJ45 universal T568A/B jacks. It is UL listed and CSA certified. It has a 6' power cord. For additional data/voice outlet options, please contact Metro customer service at 1.800.627.6770.

**Hardwired applications** require on-site modifications by a licensed electrician following all local electrical code requirements. *Tip: The base will accommodate a 3/8" diameter flex-conduit.*

# Bix

DESIGN METRO DESIGN GROUP

## Surface Materials

### Seat and back

- Fabric

### Arms

- Fabric

### Bolster

- Fabric

### Legs

- Paint

### Sled base

- Paint

### Glides

- Paint and nylon bottom

### Back screen

- Fabric

### Projection screen

- White mesh only

### Projection screen frame

- Paint

### Tablet surface

- Dark gray vinyl only

### Tablet support

- Paint

### Open storage interior

- Paint

### Storage drawer front

- Laminate (standard)
- Wood (option)
- Custom wood finish (option)

### Integrated storage drawer pull

- Paint

### Service tray frame

- Paint

### Service tray mat

- Dark gray vinyl only

### Bridge, occasional, and work-booth table surface

- Laminate with matching 3 mm plastic edge
- Wood with matching wood edge
- Custom wood finish (option)

### Bridge table frame and tilted display surface

- Paint

### Bridge table screen

- Translucent material

### Occasional and work-booth table base

- Paint (textured only)

### Grommet

- Black plastic only

### Side table surface and base cover

- Dark gray vinyl
- Cream Bix leather

### Side table base

- Paint (vinyl)
- Silver (leather)

*Note: Refer to pages 418 for additional surface materials information.*

## Programs & Services

**Fire code seating (FCS) modifications** are available to meet CAL TB133 requirements.  
▶ See page 11.

**Customer's Own Material/Leather (COM/COL) Program** is available.

▶ See Surface Materials for additional information, page 418.

*Note: Due to unusual upholstery conditions inherent in the design of Bix, not all seating fabrics may be specified. Refer to [www.metrofurniture.com](http://www.metrofurniture.com) for a list of pre-approved Designtex fabrics on Bix. Pre-approval is required for all COM fabric. Also, due to the geometric shapes and flat planes of the Bix design, seat fabric tautness will vary depending upon the amount of stretch in the fabric. Leather naturally stretches with use.*

## Designers

Metro Design Group | San Francisco

## Actual Dimensions

	Overall Depth	Width	Height	Seat Depth	Width	Seat Height From Floor	Back Height From Seat	Arm Height
Lounge	38½"	26" or 30"	29" or 31"	19½"	26"	16" or 18"	13½"	22"
Sled lounge	30½"	26" or 30"	29"	19½"	26"	16"	13½"	22"
Corner sectional	38½"	30"	29" or 31" 49½" or 51½"	19½"	19½"	16" or 18"	13½"	N.A.
Extended corner sectional	38½"	54" or 56"	29" or 31" 49½" or 51½"	19½"	48" or 72"	16" or 18"	13½"	22½"
Straight sectional, no arms	38½"	48" or 72"	29" or 31" 49½" or 51½"	19½"	48" or 72"	16" or 18"	13½"	N.A.
Straight sectional, one arm	38½"	50" or 74"	29" or 31" 49½" or 51½"	19½"	48" or 72"	16" or 18"	13½"	22½"
Straight sectional, two arms	38½"	52" or 76"	29" or 31"	19½"	48" or 72"	16" or 18"	13½"	22½"
Back screen	1¾"	23½"; 45½"; 51½"; or 69"	43½"	N.A.	N.A.	N.A.	N.A.	N.A.
Bench	19½"	48" or 72"	16" or 18"	N.A.	N.A.	16" or 18"	N.A.	N.A.
Podium	26½"	81⅞" Includes tablet	25" or 27" 52" or 54"	19½"	N.A.	16" or 18"	7" or 34"	N.A.
Podium tablet arm	17" Dia.	N.A.	26"	N.A.	N.A.	N.A.	N.A.	N.A.
Projection screen	N.A.	59"	27"	N.A.	N.A.	N.A.	N.A.	N.A.
Service tray	20"	22"	4"	N.A.	N.A.	N.A.	N.A.	N.A.
Service tray mat area	18¼"	21½"	N.A.	N.A.	N.A.	N.A.	N.A.	N.A.
Rectangular bridge table	26"	22"	18" or 46"	N.A.	N.A.	N.A.	N.A.	N.A.
Corner bridge tables	26"	26"	18" or 20" 46" or 48"	N.A.	N.A.	N.A.	N.A.	N.A.
Bridge table screen	N.A.	22"	46"	N.A.	N.A.	N.A.	N.A.	N.A.
Round occasional tables	20" or 28" Dia.	N.A.	18"	N.A.	N.A.	N.A.	N.A.	N.A.
Square occasional tables	24"	24"	18"	N.A.	N.A.	N.A.	N.A.	N.A.
Rectangular occasional tables	24"	48" or 72"	18"	N.A.	N.A.	N.A.	N.A.	N.A.
Occasional table base	18" Dia.	N.A.	N.A.	N.A.	N.A.	N.A.	N.A.	N.A.
Occasional table column	4" Dia.	N.A.	N.A.	N.A.	N.A.	N.A.	N.A.	N.A.
Round work-booth tables	20" or 28" Dia.	N.A.	27"	N.A.	N.A.	N.A.	N.A.	N.A.
Rectangular work-booth tables	36"	48" or 72"	27"	N.A.	N.A.	N.A.	N.A.	N.A.
Side table	17" Dia.	N.A.	23"	N.A.	N.A.	N.A.	N.A.	N.A.

Coalesse

# Bix

DESIGN METRO DESIGN GROUP

# Bix How To Plan

DESIGN METRO DESIGN GROUP

## Configuration guidelines — work settings with podium, benches & bridge tables

A variety of configurations may be created to support lounge-based meeting spaces using the Bix podium as a focal point. Benches and bridge tables support media projection equipment. As projection equipment varies, you will need to verify the distance required between the equipment and projection screen when planning your space. The examples below are suggested layouts.

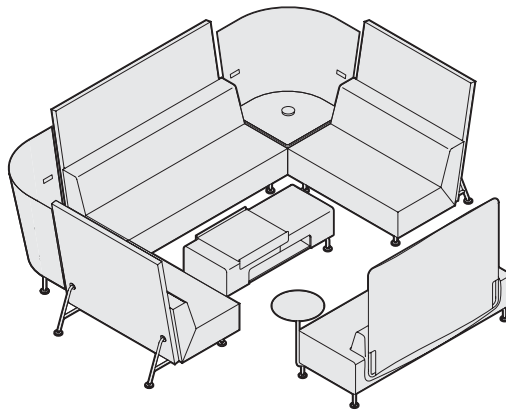

## Configuration Examples

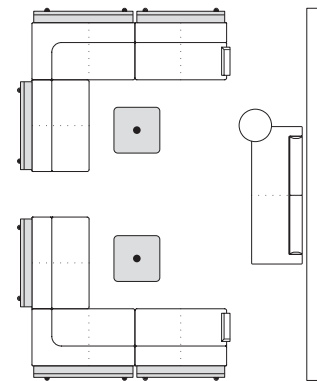
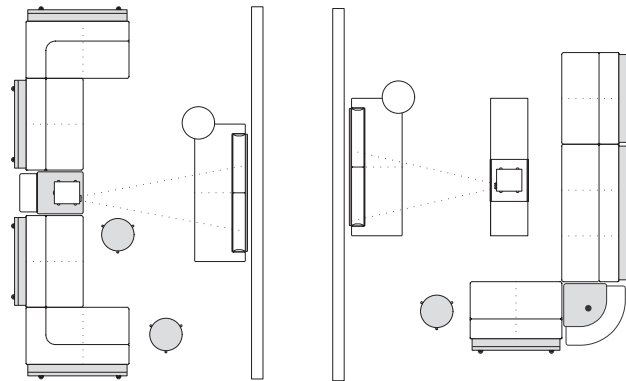
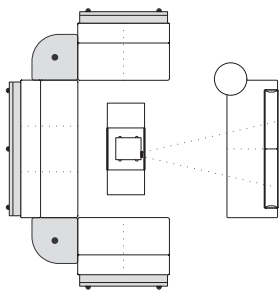
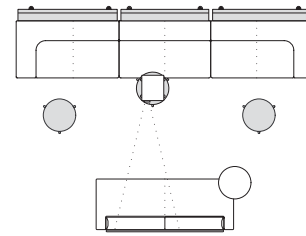
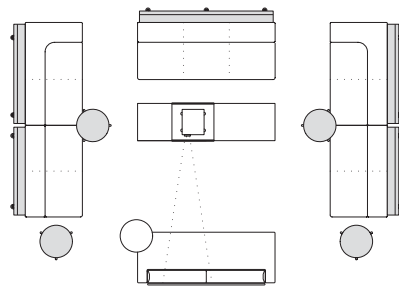
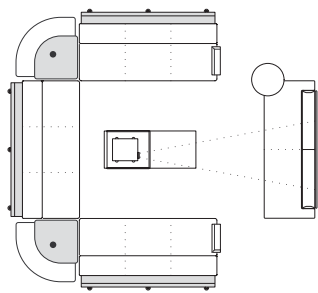

# Bix How To Plan

DESIGN METRO DESIGN GROUP

Configuration guidelines –  
 work-booths with 27" high tables  
 Two straight sections are grouped with 27" high tables to create work-booth applications.  
 Lounge chairs may also be specified with 27" high tables to create a two-person work-booth.  
 Facing seats edges should be spaced 24"–27" apart from one another to accommodate leg clearance

and maintain the correct user relationship to the work surface. The table base is centered within the 24"–27" space.

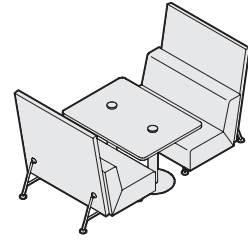

## Configuration Examples

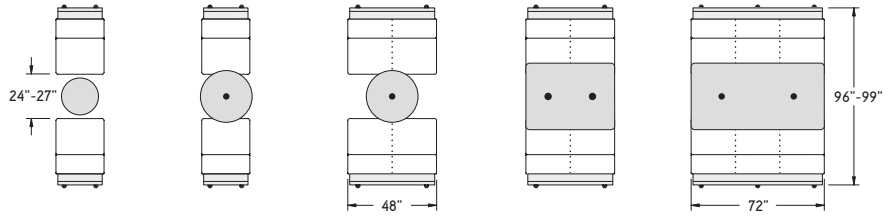

Lounge Seating

Configuration guidelines –  
 work settings with 18" high tables  
 A variety of configurations may be created by combining sectional seating and 18" high tables. The Bix system is built upon

a 12"/24" dimension module for planning. Seats are 24" wide. Rectangular tables are 24" deep. Tables are spaced 12" from seat edges. A 24" opening should be maintained for large 360° group enclaves.

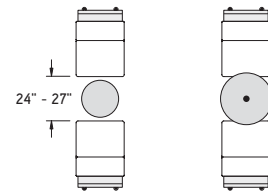

## Configuration Examples

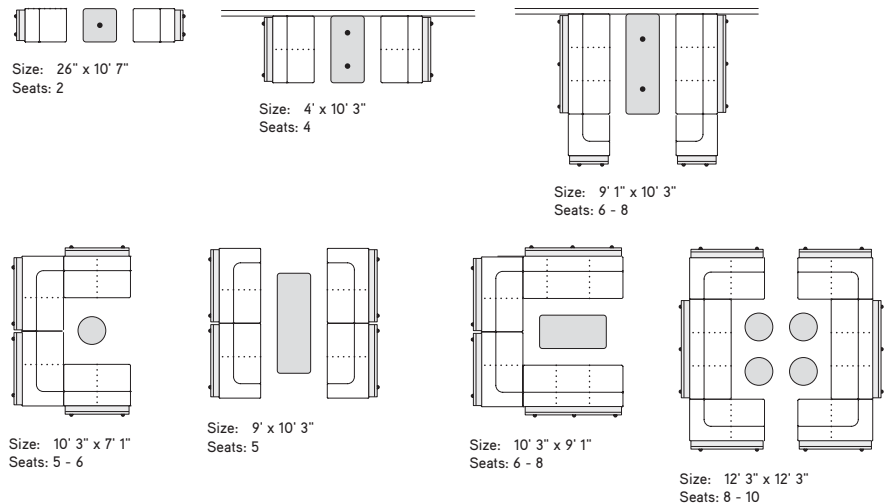



Configuration guidelines – DON'TS

- 30" wide corner sections are not intended to be freestanding. 30" wide corner sections must always be connected to an adjoining 54" wide extended corner or straight section, using the ganging hardware provided.

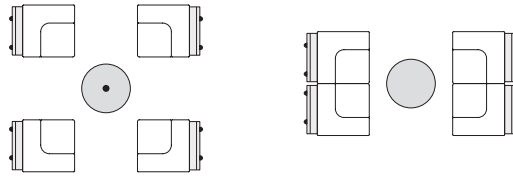

- Individual lounge chairs are independent elements not designed as a module within the seating system. The lounge chair seat is wider than the 24" system module and lounge chairs do not include ganging hardware. Bridge tables also do not connect to lounge chairs.

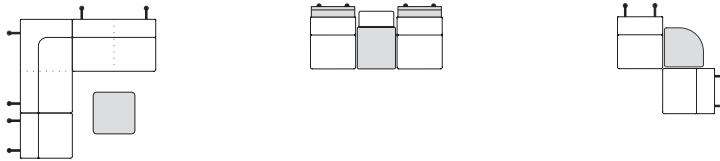

- Do not create a U-shaped configuration with a 27" high rectangular table. Access to the closed end is difficult and the table edge is too far from reach for the user.

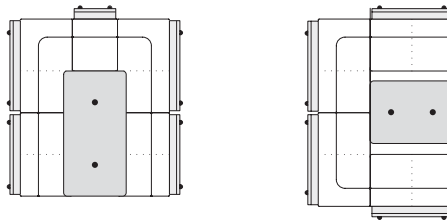

- Do not use 54" wide extended corner sections or straight sections with arms to create a work-booth configuration with 27" high tables. Access is obstructed.

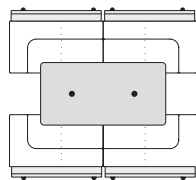

- Bridge tables must be connected on both sides to a seating section.

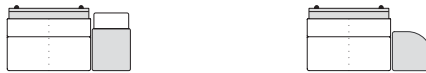

- Bridge tables do not connect to seating sections with arms. Seating sections do not gang with arms at the seam.

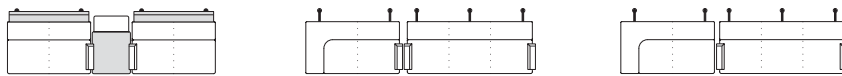

- Do not attach 30" wide corner sections to a corner bridge table. This application does not allow enough leg room for two users.

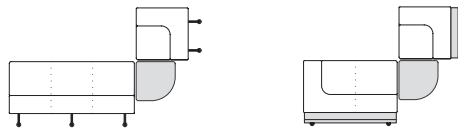

- Bridge tables do not attach to benches or podiums.

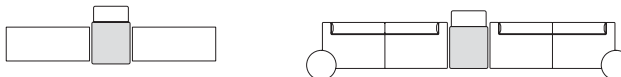

# Bix How To Plan

DESIGN METRO DESIGN GROUP

## Orientation & fabric direction

Corner units are handed from a facing position. Handedness for 30"W corner units is determined by the location of the back-screen or back support legs. Location of back-screens should be consid-

ered for each configuration. In order to create a consistent pattern across seats in the configuration, 30"W corner units are available with two seat fabric direction options. Seat fabric direction is deter-

mined by its relationship to the back-screen or back support legs. Seat and back fabric on 54"W extended corner and straight sections is always railroaded.

Examples below assume a striped patterned fabric:

### 30"W Corner Sections

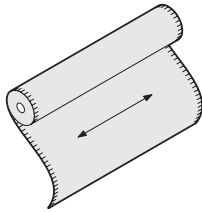

Arrow indicates direction of the pattern on the roll

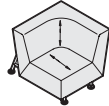

Left-hand, fabric railroaded BSC30LA

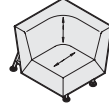

Left-hand, fabric cut-right BSC30LB

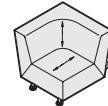

Right-hand, fabric railroaded BSC30RA

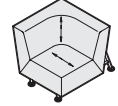

Right-hand, fabric cut-right BSC30RB

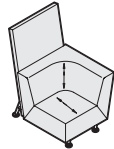

Left-hand, fabric railroaded BSCB30LA

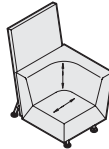

Left-hand, fabric cut-right BSCB30LB

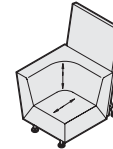

Right-hand, fabric railroaded BSCB30RA

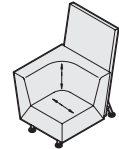

Right-hand, fabric cut-right BSCB30RB

### 54"W Extended Corner and Straight Sections

Note: Seat and back fabric is always railroaded

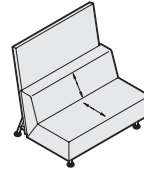
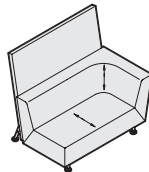

### Configuration Examples

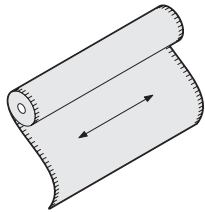

Arrow indicates direction of the pattern on the roll

Right-hand, fabric railroaded BSCB30RA

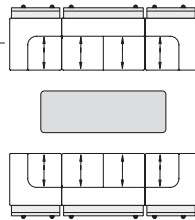

Left-hand, fabric railroaded BSCB30LA

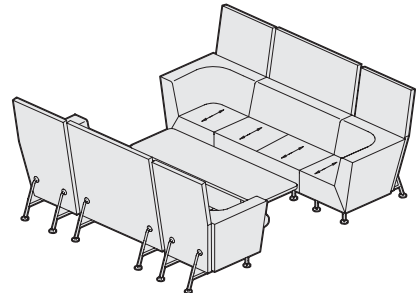

Left-hand, fabric cut-right BSCB30LB

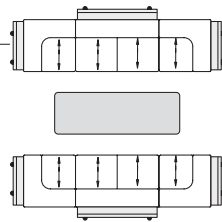

Right-hand, fabric cut-right BSCB30RB

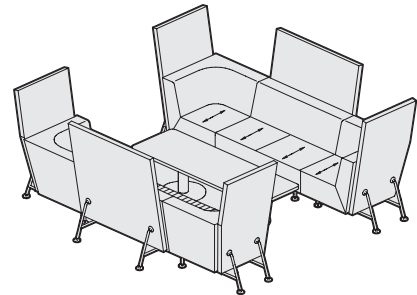

# Bix Lounge Chairs

DESIGN METRO DESIGN GROUP

*Tip: Fabric for the seat and back is specified separate from the back screen, if selected. For a monochromatic look, specify the same fabric for both the seat and back and back screen.*

*Tip: Fabrics and leathers will appear loose with comfort wrinkles when upholstered.*

*Tip: When specifying fabric in different price grades, the highest price grade prevails.*

*Tip: The COM yards and COL square footage listed on this page reflect the requirements for a single fabric that are based on non-directional 54"W material applied rail-roaded. For multi-fabric COM requirements, please refer to Multi-Fabric Yardage.*  
▶ Page 119

Standard Includes		Required to Specify
▶ Need help? Product details, page 98	<ul style="list-style-type: none"> <li>• Seat, back, and arms, if selected: fabric or leather</li> <li>• Legs: paint</li> <li>• Adjustable glides: paint to match legs</li> <li>• Back screen, if selected: fabric</li> <li>• Leveling wrench</li> </ul>	<ol style="list-style-type: none"> <li>1 Style number</li> <li>2 Number of fabrics if contrasting fabric style number is selected</li> <li>3 Fabric or leather color number for seat, back, and arms, if selected</li> <li>4 Paint color number for legs and glides</li> <li>5 Fabric color number for back screen, if selected</li> <li>6 Options, if selected (see below)</li> </ol> ▶ See <i>Surface Materials</i> , page 418.

Options	U.S. Price	Required to Specify
<b>Surface Materials</b>	<ul style="list-style-type: none"> <li>• Contrasting fabric +\$100 per fabric</li> </ul>	Add suffix <b>K</b> to the style number and select fabric color number.
	<b>Fire code seating (CAL TB133)</b>	
	<ul style="list-style-type: none"> <li>• Lounge +\$350</li> <li>• Lounge with arms +\$490</li> </ul>	Specify with <i>CAL TB133</i> . Specify with <i>CAL TB133</i> . ▶ See <i>CAL TB133 Compliance Program Chart</i> in resources section, page 14.
<b>Seat Height</b>	<ul style="list-style-type: none"> <li>• 18" seat height +\$200</li> </ul>	Specify with <i>18" seat height</i> .
<b>Related Products</b>	<ul style="list-style-type: none"> <li>• Sectional seating</li> <li>• Bench</li> <li>• Podium</li> <li>• Occasional tables</li> <li>• Work booth tables</li> <li>• Side tables</li> </ul>	▶ Page 110 ▶ Page 116 ▶ Page 117 ▶ Page 124 ▶ Page 125 ▶ Page 126

### Specification Information

Style Number	U.S. Base Prices											Leather Grades:		
	Fabric Grades:											COL	C	E
	COM	6	7	8	9	10	11	12	13	14				

### Lounge Chair

BL26XX	\$1450	\$1525	\$1562	\$1591	\$1662	\$1702	\$1734	\$1805	\$1930	\$1993	\$1630	\$2465	\$2615
COM/yds = 2¾, COL/sq ft = 55													

### Lounge Chair with Arms

BL26AA	\$2017	\$2132	\$2182	\$2221	\$2319	\$2372	\$2416	\$2514	\$2685	\$2770	\$2284	\$3202	\$3382
COM/yds = 3¾, COL/sq ft = 73													

### Lounge Chair with Back Screen

BLB26XX	\$2063	\$2208	\$2269	\$2315	\$2432	\$2496	\$2549	\$2666	\$2872	\$2974	\$2337	\$3588	\$3828
Chair: COM/yds = 2¾, COL/sq ft = 55													
Screen: COM/yds = 1¾													

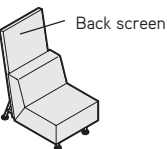
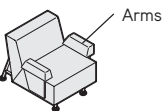
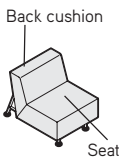

**For Canadian Pricing**  
 Multiply U.S. Price by the Canadian price factor.  
 ▶ See page 1 for details.

# Bix Sled Lounge Chairs

DESIGN METRO DESIGN GROUP

*Tip: The COM yards and COL square footage listed on this page reflect the requirements for a single fabric that are based on non-directional 54"W material applied rail-roaded. For multi-fabric COM requirements, please refer to Multi-Fabric Yardage.*  
▶ Page 119

*Tip: When specifying fabric in different price grades, the highest price grade prevails.*

Standard Includes		Required to Specify
▶ Need help? Product details, page 98	<ul style="list-style-type: none"> <li>• Seat, back, and arms, if selected: fabric or leather</li> <li>• Base and tablet support, if selected: paint</li> <li>• Glides</li> <li>• Tablet surface: dark gray vinyl only</li> </ul>	<ol style="list-style-type: none"> <li>1 Style number</li> <li>2 Number of fabrics if contrasting fabric style number is selected</li> <li>3 Fabric or leather color number for seat, back, and arms, if selected</li> <li>4 Paint color number for base and tablet, if selected</li> <li>5 Options, if selected (see below)</li> </ol> ▶ See <i>Surface Materials</i> , page 418.

Options	U.S. Price	Required to Specify
<b>Surface Materials</b>	<ul style="list-style-type: none"> <li>• Contrasting fabric</li> </ul>	+\$100 per fabric  Add suffix K to the style number and select fabric color number.
	<b>Fire code seating</b> <ul style="list-style-type: none"> <li>• Lounge</li> <li>• Lounge with arms</li> </ul>	+\$350 +\$490  Specify with <i>CAL TB133</i> . Specify with <i>CAL TB133</i> . ▶ See <i>CAL TB133 Compliance Program Chart</i> in resources section, page 14.
<b>Related Products</b>	<ul style="list-style-type: none"> <li>• Bench</li> <li>• Podium</li> <li>• Occasional tables</li> <li>• Side tables</li> </ul>	▶ Page 116 ▶ Page 117 ▶ Page 124 ▶ Page 126

Specification Information															
Style Number	U.S. Base Prices												Leather Grades:		
	Fabric Grades:												COL	C	E
	COM	6	7	8	9	10	11	12	13	14					

## Sled Lounge Chair

<b>BLD26XX</b>	\$1290	\$1365	\$1402	\$1431	\$1502	\$1542	\$1574	\$1645	\$1770	\$1833	\$1411	\$2305	\$2455
COM/yds = 2¾, COL/sq ft = 55													

## Sled Lounge Chair with Arms

<b>BLD26AA</b>	\$1857	\$1972	\$2022	\$2061	\$2159	\$2212	\$2256	\$2354	\$2525	\$2610	\$2031	\$3042	\$3222
COM/yds = 3¾, COL/sq ft = 73													

## Sled Lounge Chair with Left-Hand Tablet Arm

<b>BLD26TX</b>	\$1568	\$1643	\$1680	\$1709	\$1780	\$1820	\$1852	\$1923	\$2048	\$2111	\$1715	\$2583	\$2733
COM/yds = 2¾, COL/sq ft = 55													

## Sled Lounge Chair with Right-Hand Tablet Arm

<b>BLD26XT</b>	\$1568	\$1643	\$1680	\$1709	\$1780	\$1820	\$1852	\$1923	\$2048	\$2111	\$1715	\$2583	\$2733
COM/yds = 2¾, COL/sq ft = 55													

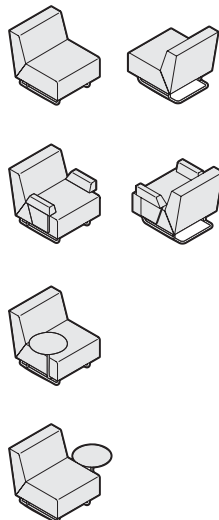

 **For Canadian Pricing**  
Multiply U.S. Price by the Canadian price factor.  
▶ See page 1 for details.

# Bix Sectional Seating

DESIGN METRO DESIGN GROUP

*Tip: Fabric for the seat and back is specified separate from the back screen, if selected. For a monochromatic look, specify the same fabric for both the seat and back, and back screen.*

*Tip: The COM yards and COL square footage listed on these pages reflect the requirements for a single fabric that are based on non-directional 54"W material applied rail-roaded. For multi-fabric COM requirements, please refer to Multi-Fabric Yardage.*  
▶ Page 119

*Tip: When specifying fabric in different price groups, the highest price group prevails.*

*Tip: Fabrics and leathers will appear loose with comfort wrinkles when upholstered.*

*Tip: 30"W corner sections are available with two seat fabric direction options – rail-roaded or cut-right. Illustrations assume a striped patterned fabric.*  
▶ Page 120

Standard Includes	Required to Specify
<ul style="list-style-type: none"> <li>• Need help? Product details, page 98</li> <li>• Seat, back, and arms, if selected: fabric or leather</li> <li>• Legs: paint</li> <li>• Adjustable glides: paint to match legs</li> <li>• Back screen, if selected: fabric</li> <li>• Leveling wrench</li> </ul>	<ol style="list-style-type: none"> <li>1 Style number</li> <li>2 Number of fabrics if contrasting fabric style number is selected</li> <li>3 Fabric or leather color number for seat, back, and arms, if selected</li> <li>4 Paint color number for legs and glides</li> <li>5 Fabric color number for back screen, if selected</li> <li>6 Options, if selected (see below)</li> </ol> <p>▶ See <i>Surface Materials</i>, page 418.</p>

Options	U.S. Price	Required to Specify
<b>Surface Materials</b> <ul style="list-style-type: none"> <li>• Contrasting fabric</li> </ul>	+ \$100 per fabric	Add suffix K to the style number and select fabric color number.
<b>Fire code seating (CAL TB133)</b> <ul style="list-style-type: none"> <li>• 30" Corner +\$560</li> <li>• 54" Corner +\$630</li> <li>• 54" Corner with one arm +\$700</li> <li>• 48" Straight +\$490</li> <li>• 48" Straight with one arm +\$560</li> <li>• 48" Straight with two arms +\$630</li> <li>• 72" Straight +\$560</li> <li>• 72" Straight with one arm +\$630</li> <li>• 72" Straight with two arms +\$700</li> </ul>		Specify with CAL TB133. Specify with CAL TB133. Specify with CAL TB133. Specify with CAL TB133. Specify with CAL TB133. Specify with CAL TB133. Specify with CAL TB133. Specify with CAL TB133. Specify with CAL TB133. Specify with CAL TB133. See CAL TB133 Compliance Program Chart in resources section, page 14.
<b>Seat Height</b> <ul style="list-style-type: none"> <li>• 18" seat height</li> </ul>	+ \$200	Specify with 18" seat height.
<b>Related Products</b> <ul style="list-style-type: none"> <li>• Bench</li> <li>• Podium</li> <li>• Bridge tables</li> <li>• Occasional tables</li> <li>• Work booth tables</li> <li>• Side tables</li> </ul>		▶ Page 116 ▶ Page 117 ▶ Page 122 ▶ Page 124 ▶ Page 125 ▶ Page 126

Specification Information													
Style Number	U.S. Base Prices											Leather Grades:	
	Fabric Grades:											COL	C
	COM	6	7	8	9	10	11	12	13	14			

### 30"W Corner Section–Left Section with Seat Fabric Rail-roaded

BSC30LA	\$2049	\$2194	\$2255	\$2301	\$2418	\$2482	\$2535	\$2652	\$2858	\$2960	\$2320	\$3234	\$3414
---------	--------	--------	--------	--------	--------	--------	--------	--------	--------	--------	--------	--------	--------

COM/yds = 4½, COL/sq ft = 90

### 30"W Corner Section–Left Section with Seat Fabric Cut-Right

BSC30LB	\$2049	\$2194	\$2255	\$2301	\$2418	\$2482	\$2535	\$2652	\$2858	\$2960	\$2320	\$3234	\$3414
---------	--------	--------	--------	--------	--------	--------	--------	--------	--------	--------	--------	--------	--------

COM/yds = 4½, COL/sq ft = 90

▶ Specification Information, continued on next page

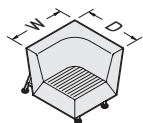
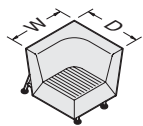

**For Canadian Pricing**  
Multiply U.S. Price by the Canadian price factor.  
▶ See page 1 for details.

► Specification Information, continued from previous page

Specification Information

Style Number	U.S. Base Prices														Leather Grades:		
	Fabric Grades:														COL	C	E
	COM	6	7	8	9	10	11	12	13	14							

**30"W Corner Section–Right Section with Seat Fabric Railroaded**

<b>BSC30RA</b>	\$2049	\$2194	\$2255	\$2301	\$2418	\$2482	\$2535	2652	\$2858	\$2960	\$2320	\$3234	\$3414
COM/yds = 4½, COL/sq ft = 90													

**30"W Corner Section–Right Section with Seat Fabric Cut-Right**

<b>BSC30RB</b>	\$2049	\$2194	\$2255	\$2301	\$2418	\$2482	\$2535	2652	\$2858	\$2960	\$2320	\$3234	\$3414
COM/yds = 4½, COL/sq ft = 90													

**30"W Corner Section with Back Screen–Left Section with Seat Fabric Railroaded**

<b>BSCB30LA</b>	\$2718	\$2944	\$3031	\$3098	\$3267	\$3360	\$3436	\$3605	\$3901	\$4050	\$3080	\$4583	\$4883
Chair: COM/yds = 4½, COL/sq ft = 90													
Screen: COM/yds = 2													

**30"W Corner Section with Back Screen–Left Section with Seat Fabric Cut-Right**

<b>BSCB30LB</b>	\$2718	\$2944	\$3031	\$3098	\$3267	\$3360	\$3436	\$3605	\$3901	\$4050	\$3080	\$4583	\$4883
Chair: COM/yds = 4½, COL/sq ft = 90													
Screen: COM/yds = 2													

**30"W Corner Section with Back Screen–Right Section with Seat Fabric Railroaded**

<b>BSCB30RA</b>	\$2718	\$2944	\$3031	\$3098	\$3267	\$3360	\$3436	\$3605	\$3901	\$4050	\$3080	\$4583	\$4883
Chair: COM/yds = 4½, COL/sq ft = 90													
Screen: COM/yds = 2													

**30"W Corner Section with Back Screen–Right Section with Seat Fabric Cut-Right**

<b>BSCB30RB</b>	\$2718	\$2944	\$3031	\$3098	\$3267	\$3360	\$3436	\$3605	\$3901	\$4050	\$3080	\$4583	\$4883
Chair: COM/yds = 4½, COL/sq ft = 90													
Screen: COM/yds = 2													

► Specification Information, continued on next page

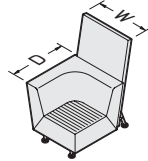
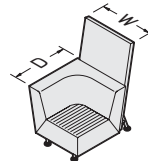
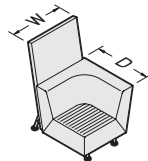
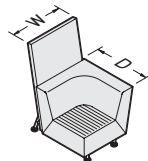
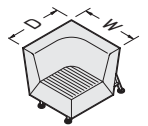
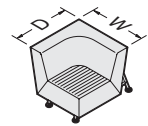

**For Canadian Pricing**  
 Multiply U.S. Price by the  
 Canadian price factor.  
 ► See page 1 for details.

*Tip: Extended corner sections are standard with a railroaded seat and back fabric direction.*  
 ▶ Page 120

*Tip: Fabrics and leathers will appear loose with comfort wrinkles when upholstered.*

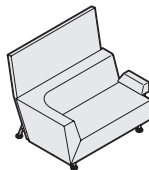
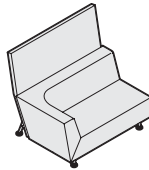
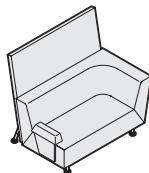
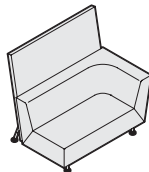
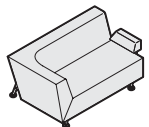
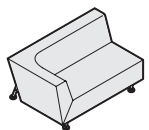
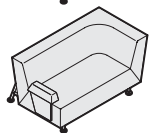
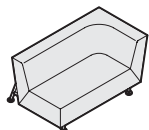

► Specification Information, continued from previous page

**Specification Information**

Style Number	U.S. Base Prices														Leather Grades:		
	Fabric Grades:														COL	C	E
	COM	6	7	8	9	10	11	12	13	14							

**54"W Extended Corner Section–Left Section**

BSE54LX	\$2847	\$3093	\$3187	\$3259	\$3441	\$3541	\$3623	\$3805	\$4124	\$4284	\$3226	\$4542	\$4812
---------	--------	--------	--------	--------	--------	--------	--------	--------	--------	--------	--------	--------	--------

COM/yds = 7, COL/sq ft = 140

**54"W Extended Corner Section–Left Section with Arm**

BSE54LA	\$3131	\$3397	\$3498	\$3575	\$3770	\$3878	\$3965	\$4160	\$4502	\$4673	\$3548	\$4996	\$5296
---------	--------	--------	--------	--------	--------	--------	--------	--------	--------	--------	--------	--------	--------

COM/yds = 7½, COL/sq ft = 149

**54"W Extended Corner Section–Right Section**

BSE54RX	\$2847	\$3093	\$3187	\$3259	\$3441	\$3541	\$3623	\$3805	\$4124	\$4284	\$3226	\$4542	\$4812
---------	--------	--------	--------	--------	--------	--------	--------	--------	--------	--------	--------	--------	--------

COM/yds = 7, COL/sq ft = 140

**54"W Extended Corner Section–Right Section with Arm**

BSE54RA	\$3131	\$3397	\$3498	\$3575	\$3770	\$3878	\$3965	\$4160	\$4502	\$4673	\$3548	\$4996	\$5296
---------	--------	--------	--------	--------	--------	--------	--------	--------	--------	--------	--------	--------	--------

COM/yds = 7½, COL/sq ft = 149

**54"W Extended Corner Section–Left Section with Back Screen**

BSEB54LX	\$3679	\$4086	\$4233	\$4346	\$4632	\$4790	\$4918	\$5204	\$5706	\$5957	\$4170	\$6479	\$6944
----------	--------	--------	--------	--------	--------	--------	--------	--------	--------	--------	--------	--------	--------

Chair: COM/yds = 7, COL/sq ft = 140  
 Screen: COM/yds = 4

**54"W Extended Corner Section–Left Section with Back Screen and Arm**

BSEB54LA	\$3962	\$4389	\$4543	\$4661	\$4960	\$5125	\$5259	\$5558	\$6083	\$6345	\$4489	\$7102	\$7627
----------	--------	--------	--------	--------	--------	--------	--------	--------	--------	--------	--------	--------	--------

Chair: COM/yds = 7½, COL/sq ft = 149  
 Screen: COM/yds = 4

**54"W Extended Corner Section–Right Section with Back Screen**

BSEB54RX	\$3679	\$4086	\$4233	\$4346	\$4632	\$4790	\$4918	\$5204	\$5706	\$5957	\$4170	\$6479	\$6944
----------	--------	--------	--------	--------	--------	--------	--------	--------	--------	--------	--------	--------	--------

Chair: COM/yds = 7, COL/sq ft = 140  
 Screen: COM/yds = 4

**54"W Extended Corner Section–Right Section with Back Screen and Arm**

BSEB54RA	\$3962	\$4389	\$4543	\$4661	\$4960	\$5125	\$5259	\$5558	\$6083	\$6345	\$4489	\$7102	\$7627
----------	--------	--------	--------	--------	--------	--------	--------	--------	--------	--------	--------	--------	--------

Chair: COM/yds = 7½, COL/sq ft = 149  
 Screen: COM/yds = 4

► Specification Information, continued on next page

*Tip: Straight sections are standard with a railroaded seat and back fabric direction.*

► Page 120

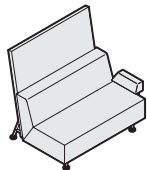
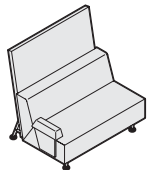
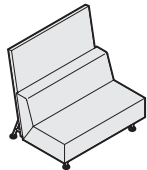
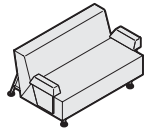
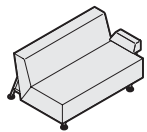
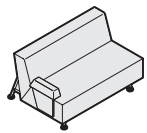
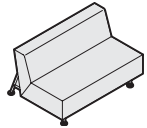

► Specification Information, continued from previous page

**Specification Information**

Style Number	U.S. Base Prices														Leather Grades:		
	Fabric Grades:														COL	C	E
	COM	6	7	8	9	10	11	12	13	14							

**48"W Straight Section**

<b>BSS48XX</b>	\$2121	\$2266	\$2327	\$2373	\$2490	\$2554	\$2607	\$2724	\$2930	\$3032	\$2401	\$3561	\$3786
----------------	--------	--------	--------	--------	--------	--------	--------	--------	--------	--------	--------	--------	--------

COM/yds = 4½, COL/sq ft = 90

**48"W Straight Section with Left Arm**

<b>BSS48AX</b>	\$2404	\$2569	\$2636	\$2688	\$2818	\$2890	\$2948	\$3078	\$3306	\$3420	\$2723	\$3929	\$4169
----------------	--------	--------	--------	--------	--------	--------	--------	--------	--------	--------	--------	--------	--------

COM/yds = 5, COL/sq ft = 99

**48"W Straight Section with Right Arm**

<b>BSS48XA</b>	\$2404	\$2569	\$2636	\$2688	\$2818	\$2890	\$2948	\$3078	\$3306	\$3420	\$2723	\$3929	\$4169
----------------	--------	--------	--------	--------	--------	--------	--------	--------	--------	--------	--------	--------	--------

COM/yds = 5, COL/sq ft = 99

**48"W Straight Section with Two Arms**

<b>BSS48AA</b>	\$2687	\$2873	\$2946	\$3003	\$3146	\$3225	\$3289	\$3432	\$3683	\$3808	\$3043	\$4382	\$4652
----------------	--------	--------	--------	--------	--------	--------	--------	--------	--------	--------	--------	--------	--------

COM/yds = 5½, COL/sq ft = 108

**48"W Straight Section with Back Screen**

<b>BSSB48XX</b>	\$2893	\$3159	\$3260	\$3337	\$3532	\$3640	\$3727	\$3922	\$4264	\$4435	\$3279	\$5353	\$5758
-----------------	--------	--------	--------	--------	--------	--------	--------	--------	--------	--------	--------	--------	--------

Chair: COM/yds = 4½, COL/sq ft = 90  
Screen: COM/yds = 3

**48"W Straight Section with Back Screen and Left Arm**

<b>BSSB48AX</b>	\$3176	\$3462	\$3570	\$3652	\$3860	\$3975	\$4068	\$4276	\$4641	\$4823	\$3599	\$5721	\$6141
-----------------	--------	--------	--------	--------	--------	--------	--------	--------	--------	--------	--------	--------	--------

Chair: COM/yds = 5, COL/sq ft = 99  
Screen: COM/yds = 3

**48"W Straight Section with Back Screen and Right Arm**

<b>BSSB48XA</b>	\$3176	\$3462	\$3570	\$3652	\$3860	\$3975	\$4068	\$4276	\$4641	\$4823	\$3599	\$5721	\$6141
-----------------	--------	--------	--------	--------	--------	--------	--------	--------	--------	--------	--------	--------	--------

Chair: COM/yds = 5, COL/sq ft = 99  
Screen: COM/yds = 3

► Specification Information, continued on next page



**For Canadian Pricing**  
Multiply U.S. Price by the Canadian price factor.  
► See page 1 for details.



*Tip: Straight sections are standard with a railroaded seat and back fabric direction.*

▶ Page 120

*Tip: Fabrics and leathers will appear loose with comfort wrinkles when upholstered.*

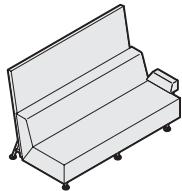
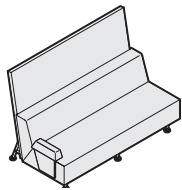
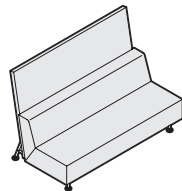
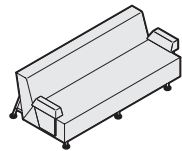
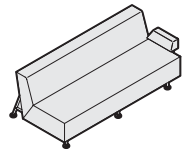
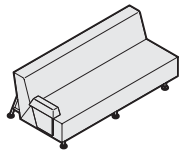
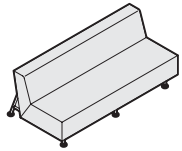

► Specification Information, continued from previous page

**Specification Information**

Style Number	U.S. Base Prices														Leather Grades:		
	Fabric Grades:														COL	C	E
	COM	6	7	8	9	10	11	12	13	14							

**72"W Straight Section**

<b>BSS72XX</b>	\$2996	\$3222	\$3309	\$3376	\$3545	\$3638	\$3714	\$3883	\$4179	\$4328	\$3395	\$4861	\$5161
----------------	--------	--------	--------	--------	--------	--------	--------	--------	--------	--------	--------	--------	--------

COM/yds = 6½, COL/sq ft = 130

**72"W Straight Section with Left Arm**

<b>BSS72AX</b>	\$3278	\$3524	\$3618	\$3690	\$3872	\$3972	\$4054	\$4236	\$4555	\$4715	\$3717	\$5313	\$5643
----------------	--------	--------	--------	--------	--------	--------	--------	--------	--------	--------	--------	--------	--------

COM/yds = 7, COL/sq ft = 139

**72"W Straight Section with Right Arm**

<b>BSS72XA</b>	\$3278	\$3524	\$3618	\$3690	\$3872	\$3972	\$4054	\$4236	\$4555	\$4715	\$3717	\$5313	\$5643
----------------	--------	--------	--------	--------	--------	--------	--------	--------	--------	--------	--------	--------	--------

COM/yds = 7, COL/sq ft = 139

**72"W Straight Section with Two Arms**

<b>BSS72AA</b>	\$3563	\$3829	\$3930	\$4007	\$4202	\$4310	\$4397	\$4592	\$4934	\$5105	\$4037	\$5768	\$6128
----------------	--------	--------	--------	--------	--------	--------	--------	--------	--------	--------	--------	--------	--------

COM/yds = 7½, COL/sq ft = 148

**72"W Straight Section with Back Screen**

<b>BSSB72XX</b>	\$4027	\$4434	\$4581	\$4694	\$4980	\$5138	\$5266	\$5552	\$6054	\$6305	\$4564	\$7422	\$7992
-----------------	--------	--------	--------	--------	--------	--------	--------	--------	--------	--------	--------	--------	--------

Chair: COM/yds = 6½, COL/sq ft = 130  
Screen: COM/yds = 4½

**72"W Straight Section with Back Screen and Left Arm**

<b>BSSB72AX</b>	\$4308	\$4735	\$4889	\$5007	\$5306	\$5471	\$5605	\$5904	\$6429	\$6691	\$4883	\$7873	\$8473
-----------------	--------	--------	--------	--------	--------	--------	--------	--------	--------	--------	--------	--------	--------

Chair: COM/yds = 7, COL/sq ft = 139  
Screen: COM/yds = 4½

**72"W Straight Section with Back Screen and Right Arm**

<b>BSSB72XA</b>	\$4308	\$4735	\$4889	\$5007	\$5306	\$5471	\$5605	\$5904	\$6429	\$6691	\$4883	\$7873	\$8473
-----------------	--------	--------	--------	--------	--------	--------	--------	--------	--------	--------	--------	--------	--------

Chair: COM/yds = 7, COL/sq ft = 139  
Screen: COM/yds = 4½

# Bix Multi-Fabric Diagram and Yardage Request Form

DESIGN METRO DESIGN GROUP

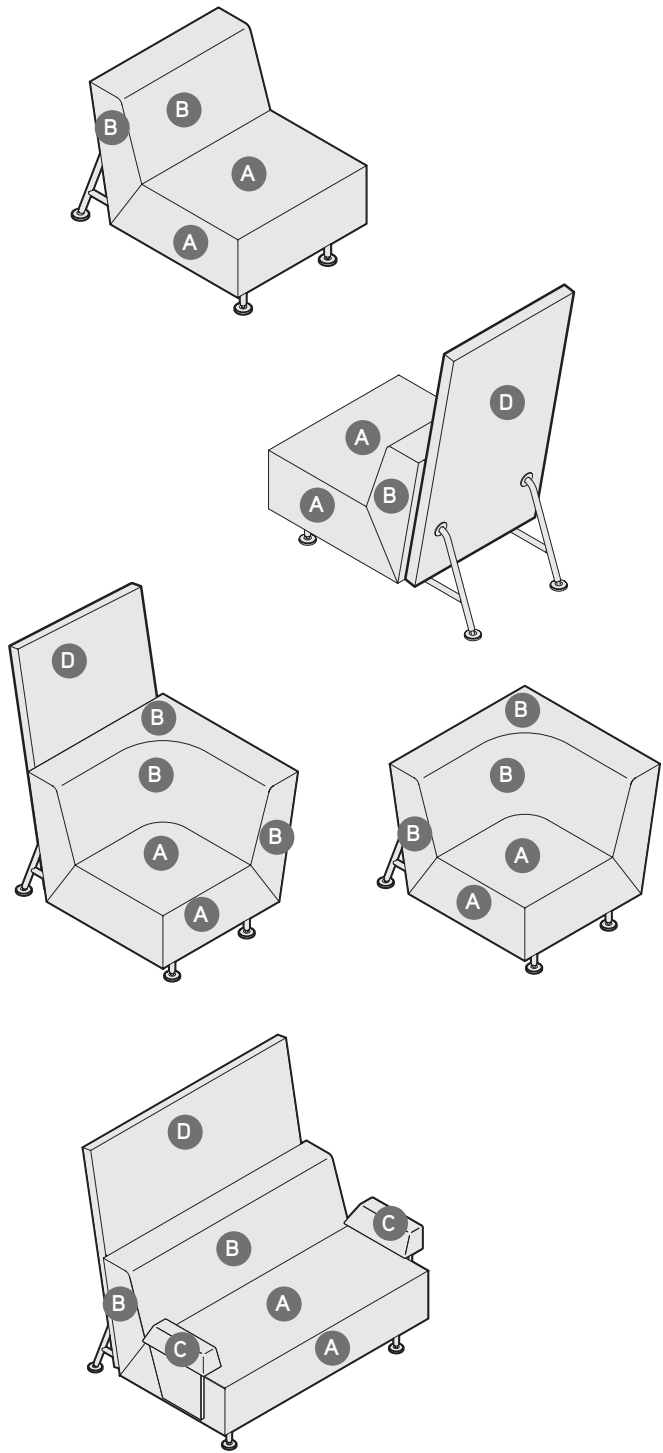

TO: \_\_\_\_\_

FROM: \_\_\_\_\_

DATE: \_\_\_\_\_

FAX...888.413.5161

Lounge Seating

**A** Seat (upholstery selections default for entire unit if B is not selected): \_\_\_\_\_

**B** Back: \_\_\_\_\_

**C** Arms (if applicable): \_\_\_\_\_

**D** Backscreen (if applicable): \_\_\_\_\_

*\*Back screen defined separately when ordered.*

*\* \$100 U.S. list per contrasting fabric specified. List price based on highest fabric grade usage.*

*Tip: Fabrics and leathers will appear loose with comfort wrinkles when upholstered.*

*Tip: The COM yards and COL square footage listed on this page reflect the requirements for a single fabric that are based on non-directional 54"W material applied railroaded.*

Standard Includes		Required to Specify
<ul style="list-style-type: none"> <li>▶ Need help? Product details, page 98</li> </ul>	<ul style="list-style-type: none"> <li>• Seat: fabric or leather</li> <li>• Legs and open storage interior, if selected: paint</li> <li>• Adjustable glides: paint to match legs</li> <li>• Leveling wrench</li> </ul>	<ol style="list-style-type: none"> <li>1 Style number</li> <li>2 Fabric or leather color number for seat</li> <li>3 Paint color number for legs, glides, and open storage interior, if selected</li> <li>4 Options, if selected (see below)</li> </ol> <p>▶ See <i>Surface Materials</i>, page 418.</p>

Options	U.S. Price	Required to Specify
<b>Surface Materials</b> <ul style="list-style-type: none"> <li>• Fire code seating (CAL TB133)</li> <li>• 48" bench</li> <li>• 72" bench</li> </ul>	<ul style="list-style-type: none"> <li>+ \$330</li> <li>+ \$400</li> </ul>	<ul style="list-style-type: none"> <li>Specify with CAL TB133.</li> <li>Specify with CAL TB133.</li> <li>▶ See CAL TB133 Compliance Program Chart in resources section, page 14.</li> </ul>
<b>Seat Height</b> <ul style="list-style-type: none"> <li>• 18" seat height</li> </ul>	<ul style="list-style-type: none"> <li>+ \$200</li> </ul>	<ul style="list-style-type: none"> <li>Specify with 18" seat height.</li> </ul>
<b>Related Products</b> <ul style="list-style-type: none"> <li>• Lounge chairs</li> <li>• Sectional seating</li> <li>• Podium</li> <li>• Side tables</li> </ul>		<ul style="list-style-type: none"> <li>▶ Page 108</li> <li>▶ Page 110</li> <li>▶ Page 117</li> <li>▶ Page 126</li> </ul>

Specification Information													
Style Number	U.S. Base Prices											Leather Grades:	
	Fabric Grades:											COL	C
	COM	6	7	8	9	10	11	12	13	14			

**48"W Bench**

<b>BB48</b>	\$1310	\$1365	\$1395	\$1419	\$1477	\$1509	\$1536	\$1594	\$1697	\$1748	\$1481	\$2240	\$2375
COM/yds = 2 1/4, COL/sq ft = 41													

**72"W Bench**

<b>BB72</b>	\$1568	\$1653	\$1693	\$1724	\$1802	\$1845	\$1880	\$1958	\$2095	\$2164	\$1775	\$2753	\$2933
COM/yds = 3, COL/sq ft = 54													

**48"W Bench with Open Storage**

<b>BBS48</b>	\$1516	\$1571	\$1601	\$1625	\$1683	\$1715	\$1742	\$1800	\$1903	\$1954	\$1714	\$2446	\$2581
COM/yds = 2 1/4, COL/sq ft = 41													

**72"W Bench with Open Storage**

<b>BBS72</b>	\$1774	\$1859	\$1899	\$1930	\$2008	\$2051	\$2086	\$2164	\$2301	\$2370	\$2007	\$2959	\$3139
COM/yds = 3, COL/sq ft = 54													

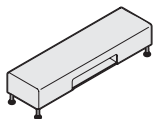
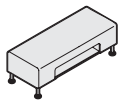
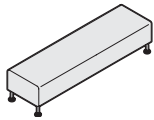
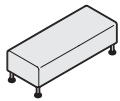

**For Canadian Pricing**  
 Multiply U.S. Price by the Canadian price factor.  
 ▶ See page 1 for details.

# Bix Podium

DESIGN METRO DESIGN GROUP

*Tip: The COM yards and COL square footage listed on this page reflect the requirements for a single fabric that are based on non-directional 54"W material applied rail-roaded. For multi-fabric COM requirements, please refer to Multi-Fabric Yardage and Square Footage Requirements. ▶ Page 119*

*Tip: When specifying fabric in different price groups, the highest price group prevails.*

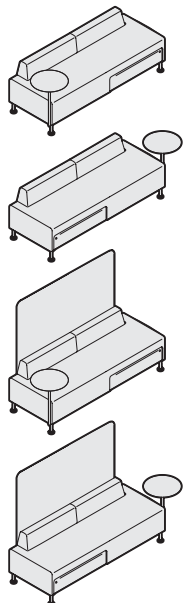

Standard Includes		Required to Specify
▶ Need help? Product details, page 98	<ul style="list-style-type: none"> <li>• Seat and bolster: fabric or leather</li> <li>• Legs, tablet support, drawer pull, and projection screen frame, if selected: paint</li> <li>• Tablet surface: dark gray vinyl only</li> <li>• Drawer front: laminate</li> <li>• Face-mounted lock, keyed random: black only</li> <li>• Projection screen, if selected: white mesh</li> <li>• Adjustable glides: paint to match legs</li> <li>• Leveling wrench</li> </ul>	<ol style="list-style-type: none"> <li>1 Style number</li> <li>2 Number of fabrics if contrasting fabric style number is selected</li> <li>3 Fabric or leather color number for seat and bolster</li> <li>4 Paint color number for legs, glides, tablet support, drawer pull, and projection screen frame, if selected</li> <li>5 Laminate color number for drawer front</li> <li>6 Options, if selected (see below)</li> </ol> ▶ See <i>Surface Materials</i> , page 418.

Options	U.S. Price	Required to Specify
<b>Surface Materials</b>		
• Contrasting fabric	+\$100 per fabric	Add suffix K to the style number and select fabric color number.
<b>Fire code seating (CAL TB133)</b>		
• Podium	+\$400	Specify with CAL TB133. ▶ See <i>CAL TB133 Compliance Program Chart</i> in resources section, page 14.
<b>Storage drawer</b>		
• Wood veneer Grade 1	+\$ 27	Specify with <i>wood drawer front</i> and select wood veneer grade 1 color number.
• Wood veneer Grade 2	+\$ 45	Specify with <i>wood drawer front</i> and select wood veneer grade 2 color number.
<b>Grade 2 laminate drawer front</b>	No cost	Specify laminate color number.
<b>Wood</b>		
• Custom wood finish		▶ Page 420
<b>Seat Height</b>	• 18" seat height	+\$200
		Specify with <i>18" seat height</i> .
<b>Related Products</b>	<ul style="list-style-type: none"> <li>• Lounge chairs</li> <li>• Sectional seating</li> <li>• Bench</li> <li>• Side tables</li> </ul>	▶ Page 108 ▶ Page 110 ▶ Page 116 ▶ Page 126

Specification Information													
Style Number	U.S. Base Prices											Leather Grades:	
	Fabric Grades:											COL	C
	COM	6	7	8	9	10	11	12	13	14			

Podium with Left Tablet													
BP72TX	\$3486	\$3692	\$3772	\$3834	\$3990	\$4076	\$4146	\$4302	\$4576	\$4713	\$3954	\$5691	\$6051
COM/yds = 6, COL/sq ft = 108													

Podium with Right Tablet													
BP72XT	\$3486	\$3692	\$3772	\$3834	\$3990	\$4076	\$4146	\$4302	\$4576	\$4713	\$3954	\$5691	\$6051
COM/yds = 6, COL/sq ft = 108													

Podium with Projection Screen and Left Tablet													
BPP72TX	\$4256	\$4462	\$4542	\$4604	\$4760	\$4846	\$4916	\$5072	\$5346	\$5483	\$4828	\$6461	\$6821
COM/yds = 6, COL/sq ft = 108													

Podium with Projection Screen and Right Tablet													
BPP72XT	\$4256	\$4462	\$4542	\$4604	\$4760	\$4846	\$4916	\$5072	\$5346	\$5483	\$4828	\$6461	\$6821
COM/yds = 6, COL/sq ft = 108													

# Bix Multi-Fabric Diagram and Yardage Request Form

DESIGN METRO DESIGN GROUP

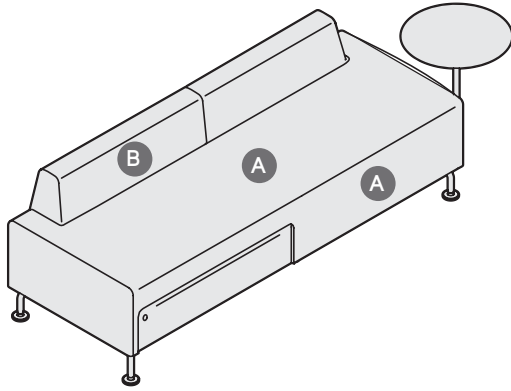

TO: \_\_\_\_\_

FROM: \_\_\_\_\_

DATE: \_\_\_\_\_

FAX...888.413.5161

**A** Seat (upholstery selections default for entire unit if B is not selected): \_\_\_\_\_

**B** Back: \_\_\_\_\_

*\* \$100 U.S. list per contrasting fabric specified. List price based on highest fabric grade usage.*



**For Canadian Pricing**  
Multiply U.S. Price by the  
Canadian price factor.  
▶ See page 1 for details.

# Bix Multi-Fabric Yardage

DESIGN METRO DESIGN GROUP

Multi-Fabric Yardage					
DESCRIPTION	STYLE NUMBER	COM YDS*			
		SEAT	BACK	ARM(S)	BACK SCREEN
Lounge chair	BL26XX	1¾	1¾	N.A.	N.A.
Lounge chair with arms	BL26AA	1¾	1¾	1	N.A.
Lounge chair with back screen	BLB26XX	1¾	1¾	N.A.	1¾
Sled lounge chair	BLD26XX	1¾	1¾	N.A.	N.A.
Sled lounge chair with arms	BLD26AA	1¾	1¾	1	N.A.
Sled lounge chair with left-hand tablet arm	BLD26TX	1¾	1¾	N.A.	N.A.
Sled lounge chair with right-hand tablet arm	BLD26XT	1¾	1¾	N.A.	N.A.
30"W corner section-left section with seat fabric railroaded	BSC30LA	2	2½	N.A.	N.A.
30"W corner section-left section with seat fabric cut-right	BSC30LB	2	2½	N.A.	N.A.
30"W corner section-right section with seat fabric railroaded	BSC30RA	2	2½	N.A.	N.A.
30"W corner section-right section with seat fabric cut-right	BSC30RB	2	2½	N.A.	N.A.
30"W corner section with back screen-left section with seat fabric railroaded	BSCB30LA	2	2½	N.A.	2
30"W corner section with back screen-left section with seat fabric cut-right	BSCB30LB	2	2½	N.A.	2
30"W corner section with back screen-right section with seat fabric railroaded	BSCB30RA	2	2½	N.A.	2
30"W corner section with back screen-right section with seat fabric cut-right	BSCB30RB	2	2½	N.A.	2
54"W extended corner section-left section	BSE54LX	2½	3	N.A.	N.A.
54"W extended corner section-left section with arm	BSE54LA	2½	3	½	N.A.
54"W extended corner section-right section	BSE54RX	2½	3	N.A.	N.A.
54"W extended corner section-right section with arm	BSE54RA	2½	3	½	N.A.
54"W extended corner section-left section with back screen	BSEB54LX	2½	3	N.A.	4
54"W extended corner section-left section with back screen and arm	BSEB54LA	2½	3	½	4
54"W extended corner section-right section with back screen	BSEB54RX	2½	3	N.A.	4
54"W extended corner section-right section with back screen and arm	BSEB54RA	2½	3	½	4
48"W straight section	BSS48XX	2½	2½	N.A.	N.A.
48"W straight section with left arm	BSS48AX	2½	2½	½	N.A.
48"W straight section with right arm	BSS48XA	2½	2½	½	N.A.
48"W straight section with two arms	BSS48AA	2½	2½	1	N.A.
48"W straight section with back screen	BSSB48XX	2½	2½	N.A.	3
48"W straight section with back screen and left arm	BSSB48AX	2½	2½	½	3
48"W straight section with back screen and right arm	BSSB48XA	2½	2½	½	3
72"W straight section	BSS72XX	4½	4½	N.A.	N.A.
72"W straight section with left arm	BSS72AX	4½	4½	½	N.A.
72"W straight section with right arm	BSS72XA	4½	4½	½	N.A.
72"W straight section with two arms	BSS72AA	4½	4½	1	N.A.
72"W straight section with back screen	BSSB72XX	4½	4½	N.A.	4½
72"W straight section with back screen and left arm	BSSB72AX	4½	4½	½	4½
72"W straight section with back screen and right arm	BSSB72XA	4½	4½	½	4½

\*Fabric yardage is based on non-directional/solid fabrics. use conversion chart on the following page for repeat/printed fabric yardage.

**Multi-Fabric Yardage**

DESCRIPTION	STYLE NUMBER	COM YDS*			
		SEAT CUSHION	BACK CUSHION	ARM(S)	BACK SCREEN
Podium with left tablet	BP72TX	3½	2½	N.A.	N.A.
Podium with right tablet	BP72XT	3½	2½	N.A.	N.A.
Podium with projection screen and left tablet	BPP72TX	3½	2½	N.A.	N.A.
Podium with projection screen and right tablet	BPP72XT	3½	2½	N.A.	N.A.

\*Fabric yardage is based on non-directional/solid fabrics. Use conversion chart below for repeat/printed fabric yardage.

**Non-standard fabric requirements**

Yardage requirements shown are based on non-directional 54"W material applied railroaded. Coalesse will apply fabric railroaded unless instructed otherwise on the dealer's purchase order. The following conversion chart should be used to determine yardage requirements when COM has a repeat of 2" or more. Please contact Coalesse customer service for a yardage quotation if the fabric is less than 54" wide, has a repeat of more than 24", or if the fabric must be cut-right.

**CONVERSION CHART**

PRODUCT	REPEAT		
	2"- 8"	9"- 14"	15"- 24"
<b>Bix</b>	15%	30%	75%

Yardage quotations will also be provided for order of 10 or more pieces.

**Pattern matching on Bix**

Due to Coalesse's high standards for pattern matching, we reserve the right to apply the following upcharges for extra labor incurred by a pattern or material that poses such challenges:

<b>Lounge or seat</b>	\$100 U.S. net per piece
<b>Backscreen</b>	\$50 U.S. net per piece

Customers will be informed if an upcharge will be applied to their order during the approval process. Should Coalesse receive an order without prior approval, it will be held as pending until the customer accepts such charges. The upcharge will be applied per item where applicable.



**For Canadian Pricing**

Multiply U.S. Price by the Canadian price factor.

► See page 1 for details.

**Cutting direction guidelines**

Cutting direction is based on the fabric width and the way the fabric is cut from the roll and applied to Coalesse products. There are two cutting directions: railroaded or cut-right.

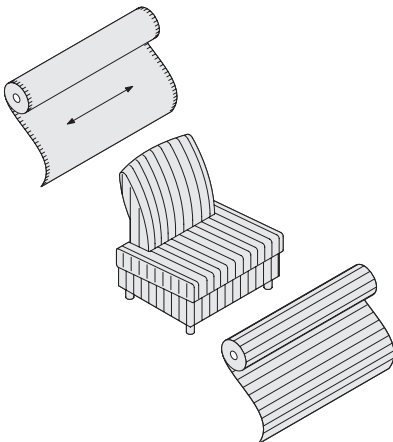

**Horizontal or railroaded** (across roll, warp horizontal) means fabric is cut across the roll; selvages are on the top and bottom.

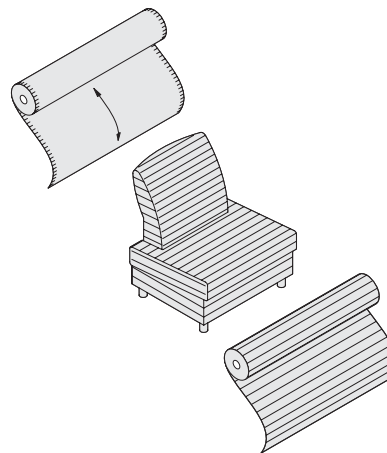

**Vertical or cut-right** (down roll, warp vertical) means fabric is cut in the same direction it is woven; selvages are on the left and right sides.

Coalesse reserves the right to railroad or apply fabric according to weave unless instructions specify otherwise. Fabrics are railroaded when possible to avoid seams in large upholstered areas and/or single cushion units. If a fabric is questionable, a cutting of adequate size showing full repeat (if any) should be sent to Coalesse for a fabric requirement quotation.

# Bix Service Tray

DESIGN METRO DESIGN GROUP

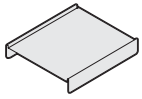

Standard Includes		Required to Specify
-------------------	--	---------------------

- |   |  |   |
|---|--|---|
| ▶ Need help?<br>Product details,<br>page 98 | <ul style="list-style-type: none"> <li>• Tray: paint</li> <li>• Mat: dark gray vinyl only</li> </ul> | 1 Style number<br>2 Paint color number for tray<br>▶ See <i>Surface Materials</i> , page 418. |
|---|--|---|

Related Products	
------------------	--

- |        |            |
|--------|------------|
| Bench  | ▶ Page 116 |
| Podium | ▶ Page 117 |

Specification Information				
Dimensions			Style	U.S.
D	W	H	Number	Price

20"	22"	4"	BATRAY	\$238
-----	-----	----	--------	-------

## Service Tray

20"	22"	4"	BATRAY	\$238
-----	-----	----	--------	-------



**For Canadian Pricing**  
 Multiply U.S. Price by the  
 Canadian price factor.  
 ▶ See page 1 for details.



# Bix Bridge Tables

DESIGN METRO DESIGN GROUP

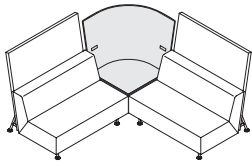

► Need help?  
Product details,  
page 98

### Standard Includes

- Top:
  - Laminate top (Grade 1 laminates) with matching plastic edge
  - Laminate top (Grade 1 Steelcase) with contrasting plastic edge
  - Wood top with matching flat wood edge
- Frame, tilted display surface for rectangular tables, and support leg for corner tables, if selected: paint
- Grommet, if selected: black plastic only
- Screens, if selected: translucent material only
- Wire management clips: black plastic only
- Attachment hardware

### Required to Specify

- 1 Style number
- 2 Laminate or wood color number for top
- See *Hardwood and Veneer Matrix*, page 456
- 3 Plastic edge color number for top with Grade 1 Steelcase or Grade 2 laminate, if selected
- 4 Paint color number for frame, tilted display surface for rectangular tables, and support leg for corner tables, if selected
- 5 Options, if selected (see below)
- See *Surface Materials*, page 418.

*Tip: 20" table height must be used in conjunction with 18" seat height in the sectional seating.*

### Options

### U.S. Price

### Required to Specify

<b>Surface Materials</b>	<b>Wood</b> • Custom wood finish		► Page 420
<b>Cable Management</b>	• PDV module: black plastic	+\$320	Specify with <i>PDV module</i> .
<b>Corner Bridge Table Height</b>	• 20" table height	+\$200	Specify with <i>20" table height</i> .
<b>Related Products</b>	• Sectional seating		► Page 110

### Specification Information

Dimensions			Style Number	U.S. Base Prices			
D	W	H		Lam 1	Lam 2	Wood 1	Wood 2

### Rectangular Bridge Table

26"	22"	18"	BTB2226	\$782	\$821	\$ 964	\$1062
-----	-----	-----	---------	-------	-------	--------	--------

### Rectangular Bridge Table with Grommet

26"	22"	18"	BTB2226U	\$831	\$873	\$1013	\$1111
-----	-----	-----	----------	-------	-------	--------	--------

► Specification Information, continued on next page

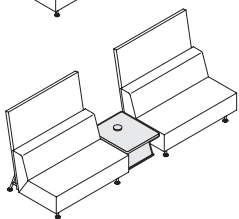
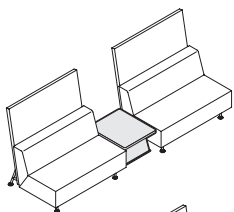

### Edge Profiles

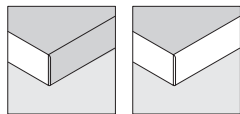

Plastic edge      Wood edge



**For Canadian Pricing**  
Multiply U.S. Price by the  
Canadian price factor.  
► See page 1 for details.

► Specification Information, continued from previous page

Specification Information

Dimensions			Style Number	U.S. Base Prices			
D	W	H		Lam 1	Lam 2	Wood 1	Wood 2

**Rectangular Bridge Table with Screen**

26"	22"	46"	BTBS2226	\$1180	\$1239	\$1362	\$1460
-----	-----	-----	----------	--------	--------	--------	--------

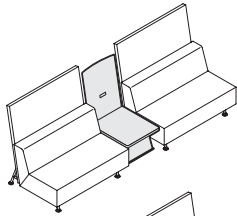

**Rectangular Bridge Table with Grommet and Screen**

26"	22"	46"	BTBS2226U	\$1230	\$1292	\$1412	\$1510
-----	-----	-----	-----------	--------	--------	--------	--------

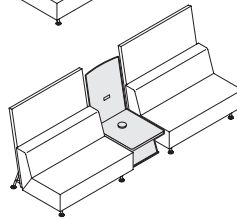

**Corner Bridge Table**

26"	22"	18"	BTB2626	\$ 886	\$ 930	\$1092	\$1190
-----	-----	-----	---------	--------	--------	--------	--------

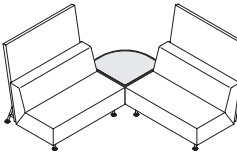

**Corner Bridge Table with Grommet**

26"	22"	18"	BTB2626U	\$ 935	\$ 982	\$1141	\$1239
-----	-----	-----	----------	--------	--------	--------	--------

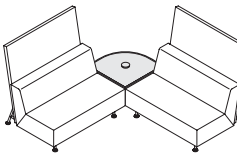

**Corner Bridge Table with Screen**

26"	22"	46"	BTBS2626	\$1407	\$1477	\$1613	\$1711
-----	-----	-----	----------	--------	--------	--------	--------

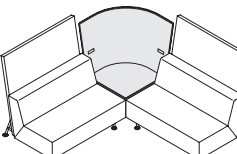

**Corner Bridge Table with Grommet and Screen**

26"	22"	46"	BTBS2626U	\$1456	\$1529	\$1662	\$1760
-----	-----	-----	-----------	--------	--------	--------	--------

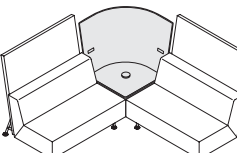

**For Canadian Pricing**  
 Multiply U.S. Price by the  
 Canadian price factor.  
 ► See page 1 for details.

# Bix 18"H Occasional Tables

DESIGN METRO DESIGN GROUP

Standard Includes		Required to Specify
<ul style="list-style-type: none"> <li>▶ Need help? Product details, page 98</li> </ul>	<ul style="list-style-type: none"> <li>• Top:                             <ul style="list-style-type: none"> <li>- Laminate top (Grade 1 laminates) with matching plastic edge</li> <li>- Laminate top (Grade 1 Steelcase) with contrasting plastic edge</li> <li>- Wood top with matching flat wood edge</li> </ul> </li> <li>• Base: textured paints only</li> <li>• Grommet, if selected: black plastic only</li> </ul>	<ol style="list-style-type: none"> <li>1 Style number</li> <li>2 Laminate or wood color number for top</li> </ol> <ul style="list-style-type: none"> <li>▶ See <i>Hardwood and Veneer Matrix</i>, page 456</li> </ul> <ol style="list-style-type: none"> <li>3 Plastic edge color number for top with Grade 1 Steelcase or Grade 2 laminate, if selected</li> <li>4 Textured paint color number for base</li> <li>5 Options, if selected (see below)</li> </ol> <ul style="list-style-type: none"> <li>▶ See <i>Surface Materials</i>, page 418.</li> </ul>

Options	U.S. Price	Required to Specify
<b>Surface Materials</b> <ul style="list-style-type: none"> <li>• Wood                             <ul style="list-style-type: none"> <li>• Custom wood finish</li> </ul> </li> </ul>		▶ Page 420
<b>Cable Management</b> <ul style="list-style-type: none"> <li>• PDV module: black plastic</li> </ul>	+\$320 each	Specify with PDV module.
<b>Related Products</b> <ul style="list-style-type: none"> <li>• Lounge chair</li> <li>• Sectional seating</li> </ul>		▶ Page 108 ▶ Page 110

Tip: One or two power, data, and voice modules are available on rectangular occasional tables.

### Specification Information

Dimensions			Diameter	Style Number	U.S. Base Prices			
D	W	H			Lam 1	Lam 2	Wood 1	Wood 2

#### Round Occasional Tables

N.A.	N.A.	18"	20"	BTC20001	\$ 905	\$ 999	\$ 999	\$1044
N.A.	N.A.	18"	28"	BTC28001	\$ 942	\$1044	\$1044	\$1142

#### Round Occasional Table with Grommet

N.A.	N.A.	18"	28"	BTC28001U	\$1004	\$1106	\$1106	\$1204
------	------	-----	-----	-----------	--------	--------	--------	--------

#### Square Occasional Table

24"	24"	18"	N.A.	BTC24241	\$ 930	\$1030	\$1030	\$1092
-----	-----	-----	------	----------	--------	--------	--------	--------

#### Square Occasional Table with Grommet

24"	24"	18"	N.A.	BTC24241U	\$ 991	\$1091	\$1091	\$1153
-----	-----	-----	------	-----------	--------	--------	--------	--------

#### Rectangular Table

24"	48"	18"	N.A.	BTC24481	\$1504	\$1660	\$1660	\$1785
24"	72"	18"	N.A.	BTC24721	\$1541	\$1713	\$1713	\$1900

#### Rectangular Occasional Tables with Grommets

24"	48"	18"	N.A.	BTC24481U	\$1627	\$1783	\$1783	\$1908
24"	72"	18"	N.A.	BTC24721U	\$1664	\$1836	\$1836	\$2023

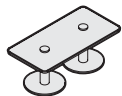
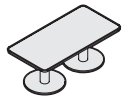

#### Edge Profiles

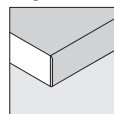

Plastic edge

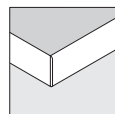

Wood edge



**For Canadian Pricing**  
 Multiply U.S. Price by the Canadian price factor.  
 ▶ See page 1 for details.

# Bix 27"H Work-Booth Tables

DESIGN METRO DESIGN GROUP

Standard Includes	Required to Specify
-------------------	---------------------

<p>► Need help? Product details, page 98</p> <ul style="list-style-type: none"> <li>• Top:                             <ul style="list-style-type: none"> <li>- Laminate top (Grade 1 laminates) with matching plastic edge</li> <li>- Laminate top (Grade 1 Steelcase) with contrasting plastic edge</li> <li>- Wood top with matching flat wood edge</li> </ul> </li> <li>• Base: textured paints only</li> <li>• Grommet, if selected: black plastic only</li> </ul>	<ul style="list-style-type: none"> <li>1 Style number</li> <li>2 Laminate or wood color number for top ► See <i>Hardwood and Veneer Matrix</i>, page 456</li> <li>3 Plastic edge color number for top with Grade 1 Steelcase or Grade 2 laminate, if selected</li> <li>4 Textured paint color number for base</li> <li>5 Options, if selected (see below) ► See <i>Surface Materials</i>, page 418.</li> </ul>
---	--

Options	U.S. Price	Required to Specify
---------	------------	---------------------

<p><b>Surface Materials</b></p> <ul style="list-style-type: none"> <li>• <b>Wood</b></li> <li>• Custom wood finish</li> </ul>		<p>► Page 420</p>
<p><b>Cable Management</b></p> <ul style="list-style-type: none"> <li>• PDV module: black plastic</li> </ul>	<p>+ \$320 each</p>	<p>Specify with PDV module.</p>
<p><b>Related Products</b></p> <ul style="list-style-type: none"> <li>• Lounge chair</li> <li>• Sectional seating</li> </ul>		<p>► Page 108 ► Page 110</p>

*Tip: One or two power, data, and voice modules are available on rectangular occasional tables.*

Specification Information									
---------------------------	--	--	--	--	--	--	--	--	--

Dimensions			Diameter	Style Number	U.S. Base Prices			
D	W	H			Lam 1	Lam 2	Wood 1	Wood 2

### Round Work-Booth Tables

N.A.	N.A.	27"	20"	BTW20003	\$ 930	\$ 976	\$1024	\$1069
N.A.	N.A.	27"	28"	BTW28003	\$ 967	\$1015	\$1069	\$1167

### Round Work-Booth Table with Grommet

N.A.	N.A.	27"	28"	BTW28003U	\$1028	\$1079	\$1130	\$1228
------	------	-----	-----	-----------	--------	--------	--------	--------

### Rectangular Work-Booth Tables

36"	48"	27"	N.A.	BTW36483	\$1767	\$1855	\$1964	\$2151
36"	72"	27"	N.A.	BTW36723	\$1956	\$2054	\$2153	\$2434

### Rectangular Work-Booth Tables with Grommets

36"	48"	27"	N.A.	BTW36483U	\$1890	\$1984	\$2087	\$2274
36"	72"	27"	N.A.	BTW36723U	\$2079	\$2183	\$2276	\$2557

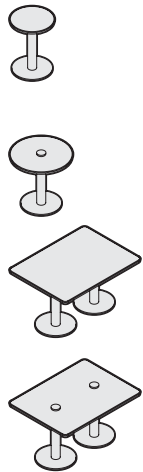

#### Edge Profiles

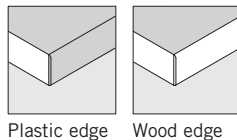

 **For Canadian Pricing**  
Multiply U.S. Price by the Canadian price factor.  
► See page 1 for details.

### Side Table–Vinyl Version



Standard Includes	Required to Specify
-------------------	---------------------

- |   |   |  |
|---|---|--|
| <ul style="list-style-type: none"> <li>▶ Need help? Product details, page 98</li> </ul> | <ul style="list-style-type: none"> <li>• Base: paint</li> <li>• Table surface and base cover: dark gray vinyl only</li> </ul> | <ul style="list-style-type: none"> <li>1 Style number</li> <li>2 Paint color number for base</li> <li>▶ See <i>Surface Materials</i>, page 418.</li> </ul> |
|---|---|--|

Related Products
------------------

- |  |  |
|--|--|
| <ul style="list-style-type: none"> <li>Lounge chairs</li> <li>Sectional seating</li> <li>Podium</li> </ul> | <ul style="list-style-type: none"> <li>▶ Page 108</li> <li>▶ Page 110</li> <li>▶ Page 117</li> </ul> |
|--|--|

Specification Information
---------------------------

Dimensions		Style	U.S.
Diameter	H	Number	Price

#### Side Table with Vinyl Surface

17"	23"	BTS1700	\$451
-----	-----	---------	-------

### Side Table–Leather Version



Standard Includes	Required to Specify
-------------------	---------------------

- |   |   |  |
|---|---|--|
| <ul style="list-style-type: none"> <li>▶ Need help? Product details, page 98</li> </ul> | <ul style="list-style-type: none"> <li>• Base: silver</li> <li>• Table surface and base cover: cream Bix leather</li> </ul> | <ul style="list-style-type: none"> <li>1 Style number</li> <li>2 Leather color number for table surface and base cover</li> <li>▶ See <i>Surface Materials</i>, page 418.</li> </ul> |
|---|---|--|

Related Products
------------------

- |  |  |
|--|--|
| <ul style="list-style-type: none"> <li>Lounge chairs</li> <li>Sectional seating</li> <li>Podium</li> </ul> | <ul style="list-style-type: none"> <li>▶ Page 108</li> <li>▶ Page 110</li> <li>▶ Page 117</li> </ul> |
|--|--|

Specification Information
---------------------------

Dimensions		Style	U.S.
Diameter	H	Number	Price

#### Side Table with Leather Surface

17"	23"	BTSL1700	\$680
-----	-----	----------	-------



**For Canadian Pricing**  
 Multiply U.S. Price by the  
 Canadian price factor.  
 ▶ See page 1 for details.