

Perimeter

ITG-36

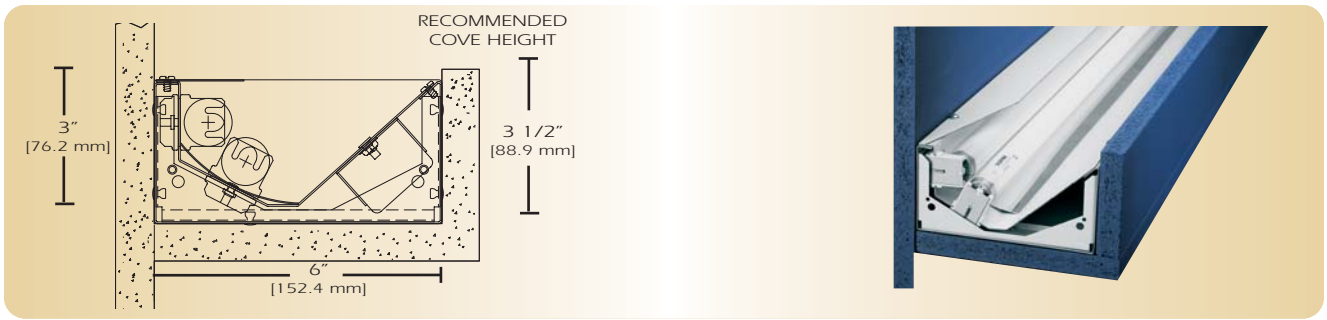

TYPE _____

FEATURES

The ITG was designed specifically for concealed cove and wall mounted applications. The three-part reflector system provides uniform brightness and eliminates socket shadows. The ITG provides easy installation and maximum efficiency for general illumination and accent lighting.

SPECIFICATIONS

- Housing:** The concealed cove is made of 20-gauge cold rolled steel riveted construction form a 3" x 6" rectangular profile. Finished end caps are 20-gauge cold rolled steel, with no exposed hardware or knockouts.
- Reflector:** The three part reflector assembly is engineered with a straight reflector lamp shield of 20-gauge cold rolled steel finished in high gloss white enamel. The rear-curved reflector is .025 specular anodized aluminum and front reflector is made of 20-gauge cold rolled steel finished in high gloss white enamel.
- Electrical:** Ballast is electronic, high power factor, thermally protected class P, sound rated A, with less than 20% total harmonic distortion. The minimum number of ballasts will be used unless otherwise specified.
- Mounting:** Concealed cove is provided with opening for power feed and key slots for mounting. See linear and installation section for more details.
- Finish:** Fixture housing and steel components are finished in baked white enamel applied over a five-stage pretreatment process.
- Lamps:** Fixtures are provided for use with one or two 32 watt T8 lamps, 28 watt T5 or 54 watt T5 HO lamps or compact fluorescent lamps. (Supplied by Others)
- Certification:** Luminaires are U. L. Listed, C. S. A. certified and are Union Made in the United States of America I.B.E.W.

ORDERING GUIDE

MODEL NO.	DIRECTION	LAMPS	MOUNTING	LENGTH	FINISH	VOLTAGE	OPTIONS
ITG-36	I						
ITG-36	I = Indirect	132 T8 232 T8 139 CF 140 CF 128 T5 228 T5 154T5 HO 254T5 HO O =Other Specify	CS = Concealed EX = Exposed See Accessories	2 = ft 3 = ft 4 = ft 6 = ft 8 = ft for other, please enter row length (eg. 48=48ft)	W = White CC = Custom Color	120v 277v	See Options Below

Example: **ITG36-I-232T8-CS-4-W-120V**
ITG36 indirect with two 32 watt T8 lamps concealed application four foot fixture finished in baked white enamel 120v electronic ballast less than 20% total harmonic distortion.

OPTIONS

- E10=** Electronic ballast, high power factor, thermally protected class P, sound rated A, < 10% total harmonic distortion
- DIM=** Dimming Ballast
- EPC=** Emergency Battery Pack
- EMC=** Emergency Circuit
- TCW=** Two Circuit Wiring
- TDW=** Tandem Wiring
- OTH=** See Accessories for other options available

LINEAR SECTIONS AND SUSPENSION LOCATION

CONCEALED COVE AND EXPOSED WALL MOUNTING

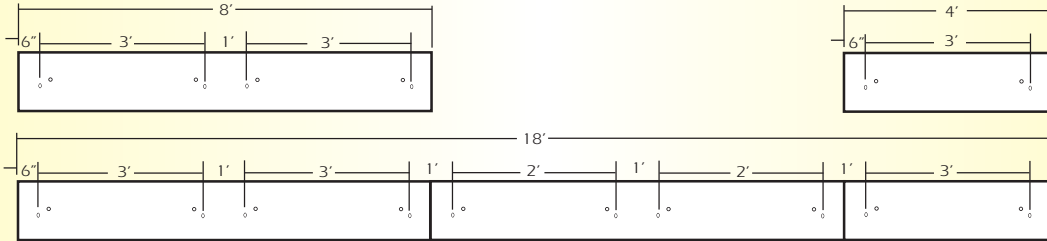

INSTALLATION PREPARATION

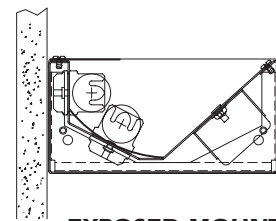
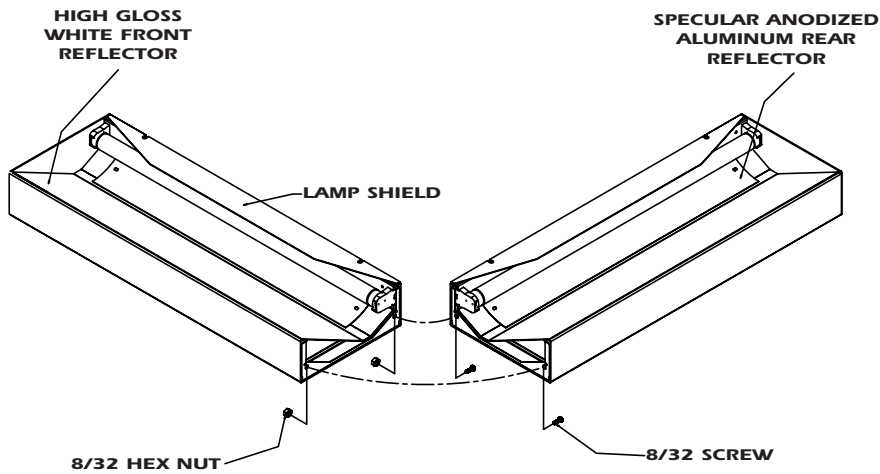

EXPOSED MOUNTING

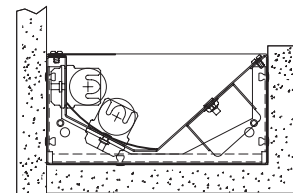

CONCEALED MOUNTING

PHOTOMETRY

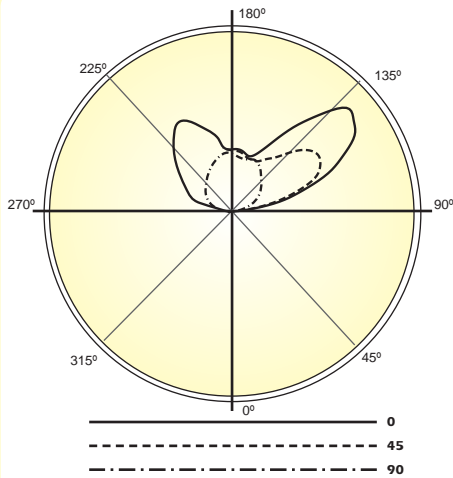

Candela Distribution:

Vert. Angle	0	45	90	135	180
90	9.10	27.2	30.2	25.1	13.6
95	53.7	130	139	128	55.8
100	95.4	270	307	276	94.2
105	131	403	445	406	128
110	149	522	598	520	148
115	162	573	709	593	162
120	177	592	811	596	183
125	208	568	852	562	209
130	227	502	861	499	236
135	237	414	730	417	250
140	264	367	587	357	259
145	279	328	439	314	297
150	300	319	352	319	295
155	311	315	327	329	314
160	341	326	336	326	329
165	320	333	343	331	323
170	333	331	338	296	347
175	355	333	333	328	351
180	342	342	342	342	342

Optical Distribution:
Indirect

Coefficients of Utilization - Zonal Cavity Method:

pfc = 0.20

	.8	.7	.5	.3	.1	0
pcc	.8	.7	.5	.3	.1	0
pw	.7 .5 .3 .1	.7 .5 .3 .1	.5 .3 .1	.5 .3 .1	.5 .3 .1	0
RCR						
0	56 56 56 56	48 48 48 48	32 32 32	18 18 18	6 6 6	0
1	51 48 46 44	43 41 40 38	28 27 26	16 15 15	5 5 5	0
2	46 42 39 36	39 36 33 31	25 23 22	14 13 12	4 4 4	0
3	42 37 33 30	36 32 28 26	22 20 18	12 11 10	4 3 3	0
4	38 32 28 25	32 28 24 22	19 17 15	11 10 9	3 3 3	0
5	35 29 24 21	30 25 21 18	17 14 13	9 8 7	3 2 2	0
6	32 25 21 18	27 22 18 16	15 13 11	8 7 6	2 2 2	0
7	29 23 18 15	25 19 16 13	13 11 9	8 6 5	2 2 1	0
8	27 20 16 13	23 17 14 12	12 10 8	7 6 5	2 1 1	0
9	25 18 14 12	21 16 12 10	11 9 7	6 5 4	2 1 1	0
10	23 17 13 10	20 14 11 9	10 8 6	5 4 3	1 1 1	0

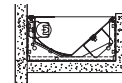

Total Luminaire Optical Efficiency = 59.4%