

JAZZ Series

JAZ-FE-DI

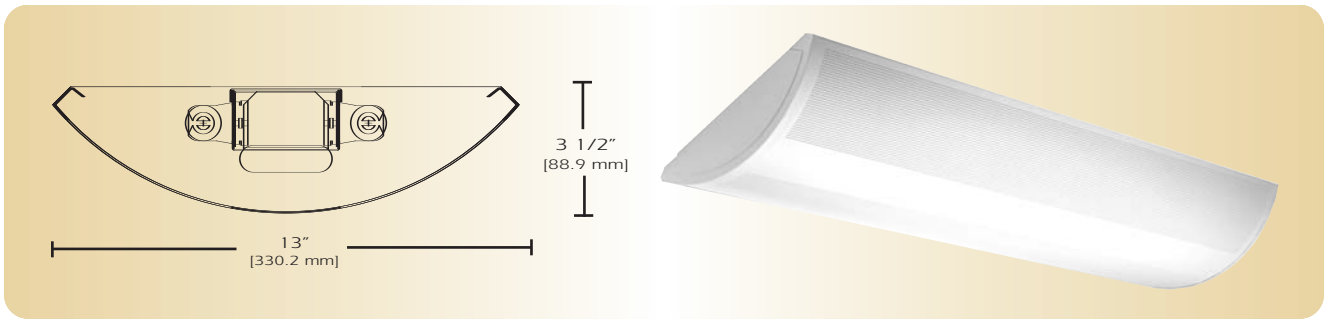

TYPE _____

FEATURES

The Jazz Flat End DI is one variation of a complete family of direct/indirect fluorescent luminaires. Constructed of perforated steel, it features uninterrupted, perfectly aligned continuous rows. The Jazz Flat End DI series can be furnished with a wide variety of perforated accent patterns in addition to the standard pattern. The standard pattern is two continuous perforated sections 5 1/2" wide on each side separated by a 3 1/4" solid band in the center of the fixture. The perforations are 1/16" holes on 3/32" straight centers. Perforated corporate logos can also be supplied as a feature for reception areas and conference rooms. The computer designed optical system creates a widespread indirect distribution, while the variety of direct components provides useful contrast.

SPECIFICATIONS

Housing: One piece die formed 20-gauge cold rolled steel welded construction forming a 13" x 3 1/2" rounded profile. Continuous perforated sections are 1/16" x 3/32" straight centers with white .020 translucent overlay. Perforated sides are 5 1/2" wide and end 1" from fixture end. Finished end caps are 18-gauge cold rolled steel with no exposed hardware or knockouts. Special logo designs and perforated patterns are available.

Reflector: Die formed 20 gauge cold rolled steel minimum 90% reflectivity finished in high gloss baked white enamel. Die formed specular reflector is also available.

Electrical: Ballast is electronic, high power factor, thermally protected class P, sound rated A, with less than 20% total harmonic distortion. The minimum number of ballasts will be used unless otherwise specified.

Mounting: Standard Installation is an adjustable self-locking aircraft cable assembly 48" x 3/32" in diameter with 5" canopy. One 16/4 SJT straight 54" cord is supplied with each power feed. Standard pendants are available in 24" lengths. See Accessories for additional mounting.

Finish: Fixture housing and steel components are finished in baked white enamel applied over a five-stage pretreatment process.

Lamps: Fixtures are provided for use with two 32 watt T8 lamps or 54 watt T5 HO lamps. (Supplied by Others)

Certification: Luminaires are U. L. Listed, C. S. A. certified and are Union Made in the United States of America I.B.E.W.

ORDERING GUIDE

MODEL NO.	DIRECTION	NO. OF LAMPS	LAMPS	MOUNTING	LENGTH	FINISH	VOLTAGE	OPTIONS
JAZ-FE	DI	2	17T8 25T8 32T8 14T5 21T5 28T5 24T5HO 39T5HO 54T5HO	AC= Cable PD= Pendant	2= ft 3= ft 4= ft 6= ft 8= ft	W= White CC= Custom Color	120v 277v	See Options Below
		O=Other Specify		See Accessories	for other, please enter row length (eg. 48=48ft)			

Example: **JAZ-FE-DI-232T8-AC-4'-W-120V**
 Jazz flat end direct/indirect luminaire with continuous perforated shielding for two 32 watt T8 lamps with two 48 inch air craft cable and power feed four foot fixture finished in baked white enamel 120V electronic ballast less than 20% total harmonic distortion.

OPTIONS

- E10=** Electronic ballast, high power factor, thermally protected class P, sound rated A, < 10% total harmonic distortion
- DIM=** Dimming Ballast
- EPC=** Emergency Battery Pack
- EMC=** Emergency Circuit
- TCW=** Two Circuit Wiring
- TDW=** Tandem Wiring
- QCW=** Quick Connect Wiring
- OTH=** See Accessories for other options available

126 Chestnut Street, Warwick RI 02888
 t. (401) 467-8232 / f. (401) 941-2960 / e. sales@dayolite.com
 www.dayolite.com



LINEAR SECTIONS AND SUSPENSION LOCATION

SUSPENSION MOUNTING

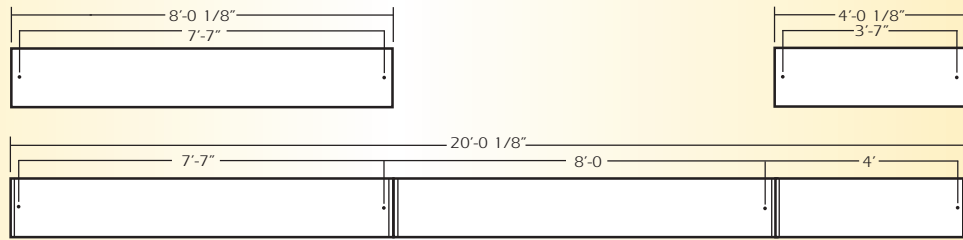

CORNERS

Corners and fixture extensions are custom fabricated to precise dimensions. Please indicated the specific requirements on the layout

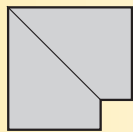

C2
90° Corner

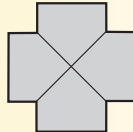

C4
4-Way Corner (Cross)

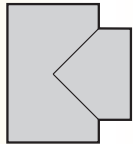

C3
3-Way Corner (Tee)

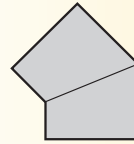

1° AC
Angular Corner

For any angular corner, ()° must be specified and dimensions must be included on the layout

For any pattern, a layout must accompany the order.

INSTALLATION PREPARATION

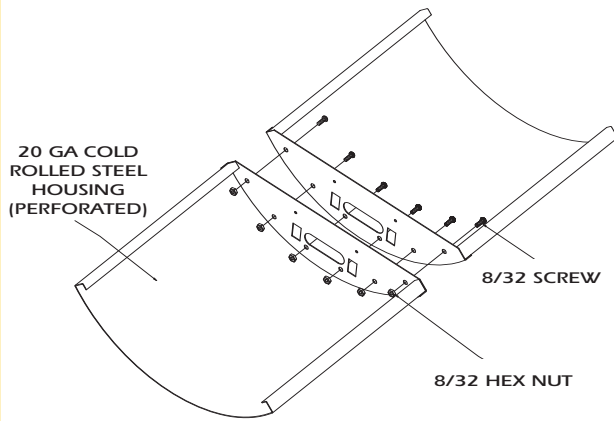

MOUNTING INSTALLATION

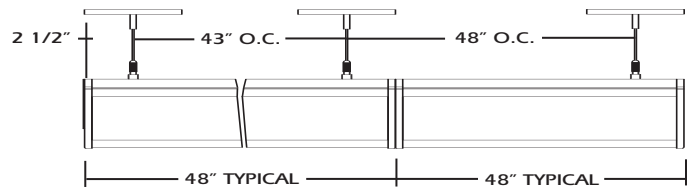

PHOTOMETRY

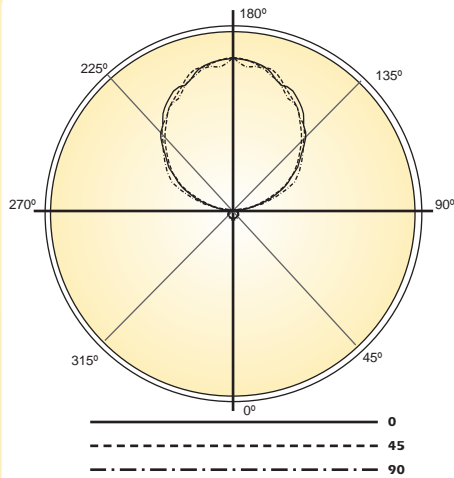

LAMP (2) 32W T8
LUMENS: 2900 PER LAMP

Candela Distribution:

Vert. Angle	0	22.5	45	67.5	90
0	72.6	72.6	72.6	72.6	72.6
10	66.5	72.3	82.8	86.3	75.3
20	74.6	74.4	78.7	77.7	77.5
30	66.3	69.3	70.0	74.8	69.6
40	65.3	62.6	63.2	64.1	63.3
50	51.0	50.9	54.4	60.6	56.6
60	45.8	49.8	44.7	45.1	47.2
70	41.5	36.7	37.6	38.0	33.2
80	27.4	24.1	26.2	32.8	31.8
90	9.24	23.0	29.6	35.2	31.4
100	156	188	171	162	153
110	405	396	418	471	462
120	634	617	638	659	704
130	843	830	812	839	844
140	1042	1045	987	983	1023
150	1211	1196	1157	1158	1150
160	1266	1309	1299	1281	1265
170	1391	1391	1372	1363	1372
180	1422	1422	1422	1422	1422

Optical Distribution:
Direct/Indirect

Coefficients of Utilization - Zonal Cavity Method:

pfc = 0.20

	.8	.7	.5	.3	.1	0
pcc	.8	.7	.5	.3	.1	0
pw	.7 .5 .3 .1	.7 .5 .3 .1	.5 .3 .1	.5 .3 .1	.5 .3 .1	0
RCR						
0	73 73 73 73	63 63 63 63	44 44 44	27 27 27	12 12 12	5
1	66 63 60 57	57 54 52 50	38 37 35	24 23 22	10 10 9	3
2	60 54 50 46	51 47 43 40	33 31 29	20 19 18	9 8 8	3
3	54 48 42 38	47 41 37 34	29 26 24	18 16 15	8 7 6	2
4	49 42 36 32	42 36 32 28	26 23 20	16 14 13	7 6 5	2
5	45 37 31 27	39 32 27 24	23 20 17	14 12 11	6 5 5	1
6	41 33 27 23	35 29 24 20	20 17 15	12 11 9	5 4 4	1
7	38 29 24 20	33 26 21 17	18 15 13	11 9 8	5 4 3	1
8	35 26 21 17	30 23 18 15	16 13 11	10 8 7	4 3 3	1
9	32 24 19 15	28 21 16 13	15 12 10	9 7 6	4 3 2	1
10	30 22 17 13	26 19 15 12	13 10 8	8 7 5	3 3 2	0

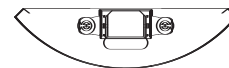

Total Luminaire Optical Efficiency = 75.4%