

Surface Operation

Lighting Burners
All burners are ignited by electric ignition. There are no open-flame, "standing" pilots.

Surface Burners-Automatic Re-ignition
To light the surface burners, push and turn the appropriate control knob counter clockwise to any position. This control is both a gas valve and an electric switch. Burners will ignite at any "ON" position with the automatic re-ignition system. If the flame goes out for any reason, the burners will automatically reignite if the gas is still flowing. When gas is permitted to flow to the burners, the electric igniters start sparking. On all surface igniters you should hear a "clicking" sound. If you do not, turn off the control and check that the unit is plugged in and that the fuse or circuit breaker is not blown or tripped.

Within a few moments, enough gas will have traveled to the burner to light. When the burner lights, turn the burner control to any position to adjust the flame size. Setting the proper flame height for the desired cooking process and selecting the correct cooking vessel will result in superior cooking performance, while also saving time and energy.

Surface Cooking Tips

- Use low or medium flame heights when cooking in vessels that are poor conductors of heat, such as glass, ceramic, and cast-iron. Reduce the flame height until it covers approximately 1/3 of the cooking vessel diameter. This will ensure more even heating within the cooking vessel and reduce the likelihood of burning or scorching the food.
- Reduce the flame if it is extending beyond the bottom of the cooking vessel. A flame that extends along the sides of the vessel is potentially dangerous, heats the utensil handle and kitchen instead of the food, and wastes energy.
- Reduce the flame height to the minimum level necessary to perform the desired cooking process. Remember that food cooks just as quickly at a gentle boil as it does at a rolling boil. Maintaining a higher boil than is necessary wastes energy, cooks away moisture, and causes a loss in food flavor and nutrient level.
- The minimum pot or pan (vessel) diameter recommended is 6" (15 cm) on the larger burners. Pots or pans as small as 4" (10 cm) should be used on the smaller burners.

Oven Functions

Conventional and Convection Cooking
Because of variations in food density, surface texture and consistency, some foods may be prepared more successfully using the conventional bake setting. For this reason, conventional baking is recommended when preparing baked goods such as custard. The user may find other foods that are also prepared more consistently in conventional bake. It is recommended to use this function for single-rack baking.

- **BAKE (Natural Airflow Bake)**
Use this setting for baking, roasting, and casseroles.
- **CONVECTION BAKE**
Use this setting to bake and roast foods at the same time with minimal taste transfer.
- **TRU CONV (Tru Convec™)**
Use this setting for broiling dark meats at 1" thickness or less where rare or medium doneness is desired.
- **CONV ROAST (Convection Roast)**
Use this setting for roasting whole turkeys, whole chickens, hams, etc.
- **CONVECTION BROIL (Infrared Convection Broil)**
Use this setting to broil thick cuts of meat.
- **HI BROIL**
Use this setting for broiling dark meats at 1" thickness or less where rare or medium doneness is desired.
- **MED BROIL**
Use this setting for broiling white meats such as chicken or meats greater than 1" thick that would be over-browned in high broil.
- **Low Broil**
Use this setting for delicate broiling such as meringue.
- **Self Clean**
Use this function to clean oven.
- **Convection Dehydrate**
Use this function to dehydrate fruits and vegetables.
- **Convection Defrost**
Use this function to defrost foods.

Range Controls

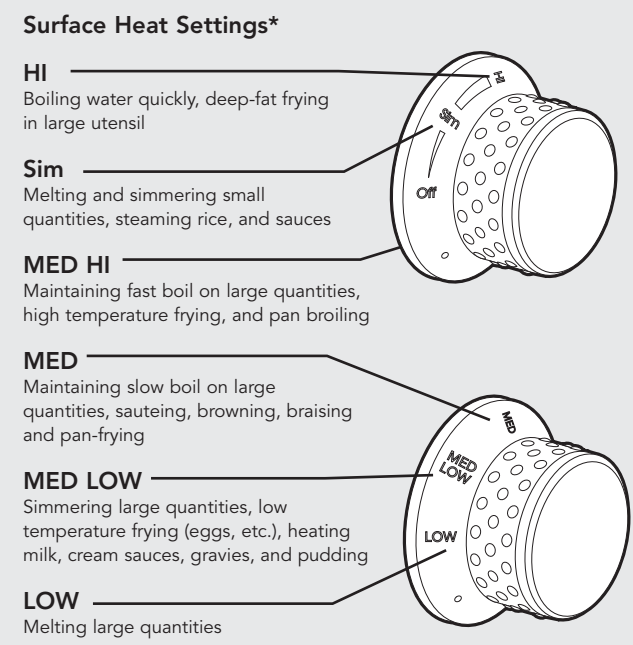
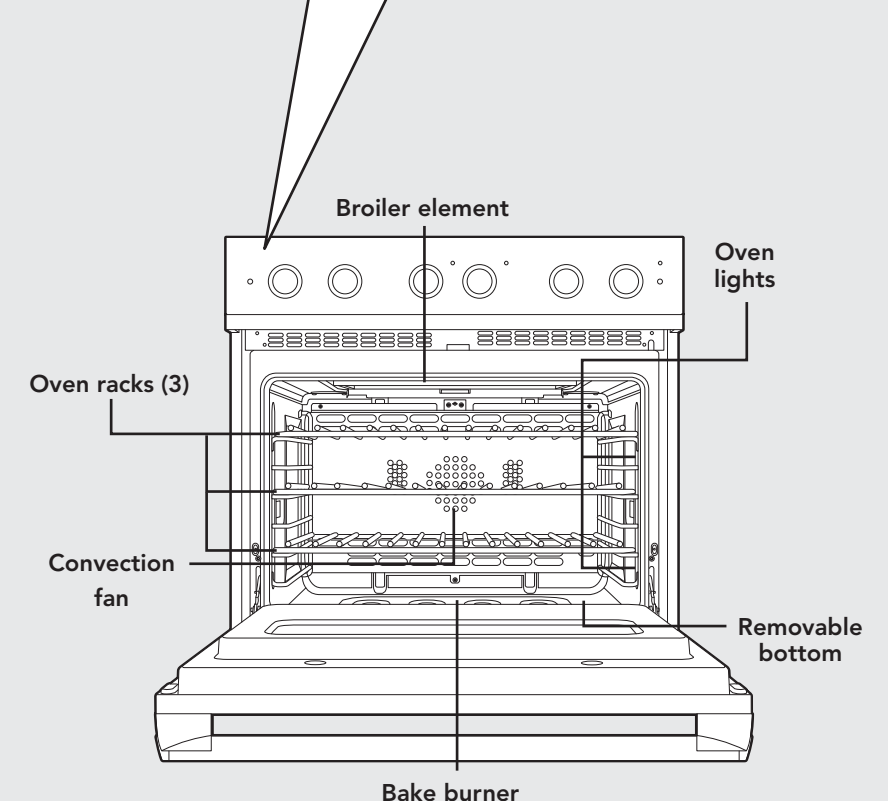
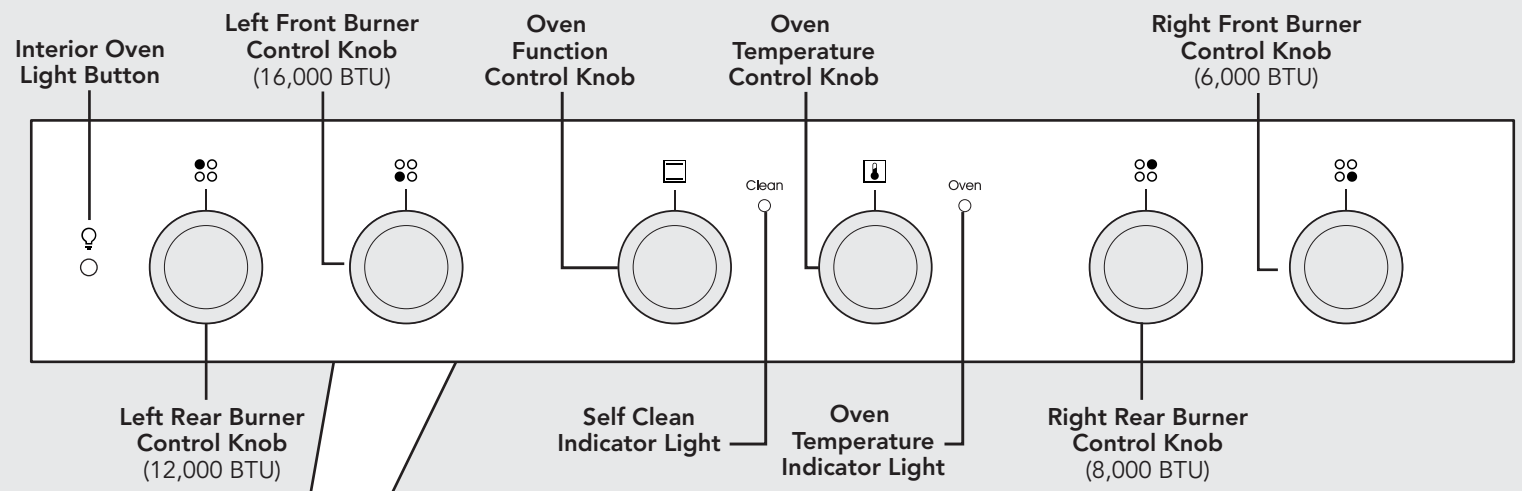

**Note: The above information is given as a guide only. You may need to vary the heat settings to suit your personal requirements.*

Oven Settings

BAKE (Natural Airflow Bake)
Full power heat is radiated from the U-shaped bake burners in the bottom of the oven cavity and is circulated with natural airflow. This function is recommended for single rack baking. Many cookbooks contain recipes to be cooked in the conventional manner. Conventional baking is suitable for dishes that require a high temperature. Use this setting for baking and casseroles.

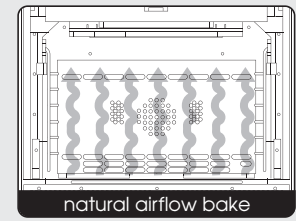

CONVECTION BAKE
Heat is radiated from the U-shaped bake burners in the bottom of the oven cavity. The heated air is circulated by one motorized fan in the rear of the oven providing a more even heat distribution. Multiple rack use is possible for the largest baking job. When roasting, cool air is quickly replaced—searing meats on the outside and retaining more juices and natural flavor on the inside with less shrinkage. This even circulation of air equalizes the temperature throughout the oven cavity and eliminates the hot and cold spots found in conventional ovens.

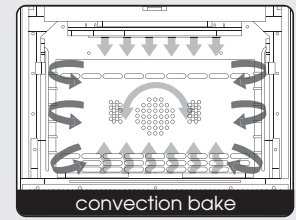

TRU CONV (TruConvec™)
The rear element only operates at full power. There is no direct heat from the bottom or top elements. The motorized fan in the rear of the oven circulates air in the oven cavity for even heating. Use this setting for foods that require gentle cooking such as pastries, souffles, yeast breads, quick breads and cakes. Breads, cookies, and other baked goods come out evenly textured with golden crusts. No special bakeware is required. Use this function for single rack baking, multiple rack baking, roasting, and preparation of complete meals. This setting is also recommended when baking large quantities of baked goods at one time.

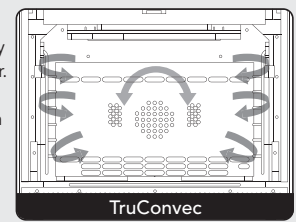

CONV ROAST (Convection Roast)
The convection element runs in conjunction with the inner and outer broil elements. The reversible convection fan runs at a higher speed in each direction. This transfer of heat (mainly from the convection element) seals moisture inside of large roasts. A time savings is gained over existing, single fan convection roast modes. Use this setting for whole turkeys, whole chickens, hams, etc.

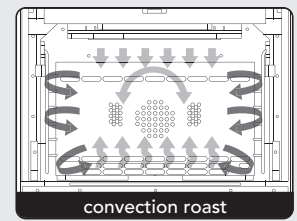

CONV BROIL (Infrared Convection Broil)
The top element operates at full power. This function is exactly the same as regular broiling with the additional benefit of air circulation by the motorized fan in the rear of the oven. Smoke is reduced since the airflow also reduces peak temperatures on the food. Use this setting for broiling thick cuts of meats.

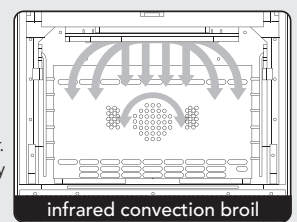

HI BROIL
Heat radiates from both broil elements, located in the top of the oven cavity, at full power. The distance between the foods and the broil elements determines broiling speed. For fast broiling, food may be as close as 2 inches (5 cm) to the broil element or on the top rack. Fast broiling is best for meats where rare to medium doneness is desired. Use this setting for broiling small and average cuts of meat.

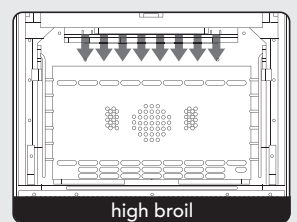

MED BROIL
Inner and outer broil elements pulse on and off to produce less heat for slow broiling. Allow about 4 inches (10 cm) between the top

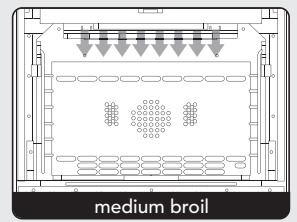

MED BROIL (cont.)
surface of the food and the broil element. Slow broiling is best for chicken and ham in order to broil food without over-browning it. Use this setting for broiling small and average cuts of meat.

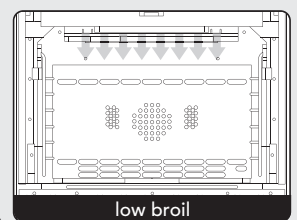

LOW BROIL
This mode uses only a fraction of the available power to the inner broil element for delicate top-broiling. The inner broil element is on for only part of the time. Use this setting to gently brown meringue on racks 3 or 4 in 3-4 minutes.

Convection Dehydration
This oven is designed not only to cook, but also to dehydrate fruits and vegetables.
1. Prepare the food as recommended.
2. Arrange the food on drying racks (not included with the oven; contact a local store handling speciality cooking utensils).
3. Set the appropriate low temperature and turn the selector to "TRU CONV".

Convection Defrost
1. Place the frozen food on a baking sheet.
2. Set the temperature control to "OFF".
3. Turn the selector to "TRU CONV".

Self-Clean Cycle
This range features a self-cleaning cycle. During this cycle, the oven reaches elevated temperatures in order to burn off soil and deposits. A powder ash residue is left in the bottom of the oven after completion of the self-clean cycle. See *Use and Care Manual* for self-clean cycle instructions.

Warnings

Warning and Important Safety Instructions appearing in this manual are not meant to cover all possible conditions and situations that may occur. Common sense, caution, and care must be exercised when installing, maintaining, or operating the appliance.

ALWAYS contact the manufacturer about problems or conditions you do not understand.

DANGER

Hazards or unsafe practices which WILL result in severe personal injury or death

WARNING

Hazards or unsafe practices which COULD result in death severe personal injury or death

CAUTION

Hazards or unsafe practices which COULD result in minor personal injury. All safety messages will identify the hazard, tell you how to reduce the chance of injury, and tell you what can happen if the instructions are not followed.

Recognize Safety Symbols, Words, Labels
Read and follow all instructions before using this appliance to prevent the potential risk of fire, electric shock, personal injury or damage to the appliance as a result of improper usage of the appliance. Use appliance only for its intended purpose as described in this manual.

To ensure proper and safe operation: Appliance must be properly installed and grounded by a qualified technician. **DO NOT** attempt to adjust, repair, service, or replace any part of your appliance unless it is specifically recommended in this manual. All other servicing should be referred to a qualified servicer. Have the installer show you the location of the gas shutoff valve and how to shut it off in an emergency.

CAUTION

To prevent possible damage to cabinets and cabinet finishes, use only materials and finishes that will not discolor or delaminate and will withstand temperatures up to 194° F (90° C). Heat and moisture resistant adhesive must be used if the product is to be installed in laminated cabinetry. Check with your builder or cabinet supplier to make sure that the materials meet these requirements.

Important Safety Notice and Warning

The California Safe Drinking Water and Toxic Enforcement Act of 1986 (Proposition 65) requires the Governor of California to publish a list of substances known to the State of California to cause cancer or reproductive harm, and requires businesses to warn customers of potential exposures to such substances. Users of this appliance are hereby warned that when the oven is engaged in the self-clean cycle, there may be some low-level exposure to some of the listed substances, including carbon monoxide. Exposure to these substances can be minimized by properly venting the oven to the outdoors by opening the windows and/or door in the room where the appliance is located during the self-clean cycle.

Important notice regarding pet birds:

NEVER keep pet birds in the kitchen or in rooms where the fumes from the kitchen could reach. Birds have a very sensitive respiratory system. Fumes released during an oven self-cleaning cycle may be harmful or fatal to birds. Fumes released due to overheated cooking oil, fat, margarine and overheated non-stick cookware may be equally harmful.

About Your Appliance

WARNING

NEVER use appliance as a space heater to heat or warm a room to prevent potential hazard to the user and damage to the appliance. Also, **DO NOT** use the rangetop or oven as a storage area for food or cooking utensils.

- For proper oven performance and operation, **DO NOT** block or obstruct the oven vent duct located on the right side of the air grille.
- Avoid touching oven vent area while oven is on and for several minutes after oven is turned off. When the oven is in use, the vent and surrounding area become hot enough to cause burns. After oven is turned off, **DO NOT** touch the oven vent or surrounding areas until they have had sufficient time to cool.
- Other potentially hot surfaces include rangetop, areas facing the rangetop, oven vent, surfaces near the vent opening, oven door, areas around the oven door and oven window.
- The misuse of oven doors (e.g. stepping, sitting, or leaning on them) can result in potential hazards and/or injuries.

Warnings (cont.)

WARNING

This range features a self-cleaning cycle. During this cycle, the oven reaches elevated temperatures in order to burn off soil and deposits. A powder ash residue is left in the bottom of the oven after completion of the self-clean cycle.

Note: DO NOT use commercial oven cleaners inside the oven. Use of these cleaners can produce hazardous fumes or can damage the porcelain finishes. DO NOT line the oven with aluminum foil or other materials. These items can melt or burn during a self-clean cycle, causing permanent damage to the oven.

WARNING

To avoid risk of property damage, personal injury or death; follow information in this manual exactly to prevent a fire or explosion. **DO NOT** store or use gasoline or other flammable vapors and liquids in the vicinity of this or any appliance.

CAUTION

DO NOT touch the exterior portions of the oven after self-cleaning cycle has begun, since some parts become extremely hot to the touch!

During the first few times the self-cleaning feature is used, there may be some odor and smoking from the "curing" of the binder in the high-density insulation used in the oven. When the insulation is thoroughly cured, this odor will disappear. During subsequent self-cleaning cycles, you may sense an odor characteristic of high temperatures.

KEEP THE KITCHEN WELL-VENTED DURING THE SELF-CLEAN CYCLE.

WARNING

If the information in this manual is not followed exactly, a fire or explosion may result causing property damage, personal injury or death.

WHAT TO DO IF YOU SMELL GAS:
 • **DO NOT** try to light any appliance.
 • **DO NOT** touch any electrical switch.
 • **DO NOT** use any phone in your building.
 • Immediately call your gas supplier from a neighbor's phone. Follow the gas supplier's instructions.
 • If you cannot reach your gas supplier, call the fire department.

Installation and service must be performed by a qualified installer, service agency or the gas supplier.

WARNING

ELECTRICAL SHOCK HAZARD
DO NOT touch a hot oven light bulb with a damp cloth as the bulb could break. Should the bulb break, disconnect power to the appliance before removing bulb to avoid electrical shock.

WARNING

DO NOT use commercial oven cleaners inside the oven. Use of these cleaners can produce hazardous fumes or can damage the porcelain finishes.

WARNING

TIPPING HAZARD
 To reduce the risk of the appliance tipping, it must be secured by a properly installed anti-tip bracket(s). To make sure the bracket has been installed properly, look behind the range with a flashlight to verify proper installation engaged in the rear top left corner of the range.
 • THIS RANGE CAN TIP
 • INJURIES TO PERSONS CAN RESULT
 • INSTALL ANTI-TIP DEVICE PACKED WITH RANGE
 • SEE INSTALLATION INSTRUCTIONS

Warnings (cont.)

WARNING

ELECTRICAL SHOCK HAZARD
 Disconnect the electric power at the main fuse or circuit breaker before replacing bulb.

WARNING

BURN OR ELECTRICAL SHOCK HAZARD
 Make sure all controls are OFF and oven is COOL before cleaning. Failure to do so can result in burns or electrical shock.

WARNING

BURN HAZARD
 The oven door, especially the glass, can get hot. **Danger of burning: DO NOT touch the glass!**

CAUTION

To avoid sickness and food waste, **DO NOT** allow defrosted food to remain in the oven for more than two hours.

CAUTION

You must carefully check the food during the dehydration process to ensure that it does not catch fire.

CAUTION

BURN HAZARD
 When self-cleaning, surfaces may get hotter than usual. Therefore, children should be kept away.

CAUTION

DO NOT store items of interest to children over the unit. Children climbing to reach items could be seriously injured.

NOTICE

DO NOT turn the Temperature Control on during defrosting. Turning the convection fan on will accelerate the natural defrosting of the food without the heat.

NOTICE

Avoid any damage to oven vents. The vents need to be unobstructed and open to provide proper airflow for optimal oven performance.

NOTICE

The Cooling Fan should be operating when the unit is in operation. If you notice the cooling fan is not operating or you observe unusual or excessive noise coming from the cooling fan, contact a Viking Authorized Service Center before continuing operation. Failure to do so can result in damage to the oven or surrounding cabinets.

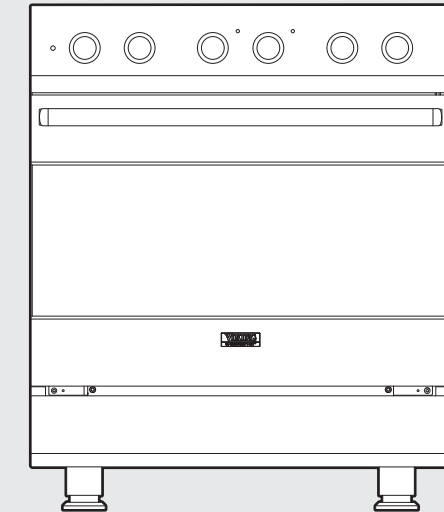

Designer Freestanding 30" Dual Fuel Self-Clean Sealed Burner Range