

wall mount
verve™ I

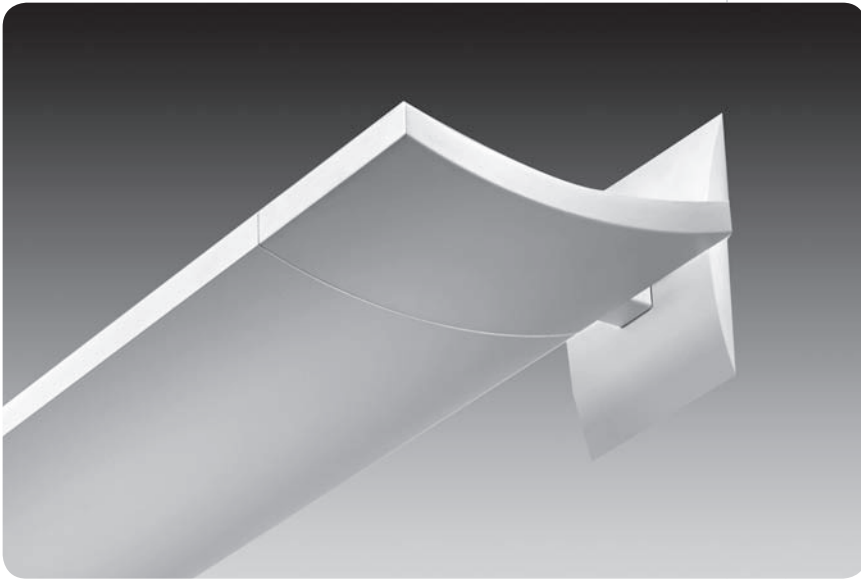

features

Wall mounted indirect fluorescent with softly contoured housing and end caps.

Elegant wall-mount version of Focal Point's suspended Verve™ I.

Slim profile only 1.32" high.

One piece extruded aluminum housing with 5" die-cast end caps.

Luminaire effectively distributes light onto walls and into a space.

Verve™ is an excellent choice for any open office application.

companion luminaire

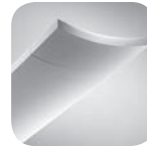

linear

dimensional data

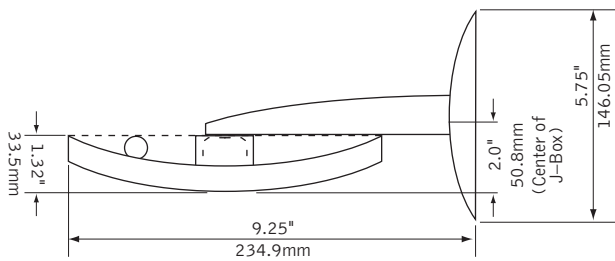

lamping options

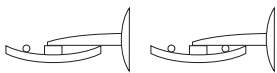

T5/T5HO LAMPS

fixture information

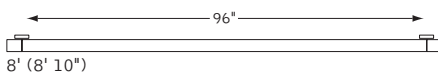
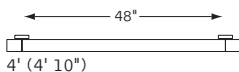

performance

1-Lamp T5HO
94% Efficiency
2181 cd @ 135°

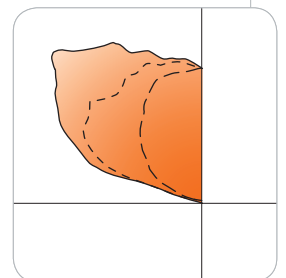

Visit focalpointlights.com for complete photometric data.

fixture:

project:

mounting information

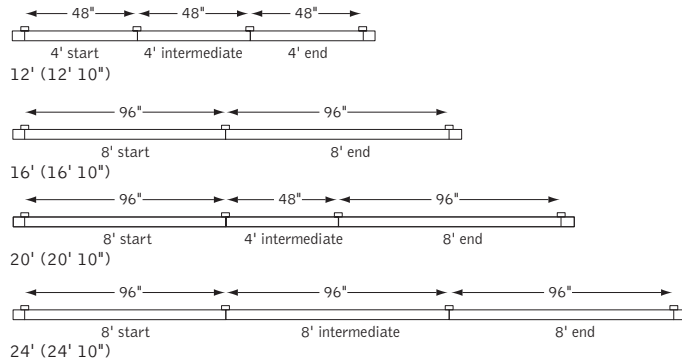

Consult factory for additional row length information.

specifications

construction

One-piece, .090" thick channel housing of 6063-T6 extruded aluminum.
 Die-cast 5" end cap fastened to housing.
 For row installation, internal coupler mechanically fastens to adjoining luminaires, forming hairline joint.
 Standard lengths are available in 4' and 8'.
 All luminaires are provided with mounting brackets.

- 4' unit weight: 11 lbs.
- 8' unit weight: 20 lbs.

optic

Reflector fabricated of low iridescent, semi specular premium grade aluminum.

electrical

Luminaires are pre-wired with factory installed branch circuit wiring and over-molded quick connects.
 Electronic ballasts are thermally protected and have a Class "P" rating.
 Optional dimming ballasts available.
 UL and cUL listed.

finish

Polyester powder coat applied over a 5-stage pretreatment.
 Mounting arm and brackets finished to match housing.

ordering

fixture series	FV1W
Verve I	FV1W
shielding	SD
Solid Housing	SD
lamping	
1 Lamp T5	1T5
1 Lamp T5HO	1T5HO
2 Lamp T5	2T5
2 Lamp T5HO	2T5HO
circuit	
Single Circuit	1C
Dual Circuit	2C
(Multiple lamp luminaires only)	
voltage	
120 Volt	120
277 Volt	277
347 Volt	347
ballast	
Electronic Program Start <10% THD	S
Electronic Dimming Ballast*	D
mounting	WM
Wall Mount	WM
factory options	
Emergency Circuit*	EC
Emergency Battery Pack*	EM
HLR/GLR Fuse	FU
Include 3000K Lamp	L830
Include 3500K Lamp	L835
Include 4100K Lamp	L841
finish	
Matte Satin White	WH
Titanium Silver	TS
(louver painted to match housing)	
luminaire length	
4'	4'
8'	8'
12' (8'+4')	12'
16' (8'+8')	16'
20' (8'+4'+8')	20'
24' (8'+8'+8')	24'

* for more information see Reference section.

wall mount
verve™ I

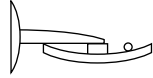

Filename: FV1WSD1T5H.IES
 Catalog #: FV1W-SD-1T5H0-1C-120-S-WM-WH-4'
 Efficiency: 94.0%
 Test #: 10501.0

CANDLEPOWER DISTRIBUTION

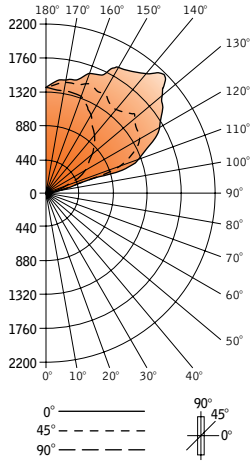

Vertical Angle	Horizontal Angle				Zonal Lumens
	0°	22.5°	45°	67.5°	
0°	0	0	0	0	0
5°	0	0	0	0	0
15°	0	0	0	0	0
25°	0	0	0	0	0
35°	0	0	0	0	0
45°	0	0	0	0	0
55°	0	0	0	0	0
65°	0	0	0	0	0
75°	0	0	0	0	0
85°	0	0	0	0	0
90°	0	0	0	0	0
95°	119	116	116	120	39
105°	636	632	606	534	197
115°	1263	1261	1153	832	420
125°	1773	1727	1544	962	649
135°	2181	2039	1664	1119	884
145°	1946	1800	1469	1189	1028
155°	1716	1623	1469	1309	1192
165°	1544	1512	1440	1353	1286
175°	1396	1383	1361	1328	1316
180°	1319	1319	1319	1319	1319

LUMEN SUMMARY

Zone	Lumens	% Lamp	% Fixt
90°-120°	1174	23.5	25.0
90°-130°	2023	40.5	43.0
90°-150°	3651	73.0	77.7
90°-180°	4700	94.0	100.0
Total Luminaire	4700	94.0	100.0