

Progeny

Progeny seating line is designed to meet high-traffic needs in a reception area, waiting room, and lounge.

Back is upholstered.

Arms are made of urethane-covered steel. Maple wood arm caps are optional on wood chair models.

Seat is upholstered. A zipper allows the cover to be field replaceable. Seat can snap in and out for easy replacement.

Legs and frame are constructed with either steel tubing that has a powder-coat paint finish that is corrosion resistant or hardwood maple veneers.

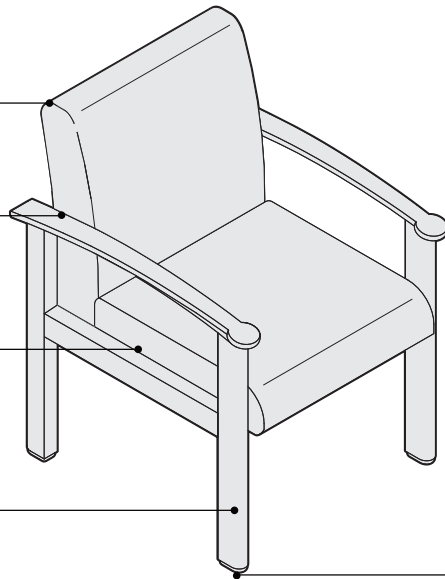

Nylon glides are standard on all four legs.

Product Details

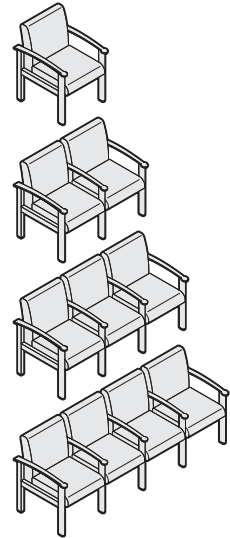

Tandem chair is available as a single unit or in two-, three-, or four-seat units. Each model is available in a narrow or wide seat width.

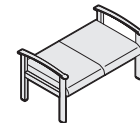

Two-seater bench provides additional seat width. It does not have a back.

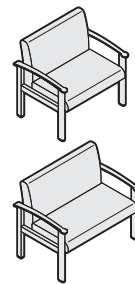

Bariatric chair offers extra seat width for additional comfort and is reinforced to support additional weight.

Actual Dimensions

▶ See page 248

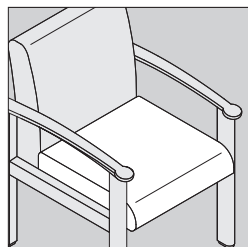

Seats are equipped with UltraFlex webbing, which is a suspension system that distributes weight evenly over the entire seating surface to provide more comfort for the user.

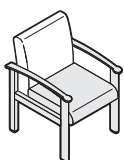

Different fabrics can be specified on the seat and back. Fabric on the back will match the fabric on the arm panel.

Moisture barrier on the seat is available as an option.

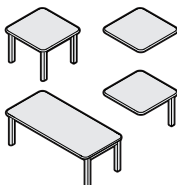

Tables are available in freestanding and ganging models.

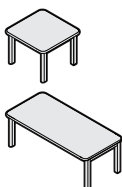

Freestanding tables are available in square and rectangular shapes. Both shapes are available with metal or wood legs to coordinate with the chairs.

Connections



Ganging tables are available in end-of-run, corner, or center models that are connected between chairs. End-of-run tables are available with metal or wood legs. Attaching hardware is included.

Wiring & Cabling

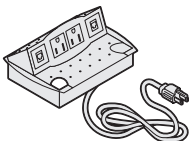

Interport power/data module can be installed on table tops. The module top flips up to access two electrical outlets and two data ports. Module is located in the center on square tables and off-center on rectangular tables.

Surface Materials

All Nurture seating with standard upholstery fabrics comply with the State of California Technical Bulletin 117.

Frame and legs

- Powdercoat paint (standard on metal models)
- Maple wood (standard on wood models)

Open arms

- Urethane (standard on metal and wood models)
- Maple wood arm cap (option on wood models)

Seat and back

- Fabric
 - Fabric with moisture barrier (option on seat only)
- Tip: Certain fabrics and vinyl will appear loose with comfort wrinkles when upholstered. Moisture barrier option may cause additional puddling on seat depending on the specified fabric.*

Glides

- Nylon

Table legs

- Powdercoat paint (standard on metal models)
- Maple wood (standard on wood models)

Table tops

- Laminate with specifiable T-mold edge band

Interport power/data module

- Matte Black

Progeny, continued

Actual Dimensions							
Chair Features	Overall Depth	Width	Height	Seat Depth	Width	Height	Arm Height
Narrow tandem chair	25¼"	24"	34¼"	18½"	19¼"	17½"	24"
Narrow two-seat tandem	25¼"	44¾"	34¼"	18½"	19¼"	17½"	24"
Narrow three-seat tandem	25¼"	65½"	34¼"	18½"	19¼"	17½"	24"
Narrow four-seat tandem	25¼"	86"	34¼"	18½"	19¼"	17½"	24"
Tandem bench	25¾"	46"	24"	25¾"	41¾"	17½"	24"
Wide tandem chair	25¼"	26"	34¼"	18½"	21¼"	17½"	24"
Wide two-seat tandem	25¼"	48¾"	34¼"	18½"	21¼"	17½"	24"
Wide three-seat tandem	25¼"	71½"	34¼"	18½"	21¼"	17½"	24"
Wide four-seat tandem	25¼"	94¼"	34¼"	18½"	21¼"	17½"	24"
Bariatric tandem chair	25¼"	34¾" or 44¾"	34¼"	18½"	30" or 40"	17½"	24"

Actual Dimensions			
Table Features	Overall Depth	Width	Height
Freestanding square table	22"	22¾"	15¾"
Freestanding rectangular table	22"	46½"	15¾"
Ganging corner table	28"	28"	15¾"
Ganging end-of-run table	22"	22¾"	15¾"
Ganging narrow table	20"	22¾"	15¾"
Ganging wide table	22"	22¾"	15¾"

Progeny

Tandem Chairs

Metal

Standard Includes		Required to Specify
<ul style="list-style-type: none"> ▶ Need help? Product details, page 246 	<ul style="list-style-type: none"> • Frame and legs: paint • Open arms: urethane to match frame • Seat and back: fabric • Nylon glides to match frame 	<ol style="list-style-type: none"> 1 Style number 2 Paint color for frame and legs 3 Fabric color number for seat and back 4 Options, if selected (see below) <ul style="list-style-type: none"> ▶ See <i>Surface Materials</i>, page 691.

Tip: Different fabrics for the seat and back can be specified. If the fabrics are in different price groups, calculate list price by adding the two price groups together and dividing by two.

Options	U.S. Price	Required to Specify
Surface Materials <ul style="list-style-type: none"> • Moisture barrier • Fire code seating • Single-seat tandem chairs • Two-seat tandem chairs • Three-seat tandem chairs • Four-seat tandem chairs 	<ul style="list-style-type: none"> • Moisture barrier +\$104 per seat • Fire code seating • Single-seat tandem chairs +\$188 • Two-seat tandem chairs +\$376 • Three-seat tandem chairs +\$470 • Four-seat tandem chairs +\$658 	<ul style="list-style-type: none"> Specify with <i>moisture barrier</i>. Add suffix F to the style number. Add suffix F to the style number. Add suffix F to the style number. Add suffix F to the style number.

Specification Information											
U.S. Base Prices											
Style Number	Fabric Price Group 1	Fabric Price Group 2	Fabric Price Group 3	Fabric Price Group 4	Fabric Price Group 5	Fabric Price Group 6	Fabric Price Group 7	Fabric Price Group 8	Fabric Price Group 9	Fabric Price Group 10	COM

Tandem Chairs

Narrow

HN7161M	\$1166	\$1206	\$1246	\$1276	\$1308	\$1330	\$1362	\$1410	\$1472	\$1510	\$1218
----------------	--------	--------	--------	--------	--------	--------	--------	--------	--------	--------	--------

Wide

HN7171M	\$1135	\$1175	\$1215	\$1245	\$1277	\$1299	\$1331	\$1379	\$1441	\$1479	\$1187
----------------	--------	--------	--------	--------	--------	--------	--------	--------	--------	--------	--------

Two-Seat Tandem Chairs

Narrow

HN7162M	\$1927	\$2007	\$2083	\$2145	\$2207	\$2255	\$2319	\$2411	\$2537	\$2613	\$1979
----------------	--------	--------	--------	--------	--------	--------	--------	--------	--------	--------	--------

Wide

HN7172M	\$1894	\$1974	\$2050	\$2112	\$2174	\$2222	\$2286	\$2378	\$2504	\$2580	\$1946
----------------	--------	--------	--------	--------	--------	--------	--------	--------	--------	--------	--------

▶ Specification Information, continued on next page

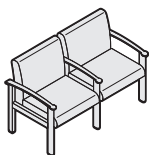
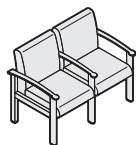
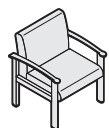

For Canadian Pricing

Multiply U.S. Price by the Canadian price factor.

▶ See page 1 for details.

► Specification Information, continued from previous page

Specification Information

U.S. Base Prices

Style Number	Fabric Price Group 1	Fabric Price Group 2	Fabric Price Group 3	Fabric Price Group 4	Fabric Price Group 5	Fabric Price Group 6	Fabric Price Group 7	Fabric Price Group 8	Fabric Price Group 9	Fabric Price Group 10	COM
--------------	----------------------	----------------------	----------------------	----------------------	----------------------	----------------------	----------------------	----------------------	----------------------	-----------------------	-----

Three-Seat Tandem Chairs

Narrow

HN7163M	\$2738	\$2856	\$2974	\$3066	\$3160	\$3230	\$3324	\$3464	\$3652	\$3768	\$2790
----------------	--------	--------	--------	--------	--------	--------	--------	--------	--------	--------	--------

Wide

HN7173M	\$2713	\$2831	\$2949	\$3041	\$3135	\$3205	\$3299	\$3439	\$3627	\$3743	\$2765
----------------	--------	--------	--------	--------	--------	--------	--------	--------	--------	--------	--------

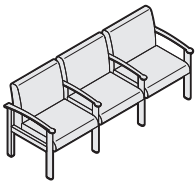
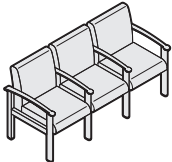

Four-Seat Tandem Chairs

Narrow

HN7164M ❌11/11	\$3556	\$3712	\$3868	\$3992	\$4118	\$4212	\$4336	\$4524	\$4772	\$4928	\$3608
--	--------	--------	--------	--------	--------	--------	--------	--------	--------	--------	--------

Wide

HN7174M ❌11/11	\$3525	\$3681	\$3837	\$3961	\$4087	\$4181	\$4305	\$4493	\$4741	\$4897	\$3577
--	--------	--------	--------	--------	--------	--------	--------	--------	--------	--------	--------

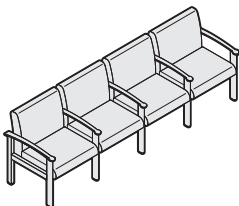
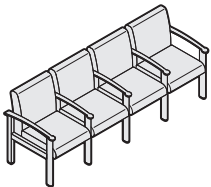

Families of Seating



For Canadian Pricing

Multiply U.S. Price by the Canadian price factor.

► See page 1 for details.

❌11/11 = Last order entry
November 20, 2011

Tandem Chairs

Wood

Standard Includes		Required to Specify
<ul style="list-style-type: none"> ▶ Need help? Product details, page 246 	<ul style="list-style-type: none"> • Frame and legs: maple wood • Open arms: urethane • Seat and back: fabric • Nylon glides: black 	<ol style="list-style-type: none"> 1 Style number 2 Wood color number for frame and legs 3 Urethane color for arms: black, graphite, or wheat 4 Fabric color number for seat and back 5 Options, if selected (see below) <ul style="list-style-type: none"> ▶ See <i>Surface Materials</i>, page 691

Tip: Different fabrics for the seat and back can be specified. If the fabrics are in different price groups, calculate list price by adding the two price groups together and dividing by two.

Options	U.S. Price	Required to Specify
Surface Materials Moisture barrier <ul style="list-style-type: none"> • Moisture barrier Fire code seating <ul style="list-style-type: none"> • Single-seat tandem chairs • Two-Seat tandem chairs • Three-seat tandem chairs • Four-seat tandem chairs 	+\$104 per seat +\$188 +\$376 +\$470 +\$658	Specify with <i>moisture barrier</i> . Add suffix F to the style number. Add suffix F to the style number. Add suffix F to the style number.
Arm caps <ul style="list-style-type: none"> • Wood arm caps 	+\$ 94 per cap	Specify with <i>wood arm caps</i> .

Specification Information											
U.S. Base Prices											
Style Number	Fabric Price Group 1	Fabric Price Group 2	Fabric Price Group 3	Fabric Price Group 4	Fabric Price Group 5	Fabric Price Group 6	Fabric Price Group 7	Fabric Price Group 8	Fabric Price Group 9	Fabric Price Group 10	COM

Tandem Chairs

Narrow

HN7161W	\$1195	\$1235	\$1275	\$1305	\$1337	\$1359	\$1391	\$1439	\$1501	\$1539	\$1247
----------------	--------	--------	--------	--------	--------	--------	--------	--------	--------	--------	--------

Wide

HN7171W	\$1197	\$1237	\$1277	\$1307	\$1339	\$1361	\$1393	\$1441	\$1503	\$1541	\$1249
----------------	--------	--------	--------	--------	--------	--------	--------	--------	--------	--------	--------

Two-Seat Tandem Chairs

Narrow

HN7162W	\$2020	\$2100	\$2176	\$2238	\$2300	\$2348	\$2412	\$2504	\$2630	\$2706	\$2072
----------------	--------	--------	--------	--------	--------	--------	--------	--------	--------	--------	--------

Wide

HN7172W	\$2095	\$2175	\$2251	\$2313	\$2375	\$2423	\$2487	\$2579	\$2705	\$2781	\$2147
----------------	--------	--------	--------	--------	--------	--------	--------	--------	--------	--------	--------

▶ **Specification Information, continued on next page**

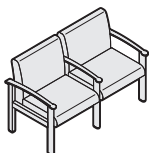
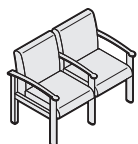

► Specification Information, continued from previous page

Specification Information

U.S. Base Prices

Style Number	Fabric Price Group 1	Fabric Price Group 2	Fabric Price Group 3	Fabric Price Group 4	Fabric Price Group 5	Fabric Price Group 6	Fabric Price Group 7	Fabric Price Group 8	Fabric Price Group 9	Fabric Price Group 10	COM
--------------	----------------------	----------------------	----------------------	----------------------	----------------------	----------------------	----------------------	----------------------	----------------------	-----------------------	-----

Three-Seat Tandem Chairs

Narrow

HN7163W	\$2823	\$2941	\$3059	\$3151	\$3245	\$3315	\$3409	\$3549	\$3737	\$3853	\$2875
----------------	--------	--------	--------	--------	--------	--------	--------	--------	--------	--------	--------

Wide

HN7173W	\$2933	\$3051	\$3169	\$3261	\$3355	\$3425	\$3519	\$3659	\$3847	\$3963	\$2985
----------------	--------	--------	--------	--------	--------	--------	--------	--------	--------	--------	--------

Four-Seat Tandem Chairs

Narrow

HN7164W X11/11	\$3654	\$3810	\$3966	\$4090	\$4216	\$4310	\$4434	\$4622	\$4870	\$5026	\$3706
------------------------------	--------	--------	--------	--------	--------	--------	--------	--------	--------	--------	--------

Wide

HN7174W X11/11	\$3777	\$3933	\$4089	\$4213	\$4339	\$4433	\$4557	\$4745	\$4993	\$5149	\$3829
------------------------------	--------	--------	--------	--------	--------	--------	--------	--------	--------	--------	--------

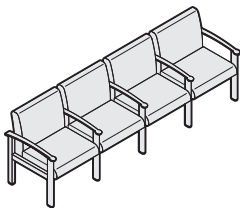
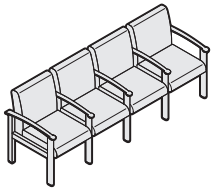
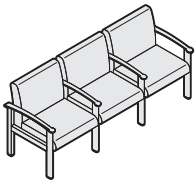
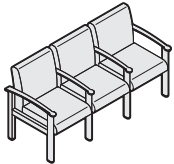

Families of Seating



For Canadian Pricing

Multiply U.S. Price by the Canadian price factor.

► See page 1 for details.

X11/11 = Last order entry
November 20, 2011

Two-Seat Bench

Metal

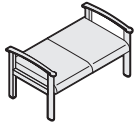

Standard Includes		Required to Specify
<ul style="list-style-type: none"> ▶ Need help? Product details, page 246 	<ul style="list-style-type: none"> • Frame and legs: paint • Open arms: urethane to match frame • Seat: fabric • Nylon glides to match frame 	<ol style="list-style-type: none"> 1 Style number 2 Paint color for frame and legs 3 Fabric color number for seat 4 Options, if selected (see below) <p>▶ See <i>Surface Materials</i>, page 691.</p>

Options	U.S. Price	Required to Specify
Surface Materials <ul style="list-style-type: none"> • Moisture barrier • Moisture barrier • Fire code seating • CAL 133 	 +\$208 +\$376	 Specify with <i>moisture barrier</i> . Add suffix F to the style number.

Specification Information											
Style Number	U.S. Base Prices										COM
	Fabric Price Group 1	Fabric Price Group 2	Fabric Price Group 3	Fabric Price Group 4	Fabric Price Group 5	Fabric Price Group 6	Fabric Price Group 7	Fabric Price Group 8	Fabric Price Group 9	Fabric Price Group 10	
HN7182M	\$1168	\$1208	\$1247	\$1278	\$1309	\$1332	\$1364	\$1411	\$1474	\$1511	\$1220



For Canadian Pricing

Multiply U.S. Price by the Canadian price factor.

▶ See page 1 for details.

Two-Seat Bench

Wood

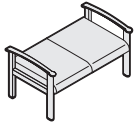

Standard Includes		Required to Specify
<ul style="list-style-type: none"> ▶ Need help? Product details, page 246 	<ul style="list-style-type: none"> • Frame and legs: maple wood • Open arms: urethane • Seat: fabric • Nylon glides: black 	<ol style="list-style-type: none"> 1 Style number 2 Wood color number for frame and legs 3 Urethane color for arms: black, graphite, or wheat 4 Fabric color number for seat 5 Options, if selected (see below) <ul style="list-style-type: none"> ▶ See <i>Surface Materials</i>, page 691.

Options	U.S. Price	Required to Specify
Surface Materials <ul style="list-style-type: none"> • Moisture barrier • Moisture barrier • Fire code seating • CAL 133 	 +\$208 +\$376	Specify with <i>moisture barrier</i> . Add suffix F to the style number.
<ul style="list-style-type: none"> • Arm caps • Wood arm caps 	+\$188	Specify with <i>wood arm caps</i> .

Specification Information											
Style Number	U.S. Base Prices										COM
	Fabric Price Group 1	Fabric Price Group 2	Fabric Price Group 3	Fabric Price Group 4	Fabric Price Group 5	Fabric Price Group 6	Fabric Price Group 7	Fabric Price Group 8	Fabric Price Group 9	Fabric Price Group 10	
HN7182W	\$1301	\$1341	\$1380	\$1411	\$1442	\$1465	\$1497	\$1544	\$1607	\$1644	\$1353

Families of Seating

 **For Canadian Pricing**
 Multiply U.S. Price by the Canadian price factor.
 ▶ See page 1 for details.

Bariatric Chairs

Metal

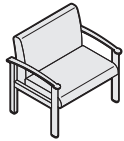

Tip: Different fabrics for the seat and back can be specified. If the fabrics are in different price groups, calculate list price by adding the two price groups together and dividing by two.

Standard Includes **Required to Specify**

- | | | |
|--|---|--|
| <ul style="list-style-type: none"> ▶ Need help? Product details, page 246 | <ul style="list-style-type: none"> • Frame and legs: paint • Open arms: urethane to match frame • Seat and back: fabric • Nylon glides to match frame | <ul style="list-style-type: none"> 1 Style number 2 Paint color for frame and legs 3 Fabric color number for seat and back 4 Options, if selected (see below) ▶ See <i>Surface Materials</i>, page 691. |
|--|---|--|

Options **U.S. Price** **Required to Specify**

Surface Materials	<ul style="list-style-type: none"> • Moisture barrier • Moisture barrier +\$104 • Fire code seating • CAL 133 +\$282 	<ul style="list-style-type: none"> Specify with <i>moisture barrier</i>. Add suffix F to the style number.
--------------------------	--	---

Specification Information

Style Number	Width	U.S. Base Prices										COM
		Fabric Price Group 1	Fabric Price Group 2	Fabric Price Group 3	Fabric Price Group 4	Fabric Price Group 5	Fabric Price Group 6	Fabric Price Group 7	Fabric Price Group 8	Fabric Price Group 9	Fabric Price Group 10	
HN7171MB30	30"	\$1726	\$1778	\$1830	\$1872	\$1914	\$1944	\$1986	\$2048	\$2132	\$2184	\$1778
HN7171MB40	40"	\$2026	\$2106	\$2182	\$2244	\$2306	\$2354	\$2418	\$2510	\$2636	\$2712	\$2078



For Canadian Pricing

Multiply U.S. Price by the Canadian price factor.

▶ See page 1 for details.

Bariatric Chairs

Wood

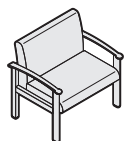

Tip: Different fabrics for the seat and back can be specified. If the fabrics are in different price groups, calculate list price by adding the two price groups together and dividing by two.

Standard Includes	Required to Specify
-------------------	---------------------

- | | |
|--|--|
| ▶ Need help? Product details, page 246 | <ul style="list-style-type: none"> • Frame and legs: maple wood • Open arms: urethane • Seat and back: fabric • Nylon glides: black |
| | <ol style="list-style-type: none"> 1 Style number 2 Wood color number for frame and legs 3 Urethane color for arms: black, graphite, or wheat 4 Fabric color number for seat and back 5 Options, if selected (see below) <p>▶ See <i>Surface Materials</i>, page 691.</p> |

Options	U.S. Price	Required to Specify
---------	------------	---------------------

Surface Materials	Moisture barrier	+\$104	Specify with <i>moisture barrier</i> .
	Fire code seating	+\$282	Add suffix F to the style number.
	Arm caps	+\$188	Specify with <i>wood arm caps</i> .

Specification Information

Style Number	Width	U.S. Base Prices										COM
		Fabric Price Group 1	Fabric Price Group 2	Fabric Price Group 3	Fabric Price Group 4	Fabric Price Group 5	Fabric Price Group 6	Fabric Price Group 7	Fabric Price Group 8	Fabric Price Group 9	Fabric Price Group 10	
HN7171WB30	30"	\$1855	\$1907	\$1959	\$2001	\$2043	\$2073	\$2115	\$2177	\$2261	\$2313	\$1907
HN7171WB40	40"	\$1999	\$2079	\$2155	\$2217	\$2279	\$2327	\$2391	\$2483	\$2609	\$2685	\$2051

For Canadian Pricing
 Multiply U.S. Price by the Canadian price factor.
 ▶ See page 1 for details.

Freestanding Tables

Metal

	Standard Includes	Required to Specify
▶ Need help? Product details, page 247	<ul style="list-style-type: none"> • Top: laminate • Edge band: plastic • Legs: paint • Nylon glides to match frame 	<ol style="list-style-type: none"> 1 Style number 2 Laminate color number for top 3 Plastic color number for edge band 4 Paint color number for legs 5 Options, if selected (see below) <p>▶ See <i>Surface Materials</i>, page 691.</p>

	Options	U.S. Price	Required to Specify
Top	<ul style="list-style-type: none"> • Wood top for square table • Wood top for rectangular table 	<p>+\$260</p> <p>+\$520</p>	<p>Specify <i>with wood top</i> and select wood color number for top.</p> <p>Specify <i>with wood top</i> and select wood color number for top.</p>
Wiring & Cabling	<p>☒11/11 • Interport power/data module</p>	<p>+\$274</p>	<p>Specify <i>with interport power/data module</i>.</p>

Tip: Power module will be located in the center on square tables and off-center on rectangular tables.

Specification Information				
Dimensions			Style	U.S. Base
D	W	H	Number	Price

Freestanding Square Table

22"	22 ³ / ₈ "	15 ³ / ₄ "	HN71T1M	\$555
-----	----------------------------------	----------------------------------	----------------	-------

Freestanding Rectangular Table

22"	46 ⁵ / ₈ "	15 ³ / ₄ "	HN71T2M ☒11/11	\$739
-----	----------------------------------	----------------------------------	-----------------------	-------

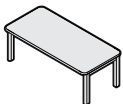

For Canadian Pricing

Multiply U.S. Price by the Canadian price factor.

▶ See page 1 for details.

☒11/11 = Last order entry
November 20, 2011

Freestanding Tables

Wood

Standard Includes		Required to Specify
<ul style="list-style-type: none"> ▶ Need help? Product details, page 247 	<ul style="list-style-type: none"> • Top: laminate • Edge band: plastic • Legs: maple wood • Nylon glides: black 	<ul style="list-style-type: none"> 1 Style number 2 Laminate color number for top 3 Plastic color number for edge band 4 Options, if selected (see below) ▶ See <i>Surface Materials</i>, page 691.

Options	U.S. Price	Required to Specify
Top		
• Wood top for square table	+\$260	Specify <i>with wood top</i> and select wood color number for top.
• Wood top for rectangular table	+\$520	Specify <i>with wood top</i> and select wood color number for top.
Wiring & Cabling		
✕11/11 • Interport power/data module	+\$274	Specify <i>with interport power/data module</i> .

Tip: Power module will be located in the center on square tables and off-center on rectangular tables.

Specification Information

Dimensions			Style	U.S. Base
D	W	H	Number	Price
:	:	:	:	:

Freestanding Square Table

22"	22¾"	15¾"	HN71T1W	\$635
:	:	:	:	:

Freestanding Rectangular Table

22"	46½"	15¾"	HN71T2W ✕11/11	\$820
:	:	:	:	:

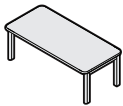

For Canadian Pricing

Multiply U.S. Price by the Canadian price factor.

▶ See page 1 for details.

✕11/11 = Last order entry
November 20, 2011

Ganging Tables

Standard Includes	Required to Specify
<ul style="list-style-type: none"> ▶ Need help? Product details, page 247 • Top: laminate • Edge band: plastic • Legs, if selected: paint or maple wood • Nylon glides on legs, if selected 	<ol style="list-style-type: none"> 1 Style number 2 Laminate color number for top 3 Plastic color number for edge band 4 Paint or wood color for legs, if selected 5 Options, if selected (see below) <p>▶ See <i>Surface Materials</i>, page 691.</p>

Options	U.S. Price	Required to Specify
Top <ul style="list-style-type: none"> • Wood top for center and end-of-run tables • Wood top for ganging corner tables 	+\$260 +\$520	Specify <i>with wood top</i> and select wood color number for top. Specify <i>with wood top</i> and select wood color number for top.
Wiring & Cabling <ul style="list-style-type: none"> • ✕11/11 Interport power/data module 	+\$274	Specify <i>with interport power/data module</i> .

Specification Information				
Dimensions			Style	U.S. Base
D	W	H	Number	Price

Ganging Narrow Center Table

20"	22 $\frac{3}{8}$ "	15 $\frac{3}{4}$ "	HN71TSG2	\$421
-----	--------------------	--------------------	-----------------	-------

Ganging Wide Center Table

22"	22 $\frac{3}{8}$ "	15 $\frac{3}{4}$ "	HN71TSG1 ✕11/11	\$491
-----	--------------------	--------------------	---	-------

Ganging End-of-Run Table with Metal Legs

22"	22 $\frac{3}{8}$ "	15 $\frac{3}{4}$ "	HN71TERM ✕11/11	\$528
-----	--------------------	--------------------	---	-------

Ganging End-of-Run Table with Wood Legs

22"	22 $\frac{3}{8}$ "	15 $\frac{3}{4}$ "	HN71TERW ✕11/11	\$608
-----	--------------------	--------------------	---	-------

Ganging Corner Table with Metal Legs

28"	28"	15 $\frac{3}{4}$ "	HN71TCGM	\$573
-----	-----	--------------------	-----------------	-------

Ganging Corner Table with Wood Legs

28"	28"	15 $\frac{3}{4}$ "	HN71TCGW	\$573
-----	-----	--------------------	-----------------	-------



For Canadian Pricing
 Multiply U.S. Price by the Canadian price factor.
 ▶ See page 1 for details.

✕11/11 = Last order entry
 November 20, 2011

Surface Materials

Nurture Surface Materials	692
Color Availability Matrix for Nurture Casegoods	694
Color Availability Matrix for Nurture Seating and Tables	696
Recommended Worksurface Edge Finishes	700
Steelcase Seating Surface Materials	701
Steelcase Wood Seating Surface Materials	702
Turnstone Seating Surface Materials	703
Visual Worktools Surface Materials	704
Upholstery and Color Numbers	706
Nurture Graded-In Programs	
Acrylic Panel	708
Solid Surface	708
Upholstery	709
Fabric Application Direction Guidelines	712

Nurture Surface Materials

This listing includes all the surface material choices that are available for the Nurture products in this specification guide.

Resources

For more information about Nurture surface materials or to get surface material samples, contact Nurture at 1.800.342.8562.

Materials and colors are not available on every product. Refer to the Color Availability Matrices before specifying.

Plastisol/Urethane

6059 Sterling Dark
6161 Graphite
6162 Taupe
6205 Black

Paint

4750 Champagne Metallic
4798 Sterling
4799 Platinum Metallic
4851 Wheat
4853 Cream
4854 Graphite
4855 Silver
7207 Black
7225 Sand
7237 Slate
7238 Fieldstone
7239 Midnight
7241 Arctic White
7243 Seagull

Metal

Polished Chrome
Brushed Stainless Steel
Nickel Steel

Wood

Veneer

3402 Clear Cherry
3412 Natural Cherry **E**
3416 Light Cherry (W-15)
3422 Medium Cherry
3456 Clear on Ash
3457 Almond on Ash
3458 Samba on Ash
3459 Cognac on Ash
3460 Dark Rum on Ash
3461 Shiraz on Ash
3462 Flamenco on Ash
3522 Clear Maple
3572 Amber Maple
3575 Sugarloaf Maple
3576 Almond Cherry
3577 Samba Cherry
3578 Cognac Cherry
3579 Dark Rum Cherry
3580 Shiraz Cherry
3581 Flamenco Cherry
3592 Blonde on Maple
3602 Desert Oak
3620 English Oak (W-20)
3730 Mahogany (W-45)
3772 Medium Mahogany on Walnut
3970 Ebony (W-60)

Laminate

Laminate

2570 Sugarloaf Maple
2571 Almond Cherry
2572 Samba Cherry
2573 Cognac Cherry
2574 Dark Rum Cherry
2575 Shiraz Cherry
2576 Flamenco Cherry

Steelcase High-Pressure Laminate

Applies to:

- Cura Tables
- Exchange Tables
- Folio Worksurfaces
- Malibu Tables
- Neighbor Tables
- Progeny Tables
- Rave Tables
- Sieste Tables
- Sine Tables
- Sonata Tops
- Sync

Fiber Laminate

2850 Vanadium Fiber
2851 Rhyme Fiber
2852 Tungsten Fiber
2854 Vellum Fiber
2859 Novell Fiber
2860 Granite Fiber
2861 Coconut Fiber
2862 Stucco Fiber

Micro Laminate

2920 Marl Micro
2921 Gypsum Micro
2922 Clay Micro
2923 Shadow Micro

Patina Laminate

2870 Blonde Bronze Patina
2871 Blackened Bronze Patina
2873 Instant Iron Patina

Solid Laminate

2722 Cream **E**
2730 Arctic White
2746 Black
2759 Warm White **E**
2766 Warm Brown V1
2782 Grey V1
2811 Mist **E**
2883 Seagull
2884 Milk
2885 Dune

Speckle Laminate

2820 Coffee Speckle
2822 Woodrose Speckle
2823 Driftwood Speckle
2824 Smoke Speckle
2825 Vanadium Speckle

Woodgrain Laminate

2409 Clear Maple
2410 Graphite Walnut
2412 Natural Cherry
2422 Medium Cherry
2511 Winter on Maple
2538 Clear Walnut
2539 Warm Oak
2592 Blonde on Maple
2714 Natural Walnut
2772 Medium Mahogany on Walnut **E**

Turnstone Laminate Collection

A selection of laminates and edge bands in this collection are available on Steelcase brand products. This collection is available with standard leadtimes and supported like standard laminates to help make ordering easy. Please see the Turnstone section of in2.steelcase.com for swatching information.

2535 Virginia Walnut
2536 Blackwood
2612 Marbled Maple
2614 Chocolate Walnut
2615 Marbled Cherry

Open Line Laminate (OLL)

Open Line laminates are available at an additional \$64 (U.S.) per surface, plus the cost of the laminate.

Example:

4' x 8' sheet = 32 square feet
32 square feet x \$1.10 = \$35.20 (U.S.) per sheet
Laminate costs vary by supplier. The cost of the laminate will be added to your invoice as a separate line on the acknowledgement.

Applies to:

- Exchange tables
- Folio Laminate worksurfaces
- Opus
- Sonata
- Jenny
- Sync

This service allows you to order non-standard laminate at an additional fee per unit. See the specification pages for upcharge information.

When processing orders for Open Line Laminate on Opus or Sonata, specify 2902 in the laminate finish field and enter the OLL manufacturer information.

Edge bands must also be specified and will incur an \$83 upcharge.

6131 White
6132 Grey
6133 Folkstone
6134 Northsea
6135 Shadow
6136 Nubian Brown
6137 Black

When processing orders for Open Line Laminate

on Jenny, Exchange tables, Folio Laminate Worksurfaces, and Sync, specify 2900 in the laminate finish field and enter the OLL manufacturer information.

Edge bands must also be specified using the plastic edge band offering.

Thermoform

2030 Arctic White
2031 Seagull
2032 Dune
2065 Sugarloaf Maple
2066 Almond Cherry
2068 Cognac Cherry
2069 Dark Rum Cherry
2070 Shiraz Cherry
2071 Flamenco Cherry
2072 Samba Cherry
6775 Sand

Solid Surface

Applies to:

- Folio Worksurfaces
- Leela
- Senza
- Sonata
- Sync
- Tava

Price Group A

2975 Bisque

Price Group B

2973 Linen

Price Group C

2972 Antarctica
2974 Canvas

E = Established

Plastic Edge Band

- 6013 Sugarloaf Maple
- 6014 Almond Cherry
- 6021 Samba Cherry
- 6022 Cognac Cherry
- 6023 Dark Rum Cherry
- 6024 Shiraz Cherry
- 6025 Flamenco Cherry

Applies to:

- Cura tables
- Exchange tables
- Folio Worksurfaces
- Sync

- 6000 Black
- 6001 Coffee
- 6034 Natural Cherry
- 6036 Medium Cherry
- 6037 Winter on Maple
- 6038 Blonde on Maple
- 6041 Natural Walnut
- 6052 Milk
- 6053 Seagull
- 6231 Graphite Walnut
- 6237 Clear Maple
- 6242 Virginia Walnut
- 6243 Blackwood
- 6245 Clear Walnut
- 6246 Warm Oak
- 6249 Platinum Solid
- 6615 Grey Value 5
- 6619 Ice **E**
- 6631 Cream
- 6635 Dawn **E**
- 6636 Mist
- 6654 Sand
- 6655 Warm White
- 6676 Marbled Maple
- 6677 Chocolate Walnut
- 6678 Marbled Cherry
- 6694 Slate
- 6695 Midnight
- 6697 Fog

Fusion

Applies to:

- Sonata island modules

Price Group 1

- 6526 Mulberry Tissue

Price Group 3

- 6523 Desert Stalk

Price Group 4

- 6525 Sheer Leaf Medium

Soft Pulls

- 6000 Black

E = Established

Markerboard

Applies to:

- Opus wardrobe cabinet with sliding door only
- White

Urethane

Applies to:

- Verge seat
- 6688 Non metallic steel

CuraNet

Applies to:

- Cura
- 5081 Ash (Silver Grey)
5083 Lily Pad (Moss)
5085 Ebony (Black)
5086 Camel
5087 Cocoa
5088 Aquamarine

Promessa

Applies to:

- Cura
- UL81 Ash
UL83 Lily Pad
UL85 Ebony
UL86 Camel
UL87 Cocoa
UL88 Aquamarine

Upholstery

- ▶ See page 706 for a complete listing of upholstery colors and numbers

California 133 Option

Nurture offers Fire Code Seating Modifications (FCS) on nearly all seating models. The most rigorous fire codes in the nation have been developed in California, and the Steelcase FCS modification is designed to meet those codes. Fire Code Seating (FCS) indicates that a product is constructed to meet the strict fire code requirements of high public occupancy areas such as hospitals, theaters, meeting rooms, and lobbies. The FCS standards will meet both the State of California Home Furnishings Technical Bulletin 133 (CAL TB 133) and Boston Fire Code (BFC). Boston adopted the California Home Furnishing Technical Bulletin CAL TB 133 test standard in 1992.

CAL 133 is specified using an "F" suffix. When an "F" suffix is available, it means that these models have been tested and certified using approved fabrics. A complete list of approved fabrics are listed on the COM website at www.Steelcase.com

If a specific chair/fabric combination has not been tested, an actual burn test can be performed on the product in the specified fabric. The cost of the test is \$700 (net). Please allow a minimum of six weeks for the production of the chair and the completion of the test.

Color Availability Matrix for Nurture Casegoods

Legend

- = Not available
- = Available
- = Available with exceptions
- ▶ See specification pages for details.

		Veneer						Laminate						Solid Surface									
		3575	3576	3577	3578	3579	3580	3581	2570	2571	2572	2573	2574	2575	2576	2730	2883	2885	2972	2973	2974	2975	
		Sugarloaf Maple	Almond Cherry	Samba Cherry	Cognac Cherry	Dark Rum Cherry	Shiraz Cherry	Flamenco Cherry	Sugarloaf Maple	Almond Cherry	Samba Cherry	Cognac Cherry	Dark Rum Cherry	Shiraz Cherry	Flamenco Cherry	Arctic White	Seagull	Dune	Antarctica	Linen	Canvas	Bisque	
Ainsley		■	■	■	■	■	■	■	■	■	■	■	■	■	■	■	■	■	■	■	■	■	■
Davenport		•	•	•	•	•	•	•	■	■	■	■	■	■	■	■	■	■	•	•	•	•	•
Exchange Table	Base	•	•	•	•	•	•	•	•	•	•	•	•	•	•	•	•	•	•	•	•	•	•
	Table Top*	•	•	•	•	•	•	•	■	■	■	■	■	■	■	■	■	■	•	•	•	•	•
Folio	Cabinets	•	•	•	•	•	•	•	■	■	■	■	■	■	■	■	■	■	•	•	•	•	•
	Laminate Worksurfaces*	•	•	•	•	•	•	•	■	■	■	■	■	■	■	■	■	■	•	•	•	•	•
	Solid Surface Worksurfaces	•	•	•	•	•	•	•	•	•	•	•	•	•	•	•	•	•	■	■	■	■	■
Opus	Cabinets	•	•	•	•	•	•	•	■	■	■	■	■	■	■	■	■	■	•	•	•	•	•
	Door pulls, table rails, and coat hooks	•	•	•	•	•	•	•	•	•	•	•	•	•	•	•	•	•	•	•	•	•	•
Park		•	•	•	•	•	•	•	■	■	■	■	■	■	■	■	■	■	•	•	•	•	•
Senza		■	■	■	■	■	■	■	■	■	■	■	■	■	■	■	■	■	■	■	■	■	■
Sonata*	Cabinets	•	•	•	•	•	•	•	■	■	■	■	■	■	■	■	■	■	■	■	■	■	■
	Rails, drawer/door pulls, and coat hooks	•	•	•	•	•	•	•	•	•	•	•	•	•	•	•	•	•	•	•	•	•	•
Sync*		•	•	•	•	•	•	•	■	■	■	■	■	■	■	■	■	■	■	■	■	■	■
Viridian		•	•	•	•	•	•	•	•	•	•	•	•	•	•	•	•	•	•	•	•	•	•
Waldorf		■	■	■	■	■	■	■	•	•	•	•	•	•	•	•	•	•	•	•	•	•	•
Overbed Tables		•	•	•	•	•	•	•	■	■	■	■	■	■	■	■	■	■	•	•	•	•	•
Headboards/Footboards		■	■	■	■	■	■	■	■	■	■	■	■	■	■	■	■	■	•	•	•	•	•

*Exchange table tops, Folio worksurfaces, Sonata tops, and Sync table tops are available in all Steelcase laminates.

▶ See page 701

Thermoform												
2030	Arctic White
2031	Seagull
2032	Dune
2065	Sugarloaf Maple
2066	Almond Cherry
2068	Cognac Cherry
2069	Dark Rum Cherry
2070	Shiraz Cherry
2071	Flamenco Cherry
2072	Samba Cherry
Fusion												
6523	Desert Stalk
6525	Sheer Leaf Medium
6526	Creamsicle
Paint												
4750	Champagne	■	.	.
4798	Sterling	■	.	.
4799	Platinum	■	.	.
7207	Black	■	.	.

Color Availability Matrix for Nurture Seating and Tables

Legend

- = Not available
- = Available
- = Available with exceptions
- ▶ See specification pages for details.

		Veneer																										
		3402	3412	3416	3422	3456	3457	3458	3459	3460	3461	3462	3522	3572	3575	3576	3577	3578	3579	3580	3581	3592	3602	3620	3730	3772	3970	
		Clear Cherry	Natural Cherry ^E	Light Cherry (W-15)	Medium Cherry	Clear on Ash	Almond on Ash	Samba on Ash	Cognac on Ash	Dark Rum on Ash	Shiraz on Ash	Flamenco on Ash	Clear Maple	Amber Maple	Sugarloaf Maple	Almond Cherry	Samba Cherry	Cognac Cherry	Dark Rum Cherry	Shiraz Cherry	Flamenco Cherry	Blonde on Maple	Desert Oak	English Oak (W-20)	Mahogany (W-45)	Medium Mahogany on Walnut	Ebony (W-60)	
Amaris	Legs	•	•	•	•	•	•	•	•	•	•	•	•	•	•	•	•	•	•	•	•	•	•	•	•	•	•	
	Arm Caps	•	•	•	•	•	•	•	•	•	•	•	•	•	•	•	•	•	•	•	•	•	•	•	•	•	•	•
Asana		•	•	•	•	•	•	•	•	•	•	•	•	•	•	•	•	•	•	•	•	•	•	•	•	•	•	•
Aspekt	Seating Frame	•	•	•	•	•	•	•	•	•	•	•	•	•	•	•	•	•	•	•	•	•	•	•	•	•	•	•
	Arm Caps	•	•	•	•	•	•	•	•	•	•	•	•	•	•	•	•	•	•	•	•	•	•	•	•	•	•	•
	Table Legs	•	•	•	•	•	•	•	•	•	•	•	•	•	•	•	•	•	•	•	•	•	•	•	•	•	•	•
	Table Top	•	•	•	•	•	•	•	•	•	•	•	•	•	•	•	•	•	•	•	•	•	•	•	•	•	•	•
Cura	Arm Caps	•	•	•	•	•	•	•	•	•	•	•	•	•	•	•	•	•	•	•	•	•	•	•	•	•	•	•
	Frame	•	•	•	•	•	•	•	•	•	•	•	•	•	•	•	•	•	•	•	•	•	•	•	•	•	•	•
	Table Top*	•	•	•	•	•	•	•	•	•	•	•	•	•	•	•	•	•	•	•	•	•	•	•	•	•	•	•
Cypress		•	•	•	•	•	•	•	•	•	•	•	•	•	•	•	•	•	•	•	•	•	•	•	•	•	•	•
Empress	Lounge Frame	•	•	•	•	•	•	•	•	•	•	•	•	•	•	•	•	•	•	•	•	•	•	•	•	•	•	•
	Lounge Arm Caps	•	•	•	•	•	•	•	•	•	•	•	•	•	•	•	•	•	•	•	•	•	•	•	•	•	•	•
Flex Back		•	•	•	•	•	•	•	•	•	•	•	•	•	•	•	•	•	•	•	•	•	•	•	•	•	•	•
Flute		•	•	•	•	•	•	•	•	•	•	•	•	•	•	•	•	•	•	•	•	•	•	•	•	•	•	•
Hawthorne	Seating	•	•	•	•	•	•	•	•	•	•	•	•	•	•	•	•	•	•	•	•	•	•	•	•	•	•	•
Jarrah	Side Trim Panel	•	•	•	•	•	•	•	•	•	•	•	•	•	•	•	•	•	•	•	•	•	•	•	•	•	•	•
	Seating Legs	•	•	•	•	•	•	•	•	•	•	•	•	•	•	•	•	•	•	•	•	•	•	•	•	•	•	•
	Arm Caps	•	•	•	•	•	•	•	•	•	•	•	•	•	•	•	•	•	•	•	•	•	•	•	•	•	•	•
Leela	Arm Caps	•	•	•	•	•	•	•	•	•	•	•	•	•	•	•	•	•	•	•	•	•	•	•	•	•	•	•
	Legs	•	•	•	•	•	•	•	•	•	•	•	•	•	•	•	•	•	•	•	•	•	•	•	•	•	•	•
	Table Top	•	•	•	•	•	•	•	•	•	•	•	•	•	•	•	•	•	•	•	•	•	•	•	•	•	•	•
Linden	Seating Base	•	•	•	•	•	•	•	•	•	•	•	•	•	•	•	•	•	•	•	•	•	•	•	•	•	•	•
	Arm Caps	•	•	•	•	•	•	•	•	•	•	•	•	•	•	•	•	•	•	•	•	•	•	•	•	•	•	•
Loria		•	•	•	•	•	•	•	•	•	•	•	•	•	•	•	•	•	•	•	•	•	•	•	•	•	•	•
Kami		•	•	•	•	•	•	•	•	•	•	•	•	•	•	•	•	•	•	•	•	•	•	•	•	•	•	•
Malibu	Seating	■	■	■	■	•	•	•	•	•	•	•	•	•	•	•	•	•	•	•	•	•	•	•	•	•	•	•
	Tables*	■	■	■	■	•	•	•	•	•	•	•	•	•	•	•	•	•	•	•	•	•	•	•	•	•	•	•
Malibu Too		■	■	■	■	•	•	•	•	•	•	•	•	•	•	•	•	•	•	•	•	•	•	•	•	•	•	•
Mineral	Arm Caps	•	•	•	•	•	•	•	•	•	•	•	•	•	•	•	•	•	•	•	•	•	•	•	•	•	•	•
Mitra	Seating Frame	•	•	•	•	•	•	•	•	•	•	•	•	•	•	•	•	•	•	•	•	•	•	•	•	•	•	•
	Arm Caps	•	•	•	•	•	•	•	•	•	•	•	•	•	•	•	•	•	•	•	•	•	•	•	•	•	•	•
	Table Legs and Bases	•	•	•	•	•	•	•	•	•	•	•	•	•	•	•	•	•	•	•	•	•	•	•	•	•	•	•
	Table Top	•	•	•	•	•	•	•	•	•	•	•	•	•	•	•	•	•	•	•	•	•	•	•	•	•	•	•

- ^E = Established
- * Also available in Steelcase Laminates.
- ▶ See page 701

Paint																																		
	4750 Champagne																																	
	4798 Sterling																																	
	4799 Platinum																																	
	4850 Silver																																	
	4851 Wheat																																	
	4853 Cream																																	
	4854 Graphite																																	
	4855 Silver																																	
	7207 Black																																	
	7225 Sand																																	
	7241 Arctic White																																	
	7243 Seagull																																	
	7237 Slate																																	
	7238 Fieldstone																																	
	7239 Midnight																																	
Plastiso/Urethane																																		
	6059 Sterling Dark																																	
	6161 Graphite																																	
	6162 Taupe																																	
	6205 Black																																	
Laminate																																		
	2570 Sugarloaf Maple																																	
	2571 Almond Cherry																																	
	2572 Samba Cherry																																	
	2573 Cognac Cherry																																	
	2574 Dark Rum Cherry																																	
	2575 Shiraz Cherry																																	
	2576 Flamenco Cherry																																	
Thermoform																																		
	2065 Sugarloaf Maple																																	
	2066 Almond Cherry																																	
	2068 Cognac Cherry																																	
	2069 Dark Rum Cherry																																	
	2070 Shiraz Cherry																																	
	2071 Flamenco Cherry																																	
	2072 Samba Cherry																																	
Solid Surface																																		
	2972 Antarctica																																	
	2973 Linen																																	
	2974 Canvas																																	
	2975 Bisque																																	

Surface Materials

Color Availability Matrix for Nurture Seating and Tables, continued

Legend

- = Not available
- = Available
- = Available with exceptions
- ▶ See specification pages for details.

		Veneer																									
		3402	3412	3416	3422	3456	3457	3458	3459	3460	3461	3462	3522	3572	3575	3576	3577	3578	3579	3580	3581	3592	3602	3620	3730	3772	3970
		Clear Cherry	Natural Cherry E	Light Cherry (W-15)	Medium Cherry	Clear on Ash	Almond on Ash	Samba on Ash	Cognac on Ash	Dark Rum on Ash	Shiraz on Ash	Flamenco on Ash	Clear Maple	Amber Maple	Sugarloaf Maple	Almond Cherry	Samba Cherry	Cognac Cherry	Dark Rum Cherry	Shiraz Cherry	Flamenco Cherry	Blonde on Maple	Desert Oak	English Oak (W-20)	Mahogany (W-45)	Medium Mahogany on Walnut	Ebony (W-60)
Neighbor	Frames	•	•	•	•	•	•	•	•	•	•	•	•	•	•	•	•	•	•	•	•	•	•	•	•	•	•
	Arm Cap	■	■	■	■	•	•	•	•	•	•	•	■	■	■	■	■	■	■	■	■	■	■	■	■	■	■
	Table Top*	■	■	■	■	•	•	•	•	•	•	•	■	■	■	■	■	■	■	■	■	■	■	■	■	■	■
Nikko	Seating Frame	•	•	•	•	•	•	•	•	•	•	•	•	•	■	■	■	■	■	■	■	•	•	•	•	•	•
	Arm Caps	•	•	•	•	•	•	•	•	•	•	•	•	•	■	■	■	■	■	■	■	•	•	•	•	•	•
Orchid		•	•	•	•	•	•	•	•	•	•	•	•	•	■	■	■	■	■	■	■	•	•	•	•	•	•
Progeny	Frame	■	■	■	■	•	•	•	•	•	•	•	■	■	■	■	■	■	■	■	■	■	■	■	■	■	■
	Arm Cap	■	■	■	■	•	•	•	•	•	•	•	■	■	■	■	■	■	■	■	■	■	■	■	■	■	■
	Table Top*	■	■	■	■	•	•	•	•	•	•	•	■	■	■	■	■	■	■	■	■	■	■	■	■	■	■
Rave	Arm Caps and Frame	■	■	■	■	•	•	•	•	•	•	•	■	■	■	■	■	■	■	■	■	■	■	■	■	■	■
	Tables*	■	■	■	■	•	•	•	•	•	•	•	■	■	■	■	■	■	■	■	■	■	■	■	■	■	■
Sequoia	Seating Frame	•	•	•	•	•	•	•	•	•	•	•	•	•	■	■	■	■	■	■	■	•	•	•	•	•	•
	Arm Caps	•	•	•	•	•	•	•	•	•	•	•	•	•	■	■	■	■	■	■	■	•	•	•	•	•	•
	Table Tops	•	•	•	•	•	•	•	•	•	•	•	•	•	•	•	•	•	•	•	•	•	•	•	•	•	•
Sieste	Arm Caps	■	■	■	■	•	•	•	•	•	•	•	■	■	■	■	■	■	■	■	■	■	■	■	■	■	■
	Legs	■	■	■	■	•	•	•	•	•	•	•	■	■	■	■	■	■	■	■	■	■	■	■	■	■	■
	Table Top*	■	■	■	■	•	•	•	•	•	•	•	■	■	■	■	■	■	■	■	■	■	■	■	■	■	■
Sieste Sleeper		■	■	■	■	•	•	•	•	•	•	•	■	■	■	■	■	■	■	■	■	■	■	■	■	■	■
Sine	Seating and Table Frame	•	•	•	•	•	•	•	•	•	•	•	•	•	•	•	•	•	•	•	•	•	•	•	•	•	•
	Table Top*	•	•	•	•	•	•	•	•	•	•	•	•	•	•	•	•	•	•	•	•	•	•	•	•	•	•
Slumber Day Bed		•	•	•	•	•	•	•	•	•	•	•	•	•	•	•	•	•	•	•	•	•	•	•	•	•	•
Sorrel	Seating Frame and Arm Caps	•	•	•	•	•	•	•	•	•	•	•	•	•	•	•	•	•	•	•	•	•	•	•	•	•	•
	Seating Backs	•	•	•	•	•	•	•	•	•	•	•	•	•	■	■	■	■	■	■	■	•	•	•	•	•	•
	Table Legs	•	•	•	•	•	•	•	•	•	•	•	•	•	•	•	•	•	•	•	•	•	•	•	•	•	•
	Table Tops	•	•	•	•	•	•	•	•	•	•	•	•	•	•	•	•	•	•	•	•	•	•	•	•	•	•
Tava	Arm and Legs	•	•	•	•	■	■	■	■	■	■	■	•	•	•	•	•	•	•	•	•	•	•	•	•	•	•
	Bench Body and Table Tops	•	•	•	•	•	•	•	•	•	•	•	•	•	•	•	•	•	•	•	•	•	•	•	•	•	•
Traditional Lounge		•	•	•	•	•	•	•	•	•	•	•	•	•	■	■	■	■	■	■	■	•	•	•	•	•	•
X-tenz Sleeper	Arm Caps	•	•	•	•	•	•	•	•	•	•	•	•	•	■	■	■	■	■	■	■	•	•	•	•	•	•
	Frame	•	•	•	•	•	•	•	•	•	•	•	•	•	•	•	•	•	•	•	•	•	•	•	•	•	•
Verge		•	•	•	•	•	•	•	•	•	•	•	•	•	•	•	•	•	•	•	•	•	•	•	•	•	•
Freestanding and Interconnecting Tables																											
	Table Top	•	•	•	•	•	•	•	•	•	•	•	•	•	•	•	•	•	•	•	•	•	•	•	•	•	•
	Metal Legs	•	•	•	•	•	•	•	•	•	•	•	•	•	•	•	•	•	•	•	•	•	•	•	•	•	•
	Wood Legs	•	•	•	•	•	•	•	•	•	•	•	•	•	■	■	■	■	■	■	■	•	•	•	•	•	•

E = Established
 * Also available in Steelcase Laminates.
 ▶ See page 701

Paint												
												4750 Champagne
												4798 Sterling
												4799 Platinum
												4850 Silver
												4851 Wheat
												4853 Cream
												4854 Graphite
												4855 Silver
												7207 Black
												7225 Sand
												7241 Arctic White
												7243 Seagull
												7237 Slate
												7238 Fieldstone
												7239 Midnight
Plastiso/Urethane												
												6059 Sterling Dark
												6161 Graphite
												6162 Taupe
												6205 Black
Laminate												
												2570 Sugarloaf Maple
												2571 Almond Cherry
												2572 Samba Cherry
												2573 Cognac Cherry
												2574 Dark Rum Cherry
												2575 Shiraz Cherry
												2576 Flamenco Cherry
Thermoform												
												2065 Sugarloaf Maple
												2066 Almond Cherry
												2068 Cognac Cherry
												2069 Dark Rum Cherry
												2070 Shiraz Cherry
												2071 Flamenco Cherry
												2072 Samba Cherry
Solid Surface												
												2972 Antartica
												2973 Linen
												2974 Canvas
												2975 Bisque

Recommended Worksurface Edge Finishes

Recommended Edge Colors

Edges

The recommended edge color will complement the laminate color you specify. Edge color is specified separately.

Steelcase Laminate Color	Recommended 3 mm Edge Color
--------------------------	-----------------------------

Fiber	
2850 Vanadium Fiber	6654 Sand
2851 Rhyme Fiber	6631 Cream
2852 Tungsten Fiber	6636 Mist
2854 Vellum Fiber	6655 Warm White
2859 Novell Fiber	6001 Coffee
2860 Granite Fiber	6000 Black
2861 Coconut Fiber	6654 Sand
2862 Stucco Fiber	6053 Seagull

Micro	
2920 Marl Micro	6053 Seagull
2921 Gypsum Micro	6654 Sand
2922 Clay Micro	6654 Sand
2923 Shadow Micro	6249 Platinum Solid

Patina	
2870 Blonde Bronze Patina	6654 Sand
2871 Blackened Bronze Patina	6615 Grey Value 5
2873 Instant Iron Patina	6615 Grey Value 5

Solid	
2722 Cream E	6631 Cream
2730 Arctic White	6697 Fog
2746 Black	6000 Black
2759 Warm White E	6655 Warm White
2811 Mist E	6636 Mist
2883 Seagull	6053 Seagull
2884 Milk	6052 Milk
2885 Dune	6654 Sand

Speckle	
2820 Coffee Speckle	6631 Cream
2822 Woodrose Speckle	6635 Dawn E
2823 Driftwood Speckle	6631 Cream
2824 Smoke Speckle	6636 Mist
2825 Vanadium Speckle	6619 Ice E

Woodgrain	
2409 Clear Maple	6237 Clear Maple
2410 Graphite Walnut	6231 Graphite Walnut
2412 Natural Cherry	6034 Natural Cherry
2422 Medium Cherry	6036 Medium Cherry
2511 Winter on Maple	6037 Winter on Maple
2538 Clear Walnut	6245 Clear Walnut
2539 Warm Oak	6246 Warm Oak
2592 Blonde on Maple	6038 Blonde on Maple
2714 Natural Walnut	6041 Natural Walnut
2772 Medium Mahogany on Walnut E	6045 Medium Mahogany on Walnut E

Nurture Laminate Color	Recommended 3 mm Edge Color
------------------------	-----------------------------

Fiber	
2570 Sugarloaf Maple	6013 Sugarloaf Maple
2571 Almond Cherry	6014 Almond Cherry
2572 Samba Cherry	6021 Samba Cherry
2573 Cognac Cherry	6022 Cognac Cherry
2574 Dark Rum Cherry	6023 Dark Rum Cherry
2575 Shiraz Cherry	6024 Shiraz Cherry
2576 Flamenco Cherry	6025 Flamenco Cherry

E = Established

This listing includes all the surface material choices that are available for the products in this specification guide.

Resources

For more information about surface materials, refer to the following resources:

Additional surface materials specification tools are available to assist you in the specification process—the Surface Materials Binders.

Surface Materials Binders

- Surface Materials Reference Manual
- A complete set of swatch cards for hard surfaces, vertical surface fabrics, and seating upholstery

Materials and colors are not available on every product. Refer to the Color Availability and Upholstery Matrices before specifying.

Plastic

- 6009 Arctic White
- 6059 Sterling Dark Solid
- 6205 Black
- 6206 Burgundy
- 6249 Platinum Solid
- 6250 Coffee
- 6256 Graphite
- 6259 Midnight
- 6268 Navy
- 6296 Sterling
- 6301 Aegean
- 6302 Baltic
- 6303 Pomegranate
- 6332 Citron
- 6333 Picasso
- 6334 Flash
- 6335 Wasabi
- 6336 Jazz
- 6337 Element
- 6338 Chili

Seating Coating

- 7000 Black
- 7005 Coffee
- 7011 Graphite

Paint

- 0835 Black
- 4799 Platinum Metallic
- 7239 Midnight

E = Established

Metal

- 8046 Polished Aluminum
- 9201 Polished Chrome

Laminate

- 2406 Clear Cherry
- 2409 Clear Maple
- 2410 Graphite Walnut
- 2412 Natural Cherry
- 2422 Medium Cherry
- 2511 Winter on Maple
- 2538 Clear Walnut
- 2539 Warm Oak
- 2714 Natural Walnut
- 2722 Cream
- 2730 Arctic White
- 2746 Black
- 2759 Warm White
- 2772 Medium Mahogany on Walnut **E**
- 2811 Mist
- 2883 Seagull
- 2884 Milk
- 2885 Dune

Elmosoft Leather

- L110 Maritime Blue
- L111 Midnight Blue
- L112 Ebony
- L113 Gunmetal
- L114 Mica
- L115 Dove Grey
- L116 Plum Pleasure
- L122 Truffle
- L128 Red Birch
- L132 Violet
- L133 Espresso
- L134 Ruby
- L135 Scarlet
- L136 Claret
- L137 Cabernet
- L138 Bourbon
- L139 Cinder
- L140 Garnet
- L143 Pecan
- L144 Chamois
- L145 Palomino
- L146 Russet
- L147 Saddle
- L148 Goldstone
- L150 Ivory
- L151 White
- L709 Sugar
- L710 Lava
- L711 Parchment
- L712 Buff
- L713 Sand
- L714 Maize
- L715 Camel
- L716 Khaki
- L717 Cameo
- L718 Mushroom
- L719 Taupe
- L720 Fawn
- L721 Rock
- L722 Desert
- L723 Storm
- L724 Mist
- L725 Teal
- L726 Celadon
- L727 Egyptian Blue
- L728 Bright Blue
- L729 Aquarium
- L730 Hunter
- L731 Fern
- L732 Edamame
- L733 Moss
- L734 Key Lime
- L735 Creamsicle
- L736 Lemon
- L737 Sunshine
- L738 Drama
- L739 Byzantium
- L740 Dazzle
- L741 Fuchsia
- L742 Flamingo

3D Knit

- 5064 Licorice
- 5065 Coconut
- 5066 Malt
- 5067 Root Beer
- 5090 Wasabi
- 5091 Maya Blue
- 5092 Graphite
- 5093 Nickel
- 5094 Tangerine
- 5095 Scarlet
- 5096 Turmeric
- 5097 Concord
- 5098 Blue Jay
- 5099 Basil

Upholstery

▶ See page 706 for a complete listing of upholstery colors and numbers.

▶ Check the COM database for specific product and fabric approvals.

Steelcase Wood Seating Surface Materials

This listing includes all the surface material choices that are available for the Steelcase Wood Seating products in this specification guide.

Resources

For more information about surface materials, refer to the following resources:

Additional surface materials specification tools are available to assist you in the specification process—the Surface Materials Binders.

Surface Materials Binders

- Surface Materials Reference Manual
- A complete set of swatch cards for hard surfaces, vertical surface fabrics, and seating upholstery

Metal

- 4798 Sterling Metallic
- 7026 Nickel
- 7207 Black
- 8046 Polished Aluminum
- 9201 Polished Chrome

Paint

- 0835 Black
- 4799 Platinum Metallic
- 7207 Black

Wood

▶ See *Color Availability Matrix for Wood Seating in Surface Materials Reference Manual for color availability by product line.*

Tip: The wood used in the construction of chairs is either maple or European beech. Wood finishes applied to maple or beech will match the color of stains applied to oak, walnut, or cherry, but will not have the same natural grain.

- 3062 Graphite Walnut
- 3402 Clear Cherry
- 3412 Natural Cherry **E**
- 3422 Medium Cherry
- 3522 Clear Maple*
- 3572 Amber on Maple
- 3592 Blonde on Maple
- 3602 Desert Oak
- 3612 Warm Oak
- 3692 Espresso Oak
- 3702 Clear Walnut
- 3712 Natural Walnut
- 3722 Dark Mahogany on Walnut
- 3752 Medium Walnut
- 3762 Dark Walnut
- 3772 Medium Mahogany on Walnut

**To ensure an understanding of the color ranges and characteristic variations of natural veneer, a sign-off sheet is required prior to orders being accepted for this clear-coat finish. The sign-off sheet is available through Steelcase advertising stock. Form number 05-0001370.*

Customiz stain is a service that allows you to create your own stain color. Minimum order quantities, per unit up-charges, and a one-time customer processing fee apply.

▶ See the *Surface Materials Reference Manual* for more information.

Upholstery

▶ See page 706 for a complete listing of upholstery colors and numbers.

▶ Check the COM database for specific product and fabric approvals.

E = Established

► For Surface Materials matrices for all Turnstone product lines, see *Surface Materials Reference Manual*.

Paint

Applies to:

- Scoop
- 4799 Platinum Metallic
- 7207 Black

Applies to:

- Jenny tablet arm
- 7207 Black

Plastic

Applies to:

- Jenny tablet arm
- Jenny end table
- Jenny coffee table
- 6205 Black

Applies to:

- Scoop
- 6618 White
- 6682 Cobblestone

Applies to:

- Jenny end table edge band
- Jenny coffee table edge band
- 6000 Black
- 6009 Arctic White
- 6034 Natural Cherry **E**
- 6037 Winter on Maple
- 6053 Seagull
- 6234 Clear Cherry
- 6242 Virginia Walnut
- 6243 Blackwood
- 6245 Clear Walnut
- 6246 Warm Oak
- 6636 Mist
- 6654 Sand
- 6676 Marbled Maple
- 6677 Chocolate Walnut
- 6678 Marbled Cherry
- 6689 Brushed Silver

Laminate

Low-Pressure Laminate

Applies to:

- Jenny tablet arm
- Jenny end table
- Jenny coffee table
- 247L Black Version 2 LPL
- 25L1 Winter on Maple LPL
- 25L5 Virginia Walnut LPL
- 25L6 Blackwood LPL
- 25L8 Clear Walnut LPL
- 25L9 Warm Oak LPL
- 262L Marbled Maple LPL
- 264L Chocolate Walnut LPL
- 267L Marbled Cherry Version 2 LPL
- 26L1 Natural Cherry Version 2 LPL
- 2L03 Brushed Silver LPL
- 2L30 Arctic White LPL
- 2L50 Vanadium Fiber LPL
- 2L52 Tungsten Fiber LPL
- 2L83 Seagull LPL
- 2L85 Dune LPL

High-Pressure Laminate

Applies to:

- Jenny tablet arm
- Jenny end table
- Jenny coffee table
- 2406 Clear Cherry
- 2412 Natural Cherry Version 2 HPL
- 2503 Brushed Silver HPL
- 2511 Winter on Maple HPL
- 2535 Virginia Walnut HPL
- 2536 Blackwood HPL
- 2538 Clear Walnut HPL
- 2539 Warm Oak HPL
- 2612 Marbled Maple HPL
- 2614 Chocolate Walnut HPL
- 2615 Marbled Cherry Version 2 HPL
- 2730 Arctic White HPL
- 2746 Black HPL
- 2850 Vanadium Fiber HPL
- 2852 Tungsten Fiber HPL
- 2883 Seagull HPL
- 2885 Dune HPL

Note: Some wood veneer finishes and woodgrain laminates share the same name. Because of the difference in materials, veneers and laminates of the same name are not an exact match but do coordinate with each other.

Wood

Applies to:

- Jenny wood legs
- Jenny wood arm
- 3412 Natural Cherry **E**
- 3522 Clear Maple
- 3762 Dark Walnut

Tip: Due to natural variations in wood, finished products may vary in color, texture and grain.

Turnstone Leather

T802 Black
T803 Port
L305 Brown Leather

Upholstery

► See *Surface Materials Reference Manual* for a complete listing of upholstery colors and numbers.

► Check the COM database for specific product and fabric approvals.

E = Established

Visual Worktools Surface Materials

This listing includes all surface material and/or finish choices applicable to Premium Whiteboards and Tackboards, and Contractor Series. Not all surface material and/or finish choices are available on all products. Please refer to the Finish Matrices.

► For surface materials matrices, see the *Visual Worktools Specification Guide*.

Paint

Price Group 2

- 0835 Black **E**
- 4750 Champagne Metallic
- 4798 Sterling Metallic
- 4799 Platinum Metallic

Metal Paint

Price Group 2

- 8043 Clear Anodized Aluminum
- 8044 Black Anodized Aluminum

Wood

Wood Trim Finishes

The wood finish is an open pore, high gloss finish on maple, cherry, or walnut. Colors match current Steelcase wood finishes in color only and do not match the Steelcase finish in sheen.

- 3412 FC/OP Natural Cherry **E**
- 3422 FC/OP Medium Cherry
- 3572 FC/OP Amber on Maple
- 3592 FC/OP Blonde on Maple
- 3712 FC/OP Natural Walnut on Walnut
- 3772 FC/OP Medium Mahogany on Walnut

Markerboard Surface

Markerboards are standard in white high-gloss 7655 e³ environmental ceramicsteel. Optional screenprint patterns are available to provide a guide for writing or drawing. See below for patterns.

Standard:

- 7655 High Gloss White

Optional Screenprint on e³ environmental ceramicsteel:

- 7656 2" Circular Dot Pattern
- 7657 2" Grid Pattern
- 7658 Music Staff Lines

Vertical Surface Fabric

Fabric Tackboard Surfaces

Tackboard surfaces are available in select Steelcase and Designtex fabrics; pricing for Designtex and Steelcase fabrics is determined by a grading program. All fabrics are applied railroaded, i.e. salvages parallel to floor.

Price Group 1

Abacus **E**

- P122 Entasis
- P123 Portico
- P124 Opus
- P125 Cusp
- P126 Artifact
- P129 Atlas

Bariolage

- G220 Etude
- G221 Andante
- G226 Cantata
- G227 Adagio
- G233 Melody
- G234 Ballata
- G235 Sonata

Designtex Graded-In Program

For additional information and fabric samples, contact your local Designtex sales representative at 1.800.221.1540.

The following fabrics are part of the program formerly known as Designtex Graded-In. These patterns can be ordered through the Select Surfaces order fulfill model.

► See *Surface Materials Reference Manual* for complete Select Surfaces ordering information.

Price Group 2

- Brunswick - 6307
- Solara - 4101

Price Group 3

- Foxtrot - 6375
- Sumo - 6499

Price Group 4

- Rivergrass - 2690

Price Group COM (Customer's Own Material)

Fabric Approval and Yardage

To confirm whether a particular COM material has already been tested for use on a specific Steelcase product or to determine actual yardage requirements:

- Visit www.steelcase.com

For additional information regarding Customer's Own Material, call

1.888.STEELCASE (1.888.783.3522) or send an e-mail to lineone@steelcase.com.

E = Established

Upholstery and Color Numbers

Upholstery

Not all fabrics are available on all products. See the COM database for specific product and fabric availability.

Price Group 1

Buzz2

- 5F01 Camel **E**
- 5F03 Tomato
- 5F04 Red **E**
- 5F05 Burgundy
- 5F06 Sky **E**
- 5F07 Blue
- 5F08 Navy
- 5F10 Grape **E**
- 5F11 Eggplant **E**
- 5F15 Stone
- 5F16 Grey
- 5F17 Black
- 5G50 Dunegrass
- 5G51 Sable
- 5G52 Barley
- 5G53 Sunrise
- 5G54 Carrot
- 5G55 Pumpkin
- 5G56 Timber
- 5G57 Rouge
- 5G58 Chocolate
- 5G59 Meadow
- 5G60 Ivy
- 5G61 Cyan
- 5G62 Atlantic
- 5G63 Crocus
- 5G64 Alpine
- 5G65 Tornado

Jacks

- 5B61 Taupe
- 5B63 Camel
- 5B64 Pewter
- 5B66 Plum
- 5B70 Midnight

Link

- 5A20 Burgundy
- 5A21 Rust
- 5A23 Green
- 5A24 Blue
- 5A25 Navy
- 5A26 Purple
- 5A27 Black
- 5A28 Ocean
- 5A29 Lichen
- 5A30 Chamois

Playground

- 5F28 Claret
- 5F29 Chile
- 5F30 Amber
- 5F31 Nut
- 5F32 Blade
- 5F33 Stone
- 5F34 Sky
- 5F35 Navy
- 5F36 Huckleberry
- 5F37 Charcoal

Seating Vinyl

- 5801 Topaz
- 5805 Foggy Night
- 5809 Black
- 5810 Forest
- 5812 Navy
- 5813 Currant
- 5814 Leaf
- 5815 Seaside
- 5817 Pebble
- 5818 Spice
- 5819 Thistle
- 5820 Coffee
- 5822 Iris

Price Group 2

Cogent: Connect

- 5S15 Coconut
- 5S16 Turmeric
- 5S17 Tangerine
- 5S18 Scarlet
- 5S19 Concord
- 5S20 Maya Blue
- 5S21 Blue Jay
- 5S22 Basil
- 5S23 Wasabi
- 5S24 Nickel
- 5S25 Graphite
- 5S26 Licorice
- 5S27 Malt
- 5S28 Root Beer
- 5S93 Blueprint
- 5S94 Lizard
- 5S95 Sailor
- 5S96 Quicksilver
- 5S97 Nugget
- 5S98 Canary
- 5S99 Lipstick

Cogent: Geode Seating

- 5S46 Bark
- 5S47 Coal
- 5S48 Smoke
- 5S49 Cobalt
- 5S50 Ink
- 5S51 Shamrock
- 5S52 Pear
- 5S53 Berry
- 5S54 Mandarin
- 5S55 Sunset
- 5S56 Citrus
- 5S57 Thunder

Cogent: Geode Vertical

- 5S31 Pebble
- 5S32 Canyon
- 5S33 Honey
- 5S34 Ice
- 5S35 Slate
- 5S36 Cement
- 5S37 Rock
- 5S38 Oyster
- 5S39 Buff
- 5S40 Toast
- 5S41 Sesame
- 5S42 Ecru
- 5S43 Dove

Cogent: Trails

- 5S29 Bronzite
- 5S30 Amethyst
- 5S84 Jasper
- 5S85 Agate
- 5S86 Lapis
- 5S87 Malachite
- 5S88 Quartz
- 5S89 Carnelian
- 5S90 Tiger Eye
- 5S91 Travertine
- 5S92 Topaz

Cricket

- 5A84 Plum
- 5A85 Camel
- 5A86 Charcoal
- 5A87 Black
- 5A90 Currant
- 5A91 Spearmint
- 5A92 Sky
- 5A93 Midnight
- 5A95 Ocean
- 5A96 Forest

Crosswalk

- 5F48 Beech
- 5F49 Moon
- 5F50 Berry
- 5F51 Admiral Blue
- 5F52 Moss
- 5F53 Persimmon
- 5F54 Bittersweet
- 5F55 Midnight
- 5F56 Poppy

Nitelights

- 5F58 Hazelnut
- 5F59 Burgundy
- 5F60 Cherry
- 5F61 Earth
- 5F62 Shore
- 5F63 Moss
- 5F64 Sea
- 5F65 Regal Blue
- 5F66 Stone
- 5F67 Moon

Regis2

- 5F18 Black
- 5F24 Pacific
- 5F26 Cherry
- 5F27 Navy

Spyder

- 5B00 Orchid **E**
- 5B01 Foggy Night **E**
- 5B04 Peri **E**
- 5B05 Merlot **E**
- 5B06 Dove **E**
- 5B07 Sage **E**
- 5B09 Topaz **E**
- 5B11 Currant **E**
- 5B12 Lichen **E**

Zoe2

- 5C90 Eggplant
- 5C91 Aloe
- 5C92 Fiddle
- 5C93 Patina
- 5C94 Peacock
- 5C95 Rain
- 5C96 Grey Flannel
- 5C97 Pebble
- 5C98 Cymbal
- 5C99 Fiesta

Price Group 3

Cogent: Tides

- 5S71 Butter
- 5S72 Snow
- 5S73 Celery
- 5S74 Wicker
- 5S75 Pool
- 5S76 Cloud
- 5S77 Grass
- 5S78 Clay
- 5S79 Hyacinth
- 5S80 Jet
- 5S81 Doe
- 5S82 Boysenberry
- 5S83 Night

Hampstead

- B351 Blue Green V4 **E**
- B359 Blue Blue
Green V5 **E**
- B366 Blue Blue Violet
V4 **E**
- B369 Blue Blue Violet
V5 **E**
- B377 Violet V5
(Low Intensity) **E**
- B389 Red Red
Violet V5 **E**
- B395 Grey V5 **E**
- B399 Black
- B406 Windflower **E**
- B413 Shale **E**
- B423 Clementine
- B424 Butter Cream
- B425 Iris
- B426 Sapphire
- B427 Turquoise
- B428 Navy
- B429 Charcoal
- B430 Spa
- B431 Plum
- B432 Cocoa
- B433 Cork
- B434 Stone
- B435 Metal
- B436 Peridot
- B437 Cactus
- B438 Sycamore
- B439 Candy Apple

Price Group 5

Bo Peep

- 5G66 Pita
- 5G67 Bone
- 5G68 Safari
- 5G69 Brown Sugar
- 5G70 Chocolate Chip
- 5G71 Candlelight
- 5G72 Honey Mustard
- 5G73 Marmalade
- 5G74 Picnic
- 5G75 Pinot
- 5G76 Bloom
- 5G77 Grapevine
- 5G78 Firefly
- 5G79 Artichoke
- 5G80 Serpent
- 5G81 Carolina
- 5G82 Blue Bonnet
- 5G83 Nautical
- 5G84 Gravel
- 5G85 Sharkskin
- 5G86 Kohl

Price Group 6

Brisa

- BR01 Black Onyx
- BR04 Truffle
- BR06 Ash
- BR07 Sage
- BR08 Celery
- BR09 Sterling Blue
- BR10 Night Navy
- BR11 Cambridge Blue
- BR12 Abyss
- BR13 Canyon
- BR14 Pompeian Red
- BR15 Salsa
- BR16 Cinnabar
- BR17 Aztec
- BR18 New Sand
- BR19 Cream
- BR20 White
- BR21 Moccasin
- BR22 Buckskin
- BR23 Prairie

Leather Price Group

- L107 Black
- L202 Dusk
- L203 Bottle
- L207 Mahogany
- L220 Soapstone
- L221 Rocky
- L224 Plum
- L500 Camel
- L503 Navy
- L507 Vineyard

E = Established

**Select Surfaces
Designtex**

For additional information and fabric samples, contact your local Designtex sales representative at 1.800.221.1540.

The following fabrics are part of the program formerly known as Designtex Graded-In. These patterns can be ordered through the Select Surfaces order fulfillment model. These materials are available on Steelcase and Nurture brand products.
▶ See *Surface Materials Reference Manual* for complete Select Surfaces ordering information.

**Price Group 2 -
Finish Code 59DB**

Bee - 4975
Ludington - 3285
Sandpiper - 3313

**Price Group 3 -
Finish Code 59DC**

Boyne - 3280
Crossroads - 2895
Great Lakes - 3282
Lagoon - 4977
Prairie - 2552
Rocket - 2693

**Price Group 4 -
Finish Code 59DD**

Astrid - 2747
At Ease - 3309
Bolzano - 3412
Bunta - 3360
Candor - 3306
Closed Loop - 2550
Easy Going - 3305
Free & Easy - 3316
Glen Arbor - 3283
Gujarat - 3357
Introvert - 2879
Kalanga - 3359
Leland - 3281
Matter of Fact - 3356
Metta - 2681
No Frills - 3318
Nonchalant - 3307
Omar Seating - 2865
Sari - 3361
Sarong - 3358
Saugatuck - 3284
To The Point - 3308
Topiary - 2897
Well Rounded - 3317

**Price Group 5 -
Finish Code 59DE**

Abex - 2072
Appleseed - 2682
Brooch - 2762
Café - 2789
Caillou - 2778
Cascadia - 2733
Crossover - 2683
Fonte - 2796
Halos - 2899
Kabuki - 2794
Metaphor - 2877
Protect - 2852
Salon - 2797
Surface - 2787
Sustain - 2851
Synchronize - 2876
Tailored Stripe - 2763
Terrasse - 2795
V - 2957

**Price Group 6 -
Finish Code 59DF**

Acacia - 2843
Agave - 2847
Alistair - 2992
Allure - 2756
Amaranth w/o Crypton - 2855u
Amuse - 2767
Arlington - 2724
Banda - 3227
Barnsbury - 2726
Bottle Bank - 2869
Cassava - 2838
Chicory - 2993
Circolo - 3229
Converge - 2873
Copa - 2641
Coupe - H245
Dahlia - 2995
Décor - H244
Dot to Dot - 2691
Downtown - 2029
Epiphany - 2734
Faconne - 2764
Friendly Faux w/Knit Backing - 2008
Griglia - 3231
Hula Hoop - 3297
Kenaf - 2859
Kenaf w/o Crypton - 2859u
Klange - 2741
Knockabout - 3326
Laureate - 2774
Palace - H254
Pivot - 3374
Pueblo - 2844
Quintessence - 3347
React - 2861
Rice - 2858
Rough & Ready - 2016
Salvage - 2867
Seed - 2839
Senna - 2848
Sequence - 2742
Sock Hop - 3298
Soda Pop - 2868
Square - 2788
Swing Set - 2421
Tangent - 2875
Tartan - 2994
Teddy - H236
Terrain - 2846
Transpose - 2874
Tumbleweed - 2845

**Price Group 7 -
Finish Code 59DG**

Amaranth - 2855
Baratto - 3266
Battista - 2718
Beam - 2785
Bon Bon - 2749
Calm - 2768
Cestino - 3270
Chakin - 7146
Coperta - 3228
Drive-In - 3299
Dwell - 2850
Faux Sure w/Knit Backing - 3351
Flux - 3239
Fuse w/Knit Backing - 3362
Garden Key - 3252
Inertia - 3235
Juxtaposition - 2744
Kaleidoscope - 2863
Lorien - H201
Minuet - 2656
Oscillate - 3238
Point - 2783
Razor Stripe - 2857
Samba - 2654
Samba Otra Vez - 2885
Spiro - 3237
Sundance - 3278
Uptown - 2024
Yoruba - 3333
Ziggurat - 2827

**Price Group 8 -
Finish Code 59DH**

Biba - H216
Chandelier - 7354
Circumference - 2884
Facets - 7350
Honor Plus - 2547
Hue - 2710
Maglia - 3233
Nexus - 3236
Polygon - 2883
Thumbnail Sketch - 2841
Titanium - 2842
Torsade - 7358
Valanka - 3279
Wire - 2743

**Price Group 9 -
Finish Code 59DJ**

Bangles - 7352
Belvedere - 3275
Gotham - 2390
Gramercy - 2599
Hofburg - 3276
Yorkshire - 2771

**Price Group 10 -
Finish Code 59DK**

Chalet - 3290
Kanthas - H238
Links - 7353
Lolland - 3263
Metamorphosis w/Knit Backing - 3367
Migration w/Knit Backing - 3373
Shimmering Tide w/Knit Backing - 3369
Tumble Stones w/Knit Backing - 3371
Wood Work w/Knit Backing - 3372

**Price Group
COM/COL
(Customer's Own
Material/Leather)**

**Fabric Approval and
Yardage**

To confirm whether a particular COM material has already been tested for use on a specific Steelcase or Nurture product or to determine actual yardage requirements:
• Visit www.steelcase.com

For additional information regarding Customer's Own Material, call 1.888.STEELCASE (1.888.783.3522) or send an e-mail to lineone@steelcase.com.

For Nurture products, call 1.800.342.8562.

Nurture Graded-In Programs

Nurture Graded-In Program: Acrylic Panel

A collection of acrylic panels are available as part of a Graded-In Program. The collection is from the Designtex Fusion offering.

These acrylic panels are Graded-In for the Sonata product only. The collection on these pages is not Graded-In for other Steel-case brands or product lines.

To order these acrylic panels, enter the finish code which corresponds with the acrylic panel price group.

Price Group	Finish Code
1	65DA
2	65DB
3	65DC
4	65DD

Then enter the acrylic panel information in the Special Acrylic Panel Information pop up window. If prompted, enter the finish code DSGNTX0002 based on the acrylic panel supplier.

Designtex

Fusion Offering

Price Group 1

Blueberry
Bluestone
Bubblegum
Canary
Candy Apple
Etch
Grape
Key Lime
Lemon
Periwinkle
Plum
Red
Sea
Searchlight
Slate
Tangerine
White
White Dot
White Rain
White Ribbon

Price Group 2

Berry Grid
Bone Linen
Cloud Grid
Espresso Sketch
Flame Sketch
Flannel Linen
Granny Smith Grid
Grapefruit Grid
Halo
Honey Sketch
Ice Sketch
Noir Linen
Orange Grid
Pistachio Sketch
Reef Linen
Scarlet Sketch
Sky Grid
Tiki Stalk
Windowbox

Price Group 3

Kenya Rush
Ogee
Prairie Stalk
Savannah Rush
Straws

Price Group 4

Coil
Convection
Desert Stalk 50% More
Drink Tray
Fingerprints
Grassland
Green Sheer Leaf
Illumination
Large Sheer Leaf
Maroon Sheer Leaf
Plain
Rock Candy
Sapphire Rock Candy
Small Sheer Leaf
Toffee Sheer Leaf
Underwood

Nurture Graded-In Program: Solid Surface

A collection of solid surfaces are available as part of a Graded-In Program. The collection is from the Corian solid surface offering.

These solid surfaces are Graded-In for the Folio, Sonata, Sync, Senza, Tava, and Leela products only. The collection on these pages is not Graded-In for other Steelcase brands or product lines.

To order these solid surfaces, enter the finish code which corresponds with the solid surface price group.

Price Group	Finish Code
A	29DA
B	29DB
C	29DC
D	29DD
E	29DE

Then enter the solid surface information in the Special Solid Surface Information pop up window. If prompted, enter the finish code CORIAN0001 based on the solid surface supplier.

Corian

Solid Surface Offering

Price Group A

Glacier White

Price Group B

Abalone
Aurora
Cameo White
Canyon
Cobalt
Flint
Maui
Mojave
Moss
Platinum
Sahara
Sand
Sandstone
Savannah
Silt
Tarragon
Vanilla

Price Group C

Acorn
Adobe
Bethany
Blue Crush
Blue Pebble
Canyon Trail
Cocoa Brown
Cottage Lane
Doeskin
Fossil
Granola
Gray Fieldstone
Gray Pebble
Mardi Gras
Matterhorn
Medea
Mosaic
Night Sky
Oat
Pine
Riviera
Sage Graystone
Shale
Silver Birch
Stone Harbor
Suede
Willow

Price Group D

Anthracite
Azurite
Bronze Patina
Bronzite
Concrete
Copperite
Designer White
Dove
Fawn
Graphic Blue
Green Tea
Hot
Lilac
Mandarin
Nocturne
Olivite
Pompeii Red
Raffia
Rice Paper
Serene Sage
Silverite
Sun
Tranquil
Venaro White
Whisper
White Jasmine

Price Group E

Aqualite
Arctic Blueberry
Arctic Ice
Arctic Lime
Arctic Mint
Arctic Strawberry
Aztec Gold
Blueberry Ice
Burled Beach
Chamois
Cinnabar
Cirrus White
Clam Shell
Earth
Ecu
Elderberry
Glacier Ice
Graylite
Jasmine
Juniper
Lava Rock
Lime Ice
Mint Ice
Natural Gray
Rain Cloud
Rosemary
Saffron
Sagebrush
Sandalwood
Slate
Sonora
Sorrel
Strawberry Ice
Thyme
Tumbleweed
Verde
Witch Hazel

Nurture Graded-In Program: Upholstery

A collection of textiles are available as part of a Graded-In Program. The collection from the leading suppliers in the market consists of high-performance textiles that meet the demands of healthcare environments. Note that not all fabrics can be applied to all seating products. Refer to the Steelcase COM database for the most current application information.

To order these fabrics, enter the finish code which corresponds with the fabric price group.

Price Group	Finish Code
2	59DB
3	59DC
4	59DD
5	59DE
6	59DF
7	59DG
8	59DH
9	59DJ
10	59DK

Then enter the fabric information in the Special Fabric Information pop up window. Enter the appropriate finish code from the list below, based on the fabric supplier.

Supplier	Finish Code
Architex	ARCHTX0001
ArcCom	ARCCOM0001
CF Stinson	CFSTIN0001
DesignTex	DSGNTX0001
Maharam	MAHARA0001
Momentum	MOMENT0001
Ultrafabrics	ULTRAF0001

Fabric application direction must be specified.

► See page 712 for *Fabric Application Direction Guidelines* to ensure fabric is specified in the correct direction.

Architex

Price Group 5

Daytona
Linen

Price Group 6

Ellipse
Joy
Matrix
Radius

Price Group 7

Animal
Authentec
Daybreak
Hyde
Patent
Sprig
Tegan
Tibet
Vanish
Voila

Price Group 8

Bonnie
Delight
Easton
Fish Out Of Water
Kenga
Mabel
Pick Up Sticks
Ruth
Sarah
Spellbound
Thrive
Your Bird Can Sing

Price Group 9

Bamboo Mate
Brook
Burst
Follow Me
Morin
Nili
Ripples

Price Group 10

Pelle

Arc-Com

Arc-Com graded-in fabrics can only be used on Nurture brand products.

Price Group 4

Duchess
Illusion
Lancaster

Price Group 5

Alamo
Cassio
Durango
Frontier
Gatsby
Pebble Beach
Shimmer
Silver Birch
Strata
Terra

Price Group 6

Allegra
Bravo
Checkmate
Chit-Chat
Etch
Fireflies
Gem
Grand Central
Grassland
Hopscotch
Jing
Leonardo
Lotus
Matrix
Palatine
Panache
Pinpoint
Sierra
Silverado
South Street
Suede Sensation
Sylvan
Tribeca
Vibrato
Willow

Price Group 7

Abacus
Aline
Aruba
Ashanti
Bauble
Beat Box
Bourbon Street
Broadway
Bronco
Cadence
Carnival
Dorset
Eclipse
Élan
Grammercy Park
Hemisphere
Hydro
Iguana
Intaglio
Iron Gate
Link
Mirage
Moon Beam
Mystique
Notting Hill
Pinball
Pong
Quadrant
Rhythm
Savannah
Stonehenge
Sublime
Symphony
Trio
Vibe
Whirlwind
Wonderland

Price Group 8

Bounce
Bubbly
Circuit
Diamond Derby
Espirit
Flora
Forsythia
Gamble
Heirloom
Jardin
Kalahari
Kendo
Kensington
Lily Pond
Masquerade
Nikko
Oasis
Piazza
Posh
Radiant
Riviera
Royal Garden
Salsa
Seagrass
Sherwood
Spotlight
Spring
Strand-It
Tango
Tatami
Tuscany
Victoria
Volley
Yoyo

Price Group 9

Francesca Wool
Francesca Wool II
Groovy
Juliet
Sagrada
Uptown
Wind Chime

Price Group 10

Fantasia
Far Out

CF Stinson

Price Group 3

Laredo
Rally

Price Group 4

Avant
Bistro
Checkmate
Cumulus
Moccasin
Naugasoft
Oxford
Rialto
Shantung
Simplicity
Symphony Classic
Whisper
Ziggy

Price Group 5

Chroma
Cirque
Dash
Geomet
Liquid
Matrix
Napa
Raffia
Southampton
Tendrill
Tessuto
Whitney

Price Group 6

Persuasion
In The Round w/Stakleen
Script
Snuggle
Sundance w/Stakleen

Price Group 7

Adirondack
Aspen
Banyan
Bali
Bari
Beeline
Block Party
Bower
Capreni
Carat
Catwalk
Couplet
Cozy
Crush
Dodgeball
Eli
Equinox
Folio
Hands On
Martini
Match Point
Mingle
Olympus
Over Under (By Patty Madden)
Petals
Pinstripe
Raquette
Rivera
Silverado W/Agion
Spandrel
Sterling W/Agion
Straight And Narrow
Tweed
Twist
Vibe
Wink W/Agion
Ybor

Price Group 8

Balance Beam
Cinnamon Blossom
Colden
Courtyard
Eclipse
Flutter
Geodesic
Hoopla
Labyrinth
Lucky Charm
Panache
Skyline
Sumatran Palm
Sunburst
Vintage
Wired

Price Group 9

Chi w/Agion
Daddy-O w/Agion
Good Fortune w/Agion
Haiku w/Agion
Jam Session w/Agion
Jump w/Agion
Now & Zen w/Agion
Tatami w/Agion
True Path w/Agion
Tuscan Lattice
Umbrian Stripe
Up Tempo w/Agion
Zen Garden w/Agion

Price Group 10

Double Time w/Agion
Glisten
In The Groove w/Agion
Mesa
Tuscan Garden
Tuscan Hills
Umbrian Landscape
Umbrian Rain
Umbrian Village
Verve w/Agion
Volterra-Hc

Designtex

Price Group 4

Bolzano
Kalanga
Metta
Parga
Rondine
Sorano
Spandau
Tarascon

Price Group 5

Alcazar
Annex
Avenza
Breena
Figure Eight
Florin
Inside Edge
Leafette
Lino
Pianta
Prism
Rumeli
Skylark

Price Group 6

Acacia
Agave
Alistair
Amuse
Anello
Arlington
Banda
Barnsbury
Bounce
Cassava
Chicory
Circolo
Copa
Dahlia
Dot To Dot
Downtown
Drawing Straws
Friendly Faux
Griglia
Gujarat
Hula Hoop
Kenaf
Lindos
Pueblo
Quintessence
Rice
Seed
Senna
Swing Set
Tartan
Terrain
Tumbleweed
Vinca

Price Group 7

Alemanya
Alkai
Amaranth
Basket Weaver
Bon Bon
Bossa Nova
Calm
Clovis
Coperta
Details
Dodge Ball
Dodge Ball Too
Faux Sure
Flux
Four Square
Inertia
Jungle Gym
Line Item
Mena
Minuet
Oscillate
Pasa Doble
Pattino
Prana
Samba
Samba Otra Vez
See Saw
Spiro
Sprocket
Tinos
Tupi
Uptown
Widget

Price Group 8

Boreas
Honor Plus
Maglia
Nexus
Southside

Price Group 10

Journey

Maharam

Maharam graded-in fabrics can only be used on Nurture brand products.

Price Group 5

Article
Ledger

Price Group 6

Candid
Chime
Flicker
Lariat
Petal
Quick
Reverie

Price Group 7

Align
Alloy
Assemblage
Beside
Bop
Chance
Corner
Crush
Current
Double Check
Kernel
Scuba
Trait
Wafer

Price Group 8

Akimbo
Box
Comment
Dart
Decode
Floret
Intertwine
Scout
Venn
Verse

Price Group 10

Chenille Cord

Momentum

Momentum graded-in fabrics can only be used on Nurture brand products.

Price Group 3

Cashmere

Price Group 4

Array
Crete
Fleck
Sublime
Tatami

Price Group 5

Bravo
Crypton Suede
Echo
Evoke
Foray
Jolt
Max
Smart Suede
Tact

Price Group 6

Brea
Clue
Crux
Icon
Kinetic
Lumiere
Paragon
Query
Radiate
Rio
Topanga
Tweed
Viva
Zoom

Price Group 7

Amenity
Bandwidth
Delmonico
Feliz
Frolic
Huntington
Hyphen
Jax
Jest
Locale
Maxim
Narration
Premise
Schmooze
Sway
Telegram

Price Group 8

Ardour
Calabasas
Catalogue
Charade
Inhabit
Pomona
Recollection
Soma

Price Group 9

Effloresce
Emanate

Ultrafabrics

Price Group 6

Ultraleather

Price Group 7

Promessa

Fabric Application Direction Guidelines

What is the issue?

Some textiles are simple and look the same regardless of how you apply them to a product. Other fabrics are patterned, textured, or have luster that will have a distinctly different appearance applied in a different direction on a chair. Because of these differences, and the fact that there are limits to how some fabrics can be applied to Nurture products, it is important to understand fabric application direction when ordering a product to avoid being disappointed.

Talking about direction

Fabrics come on rolls. The long yarns that run down the length of the roll are called the “warp” yarns. These yarns are used to define the direction you are viewing the fabric as it is applied to a chair. Fabric directionality is determined by how the fabric comes off the roll.



It is NOT determined by the way the pattern looks on the product. For example, the image below shows the fabric applied warped horizontal although the stripes appear vertical.

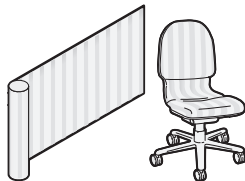

Terminology

Steelcase uses the terms warped horizontal and warped vertical. There are other terms within the industry that are used that have the same meaning:

- Warped horizontal is also referred to as:
 - railroaded or across roll
- Warped vertical is also referred to as:
 - woven way, down roll, or top out

Why is it important?

Dealers must specify fabric application direction when ordering COMs and Nurture Graded-In fabrics. We require the dealer to specify the direction because we do not know which way customers want to see a pattern on the furniture. Therefore, it is critical to know how the pattern is run on the roll to ensure that Nurture builds and ships each order to the customer’s expectation each and every time.

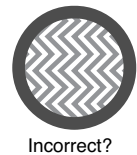

How do I know which way the fabric comes off the roll?

Most textile companies will swatch their fabrics in a warp vertical (woven way, down roll) direction. Some exceptions might be made to address patterns especially with stripes. Typically, when a fabric is swatched in a warp horizontal (railroad or across roll) direction, the direction is noted on the swatch card or fabric sample. If in doubt of a fabric direction, we encourage you to contact the textile vendor for clarification.

Vinyl

Vinyl generally only passes on Nurture product in a horizontal or across roll direction. This is due to physical properties of the material. If a vinyl is applied in the opposite direction, too much stretch in the material can compromise the overall aesthetics of the final upholstery. If a patterned vinyl is being specified and the vinyl must be run in a vertical direction, pre-approval must be arranged through Nurture. Nurture will consider the request and a decision will be made based on the specific vinyl and product combination. Contact Nurture’s Customer Care line.

Required Action Steps before Specifying

1. Verify by using Steelcase’s COM website that the fabric is approved on the product.
2. Verify the direction that the fabric can be applied. Occasionally a fabric is only approved in one direction.
3. Confirm with the customer how they want the fabric to look on the furniture.
4. Confirm using the swatch card or vendor’s website the direction the sample is shown.
5. Now you’re ready to place the order.