

Steam Oven

BS 260/261-6..

Table of Contents

Important Safety Instructions	4	Timer	29
Fire Safety	4	Calling up the Timer Menu	29
Burn Prevention	4	Timer	29
Child Safety	4	Stopwatch	30
Safety while Baking and Steaming	4	Cooking Time Duration	31
Cookware Safety	5	Cooking Time End	32
Proper Installation and Maintenance	5		
Operating for the First Time	6	Sabbath Mode	33
		Setting the Program	33
		Note	33
Avoiding Damage to the Appliance and the Cabinet	6	Child Lock	34
Steam Oven and Cabinet Fronts	6	Activating the Child Lock	34
Avoiding Damage to the Oven Interior	6	Deactivating the Child Lock	34
		Note	34
Features of your New Steam Oven	7	Safety Deactivation	35
Steam Oven	7		
Display and Controls	8	Changing the Basic Settings	36
Keys	8	Note	36
		Example: Changing the Standby Screen	36
Accessories	9		
		Basic Settings	37
Heating Modes	10		
		Care and Manual Cleaning	39
Water Tank	11	Safety Notes	39
		Oven Interior	39
First Settings after Installation	12	Cooking Inserts	39
Note	12	Racks	39
Choosing the Time Format	12	Grease Filter	39
Setting the Clock	12	Water Tank	39
Setting the Date	12	Glass Front	39
Temperature Unit °C or °F	13	Door Seal	39
Setting the Water Hardness	13		
Exiting Menu and Saving Settings	13	Cleaning Function	40
		How to Proceed	40
Calibration	14	Note	40
Calibrating the Steam Oven	14		
Note	14	Drying Function	41
		How to Proceed	41
Activating the Steam Oven	15	Note	41
Standby	15		
Activating the Steam Oven	15	Descaling Program	42
		How to Proceed	42
Setting the Steam Oven	16	Tip	43
Setting the Temperature and Heating Mode	16		
Note	17	Trouble Shooting	43
Current Oven Temperature Display	17	Error Messages	44
After Every Use	17	Power Cut	44
		Exhibition Mode	44
Meat Probe	18		
Programming the Meat Probe	18		
Note	19		
Cleaning	19		
Recommended Temperature Values	19		
Cooking Table	20		



Important Safety Instructions

Fire Safety

Read and save these instructions.

Do not use aluminum foil or protective liners to line any part of an appliance, especially surface unit drip bowls or oven bottom. Installation of these liners may result in a risk of electric shock or fire.

If materials inside an oven or warming drawer should ignite, keep door closed. Turn off the appliance and disconnect the circuit at the circuit breaker box.

Use this appliance only for its intended use as described in this manual. For example, never use the appliance for warming or heating the room. Never use the appliance for storage.

Always have a working smoke detector near the kitchen.

In the event that personal clothing or hair catches fire, drop and roll immediately to extinguish flames.

Smother flames from food fires other than grease fires with baking soda. Never use water on cooking fires.

Have an appropriate fire extinguisher available, nearby, highly visible and easily accessible near the oven.

Burn Prevention

DO NOT TOUCH HEATING ELEMENTS OR INTERIOR SURFACES OF OVEN – Heating elements may be hot even though they are dark in color. Interior surfaces of an oven become hot enough to cause burns. During and after use, do not touch, or let clothing, potholders, or other flammable materials contact heating elements or interior surfaces of oven until they have had sufficient time to cool. Other surfaces of the appliance may become hot enough to cause burns. Among these surfaces are oven vent openings, surfaces near these openings and oven doors.

Exercise caution when opening the appliance. Standing to the side, open the door (or drawer) slowly and slightly to let hot air and/or steam escape. Keep your face clear of the opening and make sure there are no children or pets near the unit. After the release of hot air and/or steam, proceed with your cooking. Keep doors shut unless necessary for cooking or cleaning purposes. Do not leave open doors unattended.

Do not heat or warm unopened food containers. Build-up of pressure may cause the container to burst and cause injury.

Always place oven racks in desired location while oven is cool. If a rack must be moved while oven is hot, do not let potholder contact the heating elements.

Always use dry potholders. Moist or damp potholders on hot surfaces may result in burns from steam. Do not let potholder touch hot heating elements. Do not use a towel or other bulky cloth.

Child Safety

When children become old enough to use the appliance, it is the legal responsibility of the parents or legal guardians to ensure that they are instructed in safe practices by qualified persons.

Do not allow anyone to climb, stand, lean, sit, or hang on any part of an appliance, especially a door, warming drawer, or storage drawer. This can damage the appliance, and the unit may tip over, potentially causing severe injury.

Do not allow children to use this appliance unless closely supervised by an adult. Children and pets should not be left alone or unattended in the area where the appliance is in use. They should never be allowed to play in its vicinity, whether or not the appliance is in use.

CAUTION – Items of interest to children should not be stored in an appliance, in cabinets above an appliance or on the backsplash. Children climbing on an appliance to reach items could be seriously injured.

Safety while Baking and Steaming

CAUTION – Hot steam can escape during use. Do not touch the ventilation openings.

CAUTION – Hot steam can escape when opening the oven door. Hot water may drip from the door. Keep children away.

CAUTION – Use an oven glove to take the cooking inserts out of the hot oven. Hot liquid may spill over when taking out the cooking inserts.



Important Safety Instructions

Cookware Safety

Do not place food directly on oven bottom.

Follow the manufacturer's directions when using cooking or roasting bags.

Proper Installation and Maintenance

WARNING: When properly cared for, your new appliance has been designed to be safe and reliable. Read all instructions carefully before use. These precautions will reduce the risk of burns, electric shock, fire, and injury to persons. When using kitchen appliances, basic safety precautions must be followed, including those in the following pages.

Have the installer show you the location of the circuit breaker or fuse. Mark it for easy reference.

This appliance must be properly installed and grounded by a qualified technician. Connect only to properly grounded outlet. Refer to Installation Instructions for details.

This appliance is intended for normal family household use only. It is not approved for outdoor use. See the Warranty. If you have any questions, contact the manufacturer.

Do not store or use corrosive chemicals, vapors, flammables or nonfood products in or near this appliance. It is specifically designed for use when heating or cooking food. The use of corrosive chemicals in heating or cleaning will damage the appliance and could result in injury.

Do not operate this appliance if it is not working properly, or if it has been damaged. Contact an authorized servicer.

Do not obstruct oven vents.

Do not repair or replace any part of the appliance unless specifically recommended in this manual. Refer all servicing to a factory authorized service center.

In the event of an error the display flashes. If this happens during self-clean, disconnect appliance from the power supply and call a qualified technician.

In the event of an error the display flashes. Disconnect appliance from the power supply and call a qualified technician.

Operating for the First Time

Remove the packaging from the appliance and dispose of it according to local regulations. Be careful to remove all accessories from the packaging. Keep packaging elements and plastic bags away from children.

Check the appliance for transport damage after unpacking it. Do not connect the appliance if it has been damaged.

The appliance must be connected by an authorised specialist. No warranty claims can be lodged for any damage resulting from incorrect connection. Observe the installation instructions.

Thoroughly clean the appliance before using it for the first time. This will eliminate any 'newness' smells and soiling.

Before operating the appliance fit the included grease filter to the inside rear wall.



This appliance is labelled in accordance with the European Directive 2002/96/EG concerning used electrical and electronic appliances (waste electrical and electronic equipment – WEEE). The guideline determines the framework for the return and recycling of used appliances as applicable.

Avoiding Damage to the Appliance and the Cabinet

Steam Oven and Cabinet Fronts

Do not cover the ventilation openings of the steam oven.

Do not take off the door seal. A damaged door seal must be changed immediately.

After taking the food out of the oven, allow the oven to cool down with the door closed. Do not leave the oven door half open, the hot air can cause damage to adjacent cabinets. The cooling fan will continue to run for a while and will then switch off automatically.

Avoiding Damage to the Oven Interior

The interior of your new steam oven is made out of high grade stainless steel. However, lack of care and maintenance might cause corrosion.

Observe the following tips to avoid corrosion in the oven. No warranty claims can be lodged for any damage resulting from non compliance with these notes.

- Clean the oven interior after it has cooled down. After cleaning, use the drying function to dry the oven interior.
- Aggressive cleaners may cause corrosion. Only use hot soapy water to clean the oven interior. Use the cleaning function.
- Do not use oven cleaner or caustic cleaners. Do not use cleaners containing chloride.
- Salt in the oven reacts aggressively. Salt residues on the oven interior may cause spots of corrosion. Always remove residues immediately.
- Spicy sauces (e.g. ketchup, mustard) and salted food (e.g. salted roasts) contain chloride and acids. These act aggressively on stainless steel. Always clean the oven interior after use.
- Only use original accessories in the oven interior. Rusting materials (e.g. serving plates, cutlery) may cause corrosion of the oven interior.
- Only use original small parts (e.g. knurled nuts). Order small parts from our after-sales service, should you lose any.

Features of your New Steam Oven

Steam Oven

This manual applies to different models.

The operation is identical for all models.



Display and controls

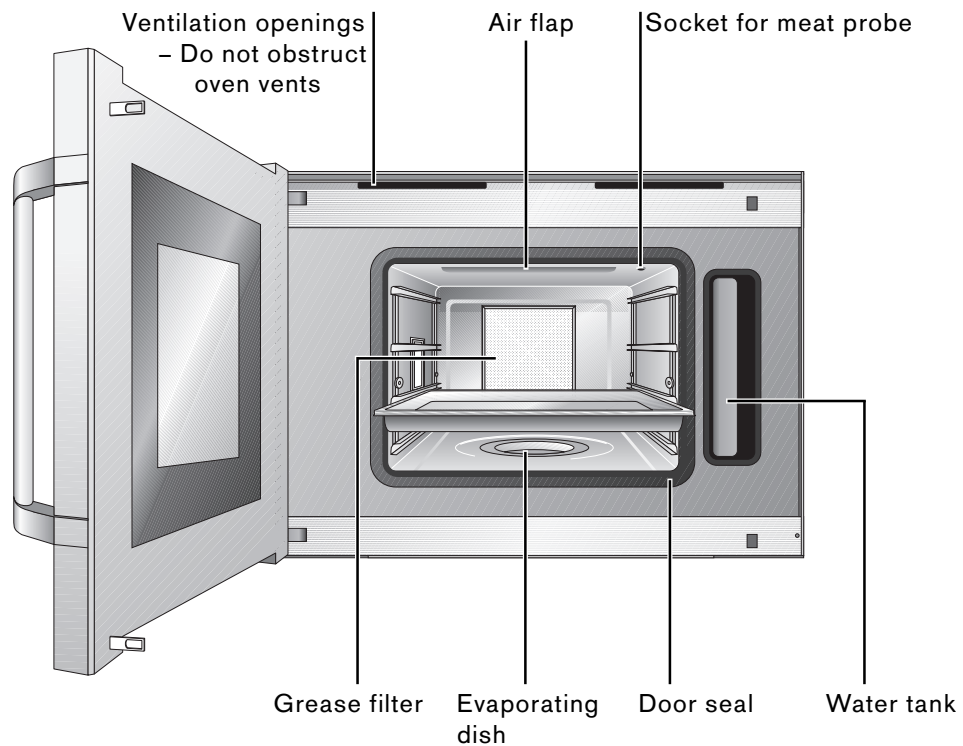

Display and Controls

Function selector

Use the left knob to select the cooking mode and moisture level you will use to prepare your meal. You can turn the knob to the right or left.

Temperature selector

You can turn the temperature selector to the right or left.

Temperature range is between 85 and 450°F.

First position to the right: switches on light

First position to the left: operates special functions (cleaning function, drying function, descaling)

Display

In the top part of the display is the status bar or a call up menu. The lower part shows the different settings.

Touch keys

The keys on the left and right beside the display are touch sensitive. The function of the keys depends on the chosen setting. The icon beside the key shows the function of the key.



Keys

Symbol	Function
>	move right
<	move left
↻	save selected values / start
C	cancel
+	increase values
-	decrease values
🕒	timer menu
🔧	basic settings menu
i	call up current oven temperature
🔒	child lock activate
🔓	child lock deactivate
🕒	extended timer
⏸	timer stop
▶	timer start

Accessories

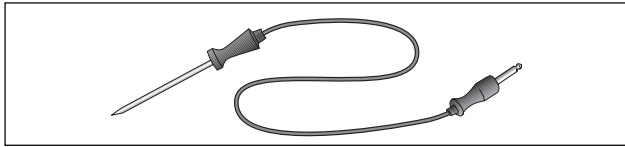
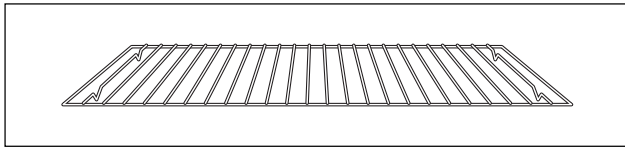
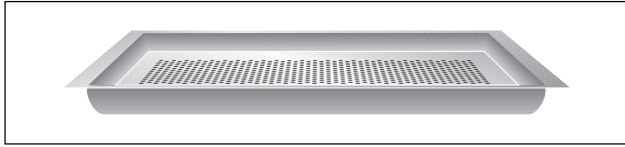
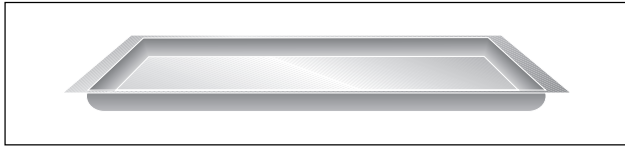

As standard, your appliance comes with the following accessories:

- Stainless steel cooking insert GN 2/3
- Stainless steel cooking insert GN 2/3, perforated
- Wire rack
- Meat probe











You can order the following special accessories:

- **KB 220-000:** Stainless steel cooking insert GN 2/3
- **KB 220-324:** Stainless steel cooking insert GN 2/3, perforated
- **KB 220-114:** Stainless steel cooking insert GN 1/3
- **KB 220-124:** Stainless steel cooking insert GN 1/3, perforated
- **GR 220-046:** Wire rack

⚠ WARNING: Do not use aluminum foil or protective liners to line any part of an appliance, especially surface unit drip bowls or oven bottom. Installation of these liners may result in a risk of electric shock or fire.

Do not place food directly on oven bottom.

Heating Modes

Display	Heating mode	Use
 100% 200°F	Moisture 100 % temperature 85 - 450°F	<p> Steaming at 200 - 230°F: fish, vegetables, side dishes. The food is completely surrounded by steam.</p> <p> Steam baking at 230 - 450°F: puff pastry, bread, bread rolls.</p>
 80% 330°F	Moisture 80 % temperature 85 - 450°F	Combination steaming: puff pastry, meat, poultry.
 60% 310°F	Moisture 60 % temperature 85 - 450°F	Combination steaming: yeast dough cakes, bread.
 30% 350°F	Moisture 30 % temperature 85 - 450°F	<p>Cooking in own moisture: pastries.</p> <p>Low-temperature cooking: meat.</p> <p>With this setting no additional steam is added, but the air flap remains closed. Thus the natural moisture of the food remains in the oven and keeps the food from drying out.</p>
 0% 350°F	Moisture 0 % temperature 85 - 450°F	Convection: cakes, biscuits, gratin.
 100°F	Dough proofing temperature 85 - 120°F	Raising yeast dough, the perfect temperature setting is 100°F. The moisture distributes the heat evenly and avoids the surface of the dough drying out.
 120°F	Defrosting temperature 100 - 140°F	Even and gentle defrosting of vegetables, meat, fish and fruit. The food will not dry out and will keep its shape.
 230°F	Regenerating temperature 140 - 280°F	Gently refresh previously prepared dishes. The moisture keeps the food from drying out. Refresh dishes on plates at 250°F, pastries at 280°F.
 100% 140°F	Cleaning aid, drying aid, descaling	The cleaning function loosens soiling with steam.

Water tank

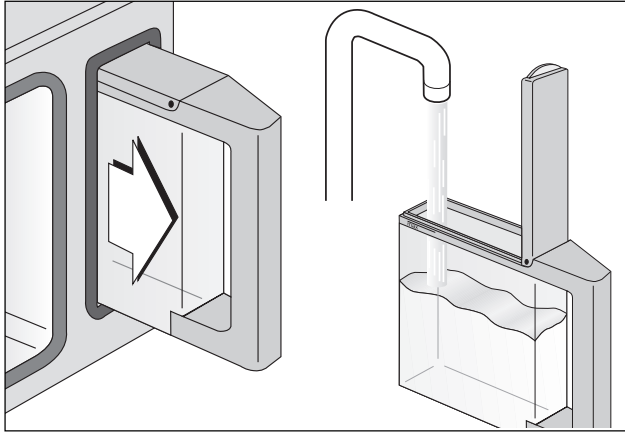

When you open the door of the oven, you will find the water tank on the side. Depending on the model, the tank is on the right or left side.

Before use, fill the water tank to the MAX marking with fresh, cold water.

If the water in your area is very hard, it is better to use filtered water or non-carbonated bottled water. Do not use demineralised water or other liquids.

Firmly close the lid of the tank. This is important for the correct functioning of the oven.

Fully insert the water tank until it engages.

If the water tank is empty, the heating stops. The  symbol appears on the display and three dashes instead of the temperature are shown.

Open the oven door (Caution: steam might escape). Slowly pull out the water tank from the slot. A small amount of water might drip from the valve. Hold the water tank level when you pull it out.

Fill the water tank to the MAX marking and re-insert it.

Empty the water tank after every use and leave it to dry with the lid open. Keep the seal in the lid clean and dry after every use. Dry the slot for the tank after every use.

Note:

Do not heat up the water tank in the oven to dry it! This will damage the water tank.

First Settings after Installation

When your new steam oven has been connected, the first settings menu appears on the display. You can set the

- time format,
- clock,
- date,
- temperature unit,
- water hardness.

Note

The first settings menu appears only after the appliance has been connected or if the appliance is without electricity for several days.

Refer to the chapter basic settings if you wish to change these parameters at any time.

Choosing the Time Format

The time format setup menu appears on the screen.

The time format can be either 12 hour format (AM/PM) or 24 hour format. The 24 hour format is pre-selected.

You can change the time format using the centre < key.

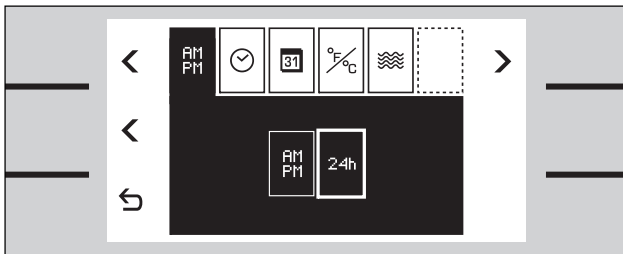

Setting the Clock

1 Using the menu key > select the clock function ☰.

08:30 appears on the screen.

2 Using the + / - keys set the correct time.

Use the arrow key > bottom right to change from hours to minutes.

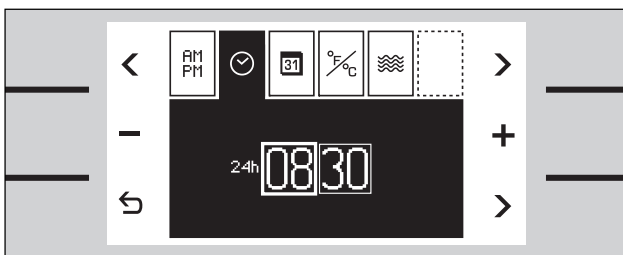

Setting the Date

1 Using the menu key > select the date function ☰.

26.10.07 appears on the screen.

2 Using the + / - keys enter day, month, year.

Use the arrow key > bottom right to change from day/month/year.

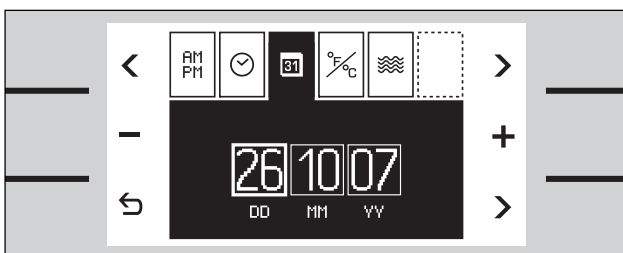

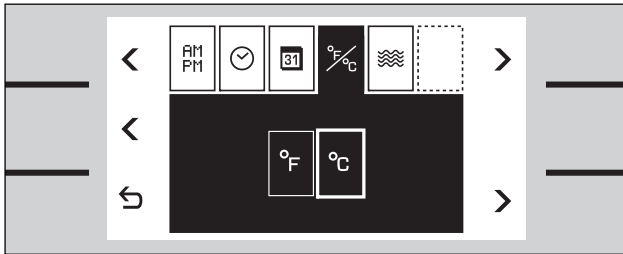

Temperature Unit °C or °F

- 1 Using the menu key **>** select the temperature unit function $\frac{°F}{°C}$. °C is pre-selected.
- 2 You can change the temperature unit using the **+ / -** keys.

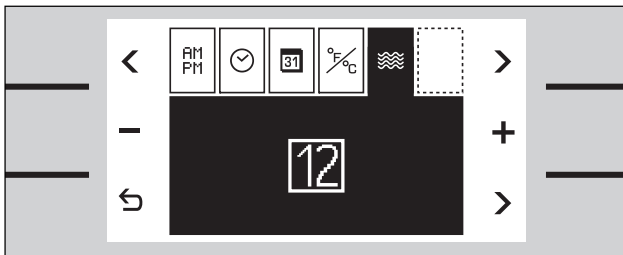

Setting the Water Hardness

- 1 Use the test kit included to test the water hardness of your tap water. Fill the phial with mains water up to the 5 ml marker.
- 2 Add indicator solution drop by drop until the colour changes from purple to yellow.
Carbonate hardness content:
1 drop = 1°KH = 1.25°e = 1.8°f
Please note: count the number of drops that are necessary and gently shake the phial after each drop.
- 3 Use the **+ / -** keys to enter the value between 1 and 18. Pre-set value is 12. Depending on the value entered the appliance will calculate the intervals for descaling.

Exiting Menu and Saving Settings

Touch the **↶** key to exit the menu. All settings are saved.

The appliance is on standby. The standby screen appears.

Calibration

The boiling point depends on the air pressure. The higher the altitude, the lower the air pressure, and also the boiling point.

During the first steaming after installation, the appliance calibrates the boiling point. During calibration, the appliance is adjusted to the pressure of the altitude where the appliance is installed.

Calibrating the Steam Oven

- 1 Remove all accessories from the oven (cooking inserts, wire rack). The oven must be empty and cold.
- 2 Fill the water tank to the MAX marking with cold water. Firmly close the lid. Fully insert the water tank until it engages.
- 3 Turn the temperature knob to 215°F and the function knob to the top position, steaming at 100% moisture.

The steam oven starts to calibrate.

During calibration more steam might escape from the oven than during normal use. Calibration takes about 15 minutes.

Note

If the oven has not yet been calibrated, **CAL** is shown beside the current oven temperature when you press the **i** info key.

Do not interrupt the calibration cycle. Do not open the oven door during calibration.

Should the calibration process be interrupted by opening the door or switching off the appliance, the steaming function will not operate properly. Switching on the appliance will automatically restart calibration until the operation has been completed.

Recalibration is not necessary after a power failure.

Recalibrate the appliance manually if you should move home to a different altitude.

- First reset all parameters to the factory setting. Refer to the chapter basic settings.
- Now it is possible to recalibrate the appliance.

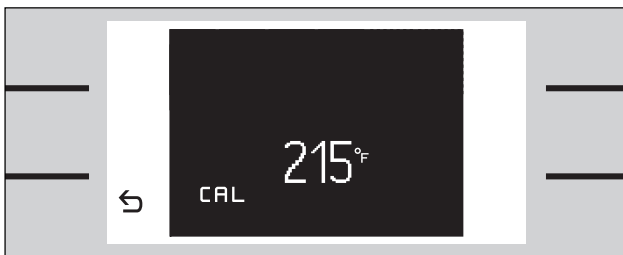

Activating the Steam Oven



Standby

The steam oven remains on standby when no operating mode is selected or the child lock is activated.

The keys are not activated. The display is not lit.

Note:

You can choose between different standby screens. GAGGENAU and the clock is pre-selected. Refer to the chapter basic settings if you want to change the standby screen.

Note:

The display contrast depends on the vertical viewing angle. You can adjust the contrast of the display in the basic settings.

Activating the Steam Oven

To leave standby do one of the following:

- touch a key
- open or close the oven door
- turn the temperature knob
- turn the function knob

Now you are able to set the required function. Read the relevant chapter on how to activate the required function.

Note:

The standby screen reappears after one minute if no further function is chosen. The display light goes off.

Setting the Steam Oven

The main operations of your steam oven are easily set using the knobs.

Using the right knob you can set the temperature. To switch on the light in the oven, turn the temperature knob one position to the right.

Temperature range:

Steaming, hot air	85 - 450°F
Dough proofing	85 - 120°F
Defrosting	100 - 140°F
Regenerating	140 - 280°F

The light in the oven remains off if the temperature is set below 140°F.

Using the left knob you can set the heating mode. The top position is steaming at 100% moisture.

Setting the Temperature and Heating Mode

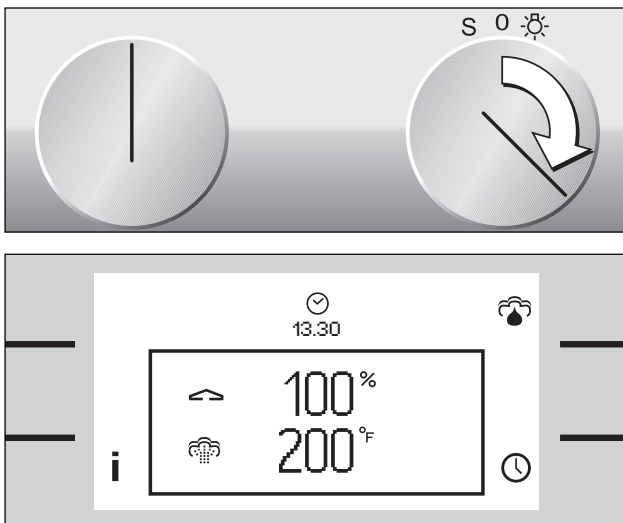

- 1 Fill the water tank to the MAX marking with cold water. Firmly close the lid. Fully insert the water tank until it engages.
- 2 Turn the function knob until the required heating mode appears on the screen.
- 3 Set the temperature knob to the required temperature. Temperature, moisture level and cooking mode symbol appear on the display. The light in the oven goes on.

The heating up symbol  appears until the required temperature is reached. The symbol appears again when the oven heats during operation.

A signal sounds when the selected temperature is reached. Press any key to switch off the signal.

Note: You can deactivate the heating up signal in the basic settings.

The temperature and heating mode can be changed at any time.

When the meal is ready switch the steam oven off using the temperature knob. The oven light goes off. The standby screen appears.

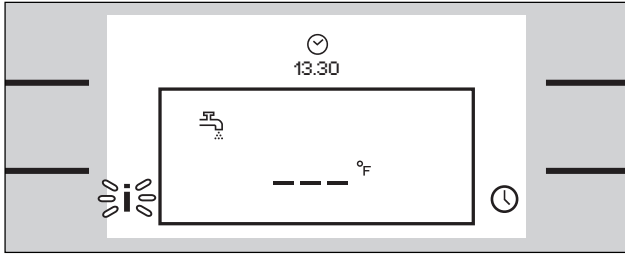

Note

If the  symbol appears on the left top side of the display and three dashes instead of the temperature, the water tank is empty. Fill the water tank to the MAX marking with fresh water.

If three dashes appear on the display instead of the temperature, the knobs have not been set to the correct position. Check the position of the temperature and function selectors.



Current Oven Temperature Display

The current oven temperature is briefly shown when you press the **i** info key. Using the  key you can return to the standard screen.

Note:

Depending on the heating mode, a slight temperature variation after heating up during use is normal.

After Every Use

Wipe the oven interior and the evaporating dish with a soft sponge. Dry the oven interior with a cloth or use the drying aid.

⚠ Warning! The water in the evaporating dish can be hot.

Empty the water tank and leave it to dry with the lid opened. Dry the slot in the appliance.

Meat Probe

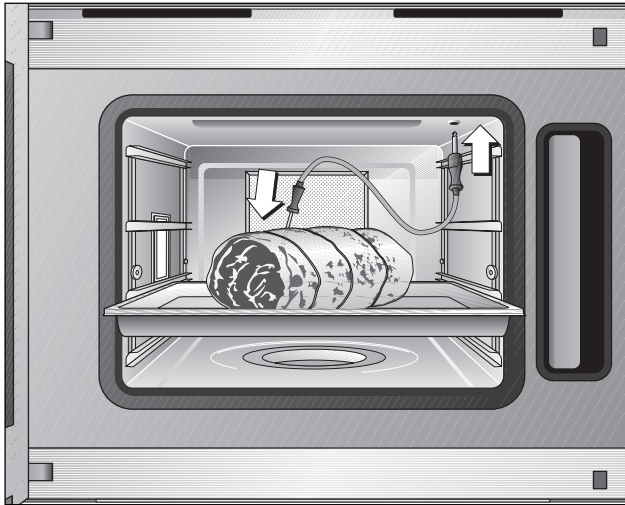

The meat probe enables you to cook your meat exactly as you want it.

Using the meat probe, during the cooking process you can measure the core temperature of the interior of the food you are preparing exactly between 33°F and 210°F.

Fully insert the tip of the meat probe in the middle of the food, at its thickest point. The tip should not be inserted into fat and should not touch any dishes, bones or fatty tissue.

In the case of poultry, do not insert the tip of the meat probe in the middle (hollow) but between the belly and the thigh.

When you connect the meat probe to the socket in the oven, the  symbol appears on the display.

The smaller temperature display on the top shows the measured temperature from the meat probe.

Programming the Meat Probe

You can program the desired core temperature for your meal. The appliance switches off automatically, when the programmed temperature has been reached.

- 1 Insert the tip of the meat probe into the meat.
- 2 Connect the meat probe to the socket.
- 3 Using the **+**/**-** keys set the correct core temperature.
The suggested temperature is 140°F.

The larger temperature display on the top shows the programmed temperature, the smaller display shows the measured temperature from the meat probe. You cannot set a temperature on the meat probe that is lower than the core temperature of the food you are preparing.

The current oven temperature is briefly shown when you press the **i** info key. The temperature display on the top shows the measured temperature from the meat probe. Using the  key you can return to the standard screen.

A signal sounds when the programmed core temperature has been reached. The appliance stops heating.

Switch the temperature knob off and open the oven door. Remove the meat probe before taking the food from the oven.

⚠ Danger, risk of burns! Use an oven glove. The meat probe gets very hot during use.

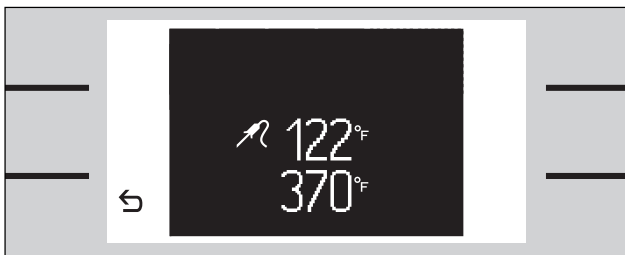
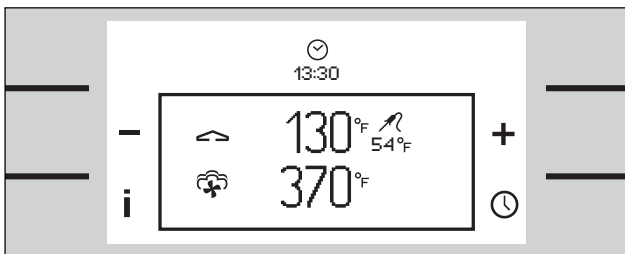

Note

Pull the meat probe from the socket if you want to end the programming.

If you program meat probe and timer simultaneously, the program that reaches the entered value first will switch off the oven.

Only use the included original meat probe. You can order the meat probe as a spare part.

Remove the meat probe from the oven when it is not in use.

Cleaning

Only rub the meat probe with a moist cloth. The meat probe is not dishwasher-proof.

Recommended Temperature Values

Beef

Roast beef / fillet of beef / entrecôte		
	blood rare	113-117 °F
	rare	122-126 °F
	medium-rare	136-140 °F
	well-done	158-167 °F
Beef roast		176-185 °F

Pork

Roast pork			162-176 °F
Back of pork	medium-rare		149-158 °F
	well-done		176 °F
Meat loaf			185 °F
Fillet of pork			149-158 °F

Veal

Fillet of veal	rare		122-126 °F
	medium-rare		136-140 °F
	well-done		158-167 °F
Roast veal		well-done	167-176 °F
Breast of veal, stuffed			167-176 °F
Back of veal	medium-rare		136-140 °F
	well-done		149-158 °F

Venison

Back of venison			140-158 °F
Leg of venison			158-167 °F
Back of venison steaks			149-158 °F
Back of hare			149-158 °F

Poultry

Chicken			185 °F
Guinea fowl			167-176 °F
Goose, turkey, duck			176-185 °F
Duck breast	medium-rare		131-140 °F
	well-done		158-176 °F
Ostrich steak			140-149 °F

Lamb

Leg of lamb	medium-rare		140-149 °F
	well-done		158-176 °F
Back of lamb	medium-rare		131-140 °F
	well-done		149-167 °F

Mutton

Leg of mutton	medium-rare		158-167 °F
	well-done		176-185 °F
Back of mutton	medium-rare		158-167 °F
	well-done		176 °F

Fish

Fillet			144-149 °F
Whole			149 °F
Tureen			144-149 °F

Other

Bread			195 °F
Pâte			162-167 °F
Tureen			140-158 °F
Foie gras			113 °F

Cooking Table

Important Notes

- Always preheat the oven. This will guarantee the best results.
- The cooking times given here are for a preheated oven. Add about 5 minutes to the cooking time if the oven has not been preheated.
- Only open the oven door for a short time and quickly put the food in.
- If you use only one level, place the cooking insert on the second level from the bottom.
- When using the perforated cooking insert or the wire rack, place the unperforated cooking insert on the level below to avoid the bottom of the oven interior and the evaporating dish becoming soiled.
- You can use simultaneously up to three levels (level 2, 3 and 4 from the bottom) for steaming, defrosting and regenerating. You can cook different dishes simultaneously without flavour transfer.
- You can only use one level for baking. Use level 1 or 2 from the bottom depending on the cakes or pastries (see baking table).
- The cooking times given are only a recommendation. The effective cooking time depends on the quality of the food, the amount and the size of the food.
- Add to the cooking time for larger amounts than those stated in the cooking table.
- Food being cooked must not come into contact with the oven compartment, grease filter or side plate.
- The steam oven door must seal well. Always keep the door seal clean.
- Do not place too much food on the wire rack or the cooking insert. This will ensure optimum circulation of the air.
- Always leave the grease filter in place during use.

Vegetables

Dish	Cooking insert	Temperature in °F	Moisture in %	Cooking time in minutes
Leaf spinach (1 lb, plucked)	perforated	210	100	2 - 5
Cauliflower (1 head, whole)	perforated	250	100	25 - 35
Cauliflower (2 lb, in roses)	perforated	250	100	10 - 15
Broccoli (2 lb, in roses)	perforated	250	100	10 - 15
Peas (2 lb)	perforated	210	100	5 - 10
Stuffed peppers	unperforated	360 - 390	80 - 100	15 - 20
Stuffed courgettes	unperforated	320 - 360	80 - 100	15 - 35
Green beans (2 lb, whole)	perforated	250	100	15 - 20
Kohlrabi (2 lb, sliced)	perforated	250	100	13 - 20
Leeks (2 lb, sliced)	perforated	250	100	5 - 10
Carrots (2 lb, sliced)	perforated	250	100	10 - 20
Jacket potatoes (2 lb, medium size)	perforated	250	100	30 - 40
Boiled potatoes (2 lb, peeled and quartered)	perforated	250	100	15 - 30

Dish	Cooking insert	Temperature in °F	Moisture in %	Cooking time in minutes
Brussel sprouts (2 lb)	perforated	250	100	15 - 20
Asparagus, green (2 lb, whole)	perforated	210	100	10 - 15
Asparagus, purple (2 lb, whole)	perforated	210	100	15 - 20
To skin tomatoes (whole)	perforated	210	100	3 - 4

Tips

- To skin tomatoes: cut peel once, place in ice water after steaming.
- Use the vegetable stock that collects in the unperforated cooking insert as a base for sauce or stock.
- Stuffed vegetables: fry the meat stuffing first.

Pulses / Rice

Dish	Cooking insert	Temperature in °F	Moisture in %	Cooking time in minutes
Long grain rice (1/2 lb + 2 cups of water)	unperforated	210	100	30 - 35
Basmati rice (1/2 lb + 2 cups of water)	unperforated	210	100	25 - 30
Lentils (1/2 lb + 3 cups of water)	unperforated	250	100	30 - 40
Pre-soaked white beans (1/2 lb + 4 cups of water)	unperforated	250	100	55 - 65

Tip

- Observe the manufacturer's recommendations.

Fish

Dish	Cooking insert	Temperature in °F	Moisture in %	Cooking time in minutes
Fish tureen (in a tureen)	wire rack	165	80	40 - 50
Salmon fillet (1 lb 12 oz)	perforated	210	100	12 - 18
Mussels (3 lb)*	perforated	210 - 250	100	8 - 12
Rolled sole, stuffed	perforated	300	80	8 - 10

* The mussels are ready when their shells open.

Meat

Dish	Cooking insert	Temperature in °F	Moisture in %	Cooking time in minutes
Fillet in puff pastry	perforated with baking paper	360 - 390	80 - 100	meat probe*
Roast pork with rind	wire rack + unperforated	1) 210 2) 320 - 340 3) 410	100 60 - 80 0	20 - 30 50 - 60 meat probe*
Roast beef	wire rack + unperforated	320 - 370	80	meat probe*
Roast pork (collar / shoulder)	wire rack + unperforated	320 - 370	60	meat probe*

* Refer to the chapter "Meat Probe" for tips on using the meat probe and the temperature table for the different meats.

Poultry

Dish	Cooking insert	Temperature in °F	Moisture in %	Cooking time in minutes
Duck (whole, 4 - 6 lb)	wire rack + unperforated	320 390*	60 - 80 60 - 80	55 - 85 15
Duck breast	unperforated	320	0 - 30	15 - 20
Chicken (whole, 2 - 3 lb)	wire rack	360	80	50 - 60
Leg of chicken (4 - 6 pieces)	wire rack	360	80	20 - 35

* Change to the higher temperature value 15 minutes before the end of cooking.

Tip

– You can also use the meat probe. Refer to the chapter "Meat Probe" for tips on using the meat probe and the temperature table for the different meats.

Low-temperature Cooking / Low-temperature Steaming

Fish or seared meat matures over a longer time at a low temperature in the oven. The food will remain juicy and preserve most of its nutrients.

Dish	Cooking insert	Temperature in °F	Moisture in %	Cooking time in minutes
Duck breast	unperforated	160 - 180	0 - 30	55 - 75
Leg of lamb (3 - 5 lb)	unperforated	160 - 180	0 - 30	180 - 240
Roast beef (3 - 5 lb)	unperforated	160	0 - 30	150 - 240

Dish	Cooking insert	Temperature in °F	Moisture in %	Cooking time in minutes
Pork medallions	unperforated	160 - 180	0 - 30	45 - 60
Boiled fillet of beef (2 lb)	unperforated	190	100	70 - 90
Bream (whole, 1 1/2 lb)	unperforated	190	100	35 - 40
Trout (whole, 12 oz)	unperforated	180 - 190	100	20 - 25
Hake (whole, 1 lb 12 oz)	unperforated	190	100	25 - 30

Tips

- Take the meat from the fridge one hour before cooking.
- Briefly sear the meat (not boiled fillet of beef) from all sides in a hot pan on the hob. Note: longer searing will shorten the cooking time in the oven.
- Put fish in the steam oven without searing it.
- You can also use the meat probe. Refer to the chapter "Meat Probe" for tips on using the meat probe and the temperature table for the different meats. Please note that the core temperature of the food will always stay below the set temperature in the oven.
- You can reduce the temperature to 140°F towards the end of the cooking time (for example if your guests arrive late).
- Serve on warmed dishes.
- 30% moisture means "Cooking in own moisture". With this setting no additional steam is added, but the air flap remains closed. Thus, the natural moisture of the food remains in the oven and prevents the food from drying out.

Dessert

Dish	Cooking insert	Temperature in °F	Moisture in %	Cooking time in minutes
Crème Brulée	wire rack	320	60	10 - 15
Yeast dumplings	unperforated	210	100	15 - 25
Baked puddings*	unperforated	360 - 390	0 - 60	20 - 40
Milk rice (10 oz rice + 2 cups of milk)	unperforated	210	100	35 - 40
Compote	unperforated	210	100	15 - 25

* Baked puddings: e.g. crumbles, bread and butter pudding, rice pudding

Miscellaneous

Dish	Cooking insert	Temperature in °F	Moisture in %	Cooking time in minutes
Vegetable flan (in a glass dish, 3 lb)	wire rack	210	100	60 - 70
Potato gratin	unperforated	360 - 390	0	35 - 50
Dumplings	perforated	190 - 200	100	15 - 25
Lasagne	unperforated	350 - 390	0	35 - 45
Soufflé (in dishes)	wire rack	350 - 390	60 - 100	10 - 20
Cooked-egg-garnish	unperforated	180	100	10 - 20
Semolina dumplings	perforated	190 - 200	100	8 - 10
Eggs (5 eggs)	perforated	210	100	8 - 15
To decrystallize honey	wire rack	110	100	180 - 240
To disinfect baby bottles	wire rack	210	100	15

Tip

– For foods that are sensitive to pressure (such as dumplings), you are best using two cooking inserts depending on the amount. This will avoid the food being crushed.

Cakes and Pastries

Dish	Cooking insert / level*	Temperature in °F	Moisture in %	Cooking time in minutes
Apple tart	wire rack / 1	370 - 390	30	30 - 45
Bagels	unperforated / 2	370 - 410	80 - 100	20 - 25
Swiss roll	unperforated / 2	370 - 410	0 - 30	8 - 11
Small flaky pastry cakes	unperforated / 2	360 - 390	80 - 100	15 - 25
Bread (2 lb)	unperforated / 2	1) 390 2) 330	80 - 100 80 - 100	15 35 - 40
Bread rolls (4 oz each)	unperforated / 2	360 - 390	80 - 100	15 - 25
Bread rolls (pre-baked)	wire rack / 2	340 - 360	60	7 - 10
Brioche (5 cups of flour)	unperforated / 2	320 - 340	60 - 80	25 - 35
Macaroons	unperforated / 2	300 - 320	0	15 - 20
Ring cake (yeast dough)	wire rack / 1	320 - 350	30 - 60	45 - 50
Fruit pie made with yeast dough	unperforated / 2	320 - 350	0	40 - 55

Dish	Cooking insert / level*	Temperature in °F	Moisture in %	Cooking time in minutes
Cookies	unperforated / 2	300 - 350	0	10 - 20
Quiche, fruit tart	wire rack / 1	370 - 410	0	45 - 60
Sponge cake	wire rack / 1	320 - 350	0 - 30	50 - 60
Cream puffs	unperforated / 2	360 - 370	0 - 30	40 - 45
Onion pie	unperforated / 2	340 - 360	60 - 80	40 - 50

* level from bottom

Tips

- Always preheat the steam oven.
- In the steam oven you can only bake on one single level.
- Always leave the grease filter in place during baking.
- 30% moisture means “Cooking in own moisture”. With this setting no additional steam is added, but the air flap remains closed. Thus the natural moisture of the food remains in the oven and keeps the food from drying out.

Regenerating (Reheating)

Reheat previously prepared dishes without loss of quality. Select the “Regenerating” heating mode.

Dish	Cooking insert	Temperature in °F	Cooking time in minutes
Meals on a plate	wire rack	250	7 - 15
Pasta, potatoes (on a plate)	wire rack	250	5 - 10
Vegetables (on a plate)	wire rack	190 - 210	7 - 15
Bread rolls (from the day before)	wire rack	280	3 - 5
Baguette (frozen)	wire rack	280	8 - 10

Tip

- To regenerate larger amounts use the unperforated cooking insert.

Dough Proofing

Raising yeast dough and other dough mixtures without drying out. Do not cover the bowl. Select the "Dough Proofing" heating mode.

Dish	Cooking insert	Temperature in °F	Cooking time in minutes
Yeast dough, baking ferment, sour dough mixture (in bowl)	wire rack	100	25 - 35

Tip

– The raising time is a rough value. Leave the dough until it has doubled in size.

Defrosting

Select the "Defrosting" heating mode.

Dish	Cooking insert	Temperature in °F	Cooking time in minutes
Berries (1/2 lb)	perforated	110 - 120	8 - 10
Roast (2 lb)	perforated	110 - 120	70 - 80
Fish fillet (1 lb)	perforated	110 - 120	15 - 20
Vegetables (1 lb)	perforated	110 - 120	20 - 30
Goulash (1 lb 4 oz)	perforated	110 - 120	40 - 50
Chicken (2 lb)	perforated	110 - 120	60 - 70
Chicken legs (1 lb)	perforated	110 - 120	30 - 35

After the time has elapsed, leave the food inside the oven for 10-15 minutes after switching off. This ensures the food is thawed right through.

Tips

- Important! Always insert an unperforated cooking insert one level below the food. Pour out the defrosting liquid of meat and poultry. Rinse with plenty of water. Clean the cooking insert in hot soapy water or in the dishwasher.
- The defrosting time depends on the size, weight and shape of the frozen food. Always freeze your food flat or in single pieces, this shortens the defrosting time.
- Only defrost the amount that you will need to prepare.
- Please observe: defrosted food might not keep and will deteriorate more quickly than fresh food. Immediately prepare defrosted food and cook it thoroughly.
- Defrosting poultry: take the poultry out of the packaging.

Preserving

Dish	Cooking insert	Temperature in °F	Moisture in %	Cooking time in minutes
Fruit, vegetables (in closed preserving jars)	wire rack / perforated	200	100	35

Tips

- Cook the fruit or vegetables immediately after buying or picking. A prolonged storage will reduce the vitamins and might lead to fermenting.
- Only use good quality fruit and vegetables.
- Check and clean the preserving jars, rubber seals and clamps.
- Disinfect the clean jars in the oven for 15 minutes at 210°F before using them for preserving.
- Open the oven door after the cooking time has elapsed.
- Leave the jars to cool down completely before taking them out of the oven.

Extracting Juice

Dish	Cooking insert	Temperature in °F	Moisture in %	Cooking time in minutes
Berry fruit	perforated	210	100	60 - 120

Tips

- Place the fruit or berries in the perforated cooking insert. Insert the perforated cooking insert with the fruit on the 2nd level from below. Place the deep unperforated cooking insert one level lower to collect the juice.
- Leave the fruit in the oven until no more juice comes out.
- You can squeeze the food in a dish towel afterwards to gain the remaining juice.

Blanching

Dish	Cooking insert	Temperature in °F	Moisture in %	Cooking time in minutes
Vegetables (for example spinach, broccoli, beans)	perforated	210	100	1 - 2

Tips

- By blanching, vegetables retain their natural colour.
- Blanching is especially suitable for vegetables that are to be frozen.
- Always preheat the oven. Insert the vegetables when the heating up symbol has gone off.
- Dip the vegetables in iced water immediately after taking them out of the oven.
- Leave the blanched vegetables to drip dry before freezing.

Preparing Yogurt

Dish	Cooking insert	Temperature in °F	Moisture in %	Cooking time in minutes
Fresh yogurt (in closed jars)	wire rack	110	80	240 - 360

Tips

- Heat milk (not long-life milk) on the hob to 190°F to avoid disturbing the yogurt bacteria.
- Important! Cool the milk in a bain-marie until it reaches 100°F to avoid destroying the yogurt bacteria.
- Stir natural yogurt (without fruit) into the milk (1-2 teaspoons for every 1/2 cup).
- Pour the yogurt into clean jars.
- Disinfect the clean yogurt jars in the oven for 15 minutes at 210°F before filling them with yogurt.
- In the case of yogurt ferment, pay attention to the notes on the packet (note: the time needed for maturity will be lengthened if you use cold milk to produce the yogurt).
- On completion, place the yogurt in the fridge.
- Add skimmed milk powder to the milk before heating it (1-2 tablespoons per 4 cups) to get a more solid yogurt.

Energy Saving Tips

- The oven heats up very quickly. This means it is time and energy efficient.
- When possible, try to cook different foods at the same time. This will ensure an even load on your appliance and will save you time and energy.
- You can often use several levels at once (only for steaming up to 210°F, not for baking).
- Avoid opening the steam oven door frequently and for prolonged periods. Otherwise, steam and heat can escape and then has to be generated again. This involves a large loss of energy and prolongs the cooking time.

Timer

Using the timer menu you can set the following:

- ⌚ timer
- ⌚ stopwatch
- 🕒 cooking time duration (not during stand-by)
- 🕒 cooking time end (not during stand-by)

Calling up the Timer Menu

Touch the key beside the symbol ⌚ to call up the timer menu.

If the appliance is on standby, touch any key. Now the display is activated. The info **i** and timer ⌚ symbols are shown.

Touch the key next to the timer symbol ⌚. The timer menu appears.



Timer

The timer counts down independently of all other settings of the appliance. You can enter a maximum value of 90 minutes.

Setting the Timer

- 1 Call up the timer menu. The timer function ⌚ is shown on the display.
- 2 Using **+** or **-** set the desired duration.
- 3 Start using the ⏪ key.

The timer menu is closed.

A signal sounds when the time has elapsed. Touch the ⌚ key to switch off the signal.

Note

To cancel an active timer:
Call up the timer menu, select the timer function ⌚ and touch the **C** key.

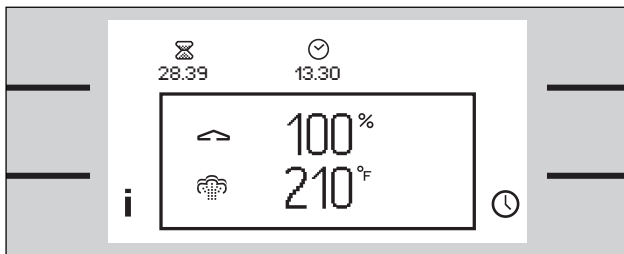
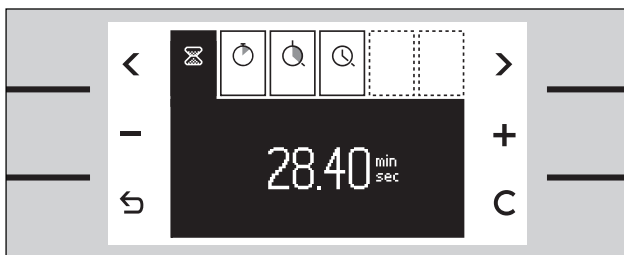

Stopwatch

The stopwatch will count the elapsed time up to 90 minutes.

The pause function pauses the stopwatch.

The stopwatch runs independently of all other settings of the appliance.

Starting the Stopwatch

- 1 Call up the timer menu.
- 2 Using < or > select the stopwatch function ⌚.
- 3 Start using the ▶ key.

The timer menu is closed.

The timer menu is closed immediately when you touch the ↵ key.

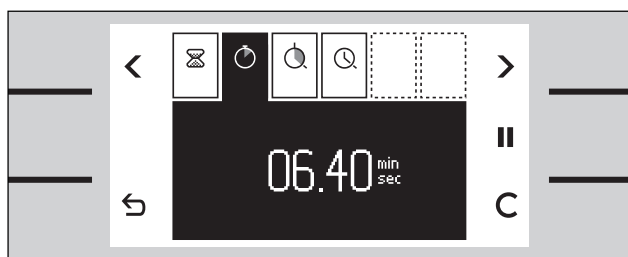
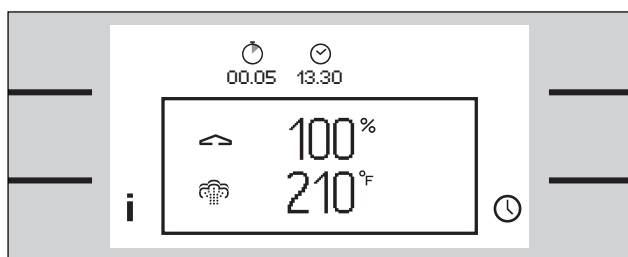
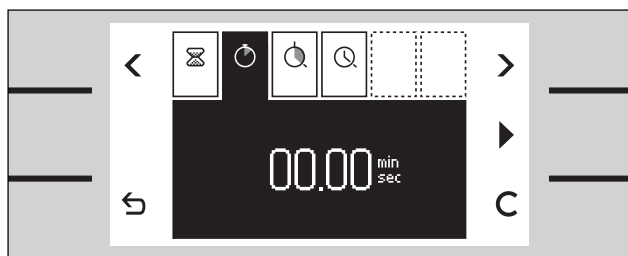

Pausing the Stopwatch

- 1 Call up the timer menu.
- 2 Using < or > select the stopwatch function ⌚.
- 3 Touch the || key. The counter stops. The key reverts to start ▶.
- 4 Start again using the ▶ key. The counter continues.

After 90 minutes the time reverts to 00:00 minutes. The symbol ⌚ in the status bar disappears. The stopwatch is switched off.

Note

To cancel the stopwatch:
Call up the timer menu, select the stopwatch function ⌚ and touch the C key.

Cooking Time Duration

If you set a cooking time duration for your meal, the appliance switches off automatically after the selected time.

This enables you to leave the kitchen while the meal is being prepared.

You can select a cooking time between 1 minute and 23 hours 59 minutes.

Select the temperature and heating mode and place your meal in the oven.

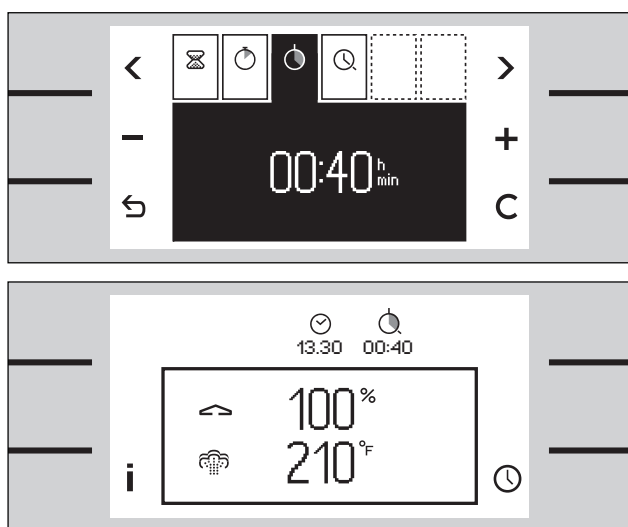

Switching off Automatically

- 1 Call up the timer menu.
- 2 Using **<** or **>** select the cooking time duration function .
- 3 Using **+** or **-** set the required cooking time.
- 4 Start the program using the **↵** key.

The timer menu is closed. Temperature and heating mode are shown on the display.

After the time has elapsed the appliance switches off. A signal sounds. Touch the  key or open the appliance door to switch off the signal.

Note

The cooking times given in the cooking table are for a preheated oven. Add about 5 minutes to the cooking time if the oven has not been preheated.

To cancel the cooking time:

Call up the timer menu. Touch the **C** key, then touch **↵** to confirm.

To change the cooking time:

Call up the timer menu. Change the time with **+** or **-**, then touch **↵** to confirm.

To stop the program:

Switch the temperature knob off.

Cooking Time End

You can program a cooking time end. Example: it is 13:30. The meal will take 40 minutes to cook and must be ready at 15:30.

Set the cooking time duration and set the cooking time end to 15:30. The electronics will calculate the start time. The appliance will start automatically at 14:50 and switch off at 15:30.

Please note that food which can easily go off should not stay in the oven too long.

Note:

Always set the desired temperature, heating mode and cooking time duration first. Only by setting these values can the cooking time end be programmed.

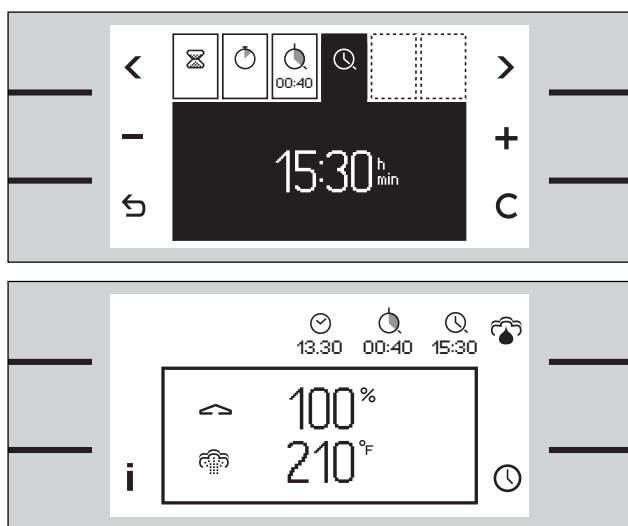

Switching on and off Automatically

- 1 Set the required cooking time.
- 2 Using **>** select cooking time end . The switch off time appears on the display.
- 3 Using **+** set a later switch-off time.
- 4 Start using the **↵** key. The timer menu is closed.

Temperature and operating mode appear on the display. The appliance is on standby and will start automatically. After the cooking time duration it will switch off.

After the time has elapsed the appliance switches off. A signal sounds. Touch the key, open the appliance door or switch off the temperature selector to switch off the signal.

Note

To cancel the cooking time:

Call up the timer menu. Touch the **C** key, then touch **↵** to confirm. Cooking time duration and end are cancelled.

To stop the program:

Switch the temperature knob off.

If the symbol flashes:

You have not set the cooking time duration. Always set the cooking time duration first.

Sabbath Mode

This function keeps the steam oven at a temperature of 185°F in the convection mode.



You can keep food warm 24 to 74 hours, without switching the oven on or off.

Please note that food which can easily go off should not stay in the oven too long.

Supposition:

The extended timer key  is available. You have to make the extended timer key available in the basic settings. See chapter basic settings.

Setting the Program

- 1 Turn the temperature knob one position to the right to the light position.
- 2 Touch the key beside the symbol . The suggested value of 28 h appears on the display.
- 3 Using **+** or **-** set the desired duration.
- 4 Start using the  key.

The cooking mode and temperature appear on the display. The oven light stays off. The keys are locked. The display lighting is switched off. The softkey tone is switched off.

At the end of the programmed time the oven stops heating. The display is empty. Switch the temperature knob off.

Note

If you cannot find the  key:
You have to make the sabbath mode key available. See chapter basic settings – sabbath mode.

To stop the program:
Switch the temperature knob off.

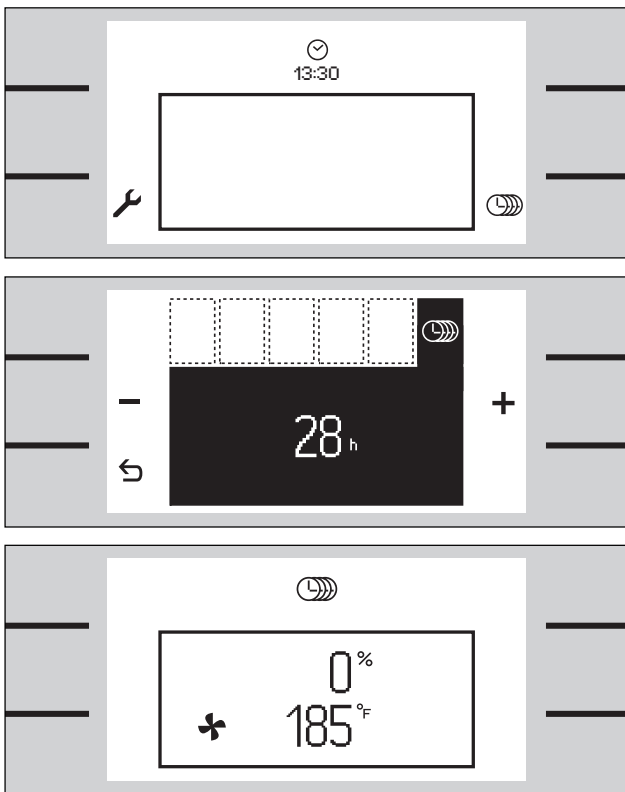

Child Lock

The steam oven has a child lock. It prevents the oven being turned on unintentionally.



Supposition:

You have to make the child lock available in the basic settings. See chapter basic settings.

Activating the Child Lock

Supposition:

The temperature knob is in the OFF position.



- 1 Touch any key. The symbol  appears beside the centre left key.
- 2 Touch the key  for at least 6 seconds.

The child lock is active, the controls are locked.

The standby screen appears. The symbol  appears in the status bar.





Deactivating the Child Lock

- 1 Touch any key. The symbol  appears beside the centre left key.
- 2 Touch the key  for at least 6 seconds.

The child lock is deactivated. You can operate the appliance as usual.

Note

If you cannot find the  key beside the centre key:
Call up the basic settings menu. Select the child lock function. Select "child lock available" .

If the child lock key is no longer required:
Call up the basic settings menu. Select the child lock function. Select "child lock not available" .

Safety Deactivation

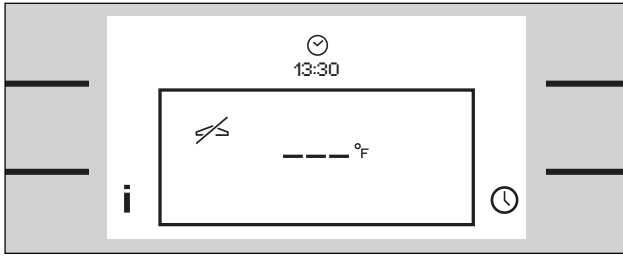

For your protection the appliance has a safety deactivation. The safety deactivation switches off the heat if the oven is left on for more than 12 hours without the controls being touched.

Exception:





The extended timer has been programmed.

Three dashes appear on the display. Switch the temperature knob off. Then you can operate the appliance as usual.



Changing the Basic Settings

Your appliance has several basic settings.

You can customize these settings:
Turn the temperature knob one position to the right to the light position.





- Call up the basic settings menu with the  key.
- Use the top  or  keys to move between the settings.
- Use the centre keys to change the selected setting. You can change several settings individually without leaving the menu.
- Touch the  key to exit the menu. All settings are saved.

Note

The status bar only shows six options.
Use the top  or  keys to move to the required option. You can scroll back- or forward with these keys.

If no key has been touched for 60 seconds the menu disappears. The standby screen appears. All settings are saved.

Example: Changing the Standby Screen

- 1 Call up the basic settings menu by turning the temperature knob one position to the right to the light position.
Touch the key next to the  symbol. The menu appears.
- 2 Use the menu key  to select the function standby screen  .
- 3 Use the middle keys  or  to select the required setting. The selected screen appears briefly.

Now you can change further settings or exit the menu with the  key.

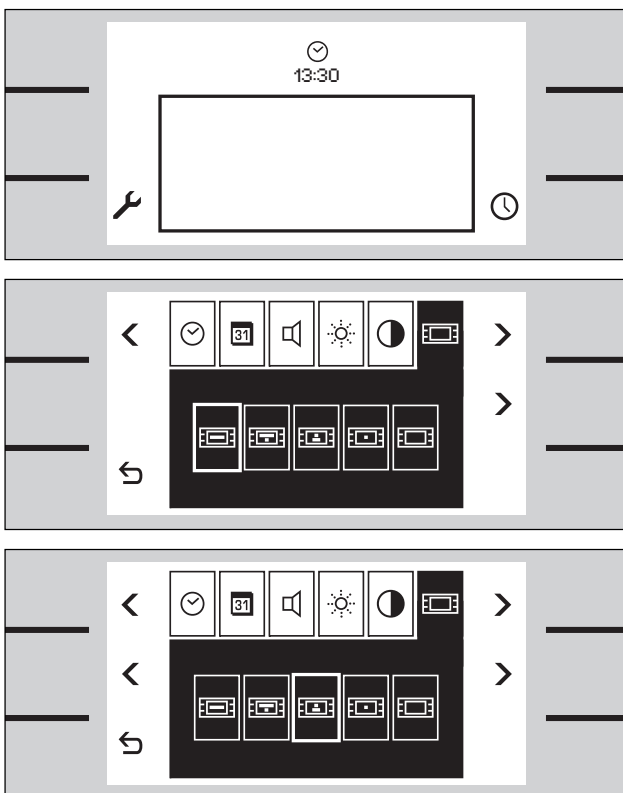

Basic Settings

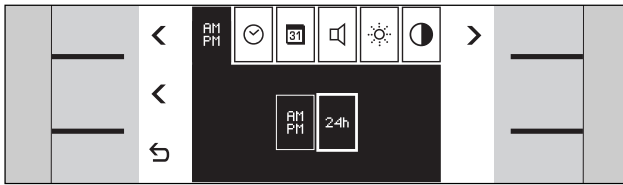

Time format

- 12 hour format (AM/PM) or 24 hour format

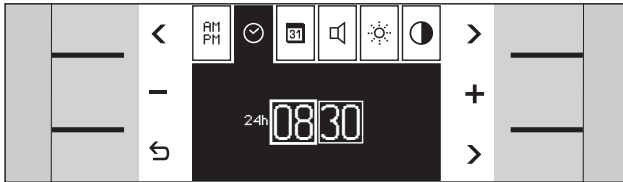

Clock

- Hours / minutes

Use the arrow key > bottom right to change from hours to minutes.

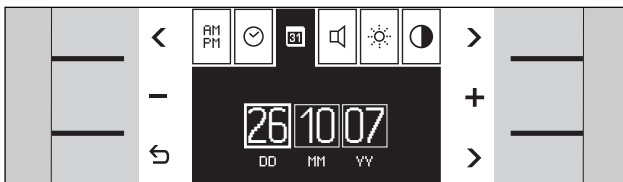

Date

- Day / month / year

Use the arrow key > bottom right to change from day to month to year.

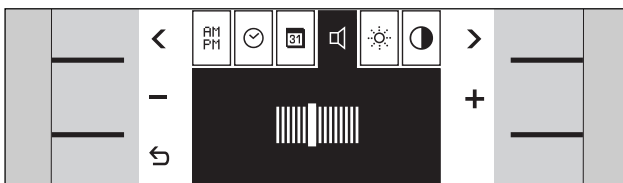

Key tones volume

- In 8 levels

Adjust the volume of the key tones.
The signal volume cannot be adjusted.

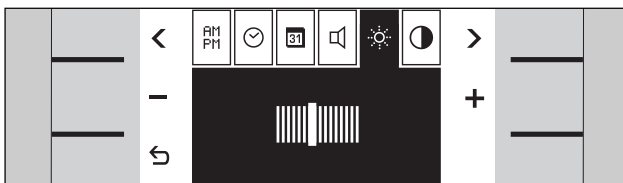

Display brightness

- In 8 levels

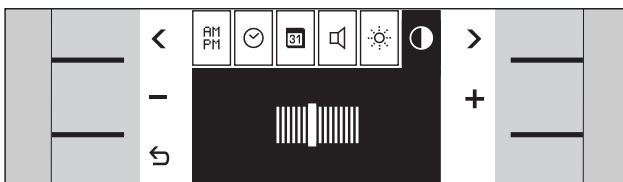

Display contrast

- In 8 levels

The display contrast depends on the viewing angle.

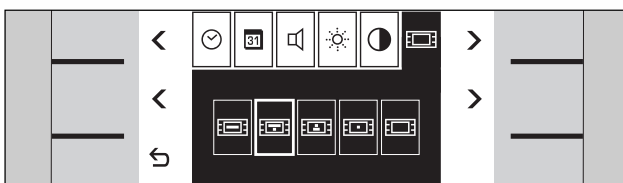

Standby screen

- Gaggenu / Gaggenu with clock / clock and date / clock / empty display

The selected screen appears briefly.

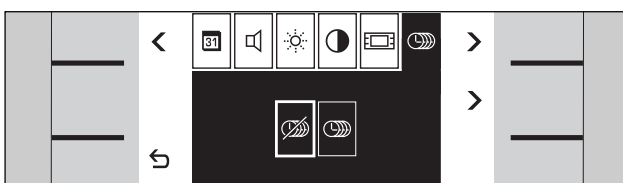

Sabbath mode

- Sabbath mode key not available / available

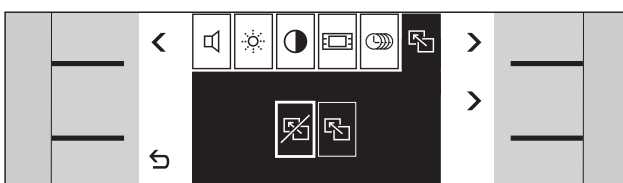

Reset all parameters to the factory setting

- No / yes

Immediately confirm a reset with the ↵ key.

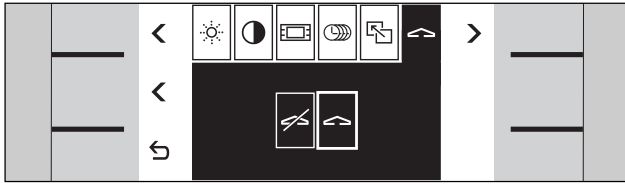

Exhibition mode

The setting ⇄ “exhibition mode not active” must be selected and must not be changed. The appliance does not heat up during exhibition mode ✂.

You can only change this setting 3 minutes after the appliance has been connected to the electricity.

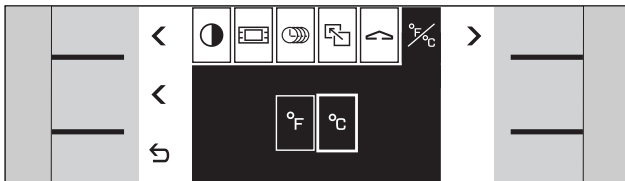

Temperature unit

- °F or °C

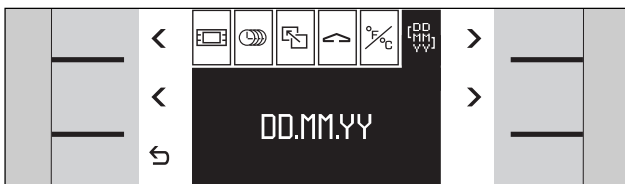

Date format

- Day.month.year or day/month/year or month/day/year

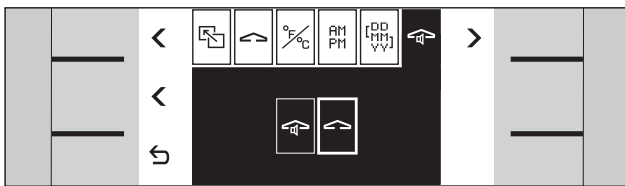

Heating up with / without signal

- heating up with signal / heating up without signal

The signal sounds when the oven has heated up.

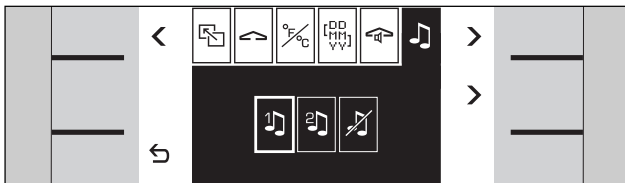

Key tones

- Sound 1 (beep) / sound 2 (click) / key tones off

Choose the key tones.

The signal tone cannot be changed.

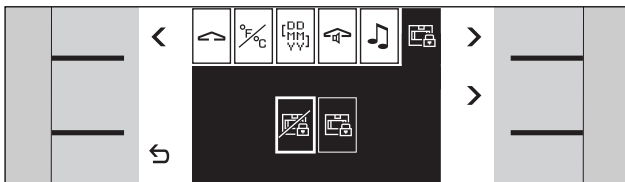

Child lock

- Child lock key not available / available



Water hardness

- Set the water hardness between 1 and 18

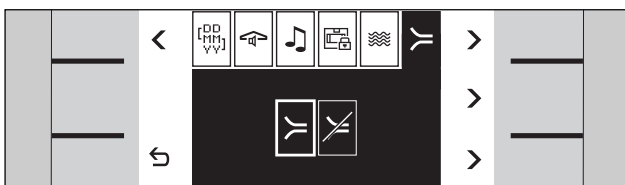

Reset the descaling symbol

- No / yes

Immediately confirm a reset with the ↵ key.

Care and Manual Cleaning

Safety Notes

⚠ Warning! Do not clean the oven using high pressure cleaners or steam jets.

⚠ Warning, risk of burns! Before cleaning, wait until the appliance has cooled down.

Oven Interior

Clean the oven interior with a cloth/sponge and a small amount of hot soapy water. Avoid residues burning in. After cleaning, leave the door open until the oven has dried or use the drying function.

Do not scrape off baked-in remainders of food. Instead, moisten them with a wet cloth and detergent.

If the oven is heavily soiled use the cleaning function for best results.

Do not use non-suitable cleaning agents:

- scouring cleaning agents
- nitro polishing agents
- distilled vinegar
- oven cleaner
- cleaners containing chloride
- abrasive sponges or objects

Cooking Inserts

Clean the cooking inserts in hot soapy water or in the dishwasher.

Soak baked-in remainders of food and clean with a brush.

Racks

You can take the racks out for easier cleaning. Undo the knurled nuts and pull out the racks to the front.

Clean the racks in a dishwasher.

Grease Filter

The grease filter can be detached in the upward direction for cleaning.

Clean the grease filter in a dishwasher.

Water Tank

Clean the water tank with hot soapy water. Leave it to dry with the lid opened. Keep the seal in the lid clean and dry after every use.

Dry the slot in the oven after every use.

Glass Front

Clean the glass front with a soft cloth and glass cleaner. Do not wipe the glass front with a soaking wet cloth as water might enter behind the glass.

Do not use aggressive, scouring cleaning agents or glass scrapers. They can scratch the surface and destroy the glass.

Only clean the display with a soft cloth. Do not wipe the display with a soaking wet cloth as water might enter behind the screen.

Door Seal

Always keep the door seal clean and free of food remains.

Do not use aggressive cleaning agents (e.g. oven cleaner) on the door seal. They can destroy the door seal.



Do not remove the door seal.

Cleaning Function

Stubborn soiling can be loosened using the cleaning function and may then be removed more easily. The cleaning function takes approx. 34 minutes.

Leave the oven to cool down completely before cleaning. Take all accessories out of the oven interior. First clean the evaporating dish to avoid residues burning in.

How to Proceed

- 1 Fill the water tank to the MAX marking with cold water. Do not use demineralised water. Fully insert the water tank until it engages.
- 2 Put a small amount of washing up liquid into the evaporating dish on the bottom of the oven interior. Close the oven door.
- 3 Turn the function knob one position to the left. Turn the temperature knob to the left to the special functions. The cleaning menu appears. The duration appears on the display.
- 4 Press  to start. The cleaning starts.
- 5 A signal is sounded after the time has elapsed. The second step (rinsing) appears on the display.
- 6 Wipe the loosened soiling in the oven interior and in the evaporating dish away with a sponge. Empty the water tank, refill with cold water and insert.
- 7 Close the oven door. Press  to start. The oven rinses.
- 8 After 2 minutes a signal is sounded. Use a sponge to soak the remaining water from the evaporating dish.
- 9 Close the oven door. Press  to start. The oven rinses again.

After 2 minutes a signal is sounded. The cleaning function has ended. Switch off the temperature knob.

Use a sponge to soak the remaining water from the evaporating dish. Dry the oven interior with a soft cloth or use the drying function.

Note

The duration of the cleaning function cannot be changed. The oven light is off during the cleaning function.

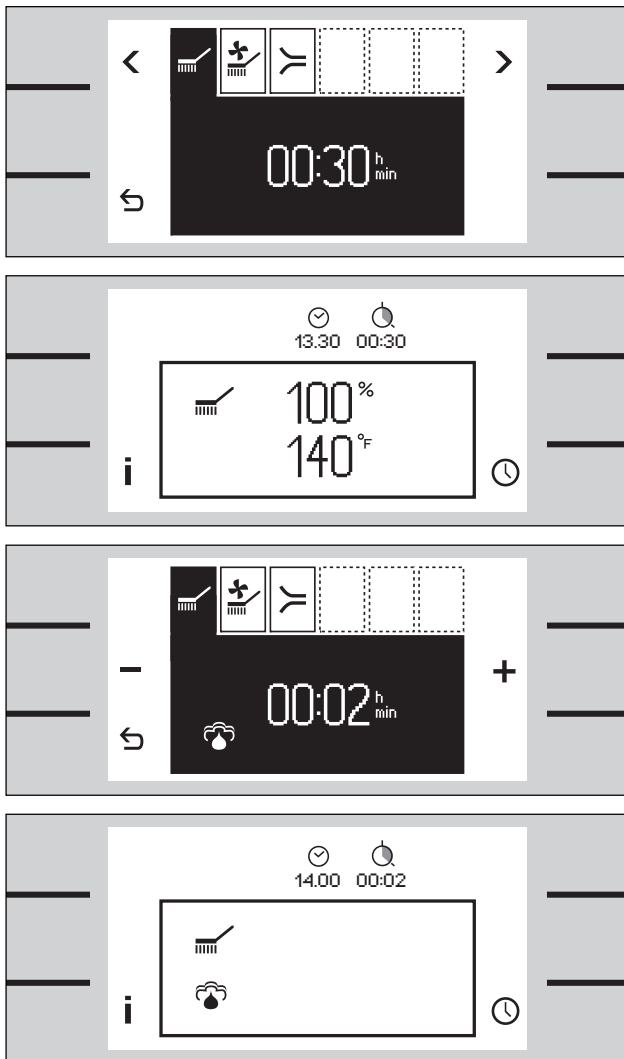

If you want to stop the cleaning function:
Switch off the temperature knob.

If three dashes appear on the display:
Operator error. Check if you have set the functions
and temperature knobs to the correct positions.

Drying Function

Use the drying function after cleaning to dry the oven interior. You can also dry the oven interior after steaming using the drying function.

Note:

Do not heat up the water tank in the oven to dry it!
This will damage the water tank.

How to Proceed

- 1 Turn the function knob one position to the left.
- 2 Turn the temperature knob to the left to the special functions.
The cleaning menu appears.
- 3 Use the > menu key to select the drying function. The duration appears on the display.
- 4 Press ↶ to start.

Temperature and moisture level appear on the display.

After the time has elapsed a signal sounds. The drying is finished. Switch the temperature knob off.

Leave the oven to cool down. Then polish the interior and the glass panel with a soft cloth.

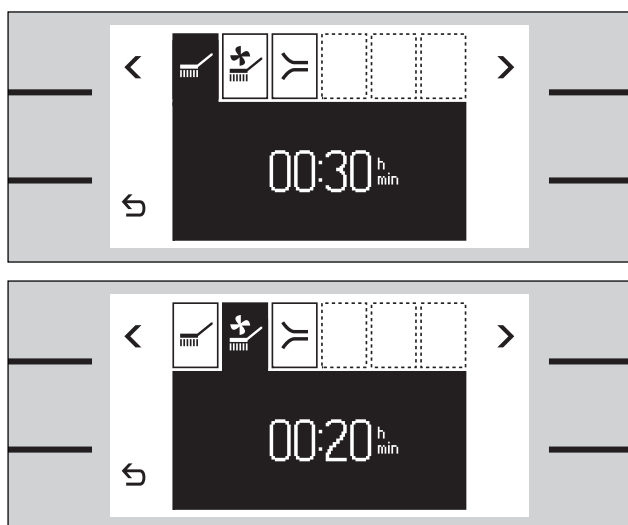

Note

If three dashes appear on the display:
Operator error. Check if you have set the functions
and temperature knobs to the correct positions.

Descaling Program

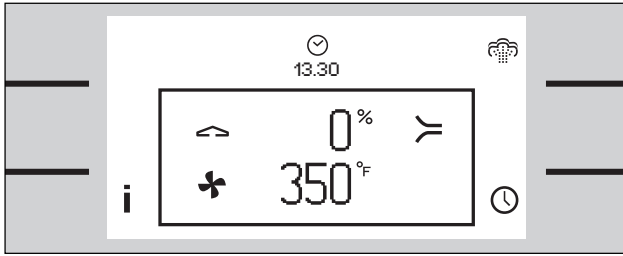

To keep your appliance in good working order, you have to descale it regularly. Descal the oven when the descaling symbol \approx appears on the display.

The descaling program consists of three steps – descaling and rinsing twice. The descaling program lasts approx. 34 minutes. Always let the program run until it has ended. The oven light is off during the descaling program.

Use a sponge to empty the evaporating dish between each of the three steps above.

Leave the oven to cool down completely before descaling. Take all accessories out of the oven interior.

Only use liquid, lemon-based descaler. Mix the descaling solution according to the manufacturer's instructions. Do not let the descaling solution come into contact with the frame of the oven.

How to proceed

- 1 Fill the water tank with 1 $\frac{1}{2}$ cups of descaling solution.
- 2 Turn the function knob one position to the left.
- 3 Turn the temperature knob to the left to the special functions. The cleaning menu appears.
- 4 Use the \triangleright menu key to select the \approx descaling function. The duration appears on the display.
- 5 Press \hookrightarrow to start.
- 6 The descaling program starts. After 30 minutes a signal is sounded.
- 7 Use a sponge to soak the descaling solution from the evaporating dish. Thoroughly rinse the water tank, fill with water and insert.
- 8 Press \hookrightarrow to start. The oven rinses. After 2 minutes a signal is sounded.
- 9 Use a sponge to soak the water from the evaporating dish. Close the oven door. Press \hookrightarrow to start. The oven rinses again.

After 2 minutes a signal is sounded. The descaling has ended. Switch off the temperature knob.

Use a sponge to wipe the oven interior and dry with a soft cloth or use the drying function.

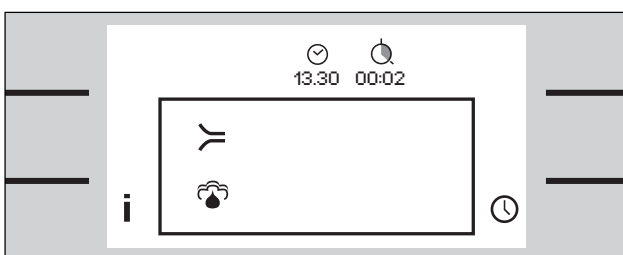
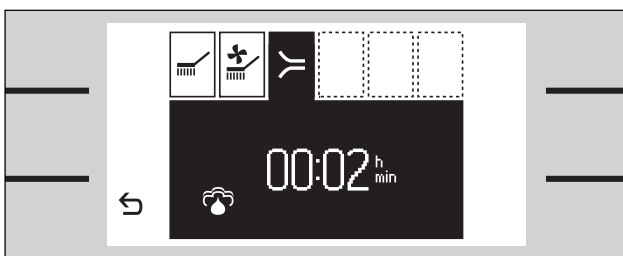
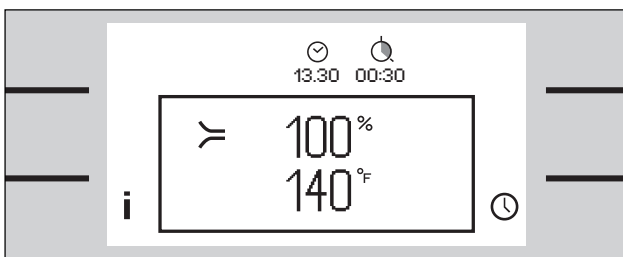
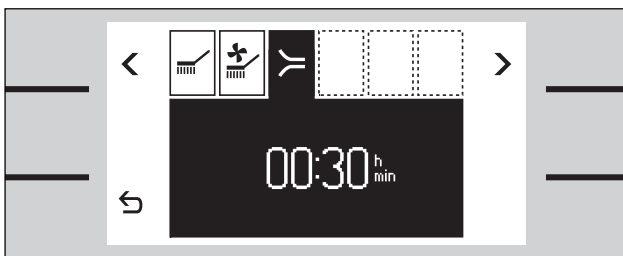

Tip

You can descale the evaporating dish between intervals. Completely fill the evaporating dish with descaling solution and the tank with water. Start the descaling program.

Trouble Shooting

In case of a malfunction first check the household fuses. If the power supply is functioning correctly contact your dealer or Gaggenau after-sales service.

Please specify the E number and FD number of the appliance when calling our after-sales service. You find these numbers on the rating plate of the appliance.

Repairs may only be carried out by authorised technicians, in order to guarantee the electrical safety of the appliance.

⚠ Warning! Incorrect repairs may result in serious injury to the user.

All poles of the appliance must be disconnected from the electricity when being repaired (switch off the household fuse or the circuit breaker in the fuse box).

For technical reasons the lamp cover cannot be removed. Lamp must only be replaced by Gaggenau after-sales service.

Important! Do not remove the lamp cover.

Non compliance with these recommendations results in the warranty coverage becoming invalid.



Error Messages

If a malfunction occurs and the appliance does not heat up, an error code will flash on the display.

If E003, E303, E115 or E215 flashes on the display the appliance is too hot. Switch off the appliance and let it cool down.

If a different error code flashes on the display call the after-sales service. Please specify the error code and the appliance type. You find the appliance type on the rating plate.

Switch off the temperature knob.

Note:

The short timer and stop clock can still be used.

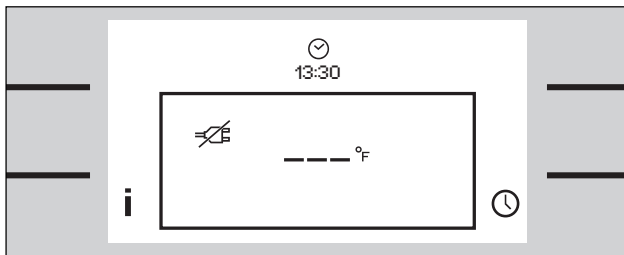

Power Cut

The appliance bridges a power cut of up to 5 minutes. The operation continues.

After a longer power cut the appliance will switch off the operation. The  symbol appears on the display and three dashes instead of the temperature.

Switch off the temperature knob and switch the appliance back on.

The "first settings" menu reappears if the appliance is without electricity for several days. You have to reset the clock.

Note: The basic settings remain stored even if the appliance is without electricity for several days.



Exhibition Mode

If the  symbol appears on the standby screen, exhibition mode is activated. The appliance does not heat up.

Disconnect the appliance from the electricity for a few seconds (switch off the household fuse or the circuit breaker in the fuse box). Within 3 minutes after reconnecting the appliance, go to the basic settings menu and deactivate exhibition mode.

Gaggenau
780 Dedham Street
Canton, MA 02021
Telephone: 877.4GAGGENAU
USA
www.gaggenau-usa.com

Gaggenau Hausgeräte GmbH
Carl-Wery-Straße 34
81739 München
Germany
www.gaggenau.com

9000186374 EB 8707 enUS

GAGGENAU