

Double Oven BX 280/281-6..

Table of Contents

Important Safety Instructions	4	Broiling Table	23
Fire Safety	4		
Burn Prevention	4	Tips and Tricks	24
Child Safety	4	Baking	24
Cleaning Safety	4	Further Tips for Baking	25
Cookware Safety	5	Rising Dough (Fermenting)	25
Proper Installation and Maintenance	5	Tips for Roasting and Broiling	25
		Defrosting	25
Operating for the First Time	6		
		Timer	26
Avoiding Damage to the Appliance and the Cabinet	6	Calling up the Timer Menu	26
Oven	6	Timer	26
Cabinet Fronts near the Oven	6	Stopwatch	27
		Cooking Time Duration	28
Features of your New Oven	7	Cooking Time End	29
Oven	7		
Display and Controls	8	Sabbath Mode	30
Keys	8	Setting the Program	30
		Note	30
Accessories	9		
		Child Lock	31
Heating Modes	10	Activating the Child Lock	31
		Deactivating the Child Lock	31
First Settings after Installation	11	Note	31
Note	11		
Choosing the Time Format	11	Additional Functions	32
Setting the Language	11	Safety Deactivation	32
Setting the Clock	11	Fast Heating up	32
Setting the Date	12		
Temperature Unit °C or °F	12	Changing the Basic Settings	33
Exiting Menu and Saving Settings	12	Note	33
		Example: Changing the Standby Screen	33
Activating the Oven	13		
Standby	13	The Following Settings Can Be Changed	34
Activating the Oven	13		
		Care and Manual Cleaning	36
Setting the Oven	14		
Setting the Temperature and Cooking Mode	14	Pyrolysis	37
Current Oven Temperature Display	14	Before Starting Pyrolysis	37
Setting the upper and lower oven	15	Setting the Program	37
Display	15	Delaying the Switch-off Time	38
		Note	38
Meat Probe	16	Cleaning Accessories with Pyrolysis	39
Programming the Meat Probe	16		
Note	17	Trouble Shooting	40
Cleaning	17	Error Messages	40
Recommended Temperature Values	17	Exhibition Mode	40
		Power Cut	41
Rotary Spit	18		
Preparation	18	Replacing the Oven Lights	41
Switching on the Rotary Spit	18	Replacing the Ceiling Light	41
Switching off the Rotary Spit	19	Replacing the Side Light	42
Note	19		
Baking Table	20		
Roasting Table	21		



Important Safety Instructions

Fire Safety

Read and save these instructions.

Do not use aluminum foil or protective liners to line any part of an appliance, especially surface unit drip bowls or oven bottom. Installation of these liners may result in a risk of electric shock or fire.

If materials inside an oven or warming drawer should ignite, keep door closed. Turn off the appliance and disconnect the circuit at the circuit breaker box.

Use this appliance only for its intended use as described in this manual. For example, never use the appliance for warming or heating the room. Never use the appliance for storage.

Always have a working smoke detector near the kitchen.

In the event that personal clothing or hair catches fire, drop and roll immediately to extinguish flames.

Smother flames from food fires other than grease fires with baking soda. Never use water on cooking fires.

Have an appropriate fire extinguisher available, nearby, highly visible and easily accessible near the oven.

Burn Prevention

DO NOT TOUCH HEATING ELEMENTS OR INTERIOR SURFACES OF OVEN – Heating elements may be hot even though they are dark in color. Interior surfaces of an oven become hot enough to cause burns. During and after use, do not touch, or let clothing, potholders, or other flammable materials contact heating elements or interior surfaces of oven until they have had sufficient time to cool. Other surfaces of the appliance may become hot enough to cause burns. Among these surfaces are oven vent openings, surfaces near these openings and oven doors.

Exercise caution when opening the appliance. Standing to the side, open the door (or drawer) slowly and slightly to let hot air and/or steam escape. Keep your face clear of the opening and make sure there are no children or pets near the unit. After the release of hot air and/or steam, proceed with your cooking. Keep doors shut unless necessary for cooking or cleaning purposes. Do not leave open doors unattended.

Do not heat or warm unopened food containers. Build-up of pressure may cause the container to burst and cause injury.

Always place oven racks in desired location while oven is cool. If a rack must be moved while oven is hot, do not let potholder contact the heating elements.

Always use dry potholders. Moist or damp potholders on hot surfaces may result in burns from steam. Do not let potholder touch hot heating elements. Do not use a towel or other bulky cloth.

Child Safety

When children become old enough to use the appliance, it is the legal responsibility of the parents or legal guardians to ensure that they are instructed in safe practices by qualified persons.

Do not allow anyone to climb, stand, lean, sit, or hang on any part of an appliance, especially a door, warming drawer, or storage drawer. This can damage the appliance, and the unit may tip over, potentially causing severe injury.

Do not allow children to use this appliance unless closely supervised by an adult. Children and pets should not be left alone or unattended in the area where the appliance is in use. They should never be allowed to play in its vicinity, whether or not the appliance is in use.

CAUTION – Items of interest to children should not be stored in an appliance, in cabinets above an appliance or on the backsplash. Children climbing on an appliance to reach items could be seriously injured.

Cleaning Safety

IMPORTANT SAFETY NOTICE: The California Safe Drinking and Toxic Enforcement Act requires the Governor of California to publish a list of substances known to the state to cause cancer, birth defects or other reproductive harm, and requires businesses to warn customers of potential exposure to such substances.

The burning of gas cooking fuel and the elimination of soil during self-cleaning can generate small amounts of Carbon Monoxide.



Important Safety Instructions

The fiberglass insulation in self-clean ovens gives off very small amounts of formaldehyde during the first several cleaning cycles.

California lists formaldehyde as a potential cause of cancer. Carbon Monoxide is a potential cause of reproductive toxicity.

Exposure to these substances can be minimized by:

1. Providing good ventilation when cooking with gas.
2. Providing good ventilation during and immediately after self cleaning the oven.
3. Operating the unit according to the instructions in this manual.

When self-cleaning, confirm that the door locks and will not open. If the door does not lock, do not run Self-Clean. Contact service.

Wipe out excessive spillage before self-cleaning the oven.

Birds have very sensitive respiratory systems. Keep pet birds out of the kitchen or other rooms where kitchen fumes could reach them. During self clean, fumes are released that may be harmful to birds. Other kitchen fumes such as overheating margarines and cooking oils may also be harmful.

Keep oven free from grease build up.

Cookware Safety

Do not place food directly on oven bottom.

Follow the manufacturer's directions when using cooking or roasting bags.

Proper Installation and Maintenance

WARNING: When properly cared for, your new appliance has been designed to be safe and reliable. Read all instructions carefully before use. These precautions will reduce the risk of burns, electric shock, fire, and injury to persons. When using kitchen appliances, basic safety precautions must be followed, including those in the following pages.

Have the installer show you the location of the circuit breaker or fuse. Mark it for easy reference.

This appliance must be properly installed and grounded by a qualified technician. Connect only to properly grounded outlet. Refer to Installation Instructions for details.

This appliance is intended for normal family household use only. It is not approved for outdoor use. See the Warranty. If you have any questions, contact the manufacturer.

Do not store or use corrosive chemicals, vapors, flammables or nonfood products in or near this appliance. It is specifically designed for use when heating or cooking food. The use of corrosive chemicals in heating or cleaning will damage the appliance and could result in injury.

Do not operate this appliance if it is not working properly, or if it has been damaged. Contact an authorized servicer.

Do not obstruct oven vents.

Do not repair or replace any part of the appliance unless specifically recommended in this manual. Refer all servicing to a factory authorized service center.

In the event of an error the display flashes. If this happens during self-clean, disconnect appliance from the power supply and call a qualified technician.

In the event of an error the display flashes. Disconnect appliance from the power supply and call a qualified technician.

Operating for the First Time

Remove the packaging from the appliance and dispose of it according to local regulations. Be careful to remove all accessories from the packaging. Keep packaging elements and plastic bags away from children.

Check the appliance for transport damage after unpacking it. Do not connect the appliance if it has been damaged.

The appliance must be connected by an authorised specialist. No warranty claims can be lodged for any damage resulting from incorrect connection. Observe the installation instructions.

Thoroughly clean the appliance before using it for the first time. This will eliminate any 'newness' smells and soiling.



This appliance is labelled in accordance with the European Directive 2002/96/EG concerning used electrical and electronic appliances (waste electrical and electronic equipment – WEEE). The guideline determines the framework for the return and recycling of used appliances as applicable.

Avoiding Damage to the Appliance and the Cabinet

Oven

Remove fruit acids such as the juice of lemons or plums etc. after every baking operation. The acid can cause spots on the oven's enamel.

Never splash water into a hot oven. This could damage the enamel.

Do not place the baking tray directly onto the bottom of the oven. Do not place utensils (for example a roaster) directly onto the bottom of the oven. Do not line the bottom of the oven with aluminium foil. This will cause a build-up of heat which can damage the enamel.

Do not cover the ventilation openings of the oven.

Do not take off the door seal. A damaged door seal must be changed immediately.

The socket for the separate heating element for the roaster and the baking stone (special accessory) can be found in the middle of the back panel at the bottom. During normal operation, please leave the cover in the socket.

Cabinet Fronts near the Oven

After taking the food out of the oven, allow the oven to cool down with the door closed. Do not leave the oven door half open, the hot air can cause damage to adjacent cabinets. The cooling fan will continue to run for a while and will then switch off automatically.

Features of your New Oven

Oven

The operation of the upper and lower oven is identical.

The rotary spit and the meat probe are only available in the lower oven.

The heating mode economy broiling is only available in the upper oven. The roaster operation is only available in the lower oven.

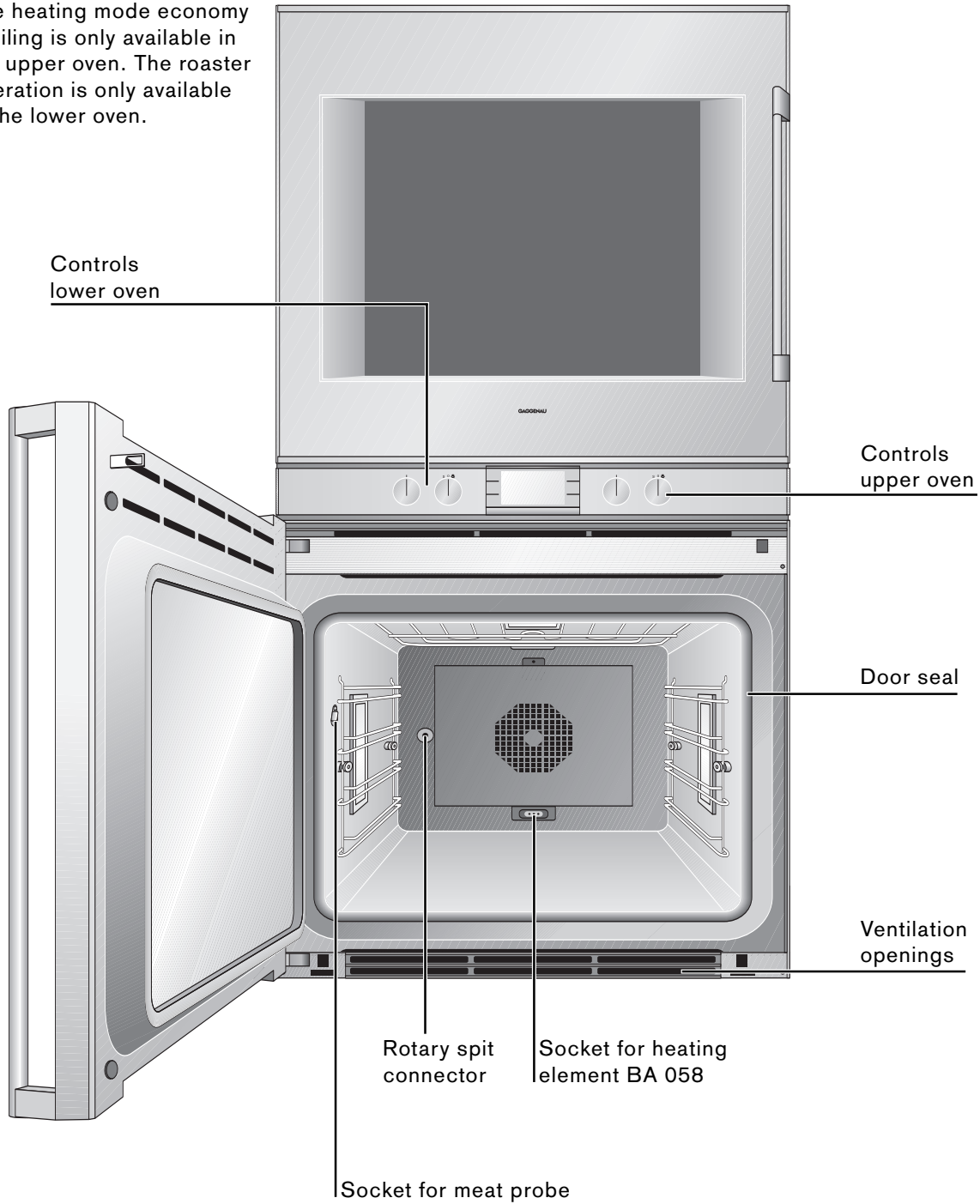

Display and Controls

Display

In the top part of the display is the status bar or a call up menu. The lower part shows the different settings.



Touch keys

The keys on the left and right beside the display are touch sensitive. The function of the keys depends on the chosen setting. The icon beside the key shows the function of the key.

Function selector

Use the left knob to select the cooking mode you will use to prepare your meal or the pyrolysis function. You can turn the knob to the right or left.



Temperature selector

You can set a temperature between 120 and 550°F or pyrolysis. You can turn the knob to the right or left. To switch on the light in the oven, turn the temperature selector one position to the right.

The light in the oven remains off if the temperature is set below 140°F.

Keys

Symbol	Function
>	move right
<	move left
↻	save selected values / start
C	cancel
+	increase values
-	decrease values
🕒	timer menu
🔧	basic settings menu
🍖	rotary spit
i	call up additional info
🔒	child lock activate
🔓	child lock deactivate
🕒	extended timer
	timer stop
▶	timer start

Accessories

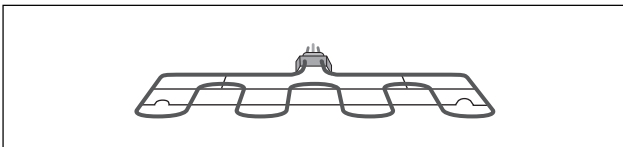
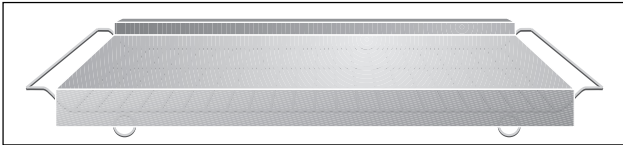
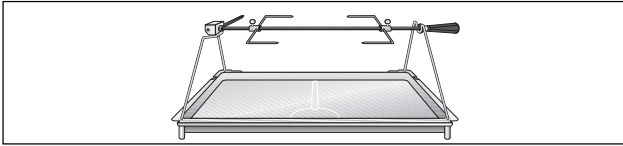
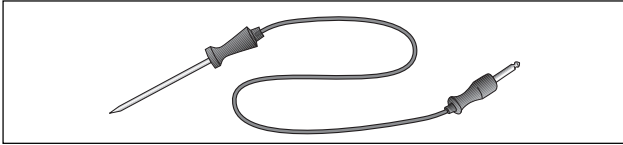
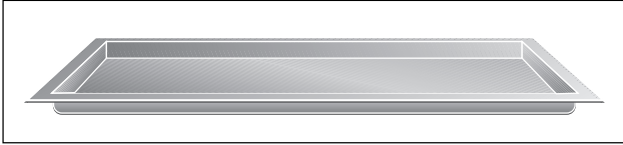
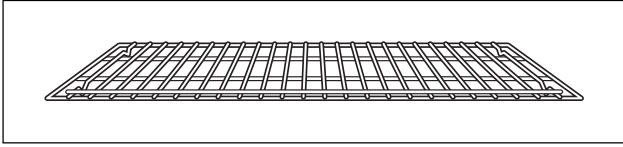

As standard, your appliance comes with the following accessories:

- Wire rack for cake tins, roasts, broiled pieces and crockery

Always insert the wire rack with the double crossbrace to the front.

- Baking tray for cakes, cookies and pastries

- Broiling tray for roasts or as a grease collecting tray

- Meat probe

- Rotary spit with support frame

You can order the following special accessories:

- Baking stone with wire rack and wooden pizza spatula for pizza and bread















Additionally you will require the heating element

- Heating element for baking stone

▲ WARNING: Do not use aluminum foil or protective liners to line any part of an appliance, especially surface unit drip bowls or oven bottom. Installation of these liners may result in a risk of electric shock or fire.

Do not place food directly on oven bottom.

Heating Modes

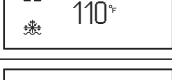
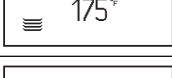
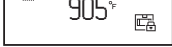
Display	Heating mode	Use
	Convection	For cakes, biscuits and puff pastry on several levels
	Economy (the oven light is off)	Energy saving convection mode for cakes, small pastries or gratins
	Convection and 1/3 bottom heat	Additional reduced heat from beneath
	Convection and bottom heat	Additional heat from beneath for moist cakes, for example fruit cakes
	Bottom heat	Further baking, for example for fruit cakes, for preserving or for food in a bain-marie
	1/3 Top and bottom heat	Bottom heat with reduced top heat
	Top and bottom heat	For cakes in tins or on trays, gratins or roasts
	Top and 1/3 bottom heat	Top heat with reduced bottom heat
	Top heat	Direct heat from the top, for example to brown meringue on a fruit cake
	Convection broiling	Evenly distributed heat for meat, poultry or whole fish
	Broiling	Broiling flat pieces of meat, sausages or fish fillets melting cheese, gratins
	Economy broiling (upper oven only)	Energy saving broiling for small amounts of food. Only the middle part of the heating element is on.
	Roaster operation (lower oven, only with special accessories)	Heated cast roaster for large quantities of meat, gratin or the Christmas turkey
	Baking stone operation (only with special accessories)	Heated baking stone for crispy pizza, bread or bread rolls like from a solid stone oven
	Dough proofing	Raising yeast dough, the perfect temperature setting is 100°F
	Defrosting	Even and gentle defrosting between 100 - 140°F depending on the food
	Keeping warm	Keep meals warm, warm porcelain dishes
	Pyrolysis	Automatic self cleaning

First Settings after Installation

When your new oven has been connected, the first settings menu appears on the display.

You can set the

- time format,
- language,
- clock,
- date,
- temperature unit.

Note

The first settings menu appears only after the appliance has been connected or if the appliance is without electricity for several days.

Refer to the chapter basic settings if you wish to change these parameters at any time.

Choosing the Time Format

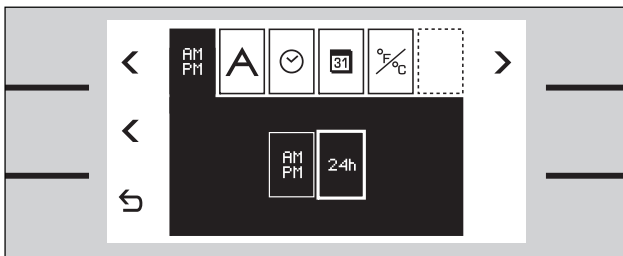

- 1 The time format setup menu appears on the screen.
The time format can be either 12 hour format (AM/PM) or 24 hour format. The 24 hour format is pre-selected.
- 2 You can change the time format using the centre < key.

Setting the Language

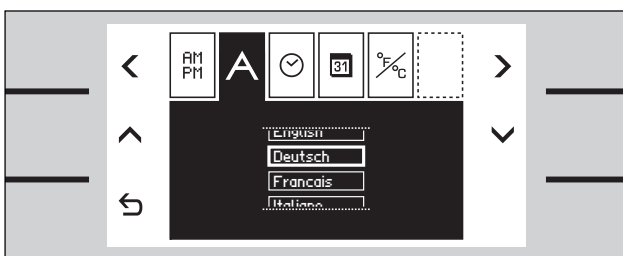

- 1 Using the menu key > select the language setup menu. The available languages for the display messages appear on the screen. German is pre-selected.
- 2 You can change the language using the ^ or v keys or switch the display messages off.

Setting the Clock

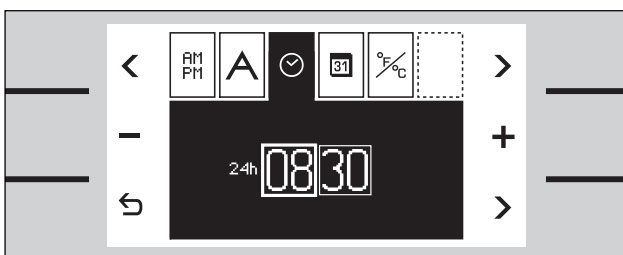

- 1 Using the menu key > select the clock function ⌚.
08:30 appears on the screen.
- 2 Using the + / - keys set the correct time.
Use the arrow key > bottom right to change from hours to minutes.

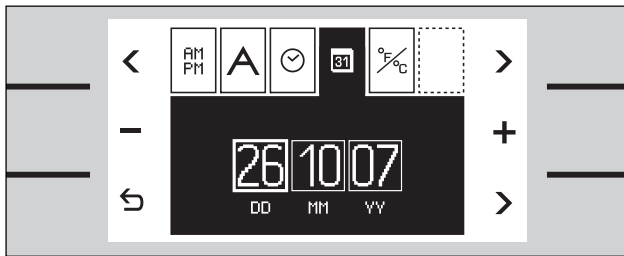

Setting the Date

- 1 Using the menu key > select the date function 31.
26.10.07 appears on the screen.
- 2 Using the + / - keys enter day, month, year.
Use the arrow key > bottom right to change from day/month/year.

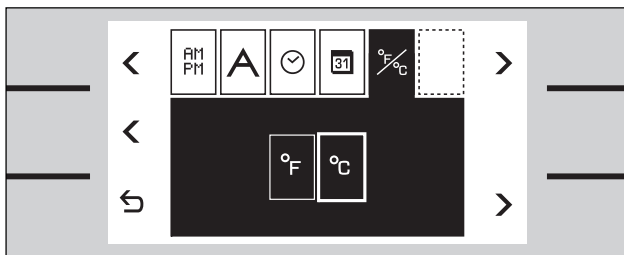

Temperature Unit °C or °F

- 1 Using the menu key > select the temperature unit function °C. °C is pre-selected.
- 2 You can change the temperature unit using the middle < key.

Exiting Menu and Saving Settings

Touch the ↵ key to exit the menu. All settings are saved.

The oven is on standby. The standby screen appears.

Activating the Oven



Standby

The oven remains on standby when no operating mode is selected or the child lock is activated.

The keys are not activated. The display is not lit.

Note:

You can choose between different standby screens. GAGGENAU and the clock is pre-selected. Refer to the chapter basic settings if you want to change the standby screen.

Note:

The display contrast depends on the vertical viewing angle. You can adjust the contrast of the display in the basic settings.

Activating the Oven

To leave standby do one of the following:

- touch a key
- open or close the oven door
- turn the temperature knob
- turn the function knob

Now you are able to set the required function. Read the relevant chapter on how to activate the required function.

Note:

The standby screen reappears after one minute if no further function is chosen. The display light goes off.

Setting the Oven

The main operations of your oven are easily set using the knobs.

Using the right knob on each of the knob pairs you can set the temperature. To switch on the light in the oven, turn the temperature knob one position to the right.

The temperature range is 120 - 550°F.

Exception:

Fermenting	85 - 120°F
Defrosting	100 - 140°F
Keeping warm	120 - 250°F
Roaster operation	120 - 430°F

Using the left knob on each of the knob pairs you can set the cooking mode. The top position is convection.

Setting the Temperature and Cooking Mode

- 1 Set the temperature knob to the required temperature.
Temperature and cooking mode symbol appear on the display. The light in the oven goes on.

To select another cooking mode:

- 2 Turn the function knob until the required cooking mode appears on the screen.

The heating up symbol  appears until the required temperature is reached. The symbol appears again when the oven heats during operation.

A signal sounds when the selected temperature is reached. Press any key to switch off the signal.
Note: You can deactivate the heating up signal in the basic settings.

The temperature and cooking mode can be changed at any time.

When the meal is ready switch the oven off using the temperature knob. The oven light goes off. The standby screen appears.

Current Oven Temperature Display

The current oven temperature is briefly shown when you press the **i** info key. Using the  key you can return to the standard screen.

Note:

Depending on the heating mode, a slight temperature variation after heating up during use is normal.

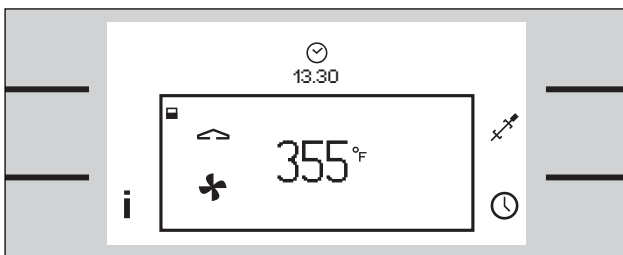
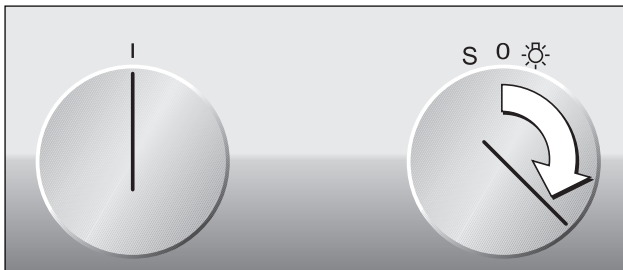



Setting the upper and lower oven



The operation of the upper and lower oven is identical. The two ovens have some different features.

- The rotary spit and the meat probe are only available in the lower oven.
- The heating mode economy broiling is only available in the upper oven. The roaster operation is only available in the lower oven.
- It is not possible to do a pyrolytic cleaning in both ovens at the same time.
- While doing a pyrolytic cleaning in one oven it is not possible to use the other oven.

Display

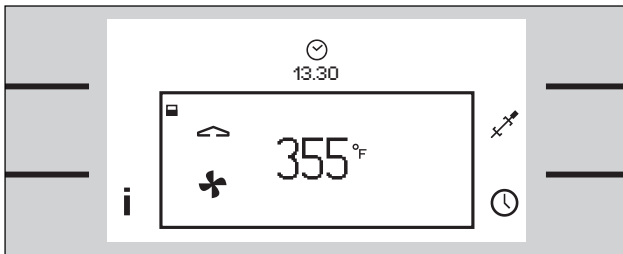
When operating only one oven the temperature and operating mode are shown on the display. The symbol  or  shows, whether the upper or lower oven is being used.



When operating both ovens at the same time the display shows the settings of both ovens. By touching the  or  key you can select the display screen for one of the ovens and change a setting, for example set the timer or check the current oven temperature. After a short while the display for both ovens appears again.

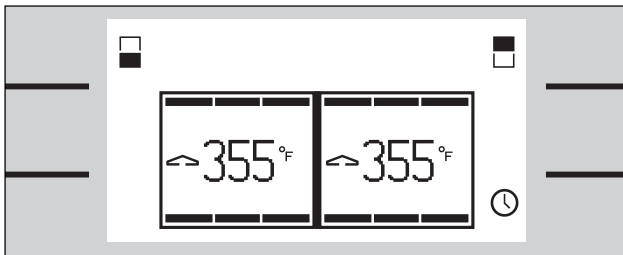

When turning a knob of one of the ovens, the settings of this oven are shown on the display. After a short while the display for both ovens appears again. You can also touch the  key to return to the display for both ovens.

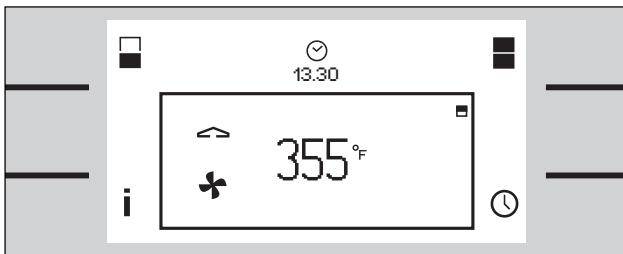

Meat Probe

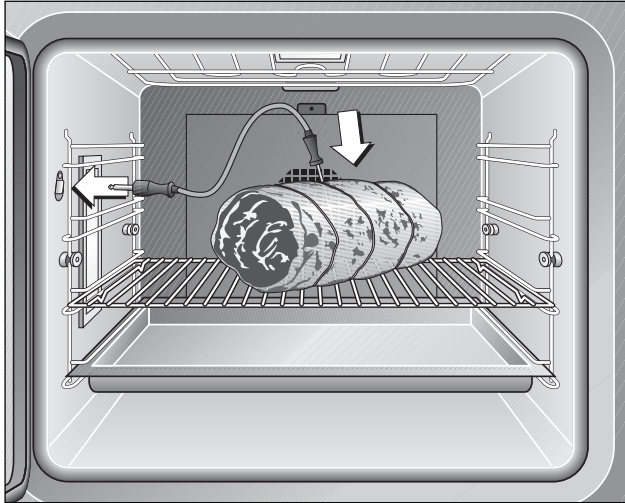

The meat probe enables you to cook your meat exactly as you want it.

Using the meat probe, during the cooking process you can measure the core temperature of the interior of the food you are preparing exactly between 33°F and 210°F.

Fully insert the tip of the meat probe in the middle of the food, at its thickest point. The tip should not be inserted into fat and should not touch any dishes, bones or fatty tissue.

In the case of poultry, do not insert the tip of the meat probe in the middle (hollow) but between the belly and the thigh.

When you connect the meat probe to the socket in the oven, the  symbol appears on the display.

The smaller temperature display on the top shows the measured temperature from the meat probe.

The meat probe is only available in the lower oven.

Programming the Meat Probe

You can program the desired core temperature for your meal. The appliance switches off automatically, when the programmed temperature has been reached.

- 1 Insert the tip of the meat probe into the meat.
- 2 Connect the meat probe to the socket.
- 3 Using the **+** / **-** keys set the correct core temperature.
The suggested temperature is 140°F.

The larger temperature display on the top shows the programmed temperature, the smaller display shows the measured temperature from the meat probe.

A signal sounds when the programmed core temperature has been reached. The appliance stops heating.

Switch the temperature knob off and open the oven door. Remove the meat probe before taking the food from the oven.

⚠ Danger, risk of burns! Use an oven glove. The meat probe gets very hot during use.

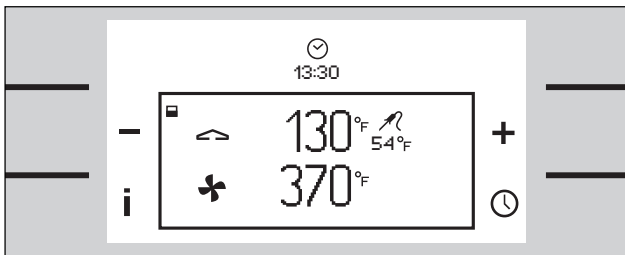

Note

Pull the meat probe from the socket if you want to end the programming.

If you program meat probe and timer simultaneously, the program that reaches the entered value first will switch off the oven.

Only use the included original meat probe. You can order the meat probe as a spare part.

Only use the meat probe up to a temperature of 440°F.

Remove the meat probe from the oven when it is not in use.

Remove the meat probe from the oven during pyrolysis.

Cleaning

Only rub the meat probe with a moist cloth. The meat probe is not dishwasher-proof.

Recommended Temperature Values

Beef		
Roast beef / fillet of beef / entrecôte		
	blood rare	113-117 °F
	rare	122-126 °F
	medium-rare	136-140 °F
	well-done	158-167 °F
Beef roast		
		176-185 °F
Pork		
Roast pork		
		162-176 °F
Back of pork		
	medium-rare	149-158 °F
	well-done	176 °F
Meat loaf		
		185 °F
Fillet of pork		
		149-158 °F
Veal		
Fillet of veal		
	rare	122-126 °F
	medium-rare	136-140 °F
	well-done	158-167 °F
Roast veal		
	well-done	167-176 °F
Breast of veal, stuffed		
		167-176 °F
Back of veal		
	medium-rare	136-140 °F
	well-done	149-158 °F
Venison		
Back of venison		
		140-158 °F
Leg of venison		
		158-167 °F
Back of venison steaks		
		149-158 °F
Back of hare		
		149-158 °F
Poultry		
Chicken		
		185 °F
Guinea fowl		
		167-176 °F
Goose, turkey, duck		
		176-185 °F
Duck breast		
	medium-rare	131-140 °F
	well-done	158-176 °F
Ostrich steak		
		140-149 °F
Lamb		
Leg of lamb		
	medium-rare	140-149 °F
	well-done	158-176 °F
Back of lamb		
	medium-rare	131-140 °F
	well-done	149-167 °F
Mutton		
Leg of mutton		
	medium-rare	158-167 °F
	well-done	176-185 °F
Back of mutton		
	medium-rare	158-167 °F
	well-done	176 °F
Fish		
Fillet		
		144-149 °F
Whole		
		149 °F
Tureen		
		144-149 °F
Other		
Bread		
		195 °F
Pâte		
		162-167 °F
Tureen		
		140-158 °F
Foie gras		
		113 °F

Rotary Spit

Use the rotary spit to grill large roasts or poultry. Grilling with the rotary spit produces a crispy crust and even browning all-round.

You can use the rotary spit in all heating modes. You get the best results in the broil or top heat modes.

The rotary spit is only available in the lower oven.

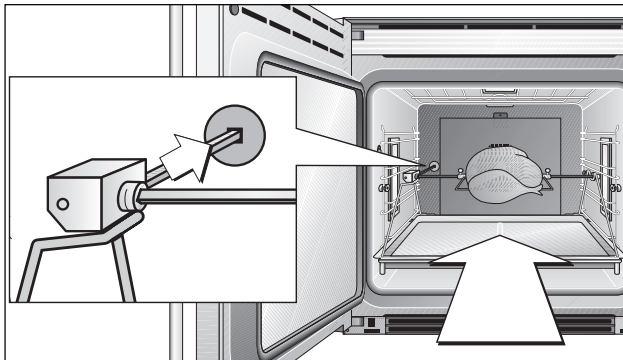
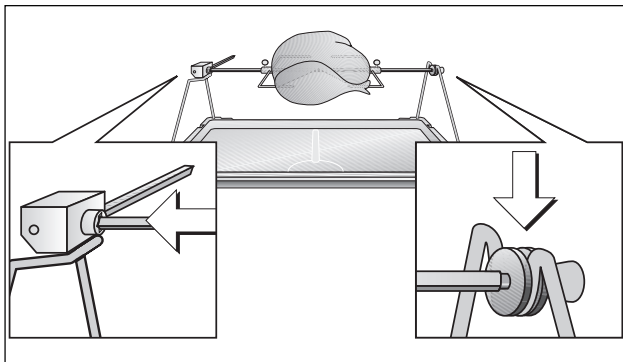
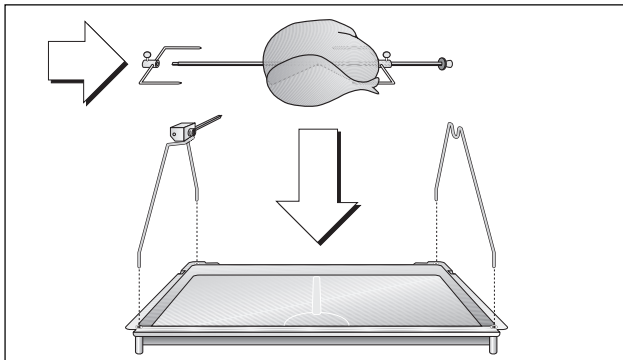

Preparation



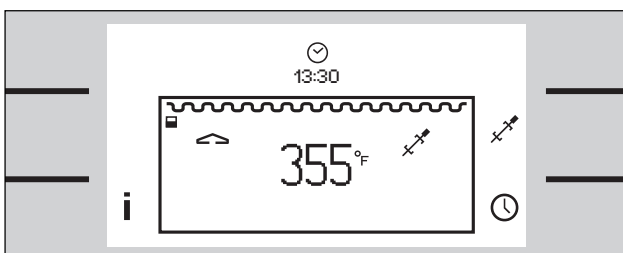

- 1 Push both spit holders in the fittings on the grilling tray. The rotary drive is on the left.
- 2 Slide the right retaining clip onto the spit and tighten the screw.
- 3 Place the food you want to prepare on the rotary spit. Secure protruding parts (e.g. wings) to make sure they do not touch the grill heating element.
- 4 Slide the left retaining clip onto the spit and tighten the screw.
- 5 Place the spit onto the spit holders. Insert the square edge into the drive.
- 6 Insert the grilling tray and the rotary spit on the lowest level of the oven. The drive shaft has to engage into the opening on the back of the oven interior.



Switching on the Rotary Spit

- 1 Set the required temperature and mode.
- 2 Touch the  key, until the  symbol appears next to the temperature display. The rotary spit is switched on.

Switching off the Rotary Spit

- 1 Touch the  key until the  symbol goes off.
- 2 Switch off the oven by the temperature selector.
- 3 **▲ WARNING, RISK OF BURNS!** Use an oven glove to take out the grilling tray with the rotary spit. Place it on a stable, heat-resistant surface.
- 4 Screw the handle on to the side of the spit to take it off.

Note

The core temperature sensor cannot be used in combination with the rotary spit.

Only use the rotary spit up to a temperature of 480°F.

Do not clean the rotary spit drive in a dishwasher.

Baking Table

Cakes and cookies	Level from below	Convection Temp. °F	Economy Temp. °F	Convection+ bottom heat Temp. °F	Top and bottom heat Temp. °F	Baking time Min.
Swiss roll	2				410	7-9
Flan base	2				330-345	30-35
Fruit flan on yeast dough	2	330			330-345	40-45
Fruit flan on short-crust pastry	2	330	330	330	330-345	40-45
Small flaky pastry cakes	1+3/2*	355	355		375	15-20
Cheesecake (high)	2	330	330	330	330-340	90-100
Cheesecake slices (flat)	2	330	330	330	330-345	45-50
Sponge cake (round)	2	320-340	320-345		340-345	50-60
Loaf cake	2	320-340	320-345		340-345	50-60
Yeast dough ring cake (tall)	1	320-345			330-345	40-50
Biscuits	1+3/2*	320-345	320-345		330-340	15-20
'Hefezopf'	2	330			330-340	30-40
Cake on baking tray (dry top)	2	330-340	330-340		330-340	40-50
Cake on baking tray (moist top)	2	330-340	330-340	340	330-340	40-50
Cream puffs	1+3/2*	355	355		355-375	20-25
Mixed-grain bread**	2	390/340			210/340	40-50

* In the economy and convection modes you can bake simultaneously on several levels.

** Preheat the appliance to the specified temperature. Switch back to the second temperature when inserting the food.

Note: The values given above should be looked upon as recommended values. We advise you to always preheat the oven.

For baking yeast dough we recommend the convection mode.
The recommended mode is printed in bold.

Roasting Table

Dish	Level from below	Convection Temp. °F	Convection broiling Temp. °F	Top and bottom heat Temp. °F	Cooking time Minutes	Meat probe temp. °F
Beef						
Roast beef 1,5 kg*	2	355		355	60-90	
Roast beef rare 1,5 kg**	2	445/355	445/355		45-50	115-120
Roast beef medium 1,5 kg**	2	445/355	445/355		60-70	130-150
Roast beef well done 1,5 kg**	2	445/355			90-100	160-175
Pork						
Pork roast 1,5 kg**	2	445/355	445/355		60-70	165-175
Pork roast with rind 1,5 kg***	2	355/390	355/390		60-70	165-175
Smoked pork 1,5 kg**	2	355/320			40-50	150-160
Leg of pork***	2	300/390	300/390		50-60	175-185
Collared roast**	2	445/355	445/355		60-70	165-175
Veal						
Roast veal**	2	445/355		445/355	60-70	165-175
Leg of veal***	2	300/355	300/355		50-60	165
Loin of veal	2	320-340			20	160-165
Stuffed breast of veal*	2	250-265			120	165-175

* First brown the meat all-round in the casserole on the cooker.

** Brown the meat at a high heat level, switch back to a lower temperature after 15-20 minutes.

*** Cook the meat at a low temperature, set the temperature higher for the last 15-20 minutes.

Note: The values given above should be looked upon as recommended values. We advise you to always preheat the oven.

The recommended mode is printed in bold.

Roasting Table

Dish	Level from below	Convection Temp. °F	Convection broiling Temp. °F	Top and bottom heat Temp. °F	Cooking time Minutes	Meat probe temp. °F
Venison						
Roast boar*	2	340-355			60-90	
Leg of venison*	2	340-355			60-80	170-175
Saddle of venison	2	330-345		340-355	20-25	150-160
Leg of lamb*	2	355-390			35-45	150-170
Poultry						
Duck 2-3 kg**	2	320/375		320/375	100-120	175-185
Duck breast	2	320		320	15-20	160
Goose 2-3 kg**	2	320/375		320/375	100-120	185-195
Turkey 3-4 kg**	2	320/375		320/375	120-355	185-195
Roast chicken	2	355	355		50-60	185

* First brown the meat all-round in the casserole on the cooker.

** Brown the meat at a high heat level, switch back to a lower temperature after 15-20 minutes.

Note: The values given above should be looked upon as recommended values. We advise you to always preheat the oven.
The recommended mode is printed in bold.

Broiling Table

Dish	Level from below	No pre-heat	Temp. °F	Broiling Minutes		Convection broiling Minutes		Cooking Time Minutes
				1.side	2.side	1.side	2.side	
Sliced pork belly	3		355-390	6	4	5	5	10
Kebab	3		375			8	8	16
Fried sausage	3		390	5	4			9
Merguez (grilled sausage)	3		390			6	6	12
Roast chicken*	2	X	355			30	30	60
Leg of chicken	3		355	20	20	15	15	30-40
Spare Ribs	3		355-390	15	15	12	12	24-30
Leg of pork**	2		300/390					50-60
Trout	3		355-390	8	8			16
Vegetable kebabs	3		390	7	7			14
Shrimp kebabs	3		345	7	7			14
Preparing au gratin								
Toasted sandwich	3		375					5-7
Crème caramel***	4	X	475					
Crème brûlée***	4	X	475					
Cake with meringue***	3		390					

Important: Only broil with the oven door closed.

For broiling use the wire rack that fits the broiling tray (accessory or special accessory, depending on the version) to collect dripping fat.

* In the case of appliances featuring a rotary spit, you are advised to use the spit in the broiling mode.

** Do not turn the leg of pork. Set the temperature high for the last 15-20 minutes.

*** You should bake this dish au gratin until it has reached the level of browning you require.

Note: The values given above should be looked upon as recommended values.
The recommended mode is printed in bold.

Baking

What to do if...	The solution
... a cake baked in a tray is too light at the bottom?	Insert the tray on a lower level and remove all other trays from the oven.
... a cake baked in a form is too light at the bottom?	Do not insert the baking form in the oven on the tray, but on the wire rack.
... a cake/small cakes and pastries are too dark at the bottom?	Insert the cake/pastries at a higher level.
... a cake is too dry?	Set the oven temperature to a slightly higher value. Preheat the oven.
... a cake is too moist on the inside or if meat is not cooked on the inside?	Set the baking or roasting temperature to a slightly lower value. Important: baking or roasting times cannot be shortened by selecting higher temperatures. It is better to choose a slightly longer baking or roasting time and to allow the dough to bake longer.
... a cake baked with hot air in a form or a rectangular form is too dark at the back?	Do not place the baking form directly in front of the rear wall of the oven, but in the middle.
... a cake sinks?	Use less fluid the next time or set the oven temperature to a value that is lower by 10 degrees. Pay attention to the stirring times specified in the recipe. Do not open the oven door too soon.
... a cake has risen in the middle and is lower at the edges?	Do not grease the edge of the spring form. After baking, carefully loosen the cake with a knife.
... a cake is too dark at the top?	Insert it on a lower level, select a lower temperature and bake the cake for a slightly longer time.
... a cake is too dark at the bottom?	Insert it at a higher level and choose a lower temperature the next time.
... a fruit cake is too light at the bottom and the fruit juices spill over?	Use the deeper grilling tray for baking.
... a cake is too dry at the bottom?	Use a toothpick to make small holes in the finished cake. Then sprinkle fruit juice or an alcoholic beverage over it. The next time, choose a temperature that is higher by 10 degrees and shorten the baking time.
... bread or a cake looks good from the outside, but is too moist on the inside?	The next time, use slightly less fluid and bake slightly longer at a lower temperature. In the case of cakes with a moist covering, first bake the base, sprinkle almonds or breadcrumbs over it and then add the covering. Pay attention to recipes and baking times.
... you have baked on several levels and your cake on the top tray is darker than on the bottom one?	If you select a slightly lower temperature, your cakes and pastries will be browned more evenly. Trays inserted at the same time need not be ready at the same time. Allow the bottom trays to bake for 5-10 minutes longer and insert them at an appropriately earlier time.
... biscuits stick to the tray?	Briefly reinsert the tray in the oven and remove the biscuits immediately.
... a cake does not come out of the tin easily?	Carefully loosen the edge with a knife. Turn out the cake again and cover the form several times with a cold wet cloth. The next time, grease the form well and additionally sprinkle breadcrumbs into it.

Further Tips for Baking

You are advised to use dark metal baking forms. You may also use light baking forms in the hot air mode. In this case, the baking time is longer.

The values in the cooking tables apply to the preheated oven. The temperature and duration depend on the quantity and consistency of the dough. This is why the tables list temperature ranges. You are advised to begin with the lowest temperature the first time. If required, set it higher the next time. A lower temperature ensures more even browning.

To find out if your cake mixture has baked properly, insert a wooden stick at the highest point of the cake around 5-10 minutes before expiry of the baking time specified in the recipe. The cake is ready if dough no longer sticks to the wood.

Rising Dough (Fermenting)

Use the fermenting mode. Set the temperature to 100°F.

For large amounts of dough (for example bread) set the temperature between 100-105°F. The dough will rise evenly from the middle to the edge.

For small pieces of dough (for example bread rolls) set the temperature between 105-115°F.

Tips for Roasting and Broiling

You can use any heat-resistant dishes. Place dishes in the middle of the wire rack. You can also use the broiling tray for large roasts.

After removing glass dishes, place them on a dry kitchen cloth or cooling grill. Do not place them on a cold or wet support surface. The glass could crack.

Before serving, allow the roast to rest for 10 minutes with the oven switched off and closed. This keeps the roast juicy.

Always broil in the closed oven. If possible, broiled pieces should be equally thick, at least 1 inch. When this is the case, they will brown evenly and will stay nice and juicy. Never grill steaks salted! Place pieces for broiling directly on the wire rack.

Poultry becomes particularly crispy brown if you coat it with butter, salt water, dripped-off fat or orange juice.

For roasting use the wire rack that fits the broiling tray (accessory or special accessory, depending on the version). Put a small amount of water into the broiling tray. This ensures that the juices of the meat are collected and the oven stays clean.

In the case of duck or goose, pierce the skin under the wings to allow the fat to drain off.

What to do, if...

... a roast has become dark and parts of the crust are burnt?
Check the insertion height and the temperature.

... a roast looks good, but the sauce is burnt?
The next time, choose a smaller roasting dish and add more fluid.

... a roast looks good, but the sauce is too light and has become watery?
The next time, choose a larger roasting dish and use less fluid.

... the table does not list a weight for the roast?
Choose the next lowest weight in the list and prolong the roasting time.

Defrosting

Use the defrosting mode. Set the temperature between 100-140°F.

Insert the wire rack with the frozen food on the second level. Insert the broiling tray below to collect the liquid.
Important: pour away the defrosting liquid.

Defrost large pieces of meat (roasts, chicken, etc.) between 110-120°F, otherwise the outer part may start to brown.

You can defrost small or flat pieces between 120-130°F.

Timer

Using the timer menu you can set the following:

- ⌚ timer
- ⌚ stopwatch
- 🕒 cooking time duration (not during stand-by)
- 🕒 cooking time end (not during stand-by)

Calling up the Timer Menu

Touch the key beside the symbol ⌚ to call up the timer menu.

If the appliance is on standby, touch any key. Now the display is activated. The info **i** and timer ⌚ symbols are shown.

Touch the key next to the timer symbol ⌚. The timer menu appears.



Timer

The timer counts down independently of all other settings of the appliance. You can enter a maximum value of 90 minutes.

Setting the Timer

- 1 Call up the timer menu. The timer function ⌚ is shown on the display.
- 2 Using **+** or **-** set the desired duration.
- 3 Start using the ⏪ key.

The timer menu is closed. The symbol ⌚ and the elapsing time are shown in the status bar.

A signal sounds when the time has elapsed. Touch the ⌚ key to switch off the signal.

Note

To cancel an active timer:
Call up the timer menu, select the timer function ⌚ and touch the **C** key.

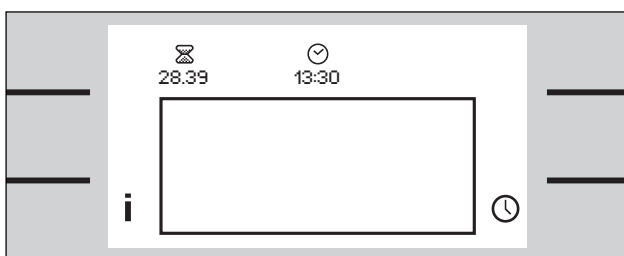
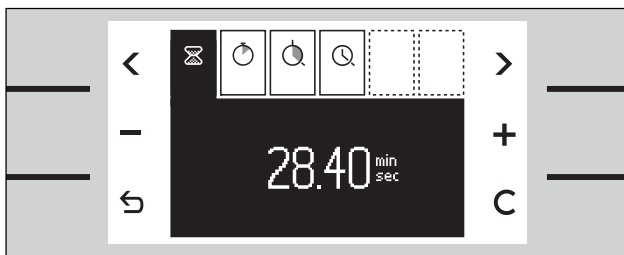

Stopwatch

The stopwatch will count the elapsed time up to 90 minutes.

The pause function pauses the stopwatch.

The stopwatch runs independently of all other settings of the appliance.

Starting the Stopwatch

- 1 Call up the timer menu.
- 2 Using < or > select the stopwatch function ⌚.
- 3 Start using the ▶ key.

The timer menu is closed. The symbol ⌚ and the elapsing time are shown in the status bar.

A signal sounds when the time has elapsed. Touch the ⌚ key to switch off the signal.

The timer menu is closed immediately when you touch the ↵ key.

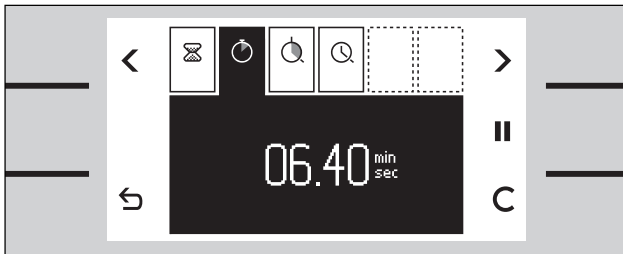
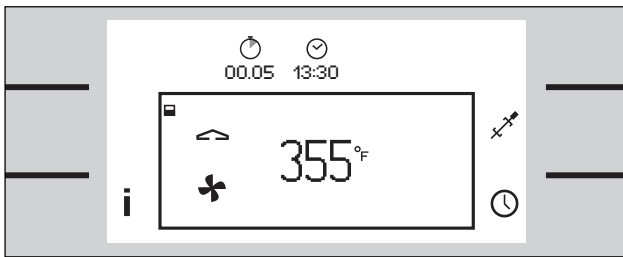
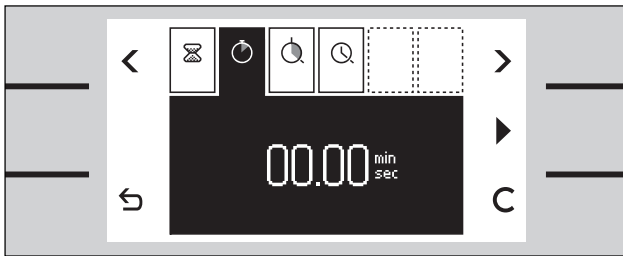

Pausing the Stopwatch

- 1 Call up the timer menu.
- 2 Using < or > select the stopwatch function ⌚.
- 3 Touch the || key. The counter stops. The key reverts to start ▶.
- 4 Start again using the ▶ key. The counter continues.

After 90 minutes the time reverts to 00:00 minutes. The symbol ⌚ in the status bar disappears. The stopwatch is switched off.

Note

To cancel the stopwatch:
Call up the timer menu, select the stopwatch function ⌚ and touch the C key.

Cooking Time Duration

If you set a cooking time duration for your meal, the appliance switches off automatically after the selected time.



This enables you to leave the kitchen while the meal is being prepared.

You can select a cooking time between 1 minute and 23 hours 59 minutes.

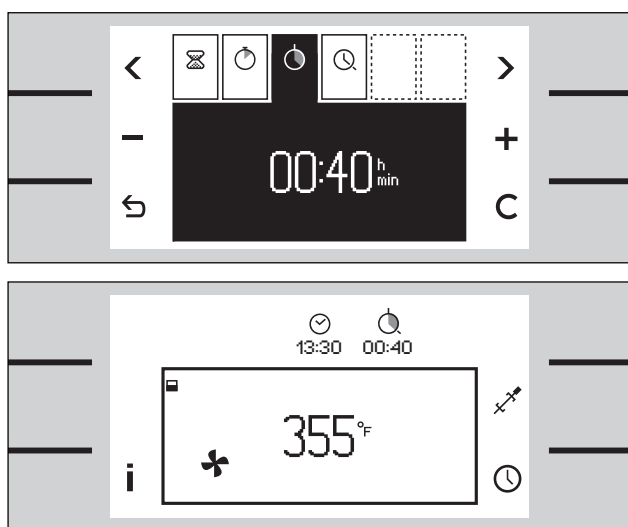
Select the temperature and heating mode and place your meal in the oven.



Switching off Automatically

- 1 Call up the timer menu.
- 2 Using < or > select the cooking time duration function .
- 3 Using + or - set the required cooking time.
- 4 Start the program using the  key.

The timer menu is closed. Temperature and heating mode are shown on the display. The elapsing time is shown in the status bar.

After the time has elapsed the appliance switches off. A signal sounds. Touch the  key or open the appliance door to switch off the signal.

Note

To cancel the cooking time:
Call up the timer menu. Touch the **C** key, then touch  to confirm.

To change the cooking time:
Call up the timer menu. Change the time with **+** or **-**, then touch  to confirm.

To stop the program:
Switch the temperature knob off.

Cooking Time End

You can program a cooking time end. Example: it is 13:30. The meal will take 40 minutes to cook and must be ready at 15:30.

Set the cooking time duration and set the cooking time end to 15:30. The electronics will calculate the start time. The appliance will start automatically at 14:50 and switch off at 15:30.

Please note that food which can easily go off should not stay in the oven too long.

Note:

Always set the desired temperature, heating mode and cooking time duration first. Only by setting these values can the cooking time end be programmed.

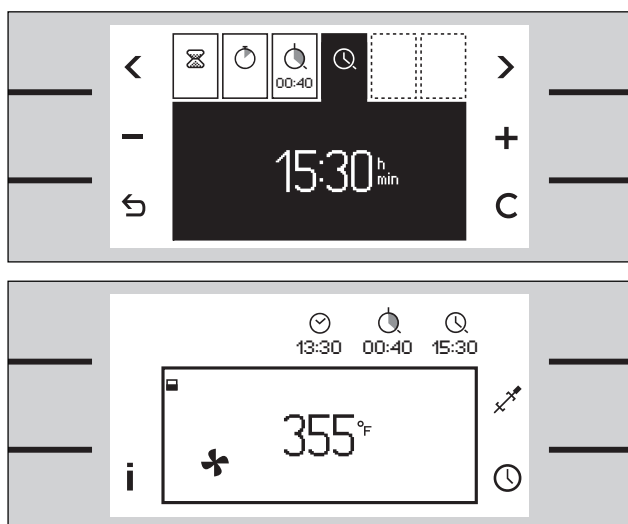

Switching on and off Automatically

- 1 Set the required cooking time.
- 2 Using **>** select cooking time end . The switch off time appears on the display.
- 3 Using **+** set a later switch-off time.
- 4 Start using the **↵** key. The timer menu is closed.

Temperature and operating mode appear on the display. The status bar appears. The appliance is on standby and will start automatically. After the cooking time duration it will switch off.

After the time has elapsed the appliance switches off. A signal sounds. Touch the  key, open the appliance door or switch off the temperature selector to switch off the signal.

Note

To cancel the cooking time:
Call up the timer menu. Touch the **C** key, then touch **↵** to confirm. Cooking time duration and end are cancelled.

To stop the program:
Switch the temperature knob off.

If the  symbol flashes:
You have not set the cooking time duration. Always set the cooking time duration first.

Sabbath Mode

This function keeps the oven at a temperature of 185°F in the top and bottom heat mode.



You can keep food warm 24 to 74 hours, without switching the oven on or off.

Please note that food which can easily go off should not stay in the oven too long.

Supposition:

The extended timer key  is available. You have to make the extended timer key available in the basic settings. See chapter basic settings.

Setting the Program

- 1 Turn the temperature knob one position to the right to the light position.
- 2 Touch the key beside the symbol . The suggested value of 28 h appears on the display.
- 3 Using **+** or **-** set the desired duration.
- 4 Start using the  key.

The cooking mode and temperature appear on the display. The oven light stays off. The keys are locked. The display lighting is switched off. The softkey tone is switched off.

At the end of the programmed time the oven stops heating. The display is empty. Switch the temperature knob off.

Note

If you cannot find the  key:
You have to make the sabbath mode key available. See chapter basic settings – sabbath mode.

To stop the program:
Switch the temperature knob off.

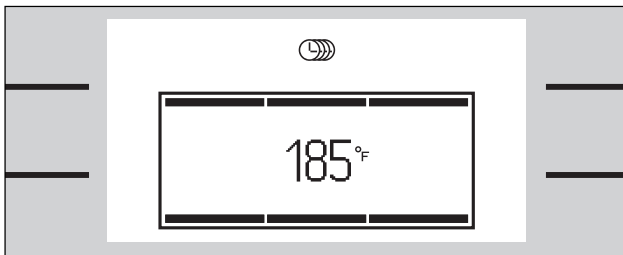

Child Lock

The oven has a child lock. It prevents the oven being turned on unintentionally.



Supposition:

You have to make the child lock available in the basic settings. See chapter basic settings.

Activating the Child Lock

Supposition:

The temperature knob is in the OFF position.



- 1 Touch any key. The symbol  appears beside the centre left key.
- 2 Touch the key  for at least 6 seconds.

The child lock is active, the controls are locked.

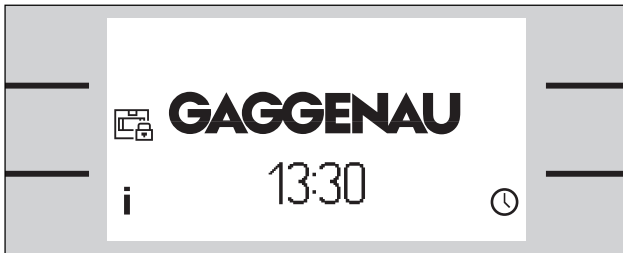
The standby screen appears. The symbol  appears in the status bar.





Deactivating the Child Lock

- 1 Touch any key. The symbol  appears beside the centre left key.
- 2 Touch the key  for at least 6 seconds.

The child lock is deactivated. You can operate the appliance as usual.

Note

If you cannot find the  key beside the centre key:
Call up the basic settings menu. Select the child lock function. Select "child lock available" .

If the child lock key is no longer required:
Call up the basic settings menu. Select the child lock function. Select "child lock not available" .

Additional Functions

Safety Deactivation

For your protection the appliance has a safety deactivation. The safety deactivation switches off the heat if the oven is left on for more than 12 hours without the controls being touched.

Three dashes appear on the display. Switch the temperature knob off. Then you can operate the appliance as usual.

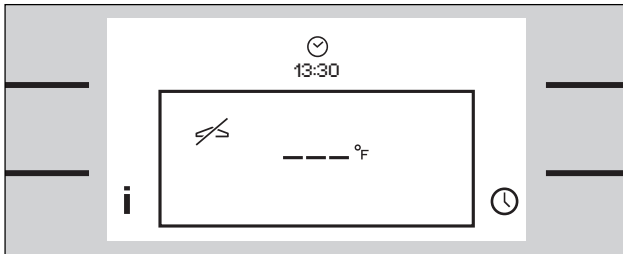

Fast Heating up

This mode heats up the oven particularly fast.





You can activate the fast heating up in the basic settings menu.

If you have selected fast heating up, always heat up the empty oven before putting the dish in the oven.



Changing the Basic Settings

Your appliance has several basic settings.

You can customize these settings: Turn the temperature knob of the upper oven one position to the right to the light position.





- Call up the basic settings menu with the  key.
- Use the top  or  keys to move between the settings.
- Use the centre keys to change the selected setting. You can change several settings individually without leaving the menu.
- Touch the  key to exit the menu. All settings are saved.

Note

The status bar only shows six options. Use the top  or  keys to move to the required option. You can scroll back- or forward with these keys.

If no key has been touched for 60 seconds the menu disappears. The standby screen appears. All settings are saved.

Example: Changing the Standby Screen

- 1 Call up the basic settings menu by turning the temperature knob one position to the right to the light position. Touch the key next to the  symbol. The menu appears.
- 2 Use the menu key  to select the function standby screen  .
- 3 Use the middle keys  or  to select the required setting. The selected screen appears briefly.

Now you can change further settings or exit the menu with the  key.

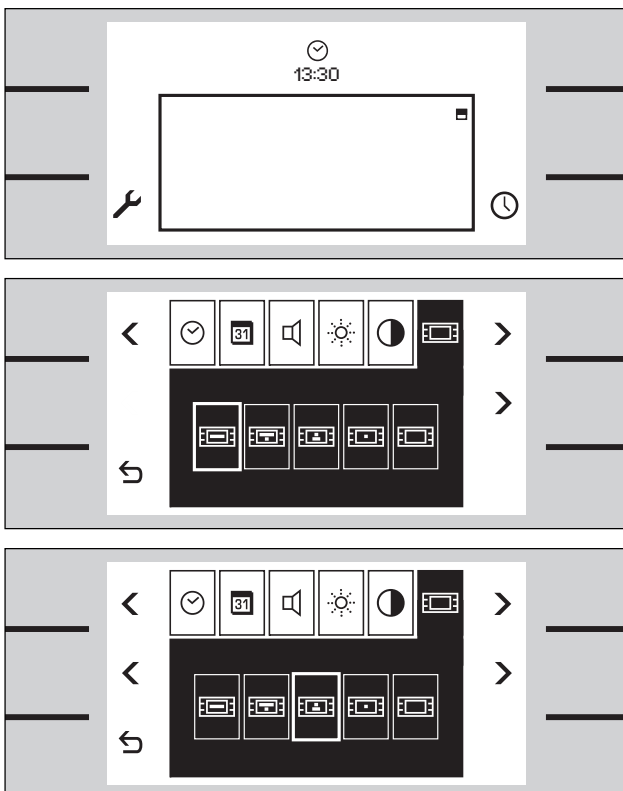

The Following Settings Can Be Changed

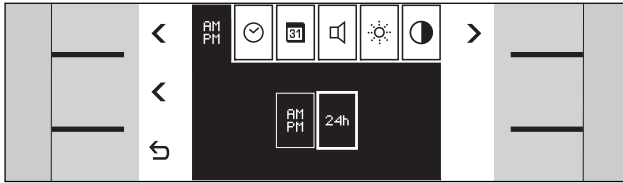

Time format

- 12 hour format (AM/PM) or 24 hour format

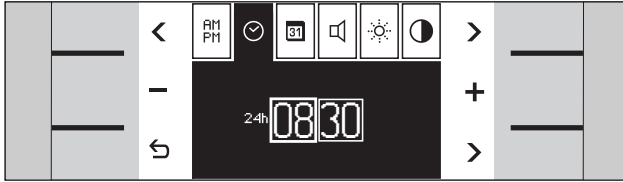

Clock

- Hours / minutes

Use the arrow key > bottom right to change from hours to minutes.

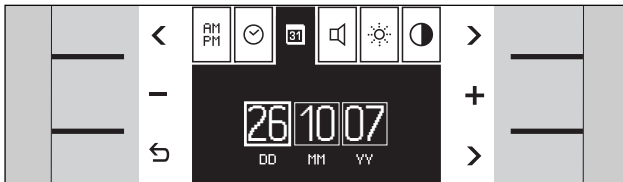

Date

- Day / month / year

Use the arrow key > bottom right to change from day to month to year.

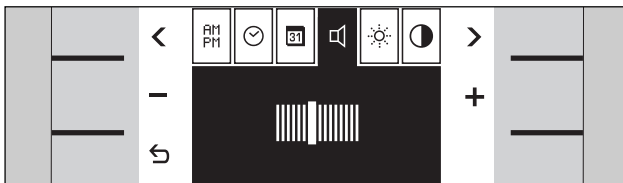

Key tones volume

- In 8 levels

Adjust the volume of the key tones.
The signal volume cannot be adjusted.

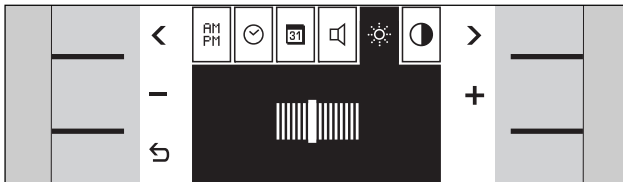

Display brightness

- In 8 levels

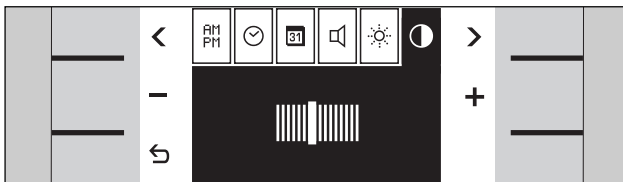

Display contrast

- In 8 levels

The display contrast depends on the viewing angle.

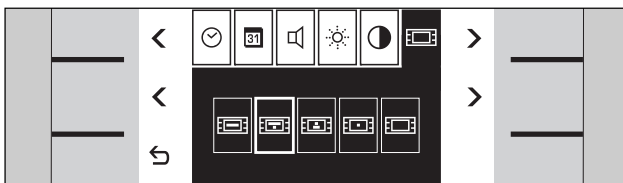

Standby screen

- Gaggenau / Gaggenau with clock / clock and date / clock / empty display

The selected screen appears briefly.

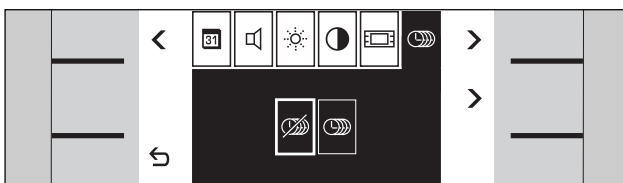

Sabbath mode

- Sabbath mode key not available / available

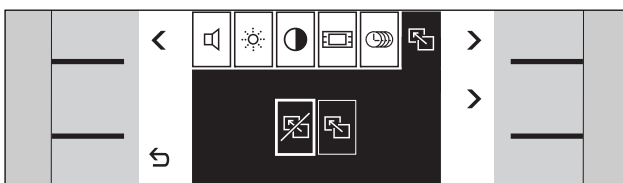

Reset all parameters to the factory setting

- No / yes

Immediately confirm a reset with the ↵ key.

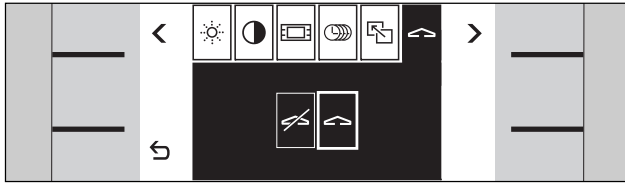

Exhibition mode

The setting ⇄ “exhibition mode not active” must be selected and must not be changed. The appliance does not heat up during exhibition mode ✂.

You can only change this setting 3 minutes after the appliance has been connected to the electricity.

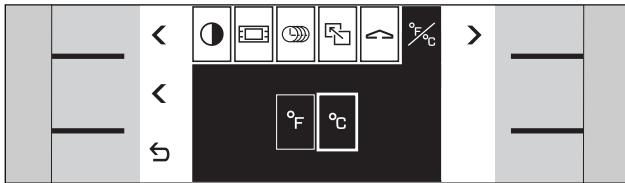

Temperature unit

- °F or °C

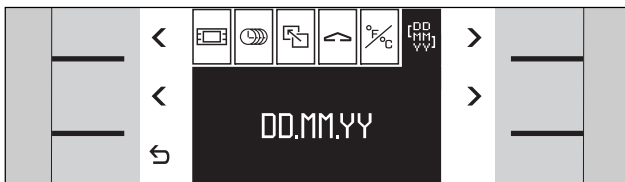

Date format

- Day.month.year or day/month/year or month/day/year

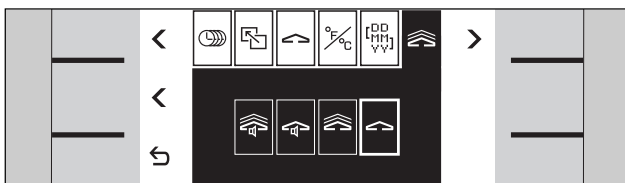

Heating up with / without signal

- Rapid heating up with signal / normal heating up with signal / rapid heating up without signal / normal heating up without signal

The signal sounds when the oven has heated up.

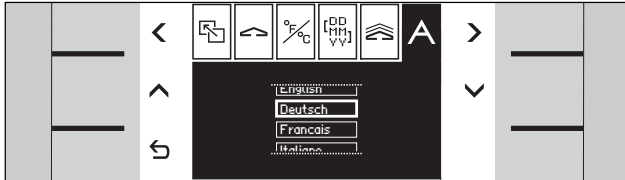

Language

- Select the language for the display messages or switch the display messages off.

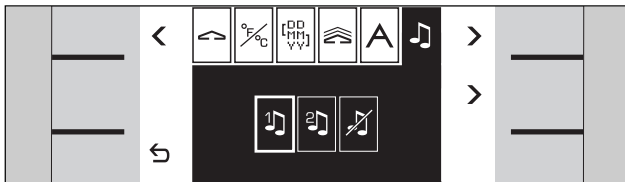

Key tones

- Sound 1 (beep) / sound 2 (click) / key tones off

Choose the key tones.

The signal tone cannot be changed.

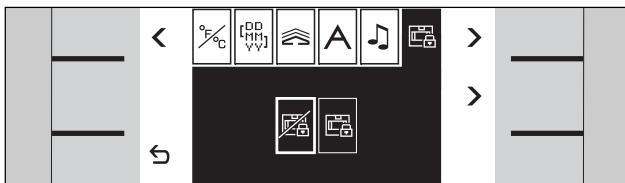

Child lock

- Child lock key not available / available

Safety Notes

▲ Warning! Do not clean the hob using high pressure cleaners or steam jets.

▲ Warning, risk of burns! Before cleaning, wait until the appliance has cooled down.

Cleaning the Oven Interior

Clean the oven with a cloth/sponge and a small amount of hot soapy water. Avoid residues burning in. After cleaning, leave the door open until the oven has dried.

Do not scrape off baked-in remainders of food. Instead, moisten them with a wet cloth and detergent.

If the oven is heavily soiled use the pyrolysis for best results.

Fruit juices from moist cakes dripping onto the oven interior can damage the enamel. Remove such soiling as soon as the oven has cooled down sufficiently.

Do not use non-suitable cleaning agents:

- scouring cleaning agents
- nitro polishing agents
- cleaners containing chloride
- abrasive sponges or objects

Note: Only use oven cleaner on the enamel in the oven interior. Do not let the oven cleaner come into contact with the door seal. Do not spray oven cleaner onto the door frame.

Cleaning the Glass Front

Clean the glass front with a soft cloth and glass cleaner. Do not wipe the glass front with a soaking wet cloth as water might enter behind the glass.

Do not use aggressive, scouring cleaning agents or glass scrapers. They can scratch the surface and destroy the glass.

A rainbow coloured shimmer may be seen on the front glass. This is the heat resistant coating.

Only clean the display with a soft cloth. Do not wipe the display with a soaking wet cloth as water might enter behind the screen.

Cleaning the Door Seal

Always keep the door seal clean and free of food remains.

Do not use aggressive cleaning agents (e.g. oven cleaner) on the door seal. They can destroy the door seal.

Do not remove the door seal.

Cleaning the Accessories

Clean accessories (baking tray, wire grill and grill pan) with hot soapy liquid.

Soak baked-in remainders and clean with a brush.

Cleaning the Baking Stone

(special accessory)

Remove coarse soiling from the baking stone. Turn the baking stone round before using it again. This will burn off most residues from the bottom side.

Note: Do not clean the baking stone with water and detergents! Moisture inside the baking stone can cause cracking.

Pyrolysis

⚠ Warning, risk of burns! Very high temperatures occur during the pyrolysis! Keep children away!

⚠ Wipe out excessive spillage before self-cleaning the oven.

During the pyrolytic self cleaning the oven is heated to 905°F. Any food residues from baking, roasting and grilling are reduced to ash.

The duration of the pyrolysis is 3 hours.

For your safety the oven door remains locked. During pyrolysis the light in the oven remains switched off.

It is not possible to do a pyrolytic cleaning in both ovens at the same time.

While doing a pyrolytic cleaning in one oven it is not possible to use the other oven.

Before Starting Pyrolysis

- Remove coarse soiling and food remains from the oven.
 - ⚠ Warning, fire risk!** Food remains, fat and meat juices may ignite during pyrolysis.
- Manually clean the door seal, the inside of the door and the glass panel. The pyrolysis does not clean these parts.
- Remove all loose interior parts (for example wire rack or meat probe) from the oven. No objects should be left in the oven!
- Close the oven door.

Setting the Program

- 1 Turn the temperature knob and the function knob one position to the left.
- 2 The pyrolysis menu appears. The switch off time appears on the display.
- 3 Press ↶ to start.

The pyrolysis menu disappears. The  symbol and the pyrolysis temperature appear on the display. The status bar shows the duration of the pyrolysis.

The oven light and the display light stay off during pyrolysis.

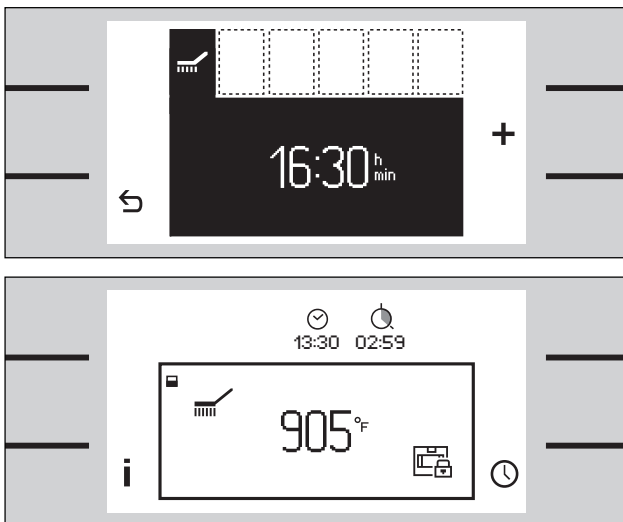

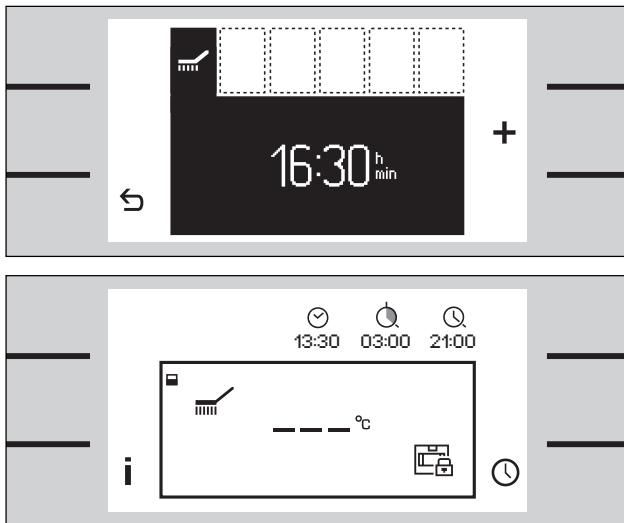

Delaying the Switch-off Time

If you want the pyrolysis to run at a later time (for example during the night), you can change the switch-off time. In this way you can use your oven during the day as usual.

Make the settings as described in 1 and 2.

3 Press the **+** key to change the switch-off time.

4 Press the **↶** key to confirm.

After confirmation the  symbol appears on the display. The status bar shows the switch-off time of the pyrolysis. Three dashes instead of the temperature are shown on the display. After the start of the pyrolysis the temperature appears on the display.

A signal is sounded at the switch-off time.
Exception: There is no signal between 22.00 and 8.00.



The pyrolysis has ended. Switch off the temperature knob.

Allow the oven to cool down fully. Then wipe out the oven using a moist cloth.

Note

The duration of the pyrolysis cannot be changed.

During pyrolysis the appliance cooling fan might be louder than usual.

If the pyrolysis does not start and the  or  symbol flashes on the display:
Check if the door is fully closed and the meat probe has been removed.

If you want to stop the pyrolysis:
Switch off the temperature knob.

For your safety the oven door remains locked. The door is automatically unlocked when the oven has cooled down and the  symbol disappears.

Cleaning Accessories with Pyrolysis

Gaggenau baking trays and broiling trays are coated with pyrolysis-proof enamel. To arrive at an optimum cleaning result, you are advised to remove all accessories from the oven before the pyrolytic cleaning process. Only this will ensure optimum heat distribution.

If you would like to remove burnt-in residues from your baking tray or your broiling tray, it is imperative that you observe the following safety notes:

- Remove extreme fatty soiling, roast juice and food remainders before the pyrolytic cleaning process.
⚠ Warning, fire risk! Food remains, fat and meat juices may ignite during pyrolysis.
- Only insert one baking tray or one broiling tray in the lowest shelf in the oven.
- Fully insert the baking tray or broiling tray.
- Do not clean wire rack, rotary spit, cast roaster, baking stone, meat probe or other accessories in the pyrolytic cleaning process.

Trouble Shooting

In case of a malfunction first check the household fuses. If the power supply is functioning correctly contact your dealer or Gaggenau after-sales service.

Please specify the E number and FD number of the appliance when calling our after-sales service. You find these numbers on the rating plate of the appliance.

Repairs may only be carried out by authorised technicians, in order to guarantee the electrical safety of the appliance.

⚠ Warning! Incorrect repairs may result in serious injury to the user.

All poles of the appliance must be disconnected from the electricity when being repaired (switch off the household fuse or the circuit breaker in the fuse box).

Non compliance with these recommendations results in the warranty coverage becoming invalid.



Error Messages

If a malfunction occurs and the appliance does not heat up, an error code will flash on the display.

If E003, E303, E115 or E215 flashes on the display the appliance is too hot. Switch off the appliance and let it cool down.

If a different error code flashes on the display call the after-sales service. Please specify the error code and the appliance type. You find the appliance type on the rating plate.

Switch off the temperature knob.

Note:

The short timer and stop clock can still be used.



Exhibition Mode

If the ~~/~~ symbol appears on the standby screen, exhibition mode is activated. The appliance does not heat up.

Disconnect the appliance from the electricity for a few seconds (switch off the household fuse or the circuit breaker in the fuse box). Within 3 minutes after reconnecting the appliance go to the basic settings menu and deactivate exhibition mode.

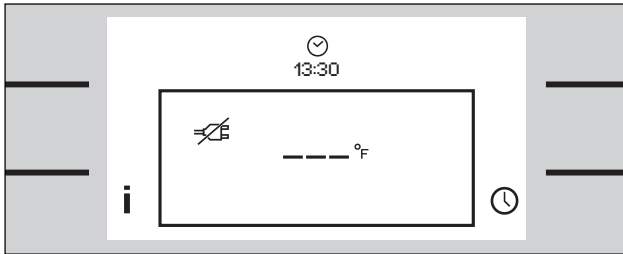

Power Cut

The appliance bridges a power cut of up to 5 minutes. The operation continues.

After a longer power cut the appliance will switch off the operation. The  symbol appears on the display and three dashes instead of the temperature.

Switch off the temperature knob and switch the appliance back on.

The “first settings” menu reappears if the appliance is without electricity for several days. You have to set the clock.

Note: The basic settings remain stored even if the appliance is without electricity for several days.

Replacing the Oven Lights

If an oven light fails, it must be replaced. Heat-resistant replacement bulbs can be obtained from the after-sales service or specialist shops. Only use these bulbs.

▲ WARNING: Make sure the appliance and lights are cool and power to the appliance has been turned off before replacing the light bulb(s). Failure to do so could result in electrical shock or burns.

The lenses must be in place when using the appliance. The lenses serve to protect the light bulb from breaking.

The lenses are made of glass. Handle carefully to avoid breaking. Broken glass could cause an injury.

Light socket is live when door is open.

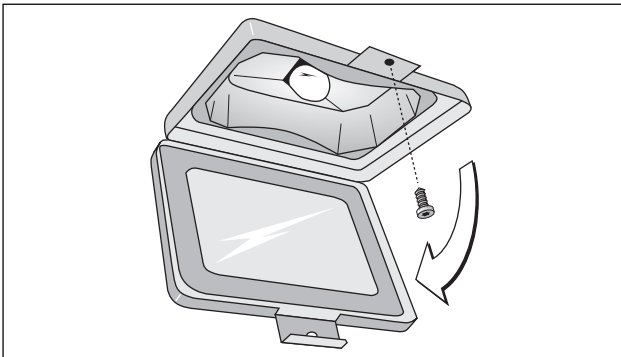

Replacing the Ceiling Light

- 1 Loosen the screw on the lamp cover. Tilt down the lamp cover.
- 2 Pull out the bulb. Push the new bulb in firmly. Make sure that the pins are in the correct position.
Note: Only use a heat-resistant halogen bulb of the same type (60 W / 230 V / G9). Do not touch the halogen lamp with your hands. Use a dry cloth.
- 3 Tilt the lamp cover up and screw it back on.
- 4 Switch the circuit breaker back on.

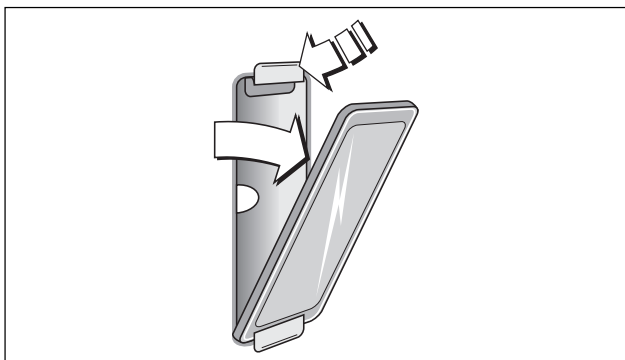
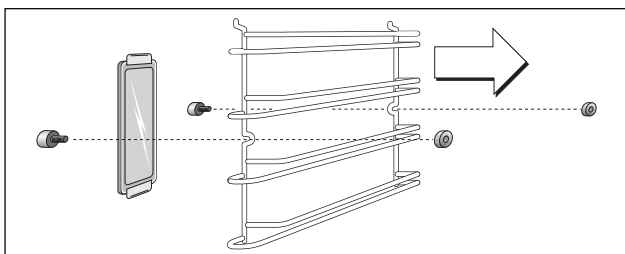

Replacing the Side Light

- 1 Place a tea towel in the oven to prevent damage.
- 2 Pull out the shelf after undoing the knurled nuts.
- 3 Push the top mounting bracket back and remove the glass cover.
- 4 Pull out the bulb. Push the new bulb in firmly. Make sure that the pins are in the correct position.
Note: Only use a heat-resistant halogen bulb of the same type (10 W / 12 V / G4). Do not touch the halogen lamp with your hands. Use a dry cloth.
- 5 Insert the glass cover under the bottom mounting bracket and press it down firmly on the top. The sloping edges must face to the interior of the oven.
- 6 Remove the tea towel and switch the circuit breaker back on.

You must replace a damaged glass cover. Suitable glass covers may be obtained from the after-sales service.

Gaggenau

5551 McFadden Avenue
Huntington Beach, CA 92649
Telephone: 877.4GAGGENAU
USA
www.gaggenau-usa.com

Gaggenau Hausgeräte GmbH

Carl-Wery-Straße 34
81739 München
Germany
www.gaggenau.com

9000157788 EB 8805 enUS

GAGGENAU