

Freestanding Tables

Freestanding Tables

are available to coordinate with multiple seating lines.

Top has a 1" thick wood core with a high-pressure laminate surface.

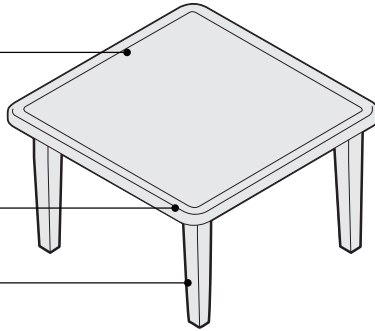

Edge is either maple wood or 3 mm plastic.

Legs are available in four styles to coordinate with multiple seating lines. Tapered leg style coordinates with Sequoia, Empress, and Nikko seating lines. Curved leg style coordinates with the Hawthorne and Linden seating lines and the metal leg style coordinates with the Jarrah seating line. The oval leg style offers an additional aesthetic option.

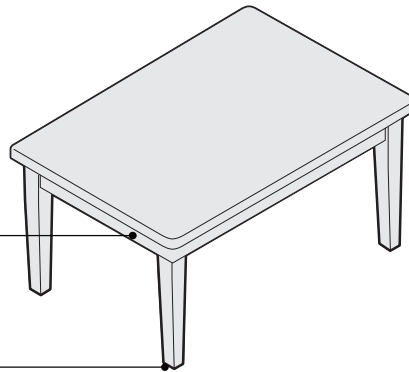

Apron, on select freestanding tables, is maple wood.

Glides are standard on legs.

Actual Dimensions

| Features | Overall Depth | Width | Height |
|-------------------------------------------------|------------------|------------------|------------|
| Freestanding Tables—Wood or Plastic Edge | | | |
| Square | 18", 26" | 18", 26" | 16" or 21" |
| Rectangle | 18", 20", or 22" | 24", 32", or 48" | 16" or 21" |

Product Details

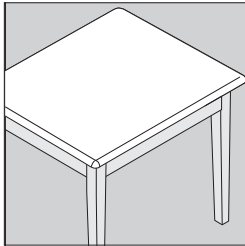

Metal (Jarrah)

Metal legs complement the Jarrah seating line.

Wood edge is a 1" thick bullnose.

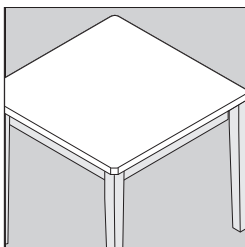

Tapered (Sequoia)

Tapered legs are maple wood construction and complement the Sequoia, Empress, and Nikko seating lines.

Plastic edge features a 3 mm radius.

Tip: The plastic edge will match standard laminate tops. A black plastic edge will be used on tables with non-standard laminate tops.



Curved (Hawthorne)

Curved Legs are maple wood construction and complement the Hawthorne and Linden seating lines.

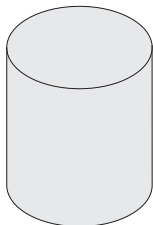

Drum table is available in two sizes. It has a High-Pressure Laminate top surface and body.



Oval

Oval Legs are maple wood construction and can be used with multiple seating lines as another aesthetic option.

Surface Materials

Table top
 • High-Pressure Laminate

Edge
 • Maple wood
 • Plastic

Legs
 • Maple wood

Table apron, if selected
 • Maple wood

Attachment brackets on interconnecting table
 • Black only

Glides
 • Black nylon only

Shipping

Tables are shipped unassembled and require field assembly of legs.

Freestanding Tables

Freestanding Tables with Wood Edge

| Standard Includes | Required to Specify |
|------------------------------------------------------------------------------------------|-----------------------------------------------------------------------------------------------------------------------------------------------------------------------------------------------------------------------------------------------------------|
| <ul style="list-style-type: none"> ▶ Need help? Product details, page 312 | <ul style="list-style-type: none"> • Top: High-Pressure Laminate • Edge: maple wood to match top • Legs: wood or paint (if metal leg selected) • Attachment brackets: black only • Glides: black nylon |
| | <ul style="list-style-type: none"> 1 Style number 2 Laminate color number for top 3 Paint color for legs, if metal leg selected ▶ See <i>Surface Materials</i>, page 691. |

| Specification Information | | | | |
|---------------------------|---|---|---------|--------|
| • Dimensions | | | • Style | • U.S. |
| D | W | H | Number | Price |

Square Tables with Metal Legs

| | | | | |
|-----|-----|-----|-------------------|-------|
| 26" | 26" | 16" | HTM262616W | \$880 |
| 26" | 26" | 21" | HTM262621W | \$880 |

Square Tables with Tapered Legs

| | | | | |
|-----|-----|-----|-------------------|-------|
| 18" | 18" | 21" | HTT181821W | \$627 |
| 26" | 26" | 16" | HTT262616W | \$701 |
| 26" | 26" | 21" | HTT262621W | \$701 |

Square Tables with Curved Legs

| | | | | |
|-----|-----|-----|----------------------------------------------------------|-------|
| 26" | 26" | 16" | HTC262616W X4/12 | \$880 |
| 26" | 26" | 21" | HTC262621W | \$880 |

Square Tables with Oval Legs

| | | | | |
|-----|-----|-----|----------------------------------------------------------|-------|
| 26" | 26" | 21" | HTV262621W X4/12 | \$701 |
|-----|-----|-----|----------------------------------------------------------|-------|

▶ **Specification Information, continued on next page**

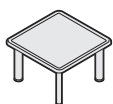

Tip: Metal leg tables complement Jarrah seating line.

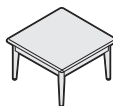

Tip: Tapered leg tables complement Sequoia, Nikko, and Empress seating lines.

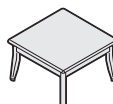

Tip: Curved leg tables complement Hawthorne and Linden seating lines.

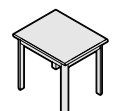

For Canadian Pricing

Multiply U.S. Price by the Canadian price factor.

▶ See page 1 for details.

X4/12 = Last order entry
April 15, 2012

► Specification Information, continued from previous page

Specification Information

| Dimensions | | | Style | U.S. |
|------------|---|---|--------|-------|
| D | W | H | Number | Price |



Rectangular Tables with Metal Legs

| | | | | |
|-----|-----|-----|----------------------------------------------------------|--------|
| 20" | 24" | 16" | HTM242016W X4/12 | \$ 701 |
| 20" | 24" | 21" | HTM242021W | \$ 701 |
| 22" | 32" | 16" | HTM322216W X4/12 | \$ 901 |
| 18" | 48" | 16" | HTM481816W | \$1024 |

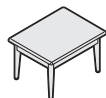

Rectangular Tables with Tapered Legs

| | | | | |
|-----|-----|-----|----------------------------------------------------------|--------|
| 20" | 24" | 16" | HTT242016W X4/12 | \$ 627 |
| 20" | 24" | 21" | HTT242021W | \$ 627 |
| 22" | 32" | 16" | HTT322216W X4/12 | \$ 722 |
| 18" | 48" | 16" | HTT481816W | \$ 769 |

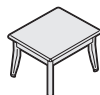

Rectangular Tables with Curved Legs

| | | | | |
|-----|-----|-----|----------------------------------------------------------|--------|
| 20" | 24" | 16" | HTC242016W X4/12 | \$ 701 |
| 20" | 24" | 21" | HTC242021W | \$ 701 |
| 22" | 32" | 16" | HTC322216W X4/12 | \$ 901 |
| 18" | 48" | 16" | HTC481816W | \$1024 |

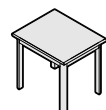

Rectangular Tables with Oval Legs

| | | | | |
|-----|-----|-----|----------------------------------------------------------|--------|
| 20" | 24" | 21" | HTV242021W X4/12 | \$ 627 |
| 18" | 48" | 16" | HTV481816W X4/12 | \$ 842 |



Round Tables with Oval Legs

| | | | | |
|--------|--|-----|---------------------------------------------------------|--------|
| 24"dia | | 21" | HTV24R21W X4/12 | \$ 786 |
|--------|--|-----|---------------------------------------------------------|--------|



Round Tables with Tapered Legs

| | | | | |
|--------|--|-----|------------------|--------|
| 24"dia | | 21" | HTT24R21W | \$ 701 |
|--------|--|-----|------------------|--------|

Families of Seating

 **For Canadian Pricing**
 Multiply U.S. Price by the
 Canadian price factor.
 ► See page 1 for details.

X4/12 = Last order entry
 April 15, 2012

Freestanding Tables, continued

Freestanding Tables with Plastic Edge

| Standard Includes | Required to Specify |
|---------------------------------------------------------------------------------------------------------------------------------------------------------------------------------------------------------------------------------------------------------|-----------------------------------------------------------------------------------------------------------------------------------------------------------------------------------------------------------------|
| <ul style="list-style-type: none"> ▶ Need help? Product details, page 312 • Top: High-Pressure Laminate • Edge: plastic to match • Legs: wood or paint (if metal leg selected) • Glides: black nylon | <ul style="list-style-type: none"> 1 Style number 2 Laminate color number for top 3 Paint color for legs, if metal selected ▶ See <i>Surface Materials</i>, page 691. |

Specification Information

| Dimensions | | | Style | U.S. |
|------------|---|---|--------|-------|
| D | W | H | Number | Price |

Square Tables with Metal Legs

| | | | | |
|-----|-----|-----|-------------------|-------|
| 26" | 26" | 16" | HTM262616P | \$640 |
| 26" | 26" | 21" | HTM262621P | \$640 |

Square Tables with Tapered Legs

| | | | | |
|-----|-----|-----|-------------------|-------|
| 26" | 26" | 16" | HTT262616P | \$640 |
| 26" | 26" | 21" | HTT262621P | \$640 |

Square Tables with Curved Legs

| | | | | |
|-----|-----|-----|----------------------------------------------------------|-------|
| 26" | 26" | 16" | HTC262616P X4/12 | \$640 |
| 26" | 26" | 21" | HTC262621P | \$640 |

Rectangular Tables with Metal Legs

| | | | | |
|-----|-----|-----|----------------------------------------------------------|-------|
| 20" | 24" | 16" | HTM242016P X4/12 | \$531 |
| 20" | 24" | 21" | HTM242021P | \$531 |
| 22" | 32" | 16" | HTM322216P X4/12 | \$653 |
| 18" | 48" | 16" | HTM481816P | \$781 |

Rectangular Tables with Tapered Legs

| | | | | |
|-----|-----|-----|----------------------------------------------------------|-------|
| 20" | 24" | 16" | HTT242016P X4/12 | \$531 |
| 20" | 24" | 21" | HTT242021P | \$531 |
| 22" | 32" | 16" | HTT322216P X4/12 | \$653 |
| 18" | 48" | 16" | HTT481816P | \$781 |

Rectangular Tables with Curved Legs

| | | | | |
|-----|-----|-----|----------------------------------------------------------|-------|
| 20" | 24" | 16" | HTC242016P X4/12 | \$531 |
| 20" | 24" | 21" | HTC242021P | \$531 |
| 22" | 32" | 16" | HTC322216P X4/12 | \$653 |
| 18" | 48" | 16" | HTC481816P | \$781 |

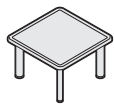

Tip: Metal leg tables complement Jarrah seating line.

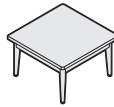

Tip: Tapered leg tables complement Sequoia, Nikko, and Empress seating lines.

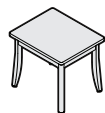
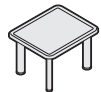
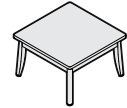

X4/12 = Last order entry
April 15, 2012

Drum Table

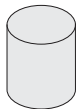

| Standard Includes | Required to Specify |
|-------------------|---------------------|
|-------------------|---------------------|

- | | | |
|------------------------------------------------------------------------------------------|-------------------------------------------------------------------------------------------------------------------|--------------------------------------------------------------------------------------------------------------------------------------------------------------|
| <ul style="list-style-type: none"> ▶ Need help? Product details, page 312 | <ul style="list-style-type: none"> • Top: High-Pressure Laminate • Edge: plastic to match | <ul style="list-style-type: none"> 1 Style number 2 Laminate color number for top ▶ See <i>Surface Materials</i>, page 691. |
|------------------------------------------------------------------------------------------|-------------------------------------------------------------------------------------------------------------------|--------------------------------------------------------------------------------------------------------------------------------------------------------------|

| Specification Information | | | |
|---------------------------|---|---------|--------|
| • Dimensions | | • Style | • U.S. |
| D | H | Number | Price |

| | | | |
|-----|-----|------------------|-------|
| 18" | 18" | SC27DT18D | \$431 |
| 24" | 18" | SC27DT24D | \$569 |
| : | : | : | : |



For Canadian Pricing

Multiply U.S. Price by the Canadian price factor.

▶ See page 1 for details.