

### INSTALLATION INSTRUCTIONS

P24022, P24122, P24129,  
P24422, P23122

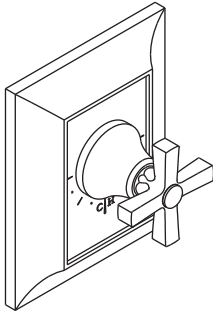

P24022-CR

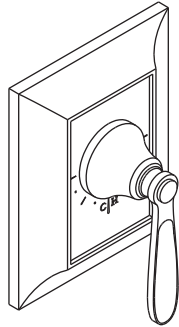

P24022-KL

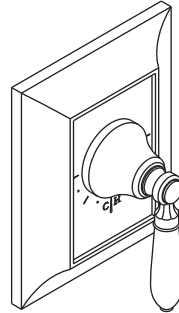

P24022-CL

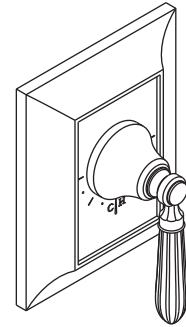

P24022-RB  
P24022-RL

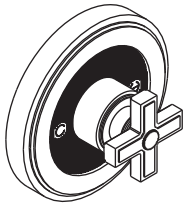

P24122-CR

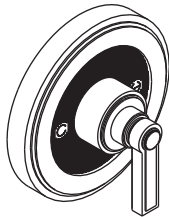

P24122-LV

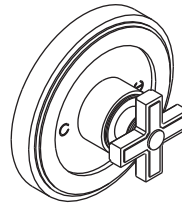

P24129-CR

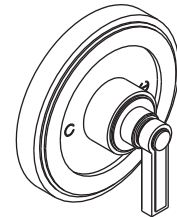

P24129-LV

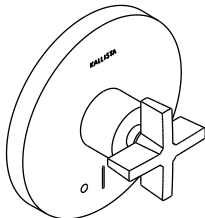

P24422-CR

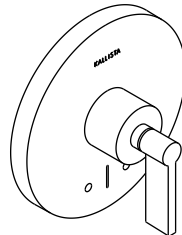

P24422-LV

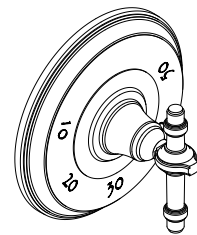

P23122-LV

### INSTALLATION INSTRUCTIONS

P24022, P24122, P24129,  
P24422, P23122

#### THANK YOU FOR CHOOSING KALLISTA

We appreciate your commitment to Kallista quality products. Please take a moment to review this manual before you install your Kallista product. If you encounter any installation or performance problems, please don't hesitate to contact us at the phone number listed at the bottom of the page.

#### BEFORE YOU BEGIN

- Prior to installation, unpack the thermostatic trim and inspect it for damage. If the product is damaged, please contact Kallista immediately at the phone number listed at the bottom of the page.
- The appearance of your product may differ from what is shown in these instructions, however, the installation procedure is the same.
- Shut off the main water supply.
- Observe all local plumbing codes.
- Kallista reserves the right to make revisions in the design of plumbing products without notice, as specified in the Price Book.

#### TOOLS AND MATERIALS



Hex  
Wrenches

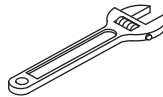

Adjustable  
Wrench

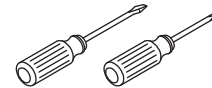

Screwdrivers

### INSTALLATION INSTRUCTIONS

P24022, P24122, P24129,  
P24422, P23122

#### 1. INSTALL THE VALVE STEM ADAPTER

**NOTE:** Check the finished wall surface as related to the graphics on the plaster guard.

- Select the correct length valve stem adapter and valve stem adapter screw for your application. Refer to the information stamped on the plaster guard to verify the wall thickness.

**For a thin wall - 3/16" (5 mm) to 9/16" (1.4 cm):** Use the 7/8" (shortest) valve stem adapter, stamped "3" on the plaster guard, and the 3/4" (1.9 cm) screw (Figure A).

**For a standard wall - 9/16" (1.4 cm) to 1-1/16" (2.7 cm):** Use the 1-3/8" (medium) valve stem adapter, stamped "1" on the plaster guard, and the 1-3/8" (3.5 cm) screw (Figure B).

**For a thick wall - 1-1/16" (2.7 cm) to 1-9/16" (4 cm):** Use the 1-7/8" (longest) valve stem adapter, stamped "2" on the plaster guard, and the 1-3/4" (4.4 cm) screw (Figure C).

- Remove and discard the plaster guard from the thermostatic valve.
- Place the spline adapter over the valve stem. Do not completely press or screw the valve stem adapter into place until instructed to do so.

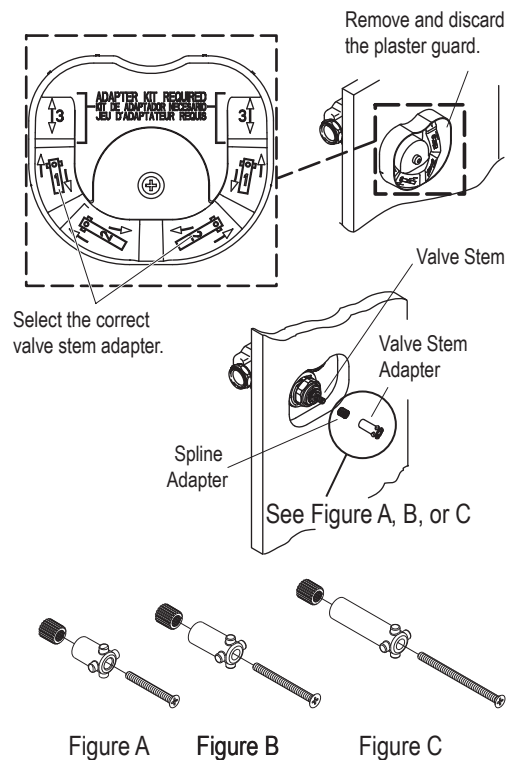

#### 2. ADJUST THE HANDLE ASSEMBLY

- Ensure the valve stem adapter is lightly placed over the spline adapter.
- Place the handle assembly over the valve stem adapter.
- Turn the handle assembly clockwise until the stop is contacted. The valve will be in the full cold position. The handle should be between 9 and 10 o'clock positions. To adjust the position of the handle, refer to the alignment instructions below.
- Rotate the handle assembly counterclockwise, through the detent, then to the high temperature limit stop.
- Verify that the handle assembly is between the 3 and 4 o'clock position
- Rotate back to the 6 o'clock position.
- Remove the handle assembly and set aside.

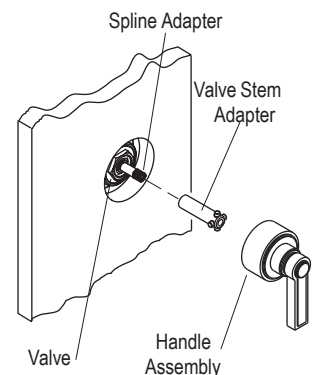

### INSTALLATION INSTRUCTIONS

P24022, P24122, P24129,  
P24422, P23122

#### 2. ADJUST THE HANDLE ASSEMBLY (cont'd.)

##### HANDLE ALIGNMENT ADJUSTMENTS

- The spline adapter allows fine adjustment of the handle alignment. To adjust, remove the handle assembly and the valve stem adapter.
- Reposition the spline adapter in a clockwise motion.
- Check the alignment.
- Reinstall the handle assembly and the valve stem adapter.
- Repeat until the handle alignment is satisfactory.

#### 3. INSTALL THE TRIM

- Ensure that the valve stem adapter is firmly pressed onto the valve stem.
- Secure the valve stem adapter to the valve with the correct length screw, as selected in the "Install the Valve Stem Adapter" section of this guide.
- Thread the two threaded studs into the threaded holes of the valve.
- Place the front plate assembly over the threaded studs.
- Thread the nuts onto the studs to secure the front plate assembly to the wall. Do not overtighten the nuts.

**NOTE:** If the front plate assembly does not lay flat on the wall surface, loosen the nuts and adjust the threaded studs, then retighten the nuts. Once properly installed, the threaded studs can not protrude more than 7/16" through the front plate assembly.

- Visually inspect the front plate assembly to ensure that the foam seal is completely covering the wall opening. If not, stop the installation and repair the wall opening.
- Place the escutcheon against the wall. The graphic lines should appear as shown to the right.
- Thread the handle assembly onto the hub of the front plate assembly to secure the escutcheon in place. The handle will be pointing downward to the 6 o'clock position.

**NOTE:** If the handle does not engage the valve or the escutcheon does not tighten to the wall, replace the valve stem adapter with an adapter of appropriate length.

