

Product and Cut-out Dimensions 60" Side by Side Combination F1811SF & K1801SF

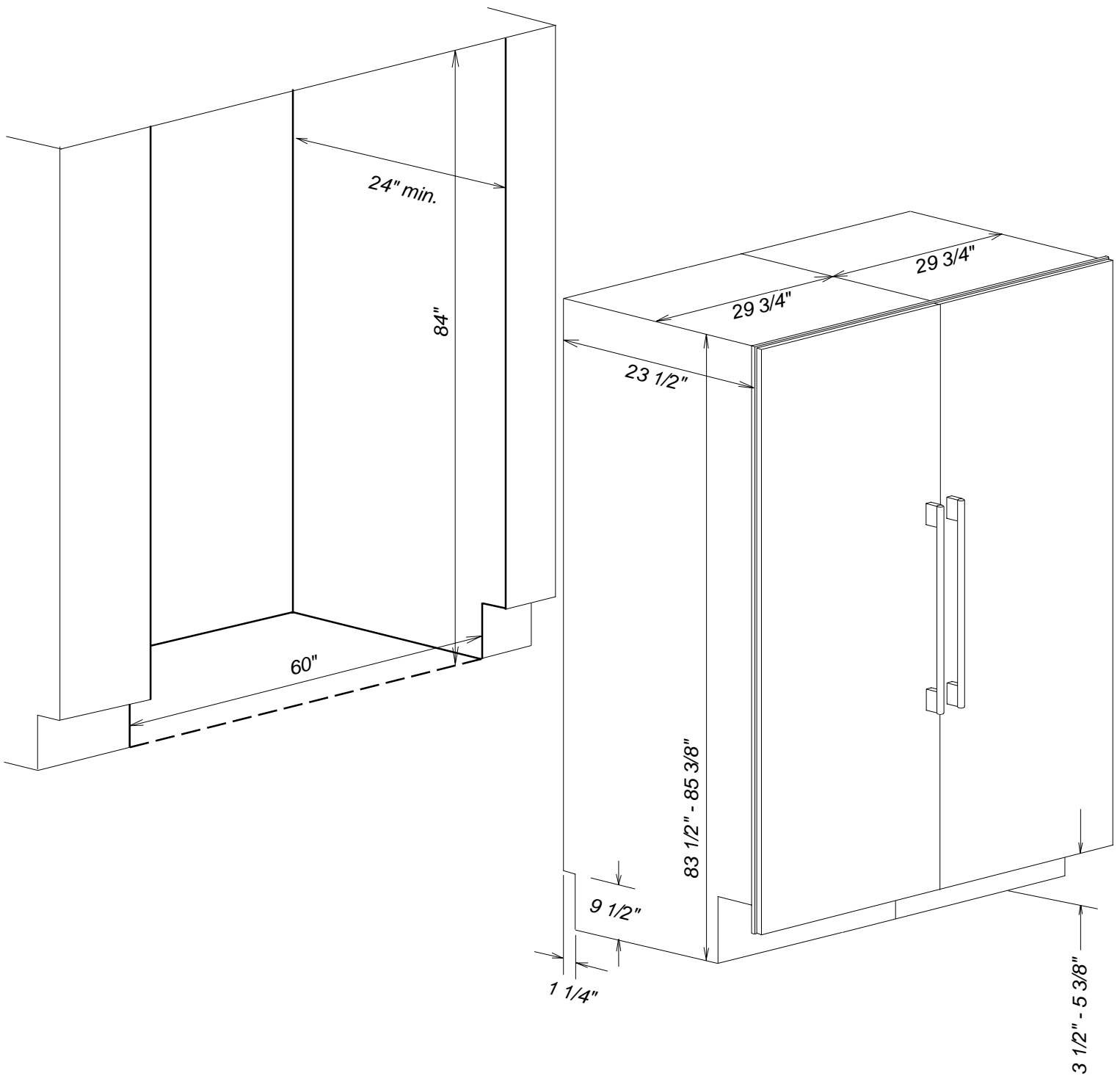

Notes

- See individual unit specs for location information
- KTF1060 Upper frame is required when combining to 60"
- KSK1002 Merging kit must be used when combining units
- All Installations must be done in accordance with local codes

NOTE: Drawing is not to scale.
SPECIFICATION SHEETS 011208

Product and Cut-out Dimensions 60" Side by Side Combination F1801SF & K1811SF

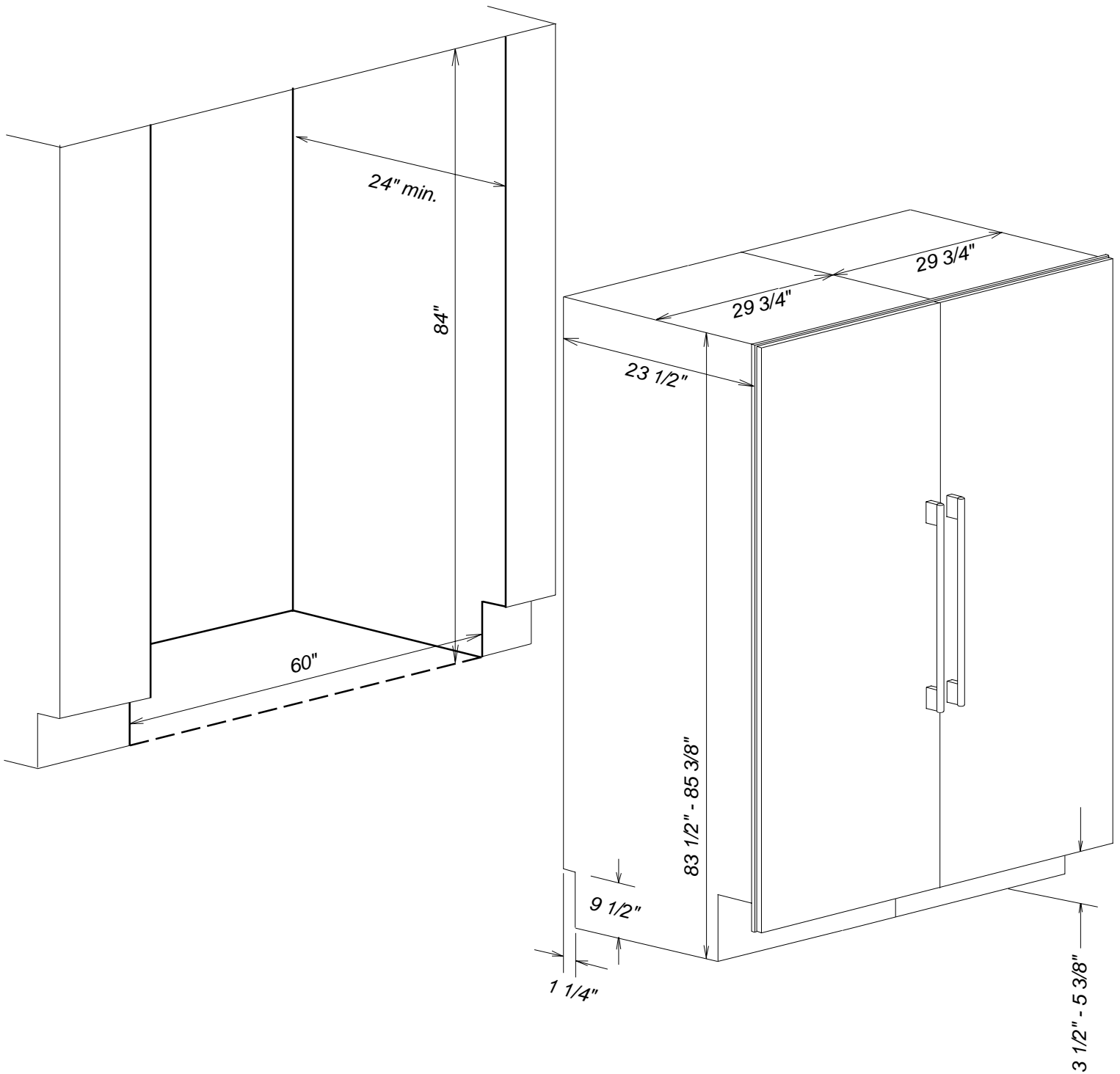

Notes

- See individual unit specs for location information
- KTF1060 Upper frame is required when combining to 60"
- KSK1002 Merging kit must be used when combining units
- All Installations must be done in accordance with local codes

NOTE: Drawing is not to scale.
SPECIFICATION SHEETS 011208